

PHARMACEUTICAL MANUFACTURING ENCYCLOPEDIA

Second Edition
Reprint Edition

by

Marshall Sittig

Volume 1
A-K



NOYES PUBLICATIONS
Westwood, New Jersey, U.S.A.

Copyright © 1988 by Marshall Sittig

No part of this book may be reproduced or utilized in any form or by any means, electronic or mechanical, including photocopying, recording or by any information storage and retrieval system, without permission in writing from the Publisher.

Library of Congress Catalog Card Number: 87-31547

ISBN: 0-8155-1144-2

Printed in the United States

Published in the United States of America by

Noyes Publications

Fairview Avenue, Westwood, New Jersey 07675

10 9 8 7 6 5 4 3

Library of Congress Cataloging-in-Publication Data

Sittig, Marshall.

Pharmaceutical manufacturing encyclopedia.

Includes bibliographies and indexes.

1. Drugs--Synthesis--Dictionaries. 2. Chemistry,

Pharmaceutical--Dictionaries. I. Title.

RS402.5.S58 1988 615'.191 87-31547

ISBN 0-8155-1144-2

Foreword

The worldwide pharmaceutical industry has a dollar sales volume greater than \$100 billion with a number of individual drugs boasting sales volumes of over \$100 million each. Indeed some drugs have been called "blockbuster drugs"—those generating at least \$300 million in new revenues each year. The profit margins in drug manufacture are higher than the rest of the chemical industry and, of course, research expenditures are huge in order to maintain position and develop new drugs in this highly competitive industry.

The present-day drug industry is one of rapid change.

Patents on current best-selling drugs are expiring. It has been estimated that the top 100 products in the marketplace will all come off patent (that is, the basic patents will expire) in the period between 1973 and 1990.

As patents expire, exclusivity of producing a trade-named product will pass and competitive-versions of the basic drug will be marketed under generic names (or other new trade names) by new manufacturers. It has been estimated that 40% of the drugs on the market in 1990 will be generic drugs.

New products will come on the market as

New products are developed through research.

Products now marketed in Europe and Asia attain approved status by the U.S. Food and Drug Administration (FDA) and enter the huge and lucrative American market.

Information on patented processes offers a number of commercial opportunities:

- (1) The patent expiration date (in the U.S. usually 17 years after the patent issuance date cited) offers the opportunity to duplicate and practice the patented process without legal conflict after expiration.
- (2) The statement of ownership of the patents affords the opportunity to license the patent in question from the patent holder.
- (3) The definition of the patented process offers the opportunity to an innovative chemist to develop a process which bypasses the original patent claims and offers a new legally clear route to an economically attractive product.

This encyclopedic work gives details for the manufacture of 1295 pharmaceuticals, now being marketed as trade-named products somewhere in the world. The pertinent process information has been obtained from examples given in the pertinent patent literature (usually U.S. patents and sometimes British patents).

In addition to the patent-derived process information, references are also cited under each drug's entry to major pharmaceutical reference works where additional information can be obtained on synthesis methods and the pharmacology of the individual products.

This work is presented in two volumes. The arrangement within the books is alphabetic by generic name. The table of contents appears at the beginning of Volume 1. There is also an index by trade names used in many of the countries in the world. Another index lists the raw materials used in the manufacture of the various drugs, an index which should be commercially valuable to suppliers of chemical raw materials to the pharmaceutical industry. These indexes appear at the end of Volume 2.

These volumes provide a handy first reference both to manufacturing process and also to other reference sources where additional details on the product may be found.

This handbook should be useful as an initial point of access to the commercial pharmaceutical literature. It can be consulted as a master source before using computerized retrieval even if computer data on the pertinent literature are readily available.

This work summarizes practical information available from the work of hundreds of pharmaceutical research laboratories and of thousands of chemists in those laboratories in developing thousands of commercial products.

Finally, it is hoped that these books will offer a sort of blueprint for entry into profitable generic drug manufacture. Companies not now in the drug business but with some expertise in fermentation processes and/or chemical synthesis may be able to add a few technical people and make a relatively small investment to get themselves on the first rung of the ladder to being pharmaceutical producers. Study of available technology, patent expiration dates and existing markets for particular trade-named drugs may well lead to routes to promising new ventures.

NOTICE

To the best of the Publisher's knowledge the information contained in this book is accurate; however, the Publisher assumes no responsibility nor liability for errors or any consequences arising from the use of the information contained herein. Final determination of the suitability of any information, procedure, or product for use contemplated by any user, and the manner of that use, is the sole responsibility of the user. The book is intended for informational purposes only. Due caution should be exercised in the use and handling of those raw materials that are potentially hazardous. Expert advice should be obtained at all times when manufacturing implementation is being considered. In the case of personal use of any of the products included, the manufacturer's medical instructions should be followed. Mention of trade names does not indicate endorsement by the Author nor the Publisher.

It should be noted that the manufacturing procedures described are based on patented processes and that a proper license must be obtained for the use of such processes, if the patent has not expired.

Contents

Introduction	1
Acebutolol	5
Aceclidine	6
Aceglutamide Aluminum	8
Acemetacin	9
Acenocoumarol (Acenocoumarin)	10
Acetaminophen	11
Acetazolamide	15
Acetohexamide	16
Acetophenazine Dimaleate	18
Acetoxolone Aluminum Salt	19
Acetrizoate Sodium	20
Acetylcysteine	21
Acetyldigitoxin	22
Acetyl Sulfisoxazole	23
Aclarubicin	24
Aclatonium Napadisylate	26
Acyclovir	27
Adenosine Triphosphate	28
Afloqualone	29
Albendazole	30
Albuterol	31
Alcufenac	33
Alcuronium Chloride	34
Alfacalcidol	35
Alfaxalone	36
Alfentanil Hydrochloride	37
Algestone Acetophenide	38
Alibendol	39
Alizapride	40
Alkofanone	41
Allopurinol	42
Alphaprodine Hydrochloride	44
Alprazolam	46
Alprenolol Hydrochloride	47
Altretamine	49
Aluminum Nicotinate	50
Amantidine Hydrochloride	50
Ambenonium Chloride	52
Ambroxol	53
Ambuphylline	54
Ambuside	55
Amcinonide	55
Amezinium Methyl Sulfate	56

Amikacin	57
Amiloride Hydrochloride	60
Amineptine Hydrochloride	61
Aminobenzoic Acid	62
Aminocaproic Acid	64
Aminoglutethimide	65
Aminometradine	66
Aminopentamide	67
Aminosalicyclic Acid	68
Amiodarone Hydrochloride	69
Amisometradine	70
Amitriptyline Hydrochloride	71
Amitriptyline Oxide	73
Amixetrine Hydrochloride	74
Amodiaquin	75
Amoxapine	76
Amoxicillin	78
Amphetamine Phosphate	81
Amphoterycin Calcium	82
Amphotericin B	83
Ampicillin	84
Ampicillin Trihydrate	88
Amrinone	90
Ancitabine Hydrochloride	91
Angiotensin Amide	92
Anileridine Dihydrochloride	93
Anisindione	94
Anisotropine Methylbromide	95
Antazoline Hydrochloride	96
Antrafenine	97
Apalcillin Sodium	98
Apazone	99
Aprindine Hydrochloride	101
Arginine Glutamate	102
Asparaginase	103
Aspartame	104
Aspirin	105
Astemizole	108
Atenolol	109
Atracurium Besylate	110
Auranofin	112
Aurothioglycanide	113
Azacyclonol	114
Azanidazole	115
Azapetine Phosphate	116
Azatadine Maleate	117
Azathioprine	118
Azidocillin	119
Azlocillin	121
Azosemide	122
Bacampicillin	124
Bacitracin	125
Baclofen	127
Barbexalone	128
Batroxobin	129
Beclamide	129
Beclomethasone Dipropionate	130

Befunolol	132
Bekanamycin Sulfate	133
Benactyzine Hydrochloride	135
Benapryzine Hydrochloride	136
Bendacort	137
Bendazac	137
Bendroflumethiazide	138
Benfluorex Hydrochloride	140
Benfurodil Hemisuccinate	141
Benorylate	143
Benoxaprofen	144
Benoxinate Hydrochloride	145
Benperidol	147
Benproperine	147
Benserazide	148
Bentiromide	150
Benzbromarone	151
Benzethonium Chloride	152
Benzoctamine HCl	153
Benzonatate	154
Benzphetamine Hydrochloride	155
Benzpyrinium Bromide	156
Benzquinamide	157
Benzthiazide	159
Benztropine Mesylate	160
Bephenium Hydroxynaphthoate	161
Bepridil	162
Betamethasone	164
Betamethasone Acetate	165
Betamethasone Benzoate	166
Betamethasone Dipropionate	167
Betamethasone Valerate	169
Betaxolol Hydrochloride	170
Betazole	171
Bethanechol Chloride	172
Bialamicol	173
Bietaserpine	174
Bifonazole	175
Biperiden	176
Bisacodyl	178
Bismuth Sodium Triglycollamate	180
Bretylum Tosylate	180
Bromazepam	181
Bromelain	183
Bromhexine	184
Bromocriptine	186
Bromopride	187
Brompheniramine Maleate	188
Bronopol	189
Brotizolam	190
Bucloxic Acid	191
Bucumolol Hydrochloride	192
Budralazine	193
Bufeniode	194
Bufetrol	195
Bufexamac	196
Buflomedil	197
Buformin HCl	198

Bumadizon	199
Bumetanide	200
Bunitrolol	202
Bupivacaine	203
Bupranolol	204
Busulfan	205
Butalamine Hydrochloride	206
Butamirate Citrate	207
Butethamine	208
Buthiazide	209
Butofilolol	210
Butorphanol	212
Butriptyline	213
Butropium Bromide	214
Cafaminol	215
Calcifediol	215
Calcitonin	217
Calcitriol	218
Calusterone	219
Camazepam	220
Candicidin	221
Canrenoate Potassium	223
Capreomycin Sulfate	224
Captodiamine	226
Captopril	227
Caramiphen Edisylate	229
Carazolol	230
Carbachol	231
Carbamazepine	232
Carbaspirin Calcium	233
Carbazochrome	234
Carbenicillin Disodium	235
Carbenicillin Indanyl Sodium	237
Carbenoxolone	238
Carbidopa	239
Carbinoxamine Maleate	241
Carbocysteine	242
Carbomycin	244
Carboquone	245
Carbuterol	245
Cargutocin	247
Carisoprodol	248
Carmofur	249
Carnitine	250
β -Carotene	252
Caroxazone	253
Carphenazine Maleate	254
Carprofen	255
Carteolol	256
Carticaine	257
Cefaclor	258
Cefadroxil	259
Cefamandole Nafate Sodium Salt	261
Cefatrizine	262
Cefazolin Sodium	263
Cefmenoxime	265
Cefoperazone	266

Cefotaxime Sodium	267
Cefoxitin Sodium	268
Cefroxadine	269
Cefsulodin	271
Ceftazidime	272
Ceftizoxime	273
Ceftriaxone Sodium	274
Cefuroxime	276
Celiprolol	277
Cephacetrile Sodium	278
Cephalexin	279
Cephaloglycin	282
Cephaloridine	283
Cephalothin Sodium	286
Cephapirin Sodium	287
Cephradine	289
Ceruletide	291
Cetiedil	292
Chenodiol	293
Chlophedianol	294
Chloral Betaine	295
Chlorambucil	296
Chloramphenicol	297
Chloramphenicol Palmitate	301
Chlorcyclizine	302
Chlordantoin	303
Chlordiazepoxide Hydrochloride	304
Chlorhexidine	306
Chlorisondamine Chloride	307
Chlormerodrin	308
Chlormezanone	309
Chloroprocaine Hydrochloride	310
Chloroquine Phosphate	312
Chlorothiazide	313
Chlorotrianisene	314
4-Chloro-3,5-Xylenol	315
Chlorphenesin Carbamate	316
Chlorpheniramine Maleate	317
Chlorphenoxamine Hydrochloride	319
Chlorproethazine HCl	321
Chlorpromazine Hydrochloride	321
Chlorpropamide	323
Chlorprothixene	325
Chlorquinaldol	326
Chlortetracycline	327
Chlorthalidone	329
Chlorthenoxazine	331
Chlorzoxazone	332
Choline Dihydrogen Citrate	333
Choline Salicylate	334
Choline Theophyllinate	335
Chromonar Hydrochloride	336
Chymopapain	337
Ciclonicate	338
Ciclopiroxolamine	339
Cicloxicilic Acid	340
Cimetidine	341
Cinepazet Maleate	343

Cinnarizine	343
Cinoxacin	345
Ciprofibrate	346
Citicoline	347
Citiolone	349
Clavulanic Acid	350
Clemastine Fumarate	351
Clemizole	353
Clenbuterol	354
Clidanac	355
Clidinium Bromide	356
Clindamycin Hydrochloride	357
Clinofibrate	358
Clobazam	359
Clobetasol	361
Clobutinol	361
Clocapramine	363
Clofezone	363
Clofibrate	364
Clofibride	367
Clofoctol	367
Clomiphene Dihydrogen Citrate	368
Clomipramine	369
Clonazepam	370
Clonidine Hydrochloride	372
Clopenthixol	374
Cloperastine	375
Cloprednol	376
Clorazepate Dipotassium	377
Clorexolone	378
Clorprenaline	380
Clortermine Hydrochloride	381
Clotiazepam	383
Clotrimazole	383
Cloxacillin	385
Cloxazolam	386
Clozapine	387
Colestipol	388
Cortisone Acetate	389
Cortivazol	390
Creatinolfosfate	392
Cromolyn Sodium	393
Crotamiton	395
Cryptenamine Tannates	395
Cyamemazine	397
Cyanocobalamin	398
Cyclacillin	401
Cyclamate Calcium	402
Cyclandelate	403
Cyclarbamate	405
Cyclizine	406
Cyclobenzaprine	407
Cyclobutylol	407
Cyclofenil	409
Cyclomethycaine	410
Cyclopentamine Hydrochloride	411
Cyclopentolate Hydrochloride	413
Cyclophosphamide	414

Cycloserine	415
Cyclosporin	416
Cyclothiazide	418
Cyrimine Hydrochloride	419
Cyproheptadine	420
Cyproterone Acetate	422
Cytarabine Hydrochloride	423
Dactinomycin	426
Danazol	427
Dantrolene Sodium	428
Dapsone	429
Daunorubicin	430
Deanol Acetamidobenzoate	432
Debrisoquin	433
Defosfamide	434
Demecarium Bromide	434
Demeclocycline Hydrochloride	436
Demegetone	438
Demexiptiline HCl	440
Deserpidine	441
Desipramine Hydrochloride	443
Desmopressin	444
Desogestrel	445
Desonide	446
Desoximetasone	447
Dexamethasone Acetate	449
Dexamethasone-21-Linoleate	450
Dexamethasone Phosphate	451
Dexbrompheniramine Maleate	453
Dexchlorpheniramine Maleate	454
Dexetimide	455
Dexpanthenol	456
Dextran 40	457
Dextroamphetamine Sulfate	458
Dextromethorphan Hydrobromide	459
Diamthazole Dihydrochloride	461
Diatrizoate Sodium	462
Diazepam	463
Diazoxide	467
Dibekacin	468
Dibenzepin Hydrochloride	470
Dibutoline Sulfate	471
Dichlorisone Acetate	472
Dichlorphenamide	473
Diclofenac Sodium	474
Dicloxacillin Sodium	476
Dicyclomine Hydrochloride	477
Dienestrol	479
Diethylcarbamazine Citrate	480
Diethylpropion HCl	481
Diethylstilbestrol	482
Diethylstilbestrol Diphosphate	484
Difenoxine	485
Diflorasone Diacetate	486
Diflucortolone Valerate	488
Diflunisal	489
Difluprednate	490

Dihydrostreptomycin Sulfate	491
Dihydrotachysterol	493
Dilazep Hydrochloride	494
Diltiazem Hydrochloride	495
Dimenhydrinate	496
Dimercaprol	498
Dimetacrine Tartrate	499
Dimethicone	500
Dimethindene Maleate	502
Dimethisoquin	503
Dimethisterone	504
Dimethoxanate	505
Dimethyl Sulfoxide	506
Dimethyl Tubocurarine Iodide	507
Dinoprost Tromethamine	508
Dinoprostone	509
Diosmin	510
Dioxyline Phosphate	512
Diphenamil Methylsulfate	514
Diphenadione	515
Diphenhydramine Hydrochloride	516
Diphenidol	518
Diphenoxylate Hydrochloride	519
Diphenpyramide	520
Diphenylpyraline Hydrochloride	521
Dipivefrin	522
Dipyridamole	523
Disopyramide Phosphate	525
Distigmine Bromide	526
Disulfiram	528
Ditazol	528
Dithiazanine Iodide	529
Dixyrazine	530
Dobesilate Calcium	531
Dobutamine	532
Docusate Calcium	534
Domiphen Bromide	534
Domperidone	535
Doxapram Hydrochloride	536
Doxepin Hydrochloride	538
Doxorubicin	539
Doxycycline	541
Dromostanolone Propionate	542
Droperidol	543
Droprenilamine HCl	545
Dyclonine Hydrochloride	545
Dydrogesterone	546
Dyphylline	547
Echothiopate Iodide	550
Econazole Nitrate	551
Ectylurea	552
Edetate Disodium	553
Edrophonium Chloride	554
Emylcamate	555
Endralazine	556
Enflurane	557
Enviomycin	559

Eperisone HCl	560
Epicillin	560
Epimestrol	562
Epinephryl Borate	563
Epirizole	563
Epitiostanol	565
Eprazinone HCl	565
Eprozinol	566
Erythromycin	568
Erythromycin Estolate	570
Erythromycin Gluceptate	571
Erythromycin Lactobionate	572
Erythromycin Stearate	573
Estazolam	574
Estradiol Cypionate	575
Estradiol Valerate	577
Estramustine Phosphate	578
Estriol Succinate	580
Ethacrynic Acid	580
Ethambutol Hydrochloride	582
Ethamivan	584
Ethamsylate	585
Ethchlorvynol	585
Ethiazide	586
Ethinamate	587
Ethinylestradiol	588
Ethionamide	589
Ethoheptazine	591
Ethopropazine Hydrochloride	592
Ethosuximide	594
Ethotoin	595
Ethoxzolamide	595
Ethyl Biscoumacetate	596
Ethylestrenol	597
Ethynodiol Diacetate	598
Etidocaine HCl	599
Etidronate Disodium	600
Etifelmine	602
Etifoxine	603
Etilefrine Pivalate Hydrochloride	604
Etiroxate	605
Etodroxizine	605
Etofenamate	607
Etofibrate	607
Etofylline Clofibrate	608
Etomidate Hydrochloride	609
Etomidoline	611
Etozolin	612
Etretnate	613
Etryptamine	614
Exalamide	615
Exiproben	616
Fazidinium Bromide	617
Febantel	618
Febuprol	619
Felypressin	619
Fenbendazole	621

Fenbufen	622
Fendiline Hydrochloride	623
Fenethylline HCl	624
Fenipentol	625
Fenofibrate	626
Fenopropfen	627
Fenoterol Hydrobromide	629
Fenoxedil	630
Fenproporex	631
Fenspiride	632
Fentanyl	633
Fentiazac	634
Fentonium Bromide	636
Feprazone	637
Ferrocholinate	638
Ferroglycine Sulfate	639
Ferrous Fumarate	639
Fibrinolysin	641
Flavoxate Hydrochloride	642
Flecainide	644
Floctafenine	645
Florantyrone	647
Floredil Hydrochloride	648
Floxacillin	649
Floxuridine	650
Fluazacort	651
Flubendazole	653
Flucloronide	654
Flucytosine	655
Fludiazepam Hydrochloride	657
Fludrocortisone Acetate	658
Flumequine	659
Flumethasone	660
Flumethiazide	661
Flunarizine HCl	662
Flunisolide	663
Flunitrazepam	664
Fluocinolone Acetonide	667
Fluocinonide	670
Fluocortin Butyl	671
Fluocortolone	673
Fluorometholone	674
Fluorouracil	676
Fluoxymesterone	678
Flupentixol	680
Fluphenazine Hydrochloride	681
Fluprednidene Acetate	683
Fluprednisolone	685
Flurandrenolide	686
Flurazepam	687
Flurbiprofen	689
Flurothyl	690
Fluroxene	691
Fluspirilene	692
Flutamide	693
Fluvoxamine Maleate	694
Folic Acid	695
Fominoben HCl	697

Fomocaine	699
Fonazine Mesylate	699
Formocortol Acetate	701
Fosfomycin	702
Fructose	703
Fumagillin	705
Furaltadone	706
Furazabol	707
Furazolidone	708
Furosemide	709
Fursultiamine	711
Furtrethonium Iodide	712
Fusafungine	713
Gallamine Triethiodide	717
Gemeprost	718
Gemfibrozil	719
Gentamicin Sulfate	720
Gepefrin	723
Glafenine	723
Glaucarubin	725
Glaziovine	726
Glibornuride	728
Gliclazide	729
Glipizide	730
Gliquidone	731
Glisoxepid	732
Glucagon	733
Glutethimide	733
Glybuzole	735
Glycopyrrolate	735
Glymidine	736
Gramicidin	738
Griseofulvin	739
Guaifenesin	740
Guanabenz	742
Guanadrel Sulfate	743
Guanethidine Sulfate	744
Guanfacine	745
Guanoxabenz Hydrochloride	746
Halazepam	748
Halcinonide	749
Haloperidol	750
Halopredone Acetate	751
Haloprogin	752
Halothane	753
Heparin	755
Hepronicate	756
Heptabarbital	757
Hetacillin Potassium	759
Hexachlorophene	760
Hexamethonium Bromide	761
Hexestrol	762
Hexetidine	763
Hexobendine	764
Hexocyclium Methyl Sulfate	765
Hexoprenaline	766

Hexylcaine Hydrochloride	768
Homofenazine	769
Hydralazine Hydrochloride	770
Hydrochlorothiazide	771
Hydrocortamate HCl	773
Hydrocortisone	775
Hydrocortisone Sodium Phosphate	778
Hydroflumethiazide	779
Hydroquinone	780
Hydroxocobalamin	781
Hydroxychloroquine Sulfate	783
Hydroxydione Sodium Succinate	785
Hydroxyphenamate	786
Hydroxyprogesterone Caproate	787
Hydroxypropyl Cellulose	788
Hydroxystilbamidine Isethionate	789
Hydroxytryptophan	791
Hydroxyurea	793
Hydroxyzine Hydrochloride	794
Ibuprofen	796
ibuproxam	798
Idoxuridine	799
Ifenprodil Tartrate	801
Ifosfamide	802
Imipramine Hydrochloride	803
Improsulfan Tosylate	804
Indalpine	805
Indanazoline	806
Indapamide	807
Indenolol	808
Indomethacin	809
Indoprofen	812
Indoramin	813
Inosine	814
Inositol	816
Inositol Niacinate	817
Insulin	818
Insulin Isothane	820
Insulin Zinc Suspension	821
Interferon	822
Iodamide	823
Iodipamide	825
Iodoalphonic Acid	826
Ioglycamic Acid	827
Iopamidol	828
Iopanoic Acid	829
Iophendylate	831
Iopronic Acid	832
Iothalmate Meglumine	833
Iothiouracil	834
Iotroxic Acid	835
Ipratropium Bromide	836
Iproniazid	837
Ipronidazole	838
Isaxonine Phosphate	839
Isoaminile	840
Isobornyl Thiocynoacetate	841

Isocarboxazid	842
Isoconazole Nitrate	843
Isoflurane	844
Isoflurophate	844
Isometheptene	846
Isoniazid	846
Isopropamide Iodide	848
Isoproterenol Sulfate	849
Isosorbide Dinitrate	850
Isothipendyl HCl	852
Isoxicam	853
Isosuprine Hydrochloride	854
Kanamycin Sulfate	856
Kebuzone	858
Ketamine Hydrochloride	859
Ketazolam	860
Ketoconazole	861
Ketoprofen	862
Ketotifen	864
Labetalol Hydrochloride	867
Lactulose	868
Letosteine	869
Levamisole Hydrochloride	870
Levodopa	871
Levothyroxine Sodium	873
Lidocaine	874
Lidoflazine	876
Lincomycin	877
Lindane	878
Liothyronine	879
Lofexidine Hydrochloride	881
Loflazepate Ethyl	882
Lonazolac	883
Loperamide Hydrochloride	884
Loprazolam	885
Lorazepam	886
Lorcainide Hydrochloride	888
Lormetazepam	889
Loxapine	890
Mafenide Acetate	892
Magaldrate	893
Malathion	894
Maltose	895
Mannitol	896
Mazaticol Hydrochloride	897
Mazindol	898
Mebendazole	899
Mebeverine Hydrochloride	900
Mebutamate	902
Mecamylamine Hydrochloride	903
Mecillinam	905
Mecizine Hydrochloride	906
Meclofenamic Acid	907
Medazepam	908
Medigoxin	910

Medrogestone	911
Medroxyprogesterone Acetate.	914
Medrysone	917
Mefenamic Acid.	918
Mefenorex Hydrochloride	919
Mefruside	920
Megestrol Acetate.	921
Melitracen	922
Melperone	923
Melphalan	924
Memantine.	926
Menadiol Sodium Diphosphate	927
Menbutone.	928
Mepazine.	929
Mepenzolate Bromide	930
Meperidine Hydrochloride.	931
Mephenesin	933
Mephenesin Carbamate.	934
Mephenoxalone	935
Mephentermine	936
Mepicycline	937
Mepindolol.	938
Mepitiostane.	939
Mepivacaine	940
Meprednisone	941
Meprobamate	942
Meptazinol	945
Mequitazine	946
Meralluride.	947
Mercaptomerin Sodium	948
Mercaptopurine	949
Mesna.	950
Mesoridazine Besylate	952
Mesterolone	953
Mestranol	954
Metampicillin Sodium	955
Metapramine.	956
Metaproterenol Sulfate.	957
Metaraminol	959
Metaxalone	960
Metergoline	961
Methacycline	962
Methadone Hydrochloride.	964
Methallenestril.	965
Methandrostenolone	967
Methapyrilene Hydrochloride	968
Methaqualone	969
Methazolamide	971
Methdilazine Hydrochloride.	972
Methenamine Hippurate	973
Methenolone Acetate.	974
Methicillin Sodium	975
Methionine.	976
Methitural	978
Methixene Hydrochloride	979
Methocarbamol	980
Methohexital Sodium.	981
Methotrexate	984
Methotrimeprazine	985

Methoxamine Hydrochloride	986
Methoxsalen	987
Methoxyflurane	988
Methscopolamine Bromide	990
Methsuximide	991
Methyldopa	992
Methylergonovine Maleate	993
Methylhexanamine Carbonate	995
Methylol Riboflavin	996
Methylphenidate Hydrochloride	997
Methylprednisolone	998
Methyltestosterone	1000
Methyprylon	1001
Methysergide Maleate	1002
Metiazinic Acid	1003
Metoclopramide HCl	1004
Metolazone	1006
Metoprolol Tartrate	1009
Metrizoic Acid	1010
Metronidazole	1011
Metyrapone	1013
Metyrosine	1014
Mexenone	1015
Mexiletine HCl	1016
Mezlocillin	1017
Mianserin	1019
Miconazole Nitrate	1020
Micronomicin	1022
Midazolam Maleate	1024
Midecamycin	1025
Midodrine	1027
Minaprine	1028
Minocycline	1029
Minoxidil	1030
Mitobronitol	1031
Mitomycin	1032
Mitopodozide	1033
Molindone	1034
Mopidamol	1035
Morclofone	1036
Motretinide	1037
Moxalactam Disodium	1039
Moxestrol	1040
Moxisylyte	1041
Muzolimine	1043
Nabilone	1045
Nadolol	1046
Nafcillin Sodium	1047
Nafiverine	1048
Nafronyl Oxalate	1049
Nalbuphine	1050
Nalidixic Acid	1051
Nalorphine	1053
Naloxone	1054
Nandrolone Decanoate	1056
Nandrolone Phenpropionate	1057
Naphazoline	1058

Naproxen	1059
Natamycin	1061
Nefopam Hydrochloride	1062
Neomycin	1063
Netilmicin	1066
Nialamide	1067
Niaprazine	1068
Nicardipine	1069
Nicergoline	1070
Niceritrol	1071
Niclosamide	1072
Nicomol	1073
Nicotinyl Alcohol	1074
Nifedipine	1076
Niflumic Acid	1077
Nifuratel	1078
Nifurfoline	1079
Nifuroxazide	1080
Nifurtinol	1081
Nifurzide	1081
Nimetazepam	1082
Nimorazole	1083
Nimustine	1085
Nitrazepam	1086
Nitrofurantoin	1088
Nitrofurazone	1090
Nomifensine Maleate	1091
Nonoxynol	1092
Nordazepam	1092
Norethandrolone	1093
Norethindrone	1094
Norethindrone Acetate	1096
Norethynodrel	1097
Norfenefrine	1098
Norfloxacin	1099
Norgestrel	1100
Nortriptyline	1101
Novobiocin	1102
Noxiptilin	1103
Noxytiolin	1105
Nylidrin	1105
Nystatin	1107
Octopamine Hydrochloride	1110
Oleandomycin	1111
Opipramol	1112
Orazamide	1113
Orgotein	1114
Ornidazole	1115
Ornipressin	1116
Orphenadrine Citrate	1117
Oxaceprol	1118
Oxacillin Sodium	1119
Oxaflozane Hydrochloride	1122
Oxaflumazine Disuccinate	1123
Oxametacine	1124
Oxamniquine	1125
Oxandrolone	1127
Oxatomide	1128

Oxazepam	1129
Oxazolam	1130
Oxeladin	1131
Oxendolone	1133
Oxethazine	1134
Oxetorone Fumarate	1135
Oxiconazole Nitrate	1136
Oxitriptan	1137
Oxitropium Bromide	1138
Oxolinic Acid	1139
Oxomemazine	1141
Oxprenolol	1142
Oxybutynin Chloride	1143
Oxyfedrine	1144
Oxymetazoline Hydrochloride	1145
Oxymorphone	1146
Oxypendyl	1147
Oxyphenbutazone	1148
Oxyphencyclimine	1150
Oxyphenisatin Acetate	1151
Oxytetracycline	1152
Oxytocin	1154
Pancuronium Bromide	1158
Papain	1159
Papaverine Monophosadenine	1160
Paramethadione	1162
Paramethasone Acetate	1163
Parapenzolate Bromide	1164
Pargyline Hydrochloride	1165
Paromomycin	1166
Pelargonic Acid	1168
Pemoline	1169
Penbutolol	1170
Penfluridol	1171
Penicillamine	1172
Penicillin G Benzathine	1174
Penicillin G Hydrabamine	1175
Penicillin G Procaine	1177
Penicillin O	1178
Penicillin V	1179
Penicillin V Hydrabamine	1181
Pentaerythritol Tetranitrate	1182
Pentagastrin	1184
Pentapiperide Methosulfate	1185
Penthienate Bromide	1186
Pentobarbital Sodium	1187
Pentoxifylline	1188
Peplomycin Sulfate	1189
Perhexiline Maleate	1190
Perimethazine	1192
Perisoxal Citrate	1192
Perlapine	1194
Perphenazine	1195
Phenactropinium Chloride	1196
Phenaglycodol	1197
Phendimetrazine Tartrate	1199
Phenelzine Sulfate	1200

Phenethicillin Potassium	1201
Phenformin	1202
Phenindamine Tartrate	1203
Pheniprazine	1204
Pheniramine Maleate	1205
Phenmetrazine	1206
Phenoperidine Hydrochloride	1207
Phenoxybenzamine Hydrochloride	1208
Phenprocoumon	1210
Phensuximide	1211
Phentermine Hydrochloride	1212
Phentolamine Hydrochloride	1214
Phenyl Aminosalicylate	1215
Phenylbutazone	1216
Phenylephrine Hydrochloride	1218
Phenylpropanolamine Hydrochloride	1220
Phenyltoloxamine	1222
Phenylramidol	1223
Phenytoin	1224
Phethenylate Sodium	1226
Phthalylsulfathiazole	1227
Phytate Sodium	1228
Phytonadione	1229
Picoperine	1230
Picosulfate Sodium	1231
Pifarnine	1233
Pimefylline Nicotinate	1234
Pimozide	1235
Pinazepam	1236
Pipamazine	1237
Pipamperone	1238
Pipazethate	1240
Pipebuzone	1241
Pipemidic Acid	1241
Pipenzolate Bromide	1243
Piperacillin Sodium	1244
Piperidolate	1245
Pipethanate Ethobromide	1246
Pipobroman	1247
Pipoxolan Hydrochloride	1248
Piprozolin	1249
Piracetam	1250
Pirbuterol	1251
Piretanide	1252
Piribedil	1253
Piritramide	1254
Piroheptine	1255
Piromidic Acid	1256
Pirozadil	1257
Pirprofen	1258
Pivampicillin	1259
Pivmecillinam	1261
Pixifenide	1262
Pizotyline Hydrochloride	1263
Poloxalkol	1265
Polyestradiol Phosphate	1266
Polymyxin	1267
Polythiazide	1268
Povidone-Iodine	1270

Practolol	1271
Prajmaline Bitartrate	1272
Pralidoxime Chloride	1273
Pramiverin	1274
Pramoxine Hydrochloride	1275
Pranoprofen	1276
Prazepam	1277
Praziquantel	1279
Prazosin	1280
Prednimustine	1281
Prednisolone	1283
Prednisolone Acetate	1285
Prednisolone Phosphate Sodium	1286
Prednisolone Stearoylglycolate	1288
Prednisolone Tebutate	1289
Prednisone	1289
Prenalterol	1292
Prenylamine	1292
Prilocaine Hydrochloride	1294
Primidone	1295
Probenecid	1296
Probucol	1297
Procabazine Hydrochloride	1298
Procatamol	1300
Prochlorperazine	1301
Procyclidine Hydrochloride	1302
Proglumetacin Maleate	1303
Promazine Hydrochloride	1305
Promegestone	1306
Promethazine Hydrochloride	1307
Propafenone Hydrochloride	1308
Propanidid	1310
Propantheline Bromide	1310
Propiram Fumarate	1312
Propoxyphene Hydrochloride	1313
Propranolol Hydrochloride	1314
Propylhexedrine	1316
Proquazone	1317
Proscillaridin	1318
Prothipendyl Hydrochloride	1319
Protionamide	1320
Protizinic Acid	1322
Protokylol	1323
Protriptyline	1324
Proxazole Citrate	1325
Proxibarbal	1326
Pyrantel Pamoate	1328
Pyrazinamide	1329
Pyrazinamide	1330
Pyridinol Carbamate	1331
Pyridostigmine Bromide	1332
Pyrilamine	1333
Pyrimethamine	1335
Pyrrithyldione	1336
Pyritinol	1337
Pyrovalerone Hydrochloride	1338
Pyrrobutamine	1339
Pyrvinium Pamoate	1340

Quinestrol	1342
Quinethazone	1343
Quingestanol Acetate	1344
Quinidine Polygalacturonate	1345
Quinupramine	1346
Ranitidine	1348
Razoxane	1349
Relaxin	1350
Reproterol	1351
Rescimetol	1352
Rescinnamine	1353
Reserpine	1354
Ribostamicin	1357
Rifampin	1358
Rimiterol	1359
Ritodrine	1360
Rociverine	1362
Rolitetracycline	1363
Rosoxacin	1364
Salicylanilide	1366
Salicylic Acid	1366
Secnidazole	1368
Secobarbital Sodium	1369
Secretin	1371
Selegiline	1372
Selenium Sulfide	1372
Silymarin	1373
Simethicone	1374
Simfibrate	1375
Sincalide	1376
Sisomicin	1377
Sobrerol	1379
Somatotropin	1380
Spectinomycin	1381
Spiperone	1383
Spiramycin	1384
Spirolactone	1385
Stallimycin Hydrochloride	1386
Stanolone	1388
Stanozolol	1389
Streptokinase	1390
Streptomycin	1391
Streptozocin	1393
Succinylsulfathiazole	1394
Sucralfate	1395
Sufentanil	1396
Sulbenicillin	1397
Sulfacetamide	1398
Sulfachlorpyridazine	1399
Sulfacytine	1400
Sulfadiazine	1401
Sulfadimethoxine	1403
Sulfadoxine	1404
Sulfaethidole	1405
Sulfaguanidine	1406
Sulfaguanol	1407

Sulfalene	1408
Sulfamerazine	1410
Sulfameter	1411
Sulfamethazine	1412
Sulfamethizole	1413
Sulfamethoxazole	1414
Sulfamethoxypyridazine	1416
Sulfamoxole	1417
Sulfaphenazole	1418
Sulfasalazine	1419
Sulfinpyrazone	1420
Sulfisomidine	1421
Sulfisoxazole	1422
Sulfoxone Sodium	1424
Sulindac	1425
Sulisobenzone	1427
Suloctidil	1428
Sulpiride	1429
Sulprostone	1431
Sultopride Hydrochloride	1432
Sultosilic Acid Piperazine Salt	1433
Sultroponium	1434
Syrosingopine	1435
Talampicillin	1437
Talniflumate	1438
Tamoxifen	1439
Tanphetamin	1440
Tegafur	1441
Temazepam	1443
Teniposide	1444
Terbutaline	1445
Terofenamate	1446
Testolactone	1447
Testosterone 17 β -Cypionate	1448
Testosterone Enanthate	1450
Tetrabenazine	1451
Tetracycline	1452
Tetracycline Phosphate Complex	1454
Tetrahydrozoline Hydrochloride	1455
Tetrazepam	1456
Thiabendazole	1458
Thiamine Disulfide	1459
Thiamphenicol	1460
Thiamylal	1462
Thiethylperazine	1463
Thihexinol	1464
Thiocarbarson	1465
Thioguanine	1466
Thiopropazate	1467
Thiopropazine	1468
Thioridazine	1469
Thiotepa	1470
Thiothixene	1471
Thiphenamil Hydrochloride	1473
Thonzylamine Hydrochloride	1474
Tiadenol	1475
Tianeptine	1476

Tiapride	1477
Tiaprofenic Acid	1478
Tiamide	1479
Tibezonium Iodide	1480
Ticarcillin Disodium	1481
Ticlopidine Hydrochloride	1482
Ticrynafen	1483
Tiemonium Iodide	1485
Tilidine Hydrochloride	1486
Timepidium Bromide	1487
Timolol Maleate	1489
Timonacic Sodium	1491
Tinidazole	1491
Tinoridine	1493
Tiocarlide	1493
Tiocloamarol	1494
Tioconazole	1495
Tiopronin	1496
Tiratricol	1497
Tiropamide	1498
Tixocortol Pivalate	1499
Tocainide	1500
Tofenacin Hydrochloride	1501
Tofisopam	1502
Tolazamide	1503
Tolazoline	1505
Tolbutamide	1506
Tolcilate	1507
Tolmetin	1508
Tolnaftate	1509
Tolonidine Nitrate	1510
Tolonium Chloride	1512
Tramadol Hydrochloride	1513
Tranexamic Acid	1514
Tranilast	1515
Tranlycypromine Sulfate	1516
Trapidil	1518
Trazodone Hydrochloride	1518
Trenbolone Acetate	1520
Trepibutone	1521
Tretinoin	1522
Triacetin	1523
Triamcinolone	1524
Triamcinolone Acetonide	1526
Triamcinolone Diacetate	1528
Triamterene	1529
Triazolam	1530
Tribenoside	1531
Trichlormethiazide	1532
Triclobisonium Chloride	1533
Triclocarban	1534
Triclofos Sodium	1535
Tridihexethyl Iodide	1536
Triethylenemelamine	1537
Trifluoperazine	1538
α,α,α -Trifluorothymidine	1539
Triflupromazine	1540
Trihexyphenidyl Hydrochloride	1541

Trilostane	1543
Trimeprazine	1544
Trimetazidine	1545
Trimethadione.	1546
Trimethobenzamide Hydrochloride.	1547
Trimethoprim	1548
Trimetozine	1550
Trioxsalen	1551
Triparanol	1552
Tripelennamine	1553
Triprolidine	1554
Trofosfamide	1556
Tromantidine Hydrochloride	1557
Tromethamine.	1558
Tropicamide.	1559
Tubocurarine Chloride	1560
Tybamate	1561
Tyloxapol	1562
Tyropanoate Sodium.	1563
Ubidecarenone	1565
Uracil Mustard.	1566
Urapidil	1567
Urokinase	1568
Valethamate Bromide	1571
Vancomycin	1572
Veralipride.	1573
Verapamil	1574
Vidarabine	1575
Viloxazine Hydrochloride	1577
Viminol	1578
Vinbarbital Sodium.	1579
Vinblastine Sulfate	1580
Vincamine	1582
Vincristine Sulfate	1584
Vindesine	1585
Viomycin	1586
Viquidil	1587
Visnadine	1588
Warfarin Sodium	1590
Xanthinol Niacinate	1592
Xibornol	1593
Xipamid	1594
Xylometazoline Hydrochloride	1596
Zeranol	1598
Zimelidine	1599
Zipeprol	1600
Zolimidine.	1601
Zomepirac	1602
Zotepine	1604
Zoxazolamine	1604
RAW MATERIALS INDEX	1606
Fermentation or Extraction.	1606
Chemicals	1609
TRADE NAME INDEX	1669

Introduction

INFORMATION SOURCES USED

A variety of sources were used to identify the patent associated with particular commercial products and to serve as a source of process information. These include the following:

- Merck Index: followed by a citation of the entry number in the Tenth (1983) Edition.¹
- DFU: The periodical publication, *Drugs of the Future*,² published in Spain.
- DOT: The periodical publication, *Drugs of Today*,³ also published in Spain.
- Kleeman & Engel: The encyclopedic German work, *Pharmazeutische Werkstoffe*,⁴ second revised edition published in 1982.
- OCDS: The 3-volume reference series on the *Organic Chemistry of Drug Synthesis*.⁵

In addition, sources of pharmacological data and comparative information on trade names used in various countries were obtained from:

- REM: The latest edition of *Remington's Pharmaceutical Sciences*.⁶
- The nonproprietary name index published by Paul de Haen.⁷
- I.N.: The biannual Swiss publication, *Index Nominum*.⁸
- PDR: The guide to commercially available U.S. drugs, the *Physicians' Desk Reference*.⁹

Finally, earlier books by this author were drawn on to provide information for some entries. These include:

The *Pharmaceutical Manufacturing Encyclopedia*, first edition.¹⁰

A book entitled, *Manufacturing Processes for New Pharmaceuticals*.¹¹ This book attempted to review processes for manufacturing drugs still in the developmental stage—those which had attained generic name status but not trade name status in most cases. Many of these have since fallen by the wayside.

The *Veterinary Drug Manufacturing Encyclopedia*.¹² The present volume deals only in "people drugs" as did its predecessor volume¹⁰ but some drugs find application in both areas.

It should be emphasized again that this is simply a guide to manufacturing processes. Under each generic named product a "Therapeutic Function" is indicated. However, the reader is referred to the *Merck Index*¹ and to *Remington*⁶ as well as to *Drugs of the Future*,² *Drugs of Today*,³ and the *Physicians' Desk Reference (PDR)*⁹ for more information on the material, its properties, its therapeutic use and its side effects. The chemist who is interested in synthesis routes is referred to Lednicer and Mitscher⁵ as well as to Kleeman & Engel⁴ for more information on routes to these products and to products having similar structures.

SALES RANKINGS OF U.S. DRUGS

In the preparation of the first edition of this volume, contact was made with IMS, Inc. of Ambler, Pa., a well-known source of international statistics. With their help, a list was prepared of the 100 top products based on U.S. sales volume in 1976; that list is given in Table 1.

Table 1: The Top 100 Generic Pharmaceuticals in the U.S. in 1976

(1) Diazepam	(51) Doxorubicin
(2) Methyldopa	(52) Propoxyphene
(3) Hydrochlorothiazide	(53) Nitrofurantoin
(4) Acetaminophen	(54) Trimethoprim
(5) Amitriptyline	(55) Betamethasone Valerate
(6) Cephalexin	(56) Pseudoephedrine
(7) Ibuprofen	(57) Diethylpropion
(8) Cephalothin	(58) Meclizine
(9) Furosemide	(59) Ampicillin Anhydrous
(10) Norethindrone	(60) Pentazocine Lactate
(11) Indomethacin	(61) Tetracycline
(12) Gentamicin Sulfate	(62) Procainamide
(13) Chlordiazepoxide	(63) Imipramine
(14) Thoridazine	(64) Chlorpromazine
(15) Norgestrel	(65) Triamcinolone Acetonide
(16) Propranolol	(66) Dipyridamole
(17) Estrogenic Substances, Conjugated	(67) Clindamycin Phosphate
(18) Ampicillin Trihydrate	(68) Miconazole Nitrate
(19) Spironolactone	(69) Chlorpheniramine Maleate
(20) Amoxicillin	(70) Theophylline
(21) Triamterene	(71) Naproxen
(22) Penicillin V	(72) Kanamycin Sulfate
(23) Isosorbide Dinitrate	(73) Pentaerythritol Tetranitrate
(24) Chlorpropamide	(74) Meperidine
(25) Chlorthalidone	(75) Neomycin Sulfate
(26) Allopurinol	(76) Oxazepam
(27) Cefazolin Sodium	(77) Guaiacol Glyceryl Ether
(28) Hydralazine	(78) Oxymetazoline
(29) Doxepin	(79) Tolazamide
(30) Clidinium Bromide	(80) Insulin Zinc Suspension
(31) Doxycycline	(81) Metronidazole
(32) Erythromycin Estolate	(82) Phentermine Resin
(33) Papaverine	(83) Erythromycin Stearate
(34) Hydroxyzine Pamoate	(84) Phenobarbital
(35) Flurazepam	(85) Povidone-Iodine
(36) Tolbutamide	(86) Quinidine Gluconate
(37) Methylprednisolone Sodium Succinate	(87) Hydroflumethiazide
(38) Clofibrate	(88) Imipramine Pamoate
(39) Ethynodiol Diacetate	(89) Methyl Phenidate
(40) Insulin Isophane	(90) Nitroglycerin
(41) Phenylpropanolamine	(91) Albumin, Normal Human Serum
(42) Diphenoxylate	(92) Cyclandelate
(43) Prochlorperazine	(93) Dicyclomine
(44) Isoxsuprine	(94) Enflurane
(45) Clorazepate	(95) Erythromycin Ethyl Succinate
(46) Diphenyl Hydantoin (Phenytoin)	(96) Minocycline
(47) Haloperidol	(97) Carbenicillin Disodium
(48) Dihydroergocornine	(98) Hydroxyzine
(49) Chlorothiazide	(99) Tobramycin Sulfate
(50) Trifluoperazine	(100) Meprobamate

This data courtesy of IMS, Inc.; interpreted by M. Sittig.

The top four items on the list each had sales over \$100 million; by coincidence the cutoff point at the end of the 100 top generic products was at the \$10 million sales level; the total sales of the 100 products listed was about \$3 billion. Of this total, some \$600 million was in anti-infective products (penicillins, antibiotics, sulfa drugs, etc.), some \$500 million in tranquilizers and some \$400 million in cardiovascular drugs. These three categories represented half the dollar total of the top 100 drugs sold in the U.S. Other major drug market areas are in antiarthritic drugs and antiulcer drugs.

Now, for this second edition, an attempt was made to list the top prescription drugs in the U.S. as of 1985—some ten years later than the earlier tabulation. This new listing was done by the author based on his interpretation of the sales list by trade name in the magazine *American Druggist* for February 1986; it gives approximate rank by generic product as of the date of manuscript preparation in 1986. See Table 2.

Table 2: The Top 100 Generic Pharmaceuticals in the U.S. in 1985

(1) Hydrochlorothiazide	(51) Temazepam
(2) Triamterene	(52) Diphenhydramine
(3) Propranolol	(53) Captopril
(4) Digoxin	(54) Dipyridamole
(5) Norethindrone	(55) Nitroglycerin
(6) Ethinyl Estradiol	(56) Isosorbide Dinitrate
(7) Diazepam	(57) Polymyxin B
(8) Acetaminophen	(58) Neomycin
(9) Amoxicillin	(59) Bacitracin
(10) Cimetidine	(60) Amiloride
(11) Furosemide	(61) Butalbital
(12) Propoxyphene	(62) Liothyronine
(13) Ibuprofen	(63) Cyclobenzaprine
(14) Estrogens, Conjugated	(64) Oxycodone
(15) Atenolol	(65) Warfarin Sodium
(16) Cephalixin	(66) Guaifenesin
(17) Norgestrel	(67) Phenylpropanolamine
(18) Methyldopa	(68) Methoxyprogesterone Acetate
(19) Levothyroxine	(69) Nicotine Polacrilex
(20) Metoprolol	(70) Allopurinol
(21) Theophylline	(71) Phenobarbital
(22) Alprazolam	(72) Doxepin
(23) Potassium Chloride	(73) Metoclopramide
(24) Phenytoin	(74) Chlorothalidone
(25) Lorazepam	(75) Aspirin
(26) Naproxen	(76) Erythromycin Stearate
(27) Erythromycin Ethyl Succinate	(77) Haloperidol
(28) Miconazole Nitrate	(78) Trimethoprim
(29) Nifedipine	(79) Sulfamethoxazole
(30) Piroxicam	(80) Tetracycline
(31) Ranitidine	(81) Clotrimazole
(32) Timolol Maleate	(82) Amitriptyline
(33) Prazosin Hydrochloride	(83) Perphenazine
(34) Cefaclor	(84) Ampicillin
(35) Chlorpropamide	(85) Tolazamide
(36) Mestranol	(86) Diflunisal
(37) Flurazepam	(87) Nitrofurantoin
(38) Indomethacin	(88) Thoridazine
(39) Penicillin V	(89) Promethazine
(40) Chlorazepate	(90) Fluocinonide
(41) Triazolam	(91) Carbamazepine
(42) Diltiazem	(92) Terbutaline
(43) Clonidine Hydrochloride	(93) Trazodone
(44) Albuterol	(94) Betamethasone Valerate
(45) Erythromycin	(95) Hydrocodone Bitartrate
(46) Levonorgestrel	(96) Fenopropfen
(47) Nadolol	(97) Hydroxyzine
(48) Sulindac	(98) Tolmetin Sodium
(49) Metaproterenol	(99) Meclizine
(50) Ethynodiol Diacetate	(100) Acyclovir

TRENDS IN PATENT EXPIRATION

It has been estimated that patents on the top 100 drugs in the U.S. market will expire in the period between 1973 and 1990.

This will help to lead to a situation where generically-designated drugs are expected to account for 40% of the prescription drug market by 1990.

BIBLIOGRAPHY

1. Windholz, M., editor, *The Merck Index*, 10th edition, Rahway, NJ, Merck & Co., Inc. (1983).
2. Prous, J.R., editor, *Drugs of the Future*, Provenza 385-87, Barcelona-13, Spain.
3. Prous, J.R., editor, *Drugs of Today*, Provenza 385-87, Barcelona-13, Spain.
4. Kleeman, A. and Engel, J., *Pharmazeutische Werkstoffe: Synthesen, Patente, Anwendungen*, Stuttgart, Germany, Georg Thieme Verlag (1982).
5. Lednicher, D. and Mitscher, L., *The Organic Chemistry of Drug Synthesis*, New York, John Wiley and Sons, Vol. 1 (1977); Vol. 2 (1980); Vol. 3 (1984).
6. Philadelphia College of Pharmacy and Science, *Remington's Pharmaceutical Sciences*, Easton, PA, Mack Publishing Co., 17th edition (1985).
7. Paul de Haen International, Inc., *Nonproprietary Name Index*, Englewood, CO, Paul de Haen International, Inc., 15th edition (1984).
8. H.P. Jasperson et al, editors, *Index Nominum*, Zurich, Switzerland, Swiss Pharmaceutical Society (1984).
9. Barnhart, E.R., editor, *Physicians Desk Reference*, Oradell, NJ, Medical Economics Co., Inc., 40th edition (1986).
10. Sittig, M., *Pharmaceutical Manufacturing Encyclopedia*, Park Ridge, NJ, Noyes Data Corp. (1979)
11. Sittig, M., *Manufacturing Processes for New Pharmaceuticals*, Park Ridge, NJ, Noyes Publications (1983).
12. Sittig, M., *Veterinary Drug Manufacturing Encyclopedia*, Park Ridge, NJ, Noyes Publications (1981).

A

ACEBUTOLOL

Therapeutic Function: Cardiovascular beta-blocker

Chemical Name: N-[3-acetyl-4-[2-hydroxy-3-[(1-methylethyl)-amino]propoxy]phenyl]butanamide

Common Name: —

Structural Formula:

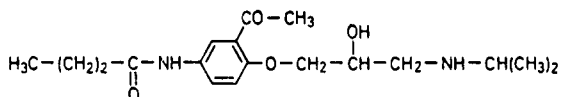

Chemical Abstracts Registry No.: 37517-30-9; 34381-68-5 (Hydrochloride)

Trade Name	Manufacturer	Country	Year Introduced
Sectral	May & Baker	UK	1975
Sectral	Specia	France	1976
Prent	Bayer	W. Germany	1977
Neptall	Rhodia Pharma	W. Germany	1977
Sectral	May & Baker	Switzerland	1980
Sectral	Roger Bellon	Italy	1980
Sectral	RBJ Pharma	Italy	1980
Acetanol	Kanebo	Japan	1981
Prent	Bayer	Italy	1981
Acecor	S.P.A.	Italy	—
Diasectral	Rhone Poulenc	—	—
Neptal	Rohm Pharma	—	—
Secradex	May & Baker	U.K.	—
Sectral	Wyeth	U.S.	—

Raw Materials

Butyramidophenol	Epichlorohydrin
Acetyl Chloride	Sodium Ethoxide
Aluminum Chloride	Isopropylamine

Manufacturing Process

Crude 5'-butyramido-2'-(2,3-epoxypropoxy)acetophenone (16 g), isopropylamine (20 g) and ethanol (100 ml) were heated together under reflux for 4 hours. The reaction mixture was concentrated under reduced pressure and the residual oil was dissolved in N hydrochloric acid. The acid solution was extracted with ethyl acetate, the ethyl acetate layers being discarded. The acidic solution was brought to pH 11 with 2 N aqueous sodium hydroxide solution and then extracted with chloroform. The dried chloroform extracts were concentrated under re-

duced pressure to give an oil which was crystallized from a mixture of ethanol and diethyl ether to give 5'-butyramido-2'-(2-hydroxy-3-isopropylaminopropoxy)acetophenone (3 g), MP 119°-123°C.

Crude 5'-butyramido-2'-(2,3-epoxypropoxy)acetophenone used as starting material was prepared as follows: p-butyramidophenol (58 g; prepared according to Fierz-David and Kuster, *Helv. Chim. Acta* 1939, 2282), acetyl chloride (25.4 g) and benzene (500 ml) were heated together under reflux until a solution formed (12 hours). This solution was cooled and treated with water. The benzene layer was separated and the aqueous layer was again extracted with benzene.

The combined benzene extracts were dried and evaporated to dryness under reduced pressure to give p-butyramidophenyl acetate (38 g) as an off-white solid, MP 102°-103°C. A mixture of p-butyramidophenyl acetate (38 g), aluminum chloride (80 g) and 1,1,2,2-tetrachloroethane (250 ml) was heated at 140°C for 3 hours. The reaction mixture was cooled and treated with iced water. The tetrachloroethane layer was separated and the aqueous layer was extracted with chloroform. The combined organic layers were extracted with 2N aqueous sodium hydroxide and the alkaline solution was acidified to pH 5 with concentrated hydrochloric acid. The acidified solution was extracted with chloroform and the chloroform extract was dried and concentrated under reduced pressure to give 5'-butyramido-2'-hydroxyacetophenone (15.6 g), MP 114°-117°C. A solution of 5'-butyramido-2'-hydroxyacetophenone (15.6 g) in ethanol (100 ml) was added to an ethanolic solution of sodium ethoxide which was prepared from sodium (1.62 g) and ethanol (100 ml). The resulting solution was evaporated to dryness under reduced pressure and dimethylformamide (100 ml) was added to the solid residue. Approximately 10 ml of dimethylformamide was removed by distillation under reduced pressure. Epichlorohydrin (25 ml) was added and the solution was heated at 100°C for 4 hours. The solution was concentrated under reduced pressure to give a residual oil which was treated with water to give a solid. The solid was dissolved in ethanol and the resulting solution was treated with charcoal, filtered and concentrated under reduced pressure to give crude 5'-butyramido-2'-(2,3-epoxypropoxy)acetophenone (16 g), MP 110°-116°C.

The crude compound may be purified by recrystallization from ethyl acetate, after treatment with decolorizing charcoal, to give pure 5'-butyramido-2'-(2,3-epoxypropoxy)acetophenone, MP 136°-138°C.

References

- Merck Index 13
- Kleeman & Engel p. 1
- PDR p. 1978
- OCDS Vol. 2 p. 109 (1980)
- DOT 11 (7) p. 264 (1975)
- I.N. p. 2
- Wooldridge, K.R.H. and Basil, B.; U.S. Patent 3,857,952; Dec. 31, 1974; assigned to May & Baker, Ltd.

ACECLIDINE

Therapeutic Function: Miotic, cholinomimetic

Chemical Name: 1-Azabicyclo[2.2.2]octan-3-ol acetate

Common Name: 3-Quinuclidinol Acetate

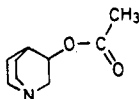
Structural Formula:

Chemical Abstracts Registry No.: 827-61-2; 6109-70-2 (Hydrochloride)

Trade Name	Manufacturer	Country	Year Introduced
Glacostat	MSD-Chibret	France	1966
Glaunorm	Farmigea	Italy	1969
Glaudin	SIFI	Italy	—

Raw Materials

Methyl Isonicotinate	Potassium Metal
Ethyl Bromoacetate	Hydrogen

Manufacturing Process

A mixture of 274 g of methyl isonicotinate, 367 g of ethyl bromoacetate and 125 cc of ethyl alcohol was stirred without heating for 4 hours in a flask equipped with a reflux condenser. (The reaction was exothermic and precautions were taken to keep the temperature below 70°C.) The reaction mixture was then left for 15 hours at room temperature.

The reaction product (1-carbethoxymethyl-4-carbomethoxy-pyridinium bromide) was obtained in crystalline form. (It formed prisms melting at 166°-169°C after recrystallization from a mixture of isopropanol and acetone.) It was not necessary to isolate it. For the following reduction step, the reaction mixture was brought into solution by the addition of about 1 liter of warm ethyl alcohol. It was then hydrogenated at about 30 atm pressure in the presence of 2 g of platinum oxide. The temperature rose during this reaction to about 40°C. After the calculated amount of hydrogen had been absorbed, the catalyst was filtered off, the solution was concentrated in vacuo, and the residual syrup was dissolved in ice water. Benzene was added and the mixture was made alkaline with an excess of concentrated ice cold potassium carbonate solution. The temperature was kept low by continuous addition of ice, and the benzene layer was separated and dried with sodium sulfate. The dried benzene solution was concentrated in vacuo and the residual oil was distilled in vacuo. BP 30 mm = 175°-182°C, $n_D^{25} = 1.4613-1.4628$. During the reduction, partial alcoholysis occurred, and the product isolated was 1-carbethoxymethyl-4-"carbalkoxy"-piperidine, wherein "carbalkoxy" represents a mixture of carbomethoxy and carbethoxy.

100 g of potassium were pulverized in 200 cc of hot toluene in a heated three-neck flask equipped with an efficient condenser, stirrer and dropping funnel. To the refluxing potassium suspension were added in small portions 229 g of the product of the previous step and about 700 cc of toluene. This addition had to be carried out very cautiously; the onset of the exothermic reaction is sometimes delayed. The addition was finished in about 1 hour. To complete the reaction, the refluxing and stirring were continued for about 4 hours. The reaction mixture was then cooled to about +5°C and about 50 cc isopropanol were added to decompose unreacted potassium. Then 2.5 liters of concentrated hydrochloric acid were added and the mixture was refluxed for 15 hours, and then concentrated in vacuo to dryness. To the residue was added with cooling an excess of 50% potassium hydroxide. Ether was then added and the resulting mixture was filtered through a fritted glass funnel, thus removing the precipitated potassium chloride. The ethereal and aqueous layers were separated, and the aqueous layer was extracted repeatedly with 500 cc portions of ether. The organic solutions were combined, dried over sodium sulfate and concentrated in vacuo. Aqueous hydrochloric acid was added to the residue until the solution became acid. The mixture was then diluted with distilled water to about 300 cc, heated with decolorizing charcoal, filtered and concentrated in vacuo to dryness. The residue was treated with isopropanol, and the precipitated crystalline product was filtered off. The product was recrystallized from a mixture of water and isopropanol and was

identified as 1-azabicyclo[2.2.2]-3-octanone hydrochloride; prisms, MP 311°-313°C, with decomposition.

A solution of 50 g of the above ketone-hydrochloride in 30 cc of water was made alkaline by the addition of 30 g of potassium hydroxide. After the alkali was dissolved, 35 g of granular potassium carbonate were added. The free basic ketone was then extracted from the viscous mixture by shaking with 4 portions of hot benzene (300 cc in each portion). The benzene extracts were decanted, filtered over sodium sulfate in order to remove any suspended alkali, and concentrated in vacuo. The residual 1-azabicyclo[2.2.2]-3-octanone was purified by sublimation (50°-70°C/0.5 mm Hg); it can also be purified by recrystallization from petroleum ether. It formed feathery crystals melting at 147°-148°C.

The product was reduced as follows:

A solution of 50 g of 1-azabicyclo[2.2.2]-3-octanone hydrochloride in 200 cc of water was hydrogenated at room temperature and 50 atm pressure with 1 g of platinum oxide as catalyst. After the calculated amount of hydrogen had been absorbed, the mixture was filtered and concentrated in vacuo to dryness. The residual product was recrystallized from a mixture of methanol and acetone and formed prisms melting above 300°C. It was identified as 1-azabicyclo[2.2.2]-3-octanol hydrochloride.

A solution of 50 g of 1-azabicyclo[2.2.2]-3-octanol hydrochloride in 30 cc water was made alkaline with 30 g of potassium hydroxide. After the alkali was dissolved 35 g of granular potassium carbonate were added. The free basic alcohol was then extracted from the viscous mixture by shaking with four portions of boiling benzene (300 cc in each portion). The benzene extracts were decanted and filtered over anhydrous sodium sulfate, to remove any suspended alkali. The combined benzene solutions were concentrated in vacuo. The residue was recrystallized from benzene and identified as 1-azabicyclo[2.2.2]-3-octanol, MP 221°-223°C. The product can also be purified by recrystallization from acetone, or by sublimation in vacuo (120°C/20 mm Hg). The alcohol was reacted with acetic anhydride to give the product aceclidine.

References

Kleeman & Engel p. 2

OCDS Vol. 2 p. 295 (1980)

I.N. p. 2

Sternbach, L.H.; U.S. Patent 2,648,667; Aug. 11, 1953; assigned to Hoffman-La Roche Inc.

ACEGLUTAMIDE ALUMINUM

Therapeutic Function: Antiulcer (free base as psychostimulant)

Chemical Name: Pentakis(N²-acetyl-L-glutaminato)tetrahydroxytrialuminum

Common Name: —

Structural Formula:

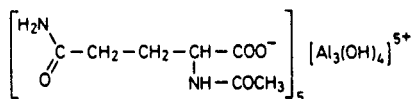

Chemical Abstracts Registry No.: 12607-92-0

Trade Name	Manufacturer	Country	Year Introduced
Glumal	Kyowa Hakko	Japan	1978
Glumal	Liade	Spain	-

Raw Materials

N-Acetyl-L-Glutamine
Aluminum Isopropoxide

Manufacturing Process

A mixture of 37.6 g of N-acetyl-L-glutamine and 1,000 ml of water is heated to 40°C, and 900 ml of an isopropanol solution containing 40.8 g of aluminum isopropoxide is added to the warm mixture with stirring. The stirring is continued for 10 minutes. The reaction mixture is filtered and the filtrate is concentrated under reduced pressure. Isopropanol is added to the aqueous solution and the salt precipitates in the solution. The precipitates are collected by filtration and upon drying, 48.5 g of the crystalline-like aluminum salt of N-acetyl-L-glutamine are obtained.

References

Merck Index 20

Kleeman & Engel p. 32

DOT 14 (2) p. 54 (1978)

I.N. p. 3

Kagawa, T., Fuji, K., Tanaka, M. and Tanaka, H.; U.S. Patent 3,787,466; Jan. 22, 1974; assigned to Kyowa Hakko Kogyo Co., Ltd.

ACEMETACIN

Therapeutic Function: Antiinflammatory

Chemical Name: 1-(p-Chlorobenzoyl)-5-methoxy-2-methylindole-3-acetoxyacetic acid

Common Name: -

Structural Formula:

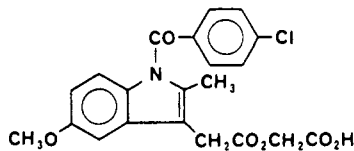

Chemical Abstracts Registry No.: 53164-05-9

Trade Name	Manufacturer	Country	Year Introduced
Rantudil	Bayer	W. Germany	1980
Rantudil	Tropon	W. Germany	-

Raw Materials

N-(p-Methoxybenzyl)-p-Chlorobenzhydrazide HCl
Benzyl Levulinoyloxyacetate
Hydrogen

Manufacturing Process

25.4 g (0.050 mol) of [1-(p-chlorobenzoyl)-5-methoxy-2-methyl-3-indoleacetoxy]-benzyl acetate were dissolved in 400 ml of glacial acetic acid and hydrogenated on 2.0 g of palladium carbon at room temperature. After the absorption of hydrogen had finished (1 hour), the catalyst was filtered off, the filtrate was concentrated by evaporation under vacuum and the compound was caused to crystallize by adding petroleum ether. The compound melted at 149.5°-150.5°C (determined on the micro-Kofler bench); the yield was 19.4 g which corresponds to 93% of the theoretical yield.

The starting material for the above step may be prepared as follows: 5 g (0.016 mol) of N¹-(p-methoxyphenyl)-p-chlorobenzhydrazide hydrochloride and 4.75 g (0.018 mol) of benzyl levulinoyloxyacetate were heated in 25 ml of glacial acetic acid for 3 hours at 80°C. The solvent was then evaporated off under vacuum. The residue was taken up in chloroform and the solution was washed neutral by shaking with sodium bicarbonate solution and thereafter with water. After drying the chloroform solution, this was subjected to chromatography on aluminium oxide, the eluate was concentrated by evaporation and the viscous oil remaining as residue was crystallized by adding ether. The compound melted at 94°-95°C. The yield was 4.1 g which corresponds to 50.7% of the theoretical yield.

References

Merck Index 21

DFU 2 (7) p. 423 (1977)

Kleeman & Engel p. 3

DOT 17 (7) p. 279 (1981)

I.N. p. 3

Boltze, K.H., Brendler, O., Dell, H.D. and Jacobi, H.; U.S. Patent 3,910,952; October 7, 1945; assigned to Tropenwerke Dinklage and Co.

Boltze, K.H., Brendler, O., Dell, H.D. and Jacobi, H.; U.S. Patent 3,966,956; June 29, 1976; assigned to Tropenwerke Dinklage and Co.

ACENOCOUMAROL (ACENOCOUMARIN)

Therapeutic Function: Anticoagulant, Vitamin K antagonist

Chemical Name: 3-(α -acetonyl-p-nitrobenzyl)-4-hydroxycoumarin

Common Name: Nicoumalone

Structural Formula:

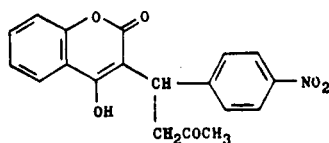

Chemical Abstracts Registry No.: 152-72-7

Trade Name	Manufacturer	Country	Year Introduced
Sintrom	Geigy	U.S.	1957
Sintrom	Geigy	W. Germany	—
Sintrom	Ciba Geigy	Switz.	—
Sintrom	Ciba-Geigy	France	1959

Trade Name	Manufacturer	Country	Year Introduced
Neo-Sintrom	Geigy	—	—
Ascumar	Star	Finland	—
Syncumar	Egyt	Hungary	—
Synthrome	Geigy	U.K.	—
Sintrom	Ciba-Geigy- Fujisawa	Japan	—

Raw Materials

4-Hydroxycoumarin
Nitrobenzalacetone

Manufacturing Process

16 parts of 4-hydroxycoumarin and 19 parts of 4-nitrobenzalacetone are thoroughly mixed and heated for 12-14 hours in an oil bath, the temperature of which is between 135° and 140°C. After cooling, the melt is dissolved in a little acetone. The solution is slowly added to a lye made up from 6 parts of sodium hydroxide in 400 parts of water while stirring and then the mixture is stirred for 30 minutes. A little animal charcoal is then added, the mixture is stirred for a further 15 minutes, 400 parts of water are added and the charcoal and undissolved components are separated by filtration under suction. The clear solution is made acid to Congo red paper with hydrochloric acid and the product which is precipitated is filtered off under suction. 3-[α -(4'-nitrophenyl)- β -acetyl ethyl]-4-hydroxycoumarin is obtained. MP 196°-199°C.

It should be noted that the process is akin to that for Warfarin except that 4-nitrobenzalacetone replaces benzalacetone as a raw material.

References

Merck Index 23

Kleeman & Engel p. 4

OCDS Vol. 1 p. 331 (1977)

I.N. p. 3

Stoll, W. and Litvan, F.; U.S. Patent 2,648,682; August 11, 1953; assigned to J.R. Geigy A.G., Switzerland.

ACETAMINOPHEN

Therapeutic Function: Analgesic, antipyretic

Chemical Name: N-(4-hydroxyphenyl)acetamide

Common Name: Paracetamol, Acetyl-p-Aminophenol, APAP

Structural Formula:

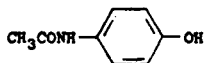

Chemical Abstracts Registry No.: 103-90-2

Trade Name	Manufacturer	Country	Year Introduced
—	—	Germany	1878

Trade Name	Manufacturer	Country	Year Introduced
Trigesic	Squibb	U.S.	1950
Apamide	Ames (Dome)	U.S.	1952
Nebis	Norwich (Eaton)	U.S.	1955
Tylenol	McNeil	U.S.	1955
Febrolin	Tilden Yates	U.S.	1957
Temptra	Mead Johnson	U.S.	1957
Fendon	Am. Pharm.	U.S.	1958
Amdil	Breon	U.S.	1958
Lyteca	Westerfield	U.S.	1962
Menalgesia	Clapp	U.S.	1963
Dial-Agesic	Borden	U.S.	1968
Tenlap	Dow	U.S.	1970
SK-APAP	SK&F	U.S.	1971
Valadol Tablets	Squibb	U.S.	1971
Tapar	Parke-Davis	U.S.	1974
Cen-Apap	Central	U.S.	1974
Acephen	G&W	U.S.	1978
St. Joseph Aspirin	St. Joseph	U.S.	1982
Panadol	Glenbrook	U.S.	1983
Pain & Fever	Lederle	U.S.	1983
Accu-Tap	Accu-Med	U.S.	—
Actamin	Buffington	U.S.	—
Aminofen	Dover	U.S.	—
Anuphen	Comatic	U.S.	—
Dapa	Ferndale	U.S.	—
Datril	Bristol-Myers	U.S.	—
Dirox	Winthrop	U.S.	—
Dolanex	Lannett	U.S.	—
Febrogestic	First Texas	U.S.	—
Halenol	Halsey	U.S.	—
Hedex	Winthrop	U.S.	—
Homoolan	Winthrop	U.S.	—
Injectapap	Johnson & Johnson	U.S.	—
Korum	Geneva	U.S.	—
Metalid	Philips-Roxane	U.S.	—
Minotal	Carnrick	U.S.	—
Neopap	Webcon	U.S.	—
Neotrend	Bristol-Myers	U.S.	—
Nilprin	AVP	U.S.	—
Panamax	Winthrop	U.S.	—
Panodil	Winthrop	U.S.	—
Parten	Parmed	U.S.	—
Phenaphen	Robins	U.S.	—
Phendex	Mallard	U.S.	—
Phrenilin	Carnrick	U.S.	—
Prompt	Delree	U.S.	—
Proval	Reid-Provident	U.S.	—
Robigesic	Robins	U.S.	—
Valorin	Otis Clapp	U.S.	—
Abrol	Rekah	Israel	—
Abrolet	Rekah	Israel	—
Acamol	Ikapharm	Israel	—
Acetalgin	Streuli	Switz.	—
Aldolor	Novis	Israel	—
Alpiny	SS Pharmaceut.	Japan	—
Alvedon	Draco	Sweden	—

Trade Name	Manufacturer	Country	Year Introduced
Anaflon	Duphar	U.K.	--
Anhiba	Hokuriku	Japan	--
APA/Aparacet	Arcana	Austria	--
Apiretal	Ern	Spain	--
Arasol	Horner	Canada	--
Benmyo	Heilmittelwerke	Austria	--
Ben-U-Ron	Benechemie	W. Germany	--
Calpol	Calmic	U.K.	--
Campain	Winthrop	Canada	--
Cetamol	Protea	Australia	--
Cetadol	Rybar	U.K.	--
Chemcetaphen	Chemo-Drug	Canada	--
Dipramat Infantil	Byk-Gulden	W. Germany	--
Dolamin	Nyal	Australia	--
Doliprane	Bottu	France	--
Dolprone	Siegfried	W. Germany	--
Dymadon	Calmic	U.K.	--
Efferalgan	UPSA	France	--
Enelfa	Dolorgiet	W. Germany	--
Exdol	Merck-Frosst	Canada	--
Febrilix	Boots	U.K.	--
Finimal	Mepros	Neth.	--
Finimal	Pharmaton	Switz.	--
Gelocatil	Gelos	Spain	--
Ildamol	Rekah	Israel	--
Kinder-Finiweh	Cesmopharma	Neth.	--
Kratofin	Kwizda	Austria	--
Labamol	Vitamed	Israel	--
Langesic	Boots	U.K.	--
Letamol	Letap	Switz.	--
Momentum	Much	W. Germany	--
Myalgin	Allied Labs	U.K.	--
Napional	Pharma Import	Austria	--
Nealgyl	Bottu	France	--
Nevral	Lepetit	Italy	--
Pacemo	Alpinapharm	Switz.	--
Pacet	Rekah	Israel	--
Painex	A.L.	Norway	--
Pamol	Marshall's Pharm.	U.K.	--
Panacete	Prosana	Australia	--
Panadol	Sterwin-Espanola	Spain	--
Panadon	Isis	Yugoslavia	--
Panasorb	Winthrop	U.K.	--
Panasorb	Bayer	W. Germany	--
Panok	B.M. Labs	U.K.	--
Pantalgin	UCB	Belgium	--
Paracet	Zdravljje	Yugoslavia	--
Paracet	Weifa	Norway	--
Paralgin	ICN	Canada	--
Paramol	Duncan Flockhart	U.K.	--
Paramolan	Trima	Israel	--
Parasin	Adams	Australia	--
Paraspen	Fisons	U.K.	--
Para-Suppo	Orion	Finland	--
Parmol	Knoll	Australia	--
Parol	Atabay	Turkey	--
Pasolind	Stada	W. Germany	--

Trade Name	Manufacturer	Country	Year Introduced
PCM	Napp	U.K.	—
Pediaphen	Ross	Canada	—
Phenipirin	Aksu	Turkey	—
Pinex	A.L.	Norway	—
Puernol	Formenti	Italy	—
Pyrinazin	Yamanouchi	Japan	—
Pyrital	Medica	Finland	—
Reliv	ACO	Sweden	—
Rivalgyl	Rivopharm	Switz.	—
Rounox	Rougier	Canada	—
Servigesic	Servipharm	Switz.	—
Setamol	Pharmacia	Sweden	—
Setol	Dif-Dogu	Turkey	—
Supramol	Sam-On	Israel	—
Tabalgin	Bayer	W. Germany	—
Tachipirina	Angelini	Italy	—
Temperal	Prodes	Spain	—
Trenodin	Fresenius	W. Germany	—
Tymol	Reckitt & Colman	W. Germany	—
Veralydon	Lelong	France	—

Raw Materials

Nitrobenzene
Acetic Anhydride

Manufacturing Process

About 250 ml of a reaction mixture obtained by the electrolytic reduction of nitrobenzene in sulfuric acid solution and containing about 23 grams of p-aminophenol by assay is neutralized while at a temperature of 60° to 65°C, to a pH of 4.5 with calcium carbonate. The calcium sulfate precipitate which forms is filtered off, the precipitate washed with hot water at about 65°C and the filtrate and wash water then combined. The solution is then extracted twice with 25 ml portions of benzene and the aqueous phase is treated with 0.5 part by weight, for each part of p-aminophenol present, of activated carbon and the latter filtered off. The activated carbon is regenerated by treatment with hot dilute caustic followed by a hot dilute acid wash, and reused a minimum of three times.

To the filtrate obtained, there are then added about 0.2 gram of sodium hydrosulfite or sodium sulfite and 15.0 grams of anhydrous sodium acetate in about 27 grams of acetic anhydride at 40°C. The reaction mixture formed is cooled to 8° to 10°C with stirring and held at this temperature for 60 minutes. A crystalline precipitate of about 27 grams of N-acetyl-p-aminophenol is obtained melting at 169°-171°C. This is equivalent to a yield of 85%.

In lieu of utilizing calcium carbonate as the neutralizing agent, calcium hydroxide, barium hydroxide, barium chloride or other alkaline earth metal salt or hydroxide forming an insoluble sulfate may be employed.

References

Merck Index 39
Kleeman & Engel p. 684
PDR p. Many References
OCDS Vol. 1 p. 111 (1977)
DOT 16 (2) p. 59 (1980)
I.N. p. 728
REM p. 1111

Wilbert, G. and De Angelis, J.; U.S. Patent 2,998,450; August 29, 1961; assigned to Warner-Lambert Pharmaceutical Company.

ACETAZOLAMIDE

Therapeutic Function: Carbonic anhydrase inhibitor, diuretic, treatment of glaucoma

Chemical Name: N-[5-(aminosulfonyl)-1,3,4-thiadiazol-2-yl]acetamide

Common Name: —

Structural Formula:

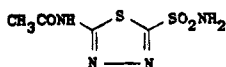

Chemical Abstracts Registry No.: 59-66-5

Trade Name	Manufacturer	Country	Year Introduced
Diamox	Lederle	U.S.	1953
Hydrazole	Softcon Products	U.S.	1975
Acetamide	Nessa	Spain	—
Acetamox	Santen	Japan	—
Acetazolam	ICN	Canada	—
Acetazolamide			
Chibret	Chibret	France	—
Albox	Kwizda	Austria	—
Atenezol	Tsuruhara	Japan	—
Defiltran	Jouveinal	France	—
Diazomid	Dif-Dogu	Turkey	—
Diamox	Theraplix	France	—
Didoc	Sawai	Japan	—
Diluran	Spofa	Czech.	—
Diuramid	Polfa	Poland	—
Diureticum-			
Holzinger	Holzinger	Austria	—
Diuriwas	Wassermann	Italy	—
Donmox	Hotta	Japan	—
Edemox	Wassermann	Spain	—
Glauconox	Llorens	Spain	—
Glaupax	Erco	Denmark	—
Glaupax	Baeschlin	W. Germany	—
Glaupax	Dispersa	Switz.	—
Inidrase	Omikron-Gagliardi	Italy	—
Nephramid	Chemiek	E. Germany	—
Oedemin	Astra	Sweden	—
Renamid	Pliva	Yugoslavia	—
Uramox	Taro	Israel	—
Zohnox	Konto	Japan	—

Raw Materials

Hydrazine Hydrate	Chlorine
Ammonium Thiocyanate	Ammonia
Acetic Anhydride	Bromine

Manufacturing Process

According to REM, hydrazine hydrate is reacted with 2 mols of ammonium thiocyanate to produce 1,2-bis(thiocarbamoyl)hydrazine which by loss of ammonia and rearrangement produces 5-amino-2-mercapto-1,3,4-thiadiazole. That compound is acetylated with acetic anhydride.

Then, as described in U.S. Patent 2,554,816, the 2-acetylamido-5-mercapto-1,3,4-thiadiazole is converted to the sulfonyl chloride by passing chlorine gas into a cooled (5°-10°C) solution in 33% acetic acid (66 parts to 4 parts of mercapto compound) used as a reaction medium. Chlorine treatment is continued for two hours. The crude product can be dried and purified by recrystallization from ethylene chloride. The pure compound is a white crystalline solid, MP 194°C, with decomposition, when heated rapidly. The crude damp sulfonyl chloride is converted to the sulfonamide by addition to a large excess of liquid ammonia. The product is purified by recrystallization from water. The pure compound is a white, crystalline solid, MP 259°C, with decomposition. The yield of sulfonamide was 85% of theory based on mercapto compound.

An alternative process is described in U.S. Patent 2,980,679 as follows. 15 grams of finely powdered 2-acetylamino-1,3,4-thiadiazole-5-mercaptain are suspended in 200 ml of water containing 4 grams of potassium bromide. From 0.5 to 1 gram of ferric chloride are subsequently added. The mass is energetically stirred and 52 grams of liquid bromide are added by increments for about 45 minutes, while keeping the reaction temperature below 10°C, and, preferably, at 4°-8°C by employing a cooling bath. Stirring is continued for a further 10 minutes, then the 2-acetylamino-1,3,4-thiadiazole-5-sulfobromide is collected on a funnel equipped with a porous diaphragm, thoroughly washed with cold water and finally subjected to amidation with liquid ammonia. The reaction mixture is allowed to stand for a certain period, then the ammonia is evaporated, after which the residue is taken up with diluted ammonia and, after decolorizing with carbon, the sulfonamide is precipitated with hydrochloric acid. The yield of crude sulfonamide obtained with this process, with respect to the starting mercapto compound is about 84%. If the amidation is carried out with 33% aqueous ammonia, the yield is slightly lower.

References

Merck Index 45

Kleeman & Engel p. 6

PDR pp. 830, 1008, 1606

OCDS Vol 1 p. 249 (1977)

I.N. p. 5

REM p. 936

Clapp, J.W. and Roblin, R.O., Jr.; U.S. Patent 2,554,816; May 29, 1951; assigned to American Cyanamid Company.

Gianfranco, P.; U.S. Patent 2,980,679; April 18, 1961; assigned to Omikron-Gagliardi Societa di Fatto, Italy.

ACETOHEXAMIDE

Therapeutic Function: Hypoglycemic

Chemical Name: 1-[(p-acetylphenyl)sulfonyl]-3-cyclohexylurea

Common Name: Cyclamide

Structural Formula:

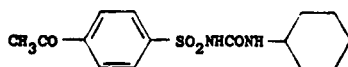

Chemical Abstracts Registry No.: 968-81-0

Trade Name	Manufacturer	Country	Year Introduced
Dymelor	Lilly	U.S.	1964
Dimelin	Shionogi	Japan	—
Dimelor	Lilly	U.K.	—
Gamadiabet	Salvat	Spain	—
Metaglutina	Perga	Spain	—
Ordimel	Lilly	Spain	—

Raw Materials

p-Aminoacetophenone	Sulfur Dioxide
Sodium Nitrite	Ammonia
Hydrogen Chloride	Cyclohexyl Isocyanate

Manufacturing Process

Preparation of p-Acetylbenzenesulfonamide: 100 grams of p-aminoacetophenone were dissolved in a solvent mixture containing 165 ml of 12 N hydrochloric acid and 165 ml of glacial acetic acid. The mixture was cooled with stirring to about 0°C. A solution containing 56.2 grams of sodium nitrite and 175 ml of water was added dropwise with stirring to the acidic solution while maintaining the temperature below 5°C.

After the addition had been completed, the acidic solution containing p-acetylphenyldiazonium chloride formed in the above reaction was added dropwise with stirring to a mixture of 530 ml of glacial acetic acid and 530 ml of benzene which had been previously cooled, and the cooled solution saturated with sulfur dioxide and to which had been added 34 g of cupric chloride dihydrate. After the addition had been completed, the reaction mixture was stirred at about 40°C for three hours, and was then poured into 3,000 ml of an ice-water mixture.

The benzene layer containing p-acetylbenzenesulfonyl chloride formed in the above reaction was separated, and the acidic aqueous phase was extracted twice with 250 ml portions of benzene. The benzene layers were combined, the combined extracts were filtered, and the benzene was evaporated from the resulting filtrate in vacuo.

The solid residue comprising p-acetylbenzenesulfonyl chloride was dissolved in 100 ml of dioxane, and the solution was added to 200 ml of 14% aqueous ammonium hydroxide. The resulting solution was stirred overnight at ambient room temperature. The p-acetylbenzenesulfonamide thus prepared was collected by filtration. Recrystallization of the filter cake from aqueous ethanol yielded purified p-acetylbenzenesulfonamide melting at about 176° to 179°C.

Preparation of N-p-Acetylphenylsulfonyl-N'-Cyclohexylurea: A reaction mixture consisting of 32.7 grams of p-acetylbenzenesulfonamide and 64 grams of anhydrous potassium carbonate in 350 ml of anhydrous acetone was stirred at refluxing temperature for about 1½ hours, thus forming the potassium salt of p-acetylbenzenesulfonamide. 30.9 grams of cyclohexylisocyanate were added dropwise to the reaction mixture. Refluxing and stirring were continued during the course of the addition and for an additional 16 hours.

The acetone was removed by evaporation in vacuo, and about 750 ml of water were added to dissolve the resulting residue. The solution was filtered. The potassium salt of N-p-acetylphenylsulfonyl-N'-cyclohexylurea formed in the above reaction, being water-soluble, passed into the filtrate. Acidification of the filtrate with 6 N aqueous hydrochloric acid caused the precipitation of N-p-acetylphenylsulfonyl-N'-cyclohexylurea which was collected by filtration. Recrystallization of the filter cake from 90% aqueous ethanol yielded purified N-p-acetylphenylsulfonyl-N'-cyclohexylurea melting at about 188°-190°C.

References

Merck Index 53

Kleeman & Engel p. 7

PDR p. 1049

OCDS Vol. 1 p. 138 (1977)

I.N. p. 6

REM p. 976

Sigal, M.V., Jr. and Van Arendonk, A.M.; U.S. Patent 3,320,312; May 16, 1967; assigned to Eli Lilly and Company.

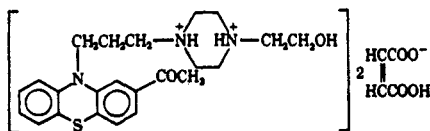
ACETOPHENAZINE DIMALEATE**Therapeutic Function:** Tranquilizer**Chemical Name:** 10-[3-[4-(2-hydroxyethyl)-1-piperazinyl]propyl]phenothiazin-2-yl methyl ketone maleate**Common Name:** —**Structural Formula:****Chemical Abstracts Registry No.:** 5714-00-1; 2751-68-0 (Acetophenazine)

Trade Name	Manufacturer	Country	Year Introduced
Tindal	Schering	U.S.	1961

Raw Materials

Sodium Amide	1-(2-Hydroxyethyl)piperazine
2-Acetylphenothiazine	Maleic Acid
1-Bromo-3-Chloropropane	

Manufacturing Process

The requisite intermediate, 10-(3-chloropropyl)-2-acetylphenothiazine is prepared as follows: To a suspension of sodamide (from 3 grams of sodium) in 300 ml of liquid ammonia is added 30 grams of 2-acetylphenothiazine. After stirring for one hour, there is added 19 grams of 1-bromo-3-chloropropane. The ammonia is allowed to evaporate and the residue is diluted with 200 ml of water. The mixture is extracted with ether and the ether solution is dried over anhydrous sodium sulfate, filtered and concentrated.

The residue consists of crude 10-(3-chloropropyl)-2-acetylphenothiazine as a viscous oil and is used in the next step without further purification. The crude base obtained from the reaction of 10-(3-chloropropyl)-2-acetylphenothiazine with 1-(2-hydroxyethyl)piperazine is purified by conversion to its dimaleate salt, MP 167°-168.5° from ethanol.

References

Merck Index 64

Kleeman & Engel p. 7

OCDS Vol. 1 p. 383 (1977)

I.N. p. 6

REM p. 1086

Sherlock, M.H. and Sperber, N.; U.S. Patent 2,985,654; May 23, 1961; assigned to Schering Corporation.

ACETOXOLONE ALUMINUM SALT

Therapeutic Function: Antiulcerative

Chemical Name: 3-(acetyloxy)-11-oxoolean-12-en-29-oic acid aluminum salt

Common Name: —

Structural Formula:

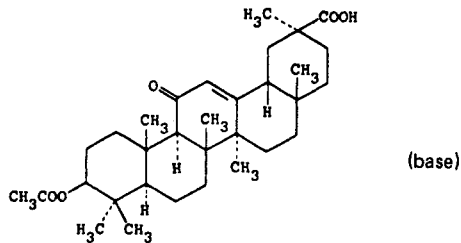

Chemical Abstracts Registry No.: 6277-14-1 (Base)

Trade Name	Manufacturer	Country	Year Introduced
Oriens	Inverni Beffa	Italy	1981

Raw Materials

3-Acetyl-18 β -glycyrhethinic Acid
Aluminum Alcoholate

Manufacturing Process

The salts of 3-acetyl-18 β -glycyrhethinic acid can be prepared by reaction between 3-acetyl-18 β -glycyrhethinic acid and an aluminum alcoholate. Preferably lower alcoholates are used, i.e., alcoholates in which the alkoxy group or groups have from one to four carbon atoms. The salification reaction may be carried out at room temperature or at an elevated temperature in conventional fashion, preferably in the presence of organic solvents. As organic solvents may be used alcohols, ethers, ketones, chlorinated solvents (methylene chloride, chloroform) ethyl acetate, etc.

References

Merck Index 70

Bonati, A.; U.S. Patent 3,764,618; October 9, 1973; assigned to Dott. Inverni & Della Befia S.p.A.

ACETRIZOATE SODIUM

Therapeutic Function: X-ray contrast medium

Chemical Name: 3-(Acetylamino)-2,4,6-triiodobenzoic acid sodium salt

Common Name: —

Structural Formula:

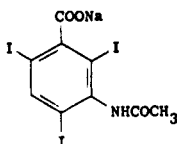

Chemical Abstracts Registry No.: 129-63-5

Trade Name	Manufacturer	Country	Year Introduced
Urokon Sodium	Mallinckrodt	U.S.	1950
Thixokon	Mallinckrodt	U.S.	1957
Cystokon	Mallinckrodt	U.S.	1964
Pyelokon-R	Mallinckrodt	U.S.	—
Salpix	Ortho	U.S.	—
Diaginol	May & Baker	U.K.	—
Diaginol	Banyu	Japan	—
Vasurix	Guerbet	France	—
Fortombrin	Dagra	Neth.	—
Iodopaque	Labaz	Switz.	—
Triurol	Lundbeck	Denmark	—

Raw Materials

3-Amino-2,4,6-triiodobenzoic Acid
Acetic Anhydride
Sodium Hydroxide

Manufacturing Process

3-amino-2,4,6-triiodobenzoic acid (51.5 g) was mixed with 125 ml of acetic anhydride containing 2 drops of concentrated sulfuric acid and refluxed for thirty minutes. The mixture was allowed to cool slightly, and then was poured into 600 ml of water at room temperature and stirred until crystallization was complete. The mixed anhydride of 3-acetylamino-2,4,6-triiodobenzoic acid with acetic acid thus prepared was then separated by filtration and washed with water. Without drying, the solid was suspended in 600 ml of water and hydrolyzed with a slight excess of ammonium hydroxide. It was necessary to warm the mixture slightly and stir it for about one-half hour in order to dissolve all the solid. The solution was then treated with activated carbon, filtered and precipitated with an excess of hydrochloric acid, filtered, washed and dried at 70°C. The yield was 51.5 g of 3-acetylamino-2,4,6-triiodobenzoic acid which melted at 276.6°–278.2°C with decomposition when placed in the melting block at 260°C and heated at the rate of 3°C per minute. Due to decomposition, the melting point varied from about 269°–280°C, depending upon the rate of heating and other conditions.

3-acetylamino-2,4,6-triiodobenzoic acid (28 g) was dissolved in a little over 50 ml of 1 N sodium hydroxide in a round-bottom flask. The pH was adjusted to slightly over 7 and the solution was evaporated on a steam bath under reduced pressure. After the residue became solid, it was further dried overnight in a vacuum desiccator containing calcium chloride. The salt weighed 31.2 g, theory being 29.0 g, indicating that the product contains about 7% water

of crystallization when dried under these conditions. The finished salt was scraped from the flask and ground.

References

Merck Index 73

Kleeman & Engel p. 8

I.N. p.7

Wallingford, V.H.; U.S. Patent 2,611,786; September 23, 1952; assigned to Mallinckrodt Chemical Works.

ACETYLCYSTEINE

Therapeutic Function: Expectorant

Chemical Name: N-acetyl-L-cysteine

Common Name: —

Structural Formula:

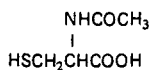

Chemical Abstracts Registry No.: 616-91-1

Trade Name	Manufacturer	Country	Year Introduced
Mucomyst	Mead Johnson	U.S.	1963
Acetein	Senju	Japan	—
Airbron	BDH	U.K.	—
Broncholysin	Spofa	Czech.	—
Brunac	Bruschettini	Italy	—
Fabrol	Ciba	—	—
Fluimucetin	Zambon	Italy	—
Fluimucetin	Inpharzam	Belgium	—
Fluimucil	Zambon	Italy	—
Inspir	Vitrum	Sweden	—
Mucolyticum	Lappe	W. Germany	—
Mucosolvin	VEB Berlin-Chemie	E. Germany	—
NAC	Mead Johnson	—	—
Parvolex	Duncan Flockhart	U.K.	—
Mucomist	Bristol	Italy	—
Mucisol	Deca	Italy	—
Rinofluimucil	Inpharzam	W. Germany	—
A.R.B.	Tokyo Tanabe	Japan	—
Mucofilin	Eisai	Japan	—

Raw Materials

L-Cysteine HCl

Acetic Anhydride

Manufacturing Process

To a suspension of 35.2 grams (0.2 mol) of L-cysteine hydrochloride monohydrate stirred in a reaction vessel containing 87 ml of 91% aqueous tetrahydrofuran under a nitrogen

atmosphere there is added 54.4 grams (0.4 mol) of sodium acetate trihydrate. The mixture is stirred for 20 minutes at room temperature to insure neutralization of the hydrochloride salt resulting in the formation of a suspension of equimolar amounts of cysteine and sodium acetate.

The mixture is then chilled to 3°-6°C by external cooling and 20 ml (20.8 grams, 0.21 mol) of acetic anhydride is added thereto in dropwise fashion with cooling in the above range. The resulting mobile suspension is stirred for 6 hours at room temperature, allowed to stand overnight, and finally heated at reflux (72°C) for 4 hours. The resulting suspension of sodium N-acetyl-L-cysteinate is then neutralized by treatment at 5°-10°C with 8 grams of hydrogen chloride. Resulting sodium chloride is removed by filtration and the product is isolated by distilling the solvent from the filtrate in vacuo and crystallizing the residue from 35 ml of water, yield 26.3 grams (80.6%) of N-acetylcysteine as a white solid, MP 109°-110°C.

References

Merck Index 82

Kleeman & Engel p. 8

PDR p. 1126

DOT 16 (2) p. 42 (1980)

I.N. p. 8

REM p. 867

Martin, T.A. and Waller, C.W.; U.S. Patent 3,184,505; May 18, 1965; assigned to Mead Johnson & Company.

ACETYLDIGITOXIN

Therapeutic Function: Cardiotonic

Chemical Name: See structural formula

Common Name: Digitoxin monoacetate

Structural Formula:

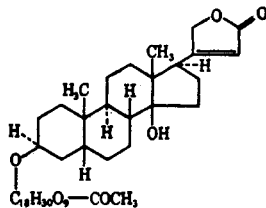

Chemical Abstracts Registry No.: 1111-39-3

Trade Name	Manufacturer	Country	Year Introduced
Acyanid	Sandoz	U.S.	1954
Acygoxine	Sandoz	France	1972
Acyanide	Sandoz	France	1954
Acyanil	—	—	—
Acyanid	Sandoz	Italy	1966
Sandolanid	Sandoz	W. Germany	1968

Raw Materials

Digitalis Ferruginea Leaves

Manufacturing Process

Acetyldigitoxin- α can be obtained from acetyldigitoxin- β by heating it in an anhydrous or aqueous organic solvent at neutral, weakly acid or weakly alkaline pH, i.e., at a pH range from about 3.5 to about 8.

The acetyldigitoxin- β used for this purpose is a cardiac glycoside which can be obtained either by splitting off the glucose residue from lanatoside A, or by extraction of the leaves of *Digitalis ferruginea*. It is composed of the aglycone digitoxigenin and 3 molecules of digitoxose, to one of which an acetyl group is attached. Acetyldigitoxin- α , obtained from acetyldigitoxin- β by rearrangement, differs from the latter in the position of the acetyl group.

The process may be carried out, for example, in the following manner: A solution of acetyldigitoxin- β in a suitable solvent, such as methanol, is boiled under reflux and then diluted with water. The unchanged acetyldigitoxin- β , which crystallizes out first, is filtered off and can again be submitted to the same process. On concentrating the filtrate, acetyldigitoxin- α separates out in crystalline form and after filtering off and recrystallizing is obtained in a pure state. The acetyldigitoxin- α crystallizes from aqueous methanol in platelets melting at 217°-221°C.

References

Merck Index 83

Kleeman & Engel p. 9

I.N. p. 8

Stoll, A. and Kreis, W.; U.S. Patent 2,776,963; January 8, 1957; assigned to Sandoz, AG, Switzerland.

ACETYL SULFOXAZOLE

Therapeutic Function: Antimicrobial

Chemical Name: N-[(4-aminophenyl)sulfonyl]-N-(3,4-dimethyl-5-isoxazolyl)sulfanilamide

Common Name: Acetylsulfafurazol

Structural Formula:

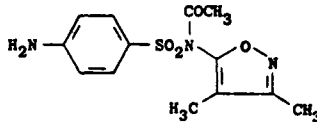

Chemical Abstracts Registry No.: 80-74-0

Trade Name	Manufacturer	Country	Year Introduced
Gantrisin Acetyl	Roche	U.S.	1954
Lipo-Gantrisin			
Acetyl	Roche	U.S.	1954
Pediazole	Ross	U.S.	—

Raw Materials

Sulfisoxazole
Acetic Anhydride

Manufacturing Process

267 grams (1 mol) of sulfisoxazole were suspended in 400 ml of acetone and 79 grams (1 mol) of dry pyridine at 20°-25°C in a round-bottom flask equipped with a stirrer and thermometer. 132 grams (1 mol) of acetic anhydride were added within 3 minutes with stirring. The sulfisoxazole dissolved in the mixture and a clear solution resulted. The temperature rose to 39°-40°C. After stirring for several minutes, the product started to crystallize as a white crystalline mush. The temperature rose to 42°-43°C, maintained itself at this temperature for 15-30 minutes, and then started to drop. Stirring was continued for 5 hours and the mixture was then allowed to stand for 10 hours. One liter of 2.5-3.0% ice-cold aqueous ammonia and some fresh ice were then added while stirring and the crystals were filtered without delay. The crystals were washed on the filter with 1 liter of ice-cold 1% ammonia and then with 1 liter of water. The material on the filter was well pressed off, washed with 200-300 ml of alcohol and dried at 70°C to constant weight. The N-mono-acetyl sulfisoxazole melted at 193°-194°C and showed a positive Bratton-Marshall reaction and a positive Hucknall-Turfat reaction.

The product is in the form of colorless crystals which are somewhat water repellent. It is insoluble in alkali but is saponified upon standing in alkaline suspension (3% ammonia). It is soluble in strong acids (20-36% HCl or 10 N H₂SO₄) and is rapidly saponified upon standing.

References

Merck Index 104

Kleeman & Engel p. 13

PDR pp. 1487, 1558

I.N. p. 10

Hoffer, Max; U.S. Patent 2,721,200; October 18, 1955; assigned to Hoffmann-La Roche Inc.

ACLARUBICIN

Therapeutic Function: Antitumor; antibiotic

Chemical Name: [1R-(1 α ,2 β ,4 β)]-2-Ethyl-1,2,3,4,6,11-hexahydro-2,5,7-trihydroxy-6,11-dioxo-4-[[O-2,3,6-trideoxy- α -L-glycero-hexopyranos-4-ulos-1-yl-(1 \rightarrow 4)-O-2,6-dideoxy- α -L-lyxohexopyranosyl-(1 \rightarrow 4)-2,3,6-trideoxy-3-(dimethylamino)- α -L-lyxohexopyranosyl]-oxy]-1-naphthacene-carboxylic acid methyl ester

Common Name: Aclacinomycin A

Structural Formula:

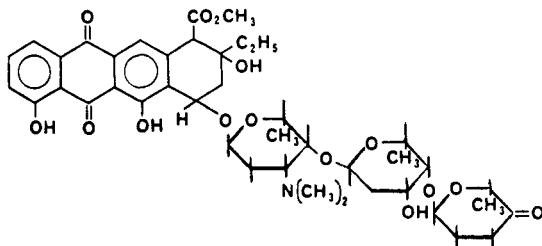

Chemical Abstracts Registry No.: —

Trade Name	Manufacturer	Country	Year Introduced
Aclacinon	Yamanouchi	Japan	1981
Aclacinomycine	Roger Bellon	France	1981

Raw Materials

Carbohydrates (By Fermentation)

Manufacturing Process

An aqueous medium having the following composition was prepared:

	Percent
Potato starch	1
Glucose	1
Prorich	1.5
KH ₂ PO ₄	0.1
K ₂ HPO ₄	0.1
MgSO ₄ ·7H ₂ O	0.1
NaCl	0.3
Minerals*	0.125
Silicone (KM75)	0.05
pH	7.0

*2.8 g CuSO₄·5H₂O, 0.4 g FeSO₄·7H₂O, 3.2 g MnCl₂·4H₂O,
0.8 g ZnSO₄·7H₂O in 500 ml water

100 ml of this medium was sterilized at 120°C for 15 min in a 500 ml Sakaguchi-shaking flask which was inoculated from an agar slant culture of *Streptomyces galilaeus* MA144-M1 by platinum loop. Incubation proceeded for 48 hr at 28°C on a reciprocal shaker. 10 l of the previously sterilized medium in a 20 l stainless steel jar fermenter were aseptically inoculated with 200 ml of the above seed cultures. Fermentation was carried out at 28°C for 32 hours with agitation (240 rpm) and aeration (5 l/min). The cultured broth obtained was adjusted to pH 4.5, mixed with an adsorbent siliceous earth material and filtered from the mycelium. The filtrate and cake obtained thereby were extracted separately. The cake was suspended in acetone (3 l/kg wet cake), stirred for 2 hr and filtered, and the cake was further extracted with acetone once again. The extracts thus obtained were evaporated to one-tenth volume in vacuo. The culture filtrate was adjusted to pH 6.8 and extracted twice with one-third volume of ethyl acetate, and the ethyl acetate extracts were concentrated to one-tenth volume in vacuo.

Twenty grams of the resulting oily substances were mixed with 20 grams of silicic acid (Malinckrodt Chemical Co.), applied to a column 40 cm in length and 4.5 cm in diameter filled with silicic acid, and eluted with a benzene-acetone-methanol mixture. The initial eluate which eluted with a 1:1:0 mixture was discarded and the active fractions eluted with 1:3:0 and 1:3:0.3 mixtures were collected and concentrated to dryness in vacuo. 11.5 g of this crude substance was then dissolved in a small amount of ethyl acetate and applied to the same silicic acid column as above. After discarding the initial eluates by the 1:1 and 2:1 benzene-acetone mixtures, aclacinomycin B fractions were first eluted with the above mixtures of 1:3 and 1:5 ratio, and aclacinomycin A fractions were then eluted with the 1:5:0.5 and 1:5:1 benzene-acetone-methanol mixtures. The eluates were dried over anhydrous sodium sulfate and concentrated to dryness in vacuo. 4.8 g of crude aclacinomycin A and 3.5 g of aclacinomycin B were obtained as yellow powder.

2.0 g of crude aclacinomycin A obtained as above were dissolved in a small amount of chloroform, applied to a column 20 cm in length and 20 cm in diameter filled with 30 g of silicic acid. After eluting off the pigments containing aglycone and aclacinomycin B and other impurities with chloroform and 1.5% methanol-containing chloroform, aclacinomycin A fractions

were eluted with 2% methanol-containing chloroform, and concentrated to dryness in vacuo. 53 mg of yellow powder of aclacinomycin A was obtained. Its melting point was 129° to 135°C.

References

DFU 2 (3) 171 (1978) (as Aclacinomycin A)

DOT 18 (10) 517 (1982)

I.N. p. 42 (1984)

Umezawa, H., Takeuchi, T., Hamada, M., Takamatsu, A. and Oki, T.; U.S. Patent 3,988,315; October 26, 1976; assigned to Zaidan Hojin Biseibutsu Kagaku Kenkyu Kai

ACLATONIUM NAPADISYLATE

Therapeutic Function: Cholinergic

Chemical Name: 2-[2-(Acetyloxy)-1-oxopropoxy]-N,N,N-trimethylethanaminium-1,5-naphthalenedisulfonate(2:1)

Common Name: Bis[Acetoxy-methyl acetic acid trimethylammoniummethyl ester]-naphthalene-1,5-disulfonate

Structural Formula:

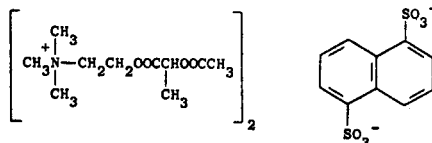

Chemical Abstracts Registry No.: 55077-30-0

Trade Name	Manufacturer	Country	Year Introduced
Abovis	Toyama	Japan	1981

Raw Materials

Bis(Choline)-Naphthalene-1,5-Disulfonate
Lactic Acid Anhydride Diacetate

Manufacturing Process

5.2 g of bis(choline)-naphthalene-1,5-disulfonate was suspended in 30 ml of acetonitrile, and 10 g of lactic acid anhydride diacetate was added thereto. This mixture was refluxed for 3 hours. The resulting reaction mixture was allowed to stand at room temperature while cooling to precipitate the desired product crystals, which were collected by filtration. 5.5 g (76% yield) of the desired product having a melting point of 189° to 191°C were obtained.

References

Merck Index 110

DFU 7 (4) 227 (1982)

DOT 19 (1) 8 (1983)

I.N. p. 42

Miura, K., Takagawa, N., Suzuki, Y. and Matsumoto, Y.; U.S. Patent 3,903,137; September 2, 1975; assigned to Toyama Chemical Co., Ltd.

ACYCLOVIR

Therapeutic Function: Antiviral

Chemical Name: 2-Amino-1,9-dihydro-9-[(2-hydroxyethoxy)methyl]-6H-purin-6-one

Common Name: Acycloguanosine; 9-(2-hydroxyethoxymethyl)guanine

Structural Formula:

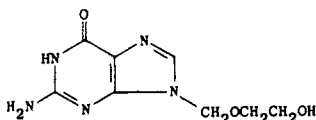

Chemical Abstracts Registry No.: 59277-89-3

Trade Name	Manufacturer	Country	Year Introduced
Zovirax	Burroughs-Wellcome	U.K.	1981
Zovirax	Burroughs-Wellcome	U.S.	1982
Zovirax	Burroughs-Wellcome	Switz.	1982
Zovirax	Burroughs-Wellcome	W. Germany	1983
Zovirax	Burroughs-Wellcome	Sweden	1983
Zovirax	Burroughs-Wellcome	France	1983

Raw Materials

Sodium Nitrite
2-Chloro-9-(2-Hydroxyethoxymethyl)adenine
Ammonia

Manufacturing Process

Solid sodium nitrite (0.97 g) was added at room temperature with stirring over a period of one hour to a solution of 2-chloro-9-(2-hydroxyethoxymethyl)adenine (0.5 g) in glacial acetic acid (10 ml). The reaction mixture was stirred for an additional 4½ hours. The white solid was removed by filtration, washed with cold acetic acid and then well triturated with cold water to remove the sodium acetate present. The solid product was retained. The combined acetic acid filtrate and wash was evaporated at reduced pressure and 40°C bath temperature and the residual oil triturated with cold water. The resulting solid material was combined with the previously isolated solid and the combined solids dried and recrystallized from ethanol to give 2-chloro-9-(2-hydroxyethoxymethyl)-hypoxanthine (0.25 g), MP>310°C. Elemental analysis and NMR spectrum were consistent with this structure.

A mixture of 2-chloro-9-(2-hydroxyethoxymethyl)-hypoxanthine (0.375 g) and methanol (80 ml) saturated with anhydrous ammonia was heated in a bomb at 125°C for 5 hours. The bomb was cooled in an ice bath and the reaction mixture removed. Solvent and excess ammonia were removed under reduced pressure at 50°C. After the residue was triturated with cold water to remove the ammonium chloride formed, the remaining solid was dried and then recrystallized from methanol to give pure 9-(2-hydroxyethoxymethyl)guanine (0.24 g), MP 256.5°-257°C.

References

Merck Index 140
DFU 4 (11) 842 (1979)
Kleeman & Engel p. 14
PDR p. 773
OCDS Vol. 3 p. 229

DOT 18 (2) 52 (1982)

REM p. 1231

Schaeffer, H.J.; U.S. Patent 4,199,574; April 22, 1980; assigned to Burroughs-Wellcome Co.

ADENOSINE TRIPHOSPHATE

Therapeutic Function: Coenzyme; vasodilator

Chemical Name: Adenosine 5'-(tetrahydrogen triphosphate)

Common Name: ATP; Triphosadenine

Structural Formula:

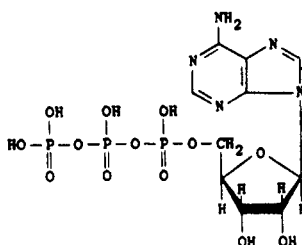

Chemical Abstracts Registry No.: 56-65-5

Trade Name	Manufacturer	Country	Year Introduced
Atepodin	Medix	Spain	—
Atriphos	Biochimica	Switz.	—
Estriadin	Boizot	Spain	—
Striadyne	Auclair	France	—
Triphosphodine	I.C.I.	U.K.	—

Raw Materials

1,3-Dicyclohexylguanidinium adenosine 5'-phosphoramidate
Bis-Triethylammonium pyrophosphate

Manufacturing Process

With a solution of 0.29 part by weight of well dried 1,3-dicyclohexylguanidinium adenosine 5'-phosphoramidate in 5 parts by volume of ortho-chlorophenol is admixed a solution of 0.95 part by weight of bis-triethylammonium pyrophosphate in a mixed solvent composed of 1 part by volume of ortho-chlorophenol and 2 parts by volume of acetonitrile. The mixture is left standing at 20°C for 2 days. Then 30 parts by volume of water is added to the mixture. After washing with three 15 parts by weight volume-portions of diethyl ether, the aqueous layer is separated, and the remaining diethyl ether in the aqueous layer is removed under reduced pressure. Five parts by weight of activated charcoal is added to the aqueous layer and the mixture is stirred for 30 minutes. The activated charcoal is filtered and further 1 part by weight of activated charcoal is added to the filtrate. After 20 minutes agitation, the activated charcoal is taken out by filtration. The combined activated charcoal is washed with a little water, and eluted twice with respective 300 and 200 parts by volume-portions of 50% (volume) ethanol containing 2% (volume) of concentrated aqueous ammonia. The eluate is concentrated

to 40 parts by volume, then is passed through a column packed with 20 parts by volume of a strongly basic anion exchange resin in bead form (chloric type) (polystyrene trimethylbenzyl ammonium type resin sold under the name of Dowex-1 from Dow Chemical Company, Mich. U.S.A.). Then, the column is washed with 750 parts by volume of an acid aqueous saline solution containing 0.01 normal hydrochloric acid and 0.02 normal sodium chloride and then eluted with 600 parts by volume of an acid aqueous saline solution composed of 0.01 normal hydrochloric acid and 0.2 normal sodium chloride. After neutralizing with a diluted sodium hydroxide solution, the eluate is treated with activated charcoal to adsorb ATP as its sodium salt. The separated activated charcoal is washed with water and eluted with 60% (volume) ethanol containing 2% (volume) of concentrated aqueous ammonia. The eluate is concentrated to 0.5 part by volume, then 5 parts by volume of ethanol is added. The precipitate thus deposited is centrifuged and dried at low temperature to obtain 0.155 part by weight of tetrasodium salt of ATP containing 4 mols of water of crystallization as a colorless crystalline powder. The yield is 47% relative to the theoretical.

References

Merck Index 146

I.N. p. 983

Tanaka, K. and Honjo, M.; U.S. Patent 3,079,379; February 26, 1963; assigned to Takeda Pharmaceutical Industries, Ltd.

AFLOQUALONE

Therapeutic Function: Centrally acting muscle relaxant

Chemical Name: 6-Amino-2-(fluoromethyl)-3-(o-tolyl)-4(3H)-quinazolinone

Common Name: —

Structural Formula:

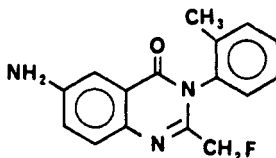

Chemical Abstracts Registry No.: 56287-74-2; 56287-75-3 (Hydrochloride)

Trade Name	Manufacturer	Country	Year Introduced
Arofuto	Tanabe Seiyaku	Japan	1983

Raw Materials

N-(2-Amino-5-Nitrobenzyl)-o-Toluidine
 Fluoroacetyl Chloride
 Acetic Anhydride
 Hydrogen

Manufacturing Process

14.4 g (0.053 mol) of N-(2-amino-5-nitrobenzoyl)-o-toluidine and 6.3 g (0.08 mol) of pyridine are dissolved in 300 ml of tetrahydrofuran. 12.2 g (0.126 mol) of fluoroacetyl chloride

are added to the solution for 10 minutes under ice-cooling. The solution is stirred at the same temperature for 30 minutes and then at room temperature for 2.5 hours. The reaction solution is allowed to stand at room temperature overnight. The crystalline precipitate is collected by filtration, washed with water and then dried. 16.4 g of N-(2-fluoroacetamido-5-nitrobenzoyl)-o-toluidine are obtained. Yield: 93.7%; MP 238°-239°C.

16.5 g (0.05 mol) of N-(2-fluoroacetamido-5-nitrobenzoyl)-o-toluidine and 25.5 g (0.25 mol) of acetic acid anhydride are dissolved in 250 ml of glacial acetic acid. The solution is refluxed for 2 hours under heating. Then, the reaction solution is evaporated to remove solvent. The residue thus obtained is poured into ice-water, and the aqueous mixture is adjusted to pH 9 with potassium carbonate. The crystalline precipitate is collected by filtration. 15.5 g of 2-fluoromethyl-3-(o-tolyl)-6-nitro-4(3H)-quinazolinone are obtained. Yield: 98.7%; MP 155°-158°C (recrystallized from ethanol).

A mixture of 2.0 g (0.064 mol) of 2-fluoromethyl-3-(o-tolyl)-6-nitro-4(3H)-quinazolinone, 0.2 g of 5% palladium-carbon and 100 ml of acetic acid is shaken for 30 minutes in hydrogen gas. The initial pressure of hydrogen gas is adjusted to 46 lb and the mixture is heated with an infrared lamp during the reaction. After 30 minutes of this reaction, the pressure of hydrogen gas decreases to 6 lb. After the mixture is cooled, the mixture is filtered to remove the catalyst. The filtrate is evaporated to remove acetic acid, and the residue is dissolved in chloroform. The chloroform solution is washed with 5% aqueous sodium hydroxide and water, successively. Then, the solution is dried and evaporated to remove solvent. The oily residue thus obtained is dissolved in 2 ml of chloroform, and the chloroform solution is passed through a column of 200 g of silica gel. The silica gel column is eluted with ethyl acetate-benzene (1:1). Then, the eluate is evaporated to remove solvent. The crude crystal obtained is washed with isopropylether and recrystallized from isopropanol. 0.95 g of 2-fluoromethyl-3-(o-tolyl)-6-amino-4(3H)-quinazolinone is obtained. Yield: 52.5%; MP 195°-196°C.

References

DFU 7 (8) 539 (1982)

DOT 19 (1) 581 (1983)

Inoue, L., Oine, T., Yamado, Y., Tani, J., Ishida, R. and Ochiai, T.; U.S. Patent 3,966,731; June 29, 1976; assigned to Tanabe Seiyaku Co., Ltd.

ALBENDAZOLE

Therapeutic Function: Anthelmintic

Chemical Name: [5-(Propylthio)-1H-benzimidazol-2-yl] carbamic acid methyl ester

Common Name: —

Structural Formula:

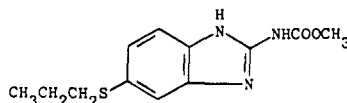

Chemical Abstracts Registry No.: 54965-21-8

Trade Name	Manufacturer	Country	Year Introduced
Zentel	SK&F	France	1981

Raw Materials

3-Chloro-6-Nitroacetanilide
 Propyl Mercaptan
 Hydrogen

Cyanamide
 Methyl Chloroformate

Manufacturing Process

A mixture of 6.65 g of 3-chloro-6-nitroacetanilide, 3.2 ml of propylmercaptan, 5.6 g of 50% sodium hydroxide and 100 ml of water is heated at reflux overnight. The cooled mixture is filtered to give the desired 2-nitro-5-propylthioaniline, MP 69.5°-71.5°C after recrystallization from ethanol then hexane-ether. NMR (CDCl₃) 40%.

The aniline (2.5 g) is hydrogenated with 1.9 ml of concentrated hydrochloric acid, 100 ml ethanol and 5% palladium-on-charcoal to give 4-propylthio-o-phenylene-diamine hydrochloride.

A mixture of 2.5 ml of 50% sodium hydroxide in 5 ml of water is added to a mixture of 1.9 g of cyanamide, 2.2 g of methylchloroformate, 3.5 ml of water and 3 ml of acetone over 45 minutes below 10°C, pH raised to 6.5. A molar equivalent solution of the diamine in 100 ml of ethanol is added. The mixture is heated until the easily volatile solvents are expelled, to about 85°C, then maintained at this temperature with some water added for one-half hour. The product, methyl 5-propylthio-2-benzimidazolecarbamate, is separated, washed to give a colorless crystalline solid, MP 208°-210°C.

References

Merck Index 197

DFU 2 (2) 81 (1977)

OCDS Vol. 2 p. 353 (1980)

DOT 15 (3) 89 (1979)

I.N. p. 50

Gyurik, R.J. and Theodorides, V.J.; U.S. Patent 3,915,986; October 28, 1975; assigned to Smith Kline Corp.

ALBUTEROL

Therapeutic Function: Bronchodilator

Chemical Name: α^1 -[[(1,1-Dimethylethyl)amino]methyl]-4-hydroxy-1,3-benzenedimethanol

Common Name: Salbutamol; α^1 -tert-butylaminomethyl-4-hydroxy-m-xylene- α^1, α^3 -diol

Structural Formula:

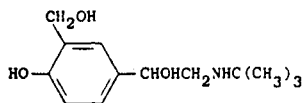

Chemical Abstracts Registry No.: 18559-94-9; 51022-70-9 (Sulfate)

Trade Name	Manufacturer	Country	Year Introduced
Ventolin	Allen & Hanburys	U.K.	1969
Sultanol	Glaxo	W. Germany	1971
Ventoline	Glaxo	France	1971
Ventolin	Glaxo	Italy	1973
Ventolin	Sankyo	Japan	1973
Ventolin	Glaxo	Switz.	1981
Ventolin	Glaxo	U.S.	1981

Trade Name	Manufacturer	Country	Year Introduced
Broncollenas	Llenas	Spain	—
Buto-Asma	Aldo Union	Spain	—
Proventil	Schering	U.S.	—
Rotacaps	Schering	—	—
Salbumol	Medica	Finland	—
Salbutol	Iltas	Turkey	—
Salbuvent	Leiras	Finland	—
Salbuvent	Nyegaard	Norway	—

Raw Materials

5-(N-benzyl-N-tert-butylglycyl)salicylic acid methyl ester hydrochloride
Lithium aluminum hydride
Hydrogen

Manufacturing Process

(a) α^1 -benzyl-tert-butylaminomethyl-4-hydroxy-m-xylene- α^1, α^3 -diol—3.0 g of 5-(N-benzyl-N-tert-butylglycyl)-salicylic acid methyl ester hydrochloride in 40 ml of water was basified with sodium bicarbonate solution and extracted into ether. The ethereal solution was dried over $MgSO_4$ and evaporated and the basic residue in 20 ml of dry tetrahydrofuran was added with stirring to 1.0 g of lithium aluminium hydride in 100 ml of dry tetrahydrofuran, over a period of 5 minutes. The light gelatinous precipitate that formed was stirred and refluxed for 8 hours after which time 7 ml of water was carefully added and the solvents were removed under reduced pressure.

The residue was acidified with dilute hydrochloric acid and brought to pH 8 with sodium hydroxide and sodium bicarbonate. The mixture was filtered and the filtrate and orange solid were separately extracted with chloroform. The combined, dried, chloroform solutions were evaporated to give 2.2 g of the crude basic triol as an orange solid, when triturated with ether. A portion of the material was recrystallized from ether/light petroleum (BP 40°-60°C) to give a white solid, MP 109°-111°C.

In an alternative process, sodium borohydride was used as the reducing agent, as follows:

36 g of 2-(benzyl-tert-butylamino)-4'-hydroxy-3'-hydroxymethyl acetophenone, hydrochloride was shaken with 100 ml of 10% sodium carbonate solution and 100 ml of ethyl acetate. The ethyl acetate layer was separated, washed with water, dried over anhydrous sodium sulfate and evaporated in vacuo.

The residual gum was dissolved in 360 ml of ethanol and cooled to 15°C in an ice/water bath, 8 g of sodium borohydride was then added in portions over 30 minutes while maintaining the temperature at 15°-20°C. After a further 30 minutes at 20°C the solution was stirred at room temperature for 2 hours. The solution was again cooled in ice and 250 ml of 2 N sulfuric acid were slowly added, then the solution was evaporated in vacuo until the ethanol had been removed. The clear aqueous solution was then treated with 250 ml of 10% sodium carbonate solution and the oil which precipitated was extracted into ethyl acetate. The ethyl acetate layer was washed with sodium carbonate solution, then with water, and was dried over anhydrous sodium sulfate and evaporated in vacuo, to a small volume. Petroleum ether (BP 40°-60°C) was added, and after standing overnight a white solid was obtained. This was filtered off to give 23 g of the product, MP 110°-114°C.

(b) α^1 -tert-butylaminomethyl-4-hydroxy-m-xylene- α^1, α^3 -diol—0.8 g of α^1 -benzyl-tert-butylaminomethyl-4-hydroxy-m-xylene- α^1, α^3 -diol in 20 ml of ethanol and 2 ml of water was shaken with hydrogen in presence of 0.50 g of pre-reduced 10% palladium on charcoal catalyst. When uptake of hydrogen was complete, the solution was filtered and evaporated under reduced pressure to give 0.4 g of the base as a colorless oil which yielded a white solid, MP 144°-145°C when triturated with ether/cyclohexane. Recrystallization from ethyl acetate-cyclohexane gave a white solid, MP 147°-149°C.

References

Merck Index 206

DFU 4 (9) 629 (1979)

Kleeman & Engel p. 813

PDR 40 pp. 916, 1649

OCDS Vol. 2 p. 43 (1980)

DOT 16 (8) 269 (1980)

I.N. p. 860

REM p. 881

Lunts, L.H.C. and Toon, P.; U.S. Patent 3,644,353; February 22, 1972; assigned to Allen & Hanburys Ltd.

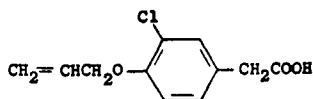
ALCOFENAC**Therapeutic Function:** Antiinflammatory**Chemical Name:** 3-Chloro-4-(2-propenyloxy)benzene-acetic acid**Common Name:** [4-(allyloxy)-3-chlorophenyl] acetic acid**Structural Formula:****Chemical Abstracts Registry No.:** 22131-79-9

Trade Name	Manufacturer	Country	Year Introduced
Mervan	Cooper	Switz.	—
Prinalgin	Berk	U.K.	1971
Neoston	Beiersdorf	W. Germany	1972
Allopydin	Chugai	Japan	1976
Zumaril	Abbott	Italy	1976
Epinal	Kyorin	Japan	1976
Darkeyfenac	Cuatrecasas-Darkey	Spain	—
Desinflam	Sintyal	Argentina	—
Medifenac	Medici	Italy	—
Mervan, Mirvan	Continental Pharma	Belgium	—
Vanadian	Federico Bonet	Spain	—
Zumaril	Sidus	Italy	—
Rentenac	Tosi	Italy	—

Raw Materials

3-Chloro-4-allyloxyphenyl acetonitrile
Potassium hydroxide

Manufacturing Process

103.7 grams of 3-chloro-4-allyloxyphenylacetonitrile in 500 cc of ethanol, 100 grams of potassium hydroxide and 100 cc of water are refluxed for 4 hours. Maximum of alcohol is evaporated, the residue is diluted with water and ice, and acidified with 20% HCl. The solid is filtered and washed with petroleum ether. 91.5 grams of acid are obtained (Yield: 81%) which is recrystallized from aqueous methanol; MP 92°-93°C.

References

Merck Index 209

Kleeman & Engel p. 19

OCDS Vol. 2 p. 68 (1980)

DOT 8 No. 9, 329 (1972)

I.N. p. 50

British Patent 1,174,535; December 17, 1969; assigned to Madan AG, Switzerland.

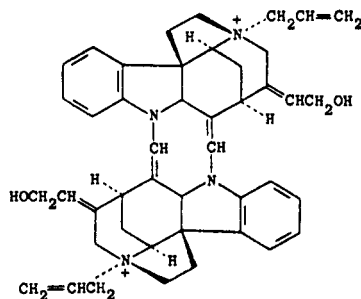
ALCURONIUM CHLORIDE**Therapeutic Function:** Skeletal Muscle Relaxant**Chemical Name:** N,N'-Diallylnortoxiferinium Dichloride**Common Name:** —**Structural Formula:****Chemical Abstracts Registry No.:** 15180-03-7

Trade Name	Manufacturer	Country	Year Introduced
Alloferin	Roche	U.K.	1966
Alloferin	Roche	W. Germany	1968
Alloferine	Roche	France	1968
Dialferin	Nippon Roche	Japan	1969
Toxiferin	Roche	—	—

Raw Materials

Diallyl Nortoxiferine Diiodide
Chloride Ion Exchange Resin

Manufacturing Process

31 g of diallylnortoxiferine diiodide are suspended in 1 liter of water and shaken with 1,100 ml of Amberlite IRA-400 [chloride ion form, described Merck Index, 7th edition, Merck & Co., Inc., Rahway, New Jersey (1960), page 1584], for 2 hours. The diiodide thereby goes into solution. The ion exchanger is filtered off and then washed in 3 portions with a total of 1 liter of water. The combined filtrates are then allowed to run through a column of 300 ml of Amberlite IRA-400 (chloride ion form), rinsed with 300 ml of water and the eluate evaporated to dryness in a vacuum while excluding air. The residue gives on recrystallization from methanol/ethanol crystalline pure colorless diallylnortoxiferine dichloride in a yield of 18.6 g. The compound contains 5 mols of water of crystallization after equilibration in air.

References

Merck Index 215

Kleeman & Engel p. 19

I.N. p. 51

Boller, A., Els, H. and Furst, A.; U.S. Patent 3,080,373; March 5, 1963; assigned to Hoffman La Roche, Inc.

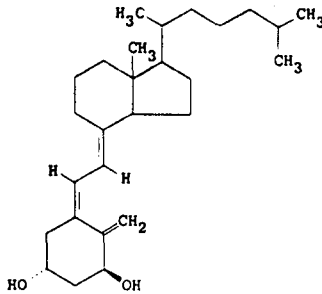
ALFACALCIDOL**Therapeutic Function:** Calcium Regulator, Vitamin D**Chemical Name:** 9,10-Secocholesta-5,7,10(19)-triene-1,3-diol**Common Name:** 1 α -Hydroxycholecalciferol; 1 α -Hydroxyvitamin D₃**Structural Formula:****Chemical Abstracts Registry No.:** 41294-56-8

Trade Name	Manufacturer	Country	Year Introduced
One-Alpha	Leo	U.K.	1978
Eins-Alpha	Thomae	W. Germany	1980
Alfarol	Chugai	Japan	1981
One-Alpha	Teljin	Japan	1981
Delakmin	Roussel	France	—
Etalpha	Leo	Denmark	—
Un-Alfa	Leo	—	—

Raw MaterialsCholesta-1,5,7-trien-3 β -ol

4-Phenyl-1,2,4-triazoline-3,5-dione

m-Chloroperbenzoic Acid

Lithium Aluminum Hydride

Manufacturing Process

1. Preparation of 1,4-cyclized adduct of cholesta-1,5,7-trien- β -ol and 4-phenyl-1,2,4-triazoline-3,5-dione: a solution of 400 mg of cholesta-1,5,7-trien-3 β -ol in 30 ml of tetrahydrofuran is cooled with ice, and 190 mg of 4-phenyl-1,2,4-triazoline-3,5-dione is added little by little to the solution under agitation. The mixture is agitated at room temperature for 1 hour and the solvent is distilled under reduced pressure. The residue is purified by chromatography using a column packed with silica gel. Fractions eluted with ether-hexane (7:3 v/v) are collected and recrystallization from ether gives 550 mg of a 1,4-cyclized adduct of cholesta-1,5,7-trien-3 β -ol and 4-phenyl-1,2,4-triazoline-3,5-dione having a melting point of 178° to 182°C.

2. Preparation of 1,4-cyclized adduct of cholesta-5,7-dien-3 β -ol-1 α -epoxide and 4-phenyl-1,2,4-triazoline-3,5-dione: 1.25 g of the 1,4-cyclized adduct of cholesta-1,5,7-trien-3 β -ol and 4-phenyl-1,2,4-triazoline-3,5-dione is dissolved in 50 ml of chloroform, and 560 mg of m-chloroperbenzoic acid is added to the solution. The mixture is agitated for 20 hours at room temperature, and 200 mg of m-chloroperbenzoic acid is further added and the mixture is agitated again for 20 hours. The reaction mixture liquid is diluted with chloroform, washed with a 10% aqueous solution of potassium carbonate and dried with magnesium sulfate. Then, the solvent is distilled under reduced pressure. The residue is purified by silica gel chromatography, and first effluent fractions eluted with ether are collected, and recrystallization from methanol gives 680 g of a crystal melting at 172° to 173°C. The second ether effluent fractions are collected, and recrystallization from methanol gives 400 mg of a 1,4-cyclized adduct of cholesta-5,7-dien-3 β -ol-1 α ,2 α -epoxide and 4-phenyl-1,2,4-triazoline-3,5-dione having a melting point of 152° to 154°C.

3. Preparation of cholesta-5,7-diene-1 α ,3 β -diol: a solution of 500 mg of the 1,4-cyclized adduct of cholesta-5,7-dien-3 β -ol-1 α ,2 α -epoxide and 4-phenyl-1,2,4-triazoline-3,5-dione in 40 ml of tetrahydrofuran is added dropwise under agitation to a solution of 600 mg of lithium aluminum hydride in 30 ml of THF. Then, the reaction mixture liquid is gently refluxed and boiled for 1 hour and cooled, and a saturated aqueous solution of sodium sulfate is added to the reaction mixture to decompose excessive lithium aluminum hydride. The organic solvent layer is separated and dried, and the solvent is distilled. The residue is purified by chromatography using a column packed with silica gel. Fractions eluted with ether-hexane (7:3 v/v) are collected, and recrystallization from the methanol gives 400 mg of cholesta-5,7-diene-1 α ,3 β -diol.

4. Preparation of 1 α ,3 β -dihydroxyprovitamin D₃: a solution of 25 mg of cholesta-5,7-diene-1 α ,3 β -diol in 650 ml of ether is subjected to radiation of ultraviolet rays for 14 minutes in an argon gas atmosphere by passing it through a Vycor filter using a 200-W high pressure mercury lamp (Model 654A-36 manufactured by Hanobia). The solvent is distilled at room temperature under reduced pressure. This operation is repeated twice, and 50 mg of the so obtained crude product is fractionated by chromatography using a column packed with 20 g of Sephadex LH-20. The first effluent fractions eluted with chloroform-hexane (65:35 v/v) give 13.5 mg of oily 1 α ,3 β -dihydroxyprovitamin D₃. The composition exhibits a maximum ultraviolet absorption at 260 m in an ether solution.

5. Preparation of 1 α -hydroxycholecalciferol: a solution of 13.5 mg of 1 α ,3 β -dihydroxyprovitamin D₃ in 200 ml of ether is allowed to stand still in the dark at room temperature in an argon gas atmosphere for 2 weeks. During this period, the position of the maximum ultraviolet absorption is shifted from 260 m μ to 264 m μ , and the absorption intensity becomes 1.6 times as high as the original intensity. The solvent is distilled at room temperature under reduced pressure, and the residue is purified by chromatography using a column packed with 10 g of Sephadex LH-20. The fractions eluted with chloroform-hexane (65:35 v/v) give 6.5 mg of oily 1 α -hydroxycholecalciferol.

References

Merck Index 4730

Kleeman & Engel p. 21

DOT 6 (3) 104 (1970); 14 (10) 441 (1978)

I.N. p. 52

Ishikawa, M., Kaneko, C., Suda, T., Yamada, S., Eguchi, Y., Sugimoto, A. and Sasaki, S.; U.S. Patent 3,929,770; December 30, 1975; assigned to Wisconsin Alumni Research Foundation.

ALFAXALONE

Therapeutic Function: Anesthetic component

Chemical Name: 3-Hydroxypregnane-11,20-dione

Common Name: Alphaxolone

Structural Formula:

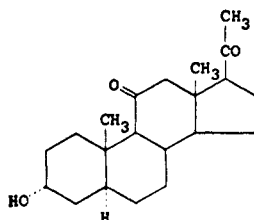

Chemical Abstracts Registry No.: 23930-19-0

Trade Name	Manufacturer	Country	Year Introduced
Althesin	Glaxo	U.K.	1972
Alfation	Nippon Glaxo	Japan	1978
Alfathesin	Glaxo	France	—
Aurantex	Glaxo	W. Germany	—

Raw Materials

3 α -Hydroxy-5 α -pregn-16-ene-11,20-dione
Hydrogen

Manufacturing Process

A solution of 3 α -hydroxy-5 α -pregn-16-ene-11,20-dione (200 mg) in freshly distilled tetrahydrofuran (8 ml) with 5% palladium on carbon (100 ml) was hydrogenated until hydrogen uptake ceased. The mixture was filtered through a pad of kieselguhr and the tetrahydrofuran removed in vacuo to give 196 mg, MP 171° to 172°C.

References

Merck Index 225

Kleeman & Engel p. 23

DOT 8 (11) 407 (1972)

I.N. p. 53

Davis, B., Pearce, D.R. and Phillips, G.H., British Patent 1,317,184; May 16, 1973; assigned to Glaxo Laboratories, Ltd.

Davis, B. and Phillips, G.H.; U.S. Patent 3,714,352; January 30, 1973; assigned to Glaxo Laboratories, Ltd.

ALFENTANIL HYDROCHLORIDE

Therapeutic Function: Narcotic analgesic

Chemical Name: N-[1-[2-(4-Ethyl-4,5-dihydro-5-oxo-1H-tetrazol-1-yl)ethyl]-4-(methoxymethyl)-4-piperidinyl]-N-phenylpropanamide hydrochloride

Common Name: —

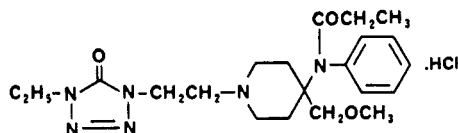
Structural Formula:**Chemical Abstracts Registry No.:** —

Trade Name	Manufacturer	Country	Year Introduced
Rapifen	Janssen	Belgium	1983
Rapifen	Janssen	Netherlands	1983
Rapifen	Janssen	W. Germany	1983
Rapifen	Janssen	U.K.	1983
Rapifen	Janssen	Switz.	1983

Raw Materials

- 1-Ethyl-1,4-dihydro-5H-tetrazol-5-one
- 1-Bromo-2-chloroethane
- N-[4-(Methoxymethyl)-4-piperidinyl]-N-phenylpropanamide

Manufacturing Process

A mixture of 22 parts of 1-ethyl-1,4-dihydro-5H-tetrazol-5-one, 45 parts of 1-bromo-2-chloroethane, 26 parts of sodium carbonate, 0.3 part of potassium iodide and 240 parts of 4-methyl-2-pentanone is stirred and refluxed overnight with water-separator. The reaction mixture is cooled, water is added and the layers are separated. The aqueous phase is extracted three times with dichloromethane. The combined organic phases are dried, filtered and evaporated. The residue is purified by column-chromatography over silica gel using trichloromethane as eluent. The pure fractions are collected and the eluent is evaporated, yielding 28.4 parts (80%) of 1-(2-chloroethyl)-4-ethyl-1,4-dihydro-5H-tetrazol-5-one as a residue.

A mixture of 1.8 parts of 1-(2-chloroethyl)-4-ethyl-1,4-dihydro-5H-tetrazol-5-one, 3.45 parts of N-[4-(methoxymethyl)-4-piperidinyl]-N-phenylpropanamide, 5 parts of sodium carbonate, 0.2 part of potassium iodide and 240 parts of 4-methyl-2-pentanone is stirred and refluxed overnight with water-separator. The reaction mixture is poured onto water and the layers are separated. The organic phase is dried, filtered and evaporated. The residue is purified by column-chromatography over silica gel using a mixture of trichloromethane and methanol (97:3 by volume) as eluent. The pure fractions are collected and the eluent is evaporated. The residue is converted into the hydrochloride salt in 2-propanone. The salt is filtered off and crystallized from 2-propanone, yielding 1.5 parts (33.3%) of N-[1-[2-(4-ethyl-4,5-dihydro-5-oxo-1H-tetrazol-1-yl)]-4-(methoxymethyl)-4-piperidinyl]-N-phenylpropanamide monohydrochloride monohydrate; melting point 140.8°C.

References

- DFU 6 (6) 335 (1981)
- OCDS Vol. 3 p. 118 (1984)
- DOT 19 (12) 683 (1983)
- I.N. p. 53
- Janssens, F.; U.S. Patent 4,167,574; September 11, 1979; assigned to Janssen Pharmaceutica NV.

ALGESTONE ACETOPHENIDE**Therapeutic Function:** Progestin; Contraceptive

Chemical Name: 16,17-[(1-Phenylethylidene)bis(oxy)] pregn-4-ene-3,20-dione

Common Name: 16 α ,17 α -Dihydroxyprogesterone acetophenide; alphasone acetophenide

Structural Formula:

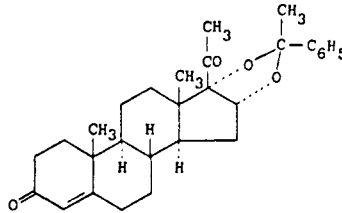

Chemical Abstracts Registry No.: 24356-94-3

Trade Name	Manufacturer	Country	Year Introduced
Neolutin Depo	Medici	Italy	1982
Neolutin Depositum	Orma	Italy	—
Droxone	Squibb	U.S.A.	—
Decadroxone	Squibb	—	—
Decadroxate	Squibb	—	—

Raw Materials

16 α ,17 α -Dihydroxyprogesterone
Acetophenone

Manufacturing Process

To a suspension of 500 mg of 16 α ,17 α -dihydroxyprogesterone in 25 ml of freshly redistilled acetophenone is added 0.125 ml of 72% perchloric acid and the mixture is agitated at room temperature for one hour. The clear solution is washed with dilute sodium bicarbonate to remove excess acid and the acetophenone layer, after addition of chloroform is separated from the aqueous phase. The organic layer is dried over sodium sulfate and after removal of the chloroform and acetophenone in high vacuum the residue is crystallized from 95% alcohol. The pure acetophenone derivative has a melting point of about 142° to 144°C.

References

- Merck Index 227
Kleeman & Engel p. 24
OCDS Vol. 2 p. 171 (1980)
DOT 19 (2) 110 (1983)
I.N. p. 54
Fried, J.; U.S. Patent 2,941,997; June 21, 1960; assigned to Olin Mathieson Chemical Corp.
Fried, J. and Diassi, P.A.; U.S. Patent 3,008,958; November 14, 1961; assigned to Olin Mathieson Chemical Corp.

ALIBENDOL

Therapeutic Function: Choleric; Antispasmodic

Chemical Name: 2-Hydroxy-N-(2-hydroxyethyl)-3-methoxy-5-(2-propenyl)benzamide

Common Name: —

Structural Formula:

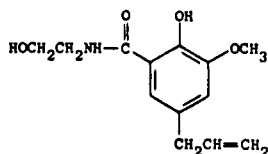

Chemical Abstracts Registry No.: 26750-81-2

Trade Name	Manufacturer	Country	Year Introduced
Cebera	Bouchara	France	1981

Raw Materials

2-Hydroxy-3-methoxy-5-allyl benzoic acid
Ethanol
Ethanolamine

Manufacturing Process

36 g of ethyl ester of 2-hydroxy-3-methoxy-5-allyl-benzoic acid [obtained by the process described by Pearl, et al., *J. Amer. Chem. Soc.*, Vol 71, 1067-1068 (1949)] and 61 g of ethanolamine were admixed and left to stand for 1 hour at ambient temperature after which it was heated for 1 hour at 120°C. The mixture was extracted with chloroform and the organic phases were washed with half diluted hydrochloric acid, then with water, and the chloroform evaporated off. The residue, after recrystallization from benzene, was a 78% yield of 2-hydroxy-3-methoxy-5-allyl-N-(β-hydroxyethyl)-benzamide having a melting point of 95°C. The product appeared in the form of colorless crystals which were insoluble in water and soluble in dilute sodium hydroxide.

References

Merck Index 230

DOT 18 (10) 525 (1982)

Clemence, F. and Le Martret, O.; U.S. Patent 3,668,238; June 6, 1972; assigned to Roussel Uclaf.

ALIZAPRIDE**Therapeutic Function:** Neuroleptic (antiemetic)**Chemical Name:** 6-Methoxy-N-[[1-(2-propenyl)-2-pyrrolidinyl] methyl]-H-benzotriazole-5-carboxamide

Common Name: —

Structural Formula:

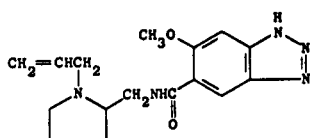

Chemical Abstracts Registry No.: 59338-93-1

Trade Name	Manufacturer	Country	Year Introduced
Plitican	Delagrance	France	1981
Vergentan	Delagrance	W. Germany	1981

Raw Materials

2-Methoxy-4,5-azimido Benzoic Acid
 1-Allyl-2-amino-methyl Pyrrolidine
 Phosphoric Anhydride

Manufacturing Process

38.6 g (0.2 mol) of 2-methoxy-4,5-azimido benzoic acid were dissolved in anhydrous toluene and 56 g (0.4 mol) of 1-allyl-2-amino-methyl pyrrolidine were added. The mixture was heated to 50°C and then 42 g (0.3 mol) of phosphoric anhydride were added. The mixture was warmed at reflux temperature for 3 hours and then cooled to 80°C. After adding water, the aqueous layer was alkalinized. The crystals were filtered, washed with water and then dissolved in 450 ml of acetone. After crystallization, the product was filtered, washed and dried.

40.4 g (yield 65%) of N-(1'-allyl-2'-pyrrolidylmethyl)-2-methoxy-4,5-azimidobenzamide having a melting point of 139°C were obtained.

References

Merck Index 231

DFU 6 (1) 11 (1981)

DOT 18 (4) 162 (1982)

I.N. p. 55

Bulteau, G., Acher, J., Collignon, C. and Monier, J.C.; U.S. Patent 4,039,672; August 2, 1977; assigned to Societe D'Etudes Scientifiques et Industrielles de l'Ile-de-France

ALKOFANONE

Therapeutic Function: Antidiarrheal

Chemical Name: 3-[(4-Aminophenyl)sulfonyl]-1,3-diphenyl-1-propanone

Common Name: —

Structural Formula:

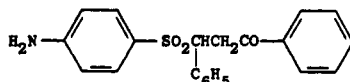

Chemical Abstracts Registry No.: 7527-94-8

Trade Name	Manufacturer	Country	Year Introduced
Clafanone	Roche	U.S.	1956
Alfone	—	—	—

Raw Materials

Benzal Acetophenone
 p-Aminobenzene Sulfinic Acid

Manufacturing Process

38 g benzal-acetophenone and 25 g p-aminobenzene-sulfinic acid are refluxed for 5 hours in 700 cc of 85% ethyl alcohol. Fine crystals soon begin to appear and fill the reaction vessel. While still hot, the mixture is suction-filtered. The reaction product is washed first with 750 cc warm absolute alcohol, then with 500 cc water, and finally again with 300 cc alcohol, and then dried in vacuo. Yield 32 g. MP 210°-212°C with decomposition.

References

Merck Index 240

Goldberg, M.W.; U.S. Patent 2,421,836; June 10, 1947; assigned to Hoffmann-La Roche, Inc.

ALLOPURINOL

Therapeutic Function: Xanthine oxidase inhibitor; gout therapy

Chemical Name: 1H-pyrazolo[3,4-d]pyrimidin-4-ol

Common Name: —

Structural Formula:

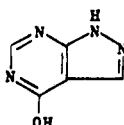

Chemical Abstracts Registry No.: 315-30-0

Trade Name	Manufacturer	Country	Year Introduced
Zyloprim	Burroughs Wellcome	U.S.	1966
Zyloric	Wellcome	Switz.	—
Zyloric	Burroughs-Wellcome	U.K.	1966
Zyloric	Wellcome	W. Germany	1967
Zyloric	Wellcome	Italy	1968
Zyloric	Wellcome	Japan	1969
Zyloric	Wellcome	France	1969
Lopurin	Boots	U.K.	1980
Adenock	Tanabe	Japan	—
Adenock	Shiraimatsu	Japan	—
Allopin	Yeni	Turkey	—
Allomaron	Nattermann	W. Germany	—
Alloprim	Iltas	Turkey	—
Alloprin	ZCN	Canada	—
Allopur	Gea	Denmark	—
Allopur	Nyegaard	Norway	—
Allopurinol	Sigfried	W. Germany	—
Allopurinol	Efeka	W. Germany	—
Allopurinol	Woelm Pharma	W. Germany	—
Allopurinol	Lederle	Japan	—
Allopurinol	Kowa	Japan	—
Allopurinol	Showa	Japan	—
Allorin	Towa	Japan	—
Allozym	Sawai	Japan	—

Trade Name	Manufacturer	Country	Year Introduced
Allural	Nativelle	Italy	--
Allural	Pan Quimica	Spain	--
Allurit	Schoum	Italy	--
Aloc	Toho Iyaku	Japan	--
Alositol	Tanabe	Japan	--
Anoprocin	Nippon Shoji	Japan	--
Antigot	Yurtoglu	Turkey	--
Anzief	Nippon Chemiphar	Japan	--
Aprinol	Daisan	Japan	--
Apurin	Gea	Denmark	--
Apurin	Medica	Finland	--
Apurol	Siegfried	Switz.	--
Bleminol	Desitin	W. Germany	--
Caplenal	Berk	U.K.	--
Capurate	Fawns & McAllan	Australia	--
Cellidrin	Hennig	W. Germany	--
Cosuric	DDSA	U.K.	--
Dabrosol	Hoyer	W. Germany	--
Embarin	Diabetylin	W. Germany	--
Epidropal	Fresenius	W. Germany	--
Flogorex	Lancet	Italy	--
Foligan	Henning	W. Germany	--
Geapur	Gea	Denmark	--
Gichtex	Gerot	Austria	--
Ketawrft	Ohta	Japan	--
Ketobun A	Isei	Japan	--
Lopurin	Generics Corp.	U.S.	--
Lysuron	Boehringer Mannheim	W. Germany	--
Masaton	Zensei	Japan	--
Melianin	Kohjin	Japan	--
Mephanol	Mepha	Switz.	--
Milurit	Egypt	Hungary	--
Monarch	SS Pharmaceutical	Japan	--
Nektronan	ICN Pharma	W. Germany	--
Neufan	Teikoku	Japan	--
Neufan	Teisan	Japan	--
Novopurol	Novopharm	Canada	--
Progout	Protea	Australia	--
Puricos	Lennon	S. Africa	--
Purinol	Horner	Canada	--
Riball	Mitsui	Japan	--
Roucol	Rougier	Canada	--
Serviprinol	Servipharm	Switz.	--
Suspendol	Merckle	W. Germany	--
Takanarumin	Takata	Japan	--
Urbol	Heilit	W. Germany	--
Urbol	Gea	Denmark	--
Uredimin	Chassot	Switz.	--
Uricemil	Farnex	Italy	--
Uricemil	Fardeco	Italy	--
Uriconorm	Streuli	Switz.	--
Uridocid	Reig Jofre	Spain	--
Uriscel	Armour Med.	Italy	--
Urobenyl	Endopharm	W. Germany	--
Urolit	Magis	Italy	--
Urosin	Boehringer Mannheim	W. Germany	--
Urozyl-SR	Restan	S. Africa	--
Urtias	Sabona	W. Germany	--

Trade Name	Manufacturer	Country	Year Introduced
Vedatan	Corvi	Italy	—
Xanturat	Grunenthal	W. Germany	—
Zylol	Teva	Israel	—

Raw Materials

Cyanoacetamide	Morpholine
Triethylorthoformate	Hydrazine Hydrate

Manufacturing Process

3-Morpholino-2-cyanoacrylamide: A stirred mixture of cyanoacetamide (63 g), triethylorthoformate (134 g), morpholine (82.5 g) and acetonitrile (37.5 ml) was heated under reflux for 4 hours. The initial reflux temperature was 117°C and the final reflux temperature was 82°C.

At the end of the reflux period the mixture was cooled to 30°C and the heavy crystalline precipitate was collected and washed with 2 X 75 ml of ethanol. The product was dried in vacuo at 30°C. Wt = 111 g. Yield = 82%, MP 173°-175°C.

3-Aminopyrazole-4-carboxamide hemisulfate: To water (253 ml) at 60°C was added 3-morpholino-2-cyanoacrylamide (63.4 g) and 85% technical hydrazine hydrate (22.7 g). The mixture was rapidly heated to 95°C and the temperature was maintained at >90°C for 20 minutes. The mixture was then cooled to 60°C and the pH carefully adjusted to 1.5 by the addition of a mixture of sulfuric acid (45.7 g) and ice (45.7 g). The acidified reaction was cooled to 5°C and the crystalline product collected and washed with cold water (2 X 100 ml) and acetone (2 X 50 ml). The product was dried in vacuo at 80°C. Wt = 5.8 g. Yield = 95%, MP 237°-239°C.

4-Hydroxypyrazolo[3,4-d]pyrimidine: A suspension of 3-aminopyrazole-4-carboxamide hemisulfate (113 g) in formamide (325 g) was stirred and heated to 145°C. The reaction was held at 145°C for 5 hours. The reaction was then cooled to 30°C and the product collected and washed with formamide (2 X 50 ml), water (2 X 150 ml) and acetone (2 X 100 ml). Wt of crude product = 79 g. The crude product was recrystallized by dissolution in a solution made from sodium hydroxide (25 g) in water (1,200 ml) with treatment at 25°C with charcoal (8 g), followed by reprecipitation by the addition of concentrated hydrochloric acid to pH 5. The product was collected and washed with cold water (2 X 300 ml), acetone (2 X 200 ml) and dried in vacuo at 60°C. Wt = 70 g. Yield = 80%.

References

Merck Index 273

Kleeman & Engel p. 27

PDR pp. 685, 774, 830, 993, 1606

OCDS Vol. 1 pp. 152, 269 (1977)

I.N. p. 57

REM p. 1111

Druey, J. and Schmidt, P.; U.S. Patent 2,868,803; January 13, 1959; assigned to Ciba Pharmaceutical Products Inc.

Hitchings, G.H. and Falco, E.A.; U.S. Patent 3,474,098; October 21, 1969; assigned to Burroughs Wellcome & Co.

Cresswell, R.M. and Mentha, J.W.; U.S. Patent 4,146,713; March 27, 1979; assigned to Burroughs Wellcome & Co.

ALPHAPRODINE HYDROCHLORIDE

Therapeutic Function: Narcotic analgesic

Chemical Name: cis-1,3-dimethyl-4-phenyl-4-piperidinol propanoate hydrochloride

Common Name: —

Structural Formula:

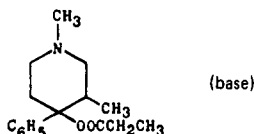

Chemical Abstracts Registry No.: 77-20-3 (Base); 49638-24-6 (Hydrochloride)

Trade Name	Manufacturer	Country	Year Introduced
Nisentil	Roche	U.S.	1949

Raw Materials

Lithium	Propionic Anhydride
Bromobenzene	Hydrogen Chloride
1,3-Dimethyl-4-piperidone	

Manufacturing Process

In a round-bottom flask provided with stirrer, dropping funnel, condenser and a gas outlet for keeping the system under nitrogen, 200 cc of dry ether is placed and 4.6 grams of lithium cut into thin strips is added. 52 grams of bromobenzene in 50 cc of dry ether are added dropwise and after addition, the mixture is refluxed for 2 hours. This procedure results in the formation of phenyl-lithium. Other aryl-lithium compounds can be prepared in a similar manner by reacting lithium metal or a lithium compound capable of transferring lithium and a compound having an exchangeable halogen group as, for example, bromonaphthalene.

The solution of phenyl-lithium is cooled to -20°C and to this a solution of 12.7 grams of 1,3-dimethyl-4-piperidone, prepared according to the method of Howton, *J. Org. Chem.* 10, 277 (1945), in ether is added dropwise with stirring. After the addition, the stirring is continued for a further 2 hours at -20°C . The lithium complex, 1,3-dimethyl-4-phenyl-4-oxylithium piperidine, which forms is soluble in the ether and can be recovered therefrom. To prepare the piperidinol, the lithium complex, while in the reaction mixture is decomposed by the addition of an ice and hydrochloric acid mixture. The acidified layer is separated, basified and extracted with ether. After drying the ether solution and removing the solvent, the residue on distillation in vacuum distills chiefly at $155^{\circ}\text{C}/10$ mm, yielding the product, 1,3-dimethyl-4-phenyl-4-hydroxy piperidine, which, on crystallization from n-hexane melts at 102°C . On treatment with propionic anhydride catalyzed with a trace of sulfuric acid, 1,3-dimethyl-4-propionoxy-4-phenyl piperidine is attained. The latter compound can be converted into the hydrochloride salt by reaction with hydrogen chloride. This salt after crystallization from acetone has a melting point of 209°C .

References

- Merck Index 302
- Kleeman & Engel p. 29
- PDR p. 1494
- OCDS Vol. 1 pp. 304 & 2328 (1977)
- I.N. p. 60
- REM p. 1107
- Lee, J. and Ziering, A.; U.S. Patent 2,498,433; February 21, 1950; assigned to Hoffmann-La Roche Inc.

ALPRAZOLAM

Therapeutic Function: Tranquilizer

Chemical Name: 8-Chloro-1-methyl-6-phenyl-4H-s-triazolo[4,3-a][1,4]benzodiazepine

Common Name: —

Structural Formula:

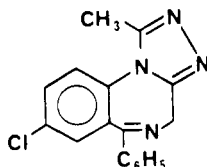

Chemical Abstracts Registry No.: 28981-97-7

Trade Name	Manufacturer	Country	Year Introduced
Xanax	Upjohn	U.S.	1981
Xanax	Upjohn	Switz.	1982
Xanax	Upjohn	U.K.	1983
Xanax	Upjohn	Australia	1983

Raw Materials

2,6-Dichloro-4-phenylquinoline	Paraformaldehyde
Hydrazine Hydrate	Phosphorus Tribromide
Triethyl Orthoacetate	Ammonia
Sodium Periodate	

Manufacturing Process

6-Chloro-2-hydrazino-4-phenylquinoline: A stirred mixture of 2,6-dichloro-4-phenylquinoline (2.7 g, 0.01 mol) and hydrazine hydrate (6.8 g) was refluxed under nitrogen for 1 hour and concentrated in vacuo. The residue was suspended in warm water, and the solid was collected by filtration, dried and recrystallized from ethyl acetate-Skelly B hexanes to give 1.81 g (67% yield) of 6-chloro-2-hydrazino-4-phenylquinoline of melting point 156.5°–157°C.

7-Chloro-1-methyl-5-phenyl-s-triazolo[4,3-a]quinoline: A stirred mixture of 6-chloro-2-hydrazino-4-phenylquinoline (1.4 g, 0.0052 mol), triethyl-orthoacetate (0.925 g, 0.0057 mol) and xylene (100 ml) was refluxed, under nitrogen, for 2 hours 40 minutes. During this period the ethanol formed in the reaction was removed by distillation through a short, glass helix-packed column. The mixture was concentrated to dryness in vacuo and the residue was crystallized from methanol-ethyl acetate to give: 1.28 g of 7-chloro-1-methyl-5-phenyl-s-triazolo[4,3-a]-quinoline (83.9% yield). The analytical sample was crystallized from methylene chloride:methanol and had a melting point 252.5°–253.5°C.

5-Chloro-2-(3-methyl-4H-1,2,4-triazolo-4-yl)benzophenone (Oxidation of 7-chloro-1-methyl-5-phenyl-s-triazolo[4,3-a]quinoline): A stirred suspension of 7-chloro-1-methyl-5-phenyl-s-triazolo[4,3-a]quinoline (2.94 g, 0.01 mol) in acetone (110 ml) was cooled in an ice-bath and treated slowly with a solution prepared by adding sodium periodate (2 g) to a stirred suspension of ruthenium dioxide (200 mg) in water (35 ml). The mixture became dark. Additional sodium periodate (8 g) was added during the next 15 minutes. The ice-bath was removed and the mixture was stirred for 45 minutes. Additional sodium periodate (4 g) was added and the mixture was stirred at ambient temperature for 18 hours and filtered. The solid was washed with acetone and the combined filtrate was concentrated in vacuo. The residue was suspended in water and extracted with methylene chloride. The extract was dried over anhydrous potassium carbonate and concentrated. The residue was chromatographed on silica

gel (100 g) with 10% methanol and 90% ethyl acetate; 50 ml fractions were collected. The product was eluted in fractions 10-20 and was crystallized from ethyl acetate to give: 0.405 g of melting point 168°-169.5°C and 0.291 g of melting point 167.5°-169°C (23.4% yield) of 5-chloro-2-[3-methyl-4H-1,2,4-triazol-4-yl]benzophenone. The analytical sample had a melting point of 168°C.

5-Chloro-2-[3-(hydroxymethyl)-5-methyl-4H-1,2,4-triazol-4-yl]benzophenone: A stirred mixture of 5-chloro-2-[3-methyl-4H-1,2,4-triazol-4-yl]benzophenone, (2.98 g, 0.01 mol) para-formaldehyde (3 g) and xylene (100 ml) was warmed under nitrogen, in a bath maintained at 125°C for 7 hours. The mixture was then concentrated in vacuo. The residue was chromatographed on silica gel (150 g) with 3% methanol-97% chloroform. Fifty ml fractions were collected. The product was eluted in fractions 20-44. The fractions were concentrated and the residue was crystallized from ethanol-ethyl acetate to give: 1.64 g of melting point 138°-142°C; 0.316 g of melting point 138.5°-141°C; 0.431 g of melting point 139°-141°C (72.8% yield) of 5-chloro-2-[3-(hydroxymethyl)-5-methyl-4H-1,2,4-triazol-4-yl]benzophenone. The analytical sample had a melting point of 138°-139°C.

5-Chloro-2-[3-(bromomethyl)-5-methyl-4H-1,2,4-triazol-4-yl]benzophenone: A solution of 5-chloro-2-[3-(hydroxymethyl)-5-methyl-4H-1,2,4-triazol-4-yl]benzophenone (328 mg, 0.001 mol) in dry, hydrocarbon-stabilized chloroform (5 ml) was cooled in an ice-bath and treated with phosphorus tribromide (0.1 ml). The colorless solution was kept in the ice-bath for 55 minutes, at ambient temperature (22°-24°C), for 5 hours. The resulting yellow solution was poured into a mixture of ice and dilute sodium bicarbonate. This mixture was extracted with chloroform. The extract was washed with brine, dried over anhydrous magnesium sulfate and concentrated. The residue was crystallized from methylene chloride-ethyl acetate to give: 0.285 g of melting point 200°-240°C (decomposition) and 0.030 g of melting point 200°-220°C (decomposition) of 5-chloro-2-[3-(bromomethyl)-5-methyl-4H-1,2,4-triazol-4-yl]benzophenone. The analytical sample had a melting point of 200°-240°C.

8-Chloro-1-methyl-6-phenyl-4H-s-triazolo-[4,3-a][1,4]-benzodiazepine: A stirred suspension of 5-chloro-2-[3-(bromomethyl)-5-methyl-4H-1,2,4-triazol-4-yl]benzophenone (391 mg, 0.001 mol) in tetrahydrofuran (15 ml) was cooled in an ice-bath and treated with a saturated solution of ammonia in methanol (12.5 ml). The resulting solution was allowed to warm to ambient temperature and stand for 24 hours. It was then concentrated in vacuo. The residue was suspended in water, treated with a little sodium bicarbonate and extracted with methylene chloride. The extract was washed with brine, dried over anhydrous potassium carbonate and concentrated. The residue was crystallized from methylene chloride-ethyl acetate to give 0.220 g of crude product of melting point 227°-228.5°C. Recrystallization of this material from ethyl acetate gave 0.142 g of melting point 228°-229.5°C of 8-chloro-1-methyl-6-phenyl-4H-s-triazolo[4,3-a][1,4]-benzodiazepine.

References

- Merck Index 303
 DFU 1 (12) 551 (1976)
 Kleeman & Engel p. 30
 PDR p. 1865
 OCDS Vol. 3 p. 197 (1984)
 DOT 11 (5) 179 (1975)
 I.N. p. 60
 Hester, J.B., Jr.; U.S. Patent 3,681,343; August 1, 1972; assigned to The Upjohn Company.
 Hester, J.B., Jr.; U.S. Patent 3,781,289; December 25, 1973; assigned to The Upjohn Company.
 Hester, J.B., Jr.; U.S. Patent 3,709,898; January 9, 1973; assigned to The Upjohn Company.

ALPRENOLOL HYDROCHLORIDE

Therapeutic Function: Beta blocker

Chemical Name: 1-[(1-Methylethyl)amino]-3-[2-(2-propenyl)phenoxy]-2-propanol

Common Name: —

Structural Formula:

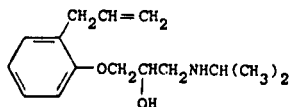

Chemical Abstracts Registry No.: 13655-52-2 (Base); 13707-88-5 (Hydrochloride)

Trade Name	Manufacturer	Country	Year Introduced
Aptol	Globopharm	Switz.	—
Aptin	Astra France	W. Germany	1967
Aptine	Lematte/Boinot	France	1971
Aprobal	Fujisawa	Japan	1971
Aptin	Byk Gulden	Italy	1972
Apillobal	Hassle	Sweden	—
Aptina	Made	Spain	—
Aptol-Duriles	Astra	—	—
Betacard	Beecham	U.K.	—
Betaptin	—	—	—
Elperl	Sawai	Japan	—
Gubernal	Geigy	France	—
Regletin	Teikoku	Japan	—
Sinalol	Kaken	Japan	—
Yobir	Maruko	Japan	—

Raw Materials

o-Allyl Epoxy Propoxy Benzene	Sodium Borohydride
Ammonia	Acetone
Hydrogen Chloride	

Manufacturing Process

A solution of 24.6 g of o-allyl-epoxypropoxybenzene dissolved in 250 ml of absolute ethanol saturated with ammonia was placed in an autoclave and heated on a steam-bath for 2 hours. The alcohol was then removed by distillation and the residue was redissolved in a mixture of methanol and ethylacetate. Hydrogen chloride gas was introduced into the solution. The hydrochloride salt was then precipitated by the addition of ether to yield 11.4 g of product. Five grams of the amine-hydrochloride thus formed were dissolved in 50 ml of methanol and 9 ml of acetone. The resulting solution was cooled to about 0°C. At this temperature 5 g of sodium borohydride were added over a period of 1 hour. Another 2.2 ml of acetone and 0.8 g of sodium borohydride were added and the solution was kept at room temperature for 1 hour, after which 150 ml of water were added to the solution. The solution was then extracted with three 100-ml portions of ether which were combined, dried over potassium carbonate, and evaporated. The free base was then recrystallized from petrol ether (boiling range 40°–60°C) to yield 2.7 g of material having a melting point of 57°C.

The corresponding hydrochloride was prepared by dissolving 2 g of the product, prepared above, in 20 ml of acetone, and adding to the resulting solution acetone saturated with hydrogen chloride until the pH was reduced to about 3. The precipitated hydrochloride salt was then recrystallized from acetone.

References

Merck Index 304

Kleeman & Engel p. 31

OCDS Vol. 1 p. 177 (1977)

DOT 9 (6) 245 (1973)

I.N. p. 60

Brandstrom, A.E., Corrodi, H.R. and Alblad, H.R.G.; U.S. Patent 3,466,376; September 9, 1969; assigned to Aktiebolaget Hassle.

ALTRETAMINE

Therapeutic Function: Antitumor agent

Chemical Name: 2,4,6-Tris(dimethylamino)-1,3,5-triazine

Common Name: Hexamethylmelamine

Structural Formula:

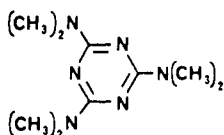

Chemical Abstracts Registry No.: 645-05-6

Trade Name	Manufacturer	Country	Year Introduced
Hexastat	Roger Bellon	France	1979
Hexastat	Rhone Poulenc	Switz.	1981
Altretamine	Rhone Poulenc	W. Germany	1982

Raw Materials

Hexamethylolmelamine-Hexamethyl Ether
Hydrogen

Manufacturing Process

50 g of hexamethylolmelamine-hexamethyl ether in 950 cc methanol are hydrogenated, at 90° to 100°C, in the presence of 2 g Raney nickel with 100 atmospheres excess pressure of hydrogen in a steel autoclave holding 2 l until the absorption of hydrogen is terminated. After the catalyst has been filtered off with suction, the methanol is distilled off. As a result, 23.1 g (86% of the theoretical) of crude hexamethylmelamine are formed having a melting point of 158° to 162°C. After recrystallization from methanol, the pure product is obtained having a melting point of 168°C.

References

Merck Index 310

DFU 5 (10) 492, 635 (1980)

DOT 18 (4) 165 (1982)

I.N. p. 61

von Brachel, H. and Kindler, H.; U.S. Patent 3,424,752; January 28, 1969; assigned to Casella Farbwerke Mainkur AG

ALUMINUM NICOTINATE

Therapeutic Function: Peripheral vasodilator

Chemical Name: 3-pyridinecarboxylic acid aluminum salt

Common Name: Tris(nicotinato)aluminum

Structural Formula:

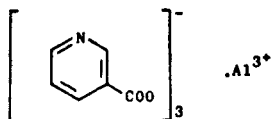

Chemical Abstracts Registry No.: 1976-28-9

Trade Name	Manufacturer	Country	Year Introduced
Nicalex	Merrell-Dow	U.S.	1960
Alunitine	Continental Pharma	Belgium	—

Raw Materials

Nicotinic Acid
Aluminum Hydroxide

Manufacturing Process

Aluminum nicotinate is prepared by dissolving nicotinic acid in hot water and adding a slurry of aluminum hydroxide to it. A slight excess of aluminum hydroxide is used in order that the final product would be free of nicotinic acid. The precipitate is collected on a filter and dried. The final product contains a mixture of aluminum nicotinate and a small but acceptable amount of aluminum hydroxide.

References

Merck Index 346

Kleeman & Engel p. 33

I.N. p. 62

Miale, J.P.; U.S. Patent 2,970,082; January 31, 1961; assigned to Walker Laboratories, Inc.

AMANTIDINE HYDROCHLORIDE

Therapeutic Function: Antiviral, anti-Parkinsonism

Chemical Name: 1-adamantanamine hydrochloride

Common Name: 1-aminoadamantane hydrochloride

Structural Formula:

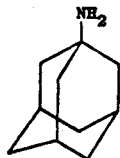

Chemical Abstracts Registry No.: 665-66-7

Trade Name	Manufacturer	Country	Year Introduced
Symmetrel	DuPont (Endo)	U.S.	1966
Symmetrel	Geigy	W. Germany	1966
Symmetrel	Geigy	U.K.	1971
Mantadan	De Angeli	Italy	1971
Mantadix	Theraplix	France	1973
Symmetrel	Fujisawa	Japan	1975
Amantadin	Ratipharm	W. Germany	—
Amantan	Byk-Gulden	—	—
Amazon	Sawai	Japan	—
Antadine	DuPont	Australia	—
Atarin	Medica	Finland	—
Contenton	SK Dauelsberg	W. Germany	—
Influenol	Santos	Spain	—
Midantan	—	—	—
Paramantin	Orion	Finland	—
Paritrel	Trima	Israel	—
PK-Mertz	Mertz	W. Germany	—
Protexin	Landerlan	Spain	—
Solu-Contenton	SK&F	W. Germany	—
Trivaline	Farmex	France	—
Viregyt	Egypt	Hungary	—
Virofral	Duphar	Belgium	—
Virofral	Ferrosan	Denmark	—
Virosol	Phoenix	Argentina	—

Raw Materials

Adamantane	Sodium Hydroxide
Hydrocyanic Acid	Hydrogen Chloride

Manufacturing Process

360 ml of 96% sulfuric acid and a solution of 13.6 grams (0.1 mol) of adamantane in 100 ml of n-hexane were emulsified in the apparatus described and provided with an inclined centrifugal stirrer. Then a mixture of 46 grams (1.7 mols) of liquid hydrocyanic acid and 29.6 grams (0.4 mol) of tertiary butanol was added dropwise within 1.5 hours at about 25°C.

After 30 minutes of postreaction, the product was poured on ice. The granular mass which precipitated [N-(adamantyl-1)formamide] was sucked off and washed with water. The raw product (37 grams) was then refluxed for 10 hours with a solution of 60 grams of NaOH in 600 ml of diethylene glycol.

After cooling, the solution was diluted with 1.5 liters of water and subjected to three extractions with ether. The amine was extracted from the ethereal solution with 2 N HCl and liberated therefrom by the addition of solid NaOH (while cooling). The alkaline solution was extracted with ether and the ethereal solution was dried with solid NaOH. Distillation resulted in 10.6 grams (70% of the theory) of 1-aminoadamantane which, after sublimation, melted at 180° to 192°C (seal capillary). It is converted to the hydrochloride.

References

- Merck Index 373
 Kleeman & Engel p. 33
 PDR p. 862
 OCDS Vol. 2 p. 18 (1980)

DOT 3 (1) 6 (1967) and 7 (2) 44 (1971)

I.N. p. 63

REM p. 927

Haaf, W.; U.S. Patent 3,152,180; October 6, 1964; assigned to Studiengesellschaft Kohle mbH, Germany

AMBENONIUM CHLORIDE

Therapeutic Function: Cholinesterase inhibitor

Chemical Name: N,N'-[({1,2-dioxo-1,2-ethanediy})bis(imino-2,1-ethanediy)] bis[2-chloro-N,N-diethylbenzenemethanaminium] dichloride

Common Name: —

Structural Formula:

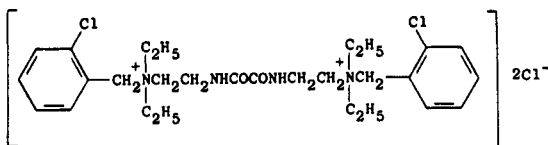

Chemical Abstracts Registry No.: 115-79-7

Trade Name	Manufacturer	Country	Year Introduced
Mytelase CL	Winthrop	U.S.	1956
Mytelase	Winthrop	W. Germany	—
Mytelase	Winthrop	France	1950
Mytelase	Winthrop	U.K.	1970
Mytelase	Nippon Shoji	Japan	—
Mysuran	Winthrop	—	—

Raw Materials

2-Diethyl Amino Ethyl Amine
Ethyl Oxalate
2-Chlorobenzyl Chloride

Manufacturing Process

N,N'-Bis(2-Diethylaminoethyl)Oxamide: A solution of 150 grams (1.32 mol) of 2-diethyl-aminoethylamine in 250 ml of xylene was gradually added to a solution of 73.0 grams (0.5 mol) of ethyl oxalate in 250 ml of xylene, with external cooling. The mixture was then refluxed for eight hours, cooled and diluted with ether. The ether-xylene solution was extracted with 10% hydrochloric acid, and the hydrochloric acid extracts were in turn extracted with ether and then made alkaline with 35% sodium hydroxide solution. The organic material which separated was extracted with ether, and the ether solution was dried over anhydrous sodium sulfate and concentrated, giving 106.5 grams of N,N'-bis(2-diethyl-aminoethyl)oxamide, MP 40°-42°C.

N,N'-Bis(2-Diethylaminoethyl)Oxamide Bis(2-Chlorobenzochloride): A solution of 7 grams (0.025 mol) of N,N'-bis(2-diethylaminoethyl)oxamide and 16.1 grams (0.1 mol) of 2-chloro-benzyl chloride in 100 ml of acetonitrile was refluxed for eleven hours. The solid which separated upon cooling was collected by filtration and recrystallized by dissolving it in

ethanol and adding ether to cause the product to separate. After drying at about 60°C (1-3 mm) there was obtained 4.1 grams of N,N'-bis(2-diethylaminoethyl)oxamide bis(2-chlorobenzochloride), MP 196°-199°C.

References

Merck Index 378

Kleeman & Engel p. 34

I.N. p. 64

REM p. 898

Kirchner, F.K.; U.S. Patent 3,096,373; July 2, 1963; assigned to Sterling Drug Inc.

Behr, L.C. and Schreiber, R.S.; U.S. Patent 2,438,200; March 23, 1948; assigned to E.I. du Pont de Nemours and Co.

AMBROXOL

Therapeutic Function: Expectorant

Chemical Name: 4-[[2-Amino-3,5-dibromophenyl)methyl]amino]-cyclohexanol

Common Name: —

Structural Formula:

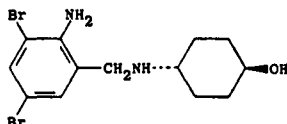

Chemical Abstracts Registry No.: 18683-91-5

Trade Name	Manufacturer	Country	Year Introduced
Mucosolvan	Thomae	W. Germany	1980
Mucosolvan	De Angeli	Italy	1981
Mucosolvan	Boehringer-Ingel	Switz.	1982
Fluixol	Ripari-Gero	Italy	—
Fluibron	Chiesi	Italy	—
Muciclar	Piam	Italy	—

Raw Materials

N-(trans-p-hydroxy-cyclohexyl)-(2-aminobenzyl)-amine
Bromine

Manufacturing Process

6.5 g of N-(trans-p-hydroxy-cyclohexyl)-(2-aminobenzyl)-amine were dissolved in a mixture of 80 cc of glacial acetic acid and 20 cc of water, and then 9.6 g of bromine were added dropwise at room temperature while stirring the solution. After all of the bromine had been added, the reaction mixture was stirred for two hours more and was then concentrated in a water aspirator vacuum. The residue was taken up in 2 N ammonia, the solution was extracted several times with chloroform, and the organic extract solutions were combined and evaporated. The residue, raw N-(trans-p-hydroxy-cyclohexyl)-(2-amino-3,5-dibromobenzyl)-amine, was purified with chloroform and ethyl acetate over silica gel in a chromatographic column, the purified product was dissolved in a mixture of ethanol and ether, and the solution was

acidified with concentrated hydrochloric acid. The precipitate formed thereby was collected and recrystallized from ethanol and ether, yielding N-(trans-p-hydroxy-cyclohexyl)-(2-amino-3,5-dibromobenzyl)-amine hydrochloride, MP 233°-234.5°C (decomposition).

References

Merck Index 383

DFU 1 (3) 95 (1976)

Kleeman & Engel p. 35

I.N. p. 64

Keck, J., Koss, F.W., Schraven, E. and Beisenherz, G.; U.S. Patent 3,536,713; October 27, 1970; assigned to Boehringer Ingelheim G.m.b.H.

AMBUPHYLLINE

Therapeutic Function: Diuretic, smooth muscle relaxant

Chemical Name: 3,7-Dihydro-1,3-dimethyl-1H-purine-2,6-dione compound with 2-amino-2-methyl-1-propanol (1:1)

Common Name: Theophylline aminoisobutanol; Bufylline

Structural Formula:

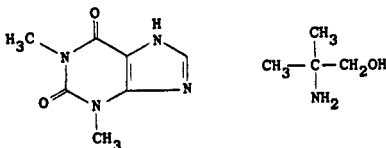

Chemical Abstracts Registry No.: 5634-34-4

Trade Name	Manufacturer	Country	Year Introduced
Butaphyllamine	Merrell-Dow	U.S.	1944
Buthoid	Merrell-Dow	U.S.	—

Raw Materials

Theophylline

2-Amino-2-methyl-1-propanol

Manufacturing Process

Equimolecular proportions of theophylline and 2-amino-2-methyl-1-propanol are dissolved in water and the water is evaporated until crystallization is almost complete. The crystals are filtered off and dried. The product has a melting point of 254°-256°C, softening at 245°C. It has a water solubility of about 55%. It may be compounded in the form of tablets, for oral administration, or may be prepared in solution for distribution in ampoules. For the manufacture of solutions for packaging in ampoules, it is more convenient to simply dissolve the theophylline and the butanol amine in water, without going through the intermediate step of separating the crystalline salt.

References

Merck Index 385

I.N. p. 64

Shelton, R.S.; U.S. Patent 2,404,319; July 16, 1946; assigned to The Wm. S. Merrell Co.

AMBUSIDE

Therapeutic Function: Diuretic, antihypertensive

Chemical Name: N'-allyl-4-chloro-6-[(3-hydroxy-2-butenylidene)amino]-m-benzenedisulfonamide

Common Name: —

Structural Formula:

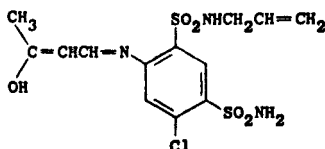

Chemical Abstracts Registry No.: 3754-19-6

Trade Name	Manufacturer	Country	Year Introduced
Hydrion	Robert Carriere	France	1970

Raw Materials

2-Allylsulfamyl-5-chloro-4-sulfamylaniline
Acetaldehyde Dimethylacetal

Manufacturing Process

Preparation of 2-Allylsulfamyl-4-Sulfamyl-5-Chloro-N-(3-Hydroxy-2-Butenylidene)Aniline or Ambuside: 2-allylsulfamyl-5-chloro-4-sulfamylaniline monohydrate (6.9 grams, 0.020 mol) was dissolved in 14 ml acetylacetaldehyde dimethylacetal at room temperature and the viscous solution was filtered. Addition of 6 drops of 10:1 H₂O/concentrated HCl, and stirring for 20 hours gave a heavy suspension. Dilution with 150 ml of ethanol, collection of the solid, washing twice with 40 ml portions of ethanol, and drying gave 6.2 grams (78%) of product, MP 204°-206°C.

References

Merck Index 386

Kleeman & Engel p. 35

OCDS Vol. 2 p. 116 (1980)

I.N. p. 64

Robertson, J.E.; U.S. Patent 3,188,329; June 8, 1955; assigned to Colgate-Palmolive Co.

AMCINONIDE

Therapeutic Function: Topical steroid; antiinflammatory agent

Chemical Name: 16 α ,17 α -Cyclopentylidenedioxy-9 α -fluoro-11 β ,21-dihydroxy-1,4-pregnadiene-3,20-dione-21-acetate

Common Name: Amcinopol

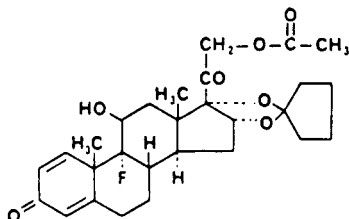
Structural Formula:

Chemical Abstracts Registry No.: 51022-69-6

Trade Name	Manufacturer	Country	Year Introduced
Cyclocort	Lederle	U.S.	1979
Amcinonid	Cyanamid	W. Germany	1981
Visderm	Lederle	Japan	1982
Penticort	Lederle	France	—
Mycoderm	Lederle	—	—

Raw Materials

16 α ,17 α -Cyclopentylidenedioxy-9 α -fluoro-11 β ,21-dihydroxy-1,4-pregnadiene-3,20-dione
Acetic Anhydride

Manufacturing Process

An 11.1 g (24.1 mmol) portion of the compound 16 α ,17 α -cyclopentylidenedioxy-9 α -fluoro-11 β ,21-dihydroxy-1,4-pregnadiene-3,20-dione is placed in a 250 ml round-bottom flask. A 100 ml portion of pyridine is added and the mixture is stirred to a complete solution. A 5.5 ml (54.6 mmol) portion of acetic anhydride is added dropwise and the mixture is stirred for 2½ hours. An 11 ml portion of methanol is added and the mixture is stirred an additional hour. This mixture is concentrated under reduced pressure to about 10 to 15 ml and then poured slowly into a mixture of ice, water and dilute hydrochloric acid. This mixture is stirred and the solid which forms is collected by filtration, washed with water to a neutral pH and air dried yielding 11.5 g. This solid is taken up in hot acetone, treated with activated charcoal and filtered while hot through diatomaceous earth. The filtrate is concentrated on a steam bath while adding n-hexane to the point of incipient crystallization. This mixture is allowed to cool to room temperature. The solid which forms is collected by filtration, washed with acetone-n-hexane (1:14) and air dried yielding 7.0 g of the desired product.

References

Merck Index 389
DFU 3 (5) 337 (1978)
Kleeman & Engel p. 36
PDR p. 1007
DOT 16 (10) 322 (1980)
I.N. p. 65
REM p. 972
Schultz, W., Sieger, G.M. and Krieger, C.; British Patent 1,442,925; July 14, 1976; assigned to American Cyanamid Company.

AMEZINIUM METHYL SULFATE

Therapeutic Function: Antihypertensive

Chemical Name: 4-Amino-6-methoxy-1-phenylpyridazinium methyl sulfate

Common Name: —

Structural Formula:

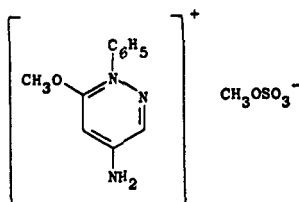

Chemical Abstracts Registry No.: 30578-37-1

Trade Name	Manufacturer	Country	Year Introduced
Regulton	Nordmark	W. Germany	1981
Regulton	Knoll	Switz.	1983

Raw Materials

1-Phenyl-4-aminopyridazone
Dimethyl Sulfate

Manufacturing Process

18.7 parts of 1-phenyl-4-aminopyridazone-(6) and 19 parts of dimethyl sulfate in 400 parts of xylene are kept at 120°C for one hour while mixing well. The reaction mixture is suction filtered, 28 parts (89.5% of the theory) of 1-phenyl-4-amino-6-methoxy-pyridazinium metho-sulfate is obtained having a melting point of 173° to 174°C after recrystallization from aceto-nitrile. The perchlorate has a melting point of 179° to 182°C.

References

Merck Index 395

DFU 5 (4) 207 (1980)

DOT 18 (7) 317 (1982)

I.N. p. 66

Reicheneder, F. and Kropp, R.; U.S. Patent 3,631,038; December 28, 1971; assigned to Badische Anilin und Soda-Fabrik A.G.

AMIKACIN

Therapeutic Function: Antibacterial

Chemical Name: (S)-O-3-amino-3-deoxy- α -D-glucopyranosyl-(1 \rightarrow 6)-O-[6-amino-6-deoxy- α -D-glucopyranosyl-(1 \rightarrow 4)]-N¹-(4-amino-2-hydroxy-1-oxobutyl)-2-deoxy-D-streptamine

Common Name: 1-N-[L(-)-4-amino-2-hydroxybutyryl] kanamycin A

Structural Formula:

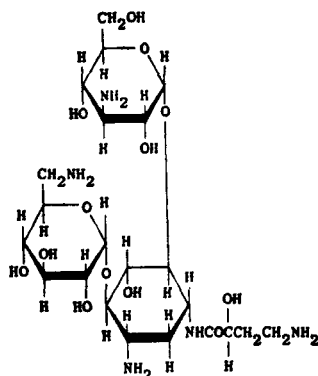

Chemical Abstracts Registry No.: 37517-28-5; 39831-55-5 (Sulfate)

Trade Name	Manufacturer	Country	Year Introduced
Amikin	Bristol	U.S.	1976
Amiklin	Bristol	France	1976
Biklin	Gruenthal	W. Germany	1976
Amikin	Bristol	U.K.	1976
Biklin	Bristol Banyu	Japan	1977
BB-K8	Bristol	Italy	1978
Amiglyde-V	Bristol	—	—
Amisin	Faro	Turkey	—
Biklin	Frika	Austria	—
Briclin	Mead-Johnson	—	—
Kaminax	Ausonia	Italy	—
Likacin	Lisapharma	Italy	—
Novamin	Bristol	—	—
Amikacin	Banyu-Seiyaku	Japan	—

Raw Materials

L-(-)- γ -Amino- α -hydroxybutyric Acid	Sodium Hydroxide
N-hydroxysuccinimide	Carbonyloxy Chloride
6'-Monobenzyloxy-carbonyl-kanamycin A	Hydrogen
Sulfuric Acid	

Manufacturing Process

Preparation of L-(-)- γ -Benzyloxycarbonylamino- α -Hydroxybutyric Acid: L-(-)- γ -amino- α -hydroxybutyric acid (7.4 g, 0.062 mol) was added to a solution of 5.2 grams (0.13 mol) of sodium hydroxide in 50 ml of water. To the stirred solution was added dropwise at 0°-5°C over a period of 0.5 hour, 11.7 grams (0.068 mol) of carbonyloxy chloride and the mixture was stirred for another hour at the same temperature. The reaction mixture was washed with 50 ml of ether, adjusted to pH 2 with dilute hydrochloric acid and extracted with four 80 ml portions of ether. The ethereal extracts were combined, washed with a small amount of saturated sodium chloride solution, dried with anhydrous sodium sulfate and filtered. The filtrate was evaporated in vacuo and the resulting residue was crystallized from benzene to give 11.6 grams (74%) of colorless plates; MP 78.5° to 79.5°C.

Preparation of N-Hydroxysuccinimide Ester of L-(-)- γ -Benzyloxycarbonylamino- α -Hydroxybutyric Acid: A solution of 10.6 grams (0.042 mol) of L-(-)- γ -benzyloxycarbonylamino- α -hydroxybutyric acid and 4.8 grams (0.042 mol) of N-hydroxysuccinimide in 200 ml of

ethyl acetate was cooled to 0°C and then 8.6 grams (0.042 mol) of dicyclohexylcarbodiimide was added. The mixture was kept overnight in a refrigerator. The dicyclohexylurea which separated was filtered off and the filtrate was concentrated to about 50 ml under reduced pressure to give colorless crystals of L-(-)- γ -benzyloxycarbonylamino- α -hydroxybutyric acid which were collected by filtration; 6.4 grams, MP 121°-122.5°C. The filtrate was evaporated to dryness in vacuo and the crystalline residue was washed with 20 ml of a benzene-n-hexane mixture to give an additional amount of L-(-)- γ -benzyloxycarbonylamino- α -hydroxybutyric acid. The total yield was 13.4 grams (92%).

Preparation of 1-[L-(-)- γ -Benzyloxycarbonylamino- α -Hydroxybutyryl]-6'-Carbobenzoxykanamycin A: A solution of 1.6 grams (4.6 mmol) of L-(-)- γ -benzyloxycarbonylamino- α -hydroxybutyric acid in 40 ml of ethylene glycol dimethyl ether (DME) was added dropwise to a stirred solution of 2.6 grams (4.2 mmol) of 6'-monobenzyloxycarbonylkanamycin A in 40 ml of 50% aqueous ethylene glycol dimethyl ether and the mixture was stirred overnight. The reaction mixture was evaporated under reduced pressure to give a brown residue 1-[L-(-)- γ -benzyloxycarbonylamino- α -hydroxybutyryl]-6'-carbobenzoxykanamycin A which was used for the next reaction without further purification.

Preparation of 1-[L-(-)- γ -Amino- α -Hydroxybutyryl] Kanamycin A: The crude product 1-[L-(-)- γ -benzyloxycarbonylamino- α -hydroxybutyryl]-6'-carbobenzoxykanamycin A was dissolved in 40 ml of 50% aqueous dioxane and a small amount of insoluble material was removed by filtration. To the filtrate was added 0.8 ml of glacial acetic acid and 1 gram of 10% palladium-on-charcoal and the mixture was hydrogenated at room temperature for 24 hours in a Parr hydrogenation apparatus. The reaction mixture was filtered to remove the palladium catalyst and the filtrate was evaporated to dryness in vacuo.

The residue was dissolved in 30 ml of water and chromatographed on a column of CG-50 ion exchange resin (NH₄⁺ type, 50 cm x 1.8 cm). The column was washed with 200 ml of water and then eluted with 800 ml of 0.1 N NH₄OH, 500 ml of 0.2 N NH₄OH and finally 500 ml of 0.5 N NH₄OH. Ten milliliter fractions were collected and fractions 146 to 154 contained 552 mg (22%, based on carbobenzoxykanamycin A, 6'-monobenzyloxycarbonylkanamycin A) of the product which was designated BB-K8 lot 2. MP 187°C (dec). Relative potency against *B. subtilis* (agar plate) = 560 mcg/mg (standard: kanamycin A free base).

A solution of 250 mg of BB-K8 lot 2 in 10 ml of water was subjected to chromatography on a column of CG-50 (NH₄⁺ type, 30 cm x 0.9 cm). The column was washed with 50 ml of water and then eluted with 0.2 N NH₄OH. Ten milliliter fractions were collected. Fractions 50 to 63 were combined and evaporated to dryness under reduced pressure to give 98 mg of the pure product base.

Preparation of the Monosulfate Salt of 1-[L-(-)- γ -Amino- α -Hydroxybutyryl] Kanamycin A: One mol of 1-[L-(-)- γ -amino- α -hydroxybutyryl] kanamycin A is dissolved in 1 to 3 liters of water. The solution is filtered to remove any undissolved solids. To the chilled and stirred solution is added one mol of sulfuric acid dissolved in 500 ml of water. The mixture is allowed to stir for 30 minutes, following which cold ethanol is added to the mixture till precipitation occurs. The solids are collected by filtration and are determined to be the desired monosulfate salt.

References

- Merck Index 405
 Kleeman & Engel p. 38
 PDR p. 692
 DOT 12 (5) 202 (1976)
 I.N. p. 68
 REM p. 1180
 Kawaguchi, H., Naito, T. and Nakagawa, S.; U.S. Patent 3,781,268; December 25, 1973; assigned to Bristol-Myers Company.

Schreiber, R.H. and Kell, J.G.; U.S. Patent 3,974,137; August 10, 1976; assigned to Bristol-Myers Company.

AMILORIDE HYDROCHLORIDE

Therapeutic Function: Potassium-sparing diuretic

Chemical Name: 3,5-Diamino-N-(aminoiminomethyl)-6-chloropyrazine carboxamide

Common Name: Guanampazine; amipramidin; amipramizide

Structural Formula:

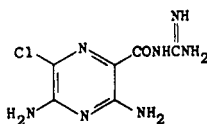

Chemical Abstracts Registry No.: 2016-88-8, 2609-46-3 (Base)

Trade Name	Manufacturer	Country	Year Introduced
Midamor	Merck	U.K.	1971
Modamide	Merck	France	1973
Arumil	Sharp & Dohme	W. Germany	1975
Midamor	Merck	U.S.	1981
Colectril	Merck	U.S.	—
Moducren	Dohme-Chibret	France	—
Moduretic	Merck	—	—
Nilurid	Merck	—	—
Pandiuren	Sintyal	Argentina	—
Puritrid	Leiras	Finland	—

Raw Materials

Methyl-3-aminopyrazinoate	Sodium
Sulfuryl Chloride	Guanidine
Ammonia	Hydrogen Chloride

Manufacturing Process

Step A: Preparation of methyl 3-amino-5,6-dichloropyrazinoate—Methyl 3-aminopyrazinoate (765 g, 5 mols) is suspended in 5 liters of dry benzene. While stirring under anhydrous conditions sulfuryl chloride (1.99 liters, 3,318 g, 24.58 mols) is added over a period of 30 minutes and stirring is continued for 1 hour. During this period, the temperature rises to about 50°C and then begins to drop. The mixture is heated cautiously to reflux (60°C), refluxed for 5 hours and then stirred overnight at room temperature. The excess sulfuryl chloride is distilled off at atmospheric pressure (distillation is stopped when vapor temperature reaches 78°C). The dark red mixture is chilled to 6°C. The crystals are filtered off, washed by displacement with two 100 ml portions of cold (8°C) benzene, then washed with 300 ml petroleum ether and dried in vacuo at room temperature, yielding 888 g (80%) of methyl 3-amino-5,6-dichloropyrazinoate in the form of red crystals, MP 228°–230°C. The crude product is dissolved in 56 liters of boiling acetonitrile and passed through a heated (70°–80°C) column of decolorizing charcoal (444 g). The column is washed with 25 liters of hot acetonitrile, the combined eluate concentrated in vacuo to about 6 liters and chilled to 5°C. The crystals that form are filtered, washed three times with cold acetonitrile, and air dried to constant weight, yielding

724 g (82% recovery, 66% overall) of methyl 3-amino-5,6-dichloropyrazinoate in the form of yellow crystals, MP 230°-234°C. After additional recrystallizations from acetonitrile the product melts at 233°-234°C.

Step B: Preparation of methyl 3,5-diamino-6-chloropyrazinoate—In a 2-liter, 3-necked flask fitted with a mechanical stirrer, thermometer and gas inlet tube is placed dry dimethyl sulfide (1 liter). Methyl 3-amino-5,6-dichloropyrazinoate (100 g, 0.45 mol) is added and the mixture stirred and heated at 65°C on a steam bath until solution is effected. A stream of dry ammonia gas is admitted to the solution with continuous stirring, over a period of 45 minutes while the temperature is maintained at 65°-70°C. The solution is cooled to about 10°C with continuous stirring and ammonia gas is admitted for an additional 1½ hours. The yellow reaction mixture is poured, with stirring, into cold water (2 liters) and the light yellow solid that separates is removed by filtration, thoroughly washed with water, and dried in a vacuum desiccator to give 82.5 g (91%) of methyl 3,5-diamino-6-chloropyrazinoate, MP 210°-212°C. Recrystallization from acetonitrile gives material melting at 212°-213°C.

Step C: Preparation of the base—A 300 ml one-necked, round-bottomed flask, equipped with a water-cooled condenser, calcium chloride tube and magnetic stirrer is charged with anhydrous methanol (150 ml) and sodium metal (5.75 g, 0.25 g atom). When the reaction is complete, the solution is treated with dry guanidine hydrochloride (26.3 g, 0.275 mol) and stirred for 10 minutes. The sodium chloride that forms is removed by filtration. The solution is concentrated in vacuo to a volume of 30 ml and the residue treated with the product of Step B, heated one minute on a steam bath and kept at 25°C for 1 hour. The product is filtered, washed well with water, dissolved in dilute hydrochloric acid and the free base precipitated by addition of sodium hydroxide to give the amiloride product base, a solid which melts at 240.5°-241.5°C.

To produce the hydrochloride, the base is suspended in water (70 ml) and treated with sufficient 6 N hydrochloric acid to dissolve the free base. The solution is filtered and treated with concentrated hydrochloric acid (5 ml). The hydrochloride salt (2.2 g, 97%) separates and is recrystallized from water (50 ml) containing concentrated hydrochloric acid (3 ml).

References

Merck Index 406

Kleeman & Engel p. 40

PDR p. 1199

OCDS Vol. 1 p. 278 (1977)

DOT 19 (3) 172 (1983)

I.N. p. 69

REM p. 941

Cragoe, E.J., Jr.; U.S. Patent 3,313,813; April 11, 1967; assigned to Merck & Co., Inc.

AMINEPTINE HYDROCHLORIDE

Therapeutic Function: CNS Stimulant

Chemical Name: 7-[[10,11-Dihydro-5H-dibenzo[a,d]cyclohepten-5-yl-amino]heptanoic acid hydrochloride

Common Name: —

Structural Formula:

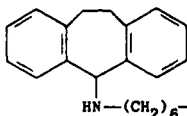

(base)

Chemical Abstracts Registry No.: 57574-09-1 (Base); 30272-08-3 (Hydrochloride)

Trade Name	Manufacturer	Country	Year Introduced
Survector	Eutherapie	France	1978
Survector	Servier	Italy	1982
Maneon	Poli	Italy	1982

Raw Materials

5-Chloro-10,11-dihydro-5H-dibenzo(a,d)cycloheptene
Ethyl 7-aminoheptanoate

Manufacturing Process

6.5 g of 5-chloro-10,11-dihydro-5H-dibenzo(a,d)cycloheptene in 60 ml of nitromethane and 10.8 g of ethyl 7-aminoheptanoate in 12 ml of nitromethane were mixed at ambient temperature. The reaction was slightly exothermic. The reaction mixture was left to stand overnight and the solvent was evaporated in vacuo. The residue was taken up in normal hydrochloric acid and the resulting precipitate was filtered off.

10.5 g of crude ethyl 7-[dibenzo(a,d)cycloheptadiene-5-yl] aminoheptanoate hydrochloride were obtained, of which a sample recrystallized from benzene gave a pure product melting instantaneously at 166° to 168°C.

The hydrochloride of the crude ester obtained above was added to 25 ml of 2 N hydrochloric acid. The whole was kept under reflux for 2 hours. The material dissolved and a new hydrochloride then reprecipitated. After cooling, the hydrochloride of the crude acid was filtered off, washed with iced water and then recrystallized from distilled water. 5.7 g of 7-[dibenzo(a,d)cycloheptadien-5-yl] aminoheptanoic acid hydrochloride were obtained, melting instantaneously at 226° to 230°C.

References

Merck Index 409

Kleeman & Engel p. 40

DOT 19 (10) 547 (1983)

I.N. p. 69

Melen, C., Danree, B. and Poignant, J.C.; U.S. Patent 3,758,528; September 11, 1973; assigned to Societe en nom Collectif Science Union et Cie; Societe Francaise de Recherche Medicale
Melen, C., Danree, B. and Poignant, J.C.; U.S. Patent 3,821,249; June 28, 1974; assigned to Societe en nom Collectif Science Union et Cie; Societe Francaise de Recherche Medicale

AMINOBENZOIC ACID

Therapeutic Function: Sunscreen agent, antirickettsial

Chemical Name: p-aminobenzoic acid

Common Name: Vitamin H, Vitamin B_x, PABA

Structural Formula:

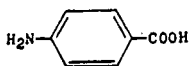

Chemical Abstracts Registry No.: 150-13-0

Trade Name	Manufacturer	Country	Year Introduced
Pabalate	Robins	U.S.	1949
Ambin	—	—	—
Hechemina	Medea	Spain	—
Pabacyd	—	—	—
Pabafilm	Owen	U.S.	—
Pabagel	Owen	U.S.	—
Pabanol	Elder	U.S.	—
Pabasin	—	—	—
Paraminol	—	—	—
Potaba	Westwood	U.S.	—
Pre-Sun	Westwood	U.S.	—
Sunbrella	Dorsey	U.S.	—

Raw Materials

Xylene
Ammonium Sulfate
Sodium Hypochlorite

Manufacturing Process

The following example illustrates in detail the preparation of amino benzoic acids from the hot reaction product obtained by the oxidation of a xylene and containing a mixture of salt, amide salt and diamide of a phthalic acid.

800 cc of hot aqueous oxidation product, obtained from the oxidation of para-xylene with ammonium sulfate, hydrogen sulfide and water are boiled and agitated for 4 hours to remove carbon dioxide, hydrogen sulfide and ammonia, sufficient water being added to maintain a constant volume. The mixture is filtered to remove a precipitate containing elemental sulfur. 12 grams of activated charcoal are added to the filtrate and the mixture held at a temperature of 180°F for 20 minutes. Filtration through diatomaceous earth removes color bodies formed during the oxidation process and yields a pale yellow filtrate. The filtrate is acidified with sulfuric acid to a pH of 3 or less to precipitate approximately 49 grams of white solid, comprising a mixture of terephthalic acid and amides of terephthalic acid, which are removed by filtration. This solid is then washed with water at 200°F and redissolved in 200 cc of water containing 28.6 grams of sodium hydroxide.

A mixture of sodium hypochlorite and sodium hydroxide is prepared by adding 27.5 grams of chlorine to a vessel equipped with cooling means and containing a solution of 50 grams of sodium hydroxide in 375 cc of water, thereafter adding sufficient water to produce 500 cc of solution. 190 cc of this cold solution are slowly added to the acid-amide solution previously prepared so as to keep the temperature of the mixture below 55°F. The mixture is stirred for 15 minutes and then heated rapidly to 200°F and maintained at that temperature for one hour. 2 grams of sodium thiosulfate are added to consume excess sodium hypochlorite. The solution is acidified to a pH of 3 or less and filtered hot. The filter cake, comprising about 26.9 grams of terephthalic acid, is then suspended in 300 cc of dilute sulfuric acid of pH about 2, heated to 200°F and filtered hot.

The filtrates are combined, cooled, and extracted with three successive 200 cc portions of ether. The pH of the filtrate is then raised to 3.5 with sodium hydroxide and the filtrate extracted with six successive 200 cc portions of ether to yield the balance of the product. The crude para-aminobenzoic acid product is recovered by evaporation of ether and is suspended in hot benzene, cooled and filtered to remove benzoic and toluic acids together with small amounts of impurities soluble in the filtrate. Recrystallization of the product from 200 cc of water yields 14.5 grams of light tan needles of para-aminobenzoic acid having an acid number of 411 (theoretical value 409).

Aminobenzoic acid can be then purified and decolorized by a process described in U.S. Patent 2,735,865.

References

Merck Index 423

PDR pp. 926, 1894

I.N. p. 1012

REM p. 787

Toland, W.G. and Heaton, C.D.; U.S. Patent 2,878,281; March 17, 1959; assigned to California Research Corporation

Spiegler, L.; U.S. Patent 2,947,781; August 2, 1960; assigned to E.I. Du Pont de Nemours and Company

Lyding, A.R.; U.S. Patent 2,735,865; February 21, 1956; assigned to Heyden Chemical Corporation

AMINOCAPROIC ACID**Therapeutic Function:** Antifibrinolytic**Chemical Name:** 6-aminohexanoic acid**Common Name:** Epsilcapramin**Structural Formula:** $\text{H}_2\text{N}(\text{CH}_2)_5\text{COOH}$ **Chemical Abstracts Registry No.:** 60-32-2

Trade Name	Manufacturer	Country	Year Introduced
Epsilon	Roche	W. Germany	1962
Epsilon-Aminoca	Roche	W. Germany	1962
Capramol	Choay	France	1963
Amicar	Lederle	U.S.	1964
Epsikapron	Kabi Vitrum	U.K.	1967
Acikaprin	Polfa	Poland	—
Amicar	Lederle	U.S.	—
Capracid	Kabi Vitrum	Sweden	—
Capracid	Bonomelli-Hommel	Italy	—
Capralense	Choay	France	—
Capramol	Italfarmaco	Italy	—
Caprolisin	Malesci	Italy	—
EACA	Kabi Vitrum	Sweden	—
Ekaprol	Difrex	Australia	—
Epsilon	Star	Finland	—
Hemocaprol	Delagrangé	France	—
Capusumine	Nichiiko	Japan	—
Hemotin	Hokuriku	Japan	—
Ipsilon	Daiichi	Japan	—
Resplamin	Kyorin	Japan	—

Raw Materials

Caprolactam

Water

Manufacturing Process

5 kg of caprolactam were heated with 40 liters of water in a pressure vessel at 250°C for

a period of four hours. These quantities of reactants correspond to a water:lactam molecular ratio of 50:1. After cooling, the small quantity of the nonsoluble substance that is formed is filtered off, and the filtrate is evaporated as far as possible. The resulting concentrate is mixed with three times its volume of strong alcohol, thereby causing the desired product, epsilon-aminocaproic acid (6-aminohexanoic acid), to crystallize out. After separating the crystalline product thus obtained, a further quantity of epsilon-aminocaproic acid can be obtained from the mother liquid if desired.

References

Merck Index 433

Kleeman & Engel p. 41

PDR pp. 872, 997

I.N. p. 13

REM p. 831

Koch, T.; U.S. Patent 2,453,234; November 9, 1948; assigned to American Enka Corporation

AMINOGLUTETHIMIDE

Therapeutic Function: Cytostatic

Chemical Name: 3-(4-Aminophenyl)-3-ethyl-2,6-piperidinedione

Common Name: α -(p-aminophenyl)- α -ethyl-glutarimide

Structural Formula:

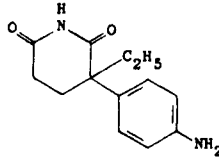

Chemical Abstracts Registry No.: 124-84-8

Trade Name	Manufacturer	Country	Year Introduced
Ellipten	Ciba	U.S.	1960
Cytadren	Ciba-Geigy	U.S.	1980
Orimeten	Ciba-Geigy	Switz.	1981
Orimeten	Ciba-Geigy	U.K.	1982

Raw Materials

α -Phenyl- α -ethyl Glutarimide

Nitric Acid

Hydrogen

Manufacturing Process

The α -(p-nitrophenyl)- α -ethyl-glutarimide starting material can be prepared as follows: 217 g of α -phenyl- α -ethyl-glutarimide are dissolved in 800 g of concentrated sulfuric acid with subsequent cooling to about -10°C and nitration is carried out at -10° to $+10^{\circ}\text{C}$ by slow addition of a mixed acid consisting of 110 g of concentrated sulfuric acid and 110 g of 63% nitric acid. The nitration solution is stirred into ice, the separated nitro compound taken up in methylene or ethylene chloride, the solution washed with water and sodium carbonate solution until

neutral and the solvent evaporated under vacuum. The residue is crystallized from methanol or ethyl acetate, whereby a yellowish crystal powder of MP 128°-136°C is obtained in a yield of about 85% which consists for the most part of α -(p-nitrophenyl)- α -ethyl-glutarimide. By recrystallization from methanol the pure p-nitrophenyl compound is obtained of MP 137°-139°C. From the residues of the mother liquors a small quantity of the isomeric α -(o-nitrophenyl)- α -ethyl-glutarimide of MP 170°-172°C can be obtained.

26.2 g of α -(p-nitrophenyl)- α -ethyl-glutarimide of MP 137°-139°C dissolved in ethyl acetate, are reduced in the presence of nickel with hydrogen in a shaking flask at 50°-70°C until the absorption of hydrogen falls off. The catalyst is then filtered off with suction and the solution concentrated and cooled, as a result of which colorless crystals of MP 146°-149°C are obtained. Recrystallization from methanol gives pure α -(p-aminophenyl)- α -ethyl-glutarimide of MP 149°-150°C (yield 97%).

Instead of ethyl acetate another solvent can be used in the above reduction, such as methanol or ethanol.

The hydrochloride of MP 223°-225°C is obtained by dissolving the base with alcohol and the corresponding quantity of hydrochloric acid gas in the hot with subsequent cooling of the solution. Colorless crystals are formed of MP 223°-225°C, which are easily soluble in water.

References

Merck Index 443

PDR p. 794

OCDS Vol. 1 p. 257 (1977)

I.N. p. 71

REM p. 1143

Hoffmann, K. and Urech, E.; U.S. Patent 2,848,455; August 19, 1958; assigned to Ciba Pharmaceutical Products, Inc.

AMINOMETRADINE

Therapeutic Function: Diuretic

Chemical Name: 6-Amino-3-ethyl-1-(2-propenyl)-2,4(1H,3H)-pyrimidinedione

Common Name: Aminometramide

Structural Formula:

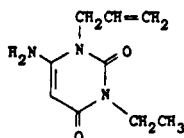

Chemical Abstracts Registry No.: 642-44-4

Trade Name	Manufacturer	Country	Year Introduced
Mincard	Searle	U.S.	1954
Mictine	Searle	—	—

Raw Materials

Monoallyl Urea

Cyanoacetic Acid

Sodium Hydroxide

Diethyl Sulfate

Manufacturing Process

85 parts of monoallylurea are dissolved in 105 parts of acetic anhydride, and 85 parts of cyanoacetic acid are added gradually and the mixture is maintained at 65°C for 2.5 hours. The mixture is distilled at 20 mm until a syrup remains. 50 parts of water are added to this syrup and distillation is resumed. The resulting syrup is dissolved in 96% ethanol at 60°C, stirred with charcoal and filtered. One to one and one-half volumes of ether are added to the filtrate at 40°C. Upon cooling the N-cyanoacetyl-N'-allylurea precipitates. It is collected on a filter and washed with ether. The white crystals melt at about 142°-143°C. The N-cyanoacetyl-N'-allylurea is dissolved by warming with 10% sodium hydroxide. Sufficient 70% sodium hydroxide is added to raise the pH to 10. The solution is maintained at 60°C for five minutes. After cooling the crystals are collected on a filter and recrystallized from water. 1-allyl-6-amino-1,2,3,4-tetrahydro-2,4-pyrimidinedione is obtained in the form of white crystals melting at 270°-272°C.

334 parts of 1-allyl-6-amino-1,2,3,4-tetrahydro-2,4-pyrimidinedione are dissolved in a solution of 88 parts of sodium hydroxide in 1,100 parts of water. While this mixture is stirred rapidly at 50°C, 430 parts of diethyl sulfate are added in the course of 30 minutes. Stirring is continued at 50°-55°C for one hour longer, and an alkaline reaction is maintained by occasional additions of small portions of 20% aqueous sodium hydroxide solution, about 300 parts in all being required. On cooling, the 1-allyl-3-ethyl-6-amino-1,2,3,4-tetrahydro-2,4-pyrimidinedione separates as the monohydrate; it is filtered off, washed with cold water, and recrystallized from water containing a small amount of sodium hydroxide to hold in solution any unreacted 1-allyl-6-amino-1,2,3,4-tetrahydro-2,4-pyrimidinedione. The air dried product thus obtained contains 1 mol of crystal water and melts over a wide range with dehydration at 75°-115°C. After dehydration by treatment with anhydrous ether, the anhydrous 1-allyl-3-ethyl-6-amino-1,2,3,4-tetrahydro-2,4-pyrimidinedione melts sharply at about 143°-144°C.

References

Merck Index 455

OCDS Vol. 1 p. 265 (1977)

I.N. p. 72

Papesch, V. and Schroeder, E.F.; U.S. Patent 2,650,922; September 1, 1953; assigned to G.D. Searle & Co.

AMINOPENTAMIDE

Therapeutic Function: Anticholinergic

Chemical Name: 4-(Dimethylamino)-2,2-diphenylvaleramide

Common Name: Dimevamide

Structural Formula:

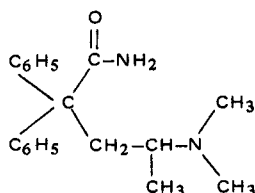

Chemical Abstracts Registry No.: 60-46-8

Trade Name	Manufacturer	Country	Year Introduced
Centrine	Bristol	U.S.	1953

Raw Materials

α,α -Diphenyl- γ -dimethylamino Valeronitrile
Hydroxylamine Hydrochloride

Manufacturing Process

A mixture of 14 g (0.05 mol) of α,α -diphenyl- γ -dimethylaminovaleronitrile, 16 g (0.2 mol) of sodium acetate, 14 g (0.2 mol) of hydroxylamine hydrochloride and 75 ml of ethyl alcohol was refluxed 18 hours. The mixture was cooled, poured into water and neutralized with ammonium hydroxide. The heavy white precipitate solidified on standing. The material was filtered and recrystallized from isopropanol. After three recrystallizations the aminopentamide product melted at 177° to 179°C.

The product is often used as the acid sulfate which is produced as follows: 252.0 g (0.85 mol) of α,α -diphenyl- γ -dimethylaminovaleramide was dissolved in one liter of isopropanol, and 70 ml of concentrated sulfuric acid was added as rapidly as possible. The mixture was heated until clear, then filtered and diluted with 1,500 ml of anhydrous ethyl acetate. The solution was cooled and filtered, and the white crystalline product was dried in vacuo over P₂O₅.

References

Merck Index 463

I.N. p. 342

Specter, M.E.; U.S. Patent 2,647,926; August 4, 1953; assigned to Bristol Laboratories, Inc.

AMINOSALICYLIC ACID

Therapeutic Function: Antitubercular

Chemical Name: 4-amino-2-hydroxybenzoic acid

Common Name: —

Structural Formula:

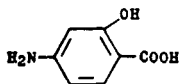

Chemical Abstracts Registry No.: 65-49-6

Trade Name	Manufacturer	Country	Year Introduced
Pamisyl	Parke David	U.S.	1948
Parasal	Panray	U.S.	1950
Rexipas	Squibb	U.S.	1954
Aminacyl	Wander	U.K.	—
B-Pas	Salvoxy-Wander	France	—
Enseals	Lilly	U.S.	—
Nemasol	I.C.N.	Canada	—
Neopasalate	Mallinckrodt	U.S.	—
Panacyl	Pharma Rheinpreussen	W. Germany	—
Paramisan	Smith & Nephew	U.K.	—
Para-Pas	Gold Leaf	U.S.	—
Pas	Sumitomo	Japan	—

Trade Name	Manufacturer	Country	Year Introduced
Pasido	Ferrosan	Sweden	—
Propasa	Merck Sharp & Dohme	—	—
Rezipas	Squibb	U.S.	—
Sanpas	Sanyo	Japan	—
Sta-Pas	Debat	France	—
Tebacin Acid	Consol, Midland	U.S.	—

Raw Materials

Sodium p-aminosalicylate
 m-Aminophenol
 Ammonium Carbonate

Manufacturing Process

As described in U.S. Patent 427,564, aminosalicylic acid may be prepared from m-amino-phenol by heating with ammonium carbonate in solution under pressure.

Alternatively, aminosalicylic acid may be made from sodium p-aminosalicylate as described in U.S. Patent 2,844,625 as follows: 196 grams of commercial sodium para-aminosalicylate (18.5% H₂O) was dissolved in 196 ml of water and 150 ml of isopropanol. 6 grams of sodium bisulfite was dissolved in the solution and the solution filtered. While stirring and keeping the temperature between 25°-31°C, seven grams of 85% formic acid and 27.5 grams of 95% sulfuric acid in 150 ml of water was added during 1½ hours. The mixture was stripped 1 hour longer, cooled to 23°C and filtered. The filter cake was washed with 100 cubic centimeters of water, further washed with 100 cc of 25% isopropanol and 100 cc of water, and vacuum dried to constant weight at 45°-50°C. Weight of p-amino-salicylic acid was 76.5 grams (92.7% yield) exhibiting a bulk density of 47 cc/oz.

References

Merck Index 485

Kleeman & Engel p. 43

I.N. p. 74

REM p. 1213

Gnehm, R. and Schmid, J.; U.S. Patent 427,564; May 13, 1890

Centolella, A.P.; U.S. Patent 2,844,625; July 22, 1958; assigned to Miles Laboratories, Inc.

Doub, L.; U.S. Patent 2,540,104; February 6, 1951; assigned to Parke Davis & Co.

AMIODARONE HYDROCHLORIDE

Therapeutic Function: Coronary vasodilator

Chemical Name: (2-butyl-3-benzofuranyl)[4-[2-diethylamino)ethoxy]-3,5-diiodophenyl]-methanone hydrochloride

Common Name: —

Structural Formula:

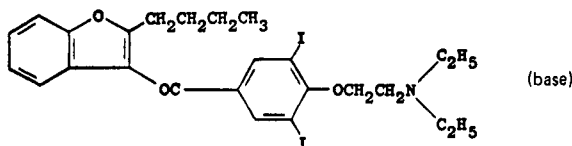

Chemical Abstracts Registry No.: 1951-25-3 (Base)

Trade Name	Manufacturer	Country	Year Introduced
Cordarone	Labaz	France	1968
Cordarone	Sigma Tau	Italy	1971
Cordarone X	Labaz	U.K.	1980
Cordarone	Labaz	Switz.	1981
Cordarexne	Labaz	W. Germany	1982
Amiodacore	C.T.S.	Israel	—
Atlansil	Roemmers	Argentina	—
Miodarone	Biosintetica	Brazil	—
Procor	Unipharm	Israel	—
Ritmocardyl	Bago	Argentina	—
Trangorex	Labaz	—	—
Uro-Septra	Biosintetica	Brazil	—

Raw Materials

2-n-Butyl-3-(3,5-diiodo-4-hydroxybenzoyl)benzofuran
Sodium Methoxide
 β -Diethylaminoethyl Chloride

Manufacturing Process

135 grams of 2-n-butyl-3-(3,5-diiodo-4 hydroxybenzoyl)benzofuran dissolved in 600 cc of ethyl carbonate were treated with 5.7 grams of sodium in the form of sodium methoxide in methanol. Then, β -diethylaminoethyl chloride which had been obtained from 51.6 grams of the hydrochloride in ethyl carbonate was introduced into a suspension of the sodium salt. The mixture was heated to a temperature of approximately 90°C which was maintained for approximately 2 hours. The mixture was cooled and allowed to stand overnight during which time the sodium chloride settled down.

The toluene solution containing diethylaminoethylether was extracted with increasingly diluted aqueous hydrochloric acid solutions while stirring. Extraction was continued until the alkalized solution produced no further precipitate. The combined aqueous solutions were washed with ether and then made strongly alkaline with aqueous sodium hydroxide. Extraction with ether was carried out three times. The organic layers were washed with water and then dried over anhydrous potassium carbonate. In order to produce the hydrochloride, the carbonate was filtered off and then the hydrochloride was precipitated from the ether solution with an ethereal hydrochloric acid solution. After the solution had been allowed to stand for a few hours, decantation was carried out and the syrupy hydrochloride residue was taken up in 500 cc of boiling acetone. The salt crystallized out by cooling. The substance was allowed to stand overnight at 0°C, and centrifuged, washed with ethyl acetate and then with ether and dried. 130 grams of 2-n-butyl-3-(3,5-diiodo-4- β -N-diethylaminoethoxybenzoyl)benzofuran hydrochloride in the form of a crystalline powder which melts at 156°C were obtained.

References

- Merck Index 491
DOT 5 (4) 123 (1969)
Tondeur, R. and Binon, F.; U.S. Patent 3,248,401; April 26, 1966; assigned to Societe Beige de l'Azote et des Produits Chimiques du Marly, SA, Belgium
- Kleeman & Engel p. 43
I.N. p. 75

AMISOMETRADINE

Therapeutic Function: Diuretic

Chemical Name: 6-Amino-3-methyl-1-(2-methyl-2-propenyl)-2,4(1H,3H)-pyrimidinedione

Common Name: —

Structural Formula:

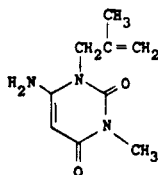

Chemical Abstracts Registry No.: —

Trade Name	Manufacturer	Country	Year Introduced
Rolicton	Searle	U.S.	1956

Raw Materials

Methallylamine	Cyanoacetic Acid
Methyl Isocyanate	Sodium Hydroxide

Manufacturing Process

Preparation of the ethyl analog is as follows (methyl isocyanate is used in amisometradine manufacture).

To a cooled and stirred solution of 142 parts of methallylamine in 900 parts of benzene, 156 parts of ethyl isocyanate are added dropwise. Upon concentration in vacuum N-ethyl-N'-methallylurea is obtained.

260 parts of this urea derivative are dissolved in 500 parts of acetic anhydride and treated with 157 parts of cyanoacetic acid at 60°C and heated at that temperature for 2 hours. The solution is then concentrated in vacuum to a syrup. 100 parts of water are added and the vacuum distillation is repeated. The remaining syrup contains a mixture of N-cyanoacetyl-N-ethyl-N'-methallylurea and a small quantity of N-cyanoacetyl-N-methallyl-N'-ethylurea.

This syrup is treated with sufficient 20% sodium hydroxide solution to raise the pH to 10. A violent reaction occurs. The reaction mixture is diluted with 50 parts of water, stirred, cooled and filtered. The material collected on the filter is recrystallized from 10% ethanol to yield a mixture of 1-methallyl-3-ethyl-6-amino-1,2,3,4-tetrahydro-2,4-pyrimidinedione and 1-ethyl-3-methallyl-6-amino-1,2,3,4-tetrahydro-2,4-pyrimidinedione melting at about 157°-159°C.

References

- Merck Index 493
 OCDS Vol. 1 p. 266
 I.N. p. 76
 Papesch, V. and Schroeder, E.F.; U.S. Patent 2,729,669; January 3, 1956; assigned to G.D. Searle & Co.

AMITRIPTYLINE HYDROCHLORIDE

Therapeutic Function: Antidepressant

Chemical Name: 3-(10,11-dihydro-5H-dibenzo[a,d]-cyclohepten-5-ylidene)-N,N-dimethyl-1-propanamine hydrochloride

Common Name: —

Structural Formula:

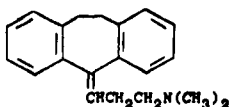

Chemical Abstracts Registry No.: 549-18-8; 50-48-6 (Base)

Trade Name	Manufacturer	Country	Year Introduced
Elavil HCl	Merck Sharp & Dohme	U.S.	1961
Elavil	DDSA	U.K.	1962
Triptizol	Merck Sharp & Dohme	Italy	1962
Laroxyl	Roche	Italy	1962
Endep	Roche	U.S.	1975
Amitril	WL/PD	U.S.	1978
Amitid	Squibb	U.S.	1979
Amavil	Mallard	U.S.	1980
Enovil	Hauck	U.S.	1982
Adepril	Lepetit	Italy	—
Adepress	Essex-Shionogi	Japan	—
Ami-Anelun	Llorente	Spain	—
Amilent	Warner-Lambert	U.S.	—
Amiprin	Kobayashi	Japan	—
Amitptanol	Kanto	Japan	—
Amitrip	Glebe	Australia	—
Amitriptol	Bracco	Italy	—
Annolytin	Kodama	Japan	—
Annolytin	Nippon Shoji	Japan	—
Deprestat	Script Intal	South Africa	—
Domical	Berk	U.K.	—
Elatrol	ICN	Canada	—
Elatrol	Teva	Israel	—
Elatrolet	Teva	Israel	—
Lantron	Yamanouchi	Japan	—
Lentizol	Warner-Lambert	U.S.	—
Levate	ICN	Canada	—
Limbitrol	Roche	France	—
Limbitrol	Roche	U.S.	—
Mareline	Elliott-Marion	Canada	—
Meravil	Medic	Canada	—
Miketorin	Mitsui	Japan	—
Mitaptyline	Toyo Pharm.	Japan	—
Mutanxion	Cetrane	France	—
Mutaspline	Cetrane	France	—
Normaln	Sawai	Japan	—
Novotriptyn	Novopharm	Canada	—
Redomex	Labaz	—	—
Saroten	Lundbeck	W. Germany	—
Saroten	Tropon	W. Germany	—
Saroten	Warner	U.K.	—
Sarotex	Lundbeck	W. Germany	—
Schuvel	Tokyo-Hosei	Japan	—
Sensival	Pfizer Taito	Japan	—

Trade Name	Manufacturer	Country	Year Introduced
Teperin	Egypt	Hungary	—
Trepiline	Lennon	South Africa	—
Triavil	Merck Sharp & Dohme	U.S.	—
Triptilin	Kimya Evi	Turkey	—
Triptyl	Farmos	Finland	—
Tryptal	Unipharm	Israel	—
Tryptanol	Merck-Banyu	Japan	—
Tryptizol	Sharpe & Dohme	W. Germany	—
Tryptizol	Sharpe & Dohme	U.K.	—

Raw Materials

Phthalic Anhydride	Hydrogen
3-(Dimethylamino)propyl Chloride	Phenylacetic Acid
Hydrochloric Acid	

Manufacturing Process

Phthalic anhydride is reacted with phenylacetic acid to form 3-benzylidenephthalide which is then hydrogenated to 2-phenethylbenzoic acid. Conversion to the acid chloride followed by intramolecular dehydrochlorination yields the ketone, 5H-dibenzo[a,d]cyclohepten-5-one. The ketone undergoes a Grignard reaction with 3-(dimethylamino)propyl chloride to give 5-(γ -dimethylaminopropylidene)-5H-dibenzo[a,d]cycloheptene.

Then, as described in U.S. Patent 3,205,264, a solution of 5-(γ -dimethylaminopropylidene)-5H-dibenzo-[a,d]-cycloheptene (42 grams; 0.153 mol) in 105 ml of ethanol is hydrogenated over Raney nickel (1.5 grams) at 65°C under an initial hydrogen pressure of 450 lb. After 1 mol of hydrogen is absorbed (3.5 hours), the reaction mixture is filtered to remove the catalyst and is acidified with 80 ml of 2.5 N hydrochloric acid (0.2 mol). The acidic solution is concentrated to dryness under vacuum and is flushed three times with 100 ml of benzene to remove residual water. The solid residue then is dried under vacuum at 40°C to yield 44.9 grams (94% of theory) of the product, MP 187°-189.5°C, equivalent weight 307, ultraviolet absorption A% 2380⁴³². Recrystallization from isopropyl alcohol and ether affords the product in high purity.

References

- Merck Index 496
- Kleeman & Engel p. 44
- PDR pp. 673, 993, 1174, 1217, 1314, 1509, 1513, 1569, 1606, 1617
- OCDS Vol. 1 pp. 151, 404
- DOT 9 (6) 219 (1973)
- I.N. p. 76
- REM p. 1093
- Tristram, E.W. and Tull, R.J.; U.S. Patent 3,205,264; September 7, 1965; assigned to Merck & Co., Inc.

AMITRIPTYLINE OXIDE

Therapeutic Function: Antidepressant

Chemical Name: 3-(3'-Dimethylaminopropylidene)dibenzo[a,d]cyclohepta-1,4-diene N-oxide

Common Name: —

Structural Formula:**Chemical Abstracts Registry No.:** 4317-14-0

Trade Name	Manufacturer	Country	Year Introduced
Equilibrin	Nattermann	W. Germany	1980
Ambivalon	Nattermann	W. Germany	—

Raw Materials

Dibenzo [a,d] cyclohepta-1,4-diene-5-one
 3-Dimethylaminopropanol Magnesium Chloride
 Hydrogen Peroxide

Manufacturing Process

31.3 g (0.1 mol) of 3-(3'-dimethylaminopropylidene)dibenzo [a,d] cyclohepta-1,4-diene hydrochloride are dissolved in water, and the free base is liberated by means of a 28% aqueous solution of sodium hydroxide. The free base is sucked off, washed with water, and dissolved in 100 ml of methanol. To the solution are added 31 ml of 30% hydrogen peroxide. After 7 days, the reaction mixture is diluted with 200 ml of water, and the major part of the methanol is evaporated in vacuum. The precipitated N-oxide crystals are filtered off, washed with water, and dried, yielding 27 g of the dihydrate of 3-(3'-dimethylaminopropylidene)dibenzo [a,d] cyclohepta-1,4-diene N-oxide with melting point of 102° to 103°C. In dehydrated state the melting point is 228° to 230°C.

By dissolving the N-oxide in acetone, and bubbling dry hydrogen chlorine gas through the solution until slightly acid reaction, the hydrochloride of the N-oxide is precipitated as a white crystalline substance with melting point of 172° to 173.6°C.

The starting material can be prepared in known manner from dibenzo [a,d] cyclohepta-1,4-diene-5-one by a Grignard reaction with 3-dimethylaminopropyl magnesium chloride, hydrolysis and dehydration of the resulting carbinol.

References

Merck Index 497
 DFU 5 (7) 329 (1980)
 Kleeman & Engel p. 45
 DOT 18 (3) 110 (1982)
 I.N. p. 77

Pedersen, J.B.; British Patent 991,651; May 12, 1965; assigned to A/S Dumex (Dumex, Ltd.)
 Merck & Co., Inc.; British Patent 1,095,786; December 20, 1967
 Pedersen, J.B.; U.S. Patent 3,299,139; January 17, 1967; assigned to A/S Dumex (Dumex, Ltd.)

AMIXETRINE HYDROCHLORIDE

Therapeutic Function: Antiinflammatory; anticholinergic; antidepressant

Chemical Name: N-(2-Phenyl-2-isoamyloxy)-ethylpyrrolidine hydrochloride

Common Name: —

Structural Formula:

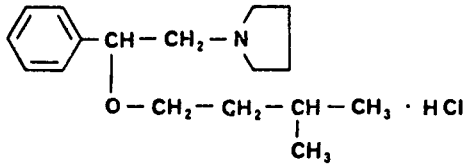

Chemical Abstracts Registry No.: 24622-52-4; 24622-72-8 (Base)

Trade Name	Manufacturer	Country	Year Introduced
Somagest	Riom	France	1972

Raw Materials

Styrene	t-Butyl Hypobromite
Isoamyl Alcohol	Pyrrrolidine
Hydrogen Chloride	

Manufacturing Process

There is heated under reflux with stirring for 10 hours: 117 g of (2-phenyl-2-isoamyloxy)-ethyl bromide, 61.5 g of pyrrolidine and 250 ml of toluene.

After filtration of the pyrrolidine hydrobromide, the toluene is removed under reduced pressure. The residue is then taken up with 4N HCl. The aqueous solution is washed with ether. It is made alkaline by a solution of 50% NaOH. It is extracted with ether. The ethereal phase is dried over anhydrous sodium sulfate, and rectified under reduced pressure after removing the solvent. There is thus obtained 90 g of a colorless oil with an amine odor.

The hydrochloride is prepared in the usual manner by dissolving the amine in anhydrous ether and adding to it the requisite amount of dry gaseous hydrochloric acid, dissolved in absolute alcohol. There is obtained a white crystalline powder melting at 150°C, very soluble in water and alcohol, very slightly soluble in ether and ethyl acetate.

The starting material above is prepared by reacting styrene with isoamyl alcohol and then reacting that product with t-butyl hypobromite.

References

- Merck Index 499
- Kleeman & Engel p. 46
- DOT 8 (9) 334 (1972)
- I.N. p. 77
- Centre Europeen de Recherches Mauvernay, RIOM; British Patent 1,253,818; November 17, 1971

AMODIAQUIN

Therapeutic Function: Antimalarial

Chemical Name: 4-[(7-Chloro-4-quinolinyl)amino]-2-[(diethylamino)-methyl]phenol

Common Name: 4-(3'-diethylaminomethyl-4'-hydroxyanilino)-7-chloroquinoline

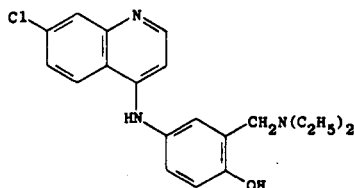
Structural Formula:

Chemical Abstracts Registry No.: 86-42-0 (Base); 69-44-3 (Dihydrochloride)

Trade Name	Manufacturer	Country	Year Introduced
Camoquin HCl	Parke Davis	U.S.	1950
Flavoquine	Roussel	France	1979
Corbutyl	I.S.H.	France	—
Camoquin	Parke-Davis	U.K.	—

Raw Materials

p-Aminophenol Hydrochloride	Diethylamine
4,7-Dichloroquinoline	Paraformaldehyde

Manufacturing Process

72.8 g (0.5 mol) of p-aminophenol hydrochloride is dissolved in 500 cc of water and added to 99 g (0.5 mol) of 4,7-dichloroquinoline. After a few minutes of warming in a steam bath, 4-(4'-hydroxyanilino)-7-chloroquinoline hydrochloride, of sufficient purity for use in further experiments, precipitates as a yellow crystalline solid. Recrystallized from methanol, the MP is over 300°C.

A mixture consisting of 13.5 g of 4-(4'-hydroxyanilino)-7-chloroquinoline hydrochloride dissolved in absolute ethanol is treated with a solution of 4.38 g of diethylamine and 1.8 g of paraformaldehyde in 20 cc of absolute ethanol. The reaction mixture is heated under reflux for 16 hours, evaporated to one-half volume and the warm solution treated with an excess of hydrogen chloride dissolved in absolute ethanol. Acetone is added to the warm solution until it becomes turbid and then the solution is cooled. The crude dihydrochloride which separates is collected and purified by recrystallization from methanol; MP 240°-242°C.

By using an equivalent amount of 4-(4'-hydroxyanilino)-7-bromoquinoline in the above procedure, 4-(3'-diethylaminomethyl-4'-hydroxyanilino)-7-bromoquinoline dihydrochloride is obtained; MP (base) 206°-208°C dec.

References

Merck Index 593

Kleeman & Engel p. 47

I.N. p. 78

REM p. 1217

Burckhalter, J.H., Jones, E.M., Rawlins, A.L., Tendick, F.H. and Holcomb, W.F.; U.S. Patent 2,474,821; July 5, 1949; assigned to Parke, Davis & Co.

AMOXAPINE

Therapeutic Function: Antidepressant

Chemical Name: 2-Chloro-11-(1-piperazinyl)dibenz[b,f][1,4]oxazepine

Common Name: —

Structural Formula:

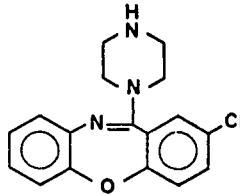

Chemical Abstracts Registry No.: 14028-44-5

Trade Name	Manufacturer	Country	Year Introduced
Asendin	Lederle	U.S.	1980
Moxadil	Lederle	France	1980
Amoxan	Lederle	Japan	1981
Omnipress	Cyanamid	W. Germany	1983
Demolox	Lederle	—	—

Raw Materials

o-(p-Chlorophenoxy)aniline Hydrochloride	Ethyl Chlorocarbonate
N-Carboethoxypiperazine	Phosphorus Pentoxide

Manufacturing Process

A mixture of 125 g of o-(p-chlorophenoxy)aniline hydrochloride and 100 ml of dry pyridine is treated cautiously with a solution of 90 ml of ethyl chlorocarbonate in 150 ml of ether. The mixture is kept at room temperature for 3 days, diluted with about 500 ml of water and extracted with 300 ml of ether. The ethereal extract is washed with 300 ml of water, dried over calcium chloride, filtered and concentrated. The resulting ethyl o-(p-chlorophenoxy)carbanilate is obtained in a viscous oil suitable for use in the next step without further purification.

A solution of 70 g of ethyl o-(p-chlorophenoxy)carbanilate and 120 g of N-carboethoxypiperazine in 100 ml of benzene containing a little sodium methoxide is heated on a steam bath for about 5 days. The solvent is removed by distillation and the residue is triturated with water. The resulting solid is dissolved in ether and dried over sodium sulfate. Filtration and concentration then yields ethyl 4-[[o-(p-chlorophenoxy)phenyl] carbamoyl]-1-piperazinecarboxylate, melting at 89° to 91°C, and suitable for cyclization.

A mixture of 10 g of the above piperazine carboxylate ester, 8 g of phosphorus pentoxide and 20 ml of phosphorus oxychloride is heated under reflux for about 1 day, diluted with 100 ml each of chloroform and benzene and quenched with 200 g of ice. The mixture is made basic with 10% sodium hydroxide. The organic layer is isolated and extracted with 150 ml of dilute hydrochloric acid. The product is precipitated from the aqueous layer by addition of 10% sodium hydroxide, extracted with benzene and dried over potassium carbonate. Recrystallization from benzene-petroleum ether gives 2-chloro-11-(1-piperazinyldibenz[b,f][1,4]-oxazepine which melts at 175° to 176°C.

References

- | | |
|---|---------------------------|
| Merck Index 598 | DFU 1 (11) 511 (1976) |
| PDR p. 1005 | OCDS Vol. 2 p. 478 (1980) |
| DOT 8 (2) 78 (1972) & 15 (3) 73 (1979) | I.N. p. 79 |
| REM p. 1094 | |
| Howell, C.F., Hardy, R.A., Jr. and Quinones, N.Q.; U.S. Patent 3,663,696; May 16, 1972; assigned to American Cyanamid Company | |
| Howell, C.F., Hardy, R.A., Jr. and Quinones, N.Q.; U.S. Patent 3,681,357; August 1, 1972; assigned to American Cyanamid Company | |

AMOXICILLIN

Therapeutic Function: Antibacterial

Chemical Name: 6-({amino-(4-hydroxyphenyl)acetyl} amino)-3,3-dimethyl-7-oxo-4-thia-1-azabicyclo[3.2.0] heptane-2-carboxylic acid

Common Name: p-Hydroxyampicillin

Structural Formula:

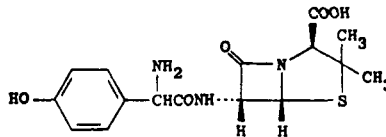

Chemical Abstracts Registry No.: 26787-78-0; 61336-70-7 (Trihydrate)

Trade Name	Manufacturer	Country	Year Introduced
Amoxil	Bencard	U.K.	1972
Clamoxyl	Beecham	W. Germany	1973
Clamoxyl	Beecham	France	1974
Larotid	Roche	U.S.	1974
Amoxil	Beecham	U.S.	1974
Polymox	Bristol	U.S.	1975
Sawacillin	Fujisawa	Japan	1975
Pasetocin	Kyowa Hakko	Japan	1975
Velamox	Zambeletti	Italy	1975
Wymox	Wyeth	U.S.	1978
Utimox	WL/PD	U.S.	1979
Agerpen	Cepa	Spain	—
A-Gram	Inava	France	—
Alfamox	Alfa	Italy	—
Alfida	Esteve	Spain	—
Alfoxil	Fako	Turkey	—
Am-73	Medici	Italy	—
Amocilline	Inpharzam	Belgium	—
Amoclen	Spofa	Czechoslovakia	—
Amodex	Robert & Carriere	France	—
Amo-Flamisan	Mazuelos	Spain	—
Amoksilin	Nobel	Turkey	—
Amoksina	Mustafa Nevzat	Turkey	—
Amolin	Takeda	Japan	—
Amorion	Orion	Finland	—
Amosin	Sanli	Turkey	—
Amox	Lusofarmaco	Spain	—
Amox	Prodes	Spain	—
Amoxamil	Lafi	Brazil	—
Amoxaren	Areu	Spain	—
Amoxi-Basileos	Basileos	Spain	—
Amoxibiotic	Aristochimica	Italy	—
Amoxicil	Dinzel	Turkey	—
Amoxicillin	Toho	Japan	—
Amoxidal	Roemmers	Argentina	—
Amoxidin	Lagap	Switz.	—
Amoxi-Gobens	Normon	Spain	—
Amoxicillin	Esseti	Italy	—

Trade Name	Manufacturer	Country	Year Introduced
Amoximedical	Medical	Spain	—
Amoxipen	Gibipharma	Italy	—
Amoxipenil	Montpellier	Argentina	—
Amoxiroger	Roger	Spain	—
Amoxi-Tabts	Beecham	—	—
Amoxyphen	Grunenthal	W. Germany	—
Amplimox	Ausonia	Italy	—
Amplimox	Iton	Italy	—
Ampy-Penyl	Proto	Switz.	—
Apitart	Isei	Japan	—
Ardine	Antibioticos	Spain	—
Aspenil	Chemil	Italy	—
Augmentin	Beecham	U.S.	—
Ax-1000	Durachemie	W. Germany	—
Axbiot	Galepharma Iberica	Spain	—
Becabil	Alfar	Spain	—
Benzoral	Biosintetica	Brazil	—
Bioxidona	Faes	Spain	—
Bristamox	Bristol	—	—
Cabermox	Caber	Italy	—
Chitacillin	Banyu	Japan	—
Cidanamox	Cidan	Spain	—
Clamox	Roussel-Diamant	Morocco	—
Clamoxyl	Wulfing	W. Germany	—
Clamoxyl	Beecham-Sevigne	France	—
Dacala	Guadalupe	Spain	—
Damoxicil	Elmu	Spain	—
Daxipen	Recofarma	Brazil	—
Delacillin	Sankyo	Japan	—
Demoksil	Deva	Turkey	—
Doksilin	Iltas	Turkey	—
Draximox	Novo	—	—
Efpenix	Toyo Jozo	Japan	—
Eupen	Uriach	Spain	—
Flemoxin	Gist-Brocades	—	—
Fullcilina	Sintyal	Argentina	—
Grinsil	Argentia	Argentina	—
Hiconcil	Allard	France	—
Himinomax	Kaken	Japan	—
Hosboral	Hosbon	Spain	—
Ibiamox	IBI	Italy	—
Imacillin	Astra	—	—
Infectomycin	Heyden	W. Germany	—
Isimoxin	ISI	Italy	—
Kapoxi	Kappa	Spain	—
Largopen	Billim	Turkey	—
Majorpen	Cyanamid	U.S.	—
Megacillin	Mulda	Turkey	—
Metifarma	Novofarma	Spain	—
Morgenxil	Morgens	Spain	—
Moxacin	C.S.L.	Australia	—
Moxal	Roger Bellon	Italy	—
Moxalin	Mead-Johnson	U.S.	—
Moxilean	Organon	—	—
Moxipin	Gamir	Spain	—
Moxyphen	Teva	Israel	—
Novamoxin	Novopharma	Canada	—

Trade Name	Manufacturer	Country	Year Introduced
Nuvosyl	Mepha	Switz.	—
Optium	Disprovent	Argentina	—
Ospanox	Biochemie	Austria	—
Pamocil	Lancet	Italy	—
Paradoxil	Bristol	—	—
Pasetocin	Kyowa	Japan	—
Penamox	Beecham	—	—
Penimox	Ibsa	Switz.	—
Piramox	Pharmax	Italy	—
Precopen	Fides	Spain	—
Primasin	Eczacibasi	Turkey	—
Raudopen	Alter	Spain	—
Raylina	Robert	Spain	—
Reloxyl	Biologia Marina	Spain	—
Remoxil	Kimya Evi	Turkey	—
Rivoxicillin	Rivopharm	Switz.	—
Robamox	Robins	U.S.	—
Sancixomal	Santos	Spain	—
Sawamezin	Sawai	Japan	—
Sigamopen	Siegfried	Switz.	—
Simplamox	ISF	Italy	—
Sinacilin	Galenika	Yugoslavia	—
Sintedix	Castillon	Spain	—
Sintoplus	Aesculapius	Italy	—
Sumox	Reid-Provident	U.S.	—
Superpeni	Efeyn	Spain	—
Tolodina	Estedi	Spain	—
Triamoxil	Squibb	U.S.	—
Trifamox	Bago	Argentina	—
Trimoksilin	Abdi Ibrahim	Turkey	—
Trimox	Squibb	U.S.	—
Unicillin	Tobishi	Japan	—
Uro-Clamoxyl	Beecham	—	—
Utimox	Parke Davis	—	—
Wassermox	Wassermann	Spain	—
Widecillin	Meiji	Japan	—
Zamocillin	Zambon	Italy	—
Zimox	Farmitalia Carlo Erba	Italy	—

Raw Materials

6-Aminopenicillanic Acid	Ethyl Chlorocarbonate
Sodium Bicarbonate	Hydrogen
O,N-Dibenzylloxycarbonyl-p-oxy-di- α -aminophenylacetic Acid	

Manufacturing Process

Ethyl chlorocarbonate (2.2 ml) was added to an ice cold solution of O,N-dibenzyloxy-carbonyl-p-oxy-di- α -aminophenylacetic acid (10 grams) and triethylamine (3.85 ml) in dry acetone (193 ml). The mixture was stirred at 0°C for 5 minutes during which triethylamine hydrochloride precipitated. The suspension was cooled to -30°C and stirred vigorously while adding as rapidly as possible an ice cold solution of 6-aminopenicillanic acid (5.85 grams) in 3% aqueous sodium bicarbonate (193 ml), the temperature of the mixture never being allowed to rise above 0°C. The resulting clear solution was stirred for 30 minutes at 0°C, and then for a further 30 minutes, without external cooling, and finally extracted with diethyl ether (3 x 200 ml) only the aqueous phase being retained.

This aqueous solution was brought to pH 2 by the addition of hydrochloric acid and the

6-(O,N-dibenzoyloxycarbonyl-p-oxy-dl- α -aminophenylacetamido)-penicillanic acid so liberated was extracted into diethyl ether (50 ml and 2 portions of 30 ml). The ether phase was washed with water (3 x 5 ml) and the water washings were discarded.

Finally, the penicillin was converted to the sodium salt by shaking the ether solution with sufficient 3% sodium bicarbonate to give a neutral aqueous phase, separating the latter and evaporating it at low pressure and temperature below 20°C. The product was finally dried over phosphorus pentoxide in vacuo to give sodium 6-(O,N-dibenzoyloxycarbonyl-p-oxy-dl- α -aminophenylacetamido)-penicillanate (9.2 grams).

A suspension of palladium on calcium carbonate (36 grams of 5%) in water (150 ml) was shaken in an atmosphere of hydrogen at room temperature and atmospheric pressure for 1 hour. A neutral solution of sodium 6-(O,N-dibenzoyloxycarbonyl-p-oxy-dl- α -aminophenylacetamido)-penicillanate (9 grams) in water (100 ml) was then added and shaking in hydrogen was resumed for one hour. The suspension was then filtered and the collected catalyst was washed well with water without being allowed to suck dry between washings. The combined filtrate and washings were then brought to pH 6.5 with dilute hydrochloric acid and evaporated to dryness at reduced pressure and temperatures below 20°C. The product was finally dried over phosphorus pentoxide in vacuo to give a solid (5.4 grams) containing 6-(p-hydroxy-dl- α -aminophenylacetamido)-penicillanic acid.

References

- Merck Index 600
 Kleeman & Engel p. 48
 PDR pp. 658, 673, 705, 993, 1315, 1606, 1769, 1997
 OCDS Vol. 1 p. 414
 DOT 19 (3) 169 (1983)
 I.N. p. 79
 REM p. 1193
 Nayler, J.H.C. and Smith, H.; U.S. Patent 3,192,198; June 29, 1965

AMPHETAMINE PHOSPHATE

Therapeutic Function: Central stimulant

Chemical Name: 1-Phenyl-2-aminopropane monophosphate

Common Name: —

Structural Formula: $C_6H_5CH_2CH(NH_2)CH_3 \cdot H_3PO_4$

Chemical Abstracts Registry No.: 139-10-6

Trade Name	Manufacturer	Country	Year Introduced
Raphetamine	Strasenburgh	U.S.	1950
Amphate	Storck	U.S.	—
Leptamine	Bowman	U.S.	—
Monophos	Durst	U.S.	—
Profetamine	Clark & Clark	U.S.	—

Raw Materials

Phenyl Nitropropylene
 Phosphoric Acid

Chemical Abstracts Registry No.: 1402-82-0 (Base)

Manufacturing Process

1 mol of phenyl-nitropropylene, $C_6H_5CH=CH(CH_2NO_2)$, is dissolved with a solvent prepared by mixing one liter of ethanol with one-half liter of acetic acid and one-half liter of 12 N sulfuric acid. The resultant solution is placed in the cathode compartment of a divided electrolytic cell containing a metallic cathode of mercury, copper, or other metal of similar nature. Current is passed, using a current density of ~ 0.2 amp/cm² of cathode surface. The temperature is kept at about 40°C during the electrolysis which is continued until at least eight Faradays of electricity have been passed.

When the reduction is completed, the 1-phenyl-2-aminopropane may be separated from the solution. A convenient way of doing this is by removing the ethanol and ethyl acetate present by evaporation and then making the residual solution strongly alkaline by addition of caustic alkali. The basic layer thus formed is separated from the aqueous solution and contains the desired 1-phenyl-2-aminopropane.

135 g (1 mol) of amphetamine (1-phenyl-2-aminopropane) were stirred into 300 cc of acetone in a stainless-steel vessel. To the resultant solution there were slowly added under constant agitation 115.3 g of 85% phosphoric acid (containing 1 mol of H_3PO_4), care being taken to avoid any sudden rise in temperature or local overheating due to the considerable amount of heat that is evolved. During the addition of the phosphoric acid a fine, white, flocculent precipitate appears which becomes more and more dense and abundant, as the quantity of added acid increases.

When the entire quantity of the phosphoric acid has thus been added, agitation of the mixture is continued for about a half-hour or more to insure complete conversion. The precipitate is then allowed to settle, the supernatant liquid is drawn off, and the residue is filtered. The precipitate thus separated may, if desired, be washed with acetone and is then dried by evaporation to constant weight. It forms a fine, white, impalpable powder consisting of pure monobasic amphetamine phosphate.

References

Merck Index 607

I.N. p. 80

Alles, G.A.; U.S. Patent 1,879,003; September 27, 1932 (amphetamine base mfg.)

Goggin, T.C.; U.S. Patent 2,507,468; May 9, 1950; assigned to Clark & Clark Co. (amphetamine conversion to phosphate)

AMPHOMYCIN CALCIUM

Therapeutic Function: Antibiotic

Chemical Name: Amphomycin calcium

Common Name: Glumamicin

Structural Formula:

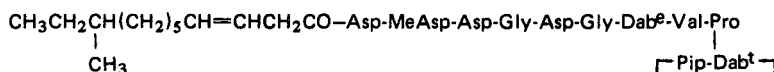

Dab^e = D-erythro- α,β -diaminobutyric acid

Dab^t = L-threo- α,β -diaminobutyric acid

Pip = D-pipecolic acid

(base)

Trade Name	Manufacturer	Country	Year Introduced
Amphocortrin CR	Warner-Lambert	U.S.	1963

Raw Materials

Amphomycin
Calcium Hydroxide

Manufacturing Process

The process for producing amphomycin comprises cultivating a strain of *Streptomyces canus* in an aqueous, nutrient-containing carbohydrate solution under submerged aerobic conditions until substantial antibacterial activity is imparted to the solution and then recovering the so-produced amphomycin from the fermentation broth.

The process of decolorizing solutions of amphomycin then involves treatment with activated charcoal, followed by the steps of (1) extracting the antibiotic into a water-immiscible organic solvent under strongly acid conditions or precipitating the amphomycin from aqueous solution by adjusting the pH to a point within the range of pH 3.0 to 4.0, (2) removing impurities from strongly acid, aqueous solution of amphomycin by extraction of the impurities with methyl isobutyl ketone and amyl acetate, (3) extracting the amphomycin from a strongly acid solution in butanol by the use of water having a pH higher than 4, (4) extracting the amphomycin from solution in water-immiscible organic solvent into water whose pH is greater than 6.0, (5) precipitating amphomycin from solution by formation of insoluble derivatives of the basic function, and (6) precipitating amphomycin from solution by formation of insoluble derivatives of the acidic function.

The amphomycin is then converted to the calcium salt with calcium hydroxide.

References

Merck Index 609

Heinemann, B., Cooper, I.R. and Kaplan, M.A.; U.S. Patent 3,126,317; March 24, 1964; assigned to Bristol-Myers Co.

AMPHOTERICIN B

Therapeutic Function: Antifungal

Chemical Name: [1R-(1R*,3S*,5R*,6R*,9R*,11R*,15S*,16R*,17R*,18S*,19E,21E,23E,25E,27E,29E,31E,33R*,35S*,36R*,37S*)]-33-[(3-amino-3,6-dideoxy-β-D-mannopyranosyl)oxy]-1,3,5,6,9,11,17,37-octahydroxy-15,16,18-trimethyl-13-oxo-14,39-dioxabicyclo[33.3.1]nonatriconta-19,21,23,25,27,29,31-heptaene-36-carboxylic acid

Common Name: —

Structural Formula:

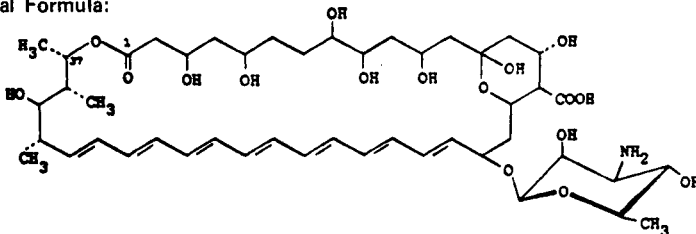

Chemical Abstracts Registry No.: 1397-89-3

Trade Name	Manufacturer	Country	Year Introduced
Fungizone	Squibb	U.S.	1958
Ampho-Moronal	Heyden	W. Germany	—
Fungizone	Squibb	France	1969
Amphocycline	Squibb	France	—
Amphozone	Squibb	—	—
Fungilin	Squibb	U.K.	—
Fungilin	Squibb	Italy	—
Fungizone	Squibb-Sankyo	Japan	—
Mysteclin	Heyden	W. Germany	—

Raw Materials

Carbohydrates
Streptomyces nodosus

Manufacturing Process

The process for producing amphotericin comprises cultivating a strain of *Streptomyces nodosus* in an aqueous nutrient medium comprising an assimilable, fermentable carbohydrate and an assimilable organic nitrogen source, under submerged aerobic conditions, until substantial antifungal activity is imparted to the medium and recovering amphotericin from the medium.

References

Merck Index 611

Kleeman & Engel p. 50

PDR pp. 1743, 1752

DOT 7 (5) 192 (1971)

I.N. p. 81

REM p. 1226

Dutcher, J.D., Gold, W., Pagano, J.F. and Vandeputte, J.; U.S. Patent 2,908,611; October 13, 1959; assigned to Olin Mathieson Chemical Corporation

AMPICILLIN

Therapeutic Function: Antibacterial

Chemical Name: 6-[D-amino-(2-phenylacetamido)] 3,3-dimethyl-7-oxo-4-thia-1-azabicyclo-[3.2.0] heptane-2-carboxylic acid

Common Name: D- α -aminobenzylpenicillin

Structural Formula:

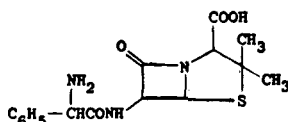
**Chemical Abstracts Registry No.:** 69-53-4

Trade Name	Manufacturer	Country	Year Introduced
Binotal	Bayer	W. Germany	1962

Trade Name	Manufacturer	Country	Year Introduced
Penicline	Delagrance	France	1963
Penbritin	Ayerst	U.S.	1963
Penbritin	Beecham	U.K.	1963
Omnipen	Wyeth	U.S.	1966
Ampisint	Proter	Italy	1969
Acucillin	Fuji	Japan	—
Adobacillin	Tobishi	Japan	—
Albipen	Gist Brocades	—	—
Alfasilin	Fako	Turkey	—
Almopen	Gist Brocades	—	—
Alpen	Lederle	U.S.	—
Amblosen	Hoechst	W. Germany	—
Amcill	Parke-Davis	U.S.	—
Amfipen	Gist Brocades	U.K.	—
Amfipen	Schering	W. Germany	—
Amipenix	Toyo Jozo	Japan	—
Ampen	Medosan	Italy	—
Ampen	ICN	Canada	—
Ampensaar	Chephasaar	W. Germany	—
Ampibeta	Violani-Farmavigor	Italy	—
Ampibiotic	Ottolenghi	Italy	—
Ampicil	Ausonia	Italy	—
Ampicillina Pharmax	Pharmax	Italy	—
Ampicillina Pierrel	Pierrel	Italy	—
Ampicina	Sigma Tau	Italy	—
Ampicyn	Protea	Australia	—
Ampifen	Intersint	Italy	—
Ampikel	Dreikehl	Spain	—
Ampilan	Ibern	Italy	—
Ampiland	Landerlan	Spain	—
Ampilisa	Lisapharma	Italy	—
Ampilux	Tubi Lux Pharma	Italy	—
Ampimed	Aristochimica	Italy	—
Ampinebiot	Bertran Hathor	Spain	—
Ampinova	Cheminova Espanola	Spain	—
Ampinoxi	Therapia	Spain	—
Ampiopen	Ibern	Italy	—
Ampi-Plena Simple	Pradel	Spain	—
Ampisil	Dif-Dogu	Turkey	—
Ampisina	Mustafa Nevzat	Turkey	—
Ampi-Tablinen	Sanorania	W. Germany	—
Ampitex	Neopharmed	Italy	—
Ampivax	Ripari-Gero	Italy	—
Ampixyl	Pharma-Plus	Switz.	—
Ampilenil	Orma	Italy	—
Amplibios	Panther-Osfa Chemie	Italy	—
Amplicid	Cifa	Italy	—
Amplipen	Labif	Italy	—
Amplipenyl	ISF	Italy	—
Ampliscocil	I.C.I.	Italy	—
Amplisom	Isom	Italy	—
Amplital	Farmitalia Carlo Erba	Italy	—
Amplizer	O.F.F.	Italy	—
Anhyphen	Gist Brocades	—	—
Anidropen	Wyeth	Italy	—
Anticyl	San Carlo	Italy	—
A-Pen	Orion	Finland	—

Trade Name	Manufacturer	Country	Year Introduced
Argocillina	Beta	Italy	--
Austrapen	CSI	Australia	--
Benusel	ICN	--	--
Bio-Ampi	Donatello	Italy	--
Biocellina	Magis	Italy	--
Bionacillin	Takata	Japan	--
Bonapicillin	Taiyo	Japan	--
Britapen Oral	Federico Bonet	Spain	--
Britcin	DDSA	U.K.	--
Bropicillina	Byk Golden	--	--
Cilleral	Bristol-Banyu	Japan	--
Citicil	C.T.	Italy	--
Combipenix	Toyo Jozo	Japan	--
Copharcilin	Cophar	Switz.	--
Deripen	Schering	W. Germany	--
Doktacillin	Astra	--	--
Domicillin	Dainippon	Japan	--
Drisilin	Drifen	Turkey	--
Espectrosira	Clariana	Spain	--
Eurocillin	Borromeo	Italy	--
Farmampil	Gazzini	Italy	--
Fidesbiotic	Fides	Spain	--
Fortapen	Continental Pharma	Belgium	--
Geycillina	Geymonat	Italy	--
Gramcillina	Caber	Italy	--
Grampenil	Argentina	Argentina	--
Guicitrina	Perga	Spain	--
Hostes Pediatrico	Lando	Argentina	--
Ikapen	Ikapharm	Israel	--
Isocillin	Kanto	Japan	--
Iwacillin	Iwaki	Japan	--
Lampocillina Orale	Sidus	Italy	--
Lifeampil	Lifepharm	Spain	--
Marisilan	Wakamoto	Japan	--
Makrosilin	Atabay	Turkey	--
Maxicillina	Antibioticos	Spain	--
Napacil	Montefarmaco	Italy	--
NC-Cillin	Nippon Chemiphar	Japan	--
Negopen	Deva	Turkey	--
Nuvapen	Cepa	Spain	--
Orocilin	isa	Brazil	--
Overcillina	Lepetit	Italy	--
Overcillina	Archifar	Italy	--
Pen Ampil	Nuovo. Const. Sanit. Naz.	Italy	--
Penbrock	Beecham	--	--
Penibrin	Teva	Israel	--
Penimic	SS Pharm.	Japan	--
Peninovel	Larma	Spain	--
Penisint B.G.	Boniscontro	Italy	--
Penoral	Nobel	Turkey	--
Penorsin	Wassermann	Spain	--
Pentrex	Banyu	Japan	--
Pentrexyl	Galenika	Yugoslavia	--
Pharcillin	Toyo Japan	Japan	--
Platocillina	Crosara	Italy	--
Plumericin	Torian	Spain	--

Trade Name	Manufacturer	Country	Year Introduced
Policilin	Bristol	—	—
Polycillin	Bristol	U.S.	—
Principen	Squibb	U.S.	—
Quimetam	Quimicos Unidos	Spain	—
Radiocillina	Radium Pharma	Italy	—
Recenacillin	Maruko	Japan	—
Resan	Alacan	Spain	—
Rivocillin	Rivopharm	Switz.	—
Saicil	Libra	Italy	—
Sentapent	Kimya Evi	Turkey	—
Sernabiotic	Libra	Italy	—
Sesquicillina	Ita	Italy	—
Sintopenyl	Aesculapius	Italy	—
SK-Ampicillin	SK&F	U.S.	—
Togram	Morgens	Spain	—
Tokiocillin	Isei	Japan	—
Totacillin	Beecham	Japan	—
Totaclox	Beecham	Japan	—
Totalciclina	Benvegna	Italy	—
Totapen	Bristol	France	—
Trafarbiot	Novopharma	Spain	—
Ultrabion	Lifasa	Spain	—
Vastacyn	Ankerfarm	Italy	—
Vexampil	Ifi	Italy	—
Viccillin	Meiji	Japan	—

Raw Materials

α -Aminophenylacetic Acid	Benzyl Chlorocarbonate
Ethyl Chlorocarbonate	Hydrogen
6-Aminopenicillanic Acid	

Manufacturing Process

α -Carbobenzoyloxyaminophenylacetic acid (0.1 mol), which is obtained by the reaction of equivalent quantities of α -aminophenylacetic acid and benzyl chlorocarbonate in aqueous sodium hydroxide, dissolved in dry acetone is stirred and cooled to approximately -5°C . To this there is added dropwise with continued cooling and stirring a solution of ethyl chlorocarbonate (0.1 mol). After approximately 10 minutes, the acylating mixture is cooled to about -5°C and then is slowly added to a stirred ice-cold mixture of 6-aminopenicillanic acid (0.1 mol), 3% sodium bicarbonate solution (0.1 mol) and acetone. This reaction mixture is allowed to attain room temperature, stirred for an additional thirty minutes at this temperature and then is extracted with ether.

The extracted aqueous solution is covered with butanol and the pH adjusted to 2 by the addition of N HCl. The acidified aqueous phase is extracted with butanol, the pH of the aqueous phase being adjusted to pH 2 each time. The combined butanol solutions which contain the free acid, α -carbobenzoyloxyaminobenzylpenicillin, are washed with water, and are then shaken with water to which sufficient 3% sodium bicarbonate has been added to bring the aqueous phase to pH 7. The process of washing and shaking is repeated with fresh water and bicarbonate solution. The combined aqueous solutions are washed with ether and then are evaporated under reduced pressure and low temperature. The product, the sodium salt of α -carbobenzoyloxyaminobenzylpenicillin, is obtained as a yellow solid in a yield of 65%.

A suspension of palladium on barium carbonate (3.7 grams of 30%) in water (20 ml) is shaken in an atmosphere of hydrogen at room temperature. The catalyst is then filtered and washed well with water, care being taken that it does not become dry. A solution of the

sodium salt of α -carbobenzyloxyaminobenzylpenicillin (4 grams) in water (20 ml) is added to the pretreated catalyst and the suspension is shaken in an atmosphere of hydrogen at room temperature and pressure for one hour. The catalyst is then filtered off, washed well with water, and the combined filtrate and washings adjusted to pH 7 with N hydrochloric acid. The resulting solution is evaporated in vacuo at a temperature below 20°C to give α -aminobenzylpenicillin (2.4 grams, 74% yield), which is assayed at approximately 48% pure by the manometric method.

References

Merck Index 612

Kleeman & Engel p. 50

PDR pp. 673, 703, 1314, 1722, 1964

OCDS Vol. 1 p. 413; Vol. 2 p. 437

I.N. p. 81

REM p. 1194

Doyle, F.P., Nayler, J.H.C., and Smith, H.; U.S. Patent 2,985,648; May 23, 1961

Kaufmann, W. and Bauer, K.; U.S. Patent 3,079,307; Feb. 26, 1963; assigned to Farbenfabriken Bayer AG, Germany

Johnson, D.A. and Wolfe, S.; U.S. Patent 3,140,282; July 7, 1964; assigned to Bristol-Myers Company

Grant, N.H. and Alburn, H.E.; U.S. Patent 3,144,445; August 11, 1964; assigned to American Home Products Corporation

AMPICILLIN TRIHYDRATE

Therapeutic Function: Antibacterial

Chemical Name: See Ampicillin

Common Name: —

Structural Formula: See Ampicillin

Chemical Abstracts Registry No.: 7177-48-2

Trade Name	Manufacturer	Country	Year Introduced
Polycillin	Bristol	U.S.	1963
Principen	Squibb	U.S.	1967
Amcill	Parke Davis	U.S.	1968
Alpen	Lederle	U.S.	1969
Totacillin	Beecham	U.S.	1970
Pensyn	Upjohn	U.S.	1972
Ro-Ampen	Rowell	U.S.	1972
Pen A	Pfizer	U.S.	1972
Trimox	Squibb	U.S.	1978
AB-PC	Tojo Jozo	Japan	—
Acillin	ICN	—	—
Amblosin	Hoechst	—	—
Amcap	Circle	U.S.	—
Amperil	Geneva Drugs	U.S.	—
Ampexin	Therapex	Canada	—
Ampical	Uva	France	—
Ampichelle	Rachelle	U.S.	—

Trade Name	Manufacturer	Country	Year Introduced
Ampicil	Jeba	Spain	—
Ampiciman	Liberman	Spain	—
Ampi-Co	Coastal	U.S.	—
Ampifar	Benedetti	Italy	—
Ampikel	Dreikehl	Spain	—
Ampilag	Lagap	Switz.	—
Ampileta	Letap	Switz.	—
Ampi-Oral	Biologia Marina	Spain	—
Ampiorus	Horus	Spain	—
Ampiscel	Rachelle	U.S.	—
Ampixyl	Pharma-Plus	Switz.	—
Ampi-Zoja	Zoja	Italy	—
Amplin	Winston	U.S.	—
Arcocillin	ICN	—	—
Benusel	ICN	—	—
Binotal	Bayer	—	—
Cetampin	CTA Pharma	Switz.	—
Cetampin	Scarium	Switz.	—
Cimexillin	Cimex	Switz.	—
Cymbi	Dolorgiet	W. Germany	—
Citicil	C.T.	Italy	—
D-Amp	Dunhall	U.S.	—
D-Cillin	Dunhall	U.S.	—
Delcillin	Marlop	U.S.	—
Divercillin	Ascher	U.S.	—
Dumopen	Dumex	Denmark	—
Dur Ampicillin	Durachemie	W. Germany	—
Espimin-Cilin	Spyfarma	Spain	—
Fuerpen	Hermes	Spain	—
Gobemicina Simple	Normon	Spain	—
Helvecillin	Helvepharm	Switz.	—
Lifeampil	Lifepharma	Spain	—
Morepen	Morejon	Spain	—
Novoexpectro	Aldon	Spain	—
Penbristol	Bristol-Myers	Austria	—
Penimaster	Liade	Spain	—
Peninovel	Larma	Spain	—
Pentraxyl	Bristol	—	—
Pentrexyl Oral	Antibioticos	Spain	—
Pentricine	Ibsa	Switz.	—
Poenbiotico	Poen	Argentina	—
Prestacilina	Pental	Spain	—
Q I Damp	Mallinckrodt	U.S.	—
Rosampline	Rosa-Phytopharma	France	—
Servicillin	Servipharm	Switz.	—
Standacillin	Biochemie	Austria	—
Sumipanto Oral	Asla	Spain	—
Texcillin	First Texas	U.S.	—
Trafarbior	Novopharma	Spain	—
Trafacilina	Bago	Argentina	—
Vampen	Vanguard	U.S.	—
Vidopen	Berk	U.K.	—

Raw Materials

Ampicillin Beta Naphthalene Sulfonate
Secondary Amines

Manufacturing Process

The known methods for the preparation of D-(-)- α -aminobenzylpenicillin by the acylation of 6-aminopenicillanic acid result in the preparation of aqueous mixtures which contain, in addition to the desired penicillin, unreacted 6-aminopenicillanic acid, hydrolyzed acylating agent, and products of side reactions such as the products of the acylating agent reacted with itself and/or with the desired penicillin, as well as other impurities.

The D-(-)- α -aminobenzylpenicillin may then be recovered from the aqueous reaction mixture by concentration to small volume and recovering the product by filtration. However, due to the fact that anhydrous D-(-)- α -aminobenzylpenicillin is soluble in water to the extent of about 20-25 mg/ml at 20°-25°C, it is very difficult to recover the product in high yields. Furthermore, the recovered D-(-)- α -aminobenzylpenicillin may be obtained in the form of a monohydrate. The monohydrates (as well as the dihydrates) of D-(-)- α -aminobenzylpenicillin possess poor biological stability.

The trihydrate which is obtained in high yields, is relatively insoluble in water, possesses high biological stability and can be obtained by contacting, at a temperature not above 60°C, an acid addition salt of D-(-)- α -aminobenzylpenicillin with an amine in a water-immiscible solvent containing at least 3 mols of water per mol of such penicillin.

The following is an example of the conduct of such a process. To a vigorously agitated mixture of 100 ml of methyl isobutyl ketone there are added at 25° to 30°C 15 ml of water and 10 ml of a mixture of secondary amines.

To this mixture there is then added slowly over a period of 30 minutes 10 grams of D-(-)- α -aminobenzylpenicillin beta-naphthalene sulfonate. The mixture is agitated for 3 hours at 25°-30°C. The product, D-(-)- α -aminobenzylpenicillin trihydrate precipitates and is collected by filtration. The filter cake of the product is washed several times with methyl isobutyl ketone and is dried at 40°C. The product is obtained in about a 90% yield and has a potency of 865 mcg/mg. It is determined by Karl Fischer analysis to have a moisture content of 13.4% by weight.

References

Merck Index 612

Kleeman & Engel p. 81

PDR pp. 993, 1606, 1758

I.N. p. 50

Johnson, D.A. and Hardcastle, G.A., Jr.; U.S. Patent 3,157,640; November 17, 1964; assigned to Bristol-Myers Company

AMRINONE

Therapeutic Function: Cardiotonic

Chemical Name: 3-Amino-5-(4-pyridinyl)-2(1H)-pyridinone

Common Name: —

Structural Formula:

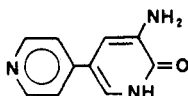

Chemical Abstracts Registry No.: 60719-84-8

Trade Name	Manufacturer	Country	Year Introduced
Inocor	Sterling Winthrop	Philippines	1982
Inocor	Sterling Winthrop	Mexico	1983
Wincoram	—	—	—

Raw Materials

3-Nitro-5-(4-pyridinyl)-2(1H)-pyridinone
Hydrogen

Manufacturing Process

A mixture containing 10 g of 3-nitro-5-(4-pyridinyl)-2(1H)-pyridinone, 200 ml of dimethylformamide and 1.5 g of 10% palladium-on-charcoal was hydrogenated under pressure (50 psi) at room temperature until the uptake of hydrogen ceased (about 30 minutes). The reaction mixture was filtered through infusorial earth and the filtrate was heated in vacuo to remove the solvent. The residual material was crystallized from dimethylformamide, washed successively with ethanol and ether, and dried in a vacuum oven at 80°C for 8 hours to yield 6 g of 3-amino-5-(4-pyridinyl)-2(1H)-pyridinone, melting point 294° to 297°C with decomposition.

References

Merck Index 616

DFU 4 (4) 245 (1979)

PDR p. 1909

OCDS Vol. 3 p. 147

DOT 18 (10) 547 (1982) & 19 (10) 581 (1983)

I.N. p. 85

Leshner, G.Y. and Opalka, C.J.; U.S. Patent 4,004,012; January 18, 1977; assigned to Sterling Drug Inc.

Leshner, G.Y. and Opalka, C.J.; U.S. Patent 4,107,315; August 15, 1978; assigned to Sterling Drug Inc.

ANCITABINE HYDROCHLORIDE

Therapeutic Function: Antineoplastic

Chemical Name: 2,3,3a,9a-Tetrahydro-3-hydroxy-6-imino-6H-furo[2',3':4,5]oxazolo[3,2-a]pyrimidine-2-methanol

Common Name: —

Structural Formula:

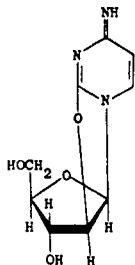

(base)

Chemical Abstracts Registry No.: 10212-25-6; 31698-14-3 (Base)

Trade Name	Manufacturer	Country	Year Introduced
Cyclo-C	Kohjin	Japan	1975

Raw Materials

Uridine	Acetic Anhydride
Trityl Chloride	Phosphorus Pentasulfide
Imidazole	Ammonia
Thiophosgene	Bromine
Hydrogen Sulfide	Hydrogen Chloride
Acetic Acid	

Manufacturing Process

A series of reaction steps may be employed in which: (1) Uridine is reacted with trityl chloride to give 5'-o-trityluridine; (2) Imidazole is reacted with thiophosgene and that product reacted with the 5'-o-trityluridine to give 2,2'-anhydro-1-(5'-o-trityl- β -D-arabinofuranosyl)uracil; (3) The preceding uracil product is converted to the thiouracil using hydrogen sulfide; (4) The trityl group is removed by treatment with 80% acetic acid; (5) A triacetylated product is obtained using acetic anhydride; (6) A dithiouracil is prepared from the uracil intermediate using phosphate pentasulfide.

Preparation of 1-(β -D-arabinofuranosyl)-2-thiocytosine: A solution of 2.0 g of 1-(2',3',5'-O-triacetyl- β -D-arabinofuranosyl)-2,4-dithiouracil in 100 ml of methanol is saturated with anhydrous ammonia at 0°C. The mixture, in a glass liner, is heated in a pressure bomb at 100°C for three hours. The reaction mixture is concentrated to a gum in vacuo, and most of the by-product acetamide is removed by sublimation at 60°C/0.1 mm. The residue is chromatographed on 100 g of silica gel. Elution of the column with methylene chloride-methanol mixtures with methanol concentrations of 2-25% gives fractions containing acetamide and a series of brown gums. The desired product is eluted with 30% methanol-methylene chloride to give a total yield of 0.386 g (30%), MP 175°-180°C (dec.). Recrystallization from methanol-isopropanol furnishes an analytical sample, MP 180°-182°C (dec.).

To a solution of 80 mg of 1-(β -D-arabinofuranosyl)-2-thiocytosine in 12 ml of water is added dropwise 3 ml of a 1 M bromine solution in carbon tetrachloride. At this point the color of the bromine persists for about 2-3 minutes after each addition. The unreacted bromine is blown off with a stream of nitrogen, and the reaction mixture is concentrated to a syrup in vacuo using a bath temperature less than 50°C. The residue is evaporated three times with 10 ml portions of ethanol, whereupon it crystallizes. The product is triturated with cold ethanol and with ether to obtain 17 mg of 2,2'-anhydro-1-(β -D-arabinofuranosyl)cytosine hydrobromide, MP 240°C (dec.).

Treatment of the hydrobromide with a slight excess of ethanolic ammonia yields the base which may then be converted to the hydrochloride.

References

- Merck Index 654
 Kleeman & Engel p. 53
 DOT 12 (8) 304 (1976)
 I.N. p. 87
 Shen, T.Y. and Ruyle, W.V.; U.S. Patent 3,463,850; August 26, 1969; assigned to Merck & Co., Inc.

ANGIOTENSIN AMIDE

Therapeutic Function: Vasoconstrictor

Chemical Name: L-asparaginyL-L-arginyL-L-valyL-L-tyrosyL-L-valyL-L-histidyL-L-protyL-L-phenylalanine

Common Name: —

Structural Formula:

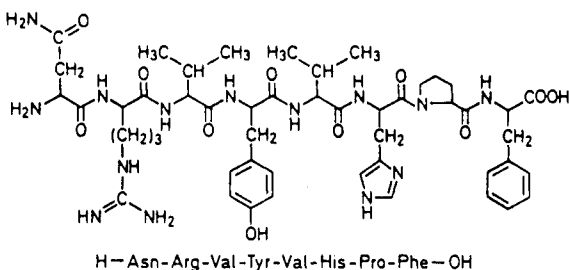

Chemical Abstracts Registry No.: 53-73-6

Trade Name	Manufacturer	Country	Year Introduced
Hypertensin	Ciba	W. Germany	1961
Hypertensin	Ciba	U.S.	1962

Raw Materials

L-AsparaginyL-L-arginyL-L-valyL-L-tyrosyL-L-valyL-L-histidyL-L-protyL-L-phenylalanine methyl ester trihydrochloride
Sodium hydroxide

Manufacturing Process

48 mg (0.042 mmol) of L-asparaginyL-L-arginyL-L-valyL-L-tyrosyL-L-valyL-L-histidyL-L-protyL-L-phenylalanine methyl ester trihydrochloride are suspended in 0.5 ml of methanol, and treated gradually in the course of one hour with 0.3 ml of N-caustic soda solution (about 7 equivalents) so that the pH value of the solution is maintained between 10.5 and 11.5. After a further 30 minutes the solution is freed from methanol under vacuum at room temperature, adjusted with 1N-acetic acid to pH 7.4 and lyophilized. The residual mixture of free peptide and inorganic salts (79 mg) is fractionated by countercurrent distribution in the system butanol/0.1 N-ammonium hydroxide. The pure octapeptide is obtained as a colorless powder which is soluble in water and methanol, more sparingly soluble in ethanol, and insoluble in acetone.

References

Merck Index 674

Kleeman & Engel p. 55

I.N. p. 89

Schwyzler, R., Iselin, B., Kappeler, H., Ritter, W. and Riuiker, B.; U.S. Patent 2,978,444; April 4, 1961; assigned to Ciba Pharmaceutical Products, Inc.

ANILERIDINE DIHYDROCHLORIDE

Therapeutic Function: Narcotic analgesic

Chemical Name: 1-[2-(4-aminophenyl)ethyl]-4-phenyl-4-piperidinecarboxylic acid ethyl ester dihydrochloride

Common Name: —

Structural Formula:

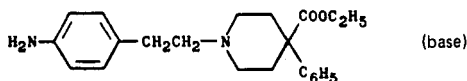

Chemical Abstracts Registry No.: 126-12-5; 144-14-9 (Base)

Trade Name	Manufacturer	Country	Year Introduced
Leritine HCl	Merck Sharpe & Dohme	U.S.	1958
Apodol Tabs	Squibb	U.S.	1965
Leritine	Merck-Frosst	Canada	—

Raw Materials

β -(p-Aminophenyl)ethyl Chloride	Sodium Carbonate
4-Phenyl-4-carboethoxy Piperidine Carbonate	Hydrogen Chloride

Manufacturing Process

A mixture of 7.8 grams (0.05 mol) of β -(p-aminophenyl)ethyl chloride hydrochloride, 12.5 grams (0.025 mol) of 4-phenyl-4-carboethoxypiperidine carbonate, 10.5 grams (0.125 mol) sodium bicarbonate, and 100 cc of anhydrous ethanol are mixed, stirred and heated under reflux for a period of approximately 40 hours and then concentrated in vacuo to dryness. The residual material is triturated with 50 cc of water, decanted, washed by decantation with an additional 50 cc of water, and then dried in vacuo to give N-[β -(p-aminophenyl)ethyl]-4-phenyl-4-carboethoxypiperidine.

The N-[β -(p-aminophenyl)ethyl]-4-phenyl-4-carboethoxypiperidine is dissolved in 50 cc of hot anhydrous ethanol, an excess (about 20 cc) of 20% alcoholic hydrochloric acid solution is added; upon scratching the side of the container crystals form. One hundred cubic centimeters of ether are then added to the mixture, the ethereal mixture is cooled, and the crystalline material which precipitates is recovered by filtration, washed with ether, and dried to give 12.7 grams of N-[β -(p-aminophenyl)ethyl]-4-phenyl-4-carboethoxypiperidine dihydrochloride which can be further purified by recrystallization from ethanol or methanol to give substantially pure material; MP 275°-277°C.

References

- Merck Index 680
 Kleeman & Engel p. 56
 OCDS Vol. 1 p. 300 (1977)
 I.N. p. 90
 Weijlard, J. and Pfister, K., III; U.S. Patent 2,966,490; December 27, 1960; assigned to Merck & Co., Inc.

ANISINDIONE

Therapeutic Function: Anticoagulant

Chemical Name: 2-(4-methoxyphenyl)-1H-indene-1,3(2H)-dione

Common Name: Anisindandione

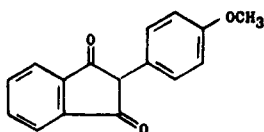
Structural Formula:**Chemical Abstracts Registry No.:** 117-37-3

Trade Name	Manufacturer	Country	Year Introduced
Miradon	Schering	U.S.	1960
Unidone	Unilabo	France	1964
Unidone	Centrane	France	—

Raw Materials

p-Methoxybenzaldehyde
Sodium Ethoxide
Phthalide

Manufacturing Process

To a hot solution of 20.6 g of sodium in 400 ml of absolute ethanol, there is added a solution of 110 g of phthalide and 110 g of p-methoxybenzaldehyde. A vigorous reaction ensues and one-half of the alcohol is distilled off over a two hour period. Ice and water are added to the red solution and the diluted solution is acidified with hydrochloric acid. The resulting gum solidifies and the aqueous phase is removed by decantation. The crude solid is recrystallized twice from two liters of ethanol yielding 2-(p-methoxyphenyl)-1,3-indandione as pale yellow crystals, MP 155°-156°C.

References

Merck Index 690
Kleeman & Engel p. 57
OCDS Vol. 1 p. 147 (1977)
I.N. p. 90
REM p. 828
Sperber, N.; U.S. Patent 2,899,358; August 11, 1959; assigned to Schering Corporation

ANISOTROPINE METHYLBROMIDE

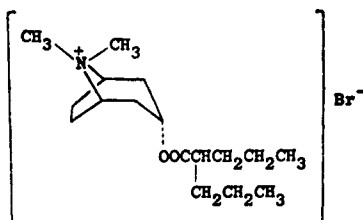
Therapeutic Function: Anticholinergic**Chemical Name:** endo-8,8-dimethyl-3-[(1-oxo-2-propylpentyl)oxy]-8-azoniabicyclo[3.2.1]-octane bromide**Common Name:** Octatropine methyl bromide**Structural Formula:**

Chemical Abstracts Registry No.: 80-50-2

Trade Name	Manufacturer	Country	Year Introduced
Valpin	Endo (Du Pont)	U.S.	1963
Valpinax	Crinos	Italy	1966
Valpin	Lacer	Spain	—
Valpin	Sankyo	Japan	—

Raw Materials

Tropine
Di-n-Propyl Acetyl Chloride
Methyl Bromide

Manufacturing Process

Preparation of Di-n-Propyl Acetyl Tropine Hydrochloride: Tropine (11.12 grams) was dissolved in 100 ml of anhydrous pyridine and to this solution was added 15.64 grams of di-n-propyl acetyl chloride. The mixture was refluxed for 6 hours. This solution was then cooled and the pyridine removed in vacuo. The residue was dissolved in chloroform. The chloroform solution was washed with 10% hydrochloric acid to remove the residual trace of pyridine. The hydrochloride of the product ester is soluble in chloroform and is not extracted from chloroform by hydrochloric acid. This is an unexpected property.

The chloroform solution of the hydrochloride was dried over anhydrous calcium sulfate, and evaporated to dryness, leaving a semisolid residue of product ester hydrochloride. This was recrystallized from chloroform-hexane mixture, MP 186°C.

Preparation of the Methyl Bromide: To the acetone solution of the free base was added an acetone solution, containing an excess of methyl bromide. Within a few minutes the methobromide started to crystallize. The mixture was allowed to stand for several hours. The crystallized solid was filtered, and additional product was obtained by evaporation of the filtrate. The yield was nearly quantitative. After recrystallization from acetone, the product melted at 329°C.

References

Merck Index 693

Kleeman & Engel p. 655

PDR p. 865

I.N. p. 699

REM p. 913

Weiner, N. and Gordon, S.M.; U.S. Patent 2,962,499; November 29, 1960; assigned to Endo Laboratories, Inc.

ANTAZOLINE HYDROCHLORIDE

Therapeutic Function: Antihistaminic

Chemical Name: 4,5-Dihydro-N-phenyl-N-(phenylmethyl)-1H-imidazole-2-methanamine

Common Name: Imidamine

Structural Formula:

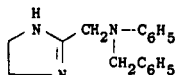

(base)

Chemical Abstracts Registry No.: 2508-72-7; 91-75-8 (Base)

Trade Name	Manufacturer	Country	Year Introduced
Antistine HCl	Ciba	U.S.	1948
Antistine	Ciba Geigy	France	1948
Antistine	Ciba	W. Germany	—
Antasten	Ciba	—	—
Arithmin	Lannett	U.S.	—
Azalone	Smith, Miller & Patch	U.S.	—
Histotab	Boots	U.K.	—
Phenazoline	Polfa	Poland	—

Raw Materials

2-Chloromethylimidazoline HCl
 N-Benzylaniline
 Hydrogen Chloride

Manufacturing Process

15.4 parts of 2-chloromethylimidazoline-hydrochloride, 45.8 parts of N-benzylaniline and 150 parts of alcohol are heated in an oil bath at 100° to 110°. After distilling off the alcohol, the reaction mass is maintained at this temperature for a further 3 hours and then triturated with water and 10 parts of sodium bicarbonate. The unconsumed benzylaniline is extracted with ether and the aqueous solution neutralized with dilute hydrochloric acid. By evaporating this solution and extracting the residue with alcohol there is obtained 2-(N-phenyl-N-benzylaminomethyl)-imidazoline-hydrochloride in the form of colorless crystals of melting point 227° to 229°.

References

Merck Index 701
 Kleeman & Engel p. 57
 OCDS Vol. 1 p. 242 (1977)
 I.N., p. 91
 Miescher, K. and Klarer, W.; U.S. Patent 2,449,241; September 14, 1948; assigned to Ciba Pharmaceutical Products, Inc.

ANTRAFENINE

Therapeutic Function: Analgesic

Chemical Name: 2-(4'-m-Trifluoromethylphenyl-piperazino)-ethyl 2-(7'-trifluoromethyl-4'-quinoly- amino)-benzoate

Common Name: —

Structural Formula:

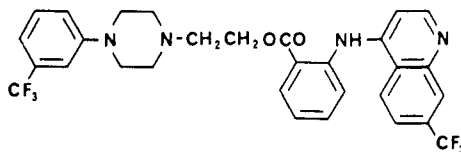

Chemical Abstracts Registry No.: 55300-29-3

Trade Name	Manufacturer	Country	Year Introduced
Stakane	Dausse	France	1977

Raw Materials

Allyl 2-(7'-Trifluoromethyl-4'-quinolinyl-amino)benzoate
 2-(4'-m-Trifluoromethylphenyl-piperazino)ethanol
 Sodium

Manufacturing Process

A mixture of 18.65 g (0.05 mol) of allyl 2-(7'-trifluoromethyl-4'-quinolylamino)-benzoate, 16.2 g (0.059 mol) of 2-(4'-m-trifluoromethylphenyl-piperazino)-ethanol, 150 ml of anhydrous toluene and 0.03 g of sodium is heated under reflux for 2½ hours, while the allyl alcohol formed during the reaction is slowly removed by distillation. A slight amount of insoluble matter is filtered off and the toluene is evaporated from the filtrate. The residue is dissolved in a mixture of methylene chloride and acetone (8:2) and this solution is passed through a silica column. Elution is carried out with the same mixture of solvents and the eluate is collected in 50 ml fractions. These fractions are examined by thin layer chromatography. Those which contain the desired almost pure ester are combined and the solvent is driven off from them. The residual product is triturated in a mixture of ether and petroleum ether, filtered off and dried. 16.8 g (yield 57%) of 2-(4'-m-trifluoromethylphenyl-piperazino)-ethyl 2-(7'-trifluoromethyl-4'-quinolylamino)-benzoate, melting point 88° to 90°C, are thus isolated.

References

Merck Index 746

DFU 2 (12) 786 (1977)

Kleeman & Engel p. 57

DOT 14 (2) 55 (1978)

I.N. p. 94

Giudicelli, D.P.R.L., Najer, H., Manory, P.M.J. and Dumas, A.P.F.; U.S. Patent 3,935,229; January 27, 1976; assigned to Synthelabo

APALCILLIN SODIUM

Therapeutic Function: Antibacterial

Chemical Name: 6-[[[(4-Hydroxy-1,5-naphthyridin-3-yl)carbonyl] amino]-phenyl acetyl]-amino]-3,3-dimethyl-7-oxo-4-thia-1-azabicyclo[3.2.0]-heptane-2-carboxylic acid

Common Name: D-α-(4-Hydroxy-1,5-naphthyridine-3-carbonamido)benzylpenicillin

Structural Formula:

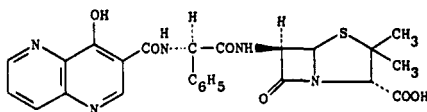

Chemical Abstracts Registry No.: 63469-19-2

Trade Name	Manufacturer	Country	Year Introduced
Lumota	Thomae	W. Germany	1982

Raw Materials

Phenacyl-6-aminopenicillate HCl	Sodium Bicarbonate
D-Phenylglycyl Chloride HCl	Sodium Thiophenoxide
4-Hydroxy-1,5-naphthyridine-3-carboxylic acid-N-succinimide ester	Triethylamine

Manufacturing Process

(a) Preparation of 6-D- α -aminobenzylpenicillin phenacyl ester: To a suspension of phenacyl 6-aminopenicillanate hydrochloride (1.85 g) and D-phenylglycyl chloride hydrochloride (1.29 g) in dichloromethane (20 ml), sodium bicarbonate (1.05 g) was added, and the resultant mixture was stirred while cooling with ice for 6 hours. The reaction mixture was filtered to eliminate the by-produced sodium chloride. The filtrate was admixed with isopropanol and concentrated under reduced pressure by the aid of a rotary evaporator. After the evaporation of dichloromethane, the precipitate was collected by filtration to give the objective compound in the form of the hydrochloride (2.19 g) MP 142° to 148°C (decomposition).

(b) Preparation of D- α -(4-hydroxy-1,5-naphthyridine-3-carboxamido)benzylpenicillin: To a solution of 6-D- α -aminobenzylpenicillin phenacyl ester (hydrochloride) (2.01 g) and triethylamine (0.808 g) in dimethylformamide (20 ml), 4-hydroxy-1,5-naphthyridine-3-carboxylic acid N-succinimide ester [(MP 310° to 311°C (decomposition))] (1.15 g) was added while cooling with ice, and the resultant mixture was stirred for 1 hour. Stirring was further continued at room temperature for 2 hours. After cooling with ice, 1% sodium bicarbonate solution (100 ml) was added thereto. The precipitated crystals were collected by filtration, washed with water and dried over phosphorus pentoxide to give D-(α -4-hydroxy-1,5-naphthyridine-3-carboxamido)benzylpenicillin phenacyl ester (2.17 g).

The above product was dissolved in dimethylformamide (65 ml), sodium thiophenoxide (0.89 g) was added thereto, and the resultant mixture was stirred at room temperature for 1 hour. To the resultant mixture, acetone (650 ml) was added, and the separated crystals were collected by filtration and washed with acetone and ether in order to give the objective compound in the form of the sodium salt (1.3 g).

In the above procedure, the use of 4-hydroxy-1,5-naphthyridine-3-carboxyl chloride in place of 4-hydroxy-1,5-naphthyridine-3-carboxylic acid N-succinimide ester can also afford the same objective compound as above. The use of sodium thio-n-propoxide in place of sodium thiophenoxide can also give the objective compound in the form of the sodium salt.

References

Merck Index 748

DFU 4 (3) 225 (1979)

DOT 19 (2) 110 (1983)

I.N. p. 94

Yamada, H., Tobiki, H., Nakatsuka, I., Tanno, N., Shimago, K. and Nakagome, T.; U.S. Patent 4,005,075; January 25, 1977; assigned to Sumitomo Chemical Co., Ltd.

APAZONE

Therapeutic Function: Antiarthritic

Chemical Name: 5-(dimethylamino)-9-methyl-2-propyl-1H-pyrazolo[1,2-a][1,2,4]benzotriazine-1,3(2H)-dione

Common Name: Azapropazone

Structural Formula:

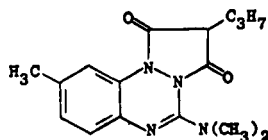

Chemical Abstracts Registry No.: 113539-59-8

Trade Name	Manufacturer	Country	Year Introduced
Prolixan	Siegfried	W. Germany	1970
Prolixan	Siegfried	Switz.	1970
Cinnamin	Nippon Chemiphar	Japan	1971
Rheumox	Robins	U.K.	1976
Prolixan	Logeais	France	1976
Prolixan	Malesci	Italy	1977
Prolixan	Embil	Turkey	—
Prodisan	Embil	Turkey	—
Prodisan	Roche	—	—
Prolix	Roche	—	—
Prolixano	Leo	—	—
Rheumox	Robins	U.S.	—
Xani	Farmakos	Yugoslavia	—

Raw Materials

3-Dimethylamino-(1,2-Dihydro-1,2,4-benzotriazine)	Sodium
Diethyl Propyl Malonate	Hydrogen
3-Dimethylamino-1,2,4-benzotriazine Oxide	Triethylamine
Propyl Malonyl Chloride	

Manufacturing Process

The following describes two alternatives for the synthesis of the closely related butyl analog.

Alternative (a): In a three-neck flask with descending condenser to 3.8 grams of 3-dimethylamino-(1,2-dihydro-1,2,4-benzotriazine) are added 0.52 gram metallic sodium, dissolved in a small volume of absolute alcohol, 4.5 g of diethylbutylmalonate (diethylpropylmalonate for Apazone) and 15 ml of xylene, in a nitrogen atmosphere. The mixture is heated for 2 hours to 70°C, then for 3 hours to 110°-130°C and for one more hour to 150°C, slowly distilling off the alcohol and most of the xylene. To the resulting light brown colored mass are added 200 ml of water. The resulting solution is extracted twice with ether or benzene and afterwards acidified with HCl. Yield 3.6 g of 1,2-butylmalonyl-3-dimethylamino-(1,2-dihydro-1,2,4-benzotriazine). After crystallization from alcohol the melting point is 189°-190°C.

Alternative (b): 3-Dimethylamino-1,2,4-benzotriazine-oxide is shaken in the presence of Raney nickel in 15 volume parts of an alcohol-acetic acid (9:1) mixture in a hydrogen atmosphere. The mixture absorbs 2 mols hydrogen per 1 mol starting material. Hydrogenation can also be effected using a palladium catalyst with a suitable solvent. After reduction it is filtered on a Büchner-funnel through a Hyflow-layer and the solvent is evaporated in vacuo under nitrogen. The residue is dissolved in 20 parts of water-free dioxane and treated at 60°C with the calculated amount of butylmalonyl chloride (propyl malonyl chloride for Apazone) (1 mol/mol) and triethylamine (2 mol/mol). The separated triethylamine hydrochloride is filtered, the dioxane-solution is evaporated under vacuo to dryness, and the residue is dissolved in 7 volume parts of boiling acetic acid. After cooling, the product separates in lightly yellowish crystals. They are dissolved in the calculated amount of 0.25 N NaOH, treated with a small amount of carbon and precipitated with HCl. Melting point of the purified product is 187°C. Yield: approximately 60% of the theoretical amount.

References

Merck Index 750

Kleeman & Engel p. 66

OCDS Vol. 2 p. 475 (1980)

i.N. p. 110

Molnar, I., Wagner-Jauregg, T., Jahn, U. and Mixich, G.; U.S. Patent 3,349,088; October 24, 1967; assigned to Siegfried AG, Switzerland

Molnar, I., Wagner-Jauregg, T., Jahn, U. and Mixich, G.; U.S. Patent 3,482,024; December 2, 1969; assigned to Siegfried AG.

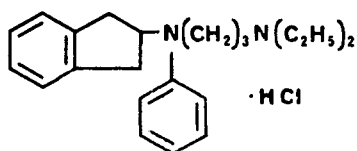
APRINDINE HYDROCHLORIDE**Therapeutic Function:** Antiarrhythmic**Chemical Name:** N-[3-(Diethylamino)propyl]-N-phenyl-2-indanamine hydrochloride**Common Name:** —**Structural Formula:****Chemical Abstracts Registry No.:** 33237-74-0; 37640-71-4 (Base)

Trade Name	Manufacturer	Country	Year Introduced
Amidonal	Madaus	W. Germany	1976
Fiboran	Sedaph	France	1977
Fibocil	Lilly	U.S.	—
Fiboran	Christiaens	Belgium	—
Ritmusin	Gebro	Austria	—

Raw Materials

N-Phenyl-2-aminoindane	Sodium Amide
α -Chloropropyl Diethyl Amine	Hydrogen Chloride
Sodium Hydroxide	

Manufacturing Process

104.6 g (0.5 mol) N-phenyl-2-aminoindane and 2.5 liters benzene are introduced into a reaction vessel of 5 liters, under an atmosphere of nitrogen. 37 g (0.95 mol) sodium amide are added and the mixture is stirred during 3 hours at room temperature.

119.7 g (0.8 mol) of γ -chloropropyl diethylamine are then quickly added. After agitation during 1 hour at room temperature, the reaction mixture is refluxed and stirred under nitrogen during 21 hours. The mixture is then allowed to cool and poured onto ice. The obtained aqueous phase is extracted by means of 500 cm³ of benzene. The benzene extract is washed two times with 200 cm³ of water and the benzene is then evaporated.

The residue is treated with 500 cm³ of hydrochloric acid (2N). The obtained solution is evaporated to dryness and the oily residue is recrystallized from ethanol. 176.9 g (yield 89.4%)

of dihydrochloride of N-phenyl-N-diethylaminopropyl-2-aminoindane are obtained, MP 208° to 210°C.

The dihydrochloride is converted into monohydrochloride by dissolving 26.36 g (0.066 mol) of dihydrochloride into 158 cm³ of water, adding drop by drop a suitable amount (0.066 mol) of caustic soda (1N), evaporating the aqueous solution to dryness, drying by means of benzene, filtering the formed sodium chloride (3.8 g) and crystallizing the cooled obtained benzene solution. 22.6 g (95%) of monohydrochloride are obtained, MP 120° to 121°C.

References

Merck Index 776

Kleeman & Engel p. 58

OCDS Vol. 2 p. 208

DOT 10 (4) 120 (1974)

REM p. 860

Vanhoof, P. and Clarebout, P.; British Patent 1,321,424; June 27, 1973; assigned to Manufacture de Produits Pharmaceutiques A. Christiaens, SA

ARGININE GLUTAMATE

Therapeutic Function: Ammonia detoxicant (hepatic failure)

Chemical Name: Glutamic Acid Compound with L-Arginine

Common Name: —

Structural Formula:

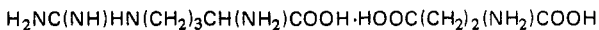

Chemical Abstracts Registry No.: 4320-30-3

Trade Name	Manufacturer	Country	Year Introduced
Modamate	Abbott	U.S.	1960
Eucol	Lefranco	France	1970

Raw Materials

L-Arginine

L-Glutamic Acid

Manufacturing Process

This salt may be prepared by mixing L-arginine with L-glutamic acid in water and crystallizing the resulting salt from the water by the addition of a polar water miscible organic solvent to the water. For instance, when 17.2 g of L-arginine and 14.5 g of L-glutamic acid were dissolved in 155 g of water, a clear homogeneous solution resulted which had a pH of 5.3. This solution was filtered and the filtrate was evaporated at 50°C under reduced pressure to a solution having a solids content of about 45%. Absolute methanol (220 g) was added to the concentrated solution of the salt and this mixture cooled to 5°C for one hour. The resulting solid salt was removed from the mixture by filtration and washed with absolute methanol. After being dried preliminarily in the air, the salt was further dried in a vacuum oven at 60°C for 3 hours. The resulting salt, L-arginine-L-glutamate, weighed 30 g (94.6% of the theoretically possible yield based on the amount of L-arginine and L-glutamic acid employed) and melted at 193°–194.5°C with decomposition.

References

Merck Index 798

DFU 3 (1) 10 (1978)

DOT 17 (3) 87 (1981)

I.N. p. 98

Barker, N.G. and Chang, R.W.H., U.S. Patent 2,851,482; September 9, 1958; assigned to General Mills, Inc.

ASPARAGINASE**Therapeutic Function:** Antineoplastic (acute leukemia)**Chemical Name:** L-Asparagine amidohydrolase**Common Name:** Colapase; L-Asnase**Structural Formula:**An enzyme of MW 133,000 \pm 5,000 believed to consist of 4 equivalent subunits.**Chemical Abstracts Registry No.:** 9015-68-3

Trade Name	Manufacturer	Country	Year Introduced
Crasnitin	Bayer	W. Germany	1969
Crasnitin	Bayer	Italy	1971
Leunase	Kyowa Hakko	Japan	1971
Kidrolase	Specia	France	1971
Crasnitin	Bayer	U.K.	1971
Eispar	Merck Sharp & Dohme	U.S.	1978
Kidrolase	Rhone-Poulenc	Canada	—
Leucogen	Bayer	—	—

Raw MaterialsErwinia bacteria
Nutrient medium**Manufacturing Process**

Therapeutically active L-asparaginase is isolated from bacteria from the genus *Erwinia*, a known genus pathogenic towards plants. L-asparaginase is conveniently isolated from this genus by growing the bacteria upon a suitable nutrient medium until a desired quantity is obtained and then extracting the L-asparaginase either by conventional cell disruption methods, or preferably, by processes more fully described in U.S. Patent 3,660,238.

References

Merck Index 849

Kleeman & Engel p. 62

PDR p. 1176

I.N. p. 102

REM p. 1143

Wade, H.E.; U.S. Patent 3,660,238; May 2, 1972

Herbert, D. and Wade, H.E.; U.S. Patent 3,686,072; August 22, 1972

ASPARTAME

Therapeutic Function: Sweetener (dietetic)

Chemical Name: N-L- α -Aspartyl-L-phenylalanine 1-methyl ester

Common Name: —

Structural Formula:

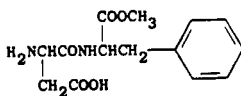

Chemical Abstracts Registry No.: 22839-47-0

Trade Name	Manufacturer	Country	Year Introduced
Canderel	Searle	France	1979
Canderel	Searle	Switz.	1981
Equal	Searle	U.S.	1982
Canderel	Wander	W. Germany	1983
Canderel	Muro	U.S.	—
Nutrasweet	Searle	U.S.	—

Raw Materials

L-Phenylalanine Methyl Ester HCl

N-Benzyloxycarbonyl-L-aspartic acid- α -p-nitrophenyl, β -benzyl Diester

Hydrogen

Manufacturing Process

A solution of 88.5 parts of L-phenylalanine methyl ester hydrochloride in 100 parts of water is neutralized by the addition of dilute aqueous potassium bicarbonate, then is extracted with approximately 900 parts of ethyl acetate. The resulting organic solution is washed with water and dried over anhydrous magnesium sulfate. To that solution is then added 200 parts of N-benzyloxycarbonyl-L-aspartic acid- α -p-nitrophenyl, β -benzyl diester, and that reaction mixture is kept at room temperature for about 24 hours, then at approximately 65°C for about 24 hours. The reaction mixture is cooled to room temperature, diluted with approximately 390 parts of cyclohexane, then cooled to approximately -18°C in order to complete crystallization. The resulting crystalline product is isolated by filtration and dried to afford β -benzyl N-benzyloxycarbonyl-L-aspartyl-L-phenylalanine methyl ester, melting at about 118.5°-119.5°C.

To a solution of 180 parts of β -benzyl N-benzyloxycarbonyl-L-aspartyl-L-phenylalanine methyl ester in 3,000 parts by volume of 75% acetic acid is added 18 parts of palladium black metal catalyst, and the resulting mixture is shaken with hydrogen at atmospheric pressure and room temperature for about 12 hours. The catalyst is removed by filtration, and the solvent is distilled under reduced pressure to afford a solid residue, which is purified by re-crystallization from aqueous ethanol to yield L-aspartyl-L-phenylalanine methyl ester. It displays a double melting point at about 190°C and 245°-247°C.

References

Merck Index 852

DOT 16 (2) 65 (1980)

I.N. p. 102

Schlatter, J.M.; U.S. Patent 3,492,131; January 27, 1970; assigned to G.D. Searle & Co.

ASPIRIN

Therapeutic Function: Analgesic, antipyretic, antiinflammatory

Chemical Name: 2-(acetyloxy)benzoic acid

Common Name: Acetylsalicylic acid

Structural Formula:

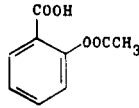

Chemical Abstracts Registry No.: 50-78-2

Trade Name	Manufacturer	Country	Year Introduced
Entab	Mayrand	U.S.	1982
Easprin	WL/PD	U.S.	1982
Ecotrin	Menley James	U.S.	1983
Zorprin	Boots	U.S.	1983
Verin	Verex	U.S.	1983
AAS	Sterwin Espanola	Spain	—
Acesal	Oranienbourg	E. Germany	—
Acetard	Benzon	Denmark	—
Acetisal	Alkaloid	Yugoslavia	—
Acetisal	Farmakos	Yugoslavia	—
Acetisal	Galenika	Yugoslavia	—
Acetical	Rekah	Israel	—
Acetophen	Merck-Frosst	Canada	—
Acetylin	Heyden	W. Germany	—
Acetylo	Chemedica	Switz.	—
Acetylosal	Maria Heil	Austria	—
Acetyl-Sal	Hartz	Canada	—
Acetysal	Jugoremedija	Yugoslavia	—
Acetysal	Krka	Yugoslavia	—
Acetysal	Zdravlje	Yugoslavia	—
Acimetten	Kwieda	Austria	—
Acisal	Pliva	Yugoslavia	—
Adiro	Bayer	—	—
Alaspine	Liba	Turkey	—
Albyl	AFI	Norway	—
Algo	Lokman	Turkey	—
Alka-Seltzer	Miles	Italy	—
Ancasal	Anca	Canada	—
Antidol	Gebro	Austria	—
Apernyl	Bayer	Japan	—
Apyron	Lingner & Fischer	W. Germany	—
Asart	SK&F	U.S.	—
Asatard	De Angelj	Italy	—
Asdol	Srbolek	Yugoslavia	—
Aspalgin	Krka	Yugoslavia	—
Aspec	Kempthorne Prosser	New Zealand	—
Aspegic	Egic	France	—
Aspercin	Otis Clapp	U.S.	—
Aspermin	Buffington	U.S.	—
Aspirin	Bayer	W. Germany	—

Trade Name	Manufacturer	Country	Year Introduced
Aspirtab	Dover	U.S.	—
Aspirvess	Miles	U.S.	—
Aspisol	Bayer	W. Germany	—
Aspro	Nicholas	Italy	—
Aspro	Pan Quimica	Spain	—
Asrivo	Rivopharm	Switz.	—
Astrin	Medic	Canada	—
Ataspin	Atabay	Turkey	—
Babyprin	Pfizer	U.S.	—
Bebaspin	Deva	Turkey	—
Bi-Prin	Boots	U.K.	—
Breoprin	Izal	U.K.	—
Bufacyl	Teva	Israel	—
Buffaprin	Buffington	U.S.	—
Buffasal	Dover	U.S.	—
Calmo Yer	Yer	Spain	—
Caprin	Sinclair	U.K.	—
Casprium	Liade	Spain	—
Catalgine	Theraplix	France	—
Cedrox	Cederroths	Sweden	—
Cemerit	Bayer	Italy	—
Claradin	Nicholas	U.K.	—
Claragine	Nicholas	France	—
Clariprin	Nicholas	—	—
Codalgina	Fass	Spain	—
Colfarit	Bayer	W. Germany	—
Contrheuma-Retard	Spitzner	W. Germany	—
Coryphen	Rougier	Canada	—
Diaforil	Maggioni	Italy	—
Domupirina	Medici Domus	Italy	—
Ecasil	Andromacco	Argentina	—
Ecoprin	Sam-On	Israel	—
Ecotrin	SK&F	U.S.	—
Empirin	Burroughs-Wellcome	U.S.	—
Endospirin	Enila-Lotecia	Brazil	—
Endyol	Guidotti	Italy	—
Entericin	Bristol-Myers	U.S.	—
Enterosarine	Sarein	France	—
Entrophen	Merck-Frosst	Canada	—
Eskotrin	SK&F	U.S.	—
Extren	Vicks	U.S.	—
Flectadol	Maggioni	Italy	—
Genasprin	Fisons	U.K.	—
Godamed	Pfieger	W. Germany	—
Globentyl	Nyegaard	Norway	—
Globoid	Nyegaard	Norway	—
Glucetyl	Technicopharm	Switz.	—
Hagedabletten	Hageda	W. Germany	—
Halgon	Togal	W. Germany	—
Idotyl	Ferrosan	Denmark	—
Juveprine	Sarget	France	—
Kilios	Farmitalia Carlo Erba	Italy	—
Levius	Pharmitalia	U.K.	—
Levius	Montedison	W. Germany	—
Licyl	A.L.	Norway	—
Longasa	Squibb	U.S.	—
Magnecyl	ACO	Sweden	—

Trade Name	Manufacturer	Country	Year Introduced
Magnyl	DAK	Denmark	—
Measurin	Breon	U.S.	—
Medisyl	Medica	Finland	—
Mejoral Infantil	Sterwin Espanola	Spain	—
Micristin	Gyogyert	Hungary	—
Neopirine	Casgrain & Charbonneau	Canada	—
Neutraceutyl	Promedica	France	—
Nibol	Bosnalijek	Yugoslavia	—
Nova-Phase	Nova	Canada	—
Novasen	Novopharm	Canada	—
Pharmacin	Optrex	U.K.	—
Premaspin	Laake	Finland	—
Pyronoval	Hoechst	W. Germany	—
Rectosalyl	Bouty	Italy	—
Reunyl	Hassle	Sweden	—
Rhodine	Specia	France	—
Rhonal	Specia	France	—
Rhonal	Rhodia Iberica	Spain	—
Rhusal	G.P.	Australia	—
Riphen	Riva	Canada	—
Rodina	Farmitalia Carlo Erba	Italy	—
Sal Adult	Beecham	U.K.	—
Sal Infant	Beecham	U.K.	—
Sargepirine	Sarget	France	—
Saspryl	Teva	Israel	—
Seclopyrine	Seclo	France	—
Servisprin	Servipharm	Switz.	—
Solprin	Reckitt	U.K.	—
Solpyron	Beecham	U.K.	—
Solucetyl	Sarback	France	—
Solusal	Hamilton	Australia	—
St. Joseph	Plough	U.S.	—
Supasa	Nordic	Canada	—
Tasprin	Ticen	U.K.	—
Temagin	Beiersdorf	W. Germany	—
Triaphen	Tranon	Canada	—
Trineral	Beiersdorf	W. Germany	—
Winsprin	Winthrop	U.S.	—

Raw Materials

Salicylic Acid
Acetic Anhydride
Ketene

Manufacturing Process

As described in U.S. Patent 2,731,492, a glass-lined reactor of 1,500 gallons capacity, fitted with a water-cooled reflux condenser, thermometers with automatic temperature registers and an efficient agitator, is employed.

To start the process, a mother liquor is made by dissolving 1,532 kg of acetic anhydride (15 mols) in 1,200 kg of toluene. To this mother liquor, add 1,382 kg of salicylic acid (10 mols), heat the reaction mixture under an efficient reflux condenser, to 88°-92°C and maintain within this temperature range for 20 hours.

The reaction mixture is now transferred to aluminum cooling tanks, and is allowed to cool slowly, over a period of 3 to 4 days, to a terminal temperature of 15°-25°C (room tempera-

ture). The acetylsalicylic acid precipitates as large, regular crystals. The mother liquor is now filtered or centrifuged from the precipitated acetylsalicylic acid and the filter cake is pressed or centrifuged as free of mother liquor as possible. The crystals are washed with distilled water until completely free of acetic acid, pressed or centrifuged as dry as possible and the filter cake is then dried in a current of warm air at a temperature of 60°-70°C.

The filtrate from this first batch will comprise a solution of 180 to 270 kg of unprecipitated acetylsalicylic acid (1.0 to 1.5 mols), 510 kg of acetic anhydride (5.0 mols), 600 kg of acetic acid (10.0 mols) (obtained as a by-product in the acetylation step) and 1,200 kg of the diluent toluene. Into this filtrate, at a temperature of 15° to 25°C, ketene gas is now passed through a sparger tube or diffuser plate, with good agitation, until a weight increase of 420.5 kg of ketene (10 mols) occurs. The reaction mixture will now contain 180-270 kg of unprecipitated acetylsalicylic acid (1.0-1.5 mols) and 1,532 kg of acetic anhydride (15 mols) in 1,200 kg of toluene. This mother liquor is recycled to the first step of the process for reaction with another batch of 1,382 kg of salicylic acid. On recirculating the mother liquor, the yield of pure acetylsalicylic acid is 1,780 to 1,795 kg per batch.

References

Merck Index 863

Kleeman & Engel p. 12

PDR (Many References)

DOT 16 (10) 359 (1980)

REM p. 1112

Kamlet, J.; U.S. Patent 2,731,492; January 17, 1956

Hamer, W.E. and Phillips, G.V.; U.S. Patent 2,890,240; June 9, 1959; assigned to Monsanto Chemicals, Limited, England

Edmunds, R.T.; U.S. Patent 3,235,583; February 15, 1966; assigned to The Norwich Pharmacal Company

ASTEMIZOLE

Therapeutic Function: Antiallergic; antihistaminic

Chemical Name: 1-[(4-Fluorophenyl)methyl]-N-[1-[2-(4-methoxyphenyl)ethyl]-4-piperidinyl]-1H-benzimidazol-2-amine

Common Name: —

Structural Formula:

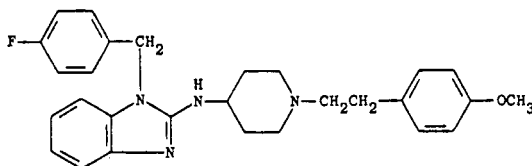

Chemical Abstracts Registry No.: —

Trade Name	Manufacturer	Country	Year Introduced
Hismanal	Janssen	U.K.	1983

Raw Materials

2-(4-Methoxyphenyl)ethyl Methane Sulfonate

1-[(4-Fluorophenyl)methyl]-N-(4-piperidyl)-1H-benzimidazol-2-amine
 Dihydrobromide
 Sodium Carbonate

Manufacturing Process

A mixture of 2.3 parts of 2-(4-methoxyphenyl)ethyl methanesulfonate, 4.9 parts of 1-[(4-fluorophenyl)methyl]-N-(4-piperidyl)-1H-benzimidazol-2-amine dihydrobromide, 3.2 parts of sodium carbonate, 0.1 part of potassium iodide and 90 parts of N,N-dimethylformamide is stirred overnight at 70°C. The reaction mixture is poured onto water. The product is extracted with methylbenzene. The extract is washed with water, dried, filtered and evaporated. The residue is purified by column-chromatography over silica gel using a mixture of trichloromethane and methanol (98:2 by volume) as eluent. The pure fractions are collected and the eluent is evaporated. The residue is crystallized from 2,2'-oxybispropane, yielding 2.2 parts (48%) of 1-(4-fluorophenylmethyl)-N-[1-[2-(4-methoxyphenyl)ethyl]-4-piperidyl]-1H-benzimidazol-2-amine; MP 149.1°C.

References

Merck Index A-1

DFU 7 (1) 10 (1982)

OCDS Vol. 3 p. 177

DOT 19 (7) 412 (1983)

I.N. p. 102

Janssens, F., Stokbroekx, R., Torremans, J. and Luyckx, M; U.S. Patent 4,219,559; August 26, 1980; assigned to Janssen Pharmaceutica N.V.

ATENOLOL

Therapeutic Function: β -Adrenergic blocking drug

Chemical Name: 4-[2-hydroxy-3-[(1-methylethyl)amino]propoxy]benzeneacetamide

Common Name: —

Structural Formula:

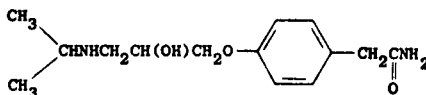

Chemical Abstracts Registry No.: 29122-68-7

Trade Name	Manufacturer	Country	Year Introduced
Tenormin	Stuart	U.K.	1976
Tenormin	I.C.I.	W. Germany	1976
Tenormin	I.C.I.	Switz.	1978
Tenormin	I.C.I.	Italy	1979
Tenormin	I.C.I.	France	1979
Tenormin	Stuart	U.S.	1981
Atenol	C.T.	Italy	—
Blokium	Prodes	Spain	—
Ibinolo	I.B.I.	Italy	—

Trade Name	Manufacturer	Country	Year Introduced
Mycord	Szabo-Kessler	Argentina	—
Normiten	Abic	Israel	—
Seles Beta	Farmitalia Carlo Erba	Italy	—
Tenoretic	Stuart	U.S.	—
Vericordin	Lazar	Argentina	—

Raw Materials

p-Hydroxyphenylacetamide
 Epichlorohydrin
 Isopropylamine

Manufacturing Process

1 gram of 1-p-carbamoylmethylphenoxy-2,3-epoxypropane and 10 ml of isopropylamine in 25 ml of methanol is heated in a sealed tube at 110°C for 12 hours. The mixture is evaporated to dryness and the residue is partitioned between 50 ml of chloroform and 50 ml of aqueous 2N-hydrochloric acid. The aqueous acidic layer is separated, made alkaline with sodium carbonate and extracted twice with 50 ml of chloroform each time. The combined extracts are dried and evaporated to dryness and the residue is crystallized from ethyl acetate. There is thus obtained 1-p-carbamoylmethylphenoxy-3-isopropylamino-2-propanol, MP 146°–148°C.

The 1-p-carbamoylmethylphenoxy-2,3-epoxypropane used as starting material may be obtained as follows: a mixture of 3.2 grams of p-hydroxyphenylacetamide, 25 ml of epichlorohydrin and 6 drops of piperidine is heated at 95°–100°C for 6 hours. The mixture is cooled and filtered and the solid product is crystallized from methanol. There is thus obtained 1-p-carbamoylmethylphenoxy-2,3-epoxypropane, MP 158°–160°C.

References

- Merck Index 868
 DFU 1 (1) 7 (1976)
 Kleeman & Engel p. 62
 PDR pp. 1786, 1788
 OCDS Vol. 2 p. 109 (1980)
 DOT 13 (2) 49 (1977) & 16 (1) 30 (1980)
 J.N. p. 103
 REM p. 904
 Barrett, A.M., Carter, J., Hull, R., Le Count, D.J. and Squire, C.J.; U.S. Patent 3,663,607; May 16, 1972; assigned to Imperial Chemical Industries Limited, England
 Barrett, A.M., Carter, J., Hull, R., Le Count, D.J. and Squire, C.J.; U.S. Patent 3,836,671; September 17, 1974; assigned to Imperial Chemical Industries Limited, England

ATRACURIUM BESYLATE

Therapeutic Function: Neuromuscular blocker

Chemical Name: N,N'-4,10-dioxo-3,11-dioxotridecylene-1,13-bis-tetrahydropapaverine di-benzenesulfonate

Common Name: —

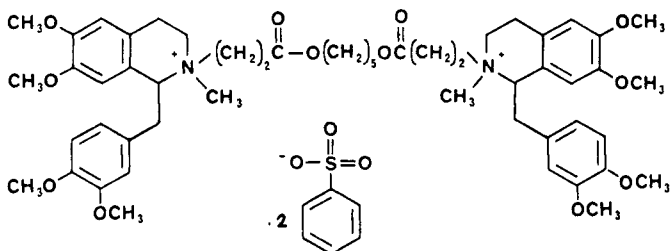
Structural Formula:

Chemical Abstracts Registry No.: 64228-81-5

Trade Name	Manufacturer	Country	Year Introduced
Tracrium	Burroughs Wellcome	U.S.	1983
Tracrium	Burroughs Wellcome	U.K.	1983
Tracrium	Burroughs Wellcome	Switz.	1983

Raw Materials

Acryloyl Chloride
Pentane-1,5-diol

Tetrahydropapaverine
Methyl Benzene Sulfonate

Manufacturing Process

Acryloyl chloride (0.2 mol) in dry benzene (60 ml) was added over 0.5 hour with mechanical stirring to pentane-1,5-diol (0.1 mol), triethylamine (0.2 mol) and pyrogallol (0.1 g) in dry benzene (100 ml). Further dry benzene (ca 100 ml) was added followed by triethylamine (10 ml), and the mixture stirred at 50°C for 0.5 hour. The triethylamine hydrochloride was filtered off and the solvent removed in vacuo to leave a yellow oil which was distilled in the presence of a trace of *p*-methoxyphenol, excluding light, to give 1,5-pentamethylene diacrylate (12.9 g; 61%; BP 90° to 95°C/0.01 mm Hg).

A solution of tetrahydropapaverine (4.43 g) and 1,5-pentamethylene diacrylate (1.30 g) in dry benzene (15 ml) was stirred under reflux for 48 hours excluding light. The solvent was removed in vacuo and the residual pale red oil dissolved in chloroform (10 ml). Addition of ether (ca 400 ml), followed by saturated ethereal oxalic acid solution (ca 500 ml) gave a flocculent white precipitate, which was filtered off, washed with ether and dried. Crystallization (twice) from ethanol gave *N,N'*-4,10-dioxo-3,11-dioxotridecylene-1,13-bis-tetrahydropapaverine dioxalate as a white powder (3.5 g; 51%; MP 117° to 121°C).

The free base, *N,N'*-4,10-dioxo-3,11-dioxotridecylene-1,13-bis-tetrahydropapaverine, was obtained by basifying an aqueous solution of the dioxalate with sodium bicarbonate solution, followed by extraction with toluene and evaporation of the solvent, to give a colorless viscous oil.

Scrupulously dried base (0.5 g) in spectroscopically pure acetonitrile (8 ml) was treated with methyl benzene sulfonate at room temperature for 22 hours. The filtered reaction mixture was added dropwise to mechanically stirred, filtered, dry ether (ca 450 ml). The flocculent white precipitate was filtered off, washed with dry ether, and dried in vacuo over P₂O₅ at 50°C to yield the product, an off-white powder melting at 85° to 90°C.

References

Merck Index A-2
DFU 5 (11) 541 (1980)
PDR p. 766

DOT 19 (2) 111 (1983)

I.N. p. 104

REM p. 925

Stenlake, J.B., Waigh, R.D., Dewar, G.H., Urwin, J. and Dhar, N.C.; U.S. Patent 4,179,507
December 18, 1979; assigned to Burroughs Wellcome Company

AURANOFIN

Therapeutic Function: Antiarthritic

Chemical Name: S-Triethylphosphinegold 2,3,4,6-tetra-O-acetyl-1-thio- β -D-glucopyranoside

Common Name: —

Structural Formula:

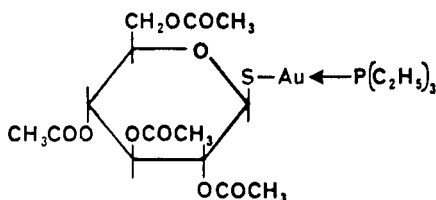

Chemical Abstracts Registry No.: 34031-32-8

Trade Name	Manufacturer	Country	Year Introduced
Ridaura	SK&F	W. Germany	1982
Ridaura	SK&F	Switz.	1983

Raw Materials

Thiodiglycol	Gold Acid Chloride Trihydrate
Triethylphosphine	Potassium Carbonate
S-(2,3,4,6-Tetra-O-acetylglucopyranosyl)thiopseudourea Hydrobromide	

Manufacturing Process

(A) Triethylphosphinegold chloride: A solution of 10.0 g (0.08 mol) of thiodiglycol in 25 ml of ethanol is mixed with a solution of 15.76 g (0.04 mol) of gold acid chloride trihydrate in 75 ml of distilled water. When the bright orange-yellow solution is almost colorless, it is cooled to -5°C and an equally cold solution of 5.0 g (0.0425 mol) of triethylphosphine in 25 ml of ethanol is added dropwise to the stirred solution. After the addition is complete, the cooled mixture is stirred for $\frac{1}{2}$ hour. Solid that separates is removed and the filtrate is concentrated to about 30 ml to yield a second crop. The combined solid is washed with aqueous-ethanol (2:1) and recrystallized from ethanol by adding water to the cloud point. The product is obtained as white needles, MP 85° to 86°C .

(B) Aurano-fin: A cold solution of 1.66 g (0.012 mol) of potassium carbonate in 20 ml of distilled water is added to a solution of 5.3 g (0.011 mol) of S-(2,3,4,6-tetra-O-acetylglucopyranosyl)thiopseudourea hydrobromide [*Methods in Carbohydrate Chemistry*, vol 2, page 435 (1963)] in 30 ml of water at -10°C . A cold solution of 3.86 g (0.011 mol) of triethylphosphinegold chloride in 30 ml of ethanol containing a few drops of methylene chloride is added to the above mixture before hydrolysis of the thiouronium salt is complete. After the addition is complete, the mixture is stirred in the cold for $\frac{1}{2}$ hour. The solid that separates

is removed, washed first with aqueous ethanol then water and dried in vacuo. There is obtained colorless crystals, MP 110° to 111°C, of S-triethylphosphinegold 2,3,4,6-tetra-O-acetyl-1-thio-β-D-glucopyranoside.

References

Merck Index 882

DFU 1 (10) 451 (1976)

PDR p. 1721

DOT 18 (9) 463 (1982)

I.N. p. 106

REM p. 1122

McGusty, E.R. and Sutton, B.M.; U.S. Patent 3,708,579; January 2, 1973; assigned to Smith Kline and French Laboratories

Nemeth, P.E. and Sutton, B.M.; U.S. Patent 3,635,945; January 18, 1972; assigned to Smith Kline and French Laboratories

AUROTHIOGLYCANIDE

Therapeutic Function: Antiarthritic

Chemical Name: [[(Phenylcarbamoyl)methyl] thio] gold

Chemical Name: Aurothioglycollic acid anilide

Structural Formula:

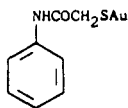

Chemical Abstracts Registry No.: 16925-51-2

Trade Name	Manufacturer	Country	Year Introduced
Lauron	Endo	U.S.	1945

Raw Materials

Potassium Bromoaurate
Sulfur Dioxide
Thioglycollic Acid Anilide

Manufacturing Process

The product is made preferably by reacting thioglycollic-acid-anilide with an aurous bromide (AuBr).

Prior art methods for making the starting material, HSCH₂CONHC₆H₅ are disclosed in an article by Beckurts et al. in *Journ. Praktische Chemie* (2) 66 p. 174, and in the literature referred to in the mentioned article.

Ten grams of the potassium salt of bromoauric acid (KBr₄) are dissolved in 100 cc of 96% ethyl alcohol. This salt is also designated as potassium auribromide. Sulfur dioxide (SO₂) is then led through this solution, through a fine capillary tube, for several minutes. This reaction produces aurous bromide (AuBr). The solution of the aurous bromide is then allowed to

stand for 2 to 3 hours until it is colorless. A precipitate of KBr is thus formed. This precipitate is separated from the solution of the aurous bromide which is added to a solution of three grams of the thioglycolic-acidanilide in 50 cc of ethyl alcohol. This is done at about 20°C. Then 300 cc of water are added to this mixture, at 20°C. The water is then removed by decantation or any suitable method, and the mixture is repeatedly thus treated with water, in order to remove all impurities which can thus be removed. The product is then centrifuged twice with 96% ethyl alcohol. It is then centrifuged three times with 100% or absolute ethyl alcohol, and then centrifuged three times with water-free ligroin (petroleum ether), i.e., the 40°-60°C fraction which is distilled from petroleum. After each centrifuging, the product is separated from the liquid which has been used during the centrifuging.

The product is then dried in a high vacuum with the use of phosphorus pentoxide (P₂O₅).

References

Merck Index 889

I.N., p. 106

Lewenstein, M.J.; U.S. Patent 2,451,841; October 19, 1948

AZACYCLONOL

Therapeutic Function: Tranquilizer

Chemical Name: α,α -Diphenyl-4-piperidinemethanol

Common Name: Gamma-pipradol

Structural Formula:

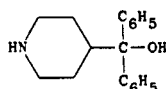

Chemical Abstracts Registry No.: 115-46-8; 1798-50-1 (Hydrochloride)

Trade Name	Manufacturer	Country	Year Introduced
Frenquel	Merrell	U.S.	1955
Frenoton	Draco	Sweden	—
Frenquel	Inibsa	Spain	—
Frenquel	Merrell-Toraude	France	—
Frenquel	Shionogi	Japan	—

Raw Materials

α -(4-Pyridyl)-benzhydrol
Hydrogen

Manufacturing Process

A mixture of 26 g (0.1 mol) of α -(4-pyridyl)-benzhydrol, 1.5 g of platinum oxide, and 250 ml of glacial acetic acid is shaken at 50°-60°C under hydrogen at a pressure of 40-50 lb/in². The hydrogenation is complete in 2 to 3 hours. The solution is filtered and the filtrate evaporated under reduced pressure. The residue is dissolved in a mixture of equal parts of methanol and butanone and 0.1 mol of concentrated hydrochloric acid is added. The mixture is cooled and filtered to give about 30 g of α -(4-piperidyl)-benzhydrol hydrochloride, MP 283°-285°C, as a white, crystalline substance.

The free base is readily obtained from the hydrochloride salt by treatment with ammonia and when so obtained has a melting point of 160°-161°C.

References

Merck Index 898

Kleeman & Engel p. 65

OCDS Vol. 1 p. 47

I.N. p. 109

Schumann, E.L., Van Campen, M.G., Jr. and Pogge, R.C.; U.S. Patent 2,804,422; August 27, 1957; assigned to The Wm. S. Merrell Co.

AZANIDAZOLE

Therapeutic Function: Antiprotozoal, antibacterial

Chemical Name: 2-Amino-4-[2-(1-methyl-5-nitroimidazol-2-yl)vinyl] pyrimidine

Common Name: Nitromidine

Structural Formula:

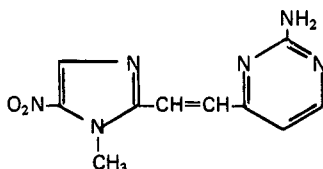

Chemical Abstracts Registry No.: —

Trade Name	Manufacturer	Country	Year Introduced
Triclose	Ist. Chemioter.	Italy	1977
Triclose	I.C.I.	Italy	—

Raw Materials

2-Amino-4-methylpyrimidine

2-Formyl-1-methyl-5-nitroimidazole

Sulfuric Acid

Manufacturing Process

Into a mixture of 1.6 g of 2-amino-4-methylpyrimidine with 10 ml of glacial acetic acid is slowly added 2.13 g of concentrated sulfuric acid. A mixture of 2.4 g of 2-formyl-1-methyl-5-nitroimidazole in 20 ml of glacial acetic acid is slowly added to the mixture of the pyrimidine under stirring. The reaction mixture is maintained at a temperature of about 55°C for 4 hours. The resultant mixture is then diluted with 200 ml of distilled water and neutralized with a saturated aqueous solution of sodium bicarbonate. A brownish-yellow precipitate (MP 232° to 235°C) is formed and recovered. The product is analyzed by infrared spectroscopy and is found to conform to 2-amino-4-[2-(1-methyl-5-nitro-2-imidazolyl)vinyl] pyrimidine.

References

Merck Index 902

DOT 14 (6) 234 (1978)

I.N. p. 109

Garzia, A.; U.S. Patent 3,882,105; May 6, 1975; assigned to Istituto Chemioterapico Italiano SpA

Garzia, A.; U.S. Patent 3,969,520; July 13, 1976; assigned to Istituto Chemioterapico Italiano SpA

AZAPETINE PHOSPHATE

Therapeutic Function: Antiadrenergic

Chemical Name: 6,7-Dihydro-6-(2-propenyl)-5H-dibenz[c,e]-azepine phosphate

Common Name: —

Structural Formula:

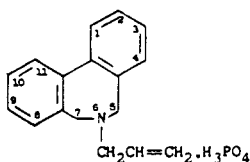

Chemical Abstracts Registry No.: 130-83-6; 146-36-1 (Base)

Trade Name	Manufacturer	Country	Year Introduced
Ilidar	Roche	U.S.	1954
Ilidar	Roche	W. Germany	—

Raw Materials

Diphenic Acid	Acetic Anhydride
Ammonia	Allyl Bromide
Lithium Aluminum Hydride	Phosphoric Acid

Manufacturing Process

29 grams of diphenic acid were stirred in 900 cc of acetic anhydride at 120°C for one hour. The cooled mixture was filtered and washed with acetic acid to give diphenic anhydride, colorless crystals, MP about 222°–226°C.

24.11 grams of diphenic anhydride were mixed with 50 cc of concentrated ammonia. The mixture warmed up and cooling was applied, after which the mixture was stirred until a clear solution formed and for 1½ hours afterward. The mixture was acidified and allowed to stand overnight. Water was added, initiating precipitation. The mixture was chilled and filtered to yield diphenamic acid, a colorless solid, MP about 191°–193°C.

23.5 grams of diphenamic acid were heated at 200°C in an oil bath, first for about 20 hours at atmospheric pressure and then for about 10 hours at about 20 mm.

Melting points were taken at intervals in order to gain an idea of the extent of reaction. The final residue was boiled with alcohol but since the solid exhibited insufficient solubility in the hot solvent, the mixture was filtered. The residue consisted of tan crystals, MP about 220°–221°C, and the filtrate on cooling gave an additional crop of tan crystals, MP about 219°–221°C. The two materials were identical and consisted of diphenimide.

5.58 g of diphenimide were placed in a Soxhlet thimble and extracted for about 3 days with a boiling mixture of 9.0 g of lithium aluminum hydride in 600 cc of sodium-dried ether. Excess lithium aluminum hydride was then decomposed cautiously with water and the mixture was filtered through a filter aid by suction. The filtrate consisted of two layers. The ether layer was separated and dried with anhydrous potassium carbonate and acidified with alcoholic hydrochloric acid to give 6,7-dihydro-5H-dibenz[c,e]azepine hydrochloride, MP about 287°-289°C.

One gram of 6,7-dihydro-5H-dibenz[c,e]azepine hydrochloride was dissolved in water, made alkaline with concentrated ammonia, and the resultant base extracted twice with benzene. The benzene layers were combined, dried with anhydrous potassium carbonate, and mixed with 0.261 g of allyl bromide at 25°-30°C. The reaction solution became turbid within a few minutes and showed a considerable crystalline deposit after standing 3½ days. The mixture was warmed 1½ hours on the steam bath in a loosely-stoppered flask, then cooled and filtered. The filtrate was washed twice with water and the benzene layer evaporated at diminished pressure. The liquid residue was dissolved in alcohol, shaken with charcoal and filtered. Addition to the filtrate of 0.3 gram of 85% phosphoric acid in alcohol gave a clear solution which, when seeded and rubbed, yielded 6-allyl-6,7-dihydro-5H-dibenz[c,e]azepine phosphate, MP about 211°-215°C with decomposition.

References

Merck Index 904

Kleeman & Engel p. 65

I.N. p. 109

Schmidt, R.A. and Wenner, W.; U.S. Patent 2,693,465; November 2, 1954; assigned to Hoffmann-La Roche, Inc.

AZATADINE MALEATE

Therapeutic Function: Antihistaminic

Chemical Name: 6,11-Dihydro-11-(1-methyl-4-piperidinylidene)-5H-benzo[5,6]cyclohepta[1,2-b]pyridine

Common Name: —

Structural Formula:

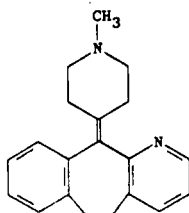

Chemical Abstracts Registry No.: 3978-86-7

Trade Name	Manufacturer	Country	Year Introduced
Idulian	Unilabo	France	1968
Optimine	Schering	U.S.	1977
Optimine	Warrick	U.K.	1978
Optimine	Warrick	Italy	1983

Trade Name	Manufacturer	Country	Year Introduced
Optimine	Byk Essex	W. Germany	1983
Trinalin	Schering	U.S.	—
Verben	Schering	—	—
Zadine	Schering	—	—

Raw Materials

N-Methyl-4-chloropiperidine	Ethyl Bromide
Polyphosphoric Acid	Magnesium
4-Aza-10,11-dihydro-5-H-dibenzo-[a,d]-cycloheptene-5 one	Maleic Acid

Manufacturing Process

Preparation of 4-aza-5-(N-methyl-4-piperidyl)-10,11-dihydro-5H-dibenzo[a,d]cycloheptene-5-ol: Add 17.4 g of N-methyl-4-chloropiperidine to a stirred mixture containing 3.2 g of magnesium, 20 ml of anhydrous tetrahydrofuran, 1 ml of ethyl bromide and a crystal of iodine. Reflux for two hours, cool to 30°–35°C and add a solution of 13 g of 4-aza-10,11-dihydro-5H-dibenzo[a,d]cycloheptene-5-one in 25 ml of tetrahydrofuran. Stir for five hours, remove the solvent by distillation in vacuo and add 250 ml of ether. Add 100 ml of 10% ammonium chloride solution and extract the mixture with chloroform. Concentrate the chloroform solution to a residue and recrystallize from isopropyl ether obtaining 20 g of the carbinol, MP 173°–174°C.

Preparation of 4-aza-5-(N-methyl-4-piperidylidene)-10,11-dihydro-5H-dibenzo[a,d]cycloheptene: Heat 5.4 g of the carbinol and 270 g of polyphosphoric acid for 12 hours at 140°–170°C. Pour into ice water and make alkaline with sodium hydroxide. Extract with ether. Dry ether solution and concentrate to a residue. Crystallize from isopropyl ether, MP 124°–126°C.

Preparation of 4-aza-5-(N-methyl-4-piperidylidene)-10,11-dihydro-5H-dibenzo[a,d]cycloheptene dimaleate: To a solution containing 4.3 g of 4-aza-(N-methyl-4-piperidylidene)-10,11-dihydro-5H-dibenzo[a,d]cycloheptene in 55 ml of ethyl acetate, add a solution of 3.45 g of maleic acid dissolved in ethyl acetate. Filter the resulting precipitate and recrystallize the desired product from an ethyl acetate-methanol mixture to yield 4-aza-5-(N-methyl-4-piperidylidene)-10,11-dihydro-5H-dibenzo[a,d]cycloheptene dimaleate, MP 152°–154°C.

References

- Merck Index 906
 PDR pp. 1643, 1657
 OCDS Vol. 2 p. 424
 DOT 5 (2) 47 (1969)
 I.N. p. 110
 REM p. 1131
 Villani, F.J.; U.S. Patents 3,326,924; January 20, 1967; 3,357,986; December 12, 1967; and 3,419,565; December 31, 1968; all assigned to Schering Corp.

AZATHIOPRINE

Therapeutic Function: Immunosuppressive

Chemical Name: 6-[(1-methyl-4-nitroimidazol-5-yl)thio] purine

Common Name: Azothioprine

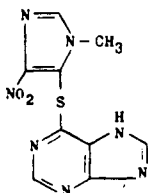
Structural Formula:**Chemical Abstracts Registry No.:** 446-86-6

Trade Name	Manufacturer	Country	Year Introduced
Imuran	Wellcome	U.K.	1964
Imurel	Wellcome	France	1967
Imurek	Wellcome	W. Germany	1967
Imuran	Wellcome	U.S.	1968
Imuran	Wellcome	Italy	1968
Imuran	Tanabe	Japan	1969
Azamun	Medica	Finland	—
Azanin	Tanabe	Japan	—
Azapress	Lennon	South Africa	—

Raw Materials

N,N'-Dimethyloxaldiamide	Nitric Acid
Phosphorus Pentachloride	6-Mercaptopurine

Manufacturing Process

N,N'-dimethyloxaldiamide is reacted with PCl_5 to give 4-chloro-1-methyl imidazole. This is nitrated with HNO_3 to give 5-nitro-1-methyl-4-chloroimidazole. Then, a mixture of 4.6 grams of anhydrous 6-mercaptapurine, 5 grams of 1-methyl-4-chloro-5-nitroimidazole and 2.5 grams of anhydrous sodium acetate in 100 ml of dry dimethyl sulfoxide was heated at 100°C for 7 hours.

After standing overnight at room temperature, the mixture was poured into 200 ml of cold water and the yellow precipitate of 6-(1'-methyl-4'-nitro-5'-imidazolyl)mercaptapurine (7.0 grams) collected. After recrystallization from 50 % aqueous acetone, the product melted at $243^\circ\text{-}244^\circ$, dec., and had an UV spectrum with λ maximum = 280 $\text{m}\mu$ at pH 1 and λ max. = 285 $\text{m}\mu$ at pH 11.

References

Merck Index 907

Kleeman & Engel p. 67

PDR p. 744

OCDS Vol. 2 p. 464

DOT 16 (10) 360 (1980)

I.N. p. 110

REM p. 1143

Hitchings, G.H. and Elion, G.B.; U.S. Patent 3,056,785; October 2, 1962; assigned to Burroughs Wellcome & Co.

AZIDOCILLIN**Therapeutic Function:** Antibacterial

Chemical Name: 6-(D-2-azido-2-phenylacetamido)-3,3-dimethyl-7-oxo-4-thia-1-azabicyclo-[3.2.0] heptane-2-carboxylic acid

Common Name: α -Azidobenzylpenicillin

Structural Formula:

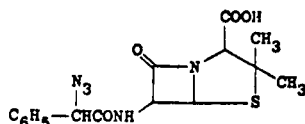

Chemical Abstracts Registry No.: 17243-38-8

Trade Name	Manufacturer	Country	Year Introduced
Nalpen	Beecham	W. Germany	1972
Longatren	Bayer	Italy	1981
Longatren	Bayer	Japan	—
Astracilina	Astra	Sweden	—
Finacillin	Sedequil	Portugal	—
Syncillin	Tropon	W. Germany	—

Raw Materials

α -Azidophenylacetic Acid	Triethylamine
Ethyl Chloroformate	Thionyl Chloride
6-Aminopenicillanic Acid	

Manufacturing Process

Example 1: α -Azidobenzylpenicillin via the Mixed Anhydride — A solution of α -azido-phenylacetic acid (8.9 grams, 0.05 mol) of triethylamine (5.1 grams, 0.05 mol) in 50 ml of dry dimethylformamide was stirred and chilled below -5°C . At this temperature ethyl chloroformate (4.7 ml) was added in portions so that the temperature was never above -5°C . After the mixture had been stirred for 20 minutes, dry acetone (100 ml), chilled to -5°C , was added in one portion, immediately followed by an ice-cold solution of 6-aminopenicillanic acid (10.8 grams, 0.05 mol) and triethylamine (5.1 grams, 0.05 mol) in 100 ml of water, and the stirring was continued for 1½ hours at 0°C .

The pH of the mixture was adjusted to 7.5 by adding a saturated sodium bicarbonate solution. After being washed twice with diethyl ether, the reaction solution was acidified to pH 2 with dilute hydrochloric acid and extracted with ether. The ether solution containing the free penicillin was washed twice with water and then extracted with 50 ml of N potassium bicarbonate solution. After freeze drying of the obtained neutral solution, the potassium salt of α -azidobenzylpenicillin was obtained as a slightly colored powder (11.2 grams, 54% yield) with a purity of 55% as determined by the hydroxylamine method (the potassium salt of penicillin G being used as a standard).

The infrared spectrum of this substance showed the presence of an azido group and a β -lactam system. The substance inhibited the growth of *Staph. aureus* Oxford at a concentration of 0.25 mcg/ml.

Example 2: α -Azidobenzylpenicillin via the Acid Chloride — 6-aminopenicillanic acid (18.5 grams, 0.085 mol) and sodium bicarbonate (21 grams, 0.025 mol) were dissolved in 200 ml of water and 100 ml of acetone. To this solution, chilled in ice, was added α -azidophenylacetyl chloride (16.6 grams, 0.085 mol), diluted with 10 ml of dry acetone. The temperature is held at 0° to 5°C and the reaction mixture was stirred for 2½ hours.

The resulting solution was treated as described in Example 1 to give the potassium salt of

α -azidobenzylpenicillin as a white powder (29.4 grams, 84% yield) with a purity of 83% as determined by the hydroxylamine method (the potassium salt of penicillin G being used as a standard).

The product showed the same properties as the product obtained in Example 1; it inhibits the growth of *Staph. aureus* Oxford at a concentration of 0.13 mcg/ml.

The α -azidophenylacetyl chloride was prepared by treating α -azidophenylacetic acid with thionylchloride in portions at room temperature and then heating the solution under reflux for one hour. The α -azidophenylacetyl chloride distils at 115°C under a pressure of 10 mm Hg.

References

Merck Index 913

Kleeman & Engel p. 68

DOT 7 (5) 186 (1971 & 8 (7) 248 (1972)

I.N. p. 111

Sjoberg, B.O.H. and Ekstrom, B.A.; U.S. Patent 3,293,242; December 20, 1966; assigned to Beecham Group Limited, England

AZLOCILLIN

Therapeutic Function: Antibacterial

Chemical Name: D- α -(imidazolidin-2-on-1-yl-carbonylamino)benzylpenicillin, sodium salt

Common Name: —

Structural Formula:

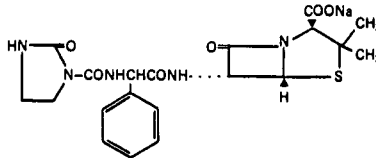

Chemical Abstracts Registry No.: 37091-66-0; 37091-65-9 (Sodium Salt)

Trade Name	Manufacturer	Country	Year Introduced
Securopen	Bayer	W. Germany	1977
Securopen	Bayer	Switz.	1980
Securopen	Bayer	U.K.	1980
Azlin	Miles	U.S.	1982
Securopen	Bayer	France	1983

Raw Materials

D(-)- α -[(imidazolidin-2-on-1-yl)carbonylamino]phenyl Acetic Acid
6-Aminopenicillanic Acid

Manufacturing Process

3.8 parts by weight of D(-)- α -[(imidazolidin-2-on-1-yl)carbonylamino]phenyl-acetic acid were dissolved in 65 parts by volume of dichloromethane. 2.7 parts by weight of 1-methyl-2-chloro-

Δ 1-pyrrolinium chloride were added, and after cooling to -10°C 2.0 parts by volume of triethylamine were added gradually. This reaction mixture was then stirred for one hour at -5°C (mixture A). 4.0 parts by weight of 6-aminopenicillanic acid in 80 parts by volume of dichloromethane were treated with 4.4 parts by volume of triethylamine and 4.0 parts by weight of anhydrous sodium sulfate and then stirred for two hours at room temperature. After filtration, the solution was cooled to -20°C and combined with the mixture A. The reaction mixture was left to reach 0°C of its own accord, and was then stirred for a further hour at 0°C . The solvent was removed in a rotary evaporator, the residue was dissolved in water, and the solution was covered with a layer of ethyl acetate and acidified with dilute hydrochloric acid at 0° to 5°C , while stirring, until pH 1.5 was reached. The organic phase was then separated off, washed with water, dried over magnesium sulfate while cooling, and filtered, and after dilution with an equal amount of ether the sodium salt of the penicillin was precipitated from the filtrate by adding a solution of sodium 2-ethylcaproate dissolved in ether containing methanol. Yield: 1.3 parts by weight.

References

Merck Index 916

Kleeman & Engel p. 69

PDR p. 1247

OCDS Vol. 3 p. 206 (1984)

DOT 13 (10) 409 (1977)

I.N. p. 111

REM p. 1200

Konig, H.B., Schrock, W., Disselknotter, H. and Metzger, K.G.; U.S. Patents 3,933,795; January 20, 1976; 3,936,442; February 3, 1976; 3,939,149; February 17, 1976; 3,974,140; August 10, 1976; 3,978,223; August 31, 1976 and 3,980,792; September 14, 1976; all assigned to Bayer AG

AZOSEMIDE

Therapeutic Function: Diuretic

Chemical Name: 5-(4'-Chloro-2'-thenylamino-5'-sulfamoylphenyl)tetrazole

Common Name: —

Structural Formula:

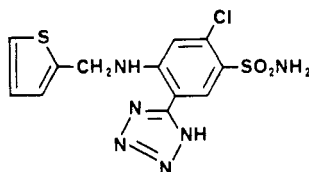

Chemical Abstracts Registry No.: 27589-33-9

Trade Name	Manufacturer	Country	Year Introduced
Diurapid	Boehringer-Mann	W. Germany	1981

Raw Materials

4-Chloro-2-fluoro-5-sulfamoyl Benzonitrile
 Thenylamine
 Sodium Azide

Manufacturing Process

The 4-chloro-5-sulfamoyl-2-thenylamino-benzonitrile used as starting material is obtained by the reaction of 4-chloro-2-fluoro-5-sulfamoyl-benzonitrile with thenylamine in anhydrous tetrahydrofuran.

Then the 5-(4'-chloro-5'-sulfamoyl-2'-thenylamino)phenyltetrazole (MP 218° to 221°C; yield 37% of theory) is obtained by the reaction of 4-chloro-5-sulfamoyl-2-thenylaminobenzonitrile (MP 170° to 174°C) with sodium azide and ammonium chloride.

References

Merck Index 922

DFU 4 (6) 393 (1979)

OCDS Vol. 3 p. 27 (1984)

Popelek, A., Lerch, A., Stach, K., Roesch, E. and Hardebeck, K.; U.S. Patent 3,665,002; May 23, 1972; assigned to Boehringer Mannheim GmbH

B

BACAMPICILLIN

Therapeutic Function: Antibacterial

Chemical Name: 6-[(Aminophenylacetyl)amino]-3,3-dimethyl-7-oxo-4-thia-1-azabicyclo-[3.2.0] heptane-2-carboxylic acid 1-[(ethoxycarbonyloxy)-ethyl ester

Common Name: 1'-Ethoxycarbonyloxyethyl 6-(D- α -aminophenylacetamido)penicillinate

Structural Formula:

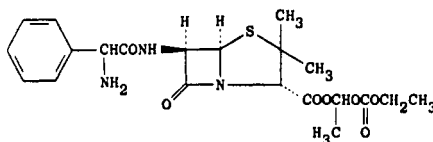

Chemical Abstracts Registry No.: 50972-17-3; 37661-08-8 (Hydrochloride)

Trade Name	Manufacturer	Country	Year Introduced
Penglobe	Astra	W. Germany	1977
Bacacil	Pfizer	Switz.	1978
Penglobe	Lematte/Boinot	France	1978
Bacacil	Pfizer	Italy	1980
Ambaxin	Upjohn	U.K.	1981
Spectrobid	Pfizer	U.S.	1981
Bacacil	Pfizer Taito	Japan	1981
Penglobe	Yoshitomi	Japan	1981
Bamaxin	Upjohn	Canada	1982
Ambacamp	Upjohn	W. Germany	—
Bacampicin	Upjohn	—	—
Velbacil	Pfizer	—	—

Raw Materials

Sodium 6-(D- α -azidophenylacetamido)penicillinate
 α -Chlorodiethyl Carbonate
 Sodium Bicarbonate
 Hydrogen

Manufacturing Process

1'-Ethoxycarbonyloxyethyl 6-(D- α -azidophenylacetamido)penicillinate (98 g) was prepared from sodium 6-(D- α -azidophenylacetamido)penicillinate (397 g, 1 mol), α -chlorodiethyl carbonate (458 g, 3 mols) and sodium bicarbonate (504 g, 6 mols). The product showed strong IR absorption at 2090 cm^{-1} and $1780\text{--}1750\text{ cm}^{-1}$ showing the presence of azido group and β -lactam and ester carbonyls.

It was dissolved in ethyl acetate (700 ml) and hydrogenated at ambient conditions over a palladium (5%) on carbon catalyst (18 g). The catalyst was removed by filtration and washed with ethyl acetate. The combined filtrates were extracted with water at pH 2.5 by addition of dilute hydrochloric acid. Lyophilization of the aqueous phase gave the hydrochloride of 1'-ethoxycarbonyloxyethyl 6-(D- α -aminophenylacetamido)penicillinate (94 g), MP 171°-176°C.

References

- Merck Index 933
 Kleeman & Engel p. 69
 PDR p. 1531
 OCDS Vol. 3 p. 204 (1984)
 DOT 11 (11) 428 (1975) & 13 (10) 415 (1977)
 I.N. p. 113
 REM p. 1200
 Ekstrom, B.A. and Sjoberg, B.O.H.; U.S. Patents 3,873,521; March 25, 1975; and 3,939,270; February 17, 1976; both assigned to Astra Lakemedal A.B.

BACITRACIN

Therapeutic Function: Antibacterial

Chemical Name: Complex polypeptide mixture containing predominantly bacitracin A

Common Name: —

Structural Formula:

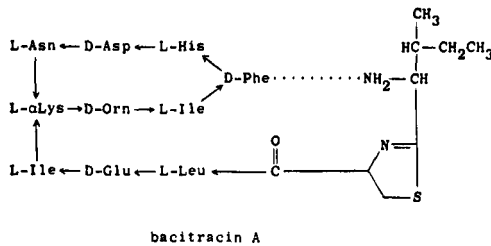

Chemical Abstracts Registry No.: 1405-87-4; 21373-17-1 (Bacitracin A)

Trade Name	Manufacturer	Country	Year Introduced
Baciguent	Upjohn	U.S.	1948
Topitracin	Comm. Solv.	U.S.	1948
Bacitracine	Novopharm	Switz.	—
Bacitracine	Diamant	France	1953
Bacitracin	Kayaku	Japan	—
Bacitracin	Upjohn	U.S.	—
Batrax	Gewo	W. Germany	—
Cicatrin	Calmic	U.K.	—
Cicatrex	Wellcome	W. Germany	—
Enterostop	Schiapparelli	Italy	—
Fortracin	A.L. Labs	U.S.	—
Hydroderm	Merck Sharpe & Dohme	U.K.	—
Medicrucin	Medice	W. Germany	—

Trade Name	Manufacturer	Country	Year Introduced
Nebacetin	Byk-Gulden	W. Germany	—
Neobacrin	Glaxo	U.K.	—
Neo-Caf	Francia	Italy	—
Neo-Polycin	Dow	U.S.	—
Neosporin	Burroughs-Wellcome	U.S.	—
Orobicin	Fulton	Italy	—
Polybactrin	Calmic	U.K.	—
Polybactrin	Wellcome	W. Germany	—
Polycin	Dow	U.S.	—
Polyfax	Wellcome	U.K.	—
Polysporin	Burroughs-Wellcome	U.S.	—
Rikospray	Riker	U.K.	—
Topitracin	Reed & Carnrick	U.S.	—

Raw Materials

Bacillus subtilis

Nutrient Medium (Soy Bean Oil Meal)

Manufacturing Process

The early patent, U.S. Patent 2,498,165 first disclosed bacitracin and described a process for preparing bacitracin, comprising cultivating *Bacillus subtilis* Tracy I in a nutritive medium, at substantially pH 7 and 37°C, for more than three days, extracting the antibiotic from the resulting medium with a low molecular weight alcohol, concentrating the resulting alcoholic solution in vacuo, acidifying the resulting concentrate, extracting the antibiotic from the resulting solution, and precipitating the antibiotic from the resulting solution, with a precipitating agent for the antibiotic, selected from the group consisting of Reinecke's salt, phosphotungstic acid, phosphomolybdic acid, molybdic acid, picric acid, ammonium rhodanilate, and azobenzene-p-sulfonic acid.

A subsequent patent, U.S. Patent 2,828,246 described a commercial process for bacitracin production. A 1,230 gallon portion of a medium containing 10% soybean oil meal, 2.50% starch and 0.50% calcium carbonate having a pH of 7.0 was inoculated with a culture of bacitracin-producing bacteria of the *Bacillus subtilis* group and the inoculated medium incubated for a period of 24 hours with aeration such that the superficial air velocity was 12.1. An assay of the nutrient medium following the fermentation revealed a yield of bacitracin amounting to 323 units/ml. This was more than twice the yields previously obtained.

Then, a patent, U.S. Patent 2,834,711 described the purification of bacitracin. In this process for purifying bacitracin, the steps comprise adding a water-soluble zinc salt to a partially purified aqueous solution of bacitracin, adjusting the pH to from 5 to 9, recovering the precipitate which forms, dissolving the precipitate in water at a pH not substantially in excess of 4, and removing the zinc ion by passing the aqueous solution through a cation exchange resin and drying the resulting solution to obtain dry solid bacitracin.

Another patent, U.S. Patent 2,915,432 describes a process of recovering and concentrating bacitracin from aqueous filtered fermentation broth containing on the order of 3% proteinaceous solids which comprises intimately contacting the broth with a synthetic organic cation exchange resin having as its functional groups nuclear sulfonic acids and having a crosslinkage of the order of 1 to 2%, with the resin being in the hydrogen form, and eluting the adsorbed bacitracin from the resin with a weak base.

Bacitracin recovery is described in U.S. Patents 3,795,663 and 4,101,539.

Raw Materials

Merck Index 937

Kleeman & Engel p. 70

PDR p. 888

I.N. p. 113

REM p. 1201

Chalet, L. and Cochrane, T.J., Jr.; U.S. Patent 2,915,432; December 1, 1959; assigned to Merck & Co., Inc.

Johnson, R.A. and Meleney, F.L.; U.S. Patent 2,498,165; February 21, 1950; assigned to U.S. Secretary of War

Freaney, T.E. and Allen, L.P.; U.S. Patent 2,828,246; March 25, 1958; assigned to Commercial Solvents Corporation

Zinn, E. and Chornock, F.W.; U.S. Patent 2,834,711; May 13, 1958; assigned to Commercial Solvents Corporation

Miescher, G.M.; U.S. Patent 3,795,663; March 5, 1974; assigned to Commercial Solvents Corp.

Kindraka, J.A. and Gallagher, J.B.; U.S. Patent 4,101,539; July 18, 1978; assigned to IMC Chemical Group, Inc.

BACLOFEN

Therapeutic Function: Muscle relaxant

Chemical Name: γ -Amino- β -(p-chlorophenyl)butyric acid

Common Name: —

Structural Formula:

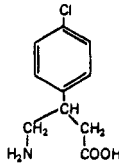

Chemical Abstracts Registry No.: 1134-47-0

Trade Name	Manufacturer	Country	Year Introduced
Lioresal	Ciba-Geigy	Switz.	—
Lioresal	Ciba-Geigy	W. Germany	1971
Lioresal	Ciba-Geigy	U.K.	1972
Lioresal	Ciba-Geigy	France	1974
Lioresal	Ciba-Geigy	Italy	1974
Lioresal	Ciba-Geigy	U.S.	1977
Lioresal	Ciba-Geigy	Japan	1979
Gabalon	Daiichi	Japan	1979
Baclon	Medica	Finland	—
Spastin	Yurtoglu	Turkey	—

Raw Materials

β -(p-Chlorophenyl)glutaric Acid Imide
Sodium Hydroxide
Bromine

Manufacturing Process

42.45 g of β -(p-chlorophenyl)glutaric acid imide are stirred into a solution of 8.32 g of sodium

hydroxide in 200 ml of water. The mixture is heated for 10 minutes at 50°C, and the solution thus formed is cooled to 10° to 15°C. At this temperature there are then added dropwise a solution of 40.9 g of sodium hydroxide in 200 ml of water and then, in the course of 20 minutes, 38.8 g of bromine. When all has been dropped in, the batch is stirred for 8 hours at 20° to 25°C. The reaction solution is then cautiously adjusted with concentrated hydrochloric acid to pH 7, whereupon finely crystalline γ -amino- β -(p-chlorophenyl)butyric acid settles out. To purify it, it is recrystallized from water. Melting point is 206° to 208°C.

References

Merck Index 939

Kleeman & Engel p. 71

PDR p. 894

OCDS Vol. 2 p. 121 (1980)

DOT 8 (2) 49 (1972)

I.N. p. 114

REM p. 925

Keberle, H., Faigle, J.W. and Wilhelm, M.; U.S. Patent 3,471,548; October 7, 1969; assigned to Ciba Corporation

Keberle, H., Faigle, J.W. and Wilhelm, M.; U.S. Patent 3,634,428; January 11, 1972; assigned to Ciba Corporation

BARBEXACLONE

Therapeutic Function: Antiepileptic

Chemical Name: (-)-N- α -Dimethylcyclohexaneethylamine compound with 5-ethyl-5-phenyl-5-phenylbarbituric acid

Common Name: —

Structural Formula:

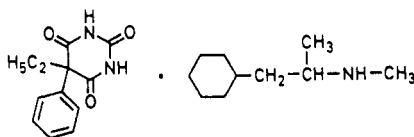

Chemical Abstracts Registry No.: 4388-82-3

Trade Name	Manufacturer	Country	Year Introduced
Maliasin	Knoll	Italy	1983

Raw Materials

Phenyl Ethyl Barbituric Acid

1-Cyclohexyl-2-methylamino Propane Hydrochloride

Manufacturing Process

25.4 g of sodium salt of phenyl ethyl barbituric acid and 19.1 g of 1-cyclohexyl-2-methylamino propane hydrochloride are boiled under reflux in a mixture of 125 cc of acetic acid ethyl ester and 125 cc of ethanol. After boiling for half an hour, the solution is filtered, while still hot, to separate the precipitated sodium chloride. The filtrate is concentrated by evaporation to about half its volume. After cooling 42.5 g of the salt of 1-cyclohexyl-2-

methylamino propane and of phenyl ethyl barbituric acid are obtained in crystalline form. Its melting point is 130°-133°C.

References

Kleeman & Engel p. 73

I.N. p. 115

Suranyi, L.; U.S. Patent 3,210,247; October 5, 1965; assigned to Knoll A.G.

BATROXOBIN

Therapeutic Function: Hemostatic

Chemical Name: See under structural formula; no defined name

Common Name: —

Structural Formula:

It is a complex enzyme of molecular weight no greater than 40,000 in monomeric form.

Chemical Abstracts Registry No.: 9039-61-6

Trade Name	Manufacturer	Country	Year Introduced
Defibrase	Serono	W. Germany	1982
Botrophase	Ravizza	Italy	—
Ophidiase	Labaz	Switz,	—
Reptilase	Disperga	Austria	—
Reptilase	Knoll	W. Germany	—

Raw Materials

Venom of Bothrops Atrox (A Pit Viper)

Phenol

Manufacturing Process

The process for preparing the enzyme composition comprises treating an aqueous solution of the snake venom at a pH of about 4 to 6 with phenol or a phenol derivative in order to precipitate an insoluble complex containing the active venom fraction and decomposing the complex in order to release the thrombinlike enzyme composition.

References

Merck Index 1010

DOT 18 (4) 169 (1982)

I.N. p. 117

Percs, E.E., Stocker, K.F., Blomback, B., Blomback, M. and Hessel, B.; U.S. Patent 3,849,252; November 19, 1974; assigned to Pentapharm A.G.

BECLAMIDE

Therapeutic Function: Anticonvulsant

Chemical Name: 3-chloro-N-(phenylmethyl)propanamide

Common Name: Benzchloropropamide, Chloroethylphenamide, Benzylchloropropionamide

Structural Formula: $\text{ClCH}_2\text{CH}_2\text{CONHCH}_2\text{C}_6\text{H}_5$

Chemical Abstracts Registry No.: 501-68-8

Trade Name	Manufacturer	Country	Year Introduced
Posedrine	Biosa	Switz.	—
Posedrine	Aron	France	1970
Beclamid	Aron	W. Germany	1975
Neuracen	Promonta	W. Germany	—
Nydrane	Lipha	U.K.	—
Nydrane	Aron (Rona)	France	—
Posedrine	Lasa	Spain	—
Posedrine	Byk Gulden	—	—
Posedrine	Spemsa	Italy	—
Seclar	Andromaco	Argentina	—

Raw Materials

Benzylamine
p-Chloropropionyl Chloride
Sodium Hydroxide

Manufacturing Process

A 100 gallon lined jacketed kettle provided with cooling is charged with 100 lb of benzylamine and 150 liters of water. The mixture is cooled to 5°C and with stirring 119 lb of β-chloropropionyl chloride and a solution of 45 lb of sodium hydroxide pellets in 40 liters of water are added simultaneously at such a rate that the temperature does not exceed 10°C. During this period the pH of the mixture should be on the alkaline side but below pH 9.5. When the addition is complete the pH should be about 8. The mixture is stirred overnight in the cold, and the solid product is filtered. The filter cake is reslurred with about 80 gallons of water, filtered, and air-dried. Yield, 128 pounds.

The crude material is recrystallized by dissolving it in the minimal quantity of hot methanol (about 50 gallons), adding Norite, and filtering hot. Upon cooling slowly (finally to about 5°C) large crystals separate; they are filtered and air-dried. Yield, 109 pounds. Melting point 92° to 93°C.

References

Merck Index 1017

Kleeman & Engel p. 74

I.N. p. 118

Cassell, R.T. and Kushner, S.; U.S. Patent 2,569,288; September 25, 1951; assigned to American Cyanamid Company

BECLOMETHASONE DIPROPIONATE

Therapeutic Function: Topical anti-inflammatory; glucocorticoid

Chemical Name: 9-chloro-11 β ,17,21-trihydroxy-16 β -methylpregna-1,4-diene-3,20-dione dipropionate

Common Name: —

Structural Formula:

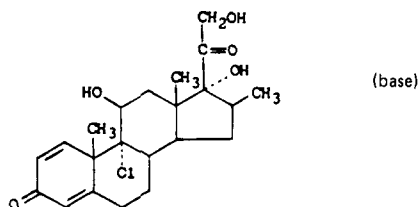

Chemical Abstracts Registry No.: 5534-09-8; 4419-39-0 (Base)

Trade Name	Manufacturer	Country	Year Introduced
Propaderm	Kyowa Hakko	Japan	1972
Becotide	Allen & Hanburys	U.K.	1972
Cleniderm	Chiesi	Italy	1974
Sanasthmyl	Glaxo	W. Germany	1975
Becotide	Glaxo	France	1976
Beconase	Glaxo	W. Germany	1976
Vanceril	Schering	U.S.	1976
Beclotide Nasal	Glaxo	Italy	1977
Becotide	Glaxo	Japan	1978
Aidesin	Shionogi	Japan	1978
Beclovent	Glaxo	U.S.	1979
Becotide	Glaxo	Switz.	1981
Becloforte	Allen & Hanburys	U.K.	1982
Aldecin	Schering	—	—
Anceron	Essex	Argentina	—
Beclacin	Kaigai	Japan	—
Beclacin	Morishita	Japan	—
Beclamet	Orion	Finland	—
Beclo-Asma	Aldo Union	Spain	—
Beclomet	Orion	Finland	—
Beclosona	Spyfarma	Spain	—
Beclovent	Meyer	U.S.	—
Becotide	Pliva	Yugoslavia	—
Betozon	Ohta	Japan	—
Betozon	Ono	Japan	—
Bronco-Turbinal	Valeas	Italy	—
Clenil	Chiesi	Italy	—
Dermisone Beclor	Frumtost	Spain	—
Entyderma	Taiyo	Japan	—
Gnadin	Pliva	Yugoslavia	—
Hibisterin	Nippon Zoki	Japan	—
Inalone	Lampugnani	Italy	—
Korbutone	Nippon Glaxo	Japan	—
Proctisone	Chiesi	Italy	—
Propaderm	Duncan	Italy	—
Propavent	Glaxo	U.K.	—
Rino-Clenil	Chiesi	Italy	—
Turbinal	Valeas	Italy	—
Vaderm	Schering	—	—
Vancenase	—	U.S.	—
Viarex	Essex	Italy	—

Trade Name	Manufacturer	Country	Year Introduced
Viarex	Schering	U.S.	—
Viarox	Byk-Essex	W. Germany	—
Zonase	Script Intal	S. Africa	—
Zonide	Script Intal	S. Africa	—

Raw Materials

16 β -Methyl-1,4-pregnadiene-11 β ,17 α ,21-triol-3,20-dione-21-acetate
Methane Sulfonyl Chloride
Sodium Methoxide
N-Chlorosuccinimide
Perchloric Acid

Manufacturing Process

6 grams of 16 β -methyl-1,4-pregnadiene-11 β ,17 α ,21-triol-3,20-dione-21-acetate is dissolved in a mixture of 35 ml of dimethylformamide and 6 ml of pyridine. To the resulting solution is added 2.5 ml of methanesulfonyl chloride and the reaction mixture maintained at 80°-85°C for about 1 hour. The resulting red solution is cooled in an ice bath and treated successively with 55 ml of methanol, 240 ml of 5% aqueous sodium bicarbonate and finally with 360 ml of water. The resulting reaction mixture is then allowed to stand at room temperature overnight after which the precipitated product is removed by filtration, washed repeatedly with water and dried to a constant weight in air at about 50°C to produce 16 β -methyl-1,4,9(11)-pregnatriene-11 α ,21-diol-3,20-dione-21-acetate.

Hydrolysis of the acetate ester with alkali, e.g., sodium methoxide in methanol, affords the free alcohol, 16 β -methyl-1,4,9(11)-pregnatriene-17 α , 21-diol-3,20-dione. To a suspension of 3 grams of 16 β -methyl-1,4,9(11)-pregnatriene-17 α ,21-diol-3,20-dione-21-acetate in 40 ml of acetone is added at 0°C with stirring 2 grams of N-chlorosuccinimide and then 7 ml of a perchloric acid solution prepared by dissolving 0.548 ml of 70% perchloric acid in 33 ml of water. The resulting reaction mixture is stirred at 0°C for about 4 hours 45 minutes.

The excess of N-chlorosuccinimide is destroyed by the addition of about 15 drops of allyl alcohol and 180 ml of water is then added with stirring. This mixture is held at 0°C for about one hour. The precipitated 16 β -methyl-1,4-pregnadiene-9 α -chloro-11 β ,17 α ,21-triol-3,20-dione-21-acetate is recovered by filtration. A solution of 250 mg of the chlorohydrin in 5 ml of 0.25N perchloric acid in methanol is stirred for about 18 hours at room temperature to produce 16 β -methyl-9 α -chloro-11 β ,17 α ,21-trihydroxy-1,4-pregnadiene-3,20-dione which is recovered by adding water to the reaction mixture and allowing the product to crystallize. Propionic anhydride is then used to convert this material to the dipropionate.

References

Merck Index 1018
Kleeman & Engel p. 74
PDR pp. 906, 1659
DOT 9 (8) 335 (1973)
I.N. p. 118
REM p. 962
Merck & Co., Inc. British Patent 912,378; December 5, 1962
Taub, D., Wendler, N.L. and Slates, H.L.; U.S. Patent 3,345,387; October 3, 1967; assigned to Merck & Co., Inc.

BEFUNOLOL

Therapeutic Function: Beta-blocker

Chemical Name: 2-Acetyl-7-(2-hydroxy-3-isopropylaminopropoxy)benzofuran

Common Name: —

Structural Formula:

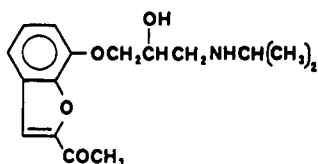

Chemical Abstracts Registry No.: 39552-01-7

Trade Name	Manufacturer	Country	Year Introduced
Bentos	Kakenyaku Kakko	Japan	1983

Raw Materials

2-Acetyl-7-hydroxybenzofuran
Epichlorohydrin
Isopropylamine

Manufacturing Process

To 8.8 g of 2-acetyl-7-hydroxybenzofuran were added 80 ml of epichlorohydrin and 0.2 g of piperidine hydrochloride and the mixture was heated at 105°C for 3 hours. After the reaction, the excess of epichlorohydrin was evaporated and the resultant was distilled under reduced pressure to give 9.3 g of 2-acetyl-7-(2,3-epoxypropoxy)benzofuran having a boiling point of 175° to 176°C/0.7 mm Hg. 6 g of the product was dissolved in 30 ml of ethanol and to the solution was added 10 ml of isopropylamine. After refluxing the mixture for 40 minutes, the solvent was evaporated from the reaction mixture. The resulting residue was recrystallized from cyclohexane-acetone to give 6 g of 2-acetyl-7-(2-hydroxy-3-isopropylaminopropoxy)benzofuran having a melting point of 115°C.

References

Merck Index 1022
DFU 6 (10) 601 (1981)
Ito, K., Mashiko, I., Kimura, K. and Nakanishi, T.; U.S. Patent 3,853,923; December 10, 1974; assigned to Kakenyaku Kakko Co., Ltd.

BEKANAMYCIN SULFATE

Therapeutic Function: Antibacterial

Chemical Name: D-Streptomine, O-3-amino-3-deoxy- α -D-glucopyranosyl-(1 \rightarrow 6)-O-[2,6-diamino-2,6-dideoxy- α -D-glucopyranosyl-(1 \rightarrow 4)]-2-deoxy sulfate (1:1)

Common Name: Aminodeoxykanamycin

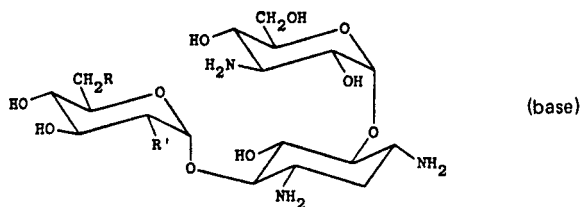
Structural Formula:

Chemical Abstracts Registry No.: 29701-07-3; 4696-76-8 (Base)

Trade Name	Manufacturer	Country	Year Introduced
Kanendomycin	Meiji Seika	Japan	1969
Stereocidin	Crinos	Italy	1980
Coltericin	Argentia	Argentina	—
Kanendomicina	Lefa	Spain	—
Kanendos	Crinos	Italy	—
Visumetazone Antibiotica	ISF	Italy	—
Visumicina	ISF	Italy	—

Raw Materials

Bacterium *S. Kanamyceticus*
Nutrient Broth

Manufacturing Process

200 liters of the medium containing 2.0% starch, 1.0% soybean meal, 0.05% KCl, 0.05% $MgSO_4 \cdot 7H_2O$, 0.3% NaCl, 0.2% $NaNO_3$ was placed in the 400 liter fermenter, the pH was adjusted to 7.5, and the medium was then sterilized (pH after the sterilization was 7.0) for 30 minutes at 120°C, inoculated with 1,000 ml of 40 hour shake-cultured broth of *S. kanamyceticus* (a selected subculture of K2-J strain) and tank-cultured at 27°-29°C. As antifoam, soybean oil (0.04%) and silicone (0.04%) were added. The broth after 48 hours was found to contain 250 mcg/ml of kanamycin.

A portion (950 ml) of the rich eluate was adjusted to pH 6.0 by the addition of sulfuric acid. Ultrawet K (7.0 g) in 70 ml water was added slowly to the neutralized eluate to precipitate kanamycin B dodecylbenzenesulfonate which was collected by filtration after adding filter-aid (Dicalite). The cake was washed with water and extracted with 100 ml methanol. After filtering and washing with methanol, sulfuric acid was added to the filtrate until no more kanamycin B sulfate precipitated. After addition of an equal volume of acetone to provide more complete precipitation, the kanamycin B sulfate was collected by filtration, washed with methanol and dried in vacuo at 50°C.

References

- Merck Index 5118
Kleeman & Engel p. 75
I.N. p. 120
REM p. 1181
Umezawa, H., Maeda, K. and Ueda, M.; U.S. Patent 2,931,798; April 5, 1960.
Johnson, D.A. and Hardcastle, G.A.; U.S. Patent 2,967,177; January 3, 1961; assigned to Bristol-Myers Co.
Rothrock, J.W. and Potter, I.; U.S. Patent 3,032,547; May 1, 1962; assigned to Merck & Co., Inc.

BENACTYZINE HYDROCHLORIDE

Therapeutic Function: Tranquilizer; anticholinergic

Chemical Name: α -Hydroxy- α -phenylbenzene acetic acid-2-(diethylamino)ethyl ester

Common Name: β -Diethylaminoethylbenzilate hydrochloride

Structural Formula:

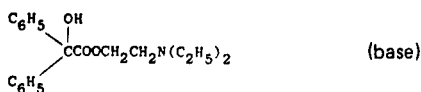

Chemical Abstracts Registry No.: 57-37-4; 302-40-9 (Base)

Trade Name	Manufacturer	Country	Year Introduced
Suavitil	Merck Sharp & Dohme	U.S.	1957
Phebex	Hoechst	U.S.	1958
Cedad	Recordati	Italy	—
Cevanol	I.C.I.	U.K.	—
Deprol	Wallace	U.S.	—
Lucidil	Smith & Nephew	U.K.	—
Morcain	Tatsumi	Japan	—
Nutinal	Boots	U.K.	—
Parasan	Medix	Spain	—
Parpon	Santen	Japan	—
Phobex	Lloyd	—	—
Phobex	Dabney & Westerfield	—	—

Raw Materials

Ethyl Benzilate	β -Diethylaminoethanol
Sodium	Hydrogen Chloride

Manufacturing Process

114 parts of ethyl benzilate, 175 parts of β -diethylaminoethanol and 0.2 part of metallic sodium were placed in a flask attached to a total-reflux variable take-off fractionating column. The pressure was reduced to 100 mm and heat was applied by an oil bath the temperature of which was slowly raised to 90°C. During three hours of heating 17 parts of ethanol distilled (35.5°C). When the distillation of the ethanol became slow, the bath temperature was raised to 120°C. When the vapor temperature indicated distillation of the amino alcohol the take-off valve was closed and the mixture was refluxed for one hour. At the end of this period the vapor temperature had dropped and two more parts of ethanol were distilled. The remaining aminoalcohol was slowly distilled for three hours. The pressure was then reduced to 20 mm and the remainder of the aminoalcohol distilled at 66°C. During the reaction the color of the solution changed from yellow to deep red. The residue was dissolved in 500 parts of ether, washed once with dilute brine, and three times with water, dried over sodium sulfate and finally dried over calcium sulfate. 500 parts of a saturated solution of HCl in absolute ether was added and the resulting precipitate filtered. Dry HCl gas was passed into the filtrate to a slight excess and the precipitate again filtered. The combined precipitates were washed with cold acetone. The 106 parts of product was purified by recrystallization from acetone as fine white crystals which melt at 177°-178°C.

References

- Merck Index 1028
Kleeman & Engel p. 76

PDR p. 1874

OCDS Vol. 1 p. 93 (1977)

DOT 9 (6) 241 (1973)

I.N. p. 120

Hill, A.J. and Holmes, R.B.; U.S. Patent 2,394,770; February 12, 1946; assigned to American Cyanamid

BENAPRYZINE HYDROCHLORIDE

Therapeutic Function: Anticholinergic, antiparkinsonism

Chemical Name: α -hydroxy- α -phenylbenzeneacetic acid 2-(ethylpropylamino)ethyl ester hydrochloride

Common Name: 2-Ethylpropylaminoethyl diphenylglycollate hydrochloride

Structural Formula:

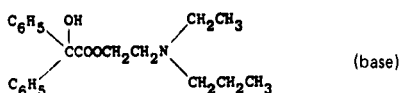

Chemical Abstracts Registry No.: 3202-55-9; 22487-42-9 (Base)

Trade Name	Manufacturer	Country	Year Introduced
Brizin	Beecham	U.K.	1973

Raw Materials

Sodium Methoxide	Methyl α,α -diphenyl Glycollate
2-Ethylpropylaminomethanol	Hydrogen Chloride

Manufacturing Process

A methanolic solution of sodium methoxide [from sodium (0.2 gram) and dry methanol (3 ml)] was added dropwise during 20 minutes to a boiling solution of methyl α,α -diphenylglycollate (11 grams) and 2-ethylpropylaminoethanol (6 grams) in light petroleum (150 ml, BP 80°-100°C) and the methanol that separated was removed by using a Dean and Starke apparatus. At the end of 5 hours no further separation of methanol occurred and the reaction mixture after being washed with water (3 x 20 ml) was extracted with 1 N hydrochloric acid (3 x 30 ml).

The acid extracts (after washing with 50 ml ether) were made alkaline with aqueous 5 N sodium hydroxide solution, the liberated base was extracted into ether (4 x 50 ml) and the ether extracts were dried (MgSO_4). Treatment of the extracts with hydrogen chloride gave the hydrochloride (11 grams, 70%), which was obtained as rectangular plates, MP 164° to 166°C, after several crystallizations from butanone.

References

Merck Index 1030

Kleeman & Engel p. 77

OCDS Vol. 2 p. 74 (1980)

DOT 9 (6) 241 (1973)

I.N. p. 121

Mehta, M.D. and Graham, J.; U.S. Patent 3,746,743; July 17, 1973; assigned to Beecham Group Limited

BENDACORT

Therapeutic Function: Glucocorticoid

Chemical Name: 21-ester of [(1-benzyl-1H-indazol-3-yl-oxy)-acetic acid with 11 β ,17 α , trihydroxy-pregn-4-ene 3,20-dione

Common Name: Ester of Bendazac with hydrocortisone

Structural Formula:

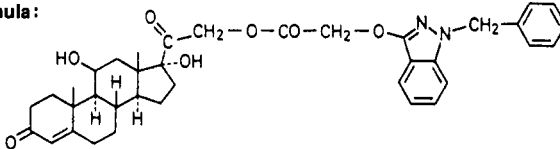

Chemical Abstracts Registry No.: 53716-43-1

Trade Name	Manufacturer	Country	Year Introduced
Versacort	Angelini	Italy	1978

Raw Materials

Hydrocortisone

Bendazac Chloride;[(1-benzyl-1H-indazol-3-yl)oxy] acetic acid chloride

Manufacturing Process

Hydrocortisone (25 g) and Bendazac chloride (21 g) are suspended in anhydrous dioxane (250 ml). Pyridine (6 ml) is added and the solution is kept under stirring for 2 hours at room temperature. Pyridine hydrochloride which separates is filtered and the clear dioxane solution is added, under strong stirring, to a solution of sodium bicarbonate (20 g) in distilled water (2,500 ml). The colorless precipitate which is formed is filtered, washed with water and dried on a porous plate. The substance crystallizes from ethanol. Needles. MP 174°-176°C. Yield: 75%.

References

Merck Index 4689

Baiocchi, L.; U.S. Patent 4,001,219; January 4, 1977

BENDAZAC

Therapeutic Function: Antiinflammatory

Chemical Name: [(1-benzyl-1H-indazol-3-yl)oxy]acetic acid

Common Name: Bendazolic acid

Structural Formula:

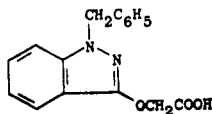

Chemical Abstracts Registry No.: 20187-55-7

Trade Name	Manufacturer	Country	Year Introduced
Versus	Angelini	Italy	1970
Zildasac	Chugai	Japan	1979
Hubersil	Hubber	Spain	—
Versus	Werfft Chemie	Austria	—

Raw Materials

1-Benzyl-3-oxy-indazole
 Chloroacetonitrile
 Hydrogen Chloride

Manufacturing Process

11 grams of the sodium salt of 1-benzyl-3-oxy-indazole are dissolved in 70 ml of absolute ethanol by heating the resulting solution to boiling and stirring. 3.5 grams of chloroacetonitrile dissolved in 5 ml of absolute ethanol are then added within 2-3 minutes and after 10 minutes a further portion of 1.7 grams of chloroacetonitrile are added. The reaction is finally brought to completion with an additional 45 minutes of boiling. The reaction mixture is allowed to cool at room temperature and is then filtered. The alcohol solution is evaporated to dryness under reduced pressure; the resulting residue is taken up again with ether and the ether solution is washed in sequence with dilute HCl, water, NaOH and water. The solution is dried on Na₂SO₄ and then the solvent is removed. The residue consists of (1-benzyl-indazole-3)oxyacetonitrile which is crystallized from methanol. It has a melting point of 93°C.

1 gram of the (1-benzyl-indazole-3)oxyacetonitrile is pulverized and is added with stirring to 5 ml concentrated HCl. By heating on a boiling water bath for 2-3 minutes, the nitrile product melts and soon thereafter solidifies. The precipitate is cooled, then filtered and washed well in a mortar with water. After dissolution in 10% Na₂CO₃, it is precipitated again with dilute HCl. After crystallization from ethanol, 1-benzyl-indazole-3-oxyacetic acid is obtained. It has a melting point of 160°C.

References

Merck Index 1033

Kleeman & Engel p. 79

OCDS Vol. 2 p. 351 (1980)

I.N. p. 121

Palazzo, G.; U.S. Patent 3,470,194; September 30, 1969; assigned to Aziende Chimiche Riunite Angelini, Francesco ACRAF SpA, Italy

BENDROFLUMETHIAZIDE**Therapeutic Function:** Diuretic, antihypertensive**Chemical Name:** 3,4-dihydro-3-(phenylmethyl)-6-(trifluoromethyl)-2H-1,2,4-benzothiadiazine-7-sulfonamide 1,1-dioxide**Common Name:** Bendrofluazide, Benzydrolumethiazide, Benzylhydroflumethiazide

Structural Formula:

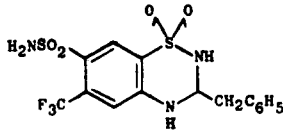

Chemical Abstracts Registry No.: 73-48-3

Trade Name	Manufacturer	Country	Year Introduced
Naturetin	Squibb	U.S.	1959
Sinesalin	I.C.I.	W. Germany	—
Naturine Leo	Leo	France	1961
Benuron	Bristol	U.S.	1965
Aprinox	Boots	U.K.	—
Benzide	Protea	Australia	—
Berkozide	Berk	U.K.	—
Bristuric	Bristol	U.S.	—
Bristuron	Bristol	—	—
Centyl	Leo	Denmark	—
Centyl	Leo-Sankyo	Japan	—
Corzide	Squibb	U.S.	—
Neo-Naclex	Glaxo	U.K.	—
Neo-Rontyl	Leo	Denmark	—
Notens	Farge	Italy	—
Pluryl	Leo	Denmark	—
Polidiuril	Bios	Italy	—
Poliuron	Lepetit	Italy	—
Rauzide	Squibb	U.S.	—
Salural	ICB	Italy	—
Salures	Ferrosan	Denmark	—
Seda-Repicin	Boehringer-Ing.	W. Germany	—
Sinesalin	Arcana	Austria	—
Sodiuretic	Squibb	Italy	—
Tensionorm	Leo	France	—
Urizid	Rekah	Israel	—

Raw Materials

α,α,α -Trifluoro-m-toluidine	Chlorosulfonic Acid
Ammonia	Phenylacetaldehyde
ω -Ethoxystyrene	

Manufacturing Process

The process is described in U.S. Patent 3,392,168 as follows:

(A) *Preparation of 5-Trifluoromethylaniline-2,4-Disulfonylchloride*—113 ml of chlorosulfonic acid is cooled in an ice bath, and to the acid is added dropwise while stirring 26.6 grams of α,α,α -trifluoro-m-toluidine. 105 grams of sodium chloride is added during 1-2 hours, whereafter the temperature of the reaction mixture is raised slowly to 150°-160°C which temperature is maintained for three hours. After cooling the mixture, ice-cooled water is added, whereby 5-trifluoromethylaniline-2,4-disulfonyl chloride separates out from the mixture.

(B) *Preparation of 5-Trifluoromethyl-2,4-Disulfamylaniline*—The 5-trifluoromethylaniline-2,4-disulfonyl chloride obtained in step (A) is taken up in ether and the ether solution dried with magnesium sulfate. The ether is removed from the solution by distillation, the residue is cooled to 0°C, and 60 ml of ice-cooled, concentrated ammonia water is added while stirring. The solution is then heated for one hour on a steam bath and evaporated

in vacuo to crystallization. The crystallized product is 5-trifluoromethyl-2,4-disulfamyl-aniline, which is filtered off, washed with water and dried in a vacuum-desiccator over phosphorus pentoxide. After recrystallization from a mixture of 30% ethanol and 70% water, the compound has a MP of 247°-248°C.

(C) *Preparation of 3-Benzyl-6-Trifluoromethyl-7-Sulfamyl-3,4-Dihydro-1,2,4-Benzothiadiazine-1,1-Dioxide*—6.4 grams of 5-trifluoromethyl-2,4-disulfamylaniline is dissolved in 12 ml of dioxane. 2.7 ml of phenylacetaldehyde and a catalytic amount of p-toluenesulfonic acid are added. After boiling for a short time under reflux, the reaction mixture crystallizes, and, after filtration and recrystallization from dioxane, the desired product is obtained with a MP of 224.5°-225.5°C.

(D) *Alternative to (C)*—9.6 grams of 5-trifluoromethyl-2,4-disulfamylaniline and 4.9 grams of ω -ethoxystyrene are dissolved in 35 ml of n-butanol. 0.5 grams of p-toluenesulfonic acid is added, and the mixture is heated on a steam bath while stirring. When the solution is clear, 55 ml of hexane is added, whereafter the mixture is heated further for one and a half hours. After cooling, the substance identical to that of Example (C) is filtered off and has a MP of 222°-223°C.

Sterile compositions containing Bendroflumethiazide for parenteral administration may be prepared as described in U.S. Patent 3,265,573.

References

Merck Index 1036

Kleeman & Engel p. 79

PDR pp. 1741, 1753, 1767

OCDS Vol. 1 p. 358 (1977)

DOT 16 (3) 94 (1980)

I.N. p. 122

REM p. 938

Goldberg, M.; U.S. Patent 3,265,573; August 9, 1966; assigned to E.R. Squibb & Sons, Inc.

Lund, F., Lyngby, K. and Godtfredsen, W.O.; U.S. Patent 3,392,168; July 9, 1968; assigned to Lovens Kemiske Fabrik ved A. Kongsted, Denmark

BENFLUOREX HYDROCHLORIDE

Therapeutic Function: Hypolipemic agent, cardiovascular drug

Chemical Name: 1-(*m*-Trifluoromethylphenyl)-2-(β -benzoyloxyethyl)aminopropane

Common Name: —

Structural Formula:

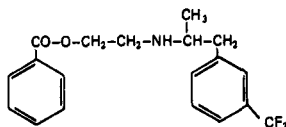

Chemical Abstracts Registry No.: 23642-66-2; 23602-78-0 (Base)

Trade Name	Manufacturer	Country	Year Introduced
Mediator	Servier	France	1976
Mediactal	Stroder	Italy	1981

Trade Name	Manufacturer	Country	Year Introduced
Medi axial Minolip	Servier Chiesi	Switz. Italy	1982 —

Raw Materials

1-(m-Trifluoromethylphenyl)-2-(β -hydroxyethyl)amino Propane
Benzoyl Chloride

Manufacturing Process

To a solution of 24.7 parts of 1-(m-trifluoromethylphenyl)-2-(β -hydroxyethyl)amino propane in 140 parts of anhydrous benzene, there were added successively 15 parts of 4.7 N hydrochloric ether and a solution of 14 parts of benzoyl chloride in 24 parts of anhydrous benzene. The addition required 10 minutes, the reaction mixture was then refluxed for 8 hours.

The solid product was collected by filtration and after recrystallization from 230 parts of ethyl acetate, there were obtained 15 parts of 1-(m-trifluoromethylphenyl)-2-(β -benzoyloxyethyl)amino propane hydrochloride melting at 161°C.

10 parts hydrochloride are put in suspension in 100 parts of water, 80 parts ether are added, then 10 parts of a concentrated solution of ammonium hydroxide. The mixture is stirred a few minutes until the salt is dissolved, then the ethered solution is poured off and dried. After the ether is eliminated, 9 parts of 1-(m-trifluoromethylphenyl)-2-(β -benzoyloxyethyl)amino propane are obtained; the base is a colorless oil.

References

Merck Index 1037

DFU 2 (8) 557 (1976)

Kleeman & Engel p. 80

DOT 13 (1) 12 (1977)

I.N., p. 122

Beregi, L. Hugon, P. and Le Douarec, J.C.; U.S. Patent 3,607,909; September 21, 1971; assigned to Science Union et Cie Societe Francaise de Recherche Medicale

BENFURODIL HEMISUCCINATE

Therapeutic Function: Coronary vasodilator, cardiotonic

Chemical Name: succinic acid monoester with 4-[2-(1-hydroxyethyl)-3-methyl-5-benzofuranyl]-2(5H)-furanone

Common Name: —

Structural Formula:

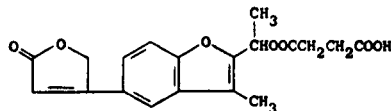

Chemical Abstracts Registry No.: 3447-95-8

Trade Name	Manufacturer	Country	Year Introduced
Eucilat	Clin Midy	France	1970

Trade Name	Manufacturer	Country	Year Introduced
Clinodilat	Mack-Midy	W. Germany	1981
Eucilat	Midy	Italy	1981
Eucilat	Clin-Comar-Bila	France	—

Raw Materials

4-(4-Methoxyphenyl)-2-oxo-2,5-dihydrofuran	Chloroacetone
Aluminum Chloride	Acetyl Chloride
Sodium Borohydride	Hydrogen Chloride
Succinic Anhydride	

Manufacturing Process

(A) Preparation of 4-[3-Acetyl-4-Hydroxyphenyl]-2-Oxo-2,5-Dihydrofuran (1567 CB):

A solution of 57 grams of 4-(4-methoxyphenyl)-2-oxo-2,5-dihydrofuran (0.3 mol) in 300 ml of methylene chloride is added slowly to 200 grams of anhydrous powdered aluminum chloride, while stirring and cooling in a bath of iced water. When this is completed, one removes the bath and leaves the reagents in contact for 10 minutes, and then introduces 72 grams of acetyl chloride at a speed sufficient to maintain refluxing of the solvent. One subsequently heats under reflux for 3 hours 30 minutes, decomposes by pouring on to crushed ice, filters off the crystalline product and washes it with water. 56 g, MP = 200°C. Yield: 80%. The product is recrystallized from acetic acid and then melts at 201°-202°C.

(B) Preparation of 4-[3-Acetyl-4-(2-Oxopropoxy)Phenyl]-2-Oxo-2,5-Dihydrofuran: 5.45

grams (0.025 mol) of compound 1567 CB prepared according to (A) dissolved in 50 ml of dimethyl formamide is stirred at room temperature for 15 minutes with 5 grams of potassium carbonate and 1 gram of sodium iodide, and 5 grams of chloroacetone are then added drop by drop. The temperature spontaneously rises a few degrees. The disappearance of the phenolic compound is checked by testing with an alcoholic solution of ferric chloride; this test should be negative at the end of the reaction (approximately 2 hours). One then dilutes with 10 volumes of water, filters the product which crystallizes out under these conditions and recrystallizes it from acetic acid. It has the form of yellow needles (4 grams yield: 63%). MP_c = 155°-157°C.

(C) Preparation of 2-Acetyl-3-Methyl-5-(2-Oxo-2,5-Dihydro-4-Furyl)Benzo[b]Furan (3556

CB): (1) A suspension of 2 grams of the compound prepared according to (B) in 20 ml of concentrated hydrochloric acid, is heated to about 50°C, just until it dissolves. Thereafter it is heated for 2 minutes to 70°C, just until precipitation commences. The mixture is allowed to cool, diluted with water, filtered, the residue washed, dried, and sublimed at 200°C and 0.1 mm pressure. 1.4 grams of product (Yield: 70%) is obtained. MP_c = 218°-221°C. A second sublimation produces a chemically pure product. MP_c = 221°-222°C.

(2) Compound 1567 CB and chloroacetone are caused to react as in (B), the mineral salts subsequently filtered, 12 ml of concentrated hydrochloric acid are added to the solution in dimethyl formamide without dilution with water, and the mixture heated for 40 minutes on a water bath. The product crystallizes in the warm mixture, the mixture is cooled to room temperature, filtered, the residue washed with water and crystallized from acetic acid. MP_c = 222°C. Yield: 60% based on compound 1567 CB.

(D) Preparation of 2-(1-Hydroxyethyl)-3-Methyl-5-(2-Oxo-2,5-Dihydro-4-Furyl)Benzo[b]-

Furan (3574 CB): 13.2 grams of compound 3556 CB of which the preparation is described in (C) are treated successively with 66 ml of methylene chloride, 27 ml of methanol and, with stirring, 1.6 grams of sodium borohydride added in stages. The reaction takes 1 hour. The mixture is poured into water acidified with a sufficient amount of acetic acid, the solvents are stripped under vacuum, the crystalline product removed, washed with water, and recrystallized from ethyl acetate. Yield: 90%. MP_k = 158°C.

(E) Preparation of 2-(1-Succinyloxyethyl)-3-Methyl-5-(2-Oxo-2,5-Dihydro-4-Furyl)Benzo[b]-Furan (409₁ CB): 8.65 grams of compound 3574 CB in 43 ml of pyridine are warmed for 30 minutes, on a water bath, with succinic anhydride. At the end of this, the pyridine is stripped off in vacuo. The mixture is treated with dilute sulfuric acid and with ether, the crystalline product filtered off, washed with water and with ether, and recrystallized from ethyl acetate (9.35 grams). $MP_c = 144^\circ C$ (measured after drying at $90^\circ C$ and 0.1 mm). Yield: 77%. The product yields an equimolecular compound with morpholine. $MP_c = 136^\circ C$ (from ethyl acetate).

References

Kleeman & Engel p. 81

OCDS Vol. 2 p. 355 (1980)

DOT 6 (6) 203 (1970)

I.N. p. 123

Schmitt, J.; U.S. Patent 3,355,463; November 28, 1967; assigned to Etablissements Clin-Byla, France

BENORYLATE

Therapeutic Function: Analgesic, antiinflammatory, antipyretic

Chemical Name: 2-(acetyloxy)benzoic acid 4-(acetylamino)phenyl ester

Common Name: Fenasprate; p-N-acetamidophenyl acetylsalicylate

Structural Formula:

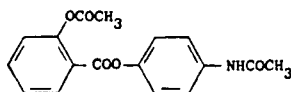

Chemical Abstracts Registry No.: 5003-48-5

Trade Name	Manufacturer	Country	Year Introduced
Benortan	Winthrop	Switz.	—
Benoral	Winthrop	U.K.	1972
Benortan	Winthrop	W. Germany	1975
Benortan	Winthrop	France	1976
Benorile	Rubio	Spain	—
Benortan	Pharmacal	Finland	—
Bentum	Inpharzam	Belgium	—
Salipran	Bottu	France	—
Sinalgin	Robin	Italy	—
Triadol	Sterling Heath	U.K.	—
Winorylate	Sterwin Espanola	Spain	—

Raw Materials

N-Acetyl-p-aminophenol
Acetyl Salicyl Chloride

Manufacturing Process

Example 1: 65 grams of N-acetyl-p-aminophenol were slurried with 400 ml of water and cooled to $10^\circ C$. 125 ml of 20% sodium hydroxide were slowly added to the mixture with

stirring, the temperature being maintained between 10° and 15°C. To the solution obtained, 75 grams of acetyl salicyloyl chloride were added with vigorous stirring over a period of ½ hr, the solution being maintained at a temperature of about 10°C. Towards the end of the reaction the pH was checked and adjusted to greater than 10 by the addition of a small amount of 20% sodium hydroxide. After all the acid chloride had been added, vigorous stirring was continued for half an hour during which time the crude product separated out. This product was filtered off, washed thoroughly with water and recrystallized from ethanol.

Example 2: 65 grams of sodium N-acetyl-p-aminophenol were slurried with 500 grams of dry benzene and 80 grams of acetyl salicyloyl chloride added. The mixture was heated under reflux for four hours and filtered hot. The excess benzene was removed under vacuum and the crude acetyl salicylic acid ester of N-acetyl-p-aminophenol crystallized from ethanol.

References

Merck Index 1043

Kleeman & Engel p. 82

DOT 8 (6) 208 (1972)

I.N. p. 123

Robertson, A.; U.S. Patent 3,431,293; March 4, 1969; assigned to Sterling Drug, Inc.

BENOXAPROFEN

Therapeutic Function: Antiinflammatory, analgesic

Chemical Name: 2-(2-p-Chlorophenyl-5-benzoxazolyl)propionic acid

Common Name: —

Structural Formula:

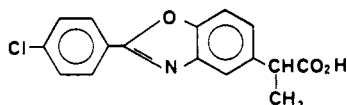

Chemical Abstracts Registry No.: 51234-28-7

Trade Name	Manufacturer	Country	Year Introduced
Opren	Dista Lilly	U.K.	1980
Coxigon	Lilly	W. Germany	1981
Inflamid	Lilly	France	1981
Coxigon	Lilly	Switz.	1982
Coxigon	Schweiz, Serum I	Switz.	1982
Oraflex	Lilly	U.S.	1982
Bexopron	Lilly	—	—

Raw Materials

Ethyl-2-(3-hydroxy-4-aminophenyl)propionate
p-Chlorobenzoyl Chloride

Manufacturing Process

The 6-benzoxazolyl analog of the 5-benzoxazolyl product is prepared as follows:

(a) *Ethyl 2-(2-p-chlorophenyl-6-benzoxazolyl)propionate*: A solution of ethyl 2-(3-hydroxy-4-aminophenyl)propionate (2.5 g) in pyridine (15 ml) was treated with p-chlorobenzoyl chloride (1.65 ml) at 5°C. After stirring for 2 hours at room temperature the solution was evaporated to dryness.

The residue was heated at 220°C until no more water was evolved, then was allowed to cool. This yielded ethyl 2-(2-p-chlorophenyl-6-benzoxazolyl)propionate.

(b) *2-(2-p-Chlorophenyl-6-benzoxazolyl)propionic acid*: A solution of ethyl 2-(2-p-chlorophenyl-6-benzoxazolyl)propionate (4 g) in aqueous sodium hydroxide (30 ml) was heated on a steam bath for one-half hour. On cooling the black solution was washed with chloroform. On acidification of the black solution with hydrochloric acid the mixture was extracted with chloroform. This solution on evaporation yielded 2-(2-p-chlorophenyl-6-benzoxazolyl)propionic acid, MP 196°C.

References

Merck Index 1044

DFU 2 (9) 565 (1977)

Kleeman & Engel p. 82

OCDS Vol. 2 p. 356 (1980)

DOT 16 (9) 283 (1980)

I.N. p. 123

Evans, D., Dunwell, D.W. and Hicks, T.A.; U.S. Patent 3,912,748; October 14, 1975; assigned to Lilly Industries Ltd.

Evans, D., Dunwell, D.W. and Hicks, T.A.; U.S. Patent 3,962,441; June 8, 1976; assigned to Lilly Industries, Ltd.

Evans, D., Dunwell, D.W. and Hicks, T.A.; U.S. Patent 3,962,452; June 8, 1976; assigned to Lilly Industries, Ltd.

BENOXINATE HYDROCHLORIDE

Therapeutic Function: Topical anesthetic

Chemical Name: 4-amino-3-butoxybenzoic acid 2-(diethylamino)ethyl ester hydrochloride

Common Name: Oxybuprocaine

Structural Formula:

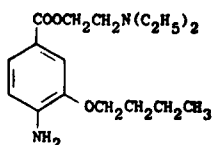

(base)

Chemical Abstracts Registry No.: 5987-82-6; 99-43-4 (Base)

Trade Name	Manufacturer	Country	Year Introduced
Dorsacaine HCl	Dorsey	U.S.	1953
Novesine	Merck-Chibret	France	1960
Anemixin	Zeria	Japan	—
Benoxil	Santen	Japan	—

Trade Name	Manufacturer	Country	Year Introduced
Benoxinate	Barnes-Hind	U.S.	—
Cebesine	Chausin-Blache	France	—
Colirio Anestésico	Collado	Spain	—
Collu-Blache	Chauvin-Blache	France	—
Conjuncaïn	Mann	W. Germany	—
Lacrimin	Santen	Japan	—
Minims Benoxinate	Smith & Nephew	U.K.	—
Novesin	Wander	Switz.	—
Novesin	Dispersa	Switz.	—
Prescaïna	Llorens	Spain	—
Scarlene	Chauvin-Blache	France	—

Raw Materials

3-Oxy-4-nitrobenzoic Acid	Ethanol
Potassium Hydroxide	Butanol
Thionyl Chloride	Diethylamino Ethanol
Hydrogen	Hydrogen Chloride

Manufacturing Process

25 grams of 3-oxy-4-nitrobenzoic acid are esterified (ethyl ester) and 26 grams of the ester are dissolved in 200 cc of absolute ether and treated with 7 grams of caustic potash in 20 cc of absolute methanol. The red potassium phenolate with 7 grams of pure butyl bromide and 7 grams of absolute alcohol are heated for 5 hours in the oven to 150°C. When cool, the alcohol is evaporated in vacuo and the butoxy-nitrobenzoic acid ethyl ester is precipitated with water. The substance is sucked off and saponified for 15 minutes with a solution of 2.5 grams of caustic potash in 30 cc of alcohol on a water bath. The alcohol is evaporated in vacuo and the 3-butoxy-4-nitrobenzoic acid is precipitated with hydrochloric acid. It forms needles which melt at 174°C. 7.9 grams of dry acid are boiled for 45 minutes under a reflux condenser with 25 cc of thionyl chloride. The excess of thionyl chloride is then removed in vacuo, and the oil is distilled. The acid chloride has a yellow color and solidifies.

7.3 grams of the acid chloride are treated with 6.6 grams of diethyl-amino-ethanol in 20 cc of absolute benzene. The mixture is then warmed for 1 hour on a water bath. When cold, it is treated with a solution of soda and washed with ether. After drying over potash, the ether and benzene are removed by distillation and 3-butoxy-4-nitrobenzoic acid diethyl-amino-ethyl ester is obtained, having a BP 215°C/2.5 mm.

5.0 grams of this product are hydrogenated in absolute alcohol solution with fresh Raney nickel. When the absorption of hydrogen ceases (5 hours), the solution is filtered and the alcohol evaporated in vacuo. The 3-butoxy-4-aminobenzoic acid diethyl-amino-ethyl ester boils at 215°-218°C at 2mm pressure; it is an almost colorless oil.

By precipitation of a solution of the ester in absolute ether with hydrogen chloride gas, the dihydrochloride is obtained; upon recrystallization from alcohol/ether, it forms crystals which melt at 196°-197°C.

References

Merck Index 1045

Kleeman & Engel p. 671

I.N. p. 716

REM p. 1057

Dr. A. Wander, AG, Switzerland; British Patent 654,484; June 20, 1951

BENPERIDOL

Therapeutic Function: Tranquillizer

Chemical Name: 1-[1-[4-(4-fluorophenyl)-4-oxobutyl]-4-piperidiny]-1,3-dihydro-2H-benzimidazol-2-one

Common Name: Benzperidol

Structural Formula:

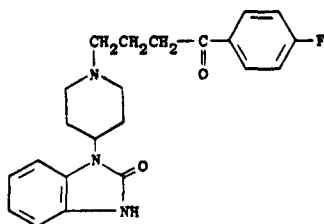

Chemical Abstracts Registry No.: 2062-84-2

Trade Name	Manufacturer	Country	Year Introduced
Frenactil	Clin-Compar-Byla	France	1965
Gliahimon	Tropon	W. Germany	1966
Anquil	Janssen	U.K.	1973

Raw Materials

γ -Chloro-4-fluorobutyrophenone
1-(4-Piperidyl)-2-benzimidazoline HCl

Manufacturing Process

A mixture of 3.4 parts of γ -chloro-4-fluorobutyrophenone, 4 parts of 1-(4-piperidyl)-2-benzimidazolinone hydrochloride, 6 parts of sodium carbonate and 0.1 part of potassium iodide in 176 parts of 4-methyl-2-pentanone is stirred and refluxed for 48 hours. The reaction mixture is cooled and 120 parts of water is added. The separated organic layer is dried over magnesium sulfate and the solvent is evaporated to leave an oily residue which is dissolved in dilute hydrochloric acid and boiled. The acidic solution is filtered and cooled at room temperature whereupon there crystallizes from solution 1-(1-[γ -(4-fluorobenzoyl)-propyl]-4-piperidyl)-2-benzimidazolinone hydrochloride hydrate melting at about 134°-142°C.

References

- Merck Index 1046
Kleeman & Engel p. 83
OCDS Vol. 2 p. 290 (1980)
I.N. p. 124
British Patent 989,755; April 22, 1965; assigned to N.V. Research Laboratorium Dr. C. Janssen
Janssen, P.A.J.; U.S. Patent 3,161,645; December 15, 1964; assigned to Research Laboratorium Dr. C. Janssen N.V.

BENPROPERINE

Therapeutic Function: Antitussive

Chemical Name: 1-[1-Methyl-2-[2-(phenylmethyl)phenoxy] ethyl] piperidine

Common Name: —

Structural Formula:

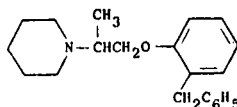

Chemical Abstracts Registry No.: 2156-27-6

Trade Name	Manufacturer	Country	Year Introduced
Tussafug	Medipharm	Switz.	—
Biascorid	Guidotti	Italy	1968
Flaveric	Pfizer Taito	Japan	1970
Tussafugsaft	Robugen	W. Germany	1976
Pirexyl	Pharmacia	Sweden	—
Biascorid	Pharmacia	Sweden	—
Pectipront	Mack	W. Germany	—

(The above trade names are for phosphate and pamoate derivatives)

Raw Materials

o-Benzylphenoxy- β -chloropropane
Piperidine

Manufacturing Process

A mixture of 26.1 g of o-benzylphenoxy- β -chloropropane and 17 g of piperidine is refluxed over a period of 32 hours until the temperature is about 124°C and a nearly solid mixture is formed due to the precipitation of a salt. The mixture is then refluxed over a period of 48 hours at about 160°C and the reaction product obtained is cooled and dissolved in methanol. The solution is concentrated under reduced pressure to yield an oil which is added to 200 ml 3N hydrochloric acid whereupon the mixture is shaken with ether, 3 x 100 ml, until the aqueous phase is clear. The ether solution is washed with water, 3 x 50 ml, and the water present in the combined aqueous phase and water used for washing is evaporated under reduced pressure methanol being added three times when the residue appears to be dry. The impure hydrochloride of o-benzylphenoxy- β -N-piperidinopropane, 41 g, obtained is dissolved in 100 ml water and 100 ml 30% aqueous sodium hydroxide solution are added, whereupon precipitated oil is extracted with ether, 1 x 100 and 2 x 50 ml. The ether solution is washed with water, 4 x 50 ml, dried with magnesium sulfate and the ether is removed under reduced pressure. The residue, 25.2 g, is distilled under reduced pressure and the main fraction, 23.2 g, BP 159°-161°C/0.2 mm.

References

Merck Index 1047
Kleeman & Engel p. 83
OCDS Vol. 2 p. 100 (1980)
DOT 13 (6) 223 (1977)
I.N. p. 124
Rubinstein, K.; U.S. Patent 3,117,059; January 7, 1964; assigned to A.B. Pharmacia

BENSERAZIDE

Therapeutic Function: Antiparkinsonism

Chemical Name: DL-serine 2-[(2,3,4-trihydroxyphenyl)methyl] hydrazide

Common Name: —

Structural Formula:

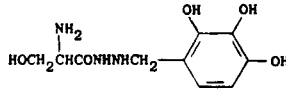

Chemical Abstracts Registry No.: 322-35-0

Trade Name	Manufacturer	Country	Year Introduced
Madopar	Roche	Italy	1974
Madopar	Roche	U.K.	1975
Modopar	Roche	France	1975
Madopar	Roche	W. Germany	1975
Neodopasol	Daiichi	Japan	1980
Madopar	Nippon Roche	Japan	1980
EC-Doparyl	Kyowa Hakko	Japan	1980
Madopark	Roche	—	—
Prolopa	Roche	—	—

Raw Materials

DL-Seryl Hydrazide HCl
 Pyrogallolaldehyde
 Hydrogen

Manufacturing Process

35.5 grams of DL-seryl-hydrazide hydrochloride was dissolved in 350 ml of water and 35 grams of pyrogallolaldehyde (2,3,4-trihydroxy-benzaldehyde) added thereto at one time. In about 5-10 minutes a clear solution resulted, whereupon slow crystallization occurred and the temperature rose to about 6°-7°C. The crystallization was permitted to continue overnight at 5°C, and the very fine precipitate was then isolated by centrifugation and in the centrifuge washed with water, ethanol, and ether, yielding the dihydrate of DL-seryl-(2,3,4-trihydroxy-benzylidene) hydrazide hydrochloride, which melted at 134°-136°C and was poorly soluble in cold water, but very readily dissolved in hot water. The condensation was also effected in absolute ethanol yielding the anhydrous form of the hydrazone, which melted at 225°-228°C.

33.5 grams of the hydrazone-dihydrate was suspended in 330 ml of methanol and hydrogenated with 2.5 grams of palladium-carbon. After the absorption of 2.8 liters of hydrogen, the catalyst was filtered off and the solution evaporated in vacuo to a weight of about 52-55 grams. It was then immediately mixed with 160 ml of absolute ethanol and permitted to crystallize for 24 hours at room temperature and then for a further 24 hours at 0°C. The product was then filtered off with suction and washed with absolute ethanol and absolute ether. The so-obtained DL-seryl-(2,3,4-trihydroxy-benzyl)-hydrazide hydrochloride formed a white crystalline powder which was readily soluble in water and which melted at 146°-148°C.

References

Merck Index 1048
 Kleeman & Engel p. 84
 DOT 10 (9) 322 (1974)
 I.N. p. 124
 Hegedus, B. and Zeller, P.; U.S. Patent 3,178,476; April 13, 1965; assigned to Hoffmann-La Roche Inc.

BENTIROMIDE

Therapeutic Function: Diagnostic aid (pancreatic function)

Chemical Name: 4-[[2-(Benzoylamino)-3-(4-hydroxyphenyl)-1-oxopropyl] amino]benzoic acid

Common Name: N-Benzoyl-L-tyrosyl-p-aminobenzoic acid

Structural Formula:

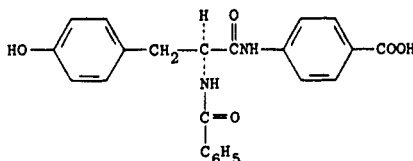

Chemical Abstracts Registry No.: 37106-97-1

Trade Name	Manufacturer	Country	Year Introduced
PFD Oral Sol	Eisai	Japan	1980
PFT Roche	Roche	Switz.	1982
Chymex	Adria	U.S.	-

Raw Materials

L-Tyrosine	N-Methylmorpholine
Benzoyl Chloride	p-Aminobenzoic Acid

Manufacturing Process

A mixture was made of L-tyrosine (18.1 g, 0.1 mol) benzoyl chloride (7.0 g, 0.05 mol) and 200 ml anhydrous THF. After stirring at reflux for 2 hours, the mixture was cooled to room temperature, and the precipitate of tyrosine hydrochloride filtered off (11 g, 46 meq. Cl⁻). The THF was evaporated and the residue extracted with CCl₄ (3 X 100 ml at reflux, discarded) and then dissolved in ethyl acetate (200 ml) filtering off insolubles. The ethyl acetate solution was evaporated to yield 13.2 g solid product, MP 159°-162°C (93%). The tyrosine was recovered (8 g) by neutralization with aqueous alkali, from the hydrochloride.

A solution was made of N-benzyl-L-tyrosine (5.7 g, 20 mmols) and N-methylmorpholine (2.04 g, 20 mmols) in 60 ml of THF, at -15°C, and to it was added ethyl chloroformate (2.08 g, 20 mmols). After 12 minutes, p-aminobenzoic acid (2.74 g, 20 mmols) dissolved in 25 ml of THF and 0.38 g of p-toluenesulfonic acid (2 mmols) were added, and the temperature allowed to rise to 5°C. After 2 hours and forty minutes, the mixture was poured into 1 liter of 0.1 N cold HCl, stirred one-half hour, filtered and dried, to give 8.7 g, MP 192°-223°C. The product was recrystallized from 90 ml methanol and 40 ml water, to give 6 g (74%) of product, N-benzoyl-L-tyrosyl-p-aminobenzoic acid, MP 240°-242°C.

References

- Merck Index 1050
- OCDS Vol. 3 p. 60 (1984)
- DOT 16 (10) 354 (1980)
- I.N. p. 125
- De Benneville, P.L. and Greenberger, N.J.; U.S. Patent 3,745,212; July 10, 1973; assigned to Rohm & Haas Co.

BENZBROMARONE

Therapeutic Function: Uricosuric, antiarthritic

Chemical Name: (3,5-dibromo-4-hydroxyphenyl)-(2-ethyl-3-benzofuranyl)methanone

Common Name: —

Structural Formula:

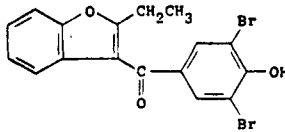

Chemical Abstracts Registry No.: 3562-84-4

Trade Name	Manufacturer	Country	Year Introduced
Desuric	Labaz	Switz.	—
Uricovac	Labaz	W. Germany	1971
Desuric	Labaz	France	1976
Desuric	Sigma Tau	Italy	1977
Urinorm	Torii	Japan	1979
Azubromaron	Azupharma	W. Germany	—
Allomaron	Nattermann	W. Germany	—
Exurate	Mead-Johnson	U.S.	—
Hipuric	Labaz	—	—
Max-Uric	Labinca	Argentina	—
Minuric	Labaz	—	—
Narcaricin	Heumann	W. Germany	—
Normurat	Grunenthal	W. Germany	—
Obaron	Mepha	Switz.	—

Raw Materials

Chloroacetone	Salicylic Aldehyde
Hydrazine Hydrate	Anisoyl Chloride
Bromine	

Manufacturing Process

The propyl analog of the benzbromarone intermediate containing an ethyl group is prepared as follows: to a solution of potassium hydroxide (56 g = 1 mol) in absolute ethyl alcohol (750 cc) is added one mol of salicylic aldehyde (122 grams). The mixture is brought to boiling point in a water-bath until the potassium salt formed is dissolved. One mol of ethyl chloromethyl ketone (106.5 grams) (methyl chloromethyl ketone or chloroacetone in the case of benzbromarone) is gradually added and the solution boiled in a reflux condenser for two hours.

After cooling, the potassium chloride precipitate is separated off by filtration, and the greater part of the solvent removed by distillation. The residue is then purified by distillation. In this way, 140 grams of 2-propionyl coumarone are obtained, boiling at 135°C under 15 mm Hg. A mixture is then prepared as follows: 215 grams of 2-propionyl coumarone, 550 cc of diethylene glycol and 200 grams of hydrazine hydrate at 85% and maintained at boiling point in a reflux condenser for 10 minutes. After cooling, 180 grams of potassium hydroxide are added and the mixture brought up to 120°-130°C. This temperature is maintained until no more nitrogen is liberated (about 1 hour). The mixture is then distilled by means of super-heated steam (150°-160°C).

The distillate is neutralized by means of concentrated HCl, decanted, and the aqueous layer extracted by means of ether. The oily layer and the ethereal extract are mixed, washed with diluted HCl, then with water, and finally dried over sodium sulfate. The solvent is removed and the residue rectified under reduced pressure. In this way, 130 grams of 2-propyl coumarone are obtained, boiling at 112°C under 17 mm of mercury.

The following substances are then placed in a 250 cc flask fitted with a stirrer and a separatory funnel: 12.96 grams of 2-propyl coumarone, 55 cc of carbon sulfide and 14 grams of anisoyl chloride. The mixture is cooled by means of iced water and 21.5 grams of stannic chloride introduced dropwise, while the mixture is stirred. Stirring is continued for three hours at 0°C, after which the mixture is allowed to stand overnight. 50 cc of carbon sulfide is added and the mixture is treated, while being stirred, with the following: 20 cc of HCl and 100 cc of iced water. The organic layer is decanted and washed with water, dried over silica gel and rectified.

16.16 grams of 2-propyl-3-anisoyl coumarone are obtained (Yield: 72%), boiling at 189°C under 0.5 mm Hg. The methoxylated coumarone so obtained is mixed as follows: 1 part of 2-propyl-3-anisoyl coumarone and 2 parts of pyridine hydrochloride and the mixture maintained for one hour under a stream of dry nitrogen in an oil bath at 210°C (under a vertical condenser). After cooling, the mixture is triturated with 0.5 N hydrochloric acid (10 parts). The aqueous layer is separated and the residue extracted with ether. The ethereal extract is treated with 20 parts of 1% caustic soda. The alkaline layer is separated by decanting and acidified by means of diluted HCl. The precipitate is purified by recrystallization in aqueous acetic acid.

0.8 part of 2-propyl-3-p-hydroxybenzoyl coumarone is obtained, melting at 123°C. Then the dibromo counterpart of benzbromarone may be prepared as follows: 8.05 g of 3-ethyl-2-p-hydroxybenzoyl coumarone, prepared as described above, are dissolved in very slight excess of 3% caustic soda. To this solution is gradually added a slight excess of bromine dissolved in a 25% aqueous solution of potassium bromide. The resultant solution is acidified with a 20% solution of sodium bisulfite, centrifuged, washed with water and then dried under vacuum. The product is then recrystallized in acetic acid and 13.6 g of 2-(4'-hydroxy-3',5'-dibromo-benzoyl)-3-ethyl coumarone obtained, MP 151°C.

References

Merck Index 1062

Kleeman & Engel p. 87

OCDS Vol. 2 p. 354 (1980)

I.N. p. 127

Hoi, N.P.B. and Beaudet, C.; U.S. Patent 3,012,042; December 5, 1961; assigned to Societe Belge de l'Azote et des Produits Chimiques du Marly, Belgium

BENZETHONIUM CHLORIDE

Therapeutic Function: Topical Antiinfective

Chemical Name: N,N-Dimethyl-N-[2-[2-[4-(1,1,3,3-tetramethylbutyl)-phenoxy] ethyl] benzene]methanaminium chloride

Common Name: —

Structural Formula:

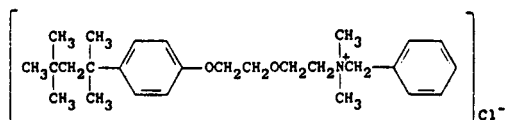

Chemical Abstracts Registry No.: 121-54-0

Trade Name	Manufacturer	Country	Year Introduced
Phemerol	Parke Davis	U.S.	1942
Premithyn	Flint	U.S.	1959
Benzalcan	Siegfried	Switz.	—
Dalidyne	Dalín	U.S.	—
Desamon	Streuli	Switz.	—
Hyarom	Teva	Israel	—
Sterilette	Farmitalia Carlo Urba	Italy	—
Uni Wash	United	U.S.	—

Raw Materials

p-Diisobutylphenol	Dichlorodiethyl Ether
Benzyl Chloride	Dimethylamine

Manufacturing Process

A mixture of 32 g of p-($\alpha,\alpha,\gamma,\gamma$ -tetramethylbutyl)phenoxyethoxyethyl-dimethylamine and 12.7 parts of benzyl chloride was warmed in 50 g of benzene for 2 hours. The benzene was then evaporated. The residual viscous mass gave a foamy, soapy solution in water.

The original starting materials are p-diisobutylphenol, dichlorodiethyl ether and dimethylamine.

References

Merck Index 1072

PDR pp. 829, 1826

I.N. p. 127

REM p. 1166

Bruson, H.A.; U.S. Patents 2,115,250; April 26, 1938; 2,170,111; August 22, 1939; and 2,229,024; January 21, 1941; all assigned to Rohm & Haas Co.

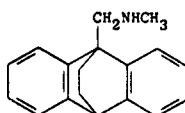
BENZOCTAMINE HCl**Therapeutic Function:** Sedative, muscle relaxant**Chemical Name:** N-Methyl-9,10-ethanoanthracene-9(10H)-methanamine**Common Name:** —**Structural Formula:**

(base)

Chemical Abstracts Registry No.: 10085-81-1; 17243-39-9 (Base)

Trade Name	Manufacturer	Country	Year Introduced
Tacitin	Ciba Geigy	Switz.	—
Tacitine	Ciba Geigy	France	1970

Trade Name	Manufacturer	Country	Year Introduced
Tacitin	Ciba Geigy	U.K.	1971
Tacitin	Ciba Geigy	Italy	1971
Tacitin	Ciba Geigy	W. Germany	1972

Raw Materials

Anthracene	Monomethylamine
Acrolein	Hydrogen

Manufacturing Process

A solution of 10 g of 9:10-dihydro-9:10-ethano-(1:2)-anthracene-(9)aldehyde (made from anthracene and acrolein) and 10 g of monomethylamine in 100 cc of ethanol is heated at 80°C for 4 hours in an autoclave. The reaction mixture is then evaporated to dryness under reduced pressure to leave a crystalline residue which is dissolved in 150 cc of ethanol and, after the addition of 2 g of Raney nickel, hydrogenated at 40°C under atmospheric pressure. When the absorption of hydrogen has subsided, the catalyst is filtered off and the filtrate evaporated under reduced pressure. An oil remains which is covered with 100 cc of 2N hydrochloric acid. The 9-methylamino-methyl-9:10-dihydro-9:10-ethano-(9:10)-anthracene hydrochloride crystallizes immediately; after crystallization from methanol it melts at 320°-322°C.

References

Merck Index 1087

Kleeman & Engel p. 88

DOT 6 (4) 123 (1970)

I.N. p. 129

Schmidt, P., Wilhelm, M. and Eichenberger, K.; U.S. Patent 3,399,201; August 27, 1968; assigned to Ciba Corp.

BENZONATATE

Therapeutic Function: Antitussive

Chemical Name: 4-(butylamino)benzoic acid 3,6,9,12,15,18,21,24,27-nonaoxaocacos-1-yl ester

Common Name: Benzonatinate

Structural Formula:

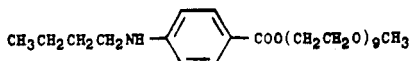

Chemical Abstracts Registry No.: 104-31-4

Trade Name	Manufacturer	Country	Year Introduced
Tessalon	Endo (Du Pont)	U.S.	1958
Ventusasin	Warren Teed	U.S.	1964
Tessalon	Ciba Geigy	Switz.	—

Raw Materials

p-Butylaminobenzoic Acid Ethyl Ester
 Nonaethylene Glycol Monomethyl Ether

Manufacturing Process

4.42 parts of para-butylamino-benzoic acid ethyl ester are put with 16.0 parts of a mixture of polyethylene glycol monomethyl ethers, boiling at 180°-220°C at a pressure of 0.01 mm of mercury, in a closed reaction vessel which is fitted with an adjustable inlet tube for solvents and a connection for distilling off in vacuo. In order to dry the mixture completely, it is heated for an hour at 100°-105°C and absolute xylene is introduced under the surface of the mixture in vacuo at a pressure of 12 mm of mercury. There is thus a constant stream of xylene steam passing through the whole apparatus, which removes the last traces of moisture and any other volatile impurities. The xylene is condensed in a cooler. The whole is cooled to 20°-30°C and 0.06 part of sodium methylate dissolved in 0.6 part of methanol is added.

Thereupon xylene is introduced again in vacuo at a temperature of 100°-105°C whereby all the methanol and the ethanol formed during re-esterification evaporates. The re-esterification is continued under these conditions until a specimen of the reaction mass is clearly soluble in cold water, which occurs after about 2-3 hours. There is now obtained in almost quantitative yield the ester of the formula

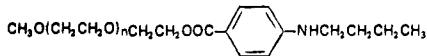

wherein n stands for approximately 7 to 9, which still contains an excess of polyethylene glycol monomethyl ether. The ester is purified by dissolving in benzene and being washed several times with a sodium carbonate solution of 5% strength. It is advantageous to agitate all the washing solutions with fresh benzene. In this distribution between benzene and sodium carbonate solution the new ester remains in the benzene, the excess polyethylene glycol monomethyl ether and a small amount of brown impurities are taken up by the dilute soda solution. By evaporating the dried and filtered benzene solution there is obtained the new ester in the form of a colorless to very faintly yellow oil which is easily soluble in most organic solvents with the exception of aliphatic hydrocarbons. The new ester is precipitated from aqueous solutions when heated to about 42°C, but it dissolves again readily on cooling.

References

Merck Index 1099

Kleeman & Engel p. 89

PDR p. 862

I.N. p. 130

REM p. 870

Matter, M.; U.S. Patent 2,714,608; August 2, 1955; assigned to Ciba Pharmaceutical Products, Inc.

BENZPHETAMINE HYDROCHLORIDE

Therapeutic Function: Antiobesity

Chemical Name: N- α -dimethyl-N-(phenylmethyl)benzeneethanamine hydrochloride

Common Name: —

Structural Formula:

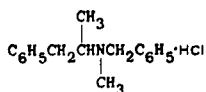

Chemical Abstracts Registry No.: 5411-22-3; 156-08-1 (Base)

Trade Name	Manufacturer	Country	Year Introduced
Didrex	Upjohn	U.S.	1960
Inapetyl	Upjohn	France	1969
Didrex	Upjohn	U.K.	—

Raw Materials

d-Desoxyephedrine Hydrochloride	Sodium Hydroxide
Benzyl Chloride	Hydrogen Chloride

Manufacturing Process

Fifty grams of d-desoxyephedrine hydrochloride was dissolved in a small amount of water and a molar excess of sodium hydroxide was added thereto. The resulting forty grams of precipitated oily d-desoxyephedrine was collected in ether and the whole was thereafter dried with anhydrous potassium carbonate. The ether was then removed, the resulting oily residue having an n_D^{22} of 1.5045 was stirred in a flask with 40 grams of anhydrous sodium carbonate at 120°C, and 34.6 grams of benzyl chloride was added dropwise thereto over a period of thirty minutes. Stirring was continued for 2 hours, whereafter the reaction mixture was extracted with benzene.

The benzene was distilled from the extract and the residue of d-N-methyl-N-benzyl- β -phenylisopropylamine was distilled at reduced pressure. The thus obtained free base, distilling at 127°C at a pressure of 0.2 mm of mercury and having an n_D^{19} of 1.5515, was dissolved in ethyl acetate and a molar equivalent of ethanolic hydrogen chloride was added thereto. Anhydrous ether was added to the mixture and d-N-methyl-N-benzyl- β -phenylisopropylamine hydrochloride precipitated from the reaction mixture as an oil which was crystallized from ethyl acetate to give crystals melting at 129° to 130°C.

References

Merck Index 1122

Kleeman & Engel p. 89

PDR p. 1841

OCDS Vol. 1 p. 70 (1977)

I.N. p. 131

REM p. 891

Heinzelman, R.V. and Aspergren, B.D.; U.S. Patent 2,789,138; April 16, 1957; assigned to The Upjohn Company

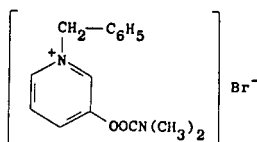
BENZPYRINIUM BROMIDE**Therapeutic Function:** Cholinergic**Chemical Name:** 3-[[Dimethylamino]carbonyl]oxy]-1-(phenylmethyl)-pyridinium bromide**Common Name:** —**Structural Formula:**

Chemical Abstracts Registry No.: 587-46-2

Trade Name	Manufacturer	Country	Year Introduced
Stigmonene	Warner Lambert	U.S.	1949

Raw Materials

Dimethylcarbamylo Chloride
3-Pyridol
Benzyl Bromide

Manufacturing Process

56 grams of dimethylcarbamylo chloride were gradually added over a period of 50 minutes to a solution of 45 grams of 3-pyridol in a mixture of 300 cc of benzene and 69 grams of triethylamine. The reaction mass was then agitated at 80°C for 3 hours and permitted to cool. The triethylamine hydrochloride was removed by filtration and solvents distilled from the filtrate under vacuum in a nitrogen atmosphere. The residual oil was then fractionated under vacuum whereby, after removal of unchanged dimethylcarbamylo chloride, a product distilling at 90°C at 0.3 mm was obtained; this product was the dimethylcarbamylo ester of 3-pyridol.

60 grams of the ester prepared as above described were dissolved in 225 cc of benzene and 92.5 grams of benzyl bromide were added thereto. The solution was stirred at room temperature for 24 hours and refluxed for 3 additional hours. At the end of this time the crude product which formed was separated, washed with benzene and dissolved in water. The aqueous solution was extracted with ether, filtered through charcoal and then evaporated to dryness in a nitrogen atmosphere; traces of water were removed by redissolving the oily residue in absolute alcohol, adding benzene and then evaporating the mixture to dryness under vacuum. The yellow oil thus obtained was then dissolved in a mixture of 300 cc of benzene and 55 cc of absolute alcohol under reflux, the solution cooled, and 340 cc of absolute ether added. The solution was then seeded and maintained at 5°C for two days. The crystalline product obtained was filtered and dried, a product melting between 115°C and 116°C being obtained. This product was the desired 1-benzyl-3-(dimethylcarbamyloxy)-pyridinium bromide.

References

Merck Index 1124

i.N., p. 131

Wuest, H.M.; U.S. Patent 2,489,247; November 22, 1949; assigned to William R. Warner & Co., Inc.

BENZQUINAMIDE

Therapeutic Function: Tranquilizer, antinauseant

Chemical Name: 2-(acetyloxy)-N,N-diethyl-1,3,4,6,7,11b-hexahydro-9,10-dimethoxy-2H-benzo[a]quinolizine-3-carboxamide

Common Name: —

Structural Formula:

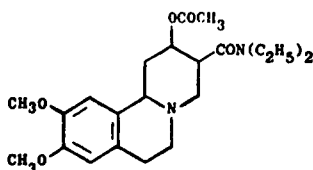

Chemical Abstracts Registry No.: 63-12-7; 30046-34-5 (Hydrochloride)

Trade Name	Manufacturer	Country	Year Introduced
Emete-Con	Roerig	U.S.	1974
Promecon	Endopharm	W. Germany	1983
Quantril	Pfizer	U.S.	—

Raw Materials

2-Oxo-3-carboxy-9,10-dimethoxy-1,2,3,4,6,7-hexahydro-11b-H-benzopyridocoline
 Diethylamine
 Hydrogen
 Hydrogen Chloride

Manufacturing Process

According to U.S. Patent 3,055,894, a solution consisting of 3.4 grams (0.01 mol) of 2-oxo-3-carboethoxy-9,10-dimethoxy-1,2,3,4,6,7-hexahydro-11b-H-benzopyridocoline and 0.8 grams (0.011 mol) of freshly distilled diethylamine dissolved in 50 ml of xylene was refluxed under a nitrogen atmosphere for 24 hours. After cooling to room temperature, the reaction mixture was successively extracted with four 100 ml portions of water. The aqueous phase was then discarded and the xylene layer was passed through a paper filter containing a bed of sodium sulfate and activated charcoal. The resulting filtrate was then heated under reduced pressure (65 mm Hg) via a water bath at 50°C in order to remove the xylene solvent, and the residual oil so obtained was cooled to approximately 5°C and held at that point until a semisolid formed (required approximately 16 hours). Recrystallization of the semisolid from aqueous ethanol in the presence of activated charcoal afforded light yellow crystals of 2-oxo-3-(N,N-diethylcarboxamido)-9,10-dimethoxy-1,2,3,4,6,7-hexahydro-11b-H-benzopyridocoline, MP 150°-152°C.

Then, as described in U.S. Patent 3,053,845, one hundred grams (0.278 mol) of 2-oxo-3-(N,N-diethylcarboxamido)-9,10-dimethoxy-1,2,3,4,6,7-hexahydro-11b-H-benzopyridocoline was dissolved in 1,500 ml of hot methanol and the resulting solution was allowed to cool to room temperature. After removal of all the dissolved oxygen therein by saturation of the solution with dry nitrogen, 5.0 grams of Adams' platinum oxide catalyst was introduced into the system in one portion while still maintaining same under a nitrogen atmosphere.

The reaction flask and its contents were then shaken at room temperature under slightly greater than one atmosphere of hydrogen pressure until the total hydrogen uptake was completed. Dissolved hydrogen gas was then removed from the reaction solution by saturation of same with respect to dry nitrogen, while the platinum black was removed by means of gravity filtration. Concentration of the resulting filtrate under reduced pressure on a steam bath then afforded a nearly quantitative yield of 2-hydroxy-3-(N,N-diethylcarboxamido)-9,10-dimethoxy-1,2,3,4,6,7-hexahydro-11b-H-benzopyridocoline as a yellow crystalline solid (mixture of the axial and equatorial forms).

A mixture consisting of 2 grams of 2-hydroxy-3-(N,N-diethylcarboxamido)-9,10-dimethoxy-1,2,3,4,6,7-hexahydro-11b-H-benzopyridocoline (OH-axial) hydrochloride (prepared by treating the base with hydrogen chloride gas in absolute ether) dissolved in 7 ml of acetic anhydride containing 3 ml of pyridine was heated at 100°C for 2 hours under a nitrogen atmosphere. At the end of this period, a crystalline precipitate had formed and the resultant mixture was subsequently diluted with an equal volume of diethyl ether and filtered.

The crystalline hydrochloride salt so obtained, i.e., the solid material collected on the filter funnel, was then converted to the corresponding free base by distribution in 10 ml of a benzene-aqueous 5% sodium carbonate system. The product recovered from the benzene extracts was then recrystallized from diisopropyl ether to afford 1.46 grams of 2-acetoxy-3-(N,N-diethylcarboxamido)-9,10-dimethoxy-1,2,3,4,6,7-hexahydro-11b-H-benzopyridocoline (CH₃COO-axial), MP 130°-131.5°C.

References

Merck Index 1125

Kleeman & Engel p. 90

PDR p. 1523

OCDS Vol. 1 p. 350 (1977)

DOT 11 (1) 11 (1975); 9 (6) 233 (1973)

I.N. p. 131

REM p. 807

Tretter, J.R.; U.S. Patent 3,053,845; September 11, 1962; assigned to Chas. Pfizer & Co., Inc.

Lombardino, J.G. and McLamore, W.M.; U.S. Patent 3,055,894; September 25, 1962; assigned to Chas. Pfizer & Co., Inc.

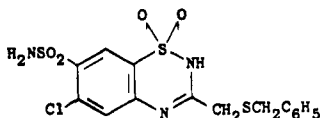
BENZTHIAZIDE**Therapeutic Function:** Diuretic, antihypertensive**Chemical Name:** 6-chloro-3-[[{(phenylmethyl)thio] methyl]-2H-1,2,4-benzothiadiazine-7-sulfonamide 1,1-dioxide**Common Name:** —**Structural Formula:****Chemical Abstracts Registry No.:** 91-33-8

Trade Name	Manufacturer	Country	Year Introduced
Exna	Robins	U.S.	1960
Dytide	SK&F	U.K.	1960
Diteriam	Roussel	France	1962
Aquatag	Tutag	U.S.	1965
Edemex	Savage	U.S.	1970
Lemazide	Lemmon	U.S.	1970
Aquapres	Coastal	U.S.	—
Aquastat	Lemmon	U.S.	—
Aquatag	Reid-Provident	U.S.	—
Decaserpyl	Roussel	France	—
Dihydrex	Astra	Sweden	—
Exosalt	Bayer	W. Germany	—
Fovane	Taito Pfizer	Japan	—
Hydrex	Trimen Labs	U.S.	—
Hy-Drine	Zemmer	U.S.	—
Proaqua	Reid Provident	U.S.	—
Regulon	Yamanouchi	Japan	—
Tensimic	Roussel	France	—
Urese	Pfizer	U.S.	—

Raw Materials

2,4-Disulfamyl-5-chloroaniline

Chloroacetaldehyde

Benzyl mercaptan

Manufacturing Process

The preparation of the dihydro analog is as follows:

(A) *Preparation of 3-Chloromethyl-6-Chloro-7-Sulfamyl-3,4-Dihydro-Benzothiadiazine-1,1-Dioxide*—To 8 ml of 40-50% chloroacetaldehyde aqueous solution and 7 ml of dimethylformamide are added 10 grams of 2,4-disulfamyl-5-chloroaniline. The mixture is heated on a steam bath for 2 hours after which it is concentrated at reduced pressure. The residue is triturated with water. The solid material is recrystallized from methanol-ether after treatment with activated carbon to give 7.2 grams of product, MP 229°-230°C.

(B) *Preparation of Benzylthiomethyl-6-Chloro-7-Sulfamyl-3,4-Dihydrobenzothiadiazine-1,1-Dioxide*—A mixture of 3-(chloromethyl)-6-chloro-7-sulfamyl-3,4-dihydrobenzothiadiazine-1,1-dioxide (0.02 mol) and benzylmercaptan (0.024 mol) in 20 ml of 10% sodium hydroxide and 20 ml of dimethylformamide is stirred at room temperature for 6 hours. After heating for 10 minutes on a steam bath, the mixture is cooled and acidified with 6 N HCl. The product, after recrystallization from acetone, melts at 210°-211°C.

References

Merck Index 1126

Kleeman & Engel p. 90

PDR pp. 1458, 1807

I.N. p. 132

REM p. 938

McLamore, W.M. and Laubach, G.D.; U.S. Patent 3,111,517; November 19, 1963; assigned to Chas. Pfizer & Co., Inc.

BENZTROPINE MESYLATE

Therapeutic Function: Antiparkinsonism

Chemical Name: 3-(Diphenylmethoxy)-8-methyl-8-azabicyclo[3.2.1]octane methanesulfonate

Common Name: Tropine benzohydril ether methanesulfonate, Benztropine methanesulfonate (See also Benzatropine Mesylate)

Structural Formula:

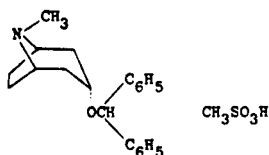

Chemical Abstracts Registry No.: 132-17-2

Trade Name	Manufacturer	Country	Year introduced
Cogentin	Merck Sharp & Dohme	U.S.	1954
Cogentinol	Astra	W. Germany	—
Cogentine	Merrell	France	1966
Cogentin	Merck Banyu	Japan	—
Akitan	Farmos	Finland	—
Bensylate	ICN	Canada	—

Raw Materials

Diphenyldiazomethane
Tropine
Hydrogen Bromide

Sodium Hydroxide
Methane Sulfonic Acid

Manufacturing Process

Diphenyldiazomethane was prepared by shaking 7.9 grams of benzophenone hydrazone and 8.8 grams of yellow mercuric oxide in petroleum ether, filtering and evaporating off the petroleum ether from the filtrate under reduced pressure. To the residual diphenyldiazomethane 2.83 grams of tropine and 4.5 ml of benzene were added. The mixture was warmed in a pan of hot water at about 85°C under reflux for 24 hours after which time the original purple color had been largely discharged. The reaction mixture was dissolved by adding benzene and water containing hydrochloric acid in excess of the quantity theoretically required to form a salt. A rather large amount of water was required since the tropine benzohydril ether hydrochloride was not very soluble and tended to separate as a third phase. The aqueous layer was separated, washed with benzene and with ether and made alkaline with an excess of sodium hydroxide. The resulting insoluble oil was extracted with benzene.

The benzene extracts were dried over potassium carbonate and evaporated under reduced pressure, leaving a residue of 4.1 grams. The residue (tropine benzohydril ether) was dissolved in ether and treated with hydrogen bromide gas until an acidic reaction was obtained. The precipitate soon became crystalline and was collected on a filter and dried. The tropine benzohydril ether hydrobromide weighed 4.1 grams. Recrystallization from absolute ethanol gave 3.3 grams of first crop melting at 247°-248°C (dec.).

Twelve grains of tropine benzohydril ether hydrobromide was converted to the free base by warming with dilute aqueous sodium hydroxide. The oily base was extracted with toluene. The toluene extract was washed with water and then extracted with about 100 ml of water containing 28.1 ml of 1.10 N methanesulfonic acid, (an equimolecular quantity). The toluene solution was extracted twice more with fresh portions of water. The combined water extracts were evaporated under reduced pressure. Residual water was removed by dissolving the residue in absolute ethanol and evaporating under reduced pressure several times. Residual alcohol was then removed by dissolving the residue in acetone and evaporating under reduced pressure several times. The resulting residue was recrystallized by dissolving in acetone and adding ether. The crystalline precipitate was collected on a filter, washed with ether and dried at 56°C in vacuo. The tropine benzohydril ether methanesulfonate weighed 10.2 grams, MP 138°-140°C.

References

Merck Index 1127
Kleeman & Engel p. 86
PDR pp. 1149, 1606
DOT 18 (2) 91 (1982)
I.N. p. 127
REM p. 928
Phillips, R.F.; U.S. Patent 2,595,405; May 6, 1952; assigned to Merck & Co., Inc.

BEPHENIUM HYDROXYNAPHTHOATE

Therapeutic Function: Anthelmintic

Chemical Name: N,N-dimethyl-N-(2-phenoxyethyl)benzenemethanaminium hydroxynaphthoate

Common Name: —

Structural Formula:

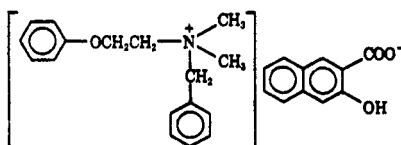

Chemical Abstracts Registry No.: 7181-73-9

Trade Name	Manufacturer	Country	Year Introduced
Alcopar	Wellcome	U.K.	1960
Alcopar	Wellcome	France	1965
Alcopara	Burroughs-Wellcome	U.S.	1967
Alcopar	Wellcome-Tanabe	Japan	—

Raw Materials

Chloro-2-phenoxyethane	Dimethyl Amine
Benzyl Chloride	2-Hydroxy-3-naphthoic acid

Manufacturing Process

First, dimethylamino-2-phenoxyethane was made by reacting chloro-2-phenoxyethane with dimethylamine. Benzyl chloride (10 grams) was then added to a solution of 1-dimethylamino-2-phenoxyethane (12.3 grams) in acetone (35 ml). The mixture warmed spontaneously and N-benzyl-N,N-dimethyl-N-2-phenoxyethylammonium chloride slowly crystallized. After 24 hours, this solid was filtered off, washed with fresh acetone and dried immediately in vacuo, MP 135°-136°C.

2-Hydroxy-3-naphthoic acid (1.88 grams) was dissolved in hot aqueous sodium hydroxide (0.5N; 20 ml) and the resulting solution was slowly added to a solution of N-benzyl-N,N-dimethyl-N-2-phenoxyethylammonium chloride (2.9 grams) in water (5 ml). A gum separated at first but it solidified on scratching. After the addition was complete, the mixture was allowed to stand at room temperature for 2 hours and then filtered. The residue was washed with water and dried in vacuo to give N-benzyl-N,N-dimethyl-N-2-phenoxyethylammonium 2-hydroxy-3-naphthoate, MP 170°-171°C.

References

Merck Index 1159
 Kleeman & Engel p. 93
 DOT 4 (3) 114 (1968)
 I.N. p. 134
 Copp, F.C.; U.S. Patent 2,918,401; December 22, 1959; assigned to Burroughs Wellcome & Co., Inc.

BEPRIDIL**Therapeutic Function:** Antianginal**Chemical Name:** 1-[2-(N-benzylanilino)-3-isobutoxypropyl]pyrrolidine

Common Name: —

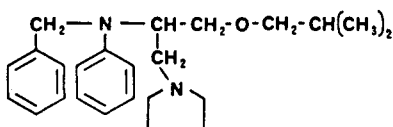
Structural Formula:**Chemical Abstracts Registry No.:** 49571-04-2

Trade Name	Manufacturer	Country	Year Introduced
Cordium	Riom	France	1981
Angopril	Cerm	France	—
Angopril	Riom	France	—

Raw Materials

1-(3-Isobutoxy-2-hydroxy)propyl Pyrrolidine	Sodium Amide
N-Benzylaniline	Thionyl Chloride

Manufacturing Process

The first step involves the preparation of 1-(3-isobutoxy-2-chloro)propyl pyrrolidine as an intermediate. 345 ml of thionyl chloride dissolved in 345 ml of chloroform are added, drop by drop, to 275 g of 1-(3-isobutoxy-2-hydroxy)propyl pyrrolidine dissolved in 350 ml of chloroform, while maintaining the temperature at approximately 45°C. The reaction mixture is heated to reflux until gas is no longer evolved. The chloroform and the excess of thionyl chloride are removed under reduced pressure. The residue is poured on to 400 g of crushed ice. The reaction mixture is rendered alkaline with soda and the resulting mixture is extracted twice with 250 ml of diethyl ether. The combined ethereal extracts are dried over anhydrous sodium sulfate. After evaporation of the solvent the residue is distilled under reduced pressure. 220 g of product are obtained having the following properties: boiling point = 96°C/3 mm, $n_D^{24} = 1.4575$.

The final product is prepared as follows. 23.4 g of sodium amide is added little by little to a solution of 92 g of N-benzylaniline in 500 ml of anhydrous xylene. The reaction mixture is then heated at 130°–135°C for 6 hours.

While maintaining the temperature at 110°C, 110 g of the product of the first step dissolved in 150 ml of xylene is added and the product heated for 6 hours at 120°C.

The product having been allowed to cool to ambient temperature, 200 ml of cold water are added. The organic phase is separated and extracted with an aqueous solution of hydrochloric acid.

After twice washing with 100 ml of diethyl ether, the aqueous phase is made alkaline with 50% caustic soda solution. The liberated base is twice extracted with 150 ml of diethyl ether. After the ether has been evaporated, the residue is distilled under reduced pressure and has a boiling point of 184°C/0.1 mm, $n_D^{20} = 1.5538$. 77 g of the pure base in the form of a viscous liquid is thus obtained. The hydrochloride, which is prepared in conventional manner, has a melting point of 128°C.

References

- Merck Index 1160
 DFU 2 (11) 713 (1977)
 Kleeman & Engel p. 93
 OCDS Vol. 3 p. 46 (1984)
 DOT 18 (9) 422 (1982)
 I.N. p. 135
 Mauvernay, R.Y., Busch, N., Moleyre, J., Monteil, A. and Simond, J.; U.S. Patent 3,962,238; June 8, 1976; assigned to Centre Europeen de Recherches Mauvernay "CERM"

BETAMETHASONE

Therapeutic Function: Glucocorticoid

Chemical Name: 9-fluoro-11 β ,17,21-trihydroxy-16 β -methylpregna-1,4-diene-3,20-dione

Common Name: —

Structural Formula:

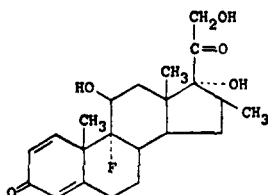

Chemical Abstracts Registry No.: 378-44-9

Trade Name	Manufacturer	Country	Year Introduced
Celestone	Schering	U.S.	1961
Becort	Rachelle	U.S.	—
Betacortil	Pfizer	U.S.	—
Betalone	Firma	Italy	—
Betamamallet	Showa	Japan	—
Betapred	Glaxo	U.K.	—
Betasolon	Pharmax	Italy	—
Betnelan	Glaxo	U.K.	—
Betnesail	Glaxo	U.K.	—
Betnesol	Glaxo	U.K.	—
Celestan	Aesca	Austria	—
Celestene	Cetrane	France	—
Celestone	Essex	Spain	—
Cuantin	I.C.N.	Canada	—
Dermovaleas	Valeas	Italy	—
Desacort-Beta	Caber	Italy	—
Diprosone	Byk-Essex	W. Germany	—
Diprosone	Unilabo	France	—
Diprostene	Centrane	France	—
Hormezone	Tobishi	Japan	—
Linosal	Wakamoto	Japan	—
Minisone	IDI	Italy	—
No-Rheumar	Janus	Italy	—
Pertene Vita	Vita	Italy	—
Rinderon	Shionogi	Japan	—
Sanbetason	Santen	Japan	—
Sclane	Promesa	Spain	—
Unicort	Unipharm	Israel	—
Valisone	Schering	U.S.	—

Raw Materials

Betamethasone Acetate
Hydrogen Chloride

Manufacturing Process

Betamethasone acetate is converted to betamethasone by means of hydrochloric acid in a methanol-chloroform-water mixture as described in U.S. Patent 3,164,618.

References

Merck Index 1196

Kleeman & Engel p. 95

PDR p. 1610

OCDS Vol. 1 p. 198 (1977)

I.N. p. 137

REM p. 962

Amiard, G., Torelli, V. and Céréde, J.; U.S. Patent 3,104,246; September 17, 1963; assigned to Roussel-UCLAF, SA, France

Rausser, R. and Oliveto, E.P.; U.S. Patent 3,164,618; January 5, 1965; assigned to Schering Corporation

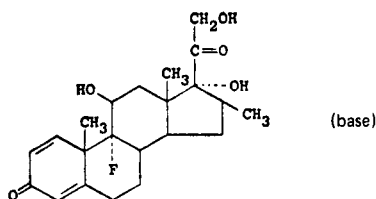
BETAMETHASONE ACETATE**Therapeutic Function:** Glucocorticoid**Chemical Name:** 9-fluoro-11 β ,17,21-trihydroxy-16 β -methylpregna-1,4-diene-3,20-dione-21-acetate**Common Name:** —**Structural Formula:****Chemical Abstracts Registry No.:** 987-24-6

Trade Name	Manufacturer	Country	Year Introduced
Celestone Soluspan	Schering	U.S.	1965
Betafluorene	Lepetit	France	—
Celestone Cronodose	Essex	Italy	—

Raw Materials

17 α ,21-Dihydroxy-16 β -methyl-4,9(11)-pregnadiene-3,20-dione 21 Acetate	
N-Bromosuccinimide	Perchloric Acid
Sodium Methoxide	Acetic Anhydride
Hydrogen Fluoride	Selenium Dioxide

Manufacturing Process

The synthesis is long and complex. For brevity, only the last steps are given here. Refer to the patents cited below for full details.

Preparation of 9 α -Bromo-11 β ,17 α ,21-Trihydroxy-16 β -Methyl-4-Pregnene-3,20-Dione 21-Acetate: To a mixture of 620 mg of 17 α ,21-dihydroxy-16 β -methyl-4,9(11)-pregnadiene-3,20-dione 21-acetate and 330 mg of N-bromosuccinimide in 10 ml of dioxane and 3.2 ml of water cooled to 10°C was added 1.8 ml of cold 1 M aqueous perchloric acid. The mixture was stirred at 15°C for 3 hours. Excess N-bromosuccinimide was destroyed by addition

of aqueous sodium thiosulfate and most of the dioxane was removed in vacuo. About 30 ml of water was added and crystalline bromohydrin, 9 α -bromo-11 β ,17 α ,21-trihydroxy-16 β -methyl-4-pregnene-3,20-dione 21-acetate, was filtered, washed with water, and dried in air.

Preparation of 9 β ,11 β -Epoxy-17 α ,21-Dihydroxy-16 β -Methyl-4-Pregnene-3,20-Dione 21-Acetate: To a stirred solution of 100 mg of the 9 α -bromo-11 β ,17 α ,21-trihydroxy-16 β -methyl-4-pregnene-3,20-dione 21-acetate in 3 ml of tetrahydrofuran and 1 ml of methanol under nitrogen was added 1.02 ml of 0.215 N methanolic sodium methoxide. After 10 minutes at 25°C, 0.2 ml of acetic acid was added and the methanol removed in vacuo. The residue was acetylated with 1.00 ml of pyridine and 0.5 ml of acetic anhydride at 60°C for 70 minutes. The mixture was taken to dryness in vacuo, water added, and the product extracted into chloroform. The residue was crystallized from ether-acetone to give pure 9 β ,11 β -epoxy-17 α ,21-dihydroxy-16 β -methyl-4-pregnene-3,20-dione 21-acetate.

Preparation of 9 α -Fluoro-11 β ,17 α ,21-Trihydroxy-16 β -Methyl-4-Pregnene-3,20-Dione 21-Acetate: To a solution of 200 mg of 9 β ,11 β -epoxy-17 α ,21-dihydroxy-16 β -methyl-4-pregnene 3,20-dione 21-acetate in 2 ml of chloroform and 2 ml of tetrahydrofuran in a polyethylene bottle at -60°C was added 2 ml of a 2:1 (by weight) mixture of anhydrous hydrogen fluoride and tetrahydrofuran. After 4 hours at -10°C the mixture was cooled to -60°C and cautiously added to a stirred mixture of 30 ml or 25% aqueous potassium carbonate and 25 ml of chloroform kept at -5°C. The aqueous phase was further extracted with chloroform and the latter phase washed with water and dried over magnesium sulfate. The residue on crystallization from acetone-ether gave pure 9 α -fluoro-11 β ,17 α ,21-trihydroxy-16 β -methyl-4-pregnene-3,20-dione 21-acetate.

Preparation of 9 α -Fluoro-11 β ,17 α ,21-Trihydroxy-16 β -Methyl-1,4-Pregnadiene-3,20-Dione 21-Acetate: 100 mg of 9 α -fluoro-11 β ,17 α ,21-trihydroxy-16 β -methyl-4-pregnene-3,20-dione 21-acetate was treated with selenium dioxide to produce the corresponding 9 α -fluoro-11 β ,17 α ,21-trihydroxy-16 β -methyl-1,4-pregnadiene-3,20-dione 21-acetate. Alternately, *Bacillus sphaericus* may be utilized.

References

Merck Index 1196

Kleeman & Engel p. 97

PDR p. 1612

I.N. p. 137

REM p. 963

Taub, D., Wendler, N.L. and Slates, H.L.; U.S. Patent 3,053,865; September 11, 1962; assigned to Merck & Co., Inc.

Rausser, R. and Oliveto, E.P.; U.S. Patent 3,164,618; January 5, 1965; assigned to Schering Corporation.

BETAMETHASONE BENZOATE

Therapeutic Function: Glucocorticoid

Chemical Name: 9-Fluoro-11 β ,17,21-trihydroxy-16 β -methylpregna-1,4-diene-3,20-dione-17-benzoate

Common Name: —

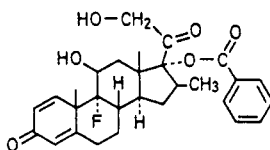
Structural Formula:**Chemical Abstracts Registry No.:** 22298-29-9

Trade Name	Manufacturer	Country	Year Introduced
Benisone	Warner Lambert	U.S.	1973
Fluorobate Gel	Texas Pharm.	U.S.	1973
Beben	Parke Davis	Italy	1974
Uticort Gel	Warner Lambert	U.S.	1977
Benisone	Cooper Vision	U.S.	1979
Bebate	Warner	U.K.	—
Beben	Vister	Italy	—
Dermizol	Roux-Ocefa	Argentina	—
Euvaderm	Sasse	W. Germany	—
Parbetan	Parke Davis	W. Germany	—
Skincort	Parke Davis	W. Germany	—
Uticort	Parke Davis	U.S.	—

Raw Materials

Betamethasone
Methyl Orthobenzoate

Manufacturing Process

A mixture of 50 g of betamethasone, 50 cc of dimethylformamide, 50 cc of methyl orthobenzoate and 1.5 g of p-toluenesulfonic acid is heated for 24 hours on oil bath at 105°C while a slow stream of nitrogen is passed through the mixture and the methanol produced as a by-product of the reaction is distilled off. After addition of 2 cc of pyridine to neutralize the acid catalyst the solvent and the excess of methyl orthobenzoate are almost completely eliminated under vacuum at moderate temperature. The residue is chromatographed on a column of 1,500 g of neutral aluminum oxide. By elution with ether-petroleum ether 30 g of a crystalline mixture are obtained consisting of the epimeric mixture of 17 α ,21-methyl orthobenzoates. This mixture is dissolved without further purification, in 600 cc of methanol and 240 cc of methanol and 240 cc of aqueous 2N oxalic acid are added to the solution. The reaction mixture is heated at 40°-50°C on water bath, then concentrated under vacuum. The residue, crystallized from acetone-ether, gives betamethasone 17-benzoate, MP 225°-231°C.

References

Merck Index 1196
Kleeman & Engel p. 98
PDR p. 1393
DOT 10 (1) 9 (1974)
I.N. p. 137
Ercoli, A. and Gardi, R.; U.S. Patent 3,529,060; September 15, 1970; assigned to Warner-Lambert Pharmaceutical Co.

BETAMETHASONE DIPROPIONATE**Therapeutic Function:** Glucocorticoid

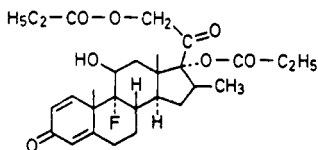
Chemical Name: —**Common Name:** —**Structural Formula:****Chemical Abstracts Registry No.:** 5593-20-4

Trade Name	Manufacturer	Country	Year Introduced
Betnovate	Glaxo	U.K.	1961
Bentelan	Glaxo	Italy	1962
Betnesol	Glaxo	France	1963
Betnesol	Glaxo	W. Germany	1965
Diprosone	Schering	U.S.	1975
Rinderon DP	Shionogi	Japan	1980
Diprolene	Schering	U.S.	1983
Alphatrex	Savage	U.S.	—
Beloderm	Belupo	Yugoslavia	—
Diproderm	Essex Espana	Spain	—
Diproderm	Aesca	Austria	—
Diproderm	Schering	U.S.	—
Diprogenta	Byk-Essex	W. Germany	—
Diprosalic	Unilabo	France	—
Diprosalic	Schering	U.K.	—
Diprostene	Cetrane	France	—
Lortisone	Schering	U.S.	—
Vanceril	Schering	U.S.	—

Raw Materials

9 α -Fluoro-11 β -hydroxy-16 β -methyl-17 α ,21-(1'-ethyl-1'-ethoxymethylenedioxy)pregna-1,4-diene-3,20-dione

Acetic Acid

Propionyl Chloride

Manufacturing Process

A solution of 9 α -fluoro-11 β -hydroxy-16 β -methyl-17 α ,21-(1'-ethyl-1'-ethoxymethylenedioxy)pregna-1,4-diene-3,20-dione (538 mg) in acetic acid (20 ml), containing 2 drops of water, was allowed to stand at room temperature for 5 hours. Dilution of the mixture with water gave a white solid (457 mg) which, after being filtered off and dried, was recrystallized from acetone to afford 9 α -fluoro-11 β ,21-dihydroxy-16 β -methyl-17 α -propionyloxypregna-1,4-diene-3,20-dione (361 mg), MP 230°-235°C.

Bethmethasone 17-propionate (812 mg) in pyridine (10 ml) was treated with propionyl chloride (0.21 ml) at 0°C for 1 hour. Dilution with water and acidification with dilute hydrochloric acid gave the crude diester. Recrystallization from acetone-petroleum ether afforded beta-methasone 17,21-dipropionate (649 mg), MP 117°C (decomposition).

References

Merck Index 1196

Kleeman & Engel p. 99

PDR pp. 888, 1429, 1601, 1614, 1631

I.N. p. 138

Elks, J., May, P.J. and Weir, N.G.; U.S. Patent 3,312,590; April 4, 1967; assigned to Glaxo Laboratories, Ltd.

BETAMETHASONE VALERATE

Therapeutic Function: Corticosteroid

Chemical Name: 9-fluoro-11 β ,17,21-trihydroxy-16 β -methylpregna-1,4-diene-3,20-dione-17-valerate

Common Name: —

Structural Formula:

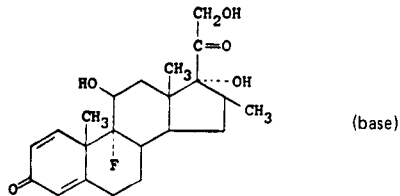

Chemical Abstracts Registry No.: 33755-46-3; 38196-44-0 (Divalerate)

Trade Name	Manufacturer	Country	Year Introduced
Valisone	Schering	U.S.	1967
Beta Dival	Fardeco	Italy	1978
Beta Val	Lemmon	U.S.	1980
Cordel	Taisho	Japan	1981
Betatrex	Savage	U.S.	1983
Betacort	ICN	Canada	—
Betacorten	Trima	Israel	—
Betaderm	K-Line	Canada	—
Betnesol	Glaxo	W. Germany	—
Betnelan	Glaxo	U.K.	—
Betnevate	Daiichi	Japan	—
Celestan	Schering	W. Germany	—
Celestoderm	Cetrane	France	—
Celestoderm	Essex Espana	Spain	—
Dermosol	Iwaki	Japan	—
Dermovaleas	Valeas	Italy	—
Ecoval	Glaxo	Italy	—
Metaderm	Riva	Canada	—
Muhibeta	Nippon Shoji	Japan	—
Novobetamet	Novopharm	Canada	—
Procto-Celestan	Byk-Essex	W. Germany	—
Recto-Betnesol	Glaxo	W. Germany	—
Retenema	Glaxo	U.K.	—
Rinderon	Shionogi	Japan	—
Rolazote	Lando	Argentina	—
Stranoval	Glaxo	Italy	—

Raw Materials

Betamethasone
Methyl Orthovalerate

Manufacturing Process

The valerate is made from betamethasone as a starting material as follows: A suspension of 9 α -fluoro-11 β ,17 α ,21-trihydroxy-16 β -methylpregna-1,4-diene-3,20-dione (betamethasone) (2 grams) in sodium dried benzene (500 ml) was distilled vigorously for a few minutes, toluene-p-sulfonic acid monohydrate (30 mg) and methyl orthovalerate (5 ml) were added and distillation was continued for 10 minutes. The mixture was then boiled under reflux for 1.5 hours after which time unreacted betamethasone alcohol (400 mg) was removed by filtration. The benzene solution was treated with solid sodium bicarbonate and a few drops of pyridine, filtered and evaporated to dryness at about 50°C. The residue, in ether, was filtered through grade III basic alumina (20 grams) to remove traces of unreacted betamethasone alcohol, the ether removed in vacuo and the residue of crude betamethasone 17,21-methyl orthovalerate was treated with acetic acid (20 ml) and a few drops of water and left overnight at room temperature.

The acetic acid solution was poured into water (100 ml) and extracted with chloroform. The chloroform extracts were washed in turn with water, saturated sodium bicarbonate solution and water, dried and evaporated in vacuo. The residual gum was triturated with ether and a white crystalline solid (1.16 grams) isolated by filtration. Recrystallization from ether (containing a small amount of acetone)-petroleum ether gave 9 α -fluoro-11 β ,21-dihydroxy-16 β -methyl-17 α -valeryloxy-pregna-1,4-diene-3,20-dione (871 mg) as fine needles.

References

Merck Index 1196
Kleeman & Engel p. 101
PDR pp. 888, 1034, 1428, 1602, 1658
I.N. p. 138
REM p. 963
Elks, J., May, P.J. and Weir, N.G.; U.S. Patent 3,312,590; April 4, 1967; assigned to Glaxo Laboratories Limited, England

BETAXOLOL HYDROCHLORIDE

Therapeutic Function: β -Adrenergic blocking agent for cardiovascular problems

Chemical Name: 1-[4-[2-(Cyclopropylmethoxy)ethyl]phenoxy]-3-[(1-methylethyl)amino]-2-propanol hydrochloride

Common Name: —

Structural Formula:

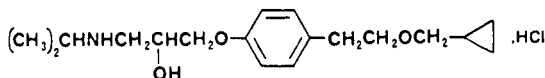

Chemical Abstracts Registry No.: 63659-18-7

Trade Name	Manufacturer	Country	Year Introduced
Kerlone	Carriere	France	1983
Kerlon	Kramer	Switz.	1983

Raw Materials

4-[2-(Cyclopropylmethoxy)ethyl] phenol
Sodium Hydroxide
Hydrogen Chloride

Epichlorohydrin
Isopropylamine

Manufacturing Process

(1) 1 g of sodium hydroxide pellets (0.025 mol) is added to a suspension of 3.8 g of 4-[2-(cyclopropylmethoxy)-ethyl]-phenol in 30 ml of water. When the solution becomes homogeneous, 2.3 ml of epichlorohydrin are added and the mixture is stirred for 8 hours. It is then extracted with ether and the extract is washed with water, dried over sodium sulfate and evaporated to dryness. The compound is purified by passing it over a silica column. 2.4 g of 1-[4-[2-(cyclopropylmethoxy)ethyl]-phenoxy]-2,3-epoxy-propane are thus obtained.

(2) 4.9 g of the preceding compound (0.02 mol) are condensed with 25 ml of isopropylamine by contact for 8 hours at ambient temperature and then by heating for 48 hours at the reflux temperature. After evaporation to dryness, the compound obtained is crystallized from petroleum ether. 5 g (yield 80%) of 2-[[4-(2-cyclopropylmethoxy)-ethyl]-phenoxy]-3-isopropylamino-propan-2-ol are thus obtained, melting point 70° to 72°C.

The hydrochloride is prepared by dissolving the base in the minimum amount of acetone and adding a solution of hydrochloric acid in ether until the pH is acid. The hydrochloride which has precipitated is filtered off and is recrystallized twice from acetone, melting point 116°C.

References

Merck Index 1197

DFU 4 (12) 867 (1979)

DOT 18 (10) 552 (1982)

Manoury, P.M.J., Caverio, I.A.G., Majer, H. and Guidicelli, D.P.R.L.; U.S. Patent 4,252,984; February 24, 1981; assigned to Synthelabo

BETAZOLE

Therapeutic Function: Diagnostic aid (gastric secretion)

Chemical Name: 1H-pyrazole-3-ethanamine

Common Name: β -aminoethylpyrazole; ametazole

Structural Formula:

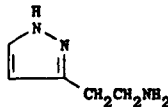

Chemical Abstracts Registry No.: 105-20-4; 138-92-1 (Dihydrochloride)

Trade Name	Manufacturer	Country	Year Introduced
Histalog	Lilly	U.S.	1953
Betazol	Lilly	W. Germany	—
Histimin	Shionogi	Japan	—

Raw Materials

Pyrene

Hydrazine Hydrate
Hydrogen

Manufacturing Process

A solution of 55 grams (1.1 mol) of hydrazine hydrate in 100 ml of methanol was cooled in a water bath and stirred while a solution of 48 grams (0.50 mol) of pure γ -pyrone in 100 ml of methanol was added over a period of about 15 minutes. After the addition was complete, the solution was allowed to stand at room temperature for about 1 hour, and was placed in a 1 liter hydrogenation bomb. 25 ml of liquid ammonia were added cautiously with stirring, followed by about 15 cc of Raney nickel catalyst. The bomb was charged with hydrogen to 1,800 pounds pressure, heated to 90°C and agitated. The quantity of hydrogen required to convert the hydrazone into the desired aminoethylpyrazole was taken up in about 3 hours. The bomb was cooled and opened, and the contents filtered. The filtrate was evaporated under reduced pressure to remove the methanol and the residual liquid was distilled under reduced pressure, whereby there were obtained 44.5 grams (81% yield) of 3- β -aminoethylpyrazole boiling at 118°-123°C at a pressure of 0.5 mm of Hg.

References

Merck Index 1198

Kleeman & Engel p. 102

I.N. p. 139

REM p. 1124

Jones, R.G.; U.S. Patent 2,785,177; March 12, 1957; assigned to Eli Lilly and Company

BETHANECHOL CHLORIDE

Therapeutic Function: Cholinergic

Chemical Name: 2-[(aminocarbonyl)oxy]-N,N,N-trimethyl-1-propanamium chloride

Common Name: Carbamylmethylcholine chloride

Structural Formula:

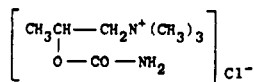

Chemical Abstracts Registry No.: 590-63-3

Trade Name	Manufacturer	Country	Year Introduced
Urecholine Cl	MSD	U.S.	1949
Urecholine Cl	MSD	Switz.	—
Duvoid	Norwich Eaton	U.S.	1978
Besacolin	Eisai	Japan	—
Bethachorol	Nichijiko	Japan	—
Mechothane	Farillon	U.K.	—
Mictone	Kenyon	U.S.	—
Mictrol	Misemer	U.S.	—
Mycholine	Glenwood	U.S.	—
Myo Hermes	Hermes	Spain	—
Myotonachol	Glenwood	U.S.	—
Myotonine	Glenwood	U.K.	—

Trade Name	Manufacturer	Country	Year Introduced
Paracholin	Kanto	Japan	—
Perista	Nissin	Japan	—
Urocarb	Hamilton	Australia	—
Urolax	Century	U.S.	—

Raw Materials

β -Methylcholine Chloride
Phosgene
Ammonia

Manufacturing Process

About 3 grams of β -methylcholine chloride are stirred at room temperature with an excess of phosgene dissolved in 50 grams of chloroform, for about 2 hours. Excess phosgene and hydrochloric acid are removed by distillation under vacuo. Additional chloroform is added to the syrup and the mixture is poured into excess ammonia dissolved in chloroform and cooled in solid carbon dioxide-acetone. The solid is filtered and extracted with hot absolute alcohol. The solid in the alcohol is precipitated with ether, filtered, and recrystallized from isopropanol. The carbaminoyl- β -methylcholine chloride obtained has a melting point of about 220°C.

References

Merck Index 1200
Kleeman & Engel p. 102
PDR pp. 830, 926, 1219, 1276
I.N. p. 139
REM p. 895
Major, R.T. and Bonnett, H.T.; U.S. Patent 2,322,375; June 22, 1943; assigned to Merck & Co., Inc.

BIALAMICOL

Therapeutic Function: Antiamebic

Chemical Name: 3,3'-Bis[(diethylamino)methyl]-5,5'-di-(2-propenyl)-[1,1'-biphenyl]-4,4'-diol

Common Name: Biallylamicol

Structural Formula:

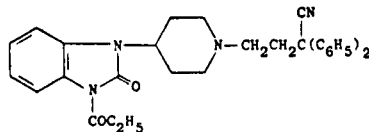

Chemical Abstracts Registry No.: 493-75-4

Trade Name	Manufacturer	Country	Year Introduced
Camoform HCl	Parke Davis	U.S.	1956

Raw Materials

Paraformaldehyde
 Diethylamine
 3,3'-Diallyl-4,4'-biphenol

Manufacturing Process

Paraformaldehyde (7.5 g) (0.25 mol) and 18.3 g (0.25 mol) of diethylamine are mixed in 25 cc of alcohol and warmed until a clear solution is obtained. The solution is cooled and mixed with 26.6 g (0.10 mol) of 3,3'-diallyl-4,4'-biphenol in 25 cc of alcohol. After standing several hours, the solution is warmed for one hour on the steam bath, allowing the alcohol to boil off. The residue is then taken up in ether and water, the ether layer separated and washed with 2% sodium hydroxide solution and finally with water. The washed ether solution is dried over solid potassium carbonate, and filtered. After acidifying with alcoholic hydrogen chloride, the ether is distilled off and the alcoholic residue diluted with an equal volume of acetone. The crystalline hydrochloride is filtered off, triturated with alcohol, diluted with several volumes of acetone, filtered and dried; MP 209°-210°C.

References

Merck Index 1209

I.N. p. 141

Rawlins, A.L., Holcomb, W.F., Jones, E.M., Tendick, F.H. and Burckhalter, J.H.; U.S. Patent 2,459,338; January 18, 1949; assigned to Parke, Davis & Co.

BIETASERPINE

Therapeutic Function: Antihypertensive

Chemical Name: 1-[2-(Diethylamino)ethyl]-11,17-dimethoxy-18-[(3,4,5-trimethoxybenzoyl)oxy] yohimban-16-carboxylic acid methyl ester

Common Name: 1-[2-(Diethylamino)ethyl] reserpine

Structural Formula:

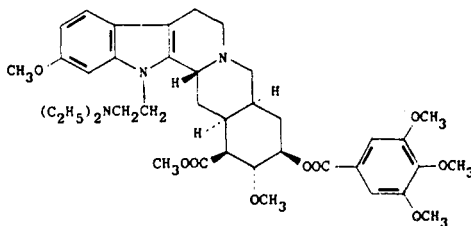

Chemical Abstracts Registry No: 53-18-9

Trade Name	Manufacturer	Country	Year Introduced
Tensibar	Le Franco	France	1967
Pleiatensin	Guidotti	Italy	—
Pleiatensin	Byla	France	—

Raw Materials

Naphthalene	Sodium
Diethylaminochloroethane	Reserpine

Manufacturing Process

The first stage is to prepare the naphthyl sodium solution in the following way:

To a solution of 0.6 g naphthalene in 10 ml tetrahydrofurane, anhydrous, used as solvent, add 96 mg sodium under a nitrogen atmosphere. After a few minutes, an intensive dark green coloration develops, while the sodium dissolves. The reaction is completed after a period of time ranging between 30 and 60 minutes.

Then add to the above solution a solution of 2.42 g reserpine in 60 ml anhydrous dioxan at 50°C.

After heating for 15 minutes (which corresponds to carrying out reaction a), add 0.6 g, diethylaminochloroethane, while the mixture is kept boiling under reflux, for 6 hours. Reaction b is then completed.

Then cool the mixture and evaporate the dioxan under reduced pressure. The pasty residue is dissolved in a mixture of 50 ml benzene and 20 ml ether, and washed several times with water.

The aqueous solutions resulting from the washing are also extracted with ether, and the ether portions are added to the main ether-benzene solution.

This solution is extracted several times with 5% acetic acid, until the silico-tungstate test (an identification test for alkaloids) yields a negative result, and the acetic solutions are washed with 10 ml ether.

After combining the acetic extracts, the solution is adjusted to a pH of 9 with sodium carbonate, which precipitates the base, which is insoluble in water.

The oily suspension obtained in this way is extracted several times with chloroform. The chloroform solutions are then washed, each with 10 ml water, then they are combined and dried over anhydrous potassium carbonate.

After filtering and evaporating the solvent under reduced pressure, the pasty residue, constituted by the enriched product, is diluted with 30 ml ether and in this way 0.225 g reserpine (which has not taken part in the reaction) is isolated by filtration.

After evaporation of the ether under reduced pressure, 1.525 g of the crude resinous base is obtained, which constitutes the required product in a crude and impure condition.

This product is purified in the following way: After dissolving in 15 ml of dry benzene, the resulting solution is filtered on an alumina column, which fixes the base.

After consecutive elutions with pure benzene, and benzene containing increasing proportions of chloroform, 0.748 g of 1-diethylaminoethyl-reserpine is isolated in the form of a resin. The crystalline acid bitartrate prepared in ethyl acetate melts at 145°-150°C, with decomposition.

References

Merck Index 1217

Kleeman & Engel p. 105

I.N. p. 142

Societe Nogentaise De Produits Chimiques and Buzas, A.; British Patent 894,866; April 26, 1962

BIFONAZOLE

Therapeutic Function: Antifungal

Chemical Name: 1-[(1,1'-Biphenyl)-4-ylphenylmethyl]-1H-imidazole

Common Name: (Biphenyl-4-yl)-imidazol-1-yl-phenylmethane

Structural Formula:

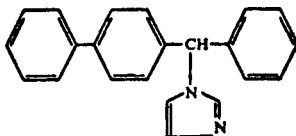

Chemical Abstracts Registry No.: —

Trade Name	Manufacturer	Country	Year Introduced
Mycospor	Bayer	W. Germany	1983

Raw Materials

4-Phenylbenzophenone	Sodium Borohydride
Imidazole	Thionyl Chloride

Manufacturing Process

38.8 g (0.15 mol) of 4-phenylbenzophenone are dissolved in 200 ml of ethanol and 3 g (0.075 mol) of sodium borohydride are added. After heating for 15 hours under reflux, and allowing to cool, the reaction mixture is hydrolyzed with water containing a little hydrochloric acid. The solid thereby produced is purified by recrystallization from ethanol. 36 g (89% of theory) of (biphenyl-4-yl)-phenyl-carbinol [alternatively named as diphenyl-phenyl carbinol or α -(biphenyl-4-yl)benzylalcohol] of melting point 72°–73°C are obtained.

13.6 g (0.2 mol) of imidazole are dissolved in 150 ml of acetonitrile and 3.5 ml of thionyl chloride are added at 10°C. 13 g (0.05 mol) of (biphenyl-4-yl)-phenyl-carbinol are added to the solution of thionyl-bis-imidazole thus obtained. After standing for 15 hours at room temperature, the solvent is removed by distillation in vacuo. The residue is taken up in chloroform and the solution is washed with water. The organic phase is collected, dried over sodium sulfate and filtered and the solvent is distilled off in vacuo. The oily residue is dissolved in ethyl acetate and freed from insoluble, resinous constituents by filtration. The solvent is again distilled off in vacuo and the residue is purified by recrystallization from acetonitrile. 8.7 g (56% of theory) of (biphenyl-4-yl)-imidazol-1-yl-phenylmethane [alternatively named as diphenyl-imidazolyl-(1)-phenyl-methane or as 1-(α -biphenyl-4-ylbenzyl)imidazole] of melting point 142°C are obtained.

References

Merck Index A-3

DFU 7 (2) 87 (1982)

DOT 19 (6) 341 (1983)

I.N. p. 142

Regal, E., Draber, W., Buchel, K.H. and Plempel, M.; U.S. Patent 4,118,487; October 3, 1978; assigned to Bayer A.G.

BIPERIDEN

Therapeutic Function: Antiparkinsonism

Chemical Name: α -bicyclo[2.2.1]hept-5-en-2-yl- α -phenyl-1-piperidinepropanol

Common Name: —

Structural Formula:

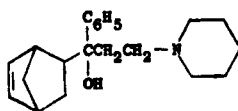

Chemical Abstracts Registry No.: 514-65-8; 1235-82-1 (Hydrochloride)

Trade Name	Manufacturer	Country	Year Introduced
Akineton HCl	Knoll	U.S.	1959
Akineton HCl	Knoll	W. Germany	—
Akineton HCl	Knoll	Switz.	—
Akinophyl	Biosedra	France	1970
Akineton	Abbott	U.K.	—
Akineton	Dainippon	Japan	—
Akineton	Medinsa	Spain	—
Dekinet	Rafa	Israel	—
Ipsatol	Orion	Finland	—
Paraden	Yurtoglu	Turkey	—
Tasmolin	Yoshitomi	Japan	—

Raw Materials

Acetophenone	Piperidine HCl
5-Chloro-2-norbornene	Magnesium
Hydrogen Chloride	Formaldehyde

Manufacturing Process

65 grams of 3-piperidino-1-phenyl propanone-1 of the summary formula $C_{14}H_{29}ON$, produced according to Mannich's reaction by reacting acetophenone with formaldehyde and piperidine hydrochloride are dissolved in 300 cc of benzene. The resulting solution is added to an organo-magnesium solution prepared from 96 grams of [Δ^5 -bicyclo-(2,2,1)-heptenyl-2]-chloride (also known as 5-chloro-2-norbornene) 18.5 grams of magnesium shavings, and 300 cc of ether.

The reaction mixture is boiled for half an hour under reflux. Thereafter the ether is removed by distillation, until the inside temperature reaches 65° - $70^{\circ}C$. The resulting benzene solution is added to 95 cc concentrated hydrochloric acid containing ice for further processing. Thereby, 3-piperidino-1-phenyl-1- [Δ^5 -bicyclo-(2,2,1)-heptenyl-2]-propanol-1 of the summary formula $C_{21}H_{29}ON$ is obtained. The compound melts at $101^{\circ}C$ and its chlorohydrate has a melting point of about $238^{\circ}C$. The compound is difficultly soluble in water, slightly soluble in ethanol, and readily soluble in methanol.

References

- Merck Index 1231
 Kleeman & Engel p. 107
 PDR p. 975
 OCDS Vol. 1 p. 47 (1977)
 DOT 18 (2) 90 (1982)
 I.N. p. 144
 REM pp. 928, 929
 Klavehr, W.; U.S. Patent 2,789,110; April 16, 1957; assigned to Knoll AG Chemische Fabriken, Germany

BISACODYL

Therapeutic Function: Laxative

Chemical Name: 4,4'-(2-pyridylmethylene)bisphenol diacetate

Common Name: —

Structural Formula:

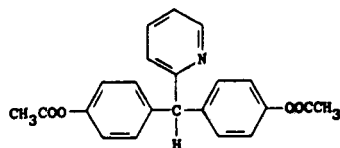

Chemical Abstracts Registry No.: 603-50-9

Trade Name	Manufacturer	Country	Year Introduced
Dulcolax	Boehr. Ingel.	U.S.	1958
Dulcolax	Thomae	W. Germany	—
Dulcolax	Boehr. Ingel.	Switz.	—
Contalax	Riker	France	1959
Bicol	Wampole	U.S.	1974
Biscolax	Fleet	U.S.	1975
Theralax	Beecham	U.S.	1976
Alaxa	Angelini	Italy	—
Anan	Ono	Japan	—
Bisacolax	ICN	Canada	—
Biomit	Sampo	Japan	—
Brocalax	Brocades-Steethman	Neth.	—
Cathalin	Hokoriku	Japan	—
Codilax	Pharbil	Belgium	—
Contalax	Fischer	Israel	—
Darmoletten	Omegin	W. Germany	—
Deficol	Vangard	U.S.	—
Delco-Lax	Delco	U.S.	—
Durolax	Boehr. Ingel.	W. Germany	—
Endokolat	Weiskopf	W. Germany	—
Ercolax	Erco	Denmark	—
Ethanis	Taisho	Japan	—
Eulaxan	Ferring	W. Germany	—
Evac-Q-Kwik	Adria	U.S.	—
Godalax	Pfleger	W. Germany	—
Hillcolax	Hillel	Israel	—
Ivilax	Bieffe	Italy	—
Laco	Paul Maney	Canada	—
Laksodil	Uranium	Turkey	—
Lax	Kanto	Japan	—
Laxadin	Teva	Israel	—
Laxagetten	Tempelhof	W. Germany	—
Laxanin N	Schwarzhaupt	W. Germany	—
Laxbene	Merckle	W. Germany	—
Laxematic	Kemifarma	Denmark	—
Med-Laxan	Med	W. Germany	—
Metalax	Star	Finland	—
Mormalene	Montefarmaco	Italy	—
Neodrast	Werner Schnur	W. Germany	—

Trade Name	Manufacturer	Country	Year Introduced
Neo-Salvilax	Para-Pharma	Switz.	—
Novolax	Krka	Yugoslavia	—
Obstilax	Zirkulin	W. Germany	—
Organolax	Azuchemie	W. Germany	—
Perilax	Nordex	Norway	—
Prontolax	Streuli	Switz.	—
Pyrilax	Berlin-Chemie	E. Germany	—
Rytmil	Vicks	U.S.	—
Sanvacual	Santos	Spain	—
Satolax	Sato	Japan	—
Serax	Hameln	W. Germany	—
Stadalax	Stada	W. Germany	—
Telemin	Funai	Japan	—
Toilax	Erco	Denmark	—
Toilex	Protea	Australia	—
Ulcolax	Ulmer	U.S.	—
Vemas	Nippon Zoki	Japan	—
Vencoll	Maruko	Japan	—
Vinco	OTW	W. Germany	—

Raw Materials

α -Pyridine Aldehyde
Phenol
Acetic Anhydride

Manufacturing Process

Preparation of (4,4'-Dihydroxy-Diphenyl)-(Pyridyl-2)-Methane—

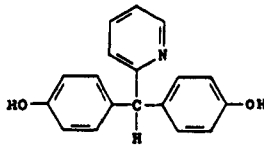

70.0 grams of α -pyridine aldehyde are fed portionwise with stirring and cooling to a mixture of 200 grams of phenol and 100 cc of concentrated sulfuric acid. The reaction mixture is allowed to stand for a while with repeated stirring, whereby it becomes syrupy, neutralized with sodium carbonate, dissolved in methanol and filtered. The filtrate is introduced into a large quantity of water and the resulting precipitate is recrystallized from a methanol/water mixture. Colorless crystals are obtained of MP 254°C. When using zinc chloride or tin tetrachloride and warming to a temperature of about 50°C, a corresponding result is obtained.

Preparation of Bisacodyl: 5 grams of (4,4'-dihydroxy-diphenyl)-(pyridyl-2)-methane are heated with 5 grams of anhydrous sodium acetate and 20 cc of acetic anhydride for three hours over a boiling waterbath. The cooled reaction mixture is poured into water, whereby after a while a colorless substance precipitates, which is filtered off with suction, washed with water and recrystallized from aqueous ethanol. Colorless bright crystals, MP 138°C are obtained.

References

Merck Index 1238
Kleeman & Engel p. 107

PDR pp. 561, 677, 879, 1569

I.N. p. 145

REM p. 800

Kottler, A. and Seeger, E.; U.S. Patent 2,764,590; September 25, 1956; assigned to Dr. Karl Thomae GmbH, Germany

BISMUTH SODIUM TRIGLYCOLLAMATE

Therapeutic Function: Lupus Erythematosus Suppressant

Chemical Name: Nitrilotriacetic acid bismuth complex sodium salt

Common Name: —

Structural Formula:



Chemical Abstracts Registry No.: 5798-43-6

Trade Name	Manufacturer	Country	Year Introduced
Bistrimate	Smith, Miller & Patch	U.S.	1946

Raw Materials

Bismuth Oxide
Triglycollamic Acid
Sodium Carbonate

Manufacturing Process

A mixture of 2.33 g of bismuth oxide (Bi_2O_3), 3.71 g of anhydrous sodium carbonate, and 7.64 g of triglycollamic acid and 40 cc of water was heated at 80°C on the water bath until all was dissolved. The solution was evaporated on the water bath to a syrup. The syrup was allowed to cool, during which time partial solidification occurred. It was then triturated with 300 cc of alcohol, and the solid anhydrous salt was collected on a filter, washed with alcohol, ground fine, and dried in a vacuum desiccator. This substance has a water solubility at 25°C of 31.8% by weight. It decomposes on heating in the melting point bath.

References

Merck Index 1279

I.N. p. 147

Lehman, R.A. and Sproull, R.C.; U.S. Patent 2,348,984; May 16, 1944

BRETYLIUM TOSYLATE

Therapeutic Function: Antiadrenergic; cardiac antiarrhythmic

Chemical Name: 2-Bromo-N-ethyl-N, N-dimethylbenzenemethanaminium 4-methylbenzene sulfonate

Common Name: —

Structural Formula:

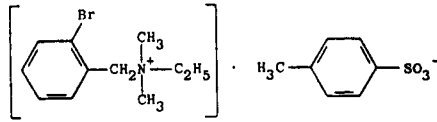

Chemical Abstracts Registry No.: 61-75-6

Trade Name	Manufacturer	Country	Year Introduced
Bretylate	Wellcome	U.K.	1973
Bretylate	Wellcome	France	1974
Bretylol	Am. Crit. Care	U.S.	1978
Critifib	Arnar-Stone	U.S.	—
Darenthin	Burroughs Wellcome	U.S.	—

Raw Materials

N-o-Bromobenzyl-N,N-dimethylamine
Ethyl-p-toluene Sulfonate

Manufacturing Process

N-o-bromobenzyl-N,N-dimethylamine (100 g) and ethyl p-toluenesulfonate (94 g) were mixed and warmed to 50°–60°C; after standing for either (a) a minimum of 96 hours at 15°–20°C or (b) a minimum of 18 hours at 50°–60°C and cooling to room temperature, a hard, crystalline mass was formed. Recrystallization of this product from acetone (2.0 ml/g of crude solid), followed by filtration and drying to 60°C gave N-o-bromobenzyl-N-ethyl-N,N-dimethylammonium p-toluenesulfonate as a white, crystalline solid, MP 97°–99°C. For this procedure it was necessary that the reactants were substantially colorless and of a high purity.

References

- Merck Index 1348
PDR p. 574
OCDS Vol. 1 p. 55 (1977)
DOT 16 (10) 359 (1980)
I.N. p. 152
REM p. 860
Copp, F.C. and Stephenson, D.; U.S. Patent 3,038,004; June 5, 1962; assigned to Burroughs Wellcome & Co.

BROMAZEPAM

Therapeutic Function: Tranquilizer

Chemical Name: 7-bromo-1,3-dihydro-5-(2-pyridinyl)-2H-1,4-benzodiazepin-2-one

Common Name: —

Structural Formula:

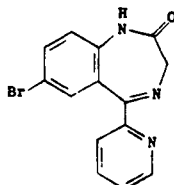

Chemical Abstracts Registry No.: 1812-30-2

Trade Name	Manufacturer	Country	Year Introduced
Lexotan	Roche	Italy	1975
Lexotan	Roche	Japan	1977
Lexotaniil	Roche	W. Germany	1977
Lexotaniil	Roche	Switz.	1977
Lexomil	Roche	France	1981
Lexotan	Roche	U.K.	1982
Compedium	Polifarma	Italy	—
Creosidin	Osiris	Argentina	—
Lectopam	Hoffman-La Roche	U.S.	—
Lenitin	Ikapharm	Israel	—
Lexaurin	Krka	Yugoslavia	—
Lexillum	Alkaloid	Yugoslavia	—
Normoc	Merckle	W. Germany	—

Raw Materials

2-(2-Aminobenzoyl)pyridine	Bromo Acetyl Bromide
Acetic Anhydride	Water
Bromine	Ammonia
Hydrogen Chloride	

Manufacturing Process

Example: 32.8 grams of 2-(2-aminobenzoyl)-pyridine and 200 cc of acetic anhydride were stirred at room temperature for 3 hours and then permitted to stand overnight. Evaporation to dryness and digestion of the residue with 200 cc of water containing a little sodium bicarbonate to make the pH slightly alkaline gave 2-(2-acetamidobenzoyl)-pyridine as a light tan powder, which upon crystallization from methanol formed colorless crystals melting at 151°-153°C.

A solution of 8.6 cc of bromine in 100 cc of acetic acid was added slowly over a 3.5 hour period to a stirred solution of 38.5 grams of 2-(2-acetamidobenzoyl)-pyridine in 250 cc of acetic acid. The dark solution was stirred for another 3 hours, permitted to stand overnight, stirred for 1 hour with N₂ sweeping, and evaporated at diminished pressure in the hood. The gummy residue (75 grams) was treated with water and ether, made alkaline with dilute sodium bicarbonate solution, and separated. Both phases contained undissolved product which was filtered off. Additional crops were obtained by further extraction of the aqueous phase with ether and evaporation of the resulting ether solutions. All these materials were recrystallized from methanol (decolorizing carbon added) yielding 2-(2-acetamido-5-bromobenzoyl)-pyridine as yellow crystals melting at 131.5°-133°C.

20.85 grams of 2-(2-acetamido-5-bromobenzoyl)-pyridine in 250 cc of 20% hydrochloric acid in ethanol were heated to reflux for 2 hours. 100 cc of alcohol were added after one hour to maintain fluidity. The mixture stood overnight, was chilled and filtered to give 20.5 grams of colorless crystalline 2-(2-amino-5-bromobenzoyl)-pyridine hydrochloride. Digestion of this hydrochloride with 0.5 liter hot water hydrolyzed this product to the free base, 2-(2-amino-5-bromobenzoyl)-pyridine which formed yellow crystals, melting at 98°-100°C. Evaporation of the alcoholic mother liquor, water digestion of the residue, and alkalization of the water digests afforded additional crops of 2-(2-amino-5-bromobenzoyl)-pyridine.

0.145 kg of 2-(2-amino-5-bromobenzoyl)-pyridine, was dissolved in 2.0 liters of glacial acetic acid. The resultant solution was placed in a 3 liter, 3-necked, round bottom flask fitted with a stirrer, thermometer and dropping funnel. The system was protected by a drying tube filled with anhydrous calcium chloride. To the solution, with stirring at room temperature, were carefully added 46.7 ml of bromoacetyl bromide. After the addition was

completed, the stirring was continued for two hours. The mixture was then warmed to 40°C, stirred at that temperature for 1.5 hours, chilled and filtered. The residue, after being washed with glacial acetic acid, was dried in vacuo over flake potassium hydroxide to give 2-(2-bromoacetamido-5-bromobenzoyl)-pyridine hydrobromide orange crystals, MP 205°-206°C, dec.

The hydrobromide was hydrolyzed to the free base as follows: 0.119 kg of 2-(2-bromoacetamido-5-bromobenzoyl)-pyridine hydrobromide was stirred with 1.2 liters of cold water for 3.5 hours. The mixture was chilled and filtered, and the residue washed with cold water and dried to give 2-(2-bromoacetamido-5-bromobenzoyl)-pyridine, MP 101°C (sinters), 103°-106°C, dec.

93.0 grams of 2-(2-bromoacetamido-5-bromobenzoyl)-pyridine was carefully added to 0.5 liter of anhydrous ammonia in a 1 liter, 3-necked, round bottom flask equipped with stirrer and reflux condenser and cooled by a Dry Ice-acetone bath. The system was protected from moisture by a drying tube containing anhydrous calcium chloride. After stirring for 2 hours, the cooling bath was removed. The mixture was then stirred for 6 hours, during which time the ammonia gradually boiled off. 0.4 liter of water was added to the solid residue and stirring was resumed for about 2 hours. The solid was then filtered off, washed with water and dried in vacuo over potassium hydroxide flakes. The residue was dissolved on a steam bath in 1.4 liters of ethyl alcohol-acetonitrile (1:1) (decolorizing charcoal added). The solution was filtered hot and the filtrate chilled overnight. The crystalline deposit was filtered off, washed with cold ethyl alcohol and dried in vacuo over flake potassium hydroxide to give 54.2 grams. 7-Bromo-1,3-dihydro-5-(2-pyridyl)-2H-1,4-benzodiazepin-2-one, MP 238°C (sinters), 239°-240.5°, dec. Further processing of the mother liquor yielded additional product.

References

- Merck Index 1357
 Kleeman & Engel p. 110
 DOT 9 (6) 238 (1973) & 11 (1) 31 (1975)
 I.N. p. 154
 REM p. 1064
 Fryer, R.I., Schmidt, R.A. and Sternbach, L.H.; U.S. Patent 3,100,770; August 13, 1963; assigned to Hoffmann-LaRoche Inc.
 Fryer, R.I., Schmidt, R.A. and Sternbach, L.H.; U.S. Patent 3,182,065; May 4, 1965; assigned to Hoffmann-LaRoche Inc.
 Fryer, R.I., Schmidt, R.A. and Sternbach, L.H.; U.S. Patent 3,182,067; May 4, 1965; assigned to Hoffmann-LaRoche Inc.

BROMELAIN

Therapeutic Function: Antiinflammatory

Chemical Name: Complex proteolytic enzyme

Common Name: —

Structural Formula: Complex protein, molecular weight 33,000

Chemical Abstracts Registry No.: 9001-00-7

Trade Name	Manufacturer	Country	Year Introduced
Ananase	Rorer	U.S.	1962
Bromelain	Nadrol	W. Germany	1965

Trade Name	Manufacturer	Country	Year Introduced
Resolvit	Mepha	Switz.	1965
Ananase	Rorer	Italy	1965
Ananase	Rorer	U.K.	1966
Extranase	Rorer	France	1969
Bromelain	Towa Yakuhin	Japan	1981
Ananase	Pharmax	U.K.	—
Ananase	Yamanouchi	Japan	—
Bromelain	Permicutan	W. Germany	—
Dayto Anase	Dayton	U.S.	—
Inflamen	Hokoriku	Japan	—
Mexase	Ciba-Geigy	France	—
Pinase	Dainippon	Japan	—
Proteolis	Benvegna	Italy	—
Resolvit	Mepha	Switz.	—
Rogorin	Saba	Italy	—
Traumanase	Arznei Muller-Rorer	W. Germany	—

Raw Materials

Pineapple Juice
Acetone

Manufacturing Process

According to U.S. Patent 3,002,891, the following describes pilot plant production of bromelain. Stripped pineapple stumps were passed four times through a three roll sugar mill press. In the second and following passes through the press, water was added to the pulp to increase the efficiency of the extraction procedure. The crude juice was screened to remove the coarse particles. Hydrogen sulfide gas was bled into the collected juice to partially saturate it. The pH was adjusted to pH 4.8 and then the juice was centrifuged.

To 50 gallons of juice were added 30 gallons of cold acetone. The precipitate which formed was removed by centrifuging in a Sharples centrifuge. This precipitate was discarded. To the supernatant liquor an additional 35 gallons of acetone was added and the precipitate was collected in a Sharples centrifuge. The wet precipitate was dropped into fresh acetone, mixed well, and then recovered by settling. The paste was then dried in a vacuum oven at a shelf temperature of 110°F. Yield: 8 pounds of enzyme per 100 gallons of juice. Activity: 4,000 MCU/g.

References

Merck Index 1360
Kleeman & Engel p. 112
PDR p. 831
I.N. p. 154
REM p. 1038
Gibian, H. and Bratfisch, G.; U.S. Patent 2,950,227; August 23, 1960; assigned to Schering AG, Germany
Heinicke, R.M.; U.S. Patent 3,002,891; October 3, 1961; assigned to Pineapple Research Institute of Hawaii

BROMHEXINE

Therapeutic Function: Expectorant, mucolytic

Chemical Name: 2-Amino-3,5-dibromo-N-cyclohexyl-N-methyl-benzenemethanamine

Common Name: N-(2-Amino-3,5-dibromobenzyl)-N-methyl-cyclohexylamine

Structural Formula:

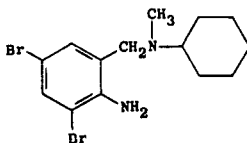

Chemical Abstracts Registry No.: 3572-43-8; 611-75-6 (Hydrochloride)

Trade Name	Manufacturer	Country	Year Introduced
Bisolvon	Boehringer Ingel.	Switz.	1963
Bisolvon	Thomae	W. Germany	1963
Bisolvon	Boehringer Ingel.	Italy	1968
Bisolvon	Boehringer Ingel.	U.K.	1968
Bisolvon	Boehringer Ingel.	France	1969
Lebelon	Towa Yakuhin	Japan	1981
L-Customed	Roha	W. Germany	1982
Aletor	Cantabria	Spain	—
Auxit	Heyden	W. Germany	—
Bendogen	Gea	Denmark	—
Bromeksin	Mulda, Yurtoglu	Turkey	—
Broncokin	Geymonat	Italy	—
Bronkese	Lennon	South Africa	—
Dakryo	Basotherm	W. Germany	—
Fulpen	Sawai	Japan	—
Mucovin	Leiras	Finland	—
Ophthosol	Winzer	W. Germany	—
Solvex	Ikapharm	Israel	—
Viscolyt	Gea	Denmark	—

Raw Materials

2-Nitrobenzyl Bromide	Hydrazine
Cyclohexylmethylamine	Bromine

Manufacturing Process

In initial steps, 2-nitrobenzylbromide and cyclohexylmethylamine are reacted and that initial product reacted with hydrazine to give N-(2-aminobenzyl)-N-methyl-cyclohexylamine.

A solution of 29.3 g of bromine in 50 cc of glacial acetic acid was slowly added dropwise to a solution of 15.9 g of N-(2-aminobenzyl)-N-methyl-cyclohexylamine, accompanied by stirring. The glacial acetic acid was decanted from the precipitate formed during the addition of the bromine solution, and the precipitate was thereafter shaken with 200 cc of 2N sodium hydroxide and 600 cc of chloroform until all of the solids went into solution. The chloroform phase was allowed to separate from the aqueous phase. The chloroform phase was decanted, evaporated to dryness and the residue was dissolved in absolute ether. The resulting solution was found to be a solution of N-(2-amino-3,5-dibromobenzyl)-N-methyl-cyclohexylamine in ethanol. Upon introducing hydrogen chloride into this solution, the hydrochloride of N-(2-amino-3,5-dibromobenzyl)-N-methyl-cyclohexylamine precipitated out. It had a melting point of 232°-235°C (decomposition).

References

Merck Index 1361

Kleeman & Engel p. 113
 OCDS Vol. 2 p. 96 (1980)
 I.N. p. 154

Keck, J.; U.S. Patent 3,336,308; August 15, 1967; assigned to Boehringer Ingelheim G.m.b.H.

BROMOCRIPTINE

Therapeutic Function: Lactation antagonist

Chemical Name: 2-bromo-12'-hydroxy-2'-(1-methylethyl)-5' α -(2-methylpropyl)ergotaman-3',6',18-trione

Common Name: 2-Bromoergocryptine

Structural Formula:

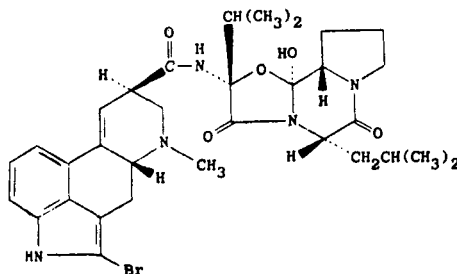

Chemical Abstracts Registry No.: 25614-03-3; 22260-51-1 (Mesylate)

Trade Name	Manufacturer	Country	Year Introduced
Parlodel	Sandoz	U.K.	1975
Pravidel	Sandoz	W. Germany	1977
Parlodel	Sandoz	Switz.	1977
Parlodel	Sandoz	U.S.	1978
Parlodel	Sandoz	France	1978
Parlodel	Sandoz	Japan	1979
Parlodel	Sandoz	Italy	1979
Bromergon	Lek	Yugoslavia	—

Raw Materials

N-Bromosuccinimide
 Ergocryptine

Manufacturing Process

A solution of 3.4 grams of N-bromosuccinimide in 60 cc of absolute dioxane is added drop wise in the dark, during the course of 5 minutes, to a stirred solution, heated to 60°C, of 9.2 grams of ergocryptine in 180 cc of absolute dioxane. The reaction mixture is stirred at this temperature for 70 minutes and is concentrated to a syrup-like consistency in a rotary evaporator at a bath temperature of 50°C. The reaction mixture is subsequently diluted with 300 cc of methylene chloride, is covered with a layer of about 200 cc of a 2 N sodium carbonate solution in a separating funnel and is shaken thoroughly. The aqueous phase is extracted thrice with 100 cc amounts of methylene chloride. The combined

organic phases are washed once with 50 cc of water, are dried over sodium sulfate and the solvent is removed under a vacuum.

The resulting brown foam is chromatographed on a 50-fold quantity of aluminum oxide of activity II-III with 0.2% ethanol in methylene chloride as eluant, whereby the compound indicated in the heading is eluted immediately after a secondary fraction which migrates somewhat more rapidly than the fractions containing the heading compound. The last fractions to leave the aluminum oxide contain varying amounts of starting material together with the heading compound, and may be subjected directly, as mixed fractions, to an after-bromination in accordance with the method described above. The fractions containing the pure heading compound are combined and crystallized from methyl ethyl ketone/isopropyl ether. Melting point 215°-218°C (decomp.), $[\alpha]_D^{20}$ -195° (c = 1 in methylene chloride).

References

Merck Index 1386

Kleeman & Engel p. 114

PDR p. 1589

DOT 12 (3) 87 (1976)

I.N. p. 155

REM pp. 929, 955

Fluckiger, E., Troxler, F. and Hofmann, A.; U.S. Patent 3,752,814; August 14, 1973; assigned to Sandoz Ltd., Switzerland

Fluckiger, E., Troxler, F. and Hofmann, A.; U.S. Patent 3,752,888; August 14, 1973; assigned to Sandoz Ltd., Switzerland

BROMOPRIDE

Therapeutic Function: Antiemetic

Chemical Name: 4-Amino-4-bromo-N-[2-(diethylamino)ethyl]-2-methoxybenzamide

Common Name: —

Structural Formula:

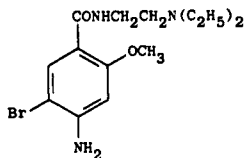

Chemical Abstracts Registry No.: 4093-35-0

Trade Name	Manufacturer	Country	Year Introduced
Praiden	Italchemi	Italy	1977
Valopride	Vita	Italy	1977
Cascapride	Cascan	W. Germany	1978
Artomey	Syncro	Argentina	—
Emepride	Roche	Switz.	—
Emoril	Roemmers	Argentina	—
Opridan	Locatelli	Italy	—
Plesium	Chiesi	Italy	—
Viaben	Schurholz	W. Germany	—

Raw Materials

Bromine
4-Aminosalicylic Acid
Dimethyl Sulfate

Acetic Anhydride
Methanol

Manufacturing Process

To 119 g (0.45 mol) of N-(2-diethylaminoethyl)-2-methoxy-4-aminobenzamide dissolved in 200 cc of acetic acid are added in the cold in small portions 69 g of acetic anhydride (0.45 mol + 50% excess). The starting material is made by esterifying 4-aminosalicylic acid with methanol, then acetylating with acetic anhydride and then methylating with dimethyl sulfate. The solution obtained is heated for 2 hours on a water bath and then boiled for 15 minutes. It is cooled at 25°C. While agitating constantly and maintaining the temperature between 25° and 30°C, there is added to the solution drop by drop 72 g of bromine dissolved in 60 cc of acetic acid. It is agitated for one hour. The mixture obtained is added to one liter of water and the base is precipitated by the addition of 30% soda. The precipitated base is extracted with 40 cc of methylene chloride. After evaporation of the solvent, the residue is boiled for two hours with 390 g of concentrated hydrochloric acid in 780 cc of water. It is cooled, diluted with one liter of water, 12 g of charcoal are added, and the mixture filtered. The base is precipitated with 30% soda. The N-(2-diethylaminoethyl)-2-methoxy-4-amino-5-bromobenzamide formed crystallizes, is centrifuged and washed with water. A yield of 85 g of base having a melting point of 129°-130°C is obtained.

To produce the dihydrochloride, the free base is dissolved in 110 cc of absolute alcohol, 9.6 g of dry hydrochloric acid dissolved in 35 cc of alcohol are added, followed by 2.8 cc of water. The dihydrochloride precipitates, is centrifuged, washed, and dried at 40°C. It was a solid white material having a melting point of 134°-135°C.

References

Merck Index 1404

Kleeman & Engel p. 115

DOT 14 (5) 193 (1978)

I.N. p. 156

Thominet, M.L.; U.S. Patents 3,177,252; April 6, 1965; 3,219,528; November 23, 1965; 3,357,978; December 12, 1967; all assigned to Societe d'Etudes Scientifiques et Industrielles de l'Île-de-France

BROMPHENIRAMINE MALEATE

Therapeutic Function: Antihistaminic

Chemical Name: (4-bromophenyl)-N,N-dimethyl-2-pyridinepropanamine maleate

Common Name: Parabromdylamine

Structural Formula:

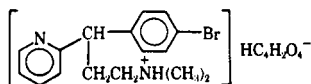

Chemical Abstracts Registry No.: 980-71-2; 86-22-6 (Base)

Trade Name	Manufacturer	Country	Year Introduced
Dimetane	Robins	U.S.	1957
Dimegan	Dexo	France	1962
Symptom 3	WL/PD	U.S.	1977
Brombay	Bay	U.S.	1983
Antial	Ellem	Italy	—
Atronist	Adams	U.S.	—
Bromfed	Muro	U.S.	—
Bromphen	Schein	U.S.	—
Bromrun	Hokuriku	Japan	—
Dimetapp	Scheurich	W. Germany	—
Dimotane	Robins	U.K.	—
Drauxin	Francia	Italy	—
Dura-Tap	Dura	U.S.	—
Ebalin	Allergo Pharma	W. Germany	—
E.N.T. Syrup	Springbok	U.S.	—
Febrica	Dexo	France	—
Gammistin	IBP	Italy	—
Ilvico	Bracco	Italy	—
Ilvin	Merck	W. Germany	—
Martigene	Martinet	France	—
Nagemid Chronule	Ortscheit	W. Germany	—
Poly Histine	Bock	U.S.	—
Probahist	Legere	U.S.	—
Rupton	Dexo	France	—
Velzane	Lannett	U.S.	—

Raw Materials

Sulfuric Acid	4-Bromobenzyl Cyanide
Sodium Amide	2-Chloropyridine
Dimethylaminoethyl Chloride	Maleic Acid

Manufacturing Process

Initially, 4-bromobenzyl-cyanide is reacted with sodium amide and 2-chloropyridine to give bromophenyl-pyridyl acetonitrile. This is then reacted with sodium amide then dimethyl amino ethyl chloride to give 4-bromophenyl-dimethylaminoethyl-pyridyl acetonitrile. This intermediate is then hydrolyzed and decarboxylated to bromphenirame using 80% H₂SO₄ at 140°-150°C for 24 hours. The brompheniramine maleate may be made by reaction with maleic acid in ethanol followed by recrystallization from pentanol.

References

- Merck Index 1417
 Kleeman & Engel p. 116
 PDR pp. 555, 674, 865, 993, 1033, 1268, 1454, 1606, 1735
 OCDS Vol. 1 p. 77 (1977)
 I.N. p. 157
 REM p. 1126
 Sperber, N., Papa, D. and Schwenk, E.; U.S. Patent 2,567,245; September 11, 1951; assigned to Schering Corporation
 Sperber, N., Papa, D. and Schwenk, E.; U.S. Patent 2,676,964; April 27, 1954; assigned to Schering Corporation

BRONOPOL

Therapeutic Function: Antiseptic

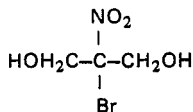
Chemical Name: 2-Bromo-2-nitropropane-1,3-diol**Common Name:** —**Structural Formula:****Chemical Abstracts Registry No.:** 52-51-7

Trade Name	Manufacturer	Country	Year Introduced
Bronosol	Green Cross	Japan	1977
Bronopol	Boots	U.K.	—

Raw Materials

Nitromethane
Formaldehyde
Bromine

Manufacturing Process

A mixture of 441 g (3 mols) of calcium chloride dihydrate, 61 g (1 mol) of nitromethane, 163 g (2 mols) of formalin (37% formaldehyde solution) and 470 ml of water was cooled to 0°C and mixed with 5 g of calcium hydroxide while stirring. The temperature thereby rose to 30°C. As soon as the temperature had fallen again, a further 32 g of calcium hydroxide (total of 0.5 mol) were added. The mixture was then cooled to 0°C and with intensive cooling and stirring, 159.8 g (1 mol, 51 ml) of bromine were dropped in at a rate so that the temperature remained at around 0°C. After the addition was ended, the mixture was stirred for a further 2 hours, when the reaction product separated in crystalline form. The product was quickly filtered on a suction filter and the crystalline sludge obtained was taken up in 450 ml of ethylene chloride and dissolved at reflux. Then by addition of magnesium sulfate, undissolved inorganic salts were separated and the solution was slowly cooled whereby 140 g (70% yield) of 2-bromo-2-nitropropane-1,3-diol precipitated in colorless crystals melting at 123°-124°C.

References

Merck Index 1421

I.N. p. 158

Wessendorf, R.; U.S. Patents 3,658,921; April 25, 1972; and 3,711,561; January 16, 1973; both assigned to Henkel & Cie G.m.b.H.

BROTIZOLAM**Therapeutic Function:** Psychotropic agent**Chemical Name:** 8-Bromo-6-(o-chlorophenyl)-1-methyl-4H-s-triazolo-[3,4c]-thieno-[2,3e]-1,4-diazepine**Common Name:** —

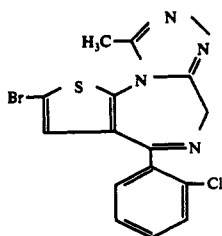
Structural Formula:

Chemical Abstracts Registry No.: 57801-81-7

Trade Name	Manufacturer	Country	Year Introduced
Lendormin	Boehringer Ingel.	Switz.	1983
Lendorm	Boehringer Ingel.	Switz.	—

Raw Materials

7-Bromo-5-(o-chlorophenyl)-3H-[2,3e] thieno-1,4-diazepin-2-one
Phosphorus Pentasulfide
Hydrazine Hydrate

Manufacturing Process

(a) 11.5 g of 7-bromo-5-(o-chlorophenyl)-3H-[2,3e]-thieno-1,4-diazepin-2-one (see German Patent 2,221,623), were heated at 55° to 60°C with 100 cc of absolute pyridine and 6.5 g of phosphorus pentasulfide for 4 hours while stirring. The mixture was allowed to cool and was then poured into 100 cc of saturated ice-cold NaCl solution. The precipitate was collected by suction filtration, washed with water, dissolved in 100 cc of methylene chloride, the solution was dried and evaporated, and the residue was treated with a little methylene chloride. After suction filtration, 6 g of brown crystalline 7-bromo-5-(o-chlorophenyl)-3H-[2,3e]-thieno-1,4-diazepine-2-thione, melting point 214°C (decomposition) were obtained.

(b) 6.0 g of this compound were suspended in 100 cc of tetrahydrofuran, and the suspension was stirred at room temperature with 1.2 g of hydrazine hydrate for 20 minutes. After evaporation to about 10 cc, 20 cc of ether were added, and the crystals were collected by suction filtration. Yield: 5.2 g of 7-bromo-5-(o-chlorophenyl)-2-hydrazino-3H-[2,3e]-thieno-1,4-diazepine, melting point about 300°C (decomposition).

(c) 5.2 g of this compound were suspended in 50 cc of orthotriethyl acetate, and the suspension was heated to 80°C. After about 30 minutes a clear solution was first formed from which later colorless crystals separated out. The mixture was allowed to cool, and the crystals were collected by suction filtration and washed with ether. Yield: 5 g of the compound, melting point 211° to 213°C.

References

Merck Index 1423
DFU 4 (2) 85 (1979)
I.N. p. 159

Weber, K.H., Bauer, A., Danneberg, P. and Kunn, F.J.; U.S. Patent 4,094,984; June 13, 1978; assigned to Boehringer Ingelheim GmbH

BUCLOXIC ACID

Therapeutic Function: Antiinflammatory

Chemical Name: 3-chloro-4-cyclohexyl- α -oxo-benzenebutanoic acid

Common Name: 4-(4-cyclohexyl-3-chlorophenyl)-4-oxobutyric acid

Structural Formula:

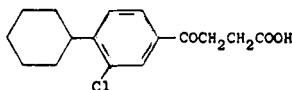

Chemical Abstracts Registry No.: 32808-51-8

Trade Name	Manufacturer	Country	Year Introduced
Esfar	Clin Midy	France	1974

Raw Materials

Phenylcyclohexane
Succinic Acid Anhydride
Chlorine

Manufacturing Process

Phenylcyclohexane and succinic acid (Bernstein Acid) anhydride are reacted in the presence of $AlCl_3$ to give 4-(4'-cyclohexylphenyl)-4-keto-n-butyric acid.

177 grams of anhydrous aluminum chloride are introduced into a 3-necked 1 liter flask. A hot solution of 144 grams of 4-(4'-cyclohexylphenyl)-4-keto-n-butyric acid in 330 ml of methylene chloride is added slowly from a dropping funnel. Slight reflux is observed during this addition. 33.2 ml of liquefied chlorine are then introduced slowly, drop by drop. This addition requires 5 hours. The solution is then poured on to 1 kg of ice containing 100 ml of concentrated hydrochloric acid. The aqueous phase is extracted twice, each time with 200 ml of methylene chloride, the organic phase is washed with water to pH 6.5 and dried and the organic solvent then evaporated. The desired acid is recrystallized from 500 ml of toluene. The yield is 64%. MP: 159°C.

References

Merck Index 1431
Kleeman & Engel p. 118
OCDS Vol. 2 p. 126 (1980)
DOT 10 (11) 294 (1974)
British Patent 1,315,542; May 2, 1973; assigned to Ets Clinbyla, France

BUCUMOLOL HYDROCHLORIDE

Therapeutic Function: Beta adrenergic blocker

Chemical Name: 8-(2-Hydroxy-3-t-butylaminopropoxy)-5-methyl coumarin hydrochloride

Common Name: —

Structural Formula:

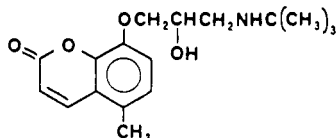

Chemical Abstracts Registry No.: 58409-59-9 (Base)

Trade Name	Manufacturer	Country	Year Introduced
Bucumarol	Sankyo	Japan	1982

Raw Materials

t-Butylamine
8-(2-Hydroxy-3-chloropropoxy)-5-methyl coumarin

Manufacturing Process

A mixture of 3 g of 8-(2-hydroxy-3-chloropropoxy)-5-methyl coumarin, 4.3 g of t-butylamine and 60 ml of ethanol is heated at 100°C in a sealed tube for 15 hours. The reaction mixture is concentrated under reduced pressure to dryness. The residue is recrystallized from a mixture of ethanol and ether to give 2.1 g of the desired product melting at 226° to 228°C (with decomposition).

References

Merck Index 1434

DFU 3 (9) 638 (1978)

DOT 19 (1) 10 (1983)

Sato, Y., Kobayashi, Y., Taragi, H., Kumakura, S., Nakayama, K. and Oshima, T.; U.S. Patent 3,663,570; May 16, 1972; assigned to Sankyo Co., Ltd.

BUDRALAZINE

Therapeutic Function: Antihypertensive

Chemical Name: 1(2H)-Phthalazinone-(1,3-dimethyl-2-butenylidene)-hydrazone

Common Name: Mesityl oxide (1-phthalazinyl) hydrazone

Structural Formula:

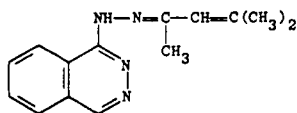

Chemical Abstracts Registry No.: 36798-79-5

Trade Name	Manufacturer	Country	Year Introduced
Buterazine	Daiichi Seiyaku	Japan	1983

Raw Materials

1-Hydrazinophthalazine HCl
Mesityl Oxide

Manufacturing Process

A mixture of 2.0 g of 1-hydrazinophthalazine hydrochloride, 1.1 g of mesityl oxide (isopropylideneacetone) and 100 ml of ethanol, was refluxed for 3 hours. The reaction mixture was concentrated *in vacuo* and the residue was dissolved in water. The water solution was neutral-

ized with sodium bicarbonate, salted out and the product was extracted with benzene. The benzene layer was passed through a comparatively short column of alumina and the solvent was removed. The residue was crystallized from ether to give 0.7 g of 1-(1,3-dimethyl-2-butenylidene) hydrazinophthalazine, melting point 131°-132°C.

References

Merck Index 1437

DFU 2 (12) 788 (1977)

DOT 18 (10) 553 (1982) & 19 (10) 582 (1983)

Ueno, K., Miyazaki, S. and Akashi, A.; U.S. Patent 3,840,539; October 8, 1974; assigned to Daiichi Seiyaku Co., Ltd.

BUFENIODE

Therapeutic Function: Antihypertensive

Chemical Name: 4-hydroxy-3,5-diiodo- α -[1-[(1-methyl-3-phenylpropyl)amino] ethyl] benzyl alcohol

Common Name: Diiodobuphenine

Structural Formula:

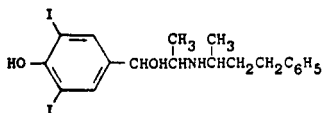

Chemical Abstracts Registry No.: 22103-14-6

Trade Name	Manufacturer	Country	Year Introduced
Proclival	Houde	France	1970
Bufeniod	Weiskopf	W. Germany	1974
Diastai	Bayropharm	Italy	1982

Raw Materials

4-Hydroxypropiophenone	Benzyl Chloride
3-Butyl-1-phenylamine	Bromide
Hydrogen	Iodine

Manufacturing Process

Buphenine is the starting material. See under the alternative name "Nylidrin" in this publication for synthesis.

24 grams of buphenine hydrochloride are suspended in a mixture of 440 ml of 34% ammonia (specific gravity = 0.89) and 315 ml of water. 41 grams of iodine dissolved in 1,080 ml of 96% alcohol are added little by little, with good stirring. During this addition, effected in about 30 min, buphenine hydrochloride dissolves fairly rapidly, and then the diiodobuphenine precipitates out as a crystalline powder. Stirring is continued for a further hour. The precipitate is suction filtered, and then washed with water, with alcohol and with ether and is finally dried in vacuo in the exsiccator in the presence of phosphoric anhydride. Thus, about 23 grams of diiodobuphenine solvated with 1 mol of ethanol are obtained in the form of a microcrystalline white powder. MP (slow) = 185°C (dec.). MP (inst.): 212°C.

References

Merck Index 1440
 Kleeman & Engel p. 119
 DOT 7 (2) 52 (1971) & 11 (8) 306 (1975)
 I.N. p. 161
 South African Patent 680,046; January 3, 1968; assigned to Laboratoires Houde, France

BUFETROL

Therapeutic Function: Antiarrhythmic

Chemical Name: 1-(tert-butylamino)-3-[2-[(tetrahydro-2-furanyl)methoxy]phenoxy]-2-propanol

Common Name: Bufetolol

Structural Formula:

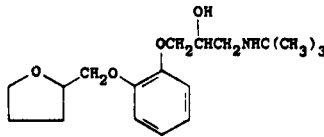

Chemical Abstracts Registry No.: 53684-49-4; 35108-88-4 (Hydrochloride)

Trade Name	Manufacturer	Country	Year Introduced
Adobiol	Yoshitomi	Japan	1974

Raw Materials

2-(2-Tetrahydrofurfuryloxy)phenol
 Epichlorhydrin
 t-Butylamine

Manufacturing Process

The preparation of a similar compound in which a methoxyethoxy group replaces the tetrahydrofurfuryloxy group in Bufetrol is described in the following example. Nine grams of o-(2-methoxyethoxy)phenol is suspended in 50 milliliters of water containing 3.7 grams of potassium hydroxide, and 5.5 grams of epichlorhydrin is added thereto with stirring. The mixture is stirred at room temperature for 7 hours, and then extracted with two 50 milliliter portions of benzene. The extract is washed with water, dried over anhydrous magnesium sulfate and the benzene is distilled off to give 8.5 grams of oily 1-(2,3-epoxypropoxy)-2-(2-methoxyethoxy)benzene showing $n_D^{20} = 1.5257$. This compound has the methoxyethoxy group in place of the 2-tetrahydrofurfuryloxy group in Bufetrol.

To a solution of 1-(2,3-epoxypropoxy)-2-(2-tetrahydrofurfuryloxy)benzene in methanol are added tert-butylamine and water, the mixture is allowed to stand at 25°-30°C for 72 hours, and then the methanol is distilled off. The residue is dissolved in toluene and the solution is extracted twice with 5% oxalic acid. The aqueous extract is dried over potassium carbonate and concentrated to give Bufetrol.

References

Merck Index 1441

Kleeman & Engel p. 119
 DOT 10 (12) 332 (1974)
 I.N. p. 161

Nakanishi, M., Muro, T., Imamura, H. and Yamaguchi, N.; U.S. Patent 3,723,476; March 27, 1973; assigned to Yoshitomi Pharmaceutical Industries, Ltd., Japan

BUFEXAMAC

Therapeutic Function: Antiinflammatory, analgesic, antipyretic

Chemical Name: 4-Butoxy-N-hydroxybenzeneacetamid

Common Name: —

Structural Formula:

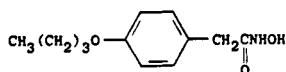

Chemical Abstracts Registry No.: 2438-72-4

Trade Name	Manufacturer	Country	Year Introduced
Parfenac	Lederle	U.K.	1973
Feximac Cream	Nicholas	U.K.	1973
Parfenac	Lederle	France	1974
Parfenac	Cyanamid	Italy	1975
Parfenac	Cyanamid	W. Germany	1976
Parfenac	Opopharma	Switz.	1976
Anderm	Lederle-Takeda	Japan	1977
Droxan	Continental Pharma	Belgium	—
Droxarol	Continental Pharma	W. Germany	—
Flogocid	Continental Pharma	—	—
Malipuram	Scheurich	W. Germany	—
Norfemac	Nordic	Canada	—
Paraderm	Continental Pharma	Belgium	—
Viafen	Zyma	Switz.	—

Raw Materials

p-Hydroxyacetophenone	Butyl Bromide
Sulfur	Morpholine
Sodium Hydroxide	Ethanol
Hydroxylamine HCl	

Manufacturing Process

(1) 136 g of p-hydroxyacetophenone, 140 g of butyl bromide, 152 g of potassium carbonate, 17 g of potassium iodide and 275 cc of ethanol are mixed and then refluxed for 48 hours. The reaction mixture is cooled, diluted with water, then extracted with ether. The ethereal phase is washed with a 10% sodium hydroxide solution, then with water, followed by drying, ether is evaporated and the product distilled under reduced pressure. 168 g of p-butyloxyacetophenone are obtained with yield of 87% (160°–162°C at 11 mm Hg).

(2) 192 g of p-butyloxyacetophenone, 42 g of sulfur and 130 g of morpholine are mixed and then refluxed for 14 hours. The resulting solution is poured into water and stirred until crystallization of the sulfurated complex. The latter is filtered, washed with water and dried. Production: 270 g (88% yield).

(3) 200 g of sodium hydroxide are dissolved in 1,500 cc of ethanol and then 293 g of the thus-obtained sulfurated complex are added. The mixture is refluxed overnight. The mixture is distilled to separate the maximum of the alcohol and then diluted with water. The resulting solution is acidified with hydrochloric acid, and extracted with ether. The ethereal phase is washed with water, followed by extraction with a 10% sodium carbonate solution. The carbonated solution is acidified with 10% hydrochloric acid, and the resulting precipitate of p-n-butyloxyphenylacetic acid is filtered and dried. 100 g of this product are obtained (70% yield).

(4) 208 g of p-n-butyloxyphenylacetic acid, 368 g of ethanol and 18 cc of sulfuric acid are refluxed for 5 hours. The mixture is diluted with water, after which it is extracted with ether. The ethereal phase is successively washed with water, then with carbonate, and again with water, following which it is dried and distilled to remove solvent. The ester is then distilled at a reduced pressure. 200 g of ethyl p-butyloxyphenylacetate are thus obtained with yield of 61% (186°C at 8 mm Hg).

(5) 7 g of hydroxylamine hydrochloride are dissolved in 100 cc of methanol. A solution of 5 g of sodium in 150 cc of methanol is added and the salt precipitate is separated by filtration. 22 g of ethyl p-n-butyloxyphenylacetate are added to the filtrate and the mixture is refluxed for 1 hour. The mixture is cooled and acidified with 20% hydrochloric acid. 14.7 g of p-n-butyloxyphenylacetohydroxamic acid are thus obtained with yield of 71% (melting point: 153°-155°C).

References

Merck Index 1442

Kleeman & Engel p. 120

DOT 12 (11) 435 (1976)

I.N. p. 161

Buu-Hoi, N.P., Lambelin, G., Lepolvre, C., Gillet, C. and Thiriaux, J.; U.S. Patent 3,479,396; November 18, 1969; assigned to Madan A.D.

BUFLOMEDIL

Therapeutic Function: Vasodilator (peripheral)

Chemical Name: 4-(1-Pyrrolidiny)-1-(2,4,6-trimethoxyphenyl)-1-butanone

Common Name: —

Structural Formula:

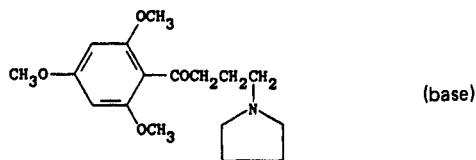

Chemical Abstracts Registry No.: 55837-25-7; 35543-24-9 (Hydrochloride)

Trade Name	Manufacturer	Country	Year Introduced
Fonzylane	Lafon	France	1976
Loftyl	Abbott	Italy	1981
Bufedil	Abbott	W. Germany	1982
Loftyl	Abbott	Switz.	1983

Trade Name	Manufacturer	Country	Year Introduced
Buflan	Pjerrel	Italy	—
Irrodan	Biomedica Foscoma	Italy	—

Raw Materials

4-Chlorobutyronitrile
 Pyrrolidine
 1,3,5-Trimethoxybenzene

Manufacturing Process

Introduce 33.6 g (0.2 mol) of 1,3,5-trimethoxybenzene and 100 ml of chlorobenzene into a 500 ml three-neck flask with stirrer, hydrochloric acid bubbler and condenser. Stir to dissolve and add 27.7 g of 4-pyrrolidinobutyronitrile (from 4-chlorobutyronitrile and pyrrolidine). Cool to about 15°–20°C and bubble hydrochloric acid gas in for 4 hours. Cool to about 5°C and add 200 cm³ of water. Stir. Decant the aqueous layer, wash again with 150 cm³ of water. Combine the aqueous layers, drive off the traces of chlorobenzene by distilling 150 cm³ of water, and heat under reflux for one hour. Cool and render alkaline by means of 60 ml of sodium hydroxide solution of 36° Baume. Extract twice with 100 ml of ether. Wash the ether with 100 ml of water. Dry the ether over sodium sulfate and slowly run in 50 ml of 5N hydrogen chloride solution in ether, at the boil. Cool in ice. Filter, wash with ether and dry in a vacuum oven. 33.6 g of crude product are obtained. Recrystallize from 200 ml of isopropanol in the presence of 3 SA carbon black. Filter. Wash and dry in a vacuum oven.

26.9 g of a white, crystalline water-soluble powder are obtained. Yield: 39.2%. Instantaneous melting point: 192°–193°C.

References

Merck Index 1443
 Kleeman & Engel p. 121
 DOT 11 (9) 339 (1975)
 I.N. p. 161
 Lafon, L; U.S. Patent 3,895,030; July 15, 1975; assigned to Orsymonde

BUFORMIN HCl

Therapeutic Function: Antidiabetic

Chemical Name: N-Butylimidodicarbonimidic diamide

Common Name: Butyldiguanide

Structural Formula:

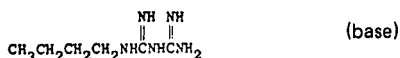

Chemical Abstracts Registry No.: 692-13-7 (Base)

Trade Name	Manufacturer	Country	Year Introduced
Silubin	Protochemie	Switz.	—
Sindiatil	Bayer	Italy	1979
Adebit	Chinoin	Hungary	—

Trade Name	Manufacturer	Country	Year Introduced
Andere	Toyama	Japan	—
Biforon	Meiji	Japan	—
Bigunal	Nikken	Japan	—
Bufonamin	Kaken Drug	Japan	—
Bulbonin	Sankyo	Japan	—
Dibetos	Kodama	Japan	—
Gliporai	Grossmann	Mexico	—
Insulamin	Iwaki	Japan	—
Panformin	Shionogi	Japan	—
Ziavetine	Teikoku Kagaku	Japan	—

Raw Materials

n-Butylamine HCl
Dicyandiamide

Manufacturing Process

105.6 g of n-butylamine hydrochloride and 79.3 g of dicyandiamide were ground intimately and mixed. The mixture was heated by means of an oil bath, gradually with stirring, and after thirty minutes when the internal temperature had reached 150°C, an exothermic reaction ensued with internal pressure rising to 178°C. The reaction mixture was removed from the oil bath until the internal temperature had fallen to 150°C and then heating was resumed at 150°C for one hour. The cooled fusion mixture was dissolved in 3 liters of acetonitrile and on cooling n-butyl-biguanide hydrochloride precipitated.

References

Merck Index 1445

OCDS Vol. 1 p. 221 (1977); 2, 21 (1980)

I.N. p. 162

Shapiro, S.L.; U.S. Patent 2,961,377; November 22, 1960; assigned to U.S. Vitamin & Pharmaceutical Corp.

BUMADIZON

Therapeutic Function: Analgesic, antipyretic, antirheumatic

Chemical Name: butylpropanedioic acid mono-(1,2-diphenylhydrazide)

Common Name: Butylmalonic acid diphenylhydrazide

Structural Formula:

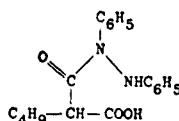

Chemical Abstracts Registry No.: 3583-64-0

Trade Name	Manufacturer	Country	Year Introduced
Eumotol	Byk-Gulden	W. Germany	1972
Eumotol	Iromedica	Switz.	1972

Trade Name	Manufacturer	Country	Year Introduced
Eumotol	Valpan	France	1976
Eumotol	Byk-Gulden	Italy	1976
Dibilan	Byk-Gulden	—	—
Rheumatol	Tosse	W. Germany	—

Raw Materials

Dicyclohexylcarbodiimide
 n-Butyl Malonic Acid Ethyl Ester
 Hydrazobenzene

Manufacturing Process

(a) A solution of 22.4 grams of dicyclohexylcarbodiimide in 120 ml of absolute tetrahydrofuran is added dropwise at 5°-10°C in an atmosphere of nitrogen to a solution of 20 grams of n-butyl malonic acid monoethyl ester and 19.6 grams of freshly recrystallized hydrazobenzene in 320 ml of anhydrous tetrahydrofuran. The mixture is then stirred for 15 hr at 25°C in an atmosphere of nitrogen, then the precipitated dicyclohexyl urea is filtered off and the filtrate, after the addition of 3 drops of glacial acetic acid, is evaporated to dryness in vacuo. The residue is dissolved in 1 liter of ether, the ethereal solution is extracted twice with 2 N potassium bicarbonate solution and twice with 2 N hydrochloric acid, whereupon it is washed with water until the washing water is neutral. The ethereal solution is dried over sodium sulfate and concentrated in vacuo. The residue is fractionally distilled under high vacuum whereupon the ester is obtained as a yellow oil. BP 170°C at 0.05 torr vacuum. Crystals which melt at 63°-65°C are obtained from cyclohexane.

(b) A suspension of 7.1 grams of the ester obtained according to (a) in 40 ml of aqueous 0.5 N sodium hydroxide solution is refluxed for 24 hours in an atmosphere of nitrogen. The solution is filtered and traces of hydrazobenzene are removed by extraction with ether. The aqueous solution is made acid to Congo paper at 10°C with concentrated hydrochloric acid, the oil which separates is dissolved in 40 ml of ethyl acetate, the ethyl acetate solution is isolated, and washed neutral with water. The solution is then extracted twice with 36 ml of 0.5 N sodium bicarbonate solution each time.

The separate extracts are made acid to Congo paper with concentrated HCl, extracted with ethyl acetate, the extracts are washed neutral with a little water, dried and concentrated under vacuum. The colorless oil which remains is recrystallized twice from ether/petroleum ether, whereupon n-butyl malonic acid-N,N'-diphenylhydrazide is obtained in the form of short needles which melt at 116°-118°C.

References

Merck Index 1451
 Kleeman & Engel p. 121
 DOT 9 (1) 14 (1973)
 I.N. p. 162
 Pfister, R., Sallmann, A. and Hammerschmidt, W.; U.S. Patent 3,455,999; July 16, 1969;
 assigned to Geigy Chemical Corporation

BUMETANIDE

Therapeutic Function: Diuretic

Chemical Name: 3-(aminosulfonyl)-5-(butylamino)-4-phenoxybenzoic acid

Common Name: —

Structural Formula:

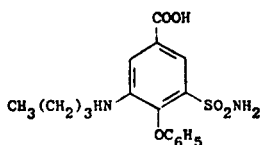

Chemical Abstracts Registry No.: 28395-03-1

Trade Name	Manufacturer	Country	Year Introduced
Burinex	Leo	U.K.	1973
Fordiuran	Thomae	W. Germany	1976
Lunetoron	Sankyo	Japan	1976
Burinex	Sigmatau	Italy	1977
Lixil	Leo	France	1978
Fontego	Polifarma	Italy	1979
Bumex	Hoffmann La Roche	U.S.	1983
Aquazone	Prodes	Spain	—
Butinat	Gerardo Ramon	Argentina	—
Cambiex	Bernabo	Argentina	—
Farmadiuril	Alter	Spain	—
Poliurene	Lepetit	—	—
Primex	Medica	Finland	—
Salurex	Byk Gulden	—	—
Salurin	Yurtoglu	Turkey	—
Segurex	Ricar	Argentina	—
Yurinex	Hemofarm	Yugoslavia	—

Raw Materials

4-Chloro-3-nitro-5 Sulfamyl Benzoic Acid	n-Butanol
Sodium Bicarbonate	Phenol
Hydrogen	

Manufacturing Process

Preparation of 3-Nitro-4-Phenoxy-5-Sulfamylbenzoic Acid: A mixture of 4-chloro-3-nitro-5-sulfamylbenzoic acid (140 grams), phenol (100 grams), sodium hydrogencarbonate (170 grams), and water (1,000 ml) was heated to 85°C while stirring and kept at this temperature for 16 hours. After cooling to 4°C, the precipitated sodium salt of 3-nitro-4-phenoxy-5-sulfamylbenzoic acid was filtered off and washed with ice water. The sodium salt was dissolved in boiling water (3,000 ml), and the 3-nitro-4-phenoxy-5-sulfamylbenzoic acid was precipitated by addition of 4 N hydrochloric acid. After cooling, the acid was isolated by suction and dried. The melting point was 255°-256°C.

Preparation of 3-Amino-4-Phenoxy-5-Sulfamylbenzoic Acid: A suspension of 3-nitro-4-phenoxy-5-sulfamylbenzoic acid (20 grams) in water (100 ml) was adjusted to pH 8 by addition of 1 N lithium hydroxide. The resulting solution was hydrogenated at room temperature and 1.1 atmospheres hydrogen pressure after addition of Pd on carbon catalyst (0.6 grams catalyst containing 10% Pd). After the hydrogen uptake had become negligible, the catalyst was removed by filtration, and the 3-amino-4-phenoxy-5-sulfamylbenzoic acid was precipitated from the filtrate by addition of 4 N hydrochloric acid to pH 2.5. After recrystallization from aqueous ethanol and drying, the melting point was 255°-256°C.

Preparation of 3-n-Butylamino-4-Phenoxy-5-Sulfamylbenzoic Acid: To a suspension of 3-amino-4-phenoxy-5-sulfamylbenzoic acid (10 grams) in n-butanol (200 ml), concentrated sulfuric acid (2 ml) was added while stirring. The reaction mixture was heated under reflux under conditions in which the water formed during the reaction could be removed. When, after dilution with n-butanol, the NMR-spectrum of a sample of the reaction mix-

ture showed at the two doublets of the aromatic protons in ring A that the butyl-3-amino-4-phenoxy-5-sulfamylbenzoate formed as an intermediate was more than 90% converted to the corresponding 3-n-butylaminobenzoate, 2 N sodium hydroxide (200 ml) was added and the boiling was continued for 45 minutes. After the saponification, the reaction mixture was neutralized to pH 8 by addition of concentrated hydrochloric acid.

By cooling, the sodium salt of 3-n-butylamino-4-phenoxy-5-sulfamylbenzoic acid precipitated. It was filtered off and recrystallized from water (100 ml). The sodium salt, crystallizing with 3 molecules of water, was then dissolved in boiling water (200 ml), 1 N hydrochloric acid was added to pH 2.5, and after cooling the precipitated 3-n-butylamino-4-phenoxy-5-sulfamylbenzoic acid was collected by filtration. After recrystallization from aqueous ethanol and drying, the pure compounds were obtained with melting point 230°-231°C.

References

Merck Index 1452

Kleeman & Engel p. 121

PDR p. 1479

OCDS Vol. 2 p. 87 (1980)

DOT 8 (6) 238 (1972) & 9 (11) 449 (1973)

I.N. p. 162

Felt, P.W.; U.S. Patent 3,634,583; January 11, 1972; assigned to Lovens Kemiske Fabrik Produktionsaktieselskab, Denmark

BUNITROLOL

Therapeutic Function: Antianginal

Chemical Name: 2-[3-[(1,1-Dimethylethyl)amino]-2-hydroxypropoxy]-benzonitrile

Common Name: —

Structural Formula:

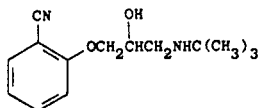

Chemical Abstracts Registry No.: 34915-68-9

Trade Name	Manufacturer	Country	Year Introduced
Stresson	Boehringer Ingel.	W. Germany	1976
Betriol	Boehringer Ingel.	Italy	1981
Betrilol	Boehringer Ingel.	Japan	1983
Betrilol	Tanabe Seiyaku	Japan	1983

Raw Materials

Epichlorohydrin
2-Cyanophenol
t-Butylamine

Manufacturing Process

Epichlorohydrin and 2-cyanophenol are first reacted to give 1-(2-cyanophenoxy)-2,3-epoxypropane.

15 g (0.085 mol) of 1-(2-cyanophenoxy)-2,3-epoxy propane were dissolved in 100 ml of ethanol and 18.6 g (0.255 mol) of t-butylamine were added thereto. After standing for 1 hour at room temperature, the solution was heated at 60°-70°C for 2 hours after which the volatile constituents were distilled off in vacuo. The residue was digested with dilute HCl, and the insoluble constituents were vacuum filtered off. Then the filtrate was made alkaline with NaOH and the precipitating base was taken up in ether. After the ether solution had been dried over MgSO₄, the ether was distilled off and the residue was dissolved in ethanol and by addition of ethereal HCl, the hydrochloride was precipitated therefrom in crystalline form which after recrystallization from ethanol with an addition of ether gave 9.8 g of 1-(2-cyanophenoxy)-2-hydroxy-3-t-butylamino propane hydrochloride having a melting point of 163°-165°C.

References

Merck Index 1457

DFU 1 (5) 210 (1976)

Kleeman & Engel p. 123

OCDS Vol. 2 pp. 106, 110 (1980)

DOT 13 (1) 15 (1977)

I.N. p. 163

Koppe, H., Engelhardt, A. and Zelle, K.; U.S. Patents 3,541,130; November 17, 1970; 3,940,489; February 24, 1976; and 3,961,071; June 1, 1976; all assigned to Boehringer Ingelheim GmbH

BUPIVACAINE

Therapeutic Function: Local anesthetic

Chemical Name: dl-1-butyl-2',6'-pipecoloxylidide

Common Name: —

Structural Formula:

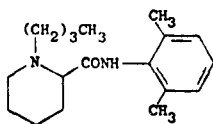

Chemical Abstracts Registry No.: 2180-92-9; 18010-40-7 (Hydrochloride)

Trade Name	Manufacturer	Country	Year Introduced
Carbostesin	Astra	W. Germany	1967
Carbostesin	Globopharm	Switz.	1967
Marcaïn	Duncan Flockhart	U.K.	1968
Marcaïn	Yoshitomi	Japan	1969
Marcaïna	Pierrel	Italy	1971
Marcaïne	Winthrop-Breón	U.S.	1973
Marcaïne	Cook-Waite	U.S.	—
Sensorcaïne	Astra	U.S.	1981
Bupivan	Abbott	U.S.	—
Meaverin	Woelm Pharma	W. Germany	—

Raw Materials

2,6-Dimethylaniline	Diethyl Malonate
Nitrosyl Chloride	Zinc Powder
Formic Acid	n-Butylbromide

Manufacturing Process

121 parts by weight of 2,6-xylylidine are heated with 400 parts of diethylmalonate at 160°C for 1 hour, and the alcohol formed by the reaction is allowed to distill off. Thereafter the reaction mass is cooled to 80°C, and 500 parts of alcohol are added. After cooling the dixylidide is sucked off, and the alcohol solution with malonic ester monoxylylidide is poured into 2,000 parts of water. The monoxylylidide precipitates, is filtered off and washed with water, and recrystallized in diluted alcohol. Nitrosation thereafter takes place by dissolving the dried monoxylylidide in chloroform and by introducing nitrosyl chloride at 0°C until the nitrosation is completed. The isonitrosomalonic ester xylidide is filtered off and dried. Thereafter the reduction takes place with zinc powder and formic acid at 90°-100°C.

The formic acid is distilled off, and the remainder dissolved in warm benzene and washed with a bicarbonate solution to a neutral reaction. After the benzene has been distilled off, the aminomalonic ester xylidide is obtained. This is treated with an equal quantity of sodium ethylate and boiled with twice the theoretical quantity of tetramethylene bromide in absolute alcohol.

After 6 hours of boiling, the sodium bromide formed is separated, and the mixture is steam-distilled in order to remove the excess of tetramethylene bromide. The remaining oil, which mainly consists of delta-bromobutylaminomalonic ester xylidide is separated from the water and boiled with 3 parts of concentrated hydrochloric acid for 3 hours. Thereafter carbon-filtering and evaporation to dryness under vacuum takes place. The residue is dissolved in water, and the pH adjusted with sodium hydroxide to 5.5. The solution is extracted twice with ether, and the water is made strongly alkaline with sodium hydroxide.

The oil precipitates and is crystallized after a time. The crystals are separated and dried under vacuum. The pipercolyl-2,6-xylylidide produced is alkylated by boiling for 10-20 hours with 0.6 part n-butylbromide in an n-butanol solution in the presence of 0.5 part potassium carbonate. The potassium carbonate is filtered off and the butanol is distilled off in vacuum. The residue is dissolved in diluted hydrochloric acid and carbon treated, after which the base is precipitated with sodium hydroxide in the form of white crystals, which are filtered off and washed with water. The base obtained, which consists of N-n-butyl-pipercolyl-2,6-xylylidide is sufficiently pure for the production of salts.

References

Merck Index 1462

Kleeman & Engel p. 124

PDR pp. 596, 825, 1915

OCDS Vol. 1 p. 17 (1977)

DOT 3 (3) 88 (1967)

I.N. p. 164

REM p. 1050

Thuresson, B. and Egnér, B.P.H.; U.S. Patent 2,792,399; May 14, 1957; assigned to AB Bofors, Sweden

Thuresson, B. and Pettersson, B.G.; U.S. Patent 2,955,111; October 4, 1960; assigned to AB Bofors, Sweden

BUPRANOLOL

Therapeutic Function: Antiarrhythmic

Chemical Name: 1-(tert-butylamino)-3-[(6-chloro-m-tolyl)oxy]-2-propanol

Common Name: Bupranol

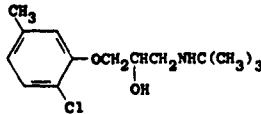
Structural Formula:

Chemical Abstracts Registry No.: 14556-46-8; 15146-80-8 (Hydrochloride)

Trade Name	Manufacturer	Country	Year Introduced
Betadrenol	Pharma-Schwarz	W. Germany	1969
Betadrenol	Adrosanol	Switz.	1969
Betadran	Logeais	France	1972
Looser (Lucer)	Kaken	Japan	1974
Panimit	Nattermann	W. Germany	—
Ophatorenin	Dr. Winzer	W. Germany	—

Raw Materials

Epichlorohydrin
2-Chloro-5-methylphenol
t-Butylamine

Manufacturing Process

A mixture of 16.3 g of (2-chloro-5-methylphenyl)glycidic ether (from epichlorohydrin and 2-chloro-5-methylphenol) and 6.2 g of t-butylamine in 50 ml of ethanol is heated at reflux for 6 hours. The solvent is removed, the residue is washed with water and then extracted with benzene. The dried extract is evaporated to give 1-t-butylamino-3-(2-chloro-5-methylphenoxy)-2-propanol. Treatment of the free base in benzene solution with dry hydrogen chloride yields the hydrochloride salt.

References

Merck Index 1463
Kleeman & Engel p. 125
I.N. p. 164
Kunz, W., Jacobi, H., Koch, C. and Geus, R.J.; U.S. Patent 3,309,406; March 14, 1967

BUSULFAN

Therapeutic Function: Antineoplastic

Chemical Name: 1,4-butanediol dimethanesulfonate

Common Name: —

Structural Formula: $\text{CH}_3\text{SO}_2\text{O}(\text{CH}_2)_4\text{OSO}_2\text{CH}_3$

Chemical Abstracts Registry No.: 55-98-1

Trade Name	Manufacturer	Country	Year Introduced
Myleran	Burroughs Wellcome	U.S.	1954
Misulban	Techni-Pharma	France	1955
Myleran	Wellcome	Switz.	1955
Myleran	Wellcome	W. Germany	1955

Trade Name	Manufacturer	Country	Year Introduced
Mablin	Takeda	Japan	—
Mielucin	Farmasimes	Spain	—
Myeleukon	Arzneimittelwerk Dresden	E. Germany	—
Mylecytan	Spofa	Czechoslovakia	—
Sulfabutin	—	—	—

Raw Materials

1,4-Butanediol
Methane Sulfonyl Chloride

Manufacturing Process

3.6 grams of redistilled 1,4-butanediol were dissolved in 10 ml of pyridine and the solution was cooled in ice and water. 9.6 grams of redistilled methane-sulfonyl-chloride were added dropwise at such a rate that the temperature did not rise above 20°C. The solution was then allowed to stand at room temperature for 30 minutes, during which time the temperature rose to 60°C. A thick precipitate of pyridine hydrochloride was formed.

The mass was cooled in ice water and was treated with 30 ml of ice cold water. On agitation, a white crystalline precipitate was formed. This was filtered off and washed well with ice cold water and allowed to drain on the pump. It weighed 7.8 grams and had a melting point of 100°C. 3.5 grams of the material were recrystallized from acetone and ether to give small white needles, having a melting point of 106°-107°C, unchanged by further recrystallization.

References

Merck Index 1470
Kleeman & Engel p. 125
PDR p. 754
I.N. p. 165
REM p. 1144
Timmis, G.M.; U.S. Patent 2,917,432; December 15, 1959; assigned to Burroughs Wellcome & Co., Inc.

BUTALAMINE HYDROCHLORIDE

Therapeutic Function: Peripheral vasodilator

Chemical Name: N,N-dibutyl-N'-(3-phenyl-1,2,4-oxadiazol-5-yl)-1,2-ethanediamine hydrochloride

Common Name: —

Structural Formula:

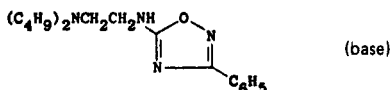

Chemical Abstracts Registry No.: 22131-35-7 (Base); 28875-47-0 (Hydrochloride)

Trade Name	Manufacturer	Country	Year Introduced
Surheme	Aron	France	1969

Trade Name	Manufacturer	Country	Year Introduced
Surheme	Spensa	Italy	1974
Adrevil	Zyma-Blaes	W. Germany	1975
Oxadilene	Lieurquin	France	—
Surem	Cepa	Spain	—

Raw Materials

Benzaldehyde	Hydroxylamine
Chlorine	Cyanamid
Dibutylaminoethyl Chloride	Sodium Amide

Manufacturing Process

Benzaldehyde and hydroxylamine may be reacted, the product chlorinated and then reacted with cyanamid to give 5-amino-3-phenyl-1,2,4-oxadiazole.

32 grams of 3-phenyl-5-amino-1,2,4-oxadiazole dissolved in about 150 ml of anhydrous benzene, 7.8 grams of sodium amide are added and the reaction mixture heated at the boiling point with stirring for 2 hours. A solution of 38.3 grams of dibutylaminoethyl chloride in benzene is then added and the mixture heated to boiling under reflux for four hours. The sodium chloride is separated as previously described, the benzene removed by vacuum distillation and 56 grams of 3-phenyl-5-(dibutylaminoethylamino)-1,2,4-oxadiazole is obtained in the form of an oil which is then converted directly to the crystalline hydrochloride. This is accomplished by dissolving the oil in ethanol and adding the stoichiometric equivalent of anhydrous ethyl ether saturated with gaseous hydrogen chloride. The recrystallized salt is found to have a melting point of 145°C.

References

Merck Index 1477

Kleeman & Engel p. 126

I.N. p. 166

Aron-Samuel, J.M.D. and Sterne, J.J.; U.S. Patent 3,338,899; August 29, 1967

BUTAMIRATE CITRATE

Therapeutic Function: Antitussive

Chemical Name: α -ethylbenzeneacetic acid 2-[2-(diethylamino)ethoxy]ethyl ester citrate

Common Name: Butamirate

Structural Formula:

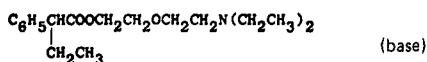

Chemical Abstracts Registry No.: 18109-81-4; 18109-80-3 (Base)

Trade Name	Manufacturer	Country	Year Introduced
Sinecod	Hommel	Switz.	1967
Sinecod	Karlspharma	W. Germany	1967
Sinecod	Bonomelli	Italy	1969
Acodeen	Hommel	Switz.	—
Acodfen	Klimitschek	Austria	—
Codesin-F	Hommel	Switz.	—

Trade Name	Manufacturer	Country	Year Introduced
Intussin	Spofa	Czechoslovakia	—
Sincoden	Hommel	Switz.	—
Sincodix	Beta	Argentina	—
Sinecod	Abello	Spain	—
Pertix-Hommel	Hommel	W. Germany	—

Raw Materials

α -Phenyl Butyric Acid Chloride
 Diethylaminoethoxyethanol
 Citric Acid

Manufacturing Process

18.2 grams of α -phenylbutyric acid chloride are dissolved in 25 ml of toluene. To this solution, there is slowly added a solution of 16.1 grams of diethylaminoethoxyethanol in 25 ml of toluene, the reaction mixture thereby becoming hot. It is then heated for 8 hr under reflux. The reaction mixture, after cooling, is carefully poured onto 75 grams of ice and made alkaline with dilute ammonia. After thorough shaking of the solution, the toluene layer is removed and washed until neutral with water. The toluene solution is treated with carbon and dried over sodium sulfate. The toluene is distilled off from the filtered solution.

The residue is α -phenylbutyric acid diethylaminoethoxyethyl ester. The basic ester is purified by distillation in a high vacuum. 10 grams of ester are added to a solution of 7 grams of citric acid in 30 ml of warm acetone. After standing for some time, the citrate of the ester crystallizes out. After suction filtration and washing with acetone the ester citrate is recrystallized from acetone. The melting point of the citrate is 75°C.

References

Merck Index 1481
 Kleeman & Engel p. 127
 OCDS Vol. 2 p. 76 (1980)
 DOT 9 (7) 280 (1973)
 I.N. p. 166
 Heusser, J.; U.S. Patent 3,349,114; October 24, 1967; assigned to Hommel AG, Switzerland

BUTETHAMINE

Therapeutic Function: Local anesthetic

Chemical Name: 2-[(2-Methylpropyl)amino] ethanol 4-aminobenzoate

Common Name: Ibylcaine

Structural Formula:

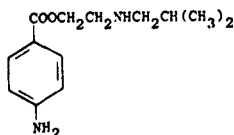

Chemical Abstracts Registry No.: 2090-89-3; 553-68-4 (Hydrochloride)

Trade Name	Manufacturer	Country	Year Introduced
Monocaine	Novocol	U.S.	1941
Dentocaine	Amer. Chem.	U.S.	—

Raw Materials

Isobutylaminoethanol	Tin Metal
p-Nitrobenzoyl Chloride	Hydrochloric Acid

Manufacturing Process

The preparation of the normal butyl analog is as follows:

10 g of isobutylaminoethanol, 16 g of p-nitrobenzoyl chloride and 5 g of sodium hydroxide in 175 cc of water were allowed to react. The temperature was maintained between 30°–40°C during reaction. The reaction mixture was extracted with ether, the ether evaporated, and the resultant oil washed with water to remove any unreacted secondary amino alcohol and then dried. The yield was 21 g or 91% of theory. The compound responded positively when tested for the presence of the amine configuration and also the nitro group. The yellow viscous oil which was formed was isobutylaminoethyl p-nitrobenzoate, 20 g of this latter material was directly reduced with 15 g of tin and 50 cc of concentrated hydrochloric acid. The temperature of the reduction was controlled by addition from time to time of small quantities of cold water to maintain the temperature at or near 70°C. When the reaction was completed 150 cc of sodium hydroxide was added and the solution then cooled to 15°C. The oil which gradually formed combined with undissolved tin to form a pasty mass which soon settled. The supernatant liquid was decanted and the residue washed two or three times with water to remove all traces of alkali. The oily mass, freed from most of its water, was then extracted with ether and filtered. The filtrate was evaporated to dryness and the yield of the base obtained was 13 g or 73.5% of theory. In order to get the melting point of the base, the monohydrochloride was first formed and purified, then the hydrochloride was dissolved in water and just neutralized with ammonia water. The colorless oil formed soon crystallized into a white solid, which after filtration and air drying, had a melting point of 74°–74.5°C. The hydrochloride was made when the oily base was dissolved in propyl alcohol and the calculated quantity of aqueous hydrochloric acid added to form the monohydrochloride of this compound. After repeated recrystallizations, a white needle crystal was formed which had a melting point at 146°C.

References

- Merck Index 1492
 Kleeman & Engel p. 128
 DOT 15 (7) 368 (1979)
 I.N. p. 168
 Goldberg, S.D.; U.S. Patent 2,139,818; December 13, 1938; assigned to Novocol Chemical Mfg. Co., Inc.

BUTHIAZIDE

Therapeutic Function: Diuretic; antihypertensive

Chemical Name: 6-Chloro-3,4-dihydro-3-(2-methylpropyl)-2H-1,2,4-benzothiadiazine-7-sulfonamide-1,1-dioxide

Common Name: Thiabutazide; butizide; isobutylhydrochlorothiazide

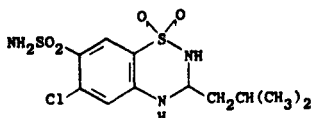
Structural Formula:

Chemical Abstracts Registry No.: 2043-38-1

Trade Name	Manufacturer	Country	Year Introduced
Saltucin	Boehringer Mannheim	W. Germany	1961
Eunephran	Servier	France	—
Intensain	Boehringer-Mannheim	W. Germany	—
Modenol	Boehringer-Mannheim	W. Germany	—
Sembrina	Boehringer-Mannheim	W. Germany	—

Raw Materials

3-Chloraniline	Ammonia
Chlorosulfonic Acid	Isovaleraldehyde

Manufacturing Process

Chlorosulfonic acid and 3-chloroaniline react to give an intermediate which when treated with ammonia yields 5-chloro-2,4-disulfamylaniline.

20 g of 5-chloro-2,4-disulfamylaniline in 15 cc of diethyleneglycol-dimethyl ether with 0.9 g of isovaleraldehyde are reacted in the presence of 0.5 cc of a saturated solution of hydrochloric acid in ethyl acetate at 80°-90°C. The reaction mixture is concentrated under reduced pressure, an oily product precipitates on the addition of water, the latter is decanted and ethanol added to the remaining oil. 3-Isobutyl-6-chloro-7-sulfamyl-3,4-dihydro-1,2,4-benzothiadiazine-1,1-dioxide crystallizes and, after recrystallization from dimethylformamide and water, melts at 241°-245°C.

References

Merck Index 1494

Kleeman & Engel p. 129

DOT 14 (3) 119 (1978)

I.N. p. 169

Ciba, Ltd.; British Patents 861,367; February 22, 1961 and 885,078; December 20, 1961

BUTOFILOLOL

Therapeutic Function: Beta blocker

Chemical Name: 1-[2-[3-[(1,1-Dimethylethyl)amino]-2-hydroxypropoxy]-5-fluorophenyl]-1-butanone

Common Name: —

Structural Formula:

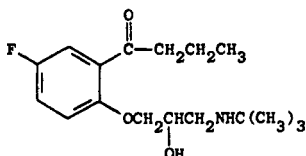

Chemical Abstracts Registry No.: 64552-17-6

Trade Name	Manufacturer	Country	Year Introduced
Cafide	Clin Midy	France	1982

Raw Materials

5-Fluorosallylaldehyde	Sodium Hydride
1-Chloro-2-hydroxy-3- <i>t</i> -butylaminopropane	Hydrogen Chloride
Propyl Magnesium Bromide	

Manufacturing Process

(a) *5-Chloromethyl-3-tert-butyl-2-(2-hydroxy-5-fluorophenyl)oxazolidine*: 5-Fluorosallylaldehyde (1.4 g, 0.01 mol) is dissolved in anhydrous benzene (20 ml) in the presence of a crystal of *p*-toluenesulfonic acid in a Dean-Stark apparatus. 1-Chloro-2-hydroxy-3-*t*-butylaminopropane (2.08 g, approximately 1 equivalent, purity 75%) is then added within a period of 10 hours in portions of 250 mg at a time at the reflux temperature of benzene and the mixture is allowed to stand overnight. An insoluble substance is precipitated on addition of ether after which the solution is filtered, concentrated and distilled. A fraction is obtained having a boiling point of 118°–123°C/10⁻³ mm of mercury. A mixture of 1.03 g (yield 43%) of isomeric oxazolidines is obtained which solidifies. This is crystallized once from hexane. Melting point 75°–78°C.

(b) *8-Aza-4,9-dioxo-11-fluoro-8-tert-butyl-2,3-benzobicyclo[4.2.1]octane*: The product of the previous stage (620 mg) is dissolved in anhydrous dimethylformamide (10 ml) and two quantities each of 300 mg of 50% sodium hydride is added within 2 hours. The mixture is then left for 24 hours at 25°C while being stirred mechanically and is then heated for 2 minutes on a water bath (80°–90°C). The mixture is poured into water, the product extracted with ether, the ethereal extract dried over anhydrous sodium sulfate and the organic phase then concentrated and filtered through a short column of activated alumina. A mixture of light petroleum and diethyl ether (75:25) is used to elute 186 mg of pure product from the column. Melting point 85°–86°C (after recrystallization from diisopropyl ether).

(c) *1-(2-Formyl-4-fluorophenoxy)-2-hydroxy-3-tert-butylaminopropane*: The compound obtained as described above (50 mg) is dissolved in a solution of 1 N hydrochloric acid (0.5 ml). The mixture is then heated on a water bath (80°–90°C) for several hours. After complete hydrolysis, which requires approximately 8 hours, the mixture is poured into an excess of water which has been basified, the solid base thus formed is extracted with ether, dried and recrystallized from diisopropyl ether. Melting point 103°–105°C.

(d) *1-[2-(1-Hydroxybutyl)-4-fluorophenoxy]-2-hydroxy-3-tert-butylaminopropane*: To a solution of propylmagnesium bromide prepared from 195 mg (8.1 X 10⁻³ mol) of magnesium, 1.08 g (8.1 X 10⁻³ mol) of bromopropane and a crystal of iodine in 10 ml of anhydrous diethyl ether under nitrogen is added a solution of the previously prepared aldehyde (197 mg, 0.73 X 10⁻³ mol) in 4 ml of an ether/tetrahydrofuran mixture (1:3 by volume) and the mixture is heated to reflux for 70 minutes. The mixture is poured into water, extracted with diethyl ether, dried over anhydrous sodium sulfate and 208 mg of an oil which is homogeneous, as shown by thin-layer chromatography, is isolated.

(e) *CM 6805 (Butofilolol)*: The previously prepared base (200 mg, 0.66 X 10⁻³ mol) is dissolved in purified acetone (8 ml). A drop of sulfuric acid solution (prepared from 35 ml of concentrated sulfuric acid and 65 ml of water) is added and the mixture heated on a water bath for 1 minute. When the solution has cooled to 5° to 10°C a solution of chromic acid (66 mg, 1 equivalent) dissolved in 2 ml of the same acid solution is quickly added and the resulting mixture is stirred while cold. The mixture is then poured into a saturated solution of sodium carbonate, the acetone is evaporated under reduced pressure on a water bath, and the organic phase is extracted with diethyl ether. After drying and evaporating the solvent

an oil is obtained (172 mg) all of which solidifies. Recrystallization is carried out from diisopropyl ether. 122 mg of CM 6805 is obtained (yield 61%). Melting point 88°–89°C.

References

Merck Index 1500

DFU 7 (2) 96 (1982)

DOT 18 (10) 551 (1982) & 19 (2) 112 (1983)

I.N. p. 169

Demarne, H.; U.S. Patent 4,252,825; February 24, 1981; assigned to C.M. Industries.

BUTORPHANOL

Therapeutic Function: Analgesic, antitussive

Chemical Name: N-Cyclobutylmethyl-3,14-dihydroxymorphinan

Common Name: –

Structural Formula:

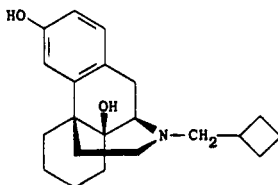

Chemical Abstracts Registry No.: 42408-82-2

Trade Name	Manufacturer	Country	Year Introduced
Stadol	Bristol-Myers	U.S.	1978
Stadol	Bristol-Myers	U.K.	1980
Moradol	Galenika	Yugoslavia	–

Raw Materials

N-Cyclobutylmethyl-14-hydroxy-3-methoxymorphinan
Hydrogen Bromide

Manufacturing Process

A mixture of 1.0 g (2.58 mmols) of N-cyclobutylmethyl-14-hydroxy-3-methoxymorphinan and 10 ml of 48% HBr was refluxed, under a nitrogen atmosphere, during five minutes. After cooling, the reaction mixture was diluted with water and made basic with aqueous ammonium hydroxide. The aqueous basic mixture was extracted with chloroform and the combined chloroform extracts were dried over anhydrous sodium sulfate. After evaporation of the solvent, the residual oil (730 mg) was taken up in dry ether and the resulting solution filtered through celite-charcoal. The filtrate was treated with a saturated solution of hydrogen chloride in dry ether. The hydrochloride salt thus obtained was collected by filtration and recrystallized from a methanol-acetone mixture to yield 565 mg (56.5%) of Butorphanol hydrochloride crystals melting at 272°–274°C (decomposition).

References

Merck Index 1503

DFU 2 (4) 231 (1977) & 3 (5) 330 (1978)

Kleeman & Engel p. 129

PDR p. 713

OCDS Vol. 2 p. 325 (1980)

DOT 14 (5) 197 (1978)

I.N. p. 170

REM p. 1107

Monkovic, I. and Conway, T.T.; U.S. Patent 3,775,414; November 27, 1973; Monkovic, I., Wong, H. and Lim, G.; U.S. Patent 3,980,641; September 14, 1976; Pachter, I.J., Belleau, B.R. and Monkovic, I.; U.S. Patent 3,819,635; June 25, 1974; and Lim, G. and Hooper, J.W.; U.S. Patent 4,017,497; April 12, 1977; all assigned to Bristol-Myers Company

BUTRIPTYLINE

Therapeutic Function: Antidepressant

Chemical Name: (\pm)-10,11-dihydro-N,N, β -trimethyl-5H-dibenzo[a,d]cycloheptene-5-propan-amine

Common Name: —

Structural Formula:



Chemical Abstracts Registry No.: 35941-65-2; 5585-73-9 (Hydrochloride)

Trade Name	Manufacturer	Country	Year Introduced
Evadyne	Ayerst	U.K.	1975
Evadene	Ayerst	Italy	1976
Centrolyse	Ayerst	—	—
Evasidol	Arcana	Austria	—

Raw Materials

Dibenzo[a,e]cycloheptadiene

Sodium Hydride

2-Methyl-3-dimethylaminopropyl Chloride

Manufacturing Process

A solution of dibenzo[a,e]cycloheptadiene in anhydrous xylene is added in a dropwise fashion with stirring to a suspension of sodium hydride in refluxing anhydrous xylene. The mixture is heated at reflux for two hours with continual agitation and there is then added dropwise a solution of 2-methyl-3-dimethylaminopropyl chloride in an equal volume of xylene. The mixture is then heated for fifteen hours, after which time it is cooled and decomposed by the cautious addition of ice water. The layers are separated and the aqueous layer extracted with ether. The combined organic layers are next extracted with 10% hydrochloric acid and the acidic extracts then rendered alkaline by the addition of ammonium hydroxide. The precipitated oil is extracted three times with chloroform. The chloroform extracts are dried and concentrated in vacuo, the residue being distilled to yield the product.

References

Merck Index 1506

Kleeman & Engel p. 131

OCDS Vol. 1 p. 151 (1977)

DOT 9 (6) 219 (1973) & 10 (7) 235 (1974)

I.N. p. 170

Villani, F.J.; U.S. Patent 3,409,640; November 5, 1968; assigned to Schering Corporation

BUTROPIUM BROMIDE

Therapeutic Function: Antispasmodic

Chemical Name: [3(S)-endo]-8-[(4-butoxyphenyl)methyl]-3-(3-hydroxy-1-oxo-2-phenylpropoxy)-8-methyl-8-azoniabicyclo[3.2.1]octane bromide

Common Name: —

Structural Formula:

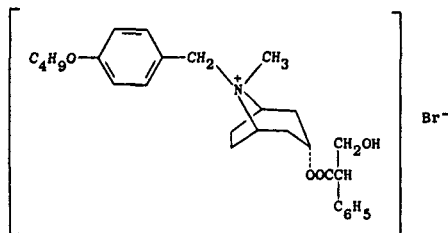

Chemical Abstracts Registry No.: 29025-14-7

Trade Name	Manufacturer	Country	Year Introduced
Coliopan	Eisai	Japan	1974

Raw Materials

Hyoscyamin

Butoxybenzyl Bromide

Manufacturing Process

To 100 ml of an isopropanol solution containing 11.8 grams of hyoscyamine base were added drop by drop with stirring 10 ml of an isopropanol solution containing 11 grams of p-n-butoxybenzyl bromide. After a while, the reaction mixture had a turbid appearance followed by separation of white crystals.

After stirring for 5 hours at room temperature, the crystals were recovered by filtration, which were then recrystallized from 120 ml of isopropanol. There was obtained 15.8 grams of white needles having the melting point of 158°-160°C.

References

Merck Index 1507

Kleeman & Engel p. 131

OCDS Vol. 2 p. 308 (1980)

DOT 10 (11) 292 (1974)

I.N. p. 170

Tanaka, S. and Hasimoto, K.; U.S. Patent 3,696,110; October 3, 1972; assigned to Eisai, KK, Japan

C

CAFAMINOL

Therapeutic Function: Nasal decongestant

Chemical Name: 3,7-Dihydro-8-[(2-hydroxyethyl)methylamino]-1,3,7-trimethyl-1H-purine-2,6-dione

Common Name: Methylcoffanolamine

Structural Formula:

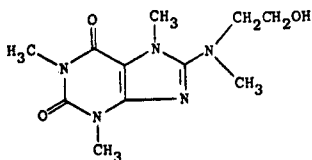

Chemical Abstracts Registry No: 30924-31-3

Trade Name	Manufacturer	Country	Year Introduced
Rhinoptil	Promonta	W. Germany	1974
Rhinetten	Arzneimittelwerk Dresden	E. Germany	—

Raw Materials

8-Chlorocaffeine
 β -N-methylaminoethanol

Manufacturing Process

21 g 8-chlorocaffeine and 15 g β -N-methylaminoethanol are heated to 140°–160°C for 30 minutes. Then the temperature is increased for 15–20 minutes to 165°–170°C. On cooling a colorless mass of crystals results. This is boiled with 50–60 ml ethanol and crystallized. Colorless crystals result which are soluble in water up to about 6%; pH of the aqueous solution is 6.9. The yield is 19 g while the MP is 162°–164°C.

References

Merck Index 1603

I.N. p. 173

Klosa, J.; U.S. Patent 3,094,531; June 18, 1963; assigned to Delmar Chemicals Ltd. (Canada)

CALCIFEDIOL

Therapeutic Function: Regulator (calcium)

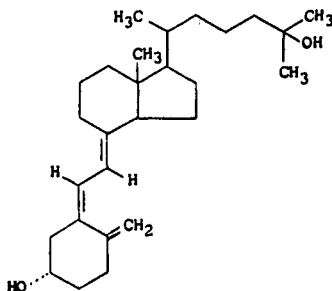
Chemical Name: 9,10-Secocholesta-5,7,10(19)-triene-3,25-diol**Common Name:** 25-Hydroxyvitamin D₃; 25-Hydroxycholecalciferol**Structural Formula:****Chemical Abstracts Registry No.:** 19356-17-3

Trade Name	Manufacturer	Country	Year Introduced
Dedrogyl	Roussel	France	1976
Delakmin	Roussel	W. Germany	1978
Calderol	Upjohn	U.S.	1980
Didrogyl	Roussel/Maestrett	Italy	1980
Dedrogyl	Hoechst	Switz.	1982
Hidroferol	Juventus	Spain	—
Calderol	Organon	U.S.	—

Raw MaterialsCholesta-5,7-diene-3 β ,25-diol**Manufacturing Process**

A solution of 125 mg of cholesta-5,7-diene-3 β ,25-diol in 125 ml of benzene and 10 ml of absolute ethanol is placed in a photo reactor equipped with a quartz lampwell cooled with water and a nitrogen inlet. The reaction mixture is cooled to about 16°C, and purged with N₂. A Hanovia 8A36, 100-watt lamp, centered in the lampwell 2.5 cm from the internal surface of the reaction mixture, is turned on for 15 minutes, including the 5–6 minutes required for the lamp to reach full brilliance. The lamp is a typical actinic energy source suitable for the irradiation step in the known synthesis of Vitamin D, and can be replaced by any such available lamp. The specific lamp used is a 100-watt high-pressure quartz mercury-vapor lamp, producing approximately 11.5 watts total radiated energy distributed over the range of 220–1400 m μ . A fast stream of water is necessary to keep the outlet water temperature below 20°C. The reaction mixture is concentrated to dryness in a rotary evaporator below room temperature. The semisolid residue is triturated with 5 ml of 35% ethyl acetate-65% Skellysolve B hexanes mixture and filtered and another 5 ml of the same solvent is used for wash. The solid contains unreacted starting material and the liquor contains the product. The liquor is poured onto a 40 g column containing TLC grade Florisil, 150–200 mesh packed wet with 35% ethyl acetate-Skellysolve B hexanes, and the products are eluted with the same solvent mixture collecting 10 ml fractions. The fractions containing the product, located by spotting on a TLC plate, are combined and evaporated to dryness below room temperature to give an oily residue. A few drops of absolute ether are added and removed under vacuum to give 25-hydroxycholecalciferol as a fluffy foam; yield 60 mg.

A solution of about 300 mg of 25-hydroxycholecalciferol prepared as described above in 5 ml of chloroform is heated for 3½ hours at 70°–75°C under N₂ in a sealed flask. The solvent is evaporated and the residue is chromatographed through a 60 g column containing TLC grade Florisil, 150–200 mesh packed wet with 35% ethyl acetate in Skellysolve B hex-

anes. The column is eluted with the same solvent mixture, collecting 10 ml fractions. The fractions which crystallize on trituration with aqueous methanol are combined and recrystallized twice from aqueous methanol to give 25-hydroxycholecalciferol hydrate; yield 120 mg, MP 81°-83°C (sinters 75°C).

A solution of 20 mg of 25-hydroxycholecalciferol hydrate, prepared as described above, in 20 ml of methylene chloride is dried with 200 mg of anhydrous sodium sulfate. The solution is filtered and the filtrate is evaporated to yield 25-hydroxycholecalciferol essentially anhydrous as an amorphous oil.

References

Merck Index 1610
 Kleeman & Engel p. 133
 PDR p. 1285
 OCDS Vol. 3 p. 101 (1984)
 DOT 13 (6) 225 (1977)
 I.N. p. 174
 Babcock, J.C. and Campbell, J.A.; U.S. Patent 3,833,622; September 3, 1974; assigned to The Upjohn Company
 Salmond, W.G.; U.S. Patent 4,001,096; January 4, 1977; assigned to The Upjohn Company

CALCITONIN

Therapeutic Function: Regulator (calcium)

Chemical Name: Complex hormone of molecular weight about 4,500

Common Name: Thyrocalcitonin

Structural Formula:

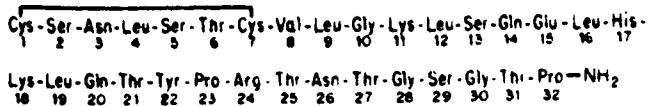

Chemical Abstracts Registry No.: 9007-12-9

Trade Name	Manufacturer	Country	Year Introduced
Calcitar	Yamanouchi	Japan	1978
Cibacalcin	Ciba Geigy	Switz.	1978
Elcitonin	Toyo Jozo	Japan	1981
Calcimar	Armour	U.S.	—
Calcitonin-Sandoz	Sandoz	Switz.	—
Calsyn	Armour	U.K.	—
Calsynar	Armour	U.K.	—
Miacalcic	Sandoz	Switz.	—
Staporos	Roussel	France	—

Raw Materials

C-cell-rich thyroid gland carcinoma

Manufacturing Process

The process for the manufacture of human calcitonin in pure form from C-cell rich medulla

carcinoma of the thyroid gland or from C-cell metastasis material is one wherein medullar carcinoma of the thyroid gland or C-cell metastasis material, which has been defatted, for example with acetone or ether, and which may have been first purified with alcohol or with aqueous trichloroacetic acid, is extracted one or more times with a solvent system containing water and an alkanol having at most 5 carbon atoms, at a pH of from about 1 to 6, and the extracted product subjected to gel chromatography using aqueous formic acid as eluant. The calcitonin may be separated into its constituents by countercurrent distribution, for example by Craig distribution using a solvent system advantageously containing n-butanol and acetic acid.

References

Merck Index 1611
 DFU 8 (2) 105 (1983)
 PDR p. 1809
 DOT 14 (4) 139 (1978)
 I.N. p. 174
 REM p. 979
 Ciba-Geigy A.G.; British Patent 1,270,595; April 12, 1972

CALCITRIOL

Therapeutic Function: Calcium regulator

Chemical Name: 9,10-Secocholesta-5,7,10(19)-triene-1,3,25-triol

Common Name: 1 α ,25-Dihydroxycholecalciferol; 1 α ,25-dihydroxyvitamin D₃

Structural Formula:

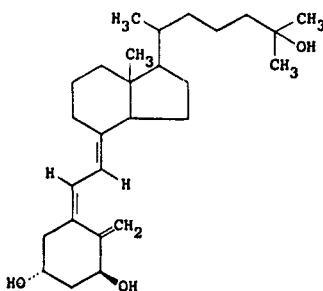

Chemical Abstracts Registry No.: 32222-06-3

Trade Name	Manufacturer	Country	Year Introduced
Rocaltrol	Roche	U.S.	1978
Rocaltrol	Roche	W. Germany	1980
Rocaltrol	Roche	U.K.	1980
Rocaltrol	Roche	Switz.	1980
Rocaltrol	Roche	Italy	1981

Raw Materials

1 α ,25-Diacetoxyprecholecalciferol
 Potassium hydroxide

Manufacturing Process

1 α ,25-Dihydroxyprecholecalciferol: A solution of 1 α ,25-diacetoxyprecholecalciferol (0.712 g, 1.42 mmols), potassium hydroxide (2.0 g, 35.6 mmols) and methanol (40 ml) was stirred at room temperature under argon for 30 hours. The reaction mixture was concentrated under reduced pressure. Water (50 ml) was added to the residue and the mixture was extracted with methylene chloride (3 x 100 ml). The combined organic extracts were washed with saturated sodium chloride solution (3 x 50 ml), dried over anhydrous sodium sulfate, filtered and evaporated under reduced pressure to give 0.619 g of 1 α ,25-dihydroxyprecholecalciferol as a thick oil.

1 α ,25-Dihydroxycholecalciferol: A solution of 1 α ,25-dihydroxyprecholecalciferol [0.619 g in dioxane (30 ml)] was heated under reflux for 30 minutes under an atmosphere of argon. The reaction mixture was concentrated under reduced pressure and the residue was purified with a Waters Associates liquid chromatograph model 202 using a 8 foot X $\frac{3}{8}$ inch Porasil A column and a 5:1 mixture of ethyl acetate-n-hexane as the eluent to give 0.474 g (80% yield based on 1 α ,25-diacetoxyprecholecalciferol) of pure 1 α ,25-dihydroxycholecalciferol. Recrystallization from methyl formate afforded 0.340 g of 1 α ,25-dihydroxycholecalciferol as colorless crystals, MP 113°-114°C.

References

Merck Index 1612

Kleeman & Engel p. 134

PDR p. 1498

OCDS Vol. 3 p. 103 (1984)

DOT 16 (5) 149 (1980)

I.N. p. 175

REM p. 1012

Uskokovic, M.R., Narwid, T.A., Iacobelli, J.A. and Baggiolini, E.; U.S. Patent 3,993,675; November 23, 1976; assigned to Hoffmann-La Roche, Inc.

CALUSTERONE

Therapeutic Function: Antineoplastic

Chemical Name: 17 β -hydroxy-7 β ,17-dimethylandrosta-4-en-3-one

Common Name: 7,17-dimethyltestosterone

Structural Formula:

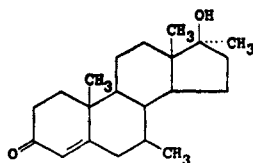

Chemical Abstracts Registry No.: 17021-26-0

Trade Name	Manufacturer	Country	Year Introduced
Methosarb	Upjohn	U.S.	1973
Riedemil	Upjohn	U.S.	—

Raw Materials

6-Dehydro-17-methyltestosterone

Methyl magnesium bromide

Manufacturing Process

As described in U.S. Patent 3,029,263, one possibility is a multistep synthesis starting from $3\beta,17\beta$ -dihydroxy-17 α -methyl-5-androstene.

Alternatively, as described in U.S. Patent 3,341,557, 6-dehydro-17-methyltestosterone may be used as the starting material. A mixture of 0.4 g of cuprous chloride, 20 ml of 4 M methylmagnesium bromide in ether and 60 ml of redistilled tetrahydrofuran was stirred and cooled in an ice bath during the addition of a mixture of 2.0 g of 6-dehydro-17-methyltestosterone, 60 ml of redistilled tetrahydrofuran and 0.2 g of cuprous chloride. The ice bath was removed and stirring was continued for four hours. Ice and water were then carefully added, the solution acidified with 3 N hydrochloric acid and extracted several times with ether. The combined ether extracts were washed with a brine-sodium carbonate solution, brine and then dried over anhydrous magnesium sulfate, filtered and then poured over a 75-g column of magnesium silicate (Florisil) packed wet with hexanes (Skellysolve B). The column was eluted with 250 ml of hexanes, 0.5 liter of 2% acetone, two liters of 4% acetone and 3.5 liters of 6% acetone in hexanes.

Four 250-ml fractions were collected followed by 150 ml fractions. The residues from fractions 8 to 16 were combined and rechromatographed over a 125-g column of magnesium silicate. The column was eluted with 6% acetone in hexanes which was collected in 150 ml portions. Fractions 18 to 29 were combined and dissolved in acetone, decolorized with charcoal, and recrystallized from acetone. One gram of a crystalline mixture of the 7-epimers of 7,17-dimethyltestosterone was obtained melting at 120° to 140°C.

References

Merck Index 1701

Kleeman & Engel p. 138

OCDS Vol. 2 p. 154 (1980)

DOT 10 (3) 85 (1974)

I.N. p. 177

REM p. 1001

Campbell, J.A. and Babcock, J.C.; U.S. Patents 3,029,263; April 10, 1962 and 3,341,557; September 12, 1967; both assigned to The Upjohn Company

CAMAZEPAM

Therapeutic Function: Anxiolytic

Chemical Name: 3-N,N-dimethylcarbamoyloxy-1-methyl-7-chloro-5-phenyl-1,3-dihydro-2H-1,4-benzodiazepin-2-one

Common Name: —

Structural Formula:

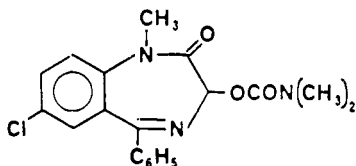

Chemical Abstracts Registry No.: 36104-80-0

Trade Name	Manufacturer	Country	Year Introduced
Albego	Simes	Italy	1977

Trade Name	Manufacturer	Country	Year Introduced
Albego	Boehringer-Ingel.	W. Germany	1978
Albego	Inpharzam	Switz.	1978
Albego	Farmasimes	Spain	—
Limpidon	Crinos	Italy	—
Nebolan	—	—	—

Raw Materials

7-Chloro-5-phenyl-1-methyl-3-hydroxy-1,3-dihydro-2H-1,4-benzodiazepine-2-one
 Phenyl chlorocarbonate
 Dimethylamine

Manufacturing Process

A suspension of 100 g of 7-chloro-5-phenyl-1-methyl-3-hydroxy-1,3-dihydro-2H-1,4-benzodiazepin-2-one in 700 ml of anhydrous pyridine, kept stirred between 0°C and +5°C, is slowly treated, during 20 to 30 minutes, with 54.5 ml phenyl chlorocarbonate. The temperature is gradually allowed to rise to 20°-25°C and stirring is maintained at this temperature during 24 hours.

2 ℓ of water are then slowly added (during about 30 minutes) and stirring is maintained during 1 hour. The precipitate which has been formed is collected on a filter, washed thoroughly with water, dried in a vacuo at 50°C and recrystallized by dissolving it at 60°C in 1,400 ml dioxane, the solution thus obtained being evaporated under reduced pressures to one-half of its volume, and 1,700 ml of ligroin (BP 80°C to 120°C) being added thereto.

7-chloro-5-phenyl-1-methyl-3-phenoxy-carbonyloxy-1,3-dihydro-2H-1,4-benzodiazepin-2-one is thus obtained, with a melting point of 162°C to 164°C.

A suspension of 45 g 3-phenoxy-carbonyloxy-1-methyl-7-chloro-5-phenyl-1,3-dihydro-2H-1,4-benzodiazepin-2-one in 450 ml methanol is treated with stirring, with 43 ml of a solution of dimethylamine in methanol (containing 31 g dimethylamine in 100 ml). Stirring is maintained at 20°C to 25°C during 5 hours. The reaction mixture is filtered, and the filtrate is diluted with 450 ml water. The precipitate thus formed, is 3-(N,N-dimethylcarbamoyloxy)-1-methyl-7-chloro-5-phenyl-1,3-dihydro-2H-1,4-benzodiazepin-2-one, which is collected on a filter, dried and recrystallized from ethyl acetate, and has a melting point of 173°C to 174°C.

References

- Merck Index 1703
 DFU 1 (10) 458 (1976)
 Kleeman & Engel p. 139
 DOT 11 (5) 182 (1975); 13 (12) 521 (1977)
 I.N. p. 177
 Ferrari, G. and Casagrande, C.; U.S. Patent 3,799,920; March 26, 1974; assigned to Siphar SA

CANDICIDIN

Therapeutic Function: Topical antifungal

Chemical Name: Heptaene macrolide antibiotic

Common Name: —

Structural Formula: —

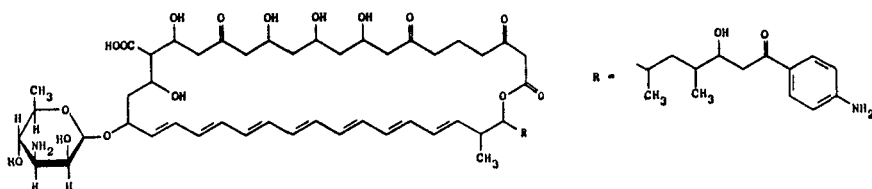

Chemical Abstracts Registry No.: 1403-17-4

Trade Name	Manufacturer	Country	Year Introduced
Candepin	Schmid	U.S.	1964
Candimon	Ayerst	U.S.	—
Prostatin	Schmid	U.S.	—
Vanobid	Merrell Dow	U.S.	—

Raw Materials

Yeast-glucose medium

Streptomyces Griseus No. 3570 bacterium

Manufacturing Process

Hubert Lechevalier et al were the first to describe "Candicidin, a New Antifungal Antibiotic," in *Mycologia* XLV, No. 2, 155-171, March-April 1953. They produced candicidin by growing a culture of the organism *Streptomyces griseus* No. 3570 on a yeast-glucose medium, isolating a "crude candicidin" from the resulting broth and purifying it. An improved extraction and purification method is described in U.S. Patent 2,872,373 and is shown in the flow diagram below.

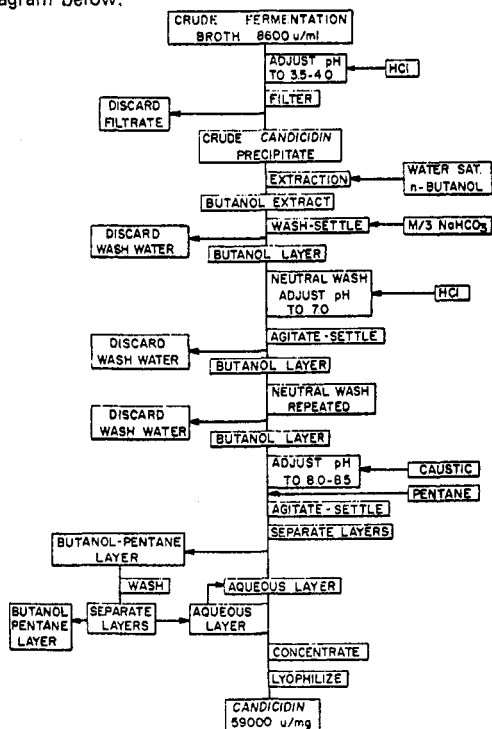

Another extraction and separation process is described in U.S. Patent 2,992,162.

References

I.N. p. 178

REM p. 1226

Siminoff, P.; U.S. Patent 2,872,373; February 3, 1959; assigned to S.B. Penick & Company, Inc.

Waksman, S.A. and Lechevalier, H.A.; U.S. Patent 2,992,162; July 11, 1961; assigned to Rutgers Research and Educational Foundation

CANRENOATE POTASSIUM

Therapeutic Function: Aldosterone antagonist, Diuretic

Chemical Name: 17-hydroxy-3-oxo-17 α -pregna-4,6-diene-21 carboxylic acid potassium salt

Common Name: —

Structural Formula: The corresponding lactone, canrenone, has the formula following.

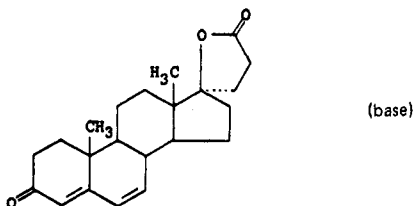

Chemical Abstracts Registry No.: 2181-04-6; 976-71-6 (Canrenone base)

Trade Name	Manufacturer	Country	Year Introduced
Spiroctan	Boehringer-Mannheim	Switz.	1968
Soldactone	Diethelm	Switz.	1968
Osyrol	Hoechst	W. Germany	1968
Soludactone	Searle	France	1971
Venactone	Lepetit	Italy	1978
Spiroctan-M	MCP Pharm.	U.K.	1981
Soldacton	Dainippon	Japan	1981
Aldactone	Boehringer-Mannheim	W. Germany	—
Aldatense	Searle	France	—
Aldatense	Spa	Italy	—
Phanurane	Specia	France	—
Sincomen	Schering	W. Germany	—
Soldactone	Searle	U.S.	—

Raw Materials

17 α -Carboxyethyl-17 β -hydroxyandrost-4-en-3-one lactone Chloranil

Manufacturing Process

The lactone is prepared as follows: A solution of 5 parts of 17 α -carboxyethyl-17 β -hydroxyandrost-4-en-3-one lactone and 5 parts of chloranil in 400 parts of xylene containing a trace of p-toluenesulfonic acid is heated at the boiling point of the solvent under reflux overnight. The solution is then cooled and filtered through approximately 200 parts of silica gel. The gel is successively washed with 5%, 10%, and 15% ethyl acetate-benzene

solutions, and the washings comprising 15% ethyl acetate are thereupon purified by chromatography on a further quantity of silica gel, using benzene and ethyl acetate as developing solvents. From the 15% ethyl acetate eluate there is obtained pure 17 α -carboxyethyl-17 β -hydroxyandrosta-4,6-dien-3-one lactone, melting at 148° to 151°C. The product solidifies above this melting point and melts again at 165°C.

References

Merck Index 1726

Kleeman & Engel p. 507

OCDS Vol. 2 p. 174 (1980)

DOT 12 (2) 45 (1976)

I.N. p. 178

Cella, J.A.; U.S. Patent 2,900,383; August 18, 1959; assigned to G.D. Searle & Co.

CAPREOMYCIN SULFATE

Therapeutic Function: Antitubercular

Chemical Name: Cyclic polypeptide antibiotic

Common Name: Caprolin

Structural Formula:

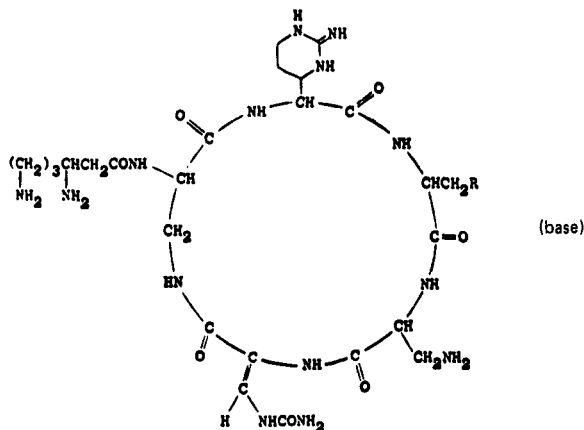

Chemical Abstracts Registry No.: 1405-37-4 (Base = 11003-38-6)

Trade Name	Manufacturer	Country	Year Introduced
Capastat	Lilly	U.K.	1966
Capastat	Serum Impfinst	Switz.	1967
Ogostac	Lilly	W. Germany	1967
Capastat	Lilly	U.S.	1971
Capastat	Lilly	Italy	1973
Capastat	Shionogi	Japan	—

Raw Materials

Glucose

Culture of NRRL-2773 bacterium

Manufacturing Process

A culture of NRRL 2773 is produced by growing the organism on a nutrient agar slant having the following composition:

Oatmeal-Tomato Paste Agar

	Grams
Tomato paste	20
Precooked oatmeal	20
Agar	15
Tap water, added to make a final volume of 1 liter.	

The slant is inoculated with spores of NRRL 2773 and is incubated for 10 days at about 30°C. The culture growth on the slant is covered with 6 ml of nutrient broth, and the slant is scraped gently to remove the organisms to provide an aqueous suspension. Employing aseptic techniques, the inoculum obtained from one 1-inch agar slant is used to inoculate a 2-liter Erlenmeyer flask containing a 500-ml portion of a sterilized vegetative culture medium having the following composition: soluble starch, 10 g; peptones, 5 g; beef extract, 5 g; sodium chloride, 5 g; yeast extract, 2.5 g; and tap water, 1,100 ml. The incubation is carried on at 28°C for 48 hours with shaking at 250 cycles per minute on a rotary shaker having a 1-inch stroke.

To produce a larger quantity of vegetative inoculum, 500 ml of the vegetative inoculum is added aseptically to a stainless steel 350-gallon fermentation tank containing 250 gallons of sterile medium having the following composition (weight/volume): glucose, 1.5%; yeast, 1.5%; and antifoam (Polyglycol No. 2000, Dow Chemical Co.), 0.02%. The inoculum is allowed to grow for about 22 hours at a temperature of 30°C. Throughout the growth period, the medium is aerated with sterile air at the rate of 17 cfm and is agitated with two 16-inch impellers rotating at 160 revolutions per minute. To a 1,700-gallon stainless steel fermentor are added 1,100 gallons of a medium having the following composition (weight/volume):

Peptone No. 159 Medium

	Percent
Glucose	2.5
Molasses	1.0
Peptones	4.0
Calcium carbonate	0.2
Hydrolyzed casein	0.6
Antifoam (Polyglycol No. 2000, Dow Chemical Co.)	0.005

The medium after sterilization is inoculated with 100 gallons of the inoculum grown in the fermentation tank. The fermentation is carried on at 30°C for about five days. The foam is controlled by the addition, when needed, of Larex No. 1 (an antifoam product, Swift and Co.). Throughout the fermentation, the medium is aerated by the addition of sterile air at the rate of 96 cfm and is agitated with two 22-inch impellers operated at 140 revolutions per minute. At the end of the fermentation, 240 lb of Dicalite 476 (a perlite filter product, Great Lakes Carbon Corporation) are added to 1,000 gallons of the antibiotic broth, and the mixture is stirred and filtered. The filter cake is washed with tap water and the wash water and the filtrate are combined to provide a total volume of 1,000 gallons.

To 500 gallons of the combined liquids are added 132 lb of Darco G-60. The mixture is stirred thoroughly and filtered, and the filtrate is discarded. The carbon filter cake is washed with 200 liters of tap water, the wash water being discarded. The washed carbon cake on which the capreomycin is adsorbed is further washed with 200 liters of 0.05 N aqueous hydrochloric acid. The acid wash is discarded. The washed carbon cake is eluted during a one-hour period with 400 liters of an aqueous acetone mixture containing 1.65 liters of 11.7 N hydrochloric acid and 80 liters of acetone. The filter cake is further eluted by washing the cake with 200 liters of an aqueous acetone mixture containing 825 ml of 11.7 N hydrochloric acid and 40 liters of acetone during a 15-minute period. The combined eluates, having a total volume of 575 liters, are concentrated in vacuo to 52.5 liters.

The concentrate is added with stirring to 525 liters of acetone and the acetone mixture is permitted to stand overnight at room temperature, during which time an oily precipitate of capreomycin separates. The supernatant is decanted and discarded, and the oily precipitate which remains is dissolved in 20 liters of distilled water. The aqueous solution is concentrated in vacuo to 12 liters to remove any residual acetone. The aqueous concentrate containing capreomycin is filtered to remove a small amount of a precipitate, which is discarded.

The filtrate containing the capreomycin is added to 240 liters of methanol with stirring. The methanolic solution of capreomycin is acidified by the addition of one liter of 10 N sulfuric acid, whereupon the precipitation of the sulfuric acid addition salt of capreomycin commences. The mixture is permitted to stand overnight for more complete precipitation. The supernatant is removed by decanting and filtering. The precipitate, consisting of the capreomycin disulfate, is washed with 10 liters of methanol and is dried in vacuo. Yield: 2,510 grams.

References

Merck Index 1732

Kleeman & Engel p. 141

PDR p. 1039

DOT 1 (1) 33 (1965)

I.N. p. 179

REM p. 1202

Herr, E.B., Jr., Hamill, R.L. and McGuire, J.M.; U.S. Patent 3,143,468; August 4, 1964; assigned to Eli Lilly and Company

CAPTODIAMINE

Therapeutic Function: Sedative

Chemical Name: 2-[[[4-(Butylthio)phenyl] phenylmethyl] thio] -N,N-dimethylethanamine

Common Name: Captodiam; captodramine

Structural Formula:

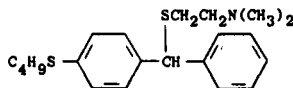

Chemical Abstracts Registry No.: 486-17-9; 904-04-1 (Hydrochloride)

Trade Name	Manufacturer	Country	Year Introduced
Covatine	Bailly	France	1958
Suvren	Ayerst	U.S.	1958
Covatix	Lundbeck	Denmark	—

Raw Materials

p-Butylmercaptobenzhydryl chloride	Thiourea
Sodium hydroxide	Sodium metal
Diethylaminoethyl chloride	

Manufacturing Process

p-Butylmercaptobenzhydryl chloride was boiled with thiourea in alcohol thereby yielding p-

butylmercaptobenzhydrylisothiouronium chloride which was then subjected to hydrolysis with dilute aqueous sodium hydroxide solution whereupon p-butylmercaptobenzhydryl mercaptan was formed.

p-Butylmercaptobenzhydryl mercaptan (28.5 g) was added to a solution of sodium (2.3 g) in absolute alcohol (75 ml), followed by the addition of a solution of diethylaminoethyl chloride (13.6 g) in toluene (50 ml). The mixture was boiled on a steam bath for 3 hours and the sodium chloride which separated out was removed by filtration. The filtrate was concentrated to one-third of its volume and dissolved in ether. The ether solution was shaken with 2 N hydrochloric acid (100 ml), and the resulting middle oily layer was separated, dissolved in water and the resulting aqueous solution was washed with ether, then treated with aqueous sodium hydroxide solution to precipitate an oil. The latter was dissolved in ether, dried with anhydrous potassium carbonate, filtered and then treated with anhydrous hydrogen chloride whereupon the desired p-butylmercaptobenzhydryl 2-diethylaminoethyl sulfide hydrochloride precipitated as a white, crystalline substance which was filtered and dried in a desiccator. The melting point of the product was 124°C.

References

Merck Index 1746

Kleeman & Engel p. 141

OCDS Vol. 1 p. 44 (1977)

I.N. p. 179

Hubner, O.F. and Petersen, P.V.; U.S. Patent 2,830,088; April 8, 1958

CAPTORIL

Therapeutic Function: Antihypertensive

Chemical Name: 1-(3-Mercapto-2-D-methylpropanoyl)-L-proline

Common Name: —

Structural Formula:

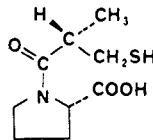

Chemical Abstracts Registry No.: 62571-86-2

Trade Name	Manufacturer	Country	Year Introduced
Lopirin	Von Heyden	W. Germany	1980
Capoten	Squibb	U.S.	1981
Lopirin	Squibb	Switz.	1981
Capoten	Squibb	U.K.	1981
Capoten	Squibb	Italy	1981
Lopril	Squibb	France	1982
Captoril	Sankyo	Japan	1983
Dilabar	Vita	Spain	—
Isopresol	Elea	Argentina	—

Raw Materials

L-proline

Isobutylene

Benzoyloxycarbonyl chloride	Hydrogen
3-Acetylthiomethyl propanoic acid	Ammonia
Trifluoroacetic acid	

Manufacturing Process

The first step is the manufacture of L-proline tert-butyl ester. L-proline (230 g) is dissolved in a mixture of water (1 ℓ) and 5 N sodium hydroxide (400 ml). The solution is chilled in an ice bath, and under vigorous stirring, 5 N sodium hydroxide (460 ml) and benzoyloxycarbonyl chloride (340 ml) are added in five equal aliquots during a half-hour period. After one hour stirring at room temperature, the mixture is extracted twice with ether and acidified with concentrated hydrochloric acid. The precipitate is filtered and dried. Yield is 442 g; MP 78°C to 80°C.

The benzoyloxycarbonyl-L-proline thus obtained (180 g) is dissolved in a mixture of dichloromethane (300 ml), liquid isobutylene (800 ml) and concentrated sulfuric acid (7.2 ml). The solution is shaken in a pressure bottle for 72 hours. The pressure is released, the isobutylene is allowed to evaporate and the solution is washed with 5% sodium carbonate, water, dried over magnesium sulfate and concentrated to dryness in vacuo, to obtain benzoyloxycarbonyl-L-proline tert-butyl ester, yield 205 g.

Benzoyloxycarbonyl-L-proline tert-butyl ester (205 g) is dissolved in absolute ethanol (1.2 ℓ) and hydrogenated at normal pressure with 10% Pd on carbon (10 g) until only a trace of carbon dioxide is observed in the hydrogen exit gas (24 hours). The catalyst is filtered off and the filtrate is concentrated in vacuo at 30 mm Hg. The residue is distilled in vacuo, to obtain L-proline tert-butyl ester, BP_{1mm} 50°C to 51°C.

The next step yields 1-(3-acetylthio-2-methylpropanoyl)-L-proline tert-butyl ester. L-proline tert-butyl ester (5.1 g) is dissolved in dichloromethane (40 ml) and the solution stirred and chilled in an ice bath. Dicyclohexylcarbodiimide (15 ml) is added followed immediately by a solution of 3-acetylthio-2-methylpropanoic acid (4.9 g) in dichloromethane (5 ml). After 15 minutes stirring in the ice bath and 16 hours at room temperature, the precipitate is filtered off and the filtrate is concentrated to dryness in vacuo. The residue is dissolved in ethyl acetate and washed neutral. The organic phase is dried over magnesium sulfate and concentrated to dryness in vacuo. The residue 1-(3-acetylthio-2-methylpropanoyl)-L-proline tert-butyl ester is purified by column chromatography (silica gel-chloroform), yield 7.9 g.

Then, 1-(3-acetylthio-2-methylpropanoyl)-L-proline is produced. The 1-(3-acetylthio-3-methylpropanoyl)-L-proline tert-butyl ester (7.8 g) is dissolved in a mixture of anisole (55 ml) and trifluoroacetic acid (110 ml). After one hour storage at room temperature the solvent is removed in vacuo and the residue is precipitated several times from ether-hexane. The residue (6.8 g) is dissolved in acetonitrile (40 ml) and dicyclohexylamine (4.5 ml) is added. The crystalline salt is boiled with fresh acetonitrile (100 ml), chilled to room temperature and filtered, yield 3.8 g, MP 187°C to 188°C. This material is recrystallized from isopropanol [α]_D -67° (C 1.4, EtOH). The crystalline dicyclohexylamine salt is suspended in a mixture of 5% aqueous potassium bisulfate and ethyl acetate. The organic phase is washed with water and concentrated to dryness. The residue is crystallized from ethyl acetate-hexane to yield the 1-(3-acetylthio-2-D-methylpropanoyl)-L-proline, MP 83°C to 85°C.

Finally, Captopril is produced. The thioester (0.85 g) is dissolved in 5.5 N methanolic ammonia and the solution is kept at room temperature for 2 hours. The solvent is removed in vacuo and the residue is dissolved in water, applied to an ion exchange column on the H⁺ cycle (Dowex 50, analytical grade) and eluted with water. The fractions that give positive thiol reaction are pooled and freeze dried. The residue is crystallized from ethyl acetate-hexane, yield 0.3 g. The 1-(3-mercapto-2-D-methylpropanoyl)-L-proline has a melting point of 103°C to 104°C.

References

- Merck Index 1747
- DFU 3 (11) 795 (1978)
- Kleeman & Engel p. 142

PDR p. 1736

OCDS Vol. 3 p. 128 (1984)

DOT 17 (6) 233 (1981); 18 (10) 554 (1982)

I.N. p. 180

REM p. 850

Ondetti, M.A. and Cushman, D.W.; U.S. Patent 4,046,889; September 6, 1977; assigned to E.R. Squibb & Sons, Inc.

Ondetti, M.A. and Cushman, D.W.; U.S. Patent 4,105,776; August 8, 1978; assigned to E.R. Squibb & Sons, Inc.

Ondetti, M.A. and Cushman, D.W.; U.S. Patent 4,154,840; May 15, 1979; assigned to E.R. Squibb & Sons, Inc.

CARAMIPHEN EDISYLATE

Therapeutic Function: Antitussive

Chemical Name: 1-Phenylcyclopentanecarboxylic acid 2-(diethylamino)-ethyl ester 1,2-ethanedisulfonate

Common Name: —

Structural Formula:

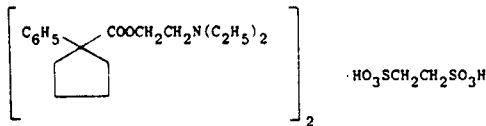

Chemical Abstracts Registry No.: 125-86-0

Trade Name	Manufacturer	Country	Year Introduced
Panparnit	Geigy	U.S.	1949
Toryn	Smith Kline	U.S.	1953
Tuss-Ade	Schein	U.S.	—
Tuss-Ornade	Smith Kline	U.S.	—

Raw Materials

1-Phenylcyclopentyl-1-carboxylic acid chloride
 Diethylaminoethanol
 Ethanedisulfonic acid

Manufacturing Process

20.8 parts of 1-phenyl-cyclopentyl-1-carboxylic acid chloride, obtained from the acid (cf. Am. Soc. 1934, 56, 715) by means of thionyl chloride, are dissolved in 250 parts by volume of absolute ether, then, while stirring and cooling with a mixture of common salt and ice a solution of 12 parts of diethylaminoethanol in 50 parts by volume of absolute ether is allowed to drop thereinto, the temperature being maintained below 0°C, whereupon stirring is continued during 2 hours at room temperature. The whole is then twice shaken out with water and once with diluted hydrochloric acid, the combined aqueous solutions are made alkaline with a potassium carbonate solution and shaken out with ether. The ethereal solution is washed with water, dried over potassium carbonate and the solvent is distilled off. The base boils at a pressure of 0.07 mm at 112°C to 115°C.

The base may then be converted to the hydrochloride or to the ethanedisulfonic acid salt (edisylate).

References

Merck Index 1750

PDR pp. 1606, 1730

OCDS Vol. 1 pg. 90 (1977)

I.N. p. 180

Martin, H. and Hafliger, F.; U.S. Patent 2,404,588; July 23, 1946; assigned to J.R. Geigy A.G. (Switzerland)

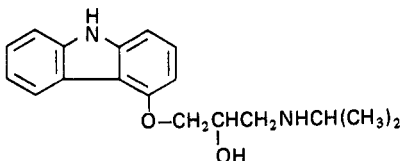
CARAZOLOL**Therapeutic Function:** Beta-adrenergic blocker**Chemical Name:** 4-(3-Isopropylamino-2-hydroxypropoxy)carbazole**Common Name:** —**Structural Formula:****Chemical Abstracts Registry No.:** 57775-29-8

Trade Name	Manufacturer	Country	Year Introduced
Conducton	Klinge	W. Germany	1980

Raw Materials

Hydroxycarbazole
 Epichlorohydrin
 Isopropylamine

Manufacturing Process

The 4-(2,3-epoxypropoxy)carbazole used as starting material is prepared as follows. A solution of 16.3 g 4-hydroxycarbazole in a mixture of 190 ml dioxan and 98 ml 1 N sodium hydroxide is, after the addition of 66 ml epichlorohydrin, stirred for 2 hours at 40°C to 45°C. The reaction mixture is then diluted with water and shaken out with methylene chloride. The methylene chloride phase is washed with water, dried over anhydrous sodium sulfate and evaporated. There are obtained 16.8 g 4-(2,3-epoxypropoxy)carbazole.

A solution of 3.5 g 4-(2,3-epoxypropoxy)carbazole in 50 ml absolute alcohol is mixed with 30 ml isopropylamine and heated for 3 hours under reflux. When the reaction is finished, the reaction mixture is evaporated to dryness. The residue obtained is taken up in methylene chloride and chromatographed over an aluminum oxide column (300 g basic aluminum oxide, activity stage IV; eluent methylene chloride). The eluted fractions are evaporated and the residue is dissolved in methanol and acidified with 2 N ethereal hydrochloric acid.

The precipitate obtained is filtered off and recrystallized from methanol. There are obtained 3.1 g (62% of theory) 4-(3-isopropylamino-2-hydroxypropoxy)carbazole hydrochloride; MP 234°C to 235°C.

References

Merck Index 1753
 DFU 2 (11) 715 (1977)
 Kleeman & Engel p. 143
 DOT 17 (2) 53 (1981) and 18 (10) 551 (1982)
 I.N. p. 180
 Boehringer Mannheim GmbH; British Patent 1,369,580; October 9, 1974

CARBACHOL

Therapeutic Function: Cholinergic

Chemical Name: 2-[(Aminocarbonyl)oxy]-N,N,N-trimethyl-ethanaminium chloride

Common Name: Carbacholine

Structural Formula:

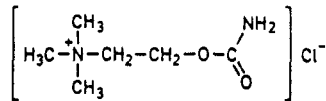

Chemical Abstracts Registry No.: 51-83-2

Trade Name	Manufacturer	Country	Year Introduced
Miostat	Alcon	U.S.	1979
Atonyl	Ferrosan	Denmark	—
Cacholitin	Vaise	Denmark	—
Carbacel	Warner-Lambert	U.S.	—
Carbamiotin	Tilden-Yates	U.S.	—
Carbyl	Tubi Lux Farma	Italy	—
Carcholin	Merck Sharpe & Dohme	U.S.	—
Doryl	Merck	W. Germany	—
Iricoline	Lematte et Boinot	France	—
Isopto-Carbachol	Alcon	U.S.	—
Jestryl	Ankerwerk	E. Germany	—
Lentin	Merck	W. Germany	—
Lentivasan	Kwizda	Austria	—
Mistura	Lederle	U.S.	—
Moryl	Savory & Moore	U.K.	—
Oftan-Karbakol	Star	Finland	—
P.V. Carbachol	Allergan	U.S.	—
Rilentol	Richter	Austria	—
Secretin	Streuli	Switz.	—
Spersacarbachol	Dispersa	Switz.	—
Tonocholin	A.F.I.	Norway	—

Raw Materials

Choline chloride Phosgene

Manufacturing Process

About 14 g of choline chloride are stirred with a solution of about 20 g of phosgene in 100 g of chloroform for about two hours at room temperature. The mixture becomes a two-phase liquid mixture. Hydrochloric acid and excess phosgene are removed by distillation in vacuo. Chloroform is added to the syrup, and the mixture is then added to a solution of excess ammonia in chloroform which was cooled with solid carbon dioxide-acetone. The mixture is

filtered, and the solid is extracted with hot absolute alcohol. The solid in the alcoholic solution is precipitated with ether, and filtered. It is recrystallized from a methyl alcohol-ether mixture; the carbaminoyl-choline chloride obtained has a melting point of about 208°-210°C.

References

Merck Index 1754

Kleeman & Engel p. 144

I.N. p. 180

REM p. 896

Major, R.T. and Bonnett, H.T.; U.S. Patent 2,374,367; April 24, 1945; assigned to Merck & Co., Inc.

CARBAMAZEPINE

Therapeutic Function: Analgesic, Anticonvulsant

Chemical Name: 5H-dibenz[b,f]azepine-5-carboxamide

Common Name: 5-carbamyl iminostilbene

Structural Formula:

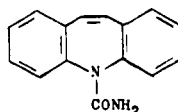

Chemical Abstracts Registry No.: 298-46-4

Trade Name	Manufacturer	Country	Year Introduced
Tegretol	Geigy	W. Germany	1964
Tegretol	Geigy	U.K.	1964
Tegretol	Geigy	France	1964
Tegretol	Geigy	U.S.	1968
Tegretol	Geigy	Italy	1972
Biston	Spofa	Czechoslovakia	—
Convuline	Protea	Australia	—
Finlepsin	Arzneimittelwerk Dresden	E. Germany	—
Hermolepsin	Laake	Finland	—
Lexin	Fujinaga	Japan	—
Mazepine	ICN	Canada	—
Neuritrol	Eczacibasi	Turkey	—
Neurotol	Farmos	Finland	—
Nordotol	Farmos	Finland	—
Servimazepine	Servipharm	Switz.	—
Stazepine	Polfa	Poland	—
Telesmin	Yoshitomi	Japan	—
Temporal	Orion	Finland	—
Teril	Taro	Israel	—
Timonil	Desitin	W. Germany	—

Raw Materials

Iminostilbene

Phosgene

Ammonia

Manufacturing Process

19.3 parts of iminostilbene are dispersed in 100 parts by volume of toluene. Phosgene is then introduced whereupon the temperature of the reaction mixture rises to 70°C. While boiling under reflux, further phosgene is introduced until all the iminostilbene has dissolved and the hydrogen chloride development is complete. The reaction mixture is then cooled and the 5-chlorocarbonyl iminostilbene which has crystallized out is filtered off under suction. It melts at 168° to 169°C.

12.8 parts of 5-chlorocarbonyl iminostilbene are dispersed in 128 parts by volume of absolute ethanol and ammonia gas is introduced for three hours into this mixture while stirring at boiling temperature. The reaction is complete after this time; the reaction mixture is cooled and the crystals which precipitate are filtered off under suction. The ammonium chloride is washed from the crystals with water and the residue is recrystallized first from absolute ethanol and then from benzene. 5-carbamyl iminostilbene is obtained which melts at 204° to 206°C.

References

Merck Index 1758

Kleeman & Engel p. 144

PDR p. 900

OCDS Vol. 1 p. 403 (1977)

DOT 1 (3) 82 (1965)

I.N. p. 181

REM p. 1077

Schindler, W.; U.S. Patent 2,948,718; August 9, 1960; assigned to Geigy Chemical Corporation

CARBASPIRIN CALCIUM

Therapeutic Function: Analgesic, antipyretic, antirheumatic

Chemical Name: 2-(Acetyloxy)benzoic acid calcium salt

Common Name: Calcium aspirin; calcium acetylsalicylate

Structural Formula:

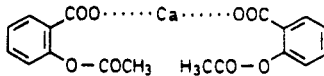

Chemical Abstracts Registry No.: 69-46-3

Trade Name	Manufacturer	Country	Year Introduced
Calurin	Dorsey	U.S.	1959
Iromin	Iromedica	Switz.	—
Soluspan	UPSA	France	1983
Iromin	Omegin	W. Germany	—
Fiogesic	Sandoz	U.S.	—
Ursinus	Dorsey	U.S.	—

Raw Materials

Acetylsalicylic acid
Calcium carbonate

Manufacturing Process

500 g of finely powdered acetylsalicylic acid and 160 g of calcium carbonate (precipitated chalk), are intimately mixed and 3,000 cc of water are added. The mixture is stirred for 15 minutes or until the reaction is completed, which is indicated by the cessation of the liberation of carbon dioxide. The temperature is desirably maintained below 20°C by any suitable means. The mass is allowed to settle until the supernatant liquor is almost clear; this usually takes about 5 minutes, and the mixture is then filtered to remove unreacted material. This part of the process is carried out as quickly as possible so as to minimize any tendency of the calcium aspirin to hydrolyze in the solution. The filtrate is cooled to about 10°C and 1 to 1½ volumes of 97% methanol, or pure wood alcohol is added. This causes the calcium aspirin to precipitate and the mass is then filtered to remove as thoroughly as possible the mother liquor. The residue of calcium aspirin is then suspended in a quantity of methanol equivalent to the volume previously used as a precipitant, and it is allowed to stand there for one hour or more with occasional or continuous agitation. The mass is again filtered, the filtrate being employed for the precipitation of calcium aspirin in a later batch. After the filtering of the first wash liquor, the calcium aspirin is again suspended in another quantity of methanol of an equivalent volume. This constitutes the second wash and it is carried out in the same way as the first wash. The filtrate is employed as a first wash in a later batch and this filtrate in turn is used, as is the filtrate of the first wash, for the precipitation of more calcium aspirin. Fresh alcohol is used as a new wash in a later batch and the washes are carried out in series. After the second wash the calcium aspirin is dried in a suitable manner, as by passing dry warm air over it, the temperature not being allowed to rise to such an extent as to decompose the aspirin; preferably the temperature is not permitted to rise above 50°C, but should be high enough to avoid deposition of water vapor, and the drying is completed when there is no longer an odor of methanol.

References

Merck Index 1615

Kleeman & Engel p. 145

PDR p. 1583

Lawrence, W.H., Jr.; U.S. Patent 2,003,374; June 4, 1935; assigned to Lee Laboratories, Inc.

CARBAZOCHROME

Therapeutic Function: Hemostatic

Chemical Name: 3-Hydroxy-1-methyl-5,6-indolinedione semicarbazone

Common Name: Adrenochrome

Structural Formula:

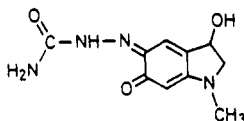

Chemical Abstracts Registry No.: 69-81-8; 13051-01-9 (Salicylate)

Trade Name	Manufacturer	Country	Year Introduced
Adrenosem	Beecham	U.S.	1953
Adrestat	Organon	U.S.	1957
Adrenoxyll	Labaz	France	1957
Adrenoxyll	Nordmark	W. Germany	—

Trade Name	Manufacturer	Country	Year Introduced
Anaroxyl	Organon	U.S.	--
Cromosil	Zambeletti	Italy	--
Cromoxin	R. Rius	Spain	--
Meronyl	Santen	Japan	--

(Many other Trade Names also for Carbazochrome Salicylate and Carbazochrome Sodium Sulfonate)

Raw Materials

Adrenalin
Silver oxide
Semicarbazide hydrochloride

Manufacturing Process

A suspension containing 1 part by weight of adrenalin and 2 to 6 parts by weight of silver oxide in 150 to 250 parts by weight of methanol or ethanol is stirred for about 10 minutes. The alcoholic adrenochrome solution obtained is separated by draining and the filtrate is quickly evaporated to dryness at low temperature and in vacuo. The red crystals of adrenochrome obtained are dissolved in 45 to 55 parts by weight of water. To this solution, 2 parts of sodium acetate dissolved in 2 to 3 parts of water and 2 parts of semicarbazide hydrochloride dissolved in 2 to 3 parts of water are added. The formed precipitate consisting of red-orange prismatic needles is separated by filtration and recrystallized from diluted ethanol. There is obtained 0.30 to 0.40 part by weight of adrenochrome monosemicarbazone dihydrate, melting at 203°C with decomposition.

References

Merck Index 1767, 1768
Kleeman & Engel p. 146
I.N. p. 182
REM p. 832

Dechamps, G., Le Bihan, H. and Baudet, C.; U.S. Patent 2,506,794; May 2, 1950; assigned to Societe Belge de l'azote et des Produits Chimiques du Marly (Belgium)

CARBENICILLIN DISODIUM

Therapeutic Function: Antibacterial

Chemical Name: N-(2-carboxy-3,3-dimethyl-7-oxo-4-thia-1-azabicyclo[3.2.0]hept-6-yl)-2-phenylmalonamic acid sodium salt

Common Name: Carboxybenzylpenicillin sodium salt

Structural Formula:

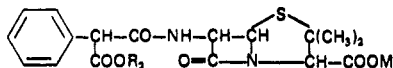

where R_2 and M are both Na.

Chemical Abstracts Registry No.: 4800-94-6; 4697-36-3 (Base)

Trade Name	Manufacturer	Country	Year Introduced
Pyopen	Beecham	Switz.	1968
Pyopen	Beecham	U.K.	1968

Trade Name	Manufacturer	Country	Year Introduced
Carindapen	Pfizer	W. Germany	1968
Pyopen	Beecham	U.S.	1970
Geopen	Roerig	U.S.	1970
Gripenin	Fujisawa	Japan	1970
Geopen	Pfizer Taito	Japan	1971
Pyocianil	Farmitalia	Italy	1972
Anabactyl	Beecham	W. Germany	—
Carbapen	C.S.L.	Australia	—
Carbecin	Beecham	—	—
Fugacillin	Astra	Sweden	—
Microcillin	Bayer	W. Germany	—
Rexcilina	Wolner	Spain	—

Raw Materials

Phenylmalonic acid	6-Amino penicillanic acid
Benzyl alcohol	Hydrogen
Thionyl chloride	Sodium bicarbonate

Manufacturing Process

The required monobenzyl phenylmalonate, MP 68°C, was prepared by treating a mixture of phenylmalonic acid (18 g) and benzyl alcohol (13 g) in carbon tetrachloride (80 ml) with dry hydrogen chloride.

Monobenzyl phenylmalonate (13.3 g) in dry benzene (100 ml) was refluxed with thionyl chloride (6.45 g) for 90 minutes, then concentrated in vacuo. The residual oil was dissolved in dry acetone (50 ml) and added to a stirred, ice-cooled solution of 6-aminopenicillanic acid (9.7 g) in N sodium bicarbonate solution (135 ml), water (150 ml), and acetone (300 ml). The mixture was stirred for 30 minutes at 0°C and then for 90 minutes at room temperature, then concentrated under reduced pressure to remove acetone. The aqueous solution was brought to pH 2 with dilute hydrochloric acid and extracted with ether (3 x 100 ml). The ether solution was washed with water and then itself extracted with sufficient N sodium bicarbonate solution to give an aqueous phase of pH 7.5. The aqueous layer was separated and evaporated at low temperature and pressure to leave the impure sodium salt of α -(benzyloxycarbonyl) benzylpenicillin.

This crude product (15.8 g) in water (360 ml) was added to a prehydrogenated suspension of 10% palladium on charcoal (4 g) in water (400 ml), and hydrogenation was continued for 30 minutes. The catalyst was removed and the filtrate was adjusted to pH 7.5 with sodium bicarbonate, then evaporated at low temperature and pressure. The residue was purified by chromatography on a column of cellulose powder, eluting first with butanol/ethanol/water mixture and then with acetone/isopropanol/water. The main fraction was evaporated at low temperature and pressure to give a 32% yield of the sodium salt of α -carboxybenzylpenicillin as a white powder. The product was estimated by manometric assay with penicillinase to be 58% pure.

References

- Merck Index 1773
- Kleeman & Engel p. 147
- PDR p. 1404
- OCDS Vol. 1 p. 414 (1977) & 2 p. 437 (1980)
- DOT 4 (3) 96 (1968)
- I.N. p. 183
- REM p. 1194
- Brain, E.G. and Naylor, J.H.C.; U.S. Patents 3,282,926; November 1, 1966 and 3,492,291; January 27, 1970; both assigned to Beecham Group Limited, England

CARBENICILLIN INDANYL SODIUM

Therapeutic Function: Antibacterial

Chemical Name: N-(2-carboxy-3,3-dimethyl-7-oxo-4-thia-1-azabicyclo[3.2.0] hept-6-yl)-2-phenylmalonic acid, 1-(5-indanyl ester), monosodium salt

Common Name: Carindacillin, Indanylcarbenicillin

Structural Formula:

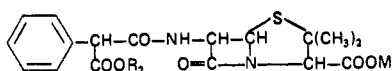

where R_2 is 5-indanyl, M is Na.

Chemical Abstracts Registry No.: 26605-69-6; 35531-88-5 (Base)

Trade Name	Manufacturer	Country	Year Introduced
Geocillin	Roerig	U.S.	1972
Carindapen	Pfizer	W. Germany	1973
Geopen	Pfizer	Switz.	1973
Geopen-U	Pfizer-Taito	Japan	1976
Unipen	Pfizer-Roerig	U.S.	—
Urobac	Pfizer-Roerig	—	—

Raw Materials

Phenylmalonic acid	Phosphorus pentachloride
5-Indanyl alcohol	Triethylamine
6-Aminopenicillanic acid	

Manufacturing Process

(A) Preparation of Phenylchlorocarbonyl Ketene: To phenylmalonic acid (20 g) in ethyl ether (100 ml) there is added phosphorus pentachloride (46 g). A vigorous reaction occurs. The reaction mixture is refluxed for 4 hours then the ether partially removed by heating on a steam bath. The reaction mixture becomes black when about half the ether is removed and the remaining ether is removed under reduced pressure (at 100 mm). The residue is distilled under vacuum and the fraction boiling at 75° to 90°C at 1.5 to 4 mm collected. The product, a yellow liquid, is redistilled at 74°C and 1.5 mm. It shows a strong peak in the infrared region of the spectrum at 4.69 μ . Repetition of this procedure but using 10 g of phenylmalonic acid instead of 20 g produces a less vigorous reaction on addition of the phosphorus pentachloride. The same product is obtained.

(B) Acylation of 6-Aminopenicillanic Acid: To a solution of the aryl halocarbonyl ketene (0.1 mol) in methylene chloride (sufficient to provide a clear solution and generally from about 5 to 10 ml per gram of ketene) there is added the proper alcohol R_2OH (0.1 mol), in this case 5-indanyl alcohol. The reaction mixture is maintained under an atmosphere of nitrogen and stirred for a period of from 20 minutes to 3 hours, care being taken to exclude moisture. The temperature may range from about -70° to about -20°C. The infrared spectrum of the mixture is then taken to determine and confirm the presence of the ketene ester. A solution of 6-aminopenicillanic acid-triethylamine salt (0.1 mol) in methylene chloride (50 ml) is added and the mixture stirred at -70° to -20°C for 10 minutes. The cooling bath is then removed and the reaction mixture stirred continuously and allowed to warm to room temperature.

Various isolation methods are then spelled out in U.S. Patent 3,679,801.

References

Merck Index 1823

Kleeman & Engel p. 155

PDR p. 1524

DOT 8 (8) 310 (1972 & 9 (4) 128 (1973)

I.N. p. 189

REM p. 1195

Butler, K.; U.S. Patents 3,557,090; January 19, 1971; 3,574,189; April 6, 1971; and 3,679,801; July 25, 1962; all assigned to Chas. Pfizer & Co., Inc.

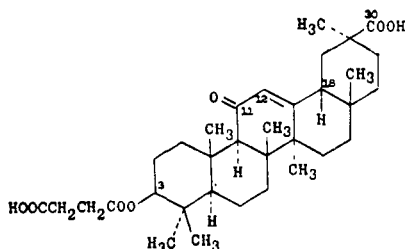
CARBENOXOLONE**Therapeutic Function:** Antiinflammatory (Gastric)**Chemical Name:** 3 β -hydroxy-11-oxo-20 β -olean-12-en-29-oic acid hydrogen butanedioate**Common Name:** Glycyrrhetic acid hydrogen succinate**Structural Formula:****Chemical Abstracts Registry No.:** 5697-56-3; 7421-40-1 (Sodium salt)

Trade Name	Manufacturer	Country	Year Introduced
Biogastrone	Winthrop	U.K.	1963
Biogastrone	Homburg	W. Germany	1970
Gastrasil	Italseber	Italy	1971
Biogastrone	Richardson-Merrell	Switz.	1978
Biogastron	Shionogi	Japan	1979
Biogastrone	Abic	Israel	—
Bioral	Biorex, Berk	U.K.	—
Duogastrone	Merrell	France	—
Duogastrone	Abic	Israel	—
Karbenol	Yutoglu	Turkey	—
Neogel	Homburg	W. Germany	—
Neutrogastrol Ulcus	Septa	Spain	—
Pyrogastone	Winthrop	U.K.	—
Sanodin	Leo	Spain	—
Sustac	Sintyal	Argentina	—
Terulcon	ISF	Italy	—
Uicofer	Mulda	Turkey	—
Ulcus-Tablinen	Sanorania	W. Germany	—
Ulkon	Eczacibasi	Turkey	—
Ventroxol	Medica	Finland	—

Raw Materials

Glycyrrhetic acid

Succinic anhydride

Manufacturing Process

23.5 g of glycyrrhetic acid were dissolved in 50 cc of dry pyridine. A solution of 6.0 g of succinic anhydride in 30 cc of dry pyridine was added, followed by 30 cc of dry triethylamine and then, for washing purposes, 5 cc of dry pyridine. The solution was heated on a boiling water bath for ten hours and then poured into excess of dilute hydrochloric acid and ice. The fine gray precipitate formed was filtered off, washed with water, dissolved in chloroform, and the solution repeatedly extracted with dilute hydrochloric acid and later with water. It was dried over sodium sulfate and evaporated to dryness. Crystallization from methanol, using charcoal to effect decolorization, gave the hydrogen succinate as cream-colored crystals, MP 291° to 294°C, with previous softening.

One molecular proportion of glycyrrhetic acid hydrogen succinate was ground with a dilute (5%) aqueous solution containing two molecular proportions of sodium hydroxide. The solution was filtered and evaporated in vacuum over concentrated sulfuric acid. The sodium salt is then obtained as a creamy white water-soluble solid. Glycyrrhetic acid is obtainable from licorice root.

References

Merck Index 1774

Kleeman & Engel p. 147

I.N. p. 183

Gottfried, S. and Baxendale, L.; U.S. Patent 3,070,623; December 25, 1962; assigned to Biorex Laboratories Limited, England

CARBIDOPA

Therapeutic Function: Muscle relaxant—Parkinsonism

Chemical Name: S- α -hydrazino-3,4-dihydroxy- α -methylbenzenepropanoic acid monohydrate

Common Name: Methyl dopahydrazine

Structural Formula:

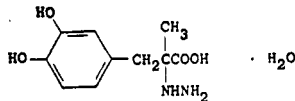

Chemical Abstracts Registry No.: 38821-49-7; 28860-95-9 (Anhydrous)

Trade Name	Manufacturer	Country	Year Introduced
Sinemet	Merck Sharp & Dohme	Italy	1974
Sinemet	Merck Sharp & Dohme	U.K.	1974
Nacom	Sharp & Dohme	W. Germany	1975
Sinemet	Chibret	France	1975
Lodosyn	Merck Sharp & Dohme	U.S.	1977
Menesit	Merck Banyu	Japan	1980
Neo-Dopaston	Sankyo	Japan	1980

Raw Materials

Vanillin
Nitroethane

Potassium cyanide
Hydrazine hydrate

Butylamine
Acetic acid
Iron

Hydrogen chloride
Hydrobromic acid
Hydrochloric acid

Manufacturing Process

To a solution of vanillin in toluene is added nitroethane, butylamine and glacial acetic acid. The mixture is refluxed and the water of reaction is steadily azeotropically removed by distillation. After the theoretical amount of water is distilled out, distillation is continued to remove excess reactants. The last trace of excess reactants is then removed at room temperature under a vacuum. The product is then triturated with a hydrocarbon solvent such as Skellysolve B and is thus obtained in a crystalline state. In general, however, it is preferred to dissolve the residue directly in toluene for use in the next step, without isolating the 1-(2-nitropropen-1-yl)-4-hydroxy-3-methoxybenzene.

A mixture of iron, ferric chloride and water is added to the toluene solution. The mixture is heated to reflux and concentrated hydrochloric acid is added dropwise at a rate calculated to keep the mixture refluxing vigorously. After the hydrochloric acid is all added, the refluxing is continued by the application of heat for several hours. A siliceous filter aid is then added to the cooled reaction mixture and the material is removed by filtration. The filter cake is washed four times, each time with 90 ml of benzene. The organic layer is then separated from the filtrate. The water layer is acidified to a pH of 2 and extracted three times with 90 ml portions of benzene.

These extracts are then combined with the organic solvent layer and the combined organic phase is extracted four times with 100 ml portions of water. It is then stirred for an hour with 230 ml of 10% sodium bisulfite solution. The organic solvent phase is then separated, washed seven times with 100 ml portions of water and dried over magnesium sulfate. Evaporation of the solvent gives 1-(4-hydroxy-3-methoxyphenyl)-2-propanone in the form of an oil.

A mixture of 59.5 g of that oily product, 1.85 liters of benzene and 1 kg of potassium bisulfite in 200 liters of water is stirred at room temperature for two hours. The precipitated bisulfite addition product of the ketone is isolated by filtration and washed with isopropanol and then with ether. Five hundred grams of the adduct is mixed with 119.5 g of potassium cyanide, 292 ml of 85% hydrazine hydrate and 910 ml of water. The mixture is stirred overnight at room temperature after which the product is isolated by filtration. The product is washed 3 times with 250 ml portions of water and then 3 times with 230 ml portions of ether. It is then air dried and vacuum dried at room temperature. The intermediate so produced has the following formula:

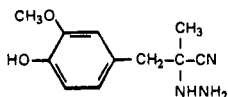

Fifty cubic centimeters of concentrated hydrochloric acid is saturated with hydrogen chloride gas at -10°C . To the solution is then added 2.5 g of the intermediate product, of the formula shown above, slowly with vigorous stirring. The mixture is allowed to stir overnight while warming at room temperature gradually. It is then concentrated in vacuo to a syrup. To the residual syrup is added 100 ml of 48% hydrobromic acid. The reaction vessel is purged with nitrogen and the reaction mixture is then refluxed for 3 hours after which it is concentrated in vacuo to a mixture of a syrup and a solid. The residue is taken up in sufficient water to form a clear solution. Activated charcoal is added and the mixture is heated to boiling and filtered.

The filtrate is concentrated to dryness in vacuo and the residue is taken up in 25 cc of ethanol. The residual ammonium bromide is removed by filtration and to the filtrate

there is added sufficient diethylamine to change the pH to 6.4. The mixture is warmed to 60°C and then cooled to room temperature. It is then allowed to stand overnight to effect complete crystallization. It is then cooled to 0°C and the product is isolated by filtration, washed with methanol and air dried. The product (α -hydrazino- α -methyl- β -(3,4-dihydroxyphenyl)-propionic acid) is recrystallized once from water using a proportion of 15 cc water per gram of product.

References

- Merck Index 1778
 Kleeman & Engel p. 148
 PDR p. 1210
 OCDS Vol. 2 p. 119 (1980)
 DOT 10 (9) 322 (1974)
 I.N. p. 184
 REM p. 929
 Chemerda, J.M., Sletzing, M. and Bollinger, F.W.; U.S. Patent 3,462,536; August 19, 1969; assigned to Merck & Co., Inc.

CARBINOXAMINE MALEATE

Therapeutic Function: Antihistaminic

Chemical Name: 2-[(4-chlorophenyl)-2-pyridinyl-methoxy] ,N,N-dimethylethanamine maleate

Common Name: —

Structural Formula:

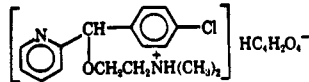

Chemical Abstracts Registry No.: 3505-38-2; 486-16-8 (Base)

Trade Name	Manufacturer	Country	Year Introduced
Clistin	McNeil	U.S.	1953
Allergefon	Lafon	France	1962
Polistin	Trommsdorf	W. Germany	1963
Cardec	Schein	U.S.	—
Cibelon	Taisho	Japan	—
Hislosine	Toho	Japan	—
Histex	Sigma	Australia	—
Histine	Pharbil	Belgium	—
Lergefin	Larma	Spain	—
Polistine	Pharbil	Netherlands	—
Rondec	Boss	U.S.	—
Ziriton	Importex	Italy	—

Raw Materials

p-Bromochlorobenzene	Magnesium
2-Pyridine aldehyde	Sodium metal
2-Dimethylaminoethyl chloride	

Manufacturing Process

As described in U.S. Patent 2,800,485 a solution of p-chlorophenylmagnesium bromide is prepared by adding dropwise a solution of 230 g (1.2 mols) of p-bromochlorobenzene in 900 cc of anhydrous ether to 26.7 g (1.1 g-atoms) of magnesium suspended in 100 cc of anhydrous ether containing a small crystal of iodine. To this solution, 107 g (1 mol) of 2-pyridine-aldehyde are added slowly with stripping at a rate to maintain refluxing. The reaction mixture is then stirred for one hour at room temperature. The mixture is then poured onto an equal volume of crushed ice and water and acidified with concentrated hydrochloric acid. The ether layer is removed. The aqueous layer is made basic with ammonia and extracted with ether. The ether solution is evaporated and the residue dried by addition of benzene and removal by distillation to give 208 g (95%) of solid α -(p-chlorophenyl)-2-pyridine-methanol melting at 78° to 80°C. The p-chlorophenyl pyridinemethanol may alternatively be prepared from 4-chloroacetophenone, pyridine and granular aluminum as described in U.S. Patent 2,606,195. In either case, the synthesis then proceeds as described in U.S. Patent 2,800,485.

A solution of 219 g (1 mol) of α -(p-chlorophenyl)-2-pyridinemethanol in one liter of dry toluene is heated to 100°C with stirring. Twenty-three grams (1 g-atom) of sodium are then added in portions. After all the sodium has reacted, a dried solution of 2-dimethylaminoethyl chloride in benzene is added. This benzene solution is prepared by dissolving 173 g (1.2 mols) of 2-dimethylaminoethyl chloride hydrochloride in the minimum amount of water, adding 500 cc of benzene followed by 300 g of sodium carbonate decahydrate, stirring, separating the benzene layer and drying.

The mixture is refluxed with stirring for ten hours, cooled and filtered. The filtrate is extracted three times with 200 cc portions of 6 N acetic acid. The aqueous acetic acid solution is then made strongly basic with 10% sodium hydroxide solution, and extracted three times with 200 cc portions of ether. The ether extract is dried with anhydrous sodium sulfate, stirred with 5 g of activated carbon and filtered to provide 2-[p-chloro- α (2-dimethylaminoethoxy)benzyl]pyridine in solution. Addition of a solution of 116 g (1 mol) of maleic acid in 1,500 cc of ether gives 323 g (79%) of solid which, on recrystallization from ethyl acetate, gives white solid 2-[p-chloro- α (2-dimethylaminoethoxy)benzyl]pyridine maleate melting at 117° to 119°C.

References

- Merck Index 1780
- Kleeman & Engel p. 150
- PDR pp. 1561, 1606
- OCDS Vol. 1 p. 43 (1977) and 2 p. 32 (1980)
- I.N. p. 184
- REM p. 1126
- Tilford, C.H. and Shelton, R.S.; U.S. Patent 2,606,195; August 5, 1952; assigned to The Wm. S. Merrell Company
- Swain, A.P.; U.S. Patent 2,800,485; July 23, 1957; assigned to McNeil Laboratories, Inc.

CARBOCYSTEINE

Therapeutic Function: Mucolytic; expectorant; nasal antiinfective

Chemical Name: S-(carboxymethyl)-L-cysteine

Common Name: —

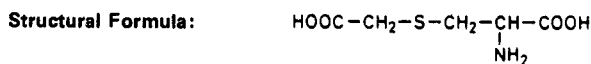

Chemical Abstracts Registry No.: 638-23-3

Trade Name	Manufacturer	Country	Year Introduced
Rhinathiol	Kramer	Switz.	—
Rhinathiol	Jouille	France	1961
Mucodyne	Berk	U.K.	1963
Transbronchin	Homburg	W. Germany	1975
Lisomucil	Lirca	Italy	1975
Mucodyne	Kyorin	Japan	1981
Actithiol	Funk	Spain	—
Bronchette	Continental Ethicals	S. Africa	—
Bronchipect	Mepros	Netherlands	—
Bronchokod	Genekod	France	—
Broncodeterge	Valderrama	Spain	—
Carbocit	C.T.	Italy	—
Flemex	Parke Davis	U.S.	—
Fluifort	Lampugnani	Italy	—
Loviscol	Robins	U.S.	—
Muciclar	Parke Davis	U.S.	—
Mucocaps	Berk	U.K.	—
Mucocis	Crosara	Italy	—
Mucolex	Warner Lambert	U.S.	—
Mucopront	Mack	W. Germany	—
Mucosirop	Berk	U.K.	—
Mucospect	Lennon	S. Africa	—
Mucoliz	Yurtoglu	Turkey	—
Pectox	Infar-Nattermann	Spain	—
Pulmoclease	UCB	Belgium	—
Reodyn	Remeda	Finland	—
Reomucil	Tosi	Italy	—
Siroxyl	Sopar	Belgium	—
Solvopect	Mepros	Netherlands	—

Raw Materials

L-Cysteine
Sodium metal
Chloroacetic acid

Manufacturing Process

There were placed 120 g of L-cysteine (0.5 mol) in a 2 liter three-necked flask equipped with a stirrer thermometer and methanol/dry ice cooling and 1.5 liters of liquid ammonia were allowed to enter at -40°C . Then there were added under continuous cooling 50 g (2.17 mols) of sodium metal in portions of 1 to 2 g during the course of one hour. The end of the reaction was recognized by the continuation of the blue color. After the end of the reaction the excess sodium was destroyed by the addition of ammonium chloride and the ammonia vaporized at normal pressure. The residue was taken up in 500 ml of water and concentrated in a vacuum to 200 ml in order to remove residual ammonia, and again treated with 300 ml of water. The entire operations were carried out under a nitrogen atmosphere.

The aqueous solution of the disodium salt of L-cysteine obtained is then reacted at 20°C to 30°C under a nitrogen atmosphere in the course of 30 minutes with stirring with a solution of 104 g of chloroacetic acid (1.1 mols) and 4 g of sodium pyrosulfite in 200 ml of water. It is also allowed to post react for 15 minutes at 20°C , the solution clarified over activated carbon and the filtrate treated with 90 ml of concentrated hydrochloric acid to a pH of 2.5.

Thereby the S-carboxymethyl-L-cysteine precipitates out in crystalline form. The product is filtered off with suction, well stirred in 500 ml of water, again filtered with suction and dried in a vacuum at 70°C. The yield is 92% based on L-cysteine.

References

Merck Index 1785

Kleeman & Engel p. 151

I.N. p. 185

Maierhofer, A. and Wagner, H.; U.S. Patent 4,129,593; December 12, 1978; assigned to Deutsche Gold- und Silber-Scheideanstalt vormals Roessler (Germany)

CARBOMYCIN

Therapeutic Function: Antibiotic

Chemical Name: 9-Deoxy-12,13-epoxy-9-oxo-leucomycin V-3-acetate-4B-(3-methyl-butanoate)

Common Name: —

Structural Formula:

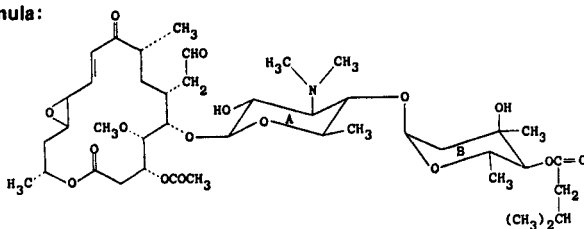

Chemical Abstracts Registry No.: 4564-87-8

Trade Name	Manufacturer	Country	Year Introduced
Magnamycin	Pfizer	U.S.	1953

Raw Materials

Nutrient broth
Streptomyces halstedii bacterium

Manufacturing Process

A selected strain of *Streptomyces halstedii* was cultivated in an aqueous nutrient medium under aerobic conditions and the resulting broth containing carbomycin antibiotics was filtered. The solutions was extracted twice at pH 6.5 with one-quarter volume of methyl isobutyl ketone. The combined extracts were concentrated to one-tenth volume under vacuum, and the antibiotics were extracted into water adjusted to a pH of about 2 with sulfuric acid. After adjusting the separated aqueous solution to pH 6.5, the antibiotic was extracted into benzene and the solution was concentrated to a small volume. Addition of hexane resulted in the separation of a solid product containing the benzene complexes of carbomycin A and carbomycin B, present in the fermentation broth.

References

Merck Index 1790

I.N. p. 186

Tanner, F.W. Jr., Lees, T.M. and Routien, J.B.; U.S. Patent 2,771,392; November 20, 1956; assigned to Chas. Pfizer & Co., Inc.

Friedman, I.J., Martin, E.G., Taylor, R.J. and Wagner, R.L. Jr.; U.S. Patent 2,960,438; November 15, 1960; assigned to Chas. Pfizer & Co., Inc.

CARBOQUONE

Therapeutic Function: Antineoplastic

Chemical Name: 2,5-Bis(1-aziridiny)-3-(1-methoxy-2-carbamoyloxyethyl)-6-methyl-1,4-benzoquinone

Common Name: Carbazilquinone

Structural Formula:

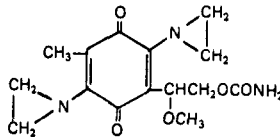

Chemical Abstracts Registry No.: 24279-91-2

Trade Name	Manufacturer	Country	Year Introduced
Esquinon	Sankyo	Japan	1974

Raw Materials

2-Methyl-5-(1-methoxy-2-carbamoyloxyethyl)-1,4-benzoquinone
Aziridine

Manufacturing Process

In 10 ml of ethanol was dissolved with heating 200 mg of 2-methyl-5-(1-methoxy-2-carbamoyloxyethyl)-1,4-benzoquinone and the resulting solution was cooled. To the cooled solution was added 0.5 ml of aziridine and then the resulting mixture was allowed to stand in a refrigerator at 5°C to 8°C for 4 days. Thereafter, the crystalline substance which precipitated *in situ* was recovered by filtration and washed with ethanol to give 50 mg of the desired product as red crystals melting at 200°C (with decomposition).

References

Merck Index 1806

Kleeman & Engel p. 151

DOT 11 (9) 344 (1975)

I.N. p. 186

Nakao, H., Arakawa, M. and Nakamura, T.; U.S. Patent 3,631,026; December 28, 1971; assigned to Sankyo Co., Ltd.

CARBUTEROL

Therapeutic Function: Bronchodilator

Chemical Name: [5-[2-[(1,1-Dimethylethyl)amino]-1-hydroxyethyl]-2-hydroxyphenyl] urea

Common Name: —

Structural Formula:

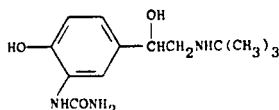

Chemical Abstracts Registry No.: 34866-47-2

Trade Name	Manufacturer	Country	Year Introduced
Bronsecur	SK&F	W. Germany	1980
Bronsecur	SK&F	Italy	1980
Pirem	Sasse	W. Germany	1982
Dilabron	Warner-Lambert	—	—
Rispan	SK&F	—	—

Raw Materials

3-Amino-4-benzyloxyacetophenone	Phosgene
Ammonia	Bromine
N-Benzyl-N-t-butylamine	Hydrogen

Manufacturing Process

A stirred solution of 40 g (0.41 m) of phosgene in 150 ml of toluene is held at 25°C with a cooling bath while a mixture of 25.2 g (0.105 m) of 3-amino-4-benzyloxyacetophenone and 220 ml of toluene are added slowly. The mixture is heated to reflux and continued for 30 minutes. Nitrogen is passed through the mixture and then concentrated in vacuo to give a crystalline isocyanate, MP 105°–106°C.

A stirred solution of the isocyanate (28.0 g) in 500 ml of dry benzene is saturated with ammonia. After one hour, the mixture is cooled to give the crystalline 4-benzyloxy-3-ureidoacetophenone, MP 184°–186°C.

To a stirred solution of 5.7 g (0.02 m) of 4-benzyloxy-2-ureidoacetophenone in 100 ml of chloroform is added 3.2 g (0.02 m) of bromine. The mixture is stirred at room temperature for about 45 minutes and the solution is concentrated in vacuo at 25°–30°C. The amorphous residue (hydrobromide salt of 4-benzyloxy- α -bromo-3-ureidoacetophenone) is dissolved in 80 ml of acetonitrile and 9.8 g (0.06 m) of N-benzyl-N-t-butylamine is added. The mixture is stirred and refluxed for 1.5 hours, then it is cooled to 0°C in an ice bath. Crystalline N-benzyl-N-t-butylamine hydrobromide is filtered. The filtrate is acidified with ethereal hydrogen chloride. The semicrystalline product is filtered after diluting the mixture with a large excess of ether. Trituration of the product with 60 ml of cold ethanol gives 4-benzyloxy- α -(N-benzyl-N-t-butylamino)-3-ureidoacetophenone hydrochloride, MP 200°–221°C (decomposition).

A solution of 10.5 g (0.0218 m) of 4-benzyloxy- α -(N-benzyl-N-t-butylamino)-3-ureidoacetophenone hydrochloride in 65 ml of methanol and 25 ml of water is added to a suspension of 1.5 g of 10% palladium-on-carbon in 10 ml of water. The mixture is hydrogenated on the Parr apparatus at room temperature, using an initial pressure of 60 psi of hydrogen. After 4 hours about 80% of the theoretical volume of hydrogen has been absorbed. The mixture is filtered, an additional 1.5 g of 10% palladium-on-carbon is added and the mixture is again hydrogenated on the Parr apparatus under the same conditions. After hydrogenating for an additional 3 hours, the mixture is filtered and the filtrate is concentrated in vacuo. The residue is stripped twice with toluene and crystallized with ether-ethanol to give α -(t-butylamino-methyl)-4-hydroxy-3-ureidobenzyl alcohol hydrochloride, MP 214°–215°C.

References

Merck Index 1817

DFU 1 (9) 412 (1976)

Kleeman & Engel p. 153

OCDS Vol. 2 p. 41 (1980)

DOT 12 (2) 483 (1976)

I.N. p. 187

Kaiser, C. and Ross, S.T.; U.S. Patent 3,763,232; October 2, 1973; assigned to Smith Kline & French Laboratories

Kaiser, C. and Ross, S.T.; U.S. Patent 3,917,847; November 4, 1975; assigned to Smith Kline Corp.

CARGUTOCIN

Therapeutic Function: Oxytotic

Chemical Name: 1-Butanoic acid-7-glycine-1,6-dicarboxytocin

Common Name: —

Structural Formula:

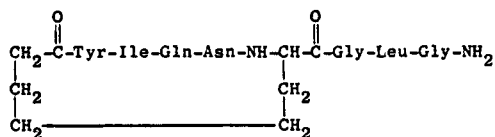

Chemical Abstracts Registry No.: 33065-67-3

Trade Name	Manufacturer	Country	Year Introduced
Statocin	Yoshitomi	Japan	1982

Raw Materials

Cyclic polypeptide
Hydrogen

Manufacturing Process

To a suspension of Z-Tyr(Bz)-Ile-Gln-Asn-Asu(OTCP)-Gly-Leu-Gly-NH₂ (1,310 mg) in DMF (350 ml) is added a suitable amount of palladium black. Hydrogen gas is introduced with stirring at room temperature (25°C) for about 40 hours. After stirring the mixture at 30°-35°C for several hours, the catalyst is filtered off and the filtrate is concentrated under reduced pressure. A large amount of ether is added to the residue, and the white coagulum is collected by filtration, washed with ether and dried. This is dissolved in water (30 ml), and the solution is filtered. The filtrate is passed through a column (3 x 11.5 cm) of Amerlite IR-45 (OH-form). The fractions which show a UV-absorption maximum at 280 mμ are combined and passed through a column (3 x 12.5 cm) of CM-Sephadex C-25 to remove the noncyclic compound and obtain neutral parts. The detection of the objective compound is made by UV-absorption at 280 mμ. The aqueous solution of the neutral parts is concentrated below 35°C, under reduced pressure, and the concentrate is lyophilized to give 504 mg of the crude title compound in the form of 5 hydrate.

References

Merck Index 1822

DFU 8 (3) 188 (1983)

DOT 19 (3) 130 (1983)

Sakakibara, S. and Yamanaka, T.; U.S. Patent 3,749,705; July 31, 1973; assigned to Yoshitomi Pharmaceutical Industries Ltd. (Japan)

CARISOPRODOL

Therapeutic Function: Skeletal muscle relaxant

Chemical Name: (1-methylethyl)carbamic acid 2-[(aminocarbonyl)oxy]methyl)-2-methylpentyl ester

Common Name: Isopropyl meprobamate

Structural Formula:

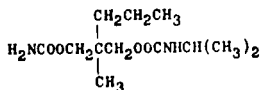

Chemical Abstracts Registry No.: 78-44-4

Trade Name	Manufacturer	Country	Year Introduced
Soma	Wallace	U.S.	1959
Rela	Schering	U.S.	1959
Sanoma	Heilit	W. Germany	—
Flexartal	Clin Midy	France	1961
Caprodat	Ferrosan	Denmark	—
Carisol	AFI	Norway	—
Carisoma	Wallace	U.S.	—
Diolene	Pharma. Farm. Spec.	Italy	—
Erbasoma	Erba	Italy	—
Meprodat	Star	Finland	—
Mioril	Rossini	Italy	—
Mioxom	Dessy	Italy	—
Myobutazolidin	Fujisawa	Japan	—
Relasom	Rafa	Israel	—
Relaxo-Powel	Erba	Italy	—
Soma	Horner	Canada	—
Soma	Guidotti	Italy	—
Somadril	Dumex	Denmark	—
Somalgit	Wallace	U.S.	—
Somalgit Simple	Inibsa	Spain	—
Somanil	Banyu	Japan	—
Soprodol	Schein	U.S.	—

Raw Materials

2-Methyl-2-propyl-1,3-propanediol
Isopropylamine

Phosgene
Sodium Cyanate

Manufacturing Process

A cooled 10% solution of 1 mol of phosgene in toluene was added with stirring to a cooled solution of 1 mol of 2-methyl-2-propyl-1,3-propanediol and 2 mols of dimethylaniline also dissolved in toluene, at such a rate that the temperature of the mixture was maintained at about 25°C. The mixture was allowed to remain at this temperature for several hours, then

cooled and extracted with cold 5% hydrochloric acid solution to remove the dimethyl-aniline. The toluene layer was dried using a suitable drying agent and the 2-methyl-2-propyl-3-hydroxypropyl chlorocarbonate used in subsequent reactions in the form of its solution in anhydrous toluene.

A quantity of solution obtained as described containing 0.1 mol of the chlorocarbonate was treated with 0.2 mol of anhydrous isopropylamine and allowed to react at ordinary room temperature. The solution was cooled, extracted with dilute hydrochloric acid and the organic layer concentrated by evaporation of the solvent. The crude monocarbamate was purified by distilling at 86° to 88°C at about 0.01 mm. It was a clear, viscous liquid.

21.7 g (0.1 mol) of N-isopropyl-2-methyl-2-propyl-3-hydroxypropyl carbamate and 7.5 g (0.11 mol) of anhydrous sodium cyanate are stirred in 200 ml anhydrous chloroform in a suitable vessel equipped with a gas inlet tube, stirrer and thermometer. While cooling the vessel, anhydrous hydrogen chloride is passed into the stirred mixture slowly for 5 hours maintaining the temperature between 0° and 5°C. Alternatively ethyl urethane in the presence of aluminum isopropylate as a catalyst may be used in place of the sodium cyanates and HCl. The mixture is then allowed to stand at room temperature overnight.

The solid material is separated by filtration and the chloroform solution concentrated to an oil under reduced pressure. The oil is dissolved in 50 ml of trichloroethylene, the solution treated with charcoal, filtered and the filtrate added to 125 ml of hexane. The crystalline material which forms on standing at refrigerator temperature is removed by filtration, washed with light petroleum ether and dried at about 50°C. Approximately 20 g of product are obtained. On recrystallizing from trichloroethylene-hexane, 17.8 g of purified compound are obtained, MP 89° to 91°C.

References

Merck Index 1824

Kleeman & Engel p. 155

PDR pp. 830, 1606, 1883

OCDS Vol. 1 p. 219 (1977)

I.N. p. 189

REM p. 926

Berger, F.M. and Ludwig, B.J.; U.S. Patent 2,937,119; May 17, 1960; assigned to Carter Products, Inc.

CARMOFUR

Therapeutic Function: Antineoplastic

Chemical Name: 5-Fluoro-N-hexyl-3,4-dihydro-2,4-dioxo-1(2H)-pyrimidinecarboxamide

Common Name: HCFU

Structural Formula:

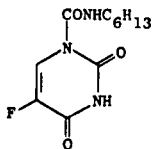

Chemical Abstracts Registry No.: 61422-45-5

Trade Name	Manufacturer	Country	Year Introduced
Mifurol	Mitsui	Japan	1981
Yamafur	Yamanouchi	Japan	1981

Raw Materials

5-Fluorouracil
n-Hexyl isocyanate

Manufacturing Process

13.0 g (0.10 mol) of 5-fluorouracil was suspended in 60 ml of dimethyl acetamide, then 14.0 g (0.11 mol) of n-hexyl isocyanate was added thereto at room temperature and stirred at 50°C for 8 hours. After the reaction mixture was concentrated under reduced pressure, the residue was poured into 400 ml of water and resultant precipitate was filtered off. The precipitate was washed and dried and 19.3 g (75.0% yield) of 5-fluoro-1-(n-hexylcarbamoyl)uracil was obtained.

The product was recrystallized from ether and there were obtained white crystals melting at 283°C (decomposition).

References

Merck Index 1828

DFU 1 (4) 235 (1982)

DOT 18 (9) 424 (1982)

I.N. p. 190

Ozaki, S. and Mori, H.; U.S. Patent 4,071,519; January 31, 1978; assigned to Mitsu Toatsu Chemicals, Inc.

CARNITINE

Therapeutic Function: Gastric and pancreatic stimulator

Chemical Name: 3-Carboxy-2-hydroxy-N,N,N-trimethyl-1-propanaminium hydroxide, inner salt

Common Name: —

Structural Formula:

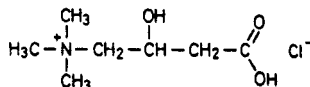

Carnitin
(Hydrochlorid)

Chemical Abstracts Registry No.: 461-06-3; 5842-94-8 (Hydrochloride)

Trade Name	Manufacturer	Country	Year Introduced
Fiatistine	Sauba	France	1978
Carnetina	Sigma Tau	Italy	1981
Nefrocarnit	Nefro Pharma	W. Germany	1983
Carnitene	Refarmed SA	Switz.	1983
Abedine	Nippon Zoki	Japan	—
Bicarnesine	Labaz	France	—
Carn	Benvegna	Italy	—

Trade Name	Manufacturer	Country	Year Introduced
Carnitan	Kakenyaku	Japan	—
Carnitine	Tyson	U.S.	—
Carnitolo	Sirt-B.R.P.	Italy	—
Entomin	Maruko	Japan	—
Metina	Francia Farm	Italy	—
Monocamin	Tanabe	Japan	—
Polycartin	Daigo Eiyo	Japan	—

Raw Materials

Trimethylamine	Epichlorohydrin
Sodium cyanide	Hydrogen chloride

Manufacturing Process

9.3 g of epichlorohydrin was added at a temperature of 40°–50°C under stirring to 9.6 g of trimethylamine hydrochloride dissolved in 10 cc of water. Continuing the reaction for an hour at the above temperature, the reaction product was concentrated under reduced pressure to obtain the crystals of 3-chloro-2-oxypopyl trimethyl ammonium chloride which were recrystallized with 25 cc of ethanol. The crystals obtained by concentrating the mother liquor were also recrystallized. The yield was 17.4 g (MP 190°C, yield 91.5%). This substance occurs as white, somewhat hygroscopic crystals and is readily soluble in water or alcohol, but insoluble in benzene, toluene, ether, acetone or chloroform.

The result of analysis assuming $(C_6H_{15}Cl_2N)^+Cl^-$ —calculated value: N, 7.45%; total Cl, 37.7%; Cl^- , 18.88%. Observed value: N, 7.36%; total Cl, 37.54%; Cl^- , 18.98%.

18.8 g of 3-chloro-2-oxypopyl trimethyl ammonium chloride was dissolved in a mixed solvent composed of 19 cc of methanol and 1 cc of water. 5.1 g of sodium cyanide dissolved in 8 cc of water was dropped into the solution at 50°C under stirring. After dropping, the mixture was held at this temperature for 30 minutes under stirring. The reaction product was then neutralized with 6 N hydrochloric acid toward pH 5, and, after cooling, sodium chloride separated out and was filtered. The filtrate was concentrated to dryness under reduced pressure, and the residue was washed with small quantity of ethanol. Drying the residue, dissolving in hot methanol, filtering off insoluble matters, and cooling mother liquor, the crystals of 3-cyano-2-oxypopyl trimethyl ammonium chloride which deposited out were filtered and dried. Yield 16.7 g [MP (decomposition) 220°–223°C, yield 93.4%].

12.5 cc of concentrated hydrochloric acid was added to 17.9 g of 3-cyano-2-oxypopyl trimethyl ammonium chloride. Gradually heating the mixture on a water bath under stirring, so bringing the temperature up to 98°C at the end of about 3 hours, 9 cc of water was added. After cooling, free hydrochloric acid was neutralized with 3 cc of 6 N sodium hydroxide, and then by adding 1 g of active charcoal, the reaction product was decolorized and filtered. The filtrate was concentrated to almost dryness under reduced pressure. Then, this concentrate was, after washing with 10 cc of ethanol, dried. Yield 24.7g.

The dried product was dissolved in 46.5 cc of glacial acetic acid by heating on a boiling water bath. The insoluble matter is removed by filtering hot, and on cooling the mother liquor, crystals of carnitine hydrochloride separated out. The crystals were filtered, washed with 10 cc of ethanol, and dried. Recrystallizing 19.7 g of the crude carnitine with methanol, 17 g of the refined carnitine was obtained [MP 195°–198°C (decomposing point), yield 86%]. The overall yield of the refined carnitine through whole steps was about 74%. Carnitine thus prepared was an odorless, white, crystalline powder, having a strong acid taste.

References

- Merck Index 1833
 Kleeman & Engel p. 156
 PDR p. 1807

DOT 19 (4) 185 (1983)

I.N. p. 190

Noguchi, J. and Sakota, N.; U.S. Patent 3,135,788; June 2, 1964; assigned to Nihon Zoki Seiyaku Kabushikikaisha (Japan)

β-CAROTENE

Therapeutic Function: As a vitamin A precursor; sunscreen agent

Chemical Name: β-Carotene

Structural Formula:

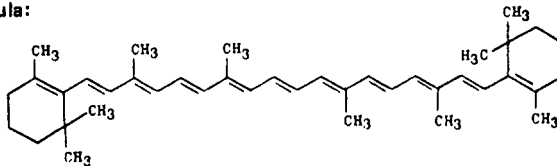

Chemical Abstracts Registry No.: 7235-40-7

Trade Name	Manufacturer	Country	Year Introduced
Carotaben	Hermal	W. Germany	1975
Solatene	Roche	U.S.	1975
Vitacarotene	Pellestier	Spain	—
Beta-Carotene	Solgar	U.S.	—

Raw Materials

3,8-Dimethyl-3,5,7-decatrien-1,9-diyne
 Phenyl Lithium
 4-(2,6,6-Trimethyl-1-cyclohexen-1-yl)-2-methyl-2-buten-1-al
 Hydrogen

Manufacturing Process

3.6 g (0.023 mol) of 3,8-dimethyl-3,5,7-decatrien-1,9-diyne were dissolved in 50 ml of absolute ether, and to the solution was added 0.05 mol of ethereal phenyl-lithium solution. The mixture was refluxed for 30 minutes. Then a solution of 11 g (0.05 mol) of 4-(2,6,6-trimethyl-1-cyclohexen-1-yl)-2-methyl-2-buten-1-al in 100 ml of ether was added dropwise, and the reaction mixture was boiled for 2 hours. The reaction mixture was then hydrolyzed with aqueous ammonium acetate solution, and the ethereal layer was separated, dried and concentrated. The residue, i.e., 1,18-di(2,6,6-trimethyl-1-cyclohexen-1-yl)-3,7,12,16-tetramethyl-4,15-dihydroxy-2,7,9,11,16-octadecapentaen-5,13-diyne, was a resinous product (having 1.9 active hydrogen atoms and absorption maxima in the ultraviolet spectrum at 326 and 341 mμ) which was used for the next step without any further purification. The resin was dissolved in 200 ml of methylene chloride, 10 ml of glacial acetic acid were added to the solution, and the mixture was cooled to -40°C in a carbon dioxide atmosphere, while stirring. Then, 9 ml of aqueous hydrobromic acid (60%) were added in one portion, the mixture was stirred at -35°C for 1½ minutes, and subsequently 200 ml of ice water were run into the mixture. After further stirring the mixture for 2 hours at 0°C, the methylene chloride layer was separated, washed with water and sodium bicarbonate solution, dried with Na₂SO₄ and concentrated in vacuo. The residue, i.e., 11,12-11',12'-bisdehydro-β-carotene, was a tough resin or a foamy solid (having no active hydrogen atoms and possessing absorption maxima in the ultraviolet

spectrum at 334 and 408 $m\mu$). This product can be purified by chromatography. The crude product can also be used for the next step without any preliminary purification.

11.4 g of 11,12-11',12'-bisdehydro- β -carotene were dissolved in 100 ml of petroleum ether (boiling range 80° to 100°C), and the solution was hydrogenated under normal conditions after the addition of 0.5 ml of quinoline and 5 g of a lead-poisoned palladium catalyst. After the calculated amount of hydrogen had been absorbed, the catalyst was removed by filtration and the filtrate was extracted with dilute sulfuric acid to remove the quinoline. By concentrating the solution in the usual manner there was obtained 11,12-11',12'-di-cis-carotene. The product was purified by recrystallization from benzene-alcohol. The purified product melts at 154°C; absorption maxima in the ultraviolet spectrum at 276, 334, 338, 401 and 405 $m\mu$. The isomerization was effected by heating the product for 10 hours at 90° to 100°C in high-boiling petroleum ether in a carbon dioxide atmosphere. The resulting β -carotene melted at 180°C; ultraviolet absorption maxima at 452 and 480 $m\mu$.

Preparation of the intermediates for the above chemical synthesis are also described in U.S. Patent 2,917,539. The other patents cited below describe a fermentation route. U.S. Patent 2,848,508 describes preparation from carrots.

References

Merck Index 1837
PDR pp. 1501, 1734
I.N. p. 136
REM p. 1005

Barnett, H.M., Hartmann, M.L., Mosher, R.C. and Espoy, H.M.; U.S. Patent 2,848,508; August 19, 1958; assigned to Barnett

Iser, O., Montavon, M., Ruegg, R. and Zeller, P.; U.S. Patent 2,917,539; December 15, 1959; assigned to Hoffman-LaRoche, Inc.

Zajic, J.E.; U.S. Patents 2,959,521 and 2,959,522; November 8, 1960; both assigned to Grain Processing Corp.

Miescher, G.M., U.S. Patent 3,001,912; September 26, 1961; assigned to Commercial Solvents Corp.

Zajic, J.E.; U.S. Patent 3,128,236; April 7, 1964; assigned to Grain Processing Corp.

CAROXAZONE

Therapeutic Function: Antidepressant

Chemical Name: 2-Oxo-2H-1,3-benzoxazine-3(4H)-acetamide

Common Name: —

Structural Formula:

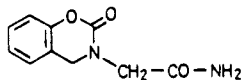

Chemical Abstracts Registry No.: 18464-39-6

Trade Name	Manufacturer	Country	Year Introduced
Timostenil	Farmitalia	Italy	1975

Raw Materials

Ethyl glycinate HCl

Hydrogen

Salicylic aldehyde
Ammonia

Phosgene

Manufacturing Process

37.9 g of ethyl glycinate hydrochloride were dissolved in 400 cc of ethanol and 33.5 g of salicylic aldehyde were added. It is refluxed for half an hour and cooled. 38 cc of triethylamine and 25 g of Raney nickel are then added whereafter hydrogenation is carried out at room temperature and under atmospheric pressure. After hydrogen adsorption was complete, the mixture was filtered and the alcohol evaporated off. The residue was taken up with acidified water, extracted with ether to eliminate part of the by-products, consisting mainly of o-cresol, then made alkaline with ammonia and extracted with ethyl acetate. The solvent was removed in vacuo and the residue crystallized from ether/petroleum ether. 36.7 g of o-hydroxybenzylaminoacetic acid ethyl ester melting at 47°C are obtained.

20 g of this compound were dissolved in 100 cc of tetrahydrofuran and 100 cc of a 30% solution of phosgene in tetrahydrofuran solution were added. After one night at room temperature, the reaction mixture was dried, taken up with 150 cc of anhydrous pyridine and allowed to stand overnight. The pyridine was then removed in vacuo and the residue dissolved in benzol was washed several times with water and chromatographed over 250 g of alumina. Elution with benzene/petroleum ether yielded 16 g of 4H-3-carboethoxymethyl-1,3-benzoxazine-2-one, melting at 90°-91°C.

5 g of this last compound were dissolved in 120 cc of absolute ethanol and saturated with NH₃ at 0°C. It was allowed to stand overnight whereafter 1.5 g of 4H-3-carboxamidomethyl-1,3-benzoxazine-2-one, melting at 205°C, were obtained. By evaporation from the mother liquors further quantities of the same product were obtained.

References

Merck Index 1842

Kleeman & Engel p. 157

OCDS Vol. 3 p. 191 (1984)

DOT 12 (6) 236 (1976)

I.N. p. 190

Bernardi, L., Coda, S., Pegrassi, L. and Suchowsky, G.K.; U.S. Patent 3,427,313; February 11, 1969; assigned to Societa Farmaceutici Italia (Italy)

CARPHENAZINE MALEATE

Therapeutic Function: Tranquilizer

Chemical Name: 1-[10-[3-[4-(2-hydroxyethyl)-1-piperazinyl] propyl] 10H-phenothiazin-2-yl]-1-propanone dimaleate

Common Name: Carfenazine maleate

Structural Formula:

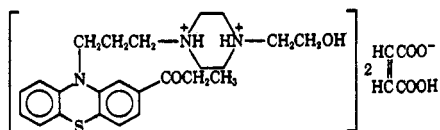

Chemical Abstracts Registry No.: 2975-34-0; 2622-30-2 (Base)

Trade Name	Manufacturer	Country	Year Introduced
Proketazine	Wyeth	U.S.	1962

Raw Materials

2-Propionylphenothiazine	Sodium Hydride
N-(2-hydroxyethyl) piperazine	Trimethylene chlorobromide

Manufacturing Process

As described in U.S. Patent 3,023,146, in a round-bottomed flask were placed 35 g of 2-propionyl phenothiazine (0.14 mol) 7 g of 50% sodium hydride in mineral oil (0.14 mol), and 240 cc of dimethyl formamide dried over sodium hydride. The resultant solution was stirred at room temperature for 2 hours, and then 88 g (0.56 mol) of trimethylene chlorobromide was added at once.

The mixture was stirred for 2 hours, heated at 60° to 70°C for 1 hour and poured into 2 liters of H₂O. The resulting suspension was extracted with ether, the ether layer separated and the ether removed under vacuum. A gummy mass remained which was dissolved in decalin and the solution was partly distilled to remove excess chlorobromide. After removal of most of the decalin under vacuum, the residue was treated with a large excess of N-(β-hydroxyethyl)-piperazine and heated on a steam bath for 2 hours. This material was extracted with dilute aqueous HCl, this acid layer neutralized with aqueous base and the resulting oil extracted into ether. The ether layer was washed with water until the washings were neutral and dried over anhydrous potassium carbonate. On treatment with maleic acid in ether a yellow solid separated which was recrystallized from isopropanol. This yellow solid had MP 175° to 177°C.

References

Merck Index 1844

Kleeman & Engel p. 154

OCDS Vol. 1 p. 383 (1977)

I.N. p. 188

REM p. 1086

Tislow, R.F., Bruce, W.F. and Page, J.A.; U.S. Patent 3,023,146; February 27, 1962; assigned to American Home Products Corporation

Sherlock, M.H. and Sperber, N.; U.S. Patent 2,985,654; May 23, 1961; assigned to Schering Corporation

CARPROFEN

Therapeutic Function: Antiinflammatory

Chemical Name: 6-Chloro-α-methylcarbazole-2-acetic acid

Structural Formula:

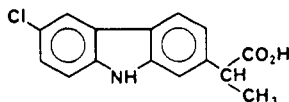

Chemical Abstracts Registry No.: 53716-49-7

Trade Name	Manufacturer	Country	Year Introduced
Imadyl	Roche	Switz.	1981
Imadyl	Roche	W. Germany	1982

Trade Name	Manufacturer	Country	Year Introduced
Imafen	Roche	—	—
Rimadyl	Roche	—	—

Raw Materials

6-Chloro- α -methyl-1,2,3,4-tetrahydrocarbazole-2-acetic acid ethyl ester
 p-Chloranil
 Sodium hydroxide
 Hydrogen chloride

Manufacturing Process

A mixture of 34.9 g of 6-chloro- α -methyl-1,2,3,4-tetrahydrocarbazole-2-acetic acid ethyl ester (mixture of diastereomers), 350 ml CP xylene and 56.0 g of p-chloranil was stirred and heated under an atmosphere of dry nitrogen. The reaction flask was wrapped in aluminum foil in order to keep out any extraneous light. After the reaction mixture had stirred at reflux temperature for 6 hours, heating and stirring were stopped and the reaction mixture was left overnight at room temperature. The supernatant liquid was decanted through a filter. The residue was triturated with 100 ml of warm benzene and the supernatant liquid was decanted through a filter. This process was repeated three more times. Ether (300 ml) was added to the combined filtrates. The solution was extracted with cold 2N sodium hydroxide (3 x 100 ml), washed by extraction with water until neutral and dried over anhydrous magnesium sulfate. Following filtration of the desiccant and evaporation of the solvent, a residue of 35.5 g remained. Crystallization from 50 ml of methanol gave 14.8 g of 6-chloro- α -methylcarbazole-2-acetic acid ethyl ester, MP 106°–107.5°C (43.2%).

A stirred mixture of 11 g of 6-chloro- α -methylcarbazole-2-acetic acid ethyl ester, 100 ml ethanol and 100 ml of 3N sodium hydroxide was heated (N₂ atmosphere). After 2 hours at reflux, the reaction mixture was concentrated to dryness under reduced pressure. Water (300 ml) and ice (200 g) were added to the residue and concentrated hydrochloric acid was added until the mixture was strongly acid. The acidic mixture was extracted with ether (3 x 200 ml). The ether extracts were combined, washed by extraction with water (3 x 100 ml) and dried over anhydrous magnesium sulfate. Following filtration of the desiccant and evaporation of the solvent, a yield of 9.8 g (98.2%) was obtained. Crystallization from CHCl₃ yielded 6.2 g (62.0%) of 6-chloro- α -methylcarbazole-2-acetic acid, MP 197°–198°C. A second crop of 1.6 g, MP 195°–199°C was obtained from the mother liquors.

References

Merck Index 1846
 DFU 2 (1) 15 (1977)
 OCDS Vol. 3 p. 169 (1984)
 DOT 18 (4) 172 (1982)
 I.N. p. 191
 Berger, L. and Corraz, A.J.; U.S. Patent 3,896,145; July 22, 1975; assigned to Hoffmann-LaRoche, Inc.

CARTEOLOL

Therapeutic Function: Beta-adrenergic receptor antagonist

Chemical Name: 5-(3-tert-Butylamino-2-hydroxypropoxy)-3,4-dihydrocarbostyrl

Common Name: —

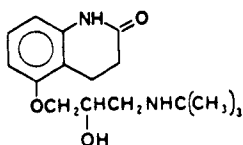
Structural Formula:

Chemical Abstracts Registry No.: 51781-06-7

Trade Name	Manufacturer	Country	Year Introduced
Mikelan	Otsuka	Japan	1981
Endak	Madaus	W. Germany	1982

Raw Materials

5-Hydroxy-3,4-dihydrocarbostyryl
Epibromohydrin
t-Butylamine

Manufacturing Process

A mixture of 1.63 g of 5-hydroxy-3,4-dihydrocarbostyryl, 2.5 g of epibromohydrin and 2 drops of piperidine was heated at a temperature of 95°C to 100°C for a period of 4 hours with stirring. The reaction mixture was then concentrated to dryness under reduced pressure and the residue was recrystallized from acetone to obtain 1.2 g of 5-(2,3-epoxy)propoxy-3,4-dihydrocarbostyryl as a colorless powder having a melting point of 172°C to 173°C.

A mixture of 0.75 g of 5-(2,3-epoxy)propoxy-3,4-dihydrocarbostyryl, 1.0 g of tert-butylamine and 25 ml of ethanol was stirred at a temperature of from 50°C to 55°C for a period of 4 hours. Ethanol and unreacted tert-butylamine were distilled off under reduced pressure and the resulting residue was dissolved in acetone.

References

- Merck Index 1850
DFU 2 (5) 288 (1977)
Kleeman & Engel p. 158
OCDS Vol. 3 p. 183 (1984)
DOT 18 (10) 551 (1982) & 19 (7) 413 (1983)
I.N. p. 191
Tamura, Y., Nakagawa, K., Yoshizaki, S. and Murakami, N.; U.S. Patent 3,910,924; October 7, 1975; assigned to Otsuka Pharmaceutical Co., Ltd.

CARTICAINE

Therapeutic Function: Local anesthetic

Chemical Name: 4-Methyl-3-[[1-oxo-2-(propylamino)propyl] amino]-2-thiophene carboxylic acid methyl ester

Common Name: —

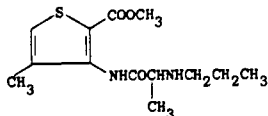
Structural Formula:

Chemical Abstracts Registry No.: 23964-58-1; 23964-57-0 (Hydrochloride)

Trade Name	Manufacturer	Country	Year Introduced
Ultracain	Hoechst	W. Germany	1976
Ultracain	Hoechst	France	1981

Raw Materials

3-Amino-2-carbomethoxy-4-methyl thiophene
 Chloropropionyl chloride
 n-Propylamine

Manufacturing Process

3- α -Chloropropionylamino-2-carbomethoxy-4-methylthiophene (prepared from 3-amino-2-carbomethoxy-4-methylthiophene and chloropropionyl chloride) was dissolved in toluene and n-propylamine added. The whole mixture was heated to boiling for 6 to 7 hours. After cooling, the propylamine hydrochloride that had formed was removed by washing with water. The toluene phase was dried with sodium sulfate, and then the solvent and excess propylamine were removed by distillation. The oily residue was taken up in ether. The hydrochloride of 3-n-propylamino- α -propionylamino-2-carbomethoxy-4-methylthiophene was obtained by introducing hydrogen chloride gas or by means of methanolic hydrogen chloride. The base boils at 162°C to 167°C under 0.3 mm of mercury pressure and the hydrochloride melts at 177°C to 178°C.

References

Merck Index 1853

Kleeman & Engel p. 158

DOT 12 (4) 132 (1976)

Ruschig, H., Schorr, M., Muschaweck, R. and Rippel, R.; U.S. Patent 3,855,243; December 17, 1974; assigned to Farbwerke Hoechst AG (Germany)

CEFACLOR

Therapeutic Function: Antibiotic

Chemical Name: 7-(D- α -Phenylglycylamido)-3-chloro-3-cephem-4-carboxylic acid

Common Name: —

Structural Formula:

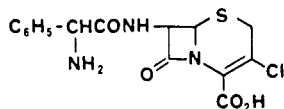

Chemical Abstracts Registry No.: 53994-73-3

Trade Name	Manufacturer	Country	Year Introduced
Ceclor	Lilly	U.S.	1979
Panoral	Lilly	W. Germany	1979
Distaclor	Dista	U.K.	1979
Ceclor	Lilly	Switz.	1980
Alfatil	Lilly	France	1980
Panacef	Lilly	Italy	1981

Trade Name	Manufacturer	Country	Year Introduced
Kefral	Shionogi	Japan	1982
Kefolor	Lilly	—	—

Raw Materials

p-Nitrobenzyl-7-amino-3-chloro-3-cephem-4-carboxylate HCl
 Hydrogen
 N,O-Bis-(trimethylsilyl)acetamide
 Methyl-3- α -carboxybenzylaminocrotonate sodium salt
 Methyl chloroformate

Manufacturing Process

Preparation of 7-amino-3-chloro-3-cephem-4-carboxylic acid: To a solution of 750 mg (1.85 mmol) of p-nitrobenzyl 7-amino-3-chloro-3-cephem-4-carboxylate hydrochloride in 20 ml of tetrahydrofuran and 40 ml of methanol was added a suspension of 750 mg of prerduced 5% palladium on carbon catalyst in 20 ml of ethanol and the suspension was hydrogenated under 50 psi of hydrogen at room temperature for 45 minutes. The catalyst was filtered and washed with THF and water. The filtrate and catalyst washes were combined and evaporated to dryness. The residue was dissolved in a water-ethyl acetate mixture and the pH adjusted to pH 3. The insoluble product was filtered and triturated with acetone. The product was then dried to yield 115 mg of 7-amino-3-chloro-3-cephem-4-carboxylic acid.

Preparation of 7-(D- α -phenylglycylamido)-3-chloro-3-cephem-4-carboxylic acid: To a suspension of 280 mg (1.2 mmol) of 7-amino-3-chloro-3-cephem-4-carboxylic acid in 14 ml of acetonitrile was added with stirring at room temperature 0.5 ml of N,O-bis-(trimethylsilyl)acetamide to form the soluble disilylmethyl derivative thereof. The solution was cooled to 0°C and was slowly added to a solution of the mixed anhydride formed by reacting 408 mg (1.5 mmol) of methyl-3- α -carboxybenzylaminocrotonate sodium salt with 161 mg (1.7 mmol) of methyl chloroformate in the presence to 2 drops of N,N-dimethylbenzyl amine in 7 ml of acetonitrile.

The mixture was stirred at ice bath temperature for 2 hours, 1 ml of methanol was added and the mixture was filtered to remove insoluble impurities. Two milliliters of water were added to the filtrate and the pH was adjusted momentarily to pH 1.5, to effect removal of the enamine block, and then to pH 4.5 with triethylamine. After stirring for an additional hour at ice bath temperature the reaction product, 7-(D- α -phenylglycylamido)-3-chloro-3-cephem-4-carboxylic acid (zwitterion) precipitated from the reaction mixture as a crystalline solid. The product was filtered, washed with acetonitrile and dried in vacuo to yield 200 mg.

References

Merck Index 1896
 DFU 2 (6) 368 (1977)
 Kleeman & Engel p. 160
 OCDS Vol. 3 p. 209 (1984)
 DOT 15 (7) 311 (1979)
 I.N. p. 193
 REM p. 1184
 Chauvette, R.R.; British Patent 1,461,323; January 13, 1977; assigned to Eli Lilly & Co.
 Chauvette, R.R.; U.S. Patent 3,925,372; December 9, 1975; assigned to Eli Lilly & Co.

CEFADROXIL

Therapeutic Function: Antibacterial

Chemical Name: 7-[[Amino-(4-hydroxyphenyl)acetyl] amino] -3-methyl-8-oxo-5-thia-1-aza-bicyclo[4.2.0] -oct-2-ene-2-carboxylic acid monohydrate

Common Name: p-Hydroxycephalexine monohydrate

Structural Formula:

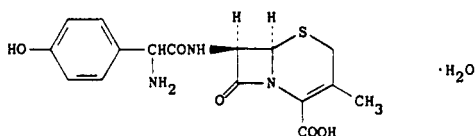

Chemical Abstracts Registry No.: 50370-12-2

Trade Name	Manufacturer	Country	Year Introduced
Oracefal	Bristol	France	1977
Duricef	Mead Johnson	U.S.	1978
Ultracef	Bristol	U.S.	1980
Duracef	Ciba Geigy	Switz.	1980
Cephamox	Bristol	W. Germany	1980
Duracef	Bristol	Italy	1980
Sedral	Banyu	Japan	1982
Baxan	Bristol	U.K.	1982
Bidocef	Bristol-Myers	—	—
Cefos	C.T.	Italy	—
Droxicef	Alfa Farm.	Italy	—

Raw Materials

Sodium N-(1-methoxycarbonyl-1-propen-2-yl)-D(-)- α -amino-(4-hydroxyphenyl)acetate
Ethyl chlorocarbonate
7-Amino-3-methyl-3-cephem-4-carboxylic acid

Manufacturing Process

1.8 g of sodium N-(1-methoxycarbonyl-1-propen-2-yl)-D(-)- α -amino-(4-hydroxyphenyl)acetate was suspended in 10 ml of acetone, and one droplet of N-methylmorpholine was added thereto, and the mixture was cooled to -15°C . There was added 0.85 g of ethyl chlorocarbonate thereto, and the mixture was reacted at -13°C to -10°C for 30 minutes, and then the reaction solution was cooled to -20°C .

On the other hand, 1 g of 7-amino-3-methyl-3-cephem-4-carboxylic acid was suspended in 20 ml of methanol, and 1.4 g of triethylamine was added thereto to be dissolved, and 0.4 ml of acetic acid was further added thereto. This solution was cooled to -20°C and the mixed anhydride prepared previously was added thereto. After the mixture was reacted at -20°C for 1 hour, the temperature of the reaction mixture was raised to 0°C over a period of 1 hour, and the mixture was reacted for 3 hours at the same temperature.

After the reaction, 1 ml of water was added to the reaction mixture, and the mixture was adjusted to a pH of 1.0 with concentrated hydrochloric acid while being cooled, and then stirred for 30 minutes. The insoluble matters were filtered off, and the filtrate was adjusted to a pH of 5.5 with triethylamine. This solution was concentrated under reduced pressure, and the residue was diluted with 20 ml of acetone to precipitate white crystals. The crystals were collected by filtration and washed with ethanol to obtain 1.46 g of white crystals of 7-[D(-)- α -amino-(4-hydroxyphenyl)acetamido]-3-methyl-3-cephem-4-carboxylic acid having a decomposition point of 197°C .

References

Merck Index 1897

Kleeman & Engel p. 161

PDR pp. 716, 1124

OCDS Vol. 2 p. 440 (1980)

DOT 13 (3) 126 (1977) & 13 (11) 471 (1977)

I.N. p. 194

REM p. 1185

Ishimaru, T. and Kodama, Y.; U.S. Patent 3,864,340; February 4, 1975; assigned to Toyama Chemical Co. Ltd. (Japan)

Crast, L.B. Jr. and Gottstein, W.J.; U.S. Patent 3,985,741; October 12, 1976; assigned to Bristol-Myers Co.

CEFAMANDOLE NAFATE SODIUM SALT

Therapeutic Function: Antibiotic

Chemical Name: Sodium 7-(D-2-formyloxy-2-phenylacetamido)-3-(1-methyl-1H-tetrazol-5-ylthiomethyl)-3-cephem-4-carboxylate

Common Name: —

Structural Formula:

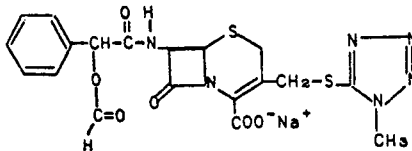

Chemical Abstracts Registry No.: 42540-40-9; 34444-01-4 (Base)

Trade Name	Manufacturer	Country	Year Introduced
Mandokef	Lilly	W. Germany	1977
Kefadol	Lilly	U.K.	1978
Mandol	Lilly	U.S.	1978
Kefandol	Lilly	France	1978
Mandokef	Lilly	Italy	1981
Cedol	Tiber	Italy	—
Cefam	Magis	Italy	—
Cefman	I.B.P.	Italy	—
Cemado	Farmochimica	Italy	—
Cemandil	S.I.T.	Italy	—
Fado	Errekappa	Italy	—
Lampomandol	A.G.I.P.S.	Italy	—
Mandolsan	San Carlo	Italy	—
Neocefal	Gibipharma	Italy	—

Raw Materials

D(-) mandelic acid

Thionyl chloride

Monotrimethyl silyl acetamide

7-Amino-3-(1-methyl-1H-tetrazol-5-yl-thiomethyl)-3-cephem-4-carboxylic acid

Formic acid

Sodium 2-ethylhexanoate

Manufacturing Process

To 21.6 kg (17.8 ℓ) of 98% formic acid was added 1.14 kg (7.5 mols) of D(-)-mandelic acid

and the reaction mixture was heated for 4 hours at 70°C with stirring. The excess formic acid was evaporated off in vacuo and the residual syrup was dissolved in 6 l of benzene. The solution was washed twice with 6 l portions of water and was dried over magnesium sulfate. The drying agent was filtered and washed with 1.5 l of benzene, the washes being added to the filtrate. The dried filtrate was evaporated in vacuo to obtain the D-(-)-mandelic acid formate ether as a syrup. The product can be crystallized from cyclohexane to yield material melting at about 55°C to 58°C.

The mandelic acid formate ester obtained as a syrup as described above is stirred for 2 hours with 2.9 kg (~1.75 l) of thionyl chloride at a temperature of about 70°C. The excess thionyl chloride is removed by evaporation and the residual green solution is vacuum distilled. The product, O-formyl mandeloyl chloride, distills over at 127°C to 130°C (15 mm) or at 108°C to 112°C (7 mm).

To 13 l of ethyl acetate were added 85.1 g (2.59 mols) of 7-amino-3-(1-methyl-1H-tetrazol-5-ylthiomethyl)-3-cephem-4-carboxylic acid and 1,361 g (10.37 mols) of monotrimethylsilyl acetamide, and the mixture was stirred at 50°C until a clear solution was obtained. The solution was cooled to 20°C and 514 g (2.59 mols) of O-formyl mandeloyl chloride was added at a rate such that the temperature of the reaction solution was maintained between about 20°C to 25°C with ice-cooling.

The reaction mixture was stirred for 1.5 hours at about room temperature after the addition of the mandeloyl chloride was completed. Five liters of water were then added to the reaction mixture and the diluted mixture was stirred for about 10 minutes. The organic layer was separated and was washed twice with water. The combined washes are extracted with 1.5 l of ethyl acetate and the extract is combined with the washed organic layer. The whole was dried over magnesium sulfate, filtered and evaporated in vacuo on a 25°C water bath to yield 1,460 g of product, 7-(D-2-formyloxy-2-phenylacetamido)-3-(1-methyl-1H-tetrazol-5-ylthiomethyl)-3-cephem-4-carboxylic acid, as a yellow foam.

The product was dissolved in 5 l of acetone and the solution was mixed with a solution of 430 g (2.59 mols) of sodium 2-ethylhexanoate in 5.4 l of acetone. The combined solutions were seeded and stirred in an ice bath for 1.5 hours. The crystalline precipitate of sodium 7-(D-2-formyloxy-2-phenylacetamido)-3-(1-methyl-1H-tetrazol-5-ylthiomethyl)-3-cephem-4-carboxylate was filtered and washed with 5 l of acetone. The crystalline salt was dried overnight in a vacuum oven at 40°C to yield 1,060 g (80%) of product, melting at 182°C to 184°C.

References

- Merck Index 1898
- DFU 2 (10) 646 (1977)
- Kleeman & Engel p. 166
- PDR p. 1059
- OCDS Vol. 2 p. 441 (1980) & 14 (4) 151 (1978)
- DOT 12 (5) 177 (1976)
- I.N. p. 196
- REM p. 1185
- Greene, J.M. and Indelicato, J.M.; U.S. Patent 3,928,592; December 23, 1975; assigned to Eli Lilly & Co.

CEFATRIZINE

Therapeutic Function: Antibiotic

Chemical Name: 7-[D- α -Amino- α -(p-hydroxyphenyl)acetamido]-3-(1,2,3-triazol-5-ylthiomethyl)-3-cephem-4-carboxylic acid

Common Name: —

Structural Formula:

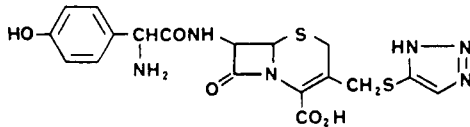

Chemical Abstracts Registry No.: 51627-14-6

Trade Name	Manufacturer	Country	Year Introduced
Bricef	Bristol-Banyu	Japan	1980
Cepticol	Banyu	Japan	1980
Cefatrix	Ausonia	Italy	1982
Latocef	Dukron	Italy	1982

Raw Materials

7-[D- α -t-Butoxycarbonylamino- α -(p-hydroxyphenyl)acetamido]-3-(1,2,3-triazol-5-ylthiomethyl)-3-cephem-4-carboxylic acid
Formic acid

Manufacturing Process

A total 6.5 g (11.55 mmol) of 7-[D- α -t-butoxycarbonylamino- α -(p-hydroxyphenyl)acetamido]-3-(1,2,3-triazol-5-ylthiomethyl)-3-cephem-4-carboxylic acid was dissolved in 175 ml (98 to 100% formic acid under anhydrous conditions. The mixture was stirred at room temperature for 2.5 hours. Part of the solution, 125 ml, was evaporated under reduced pressure to an amber oil. The oil was then azeotroped 3 times with 70 ml of toluene under reduced pressure. The residue was suspended in an 80:20 H₂O-CH₃OH solution (700 ml) and stirred for 0.5 hour until most of the solid dissolved, then filtered. The filtration was treated with 1.5 g of (Darko) charcoal for about 20 minutes. The charcoal was filtered off through a Celite pad. The solution was then freeze-dried in 9 separate 100 ml round bottom flasks. The freeze-dried material weighed 2.415 g. It was recrystallized in batches of 0.200 g as described above to yield a total of 0.923 g 7-[D- α -amino- α -(p-hydroxyphenyl)acetamido]-3-(1,2,3-triazol-5-ylthiomethyl)-3-cephem-4-carboxylic acid. NMR was consistent, indicating the presence of 0.33 mol of CH₃OH.

References

- Merck Index 1899
DFU 2 (10) 653 (1977)
OCDS Vol. 3 p. 211 (1984)
DOT 12 (5) 183 (1976)
I.N. p. 197
Kaplan, M.A. and Granatek, A.P.; U.S. Patent 3,970,651; July 20, 1976; assigned to Bristol-Myers Co.

CEFAZOLIN SODIUM

Therapeutic Function: Antibacterial

Chemical Name: (6R-trans)-3- \llbracket [(5-methyl-1,3,4-thiadiazol-2-yl)thio]methyl \rrbracket -8-oxo-7- \llbracket [(1H-tetrazol-1-yl)acetyl]amino \rrbracket -5-thia-1-azabicyclo[4.2.0]oct-2-ene-2-carboxylic acid sodium salt

Common Name: —

Structural Formula:

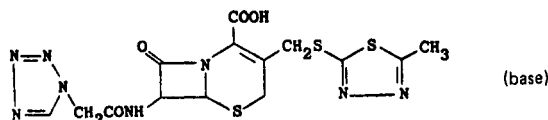

Chemical Abstracts Registry No.: 27164-46-1; 25953-19-9 (Base)

Trade Name	Manufacturer	Country	Year Introduced
Cefamedin	Fujisawa	Japan	1971
Kefzol	Lilly	U.S.	1973
Ancef	SKF	U.S.	1973
Totacef	Bristol	Italy	1973
Grammaxin	Boehr./Mann	W. Germany	1974
Kefzol	Lilly	U.K.	1974
Kefzol	Serum Impfinst.	Switz.	1974
Cefacidal	Allard	France	1976
Kefzol	Lilly	France	1976
Acef	Tiber	Italy	—
Areuzolin	Areu	Spain	—
Atirin	Intersint	Italy	—
Biazolina	Panthox & Burck	Italy	—
Bor-Cefazol	Proter	Italy	—
Brizolina	Bristol-Myers	—	—
Caricef	Antibioticos	Spain	—
Cefacene	Centrum	Spain	—
Cefalomicina	Marxer	Argentina	—
Cefamezin	Fujisawa	Japan	—
Cefazina	Chemil	Italy	—
Celmetin	A.L.	Norway	—
Cromezin	Crosara	Italy	—
Elzogram	Lilly	W. Germany	—
Fidesporin	Fides	Spain	—
Firmacel	Firma	Italy	—
Kurgan	Normon	Spain	—
Legemzolina	Legem	Spain	—
Lifezolina	Lifepharm	Spain	—
Liviclina	Sierochimica	Italy	—
Maksipor	Fako	Turkey	—
Neofazol	Rubio	Spain	—
Vifazolin	Vianex	Greece	—
Zolicef	Bristol-Myers	W. Germany	—

Raw Materials

7-Amino-cephalosporanic acid	Sodium hydroxide
1-H-Tetrazole-1-acyl chloride	Sodium bicarbonate
5-Methyl-1,3,4-thiadiazole-2-thiol	

Manufacturing Process

7-Amino-cephalosporanic acid is converted to its sodium salt and acylated with 1H-tetrazole-1-acyl chloride. The acetoxy group is then displaced by reaction with 5-methyl-1,3,4-thiadiazole-2-thiol in buffer solution. The product acid is converted to the sodium salt by NaHCO_3 .

References

Merck Index 1901
Kleeman & Engel p. 168

PDR pp. 1058, 1701
 OCDS Vol. 3 p. 442 (1984)
 DOT 7 (5) 146, 167, 181 (1971)
 I.N. p. 197
 REM p. 1185

Takano, T., Kurita, M., Nikaido, H., Mera, M., Konishi, N. and Nakagawa, R.; U.S. Patent 3,516,997; June 23, 1970; assigned to Fujisawa Pharmaceutical Co., Ltd., Japan

CEFMENOXIME

Therapeutic Function: Antibacterial

Chemical Name: 7 β -[α -Methoxyimino- α -(2-aminothiazol-4-yl)acetamido]-3-(1-methyl-1H-tetrazol-5-ylthiomethyl)-3-cephem-4-carboxylic acid

Common Name: —

Structural Formula:

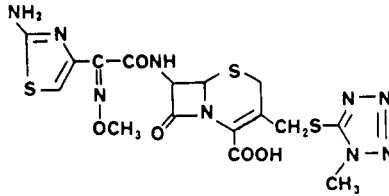

Chemical Abstracts Registry No.: 65085-01-0

Trade Name	Manufacturer	Country	Year Introduced
Tacef	Takeda	W. Germany	1983
Bestcall	Takeda	Japan	1983

Raw Materials

7 β -[α -Methoxyimino- α -(2-aminothiazol-4-yl)acetamido] cephalosporanic acid trifluoroacetic acid salt
 1-Methyl-5-mercapto-1H-tetrazole

Manufacturing Process

7 β -[α -Methoxyimino- α -(2-aminothiazol-4-yl)acetamido] cephalosporanic acid trifluoroacetic acid salt is dissolved in a solution of 272 mg of 1-methyl-5-mercapto-1H-tetrazole, 555 mg of sodium bicarbonate and 68 mg of triethylbenzylammonium bromide in 10 ml of water. The solution is heated at 60°C in nitrogen atmosphere for 6 hours. After cooling, the reaction solution is passed through a column of Amberlite XAD-2 and eluted with water and then with 2.5% ethanol. The procedure yields sodium 7 β -[α -methoxyimino- α -(2-aminothiazol-4-yl)acetamido]-3-(1-methyl-1H-tetrazol-5-ylthiomethyl)-3-cephem-4-carboxylate, MP 174°C to 175°C (decomposition).

References

Merck Index 1902
 DFU 5 (3) 146 & (12) 635 (1980) (as SCE-1365)
 DOT 19 (6) 335 & (8) 429 (1983)
 I.N. p. 198

REM p. 1189

Ochiai, M., Okada, T., Aki, O., Morimoto, A., Kawakita, K. and Matsushita, Y.; U.S. Patent 4,098,888; July 4, 1978; assigned to Takeda Chemical Industries, Ltd.

CEFOPERAZONE

Therapeutic Function: Antibiotic

Chemical Name: 7-[D-(-)- α -(4-ethyl-2,3-dioxo-1-piperazinecarboxamido)- α -(4-hydroxyphenyl)acetamido]-3-[(1-methyl-1H-tetrazol-5-yl)thiomethyl]-3-cephem-4-carboxylic acid

Common Name: —

Structural Formula:

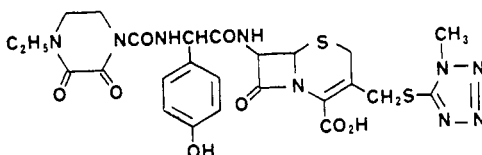

Chemical Abstracts Registry No.: 62893-19-0; 62893-20-3 (Sodium Salt)

Trade Name	Manufacturer	Country	Year Introduced
Cefobid	Pfizer	W. Germany	1981
Cefobine	Pfizer	France	1981
Cefobis	Pfizer	Switz.	1981
Cefoperazin	Pfizer Taito	Japan	1982
Cefobid	Roerig	U.S.	1982

Raw Materials

7-[D-(-)- α -Amino-p-hydroxyphenylacetamido]-3-[5-(1-methyl-1,2,3,4-tetrazolyl)-thiomethyl]- Δ^3 -cephem-4-carboxylic acid
4-Ethyl-2,3-dioxo-1-piperazinocarbonyl chloride

Manufacturing Process

To a suspension of 3.0 g of 7-[D-(-)- α -amino-p-hydroxyphenylacetamido]-3-[5-(1-methyl-1,2,3,4-tetrazolyl)thiomethyl]- Δ^3 -cephem-4-carboxylic acid in 29 ml of water was added 0.95 g of anhydrous potassium carbonate. After the solution was formed, 15 ml of ethyl acetate was added to the solution, and 1.35 g of 4-ethyl-2,3-dioxo-1-piperazinocarbonyl chloride was added to the resulting solution at 0°C to 5°C over a period of 15 minutes, and then the mixture was reacted at 0°C to 5°C for 30 minutes. After the reaction, an aqueous layer was separated off, 40 ml of ethyl acetate and 10 ml of acetone were added to the aqueous layer, and then the resulting solution was adjusted to a pH of 2.0 by addition of dilute hydrochloric acid. Thereafter, an organic layer was separated off, the organic layer was washed two times with 10 ml of water, dried over anhydrous magnesium sulfate, and the solvent was removed by distillation under reduced pressure. The residue was dissolved in 10 ml of acetone, and 60 ml of 2-propanol was added to the solution to deposit crystals. The deposited crystals were collected by filtration, washed with 2-propanol, and then dried to obtain 3.27 g of 7-[D-(-)- α -(4-ethyl-2,3-dioxo-1-piperazinocarbonylamino)-p-hydroxyphenylacetamido]-3-[5-(1-methyl-1,2,3,4-tetrazolyl)thiomethyl]- Δ^3 -cephem-4-carboxylic acid, yield 80.7%. The product forms crystals, MP 188°C to 190°C (with decomposition).

References

Merck Index 1905

DFU 4 (9) (675) & (12) 911 (1979) (as T-1551)

Kleeman & Engel p. 169

PDR p. 1521

DOT 17 (12) 535 (1981)

I.N. p. 198

REM p. 1185

Saikawa, I., Takano, S., Yoshida, C., Takashima, O., Momonoi, K., Kuroda, S., Komatsu, M., Yasuda, T. and Kodama, Y.; British Patent 1,508,071; April 19, 1978; assigned to Toyama Chemical Co., Ltd. and U.S. Patent 4,110,327; August 29, 1978; also assigned to Toyama Chemical Co., Ltd.

CEFOTAXIME SODIUM

Therapeutic Function: Antibiotic

Chemical Name: Sodium 3-acetoxymethyl-7-[2-(2-amino-4-thiazolyl)-2-methoxyimino]-acetamido-3-cephem-4-carboxylate

Common Name: —

Structural Formula:

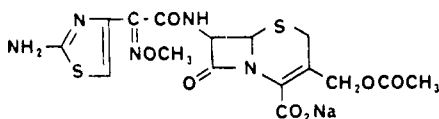

Chemical Abstracts Registry No.: 64485-93-4; 63527-52-6 (Base)

Trade Name	Manufacturer	Country	Year Introduced
Claforan	Hoechst-Roussel	W. Germany	1980
Claforan	Roussel Maestre	Italy	1980
Claforan	Roussel	France	1980
Zariviz	Hoechst	Italy	1980
Claforan	Roussel-Hoechst	Switz.	1981
Claforan	Roussel	U.K.	1981
Cefotax	Roussel	Japan	1981
Claforan	Hoechst	U.S.	1981
Pretor	Hoechst	—	—
Primafen	Hoechst	—	—
Ralopar	Hoechst	—	—
Tolycar	Hoechst	—	—

Raw Materials

Sodium bicarbonate

3-Acetoxyethyl-7-[2-(2-amino-4-thiazolyl)-2-methoxyiminoacetamido]-ceph-3-em-4-carboxylic acid (Cefotaxime)

Manufacturing Process

A solution of 8 g of sodium bicarbonate in about 20 ml of ethanol was progressively added to 45.55 g of pure 3-acetoxyethyl-7-[2-(2-amino-4-thiazolyl)-2-methoxyiminoacetamido]-ceph-3-em-4-carboxylic acid in 100 ml of distilled water and another 80 ml of ethanol and 4.5 g of activated carbon were added thereto. The mixture was stirred for 5 minutes and was filtered. The filter was rinsed with ethanol and the filtrate was evaporated to dryness under

reduced pressure. The residue was taken up in 100 ml of ethanol and evaporated to dryness again. The residue was dissolved in 100 ml of methanol and the solution was poured into 2 l of acetone. The mixture was vigorously stirred and was vacuum filtered. The recovered product was rinsed with acetone and then ether and dried under reduced pressure to obtain 43.7 g of a white product which rehydrated in air to obtain a final weight of 45.2 g of sodium 3-acetoxymethyl-7-[2-(2-amino-4-thiazolyl)-2-methoxyiminoacetamido]-ceph-3-eme-4-carboxylate.

References

- Merck Index 1907
 DFU 3 (12) 905 (1978)
 Kleeman & Engel p. 171
 PDR p. 935
 OCDS Vol. 3 p. 216 (1984)
 DOT 17 (1) 16 (1981)
 I.N. p. 198
 REM p. 1186
 Heymes, R. and Lutz, A.; U.S. Patent 4,152,432; May 1, 1979; assigned to Roussel Uclaf

CEFOXITIN SODIUM

Therapeutic Function: Antibiotic

Chemical Name: 3-Carbamoyloxymethyl-7 α -methoxy-7 β -(2-thienylacetamido)decephalosporanic acid sodium salt

Common Name: —

Structural Formula:

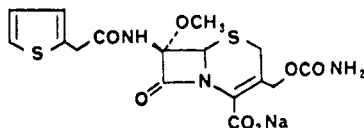

Chemical Abstracts Registry No.: 33654-30-6; 35607-66-0 (Base)

Trade Name	Manufacturer	Country	Year Introduced
Mefoxin	Merck Sharp & Dohme	U.S.	1978
Mefoxitin	Sharp/Dohme	W. Germany	1978
Mefoxin	MSD	U.K.	1978
Mefoxitin	MSD	Switz.	1979
Mefoxin	MSD	Italy	1979
Cenomycin	Daiichi-Seiyaku	Japan	1980
Mefoxin	MSD	France	1980
Merkicin	Merck Banyu	Japan	1980
Betacel	Firma	Italy	—
Boncefin	MSD	—	—
Cefaxicina	Cefa	Spain	—
Cefoctin	Teva	Israel	—
Farmoxin	Farm. Carlo Erba	Italy	—

Raw Materials

Benzhydryl 3-carbamoyloxymethyl-7 α -hydroxy-7 β -(2-thienylacetamino)-decephalosporanate

Sodium hydride
Dimethyl sulfate
Trifluoroacetic acid

Manufacturing Process

Benzhydryl 3-carbamoyloxymethyl-7 α -hydroxy-7 β -(2-thienylacetamido)decephalosporanate, 543 mg, is stirred in 15 ml dry DMSO. Sodium hydride, 24 mg (48 mg of a 50% suspension of NaH in mineral oil, which has been washed with hexane to remove the oil), is added. When hydrogen evolution has ceased, 126 mg dimethyl sulfate is added. The solution is stirred for one hour at room temperature, diluted with 100 ml benzene and washed six times with water; the last wash is made to pH 8, if necessary, by adding sodium bicarbonate. The solution is dried over MgSO₄, filtered and evaporated, leaving benzhydryl 3-carbamoyloxymethyl-7 β -(2-thienylacetamido)-7 α -methoxydecephalosporanate, which may be purified if desired by chromatography on silica gel, eluting with 25:1 chloroform-ethyl acetate.

Other methylating agents may be used in place of methyl sulfate, e.g., an equimolar amount of methyl iodide, bromide or chloride, using the same conditions, or methyl trifluoromethylsulfonate or trimethyloxonium trinitrobenzenesulfonate. The solvent in the latter two reagents is dimethyl ether-HMPA 1:1, using a reaction temperature of -20°C warming later to 25°C. In each instance, the benzhydryl 3-carbamoyloxymethyl-7 β -(2-thienylacetamido)-7 α -methoxydecephalosporanate is obtained.

Benzhydryl 3-carbamoyloxymethyl-7 β -(2-thienylacetamido)-7 α -methoxydecephalosporanate (300 mg) in 0.5 ml in anisole and 2.5 ml of trifluoroacetic acid is reacted for 15 minutes at 10°C. The resulting mixture is evaporated at reduced pressure and flushed twice with anisole. The residue is dissolved in methylene chloride and extracted with 5% sodium bicarbonate solution. The aqueous solution is adjusted to pH 1.8 with 5% phosphoric acid and extracted with ethyl acetate. The organic solution is dried and evaporated to yield the pure 3-carbamoyloxymethyl-7 α -methoxy-7 β -(2-thienylacetamido)decephalosporanic acid, MP 165°C to 167°C. This may then be converted to the sodium salt.

References

- Merck Index 1910
DFU 3 (6) 434 (1978)
Kleeman & Engel p. 173
PDR p. 1194
OCDS Vol. 2 pp. 435, 443 (1980)
DOT 14 (2) 545 (1978)
I.N. p. 199
REM p. 1186
Christiansen, B.G. and Firestone, R.A.; U.S. Patent 3,775,410; November 27, 1973; assigned to Merck & Company, Inc.
Hazen, G.C.; U.S. Patent 3,780,033; December 18, 1973; assigned to Merck & Company, Inc.

CEFROXADINE

Therapeutic Function: Antibacterial

Chemical Name: 7-[(Amino-1,4-cyclohexadien-1-yl-acetyl)amino]-3-methoxy-8-oxo-5-thia-1-azabicyclo[4.2.0]-oct-2-ene-2-carboxylic acid

Common Name: —

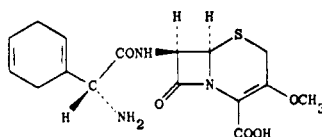
Structural Formula:

Chemical Abstracts Registry No.: 51762-05-1

Trade Name	Manufacturer	Country	Year Introduced
Oraspor	Ciba Geigy	Switz.	1981
Oraspor	Ciba Geigy	Japan	1982
Oraspor	Ciba Geigy	W. Germany	1983
Oraspor	Ciba Geigy	Italy	1983

Raw Materials

D- α -Amino- α -(1,4-cyclohexadienyl)acetic acid
 Phosphorus pentachloride
 7 β -Amino-3-methoxy-3-cephem-4-carboxylic acid hydrochloride dioxanate
 Bis(trimethylsilyl)acetamide
 Propylene oxide
 Sodium hydroxide

Manufacturing Process

A suspension of 30.64 g (0.2 mol) of D- α -amino- α -(1,4-cyclohexadienyl)-acetic acid in 600 ml of methylene chloride is cooled under a stream of argon to 6°C, whereupon hydrogen chloride is passed in for about 30 minutes until the mixture is saturated. Phosphoropentachloride (62.4 g, 0.3 mol) is added in two portions. The mixture is stirred for 2 hours at 6°C to 8°C. The colorless precipitate is filtered off under nitrogen and exclusion of moisture, washed with methylene chloride and dried for 18 hours at 0.05 mm Hg at room temperature to give D- α -amino- α -(1,4-cyclohexadienyl)-acetylchloride hydrochloride in form of colorless crystals.

A suspension of 37.3 g (0.1 mol) of 7 β -amino-3-methoxy-3-cephem-4-carboxylic acid hydrochloride dioxanate in 500 ml methylene chloride is stirred for 15 minutes at room temperature under an argon atmosphere and treated with 57.2 ml (0.23 mol) of bis(trimethylsilyl)-acetamide. After 45 minutes the faintly yellow slightly turbid solution is cooled to 0°C and treated within 10 minutes with 31.2 g (0.15 mol) of D- α -amino- α -(1,4-cyclohexadienyl)-acetylchloride hydrochloride. Thirty minutes thereafter 15 ml (about 0.21 mol) of propylene oxide is added and the mixture is further stirred for 1 hour at 0°C. A cooled mixture of 20 ml of absolute methanol in 200 ml of methylene chloride is added within 30 minutes, after another 30 minutes the precipitate is filtered off under exclusion of moisture, washed with methylene chloride and dried under reduced pressure at room temperature. The obtained hygroscopic crystals of the hydrochloride of 7 β -[D- α -(1,4-cyclohexadienyl)-acetylamino]-3-methoxy-3-cephem-4-carboxylic acid are stirred into 200 ml of ice water and the milky solution treated with about 66 ml of cold 2N sodium hydroxide solution until pH 3.5 is reached. The solution is clarified by filtration through diatomaceous earth, washed with ice water, cooled to 0°C and treated with 20 ml of 2N sodium hydroxide solution until pH 5.7 is reached. A second filtration through a glass filter frit results in a clear solution which is treated with acetone (800 ml) at 0°C. The crystals are filtered washed with acetone:water (2:1), acetone and diethyl ether and dried for 20 hours at room temperature and 0.05 mm Hg to give the 7 β -[D- α -(1,4-cyclohexadienyl)-acetylamino]-3-methoxy-3-cephem-4-carboxylic acid dihydrate.

References

Merck Index 1911
 DFU 4 (12) 911 (1979)
 OCDS Vol. 3 p. 210 (1984)

DOT 19 (4) 190 (1983)

I.N. p. 200

Scartazzini, R. and Bickel, H.; U.S. Patent 4,073,902; February 14, 1978; assigned to Ciba-Geigy Corp.

CEFSULODIN

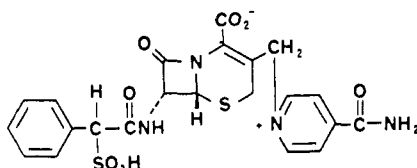
Therapeutic Function: Antibiotic**Common Name:** Sulcephalosporin**Chemical Name:** 7-(α -Sulphophenylacetamido)-3-(4'-carbamoylpyridinium)methyl-3-cephem-4-carboxylate**Common Name:** —**Structural Formula:****Chemical Abstracts Registry No.:** 52152-93-9 (Sodium salt)

Trade Name	Manufacturer	Country	Year Introduced
Pseudomonil	Ciba Geigy	W. Germany	1980
Monaspor	Ciba Geigy	Switz.	1980
Pyocefalin	Cassene Takeda	France	1981
Takesulin	Takeda	Japan	1981
Tilmapor	Ciba Geigy	Japan	1981
Monaspor	Ciba Geigy	U.K.	1982
Pseudocef	Grunenthal	W. Germany	—

Raw Materials7-(α -Sulphophenylacetamido)cephalosporanic acid

Isonicotinamide

Potassium Thiocyanate

Manufacturing Process

0.514 g (4×10^{-3} mol) of 7-(α -sulphophenylacetamido)cephalosporanic acid, 0.466 g (3×10^{-3} mol) of isonicotinamide and 2.0 g (2.06×10^{-3} mol) of potassium thiocyanate were dissolved in 2.5 ml of water. The resulting solution was allowed to stand and heated for 20 hours in a thermostat kept at 50°C and then directly purified by chromatography on an Amberlite XAD-2 column (16 x 880 mm). Subsequently, the fractions containing the cephalosporins were collected and subjected to freeze-drying to obtain 270 g of the title product in the form of a pale yellowish white powder. The product is usually used as the sodium salt.

References

Merck Index 1912

DFU 5 (2) 67 (1980)

OCDS Vol. 3 p. 214 (1984)

DOT 17 (12) 542 (1981)

I.N. p. 200

REM p. 1188

British Patent 1,387,656; March 19, 1975; assigned to Takeda Chemicals Industries, Ltd.

CEFTAZIDIME

Therapeutic Function: Antibiotic

Chemical Name: (6R,7R)-1-[(Z)-2-(2-Aminothiazol-4-yl)-2-(2-carboxyprop-2-oxymino)-acetamido]-3-(1-pyridiniummethyl)-ceph-3-em-4-carboxylic acid inner salt

Common Name: —

Structural Formula:

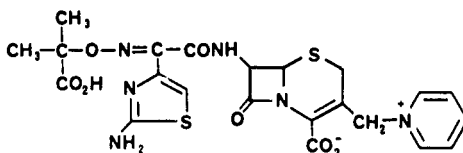

Chemical Abstracts Registry No.: 72558-82-8

Trade Name	Manufacturer	Country	Year Introduced
Fortum	Glaxo	U.K.	1983

Raw Materials

(Z)-2-(2-t-Butoxycarbonylprop-2-oxymino)-2-(2-tritylaminothiazol-4-yl)acetic acid
t-Butyl(6R,7R)-3-acetoxymethyl-7-aminoceph-3-em-4-carboxylate
Pyridine

Manufacturing Process

(a) *t-Butyl(6R,7R)-3-acetoxymethyl-7-[(Z)-2-(2-t-butoxycarbonylprop-2-oxymino)-2-(2-tritylaminothiazol-4-yl)acetamido]ceph-3-em-4-carboxylate*: A stirred solution of (Z)-2-(2-t-butoxycarbonylprop-2-oxymino)-2-(2-tritylaminothiazol-4-yl)acetic acid (572 mg) and t-butyl(6R,7R)-3-acetoxymethyl-7-aminoceph-3-em-4-carboxylate (328 mg) in dimethylformamide (10 ml) was cooled to 0°C, and 1-hydroxybenzotriazole (150 mg) was added, followed by dicyclohexylcarbodiimide (225 mg). The mixture was warmed to room temperature, stirred for 5 hours and allowed to stand overnight. The mixture was filtered, and the white solid washed with a little ether. The filtrate and washings were diluted with water (50 ml) and extracted with ethyl acetate. The organic extracts were combined, washed successively with water, 2N hydrochloric acid, water, sodium bicarbonate solution, and saturated brine, dried and evaporated. The residue was eluted through a silica column with ether. The product-containing eluate was collected and concentrated to give the title compound (533 mg). A portion was recrystallized from diisopropyl ether, MP 103°C to 113°C (decomp.); $[\alpha]_D^{20} +8.5^\circ$ (conc. 1.0, DMSO).

(b) *(6R,7R)-3-Acetoxymethyl-7-[(Z)-2-(2-aminothiazol-4-yl)-2-(2-carboxyprop-2-oxymino)acetamido]ceph-3-em-4-carboxylic acid*: Trifluoroacetic acid (18 ml) was added to a solution of the product of (a) (2.4 g) in anisole (18 ml) at 0°C. The mixture was stirred at room temperature for 2 hours and concentrated. The residue was dissolved in ethyl acetate and extracted with saturated sodium bicarbonate solution. The pH of the aqueous extracts was adjusted to 6, and the solution washed with ethyl acetate. The aqueous phase was acidified to pH 1.5 under ethyl acetate, saturated with sodium chloride, and extracted with ethyl

acetate. The combined organic extracts were washed with saturated brine, dried and evaporated. The residue was dissolved in warm 50% aqueous formic acid (20 ml) and allowed to stand for 2 hours. The mixture was diluted with water (50 ml) and filtered. The filtrate was concentrated. The residue was taken up in water (50 ml), refiltered, and lyophilized to give the title compound (920 mg).

(c) (6*R*,7*R*)-7-[(*Z*)-2-Aminothiazol-4-yl]-2-(2-carboxyprop-2-oxymino)acetamido]-3-(1-pyridiniummethyl)-ceph-3-em-4-carboxylate, monosodium salt: Pyridine (2 ml) and the product of (b) (1.8 g) were added to a stirred solution of sodium iodide (7.12 g) in water (2.2 ml) at 80°C. The solution was stirred at 80°C for 1 hour, cooled, and diluted to 100 ml with water. The pH of the solution was adjusted to 6.0 with 2N sodium hydroxide solution, and this solution was concentrated to remove pyridine. The aqueous residue was diluted to 100 ml with water, methyl isobutyl ketone (2 drops) was added, and the solution was acidified to pH 1 with 2N hydrochloric acid. The mixture was filtered, and the solid was washed with a little water. The filtrate and washings were collected and washed with ethyl acetate, and the pH adjusted to 6.0 with 2N sodium hydroxide solution. The solution was concentrated to 50 ml and applied to a column of 500 g Amberlite XAD-2 resin, using first water and then 20% aqueous ethanol as eluting solvent. The product-containing fractions were concentrated and lyophilized to give the title compound (0.56 g).

References

- Merck Index 1913
 DFU 6 (10) 612 (1981)
 PDR p. 909
 OCDS Vol. 3 p. 216 (1984)
 DOT 19 (6) 336 (1983)
 REM p. 1188
 O'Callaghan, C.H., Livermore, D.G.H. and Newall, C.E.; British Patent 2,025,398; January 23, 1980; assigned to Glaxo Group Ltd.

CEFTIZOXIME

Therapeutic Function: Antibacterial

Chemical Name: 7-[2-Methoxyimino-2-(2-amino-1,3-thiazol-4-yl)acetamido]-cephalosporanic acid

Common Name: —

Structural Formula:

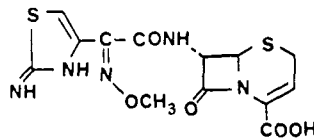

Chemical Abstracts Registry No.: 68401-81-0; 68401-82-1 (Sodium salt)

Trade Name	Manufacturer	Country	Year Introduced
Eposelin	Fujisawa	Japan	1982
Cefizox	SKF	U.S.	1983
Ceftix	Boehr./Mann	W. Germany	1983
Cefizox	Burroughs Wellcome	U.K.	—

Raw Materials

Phosphorus oxychloride
 2-Methoxyimino-2-(2-amino-1,3-thiazol-4-yl)acetic acid
 Bis(trimethylsilyl)acetamide
 7-Aminocephalosporanic acid

Manufacturing Process

Phosphorus oxychloride (2.0 g) was added at one time at 5°C to 10°C to a suspension of 2-methoxyimino-2-(2-amino-1,3-thiazol-4-yl)acetic acid (syn isomer) (2 g) in dry ethyl acetate (20 ml). After stirring for 20 minutes at 7°C to 10°C, bis(trimethylsilyl)acetamide (0.4 g) was added thereto at the same temperature. After stirring for 10 minutes at 7°C to 10°C, phosphorus oxychloride (2.0 g) was dropwise added thereto at the same temperature. The resulting mixture was stirred for 10 minutes at 7°C to 10°C, and dry dimethylformamide (0.8 g) was dropwise added thereto at the same temperature. The mixture was stirred for 30 minutes at 7°C to 10°C to give a clear solution. On the other hand, trimethylsilylacetamide (7.35 g) was added to a suspension of 7-aminocephalosporanic acid (2.45 g) in dry ethyl acetate (8 ml), after which the mixture was stirred at 40°C to give a clear solution.

To this solution was added at one time the above-obtained ethyl acetate solution at -15°C, and the resulting mixture was stirred for 1 hour at -10°C to -15°C. The reaction mixture was cooled to -30°C, and water (80 ml) was added thereto. The aqueous layer was separated, adjusted to pH 4.5 with sodium bicarbonate and subjected to column chromatography on Diaion HP-20 resin (Mitsubishi Chemical Industries Ltd.) using 25% aqueous solution of isopropyl alcohol as an eluent. The eluate was lyophilized to give 7-[2-methoxyimino-2-(2-amino-1,3-thiazol-4-yl)acetamido]cephalosporanic acid (syn isomer) (1.8 g), MP 227°C (decomp.).

References

Merck Index 1915
 DFU 5 (5) 226 (1980)
 PDR p. 1704
 OCDS Vol. 3 p. 218 (1984)
 DOT 19 (3) 133 (1983)
 I.N. p. 200
 REM p. 1189
 Takaya, T., Masugi, T., Takasugi, H. and Kochi, H.; U.S. Patent 4,166,115; assigned to Fujisawa Pharmaceutical Co., Ltd.

CEFTRIAXONE SODIUM

Therapeutic Function: Antibacterial

Chemical Name: Sodium salt of (6R,7R)-7-[2-(2-amino-4-thiazolyl)-2-(methoxyimino)acetamido]-8-oxo-3-[[[1,4,5,6-tetrahydro-4-methyl-5,6-dioxo-as-triazin-3-yl]thio]methyl]-5-thia-1-azabicyclo[4.2.0]oct-2-ene-2-carboxylic acid

Common Name: —

Structural Formula:

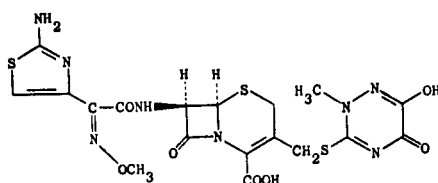

(base)

Chemical Abstracts Registry No.: 75478-69-1; 73384-59-5 (Base)

Trade Name	Manufacturer	Country	Year Introduced
Rocephin	Roche	Switz.	1982
Rocephin	Roche	W. Germany	1983
Acantex	Roche	—	—

Raw Materials

(6R,7R)-7-[2-[2-(2-Chloroacetamido)-4-thiazolyl]-2-(methoxyimino)acetamido]-8-oxo-3-[[[1,4,5,6-tetrahydro-4-methyl-5,6-dioxo-as-triazin-3-yl)thio] methyl]-5-thia-1-azabicyclo[4.2.0]oct-2-ene-2-carboxylic acid
Formic acid

Manufacturing Process

19 g of (6R,7R)-7-[2-[2-(2-chloroacetamido)-4-thiazolyl]-2-(methoxyimino)acetamido]-8-oxo-3-[[[1,4,5,6-tetrahydro-4-methyl-5,6-dioxo-as-triazin-3-yl)thio] methyl]-5-thia-1-azabicyclo[4.2.0]oct-2-ene-2-carboxylic acid are suspended in 150 ml of water together with 9.5 g of thiourea. The pH is adjusted to 6.8 with 5% sodium hydrogen carbonate solution while gassing with nitrogen and stirring, there being obtained a yellow-orange solution. The pH of the solution is held constant at 6.8-7.0 for 6 hours by adding sodium hydrogen carbonate solution by means of an autotitrator. 100% formic acid is added to the orange colored solution until the pH is 3.5. The precipitated material is filtered off under suction and washed with 100 ml of 10% formic acid. This material is denoted as (1). The filtrate is adjusted to pH 2.5 by adding 100% formic acid, whereby additional substance precipitates out. The mixture is held in an ice-bath for 1 hour, the precipitated substance is then filtered off and washed with a small amount of ice-water. This material is denoted as fraction I. The aforementioned orange-brown material (1) is suspended in 250 ml of water. The suspension is adjusted to pH 7 with 2N sodium hydroxide, there being obtained an orange-brown solution. Additional 100% formic acid is added to this solution until the pH is 3.5. The material which thereby precipitates out is filtered off under suction and discarded. The filtrate is adjusted to pH 2.5 with 100% formic acid, whereby additional substance precipitates out. The mixture is held in an ice-bath for 1 hour, the precipitated substance is then filtered off under suction and washed with a small amount of ice-water. This material is denoted as fraction II. Fractions I and II are suspended together in 500 ml of ethanol and evaporated in a rotary evaporator in order to remove water. After adding ether, the mixture is filtered under suction and the precipitate is washed successively with ether and low-boiling petroleum ether. There is thus obtained the title substance in the form of a yellowish solid material which is denoted as A.

The mother liquors and washings of fractions I and II are concentrated from a volume of about 1.7 liters to 250 ml, the pH is adjusted to 2.5 with 100% formic acid and the solution is stored overnight in a refrigerator, whereby further substance crystallizes. This is filtered off under suction and washed with a small amount of water. The residue on the suction filter is azeotropically distilled with ethanol. There is obtained solid, almost colorless title substance which is denoted as B. B is purer than A according to thin-layer chromatography.

In order to obtain pure title substance, the acid B is suspended in 150 ml of methanol and treated while stirring with 10 ml of a 2N solution of the sodium salt of 2-ethylcaproic acid in ethyl acetate. After about 10 minutes, there results a solution which is treated with 100 ml of ethanol. The mixture is extensively concentrated at 40°C in vacuo. The sodium salt precipitates out in amorphous form after adding ethanol. This salt is filtered off under suction, washed successively with ethanol and low-boiling petroleum ether and dried at 40°C in a high vacuum. There is obtained the title substance in the form of an almost colorless amorphous powder.

References

Merck Index 1916
PDR p. 1499

DOT 19 (12) 653 (1983)

I.N. p. 200

REM p. 1189

Montavon, M. and Reiner, R.; British Patent 2,022,090; December 12, 1979; assigned to F. Hoffman-La Roche & Co. A.G. (Switz.)

CEFUROXIME

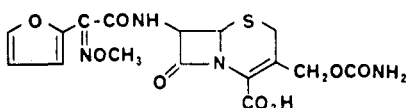
Therapeutic Function: Antibiotic**Chemical Name:** (6R,7R-3-Carbamoyloxymethyl-7-[2-(2-furyl)-2-(methoxyimino)acetamido]-ceph-3-em-4-carboxylic acid**Common Name:** —**Structural Formula:****Chemical Abstracts Registry No.:** 55268-75-2; 56238-63-2 (Sodium salt)

Trade Name	Manufacturer	Country	Year Introduced
Ultroxim	Duncan	Italy	1978
Curoxime	Glaxo	Italy	1978
Zinacef	Hoechst	W. Germany	1978
Zinacef	Glaxo	U.K.	1978
Zinacef	Glaxo	Switz.	1978
Ceroxime	Glaxo	France	1980
Zinacef	Glaxo	Japan	1982
Zinacef	Tanabe Seiyaku	Japan	1982
Zinacef	Glaxo	U.S.	1983
Altacel	Pulitzer	Italy	—
Biociclin	Del Saz & Filippini	Italy	—
Bioxima	Italsuisse	Italy	—
Cefamar	Firma	Italy	—
Cefoprim	Esseti	Italy	—
Cefumax	Locatelli	Italy	—
Cefur	Tiber	Italy	—
Cefurex	Sarm	Italy	—
Cefurin	Magis	Italy	—
Cefurox	Glaxo	—	—
Colifossim	Coli	Italy	—
Curocef	Glaxo	—	—
Duxima	Dukron	Italy	—
Furex	Lafare	Italy	—
Gibicef	Gibipharma	Italy	—
Itorex	Ausonia	Italy	—
Kefox	C.T.	Italy	—
Kesint	Proter	Italy	—
Ketocef	Glaxo	—	—
Lamposporin	Von Boch	Italy	—
Medoxin	Medici	Italy	—
Polixima	Sierochimica	Italy	—
Supero	Farmochimica	Italy	—
Ultroxim	Sigmatau	Italy	—

Raw Materials

(6R,7R)-7-Amino-3-carbamoyloxymethylceph-3-em-4-carboxylic acid
 Phosphorus pentachloride
 2-(Fur-2-yl)-2-methoxyiminoacetic acid
 Hydrogen chloride

Manufacturing Process

A stirred mixture of N,N-dimethylacetamide (75 ml), acetonitrile (75 ml), triethylamine (42 ml, 0.3 mol) and (6R,7R)-7-amino-3-carbamoyloxymethylceph-3-em-4-carboxylic acid was immersed in an ice-bath and water (10 ml) was added. The mixture was stirred at 0°C to 2°C for 45 minutes, the solid slowly dissolving to give a yellow solution.

Meanwhile a stirred suspension of phosphorus pentachloride (14.99 g, 0.072 mol) in dry dichloromethane (150 ml) was cooled to 0°C, and N,N-dimethylacetamide (27.5 ml) was added. The resulting solution was recooled to -10°C and 2-fur-2-yl)-2-methoxyiminoacetic acid (syn-isomer) (12.17 g, 0.072 mol) was added. The mixture was stirred at -10°C for 15 minutes and crushed ice (35 g) was added. The mixture was stirred at 0°C for 10 minutes, whereafter the lower dichloromethane phase was added over 10 minutes to the cephalosporin solution prepared above, cooled to -10°C so that the reaction temperature rose steadily to 0°C. The mixture was stirred at 0°C to 2°C for 1 hour, whereafter the cooling bath was removed and the reaction temperature allowed to rise to 20°C over 1 hour. The reaction mixture was then added slowly to 2N hydrochloric acid (100 ml) diluted with cold water (1.15 l) at 5°C. The pH of the two-phase mixture was adjusted to below 2 with 2N hydrochloric acid (10 ml), and the mixture was stirred and recooled to 5°C. The solid which precipitated was filtered, washed with dichloromethane (100 ml) and water (250 ml), and dried in vacuo at 40°C overnight to give the title compound (22.04 g, 86.6%).

References

Merck Index 1917
 DFU 3 (4) 266 (1978)
 Kleeman & Engel p. 177
 PDR p. 922
 OCDS Vol. 3 p. 216 (1984)
 DOT 12 (5) 189 (1976) & 15 (1) 10 (1979)
 I.N. p. 200
 REM p. 1187
 Cook, M.C., Gregory, G.I. and Bradshaw, J.; U.S. Patent 3,966,717; June 29, 1976; assigned to Glaxo Laboratories, Ltd.
 Cook, M.C., Gregory, G.I. and Bradshaw, J.; U.S. Patent 3,974,153; August 10, 1976; assigned to Glaxo Laboratories, Ltd.

CELIPROLOL

Therapeutic Function: Beta-adrenergic blocker

Chemical Name: N'-[3-Acetyl-4-[3-[(1,1-dimethylethyl)amino]-2-hydroxypropoxy]phenyl]-N,N-diethylurea

Common Name: -

Structural Formula:

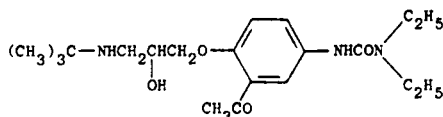

Chemical Abstracts Registry No.: 56980-93-9

Trade Name	Manufacturer	Country	Year Introduced
Selectol	Chemie Linz	Austria	1983
Selectol	Chemie Linz	W. Germany	1983

Raw Materials

3-Acetyl-4-hydroxyaniline	Epichlorohydrin
Dimethylcarbonyl chloride	t-Butylamine

Manufacturing Process

3-Acetyl-4-hydroxyaniline, in solution in pyridine, is reacted with dimethylcarbonyl chloride at room temperature to give N-(3-acetyl-4-hydroxy)-phenyl-N'-dimethylurea, which after evaporating the pyridine, taking up the residue in chloroform and evaporating the latter, is obtained in a crystalline form. Melting point: 160°-162°C. After reaction of the product in alkaline aqueous solution, with epichlorohydrin, N-[3-acetyl-4-(2',3'-epoxy)-propoxy]-phenyl-N'-dimethylurea (melting point: 98°-102°C) is obtained, and this, in turn, is reacted with excess tert-butylamine in aqueous solution at room temperature to give N-[3-acetyl-4-(3'-tert-butylamino-2'-hydroxy)-propoxy]-phenyl-N'-dimethylurea of melting point: 120°-122°C.

References

Merck Index 1921

DFU 4 (3) 181 (1979)

DOT 18 (12) 632 (1982)

I.N. p. 201

Zolss, G., Pittner, H., Stormann-Menninger-Lerchenthal, H. and Lindner, I.; U.S. Patent 3,983,169; September 28, 1976; assigned to Chemie Linz AG (Austria)

CEPHACETRILE SODIUM

Therapeutic Function: Antibiotic

Chemical Name: 7-(2-cyanoacetamido)-3-(hydroxymethyl)-8-oxo-5-thia-1-azabicyclo[4.2.0]-oct-2-ene-2-carboxylic acid acetate monosodium salt

Common Name: Sodium 7-(2-cyanoacetamido)-cephalosporanic acid

Structural Formula:

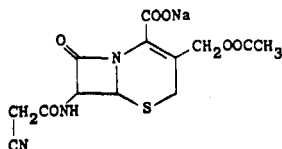

Chemical Abstracts Registry No.: 23239-41-0; 10206-21-0 (Base)

Trade Name	Manufacturer	Country	Year Introduced
Celospor	Ciba Geigy	Switz.	1969
Celospor	Ciba	France	1973
Clospor	Gruenenthal	W. Germany	1974
Celospor	Ciba	Italy	1974
Celospor	Ciba	W. Germany	1974
Celtoi	Takeda	Japan	1978

Trade Name	Manufacturer	Country	Year Introduced
Celospor	Ciba Geigy	Japan	1978
Flunicef	Alfa Farm.	Italy	—

Raw Materials

7-Amino-cephalosporanic acid
 Cyanoacetyl chloride
 Sodium hydroxide

Manufacturing Process

13.6 g (0.05 mol) of 7-amino-cephalosporanic acid are taken up in a mixture of 150 ml of methylene chloride and 19.5 ml of tributylamine (0.12 mol) and at 0°C a solution of 8.4 g of cyanoacetylchloride (0.07 mol) in 100 ml of methylene chloride is stirred in. The bath is then stirred for ½ hour at 0°C and for ½ hour at 20°C, the reaction solution is evaporated under vacuum and the residue taken up in 10% aqueous dipotassium hydrogen-phosphate solution. This aqueous phase is washed with ethyl acetate, acidified to pH 2.0 with concentrated hydrochloric acid and extracted with ethyl acetate.

After having been dried over sodium sulfate and evaporated under vacuum, this extract gives as a solid residue 14.7 g of crude 7-cyanoacetyl-amino-cephalosporanic acid which is purified by chromatography on 30 times its own weight of silica gel. The fractions eluted with chloroform plus acetone (7:3) furnish a product which crystallizes from acetone plus ether in the form of needles melting at 168° to 170°C with decomposition.

5.10 g (15 mmol) of 7-cyanoacetyl-aminocephalosporanic acid are suspended in 102 ml of distilled water and converted into the sodium salt by stirring in dropwise 15 ml of N sodium hydroxide solution.

References

Merck Index 1934

Kleeman & Engel p. 159

DOT 7 (5) 181 (1971) 9 (2) 50 (1973) & 10 (7) 239 (1974)

I.N. p. 193

Bickel, H., Bosshardt, R., Fechtig, B., Schenker, K. and Urech, J.; U.S. Patent 3,483,197; December 9, 1969; assigned to Ciba Corporation

CEPHALEXIN

Therapeutic Function: Antibiotic

Chemical Name: 7-[(Aminophenylacetyl)amino]-3-methyl-8-oxo-5-thia-1-azabicyclo[4.2.0]-oct-2-ene-2-carboxylic acid

Common Name: —

Structural Formula:

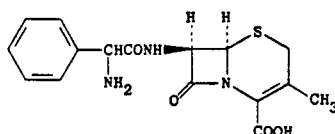

Chemical Abstracts Registry No.: 15686-71-2; 23325-78-2 (Monohydrate)

Trade Name	Manufacturer	Country	Year Introduced
Ceporex	Glaxo	U.K.	1970
Ceprorexine	Glaxo	France	1970
Cepol	Torii	Japan	1970
Keflex	Shionogi	Japan	1970
Keflex	Lilly	U.K.	1970
Keflex	Lilly	U.S.	1971
Ceporex	Glaxo	Italy	1971
Keforal	Lilly	France, Italy	1971
Oracef	Lilly	W. Germany	1971
Keflex	Serum Impfinst	Switz.	1974
Acaxina	Martin Santos	Spain	--
Acinipan	Aldon	Spain	--
Ambal	Medical	Spain	--
Amplicefal	Miluy	Spain	--
Ampligram	Hermes	Spain	--
Ausocef	Ausonia	Italy	--
Basporin	Basileos	Spain	--
Bilatox	Biopharma	Spain	--
Bioporina	Biologia Marina	Spain	--
Brisoral	Bristol-Myers	--	--
Cefabiot Oral	Galepharma Iberica	Spain	--
Cefadina	Antibioticos	Spain	--
Cefadros	Proter	Italy	--
Cefa-Iskia	Iskia	Spain	--
Cefaleh Ina	Alvarez Gomez	Spain	--
Cefalekey	Pereira	Spain	--
Cefalex-Gobens	Normon	Spain	--
Cefalival	Valles Mestre	Spain	--
Cefaloto	Lifepharma	Spain	--
Cefa-Reder	Reder	Spain	--
Cefaxin	Bristol	Italy	--
Cefibacter	Rubio	Spain	--
Ceflon	Mulda	Turkey	--
Ceflor	Coli	Italy	--
Ceforal	Teva	Israel	--
Cepexin	Glaxo	--	--
Cephalomax	Daisan	Japan	--
Cephazal	Hokuriku	Japan	--
Cepol	Torii	Japan	--
Cepoven	Glaxo	Italy	--
CEX	Glaxo	Japan	--
Chemosporal	Erba	Italy	--
Cilicef Oral	Hortel	Spain	--
Ciponium	Nippon Kayaku	Japan	--
Derantel	Nippon Chemiphar	Japan	--
Devaleksin	Deva	Turkey	--
Diabeton	Teknofarma	Italy	--
Erifalecin	Dreikehl	Spain	--
Erocetin	Roemmers	Argentina	--
Esmezin	Sawai	Japan	--
Falecina	Italquimica	Spain	--
Farexin	Lafare	Italy	--
Fergon	Alfar	Spain	--
Garasin	Wakamoto	Japan	--
Grafalex	Graino	Spain	--
Huberlexina	Hubber	Spain	--
Ibilex	I.B.I.	Italy	--
Iwalexin	Iwaki	Japan	--

Trade Name	Manufacturer	Country	Year Introduced
Janocilin	Janovich	Spain	—
Keflex	Shionogi	Japan	—
Kelfison	Davur	Spain	—
Larixin	Toyama	Japan	—
Latoral	Dukron	Italy	—
Lefosporina	Bicsa	Spain	—
Lexibiotico	Llano	Spain	—
Libesporal	Liberman	Spain	—
Llenas Biotic	Llenas	Spain	—
Lorexina	Crosara	Italy	—
Madlexin	Meiji	Japan	—
Maksipor	Fako	Turkey	—
Mamalexin	Showa	Japan	—
Mepilacin	Kanto	Japan	—
Neolexina	Asia	Spain	—
Nilexina	Pental	Spain	—
Ohlexin	Ohta	Japan	—
Oracocin	Tobishi	Japan	—
Oralexine	Novo	Denmark	—
Oroxin	Otsuka	Japan	—
Ortisporina	Turro	Spain	—
Ospexin	Biochemie	Austria	—
Palitrex	Galenira	Yugoslavia	—
Porinabis	Santos	Spain	—
Pracefal	Pradel	Spain	—
Prindex	Hosbon	Spain	—
Pyassan	Chinoi	Hungary	—
Rinesal	Kissei	Japan	—
Rogeridina	Roger	Spain	—
Salitex	Banyu	Japan	—
Sargetina	Sarget	France	—
Sartosona	Sanomed	Spain	—
Sasperos	Schiapparelli	Italy	—
Sayra	Legem	Spain	—
Sefaleksin	Ilisan	Turkey	—
Segoramin	Takata	Japan	—
Sencephalin	Takeda	Japan	—
Septilisin	Bago	Argentina	—
Syncel	Toyo Jozo	Japan	—
Taicelexin	Taiyo	Japan	—
Talinsul	Ester	Spain	—
Testaxina	Bryan	Spain	—
Tokiorexin	Isei	Japan	—
Torlasporin	Torlan	Spain	—
Wasserporina	Wassermann	Spain	—
Xahl	S.S. Seiyaku	Japan	—

Raw Materials

Sodium-D- α -phenylglycine	Zinc
Methyl acetoacetate	Hydrogen chloride
p-Nitrobenzyl-7-aminodesacetoxycephalosporanate	

Manufacturing Process

To a 1 liter flask containing dimethylformamide at 0°C, was added 24.8 g sodium N-(2-methoxycarbonyl-1-methylvinyl)-D- α -phenylglycine (prepared from sodium D- α -phenylglycine and methyl acetoacetate). The mixture was cooled to -40°C and methyl chloroformate (7.5

ml) and dimethylbenzylamine (0.26 ml) added. After stirring for 25 minutes, p-nitrobenzyl 7-aminodesacetoxycephalosporanate (32.8 g) in the form of its hydrochloride salt was added, followed by triethylamine (12.1 ml) and dimethylformamide (140 ml) over a period of 20 minutes. The reaction mixture was stirred for 2 hours at -25°C to -35°C , then warmed to 0°C and water (32 ml) added. To the resultant solution, hydrochloric acid (54 ml) was added followed by zinc (21.8 g) in portions over a period of 5 minutes, the temperature being maintained at 5°C to 10°C . Further hydrochloric acid (35 ml) was added and the solution stirred at 15°C to 20°C for 7 hours.

The pH was adjusted to 3.3 with triethylamine and semicarbazide hydrochloride (9.5 g) added. The mixture was brought back to pH 3 with further triethylamine, then stirred for 30 minutes at pH 3. The resultant mixture was adjusted slowly over 4 hours to pH 6.8 by addition of triethylamine, seeding being carried out when pH 4.5 was reached. The precipitated cephalixin was filtered off, washed with dimethylformamide (200 ml) and the cephalixin recovered, yield 75%.

References

Merck Index 1936

Kleeman & Engel p. 161

PDR p. 841

OCDS Vol. 1 p. 417 (1977) & 2 p. 439 (1980)

DOT 5 (1) 29 (1969) & 6 (5) 165 (1970)

I.N. p. 194

REM p. 1189

Davison, M., Frankham, D.B., Spence, T.W.M.; U.S. Patent 3,946,002; March 23, 1976; assigned to Lilly Industries Ltd.

CEPHALOGLYCIN

Therapeutic Function: Antibacterial

Chemical Name: 3-[(acetyloxy)methyl]-7-[(aminophenylacetyl)amino]-8-oxo-5-thia-1-azabicyclo[4.2.0]oct-2-ene-2-carboxylic acid

Common Name: 7(D- α -aminophenylacetyl-amido)-cephalosporanic acid

Structural Formula:

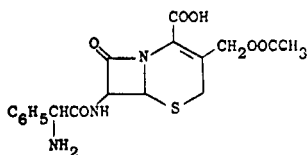

Chemical Abstracts Registry No.: 3577-01-3

Trade Name	Manufacturer	Country	Year Introduced
Kefglycin	Shionogi	Japan	1969
Kafocin	Lilly	U.S.	1970

Raw Materials

D-Phenylglycine	Carboboxy chloride
7-Amino-cephalosporanic acid	Hydrogen
Isobutyl chloroformate	

Manufacturing Process

di-Phenylglycine is resolved in a conventional manner by reaction with cinchonine, fractional crystallization of the resulting diastereoisomers, and acidification to release the phenylglycine enantiomorphs. D-phenylglycine, thus prepared, is reacted with carbobenzoxy chloride in a conventional manner to produce N-carbobenzoxy-D-phenylglycine.

A 0.60 g portion of N-carbobenzoxy-D-phenylglycine is dissolved in 10 ml of dry tetrahydrofuran. The solution is cooled in an ice-salt bath, and to it is added 0.29 ml of triethylamine with stirring over a period of 10 minutes, followed by 0.29 ml of isobutyl chloroformate, after which stirring is continued for 10 minutes at -5°C . During this time, 0.57 g of 7-amino-cephalosporanic acid and 0.29 ml of triethylamine are dissolved in 5 ml of tetrahydrofuran and 5 ml of water, and the solution is centrifuged to remove a dark sludge. The clarified solution is cooled in ice and slowly added to the reaction mixture, and stirring is continued in the ice bath for 0.5 hour, followed by one hour at room temperature.

The reaction product mixture is a homogenous solution having a pH of about 6. It is evaporated under vacuum to a semisolid residue. To the residue are added 35 ml of water and a few drops of triethylamine to raise the pH to 8. The aqueous solution obtained thereby is extracted successively with 50 ml and 35 ml portions of ethyl acetate, the pH being adjusted to 2 at each extraction with hydrochloric acid. The extracts are combined, filtered, dried over sodium sulfate, stripped of solvent, and evaporated under vacuum. The product is 7-(N-carbobenzoxy-D- α -aminophenylacetamido)cephalosporanic acid in the form of a yellow-white amorphous solid weighing 1.10 g.

Of this material 1.0 g is dissolved in 150 ml of warm 95% ethyl alcohol. To the solution is added 1.0 g of 5% palladium on carbon catalyst, and the mixture is hydrogenated at room temperature and atmospheric pressure by bubbling hydrogen into it for 3 hours with stirring. The hydrogenation product is filtered. The solid phase, comprising the catalyst and the desired product, is suspended in ethyl acetate and water and adjusted to pH 2 with hydrochloric acid. The suspension is filtered to remove the catalyst. The aqueous phase is separated from the filtrate, and is evaporated under vacuum to recover the desired product, 7-(D- α -aminophenylacetamido)cephalosporanic acid.

References

- Merck Index 1938
 Kleeman & Engel p. 163
 OCDS Vol. 1 p. 417 (1977)
 DOT 6 (5) 169 (1970)
 I.N. p. 195
 British Patent 1,017,624; January 19, 1966; assigned to Merck & Co., Inc.
 British Patent 985,747; March 10, 1965; assigned to Eli Lilly and Company
 Wall, W.F., Fatherey, M. and Boothroyd, B.; U.S. Patent 3,422,103; January 14, 1969; assigned to Glaxo Laboratories, Ltd.
 Pfeiffer, R.R. and Bottonff, E.M.; U.S. Patent 3,497,505; February 24, 1970; assigned to Eli Lilly & Co.
 Jackson, B.G.; U.S. Patent 3,671,449; June 20, 1972; assigned to Eli Lilly & Co.

CEPHALORIDINE

Therapeutic Function: Antibacterial

Chemical Name: (6R-trans)-1-[[2-Carboxy-8-oxo-7-[(2-thienylacetyl)amino]-5-thia-1-azabicyclo[4.2.0]oct-2-en-3-yl] methyl] pyridinium hydroxide inner salt

Common Name: Cefaloridin

Structural Formula:

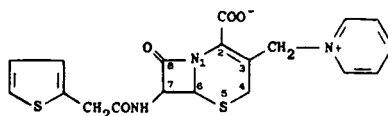

Chemical Abstracts Registry No.: 50-59-9

Trade Name	Manufacturer	Country	Year Introduced
Ceporin	Glaxo	U.K.	1964
Ceporin	Glaxo	Switz.	1965
Cephaloridin	Glaxo	W. Germany	1965
Keflodin	Lilly	France	1967
Loridine	Lilly	U.S.	1968
Ceporin	Glaxo	Italy	1976
Acaporina	Martin Santos	Spain	—
Aliporina	Asla	Spain	—
Amplicerina	Miluy	Spain	—
Ampligram	Hermes	Spain	—
Basporidina	Basileos	Spain	—
Bioporina	Biologia Marina	Spain	—
Cefabena	Jebena	Spain	—
Cefabiot	Galepharma Iberica	Spain	—
Cefaclox	Sigma Tau	Italy	—
Cefalescord	Callol	Spain	—
Cefalisan	Lifepharmia	Spain	—
Cefalobiotic	Wolner	Spain	—
Cefalogobens	Normon	Spain	—
Cefalomiso	Oftalmiso	Spain	—
Cefamusel	De La Cruz	Spain	—
Cefaresan	Alacan	Spain	—
Ceflorin	Glaxo	—	—
Cepalorin	Glaxo	—	—
Ceporan	Glaxo	—	—
Ceporan	Torii	Japan	—
Ceproduct	Glaxo	Italy	—
CER	Glaxo	Japan	—
Cidan-Cef	Cidan	Spain	—
Cilicef	Hortel	Spain	—
Cobalcina	Pradel	Spain	—
Cusisporina	Norte De Espana	Spain	—
Diclocef	Medici	Italy	—
Dinasint	Proter	Italy	—
Eldia	Legem	Spain	—
Endosporol	Cantabria	Spain	—
Enebiotic	Llano	Spain	—
Faredina	Lefare	Italy	—
Filoklin	Lifasa	Spain	—
Floridin	Coli	Italy	—
Gencefal	Morgens	Spain	—
Glaxoridin	Glaxo	—	—
Huberlexina	Hubber	Spain	—
Intrasporin	Torlan	Spain	—
Janosina	Janovich	Spain	—
Keflodin	Shionogi	Japan	—
Kefspor	Lilly	—	—
Kelfison	Davur	Spain	—

Trade Name	Manufacturer	Country	Year Introduced
Latorex	Durrón	Italy	—
Lauridin	Crosara	Italy	—
Lexibiotico	Llano	Spain	—
Libesporina	Liberman	Spain	—
Liexina	ICN	—	—
Llenas Biotic	Llenas	Spain	—
Lloncefal	Castillon	Spain	—
Poricefal	Santos	Spain	—
Prinderin	Hosbon	Spain	—
Rogeridina	Roger	Spain	—
Rolexina	Fedal	Spain	—
Sargefal	Sarget	France	—
Sintoridyn	I.S.F.	Italy	—
Sporanicum	Incasa-Wolff	Spain	—
Talinsul	Ester	Spain	—
Tapiola	Guadalupe	Spain	—
Testadina	Bryan	Spain	—
Totalmicina	Emyfar	Spain	—
Wasseridina	Wassermann	Spain	—

Raw Materials

7-Aminocephalosporanic acid
 2-Thienylacetyl chloride
 Pyridine

Manufacturing Process

7-Aminocephalosporanic acid (5.00 g) which passed through a 100-mesh sieve was suspended in boiling ethyl acetate (200 ml), and 2-thienylacetyl chloride (Cagniant, *Bull. Soc. Chim. France*, 1949, 847) (4.42 g, 1.5 equiv.) was added in ethyl acetate (20 ml). The mixture was boiled under reflux for 40 minutes, cooled, and filtered. Aniline (5.03 ml) was added, and after 1 hour the mixture was extracted with 3% sodium hydrogen carbonate solution (1 x 150 ml, 2 x 100 ml, 1 x 50 ml) and the alkaline extracts washed with ethyl acetate (3 x 100 ml). The aqueous solution was acidified to pH 1.2, and extracted with ethyl acetate (2 x 150 ml). The ethyl acetate extract was washed with water (4 x 40 ml), dried (MgSO₄), and concentrated in vacuo to low volume. The crude 7-2'-thienylacetamidocephalosporanic acid (2.5 g) which separated was collected by filtration. Evaporation of the filtrate gave a further 2.68 g (71%) of the product, which was purified by crystallization from ethyl acetate, then aqueous acetone, MP 150°C to 157°C (decomp.).

7-2'-Thienylacetamidocephalosporanic acid (7.0 g) was suspended in water (60 ml) and stirred with pyridine (7 ml) until the acid dissolved. The resulting solution (pH 5.9) was kept at 35°C for 3 days, then filtered and extracted with methylene chloride (4 x 60 ml). The methylene chloride extract was back-extracted with a little water and the total aqueous solutions were then percolated through a column of Dowex 1 x 8 resin, (100 to 200 mesh, 150 g) in the acetate form at pH 4.3. The column was washed with water until the optical rotation of the eluate fell to zero and the eluate (500 ml) was freeze-dried. The residual white solid was dissolved in the minimum volume of methanol and after a few minutes the pyridine derivative crystallized; this is the cephaloridine product.

References

Merck Index 1940
 Kleeman & Engel p. 164
 OCDS Vol. 1 p. 417 (1977)
 DOT 1 (3) 88 (1965)
 I.N. p. 195

Arkley, V., Eardley, S. and Long, A.G.; British Patent 1,030,630; May 25, 1966; assigned to Glaxo Laboratories, Ltd.

Higgins, H.M. Jr.; U.S. Patent 3,270,012; August 30, 1966; assigned to Eli Lilly & Co.

CEPHALOTHIN SODIUM

Therapeutic Function: Antibacterial

Chemical Name: 6R-trans-3-[(acetyloxy)methyl]-8-oxo-7-[(2-thienylacetyl)amino]-5-thia-1-azabicyclo[4.2.0]oct-2-ene-carboxylic acid sodium salt

Common Name: 7-(2-thienylacetamido)cephalosporanic acid

Structural Formula:

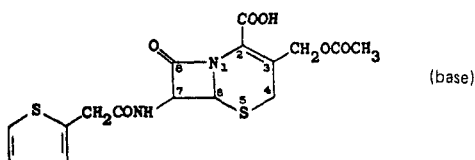

Chemical Abstracts Registry No.: 58-71-9; 153-61-7 (Base)

Trade Name	Manufacturer	Country	Year Introduced
Keflin	Lilly	U.S.	1964
Cepovenin	Hoechst/Glaxo	W. Germany	1965
Keflin	Lilly	France	1965
Keflin	Serum Impfst.	Switz.	1965
Keflin	Shionogi	Japan	1966
Keflin	Lilly	Italy	1967
Keflin	Lilly	U.K.	1969
Seffin	Glaxo	U.S.	1983
Averon	Alfar	Spain	—
Averon-I	Alfa Farm.	Italy	—
Cephalotin	Lilly	W. Germany	—
Cephation	Meiji	Japan	—
Ceporacin	Glaxo	—	—
Cepovenin	Hoechst	W. Germany	—
CET	Glaxo	Japan	—
Coaxin	Tobishi	Japan	—
Loccalline	Showa	Japan	—
Lospoven	Hoechst	—	—
Restin	Ono	Japan	—
Sodium Cephalotin	Green Cross	Japan	—
Sucira N	Mohan	Japan	—
Synclotin	Toyo Jozo	Japan	—
Toricelosis	Torii	Japan	—

Raw Materials

2-Thienylacetic acid	Thionyl chloride
7-Aminocephalosporanic acid	Sodium hydroxide

Manufacturing Process

7-(2'-Thienylacetamido)cephalosporanic acid sodium salt may be produced from 2-thienylacetyl chloride, obtainable by treatment of 2-thienylacetic acid [Ernst, *Berichte*, 19 (1886)

3281] with thionyl chloride in a conventional manner. The 2-thienylacetyl chloride is then reacted with 7-aminocephalosporanic acid and then converted to the sodium salt using sodium hydroxide.

References

- Merck Index 1943
 Kleeman & Engel p. 165
 PDR pp. 911, 1056
 OCDS Vol. 1 pp. 417, 420 (1977)
 DOT 2 (2) 44 (1966)
 I.N. p. 196
 REM p. 1187
 British Patent 982,252; February 3, 1965; assigned to Eli Lilly and Company

CEPHAPIRIN SODIUM

Therapeutic Function: Antibacterial

Chemical Name: 3-[(acetyloxy)methyl]-8-oxo-7-[[4-(pyridinylthio)acetyl]amino]-5-thia-1-azabicyclo[4.2.0]oct-2-ene-2-carboxylic acid monosodium salt

Common Name: Sodium 7-(pyrid-4-ylthioacetamido)cephalosporanate

Structural Formula:

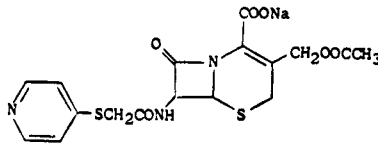

Chemical Abstracts Registry No.: 24356-60-3; 21593-23-7 (Acid)

Trade Name	Manufacturer	Country	Year Introduced
Cefadyl	Bristol	U.S.	1974
Bristocef	Bristol	W. Germany	1974
Cephaloject	Bristol	France	1974
Cefatrexyl	Essex	Switz.	1974
Brisporin	Bristol	Italy	1976
Cefatrexyl	Bristol	Japan	1977
Brisfirina	Bristol-Myers	—	—
Cefa-Lak	Bristol	—	—
Cefatrex	Bristol-Myers	—	—
Cefatrexil	Mead-Johnson	—	—
Cefatrexyl	Galenika	Yugoslavia	—
Piricef	C.T.	Italy	—
Today	Bristol-Myers	—	—

Raw Materials

Aminocephalosporanic acid	Bromoacetyl bromide
Sodium bicarbonate	2-Mercaptopyrimidine
Sodium-3-ethyl hexanoate	

Manufacturing Process

One route is that described in U.S. Patent 3,422,100 as follows, starting with aminocephalosporanic acid (ACA): 27.2 g (0.1 mol) of 7-ACA, 33.2 g (0.3 mol) of NaHCO_3 , 200 ml of water and 100 ml of acetone were mixed together, cooled to 0°C and stirred rapidly while 20.1 g (0.1 mol) of bromoacetyl bromide dissolved in 100 ml of acetone was added in one fast addition. The temperature was kept at 0° to 5°C for ten minutes, then the ice-salt bath was removed and stirring continued for one hour as the temperature approached 25°C. The mixture was concentrated in vacuo at 20°C to one-half volume and 200 ml of water added. Two 400 ml ether extracts were made and collected. The aqueous solution was covered with 200 ml of ethyl acetate and vigorously stirred and cooled while being acidified to pH 2 with 40% phosphoric acid.

The mixture was filtered, the ethyl acetate layer separated and washed with three 100 ml portions of water, dried over Na_2SO_4 , filtered and treated with 30 ml of sodium 2-ethylhexanoate in n-butanol (34 ml = 0.1 mol). The oil which settled out was scratched to induce crystallization. After stirring for 20 minutes the product, sodium 7-(α -bromoacetamido)cephalosporanate, was scraped from the sides of the flask and collected. The filter cake was washed with several portions of acetone, air dried, and dried in vacuo over P_2O_5 . The yield was 22.5 g and decomposed at 193°C.

A solution of 1.13 g (0.01 mol) of 2-mercaptopyrimidine and 1.06 g (0.01 mol) of sodium carbonate dissolved in 25 ml of water was added dropwise over a period of an hour at room temperature, to a stirred solution of 4.15 g (0.01 mol) of sodium 7-(α -bromoacetamido)cephalosporanate in 25 ml of water.

Stirring was continued an additional 90 minutes and then 50 ml of ethyl acetate was added. Forty percent H_3PO_4 was added dropwise with vigorous stirring until pH 2.5 to 3 was obtained. The product crystallized immediately and was filtered off, washed several times with water and then three times with 25 ml portions of ethyl acetate, following which it was air dried. The yield was 2.9 g of crystals that decomposed at 167° to 168°C. The IR and NMR spectra were consistent with the desired product, 7-[α -(2-pyrimidinylthio)acetamido]cephalosporanic acid monohydrate.

An alternate route is that described in U.S. Patent 3,503,967 which uses ACA in the last step.

Another alternative route is that described in U.S. Patent 3,578,661 uses bromomethylcephalosporin as one raw material.

However the acid is prepared, the sodium salt may be prepared as described in U.S. Patent 3,503,967: Five liters of methylene chloride were added to a clean dry vessel equipped with stirrer. 7-[α -(4-pyridylthio)acetamido]cephalosporanic acid (1,000 g) was added to the vessel, followed by 350 ml of triethylamine. The resultant solution was treated with decolorizing charcoal for 15 minutes and filtered. A solution of sodium-3-ethylhexanoate (27.3%) in butanol-methylene chloride was added to the filtrate with stirring. Seven thousand five hundred milliliters of acetone was added. Crystallization occurred while stirring was continued several hours under dry conditions. The crystals were collected by filtration, washed with large volumes of acetone, and then dried in vacuo at 50°C to yield about 950 g of the title compound.

References

- Merck Index 1945
- Kleeman & Engel p. 167
- PDR p. 695
- OCDS Vol. 2 p. 441 (1980)
- DOT 9 (2) 56 (1973) & 10 (11) 299 (1974)
- I.N. p. 197
- REM p. 1187

Crast, L.B. Jr.; U.S. Patent 3,422,100; January 14, 1969; assigned to Bristol-Myers Company
 Silvestri, H.H. and Johnson, D.A.; U.S. Patent 3,503,967; March 31, 1970; assigned to Bristol-Myers Company

Havranek, R.E. and Crast, L.B. Jr.; U.S. Patent 3,578,661; May 11, 1971; assigned to Bristol-Myers Company

CEPHRADINE

Therapeutic Function: Antibiotic

Chemical Name: 7-[D-2-amino-2-(1,4-cyclohexadien-1-yl)acetamido]-3-methyl-8-oxo-5-thia-1-azabicyclo[4.2.0]oct-2-ene-2-carboxylic acid

Common Name: —

Structural Formula:

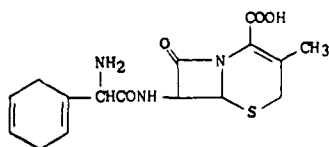

Chemical Abstracts Registry No.: 38821-53-3

Trade Name	Manufacturer	Country	Year Introduced
Sefril	Squibb	Switz.	—
Eskacef	SKF	U.K.	1972
Velosef	Squibb	U.K.	1972
Sefril	Von Heyden	W. Germany	1973
Velocef	Squibb	Italy	1973
Velosef	Squibb	U.S.	1974
Anspor	SKF	U.S.	1974
Velosef	Squibb	France	1975
Eskacef	SKF	France	1975
Dicefalin	Nippon Squibb	Japan	1978
Cefro	Sankyo	Japan	1978
Lisacef	Lisapharma	Italy	1980
Askacef	SKF	—	—
Cefamid	Gibipharma	Italy	—
Cefosan	San Carlo	Italy	—
Cefradex	Ausonia	Italy	—
Cefrag	Magis	Italy	—
Cefro	Sankyo	Japan	—
Cefrum	San Carlo	Italy	—
Celex	Aristochimica	Italy	—
Cesporan	Errekappa	Italy	—
Citichel	C.T.	Italy	—
Dimacef	Dima	Italy	—
Ecosporina	Ecobi	Italy	—
Eskacef	SKF	Italy	—
Eskacef	SK Dauelsberg	W. Germany	—
Forticef	Godecke	W. Germany	—
Lisacef	Lisapharma	Italy	—

Trade Name	Manufacturer	Country	Year Introduced
Medicef	Medici	Italy	—
Megacef	Beytout	France	—
Noblitina	Juste	Spain	—
Protocef	Ripari-Gero	Italy	—
Samedrin	Savoma	Italy	—

Raw Materials

D-Phenylglycine	Lithium
Methyl acetoacetate	Ammonia
3-Deacetoxy-7-aminocephalosporanic acid	

Manufacturing Process

In a first step, D-2-amino-2-(1,4-cyclohexadienyl)acetic acid is obtained as follows. A solution of 11.0 g (72.7 mmol) of D-phenylglycine in 900 ml distilled ammonia (which has been treated with 45 mg lithium after distillation to destroy traces of moisture) is slowly diluted with 370 ml dry tert-butyl alcohol.

Over a period of hours, 1.65 g lithium (3.27 eq) is added in small portions until a permanent blue color is obtained. The blue reaction mixture is then treated with 38 g of triethylamine hydrochloride. The ammonia is allowed to evaporate at room temperature overnight and the residual solvent is evaporated at reduced pressure. The white residue is taken up in a small amount of methanol-water and added to 4 liters of cold 1:1 chloroform-acetone to precipitate the crude product. After 20 minutes stirring the suspension is filtered and the white filter cake dried in vacuo; the filter cake is then pulverized and submitted once more to the precipitation process from 1:1 chloroform-acetone.

The white, crystalline product, 11.8 g, MP 297°C (dec), $[\alpha]_D -89.7^\circ$ (2 N NaOH) is quantitatively obtained but is slightly contaminated with lithium chloride, 0.6% ionic chlorine being found by analysis.

The product of a second step is the methyl acetoacetic ester enamine of N-2-amino-2-(1,4-cyclohexadienyl)acetic acid sodium salt. 306 mg D-2-amino-2-(1,4-cyclohexadienyl)acetic acid (2.00 mmol) are dissolved by warming in a solution of 108 mg of NaOCH_3 (2.00 mmol) in 4.3 ml reagent grade MeOH. 255 mg (0.24 ml, 2.20 mmol) methyl acetoacetate are added and the mixture refluxed for 45 minutes. The MeOH is almost totally stripped off in vacuo. Five milliliters benzene are added and distilled off to a small residual volume. The addition and distillation of benzene is repeated to insure complete removal of the MeOH and water. The product crystallizes out overnight from a small residual volume of benzene. It is filtered off, washed with benzene, and dried in vacuo. Yield 463 mg.

Then 3-deacetoxy-7-aminocephalosporanic acid is condensed with the abovedescribed sodium salt in the presence of triethylamine to give cephradine.

References

- Merck Index 1947
- Kleeman & Engel p. 175
- PDR pp. 1703, 1771
- OCDS Vol. 2 p. 440 (1980)
- DOT 9 (3) 89 (1973)
- I.N. p. 199
- REM p. 1188
- Weisenborn, F.L., Dolfini, J.E., Bach, G.G. and Bernstein, J.; U.S. Patent 3,485,819; December 23, 1969; assigned to E.R. Squibb & Sons, Inc.

CERULETIDE

Therapeutic Function: Stimulant (gastric secretory)

Chemical Name: Decapeptide of empirical formula $C_{58}H_{73}N_{13}O_{21}S_2$

Common Name: Cerulein; caerulein

Structural Formula:

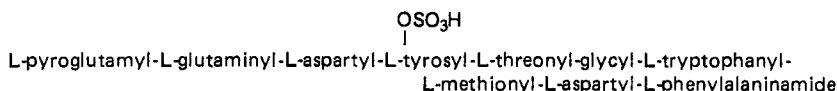

Chemical Abstracts Registry No.: 17650-98-5

Trade Name	Manufacturer	Country	Year Introduced
Ceosunin	Kyowa Hakko	Japan	1976
Takas	Carlo Erba	W. Germany	1978
Takus	Essex	Switz.	1981
Tymtran	Adria	U.S.	1982
Cerulex	Farmitalia Erba	France	1983

Raw Materials

L-Pyroglutamyl-L-glutaminy-L-aspartyl-L-tyrosine azide
 L-Threonyl-glycyl-L-tryptophanyl-L-methionyl-L-aspartyl-L-phenylalaninamide
 Pyridine sulfuric anhydride
 Sodium carbonate

Manufacturing Process

The tetrapeptide, L-pyroglutamyl-L-glutaminy-L-aspartyl-L-tyrosine-azide (I), is condensed with the hexapeptide, L-threonyl-glycyl-L-tryptophanyl-L-methionyl-L-aspartyl-L-phenylalaninamide (II), having the hydroxyl of the threonyl radical blocked by an acyl radical in a suitable solvent, such as dimethylformamide, to obtain the decapeptide, L-pyroglutamyl-L-glutaminy-L-aspartyl-L-tyrosyl-L-threonyl-glycyl-L-tryptophanyl-L-methionyl-L-aspartyl-L-phenylalaninamide (III) having the hydroxy group of the threonyl radical blocked by an acyl radical. The decapeptide (III) is treated, at low temperature, with the complex anhydrous pyridine sulfuric anhydride finally to obtain the decapeptide, L-pyroglutamyl-L-glutaminy-L-aspartyl-L-tyrosyl-L-threonyl-glycyl-L-tryptophanyl-L-methionyl-L-aspartyl-L-phenylalaninamide (IV) having the phenolic group of the tyrosyl radical protected by a sulfate radical and the hydroxyl of the threonyl radical protected by an acyl radical.

Finally, by mild alkaline hydrolysis of the decapeptide (IV) one obtains the decapeptide product.

References

- Merck Index 1963
 DFU 1 (8) 359 (1976)
 Kleeman & Engel p. 178
 DOT 15 (11) 13 (1979)
 I.N. p. 203
 REM p. 1274
 Bernardi, L., Bosio, G., De Castiglione, R. and Goffredo, O.; U.S. Patent 3,472,832; Oct. 14, 1969; assigned to Societa Farmaceutici Italia (Italy)

CETIEDIL

Therapeutic Function: Vasodilator (peripheral)

Chemical Name: α -Cyclohexyl-3-thiopheneacetic acid 2-(hexahydro-1H-azepin-1-yl)ethyl ester

Common Name: —

Structural Formula:

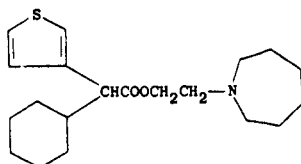

Chemical Abstracts Registry No.: 14176-10-4; 16286-69-4 (Citrate)

Trade Name	Manufacturer	Country	Year Introduced
Stratene	Innothera	France	1973
Stratene	Sigmatau	Italy	1976
Fusten	Galenica	Greece	—
Huberdilat	Hubber	Spain	—
Vasocet	Winthrop	—	—

Raw Materials

Sodium metal	(3-Thienyl)-acetonitrile
1-(2-Chloroethyl)-hexahydro-1H-azepine	Cyclohexyl bromide

Manufacturing Process

In a 100 ml flask fitted with a mechanical stirrer, a vertical condenser protected by a calcium chloride stopper, a dropping-funnel and a source of nitrogen were introduced 30 ml of hexamethylenephosphotriamide and 2.3 g (0.1 mol) of finely cut sodium wire. A mixture of 12.3 g (0.1 mol) of (3-thienyl)-acetonitrile and 16.3 g (0.1 mol) of cyclohexyl bromide was then quickly added at a temperature of 20°C. The reaction mixture was then maintained under nitrogen atmosphere and stirred for 12 hours at room temperature. The excess of sodium was destroyed by adding 5 ml of ethanol and the organic solution was slowly poured into 100 ml of a 1 N iced solution of hydrochloric acid. The solution was extracted twice with 100 ml ether. The ethereal phases were collected, washed with water, dried and concentrated under reduced pressure. The crude product was then purified by chromatography on a silica column (150 g of silica) using a 1/1 benzene/cyclohexane mixture as elution agent. The product obtained was rectified by distillation.

In this manner, 3.4 g of α -(3-thienyl)- α -cyclohexylacetonitrile were obtained, which represents a yield of 16%.

The nitrile may then be hydrolyzed to cyclohexyl-(3-thienyl)acetic acid which is reacted with 1-(2-chloroethyl)-hexahydro-1H-azepine to give cetiedil. It is commonly used as the citrate.

References

- Merck Index 1976
- Kleeman & Engel p. 179
- OCDS Vol. 3 p. 42 (1984)
- DOT 10 (4) 126 (1974)

I.N. p. 204

Pigerol, C., De Cointet De Fillain, P., Grain, C. and Le Blat, J.; U.S. Patent 4,108,865; August 22, 1978; assigned to Labaz (France)

CHENODIOL

Therapeutic Function: Solubilizer for cholesterol gallstones

Chemical Name: 3,7-Dihydroxycholan-24-oic acid

Common Name: Chenodeoxycholic acid; chenic acid

Structural Formula:

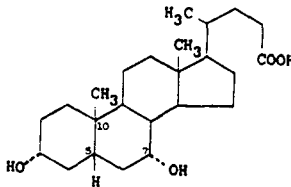

Chemical Abstracts Registry No.: 474-25-9

Trade Name	Manufacturer	Country	Year Introduced
Chenofalk	Falk	W. Germany	1974
Chenofalk	Pharmacolor	Switz.	1974
Chenossil	Giuliani	Italy	1975
Chenodex	I.S.H.	France	1977
Chendol	Weddell	U.K.	1978
Regalen	Eisai	Japan	1982
Chenocol	Yamanouchi	Japan	1982
Chenix	Reid-Rowell	U.S.	1983
Aholit	Vetprom	Yugoslavia	—
Bilo	Ittas	Turkey	—
Calcolise	Prodes	Spain	—
Carbilcolina	Ralay	Spain	—
Chelobil	Oftalmiso	Spain	—
Chemicolina	Ern	Spain	—
Chenar	Armour-Montagu	—	—
Chendal	Tika	Sweden	—
Chendix	Weddell	U.K.	—
Chendol	Weddell	U.K.	—
Chenoacid	Falk	W. Germany	—
Chenodecil	Aldon	Spain	—
Chenodex	Houde	France	—
Chenomas	Guadalupe	Spain	—
Chenotar	Armour	—	—
Cholonorm	Gruenenthal	W. Germany	—
Cholasa	Tokyo Tanabe	Japan	—
Cholestex	Ikapharm	Israel	—
Duanox	Roche	—	—
Flujbil	Zambon	Italy	—
Gamiquenol	Gamir	Spain	—
Hekbilin	Hek	W. Germany	—
Henohol	Galenika	Yugoslavia	—

Trade Name	Manufacturer	Country	Year Introduced
Kebilis	Hoechst-Roussel	—	—
Kenolite	Leurquin	France	—
Quenobilan	Estedi	Spain	—
Soluston	Rafa	Israel	—
Ulmenid	Roche	—	—

Raw Materials

7-Acetyl-12-ketochenodeoxycholic acid
 Hydrazine hydrate
 Potassium hydroxide

Manufacturing Process

To 1,400 ml of an approximately 50% water/triglycol solution of the potassium salt of chenodeoxycholic acid, obtained by the Wolff-Kishner reduction (using hydrazine hydrate and potassium hydroxide) from 50 g of 7-acetyl-12-ketochenodeoxycholic acid, 220 ml of dilute hydrochloric acid is added to bring the pH to 2. The solution is stirred and the crude chenodeoxycholic acid precipitates. The precipitate is recovered and dried to constant weight at about 60°C. About 36 g of the crude chenodeoxycholic acid, melting in the range of 126°–129°C, is obtained.

25 g of crude chenodeoxycholic acid so obtained is dissolved in 750 ml of acetonitrile while stirring and heating. 3 g of activated charcoal is added and then removed by suction filtering. The resulting liquid filtrate is cooled, the pure chenodeoxycholic acid crystallizing out. The crystals are recovered by suction filtering and the recovered crystals dried under vacuum. The yield is 19 g of pure chenodeoxycholic acid with a melting range of 168°–171°C.

References

Merck Index 2007
 Kleeman & Engel p. 181
 PDR p. 1446
 DOT 8 (7) 273 (1972) & 12 (2) 52 (1976)
 I.N. p. 17
 REM p. 812
 Maeke, S. and Rambacher, P.; U.S. Patent 4,163,017; July 31, 1979; assigned to Diamalt A.G. (Germany)

CHLOPHEDIANOL

Therapeutic Function: Antitussive

Chemical Name: 2-Chloro- α -[2-(dimethylamino)ethyl]- α -phenylbenzenemethanol

Common Name: Clofedanol

Structural Formula:

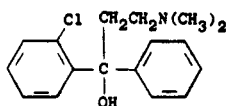

Chemical Abstracts Registry No.: 791-35-5; 511-13-7 (Hydrochloride)

Trade Name	Manufacturer	Country	Year Introduced
Detigon	Bayer	W. Germany	1958
Detigon	Bayer	Italy	1959
Ulo	Riker	U.S.	1960
Tussiplegyl	Bayer	France	1969
Colorin	Nippon Shinyaku	Japan	1981
Abehol	Piiva	Yugoslavia	—
Anayok	Chibi	Italy	—
Baltix	Kobanyai	Hungary	—
Demax	Orma	Italy	—
Dencyl	Bencard	U.K.	—
Eletuss	Serpero	Italy	—
Eutus	Eupharma	Italy	—
Farmatox	Cifa	Italy	—
Fugatox	Ifisa	Italy	—
Gen-Tos	Morgens	Spain	—
Gutabex	Russi	Italy	—
Pectolitan	Kettelhack Riker	W. Germany	—
Prontosed	Francia	Italy	—
Refugal	Bayer	—	—
Tigonal	I.B.P.	Italy	—
Tuxidin	Gazzini	Italy	—
Tuxinil	Bieffe	Italy	—
Ulone	Riker	—	—

Raw Materials

o-Chlorobenzophenone	Hydrogen
Acetonitrile	Methyl sulfate
Sodium amide	

Manufacturing Process

This compound may be produced by reacting o-chlorobenzophenone with acetonitrile in the presence of sodium amide or another strongly basic condensing agent, to form the nitrile of β -phenyl- β -o-chlorophenyl-hydracrylic acid, which is then hydrogenated to yield 1-phenyl-1-o-chlorophenyl-3-aminopropanol-1. The latter intermediate compound is subsequently dimethylated with an agent such as methyl sulfate to provide the desired end product 1-o-chlorophenyl-1-phenyl-3-dimethylaminopropanol.

References

Merck Index 2018

Kleeman & Engel p. 226

I.N. p. 244

REM p. 871

Lorenz, R., Gosswald, R. and Henecka, H.; U.S. Patent 3,031,377; April 24, 1962; assigned to Farbenfabriken Bayer AG, Germany

CHLORAL BETAINE

Therapeutic Function: Sedative

Chemical Name: Adduct of chloral hydrate with betaine

Common Name: —

Structural Formula: $\text{CCl}_3\text{CH}(\text{OH})_2 \cdot (\text{CH}_3)_3\text{N}^+\text{CH}_2\text{COO}^-$

Chemical Abstracts Registry No.: 2218-68-0

Trade Name	Manufacturer	Country	Year Introduced
Beta-Chlor	Mead-Johnson	U.S.	1963

Raw Materials

Betaine hydrate
Chloral hydrate

Manufacturing Process

An intimate mixture of betaine hydrate (67.5 g) and chloral hydrate (100 g) was warmed to ca. 60°C when an exothermic reaction occurred and the mixture became pasty. It was then stirred at 60°C for 30 minutes. The residue solidified on cooling and was crystallized from a small amount of water. The product separated in hard, colorless prisms of MP 122.5° to 124.5°C (corr).

References

Merck Index 2026

Kleeman & Engel p. 184

Petrow, V., Thomas, A.J. and Stephenson, O.; U.S. Patent 3,028,420; April 3, 1962; assigned to The British Drug Houses Limited, England

CHLORAMBUCIL

Therapeutic Function: Antineoplastic

Chemical Name: 4-[bis(2-chloroethyl)amino]benzenebutanoic acid

Common Name: —

Structural Formula:

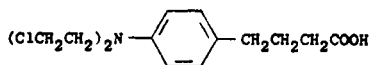

Chemical Abstracts Registry No.: 305-03-3

Trade Name	Manufacturer	Country	Year Introduced
Leukeran	Burroughs-Wellcome	U.S.	1957
Leukeran	Wellcome	W. Germany	—
Leukeran	Wellcome	Switz.	—
Ambochlorin	Simes	Italy	—
Chloraminophene	Techni-Farma	France	—
Linfolysin	I.S.M.	Italy	—

Raw Materials

Acetanilide
Hydrogen
Phosphorus oxychloride

Maleic acid
Ethylene oxide

Manufacturing Process

Acetanilide and maleic acid are condensed to give β -(p-acetaminobenzoyl)acrylic acid which is hydrogenated to give methyl- γ -(p-aminophenyl)butyrate. That is reacted with ethylene oxide and then with phosphorus oxychloride to give the methyl ester which is finally hydrolyzed to give chlorambucil.

References

Merck Index 2031

Kleeman & Engel p. 184

PDR p. 752

DOT 16 (5) 70 (1980)

I.N. p. 208

REM p. 1145

Phillips, A.P. and Mentha, J.W.; U.S. Patent 3,046,301; July 24, 1962; assigned to Burroughs Wellcome & Co. (U.S.A.) Inc.

CHLORAMPHENICOL

Therapeutic Function: Antimicrobial

Chemical Name: D(-)-threo-2,2-dichloro-N- $[\beta$ hydroxy- α -(hydroxymethyl)-p-nitrophenethyl]-acetamide

Common Name: —

Structural Formula:

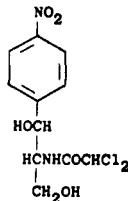

Chemical Abstracts Registry No.: 56-75-7

Trade Name	Manufacturer	Country	Year Introduced
Leukomycin	Bayer	W. Germany	—
Chloromycetin	Warner-Lambert	Switz.	—
Chloromycetin	Parke-Davis	U.S.	1949
Chloramphenicol	MSD-Chibret	France	1954
Econochlor Sol	Alcon	U.S.	1975
Amboken	Gedeon Richter	Mexico	—
Amphicol	McKesson	U.S.	—
Antacin	Sumitomo	Japan	—
Aquamycin	Winzer	W. Germany	—
Bemacol	Int'l. Multifoods	U.S.	—
Berlicetin	Ankerwerk	E. Germany	—
Biocetin	Tasman Vaccine	U.K.	—
Biophenicol	Biochemie	Austria	—
Cafenolo	Benvegna	Italy	—
Catilan	Hoechst	W. Germany	—
Cebenicol	Chauvin-Blache	France	—

Trade Name	Manufacturer	Country	Year Introduced
Chemicetina	Erba	Italy	—
Chemyzin	S.I.T.	Italy	—
Chlomin	Knoll	W. Germany	—
Chloramex	Dumex	Denmark	—
Chloramol	Protea	Australia	—
Chloramphenicol-POS	Ursapharm	W. Germany	—
Chlorasol	Evsco	U.S.	—
Chlora-Tabs	Evsco	U.S.	—
Chloricol	Evsco	U.S.	—
Chlornitromycin	Farmakhim	Bulgaria	—
Chlorocid	Egypt	Hungary	—
Chloromycetin	Sankyo	Japan	—
Chloronitrin	Jenapharm	E. Germany	—
Chloroptic	Allergan	U.S.	—
Chlorsig	Sigma	Australia	—
Chloramidina	Arco	Switz.	—
Clorbiotina	Wassermann	Spain	—
Clorofenicina	Antibioticos	Spain	—
Clorosintex	Angelini	Italy	—
Cylphenicol	Trent	U.S.	—
Desphen	Despopharm	Switz.	—
Detreomine	Polfa	Poland	—
Devamycetin	Deva	Turkey	—
Dextromycin	V.N.I.Kh.F.J.	USSR	—
Doctamicina	Docta	Switz.	—
Farmicetina	Erba	Italy	—
Globenicol	Gist-Brocades	—	—
Glorous	Sanwa	Japan	—
Halomycetin	Kwizda	Austria	—
Hortfenicol	Hortel	Spain	—
Ismicetina	I.S.M.	Italy	—
Isophenicol	Bouchara	France	—
Kamaver	Engelhard	W. Germany	—
Kemicetin	Aesca	Austria	—
Kemicetine	Fujisawa	Japan	—
Kemicetine	Erba	Italy	—
Kemicetine	Vifor	Switz.	—
Kemicetine	I.C.N.	Canada	—
Kemicotine	Erba	U.K.	—
Kloromisin	Biofarma	Turkey	—
Labamicol	Labatec	Switz.	—
Levomycetin	Provita	Austria	—
Lomecitina	Locatelli	Italy	—
Loromisin	Atabay	Turkey	—
Medichol	Copanos	U.S.	—
Micochlorine	Continental Pharma	Belgium	—
Misetin	Dif-Dogu	Turkey	—
Mycetin	Farmigea	Italy	—
Mychel	Rachelle	U.S.	—
Mycinol	Horner	Canada	—
Neocetin	Uranium	Turkey	—
Novochlorcap	Novopharm	Canada	—
Novaphenicol	Nova	Canada	—
Novophenicol	Solac	France	—
Oftakloram	Tan	Turkey	—
Oftalent	Weifa	Norway	—
Oleomycetin	Winzer	W. Germany	—

Trade Name	Manufacturer	Country	Year Introduced
Ophthaphenicol	Faure	France	—
Oralmisetin	Mulda	Turkey	—
Otachron	Alpine	Austria	—
Otomycin	Pliva	Yugoslavia	—
Pantovernil	Heyden	W. Germany	—
Paraxin	Boehr/Mann.	W. Germany	—
Paraxin	Yamanouchi	Japan	—
Pedimycetin	T.E.M.S.	Turkey	—
Pentamycetin	Pentagone	Canada	—
Pentocetine	Ibsa	Switz.	—
Rivomycin	Rivopharm	Switz.	—
Romphenil	Zeria	Japan	—
Septicol	Streuli	Switz.	—
Serviclofen	Servipharm	Switz.	—
Sificetina	Sifi	Italy	—
Sno-Paenicol	Smith & Nephew	U.K.	—
Sopamycetin	Pharbec	Canada	—
Spersanicol	Dispersa	Switz.	—
Suismycetin	Lagap	Switz.	—
Synthomycetin	Abic	Israel	—
Tevocin	Tevcon	U.S.	—
Thilocanfol	Thilo	W. Germany	—
Tifomycine	Roussel	France	—
Veticol	Copanos	U.S.	—
Viceton	Int'l. Multifoods	U.S.	—
Viklorin	Ilsan	Turkey	—
Vitaklorin	Iltas	Turkey	—

Raw Materials

Sodium	Benzaldehyde
β -Nitroethanol	Nitric acid
Methyl dichloroacetate	Hydrogen
Acetic anhydride	

Manufacturing Process

Chloramphenicol may be prepared by fermentation or by chemical synthesis. The fermentation route to chloramphenicol is described in U.S. Patents 2,483,871 and 2,483,892. To quote from U.S. Patent 2,483,892: The cultivation of *Streptomyces venezuelae* may be carried out in a number of different ways. For example, the microorganism may be cultivated under aerobic conditions on the surface of the medium or it may be cultivated beneath the surface of the medium, i.e., in the submerged condition, if oxygen is simultaneously supplied.

Briefly stated, the production of chloramphenicol by the surface culture method involves inoculating a shallow layer, usually less than about 2 cm, of a sterile, aqueous nutrient medium with *Streptomyces venezuelae* and incubating the mixture under aerobic conditions at a temperature between about 20° and 40°C, preferably at room temperature (about 25°C), for a period of about 10 to 15 days. The mycelium is then removed from the liquid and the culture liquid is then treated by methods described for isolating therefrom the desired chloramphenicol.

The synthetic route to chloramphenicol is described in U.S. Patent 2,483,884 as follows: 1.1 g of sodium is dissolved in 20 cc of methanol and the resulting solution added to a solution of 5 g of benzaldehyde and 4.5 g of β -nitroethanol in 20 cc of methanol. After standing at room temperature for a short time the gel which forms on the mixing of the reactants changes to a white insoluble powder. The precipitate is collected, washed with methanol and ether and then dried. The product thus produced is the sodium salt of

1-phenyl-2-nitropropane-1,3-diol.

Eighteen grams of the sodium salt of 1-phenyl-2-nitropropane-1,3-diol is dissolved in 200 cc of glacial acetic acid. 0.75 g of palladium oxide hydrogenation catalyst is added and the mixture shaken at room temperature under three atmospheres pressure of hydrogen overnight. The reaction vessel is opened, 2.5 g of 10% palladium on carbon hydrogenation catalyst added and the mixture shaken under three atmospheres pressure of hydrogen for 3 hours. The catalyst is removed from the reaction mixture by filtration and the filtrate concentrated under reduced pressure. Fifty cubic centimeters of n-propanol is added to the residue and the insoluble inorganic salt removed by filtration.

The filtrate is treated with excess hydrochloric acid and evaporated to obtain a pale yellow oil. Five grams of the oil thus obtained is treated with 15 cc of saturated potassium carbonate solution and the mixture extracted with 50 cc of ether, then with 30 cc of ethyl acetate and finally with two 30 cc portions of ethanol. Evaporation of the solvent from the extract gives the following quantities of the desired 1-phenyl-2-aminopropane-1,3-diol: 0.5 g, 1.0 g and 3.1 g.

1.7 g of 1-phenyl-2-aminopropane-1,3-diol is treated with 1.6 g of methyl dichloroacetate and the mixture heated at 100°C for 1½ hours. The residue is washed with two 20 cc portions of petroleum ether and the insoluble product collected. Recrystallization from ethyl acetate yields the desired (dl)-reg.-1-phenyl-2-dichloroacetamidopropane-1,3-diol in pure form; MP 154° to 156°C.

Five hundred milligrams of (dl)-reg.-1-phenyl-2-dichloroacetamidopropane-1,3-diol is added to a solution consisting of 1 cc of pyridine and 1 cc of acetic anhydride and the resulting reaction mixture heated at 100°C for ½ hour. The reaction mixture is evaporated to dryness under reduced pressure and the residue taken up in and crystallized from methanol. Recrystallization from methanol produces the pure diacetate of (dl)-reg.-1-phenyl-2-dichloroacetamidopropane-1,3-diol (MP 94°C).

Two hundred milligrams of the diacetate of (dl)-reg.-1-phenyl-2-dichloroacetamidopropane-1,3-diol is added to a mixture consisting of 0.25 cc of concentrated nitric acid and 0.25 cc of concentrated sulfuric acid at 0°C. The reaction mixture is stirred until solution is complete, poured onto 25 g of ice and the mixture extracted with ethyl acetate. The ethyl acetate extracts are evaporated under reduced pressure and the diacetate of (dl)-reg.-1-p-nitrophenyl-2-dichloroacetamidopropane-1,3-diol so produced purified by recrystallization from ethanol; MP 134°C.

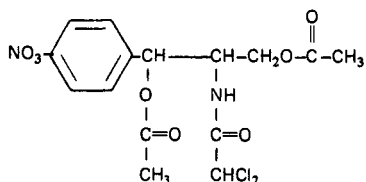

Five hundred milligrams of the diacetate of (dl)-reg.-1-p-nitrophenyl-2-dichloroacetamidopropane-1,3-diol is dissolved in a mixture consisting of 25 cc of acetone and an equal volume of 0.2 N sodium hydroxide solution at 0°C and the mixture allowed to stand for one hour. The reaction mixture is neutralized with hydrochloric acid and evaporated under reduced pressure to dryness. The residue is extracted with several portions of hot ethylene dichloride, the extracts concentrated and then cooled to obtain the crystalline (dl)-reg.-1-p-nitrophenyl-2-dichloroacetamidopropane-1,3-diol; MP 171°C.

References

- Merck Index 2035
 Kleeman & Engel p. 185
 PDR pp. 1321, 1379, 1606, 1999

OCDS Vol. 1 p. 75 (1977) & 2 pp. 28, 45 (1980)

I.N. p. 209

REM p. 1208

Bartz, Q.R.; U.S. Patent 2,483,871; October 4, 1949; assigned to Parke, Davis & Company

Crooks, H.M., Jr., Rebstock, M.C., Controulis, J. and Bartz, Q.R.; U.S. Patent 2,483,884;

October 4, 1949; assigned to Parke, Davis & Company

Ehrlich, J., Smith, R.M. and Penner, M.A.; U.S. Patent 2,483,892; October 4, 1949; as-

signed to Parke, Davis & Company

Carrara, G.; U.S. Patent 2,776,312; January 1, 1957

Slack, R.; U.S. Patent 2,786,870; March 26, 1957; assigned to Parke, Davis & Company

CHLORAMPHENICOL PALMITATE

Therapeutic Function: Antibacterial; antirickettsial

Chemical Name: D(-)-threo-1-p-nitrophenyl-2-dichloroacetamido-3-palmitoyloxypropane-1-ol

Common Name: —

Structural Formula:

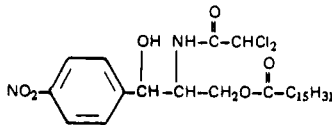

Chemical Abstracts Registry No.: 530-43-8

Trade Name	Manufacturer	Country	Year Introduced
Chloromycetin	Parke Davis	U.S.	1951
B-CP	Biokema	Switz.	—
Berlicetin	Ankerwerk	E. Germany	—
Chlorambon	Biokema	Switz.	—
Chloromisol	Maïpe	Spain	—
Colimycin	Biofarma	Turkey	—
Detreopal	Polfa	Poland	—
Hortfenicol	Hortel	Spain	—
Levomycetina	Lepetit	Italy	—
Paidomicetina	Lafare	Italy	—
Protophenicol	Arco	Switz.	—
Sintomicetina	Lepetit	—	—

Raw Materials

Palmitoyl chloride
Chloramphenicol

Manufacturing Process

1,674 g of palmitoyl chloride is added to 1,870 g of D(-)-threo-1-p-nitrophenyl-2-dichloroacetamidopropane-1,3-diol (chloramphenicol) in 2,700 cc of pyridine and the solution stirred for 1 hour. The mixture is poured into 16 liters of water and the solid collected. Recrystallization of the crude product from benzene yields the desired D(+)-threo-1-p-nitrophenyl-2-dichloroacetamido-3-palmitoyloxypropane-1-ol in pure form: MP 90°C.

References

Merck Index 2036

PDR p. 1324

I.N. p. 210

REM p. 1209

Edgerton, W.H.; U.S. Patent 2,662,906; December 15, 1953; assigned to Parke, Davis & Co.

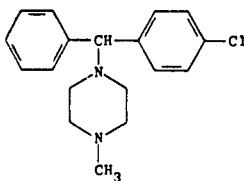
CHLORCYCLIZINE**Therapeutic Function:** Antihistaminic**Chemical Name:** 1-[(4-Chlorophenyl)phenylmethyl]-4-methylpiperazine**Common Name:** Histachlorazine**Structural Formula:****Chemical Abstracts Registry No.:** 82-93-9; 1620-21-9 (Hydrochloride)

Trade Name	Manufacturer	Country	Year Introduced
Perazil	Burroughs-Wellcome	U.S.	1949
Di-Paralene	Abbott	U.S.	1950
Histantin	Burroughs-Wellcome	—	—
Histofax	Burroughs-Wellcome	U.K.	—
Mantadil	Burroughs-Wellcome	U.S.	—
Prurisedine	Couvreur	Belgium	—
Trihistan	Revit	Switz.	—
Trihistan	Gea	Denmark	—
Trihistan	Weifa	Norway	—

Raw Materials

4-Chlorobenzhydryl chloride

Methyl piperazine

Manufacturing Process

0.08 mol (19 g) of 4-chlorobenzhydryl chloride and 0.16 mol (16 g) of methylpiperazine were mixed in about 20 cc of dry benzene. The flask containing the reaction mixture was covered by a watch glass and set in a steam bath, and heating was continued for 6 hours. The contents of the flask were partitioned between ether and water and the ethereal layer was washed with water until the washings were neutral. The ethereal layer was extracted successively with 30- and 10-cc portions of 3N hydrochloric acid. On evaporation of the ether layer there remained a residue of 2.5 g. The aqueous extracts were united and basified with concentrated alkali. The oily base was taken into ether and dried over potassium carbonate. On evaporation of the ether, N-methyl-N'-(4-chlorobenzhydryl) piperazine was recovered in the form of a viscous oil in 75% yield. The N-methyl-N'-(4-chlorobenzhydryl) piperazine was dissolved in absolute alcohol and ethanolic hydrogen chloride added in excess. The dihydrochloride crystallized

on addition of absolute ether and was recrystallized from the same solvent mixture in the form of longish prisms melting at about 216°C.

References

Merck Index 2045

Kleeman & Engel p. 188

PDR p. 754

OCDS Vol. 1 p. 58 (1977)

I.N. p. 211

REM p. 1132

Baitzly, R. and Castillo, J.C.; U.S. Patent 2,630,435; March 3, 1953; assigned to Burroughs-Wellcome & Co. (U.S.A.) Inc.

CHLORDANTOIN

Therapeutic Function: Topical antifungal

Chemical Name: 5-(1-Ethylpentyl)-3-[(trichloromethyl)thio]-2,4-imidazolidinedione

Common Name: Clodantoin

Structural Formula:

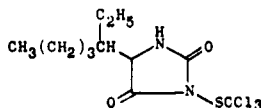

Chemical Abstracts Registry No.: 5588-20-5

Trade Name	Manufacturer	Country	Year Introduced
Sporostacin	Ortho	U.S.	1960
Sporostacin	Ortho	U.K.	—
Gynelan	Eisai	Japan	—

Raw Materials

Perchloromethyl mercaptan

5-(1-Ethylpentyl)hydantoin sodium salt

Manufacturing Process

Perchloromethylmercaptan is reacted with the sodium salt of 5-(1-ethylpentyl)hydantoin.

References

Merck Index 2047

Kleeman & Engel p. 225

I.N. p. 243

Kittleson, A.R.; U.S. Patent 2,553,770; May 22, 1951; assigned to Standard Oil Development Company

Hawley, R.S., Kittleson, A.R. and Smith, P.V. Jr.; U.S. Patent 2,553,775; May 22, 1951; assigned to Standard Oil Development Company

CHLORDIAZEPOXIDE HYDROCHLORIDE

Therapeutic Function: Tranquilizer

Chemical Name: 7-chloro-N-methyl-5-phenyl-3H-1,4-benzodiazepin-2-amino-4-oxide hydrochloride

Common Name: Metaminodiazepoxide hydrochloride; methaminodiazepoxide hydrochloride

Structural Formula:

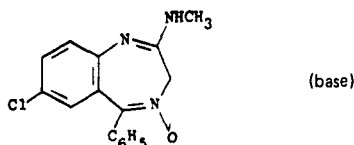

Chemical Abstracts Registry No.: 438-41-5; 58-25-3 (Base)

Trade Name	Manufacturer	Country	Year Introduced
Librium	Roche	W. Germany	1960
Librium	Roche	U.S.	1960
Librium	Roche	Switz.	1960
Librium	Sauter	U.K.	1960
Librium	Roche	France	1961
Librium	Roche	Italy	1961
SK-Lygen	SKF	U.S.	1976
Diazachel	Rachelle	U.S.	1976
A-Poxide	Abbott	U.S.	1977
Zetran	Hauck	U.S.	1978
Balance	Yamanouchi	Japan	—
Bent	Pharma. Farm. Spec.	Italy	—
Benzodiapin	Lisapharma	Italy	—
Binomil	Uriach	Spain	—
Cebrum	Cifa	Italy	—
Chemdipoxide	Chemo-Drug	Canada	—
Chlordiazachel	Rachelle	U.S.	—
Contol	Takeda	Japan	—
Diapax	Therapex	Canada	—
Dolibrax	Roche	France	—
Elenium	Polfa	Poland	—
Endequil	Panther-Osfa	Italy	—
Equibral	Ravizza	Italy	—
Gene-Poxide	Franca	Canada	—
Huberplex	Hubber	Spain	—
I-Liberty	I-Pharmcal	U.S.	—
Labican	Boniscontro-Gazzone	Italy	—
Lentotran	Farm Patria	Portugal	—
Lixin	I.S.M.	Italy	—
Medilium	Medic	Canada	—
Murcil	Reid-Provident	U.S.	—
Napoton	Chemimportexport	Rumania	—
Normide	Inibsa	Spain	—
Novopoxide	Novopharm	Canada	—
Omnalio	Estedi	Spain	—
Peast C	Sawai	Japan	—
Protensin	Elliott-Marion	Canada	—
Psicofar	Terapeutico	Italy	—

Trade Name	Manufacturer	Country	Year Introduced
Psicoterina	Francia	Italy	—
Radepur	Arzneimittelwerk Dresden	E. Germany	—
Reliberan	Geymonat Sud	Italy	—
Relium	Riva	Canada	—
Risolid	Dumex	Denmark	—
Sakina	Causytn	Italy	—
Sereen	Foy	U.S.	—
Smail	Saita	Italy	—
Solium	Horner	Canada	—
Sophiamin	Santen	Japan	—
Trakipearl	Hishiyama	Japan	—
Tropium	D.D.S.A.	U.K.	—
Untensin	Pharmador	S. Africa	—
Via-Quil	Denver	Canada	—

Raw Materials

2-Amino-5-chlorobenzophenone	Hydroxylamine
Chloroacetyl chloride	Methylamine
Hydrogen chloride	

Manufacturing Process

A mixture of 202 g 2-amino-5-chlorobenzophenone, 190 g hydroxylamine hydrochloride, 500 cc pyridine and 1,200 cc alcohol was refluxed for 16 hours, then concentrated in vacuo to dryness. The residue was treated with a mixture of ether and water. The water was separated, the ether layer containing a considerable amount of precipitated reaction product was washed with some water and diluted with petroleum ether. The crystalline reaction product, 2-amino-5-chlorobenzophenone- α -oxime, was filtered off. The product was recrystallized from a mixture of ether and petroleum ether forming colorless prisms, MP 164° to 167°C.

To a warm solution (50°C) of 172.5 g (0.7 mol) of 2-amino-5-chlorobenzophenone- α -oxime in one liter glacial acetic acid were added 110 cc (1.47 mols) chloroacetyl chloride. The mixture was heated for 10 minutes at 50°C and then stirred at room temperature for 15 hours. The precipitated yellow prisms, 2-chloromethyl-4-phenyl-6-chloroquinazoline 3-oxide hydrochloride, were filtered off, melting range 128° to 150°C with dec.

The acetic acid mother liquor, containing the rest of the reaction product, was concentrated in vacuo. The residue was dissolved in methylene chloride and washed with ice cold sodium carbonate solution. The organic solution was dried, concentrated in vacuo to a small volume and diluted with ether and petroleum ether. Fine yellow needles of 2-chloromethyl-4-phenyl-6-chloroquinazoline 3-oxide precipitated. The pure base was recrystallized from a mixture of methylene chloride, ether and petroleum ether, MP 133° to 134°C.

Ninety-eight grams of 6-chloro-2-chloromethyl-4-phenylquinazoline 3-oxide hydrochloride were introduced into 600 cc of ice cold 25% methanolic methylamine. The mixture was initially cooled to about 30°C and then stirred at room temperature. After 15 hours the reaction product which precipitated was filtered off. The mother liquor was concentrated in vacuo to dryness. The residue was dissolved in methylene chloride, washed with water and dried with sodium sulfate. The methylene chloride solution was concentrated in vacuo and the crystalline residue was boiled with a small amount of acetone to dissolve the more soluble impurities. The mixture was then cooled at 5°C for 10 hours and filtered. The crystalline product, 7-chloro-2-methylamino-5-phenyl-3H-1,4-benzodiazepine 4-oxide, was recrystallized from ethanol forming light yellow plates, MP 236° to 236.5°C.

A solution of 7-chloro-2-methylamino-5-phenyl-3H-1,4-benzodiazepine 4-oxide in an equivalent amount of methanolic hydrochloric acid was diluted with ether and petroleum ether.

The precipitated hydrochloride was filtered off and recrystallized from methanol, MP 213°C.

References

Merck Index 2049

Kleeman & Engel p. 188

PDR pp. 993, 1510, 1606, 1723, 1999

OCDS Vol. 1 p. 365 (1977) & 2 p. 401 (1980)

DOT 9 (6) 236 (1973)

REM p. 1061

Sternbach, L.H.; U.S. Patent 2,893,992; July 7, 1959; assigned to Hoffmann-LaRoche, Inc.

CHLORHEXIDINE

Therapeutic Function: Antimicrobial

Chemical Name: N,N'-bis(4-chlorophenyl)-3,12-diimino-2,4,11,13-tetraazatetradecane-diimidamide

Common Name: 1,6-di(4'-Chlorophenyldiguanido)hexane

Structural Formula:

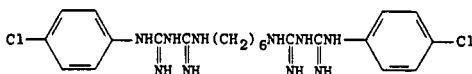

Chemical Abstracts Registry No.: 55-56-1

Trade Name	Manufacturer	Country	Year Introduced
Hibiclens	Stuart	U.S.	1976
Hibitane	I.C.I.	France	1976
Corsodyl	I.C.I.	U.K.	1977
Souplens	Chauvin-Blache	France	1978
Hibitane	Stuart	U.S.	1979
Hibistat	ICI	U.S.	1980
Abacil	Pofa	Poland	—
Aseptigel	Medicornea	France	—
Bactigras	Smith & Nephew	U.K.	—
Biotensid	Arcana	Austria	—
Cetal	Orapharm	Australia	—
Chlorhexamed	Blendax	W. Germany	—
Chlorohex	Geistlich	Switz.	—
Dacrine	Chibret	France	—
Dentosmin	VEB Leipz. Arz.	E. Germany	—
Desmanol	Schulke & Mayr	W. Germany	—
Desocort	Chauvin-Blache	France	—
Dialens	Chauvin-Blache	France	—
Eludril	Inava	France	—
Hexadol	Green Cross	Japan	—
Hibiscrub	ICI-Pharma	France	—
Hibiscrub	ICI	Japan	—
Hibitane	Sumitomo	Japan	—
Larylin	Beiersdorf	W. Germany	—
Lisium	Brunton Chemists	U.K.	—

Trade Name	Manufacturer	Country	Year Introduced
Manusan	Polfa	Poland	—
Maskin	Maruishi	Japan	—
Nolvasan	Fort Dodge	U.S.	—
Oronine	Otsuka	Japan	—
Pabron	Taisho	Japan	—
Plac Out	Bernabo	Argentina	—
Plak-Out	Hawe-Neos	Switz.	—
Plurexid	Sythemedica	France	—
Rhino-Blache	Chauvin-Blache	France	—
Rotersept	Roter	Neth.	—
Scarlene	Chauvin-Blache	France	—
Secalan	Zyma	Switz.	—
Septalone	Abic	Israel	—
Sterilone	Roter	Neth.	—
Trachitol	Engelhard	W. Germany	—
Vitacontact	Faure	France	—

Raw Materials

Hexamethylene bis-dicyandiamide
p-Chloroaniline hydrochloride

Manufacturing Process

25 parts of hexamethylene bis-dicyandiamide, 35 parts of p-chloroaniline hydrochloride and 250 parts of β -ethoxyethanol are stirred together at 130°C to 140°C for 2 hours under reflux. The mixture is then cooled and filtered and the solid is washed with water and crystallized from 50% aqueous acetic acid. 1,6-di(N₁,N₁'-p-chlorophenyldiguanido-N₅,N₅')hexane dihydrochloride is obtained as colorless plates of MP 258°C to 260°C.

The following is an alternative route: 19.4 parts of p-chlorophenyldicyandiamide, 9.4 parts of hexamethylenediamine dihydrochloride and 100 parts of nitrobenzene are stirred together and heated at 150°C to 160°C for 6 hours. The mixture is cooled, diluted with 200 parts of benzene and filtered. The solid residue is washed with benzene and crystallized from 50% acetic acid. 1,6-di(N₁, N₁'-p-chlorophenyldiguanido-N₅,N₅')hexane dihydrochloride is obtained.

References

Merck Index 2057
Kleeman & Engel p. 189
PDR p. 1781
I.N. p. 212
REM p. 1159
Rose, F.L. and Swain, G.; U.S. Patent 2,684,924; July 27, 1954; assigned to Imperial Chemical Industries, Ltd.

CHLORISONDAMINE CHLORIDE

Therapeutic Function: Antihypertensive

Chemical Name: 4,5,6,7-Tetrachloro-1,3-dihydro-2-methyl-2-[2-(trimethylammonio)ethyl]-2H-isoindolium dichloride

Common Name: Chlorisondamine dimethochloride

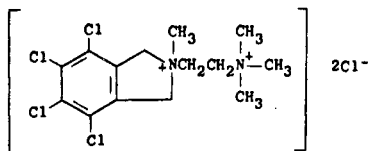
Structural Formula:**Chemical Abstracts Registry No.:** 69-27-2

Trade Name	Manufacturer	Country	Year Introduced
Ecolid Chloride	Ciba	U.S.	1956

Raw Materials

3,4,5,6-Tetrachlorophthalic anhydride	Methyl iodide
2-Dimethylaminoethyl amine	Silver chloride
Lithium aluminum hydride	

Manufacturing Process

50 parts by weight of 3,4,5,6-tetrachlorophthalic anhydride is added with stirring and cooling to 30 parts by volume of 2-dimethylaminoethyl amine. The mixture is heated at 170°C for 4 minutes and the oily residue then dissolved in 200 parts by volume of hot ethanol. On cooling, N-(2'-dimethylaminoethyl)-3,4,5,6-tetrachlorophthalimide separates. It crystallizes from ethanol and melts at 184°-186°C.

6 parts by weight of N-(2'-dimethylaminoethyl)-3,4,5,6-tetrachlorophthalimide is extracted continuously with 300 parts by volume of dry ether in which have been dissolved 3.1 parts by weight of lithium aluminum hydride. After 48 hours the excess lithium aluminum hydride is destroyed by cautious addition of 9 parts by volume of ethyl acetate while stirring. There is then added in succession with stirring 3 parts by volume of water, 6 parts by volume of 15% aqueous sodium hydroxide and 9 parts by volume of water. The granular precipitate of lithium and aluminum salts are filtered and washed with ether. The ether is distilled off, yielding the crude, oily 4,5,6,7-tetrachloro-2-(2'-dimethylaminoethyl)-isoindoline. The above base is dissolved in 25 parts by volume of 90% ethanol and refluxed 2 hours with 6 parts by volume of methyl iodide. 4,5,6,7-tetrachloro-2-(2'-dimethylaminoethyl)-isoindoline dimethiodide separates during the reaction. It is collected by filtration and recrystallized from a mixture of ethanol and water; MP 244°-246°C.

4,5,6,7-tetrachloro-2-(2'-dimethylaminoethyl)-isoindoline dimethochloride is prepared by shaking an aqueous solution of the dimethiodide with an excess of freshly prepared silver chloride and evaporating to dryness the aqueous solution after removal of the silver salts. 4,5,6,7-tetrachloro-2-(2'-dimethylaminoethyl)-isoindoline dimethochloride is recrystallized from ethanol-ethylacetate; MP 276°-280°C.

References

Merck Index 2068

I.N. p. 213

Huebner, C.F.; U.S. Patent 3,025,294; March 13, 1962; assigned to Ciba Pharmaceutical Products, Inc.

CHLORMERODRIN**Therapeutic Function:** Diuretic

Chemical Name: 1-[3-(Chloromercuri)-2-methoxypropyl] urea

Common Name: Chlormeroprin

Structural Formula:

$$\text{ClHgCH}_2\underset{\text{OCH}_3}{\text{CH}}\text{CH}_2\text{NHC(=O)NH}_2$$

Chemical Abstracts Registry No.: 62-37-3

Trade Name	Manufacturer	Country	Year Introduced
Neohydrin	Lakeside	U.S.	1952
Asahydrin	Pharmacia	Sweden	—
Bucohydral	Vifor	Switz.	—
Mercloran	Parke Davis	U.S.	—
Merilid	Pharmacia	Sweden	—
Oricur	Medix	Denmark	—
Orimercur	Reder	Spain	—
Ormerdan	Parke Davis	U.S.	—

Raw Materials

Allyl urea
Mercuric acetate
Sodium chloride

Manufacturing Process

To a refluxing solution of 100 g of allyl urea and 600 ml of absolute methanol there was added with stirring a suspension of 319 g of mercuric acetate and 600 ml of absolute methanol and 60 ml of glacial acetic acid; complete solution resulted. After 6 hours of refluxing, the solution was cooled and clarified by filtration. To this solution there were added 50 g of sodium chloride and 240 ml of water. After a short time a heavy white precipitate settled out. This precipitate, which was 3-chloromercuri-2-methoxy-propylurea, was filtered, washed and dried.

References

Merck Index 2071
Kleeman & Engel p. 191
I.N. p. 213
REM p. 489
Foreman, E.L.; U.S. Patent 2,635,983; April 21, 1953; assigned to Lakeside Laboratories, Inc.

CHLORMEZANONE

Therapeutic Function: Tranquilizer

Chemical Name: 2-(4-Chlorophenyl)tetrahydro-3-methyl-4H-1,3-thiazin-4-one 1,1-dioxide

Common Name: Chloromethazanone

Structural Formula:

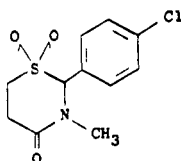

Chemical Abstracts Registry No.: 80-77-3

Trade Name	Manufacturer	Country	Year Introduced
Trancopal	Winthrop-Breon	U.S.	1958
Supotran	Winthrop	France	1965
Alinam	Lucien	France	—
Chlomedinon	Taiyo	Japan	—
Lumbaxol	Aldo Union	Spain	—
Metsapal	Leiras	Turkey	—
Muscotal	Farmos	Finland	—
Muskel	Winthrop	W. Germany	—
Myolespen	Dojin	Japan	—
Relizon	Mochida	Japan	—
Rexan	Labif	Italy	—
Rilaquil	Guidotti	Italy	—
Tanafol	A.M.S.A.	Italy	—
Trancote	Sawai	Japan	—
Transanate	Teikoku	Japan	—

Raw Materials

4-Chlorobenzaldehyde	Methylamine
β -Mercaptopropionic acid	Potassium permanganate

Manufacturing Process

A solution of 4-chlorobenzaldehyde is reacted with β -mercaptopropionic acid and with methylamine. The mixture is refluxed in benzene and water is removed from an overhead separator. The reaction mixture was cooled, washed with dilute ammonium hydroxide and water, and the benzene was removed by distillation in vacuo. The oily residue was taken up in ether from which it crystallized. The precipitate was recrystallized twice from ether to yield 2-(4-chlorophenyl)-3-methyl-4-metathiazanone.

A solution of 11.2 g of potassium permanganate in 100 ml of warm water was added dropwise to a well stirred solution of 10 g of 2-(4-chlorophenyl)-3-methyl-4-metathiazanone in 50 ml of glacial acetic acid. The temperature was kept below 30°C with external cooling. An aqueous sodium bisulfite solution was then added to remove the manganese dioxide. The thick whitish oil which separated was taken up in chloroform and the extract was washed with water. Removal of the chloroform by distillation in vacuo yielded an oily residue which solidified. The solid was recrystallized from isopropyl alcohol to give 5 g of the product, 2-(4-chlorophenyl)-3-methyl-4-metathiazanone-1,1-dioxide, MP 116.2° to 118.6°C (corr.).

References

- Merck Index 2072
- Kleeman & Engel p. 191
- PDR p. 1934
- DOT 9 (6) 243 (1973)
- I.N. p. 214
- REM p. 1074
- British Patent 815 203; June 17, 1959; assigned to Sterling Drug, Inc.

CHLOROPROCAINE HYDROCHLORIDE

Therapeutic Function: Local anesthetic

Chemical Name: 4-amino-2-chlorobenzoic acid 2-diethylaminoethyl ester hydrochloride

Common Name: —

Structural Formula:

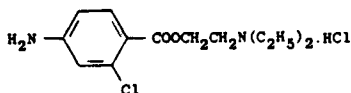

Chemical Abstracts Registry No.: 3858-89-7; 133-16-4 (Base)

Trade Name	Manufacturer	Country	Year Introduced
Nesacaine	Astra	U.S.	1956
Nesacaine	Pennwalt	U.S.	—
Nesacaine	Strasensburgh	U.S.	—
Halestyn	—	—	—
Piocaine	Teikoku-Nagase	Japan	—

Raw Materials

2-Chloro-4-amino benzoic acid	Thionyl chloride
β -Diethyl amino ethanol	Hydrogen chloride

Manufacturing Process

In the first step, 2-chloro-4-aminobenzoyl chloride hydrochloride is prepared by refluxing a mixture of 25 cc of purified thionyl chloride and 10 g of 2-chloro-4-aminobenzoic acid until all of the solid has gone into solution. To the cooled solution is added 150 cc of dry ethyl ether. A brisk stream of dry hydrogen chloride is passed into the solution until the precipitation of 2-chloro-4-aminobenzoyl chloride hydrochloride is complete. The acyl halide is removed by filtration and dried in a vacuum desiccator.

In the second step, the diethylaminoethyl 2-chloro-4-aminobenzoate hydrochloride is prepared by refluxing equimolar proportions of the hydrochloride of β -diethylaminoethanol in a suitable inert solvent such as a mixture of dry toluene and tetrachloroethane and the hydrochloride of 2-chloro-4-aminobenzoyl chloride until the reaction as indicated by the cessation of hydrogen chloride evolution is complete. The supernatant solvents are decanted from the reaction product which can be conveniently purified by crystallization from absolute ethanol.

An alternative purification can be effected by dissolving the reaction product in water. The ester base is liberated by rendering the clarified aqueous solution alkaline. Removal of the base from the alkaline solution is achieved by extraction with a suitable solvent such as benzene or ether. The pure hydrochloride of diethylaminoethyl 2-chloro-4-aminobenzoate is then precipitated from the dried extract by the addition of dry hydrogen chloride. After removal by filtration and recrystallization from ethanol it is found to have a melting point of 173° to 174°C.

References

- Merck Index 2131
- Kleeman & Engel p. 193
- PDR p. 594
- OCDS Vol. 1 p. 11 (1977)
- I.N. p. 220
- REM p. 1050
- Marks, H.C. and Rubin, M.I.; U.S. Patent 2,460,139; January 25, 1949; assigned to Wallace & Tiernan Products, Inc.

CHLOROQUINE PHOSPHATE

Therapeutic Function: Antimalarial

Chemical Name: N⁴-(7-chloro-4-quinolinyl)-N¹,N¹-diethyl-1,4-pentanediamine phosphate

Common Name: —

Structural Formula:

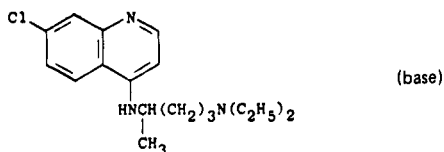

Chemical Abstracts Registry No.: 50-63-5; 54-05-7 (Base)

Trade Name	Manufacturer	Country	Year Introduced
Nivaquine	Specia	France	1949
Aralen	Winthrop	U.S.	—
Arthrochin	Arcana	Austria	—
Artri	Badrial	France	—
Aspiquinol	Bayer	France	—
Avloclor	I.C.I.	U.K.	—
Chemochin	Pliva	Yugoslavia	—
Clorochina	Bayer	Italy	—
Cidanchin	Cidan	Spain	—
Delagil	Egyt	Hungary	—
Dichinalex	Savonna	Italy	—
Elestol	Bayer	France	—
Heliopar	Farmos	Finland	—
Imagon	Astra	—	—
Lagaquin	Legap	Switz.	—
Letaquine	Letap	Switz.	—
Malarex	Dumex	Denmark	—
Quinachlor	Cophar	Switz.	—
Quinercil	Robert et Carriere	France	—
Quinilon	Sumitomo	Japan	—
Resochin	Bayer	Japan	—
Rivoquine	Rivopharm	Switz.	—
Serviquin	Servipharm	Switz.	—
Silbesan	Atmos	W. Germany	—
Siragon	Biochemie	Austria	—
Tresochin	Bayer	—	—

Raw Materials

4,7-Dichloroquinoline
1-Diethylamino-4-aminopentane
Phosphoric acid

Manufacturing Process

105 g of 4,7-dichloroquinoline (MP 93° to 94°C) are heated with 200 g of 1-diethylamino-4-aminopentane for 7 hours in an oil bath to 180°C while stirring, until a test portion dissolved in diluted nitric acid does not show a precipitation with sodium acetate solution. The mixture is dissolved in diluted acetic acid and made alkaline by adding sodium lye.

The base is extracted with ether, dried with potassium carbonate, the ether removed by distillation and the residue fractionated. The 4-(5'-diethylaminopentyl-2'-amino)-7-chloro-quinoline (BP 212° to 214°C/0.2 mm) is obtained. On cooling the compound solidifies crystalline. It melts, recrystallized from benzene, at 88°C. The base combines with phosphoric acid to yield a diphosphate salt.

References

Merck Index 2136

Kleeman & Engel p. 194

PDR p. 1902

OCDS Vol. 1 p. 341 (1977)

I.N. p. 220

REM p. 1218

Andersag, H., Breitner, S. and Jung, H.; U.S. Patent 2,233,970; March 4, 1941; assigned to Winthrop Chemical Company, Inc.

CHLOROTHIAZIDE

Therapeutic Function: Diuretic, Antihypertensive

Chemical Name: 6-chloro-2H-1,2,4-benzothiadiazine-7-sulfonamide 1,1-dioxide

Common Name: —

Structural Formula:

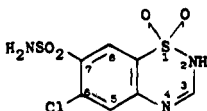

Chemical Abstracts Registry No.: 58-94-6

Trade Name	Manufacturer	Country	Year Introduced
Diuril	Merck Sharp & Dohme	U.S.	1957
Diurilix	Theraplix	France	1959
Aldoclor	MSD	U.S.	—
Azide	Fawns & McAllan	Australia	—
Chlorosal	Teva	Israel	—
Chloroserpine	Schein	U.S.	—
Chlotride	Sharp & Dohme	W. Germany	—
Clotride	MSD	Italy	—
Diubram	Bramble	Australia	—
Diupres	MSD	U.S.	—
Diuret	Protea	Australia	—
Diurone	Knoll	Australia	—
Fenuril	Pharmacia	Sweden	—
Lyovac	MSD	U.S.	—
Niagar	Cimes	Belgium	—
Ro-Chlorozide	Robinson	U.S.	—
Salisan	Ferrosan	Denmark	—
Saluren	Croce Bianca	Italy	—
Saluretil	Gayoso Wellcome	Spain	—
Saluric	MSD	U.K.	—
Salutrid	Leiras	Finland	—

Trade Name	Manufacturer	Country	Year Introduced
SK-Chlorothiazide	SK&F	U.S.	—
Urinex	Orion	Finland	—

Raw Materials

m-Chloroaniline	Ammonia
Chlorosulfonic acid	Formic acid

Manufacturing Process

(A) m-Chloroaniline (64 g, 0.5 mol) was added dropwise with stirring to 375 ml of chlorosulfonic acid in a 3-liter round bottom, 3-necked flask cooled in an ice bath. Sodium chloride (350 g) was added portionwise over a period of 1 to 2 hours and the mixture then heated gradually in an oil bath to 150°C. After 3 hours at 150° to 160°C, the flask was cooled thoroughly in an ice bath and the contents treated with a liter of cold water. The product was extracted with ether and the extract washed with water and dried over sodium sulfate.

After removal of ether on the steam bath, the residual 5-chloroaniline-2,4-disulfonyl chloride, which may be crystallized from benzene-hexane MP 130° to 132°C, was cooled in an ice bath and treated with 150 ml of 28% ammonium hydroxide in a 2-liter Erlenmeyer flask. The mixture was heated on the steam bath for 1 hour, cooled and the product collected on the filter, washed with water and dried. Upon crystallization from dilute alcohol 5-chloro-2,4-disulfamylaniline was obtained as colorless needles, MP 251° to 252°C.

(B) A solution of 88 g of 5-chloro-2,4-disulfamylaniline in 1.1 liters of 88% formic acid was heated under reflux for 2 hours. After removal of 200 ml of solvent by distillation, one liter of water was added and the product collected, washed with water and dried. Crystallization from dilute alcohol afforded 6-chloro-7-sulfamyl-1,2,4-benzothiadiazine-1,1-dioxide as colorless needles, MP 342.5° to 343°C, as described in U.S. Patent 2,809,194.

References

Merck Index 2143

Kleeman & Engel p. 194

PDR pp. 830, 993, 1133, 1168, 1606, 1723

OCDS Vol. 1 pp. 321, 355 (1977) & 2 p. 395 (1980)

I.N. p. 221

REM p. 938

Novello, F.C.; U.S. Patent 2,809,194; October 8, 1957; assigned to Merck & Co., Inc.

Hinkley, D.F.; U.S. Patent 2,937,169; May 17, 1960; assigned to Merck & Co., Inc.

CHLOROTRIANISENE

Therapeutic Function: Estrogen

Chemical Name: 1,1',1''-(1-chloro-1-ethenyl-2-ylidene)tris[4-methoxybenzene]

Common Name: Tri-p-anisylchloroethylene

Structural Formula:

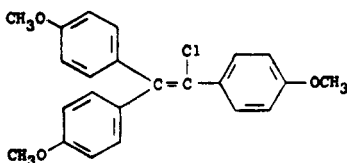

Chemical Abstracts Registry No.: 569-57-3

Trade Name	Manufacturer	Country	Year Introduced
TACE	Merrell	U.S.	1952
TACE FN	Merrell	France	1959
Anisene	Farmila	Italy	—
Clorotrisin	Courtois	Italy	—
Merbentul	Merrell	W. Germany	—
Triagen	Gentili	Italy	—

Raw Materials

Tris-*p*-methoxyphenyl ethylene
Chlorine

Manufacturing Process

The following method is described in U.S. Patent 2,430,891. To a solution of 10 parts of tris-*p*-methoxyphenyl ethylene in 35 to 40 parts of carbon tetrachloride is added a solution of 2.0 parts of chlorine in 50 parts of carbon tetrachloride, with stirring, and over a period of ½ hour. The carbon tetrachloride is then removed by distillation on a steam bath and the residual oil is recrystallized from 250 to 400 parts of methanol, decolorizing with charcoal or the like if necessary. Tris-*p*-methoxyphenyl chloroethylene is obtained in a yield of 65 to 75%. It melts at 113° to 114°C.

References

Merck Index 2149

Kleeman & Engel p. 195

PDR p. 1239

OCDS Vol. 1 p. 104 (1977)

I.N. p. 221

REM p. 988

Shelton, R.S. and Van Campen, M.G. Jr.; U.S. Patent 2,430,891; November 18, 1947; assigned to the Wm. S. Merrell Company

4-CHLORO-3,5-XYLENOL

Therapeutic Function: Topical antiseptic and disinfectant

Chemical Name: 4-Chloro-3,5-dimethylphenol

Common Name: —

Structural Formula:

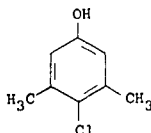

Chemical Abstracts Registry No.: 88-04-0

Trade Name	Manufacturer	Country	Year Introduced
Septiderm	Fougera	U.S.	1960
Anti-Sept	Seamless	U.S.	—

Trade Name	Manufacturer	Country	Year Introduced
Bacillotox	Bode	W. Germany	—
Baktol	Bode	W. Germany	—
Cruex	Pharmacraft	U.S.	—
Dettol	Reckitt & Coleman	U.K.	—
Fungoid	Pedinol	U.S.	—
Ice-O-Derm	Wampole	U.S.	—
Metasep	Marion	U.S.	—
Micro-Guard	Sween	U.S.	—
Orlex	Baylor	U.S.	—
Otall	Saron Pharmacal	U.S.	—
Pedi-Pro Foot Powder	Pedinol	U.S.	—
Rezamid	Dermik	U.S.	—
Rocapyol	Plurosan	Austria	—
Roxenol	Saunders	Canada	—
Satinasept	Mack	W. Germany	—
Sween-Soft	Sween	U.S.	—
Valvanol	Asid	W. Germany	—
Zetar	Dermik	U.S.	—

Raw Materials

Sulfuryl chloride
m-5-Xylenol

Manufacturing Process

546 g of intermediate xylenol fraction having a crystallizing point of 45°C mixed with an equal weight of m-5-xylenol are placed in a suitable vessel, equipped with stirring gear, and 273 g of sulfuryl chloride are added slowly. The temperature rises in the course of the reaction to about 40°C. When all the sulfuryl chloride is added the reaction mixture is heated to 80°C and the acid gases removed as far as possible by air-blowing or any other suitable means. On cooling a quantity of the required chlor-xylenol separates out and is removed from the mother liquor. Further quantities of the material required can be isolated by vacuum distillation of the mother liquors and further crystallization. In all, 200 to 208 g of material substantially 2-chlor-m-5-xylenol can be obtained having a melting point of 112°C to 115°C. The material can be purified if desired by crystallization from a solvent such as a hydrocarbon.

References

Merck Index 2152
Kleeman & Engel p. 196
PDR pp. 1397, 1662, 1790
I.N. p. 222
REM p. 1168
Gladden, G.W.; U.S. Patent 2,350,677; June 6, 1944; assigned to W.W. Cocker

CHLORPHENESIN CARBAMATE

Therapeutic Function: Skeletal muscle relaxant

Chemical Name: 3-(4-chlorophenoxy)-1,2-propanediol-1-carbamate

Common Name: 3-p-chlorophenoxy-2-hydroxypropyl carbamate

Structural Formula:

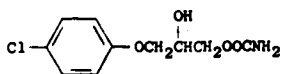

Chemical Abstracts Registry No.: 886-74-8

Trade Name	Manufacturer	Country	Year Introduced
Maolate	Upjohn	U.S.	1967
Kolpicortin	Doetsch Grether	Switz.	—
Rinlaxer	Taisho	Japan	—

Raw Materials

p-Chlorophenol	Phosgene
Glyceryl monochlorohydrin	Ammonia

Manufacturing Process

1.0 mol of 3-p-chlorophenoxy-1,2-propanediol (chlorphenesin) is suspended in 1,000 ml of benzene in a 5-liter flask equipped with a dropping funnel, thermometer and stirrer. 1.0 mol of phosgene in 500 ml of cold, dry benzene is then added dropwise over a period of 45 minutes, the resulting mixture being maintained at 30°C until all solid material is dissolved. 1.0 mol of triethylamine is added dropwise and the resulting reaction mixture stirred for 45 minutes at 30°C following the addition. The reaction mixture is then cooled to 5°C and extracted repeatedly with 600 ml portions of cold water to remove the triethylamine hydrochloride.

The benzene fraction, containing the intermediate 3-p-chlorophenoxy-3-hydroxypropyl chlorocarbonate, is added to 600 ml of cold concentrated ammonium hydroxide and the resulting reaction mixture agitated vigorously at 5°C for 7 hours. The crude 3-p-chlorophenoxy-2-hydroxypropyl carbamate solid is then filtered off, dissolved in hot benzene, dried to remove all traces of water, and permitted to crystallize out. Several recrystallizations from solvent mixtures of benzene and toluene, with small amounts of acetone, produced a crystalline white solid in about 65% yield. The product is 3-p-chlorophenoxy-2-hydroxypropyl carbamate, melting at 89° to 91°C. The chlorphenesin starting material is made by reacting p-chlorophenol with glyceryl monochlorohydrin as noted in U.S. Patent 3,214,336.

References

- Merck Index 2156
 Kleeman & Engel p. 198
 PDR p. 1850
 OCDS Vol. 1 p. 118 (1977)
 DOT 2 (4) 138 (1966)
 I.N. p. 223
 REM p. 927
 Collins, R.J. and Matthews, R.J.; U.S. Patent 3,161,567; December 15, 1964; assigned to The Upjohn Company
 Parker, H.E.; U.S. Patent 3,214,336; October 26, 1965; assigned to The Upjohn Company

CHLORPHENIRAMINE MALEATE

Therapeutic Function: Antihistaminic

Chemical Name: γ -(4-Chlorophenyl)-N,N-dimethyl-2-pyridinepropanamine maleate

Common Name: Chlorophenyl pyridyl propyldimethylamine maleate; chlorphenamine maleate; chlorprophen-pyridamine maleate

Structural Formula:

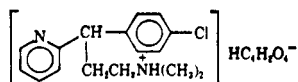

Chemical Abstracts Registry No.: 113-92-8; 132-22-9 (Base)

Trade Name	Manufacturer	Country	Year Introduced
Chlor-Trimeton	Schering	U.S.	1949
Teldrin	SKF	U.S.	1954
Drize	Ascher	U.S.	1967
Histaspan	U.S.V.	U.S.	1968
Allerbid	Amfre-Grant	U.S.	1971
Antagonate	Dome	U.S.	1973
Animing	Nisshin Seiyaku	Japan	1981
Ahiston	Ikapharm	Israel	—
Alaspan	Almay	U.S.	—
Alermine	Reid-Provident	U.S.	—
Allerdor	Fellows-Testagar	U.S.	—
Allergex	Protea	Australia	—
Allergin	Dellsberger	Switz.	—
Allergin	Sankyo	Japan	—
Allergisan	Pharmacia	Sweden	—
Allersan	Pharmacia	Sweden	—
Allertab	Tri-State	Italy	—
Allerton	Scalari	Italy	—
Anaphyl	Sam-On	Israel	—
Anthistamin-Sigletten	Rohm Pharma	W. Germany	—
Atalis-D	Kanto	Japan	—
Bismilla	Fuso	Japan	—
Chlo-Amine	Hollister-Stier	U.S.	—
Chlodamine	Maruko	Japan	—
Chloramate	Reid-Provident	U.S.	—
Chloramin	Langley	Australia	—
Chlor-Hab	Danbury	U.S.	—
Chlor-Mal	Rugby	U.S.	—
Chlormene	Robinson	U.S.	—
Chloroton	Cenci	U.S.	—
Chlorphen	Pro Doc	Canada	—
Chlor-Tel	Garden	U.S.	—
Chlortrone	Barlowe Cote	Canada	—
Clorten	Panthox & Burck	Italy	—
C-Meton	S.S. Pharm.	Japan	—
Cotuxinf	Saub	France	—
Dallery	Laser	U.S.	—
Decongestant Elixir	Schein	U.S.	—
Demazin	Schering	U.S.	—
Donatussin	Laser	U.S.	—
Dow-Chlorpheniramine	Dow	U.S.	—
Hexapneumine	Doms	France	—
Histachlor	Vitamix	U.S.	—
Histadur	Wynn	U.S.	—
Histaids	Ohio Medical	U.S.	—
Histalen	Len-Tag	U.S.	—
Histamic	Metro-Med	U.S.	—
Histapen	Douglas	New Zealand	—

Trade Name	Manufacturer	Country	Year Introduced
Histol	Blaine	U.S.	—
Isoclor	Arnar-Stone	U.S.	—
Kloromin	Halsey	U.S.	—
Lekrica	Yoshitomi	Japan	—
Lorphen	Geneva	U.S.	—
Neoallermine	Taiyo	Japan	—
Neorestamin	Kowa	Japan	—
Niratron	Progress	U.S.	—
Novahistine	Dow	U.S.	—
Novopheniram	Novopharm	Canada	—
Piriton	Allen & Hanbury	U.K.	—
Pneumopan	Sauba	France	—
Polaronic	Byk Essex	W. Germany	—
Poracemin	Horita	Japan	—
Probahist	Legere	U.S.	—
Propofan	Lepetit	France	—
Pyridamal	Bel-Mar	U.S.	—
Pyrroxate	Upjohn	U.S.	—
Quadrahist	Schein	U.S.	—
Rachelamine	Rachelle	U.S.	—
Rumicine	Cetrane	France	—
Singlet	Dow	U.S.	—
Synistamine	Sigmapharm	Austria	—
Trimeton	Essex	Italy	—
Trymegen	Medco	U.S.	—
U.R.I.	ICN	U.S.	—
Vitac	Egnaro	France	—

Raw Materials

4-Chlorobenzyl cyanide	Sodium amide
2-Chloropyridine	Sulfuric acid
Dimethylaminoethyl chloride	

Manufacturing Process

See "Brompheniramine Maleate." The starting material is simply a chlorophenyl compound.

References

Merck Index 2157

Kleeman & Engel p. 196

PDR pp. 992, 1033, 1246, 1606

OCDS Vol. 1 p. 77 (1977)

I.N. p. 222

Sperber, N., Papa, D. and Schwenk, E.; U.S. Patents 2,567,245; September 11, 1951; and 2,676,964; April 27, 1954; both assigned to Schering Corporation

CHLORPHENOXAMINE HYDROCHLORIDE

Therapeutic Function: Muscle relaxant; Antiparkinsonism

Chemical Name: 2-[1-(4-chlorophenyl)-1-phenylethoxy]-N,N-dimethylethanamine hydrochloride

Common Name: —

Structural Formula:

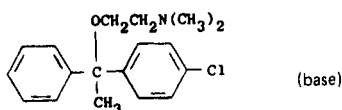

Chemical Abstracts Registry No.: 562-09-4; 77-38-3 (Base)

Trade Name	Manufacturer	Country	Year Introduced
Phenoxene	Dow	U.S.	1959
Systral	Lucien	France	1963
Clorevan	Evans	U.K.	—
Contristamine	Noristan	S. Africa	—
Rodavan	Asta	W. Germany	—
Systral	Asta	W. Germany	—
Systral	Kyorin	Japan	—

Raw Materials

Methyl chloride	Magnesium
4-Chlorobenzophenone	Sodium amide
Dimethylaminoethyl chloride	Hydrogen chloride

Manufacturing Process

A Grignard solution is prepared by introducing methyl chloride into a boiling suspension of 36 g of magnesium in 1,000 cc of absolute ether until all the magnesium has reacted. 216 grams of 4-chloro-benzophenone are slowly added to the Grignard solution with ice cooling and stirring; after 15 hours, the thus-obtained product is poured into a mixture of 200 g of ammonium chloride and ice, whereupon it is separated with ether. The separated ether layer is dried with sodium sulfate, and the ether is distilled. The residual carbinol is added to a suspension of 45 g of sodium amide in 500 cc of toluene. To the thus-obtained mixture there are added 125 g of dimethylaminoethyl chloride, and the mixture is heated at boiling temperature for 3 hours with stirring.

The mixture is taken up with water and the base is extracted from the toluene with dilute hydrochloric acid. The hydrochloric solution is rendered alkaline with caustic soda, the base is separated with ether, dried, and after distillation of the ether fractionated in vacuo, BP at 0.05 mm Hg, 150° to 153°C. The basic ether is then dissolved in dry ether, and ether saturated with dry hydrogen chloride is added dropwise with stirring. An excess of hydrogen chloride must be avoided as it may produce decomposition to the corresponding diphenyl ethylene. The ether-moist hydrochloride is preferably dried at once in vacuo and subsequently reprecipitated from acetone-ether and then again dried in vacuo over phosphorus pentoxide. Hydrochloride, MP 128°C.

References

Merck Index 2159

Kleeman & Engel p. 198

OCDS Vol. 1 p. 44 (1977)

I.N. p. 223

REM p. 931

Arnold, H., Brock, N. and Kuhas, E.; U.S. Patent 2,785,202; March 12, 1957; assigned to Asta-Werke A.G. Chemische Fabrik, Germany

CHLORPROETHAZINE HCl

Therapeutic Function: Muscle relaxant; tranquilizer

Chemical Name: 2-Chloro-N,N-diethyl-10H-phenothiazine-10-propanamine

Common Name: —

Structural Formula:

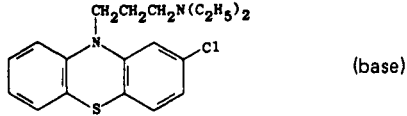

Chemical Abstracts Registry No.: 84-01-5 (Base)

Trade Name	Manufacturer	Country	Year Introduced
Neuriplege	Genevrier	France	1961

Raw Materials

2-Bromo-2'-(3''-dimethylaminopropyl)-amino-4'-chlorodiphenyl sulfide
 Copper powder
 Potassium carbonate
 Hydrogen chloride

Manufacturing Process

2-Bromo-2'-(3''-dimethylaminopropyl)-amino-4'-chlorodiphenylsulfide (10 g) is dissolved in dimethylformamide (80 cc). To this solution is added potassium carbonate (5 g) and copper powder (0.4 g). It is then heated under reflux for 48 hours, cooled, and the insoluble matter filtered off. After washing with dimethylformamide (20 cc), the filtrate is taken up in distilled water (200 cc). The base formed is extracted with ether (3 times with 50 cc), the ethereal solution is dried over sodium sulfate, the ether driven off on a water-bath and the residue distilled. In this way there is obtained 3-chloro-10-(3'-dimethylaminopropyl)-phenothiazine (6.4 g) which boils at 210°C to 225°C under 0.7 mm of mercury. The hydrochloride is made by the action of ethereal hydrogen chloride on the base dissolved in acetone; this hydrochloride melts at 180°C.

References

Merck Index 2161
 OCDS Vol. 1 p. 379 (1977)
 I.N. p. 224
 Buisson, P., J.C., Gaillot, P. and Gaudechon, J.; U.S. Patent 2,769,002; October 30, 1956; assigned to Societe des Usines Chimiques Rhone-Poulenc (France)

CHLORPROMAZINE HYDROCHLORIDE

Therapeutic Function: Tranquilizer

Chemical Name: 2-chloro-N,N-dimethyl-10H-phenothiazine-10-propanamine hydrochloride

Common Name: N-(3-dimethylaminopropyl)-3-chlorophenothiazine

Structural Formula:

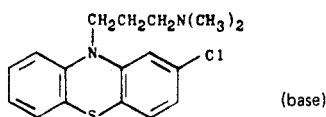

Chemical Abstracts Registry No.: 69-09-0; 50-53-3 (Base)

Trade Name	Manufacturer	Country	Year Introduced
Thorazine	SKF	U.S.	1954
Chlor-PZ	USV	U.S.	1973
Promapar	Parke Davis	U.S.	1973
Prochel	Rachelle	U.S.	1975
Acemin	Sankyo	Japan	—
Chloractil	D.D.S.A.	U.K.	—
Chlorazin	Streuli	Switz.	—
Chlorpromados	Holz	W. Germany	—
Chlor-Promanyl	Paul Maney	Canada	—
Chlorprom-Ez-Ets	Barlowe Cote	Canada	—
Contomin	Yoshitomi	Japan	—
Copormin	Kaken	Japan	—
Cromedazine	Fellows-Testagar	U.S.	—
Doimazin	Nippon Shinyaku	Japan	—
Elmarine	Elliott-Marion	Canada	—
Epokuhl	Kyowa	Japan	—
Esmind	Otsuka	Japan	—
Fenactil	Polfa	Poland	—
Hibanil	Mekos	Sweden	—
Hibernal	Leo	Sweden	—
Ishitomin	Kanto	Japan	—
Klorazin	Star	Finland	—
Klorproman	Orion	Finland	—
Klorpromex	Dumex	Denmark	—
Largactil	Specia	France	—
Megaphen	Bayer	W. Germany	—
Neurazine	Misr. Co-Pharm.	Egypt	—
Norcozine	Iwaki	Japan	—
Procalm	Bramble	Australia	—
Promachlor	Geneva	U.S.	—
Promacid	Knoll	Australia	—
Promactil	Wassermann	Spain	—
Promexin	Meiji	Japan	—
Promosol	Horner	Canada	—
Propafenin	Deut. Hydrierwerk	E. Germany	—
Protran	Protea	Australia	—
Prozin	Dumex	Denmark	—
Prozin	Lusofarmaco	Italy	—
Psychozine	O'Neal, Jones & Feldman	U.S.	—
Psylkatil	Farmos	Finland	—
Repazine	Lennon	S. Africa	—
Taroctyl	Taro	Israel	—
Wintermin	Shionogi	Japan	—

Raw Materials

Chlorophenthiazine
3-Dimethylamino-1-chloropropane

Sodium amide
Hydrogen chloride

Manufacturing Process

To a boiling suspension of 11.6 g of chlorophenthiazine (consisting of a mixture of two isomers melting at 196° to 198°C and 116° to 117°C, respectively, the latter in minor proportion) and 2.4 g of sodamide (80%) in 60 cc of xylene, there are added over a period of one hour 7.5 g of 3-dimethylamino-1-chloropropane in solution in its own weight of xylene. At the end of the addition, heating is continued for one hour under reflux. After cooling, the contents are taken up in acidified water and the xylene separated. The aqueous layer is made strongly alkaline by means of sodium hydroxide in order to liberate the base and this is extracted with ether. On distillation of the ethereal extract there is obtained 10-(3'-dimethylamino-propyl)-chlorophenthiazine which distills at 200° to 205°C under a pressure of 0.8 mm Hg. Its hydrochloride, recrystallized from chlorobenzene, melts at 177° to 178°C. The chlorophenthiazine may be prepared by reacting m-chlorodiphenylamine with sulfur in the presence of an iodine catalyst.

References

Merck Index 2163

Kleeman & Engel p. 199

PDR p. 1728

OCDs Vol. 1 pp. 319, 378 (1977), 2 p. 409 (1980) & 3 p. 72 (1984)

I.N. p. 224

REM p. 1086

Charpentier, P.; U.S. Patent 2,645,640; July 14, 1953; assigned to Societe des Usines Chimiques Rhone-Poulenc, France

CHLORPROPAMIDE

Therapeutic Function: Oral hypoglycemic

Chemical Name: 4-chloro-N-[(propylamino)carbonyl] benzenesulfonamide

Common Name: 1-(p-chlorobenzenesulfonyl)-3-propylurea

Structural Formula:

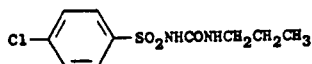

Chemical Abstracts Registry No.: 94-20-2

Trade Name	Manufacturer	Country	Year Introduced
Diabinese	Pfizer	U.S.	1958
Diabinese	Pfizer	France	1960
Dynalase	Pharmadyne	U.S.	1980
Insulase	Premo	U.S.	1980
Abemide	Kabayashi	Japan	—
Adiabene	Belupo	Yugoslavia	—
Arodoc-C	Sawai	Japan	—
Biadibe	Guidotti	Italy	—
Bioglumin	Uriach	Spain	—
Catanil	De Angeli	Italy	—
Chloronase	Hoechst	W. Germany	—
Chloronase	Hoechst	Japan	—
Clordiabet	Carulla-Vekar	Spain	—
Clordiasan	Santos	Spain	—
Cloro-Hipoglucina	Lefa	Spain	—

Trade Name	Manufacturer	Country	Year Introduced
Diabemide	Guidotti	Italy	—
Diabet	Pages Maruny	Spain	—
Diabetabs	Wolfs	Belgium	—
Diabetasi	Biagini	Italy	—
Diabetoral	Boehr/Mann.	W. Germany	—
Diabexan	Crosara	Italy	—
Diabitex	Irapharm	Israel	—
Diamei-Ex	Ibsa	Switz.	—
Diamide	Kanto	Japan	—
Gliconorm	Gentili	Italy	—
Glucamide	Lemmon	U.S.	—
Glucosulfina	Infale	Spain	—
Meldian	Pliva	Yugoslavia	—
Melisar	Beolet	Italy	—
Melitase	Berk	U.K.	—
Mellitot	Ono	Japan	—
Melormin	Farmos	Finland	—
Normoglic	Salfa	Italy	—
Novopropamide	Novopharm	Canada	—
Orabet	Deva	Turkey	—
Orabines	Biofarma	Turkey	—
Orbin	Biles	Turkey	—
Prodiaben	Labif	Italy	—
Promide	Protea	Australia	—
Shuabate	Toyama	Japan	—
Stabinol	Horner	Canada	—
Toyomelin	Toyo Jozo	Japan	—

Raw Materials

Propyl isocyanate
 p-Chlorobenzene sulfonamide
 Triethylamine

Manufacturing Process

A solution of 54 g (0.64 mol) of propyl isocyanate in 60 ml of anhydrous dimethylformamide was added to a cold, well-stirred suspension of 81 g (0.42 mol) of dry p-chlorobenzenesulfonamide in 210 ml of anhydrous triethylamine during the course of 20 to 30 minutes. The mildly exothermic reaction was completed by allowing it to stand at room temperature for about 5 hours. The reaction mixture was then slowly added to 3 liters of cold 20% acetic acid during the course of about one hour, constant agitation being maintained throughout the addition.

After the addition was complete, the desired product, which had crystallized out, was filtered and washed well with about 2 liters of cold water. The crude material was then dissolved in 1 liter of cold 5% sodium carbonate and the resulting solution was immediately filtered from an insoluble gum. The product was then reprecipitated, by slowly adding the filtrate to 3 liters of 20% acetic acid. The precipitate, which is very nearly pure N-(p-chlorobenzenesulfonyl)-N'-propylurea, was then dried and subsequently recrystallized from about 800 ml of benzene to give a 59% yield of pure product, MP 129.2° to 129.8°C.

References

Merck Index 2164
 Kleeman & Engel p. 200
 PDR pp. 830, 993, 1034, 1417, 1999
 OCDS Vol. 1 p. 137 (1977)
 I.N. p. 225

REM p. 976

McLamore, W.M.; U.S. Patent 3,349,124; October 24, 1967; assigned to Chas. Pfizer Co., Inc.

CHLORPROTHIXENE

Therapeutic Function: Tranquilizer

Chemical Name: 3-(2-chloro-9H-thioxanthen-9-ylidene)-N,N-dimethyl-1-propanamine

Common Name: —

Structural Formula:

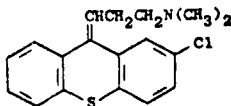

Chemical Abstracts Registry No.: 113-69-7; 6469-93-8 (Hydrochloride)

Trade Name	Manufacturer	Country	Year Introduced
Taractan	Roche	France	1960
Taractan	Roche	U.S.	1962
Clothixen	Yoshitomi	Japan	—
Cloxxan	Orion	Finland	—
Minithixen	Spofa	Czechoslovakia	—
Paxyl	Ikapharm	Israel	—
Tra-Quilan	Eisai	Japan	—
Truxal	Tropon	W. Germany	—
Truxal	Toyama	Japan	—
Truxaletten	Tropon	W. Germany	—

Raw Materials

3-Dimethylaminopropyl chloride	Magnesium
2-Chlorothiixanthenone	Ethyl bromide
Acetyl chloride	

Manufacturing Process

Chlorprothixene may be prepared as described in U.S. Patent 2,951,082. Magnesium turnings, 4.86 g (0.2 g-atom) was placed in a 500 ml reaction flask fitted with a mercury sealed stirrer, reflux condenser and a dropping funnel. Tetrahydrofuran, 50 ml and calcium hydride, 500 mg, were added. Ethyl bromide, 2.18 g and a crystal of iodine then were added. A vigorous reaction set in that evolved sufficient heat to induce refluxing. After 5 minutes, a solution of 3-dimethylaminopropyl chloride (dried over calcium hydride) in 50 ml of tetrahydrofuran was added to the refluxing solution at such a rate that gentle refluxing was maintained. The addition required 25 minutes.

The reaction mixture was stirred at reflux for an additional 30 minutes when nearly all of the magnesium had dissolved and determination of magnesium in an aliquot of the solution showed that an 82% yield of Grignard reagent had been obtained. The reaction mixture was cooled in an ice bath and stirred while 24.67 g (0.1 mol) of 2-chlorothiixanthenone was added over a period of 10 minutes. The reaction was stirred at room temperature for 30 minutes then allowed to stand overnight in the refrigerator. The tetrahydrofuran was evaporated at 50°C under reduced pressure. Benzene, 150 ml, was added to the residue.

The mixture was hydrolyzed in the cold by the dropwise addition of 50 ml of water. The benzene layer was separated by decantation and the gelatinous precipitate washed with two 100 ml portions of benzene.

The precipitate was then mixed with diatomaceous earth, collected on a filter, and washed with water and extracted with two 100 ml portions of boiling benzene. The aqueous filtrate was extracted with 50 ml of benzene, the combined benzene extracts washed with water and evaporated to dryness under reduced pressure. The crystalline residue, MP 140° to 147°C, weighed 30.8 g. Recrystallization from a mixture of benzene and hexane gave 27.6 g (83%) of 2-chloro-10-(3-dimethylaminopropyl)-10-hydroxythioxanthene, MP 152° to 154°C. Analytically pure material from another experiment melted at 153° to 154°C.

2-Chloro-10-(3-dimethylaminopropyl)-10-hydroxythioxanthene, 3.34 g (0.01 mol) obtained as described was dissolved in 15 ml of dry, alcohol-free chloroform. Acetyl chloride, 2.36 g (0.03 mol) was added and the clear yellow solution was refluxed for one hour in a system protected by a drying tube. The solvent then was evaporated on the steam bath under reduced pressure and the residue dissolved in absolute alcohol. The hydrochloride of 2-chloro-10-(3-dimethylaminopropylidene)-thioxanthene was precipitated by the cautious addition of absolute ether. After drying at 70°C the yield of white crystalline 2-chloro-10-(3-dimethylaminopropylidene)-thioxanthene hydrochloride, MP 189° to 190°C (to a cloudy melt), was 3.20 g (90%). This material is a mixture of geometric isomers.

Trans-2-chloro-9-(ω -dimethylamino-propylidene)-thioxanthene [MP 98°C, MP of the hydrochloride 225°C (corr.)], is a valuable medicinal agent, being used as a tranquilizer and anti-emetic agent, whereas the corresponding cis isomer (MP 44°C, MP of the hydrochloride 209°C) is not useful for these indications, as described in U.S. Patent 3,115,502, which describes procedures for conversion of the cis to the trans form.

References

Merck Index 2166

Kleeman & Engel p. 200

PDR p. 1503

OCDS Vol. 1 p. 389 (1977)

DOT 9 (6) 229 (1973)

I.N. p. 225

REM p. 1087

Sprague, J.M. and Engelhardt, E.L.; U.S. Patent 2,951,082; August 30, 1960; assigned to Merck & Co., Inc.

Schlapfer, R. and Spiegelberg, H.; U.S. Patent 3,115,502; December 24, 1963; assigned to Hoffmann-LaRoche Inc.

CHLORQUINALDOL

Therapeutic Function: Antibacterial

Chemical Name: 5,7-Dichloro-2-methyl-8-quinolinol

Common Name: Hydroxydichloroquinaldine, chloroquinaldol

Structural Formula:

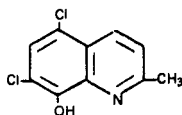

Chemical Abstracts Registry No.: 72-80-0

Trade Name	Manufacturer	Country	Year Introduced
Sterosan	Geigy	U.S.	1954
Gynotherax	Bouchard	France	1967
Afungyl	Egyt	Hungary	—
Chinosicc	Schering	W. Germany	—
Chinotiol	Bouty	Italy	—
Gyno-Sterosan	Geigy	W. Germany	—
Intensol	Anasco	W. Germany	—
Lonjee	Sampo	Japan	—
Phylleten	Muller-Rorer	W. Germany	—
Quesil	Egyt	Hungary	—
Rub-All T	Toyama	Japan	—
Saprosan	C.I.F.	Rumania	—
Serviderm	Servipharm	Switz.	—
Siogeno	Geigy	W. Germany	—
Siogene	Geigy	France	—
Siosteran	Fujisawa	Japan	—
Steroxin	Geigy	U.K.	—

Raw Materials

8-Hydroxyquinaldine
Chlorine

Manufacturing Process

11.1 parts of 8-hydroxy-quinaldine are dissolved in 140 parts of formic acid. Chlorine is introduced into this solution under cooling, until the increase in weight corresponds to the required quantity of chlorine and a test of the chlorination mixtures gives no more dyestuff formation with diazo-benzene in an acetic acid solution.

When the chlorination is complete, the reaction mixture is poured into 1,000 parts of water and treated with a dilute sodium bisulfite solution, until no more reaction may be observed with starch-potassium iodide paper. Thereby the 5,7-dichloro-8-hydroxy-quinaldine separates out in form of a weakly yellowish colored precipitate. The same is filtered off and thoroughly washed with water.

After drying, 15 parts of 5,7-dichloro-8-hydroxy-quinaldine melting at 111°C to 112°C are obtained. When recrystallized from alcohol, the product is obtained in voluminous, slightly yellowish needles having the melting point of 111.5°C to 112°C.

References

Merck Index 2168
Kleeman & Engel p. 201
I.N. p. 225
Senn, E.; U.S. Patent 2,411,670; November 26, 1946; assigned to J.R. Geigy AG

CHLORTETRACYCLINE

Therapeutic Function: Antibacterial

Chemical Name: 7-chloro-4-dimethylamino-1,4,4a,5,5a,6,11,12a-octahydro-3,6,10,12,12a-pentahydroxy-6-methyl-1,11-dioxo-2-naphthacene-carboxamide

Common Name: —

Structural Formula:

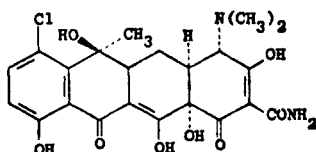

Chemical Abstracts Registry No.: 57-62-5

Trade Name	Manufacturer	Country	Year Introduced
Aureomycin	Lederle	U.S.	1948
Aureomycine	Specia	France	1951
Aureum	Farmigea	Italy	—
Aufac	Amer. Cyanamid	U.S.	—
B-Aureo	Biokema	Switz.	—
Chevita C-10	Chevita	W. Germany	—
Chlortet	Langley	Australia	—
Chrysomycin	Dispersa	Switz.	—
Clorteta	Pierrel	Italy	—
Colircusi Aureomicina	Cusi	Spain	—
CTC Soluble	Diamond Shamrock	U.S.	—
Vi-Mycin	Vineland Chemical	U.S.	—

Raw Materials

- Sucrose
- Corn steep liquor
- S. aureofaciens* bacterium

Manufacturing Process

The following process description is taken from U.S. Patent 2,987,449. An appropriate *S. aureofaciens* strain such as mutant S1308 (ATCC No. 12,748) is grown aerobically in a suitable inoculum medium. A typical medium used to grow the primary inoculum is prepared according to the following formula: sucrose, 20.0 g; corn steep liquor, 16.5 ml; ammonium sulfate, 2.0 g; calcium carbonate, 7.0 g; and water to 1,000 ml.

A 100 ml aliquot of this medium is placed in a 500 ml Erlenmeyer flask and sterilized by autoclaving for 20 minutes under 15 psi pressure. Spores of mutant strain *S. aureofaciens* S1308 (ATCC No. 12,748) are washed from an agar slant into the flask with sterile distilled water to form a suspension containing approximately 10^8 spores per milliliter. A 1.0 ml portion of this suspension is used to inoculate the fermentation media in the example which follows. A fermentation medium consisting of the following ingredients was prepared.

	Grams
$(\text{NH}_4)_2\text{SO}_4$	5.0
CaCO_3	9.0
NH_4Cl	1.5
$\text{MgCl}_2 \cdot 6\text{H}_2\text{O}$	2.0
$\text{FeSO}_4 \cdot 7\text{H}_2\text{O}$	0.06
$\text{MnSO}_4 \cdot 4\text{H}_2\text{O}$	0.05
$\text{CoCl}_2 \cdot 6\text{H}_2\text{O}$	0.005
$\text{ZnSO}_4 \cdot 7\text{H}_2\text{O}$	0.1
Corn steep liquor	25.0
Cornstarch	55.0
Water to 1,000 ml	

25 ml aliquots of this fermentation medium were placed in each of two 250 ml Erlenmeyer flasks and 0.5 ml of lard oil was added to each flask. Then 0.002 mg/ml of riboflavin was added to one flask, the other flask being retained as a control. The flasks were sterilized in an autoclave for 20 minutes under 15 psi pressure, then cooled to room temperature ($25^{\circ}\pm 5^{\circ}\text{C}$). At this point, a 1.0 ml portion of inoculum of mutant strain *S. aureofaciens* S1308 (ATCC No. 12,748) was added to each of the two flasks. The flasks were incubated at 25°C for 120 hours on a rotary shaker operating at 180 rpm. Upon completion of the fermentation period the mashers were assayed for 7-chlorotetracycline content.

The increase in production due to the addition of riboflavin was very noticeable in the above example. A similar effect was reported for cupric sulfate pentahydrate addition according to U.S. Patent 3,050,446.

References

Merck Index 2170

Kleeman & Engel p. 203

PDR p. 1007

OCDS Vol. 1 p. 212 (1977)

I.N. p. 226

REM p. 1208

Duggar, B.M.; U.S. Patent 2,482,055; September 13, 1949; assigned to American Cyanamid Company

Niedercorn, J.G.; U.S. Patent 2,609,329; September 2, 1952; assigned to American Cyanamid Company

Winterbottom, R., Mendelsohn, H., Muller, S.A., and McCormick, J.R.D.; U.S. Patent 2,899,422; August 11, 1959; assigned to American Cyanamid Company

Miller, P.A., Goodman, J.J., Sjolander, N.O. and McCormick, J.R.D.; U.S. Patent 2,987,449; June 6, 1961; assigned to American Cyanamid Company

Goodman, J.J.; U.S. Patent 3,050,446; August 21, 1962; assigned to American Cyanamid Company

CHLORTHALIDONE

Therapeutic Function: Diuretic, antihypertensive

Chemical Name: 2-Chloro-5-(1-hydroxy-3-oxo-1-isoindolinyl)benzenesulfonamide

Common Name: Chlortalidone

Structural Formula:

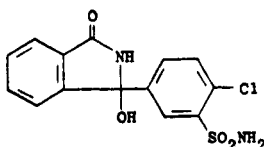

Chemical Abstracts Registry No.: 77-36-1

Trade Name	Manufacturer	Country	Year Introduced
Hygroton	Geigy	U.S.	1960
Hygroton	Ciba Geigy	France	1960
Hygroton	Ciba Geigy	Switz.	1960
Hygroton	Ciba Geigy	W. Germany	1960

Trade Name	Manufacturer	Country	Year introduced
Hygroton	Ciba Geigy	U.K.	1960
Igroton	Geigy	Italy	1961
Thalitone	Boehr/Ingel.	U.S.	1982
Aquadon	Ikapharm	Israel	—
Hybasedock	Sawai	Japan	—
Hydoban	Medica	Finland	—
Hydro-Long	Sanorama	W. Germany	—
Hygroton	Pliva	Yugoslavia	—
Hygroton	Geigy	Japan	—
Hypertol	Farmos	Finland	—
Igriina	Benedetti	Italy	—
Novothalidone	Novopharm	Canada	—
Regretron	U.S.V.	U.S.	—
Renon	Medal	Italy	—
Servidone	Servipharm	Switz.	—
Urid	Protea	Australia	—
Uridon	I.C.N.	Canada	—
Urolin	Sidus	Italy	—
Zambesil	Spemsa	Italy	—

Raw Materials

4-Chloro-3-amino-benzophenone-2'-carboxylic acid
 Sodium nitrate
 Hydrogen chloride
 Sulfur dioxide
 Thionyl chloride
 Ammonia

Manufacturing Process

15 parts of aqueous 46% sodium nitrite solution are gradually added to a mixture of 27.5 parts of 4-chloro-3-amino-benzophenone-2'-carboxylic acid, 200 parts of glacial acetic acid and 20 parts of 37% hydrochloric acid at 0° to 10°C. The solution of the diazonium salt is poured into an ice-cooled mixture of 200 parts of 30% sulfur dioxide solution in glacial acetic acid and 3 parts of crystallized cupric chloride in 15 parts of water. Nitrogen is developed and, after a short time, the 4-chloro-2'-carboxy-benzophenone-3-sulfochloride crystallizes out. After 1 hour it is filtered off and washed with water. MP 178° to 182°C.

35.9 parts of 4-chloro-2'-carboxy-benzophenone-3-sulfochloride and 50 parts of thionyl chloride are heated first for 3 hours at 30° to 35°C and then for 1 hour at 45°C. The excess thionyl chloride is distilled off in the vacuum, the dichloride, 3-chloro-3-(3'-chloro-sulfonyl-4'-chlorophenyl)phthalide, which remains as a crystallized mass is dissolved in 150 parts of chloroform and a mixture of 200 parts of 25% aqueous ammonia solution and 200 parts of ethanol is added dropwise at about 10°C while stirring and cooling. After stirring for 1 hour at 40°C, the solvent is distilled off in the vacuum and diluted hydrochloric acid is added to the residue whereupon the 1-oxo-3-(3'-sulfonyl-4'-chloro-phenyl)-3-hydroxy-isoindoline which is tautomeric to the 4-chloro-2'-carbonyl-benzophenone-3-sulfonamide, separates out. On recrystallizing from diluted ethanol, the isoindoline derivative melts at 215°C on decomposition.

Instead of reacting the dichloride in aqueous solution with ammonia, it can also be reacted at -50° to -40°C with a great excess of liquid ammonia. After removal of the ammonia, the crude product obtained is recrystallized as described above.

References

Merck Index 2171
 Kleeman & Engel p. 202

PDR pp. 509, 676, 682, 830, 993, 1326, 1606, 1786, 1813, 1820, 1999

OCDS Vol. 1 p. 322 (1977)

DOT 16 (1) 32 (1980)

I.N. p. 226

REM p. 938

Graf, W., Schmid, E. and Stoll, W.G.; U.S. Patent 3,055,904; September 25, 1962; assigned to Geigy Chemical Corporation

CHLORTHENOXAZINE

Therapeutic Function: Antipyretic; analgesic

Chemical Name: 2-(2-Chloroethyl)-2,3-dihydro-4H-1,3-benzoxazin-4-one

Common Name: —

Structural Formula:

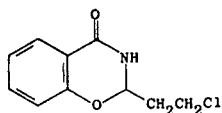

Chemical Abstracts Registry No.: 132-89-8

Trade Name	Manufacturer	Country	Year Introduced
Reugaril	Farber	Italy	1966
Apirogen	Dessy	Italy	—
Betix	Saba	Italy	—
Fiobrol	Geigy	W. Germany	—
Ossazin	Scalari	Italy	—
Ossazone	Broccieri	Italy	—
Ossipirina	Radiumpharma	Italy	—
Oxal	Saita	Italy	—
Reulin	Isola-IBI	Italy	—
Reumital	Farge	Italy	—
Valtorin	Boehr./Ingel.	—	—

Raw Materials

Acrolein
Hydrogen chloride
Salicylamide

Manufacturing Process

A mixture of 4 liters chloroform and 1,050 cc ethanol was saturated with dry hydrogen chloride gas at -5°C to $+5^{\circ}\text{C}$ in a vessel having a net volume of 15 liters and provided with a stirring device, reflux cooler, gas feed line, thermometer and dropping funnel. 455 g acrolein which had been precooled to 0°C were added dropwise to the solution over a period of 1 to 2 hours while maintaining the temperature below $+5^{\circ}\text{C}$ and vigorously stirring. 1,070 g salicylamide and 1,080 g glacial acetic acid were added to the resulting solution of β -chloropropionaldehyde acetal, thereby forming a suspension which was heated to 60°C while stirring. A clear solution was formed which was maintained at 60°C for an additional hour. The solution was allowed to cool to about 40°C and was then washed with water by passing a strong stream of water under the surface of the chloroform and continuously withdrawing the upper phase. When the water had reached a pH of 3-4, the precipitated reaction product was separated by

vacuum filtration. The chloroform phase of the filtrate was evaporated under a weak vacuum and the residue was combined with the precipitate first obtained. The combined products were stirred with 2 liters of a 5% sodium hydroxide solution. The raw reaction product was then washed with water, dried and recrystallized from ethanol. The product had the melting point of 146°C to 147°C (decomposition). The yield was 1,260 g, corresponding to 76% of the theoretical yield.

References

Merck Index 2172

Kleeman & Engel p. 203

I.N. p. 226

Ohnacker, G. and Scheffler, H.; U.S. Patent 2,943,087; June 28, 1960; assigned to Dr. Karl Thomae G.m.b.H. (Germany)

CHLORZOAZONE

Therapeutic Function: Skeletal muscle relaxant

Chemical Name: 5-chloro-2(3H)-benzoxazolone

Common Name: 5-chloro-2-hydroxybenzoxazole

Structural Formula:

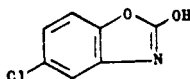

Chemical Abstracts Registry No.: 95-25-0

Trade Name	Manufacturer	Country	Year Introduced
Paraflex	McNeil	U.S.	1958
Benzoflex	Benzon	Denmark	—
Biomioran	Bioindustria	Italy	—
Chroxin	Kanyo	Japan	—
Chlozoxine	Sanko	Japan	—
Deltapyrin	Kodama	Japan	—
Escoflex	Streuli	Switz.	—
Framenco	Fuso	Japan	—
Kiricoron	Sampo	Japan	—
Mesin	Yamanouchi	Japan	—
Myoflex	Pliva	Yugoslavia	—
Myoflexin	Chinoïn	Hungary	—
Oxyren	Astra	—	—
Paraflex	Cilag	W. Germany	—
Pathorysin	Kowa	Japan	—
Remoflex	Belupo	Yugoslavia	—
Solaxin	Eisai	Japan	—
Sorazin	Toho	Japan	—
Trancrol	Mohan	Japan	—

Raw Materials

2-Amino-5-chlorobenzoxazole

Hydrogen chloride

Sodium hydroxide

Manufacturing Process

A solution of 16.9 g (0.1 mol) of 2-amino-5-chlorobenzoxazole in 200 ml of 1 N HCl is refluxed until precipitation is complete. The resulting solid is collected by filtration, dissolved in 200 ml of 1 N NaOH and the solution extracted with 50 ml of ether. Acidification of the alkaline solution gives a precipitate which is purified by crystallization from acetone to give 2-hydroxy-5-chlorobenzoxazole melting at 191° to 191.5°C.

References

Merck Index 2174

Kleeman & Engel p. 204

PDR pp. 830, 993, 1093, 1441, 1606, 1999

OCDS Vol. 1 p. 323 (1977)

I.N. p. 227

REM p. 926

Marsh, D.F.; U.S. Patent 2,895,877; July 21, 1959; assigned to McNeil Laboratories, Inc.

CHOLINE DIHYDROGEN CITRATE

Therapeutic Function: Lipotropic

Chemical Name: (2-Hydroxyethyl)trimethylammonium citrate

Common Name: —

Structural Formula: $[\text{HOCH}_2\text{CH}_2\text{N}^+(\text{CH}_3)_3] [\text{C}_6\text{H}_7\text{O}_7^-]$

Chemical Abstracts Registry No.: 77-91-8

Trade Name	Manufacturer	Country	Year Introduced
Chothyn	Flint	U.S.	1945
Citrocholine	United	U.S.	1949
Lipocholin	—	—	—

Raw Materials

Trimethyl amine

Ethylene oxide

Citric acid

Manufacturing Process

30 lb of trimethylamine were added to 70.4 lb of methyl alcohol to which 9.2 lb of water had previously been added. To the resulting solution in a closed vessel 23 lb of ethylene oxide gas were introduced and the resulting mixture then maintained at a temperature of 16°C to 30°C and agitated for 6 hours. During the reaction the pressure in the reaction vessel varied from about 17.5 psi at the start of the reaction to 0 psi at the end of the reaction. The resulting solution was then added with agitation to a refluxing solution of 40 liters of isopropyl alcohol containing 95 lb of citric acid dissolved therein. This mixture was then cooled to 0°C and held at that temperature overnight. The white crystalline choline dihydrogen citrate which formed was separated from the solvent mixture by filtration and dried in vacuo. 117 lb of anhydrous, crystalline choline dihydrogen citrate having a purity of 99.6% were obtained. This was a yield of 78% based on the amount of trimethylamine employed.

References

Merck Index 2187

I.N. p. 227

REM p. 1026

Klein, H.C., DiSalvo, W.A. and Kapp, R.; U.S. Patent 2,870,198; January 20, 1959; assigned to Nopco Chemical Co.

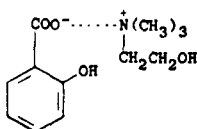
CHOLINE SALICYLATE**Therapeutic Function:** Analgesic, antipyretic**Chemical Name:** 2-hydroxy-N,N,N-trimethyl-ethanaminium salt with 2-hydroxy benzoic acid**Common Name:** Choline salicylic acid salt**Structural Formula:****Chemical Abstracts Registry No.:** 2016-36-6

Trade Name	Manufacturer	Country	Year Introduced
Arthropan	Purdue Frederick	U.S.	1959
Actasal	Purdue Frederick	U.S.	1959
Atilen	Spofa	Czechoslovakia	—
Audax	Napp	U.K.	—
Audax	Ethimed	S. Africa	—
Audax	Mundipharma	W. Germany	—
Bonjela	Lloyds	U.K.	—
Mundisal	Mundipharma	Switz.	—
Mundisal	Erco	Denmark	—
Otho	Purdue Frederick	U.S.	—
Sachol	Polfa	Poland	—
Rheumavincin	Owege	W. Germany	—
Salicol	Sais	Italy	—
Satibon	Grelan	Japan	—
Syrap	Carrion	France	—
Teejel	Napp	U.K.	—
Tegunor	Mundipharma	W. Germany	—
Trilisate	Purdue Frederick	U.S.	—

Raw Materials

Choline chloride
Sodium salicylate

Manufacturing Process

A method of preparation is to react an acid salt of choline (such as choline chloride or choline bromide) with an alkaline salt of salicylic acid (such as sodium salicylate, potassium salicylate, or magnesium salicylate) in an alcoholic media.

References

Merck Index 2189

Kleeman & Engel p. 205

I.N. p. 228

Broh-Kahn, E.H. and Sasmor, E.J.; U.S. Patent 3,069,321; December 18, 1962; assigned to Laboratories for Pharmaceutical Development, Inc.

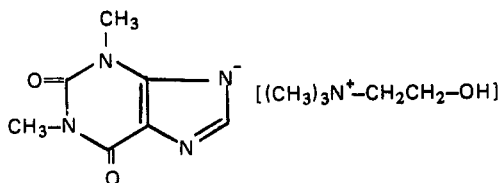
CHOLINE THEOPHYLLINATE**Therapeutic Function:** Smooth muscle relaxant**Chemical Name:** Theophylline cholate**Common Name:** Oxotriphylline; oxytrimethyline**Structural Formula:****Chemical Abstracts Registry No.:** 4499-40-5

Trade Name	Manufacturer	Country	Year Introduced
Sabidal S.R.	Zyma	U.K.	1983
Brondaxin	Ferrosan	Denmark	—
Cholecyl	Substantia	Spain	—
Choledyl	Nepera	U.S.	—
Cholegyl	Substantia	Neth.	—
Chophyllin	Ferratton	Denmark	—
Euspirax	Asche	W. Germany	—
Glomax	Midlands Int. Chem.	U.K.	—
Isoperin	Spofa	Yugoslavia	—
Monofillina	Manetti Roberts	Italy	—
Novotriphyl	Novopharm	Canada	—
Rouphylline	Rougier	Canada	—
Sclerofillina	Medici Domus	Italy	—
Teocolina	Nessa	Spain	—
Teofilcolina	Salfa	Italy	—
Teovent	Ferrosan	Denmark	—

Raw Materials

Theophylline

Choline bicarbonate

Manufacturing Process

18 parts by weight of theophylline are added to 37.8 parts by weight of aqueous choline bicarbonate (47% assay) and the mixture stirred and heated at 80°C to 90°C until the evolution

of carbon dioxide has ceased and complete solution effected. Water is separated from the reaction mixture by distillation under a vacuum sufficient to keep the still temperature between 50°C and 55°C. After about 15 parts by weight of water have been separated, about 80 parts by weight of isopropyl alcohol are added and the mixture subjected to further distillation under a vacuum sufficient to keep the mixture boiling at about 40°C. The distillation removes some of the water as an azeotrope with the isopropyl alcohol. During the removal of the water-isopropyl alcohol azeotrope a crystalline precipitate forms. The mixture is further cooled slowly to 5°C and the crystalline precipitate filtered off. The choline theophyllinate crystals are then washed with isopropyl alcohol and dried under vacuum at about 70°C. A second crop of the product may be obtained from the mother liquor by further reduction in volume and cooling. A yield of 90.5% of theory of choline theophyllinate is obtained completely free of inorganic salts.

References

Merck Index 2190

I.N. p. 228

REM p. 872

Ladenburg, K., Duesel, B.F. and Fand, T.I.; U.S. Patent 2,776,287; January 1, 1957; assigned to Nepera Chemical Co., Inc.

CHROMONAR HYDROCHLORIDE

Therapeutic Function: Coronary vasodilator

Chemical Name: [[3-[2-(Diethylamino)ethyl]-4-methyl-2-oxo-2H-1-benzopyran-7-yl]oxy]acetic acid ethyl ester hydrochloride

Common Name: Carbocromene

Structural Formula:

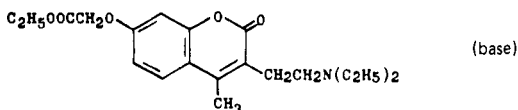

Chemical Abstracts Registry No.: 655-35-6; 804-10-4 (Base)

Trade Name	Manufacturer	Country	Year Introduced
Intensain	Hoechst	Switz.	1963
Intensain	Cassella	W. Germany	1963
Intensain	Diamant	France	1966
Intensain	Pierrel	Italy	1971
Antiagor	I.S.M.	Italy	—
Beta-Intensain	Cassella	W. Germany	—
Cardiocap	Fidia	Italy	—
Cromene	Scharper	Italy	—
Intensain	Takeda	Japan	—
Intensacrom	Albert Farma	Spain	—
Sedo-Intensain	Diamant	France	—
Intenkordin	Polfa	Poland	—

Raw Materials

Resorcinol

2-(2-Diethylaminoethyl)acetic acid ethyl ester

Bromoacetic acid ethyl ester

Manufacturing Process

18.7 g of 3- β -diethylaminoethyl-4-methyl-7-hydroxy-coumarin chlorhydrate are dissolved in 200 cc methyl ethyl ketone and 18 g anhydrous potassium carbonate are added. The mixture is stirred for 1 hour at 70°C and then 12 g bromoacetic acid ethyl ester are allowed to drop in. The reaction mixture is stirred under reflux for 9 hours and then it is filtered off with suction in the heat. The filtrate is concentrated in the vacuum to dryness and the resultant residue is dissolved in ether. The etheric solution is washed with diluted caustic soda solution for several times and, subsequently, dried with Glauber's salt. By introduction of hydrochloric acid gas into the etheric solution the reaction product is precipitated in the form of chlorhydrate. Yield: 15 g of 3- β -diethylaminoethyl-4-methyl-coumarin-7-ethyl oxyacetate chlorhydrate having a melting point of 154° to 156°C (= 63% of the theory).

The starting material is produced by reacting resorcinol with 2-(2-diethylaminoethyl)acetic acid ethyl ester.

References

Merck Index 2217

Kleeman & Engel p. 150

OCDS Vol. 1 p.331 (1977)

I.N. p. 185

Ritter, H., Hanau, K., Beyerle, R. and Nitz, R.-E.; U.S. Patent 3,282,938; November 1, 1966; assigned to Cassella Fabwerke Mainkur AG, Germany

CHYMOPAPAIN

Therapeutic Function: Proteolytic enzyme used in chemical nucleolysis

Chemical Name: See "Structural Formula" below.

Common Name: —

Structural Formula: Chymopapain is a sulfhydryl enzyme similar to papain. Has components of molecular weight about 35,000.

Trade Name	Manufacturer	Country	Year Introduced
Chymodiactin	Smith	U.S.	1982
Chemolase	Ortho-Tex	U.S.	—
Discase	Travenol	U.S.	—

Chemical Abstracts Registry No.: 9001-09-06

Raw Materials

Papaya latex

Hydrochloric acid

Manufacturing Process

The undried latex of papaya is mixed with about three times its weight of hundredth normal hydrochloric acid. To this mixture is then added dilute hydrochloric acid (about normal) until a pH of substantially 2 has been attained. The acidified latex is next allowed to stand over night or longer in a cold place (0°C to 10°C). The material still in solution is then separated out, by any convenient means, such as filtration through paper. From the soluble portion, a

small amount of inert protein is precipitated, by half saturation with sodium chloride at about 10°C. The desired enzyme is next precipitated as a nearly pure protein by raising the concentration of salt to full saturation, while the pH is kept at a level of substantially 2, by the addition of normal alkali, if necessary. The precipitate of protein is removed by any suitable means, and may be kept as a thick paste out of contact with the air, and in the cold. The keeping properties at higher temperatures are enhanced by addition of enough alkali to the protein to bring its pH to 4.5-6.0.

This protein may be further purified, if desired, and eventually may be crystallized, by redissolving the paste in saturated sodium chloride solution by adjusting the pH to 4.5-6.0, and reprecipitating the enzyme protein by the gradual addition of acid in the cold, until a pH of approximately 2.0 is obtained; or, the purification may be accomplished by dissolving the protein in acid at a pH of 2, and then precipitating the enzyme, by increasing the concentration of salt.

When the activity and other properties of the several times recrystallized new enzyme protein are compared with those of the uncrystallized precipitate obtained in the first stages of the process, it is found that even in the first stages, the enzyme is present in sufficiently pure form for most purposes.

References

Merck Index 2244

PDR p. 1732

DOT 19 (7) 413 (1983) & (8) 454 (1983)

I.N. p. 229

REM p. 1036

Jansen, E.F. and Balls, A.K.; U.S. Patent 2,313,875; March 16, 1943; assigned to Government of the U.S.A.

Stern, I.J.; U.S. Patent 3,558,433; January 26, 1971; assigned to Baxter Laboratories, Inc.

CICLONICATE

Therapeutic Function: Vasodilator

Chemical Name: 3-Pyridinecarboxylic acid 3,3,5-trimethylcyclohexyl ester

Common Name: Cyclonicate

Structural Formula:

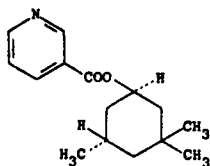

Chemical Abstracts Registry No.: 53449-58-4

Trade Name	Manufacturer	Country	Year Introduced
Bled	Poli	Italy	1978
Bled	Poli	Switz.	1981
Cortofludan	Knoll	W. Germany	—
Elastan 200	Byk Liprandi	Argentina	—

Raw Materials

trans-3,3,5-Trimethylcyclohexanol
 Niacin chloride hydrochloride
 Sodium hydroxide

Manufacturing Process

To a solution of 142 g (1 mol) of trans-3,3,5-trimethylcyclohexanol in 400 cc of anhydrous benzene heated to 70°C is added gradually 178 g (1 mol) of niacin chloride hydrochloride. Heating is carried out under reflux conditions for 3 hours, the solution is cooled, the ester hydrochloride is filtered off and then recrystallized in an ethanol-ethyl ether mixture to obtain 227 g (80% yield) of product melting at 155°C to 157°C.

By treating the hydrochloride with an aqueous solution of NaOH at 0°C, the free base is obtained in the form of a viscous white liquid which boils at 115°C under 0.05 mm.

References

Merck Index 2249
 DOT 19 (1) 12 (1983)
 I.N. p. 231
 British Patent 1,409,990; October 15, 1975; assigned to Poli Industria Chimica S.p.A. (Italy)

CICLOPIROXOLAMINE

Therapeutic Function: Antifungal

Chemical Name: 6-Cyclohexyl-1-hydroxy-4-methyl-2(1H)-pyridone ethanolamine salt

Common Name: —

Structural Formula:

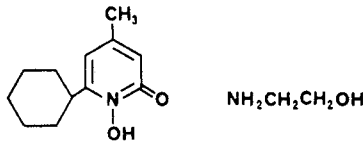

Chemical Abstracts Registry No.: 41621-49-2; 29342-05-0 (Base)

Trade Name	Manufacturer	Country	Year Introduced
Batrafen	Cassella-Riedel	W. Germany	1980
Batrafen	Hoechst	Japan	1981
Loprox	Hoechst	Canada	1983
Loprox	Hoechst	U.S.	1983

Raw Materials

4-Methyl-6-cyclohexyl-2-pyrone
 Hydroxylamine hydrochloride
 Ethanolamine

Manufacturing Process

Ciclopirox may be produced as follows: 2 g of 4-methyl-6-cyclohexyl-2-pyrone were heated with 1 g of hydroxylamine hydrochloride and 5 g of 2-aminopyridine to 80°C for 8 hours.

The reaction mixture was then dissolved in methylene chloride, the amine was removed by shaking with dilute hydrochloric acid, the reaction product was extracted from the organic phase by means of dilute sodium hydroxide solution and the alkaline solution was acidified with acetic acid to a pH value of 6. The 1-hydroxy-4-methyl-6-cyclohexyl-2-pyridone precipitated in crystalline form. It was filtered off with suction, washed with water and dried. The yield was 1.05 g (49% of theory); melting point 143°C.

Reaction of ciclopirox with ethanolamine gives the desired product.

References

Merck Index 2250

DFU 4 (11) 795 (1979)

Kleeman & Engel p. 206

PDR p. 940

OCDS Vol. 2 p. 282 (1980)

DOT 17 (9) 364 (1981)

I.N. p. 231

REM p. 1230

Lohaus, G. and Dittmar, W.; U.S. Patents 3,972,888; August 3, 1976; and 3,883,545; May 13, 1975; both assigned to Hoechst A.G.

CICLOXILIC ACID

Therapeutic Function: Choleric

Chemical Name: cis-2-Hydroxy-2-phenylcyclohexanecarboxylic acid

Common Name: —

Structural Formula:

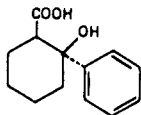

Chemical Abstracts Registry No.: 57808-63-6

Trade Name	Manufacturer	Country	Year Introduced
Plecton	Guidotti	Italy	1975
Sintiabil	Sintyal	Argentina	—

Raw Materials

2-Hydroxymethyl cyclohexanone	Bromobenzene
Potassium permanganate	Magnesium

Manufacturing Process

25 g of 2-hydroxy-methyl-cyclohexanone, diluted in 20 cc of ether, were dropped into a vessel containing an ether suspension of phenyl-magnesium-bromide (prepared from 19.6 g of magnesium and 128 g of bromobenzene in 300 cc of ether according to usual techniques by stirring and external ice-cooling). The mixture was stirred for some time, then the magnesium compound was decomposed by pouring it carefully into water and ice; the magnesium hydroxide was dissolved in 50 cc of a saturated solution of ammonium chloride, the ether portion was separated and the aqueous portion extracted with further ether.

Collected and dried ether extracts were evaporated and the residue vacuum distilled yielded 15 g of a thick oil of boiling point at 0.1 to 0.2 mm Hg 127°C to 135°C.

This product crystallized by dissolving in ether and reprecipitation with petroleum ether yielded 7 g of 1-phenyl-2-hydroxy-ethylene-cyclohexan-1-ol, melting point (Kofler) 81°C to 83°C.

The thus obtained product was dried and finely powdered, and then suspended in 1.4 liters of an aqueous solution of 14 g of KMnO_4 and 7 g of Na_2CO_3 , and the suspension was thoroughly stirred for one day.

After filtering off the MnO_2 , thus formed, a small amount of Na_2SO_3 was added until the violet coloration disappeared; MnO_2 was filtered again and the alkaline solution was acidified with concentrated HCl .

After one day standing in a refrigerator, the product was filtered and washed with water, thus yielding 5 g of 2-phenyl-2-hydroxy-cyclohexane-carboxylic acid, melting point (Kofler) 143°C to 145°C.

References

Kleeman & Engel p. 207

DOT 15 (4) 185 (1979)

I.N. p. 18

Turbanti, L.; U.S. Patent 3,700,775; October 24, 1972

CIMETIDINE

Therapeutic Function: Antiulcer drug

Chemical Name: N-cyano-N'-methyl, N''-[2-[[[5-methyl-1H-imidazol-4-yl)methyl] thio]-ethyl] guanidine

Common Name: —

Structural Formula:

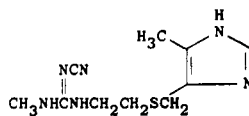

Chemical Abstracts Registry No.: 51481-61-9

Trade Name	Manufacturer	Country	Year Introduced
Tagamet	SKF	U.K.	1977
Tagamet	SKF	U.S.	1977
Tagamet	SKF	France	1977
Tagamet	SKF	W. Germany	1977
Tagamet	SKF	Switz.	1977
Euroceptor	Zambon	Italy	1978
Tagamet	Fujisawa/SKF	Japan	1982
Cimetag	Cehasol	Austria	1983
Acibilin	Exa	Argentina	—
Aciloc	Orion	Finland	—
Altramet	Lek	Yugoslavia	—
Belomet	Belupo	Yugoslavia	—
Biomag	Pulitzer	Italy	—
Brumetidina	Bruschettini	Italy	—

Trade Name	Manufacturer	Country	Year Introduced
Cimetum	Sintyal	Argentina	—
Cinamet	Isis	Yugoslavia	—
Cinulcus	Wassermann	Spain	—
Citius	Prodes	Spain	—
Civent	Medica	Finland	—
Fremet	Antibioticos	Spain	—
Gastromet	Sigurta	Italy	—
Itacem	Italchemie	Italy	—
Mansal	Vita	Spain	—
Peptol	Horner	Canada	—
Stomakon	Andromaco	Brazil	—
Tametin	Giuliani	Italy	—
Tratul	Ricar	Argentina	—
Ulcedin	Agips	Italy	—
Ulcedine	I.C.N.-Usafarma	Brazil	—
Ulcerfen	Finadiet	Argentina	—
Ulcestop	Gibipharma	Italy	—
Ulcimet	Farmasa	Brazil	—
Ulcodina	Locatelli	Italy	—
Ulcomet	Italfarmaco	Italy	—
Ulhys	Farnex	Italy	—

Raw Materials

2-Chloroacetic acid ethyl ester	Formamide
Potassium hydroxide	Sodium
Cysteamine	Ammonia
Carbon disulfide	Cyanamide
Dimethyl sulfate	Methylamine

Manufacturing Process

In an initial step, 2-chloroacetic acid ethyl ester is reacted with formamide to give 5-methylimidazole-4-carboxylic acid ethyl ester. Then sodium in ammonia is used to convert that to 4-hydroxymethyl-5-methylimidazole-hydrochloride. Cysteamine HCl ($\text{HSCH}_2\text{CH}_2\text{NH}_2 \cdot \text{HCl}$) is then reacted to give 4-(2-aminomethyl)-thiomethyl-5-methylimidazole di-HCl. Then N-cyanamido-5,5-dimethyl-dithio-carbonate (from cyanamid, KOH, CS_2 and $(\text{CH}_3)_2\text{SO}_4$) is reacted to give a further intermediate which is finally reacted with methylamine to give cimetidine.

The preparation of the pyridyl analogs of the imidazolyl compounds of the type of cimetidine are discussed in the patent cited below.

Further references are given by Kleeman & Engel in the reference below.

References

- Merck Index 2254
- DFU 1 (1) 13 (1976)
- Kleeman & Engel p. 208
- PDR p. 1725
- OCDS Vol. 2 p. 353 (1980)
- DOT 13 (5) 187 (1977) & 16 (11) 393 (1980)
- I.N. p. 232
- REM p. 797
- Durant, G.J., Emmett, J.C. and Ganellin, C.R.; U.S. Patent 3,876,647; April 8, 1975; assigned to Smith Kline & French Laboratories Limited

CINEPAZET MALEATE

Therapeutic Function: Antianginal

Chemical Name: 4-[1-Oxo-3-(3,4,5-trimethoxyphenyl)-2-propenyl]-1-piperazineacetic acid ethyl ester (Z)-2-butenedioate (1:1)

Common Name: Ethyl cinepazate maleate

Structural Formula:

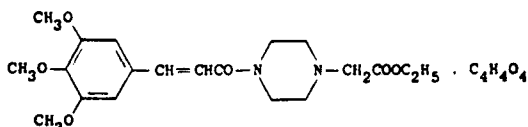

Chemical Abstracts Registry No.: 50679-07-7; 23887-41-4 (Base)

Trade Name	Manufacturer	Country	Year Introduced
Vascoril	Delalande	France	1971
Vascoril	Delalande	Italy	1974

Raw Materials

1-Piperazino ethyl acetate	Sodium bicarbonate
3,4,5-Trimethoxy cinnamoyl chloride	Maleic acid

Manufacturing Process

A solution of 1-piperazino ethyl acetate (0.2 mol) in benzene (300 ml) is treated with 3,4,5-trimethoxy cinnamoyl chloride (0.2 mol) in the presence of sodium bicarbonate (0.3 mol). After contacting for one hour at room temperature, the mixture is refluxed for a further hour. The benzene solution is then treated with an aqueous solution of sodium bicarbonate. After evaporation of the solvent, a solid product is obtained which is recrystallized from isopropyl ether. Melting point = 96°C. This base, when treated with hydrochloric acid, gives a hydrochloride having a melting point of 200°C with decomposition. By the action of maleic acid the acid maleate is obtained, having a melting point of 130°C.

References

- Merck Index 2266
 Kleeman & Engel p. 210
 OCDS Vol. 3 p. 157 (1984)
 DOT 10 (12) 336 (1974)
 I.N. p. 233
 Fauran, C., Huguet, G., Raynaud, G., Pourrias, B. and Turin, M.; U.S. Patent 3,590,034; June 29, 1971; assigned to Delalande S.A. (France)

CINNARIZINE

Therapeutic Function: Antihistaminic

Chemical Name: 1-(diphenylmethyl)-4-(3-phenyl-2-propenyl)piperazine

Common Name: —

Structural Formula:

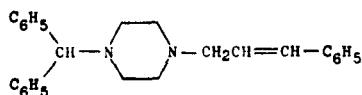

Chemical Abstracts Registry No.: 298-57-7

Trade Name	Manufacturer	Country	Year Introduced
Stugeron	Janssen	U.K.	1961
Stutgeron	Janssen	W. Germany	1961
Midronal	Delalande	France	1962
Sturgeron	Janssen	Italy	1970
Aplactan	Janssen	Belgium	1970
Stugeron	Cilag-Chemie	Switz.	1980
Amynoral	Delalande	France	—
Annarizine	Sioe	Japan	—
Antigeron	Farmasa	Brazil	—
Aplactan	Eisai	Japan	—
Aplexal	Taiyo	Japan	—
Apomiterl	Teizo	Japan	—
Apotomin	Kowa	Japan	—
Apsatan	Wakamoto	Japan	—
Artate	Nippon Chemiphar	Japan	—
Carecin	Zensei	Japan	—
Cerebolan	Tobishi	Japan	—
Cerepar	Merckle	W. Germany	—
Cero-Aterin	Chassot	Switz.	—
Cinaperazine	Kinki	Japan	—
Cinazin	Siegfried	Switz.	—
Cinazyn	Italchimici	Italy	—
Cinnabene	Merckle	W. Germany	—
Cinnacet	Schwarzhaupt	W. Germany	—
Cinnageron	Streuli	Switz.	—
Cinnarizine	Green Cross	Japan	—
Cinnipirine	A.C.F.	Neth.	—
Coldrin	J&J	U.S.	—
Corathiem	Ohta	Japan	—
Cysten	Tsuruhara	Japan	—
Denapol	Teikoku	Japan	—
Dismaren	Gerardo Ramon	Argentina	—
Ederal	Esteve	Spain	—
Eglen	Tatsumi	Japan	—
Folcodal	Syncro	Argentina	—
Giganten	Tropen	W. Germany	—
Glanil	Leo	Sweden	—
Hilactan	Kyoritsu	Japan	—
Hirdsyn	Fuso	Japan	—
Izaberizin	Tohu	Japan	—
Katoseran	Hishiyama	Japan	—
Midronal	Delalande	France	—
Milactan	Miwa	Japan	—
Myodel	Delalande	France	—
Olamín	Siegfried	Switz.	—
Pericephal	Hofmann	Austria	—
Plegítux	Carrion	France	—
Processine	Sankyo	Japan	—
Purazine	Lennon	S. Africa	—
Razlin	S.S. Pharm.	Japan	—
Ribrain	Endopharm	W. Germany	—

Trade Name	Manufacturer	Country	Year Introduced
Roïn	Maruishi	Japan	—
Salarizine	Iwaki	Japan	—
Sapratol	Takeda	Japan	—
Sedatromin	Takata	Japan	—
Sefal	Nobel	Turkey	—
Sigmal	Fuji Zoki	Japan	—
Siptazin	Isei	Japan	—
Spaderizine	Kotobuki	Japan	—
Stunarone	Abic	Israel	—
Toliman	Corvi	Italy	—
Tolesmin	Sato	Japan	—
Torizin	Towa	Japan	—

Raw Materials

Cinnamoyl chloride
Benzhydryl piperazine
Lithium aluminum hydride

Manufacturing Process

This compound can be prepared by the reaction of cinnamoyl chloride with benzhydryl-piperazine. The reaction is carried out in dry benzene under reflux. The benzene is then evaporated, the residue taken up in chloroform, washed with dilute HCl and then made alkaline.

The chloroform layer is washed with a dilute aqueous sodium hydroxide solution, thereafter with water, and is finally dried over potassium carbonate. The residue, which is obtained after evaporation of the chloroform, is dissolved by heating in a mixture of 25% of toluene and 75% of heptane. On cooling this solution to about 20°C the product precipitates. That compound is reduced with LiAlH_4 to give cinnarizine.

References

Merck Index 2281
DFU 3 (8) 572 (1978)
Kleeman & Engel p. 272
OCDS Vol. 1 p. 58 (1977)
DOT 16 (10) 360 (1974) & 18 (1) 27 (1982)
I.N. p. 234
Janssen, P.A.J.; U.S. Patent 2,882,271; April 14, 1959; assigned to Laboratoria Pharmaceutica Dr. C. Janssen, Belgium

CINOXACIN

Therapeutic Function: Antibacterial

Chemical Name: 1-Ethyl-6,7-methylenedioxy-4(1H)-oxocinnoline-3-carboxylic acid

Common Name: —

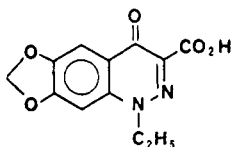
Structural Formula:

Chemical Abstracts Registry No.: 28657-80-9

Trade Name	Manufacturer	Country	Year Introduced
Cinobac	Lilly	U.K.	1979
Cinobac	Lilly	Switz.	1979
Cinobactin	Lilly	W. Germany	1980
Cinobac	Lilly	U.S.	1981
Cinobact	Shionogi	Japan	1983
Cinobactin	Lilly	Sweden	1983

Raw Materials

1-Ethyl-6,7-methylenedioxy-4(1H)-oxocinnoline-3-carbonitrile
Hydrogen chloride

Manufacturing Process

About 23 g (0.095 mol) of 1-ethyl-6,7-methylenedioxy-4(1H)-oxocinnoline-3-carbonitrile were added to a mixture of 200 ml of concentrated hydrochloric acid and 200 ml of acetic acid. The resultant reaction mixture was heated under reflux for 18 hours. The excess acids were removed under vacuum, and the residue was taken up in 150 ml of a 5% sodium bicarbonate solution. The resultant solution was treated with 5 g of charcoal and filtered. The filtrate was made acidic by the addition of hydrochloric acid and the resulting precipitate was removed by filtration. 23 g, representing a yield of 91.6% of 1-ethyl-6,7-methylenedioxy-4(1H)-oxocinnoline-3-carboxylic acid as light tan crystals which melted at 261°C to 262°C with decomposition were recovered.

References

Merck Index 2284
DFU 3 (1) 22 (1978)
Kleeman & Engel p. 213
PDR p. 836
OCDS Vol. 2 p. 388 (1980)
DOT 11 (10) 402 (1975) & 16 (2) 45 (1980)
I.N. p. 235
REM p. 1216
White, W.A.; U.S. Patent 3,669,965; June 13, 1972; assigned to Eli Lilly & Company

CIPROFIBRATE

Therapeutic Function: Hypolipemic

Chemical Name: 2-[4-(2',2'-Dichlorocyclopropyl)phenoxy]-2-methylpropionic acid

Common Name: —

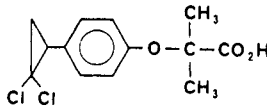
Structural Formula:

Chemical Abstracts Registry No.: 52214-83-3

Trade Name	Manufacturer	Country	Year Introduced
Lipanor	Winthrop	France	1983

Raw Materials

p-(2,2-Dichlorocyclopropyl)phenol	Acetone
Sodium hydroxide	Chloroform

Manufacturing Process

A mixture of 8 g (0.0356 mol) of p-(2,2-dichlorocyclopropyl)phenol, 11.2 g (0.28 mol) of sodium hydroxide pellets, 11 g of chloroform and 350 ml of acetone was prepared at 0°C. The cooling bath was removed, the mixture stirred for a minute and then heated on a steam bath to reflux temperature. The reaction mixture was stirred at reflux for three hours and then concentrated in vacuo. The residual gum was partitioned between dilute hydrochloric acid and ether, and the ether layer was separated, dried and concentrated in vacuo. The residual oil (14 g) was partitioned between dilute aqueous sodium bicarbonate and ether. The sodium bicarbonate solution was acidified with concentrated hydrochloric acid and extracted with ether. The ether solution was dried over anhydrous sodium sulfate and concentrated. The residue (9.5 g of yellow oil) was crystallized twice from hexane to give 6.0 g of 2-[p-(2,2-dichlorocyclopropyl)phenoxy]-2-methyl propionic acid in the form of a pale cream-colored solid, MP 114°C to 116°C.

References

- Merck Index 2286
 DFU 2 (5) 297 (1977)
 OCDS Vol. 3 p. 44 (1984)
 I.N. p. 235
 Phillips, D.K.; U.S. Patent 3,948,973; April 6, 1976; assigned to Sterling Drug, Inc.

CITICOLINE

Therapeutic Function: Cerebral circulation stimulant

Chemical Name: Cytidine 5'-(trihydrogen diphosphate)mono[2-(trimethylammonio)ethyl]-ester hydroxide inner salt

Common Name: Citidoline; cytidine diphosphate choline

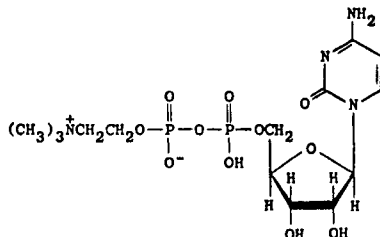
Structural Formula:

Chemical Abstracts Registry No.: 987-78-0

Trade Name	Manufacturer	Country	Year Introduced
Nicholin	Cyanamid	Italy	1971
Rexort	Cassenne Takeda	France	1977
Alaton	Zambon	Italy	—
Andes	Nippon Kayaku	Japan	—
Brassel	Alfa Farmaceutici	Italy	—
CDP-Choline	Kowa	Japan	—
Cereb	Ohta	Japan	—
Ceregut	Kodama	Japan	—
Cidifos	Neopharmed	Italy	—
Colite	Nippon Chemiphar	Japan	—
Corenalin	Kaken	Japan	—
Cyscholin	Kanto	Japan	—
Daicoline	Daisan	Japan	—
Difosfocin	Magis	Italy	—
Emicholine	Dojin	Japan	—
Emilian	Beppu	Japan	—
Ensign	Yamanouchi	Japan	—
Erholen	Nichiiko	Japan	—
Haibrain	Ono	Japan	—
Haocolin	Fuso	Japan	—
Hornbest	Hoei	Japan	—
Intelon	Takata	Japan	—
Meibis	Sanken	Japan	—
Neucolis	Nippon Shinyaku	Japan	—
Nicholin	Takeda	Japan	—
Niticolin	Morishita	Japan	—
Plube	Mochida	Japan	—
Recognan	Toyo Jozo	Japan	—
Rupis	Vitacain	Japan	—
Sauran	Abello	Spain	—
Sinkron	Ripari-Gero	Italy	—
Sintoclar	Pulitzer	Italy	—
Somazina	Ferrer	Spain	—
Startonyl	Cyanamid	—	—
Suncholin	Mohan	Japan	—

Raw Materials

Cytidine-5'-monophosphate
 Choline
Brevibacterium ammoniagenes

Manufacturing Process

A 250 ml conical flask containing 30 ml of a reaction liquor (pH 7.0) having a composition of 7.38 mg/ml of disodium salt of CMP (cytidine-5'-monophosphate), 24 mg/ml of choline, 10 mg/ml of glucose, 100 mg/ml of acetone-dried cells of *Brevibacterium ammoniagenes* ATCC 6872, 11.6 mg/ml of monopotassium phosphate, 20 mg/ml of dipotassium phosphate and 2.96 mg/ml of magnesium sulfate, (MgSO₄·7H₂O), was subjected to culturing at 30°C for 4 hours. Cytidine diphosphate choline was formed and accumulated at a concentration of 3.8 mg/ml in the culture liquor.

The pH of 1.2 liters of filtrate containing 3.8 mg/ml of cytidine diphosphate choline, obtained by removing solid matters from the culturing liquor, was adjusted to a pH of 8.5 with a 0.5N KOH solution. The filtrate was passed through a column of strongly basic anion exchange resin, Dowex 1 x 2 (formic acid type). After washing the resin with water, a formic acid

solution was passed through the column with gradual increase in the concentration of formic acid (until 0.04N max.). A fraction of cytidine diphosphate choline was collected by elution according to the so-called gradient elution method and absorbed onto carbon powders. Then, elution was effected with acetone, and the eluate was concentrated and dried. 1.3 g of cytidine diphosphate choline powders were obtained.

References

Merck Index 2290

Kleeman & Engel p. 214

DOT 4 (2) 68 (1968)

I.N. p. 237

Nakayama, K. and Hagino, H.; U.S. Patent 3,684,652; August 15, 1972; assigned to Kyowa Hakko Kogyo Co., Ltd. (Japan)

Nakamachi, H., Kamiya, K. and Nishikawa, M.; U.S. Patent 3,687,932; August 29, 1972; assigned to Takeda Chemical Industries, Ltd. (Japan)

CITIOLONE

Therapeutic Function: Treatment of hepatic disorders

Chemical Name: 2-Acetamido-4-mercaptobutyric acid γ -lactone

Common Name: Acetylhomocystein thiolactone; acetamido thiobutyrolactone

Structural Formula:

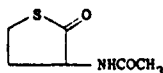

Chemical Abstracts Registry No.: 1195-16-0

Trade Name	Manufacturer	Country	Year Introduced
Citiolase	Roussel Maestretti	France	1970
Thioxidrene	Bottu	France	1972
Citiolase	Roussel Maestretti	Italy	1976
Mucorex	Berenguez-Beneyto	Spain	—
Reducdyn	Nordmark	W. Germany	—
Sitilon	Roussel	—	—
Thioncycline	Merrell	France	—

Raw Materials

Acetyl methionine	Ammonia
Sodium	Hydrogen chloride

Manufacturing Process

12.73 kg of acetyl methionine are gradually introduced into a brine-cooled pressure-tight apparatus provided with a stirrer and containing 140 liters of liquid ammonia at -50°C . The amino acid is dissolved after a short time; 6.5 kg of sodium metal are then introduced over a period of from 4 to 5 hours at a temperature of from -40°C to -50°C . Eventually, a persistent blue coloration of the ammoniacal solution indicates the end of the reaction. The ammonia is distilled off and the residue is taken up in 70 liters of methanol. In order to remove ammonia which has been formed from sodium amide, 30 to 40 liters of methanol are distilled off and the residue is made up with methanol to 80 liters. The strongly alkaline solution is neutralized with 22 liters of concentrated aqueous hydrochloric acid. The solution is filtered

off from the precipitated sodium chloride and evaporated to dryness *in vacuo*. The closing of the thiolactone ring takes place as a result of the evaporation of the solution to dryness in the acid pH range and the N-acetyl homocystein originally present is converted into N-acetyl homocystein thiolactone. In order to isolate this compound, the residue is recrystallized from 25% aqueous alcohol.

9 kg of N-acetyl homocystein thiolactone are obtained, this corresponding to a yield of 85% of the theoretical.

References

Merck Index 2291

Kleeman & Engel p. 215

DOT 7 (1) 14 (1971)

I.N. p. 237

British Patent 955,231; April 15, 1964; assigned to Deutsche Gold- und Silber- Scheideanstalt Vormals Roessler (Germany)

CLAVULANIC ACID

Therapeutic Function: Antibacterial

Chemical Name: 3-(2-Hydroxyethylidene)-7-oxo-4-oxa-1-azabicyclo[3.2.0]heptane-2-carboxylic acid

Common Name: —

Structural Formula:

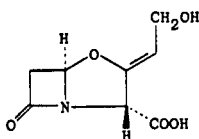

Chemical Abstracts Registry No.: 58001-44-8

Trade Name	Manufacturer	Country	Year Introduced
Augmentin	Beecham	U.K.	1981
Augmentin	Beecham	Switz.	1982
Augmentan	Beecham	W. Germany	1982
Synulox	Beecham	—	—

Raw Materials

Dextrin

Soybean flour

Bacterium Streptomyces Clavuligerus

Manufacturing Process

100 ml of sterile water was added to a sporing culture which had been grown on Bennetts agar in a Roux bottle for 10 days at 26°C. A mycelium/spore suspension was produced and used to inoculate 75 liters of steam sterilized medium of the following composition in tap water.

Dextrin	2% W/V
Arkaso ^y '50'*	1% W/V
10% Pluronic L81 in soybean oil	0.03% V/V

*Arkaso^y is soybean flour supplied by British Arkady Co., Old Trafford, Manchester, UK

The pH of the medium was adjusted to 7.0

The medium was contained in a 100 liter stainless steel baffled fermenter, agitated by a 7½ inch vaned disc impeller at 140 rpm. Sterile air was supplied at 75 liters per minute and the tank incubated for 72 hours at 26°C.

The contents of the seed fermenter were used to inoculate 1,500 liters of steam sterilized medium of the following composition in tap water.

Arkaso ^y '50'	1.5% W/V
Glycerol	1.0% W/V
KH ₂ PO ₄	0.1% W/V
10% Pluronic L81 in soybean oil	0.2% V/V

The pH of the medium was adjusted to 7.0

The medium was contained in a 2,000 liter stainless steel fully baffled fermenter agitated by two 19 inch vaned disc impellers at 106 rpm.

Sterile air was supplied at 1,200 liters per minute. Antifoam was added in 25 ml amounts as required. (10% Pluronic L81 in soybean oil.) The fermentation was controlled at 26°C until a maximum yield of clavulanic acid was obtained between 3-5 days when 200-300 µg/ml of clavulanic acid were produced.

References

Merck Index 2311

DFU 2 (6) 372 (1977)

PDR p. 659

DOT 19 (3) 169 (1983)

I.N. p. 18

REM p. 1200

Cole, M., Howarth, T.T. and Reading, C.; U.S. Patent 4,110,165; August 29, 1978; assigned to Beecham Group, Ltd. (U.K.)

CLEMASTINE FUMARATE

Therapeutic Function: Antihistaminic

Chemical Name: 2-[2-[1-(4-chlorophenyl)-1-phenylethoxy] ethyl] -1-methylpyrrolidine hydrogen fumarate

Common Name: Meclostin

Structural Formula:

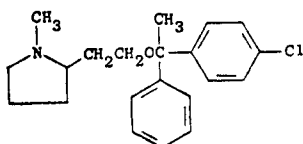

(base)

Chemical Abstracts Registry No.: 14976-57-9; 15686-51-8 (Base)

Trade Name	Manufacturer	Country	Year Introduced
Tavegyl	Sandoz	France	1967
Tavegyl	Sandoz	Switz.	1967
Tavegil	Sandoz	W. Germany	1967
Tavegyl	Sandoz	Italy	1968
Tavegyl	Sankyo	Japan	1970
Tavegil	Sandoz	U.K.	1971
Tavist	Dorsey	U.S.	1978
Agasten	Sandoz	—	—
Alagyl	Sawai	Japan	—
Aloginan	Tobishi	Japan	—
Alphamin	S.S. Pharm.	Japan	—
Anhistan	Nippon Zoki	Japan	—
Antriptin	Nippon Yakuhin	Japan	—
Arrest	Taisho	Japan	—
Batomu	Zensei	Japan	—
Benanzyl	Isei	Japan	—
Chlonaryl	Ohta	Japan	—
Clemanil	Kyoritsu	Japan	—
Fuluminol	Tatsumi	Japan	—
Fumalestine	Hishiyama	Japan	—
Fumaresutin	Hishiyama	Japan	—
Inbestan	Maruko	Japan	—
Kinotomin	Toa Eiyo	Japan	—
Lacretin	Toyo Tanabe	Japan	—
Lecasol	Kaken	Japan	—
Maikohis	Nichiiko	Japan	—
Mallermin-F	Taiyo Yakuko	Japan	—
Marsthine	Towa	Japan	—
Masletine	Shioe	Japan	—
Piloral	Nippon Kayaku	Japan	—
Raseltin	Maruishi	Japan	—
Reconin	Toyama	Japan	—
Romien	Fuji Zoki	Japan	—
Telgin G	Taiyo	Japan	—
Trabest	Hoei	Japan	—
Xolamin	Sanko	Japan	—

Raw Materials

α -Methyl p-chlorobenzhydrol	Sodium amide
N-Methyl-pyrrolidyl-(2)-ethyl chloride	Fumaric acid

Manufacturing Process

9.9 g of α -methyl-p-chlorobenzhydrol are added to a suspension of 2.3 g of powdered sodamide in 30 cc of benzene. Subsequently 7.4 g of N-methylpyrrolidyl-(2)-ethyl chloride are added and the solution is heated to the boil at reflux for 20 hours. Then shaking is first effected with water and then 4 times each time with 25 cc of 2N hydrochloric acid. The acid extracts are made alkaline with potassium hydroxide solution while cooling strongly, and the precipitated oil is extracted with ether. After drying of the ethereal solution over potassium carbonate, the solvent is evaporated and the residue is fractionally distilled in a high vacuum, whereby N-methyl-2-[2'-(α -methyl-p-chlorobenzhydroxy)-ethyl]-pyrrolidine boils over at 154°C/0.02 mm Hg. The base is converted to the fumarate by reaction with fumaric acid.

References

Merck Index 2314

Kleeman & Engel p. 216
 PDR p. 1597
 OCDS Vol. 2 p. 32 (1980)
 I.N. p. 239
 REM p. 1127

British Patent 942,152; November 20, 1963; assigned to Sandoz Ltd.

CLEMIZOLE

Therapeutic Function: Antihistaminic

Chemical Name: 1-[(4-Chlorophenyl)methyl]-2-(1-pyrrolidinylmethyl)-1H-benzimidazole

Common Name: —

Structural Formula:

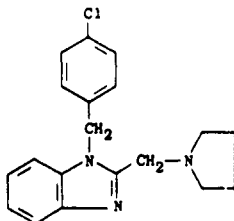

Chemical Abstracts Registry No.: 442-52-4; 1163-36-6 (Hydrochloride)

Trade Name	Manufacturer	Country	Year Introduced
Allercur	Roerig	U.S.	1960
Reactrol	Purdue Frederick	U.S.	1961
Allercur	Schering	Switz.	—
Allerpant	Panther-Osfa	Italy	—
Deliproct	S.E.P.S.S.	France	—
Penargyl	Morgan	Italy	—
Ultralan	S.E.P.S.S.	France	—
Ultraproct	S.E.P.S.S.	France	—

Raw Materials

o-Nitrochlorobenzene	Hydrogen
p-Chlorobenzylamine	Pyrrolidine
Chloroacetyl chloride	

Manufacturing Process

From 13.1 g of N-p-chlorobenzyl-2-nitroaniline (MP 110°C, obtained in the form of orange-red needles, from o-nitrochlorobenzene and p-chlorobenzylamine by reaction for 3 hours at 150°C) by reduction with Raney-nickel and hydrogen, in which reaction the substance may be suspended in methanol or dissolved in methanol-ethyl acetate at normal pressure and at about 40°C with combination of the theoretical quantity of hydrogen, 12.2 g are obtained of o-amino-N-p-chlorobenzylaniline, which after recrystallization from aqueous methanol has a MP of 90°C.

8 g of o-amino-N-p-chlorobenzylaniline and 2.8 g of pyridine are dissolved in dry ether and reacted with an ethereal solution of 3.9 g of chloroacetyl chloride with cooling in a mixture of

ice and common salt. 8 g of N-p-chlorobenzyl-N'-chloroacetyl-o-phenylene diamine are obtained which can be worked up in the form of the crude product and, in the slightly colored form, has a MP of 130°C.

7.6 g of this compound are boiled with 3.9 g of pyrrolidine in 70 cc of toluene for some hours under reflux. After extraction by shaking with water and treatment with hydrochloric acid the hydrochloride is produced of N-p-chlorobenzyl-N'-pyrrolidylacetyl-o-phenylene diamine together with some 1-p-chlorobenzyl-2-N-pyrrolidylmethyl-benzimidazole. The former, after recrystallization from butanol, melts with foaming at 205°C, the latter, after recrystallization from butanol melts at 239°C to 241°C, and is in the form of white microscopic rods. Boiling in nitrobenzene converts the former compound into the latter.

References

Merck Index 2315

Kleeman & Engel p. 217

OCDS Vol. 1 p. 324 (1977)

I.N. p. 239

Schenck, M. and Heinz, W.; U.S. Patent 2,689,853; September 21, 1954; assigned to Schering A.G. (Germany)

CLENBUTEROL

Therapeutic Function: Antiasthmatic

Chemical Name: 4-Amino-3,5-dichloro-[[[1,1-dimethylethylamino] methyl] benzene-methanol

Common Name: —

Structural Formula:

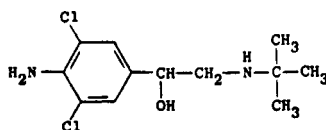

Chemical Abstracts Registry No.: 37148-27-9

Trade Name	Manufacturer	Country	Year Introduced
Spiropent	Thomae	W. Germany	1977
Monores	Valeas	Italy	1981

Raw Materials

1-(4'-Aminophenyl)-2-t-butylaminoethanol-(1)-HCl
Chlorine
Hydrogen chloride

Manufacturing Process

127 g of 1-(4'-aminophenyl)-2-t-butylaminoethanol-(1)-hydrochloride were dissolved in a mixture of 250 cc of glacial acetic acid and 50 cc of water, and chlorine added while stirring the solution and maintaining the temperature of the reaction mixture below 30°C by cooling with ice water. After all of the chlorine had been added, the reaction mixture was stirred for thirty minutes more, then diluted with 200 cc of water, and made alkaline with concen-

trated ammonia while cooling with ice, taking care that the temperature of the reaction mixture did not rise above 40°C. The alkaline mixture was extracted three times with 200 cc portions of chloroform, and the chloroform extract solutions were combined, dried with sodium sulfate and evaporated. The residue, the free base 1-(4'-amino-3',5'-dichlorophenyl)-2-t-butylaminoethanol-(1), was dissolved in absolute ethanol, gaseous hydrogen chloride was passed through the solution, and the precipitate formed thereby was collected. It was identified to be 1-(4'-amino-3',5'-dichlorophenyl)-2-t-butylaminoethanol-(1)-hydrochloride, melting point 174.0°C to 175.5°C (decomp.).

References

Merck Index 2316

DFU 1 (5) 221 (1976)

Kleeman & Engel p. 218

DOT 14 (2) 59 (1978) & 17 (8) 339 (1981)

I.N. p. 240

Keck, J., Kruger, G., Machleidt, H., Noll, K., Engelhardt, G. and Eckenfels, A.; U.S. Patent 3,536,712; October 27, 1970; assigned to Boehringer Ingelheim G.m.b.H. (Germany)

CLIDANAC

Therapeutic Function: Antiinflammatory; antipyretic

Chemical Name: 6-Chloro-5-cyclohexyl-2,3-dihydro-1H-indene-1-carboxylic acid

Common Name: —

Structural Formula:

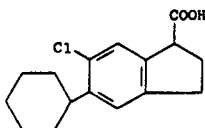

Chemical Abstracts Registry No.: 34148-01-1

Trade Name	Manufacturer	Country	Year Introduced
Indanal	Takeda	Japan	1981
Britai	Bristol Banyu	Japan	1981

Raw Materials

N-Chlorosuccinimide

5-Cyclohexyl-1-indancarboxylic acid

Manufacturing Process

N-chlorosuccinimide (8.2 g, 0.0614 mol) was added to a stirred, cooled (ice-water) solution of (±)-5-cyclohexyl-1-indancarboxylic acid (10.0 g, 0.0409 mol) in dimethylformamide (82 ml). The solution was stirred for fifteen minutes at 0°C, thirty minutes at 25°C, nine hours at 50°C, followed by eight hours at 25°C. The solution was diluted with cold water (400 ml) and stirred until the precipitated product turned granular (fifteen minutes). The crude product was collected, washed with cold water, and dried. Crystallization from Skellysolve B with charcoal treatment gave colorless crystals (6.65 g, 58%), MP 149°C to 150°C. The product was recrystallized twice from Skellysolve B to give (±)-6-chloro-5-cyclohexyl-1-indancarboxylic acid as colorless crystals, MP 150.5°C to 152.5°C.

References

Merck Index 2319

DFU 4 (3) 229 (1979)

DOT 17 (8) 319 (1981)

I.N. p. 240

Juby, P.F., DeWitt, R.A.P. and Hudyma, T.W.; U.S. Patent 3,565,943; February 23, 1971; assigned to Bristol-Myers Co.

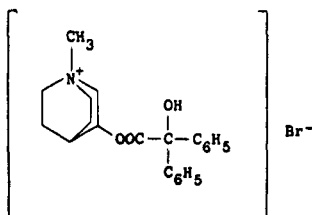
CLIDINIUM BROMIDE**Therapeutic Function:** Anticholinergic**Chemical Name:** 3-[(hydroxydiphenylacetyl)oxy]-1-methyl-1-azoniabicyclo[2.2.2]octane bromide**Common Name:** —**Structural Formula:****Chemical Abstracts Registry No.:** 3485-62-9

Trade Name	Manufacturer	Country	Year Introduced
Librax	Roche	U.S.	1961
Quarzan	Roche	U.S.	1976
Dolibrax	Roche	France	—

Raw Materials

1-Azabicyclo[2.2.2]-3-octanol	Sodium
Diphenylchloroacetyl chloride	Methyl bromide

Manufacturing Process

5.12 g of 1-azabicyclo[2.2.2]-3-octanol were refluxed with a suspension of 0.92 g of finely divided sodium in 50 cc of toluene, until most of the sodium had reacted (about 4 hours). The thus-obtained suspension of the white amorphous alcoholate was cooled with ice, and reacted with 10.16 g of diphenylchloroacetyl chloride, which was added in form of a solution in approximately 40 cc of toluene. The mixture was stirred for 1 hour at room temperature. Small amounts of unreacted sodium were destroyed with isopropanol, and 120 cc of 1 N hydrochloric acid were then added. The mixture was refluxed for ½ hour, in order to convert the first formed product, diphenylchloroacetic acid ester of 1-azabicyclo[2.2.2]-3-octanol, into the corresponding benzoic acid ester.

The toluene phase was separated and discarded. The aqueous phase, together with a precipitated water- and toluene-insoluble oil, was made alkaline and extracted repeatedly with chloroform. The chloroform solution was concentrated in vacuo. The residue was re-

crystallized from a mixture of acetone and ether (alternatively, from chloroform and ether), and formed needles melting at 164° to 165°C. It was identified as 3-benziloyloxy-1-azabicyclo[2.2.2]octane.

3-Benziloyloxy-1-azabicyclo[2.2.2]octane methobromide was prepared by adding 20 cc of a 30% solution of methyl bromide in ether to a solution of 2.5 g of 3-benziloyloxy-1-azabicyclo[2.2.2]octane in 20 cc of chloroform. After standing for 3 hours at room temperature and 15 hours at +5°C, a crystalline precipitate had formed. This was filtered off and recrystallized from a mixture of methanol, acetone, and ether; prisms melting at 240° to 241°C.

References

Merck Index 2320

Kleeman & Engel p. 219

PDR pp. 1510, 1606, 1999

I.N. p. 240

REM p. 914

Sternbach, L.H.; U.S. Patent 2,648,667; August 11, 1953; assigned to Hoffmann-LaRoche, Inc.

CLINDAMYCIN HYDROCHLORIDE

Therapeutic Function: Antibacterial

Chemical Name: 7(S)-chloro-7-deoxylincomycin hydrochloride

Common Name: —

Structural Formula:

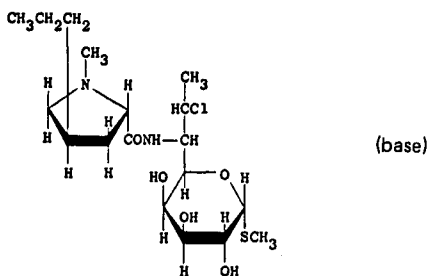

Chemical Abstracts Registry No.: 21462-39-5; 18323-44-9 (Base)

Trade Name	Manufacturer	Country	Year Introduced
Dalacin-C	Diethelm	Switz.	1968
Sobelin	Upjohn	W. Germany	1968
Cleocin	Upjohn	U.S.	1970
Dalacin-C	Upjohn	U.K.	1970
Dalacin	Sumitomo	Japan	1971
Dalacin C	Upjohn	Italy	1975
Dalacin	Alter	Spain	—

Raw Materials

Lincomycin hydrochloride

Triphenyl phosphine

Acetonitrile

Hydrogen chloride

Manufacturing Process

The following procedure is described in U.S. Patent 3,475,407. A solution of 50 g of lincomycin hydrochloride, 120 g of triphenylphosphine, and 500 ml of acetonitrile in a 3 liter flask equipped with a stirrer was cooled in an ice bath and 500 ml of carbon tetrachloride was added in one portion. The reaction mixture was then stirred for 18 hours without addition of ice to the cooling bath. The reaction was evaporated to dryness under vacuum on a 50° to 60°C water bath, yielding a clear, pale yellow viscous oil. An equal volume of water was added and the mixture shaken until all of the oil was dissolved. The resulting suspension of white solid ($\phi_3\text{PO}$) was filtered through a sintered glass mat and discarded. The filtrate was adjusted to pH 11 by addition of 6N aqueous sodium hydroxide. A solid precipitated.

The resulting slurry was extracted with four 300 ml portions of chloroform. The aqueous phase was discarded. The combined chloroform extract was washed once with 100 ml of saturated aqueous sodium chloride solution and the sodium chloride phase was discarded. The chloroform phase was evaporated to dryness under vacuum on a 50° to 60°C water bath and an equal volume of methanol was added to the residue and the resulting solution heated at reflux for 1 hour. The methanol solution was evaporated to dryness under vacuum on a 50° to 60°C water bath. The residue was a clear pale yellow viscous oil. An equal volume of water and 10 ml of 37% aqueous HCl was added and the resultant was shaken until the oil dissolved and a white solid (more $\phi_3\text{PO}$) remained in suspension. The suspension was filtered through a sintered glass mat at pH 1 to 2 and the solid discarded.

The filtrate was extracted twice with 100 ml of carbon tetrachloride. The carbon tetrachloride phase was discarded. The aqueous phase was adjusted to pH 11 by addition of 6 N aqueous sodium hydroxide and extracted four times with 300 ml portions of chloroform. The combined chloroform extract was washed three times with 100 ml of saturated aqueous sodium chloride solution and the sodium chloride phase was discarded. The chloroform extract was dried over anhydrous magnesium sulfate, filtered and the filtrate evaporated to dryness under vacuum on a 50° to 60°C water bath. The residue was a clear, colorless glass weighing 45 g analyzing about 95% 7(S)-chloro-7-deoxylincomycin. To the crude product there was added 100 ml of ethanol with warming until a clear solution was obtained. Then 150 ml ethyl acetate was added and the resultant filtered through a glass mat and the filtrate adjusted to pH 1 by the addition of saturated ethanolic HCl. Crystallization soon occurred. The resultant was allowed to stand at 0°C for 18 hours and then filtered through a sintered glass mat. The solid was dried under vacuum at 60°C for 18 hours yielding 35 g, a 67% yield of 7(S)-chloro-7-deoxylincomycin hydrochloride as an ethanol solvate.

References

Merck Index 2321

Kleeman & Engel p. 220

PDR p. 1827

DOT 5 (1) 32 (1969) & 7 (5) 188 (1972)

I.N. p. 240

REM p. 1209

Birkenmeyer, R.D.; U.S. Patent 3,475,407; October 28, 1969; assigned to The Upjohn Company

Kagan, F. and Magerlein, B.J.; U.S. Patent 3,509,127; April 28, 1970; assigned to The Upjohn Company

CLINOFIBRATE

Therapeutic Function: Antihyperlipoproteinemic

Chemical Name: 2,2'-(Cyclohexylidenebis(4,1-phenyleneoxy)) bis[2-methylbutanoic acid]

Common Name: —

Structural Formula:

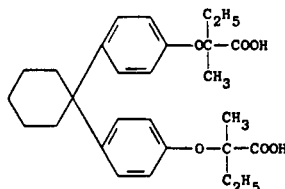

Chemical Abstracts Registry No.: 30299-08-2

Trade Name	Manufacturer	Country	Year Introduced
Lipocrin	Sumitomo	Japan	1981
Lipocyclin	Sumitomo	Japan	—

Raw Materials

Bis-(phenyleneoxy)cyclohexane
Methyl ethyl ketone

Manufacturing Process

Into a mixture of 6.0 g of a bishydroxyphenyl derivative,

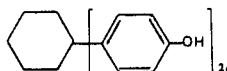

and 44.0 g of methyl ethyl ketone was added 16.2 g of crushed potassium hydroxide or sodium hydroxide. Chloroform was added dropwise into the above mixture with stirring at 20°C to 80°C, and the resultant mixture was heated for 20 hours under reflux to complete the reaction. Thereafter the reaction mixture was concentrated to give a residue. Into the residue was added water. After cooling, the resultant mixture was treated with activated charcoal and acidified by diluted hydrochloric acid or sulfuric acid to give an oily substance. The oily substance was extracted by ether and the ether solution was contacted with aqueous diluted Na₂CO₃ solution. The separated aqueous layer was washed with ether, acidified and again extracted with ether. The obtained ester layer was dried over anhydrous sodium sulfate and concentrated to give 1.0 g of a crude product which was purified by recrystallization or chromatography, to give crystals MP 143°C to 146°C (decomp.).

References

Merck Index 2322

DFU 3 (12) 905 (1978)

DOT 18 (5) 221 (1982)

I.N. p. 241

Nakamura, Y., Agatsuma, K., Tanaka, Y. and Aono, S.; U.S. Patent 3,716,583; February 13, 1973; assigned to Sumitomo Chemical Co., Ltd. (Japan)

CLOBAZAM

Therapeutic Function: Tranquilizer

Chemical Name: 7-chloro-1-methyl-5-phenyl-1H-1,5-benzodiazepine-2,4(3H,5H)-dione

Common Name: —

Structural Formula:

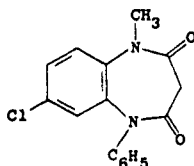

Chemical Abstracts Registry No.: 22316-47-8

Trade Name	Manufacturer	Country	Year Introduced
Urbanyl	Diamant	France	1975
Frisium	Albert-Pharm.	Italy	1977
Frisium	Hoechst	W. Germany	1978
Urbanul	Hoechst	Switz.	1979
Frisium	Hoechst	U.K.	1979
Castilium	Hoechst	—	—
Clarmyl	Roussel-Iberica	Spain	—
Clopax	Prodes	Spain	—
Karidium	Hoechst	—	—
Noiafren	Hoechst	—	—
Sentil	Hoechst	—	—
Urbadan	Roussel	—	—
Urbanil	Sarsa	Brazil	—
Urbanol	Roussel	—	—

Raw Materials

N-Phenyl-N-(2-amino-5-chlorophenyl)malonic acid ethyl ester amide
Sodium
Ethanol
Methyl iodide

Manufacturing Process

1.65 g of N-phenyl-N-(2-amino-5-chlorophenyl)-malonic acid ethyl ester amide of MP 108° to 109°C are added to a sodium ethoxide solution, prepared from 20 ml of absolute alcohol and 150 mg of sodium. The solution is allowed to rest for 5 hours at room temperature. Then 1 ml of methyl iodide is added and the reaction mixture is refluxed for 7 hours. After evaporation of the solution in vacuo it is mixed with water and the solution is shaken with methylene chloride. The methylene chloride phase is dried and evaporated. By treatment of the residue with ethyl acetate/charcoal are isolated 500 mg of 7-chloro-1-methyl-5-phenyl-1H-1,5-benzodiazepine-2,4-(3H,5H)-dione of MP 180° to 182°C. The yield amounts to 34% of theory.

References

Merck Index 2325
Kleeman & Engel p. 221
OCDS Vol. 2 p. 406 (1980)
DOT 9 (6) 240 (1973), 11 (1) 39 (1975) & 16 (1) 9 (1980)
I.N. p. 241
REM p. 1083
Hauptmann, K.H., Weber, K.-H., Zeile, K., Danneberg, P. and Giesemann, R.; South African Patent 68/0803; February 7, 1968; assigned to Boehringer Ingelheim GmbH, Germany

CLOBETASOL

Therapeutic Function: Corticosteroid, Antiinflammatory

Chemical Name: 21-chloro-9-fluoro-11 β ,17-dihydroxy-16 β -methylpregna-1,4-diene-3,20-dione

Common Name: —

Structural Formula:

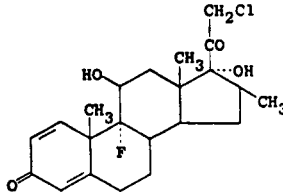

Chemical Abstracts Registry No.: 25122-41-2; 25122-46-7 (Propionate)

Trade Name	Manufacturer	Country	Year Introduced
Dermovate	Glaxo	U.K.	1973
Dermoxin	Glaxo	W. Germany	1976
Clobesol	Glaxo	Italy	1977
Dermoval	Glaxo	France	1978
Dermovate	Glaxo	Japan	1979
Dermadex	Glaxo	—	—

Raw Materials

Betamethasone-21-methanesulfonate
Lithium chloride
Propionic anhydride

Manufacturing Process

A solution of betamethasone 21-methanesulfonate (4 g) in dimethylformamide (25 ml) was treated with lithium chloride (4 g) and the mixture heated on the steam bath for 30 minutes. Dilution with water gave the crude product which was recrystallized to afford the title compound, MP 226°C.

Clobetasol is usually converted to the propionate as the useful form by reaction with propionic anhydride.

References

Merck Index 2330
Kleeman & Engel p. 222
DOT 9 (8) 339 (1973)
I.N. p. 242
Elks, J., Phillipps, G.H. and May, P.J.; U.S. Patent 3,721,687; March 20, 1973; assigned to Glaxo Laboratories Limited, England

CLOBUTINOL

Therapeutic Function: Antitussive

Chemical Name: 4-chloro- α -[2-(dimethylamino)-1-methylethyl]- α -methylbenzeneethanol

Common Name: —

Structural Formula:

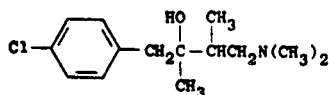

Chemical Abstracts Registry No.: 14860-49-2; 1215-83-4 (Hydrochloride)

Trade Name	Manufacturer	Country	Year Introduced
Silomat	Boehr./Ingel.	Switz.	1960
Silomat	Thomae	W. Germany	1960
Camaldin	Boehr./Ingel.	Italy	1962
Silomat	Badrial	France	1969
Silomat	Morishita	Japan	1975
Biotertussin	Bioter	—	—
Lomisat	Boehr./Ingel.	—	—
Pertoxil	Violani-Farmavigor	Italy	—

Raw Materials

3-Methyl-4-dimethylamino-butanone-(2)	Magnesium
p-Chlorobenzyl chloride	Hydrogen chloride

Manufacturing Process

A solution of 0.2 mol (33 g) of 3-methyl-4-dimethylamino-butanone-(2) [produced according to Mannich, *Arch. Pharm.*, vol. 265, page 589 (1927)] in 50 cc absolute ether was added dropwise, while stirring and cooling with ice, to a Grignard solution of 0.4 mol p-chlorobenzylmagnesium-chloride which was produced from 64.5 g p-chlorobenzyl-chloride and 9.8 g magnesium in 200 cc absolute ether. The reaction product was heated for an additional one-half hour under reflux to bring the reaction to completion, and thereafter the reaction mixture was decomposed into an ether phase and an aqueous phase with about 50 cc concentrated hydrochloric acid and about 200 g ice. The ether phase was discarded and the aqueous phase was adjusted to an alkaline pH with ammonia and then thoroughly extracted with ether. After concentrating the united, dried ether extract solutions, the oily residue was fractionally distilled. The reaction product was obtained in the form of a colorless oil having a boiling point of 179° to 181°C. The yield was 48.5 g corresponding to 95% of theory.

The hydrochloride addition salt of the above reaction product was prepared in customary fashion, that is, by reaction with hydrochloric acid, followed by fractional crystallization from a mixture of alcohol and ether. The two possible racemic forms were obtained thereby. The difficultly soluble racemate had a melting point of 169° to 170°C and the more readily soluble racemate had a boiling point of 145° to 148°C.

References

- Merck Index 2332
 Kleeman & Engel p. 224
 OCDS Vol. 2 p. 121 (1980)
 I.N. p. 242
 Berg, A.; U.S. Patent 3,121,087; February 11, 1964; assigned to Dr. Karl Thomae GmbH, Germany

CLOCAPRAMINE

Therapeutic Function: Neuroleptic

Chemical Name: 1'-[3-(3-Chloro-10,11-dihydro-5H-dibenz[b,f]azepin-5-yl)propyl] [1,4-bi-piperidine] 4-carboxamide

Common Name: Clocarpramine

Structural Formula:

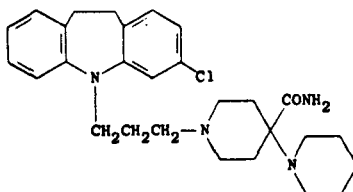

Chemical Abstracts Registry No.: 47739-98-0

Trade Name	Manufacturer	Country	Year Introduced
Clofekton	Yoshitomi	Japan	1974

Raw Materials

3-Chloro-5-(3-chloropropyl)-10,11-dihydro-5H-dibenz(b,f)azepine
4-Carbamoyl-4-piperidinopiperidine

Manufacturing Process

A mixture of 5.0 g of 3-chloro-5-(3-chloropropyl)-10,11-dihydro-5H-dibenz(b,f)azepine, 5.0 g of 4-carbamoyl-4-piperidinopiperidine and 50 ml of dimethylformamide is heated at 100°C for 10 hours. The solvent is distilled off. After the addition of a 2% sodium carbonate solution to the flask, the content is scratched to yield a semisolid, which is dissolved in 50 ml of isopropanol. A solution of 5 g of maleic acid in 50 ml of isopropanol is added, and the precipitate is collected by filtration and recrystallized from isopropanol to give 5.6 g of crystalline 3-chloro-5-[3-(4-carbamoyl-4-piperidino-piperidino)propyl]-10,11-dihydro-5H-dibenz-(b,f)azepine di(hydrogen maleate) with 1/2 molecule of water of crystallization melting at 181°C to 183°C.

References

- Merck Index 2334
Kleeman & Engel p. 224
OCDS Vol. 2 p. 416 (1980)
DOT 10 (5) 161 (1974)
I.N. p. 243
Nakanishi, M. and Tashiro, C.; U.S. Patent 3,668,210; June 6, 1972; assigned to Yoshitomi Pharmaceutical Industries, Ltd. (Japan)

CLOFEZONE

Therapeutic Function: Analgesic; antiinflammatory

Chemical Name: Equimolar mixture of Clofexamide which is 2-(p-chlorophenoxy)-N-[2-(diethylamino)ethyl]acetamide with phenylbutazone

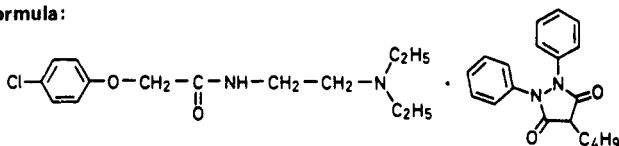
Common Name: —**Structural Formula:****Chemical Abstracts Registry No.:** 17449-96-6; 60104-29-2 (Dihydrate)

Trade Name	Manufacturer	Country	Year Introduced
Perclusone	Anphar-Rolland	France	1967
Perclusone	Heinrich Mack	W. Germany	1974
Panas	Grelan	Japan	1976
Perclusone	Pierrel	Italy	1976
Perclusone	Abic	Israel	—
Perclustop	Uquifa	Spain	—

Raw Materials

Phenylbutazone
 p-Chlorophenoxyacetic acid diethylamino ethylamide (Clofexamide)

Manufacturing Process

935 g of phenylbutazone are dissolved, with heating to a lukewarm state, in 2.7 liters of acetone containing 20% water, and the mixture is filtered if necessary. 853.5 g of p-chlorophenoxyacetic acid diethylamino ethylamide are dissolved in 300 cc of acetone containing 20% water, and the solution is poured into the phenylbutazone solution. There is slight heating, and the solution clarifies. The salt crystallizes rapidly. Drying is effected on a Buchner funnel and the mixture is washed in 450 cc of acetone containing 20% of water. The 1,702 g of product obtained is recrystallized in 2,450 cc of acetone containing 20% of water and, after drying in an oven at 37°C, 1,585 g (86%) of product are obtained. The product is in the form of a white crystalline powder having a melting point of from 87°C to 89°C in the Maquenne block.

References

Kleeman & Engel p. 227
 I.N. p. 245
 Rumpf, P. and Thuillier, J.E.; U.S. Patent 3,491,190; January 20, 1970

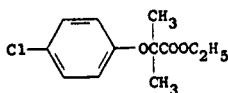
CLOFIBRATE**Therapeutic Function:** Cholesterol reducing agent**Chemical Name:** 2-(4-chlorophenoxy)-2-methylpropanoic acid ethyl ester**Common Name:** Ethyl p-chlorophenoxyisobutyrate**Structural Formula:**

Chemical Abstracts Registry No.: 637-07-0

Trade Name	Manufacturer	Country	Year Introduced
Atromid-S	I.C.I.	U.K.	1963
Skleromexe	Merckle	W. Germany	1964
Atromid-S	Ayerst	U.S.	1967
Atromidin	I.C. Pharma	Italy	1969
Liposid	Ohta	Japan	1970
Amotril	Sumitomo	Japan	—
Apoterin A	Seiko	Japan	—
Arterioflexin	Arcana	Austria	—
Arterioflexin	Protea	Australia	—
Artes	Farmos	Finland	—
Artevil	N.C.S.N.	Italy	—
Ateculon	Nippon Chemiphar	Japan	—
Ateles	Tokyo Hosei	Japan	—
Atemarol	Kowa	Japan	—
Ateriosan	Finadiet	Argentina	—
Aterosol	Ferrosol	Denmark	—
Athebrate	Karenyaku	Japan	—
Atherolate	Fuji Zoki	Japan	—
Atheromide	Ono	Japan	—
Atherolip	Solac	France	—
Atheropront	Mack	W. Germany	—
Atmol	Taisho	Japan	—
Atosterine	Kanto	Japan	—
Atrofort	Dif-Dogu	Turkey	—
Atrolen	Firma	Italy	—
Atromidin	I.C.P.	Italy	—
Atrovis	Novis	Israel	—
Auparton	Samya	Japan	—
Binograc	Zeria	Japan	—
Bioscleran	Pfleger	W. Germany	—
Bresit	Toyo Jozo	Japan	—
Cartagyl	Sopar	Belgium	—
Cholenal	Yamanouchi	Japan	—
Cholestol	Toho	Japan	—
Cholesrun	Hokuriku	Japan	—
Citiflus	C.T.	Italy	—
Claresan	Sarbach	France	—
Claripex	I.C.N.-Usafarma	Brazil	—
Clarol	Toyama	Japan	—
Climinon	Meiji	Japan	—
Cloberat	Negrone	Italy	—
Clobrat	Weifa	Norway	—
Clobrate	Chugai	Japan	—
Clobren	Morishita	Japan	—
Clof	Siegfried	Switz.	—
Clofbate	Mohan	Japan	—
Clofibril	Farmochimica	Italy	—
Clofinit	Gentili	Italy	—
Clofipront	Mack	W. Germany	—
Clofirem	Roland-Marie	France	—
Deliva	Nippon Kayaku	Japan	—
Geromid	Zoja	Italy	—
Healthstyle	Sawai	Japan	—
Hyclorate	Funay	Japan	—
Hypocerol	Fuso	Japan	—
Ipolidip	Isnardi	Italy	—

Trade Name	Manufacturer	Country	Year Introduced
Klofiran	Remeda	Finland	—
Levatrom	Abic	Israel	—
Lipavil	Farmades	Italy	—
Lipavlon	Avlon	France	—
Lipidicon	Aristochimica	Italy	—
Liprinal	Bristol	U.K.	—
Liprinal	Banyu	Japan	—
Miscleron	Chinoïn	Hungary	—
Normolipol	Delagrange	France	—
Novofibrate	Novopharm	Canada	—
Recolip	Benzon	Denmark	—
Sclerovasal	I.T.I.	Italy	—
Scrobin	Nikken	Japan	—
Sklero-Tablinen	Sanorania	W. Germany	—
Ticlobran	Siegfried	Switz.	—
Xyduril	Dorsh	W. Germany	—
Yoclo	Shinshin	Japan	—

Raw Materials

p-Chlorophenoxyisobutyric acid
Ethanol

Manufacturing Process

The ethyl p-chlorophenoxyisobutyrate may be obtained by heating a mixture of 206 parts of dry p-chlorophenoxyisobutyric acid, 1,000 parts of ethanol and 40 parts of concentrated sulfuric acid under reflux during 5 hours. The alcohol is then distilled off and the residue is diluted with water and extracted with chloroform. The chloroform extract is washed with sodium hydrogen carbonate solution, dried over sodium sulfate and the chloroform removed by distillation. The residue is distilled under reduced pressure and there is obtained ethyl p-chlorophenoxyisobutyrate, BP 148° to 150°C/20 mm.

The p-chlorophenoxyisobutyric acid used as starting material may be obtained as follows. A mixture of 200 parts of p-chlorophenol, 1,000 parts of acetone and 360 parts of sodium hydroxide pellets is heated under reflux and 240 parts of chloroform are gradually added at such a rate that the mixture continues to reflux without further application of heat.

When addition is complete the mixture is heated under reflux during 5 hours and then the acetone is removed by distillation. The residue is dissolved in water, acidified with hydrochloric acid and the mixture extracted with chloroform. The chloroform extract is stirred with sodium hydrogen carbonate solution and the aqueous layer is separated. The alkaline extract is acidified with hydrochloric acid and filtered. The solid product is drained free from oil on a filter pump, then washed with petroleum ether (BP 40° to 60°C), and dried at 50°C. The solid residue, MP 114° to 116°C, may be crystallized from methanol (with the addition of charcoal) to give p-chlorophenoxyisobutyric acid, MP 118° to 119°C.

References

- Merck Index 2340
Kleeman & Engel p. 227
PDR p. 613
OCDS Vol. 1 p. 119 (1977) & 2 pp. 79, 101, 432 (1980)
DOT 11 (4) 141 (1975)
I.N. p. 245
REM p. 863
Jones, W.G.M., Thorp, J.M. and Waring, W.S.; U.S. Patent 3,262,850; July 26, 1966; assigned to Imperial Chemical Industries Limited, England

CLOFIBRIDE

Therapeutic Function: Hypocholesterolemiant

Chemical Name: 3-(Dimethylaminocarbonyl)-propyl-4'-chlorophenoxyisobutyrate

Common Name: —

Structural Formula:

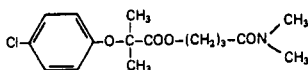

Chemical Abstracts Registry No.: —

Trade Name	Manufacturer	Country	Year Introduced
Lipenan	Charpentier	France	1974
Evimot	Muller Rorer	W. Germany	1978

Raw Materials

Ethyl 4'-chlorophenoxyisobutyrate
4-Hydroxy-N,N-dimethylbutyramide

Manufacturing Process

48.5 parts of ethyl 4'-chlorophenoxyisobutyrate are dissolved in 200 parts by volume of dry toluene in the presence of 26.2 parts of 4-hydroxy-N,N-dimethyl butyramide and 2 parts of aluminum isopropylate. The solution is heated for 8 hours, while collecting the toluene-ethanol azeotrope, in an apparatus provided with a distillation column at a controllable rate of reflux. After this it is filtered, the solvent is evaporated in vacuo and the residue is distilled. An almost colorless, slightly yellow oil is obtained, the purity of which by chromatographic examination in the gaseous phase is of the order of 99.5%. Its boiling point is 175°C under 0.1 torr.

This oil is kept supercooled at the ambient temperature. Crystallization may be obtained by cooling or by seeding with crystals of the product. The melting point is 34°C (instantaneous on the Maquenne block).

The product can be recrystallized. For this, it is dissolved, for example, at the ambient temperature in petrol ether, ethyl ether or isopropyl ether, and this solution is cooled at about -50°C while stirring. After drying over sulfuric acid under vacuum, white needles of very great purity are thus obtained.

References

DOT 9 (5) 169 (1973)

I.N. p. 246

Nordmann, J., Mattioda, G.D. and Loiseau, G.P.M.H.; U.S. Patent 3,792,082; February 12, 1974; assigned to Ugine Kuhlmann

CLOFOCTOL

Therapeutic Function: Antiinfective; bacteriostatic

Chemical Name: 2-(2,4-Dichlorobenzyl)-4-(1,1,3,3-tetramethylbutyl)-phenol

Common Name: —

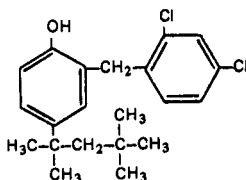
Structural Formula:

Chemical Abstracts Registry No.: 37693-01-9

Trade Name	Manufacturer	Country	Year Introduced
Octofene	Debat	France	1978

Raw Materials

p-(1,1,3,3-Tetramethylbutyl)phenol
2,4-Dichlorobenzyl chloride
Zinc chloride

Manufacturing Process

The following were introduced into a 1 liter flask provided with a reflux condenser: 206 g (1 mol) of p-(1,1,3,3-tetramethylbutyl)-phenol, 147 g (0.75 mol) of 2,4-dichlorobenzyl chloride, 27 g (0.2 mol) of pure melted zinc chloride, and 750 ml of anhydrous chloroform.

The mixture was heated to reflux for 24 hours. The chloroformic reaction mixture was washed with water, and then dried over anhydrous sodium sulfate. The chloroform was evaporated off and the oil obtained was fractionally distilled under a pressure of 0.2 mm Hg. The fraction distilling at 140°C to 160°C, being the desired product indicated above, was collected and crystallized. Yield: 94 g (32% of theory); MP 78°C (after recrystallization in petroleum ether).

References

Kleeman & Engel p. 228

DOT 15 (4) 171 (1979)

I.N. p. 246

Debat, J.; U.S. Patent 3,830,852; August 20, 1974; assigned to Institute de Recherches Chimiques et Biologiques Appliquees (I.R.C.E.B.A.) (France)

CLOMIPHENE DIHYDROGEN CITRATE

Therapeutic Function: Antiestrogen (fertility inducer)

Chemical Name: 2-[4-(2-Chloro-1,2-diphenylethenyl)-phenoxy]N,N-diethylethanamine dihydrogen citrate

Common Name: Clomifen citrate

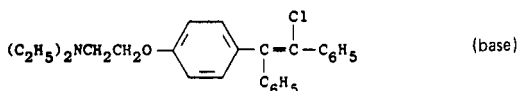
Structural Formula:

Chemical Abstracts Registry No.: 50-41-9; 911-45-5 (Base)

Trade Name	Manufacturer	Country	Year Introduced
Clomid	Lepetit	Italy	1966
Clomid	Merrell Dow	U.K.	1966
Clomid	Doetsch Grether	Switz.	1967
Clomid	Merrell National	U.S.	1967
Dyneric	Merrell	W. Germany	1967
Clomid	Merrell	France	1968
Serophene	Serono	U.S.	1982
Clomivid	Draco	Sweden	—
Clostilbegyt	Egyt	Hungary	—
Gravosan	Spofa	Czechoslovakia	—
Ikaclomine	Ika	Israel	—
Omifin	Inibsa	Spain	—
Prolifen	Chiesa	Italy	—

Raw Materials

4-(β -Diethylaminoethoxy)benzophenone	Hydrogen chloride
Benzyl magnesium chloride	Citric acid
N-Chlorosuccinimide	

Manufacturing Process

A mixture of 20 g of 1-[p-(β -diethylaminoethoxy)phenyl]-1,2-diphenylethanol in 200 cc of ethanol containing an excess of hydrogen chloride was refluxed 3 hours. The solvent and excess hydrogen chloride were removed under vacuum, and the residue was dissolved in a mixture of ethyl acetate and methylene chloride. 1-[p-(β -diethylaminoethoxy)phenyl]-1,2-diphenylethylene hydrochloride was obtained, melting at 148° to 157°C. This hydrochloride salt was treated with N-chlorosuccinimide in dry chloroform under reflux. The product then obtained was converted to the free base and treated with citric acid. The dihydrogen citrate salt of 1-[p-(β -diethylaminoethoxy)phenyl]-1,2-diphenylchloroethylene was obtained, melting at 116.5° to 118°C.

The intermediate 1-[p-(β -diethylaminoethoxy)phenyl]-1,2-diphenylethanol was obtained by treating 4-(β -diethylaminoethoxy)benzophenone with benzylmagnesium chloride. It melted at 95° to 96°C.

References

- Merck Index 2349
 DFU 3 (11) 850 (1978)
 Kieeman & Engel p. 230
 PDR pp. 1225, 1699
 OCDS Vol. 1 pp. 105, 148 (1977) & 2 p. 127 (1980)
 I.N. p. 247
 REM p. 990
 Allen, R.E., Palopoli, F.P., Schumann, E.L. and Van Campen, M.G. Jr.; U.S. Patent 2,914,563; November 24, 1959; assigned to The Wm. S. Merrell Company

CLOMIPRAMINE

Therapeutic Function: Antidepressant

Chemical Name: 3-Chloro-10,11 dihydro-N,N-dimethyl-5H-dibenz[b,f]azepine-5-propan-amine

Common Name: Chlorimipramine

Structural Formula:

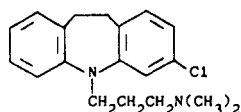

Chemical Abstracts Registry No.: 303-49-1; 17321-77-6 (Hydrochloride)

Trade Name	Manufacturer	Country	Year Introduced
Anafranil	Ciba Geigy	Switz.	1968
Anafranil	Ciba Geigy	W. Germany	1968
Anafranil	Fujisawa	Japan	1970
Anafranil	Ciba Geigy	Italy	1970
Anafranil	Ciba Geigy	U.K.	1970
Anafranil	Ciba Geigy	Australia	1983
Marunil	Unipharm	Israel	—
Hydiphen	Arzneimittelwerk Dresden	E. Germany	—

Raw Materials

3-Chloroiminodibenzyl
Sodium amide
 γ -Dimethylaminopropyl chloride

Manufacturing Process

22.9 parts of 3-chloroiminodibenzyl are dissolved in 300 parts by volume of xylene, and 4 parts of sodium amide, pulverized and suspended in toluene, are added thereto while stirring and maintaining the whole under a nitrogen atmosphere. The xylene solution immediately turns dark colored, but upon crystallization of the sodium salt therefrom it becomes again light-colored. The reaction mixture is stirred for about 2 hours at 80°C until the development of ammonia has terminated. A solution of γ -dimethylaminopropyl chloride in toluene, prepared by setting free a corresponding amount of the free base from 17.4 parts of its hydrochloride salt by addition of aqueous sodium hydroxide solution in about 10% excess, extraction with toluene and drying for 2 hours over anhydrous sodium sulfate is added to the xylene solution containing the sodium salt mentioned above and the whole is stirred under reflux for 15 hours. Precipitated sodium chloride is filtered off and the filtrate is concentrated. The residue is diluted with ether, and the hydrochloride of 3-chloro-5-(γ -dimethylaminopropyl)-iminodibenzyl is precipitated by introducing dry, gaseous hydrogen chloride. It is filtered off under suction and purified by repeated recrystallization from acetone; the pure substance melts at 191.5°C to 192°C.

References

Merck Index 2350
Kleeman & Engel p. 231
DOT 4 (4) 143 (1968) & 9 (6) 218 (1973)
I.N. p. 248
Schindler, W. and Dietrich, H.; U.S. Patent 3,515,785; June 2, 1970; assigned to Geigy Chemical Corp.

CLONAZEPAM

Therapeutic Function: Anticonvulsant

Chemical Name: 5-(o-chlorophenyl)-1,3-dihydro-7-nitro-2H-1,4-benzodiazepin-2-one

Common Name: —

Structural Formula:

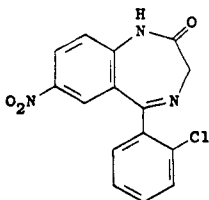

Chemical Abstracts Registry No.: 1622-61-3

Trade Name	Manufacturer	Country	Year Introduced
Rivotril	Roche	France	1973
Rivotril	Roche	U.K.	1974
Clonopin	Roche	U.S.	1975
Rivotril	Roche	Italy	1975
Rivotril	Roche	W. Germany	1976
Rivotril	Roche	Switz.	1976
Rivotril	Roche	Japan	1980
Rancedon	Sumitomo	Japan	1981
Anteplepsin	Arzneimittelwerk Dresden	E. Germany	—
Clonex	Teva	Israel	—
Iktorivil	Roche	—	—
Landsen	Sumitomo	Japan	—

Raw Materials

2-Amino-2'-nitrobenzophenone	Sodium nitrite
Hydrogen chloride	Hydrogen
Bromoacetyl bromide	Ammonia
Pyridine	Potassium nitrate
Sulfuric acid	

Manufacturing Process

The following description is taken from U.S. Patent 3,116,203. A stirred solution of 75 g of 2-amino-2'-nitrobenzophenone in 700 ml of hot concentrated hydrochloric acid was cooled to 0°C and a solution of 21.5 g of sodium nitrite in 50 ml of water was added in the course of 3 hours. The temperature of the suspension was kept at 2° to 7°C during the addition. The resulting clear solution was poured into a stirred solution of 37 g of cuprous chloride in 350 ml of hydrochloric acid 1:1. The solid which had formed after a few minutes was filtered off, washed with water and recrystallized from ethanol. Crystals of 2-chloro-2'-nitrobenzophenone melting at 76° to 79°C were obtained.

A solution of 20 g of 2-chloro-2'-nitrobenzophenone in 450 ml of ethanol was hydrogenated at normal pressure and room temperature with Raney nickel. After uptake of about 6 liters of hydrogen the catalyst was filtered off, and the alcohol then removed in vacuo. The residue was distilled in a bulb tube at 0.4 mm and a bath temperature of 150° to 165°C giving a yellow oil. The oil was dissolved in alcohol, and on addition of water, needles of 2-amino-2'-chlorobenzophenone melting at 58° to 60°C were obtained.

To a solution of 42 g of 2-amino-2'-chlorobenzophenone in 500 ml of benzene, 19 ml of bromoacetyl bromide was added dropwise. After refluxing for 2 hours, the solution was cooled, washed with 2N sodium hydroxide and evaporated. The residue was recrystallized from methanol giving crystals of 2-bromo-2'-(2-chlorobenzoyl) acetanilide melting at 119° to 121°C.

To a solution of 14.5 g of 2-bromo-2'-(2-chlorobenzoyl)acetanilide in 100 ml of tetrahydrofuran, an excess of liquid ammonia (ca 150 ml) was added. The ammonia was kept refluxing with a dry-ice condenser for 3 hours after which time the ammonia was allowed to evaporate and the solution was poured into water. Crystals of 2-amino-2'-(2-chlorobenzoyl)acetanilide were collected, which after recrystallization from ethanol melted at 162° to 164°C.

A solution of 3 g of 2-amino-2'-(2-chlorobenzoyl)acetanilide in 50 ml of pyridine was refluxed for 24 hours after which time the pyridine was removed in vacuo. The residue was recrystallized from methanol and a mixture of dichloromethane and ether giving crystals of 5-(2-chlorophenyl)-3H-1,4-benzodiazepin-2(1H)-one melting at 212° to 213°C.

To a solution of 13.5 g of 5-(2-chlorophenyl)-3H-1,4-benzodiazepin-2(1H)-one in 60 ml of concentrated sulfuric acid, a solution of 5.5 g of potassium nitrate in 20 ml concentrated sulfuric acid was added dropwise. The solution then was heated in a bath at 45° to 50°C for 2½ hours, cooled and poured on ice. After neutralizing with ammonia, the formed precipitate was filtered off and boiled with ethanol. A small amount of white insoluble material was then filtered off. The alcoholic solution on concentration yielded crystals of 7-nitro-5-(2-chlorophenyl)-3H-1,4-benzodiazepin-2(1H)-one which, after recrystallization from dichloromethane, melted at 238° to 240°C.

References

Merck Index 2352

Kleeman & Engel p. 232

PDR p. 1481

DOT 9 (6) 237 (1973) & 9 (12) 487 (1973)

I.N. p. 248

REM p. 1077

Kariss, J. and Newmark, H.L.; U.S. Patents 3,116,203; December 31, 1963; and 3,123,529; March 3, 1964; both assigned to Hoffmann-LaRoche, Inc.

Keller, O., Steiger, N. and Sternbach, L.H.; U.S. Patents 3,121,114; February 11, 1964; and 3,203,990; August 31, 1965; both assigned to Hoffmann-LaRoche, Inc.

Focella, A. and Rachlin, A.I.; U.S. Patent 3,335,181; August 8, 1967; assigned to Hoffmann-LaRoche, Inc.

CLONIDINE HYDROCHLORIDE

Therapeutic Function: Antihypertensive

Chemical Name: 2-(2,6-dichloroanilino)-2-imidazoline hydrochloride

Common Name: —

Structural Formula:

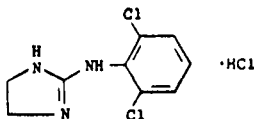

Chemical Abstracts Registry No.: 4205-91-8; 4205-90-7 (Base)

Trade Name	Manufacturer	Country	Year Introduced
Catapresan	Boehr/Ingel	W. Germany	1966
Catapresan	Boehr/Ingel	Switz.	1966
Catapresan	Boehr/Ingel	Italy	1970

Trade Name	Manufacturer	Country	Year Introduced
Catapres	Tanabe	Japan	1970
Catapres	Boehr./Ingel	U.K.	1971
Catapresan	Boehr./Ingel	France	1971
Catapres	Boehr./Ingel	U.S.	1974
Bapresan	Chemie Linz.	Austria	—
Caprysin	Star	Finland	—
Clonilou	Hermes	Spain	—
Clonisin	Leiras	Finland	—
Clonnirit	Rafa	Israel	—
Dixarit	W.B. Pharm	U.K.	—
Haemiton	Arzneimittelwerk Dresden	E. Germany	—
Ipotensium	Pierrel	Italy	—
Isoglaucan	Boehr./Ingel	W. Germany	—
Normopresan	Rafa	Israel	—
Tensinova	Cheminova	Spain	—

Raw Materials

2,6-Dichloroaniline	Ammonium thiocyanate
Methyl iodide	Ethylene diamine
Hydrogen chloride	

Manufacturing Process

N-(2,6-dichlorophenyl)thiourea (MP 149°C) was prepared in customary manner from 2,6-dichloroaniline (*Organic Synthesis* III, 262-263) and ammonium thiocyanate. 16.0 g of this thiourea derivative were refluxed for 2½ hours together with 16 g of methyl iodide in 150 cc of methanol. Thereafter, the methanol was evaporated out of the reaction mixture in vacuo, leaving as a residue 22 g of N-(2,6-dichlorophenyl)-S-methyl-isothiuronium hydroiodide of the formula

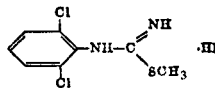

having a melting point of 170°C. The entire residue was then admixed with an excess (120%) above the molar equivalent of ethylenediamine, and the mixture was heated for about one hour at 130° to 150°C. Methyl mercaptan was given off. Thereafter, the reaction mixture comprising 2-(2',6'-dichloroanilino)-1,3-diazacyclopentene-(2) hydroiodide was taken up in hot dilute acetic acid, and the resulting solution was made alkaline with 2 N NaOH. A precipitate formed which was separated by vacuum filtration, washed with water and dried. 4.0 g of 2-(2',6'-dichloroanilino)-1,3-diazacyclopentene-(2) were obtained. The product had a melting point of 130°C.

The free base was then dissolved in absolute methanol, and the resulting solution was then adjusted to an acid pH value with an ethereal hydrochloric acid solution. The acidified solution was purified with charcoal and then dry ether was added thereto until crystallization took place. The hydrochloride, prepared in this customary manner, had a melting point of 305°C according to U.S. Patent 3,202,660.

References

- Merck Index 2353
- Kleeman & Engel p. 232
- PDR p. 675
- OCDS Vol. 1 p. 241 (1977)
- DOT 9 (3) 97 (1973)
- I.N. p. 249
- REM p. 845

Zeile, K., Hauptmann, K.-H. and Stahle, H.; U.S. Patents 3,202,660; August 24, 1965; and 3,236,857; February 22, 1966; both assigned to Boehringer Ingelheim GmbH, Germany

CLOPENTHIXOL

Therapeutic Function: Antipsychotic

Chemical Name: 4-[3-(2-Chloro-9H-thioxanthen-9-ylidene)propyl]-1-piperazineethanol

Common Name: —

Structural Formula:

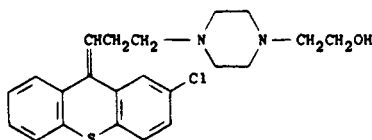

Chemical Abstracts Registry No.: 982-24-1; 633-59-0 (Dihydrochloride)

Trade Name	Manufacturer	Country	Year Introduced
Ciatyl	Tropon	W. Germany	1961
Sordinol	Bracco	Italy	1967
Clopixol	Lundbeck	U.K.	1978
Cisordinol	Lundbeck	—	—
Sordenac	Lundbeck	—	—
Thiapax	Ikapharm	Israel	—

Raw Materials

2-Chloro-9-(3'-dimethylaminopropylidene)-thioxanthen
N-(β-hydroxyethyl)-piperazine

Manufacturing Process

A mixture of 31.5 g (0.1 mol) of 2-chloro-9-(3'-dimethylaminopropylidene)-thioxanthen (MP 97°C) and 100 g of N-(β-hydroxyethyl)-piperazine is heated to 130°C and boiled under reflux at this temperature for 48 hours. After cooling, the excess of N-(β-hydroxyethyl)-piperazine is evaporated in vacuo, and the residue is dissolved in ether. The ether phase is washed with water and extracted with dilute acetic acid, and 2-chloro-9-[3'-N-(N'-β-hydroxyethyl)-piperazinypropylidene]-thioxanthen separated from the aqueous acetic acid solution by addition of dilute sodium hydroxide solution to basic reaction. The free base is extracted with ether, the ether phase dried over potassium carbonate, the ether evaporated and the residue dissolved in absolute ethanol. By complete neutralization of the ethanolic solution with a solution of dry hydrogen chloride in absolute ethanol, the dihydrochloride of 2-chloro-9-[3'-N-(N'-β-hydroxyethyl)-piperazinypropylidene]-thioxanthen is produced and crystallizes out as a white substance melting at about 250°C to 260°C with decomposition. The yield is 32 g.

References

- Merck Index 2357
- Kleeman & Engel p. 234
- OCDS Vol. 1 p. 399 (1977)
- DOT 9 (6) 229 (1973)

I.N. p. 249

Petersen, P.V., Lassen, N.O. and Holm, T.O.; U.S. Patent 3,149,103; September 15, 1964; assigned to Kefalas A/S (Denmark)

CLOPERASTINE

Therapeutic Function: Antitussive

Chemical Name: 1-[2-[(p-chloro- α -phenylbenzyl)oxy]ethyl] piperidine

Common Name: —

Structural Formula:

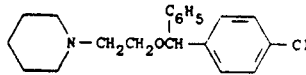

Chemical Abstracts Registry No.: 3703-76-2

Trade Name	Manufacturer	Country	Year Introduced
Hustazol	Yoshitomi	Japan	1972
Seki	Symes	Italy	1981

Raw Materials

p-Chlorobenzhydryl bromide
Ethylene chlorohydrin
Piperidine

Manufacturing Process

The manufacture of a related compound is first described. 28.1 parts of p-chloro-benzhydryl bromide are heated to boiling, under reflux and with stirring, with 50 parts of ethylene chlorohydrin and 5.3 parts of calcined sodium carbonate. The reaction product is extracted with ether and the ethereal solution washed with water and dilute hydrochloric acid. The residue from the solution in ether boils at 134° to 137°C under 0.2 mm pressure and is p-chloro-benzhydryl-(β -chloroethyl) ether.

28.1 parts of this ether are heated with 12 parts of methylethylamine (100%) in a sealed tube for 4 hours at 110°C. The product of the reaction is extracted several times with dilute hydrochloric acid, the acid solution made alkaline, in the cold, with concentrated caustic soda solution and the base which separates taken up in ether. The ether extract is washed with concentrated potassium carbonate solution, evaporated down, and the residue distilled in vacuo. The product is β -methylethyl aminoethyl p-chlorobenzhydryl ether, BP 152° to 153°C/0.1 mm.

Reaction with dimethylethylamine instead of methylethylamine leads directly to a quaternary compound, which type of compound can also be obtained by reacting the tertiary aminoethyl ether with reactive esters.

If 18 parts of piperidine are used instead of 12 parts of methylethylamine then the same procedure results in the formation of p-chloro-benzhydryl-(β -piperidino-ethyl) ether, boiling at 178° to 180°C under 0.15 mm pressure.

References

Merck Index 2358
Kleeman & Engel p. 234

I.N. p. 250

British Patent 670,622; April 23, 1952; assigned to Parke, Davis & Company

CLOPREDNOL

Therapeutic Function: Glucocorticoid

Chemical Name: 6-Chloro-11,17,21-trihydroxypregna-1,4,6-triene-3,20-dione

Common Name: —

Structural Formula:

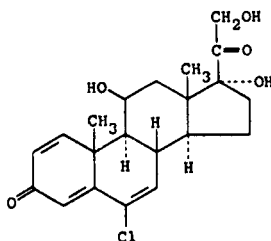

Chemical Abstracts Registry No.: 5251-34-3

Trade Name	Manufacturer	Country	Year Introduced
Syntestan	Syntex	W. Germany	1980
Novacort	Syntex	Switz.	1983
Synclopred	Syntex	—	—

Raw Materials

6 α -Chlorohydrocortisone 21-acetate
Chloranil

Manufacturing Process

A mixture of 5 g of the 21-acetate of 6 α -chlorohydrocortisone, 7 g of chloranil and 100 cc of n-amyl alcohol was refluxed for 16 hours, cooled and diluted with ether. The solution was successively washed with water, 5% sodium carbonate solution and water, dried over anhydrous sodium sulfate, filtered and evaporated to dryness under reduced pressure. Chromatographic purification of the residue yielded the 21-acetate of 6-chloro- $\Delta^{1,4,6}$ -pregnatriene-11 β ,17 α ,21-triol-3,20-dione.;

References

Merck Index 2361

DFU 2 (1) 18 (1977)

OCDS Vol. 2 p. 182 (1980)

DOT 17 (10) 393 (1981)

I.N. p. 250

Ringold, H.J. and Rosenkranz, G.; U.S. Patent 3,232,965; February 1, 1966; assigned to Syntex Corp.

CLORAZEPATE DIPOTASSIUM

Therapeutic Function: Tranquillizer

Chemical Name: 7-chloro-2,3-dihydro-2,2-dihydroxy-5-phenyl-1H-1,4-benzodiazepine-3-carboxylic acid dipotassium salt

Common Name: —

Structural Formula:

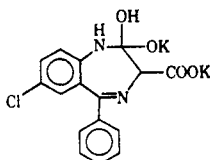

Chemical Abstracts Registry No.: 15585-90-7; 20432-69-3 (Base)

Trade Name	Manufacturer	Country	Year Introduced
Tranxene	Clin Comar	France	1968
Tranxilium	Mack	W. Germany	1969
Tranxilium	Cun Midy	Switz.	1969
Transene	Zambeletti	Italy	1970
Tranxene	Abbott	U.S.	1972
Tranxene	Boehr./Ingel.	U.K.	1973
Mendon	Dainippon	Japan	1980
Anxidin	Orion	Finland	—
Azene	Endo	U.S.	—
Belseren	Mead Johnson	—	—
Enadine	York	Argentina	—
Nansius	Prodes	Spain	—
Noctran	Clin-Comar-Byla	France	—
Tranex	Idravije	Yugoslavia	—
Tranxilen	Leo	Sweden	—

Raw Materials

2-Amino-5-chlorobenzonitrile	Bromobenzene
Methyl aminomalonate	Magnesium
Potassium hydroxide	

Manufacturing Process

(A) Preparation of (2-Amino-5-Chlorophenyl)Phenylmethanimine (4356 CB): A solution of 228.7 g (1.5 mols) of 2-amino-5-chlorobenzonitrile in 1,800 ml of dry ether is added slowly in the course of about 3.5 hours to a solution of phenyl magnesium bromide prepared from 109 g (4.5 g-atoms) of magnesium turnings and 848 g (5.4 mols) of bromobenzene in 3,600 ml of anhydrous ether, and the mixture then heated under reflux for 15 hours.

The complex is decomposed by stirring the reaction mixture into a solution prepared from 500 g of ammonium chloride in 2,000 ml of water to which 3 kg of crushed ice have been added. After extraction and washing, the ether is evaporated in vacuo at 40°C. The oily residue is taken up in 500 ml of petroleum ether and left to crystallize by cooling at -20°C. The yellowish crystals formed are dried (309 g); MP_k (Kofler block): 74°C; yield: 92%.

(B) *Preparation of 7-Chloro-3-Methoxycarbonyl-5-Phenyl-2-Oxo-2,3-Dihydro-1H-Benzo [f]-1,4-Diazepine (4347 CB)*: A solution of 9.2 g (0.04 mol) of compound 4356 CB in 20 ml of methanol is added dropwise, in the course of one hour and 30 minutes, to a boiling solution of 9.2 g (0.05 mol) of the hydrochloride of methyl aminomalonate in 30 ml of methanol. When this is completed, heating under reflux is continued for 30 minutes and the product then concentrated to dryness under reduced pressure. The residue is taken up in water and ether, the ethereal layer separated, the product washed with water and dried over sodium sulfate. The solvent is evaporated under reduced pressure. The residue, which consists of the methyl ester, could not be obtained in the crystalline state. It is dissolved in 25 ml of acetic acid, heated under reflux for 15 minutes, the product evaporated to dryness and the residual oil taken up in ether. A colorless solid separates which is filtered by suction and recrystallized from methanol. Colorless crystals are obtained (4.7 g); MP_k (Kofler block): 226°C. A second crop (1.5 g) is obtained on concentration of the mother liquor; MP_k (Kofler block): 222°C; total quantity 6.2 g, corresponding to a yield of 47%.

(C) *Preparation of Dipotassium Salt of [2-Phenyl-2-(2-Amino-5-Chlorophenyl)-1-Azavinyl] Malonic Acid (4306 CB)*: 50 g of caustic potash are dissolved in 1,350 ml of 96% ethyl alcohol, and 82 g (0.25 mol) of compound 4347 CB are then added all at once at a temperature of about 70°C. The solid dissolves rapidly to form a yellow solution which then loses color while simultaneously an abundant colorless precipitate appears.

After cooling, the solid is filtered by suction and washed with alcohol at 96°C. The product is dried at ordinary temperature in a high vacuum. A colorless solid is obtained (quantitative yield), which is completely soluble in water. The aqueous solution is strongly alkaline in reaction; when acidified with acetic acid and heated on a water bath, it yields a precipitate of 7-chloro-5-phenyl-2-oxo-2,3-dihydro-1H-benzo[f]-1,4-diazepine.

References

- Merck Index 2364
 Kleeman & Engel p. 311
 PDR p. 553
 DOT 4 (4) 137 (1968) & 9 (6) 238 (1973)
 I.N. p. 251
 REM p. 1061
 Schmitt, J.; U.S. Patent 3,516,988; June 23, 1970

CLOREXOLONE

Therapeutic Function: Diuretic

Chemical Name: 6-Chloro-2-cyclohexyl-2,3-dihydro-3-oxo-1H-isoindole-5-sulfonamide

Common Name: —

Structural Formula:

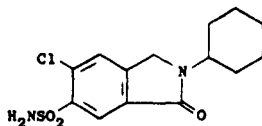

Chemical Abstracts Registry No.: 2127-01-7

Trade Name	Manufacturer	Country	Year Introduced
Speciatensol	Specia	France	1966
Flonatriil	Specia	France	—
Nefrolan	May & Baker	U.K.	—
Nefrolan	Teikoku Zoki	Japan	—

Raw Materials

4-Chlorophthalimide	Sulfuric acid
Cyclohexylamine	Stannous chloride
Tin	Sodium nitrite
Hydrogen chloride	Sulfur dioxide
Potassium nitrate	Ammonia

Manufacturing Process

4-chlorophthalimide (263 g) was reacted in amyl alcohol (2.6 l) with cyclohexylamine (143.5 g, 1 mol) at reflux temperature for 16 hours to give N-cyclohexyl-4-chlorophthalimide (250 g, 66%) as a solid, MP 134°C to 136°C.

N-cyclohexyl-1-chlorophthalimide (250 g) was dissolved in glacial acetic acid (2.5 l), concentrated hydrochloric acid (555 ml) and tin (278 g) were added and the suspension was heated on a steam bath for 16 hours. The cooled solution was filtered and concentrated to dryness in vacuo to give a white solid. This solid was dissolved in water and the precipitated oil extracted with chloroform. The chloroform solution was dried and concentrated in vacuo to give a solid which, after recrystallization, yielded 5-chloro-2-cyclohexylisindolin-1-one (43%), MP 140°C to 142°C.

5-chloro-2-cyclohexylisindolin-1-one (102.9 g) was dissolved in concentrated sulfuric acid (665 ml); potassium nitrate (723 g) in concentrated sulfuric acid (166 ml) was added at 0°C. The reaction mixture was allowed to warm to room temperature and stirred at 25°C for 12 hours. The reaction mixture was poured onto ice to give a cream solid which, after recrystallization from benzene, gave 5-chloro-2-cyclohexyl-6-nitroisindolin-1-one (46.7 g, 44%) as a white solid, MP 164°C to 168°C.

5-chloro-2-cyclohexyl-6-nitroisindolin-1-one (93.9 g) was reduced in concentrated hydrochloric acid (1,970 ml) with stannous chloride (376 g). The reaction temperature rose to 70°C. The resulting solution was cooled in ice and filtered. The product was washed well with water, filtered and dried to give 6-amino-5-chloro-2-cyclohexylisindolin-1-one (74.1 g, 87.6%) which, after recrystallization from benzene, had a MP of 216°C to 218°C.

6-amino-5-chloro-2-cyclohexylisindolin-1-one (42.5 g) was dissolved in concentrated hydrochloric acid (425 ml) and the solution diazotized by the addition of sodium nitrite (21.25 g) in water (125 ml). The resulting diazonium salt solution was added to a solution of liquid sulfur dioxide (93 ml) in glacial acetic acid (243 ml) containing cuprous chloride (2.25 g). A yellow solid was precipitated; this was filtered off, washed, dried and recrystallized from benzene to give 5-chloro-2-cyclohexylisindolin-1-one-6-sulfonyl chloride (45 g, 80%) as a cream solid, MP 171°C to 174°C.

This sulfonyl chloride (23.7 g) was reacted with liquid ammonia (237 ml) to give 5-chloro-2-cyclohexyl-6-sulfamoylisindolin-1-one (14.2 g, 53%), MP 259°C to 261°C.

References

Merck Index 2365

Kleeman & Engel p. 235

DOT 2 (4) 128 (1966)

I.N. p. 251

Lee, G.E. and Wragg, W.R.; U.S. Patent 3,183,243; May 11, 1965; assigned to May & Baker, Ltd.

CLORPRENALINE

Therapeutic Function: Bronchodilator

Chemical Name: 2-chloro- α -[[(1-methylethyl)amino] methyl] benzenemethanol

Common Name: —

Structural Formula:

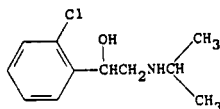

Chemical Abstracts Registry No.: 3811-25-4; 5588-22-7 (Hydrochloride monohydrate)

Trade Name	Manufacturer	Country	Year Introduced
Asthone	Eisai	Japan	1970
Aremans	Zensei	Japan	—
Asnormal	Sawai	Japan	—
Bronocon	Wakamoto	Japan	—
Clopinerin	Nippon Shoji	Japan	—
Clorprenaline	Kongo	Japan	—
Conselt	Sana	Japan	—
Cosmoline	Chemiphar	Japan	—
Fusca	Hoei	Japan	—
Kalutein	Tatsumi	Japan	—
Pentadol	Showa	Japan	—
Propran	Kobayashi Kako	Japan	—
Restanolon	Isei	Japan	—
Troberin	Nippon Zoki	Japan	—

Raw Materials

o-Chloroacetophenone	Bromine
Sodium borohydride	Isopropylamine

Manufacturing Process

To a solution of 279 g of o-chloroacetophenone in 2 liters of anhydrous diethyl ether were added about 3 g of dibenzoyl peroxide. 5 g of bromine were added to the resulting solution, and after 3 minutes, the color of bromine had been discharged, indicating that the formation of ω -bromo-o-chloroacetophenone had been initiated. A further amount of 288 g of bromine was added dropwise to the reaction mixture over a 1½ hour interval. After the addition of the bromine had been completed, the reaction mixture was stirred for one-half hour and poured over about 1 kg of crushed ice.

After the ice had melted, the resulting aqueous and ethereal layers were separated. The ethereal layer containing ω -bromo-o-chloroacetophenone was washed with successive 500 ml quantities of water, 5% sodium carbonate solution and again with water to remove the hydrogen bromide formed as a by-product in the reaction. The ethereal layer was dehydrated by contacting with anhydrous magnesium sulfate. The drying agent was removed by filtration and the ether was evaporated from the filtrate. The residue remaining after the evaporation consisted of about 400 g of ω -bromo-o-chloroacetophenone.

A solution of 400 g of ω -bromo-o-chloroacetophenone in one liter of methanol was cooled to about 25°C. A cold solution of 92.5 g of sodium borohydride in one liter of methanol was added as rapidly as possible to this cooled solution while maintaining the temperature

below about 25°C. After the addition had been completed, the reaction mixture was allowed to stand for 4 hours at ambient room temperature, to complete the reduction of the keto group of the ω -bromo-*o*-chloroacetophenone. The reaction mixture containing a mixture of *o*-chlorophenyl ethylene- β -bromohydrin and *o*-chlorophenyl ethylene oxide was then evaporated in vacuo at room temperature to a syrup which was poured into about one liter of 5% hydrochloric acid to decompose any borate-alcohol complexes.

The two compounds were dissolved in diethyl ether by extracting the acidic layer three times with successive 500 ml portions of diethyl ether. The combined ether extracts were dried over anhydrous magnesium sulfate and filtered, and the ether was removed by evaporation in vacuo. A residue consisting of 400 g of a mixture of *o*-chlorophenyl ethylene- β -bromohydrin and *o*-chlorophenyl ethylene oxide was obtained.

400 g of a mixture of *o*-chlorophenyl ethylene- β -bromohydrin and *o*-chlorophenyl ethylene oxide were dissolved in one liter of anhydrous ethanol. To this solution was added a solution of 306 g of isopropylamine in one liter of anhydrous ethanol. The reaction mixture was heated at refluxing temperature for about 16 hours, thus forming *N*-[β -(*o*-chlorophenyl)- β -hydroxyethyl]-isopropylamine. The solvent was removed in vacuo, and to the residue was added a solution containing 200 ml of 12 N HCl in 2,500 ml of water.

The acidic solution was washed twice with 500 ml portions of ether which were discarded. The acidic layer was then made basic by the addition of 250 ml of 5% (w/v) sodium hydroxide, thus liberating the free base of *N*-[β -(*o*-chlorophenyl)- β -hydroxyethyl]-isopropylamine. The free base was extracted with two successive one liter portions of diethyl ether. The combined ether extracts were dried over anhydrous magnesium sulfate, filtered and concentrated in vacuo to remove all of the solvents. *N*-[β -(*o*-chlorophenyl)- β -hydroxyethyl]-isopropylamine was thus obtained, according to U.S. Patent 2,887,509.

The *N*-[β -(*o*-chlorophenyl)- β -hydroxyethyl]-isopropylamine obtained by the foregoing procedure was dissolved in about 3 liters of ether and dry hydrogen chloride gas was bubbled into the solution until it was saturated, whereupon the hydrochloride salt of *N*-[β -(*o*-chlorophenyl)- β -(hydroxy)-ethyl] isopropylamine precipitated. The salt was separated from the ether by filtration, and was dissolved in two liters of anhydrous ethanol. The alcoholic solution was decolorized with charcoal and filtered.

Three liters of anhydrous ether were added thereto and the *N*-[β -(*o*-chlorophenyl)- β -hydroxyethyl]-isopropylamine hydrochloride precipitated in crystalline form as the monohydrate. The mixture was maintained at about 0°C for 40 hours and then filtered. The filter cake was washed with ether and dried. About 209 g of *N*-[β -(*o*-chlorophenyl)- β -(hydroxy)-ethyl] isopropylamine hydrochloride monohydrate, melting at about 163° to 164°C, were obtained according to U.S. Patent 2,816,059.

References

Merck Index 2368

Kleeman & Engel p. 236

OCDS Vol. 2 p. 39 (1980)

I.N. p. 252

Mills, J.; U.S. Patent 2,816,059; December 10, 1957; assigned to Eli Lilly and Company
Nash, J.F.; U.S. Patent 2,887,509; May 19, 1959; assigned to Eli Lilly and Company

CLORTERMINE HYDROCHLORIDE

Therapeutic Function: Antiobesity drug

Chemical Name: 2-chloro- α - α -dimethylbenzeneethanamine hydrochloride

Common Name: 1-(*o*-chlorophenyl)-2-methyl-2-aminopropane hydrochloride

Structural Formula:

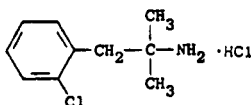

Chemical Abstracts Registry No.: 10389-72-7; 10389-73-8 (Base)

Trade Name	Manufacturer	Country	Year Introduced
Voranil	USV	U.S.	1973

Raw Materials

<i>o</i> , α -Dichlorotoluene	Magnesium
Acetone	Sulfuric acid
Sodium cyanide	Hydrogen chloride

Manufacturing Process

To a Grignard reagent (prepared from 50.0 g of *o*, α -dichloro-toluene and 7.45 g of magnesium in diethyl ether) is added 18.0 g of acetone at such rate that constant reflux is maintained. The reaction mixture is allowed to stand overnight at room temperature, and is then poured onto a mixture of 20% sulfuric acid and ice. The organic layer is separated, washed with water, an aqueous solution of sodium hydrogen carbonate and again with water, dried over magnesium sulfate and evaporated to dryness. The residue is distilled under reduced pressure to yield 42.6 g of 1-(*o*-chlorophenyl)-2-methyl-2-propanol, BP 120° to 122°C/12.5 mm.

To 29.0 ml of glacial acetic acid, cooled to 15°C, is added 11.5 g of sodium cyanide (98%) while stirring, and then dropwise 32.4 ml of concentrated sulfuric acid, dissolved in 29 ml of glacial acetic acid, while maintaining a temperature of 20°C. The 1-(*o*-chlorophenyl)-2-methyl-2-propanol is added moderately fast, allowing the temperature to rise spontaneously. After completing the addition, the reaction mixture is heated to 70°C and stirred, and is then poured onto a mixture of water and ice. The aqueous mixture is neutralized with sodium carbonate and extracted with diethyl ether. The organic solution is washed with water, dried over magnesium sulfate and evaporated to dryness.

The oily residue is taken up in 100 ml of 6 N aqueous hydrochloric acid and refluxed until a clear solution is obtained. The latter is made basic with aqueous ammonia and extracted with diethyl ether; the organic solution is separated, washed, dried and evaporated. The residue is distilled under reduced pressure to yield 26.3 g of 1-(*o*-chlorophenyl)-2-methyl-2-propylamine, BP 116° to 118°C/16 mm.

The 1-(*o*-chlorophenyl)-2-methyl-2-propylamine hydrochloride is prepared by adding ethanolic hydrogen chloride to an ice-cold solution of the free base in ethanol; the desired salt precipitates and is recrystallized from ethanol, MP 245° to 246°C.

References

- Merck Index 2369
- Kleeman & Engel p. 236
- I.N. p. 253
- REM p. 891
- Finocchio, D.V. and Heubner, C.F.; U.S. Patent 3,415,937; December 10, 1968; assigned to Ciba Corporation

CLOTIAZEPAM

Therapeutic Function: Tranquilizer

Chemical Name: 5-(o-Chlorophenyl)-7-ethyl-1,3-dihydro-1-methyl-1H-thieno[2,3-e]-1,4-diazepin-2-one

Common Name: —

Structural Formula:

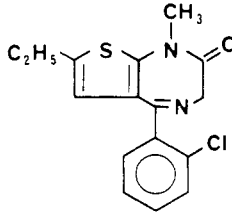

Chemical Abstracts Registry No.: 33671-46-4

Trade Name	Manufacturer	Country	Year Introduced
Rize	Yoshitomi	Japan	1979
Trecalmo	Trpon	W. Germany	1979

Raw Materials

2-N-Methyl-aminoacetamido-3-o-chlorobenzyl-5-ethylthiophene
Acetic acid

Manufacturing Process

To a solution of 10 g of 2-N-methyl-aminoacetamido-3-o-chlorobenzoyl-5-ethylthiophene in 50 ml of pyridine are added 20 ml of benzene and 1.9 g of acetic acid. The resulting mixture is refluxed with stirring for 10 hours in a flask provided with a water-removing adaptor. The reaction mixture is concentrated, and the residue is extracted with chloroform. The chloroform layer is washed with water and then with a sodium hydrogen carbonate solution, then dried over magnesium sulfate. The chloroform is distilled off under reduced pressure, and toluene is added to the residue. Thus is precipitated white crystalline 5-o-chlorophenyl-7-ethyl-1-methyl-1,2-dihydro-3H-thieno-[2,3-e] [1,4] diazepin-2-one, MP 105°C to 106°C.

References

- Merck Index 2373
DFU 1 (8) 363 (1976)
Kleeman & Engel p. 237
DOT 16 (1) 13 (1980)
I.N. p. 254
Nakanishi, M., Araki, K., Tahara, T. and Shiroki, M.; U.S. Patent 3,849,405; November 19, 1974; assigned to Yoshitomi Pharmaceutical Industries, Ltd.

CLOTRIMAZOLE

Therapeutic Function: Antifungal

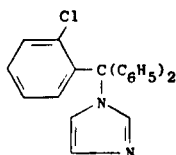
Chemical Name: 1-[(2-chlorophenyl)diphenylmethyl]-1H-imidazole**Common Name:** 1-(o-chlorotrityl)imidazole**Structural Formula:****Chemical Abstracts Registry No.:** 23593-75-1

Trade Name	Manufacturer	Country	Year Introduced
Canesten	Bayer	U.K.	1973
Canesten	Bayer	Italy	1973
Canesten	Bayer	W. Germany	1973
Lotrimin	Schering	U.S.	1975
Empecid	Bayer	Japan	1976
Trimysten	Bellon	France	1978
Mycelex	Miles	U.S.	1979
Baycuten	Bayrofarm	W. Germany	—
Gyne-Lotrimin	Debay	U.S.	—
Micoter	Cusi	Spain	—
Myclo	Boehr./Ing.	—	—
Mycosporin	Bayer	—	—

Raw Materials

o-Chlorophenyldiphenylmethyl chloride
Imidazole

Manufacturing Process

156.5 g (0.5 mol) o-chlorophenyldiphenylmethyl chloride and 34 g (0.5 mol) imidazole are dissolved in 500 ml acetonitrile, with stirring, and 51 g (0.5 mol) triethylamine are added, whereupon separation of triethylamine hydrochloride occurs even at room temperature. In order to complete the reaction, heating at 50°C is carried out for 3 hours. After cooling, one liter of benzene is added and the reaction mixture is stirred, then washed salt-free with water. The benzene solution is dried over anhydrous sodium sulfate, filtered and concentrated by evaporation; giving 167 g crude 1-(o-chlorophenylbisphenylmethyl)-imidazole. By recrystallization from acetone, 115 g (= 71% of the theory) of pure 1-(o-chlorophenylbisphenylmethyl)-imidazole of MP 154° to 156°C are obtained.

References

Merck Index 2374

Kleeman & Engel p. 238

PDR pp. 1257, 1631

DOT 10 (1) 32 (1974)

I.N. p. 254

REM p. 1227

Buechel, K.H., et al; South African Patent 69/0039; January 3, 1969; assigned to Farbenfabriken Bayer AG, Germany

Buechel, K.H., Regel, E. and Plempel, M.; U.S. Patent 3,660,577; May 2, 1972; and U.S.

Patent 3,705,172; Dec. 5, 1972; both assigned to Farbenfabriken Bayer A.G. (Germany)

CLOXACILLIN

Therapeutic Function: Antibacterial

Chemical Name: 6-[[[3-(2-chlorophenyl)-5-methyl-4-isoxazolyl] carbonyl]-amino]-3,3-dimethyl-7-oxo-4-thia-1-azabicyclo[3.2.0]heptane-2-carboxylic acid

Common Name: [3-(o-Chlorophenyl)-5-methyl-4-isoxazolyl] penicillin

Structural Formula:

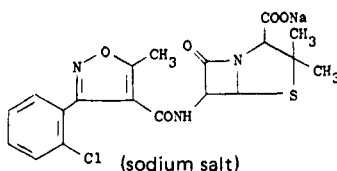

Chemical Abstracts Registry No.: 61-72-3; 642-78-4 (Sodium Salt)

Trade Name	Manufacturer	Country	Year Introduced
Orbenin	Beecham	U.K.	1962
Cloxyphen	Allard	France	1964
Orbenin	Beecham	W. Germany	1964
Tegopen	Bristol	U.S.	1965
Cloxapen	Beecham	U.S.	1976
Acucillin	Fuji	Japan	—
Ampiclox	Beecham	W. Germany	—
Austrastaph	C.S.L.	Australia	—
Bactopen	Beecham	—	—
Benicil	Ibsa	Switz.	—
Ellecid	Pharmax	Italy	—
Ekvacilline	Astra	—	—
Gelstaph	Beecham	—	—
Kloxerate	Duphar	U.K.	—
Methocillin-S	Meiji	Japan	—
Novocloxin	Novopharm	Canada	—
Orbenil	Teva	Israel	—
Orbenine	Beecham-Sevigne	France	—
Penstapho-N	Bristol	—	—
Prostaphlin	Galenika	Yugoslavia	—
Prostaphlin	Banyu	Japan	—
Rivoclox	Rivopharm	Switz.	—
Solcillin-C	Takeda	Japan	—
Staphybiotic	Delagrange	France	—
Syntarpen	Polfa	Poland	—
Totaclox	Beecham	Japan	—

Raw Materials

Ethyl acetoacetate
 o-Chlorobenzohydroxamic acid chloride
 6-Aminopenicillanic acid

Manufacturing Process

The reaction between 6-aminopenicillanic acid (6.5 g) and 3-o-chlorophenyl-5-methylisoxazole-4-carbonyl chloride (7.66 g) gave the sodium salt of 3-o-chlorophenyl-5-methyl-4-isoxazolylpenicillin (9.98 g) as a pale yellow solid. Colorimetric assay with hydroxylamine against a benzylpenicillin standard indicated a purity of 68%.

The 3-*o*-chlorophenyl-5-methylisoxazole-4-carboxylic acid, from which the acid chloride was prepared, was obtained by hydrolysis of the ester product of the reaction between *o*-chlorobenzohydroxamic chloride and ethyl acetoacetate in methanolic sodium methoxide. Reaction with thionyl chloride gave the starting material.

References

Merck Index 2376

Kleeman & Engel p. 239

PDR pp. 673, 1606

OCDS Vol. 1 p. 413 (1977)

I.N. p. 254

REM p. 1195

Doyle, F.P. and Nayler, J.H.C.; British Patent 905,778; September 12, 1962; assigned to Beecham Research Laboratories, Ltd.

Doyle, F.P. and Nayler, J.H.C.; U.S. Patent 2,996,501; August 15, 1961

CLOXAZOLAM

Therapeutic Function: Tranquilizer

Chemical Name: 10-chloro-11b-(2-chlorophenyl)-2,3,7,11b-tetrahydrooxazolo[3,2-d][1,4]-benzodiazepin-6(5H)-one

Common Name: —

Structural Formula:

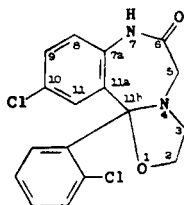

Chemical Abstracts Registry No.: 24166-13-0

Trade Name	Manufacturer	Country	Year Introduced
Sepazon	Sankyo	Japan	1974
Enadel	Pfizer Taito	Japan	1974
Lubalix	Lubapharm	Switz.	1983
Betavel	Pharm. Investi	Spain	—
Olcadil	Sankyo	Japan	—
Tolestan	Roemmers	Argentina	—

Raw Materials

5-Chloro-2-bromoacetyl-amino-*o*-chlorobenzophenone
Ethanolamine

Manufacturing Process

As described in U.S. Patent 3,772,371: To a solution of 5.8 g of 5-chloro-2-bromoacetyl-amino-*o*-chlorobenzophenone in 120 ml of ethanol were added 0.95 g of ethanolamine and 1.3 g of sodium acetate. The resulting mixture was heated under reflux for 16 hours.

After completion of the reaction, the solvent was distilled off and the residue was extracted with dichloromethane. The extract was washed with water, dried over anhydrous sodium sulfate and the solvent was distilled off to give 3.25 g of the desired product melting at 202° to 204°C with decomposition.

References

Merck Index 2377

Kleeman & Engel p. 240

DOT 11 (1) 35 (1975)

I.N. p. 254

Tachikawa, R., Takagi, H., Kamioka, T., Fukunaga, M., Kawano, Y. and Miyadera, T.; U.S. Patents 3,696,094; October 3, 1972; and 3,772,371; November 13, 1973; both assigned to Sankyo Company Limited, Japan

CLOZAPINE

Therapeutic Function: Tranquilizer

Chemical Name: 8-chloro-11-(4-methyl-1-piperazinyl)-5H-dibenzo[b,e] [1,4] diazepine

Common Name: —

Structural Formula:

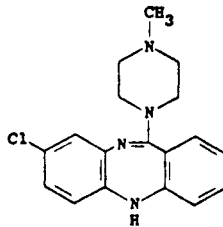

Chemical Abstracts Registry No.: 5786-21-0

Trade Name	Manufacturer	Country	Year Introduced
Leponex	Wander	W. Germany	1974
Leponex	Wander	Switz.	1975
Clozaril	Sandoz	—	—

Raw Materials

2-Amino-4-chlorodiphenylamine-2'-carboxylic(4''-methyl)piperazide
Phosphoroxchloride

Manufacturing Process

7.4 g of 2-amino-4-chlorodiphenylamine-2'-carboxylic acid (4''-methyl)piperazide and 35 ml of phosphoroxchloride are heated for 3 hours under reflux in the presence of 1.4 ml of N,N-dimethylaniline. Upon concentration of the reaction mixture in vacuo as far as possible, the residue is distributed between benzene and ammonia/ice water. The benzene solution is extracted with dilute acetic acid. The acid extract is clarified with charcoal and treated with concentrated ammonia water to precipitate the alkaline substance, which is dissolved in ether. The ethereal solution is washed with water and dried over sodium sulfate. The residue obtained yields, after recrystallization from ether/petroleum ether 2.9 g

(41% of the theoretical yield) of 8-chloro-11-(4-methyl-1-piperazinyl)-5H-dibenzo[b,e][1,4]-diazepine in the form of yellow grains of melting point 182° to 184°C (from acetone/petroleum ether).

References

Merck Index 2378

Kleeman & Engel p. 240

OCDS Vol. 2 p. 425 (1980)

DOT 9 (1) 17 & (6) 232 (1973)

I.N. p. 255

Schmutz, J. and Hunziker, F.; U.S. Patent 3,539,573; November 10, 1970

COLESTIPOL

Therapeutic Function: Antihyperlipoproteinemic

Chemical Name: N-(2-aminoethyl)-1,2-ethanediamine polymer with (chloromethyl)oxirane

Common Name: --

Structural Formula: See Chemical Name

Chemical Abstracts Registry No.: 26658-42-4

Trade Name	Manufacturer	Country	Year Introduced
Colestid	Upjohn	U.S.	1977
Colestid	Upjohn	U.K.	1978
Colestid	Upjohn	W. Germany	1978
Colestid	Upjohn	Switz.	1978
Lestid	Upjohn	--	--

Raw Materials

Epichlorohydrin

Tetraethylene pentamine

Manufacturing Process

Into a 1,000 gallon, jacketed, glass-lined reactor equipped with baffles and a two-speed (67 and 135 rpm) reversed impeller is introduced 200 g of Richonate 60B (a 60% aqueous slurry of sodium salts of alkylbenzenesulfonic acids) and 364 liters of deionized water, followed by 90.5 kg of tetraethylenepentamine rinsed in with 5 gallons of toluene. The solution is stirred at the low speed and then 500 gallons of toluene are added to form a dispersion. To the stirred dispersion is added 109 kg of epichlorohydrin, rinsed in with 5 gallons of toluene, and the resulting mixture is heated at reflux for two hours. The reaction mixture is cooled to about 20°C and then treated with 58.5 kg of a filtered 50% aqueous solution of sodium hydroxide. The mixture is removed from the reactor and filtered, and the copolymer is collected and dried by treating it first with hot (75°C to 80°C) filtered nitrogen and then with an 80°C air stream. The resulting crude product is returned to the reactor, washed extensively with filtered deionized water (at the low speed), dried with an 80°C air stream and blended until homogeneous to give about 155 kg of a dry tetraethylenepentamine-epichlorohydrin copolymer hydrochloride, particle diameter 0.002-0.02 inch.

References

Merck Index 2440

PDR p. 1832

DOT 14 (2) 69 (1978)

I.N. p. 259

REM p. 864

Lednicer, D. and Peery, C.Y.; U.S. Patent 3,803,237; April 9, 1974; assigned to The Upjohn Co.

CORTISONE ACETATE

Therapeutic Function: Glucocorticoid

Chemical Name: 17 α ,21-dihydroxy-4-pregnene-3,11,20-trione-21-acetate

Common Name: —

Structural Formula:

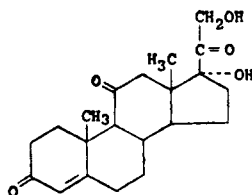

(base)

Chemical Abstracts Registry No.: 50-04-4; 53-06-5 (Base)

Trade Name	Manufacturer	Country	Year Introduced
Cortone Acetate	MSD	U.S.	1950
Acetisone	Farmigea	Italy	—

Raw Materials

3(α)-Hydroxy-21-acetoxy-11,20-diketopregnane
 Potassium cyanide
 Acetic acid
 Chromic acid
 Phosphorus oxychloride
 Osmium tetroxide

Manufacturing Process

The following technique is described in U.S. Patent 2,541,104. A solution of 2.0 g of 3(α)-hydroxy-21-acetoxy-11,20-diketo-pregnane, which can be prepared as described in *Helv. Chim. Acta* 27, 1287 (1944), is treated in a mixture of 25 cc of alcohol and 6.4 cc of acetic acid at 0°C with 6.0 g of potassium cyanide. The solution is allowed to warm to room temperature and after 3 hours is diluted with water. The addition of a large volume of water to the alcohol-hydrogen cyanide mixture precipitates a gum which is extracted with chloroform or ethyl acetate. The extract is washed with water, and evaporated to small volume under reduced pressure. The crystalline precipitate (1.3 g) consists of 3(α),20-dihydroxy-20-cyano-21-acetoxy-11-keto-pregnane; dec. 175° to 185°C.

A solution of 0.60 g of chromic acid in 1.2 cc of water and 11 cc of acetic acid is added to a solution containing about 1.2 g of 3(α),20-dihydroxy-20-cyano-21-acetoxy-11-keto-pregnane at room temperature. After 1 hour, water is added and the product, which precipitates, is filtered and recrystallized from ethyl acetate to produce 3,11-diketo-20-hydroxy-20-cyano-21-acetoxy-pregnane; dec. 214° to 217°C.

0.40 cc of phosphorus oxychloride is added to a solution containing about 950 mg of 3,11-diketo-20-hydroxy-20-cyano-21-acetoxy-pregnane dissolved in 3 cc of pyridine. After standing at room temperature for 24 hours, the solution is poured into water and dilute hydrochloric acid, extracted with benzene and concentrated to dryness. The crude product, after chromatography gives one main constituent, namely Δ^{17} -3,11-diketo-20-cyano-21-acetoxy-pregnane; MP 189° to 190°C.

A solution of 1.0 g of Δ^{17} -3,11-diketo-20-cyano-21-acetoxy-pregnane in 10 cc of benzene is treated with 1.0 g of osmium tetroxide and 0.43 g of pyridine. After standing at room temperature for 18 hours, the resulting solution is treated successively with 50 cc of alcohol, and with 50 cc of water containing 2.5 g of sodium sulfite. The mixture is stirred for 30 hours, filtered, and the filtrate acidified with 0.5 cc of acetic acid and concentrated to small volume in vacuo. The aqueous suspension is then extracted four times with chloroform, the chloroform extracts are combined, washed with water and concentrated to dryness in vacuo. Recrystallization of the residue from acetone gives 3,11,20-triketo-17(α)-21-dihydroxy-pregnane; MP 227° to 229°C. This compound is then treated with acetic anhydride and pyridine for 15 minutes at room temperature to produce 3,11,20-triketo-17(α)-hydroxy-21-acetoxy-pregnane or cortisone acetate.

References

Merck Index 2510

Kleeman & Engel p. 246

OCDS Vol. 1 pp. 188, 190 (1977)

I.N. p. 265

REM p. 964

Reichstein, T.; U.S. Patent 2,403,683; July 9, 1946

Gallagher, T.F.; U.S. Patent 2,447,325; August 17, 1948; assigned to Research Corporation

Sarett, L.H.; U.S. Patent 2,541,104; February 13, 1951; assigned to Merck & Co., Inc.

CORTIVAZOL

Therapeutic Function: Glucocorticoid

Chemical Name: 11 β ,17,21-trihydroxy-6,16 α -dimethyl-2¹-phenyl-2¹H-pregna-2,4,6-trieno-[3,2-c]pyrazol-20-one-21-acetate

Common Name: —

Structural Formula:

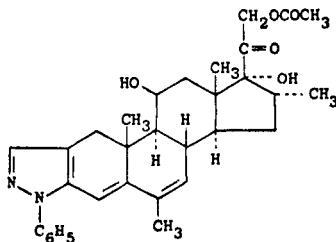

Chemical Abstracts Registry No.: 1110-40-3

Trade Name	Manufacturer	Country	Year Introduced
Diaster	Diamant	France	1972
Altim	Roussel	France	—

Trade Name	Manufacturer	Country	Year Introduced
Idaltim	Roussel	—	—
Dilaster	Roussel	—	—

Raw Materials

11 β ,17 α ,21-Trihydroxy-6,16 α -dimethyl-4,6-pregnadiene-3,20-dione
 Formaldehyde
 Hydrogen chloride
 Ethyl formate
 Phenyl hydrazine
 Formic acid
 Acetic anhydride

Manufacturing Process

To a suspension of 25.0 g of 11 β ,17 α ,21-trihydroxy-6,16 α -dimethyl-4,6-pregnadiene-3,20-dione in 1.5 liters of alcohol-free chloroform cooled to about 5°C in an ice bath is added with constant stirring 750 ml of cold, concentrated hydrochloric acid and then 750 ml of formalin (low in methanol). The mixture is removed from the ice bath and stirred at room temperature for 7 hours. The layers are separated and the aqueous phase is back-extracted twice with chloroform. The combined organic layers are washed twice with a 5% solution of sodium bicarbonate, and twice with a saturated salt solution. The solution is dried over magnesium sulfate and evaporated to dryness under reduced pressure.

The residue is triturated with methanol to afford a crystalline solid. This material contains no detectable amount of starting material by paperstrip chromatography but shows two UV absorbing spots near the solvent front (methanol-formamide 2:1 vs benzene-n-hexane 1:1). An aliquot is recrystallized three times from a mixture of benzene and n-hexane to give 17 α ,20,20,21-bis(methylenedioxy)-11 β -hydroxy-6,16 α -dimethyl-4,6-pregnadiene-3-one which is used in the subsequent step of the synthesis without further purification.

17 α ,20,20,21-bis(methylenedioxy)-11 β -hydroxy-6,16 α -dimethyl-4,6-pregnadiene-3-one (500 mg) is dissolved in 25 cc of benzene and then about 5 cc of benzene is removed by distillation at normal pressure. The resulting solution is cooled to room temperature. Then 0.75 cc of freshly distilled ethyl formate is added. The air in the system is replaced with nitrogen and 150 mg of sodium hydride (as a 57% dispersion in mineral oil) is added. The mixture is stirred under nitrogen at room temperature for three hours. Then 15 cc of a saturated aqueous solution of sodium dihydrogen phosphate is added and the product is extracted into ether.

The ether extracts are extracted with 2 N sodium hydroxide and the sodium hydroxide extracts are acidified with sodium dihydrogen phosphate and extracted again into ether. The ether extract is evaporated to dryness to give about 500 mg of a crude product. From the ether solution there is obtained about 290 mg of yellow crystals, MP 220° to 236°C which is 17 α ,20,20,21-bis(methylenedioxy)-11 β -formyloxy-2-hydroxy-methylene-6,16 α -dimethyl-4,6-pregnadiene-3-one. The analytical sample is recrystallized from ethyl acetate and has a melting point of 249° to 255°C, $[\alpha]_D^{27}$ -217°, IR 5.81 and 8.37 μ . From the mother liquor is obtained about 127 mg of 17 α ,20,20,21-bis(methylenedioxy)-11 β -hydroxy-2-hydroxymethylene-6,16 α -dimethyl-4,6-pregnadiene-3-one. The analytical sample is recrystallized from ether and has a melting point of 200° to 204°C, $[\alpha]_D^{27}$ -197°, IR 6.05 to 6.2 and 6.4 μ .

The 17 α ,20,20,21-bis(methylenedioxy)-11 β -hydroxy-2-hydroxymethylene-6,16 α -dimethyl-4,6-pregnadiene-3-one (1.19 g) is dissolved in 25 cc of ethanol. 300 mg of phenyl hydrazine is added and the mixture is refluxed under nitrogen for one hour. About 25 cc of water is added. The product is then extracted into 150 cc of ether. The extracts are washed with 2 N HCl, with saturated sodium bicarbonate, water and saturated sodium chloride solution, and then dried over sodium sulfate and evaporated to dryness to give about 1.2 g

of crude product. On crystallization from ether there is obtained as a major component the 17 α ,20,20,21-bis(methylenedioxy)-11 β -hydroxy-6,16 α -dimethyl-2'-phenyl-4,6-pregnadieno-[3,2-c] pyrazole.

17 α ,20,20,21-bis(methylenedioxy)-11 β -hydroxy-6,16 α -dimethyl-2'-phenyl-4,6-pregnadieno-[3,2-c] pyrazole (430 mg), is heated on a steam bath under nitrogen with 40 cc of a 60% aqueous solution of formic acid for about 30 minutes. About 40 cc of water is added and the mixture is then extracted into 200 cc of chloroform. The chloroform solution is washed with water, saturated sodium bicarbonate solution and water, then dried over sodium sulfate and evaporated under vacuum to give 430 mg of crude product. This is dissolved in 60 cc of absolute methanol, and 0.1 equivalent of sodium methoxide in methanol is added.

The mixture is stirred under nitrogen at room temperature for 15 minutes. It is then acidified with acetic acid and the solvent is removed under vacuum at room temperature. About 20 cc of water is added and the product is extracted into 150 cc of ethyl acetate. The ethyl acetate solution is washed with saturated sodium bicarbonate and then with water. It is then dried over sodium sulfate and taken to dryness to give an amorphous solid.

The crude product obtained above is dried in high vacuum and then dissolved in 4 cc of pyridine. About 3 cc of acetic anhydride is added. The mixture is then heated on the steam bath for about 15 minutes and then evaporated to dryness in vacuo. About 20 cc of water is added. The product is then extracted into 150 cc of ethyl acetate, washed with saturated sodium bicarbonate solution and water, and dried over sodium sulfate. The solvent is removed in vacuo to give a residue which is crystallized from ethyl acetate-benzene to yield about 250 mg of 11 β ,17 α ,21-trihydroxy-6,16 α -dimethyl-20-oxo-2'-phenyl-4,6-pregnadieno-[3,2-c] pyrazole 21-acetate, as described in U.S. Patent 3,300,483.

References

Merck Index 2513

Kleeman & Engel p. 248

OCDS Vol. 2 p. 191 (1980)

DOT 8 (10) 374 (1972)

I.N. p. 265

Tishler, M., Steinberg, N.G. and Hirschmann, R.F.; U.S. Patents 3,067,194; December 4, 1962; and 3,300,483; January 24, 1967; both assigned to Merck & Co., Inc.

CREATINOL FOSFATE

Therapeutic Function: Cardiotoxic

Chemical Name: 1-(2-Hydroxyethyl)-1-methylguanidine dihydrogen phosphate

Common Name: —

Structural Formula:

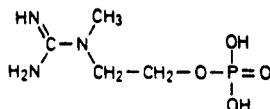

Chemical Abstracts Registry No.: 6903-79-3

Trade Name	Manufacturer	Country	Year Introduced
Aplodan	Simes	Italy	1968

Trade Name	Manufacturer	Country	Year Introduced
Dragosil	Farmasimes	Spain	—
Nergize	Byk Liprandi	Argentina	—

Raw Materials

Creatinol phosphate
Polyphosphoric acid

Manufacturing Process

In a reactor put 80 kg of polyphosphoric acid having the following composition: $H_5P_3O_{10}$ - 60%; $(HPO_3)_6$ - 10%; $H_4P_2O_7$ - 15%; $(HPO_3)_x$ - 10%; total content in P_2O_5 about 83%; this is heated to about 160°C.

Then 360 kg of creatinol phosphate are added to the polyphosphoric acid; continue to heat for about two hours under vacuum until the reaction water is eliminated.

The molten mass is then poured into ethanol at 95°C, the solution cooled down to 10°C and the precipitated product separated by centrifugation. The resulting product is dissolved in the minimum quantity of warm water and the solution poured into ethanol.

Thus 297 kg of the phosphoric ester of the creatinol are obtained having these characteristics: MP 240°C to 243°C.

References

Kleeman & Engel p. 249

I.N. p. 268

Allievi, E.; U.S. Patent 4,012,467; March 15, 1977

CROMOLYN SODIUM

Therapeutic Function: Bronchodilator

Chemical Name: 5,5'-(2-Hydroxy-1,3-propanediyl)bis-(oxy)] bis[4-oxo-4H-1-benzopyran-2-carboxylic acid] disodium salt

Common Name: Cromogycinic acid sodium salt; disodium cromogycate

Structural Formula:

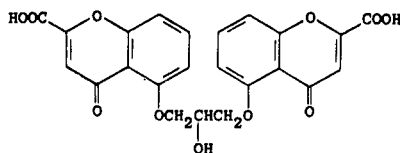

Chemical Abstracts Registry No.: 15826-37-6; 16110-51-3 (Base)

Trade Name	Manufacturer	Country	Year Introduced
Intal	Fisons	U.K.	1969
Intal	Fisons	W. Germany	1970
Lomudal	Fisons	Switz.	1970
Intal	Fujisawa	Japan	1971
Frenasma	Italseber	Italy	1971

Trade Name	Manufacturer	Country	Year Introduced
Lomudal	Fisons	France	1972
Intal	Fisons	U.S.	1973
Aarane	Fisons	U.S.	1973
Nalcrom	Fisons	Italy	1983
Aarane	Syntex	U.S.	—
Alercrom	Osiris	Argentina	—
Colimone	Fisons	W. Germany	—
Cromo-Asma	Aldo	Spain	—
Cusicrom	Cusi	Spain	—
Frenal	I.S.F.	Italy	—
Gastrofrenal	I.S.F.	Italy	—
Kromolin	Iltas	Turkey	—
Lomupren	Fisons	W. Germany	—
Nalcrom	Fisons	U.K.	—
Nasmil	Lusofarmaco	Spain	—
Nebulasma	Septa	Spain	—
Opticron	Fisons	France	—
Rynacrom	Fisons	U.K.	—

Raw Materials

2,6-Dihydroxyacetophenone	Epichlorohydrin
Diethyl oxalate	Sodium hydroxide

Manufacturing Process

To a solution of 970 parts of 2,6-dihydroxyacetophenone and 325 parts of epichlorohydrin in 1,500 parts of hot isopropanol was added, with stirring under reflux, a solution of 233 parts of 85% KOH in 2,500 parts of isopropanol and sufficient water (ca 100 parts) to dissolve the solid. The mixture was heated, with stirring, under reflux for 48 hours. Half the solvent was then distilled off and 5,000 parts of water were added. The mixture was cooled and the solid filtered off and washed with isopropanol and ether. It was then recrystallized from 12,500 parts of isopropanol to obtain a first crop of 380 parts and a second crop, after concentration, of 300 parts of 1,3-bis(2-acetyl-3-hydroxyphenoxy)-2-hydroxypropane.

4.6 parts of 1,3-bis(2-acetyl-3-hydroxyphenoxy)-2-hydroxypropane were reacted with diethyl oxalate and the product cyclized to obtain 4.4 parts of pure diethyl ester of 1,3-bis(2-carboxychromon-5-yloxy)-2-hydroxypropane as pale yellow crystals melting between 180° and 182°C from a mixture of benzene and petrol. 4 parts of the diethyl ester of 1,3-bis(2-carboxychromon-5-yloxy)-2-hydroxypropane were saponified with sodium hydroxide to obtain 3.2 parts of the disodium salt tetrahydrate as colorless crystals from aqueous alcohol.

References

- Merck Index 2580
- Kleeman & Engel p. 250
- PDR p. 876
- OCDS Vol. 3 pp. 66, 235 (1984)
- DOT 10 (7) 246 (1974) & 14 (7) 283 (1978)
- I.N. p. 19
- REM p. 1131
- Fitzmaurice, C. and Lee, T.B.; U.S. Patent 3,419,578; December 31, 1968; assigned to Fisons Pharmaceuticals Limited, England

CROTAMITON

Therapeutic Function: Scabicide

Chemical Name: N-ethyl-N-(2-methylphenyl)-2-butenamide

Common Name: Crotonyl-N-ethyl-o-toluidine

Structural Formula:

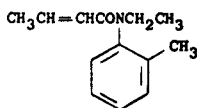

Chemical Abstracts Registry No.: 483-63-6

Trade Name	Manufacturer	Country	Year Introduced
Eurax	Ciba Geigy	France	1949
Eurax	Ciba Geigy	U.S.	1949
Crotan	Owen	U.S.	1982
Crotamitex	Tropon	W. Germany	—
Euraxil	Geigy	W. Germany	—
Servitamitone	Servipharm	Switz.	—
Veteusan	Veterinaria	Switz.	—

Raw Materials

Crotonyl chloride
N-Ethyl-o-toluidine

Manufacturing Process

10.5 parts of crotonyl chloride are dropped in such a manner into 27 parts of N-ethyl-o-toluidine, while stirring, that the temperature rises to 130° to 140°C. After cooling, the reaction product is dissolved in ether or other solvent that is immiscible with water, and the solution is washed successively with hydrochloric acid, alkali solution and water. After distilling off the solvent, the residue is distilled in vacuo. The crotonic-acid-N-ethyl-o-toluidide boils at 153° to 155°C at a pressure of 13 mm and is a slightly yellowish oil. Instead of carrying the reaction out in the presence of an excess of N-ethyl-o-toluidine, it may be carried out in the presence of an acid-combining agent, for example, potash, advantageously in a solvent (e.g., acetone).

References

Merck Index 2583
Kleeman & Engel p. 251
I.N. p. 269
REM p. 1239
British Patent 615,137; January 3, 1949; assigned to J.R. Geigy AG, Switzerland

CRYPTENAMINE TANNATES

Therapeutic Function: Antihypertensive

Chemical Name: Complex alkaloid mixture

Common Name: —

Structural Formula: $C_{32}H_{49}O_6N$ ·Tannate

Chemical Abstracts Registry No.: —

Trade Name	Manufacturer	Country	Year Introduced
Unitensen	Neisler	U.S.	1954

Raw Materials

Veratrum viride	Benzene
Triethylamine	Hydrogen chloride
Tannic acid	

Manufacturing Process

Initial Extraction Technique: Continuous extraction apparatus was employed, including an extractor designed to contain the starting plant materials, a distillation flask to hold the solvent mixture, the flask being equipped with a reflux condenser, a drip device to facilitate the removal of the volatilized mixture from the condenser and to percolate it through the continuous extractor, and a Soxhlet type return. Means for heating the continuous extraction system were provided.

1,000 g of *Veratrum viride* powder was placed in a continuous plant extractor and a mixture of 2,000 ml of benzene and 20 ml of triethylamine was poured over a *Veratrum* powder in the reactor and permitted to siphon into the distillation flask. Approximately 50 g of an inert desiccant (Drierite) was added to the distillation flask, heat applied to initiate the distillation of the reaction mixture in the flask, and the continuous extraction procedure continued for 8 hours, during which time constant, gentle heat was applied to insure refluxing of the mixture (about 80° to 90°C). The extraction procedure was discontinued and the contents of the distillation flask filtered. The resulting filtrate was concentrated by distilling off and recovering a large portion of the benzene solvent together with virtually all of the triethylamine base. 50 ml of the concentrated benzene solution was thus obtained.

Preparation of Alkaloid Mixture: 50 ml of the concentrated benzene solution, obtained as described was rapidly stirred, and a saturated solution of hydrogen chloride in ether added to the concentrated benzene solution until no more precipitate was obtained. The resulting precipitate was recovered by filtration and comprised the crude hydrochlorides of the extracted alkaloids and the hydrochloride of any unrecovered triethylamine. This material was dried by heating at a temperature of about 75°C for 6 hours, the crude, dried precipitate ground with 50 ml of isopropanol and to this slurry was added 1,000 ml of water. The resulting mixture was filtered. To the clear filtrate, cooled to 5°C, there was slowly added with rapid stirring, a 10% aqueous solution of ammonium hydroxide, until complete precipitation was accomplished. The precipitate was filtered off, washed with water and dried by heating at about 75°C for 6 hours.

There was thus obtained a mixture of *Veratrum viride* alkaloids having substantial utility as a hypertension reducing agent, without the concomitant marked side-actions normally associated with the clinical use of *Veratrum viride* extracts. This material may be clinically administered in this form, or further purification may be performed as described hereinafter.

Preparation of Alkaloid III: 100 g of the alkaloid mixture was dissolved in a liter of benzene and the resulting mixture filtered. The filtrate was diluted with approximately 4 liters of an aliphatic hydrocarbon solvent (Skellysolve B) and the resulting mixture filtered. The filtrate was cooled with Dry Ice to cause precipitation, and the alkaloid removed by filtration. There was thus obtained an alkaloid, which, for convenience, is called Alkaloid III, having analytical values consistent with a molecular formula $C_{32}H_{49}O_6N$, apparently an ester of a tertiary alkaline.

This material sinters at a temperature above about 125°C and melts at 130° to 135°C; UV absorption; λ maximum 255 μ , λ minimum 240 μ . It contains one ester group and no N-methyl groups.

Preparation of Alkaloid III Tannate: 20 g of Alkaloid III was dissolved in 200 ml of isopropyl alcohol at room temperature and a mixture of 30 g of tannic acid dissolved in 300 ml of isopropyl alcohol, maintained at 40° to 50°C was added thereto with rapid stirring. The mixture was cooled to 20°C, filtered and the precipitate dried at about 80°C. There was thus obtained 33.5 g of the tannate salt of Alkaloid III, as a pale yellow amorphous powder, relatively insoluble in water, and having an indefinite melting point.

References

Merck Index 2596

PDR p. 1875

I.N. p. 270

REM p. 850

Cavallito, C.J.; U.S. Patent 2,789,977; April 23, 1957; assigned to Irwin, Neisler and Company

CYAMEMAZINE

Therapeutic Function: Tranquilizer

Chemical Name: 10-[3-(dimethylamino)-2-methylpropyl]-10H-phenothiazine-2-carbonitrile

Common Name: Cyamepromazine

Structural Formula:

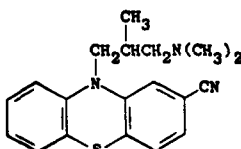

Chemical Abstracts Registry No.: 3546-03-0

Trade Name	Manufacturer	Country	Year Introduced
Terckian	Theraplix	France	1972

Raw Materials

3-Chlorophenthiazine

Cupric cyanide

Sodium amide

1-Dimethylamino-2-methyl-3-chloropropane

Manufacturing Process

The 3-cyanophenthiazine used as starting material can be prepared by the action of cupric cyanide on 3-chlorophenthiazine in boiling quinoline. It has a first melting point of about 185°C and a second of about 203° to 205°C.

A solution of 3-cyanophenthiazine (10 g) in anhydrous xylene (75 cc) is heated under reflux and treated with 95% sodamide (2.15 g). The heating is continued for 1 hour and

then a solution of 1-dimethylamino-2-methyl-3-chloropropene (7.05 g) in xylene (70 cc) is added over 15 minutes. The mixture is heated under reflux for 20 hours and then cooled. The reaction mixture is treated with water (40 cc) and N methane-sulfonic acid (75 cc). The xylene phase is removed and the aqueous phase is made alkaline with sodium hydroxide. The free base obtained is extracted with ether and the ethereal extracts are dried over anhydrous potassium carbonate and concentrated to dryness. The residue is distilled in vacuo. 3-Cyano-10-(3-dimethylamino-2-methylpropyl)phthiazine (8.5 g), BP 180° to 205°C/0.9 mm Hg, is thus obtained. The acid maleate prepared in and recrystallized from ethanol melts at 204° to 205°C.

References

Merck Index 2678

Kleeman & Engel p. 252

DOT 8 (6) 216 (1972)

I.N. p. 271

Jacob, R.M. and Robert, J.G.; U.S. Patent 2,877,224; March 10, 1959; assigned to Societe des Usines Chimiques Rhone-Poulenc, France

CYANOCOBALAMIN

Therapeutic Function: Hematinic

Chemical Name: 5,6-Dimethylbenzimidazolyl cyanocobamide

Common Name: Vitamin B₁₂

Structural Formula:

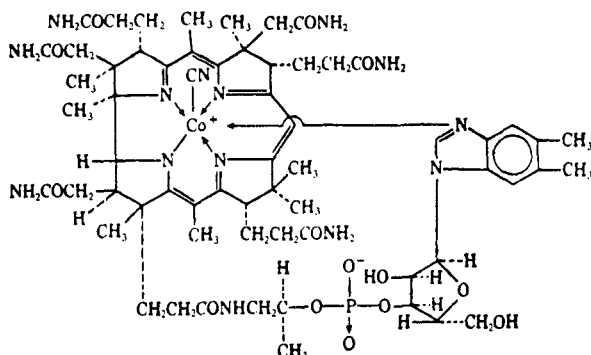

Chemical Abstracts Registry No.: 68-19-9

Trade Name	Manufacturer	Country	Year Introduced
Berubigen	Upjohn	U.S.	1949
Rubramin	Squibb	U.S.	1949
Bevidox	Abbott	U.S.	1949
Betalin	Lilly	U.S.	1949
Cobione	MSD	U.S.	1949
Docibin	National	U.S.	1950
Ducobee	Breon	U.S.	1950
Dodex	Organon	U.S.	1950
Be-Dodec	Schiefelin	U.S.	1950

Trade Name	Manufacturer	Country	Year Introduced
B-Twelvora	Sherman	U.S.	1950
Crystamin	Armour	U.S.	1951
Bexil	Conal	U.S.	1951
Redisol	MSD	U.S.	1951
Bevatine	Dorsey	U.S.	1953
Vibalt	Roerig	U.S.	1954
Bedoce	Lincoln	U.S.	1957
Vi-Twel	Cooper	U.S.	1960
Cyano-Gel	Maurry	U.S.	1961
Clarex	Minn. Pharm.	U.S.	1962
Cyredin	Merrell Nat	U.S.	1967
Feryl	Central	U.S.	1978
Dicopac	Kaken	Japan	1979
Anacobin	Allen & Hanburys	U.K.	—
Actamin	Yashima	Japan	—
Apavit B12	Locatelli	Italy	—
Antipernicin	Galenika	Yugoslavia	—
Arcavit B12	Arcana	Austria	—
Arcored	Arco	Switz.	—
Arphos	Fournier	France	—
Bedocefarm	Wolner	Spain	—
Bedodeka	Teva	Israel	—
Beduzin	Dincel	Turkey	—
Behapan	Kabi-Vitrum	Sweden	—
Berubi	Redel	W. Germany	—
Betolvex	Dumex	Denmark	—
Bexibee	N. American	U.S.	—
Bidocit	Ausonia	Italy	—
B12 Mille	Delagrangé	France	—
B12 Vicotrat	Heyl	W. Germany	—
Cabadon M	Reid-Provident	U.S.	—
Cincamil Bedoce	Andromaco	Spain	—
Cobalomin	S. Pacific	Australia	—
Cobalparen	Saarstickstoff-Fatoo	W. Germany	—
Cobavite	Lemmon	U.S.	—
Cocavitan	Coca	Spain	—
Copharvit	Cophar	Switz.	—
Cyanabin	Stickley	Canada	—
Cyanovit	Adrian-Marinier	France	—
Cykobemin	Kabi-Vitrum	Sweden	—
Cytakon	Glaxo	U.K.	—
Cytamen	Glaxo	U.K.	—
Cytobion	Merck	W. Germany	—
Dobetin	Angelini	Italy	—
Docetasan	Santos	Spain	—
Docivit	Robisch	W. Germany	—
Dodecabee	Miller	U.S.	—
Dodecavite	U.S.V.	U.S.	—
Dodevitina	C.T.	Italy	—
Eocill B12	Nessa	Spain	—
Ertamin	Erf-to-Chemie	W. Germany	—
Eritron	Manetti-Roberts	Italy	—
Eritrovit B12	Lisapharma	Italy	—
Erycytol	Sanabo	Austria	—
Fiviton B12	Alfar	Spain	—
Hemomin	Kirk	U.S.	—
Hemosalus	Totalfarm	Italy	—
Hepacon B12	Consolidated	U.K.	—

Trade Name	Manufacturer	Country	Year Introduced
Hepcovite	Endo	U.S.	—
Juvabe	Dolder	Switz.	—
Lifaton B12	Lifasa	Spain	—
Lophakomb B12	Lomapharm	W. Germany	—
Milbedoc	Andromaco	Spain	—
Millevit	Nordmark	W. Germany	—
Neo-Cytamen	Bilim	Turkey	—
Neurobaltina	Sidus	Italy	—
Neuro Liser B12	Perga	Spain	—
Nova-Rubi	Novar	Canada	—
Noventabedoce	Andromaco	Spain	—
Omeogen	UCB-Smit	Italy	—
Optovite B12	Normon	Spain	—
Permicipur	Mulli	W. Germany	—
Plentasal	Lopez-Brea	Spain	—
Primabalt	Primedics	U.S.	—
Rectocenga	Biotherax	France	—
Redamin	Washington	Italy	—
Reedvit	Celtia	Argentina	—
Retidex B12	Dexter	Spain	—
Rubesol	Central	U.S.	—
Rubraluy	Miluy	Spain	—
Ruvite	Savage	U.S.	—
Sancoba	Santen	Japan	—
Sorbevit B12	Casen	Spain	—
Sorbigen B12	Gentili	Italy	—
Surgevit	Maipe	Spain	—
Twel-Be	Pitman-Moore	U.S.	—
Vicapanbiz	Merckle	W. Germany	—
Viemín 12	Valeas	Italy	—
Vitarubin	Streuli	Switz.	—

Raw Materials

Milorganite (activated sewage sludge)	Sodium nitrite
Potassium cyanide	Hydrochloric acid

Manufacturing Process

The following is taken from U.S. Patent 3,057,851. Milorganite was extracted with water to obtain an aqueous extract containing vitamin B₁₂ active substances. This aqueous extract was purified by treatment with an ion exchange resin according to the following method. An aqueous extract of milorganite, 100 ml containing 300 µg of vitamin B₁₂ active substances and 4.5 grams of total solids, was combined with 0.5 gram of sodium nitrite and 0.4 gram of potassium cyanide. The resulting solution was adjusted to pH 4.0 with hydrochloric acid and heated to boiling. The boiled solution was filtered through a Super-Cel filter surface, and the filter was then washed with water. The filtrate was obtained in a total volume of 130 ml including the washings.

Amerlite XE-97, an ion exchange resin of the carboxyl type (Rohm and Haas), was classified to an average wet particle size of 100 to 150 mesh. The classified resin was utilized in the hydrogen form, and was not buffered during the ion exchange fractionation. The classified resin, in the amount of 35 ml, was packed into a glass column having a diameter of 25 mm and a height of 250 mm. The cyanide-treated aqueous extract of milorganite was infused gravitationally into the ion exchange bed at a rate of 3 ml per minute.

The effluent was discarded and the resin bed was then washed with the following solutions in the specified sequence: (1) 120 ml of an aqueous 0.1 N hydrochloric acid solution;

(2) 75 ml of an aqueous 85% acetone solution; and (3) 70 ml of an aqueous 0.1 N hydrochloric acid solution. After washing, the resin bed was eluted with an aqueous 60% dioxane solution containing 0.1 N of hydrochloric acid. In this elution, 8 ml of colored eluate was collected. This portion of the eluate was found to contain 295 μg of cyanocobalamin and 9 mg of total solids.

References

Merck Index 9822

Kleeman & Engel p. 252

PDR pp. 655, 785, 872, 905, 916, 966, 1083, 1603, 1989

I.N. p. 272

REM pp. 1020, 1022

Rickes, E.L. and Wood, T.R.; U.S. Patents 2,703,302 and 2,703,303; both dated March 1, 1955; both assigned to Merck & Co., Inc.

Speedie, J.D. and Hull, G.W.; U.S. Patent 2,951,017; August 30, 1960; assigned to The Distillers Company Limited, Scotland

McDaniel, L.E.; U.S. Patent 3,000,793; September 19, 1961; assigned to Merck & Co., Inc.

Long, R.A.; U.S. Patent 3,018,225; January 23, 1962; assigned to Merck & Co., Inc.

Van Melle, P.J.; U.S. Patent 3,057,851; October 9, 1962; assigned to Armour-Pharmaceutical

Bernhauer, K., Friedrich, W. and Zeller, P.; U.S. Patent 3,120,509; February 4, 1964; assigned to Hoffmann-La Roche Inc.

CYCLACILLIN

Therapeutic Function: Antibacterial

Chemical Name: 6-(1-aminocyclohexanecarboxamido)-3,3-dimethyl-7-oxo-4-thia-1-azabicyclo[3.2.0]heptane-2-carboxylic acid

Common Name: 6-(1-aminocyclohexanecarboxamido)penicillanic acid; 1-aminocyclohexylpenicillin; ciclacillin

Structural Formula:

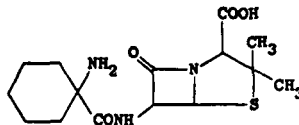

Chemical Abstracts Registry No.: 3485-14-1

Trade Name	Manufacturer	Country	Year Introduced
Ultracillin	Gruenthal	W. Germany	1972
Wybital	Wyeth	Japan	1972
Vastollin	Takeda	Japan	1972
Ultracillin	Gruenthal	Switz.	1973
Cyclapen	Wyeth	U.S.	1979
Calthor	Ayerst	U.K.	1980
Bionacillin-C	Takata	Japan	—
Citocilina	Medinsa	Spain	—
Citosarin	Toyo Jozo	Japan	—
Orfilina	Orfi	Spain	—
Peamezin	Sawai	Japan	—
Syngacillin	Wyeth	—	—
Vasticillin	Takeda	Japan	—
Vipicil	Wyeth	—	—

Raw Materials

6-Aminopenicillanic acid
1-Amino-1-cyclohexane carboxylic acid chloride

Manufacturing Process

To 21.6 g (0.10 mol) of 6-aminopenicillanic acid (6-APA) and 213 ml of methylene chloride in a dry 500 ml 3-neck flask fitted with stirrer, thermometer, nitrogen inlet and reflux condenser with drying tube, 25.3 g (0.25 mol) of triethylamine and 13.4 g (0.11 mol) of N,N-dimethylaniline were added. After stirring at reflux for one hour, the mixture was cooled and 21.7 g (0.20 mol) of trimethylchlorosilane was added dropwise at 12° to 15°C.

The mixture was refluxed for 45 minutes, cooled under nitrogen, and 19.8 g (0.10 mol) of 1-amino-1-cyclohexane-carboxylic acid chloride HCl was added portionwise at -10°C over 20 minutes. The mixture was stirred for an additional hour while the temperature rose to 20°C. The reaction mixture was poured into 200 ml of cold water with stirring and the two-phase mixture clarified by filtration. Dilute sodium hydroxide solution was added to the filtrate at 5° to 10°C to pH 5.4.

After stirring overnight at room temperature, the crystalline product was collected by filtration, washed with water and finally with acetone, and then dried at 45°C; yield of hydrate, 29.9 g or 79% of theory based on 6-APA; iodometric assay, 922 mcg per mg; bioassay, 921 mcg per mg, as described in U.S. Patent 3,478,018.

References

- Merck Index 2693
Kleeman & Engel p. 205
PDR p. 1945
OCDS Vol. 2 p. 439 (1980)
DOT 8 (5) 168 (1972)
I.N. p. 230
REM p. 1200
Alburn, H.E., Grant, N.H. and Fletcher, H. III; U.S. Patent 3,194,802; assigned to American Home Products Corporation
Robinson, C.A. and Nescio, J.J.; U.S. Patent 3,478,018; November 11, 1969; assigned to American Home Products Corporation

CYCLAMATE CALCIUM

Therapeutic Function: Nonnutritive sweetener

Chemical Name: Cyclohexylsulfamic acid calcium salt

Common Name: —

Structural Formula:

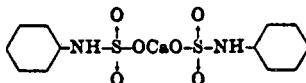

Chemical Abstracts Registry No.: 139-06-0

Trade Name	Manufacturer	Country	Year Introduced
Sucaryl Calcium	Abbott	U.S.	1953
Sucaryl Calcium	Abbott	France	1966

Raw Materials

Cyclohexylamine
 Ammonium sulfamate
 Calcium hydroxide

Manufacturing Process

220 parts by weight, 2.22 mols, of cyclohexylamine and 57 parts by weight, 0.50 mol, of ammonium sulfamate were mixed at room temperature and heated with agitation. At the end of one-half hour of heating the temperature had reached 110°C and approximately one-half mol of ammonia had been evolved. Heating was continued under reflux at 133°C for 22 additional hours. A second half-mol of ammonia was liberated. The ammonia yield was 100%.

The reaction mixture was cooled to 100°C. To the mixture was added a water slurry containing 20.3 parts by weight, 0.55 equivalent, of calcium hydroxide and 700 parts by weight of water. Cyclohexylamine was then removed by azeotropic distillation with water.

The amine which was recovered can be reused after drying.

The residue from the distillation was evaporated to dryness in a vacuum oven at 50°C and the resulting product analyzed. The product weighing 105.5 parts by weight, 0.488 equivalent, was obtained which is a 98% yield of the technical calcium cyclohexylsulfamate dihydrate.

References

Merck Index 1636

I.N. p. 273

Cummins, E.W. and Johnson, R.S.; U.S. Patent 2,799,700; July 16, 1957; assigned to E.I. du Pont de Nemours & Co.

McQuaid, H.S.; U.S. Patent 2,804,477; August 27, 1957; assigned to E.I. du Pont de Nemours & Co.

Freifelder, M.; U.S. Patent 3,082,247; March 19, 1963; assigned to Abbott Laboratories

Birsten, O.G. and Rosin, J.; U.S. Patents 3,361,798; January 2, 1968; and 3,366,670; January 30, 1968; both assigned to Baldwin-Montrose Chemical Co., Inc.

CYCLANDELATE

Therapeutic Function: Antispasmodic

Chemical Name: α -hydroxybenzeneacetic acid 3,3,5-trimethylcyclohexyl ester

Common Name: 3,3,5-trimethylcyclohexyl mandelate

Structural Formula:

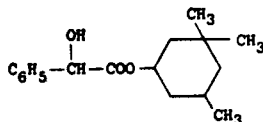

Chemical Abstracts Registry No.: 456-59-7

Trade Name	Manufacturer	Country	Year Introduced
Cyclospasmol	Ives	U.S.	1958
Cyclospasmol	Beytout	France	1972
Acyclin	Arcana	Austria	—

Trade Name	Manufacturer	Country	Year Introduced
Anaspat	I.C.I.	Italy	—
Anticen	Nippon Kayaku	Japan	—
Aposelebin	Hokuriku	Japan	—
Capilan	Takeda	Japan	—
Capistar	Kowa	Japan	—
Ceaclan	Mohan	Japan	—
Cepidan	Meiji	Japan	—
Circle-One	Funai	Japan	—
Circulat	Kozani	Japan	—
Cyclan	Ohta	Japan	—
Cyclan-Cap	Nichiiko	Japan	—
Cyclansato	S.S. Pharm.	Japan	—
Cycleat Cap	Hishiyama	Japan	—
Cyclobral	Norgine	U.K.	—
Cyclolyt	Taro	Israel	—
Hacosan	Sankyo	Japan	—
Hi-Cyclane Cap	Tyama	Japan	—
Lisospasm	Chibi	Italy	—
Mandelic	Seiko	Japan	—
Marucyclan	Maruko	Japan	—
Mitalon	Toyo	Japan	—
Newcellan	Kowa	Japan	—
Perebral	Biopharma	France	—
Salciate	Morishita	Japan	—
Sancyclan	Santen	Japan	—
Sepyron	Sankyo	Japan	—
Spadellate	Zeria	Japan	—
Spasmione	Ravizza	Italy	—
Spasmocyclon	Kettelhack Riker	W. Germany	—
Syklandal	Orion	Finland	—
Vasodyl	Morrith	Spain	—
Vasosyklan	Farmos	Finland	—
Venala	Mochida	Japan	—
Zirkulat	Nippon Shoji	Japan	—

Raw Materials

dl-Mandelic acid
3,3,5-Trimethylcyclohexanol

Manufacturing Process

50 g of dl-mandelic acid are heated for 6 hours at approximately 100°C with 50 g of 3,3,5-trimethylcyclohexanol (mixture of cis and trans isomers), while passing dry hydrochloric acid gas as a catalyst through the mixture. The reaction product is subsequently poured out into water. After neutralization with potassium bicarbonate the ester is extracted with ether. The ether extract is dried with sodium sulfate, the ether is distilled off and the residue is distilled in vacuo. The fraction, which has a boiling point of 192° to 194°C at 14 mm, consists of the 3,3,5-trimethylcyclohexyl ester of mandelic acid, which is obtained in a yield of about 70%. The liquid solidifies to a colorless solid substance having a melting point of 50° to 53°C, according to U.S. Patent 2,707,193.

It has been found that crude cyclandelate may be purified by the following procedure. Crude cyclandelate is dissolved in a solvent chosen for convenience from the class of saturated hydrocarbons. The crude cyclandelate solution is stirred for a suitable interval, typically 1 to 5 hours, with an aqueous solution of sodium borohydride (NaBH₄) at temperatures ranging from 25° to 65°C. The preferred temperature range is 40° to 50°C. The pH of the solution may be adjusted to any desired level in the range between 2.5 to 11.5. The preferred pH range is 8.0 to 11.0 because at lower pH levels borohydride is unstable

and decomposes rapidly. The amount of sodium borohydride used ranges from about 0.5 to 2.0 wt % of the amount of cyclandelate present.

At the end of the stirring period cyclandelate is recovered by well-known procedures. For instance, the aqueous organic layers may be separated gravimetrically and the product organic layer washed with an appropriate solvent and then distilled, according to U.S. Patent 3,663,597.

References

Merck Index 2695

Kleeman & Engel p. 254

PDR pp. 1606, 1947, 1999

OCDS Vol. 1 p. 94 (1977)

I.N. p. 273

REM p. 852

Flitter, D.; U.S. Patent 3,663,597; May 16, 1972; assigned to American Home Products Corporation

Nauta, W.T.; U.S. Patent 2,707,193; April 26, 1955; assigned to N.V. Koninklijke Pharmaceutische Fabrieken Voorbeem Brocades-Stheeman & Pharmacia, Netherlands

CYCLARBAMATE

Chemical Name: 1,1-Dimethylol cyclopentane N,N'-diphenyl-dicarbamate

Common Name: Cyclopentaphene

Structural Formula:

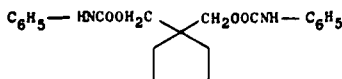

Chemical Abstracts Registry No.: 5779-54-4

Trade Name	Manufacturer	Country	Year Introduced
Casmalon	Cassenne	France	1961

Raw Materials

1,1-Dimethylol cyclopentane

Phenyl isocyanate

Manufacturing Process

This compound is obtained by heating a mixture of 1,1-dimethylol cyclopentane and phenyl isocyanate at a temperature of 85°C to 90°C for one-half hour. The resultant product is washed with petroleum ether, recrystallized from methanol, dissolved in acetone (impurities are filtered off) and recrystallized from acetone.

The compound appears in the form of a white powder or of needle-shaped crystals (MP = 147°C to 149°C), which are tasteless and odorless.

References

Merck Index 2696

I.N. p. 274

Rosenberg, E.E.; U.S. Patent 3,067,240; December 4, 1962; assigned to Laboratoires Cassenne (France)

CYCLIZINE

Therapeutic Function: Antinauseant

Chemical Name: 1-diphenylmethyl-4-methylpiperazine

Common Name: —

Structural Formula:

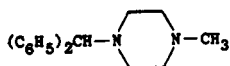

Chemical Abstracts Registry No.: 82-92-8; 303-25-3 (Hydrochloride)

Trade Name	Manufacturer	Country	Year Introduced
Marezine	Burroughs-Wellcome	U.S.	1953
Marzine	Wellcome	France	1965
Bon Voyage	Cupal	U.K.	—
Cleamine	Kodama	Japan	—
Echnatol	Gerot	Austria	—
Fortravel	Chemofux	Austria	—
Happy Trip	Mepros	Neth.	—
Maremal	Gayoso Wellcome	Spain	—
Migwell	Wellcome	France	—
Motozina	Biomedica Foscama	Italy	—
Reis-Fit	A.P.F.	Neth.	—
Valoid	Burroughs-Wellcome	U.K.	—

Raw Materials

Benzhydryl chloride
N-Methyl piperazine

Manufacturing Process

One-tenth mol (20 g) of benzhydryl chloride was mixed with 0.19 mol (19 g) of N-methyl-piperazine and about 10 cc of benzene and the whole was heated on the steam bath four hours. The contents of the flask was partitioned between ether and water, and the ethereal layer was washed with water until the washings were neutral. The base was then extracted from the ethereal layer by N hydrochloric acid and the extract, made acid to Congo red paper, was evaporated under vacuum. 29.5 g of the pure dihydrochloride of N-methyl-N'-benzhydryl piperazine was recovered from the residue by recrystallization from 95% alcohol melting above 250°C with decomposition.

The addition of alkali to an aqueous solution of the dihydrochloride liberated the base which was recovered by recrystallization from petroleum ether melting at 105.5° to 107.5°C.

References

Merck Index 2703
Kleeman & Engel p. 254
PDR p. 754
OCDS Vol. 1 p. 58 (1977)
I.N. p. 274
REM p. 807
Baltzly, R. and Castillo, J.C.; U.S. Patent 2,630,435; March 3, 1953; assigned to Burroughs Wellcome & Co. (U.S.A.) Inc.

CYCLOBENZAPRINE

Therapeutic Function: Muscle relaxant

Chemical Name: 5-(3-Dimethylaminopropylidene)-dibenzo [a,e] cycloheptatriene

Common Name: —

Structural Formula:

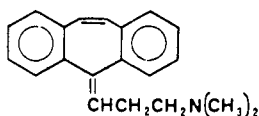

Chemical Abstracts Registry No.: 303-53-7; 6202-23-9 (Hydrochloride)

Trade Name	Manufacturer	Country	Year Introduced
Flexeril	Merck Sharp & Dohme	U.S.	1977

Raw Materials

Dibenzo [a,d] cycloheptene-5-one	Magnesium
3-Dimethylaminopropyl chloride	Hydrogen chloride

Manufacturing Process

In an initial step, dibenzo [a,d] cyclohepten-5-one is reacted with the Grignard reagent of 3-dimethylaminopropyl chloride and hydrolyzed to give 5-(3-dimethylaminopropyl)-dibenzo [a,d] - [1,4] cycloheptatriene-5-ol. Then 13 g of that material, 40 ml of hydrochloric acid, and 135 ml of glacial acetic acid is refluxed for 3½ hours. The solution is then evaporated to dryness in vacuo and added to ice water which is then rendered basic by addition of ammonium hydroxide solution. Extraction of the basic solution with chloroform and removal of the solvent from the dried chloroform extracts yields the crude product which when distilled in vacuo yields essentially pure 5-(3-dimethylaminopropylidene)-dibenzo [a,d] [1,4] cycloheptatriene, BP 173°C to 177°C at 1.0 mm.

References

Merck Index 2706

DFU 2 (5) 299 (1977)

Kleeman & Engel p. 255

PDR p. 1178

OCDS Vol. 3 p. 77 (1984)

DOT 14 (12) 467 (1978)

I.N. p. 275

REM p. 926

Villani, F.J.; U.S. Patent 3,409,640; November 5, 1968; assigned to Schering Corporation

CYCLOBUTYROL

Therapeutic Function: Choleric

Chemical Name: α -(Hydroxy-1-cyclohexyl) butyric acid

Common Name: —

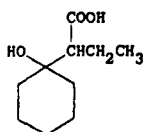
Structural Formula:**Chemical Abstracts Registry No.:** 512-16-3

Trade Name	Manufacturer	Country	Year Introduced
Hebucol	Logeais	France	1957
Bas-Bil	Isola-Ibi	Italy	—
Citoliver	Bayropharm	Italy	—
Cytinium	Roques	France	—
Dibilene	Logeais	France	—
Epo-Bon	Sierochimica	Italy	—
Juwallax	Pierrel	Italy	—
Lipotrin	Eisai	Japan	—
Riphole N	Nichiko	Japan	—
Secrobil	Medital	Italy	—
Tribil	Biol. Italia	Italy	—
Tribilina	Farge	Italy	—
Trommogalloi	Trommsdorf	W. Germany	—

Raw Materials

Cyclohexanone	Zinc
Ethyl α -bromobutyrate	Sulfuric acid
Barium hydroxide	

Manufacturing Process

Into a balloon flask with two lateral necks furnished with an efficient mechanical agitator and protected from moisture by a calcium chloride guard, there are introduced 12 g (0.185 mol) of pure powdered zinc and 20 ml of a solution of 16.6 g (0.17 mol) of anhydrous cyclohexanone and 31.5 g (0.16 mol) of ethyl α -bromobutyrate in 25 ml of anhydrous benzene. With vigorous stirring in a manner to put the zinc into suspension, the balloon flask is gradually heated in an oil bath to 100°C to 105°C. After a few minutes, a reaction starts, causing violent boiling which is maintained while adding the balance of the reactants. Boiling is then continued for one hour. After cooling, the reaction mixture is turned into a beaker containing 30 ml of sulfuric acid to half (by volume) with ice. After agitation, the mixture is decanted into a container for separation. The aqueous phase is reextracted with benzene. The pooled benzene solutions are washed with dilute (10%) cold sulfuric acid, then with cold sodium carbonate (5%) and then with ice water, and dried over anhydrous sodium sulfate. The benzene is evaporated and the ester, which is ethyl α -(hydroxy-1-cyclohexyl) butyrate, is distilled off under reduced pressure. The yield obtained was 17 to 19 g or 49% to 55%.

The ester was saponified with baryta in aqueous methanol as follows:

21.5 g (0.1 mol) of the above ethyl ester is saponified by boiling under reflux for 4 hours, while agitating, with 30 g (0.095 mol) of barium oxide hydrated to 8H₂O in 250 ml of a mixture of equal volumes of methanol and water. After concentration to one-half its volume under reduced pressure and filtration, the aqueous solution is washed with ether and then acidified at 0°C with 10% hydrochloric acid. The acid liberated in oily form is extracted with ether. The ether is washed with water, dried and evaporated. The yield is 75–80% (14–15 g of crude acid) which crystallizes spontaneously little by little. It can be crystallized in a mixture of ether and petroleum ether (1:10) or, with better yield, in light gasoline or oil (solubility of the pure acid ranges from 0.3% at 0°C to 100% at the boiling point). The yield of crystals is 75–80%. The α -(hydroxy-1-cyclohexyl) butyric acid thus obtained is a colorless crystalline product with a melting point of 81°C to 82°C.

References

Merck Index 2709

Kleeman & Engel p. 256

I.N. p. 275

Maillard, J.G.A.E., Morin, R.M. and Benard, M.M.M.; U.S. Patent 3,065,134; November 20, 1962; assigned to Societe d'Exploitation des Laboratoires Jacques Logeais (S.A.R.L.) (France)

CYCLOFENIL

Therapeutic Function: Ovulation stimulant

Chemical Name: 4-[[4-(acetyloxy)phenyl] cyclohexylidene]methyl] phenol acetate

Common Name: p,p'-diacetoxybenzhydrylidene cyclohexane

Structural Formula:

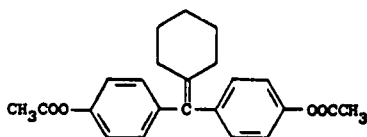

Chemical Abstracts Registry No.: 2624-43-3

Trade Name	Manufacturer	Country	Year Introduced
Ondogyne	Roussel	France	1970
Sexovid	Teikoku Hormon	Japan	1972
Fertodur	Schering	W. Germany	1972
Ondonvid	Roussel	U.K.	1972
Fertodur	Schering	Italy	1974
Klofenil	Yurtoglu	Turkey	—
Neoclym	Poli	Italy	—
Sexovid	Ferrosan	Sweden	—

Raw Materials

p-Bromoanisole	Ammonium chloride
p-Hydroxyphenyl cyclohexyl ketone	Magnesium
Potassium hydroxide	Acetic anhydride

Manufacturing Process

(A) *Preparation of p-Hydroxy-p'-Methoxybenzhydrylidene cyclohexane:* To a Grignard solution prepared from 110 g of magnesium (4.5 mols) and 840 g of p-bromoanisole (4.5 mols) in one liter of anhydrous ether, there was added dropwise with vigorous agitation 307 g of p-hydroxyphenyl cyclohexyl ketone (1.5 mols) dissolved in one liter of anhydrous ether. Upon completion of the addition the reaction mixture was refluxed for 2.5 hours with agitation, and was then cooled. Thereupon 15 mols of ammonium chloride dissolved in 3 liters of water were added. The ethereal layer was separated, washed with water, dried over anhydrous sodium sulfate and distilled. Yield: 370 g. BP 180° to 190°C at 0.1 mm. The substance was recrystallized from a mixture of carbon tetrachloride and petroleum ether. MP 145° to 146°C.

(B) *Preparation of p,p'-Dihydroxybenzhydrylidene cyclohexane:* A mixture of 118 g of

p-hydroxy-p'-methoxybenzhydrylidencyclohexane (0.4 mol), 120 g of potassium hydroxide pellets and 500 ml of triethylene glycol was stirred 4 hours at 220°C. When the reaction mixture was poured into water the substance crystallized, and the crystals were filtered off and washed with water. The substance was then recrystallized from a mixture of ethanol and petroleum ether. Yield: 104 g. MP 235° to 236°C.

(C) Preparation of p,p'-Diacetoxybenzhydrylidencyclohexane: 56 g of p,p'-dihydroxybenzhydrylidencyclohexane (0.2 mol) was mixed with 250 ml of acetic anhydride and 500 ml of pyridine. The mixture was refluxed for 2 hours and was then poured into water, the substance crystallizing out. The crystals were filtered off and washed with water. Finally the substance was recrystallized from ethanol. Yield: 62 g. MP 135° to 136°C.

References

Merck Index 2714

Kleeman & Engel p. 256

DOT 7 (1) 11 (1971)

I.N. p. 275

Olsson, K.G., Wahlstam, H.E.A., Sundbeck, B., Barany, E.H. and Miquel, J.F.; U.S. Patent 3,287,397; November 22, 1966

CYCLOMETHYCAINE

Therapeutic Function: Topical anesthetic

Chemical Name: 4-(cyclohexyloxy)benzoic acid 3-(2-methyl-1-piperidiny)propyl ester

Common Name: —

Structural Formula:

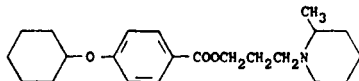

Chemical Abstracts Registry No.: 139-62-8

Trade Name	Manufacturer	Country	Year Introduced
Surfacaine	Lilly	U.S.	1948
Topocaine	Lilly	—	—

Raw Materials

Ethyl p-hydroxybenzoate	Sodium
Cyclohexyl bromide	Sodium hydroxide
3-(2'-Methylpiperidino)propyl chloride	

Manufacturing Process

7.4 g of sodium are dissolved in 250 cc of isoamyl alcohol, 53 g of ethyl p-hydroxybenzoate are added and the mixture is heated to refluxing temperature for about 15 minutes. To the cooled mixture, 65 g of cyclohexyl bromide are added and the mixture is refluxed for about 3 hours. The isoamyl alcohol is removed by evaporation in vacuo and the residue is extracted with 10% aqueous sodium hydroxide solution to remove the unreacted ethyl p-hydroxybenzoate.

The alkali-insoluble residue comprising ethyl p-cyclohexyloxybenzoate is hydrolyzed by refluxing with 10% sodium hydroxide solution for about 3 hours. The alkaline reaction mixture is acidified with hydrochloric acid whereupon p-cyclohexyloxybenzoic acid precipitates. The precipitate is separated by filtration, washed with water and dried. It melts at about 178° to 180°C. Yield: about 7%.

62 g of p-cyclohexyloxybenzoic acid and 49.5 g of 3-(2'-methylpiperidino)-propyl chloride are dissolved in 300 cc of dry isopropanol and the mixture refluxed for about 12 hours. About half of the isopropanol is then distilled off and the residual solution cooled to about 0°C. 3(2'-methylpiperidino)-propyl p-cyclohexyloxybenzoate hydrochloride precipitates as a white crystalline compound. It is filtered off, washed once with ether and recrystallized from isopropanol.

3(2'-Methylpiperidino)-propyl p-cyclohexyloxybenzoate hydrochloride thus prepared melted at about 178° to 180°C. Analysis showed the presence of 8.88% chlorine as compared with the calculated value of 8.96%.

References

Merck Index 2729

Kleeman & Engel p. 257

OCDS Vol. 1 p. 14 (1977)

I.N. p. 276

REM p. 1055

McElvain, S.M. and Carney, T.P.; U.S. Patent 2,439,818; April 20, 1948

CYCLOPENTAMINE HYDROCHLORIDE

Therapeutic Function: Vasoconstrictor

Chemical Name: N- α -dimethylcyclopentaneethanamine hydrochloride

Common Name: Cyclopentadrine

Structural Formula:

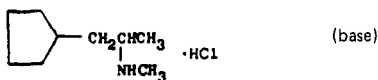

Chemical Abstracts Registry No.: 102-45-4 (Base)

Trade Name	Manufacturer	Country	Year Introduced
Clopene	Lilly	U.S.	1951
Cyclonaranol	Hepatrol	France	—
Nazett	A.L.	Norway	—

Raw Materials

Cyclopentanone	Magnesium
Cyanoacetic acid	Methyl iodide
Ammonium acetate	Methylamine
Hydrogen	Hydrogen chloride

Manufacturing Process

A mixture of 126 g (1.5 mols) of cyclopentanone, 128 g (1.5 mols) cyanoacetic acid, 31 g (0.5 mol) of ammonium acetate and 200 cc of dry benzene is heated under a refluxing

condenser and a water trap. The mixture is refluxed for about 12 hours after which time no more water collects in the trap, and the formation of cyclopentylideneacetonitrile is complete. The reaction mixture comprising a mixture of cyclopentylideneacetonitrile and cyclopentylideneacetic acid is washed with about one liter of 2% hydrochloric acid and the benzene layer is separated and the mixture is distilled to cause decarboxylation of the cyclopentylideneacetic acid present. The distillate comprising cyclopentylideneacetonitrile which boils at 172° to 175°C is purified by distillation.

A mixture of 53.5 g (0.5 mol) of cyclopentylideneacetonitrile dissolved in 50 cc of absolute ethanol and 0.5 g of a palladium-carbon catalyst is hydrogenated with hydrogen at a pressure of about 40 lb for about 3 hours. An additional amount of 0.8 g of palladium-carbon catalyst is then added and the hydrogenation continued for about 4 hours during which time the reduction is substantially completed and the cyclopentylideneacetonitrile is converted to cyclopentylacetonitrile. The reaction mixture is filtered to remove the catalyst and the alcohol is evaporated in vacuo.

The residue comprising chiefly cyclopentylacetonitrile is washed with dilute hydrochloric acid to remove any amine which may have been formed during the hydrogenation process, and the organic residue comprising cyclopentylacetonitrile is dissolved in ether, the ether solution dried over anhydrous magnesium sulfate and distilled. The cyclopentylacetonitrile boils at 185° to 187°C and has a refractive index of $n_D^{25} = 1.4456$.

To an ethereal solution of methyl magnesium iodide prepared from 26.7 g (1.1 mols) of magnesium and 160 g (1.13 mols) of methyl iodide in 200 cc of dry ether, is added a solution of 79 g (0.72 mol) of cyclopentylacetonitrile in 100 cc of dry ether. The reaction mixture is refluxed for 4 hours. The reaction mixture is then decomposed with ice in the usual way, and the ether layer containing the cyclopentylacetone is separated, is dried over anhydrous magnesium sulfate and the ether removed by evaporation. The residue comprising cyclopentylacetone is purified by distillation in vacuo. The cyclopentylacetone boils at 82° to 84°C at about 32 mm pressure.

A mixture of 75 g (0.6 mol) of cyclopentylacetone, 75 g (2.4 mols) of methylamine, and 10 g of Raney nickel catalyst is placed in a high pressure bomb previously cooled to a temperature below -6°C, and hydrogen is admitted under an initial pressure of about 2,000 psi. The bomb is then heated to about 135° to 150°C for about 2 hours, during which time reductive amination takes place and 1-cyclopentyl-2-methylaminopropane is produced. During the period of heating the reaction mixture is agitated by rocking the bomb. The bomb is then cooled and opened thus permitting the escape of hydrogen and most of the excess methylamine. The reaction mixture is filtered to remove the nickel catalyst and the filtrate comprising 1-cyclopentyl-2-methylaminopropane is purified by distillation under reduced pressure. 1-Cyclopentyl-2-methylaminopropane boils at 83° to 86°C at about 30 mm pressure.

1-Cyclopentyl-2-methylaminopropane thus produced is a colorless liquid of slightly ammoniacal odor. It has a refractive of $n_D^{25} = 1.4500$. Analysis showed the presence of 9.79% N as compared with a calculated value of 9.99% N.

141 g (1 mol) of 1-cyclopentyl-2-methylaminopropane are dissolved in 500 cc of dry ether, and dry hydrogen chloride is passed into the solution until the weight of the mixture and container has increased by 36 g. During the addition of the hydrogen chloride, the hydrochloric acid addition salt of 1-cyclopentyl-2-methylaminopropane precipitates as a white powder. The salt is filtered off and washed with dry ether. 1-Cyclopentyl-2-methylaminopropane hydrochloride thus prepared melts at about 113° to 115°C. The yield is practically quantitative.

References

Merck Index 2733

Kleeman & Engel p. 258

I.N. p. 277

Rohrmann, E.; U.S. Patent 2,520,015; August 22, 1950; assigned to Eli Lilly and Company

CYCLOPENTOLATE HYDROCHLORIDE

Therapeutic Function: Anticholinergic (ophthalmic)

Chemical Name: α -(1-hydroxycyclopentyl)benzene-acetic acid 2-(dimethylamino)ethyl ester hydrochloride

Common Name: —

Structural Formula:

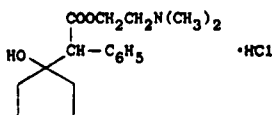

Chemical Abstracts Registry No.: 5870-29-1; 512-15-2 (Base)

Trade Name	Manufacturer	Country	Year Introduced
Cyclogyl	Schieffelin	U.S.	1953
Cyplegin	Santen	Japan	1972
Skiacol	P.O.S.	France	1976
Pentolair	Pharmafair	U.S.	1983
Ciclolux	Tubi Lux Pharma	Italy	—
Cicloplegic	Frumtost	Spain	—
Colircusi Ciclopejico	Cusi	Spain	—
Cyclomydrin	Alcon	U.S.	—
Cyclopen	Irving	Australia	—
Cyclopentol	Cusi	Belgium	—
Mydplegic	Cooper Vision	Puerto Rico	—
Mydrilate	W.B. Pharm.	U.K.	—
Oftan-Syklo	Star	Finland	—
Zykolate	Mann	W. Germany	—

Raw Materials

Sodium phenyl acetate	Magnesium
Isopropyl bromide	Cyclopentanone
β -Chloroethyl dimethylamine	

Manufacturing Process

To a well stirred suspension of 9 g of sodium phenyl acetate and 2.4 g of magnesium turnings in 25 cc of anhydrous ether, a solution of 9.4 cc of isopropyl bromide in 50 cc of anhydrous ether are added. The mixture is refluxed for one hour (during which time propane is evolved) and then 5 cc of cyclopentanone in 25 cc of anhydrous ether are added dropwise. The mixture is then refluxed for one hour and poured over ice water containing some hydrochloric acid. The ether solution is separated and extracted with 200 cc of 5% sodium hydroxide. The alkaline solution on acidification gives the free acid which is filtered off, dried in a desiccator and recrystallized from a mixture of ethylene dichloride and petroleum ether.

The product is 2-phenyl-2-(1-hydroxycyclopentyl)ethanoic acid, melting at 95° to 97°C. Of this product, 4.5 g in 30 cc of dry isopropyl alcohol are refluxed for 16 hours with 2.5 g of β -chloroethyl dimethyl amine. The solution is cooled and filtered clear from the solid by-product. The solvent is removed under reduced pressure on the steam bath and the residue is washed with anhydrous ether. It is dissolved in ethyl acetate from which it crystallizes. It is the hydrochloride of β -(dimethylamino)ethyl ester of 2-phenyl-2-(1-hydroxycyclopentyl) ethanoic acid, melting at 134° to 136°C.

References

Merck Index 2740

Kleeman & Engel p. 259

OCDS Vol. 1 p. 92 (1977)

I.N. p. 277

REM p. 914

Treves, G.R.; U.S. Patent 2,554,511; May 29, 1951; assigned to Schieffelin & Co.

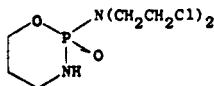
CYCLOPHOSPHAMIDE**Therapeutic Function:** Antineoplastic**Chemical Name:** N,N-Bis(2-chloroethyl)tetrahydro-2H-1,3,2-oxazaphosphorin-2-amine-2-oxide**Common Name:** Cyclophosphane; cytophospane**Structural Formula:****Chemical Abstracts Registry No.:** 50-18-0

Trade Name	Manufacturer	Country	Year Introduced
Cytosan	Mead Johnson	U.S.	1959
Endoxan	Lucien	France	1960
Neosar	Adria	U.S.	1982
Carloxan	Laake	Finland	—
Cicloblastina	Montedison	W. Germany	—
Cyclostin	Farm. Carlo Erba	Italy	—
Cytophosphan	Taro	Israel	—
Edoxana	Asta	W. Germany	—
Edoxana	W.B. Pharm.	U.K.	—
Genoxal	Funk	Spain	—
Procytox	Horner	Canada	—
Sendoxan	Pharmacia	Sweden	—

Raw MaterialsN,N'-Bis(β -chloroethyl)phosphoric acid amide dichloride

Triethylamine

1,3-Propanolamine

Manufacturing Process

A solution of 7.5 g ($\frac{1}{10}$ mol) of 1,3-propanolamine and 20.2 g of triethylamine in 100 cc of absolute dioxane is added dropwise at 25°C to 30°C while stirring well to a solution of 25.9 g ($\frac{1}{10}$ mol) of N,N-bis-(β -chloroethyl)-phosphoric acid amide dichloride in 100 cc of absolute dioxane. After the reaction is complete, the product is separated from the precipitated triethylamine hydrochloride and the filtrate is concentrated by evaporation in waterjet vacuum at 35°C. The residue is dissolved in a large amount of ether and mixed to saturation with water. The N,N-bis-(β -chloroethyl)-N,O-propylene phosphoric acid diamide crystallizes out of the ethereal solution, after it has stood for some time in a refrigerator, in the form of colorless water-soluble crystals. MP 48°C to 49°C. Yield: 65% to 70% of the theoretical.

References

Merck Index 2741

Kleeman & Engel p. 259

PDR pp. 569, 719

OCDS Vol. 3 p. 161 (1984)

DOT 16 (5) 169 (1980)

I.N. p. 278

REM p. 1146

Arnold, H., Brock, N. and Bourseaux, F.; U.S. Patent 3,018,302; January 23, 1962; assigned to Asta-Werke A.G. Chemische Fabrik (W. Germany)

CYCLOSERINE

Therapeutic Function: Antitubercular

Chemical Name: D-4-amino-3-isoxazolidinone

Common Name: Orientomycin

Structural Formula:

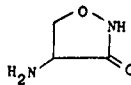

Chemical Abstracts Registry No.: 68-41-7

Trade Name	Manufacturer	Country	Year Introduced
Oxamycin	Merck Sharpe & Dohme	U.S.	1956
Seromycin	Lilly	U.S.	1956
Aristoserina	Aristochimica	Italy	—
Ciclovalidin	Bracco	Italy	—
Cyclomycin	Shionogi	Japan	—
Cycloserine	Lilly	U.S.	—
D-Cycloserin	Roche	W. Germany	—
Farmiserina	Farm. Carlo Erba	Italy	—
Micoserina	Beolet	Italy	—
Miroseryn	Morgan	Italy	—
Orientomycin	Kayaru-Kaken Yaku	Japan	—
Setavax	I.C.N.	—	—
Tisomycin	Lilly	—	—

Raw Materials

β -Aminoxyalanine ethyl ester
Bacterium *Streptomyces lavendulae*

Soybean meal
Potassium hydroxide

Manufacturing Process

Cycloserine may be made by a fermentation process or by direct synthesis. The fermentation process is described in U.S. Patent 2,773,878. A fermentation medium containing the following proportions of ingredients was prepared:

	Parts by Weight
Soybean meal	30.0
Cornstarch	5.0
Corn steep liquor	3.0
Sodium nitrate	3.0

This material was made up with distilled water to provide 41 g per liter, and the mixture was adjusted to pH 7.0 with potassium hydroxide solution. To the mixture were added per liter 5.0 g of calcium carbonate and 7.5 ml of soybean oil. 2,000 ml portions of this medium were then added to fermentation vessels, equipped with stirrers and aeration spargers, and sterilized at 121°C for 60 minutes. After cooling the flasks were inoculated with a suspension of strain No. ATCC 11924 of *Streptomyces lavendulae*, obtained from the surface of agar slants. The flasks were stirred for 4 days at 28°C at approximately 1,700 rpm. At the end of this period the broth was found to contain cycloserine in the amount of about 250 C.D.U./ml of broth. The mycelium was separated from the broth by filtration. The broth had a pH of about 7.5. Tests showed it to be highly active against a variety of microorganisms.

The direct synthetic process is described in U.S. Patent 2,772,280. A solution of 73.3 g (0.332 mol) of β -aminoxalanine ethyl ester dihydrochloride in 100 ml of water was stirred in a 500 ml 3-necked round-bottomed flask cooled in an ice-bath. To the above solution was added over a 30-minute period 65.6 g (1.17 mols) of potassium hydroxide dissolved in 100 ml of water. While the pH of the reaction mixture was 7 to 10.5, a red color appeared which disappeared when the pH reached 11 to 11.5. The light yellow solution was allowed to stand at room temperature for ½ hour and then added to 1,800 ml of 1:1 ethanol-isopropanol. The reaction flask was washed twice with 10 ml portions of water and the washings added to the alcohol solution. The precipitated salts were filtered out of the alcohol solution and the filtrate cooled to 5°C in a 5 liter 3-necked round-bottomed flask. To the cold, well-stirred solution was added dropwise over a 35-minute period sufficient glacial acetic acid to bring the pH of the alcohol solution to 6.0. When the pH of the solution had reached 7 to 7.5, the solution was seeded and no further acetic acid added until crystallization of the oil already precipitated had definitely begun. The crystalline precipitate was collected on a filter, washed twice with 1:1 ethanol-isopropanol and twice with ether. The yield of 4-amino-3-isoxazolidone was 22.7 g.

References

Merck Index 2747

Kleeman & Engel p. 260

PDR p. 1069

OCDS Vol. 3 p. 14 (1984)

I.N. p. 278

REM p. 1210

Fermentation Process:

Shull, G.M., Routien, J.B. and Finlay, A.C.; U.S. Patent 2,773,878; December 11, 1956; assigned to Chas. Pfizer & Co., Inc.

Harned, R.L.; U.S. Patents 2,789,983; April 23, 1957; and 3,124,590; March 10, 1964; both assigned to Commercial Solvents Corporation

Howe, E.E.; U.S. Patent 2,845,433; July 29, 1958; assigned to Merck & Co., Inc.

Synthetic Process:

Peck, R.L.; U.S. Patent 2,772,280; November 27, 1956; assigned to Merck & Co., Inc.

Holly, F.W. and Stammer, C.H.; U.S. Patent 2,840,565; June 24, 1958; assigned to Merck & Co., Inc.

CYCLOSPORIN

Therapeutic Function: Immunosuppressive

Chemical Name: Cyclic oligopeptide (See Structural Formula)

Common Name: Ciclosporin

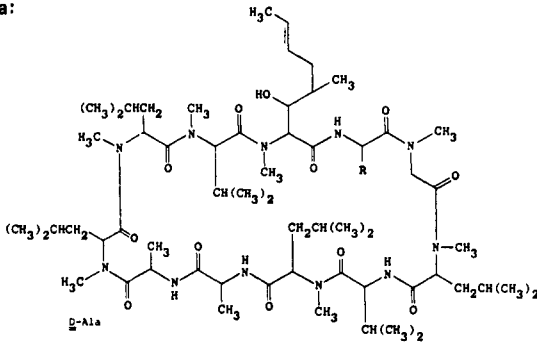
Structural Formula:**Chemical Abstracts Registry No.:** —

Trade Name	Manufacturer	Country	Year Introduced
Sandimmune	Sandoz	U.S.	1983
Sandimmun	Sandoz	U.K.	1983
Sandimmun	Sandoz	W. Germany	1983
Sandimmune	Sandoz	Switz.	1983

Raw Materials

Sucrose
 Corn steep liquor
 Fungus *Cylindrocarpon Lucidum* (NRRL 5760)

Manufacturing Process

10 liters of a nutrient solution (of which each liter contains 30 g of sucrose, 10 g of corn steep, 3 g of NaNO_3 , 1 g of K_2HPO_4 , 0.5 g of $\text{MgSO}_4 \cdot 7\text{H}_2\text{O}$, 0.5 g of KCl and 0.01 g of $\text{FeSO}_4 \cdot 7\text{H}_2\text{O}$) are inoculated with 100 cc of a conidia and mycelium suspension of the strain NRRL 5760, and incubation is effected in 700 cc penicillin flasks at 27°C for 11 days.

The mycelium, which has been separated from the culture liquid, is extracted in a Turrax apparatus by crushing and stirring with 3.5 liters of 90% methanol, and the crushed mycelium, which is separated from the solvent by filtering with suction, is again treated twice in the same manner with 90% methanol. The combined filtrates are concentrated by evaporation in a vacuum at a bath temperature of 40°C to such an extent that the vapor mainly consists of water alone. The resulting mixture is extracted six times with the same volume of ethylene chloride by shaking, whereupon the combined ethylene chloride solutions are purified by extraction with water and are concentrated by evaporation in a vacuum at a bath temperature of 40°C. The resulting residue is chromatographed on 250 g of silica gel (silica gel 60 Merck, grain size 0.063–0.200 mm), using chloroform containing 2% of methanol as eluant, and is collected in 200 cc fractions. The fractions which are antibiologically active against *Aspergillus niger* in the plate diffusion test are combined, evaporated to dryness as described above, and after dissolving in methanol are chromatographed on 110 g of Sephadex LH20 with the same solvent, whereupon those 20 cc fractions showing an antibiotic effect against *Aspergillus niger* in the test indicated above, are combined. A test in the thin layer chromatogram, e.g., with silica gel on Polygram foils and hexane/acetone (1:1) as eluant, indicates that the residue of the methanol solution evaporated as described above mainly consists of the two new antibiotics S 7481/F-1 and S 7481/F-2. These are separated and simultaneously purified by a further chromatography of the mixture thereof, using a 1,000-fold amount of silica gel on the above indicated quality and chloroform contains 2% of methanol. A testing of the eluate fractions having a volume in milliliters which is half as large as the weight of the silica gel in grams, in the thin layer chromatogram, indicates that the antibiotic S 7481/F-1 appears first in the eluate, followed by a mixture of the two antibiotics and finally by homogeneous S 7481/F-2.

Further amounts of the two antibiotics may be obtained from the mixture by repeating chromatography under the same conditions.

References

Merck Index 2748

DFU 4 (8) 567 (1979)

PDR p. 1592

DOT 19 (7) 413 & (12) 665 (1983)

I.N. p. 231

REM p. 1147

Harri, E. and Ruegger, A.; U.S. Patent 4,117,118; September 26, 1978; assigned to Sandoz, Ltd. (Switz.)

CYCLOTHIAZIDE

Therapeutic Function: Diuretic, Antihypertensive

Chemical Name: 3-bicyclo[2.2.1]hept-5-en-2-yl-6-chloro-3,4-dihydro-2H-1,2,4-benzothiazide-7-sulfonamide 1,1-dioxide

Common Name: —

Structural Formula:

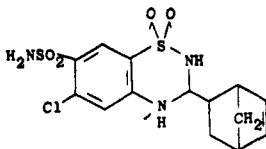

Chemical Abstracts Registry No.: 2259-96-3

Trade Name	Manufacturer	Country	Year Introduced
Anhydron	Lilly	U.S.	1963
Fluidil	Adria	U.S.	1980
Baronorm	Roussel	France	—
Cycloteriam	Roussel	France	—
Dimapres	Dieckmann	W. Germany	—
Doburil	Pharmacia	Sweden	—
Doburil	Boehr/Ingel.	—	—
Tensodiural	Rafa	Israel	—
Valmiran	Boehr/Tanabe	Japan	—

Raw Materials

6-Chloro-4-aminobenzene-1,3-disulfonamide
2,5-Endomethylene- Δ^3 -tetrahydrobenzaldehyde

Manufacturing Process

A mixture of 8.5 g (0.03 mol) of 6-chloro-4-amino-benzene-1,3-disulfonamide, 4.0 g (0.033 mol) of 2,5-endomethylene- Δ^3 -tetrahydrobenzaldehyde and 25 cc of diethylene-glycol-dimethyl ether was heated for 2 hours at 100°C. During this time the major portion of the initially undissolved crystals went into solution; thereafter, the reaction mixture was allowed to stand for 14 hours at room temperature, during which the remaining undissolved crystals also went into solution. The reddish, clear solution thus obtained was admixed

with 50 cc of chloroform. The greyish-white precipitate formed thereby was separated by vacuum filtration, washed with a small amount of chloroform, dried and recrystallized from aqueous methanol. 7.5 g of white crystalline needles having a melting point of 229° to 230°C were obtained.

References

Merck Index 2749

Klaeman & Engel p. 261

OCDS Vol. 1 p. 358 (1977)

I.N. p. 278

REM p. 939

Müller, E. and Hasspacher, K.; U.S. Patent 3,275,625; September 27, 1966; assigned to Boehringer Ingelheim GmbH, Germany

CYCRIMINE HYDROCHLORIDE

Therapeutic Function: Muscle relaxant; Antiparkinsonism

Chemical Name: α -cyclopentyl- α -phenyl-1-piperidinepropanol hydrochloride

Common Name: —

Structural Formula:

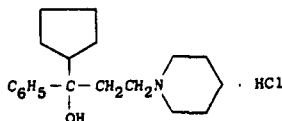

Chemical Abstracts Registry No.: 126-02-3; 77-39-4 (Base)

Trade Name	Manufacturer	Country	Year Introduced
Pagitane	Lilly	U.S.	1953
Pagitane	Lilly	Italy	—

Raw Materials

Bromobenzene	Magnesium
Cyclopentyl- β -(N-piperidyl)ethyl ketone	Hydrogen chloride

Manufacturing Process

The manufacture of the cyclohexyl analog is as follows. Phenyl magnesium bromide was prepared from 48.5 g (0.308 mol) of bromobenzene, 7 g (0.29 mol) of magnesium, and 125 ml of dry ether. To it was added at 5°C over a period of ½ hour 40 g (0.18 mol) of cyclohexyl β -(N-piperidyl)-ethyl ketone (BP 115° to 117°C/1 mm) in 125 ml of dry ether. The mixture was allowed slowly to come to room temperature, refluxed for one hour, and then poured into ice containing 80 ml of concentrated hydrochloric acid. Ammonium chloride (100 g) and 200 ml of concentrated ammonium hydroxide were added and the organic layer was separated. After drying and removing the solvent, the residue was distilled under reduced pressure. The base distilled at 158° to 170°C (1 mm) and solidified. Upon recrystallization from methanol it melted at 112° to 113°C.

References

Merck Index 2752

Klaeman & Engel p. 262

OCDS Vol. 1 p. 47 (1977)

I.N. p. 279

REM p. 932

Ruddy, A.W. and Becker, T.J.; U.S. Patent 2,680,115; June 1, 1954; assigned to Winthrop-Stearns Inc.

CYPROHEPTADINE

Therapeutic Function: Antipruritic, Antihistaminic, Appetite stimulant

Chemical Name: 4-(5H-dibenzo[a,d]cyclohepten-5-ylidene)-1-methylpiperidine

Common Name: —

Structural Formula:

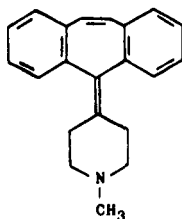

Chemical Abstracts Registry No.: 129-03-3; 969-33-5 (Hydrochloride)

Trade Name	Manufacturer	Country	Year Introduced
Periactin	Merck Sharp & Dohme	U.S.	1961
Nuran	Merck Sharp & Dohme	W. Germany	1961
Periactin	Chibret	Switz.	1961
Periactin	MSD	U.K.	1961
Periactin	MSD	Italy	1961
Periactine	MSD-Chibret	France	1962
Anarexol	MSD	—	—
Antegan	Frosst	Australia	—
Cipractin	Andromaco	Spain	—
Cipro	Beta	Argentina	—
Cypromin	Sawai	Japan	—
Ifracarl	Showa	Japan	—
Oractine	Teva	Israel	—
Periactol	Sharp & Dohme	W. Germany	—
Peritol	Egyt	Hungary	—
Sigloton	Miluy	Spain	—
Sipraktin	Kimya Evi	Turkey	—
Siprodin	Saba	Turkey	—
Vimicon	Merck-Frosst	Canada	—

Raw Materials

Ethyl Bromide	Magnesium
4-Chloro-1-methyl piperidine	Acetic anhydride
Dibenzo[a,e]cycloheptatrien-5-one	Sodium hydroxide
Hydrogen chloride	

Manufacturing Process

(A) Preparation of 1-Methyl-4-Piperidyl-Magnesium Chloride: Magnesium turnings (5.45 g, 0.22 g-atom) were placed in a 500 ml 3-necked flask provided with a condenser, Hershberg stirrer and dropping funnel and protected with a drying tube. An atmosphere of dry nitrogen was maintained in the apparatus throughout the reaction. The magnesium was covered with 20 ml of dry tetrahydrofuran. A crystal of iodine and 1.2 g of ethyl bromide were added and after the reaction had subsided (formation of ethylmagnesium bromide) a solution of 29.4 g (0.22 mol) of 4-chloro-1-methyl-piperidine in dry tetrahydrofuran (total volume, 103 ml) was added dropwise at such a rate that gentle reflux was maintained.

The solution of 4-chloro-1-methylpiperidine in tetrahydrofuran was dried over calcium hydride at ice-bath temperature prior to use. When the addition of the halide was complete the reaction mixture was refluxed with stirring for one hour. In some subsequent experiments this period of refluxing was omitted with no deleterious result.

(B) Preparation of 1-Methyl-4-(5-Hydroxy-5-Dibenzo[a,e] Cycloheptatrienyl)-Piperidine: The solution of the Grignard reagent prepared in (A) was cooled to 5° to 10°C and stirred while 22.7 g (0.11 mol) of dibenzo[a,e] cycloheptatrien-5-one was added in portions. After stirring for 1 hour during which time the reaction mixture was allowed to warm up to room temperature, the bulk of the tetrahydrofuran was distilled at 40° to 50°C under reduced pressure. Benzene, 150 ml, was added and the reaction mixture stirred and cooled in an ice-bath while water, 100 ml, was added gradually. The benzene layer was separated by decantation and the gelatinous residue extracted three times with 75 ml portions of boiling benzene.

The solvent was evaporated from the combined benzene extracts to give 33.4 g of a clear light brown resin. Crystallization from an alcohol-water mixture gave 19.5 g of 1-methyl-4-(5-hydroxy-5-dibenzo[a,e] cycloheptatrienyl)-piperidine, MP 156° to 157°C. Two recrystallizations from alcohol-water mixtures followed by two recrystallizations from benzene-hexane mixtures gave analytically pure product, MP 166.7° to 167.7°C.

(C) Preparation of 1-Methyl-4-(5-Dibenzo[a,e] Cycloheptatrienylidene)-Piperidine Hydrochloride: 1-Methyl-4-(5-hydroxy-5-dibenzo[a,e] cycloheptatrienyl)-piperidine (3.05 g, 0.01 mol) was dissolved in glacial acetic acid, 15 ml. The solution was saturated with dry hydrogen chloride with external cooling. A white solid separated. Acetic anhydride (3.07 g, 0.03 mol) was added and the mixture heated on the steam bath for one hour. The solid dissolved in the first 5 minutes of the heating period.

The reaction mixture was poured into 25 ml of water and the mixture made strongly basic with 10 N sodium hydroxide solution. The mixture was extracted 3 times with 50 ml portions of benzene, the combined extracts washed with water and concentrated to a volume of approximately 50 ml. The solution was saturated with dry hydrogen chloride and the white crystalline product collected and dried. The yield of product, MP 251.6° to 252.6°C (dec.) was 2.5 g. Recrystallization from a mixture of absolute alcohol and absolute ether gave a product, MP 252.6° to 253.6°C. A sample was analyzed after drying for 7 hours at 110°C over phosphorus pentoxide in vacuo.

(D) Preparation of 1-Methyl-4-(5-Dibenzo[a,e] Cycloheptatrienylidene)-Piperidine: The hydrochloride salt, 4.3 g, was suspended in 100 ml of warm water and the mixture made strongly alkaline by the addition of 15 ml of 5% sodium hydroxide. The mixture was extracted with four 50 ml portions of benzene and the extracts dried over sodium sulfate. Evaporation of the benzene on the steam-bath at reduced pressure left 3.7 g (97%) of the base, MP 110.3° to 111.3°C. Recrystallization from a mixture of alcohol and water gave product, MP 112.3° to 113.3°C.

References

Merck Index 2766

Kleeman & Engel p. 263

PDR pp. 830, 1208, 1606, 1999

OCDS Vol. 1 p. 151 (1977)

I.N. p. 280

REM p. 1132

Engelhardt, E.L.; U.S. Patent 3,014,911; December 26, 1961; assigned to Merck & Co., Inc.

CYPROTERONE ACETATE

Therapeutic Function: Antiandrogen

Chemical Name: 6-chloro-1 β ,2 β -dihydro-17-hydroxy-3'H-cyclopropa[1,2]pregna-1,4,6-triene-3,20-dione acetate

Common Name: —

Structural Formula:

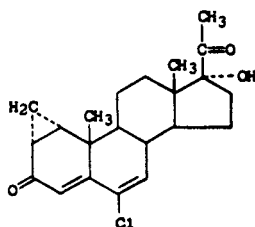

(base)

Chemical Abstracts Registry No.: 2098-66-01

Trade Name	Manufacturer	Country	Year Introduced
Androcur	Schering	W. Germany	1973
Androcur	Schering	Switz.	1973
Androcur	Schering	U.K.	1974
Androcur	Schering	Italy	1975
Androcur	Schering	Japan	1982
Cyprostat	Schering	—	—
Diane	Schering	W. Germany	—

Raw Materials

1,2 α -Methylene- $\Delta^{4,6}$ -pregnadiene-17 α -ol-3,20-dione-17-acetate
 Perbenzoic acid
 Acetic acid

Manufacturing Process

2.34 g of 1,2 α -methylene- $\Delta^{4,6}$ -pregnadiene-17 α -ol-3,20-dione-17-acetate are dissolved in 18.25 cc of ethylene chloride which contains 844 mg of perbenzoic acid. The solution is stored for 16 hours at +5°C and 7 hours at room temperature. It is then diluted with methylene chloride and, with aqueous ferrous sulfate solution, sodium bicarbonate solution and with water washed until neutral.

The organic phase is dried over sodium sulfate and then concentrated to dryness. 1.62 g of the thus obtained crude 1,2 α -methylene-6,7 α -oxido- Δ^4 -pregnene-17 α -ol-3,20-dione-17-acetate are dissolved in 109 cc of glacial acetic acid. This solution is then saturated at room temperature with hydrogen chloride gas and stored for 20 hours. It is then diluted with methylene chloride and washed with water until neutral.

The organic phase is dried over sodium sulfate and then concentrated to dryness. The thus obtained crude 6-chloro-1 α -chloromethyl- $\Delta^{4,6}$ -pregnadiene-17 α -ol-3,20-dione-17-acetate is heated to boiling in 20 cc of collidine for 20 minutes under nitrogen. After dilution with ether it is washed with 4 N hydrochloric acid and washed with water until neutral.

After drying over sodium sulfate and concentration to vacuum the remaining residue is subjected to chromatography over silica gel. Using a benzene-ethyl acetate mixture (19:1) there is eluated 900 mg of 6-chloro-1,2 α -methylene- $\Delta^{4,6}$ -pregnadiene-17 α -ol-3,20-dione-17-acetate, which upon recrystallization from isopropyl ether melts at 200° to 201°C.

References

Merck Index 2769

Kleeman & Engel p. 263

OCDS Vol. 2 p. 166 (1980)

DOT 10 (1) 12 (1974)

I.N. p. 280

Wiechert, R.; U.S. Patent 3,234,093; February 8, 1966; assigned to Schering AG, Germany

CYTARABINE HYDROCHLORIDE

Therapeutic Function: Cancer chemotherapy

Chemical Name: 4-amino-1 β -D-arabinofuranosyl-2(1H)-pyrimidinone hydrochloride

Common Name: β -cytosine arabinoside

Structural Formula:

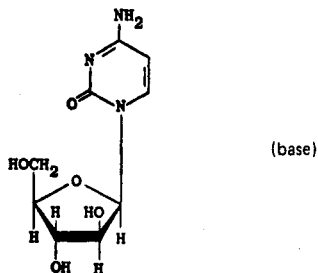

Chemical Abstracts Registry No.: 69-74-9; 147-94-4 (Base)

Trade Name	Manufacturer	Country	Year Introduced
Cytosar	Upjohn	U.S.	1969
Cytosar	Upjohn	U.K.	1970
Alexan	Mack	W. Germany	1971
Kilocyde	Nippon Shinyaku	Japan	1971
Cytosar	Diethelm	Switz.	1971
Aracytine	Upjohn	France	1972
Aracytin	Upjohn	Italy	1972
Arabitin	Sankyo	Japan	—
Cyclocide	Nippon Kayaku	Japan	—
Erfalfa	Intes	Italy	—
Iretin	Torii	Japan	—
Udecil	Upjohn	W. Germany	—

Raw Materials

1-(2,3,5-Tri-O-acetyl- β -arabinofuranosyl)uracil
 Phosphorus pentasulfide
 Ammonia

Manufacturing Process

(A) Preparation of 1-(2,3,5-Tri-O-Acetyl- β -D-Arabinofuranosyl)-4-Thiouracil: A mixture of 1.85 g (5.0 mmol) of 1-(2,3,5-tri-O-acetyl- β -arabinofuranosyl)uracil, 1.23 g (5.55 mmol) of phosphorus pentasulfide, and 30 ml of pyridine was heated under gentle reflux for 2.5 hours with exclusion of moisture. The reaction mixture was cooled, and the supernatant solution was transferred by means of a pipette into a mixture of crushed ice and water. The reaction flask was washed twice with pyridine, and these washings were added to the ice-water mixture. This mixture was kept at about 25°C until the ice had melted, and was then stored at 0°C for one hour. A pale yellow precipitate that formed was collected on a filter, washed with ice-water, and dried in air.

This material was triturated with chloroform, and the chloroform mixture was filtered. A small amount of undissolved material collected on the filter and it was washed with chloroform. The chloroform solution (filtrate plus washings) was washed three times with ice-water, twice with ice-cold 3 N sulfuric acid, twice with ice-cold saturated aqueous sodium bicarbonate solution, twice with ice-water, and then dried over anhydrous sodium sulfate. The chloroform was removed under reduced pressure at a bath temperature of about 40°C, leaving a yellow, somewhat gummy residue. This yellow residue was dissolved in absolute methanol which was then evaporated at reduced pressure at about 40°C, and the residue was then held for 2 hours at 0.5 to 2.0 mm pressure and a bath temperature of about 50°C. There was thus obtained 1.69 g of 1-(2,3,5-tri-O-acetyl- β -D-arabinofuranosyl)-4-thiouracil.

(B) Preparation of 1- β -D-Arabinofuranosylcytosine: In a glass liner, a mixture of 1.16 g (3.0 mmol) of 1-(2,3,5-tri-O-acetyl- β -D-arabinofuranosyl)-4-thiouracil prepared in (A) and about 60 ml of absolute methanol which had been saturated with anhydrous ammonia at 0°C was heated in a steel bomb at 98° to 105°C for 35 hours. After cooling to about 25°C and venting the bomb, the dark solution was filtered into a round-bottom flask. The methanol and excess ammonia were then removed under reduced pressure at about 25°C. The residual syrup was dissolved in absolute methanol, and the methanol was removed under reduced pressure at a bath temperature of about 40°C. This procedure of dissolving in absolute methanol and removing the solvent was repeated, and the residue was held under reduced pressure at a bath temperature of 45°C for 12 hours.

The resulting semisolid was triturated thoroughly with absolute methanol, and the resulting suspension was chilled at 0°C. A pale tan solid that separated was collected on a filter and washed repeatedly with methanol. After washing with anhydrous ether, there was obtained 430 mg of 1- β -D-arabinofuranosylcytosine.

(C) Preparation of 1- β -D-Arabinofuranosylcytosine Hydrochloride: The absolute methanolic filtrate obtained after triturating and filtering the 1- β -D-arabinofuranosylcytosine in (B) above was warmed and stirred with decolorizing charcoal. The mixture was filtered through a bed of filter aid, and the filter bed was washed repeatedly with absolute methanol. The combined filtrate and washings were pale yellow. The solution was diluted to faint cloudiness with anhydrous ether, and an excess of anhydrous hydrogen chloride was introduced. Crystallization began at about 25°C and further crystallization was induced by chilling at 0°C for 14 hours. The crystalline product was collected on a filter, washed with anhydrous ether, and dried in air. There was thus obtained 180 mg of pale yellow 1- β -D-arabinofuranosylcytosine hydrochloride melting at 186° to 189°C.

The pale yellow product was dissolved in warm, absolute methanol, and the solution after mixing with decolorizing charcoal was filtered through a bed of filter aid. The filter bed was washed with warm absolute methanol, and the combined methanolic filtrate and

washings were warmed and diluted with anhydrous ether to incipient crystallization. The methanol-ether mixture was kept at about 25°C for about 1 hour and then chilled, first at 0°C, and then at -20°C. The resulting colorless needles were collected on a filter, washed with anhydrous ether, and dried at 85°C, yielding 100 mg of 1-β-D-arabinofuranosylcytosine hydrochloride having a melting point of 186° to 188°C.

References

Merck Index 2778

Kleeman & Engel p. 264

PDR p. 1833

DOT 13 (11) 477 (1977)

I.N. p. 281

REM p. 1147

Hunter, J.H.; U.S. Patent 3,116,282; December 31, 1963; assigned to The Upjohn Company

D

DACTINOMYCIN

Therapeutic Function: Cancer chemotherapy

Chemical Name: Complex actinomycin, see structural formula

Common Name: Meractinomycin; Actinomycin D; Actinomycin A_{1V}

Structural Formula:

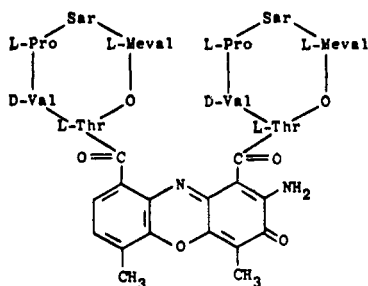

Chemical Abstracts Registry No.: 50-76-0

Trade Name	Manufacturer	Country	Year Introduced
Cosmegen	Merck Sharp & Dohme	U.S.	1965
Lyovac	Merck Sharp & Dohme	W. Germany	1966
Cosmegen	Merck Banyu	Japan	1969
Cosmegen	Merck Sharp & Dohme	Italy	1973

Raw Materials

Bacterium *Actinomyces antibioticus*
Nutrient medium

Manufacturing Process

An incubated culture of *Actinomyces antibioticus* was prepared using a medium consisting of 1% tryptone-peptone, 0.5% starch, 0.2% K₂HPO₄, 0.2% NaCl and 0.25% agar in distilled water, grown at a temperature of approximately 25° to 35°C, the incubation being complete after 6 to 10 days. 50 liters of this incubated culture are extracted approximately six times with ether, using 20 liters of ether for each extraction.

The final extract is faintly pale yellow in color, whereas the previous extracts are orange. The combined ether extracts are concentrated to dryness and about 3 grams of a reddish-brown residue is obtained. The residue is stirred with approximately 400 cc of petroleum ether for two to three hours, the solvent decanted and the residue treated again with approximately 400 cc of petroleum ether. A pale yellow oil constituting crude actinomycin

B is recovered by evaporation from the petroleum ether.

The dark petroleum ether insoluble residue is dissolved in 1 liter of benzene with gentle heating. Usually a small amount of black amorphous material remains undissolved and is filtered off. The benzene solution is permitted to drop through a chromatographic tower (60 x 5 cm) packed with aluminum oxide (according to Brockman). The pigment is readily adsorbed. The column is washed with about 1 liter of benzene during which operation very little migration of the color bands occurs.

The column is then washed with benzene-acetone solution (15:85) whereby a chromatogram develops. By continued washing, light yellow colored pigments pass out of the column. When the main band (orange-red) reaches the lower end of the column, a solution of 30:70 acetone-benzene is passed through the column. The latter solvent elutes the pigment and when the eluate is very pale in color, washing is discontinued.

The eluate is concentrated to dryness under reduced pressure, taken up in 25 cc of hot acetone, filtered, and diluted with ether. The pigment which crystallizes as red-brick colored platelets is essentially pure but may be recrystallized if desired from hot ethyl acetate. An analysis of the product showed C = 59.01; H = 6.81; N = 13.38.

References

Merck Index 2792

Kleeman & Engel p. 265

PDR p. 1151

I.N. p. 282

REM p. 1148

Waksman, S.A. and Woodruff, H.B.; U.S. Patent 2,378,876; June 19, 1945; assigned to Merck & Co., Inc.

DANAZOL

Therapeutic Function: Anterior pituitary suppressant

Chemical Name: 17 α -pregna-2,4-dien-20-yno[2,3,-d] isoxazol-17-ol

Common Name: —

Structural Formula:

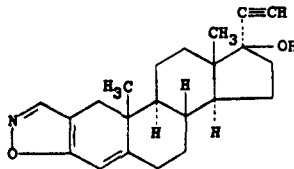

Chemical Abstracts Registry No.: 17230-88-5

Trade Name	Manufacturer	Country	Year Introduced
Danol	Winthrop	U.K.	1974
Danocrine	Sterling Winthrop	U.S.	1976
Winobanin	Winthrop	W. Germany	1976
Danatrol	Winthrop	Switz.	1976
Bonzol	Tokyo Tanabe	Japan	1983
Chronogyn	Winthrop	U.S.	—
Cyclomen	Winthrop	Canada	—

Trade Name	Manufacturer	Country	Year Introduced
Danatrol	Sterwin Espanola	Spain	—
Ladogal	Ross	U.S.	—
Ladogar	Winthrop	—	—

Raw Materials

17 α -Ethynyl-2-hydroxymethylene-4-androsten-17 β -ol-3-one
 Hydroxylamine
 Sodium acetate
 Acetic acid

Manufacturing Process

Danazol was prepared from 4.32 grams of 17 α -ethynyl-2-hydroxymethylene-4-androsten-17 β -ol-3-one, 1.00 gram of hydroxylamine hydrochloride, 1.12 grams of fused sodium acetate and 135 ml of acetic acid. To a 500 ml, 3-necked flask, equipped with a sealed Hershberg-type stirrer, a reflux condenser and a stopper, was added the above androstenone derivative in 300 ml of 95% ethanol. Stirring was commenced and a slurry of fused sodium acetate and hydroxylamine hydrochloride in glacial acetic acid was added.

The mixture was refluxed gently on a steam bath for 1½ hours. Fifteen minutes after initiating the reaction, the reaction mixture gave a negative ferric chloride test. Most of the ethanol and acetic acid were removed by distillation in vacuo, 300 ml of water and 300 ml of ether were added to the concentrate, and the mixture was shaken. The layers were separated, the aqueous layer extracted with fresh ether, and the combined ether extracts were washed with water, dried over anhydrous sodium sulfate, filtered and evaporated to dryness in vacuo. The residue was crystallized by trituration with ether, and the crystals were collected by filtration, washed with hexane and dried. The mother liquors were concentrated to dryness and dissolved in a minimum amount of acetone, whereupon a second crop was obtained. The two crops were combined, dissolved in ethyl acetate, decolorized with activated charcoal, and recovered by concentration.

There was thus obtained 2.35 grams of 17 α -ethynyl-17 β -hydroxy-4-androsteno[2,3-d]isoxazole, MP 224.2°-226.8°C (corr.) when recrystallized from acetone; $[\alpha]_D^{25} = +7.5 \pm 0.2^\circ$ (in 95% ethanol); ultraviolet maximum at 286 m μ (E = 11,300).

References

Merck Index 2799
 Kleeman & Engel p. 266
 PDR p. 1907
 OCDS Vol. 2 p. 157 (1980)
 DOT 11 (2) 52 (1975) & 18 (5) 223 (1982)
 I.N. p. 283
 REM p. 997
 Clinton, R. and Hanson, A.; U.S. Patent 3, 135,743; June 2, 1964; assigned to Sterling Drug

DANTROLENE SODIUM

Therapeutic Function: Skeletal muscle relaxant

Chemical Name: 1-[[5-(4-nitrophenyl)-2-furanyl]-methylene]amino]-2,4-imidazolidinedione sodium salt

Common Name: 1-[[5-(p-nitrophenyl)furfurylidene]-amino]hydantoin sodium salt

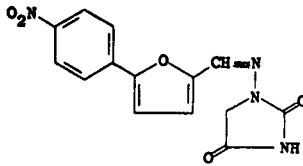
Structural Formula:

(base)

Chemical Abstracts Registry No.: 28468-30-0; 7261-97-4 (Base)

Trade Name	Manufacturer	Country	Year Introduced
Dantrium	Norwich Eaton	U.S.	1974
Dantrium	Eaton	U.K.	1975
Dantamacrin	Roehm	W. Germany	1978
Dantrium	Oberval	France	1979
Dantrium	Yamanouchi	Japan	1981
Dantrium	Formenti	Italy	1981
Dantrix	S.I.T.	Italy	—

Raw Materials

5-(p-Nitrophenyl)-2-furaldehyde
 1-Aminohydantoin hydrochloride
 Sodium hydroxide

Manufacturing Process

5-(p-Nitrophenyl)-2-furaldehyde (40.0 grams, 0.2 mol) is dissolved in dimethylformamide. An aqueous solution of 1-aminohydantoin hydrochloride (30.0 grams, 0.2 mol) is added. The solution is chilled and diluted with water. The crude material is collected and recrystallized from aqueous dimethylformamide to yield 10.0 grams (16%), MP 279°-280°C. This compound is then converted to the sodium salt.

References

Merck Index 2803
 Kleeman & Engel p. 266
 PDR p. 1273
 OCDS Vol. 2 p. 242 (1980)
 DOT 17 (9) 384 (1981)
 I.N. p. 284
 REM p. 922
 Davis, C.S. and Snyder, H.R. Jr.; U.S. Patent 3,415,821; December 10, 1968; assigned to The Norwich Pharmacal Company

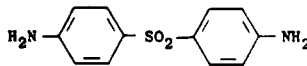
DAPSONE**Therapeutic Function:** Antibacterial (leprostatic)**Chemical Name:** 4,4'-Sulfonylbisbenzamine**Common Name:** bis(4-Aminophenyl)sulfone; Diaphenylsulfone**Structural Formula:**

Chemical Abstracts Registry No.: 80-08-0

Trade Name	Manufacturer	Country	Year Introduced
Avlosulfon	Ayerst	U.S.	1957
Dapsone	Jacobus	U.S.	—
Disulone	Specia	France	—
Maloprim	Wellcome	U.K.	—
Novophone	—	—	—
Protogen	Yoshitomi	Japan	—
Sulfona Oral	Esteve	Spain	—
Udolac	I.C.I.	U.K.	—

Raw Materials

p-Chloronitrobenzene	Stannous chloride
Acetamidobenzene sodium sulfonate	Hydrogen chloride

Manufacturing Process

p-Chloronitrobenzene is reacted with $\text{NaSO}_2\text{C}_6\text{H}_5\text{NHCOCH}_3$ to give as an intermediate, $\text{O}_2\text{NC}_6\text{H}_4\text{SO}_2\text{C}_6\text{H}_5\text{NHCOCH}_3$ which is then reduced and deacetylated to give the product, dapsone. Alternatively, benzene and sulfuric acid react to give phenyl sulfone which is nitrated, then reduced to give dapsone.

References

Merck Index 2808

Kleeman & Engel p. 267

PDR p. 951

OCDS Vol. 1 p. 139 (1977) & 2 p. 112 (1980)

I.N. p. 284

Weijiard, J. and Messerly, J.P.; U.S. Patent 2,385,899; October 2, 1945; assigned to Merck & Co., Inc.

DAUNORUBICIN

Therapeutic Function: Cancer chemotherapy

Chemical Name: (8S-cis)-8-acetyl-10-[(3-amino-2,3,6-trideoxy- α -L-lyxo-hexopyranosyl)oxy]-7,8,9,10-tetrahydro-6,8,11-trihydroxy-1-methoxy-5,12-naphthacenedione

Common Name: Rubidomycin, Antibiotic F.I. 1762

Structural Formula:

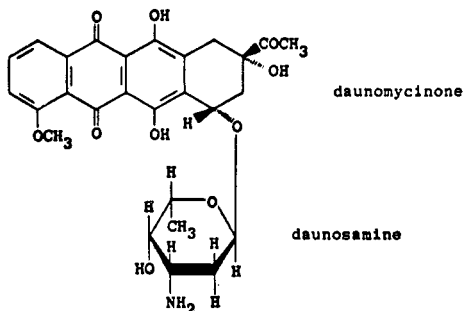

Chemical Abstracts Registry No.: 20830-81-3

Trade Name	Manufacturer	Country	Year Introduced
Cerubidine	Specia	France	1968
Daunoblastin	Farmitalia	W. Germany	1968
Daunoblastina	Farmitalia	Italy	1968
Daunomycin	Meiji Seika	Japan	1970
Cerubidin	May & Baker	U.K.	1971
Cerubidine	Ives	U.S.	1979
Cerubidine	Rhone-Poulenc	Canada	—
Ondena	Bayer	—	—
Rubomycin	Medexport	U.S.S.R.	—

Raw Materials

Bacterium *Streptomyces F.I. 1762*
Glucose

Manufacturing Process

Two 300 ml Erlenmeyer flasks are prepared, each of them containing 60 ml of the following vegetative medium in tap water: 0.6% peptone, 0.3% dry yeast and 0.05% calcium nitrate. The pH after sterilization by heating in an autoclave to 120°C for 20 minutes is 7.2.

Each flask was inoculated with mycelium of *Streptomyces F.I. 1762* whose quantity corresponds to one-fifth of a suspension in sterile water of the mycelium of a 10 day old culture growth in a test tube containing the following ingredients dissolved in tap water.

	Percent
Saccharose	2
Dry yeast	0.1
Potassium hydrogen phosphate	0.2
Sodium nitrate	0.2
Magnesium sulfate	0.2
Agar	2

The flasks are incubated at 28°C for 48 hours on a rotary shaker with a stroke of 60 mm at 220 rpm. 2 ml of a vegetative medium thus grown are used to inoculate 300 ml Erlenmeyer flasks containing 60 ml of the following productive medium in tap water at pH 7.0.

	Percent
Glucose	4
Dry yeast	1.5
Sodium chloride	0.2
Potassium hydrogen phosphate	0.1
Calcium carbonate	0.1
Magnesium sulfate	0.01
Iron sulfate	0.001
Zinc sulfate	0.001
Copper sulfate	0.001

(The medium had been sterilized at 120°C for 20 minutes, the glucose being previously sterilized separately at 110°C for 20 minutes.) It is incubated at 28°C under the conditions described for the vegetative media. After 120 hours of fermentation a maximum activity corresponding to a concentration of 60 µg/ml is achieved.

References

Merck Index 2815

PDR p. 1944

DOT 16 (11) 371 (1980)

I.N. p. 285

REM p. 1148

British Patent 1,003,383; September 2, 1965; assigned to Sta Farmaceutica Italia, Italy

DEANOL ACETAMIDOBENZOATE

Therapeutic Function: Psychostimulant

Chemical Name: 4-(acetylamino)benzoic acid compound with 2-(dimethylaminoethanol) (1:1).

Common Name: —

Structural Formula:

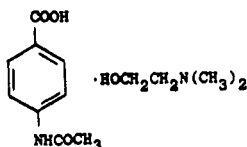

Chemical Abstracts Registry No.: 3635-74-3

Trade Name	Manufacturer	Country	Year Introduced
Deaner	Riker	U.S.	1958
Bimanol	Polfa	Poland	—
Cervoxan	S.M.B.	Belgium	—
Deanol	Kettelhack Riker	W. Germany	—
Diforene	Choay	France	—
Pabenol	Gentili	Italy	—

Raw Materials

p-Acetylamino benzoic acid
2-Dimethylaminoethanol

Manufacturing Process

About 40 grams (0.223 mol) of p-acetylamino benzoic acid was dissolved in 600 ml of absolute methanol, and the solution was heated to reflux temperature. Heating was discontinued, and, with mechanical stirring, 19.9 grams (0.223 mol) of 2-dimethylaminoethanol was added through a dropping funnel as fast as the exothermic nature of the reaction permitted. The reaction mixture was allowed to cool to room temperature (2.5-3 hours) under mechanical agitation, and the solution was suction-filtered through Celite filter aid. The filtrate was poured into 500 ml of anhydrous ethyl ether, seeded with a few crystals of 2-dimethylaminoethanol p-acetylamino benzoate. The seeding crystals were obtained by introducing 3 to 6 drops of the filtered reaction mixture into a test tube containing 10 ml of anhydrous diethyl ether. The contents of the test tube were thoroughly shaken and allowed to stand at room temperature. The salt crystallized out within not more than 10-15 minutes.

The crude product (48.4 grams, 80.9% yield) was recrystallized from an absolute ethanol-ethyl acetate solvent system by suspending the salt in boiling anhydrous ethyl acetate and just enough absolute ethanol was gradually added to effect solution after which the solu-

tion was concentrated to about two-thirds of the original volume on the steam bath, charcoal treated, and suction-filtered through Celite filter aid. The white crystals of 2-dimethylaminoethanol p-acetylamino benzoate obtained, dried at room temperature at a pressure of 0.08 mm Hg for 15 hours, melted at 159.0°-161.5°C.

References

Merck Index 2827

Kleeman & Engel p. 267

I.N. p. 285

REM p. 1136

British Patent 879 259; October 11, 1961; assigned to Riker Laboratories, Inc.

DEBRISOQUIN

Therapeutic Function: Antihypertensive

Chemical Name: 3,4-Dihydro-2(1H)-isoquinolinecarboximidamide

Common Name: Isocaramidine

Structural Formula:

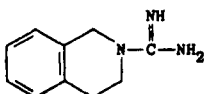

Chemical Abstracts Registry No.: 1131-64-2; 581-88-4 (Sulfate)

Trade Name	Manufacturer	Country	Year Introduced
Declinax	Roche	U.K.	1967
Bonipress	Ikapharm	Israel	—
Redu-Press	Protea	Australia	—
Tendor	Chinoin	Hungary	—

Raw Materials

1,2,3,4-Tetrahydroisoquinoline
2-Methyl-2-isothiourea sulfate

Manufacturing Process

27 g of 1,2,3,4-tetrahydroisoquinoline was added at room temperature to a solution of 28 g of 2-methyl-2-isothiourea sulfate in 80 ml of water. The resulting mixture was kept at room temperature with occasional shaking. After a short period of time, methylmercaptan began to escape, and the mixture warmed up slightly. After then standing for 24 hours, crystals formed. They were filtered off and rinsed with ice cold water. Recrystallization from approximately 100 ml of water yielded 1,2,3,4-tetrahydroisoquinoline-2-carboximidamide sulfate melting at 278°C to 280°C (uncorr.).

Another batch prepared in the same manner melted at 284°C to 285°C due to a minute difference in moisture content.

Both batches prepared above analyzed correctly for $(C_{10}H_{13}N_3)_2 \cdot H_2SO_4$.

References

Merck Index 2828

OCDS Vol. 1 p. 350 (1977) & 2 p. 374 (1980)

DOT 16 (4) 137 (1980)

I.N. p. 286

Wenner, W.; U.S. Patent 3,157,573; November 17, 1964; assigned to Hoffmann-LaRoche, Inc.

DEFOSFAMIDE

Therapeutic Function: Antineoplastic

Chemical Name: N,N,O-tris-(β -chloroethyl)-N'-(γ -hydroxy-n-propyl)-phosphoric acid ester diamide

Common Name: Desmofosfamide; trichlorethoxyphosphamide

Structural Formula:

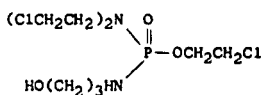

Chemical Abstracts Registry No.: 3733-81-1

Trade Name	Manufacturer	Country	Year Introduced
Mitarson	Asta-Werke	W. Germany	1961

Raw Materials

N,N-bis(β -chloroethyl)phosphoric acid amide dichloride
Ethylene chlorohydrin
1,3-Propanolamine

Manufacturing Process

A solution of 8 g of ethylene chlorohydrin and 10.2 g of triethylamine in 50 cc of absolute dioxane is slowly added dropwise to a solution of 25.9 g of N,N-bis-(β -chloroethyl)-phosphoric acid amide dichloride in 100 cc of absolute dioxane. The mixture is then heated for 2 hours at 60°C. After cooling, a solution of 7.5 g of 1,3-propanolamine and 10.2 g of triethylamine in 50 cc of absolute dioxane is added dropwise while stirring well and at a temperature up to 30°C. The mixture is left to stand for another 12 hours. The liquid is filtered off with suction from the precipitated triethylamine hydrochloride. The filtrate is filtered through carbon and concentrated by evaporation in water-jet vacuum at 40°C. The residue is dissolved in a little alcohol. Copious amounts of ether are added and the solution is left overnight in a refrigerator. It is then again filtered through carbon, the ether is evaporated and the residual volatile fractions are removed under high vacuum at 55°C. The result is a yellowish, fairly viscous oil, which is insoluble in water.

References

Merck Index 2840

I.N. p. 288

Arnold, H., Bourseaux, F. and Brock, N.; U.S. Patent 3,035,080; May 15, 1962; assigned to Asta-Werke A.G. Chemische Fabrik (W. Germany)

DEMECARIUM BROMIDE

Therapeutic Function: Cholinergic (ophthalmic)

Chemical Name: 3,3'-[1,10-decanediylbis[(methylimino)carbonyloxy]] bis[N,N,N-trimethylbenzenaminium] dibromide

Common Name: —

Structural Formula:

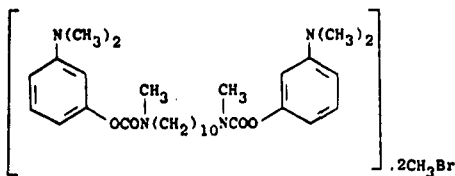

Chemical Abstracts Registry No.: 56-94-0

Trade Name	Manufacturer	Country	Year Introduced
Humorsol	MSD	U.S.	1959
Tonilen	Frumtost	Spain	—
Tosmilen	Chibret	France	—
Tosmilen	Chugai	Japan	—
Tosmilen	Linz	Austria	—
Tosmilen	Lentia	W. Germany	—
Tosmilen	Astra	U.K.	—

Raw Materials

N,N,N,N-Tetramethyldecamethylene diamine	Phosgene
m-Dimethylaminophenol	Sodium
Methyl bromide	

Manufacturing Process

N,N,N,N'-tetramethyldecamethylene diamine is reacted with phosgene in toluene under agitation. The phosgene which escapes through an ascending cooling tube together with the evolved methyl chloride is condensed in a cold trap. As soon as immixture has been completed, the temperature is raised to 100°C and the phosgene recovered in the trap is vaporized and bubbled through the solution again, the escaping gas being recondensed and returned once more. The repeated passage through the reagents of the phosgene that has not yet reacted is continued for 7 hours. When the solution is cool it is passed through a filter, the remaining phosgene is removed from the clear solution by distillation and the remainder distilled in vacuo.

A solution of 11.9 parts of m-dimethylaminophenol in 90 parts of xylene (isomer mixture) is added to a solution of sodium methylate consisting of 2.0 parts of sodium and 25 parts of methanol. The methanol is then completely removed by distillation and the temperature raised until the boiling point of the xylene is reached. The decamethylene-bis-(N-methyl carbamic chloride) is added to the remainder which contains the sodium salt of m-dimethylaminophenol in the form of solid crystals. The reagent mixture is heated and maintained at a temperature of 100°C and continuously agitated. After having been cooled it is washed three times in water, three times in a 5% solution of caustic soda, and another three times in water. The xylene is then evaporated in vacuo and the oily residue freed of any remaining traces of xylene by allowing it to stand in air when the product crystallized completely. In this manner 15.6 parts of decamethylene-bis-(N-methyl carbamic acid m-dimethylaminophenylester) are obtained. This is in turn reacted with methyl bromide to give the desired product. The decamethylene-bis-(N-methyl carbamic acid m-dimethylaminophenylester-bromomethylate) appears after precipitation from a solution in acetic acid with methyl ethyl ketone in the form of a finely crystalline powder with a micro melting point between 164° and 170°C.

References

Merck Index 2857

Kleeman & Engel p. 270

PDR p. 1182

I.N. p. 290

REM p. 898

Schmid, O.; U.S. Patent 2,789,981; April 23, 1957; assigned to Oesterreichische Stickstoffwerke AG, Austria.

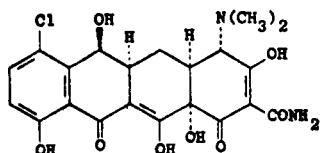
DEMECLOCYCLINE HYDROCHLORIDE**Therapeutic Function:** Antibacterial**Chemical Name:** 7-chloro-4-dimethylamino-1,4,4a,5,5a,6,11,12a-octahydro-3,6,10,12,12a-pentahydroxy-1,11-dioxo-2-naphthacene-carboxamide**Common Name:** 7-chloro-6-demethyltetracycline**Structural Formula:**

(base)

Chemical Abstracts Registry No.: 127-33-3; 64-73-3 (Hydrogen chloride)

Trade Name	Manufacturer	Country	Year Introduced
Declomycin	Lederle	U.S.	1959
Ledermycine	Lederle	Japan	1970
Ledermycine	Lederle	France	1971
Actaciclina	Courtois	Italy	—
Benaciclín	Jebena	Spain	—
Bioterciclín	Lisapharma	Italy	—
Clortetrín	Medosan	Italy	—
Compleciclín	Andromaco	Spain	—
Demebronc	Lederle	W. Germany	—
Demeplus	Boniscontro-Gazzone	Italy	—
Deme-Proter	Proter	Italy	—
Demetetra	Pierrel	Italy	—
Demetetraciclín	Bios	Italy	—
Demetraclín	Weles	Italy	—
Demetraciclina	Librac	Italy	—
Detracín	Sierochimica	Italy	—
Detravis	Vis	Italy	—
Dimeral	Panther-Osfa	Italy	—
D-Siklín	Dif-Dogu	Turkey	—
Duramycin	Ilisan	Turkey	—
Elkamicina	Biotraching	Italy	—
Fidocín	Farmaroma	Italy	—
Isodemetil	Isola Ibi	Italy	—
Latomicina	Farber-R.E.F.	Italy	—
Ledermicina	Lederle	Italy	—
Magis-Ciclina	Tiber	Italy	—
Meciclín	Citobios	Switz.	—

Trade Name	Manufacturer	Country	Year Introduced
Mexocine	Specia	France	—
Mirciclina	Francia	Italy	—
Neo-Cromaciclín	Panther-Osfa	Italy	—
Perciclina	Atral	Portugal	—
Provimicina	Lifasa	Spain	—
Temet	Colli	Italy	—
Tetradek	S.I.T.	Italy	—
Tollercin	Scalari	Italy	—
Veraciclina	A.F.I.	Italy	—

Raw Materials

Bacterium *S. aureofaciens*
Corn starch

Manufacturing Process

According to U.S. Patent 2,878,289, a suitable medium for the preparation of inocula for the fermentation may be prepared with the following substances.

Sucrose, g/l	30
(NH ₄) ₂ SO ₄ , g/l	2
CaCO ₃ , g/l	7
Corn steep liquor, ml/l	16.5

The pH of the medium thus prepared is about 6.8. An 8 ml portion is measured into an 8 inch Brewer tube and sterilized at 120°C for 20 minutes. The sterilized medium is then inoculated with 0.5 ml of an aqueous spore suspension of a strain of *S. aureofaciens* capable of producing chlorodemethyltetracycline, such as S-604, containing approximately 40-60 million spores per milliliter. The inoculated medium is incubated for 24 hours at 28°C on a reciprocating shaker operated at 110 cycles per minute.

A suitable fermentation medium contains water and a source of assimilable carbon and nitrogen and essential mineral salts. A typical medium suitable for production of chlorodemethyltetracycline is as follows:

Corn starch, g/l	55
CaCO ₃ , g/l	7
(NH ₄) ₂ SO ₄ , g/l	5
NH ₄ Cl, g/l	1.5
FeSO ₄ ·7H ₂ O, mg/l	40
MnSO ₄ ·4H ₂ O, mg/l	50
ZnSO ₄ ·7H ₂ O, mg/l	100
CoCl ₂ ·6H ₂ O, mg/l	5
Corn steep liquor, g/l	30
Cottonseed meal, g/l	2
Lard oil, % v/v	2.0

According to U.S. Patent 3,154,476, a culture of *Streptomyces aureofaciens* (ATCC 13900) is grown in approximately 50 ml of an aqueous medium containing, per 1,000 ml, 30 grams extraction process soybean meal, 1 gram sodium chloride, 50 grams glucose and 7 grams calcium carbonate in a 250 ml Erlenmeyer flask. The flask is agitated on a rotary shaker (280 cycles per minute) in a room maintained at 25°C for a period of 72 hours.

Ten percent of the resulting inoculum is then transferred to a 250 ml Erlenmeyer flask containing 50 ml of the medium employed above and the flask agitated a further 72 hours under the same conditions. One ml of the resulting inoculum is then employed for the inoculation of 10 ml of an aqueous medium containing, per 1,000 ml, 30 grams extraction

process soybean meal, 1 gram sodium chloride, 50 grams glucose and 7 grams calcium carbonate, in a 1" x 6" test tube.

In addition, 1 mg of sterile S-2-hydroxyethyl-DL-homocysteine is added to the tube and the tube is shaken on a rotary shaker at 280 cycles per minute at 25°C for seven days. The contents of the tube were then acidified to pH 2 by the addition of sulfuric acid and centrifuged. Examination of the supernatant liquid by paper chromatography employing the methods of Bohonos et al, *Antibiotics Annual* (1953-4, page 49), demonstrates the presence of 7-chloro-6-demethyltetracycline, 7-chlorotetracycline and tetracycline.

References

Merck Index 2858

Kleeman & Engel p. 270

PDR p. 1008

I.N. p. 290

REM p. 1204

McCormick, J.R.D., Hirsch, U., Jensen, E.R. and Sjolander, N.O.; U.S. Patent 2,878,289; March 17, 1959; assigned to American Cyanamid Company

Szumski, S.A.; U.S. Patent 3,012,946; December 12, 1961; assigned to American Cyanamid Company

Goodman, J.J. and Matrishin, M.; U.S. Patent 3,019,172; assigned to American Cyanamid Company

Goodman, J.J.; U.S. Patent 3,050,446; August 21, 1962; assigned to American Cyanamid Company

Neidleman, S.L.; U.S. Patent 3,154,476; October 27, 1964; assigned to Olin Mathieson Chemical Corporation

DEMEGESTONE

Therapeutic Function: Progestin

Chemical Name: 17-methyl-19-norpregna-4,9-diene-3,20-dione

Common Name: —

Structural Formula:

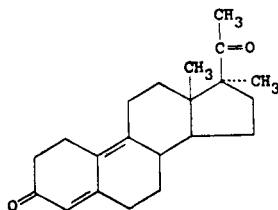

Chemical Abstracts Registry No.: 10116-22-0

Trade Name	Manufacturer	Country	Year Introduced
Lutionex	Roussel	France	1974

Raw Materials

3-Methoxy-19-nor- $\Delta^{1,3,5(10)16}$ -pregnatetraene-20-one
 Methyl iodide
 Acetic acid
 Chromic acid

Lithium
 Ammonia
 Bromine

Manufacturing Process

Step A: Preparation of 3-Methoxy-17 α -Methyl-19-Nor- $\Delta^{1,3,5(10)}$ -Pregnatriene-20-one — Under agitation and an inert atmosphere, 1.150 grams of lithium were introduced into one liter of ammonia cooled to a temperature of -70°C . For 15 minutes this reaction mixture was agitated, then, while maintaining the temperature at about -75°C , one liter of ether was added thereto, followed by 20 grams of 3-methoxy-19-nor- $\Delta^{1,3,5(10),16}$ -pregnatetraene-20-one. The mixture was allowed to stand for 2 hours at a temperature of -75°C under continued agitation and under continued inert atmosphere. Next, 160 cc of methyl iodide were added and the reaction mixture was again agitated for 2 hours at -75°C .

Thereafter, the ammonia was evaporated, 1 liter of water was added thereto and the aqueous phase was separated and extracted with ether. The ethereal phases now combined were washed with water until the wash waters were neutral, then dried over sodium sulfate, filtered and distilled to dryness to obtain 21 grams of product, which was dissolved in 210 cc of ethanol under reflux. Next, 21 cc of acetic acid and 21 grams of Girard's reactant T were added thereto. The mixture was agitated for $1\frac{1}{2}$ hours under an atmosphere of nitrogen while maintaining the reflux. Thereafter, the reaction mixture was cooled to room temperature and then poured into 1,050 cc of water. Next, 155 cc of 2 N sodium hydroxide solution were added and finally the mixture was extracted with ether.

The combined ethereal phases were washed with water until the wash waters were neutral, dried over sodium sulfate, filtered and evaporated to dryness to obtain 16.80 grams of raw product which was purified by redissolving the product obtained in acetone under reflux and by recrystallization by heating and cooling.

13.185 grams of 3-methoxy-17 α -methyl-19-nor- $\Delta^{1,3,5(10)}$ -pregnatriene-20-one were thus obtained in the form of a colorless, solid product. The product was easily soluble in ether, soluble in alcohol, benzene and chloroform and insoluble in water. This product had a melting point of 109°C and a specific rotation of $[\alpha]_{\text{D}}^{20} = +75^{\circ} \pm 1^{\circ}$ ($c = 0.5\%$ in chloroform). The starting compound, 3-methoxy-19-nor- $\Delta^{1,3,5(10),16}$ -pregnatetraene-20-one, was obtained according to the process described by Burn, *J. Chem. Soc.* 1962, page 364.

Step B: Preparation of 3-Methoxy-17 α -Methyl-19-Nor- $\Delta^{2,5(10)}$ -Pregnadiene-20-ol — 500 cc of ammonia and a solution of 20 grams of 3-methoxy-17 α -methyl-19-nor- $\Delta^{1,3,5(10)}$ -pregnatriene-20-one were admixed with 400 cc of THF, and 10 cc of ethanol were added. The temperature was lowered to -35°C . 2.150 grams of lithium were added under an inert atmosphere and the reaction mixture was agitated for 15 minutes, after which 10 cc of ethanol and 2.150 grams of lithium were added. After agitating for 15 minutes, 30 cc of ethanol, then 2.150 grams of lithium were added. After maintaining the mixture at -35°C for 30 minutes, 30 cc of ethanol were added. The ammonia was evaporated by bringing the temperature to $+20^{\circ}\text{C}$. 500 cc of water were added and the mixture was extracted with ether.

The aqueous phase was discarded and the combined ethereal phases were washed with water, dried over sodium sulfate, filtered and distilled to dryness, to obtain 20.240 grams of 3-methoxy-17 α -methyl-19-nor- $\Delta^{2,5(10)}$ -pregnadiene-20-ol, which product was utilized as such for the next step. The compound occurred in the form of an amorphous product which was soluble in alcohol, ether, benzene and acetone and insoluble in water.

Step C: Preparation of 17 α -Methyl-19-Nor- $\Delta^{5(10)}$ -Pregnene-20-ol-3-one — 20 grams of the compound prepared in Step B were dissolved in 35 cc of acetone, while agitating the solution for 15 minutes at room temperature. Thereafter, 300 cc of acetic acid containing 25% of water were added to the reaction mixture, which was then agitated for 3 hours and thereafter poured into a water-ether mixture and agitated for 10 minutes. The aqueous phase was separated after extracting with ether. The ethereal phases were washed first with an aqueous solution of sodium bicarbonate, then with water, dried over sodium sulfate, filtered and distilled to dryness to obtain 19.140 grams of 17 α -methyl-19-nor- $\Delta^{5(10)}$ -pregnene-20-ol-3-one. This product was utilized as such for the following step. The compound occurred in the form of a colorless, amorphous product which was soluble in alcohol, ether, benzene, acetone and chloroform and insoluble in water.

Step D: Preparation of 17 α -Methyl-19-Nor- $\Delta^5(10)$ -Pregnene-3,20-Dione — 20.5 grams of the compound prepared in Step C were dissolved in 615 cc of acetone under an atmosphere of nitrogen and under agitation. The solution obtained was cooled to -20°C . Next 21 cc of a solution of 54 grams of chromic acid anhydride and 46 cc of dilute sulfuric acid were added thereto. The solution was allowed to stand for 1 hour under agitation at about -10°C . It was then poured into 2 liters of a mixture of ice and water and extracted with benzene. The combined organic phases were washed first with water, then with a saturated solution of sodium bicarbonate and again with water. Next these phases were dried over magnesium sulfate and distilled to dryness.

20.40 grams of crude product were thus obtained, which was purified by subjecting it to chromatography through magnesium silicate and elution with benzene containing 2.5% of acetone, and recrystallization from isopropyl ether to obtain 8.50 grams of 17 α -methyl-19-nor- $\Delta^5(10)$ -pregnene-3,20-dione in the form of a colorless crystallized product. This product was soluble in alcohol, ether, acetone, benzene and chloroform and insoluble in water. This product had a melting point of 138°C , and a specific rotation of $[\alpha]_{\text{D}}^{20} = +168.5^{\circ} \pm 3.5^{\circ}$ ($c = 0.50\%$ in chloroform).

Step E: Preparation of 17 α -Methyl-19-Nor- $\Delta^{4,9}$ -Pregnadiene-3,20-Dione — Under agitation and an atmosphere of nitrogen, 8.50 grams of the compound prepared in Step D were dissolved in 85 cc of pyridine and cooled to 0°C . Next, 16.3 cc of a 29% bromine solution in methanol were added thereto. The agitation was continued for 30 minutes at the temperature of 0°C . Thereafter the temperature was raised to room temperature and the solution was allowed to stand for 16 hours under agitation. The solution was then poured into 850 cc of a mixture of ice and water and after 82 cc of hydrochloric acid were added, the mixture was extracted with methylene chloride. The combined organic phases were washed with water until the wash waters were neutral, then dried over magnesium sulfate and finally distilled to dryness to obtain 8.480 grams of a crude product which was purified by recrystallization from isopropyl ether. In this manner, 5.810 grams of 17 α -methyl-19-nor- $\Delta^{4,9}$ -pregnadiene-3,20-dione having a melting point of 106°C and a specific rotation $[\alpha]_{\text{D}}^{20} = -270^{\circ} \pm 4.5^{\circ}$ ($c = 0.5\%$ in ethanol) were obtained.

References

Merck Index 2860

Kleeman & Engel p. 271

DOT 11 (4) 143 (1975)

I.N. p. 291

Vignau, M., Bucourt, R., Tessier, J., Costerousse, G., Nedelec, L., Gasc, J.-C., Joly, R., Warnant, J. and Goffinet, B.; U.S. Patent 3,453,267; July 1, 1969; assigned to Roussel-Uclaf, France

Joly, R., Warnant, J. and Farcilli, A.; U.S. Patent 3,547,959; December 15, 1970; assigned to Roussel-UCLAF, France

DEMEXIPTILINE HCl

Therapeutic Function: Antidepressant

Chemical Name: 5H-Dibenzo[a,d]cyclohepten-5-one-O-[2-(methylamino)ethyl] oxime

Common Name: —

Structural Formula:

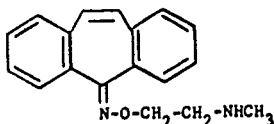

(base)

Chemical Abstracts Registry No.: —

Trade Name	Manufacturer	Country	Year Introduced
Deparon	Aron	France	1981

Raw Materials

5-Oximino-5H-dibenzo[a,d] cycloheptene Methylaminoethyl chloride	Sodium Hydrogen chloride
---	-----------------------------

Manufacturing Process

1.15 g of Na are dissolved in 100 ml of absolute ethanol; 10 g of 5-oximino-5H-dibenzo[a,d]-cycloheptene are introduced, followed by boiling under reflux for 1 hour and evaporation to dryness. The residue is dissolved in dimethylformamide and part of the solvent is distilled off. The solution is now cooled to about 20°C and there are added 5.3 g of methylaminoethyl chloride which is prepared below 10°C from the corresponding hydrochloride by supersaturation with potassium carbonate. The mixture is then heated to 100°C for 1½ hours. Finally, the mixture is evaporated to dryness, the residue dissolved in ether/water and the ethereal phase washed with water. After drying of the ethereal phase with potassium carbonate, 8.5 g of the hydrochloride of 5-β-methylaminoethoxyimino-5H-dibenzo[a,d] cycloheptene (melting point 232°C to 233°C) are obtained.

References

Merck Index 2862

DFU 7 (1) 19 (1982)

DOT 17 (12) 548 (1981)

I.N. p. 291

Schutz, S., Behner, O. and Hoffmeister, F.; U.S. Patent 3,963,778; June 15, 1976; assigned to Bayer A.G. (W. Germany)

DESERPIDINE

Therapeutic Function: Antihypertensive

Chemical Name: 17α-methoxy-18β-[(3,4,5-trimethoxybenzoyl)oxy]-3β,20α-yohimban-16β-carboxylic acid methyl ester

Common Name: 11-desmethoxyreserpine

Structural Formula:

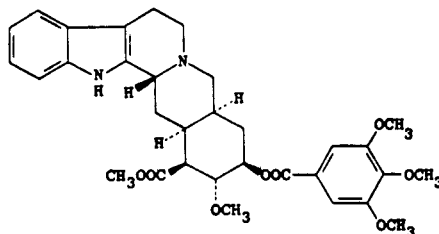

Chemical Abstracts Registry No.: 131-01-1

Trade Name	Manufacturer	Country	Year Introduced
HarmonyI	Abbott	U.S.	1957
Enduronyl	Abbott	U.S.	—
HarmonyI	Abbott	U.S.	—
HarmonyI	Abbott	U.K.	—
Oreticyl	Abbott	U.S.	—
Raunormine	Ono	Japan	—

Raw Materials

Rauwolfia roots
Methanol

Manufacturing Process

500 parts by weight of dried, finely ground roots of *Rauwolfia canescens* are extracted batchwise with methanol at its boiling point, using the following volumes and times, and filtering each extract while hot: 2,000 parts by volume, 1 hour; 1,000 parts by volume, 45 minutes; 1,000 parts by volume, 30 minutes; 1,000 parts by volume, 30 minutes. The extracts are combined and evaporated in vacuo to 75 parts by volume of a thick syrupy solution.

After the addition of 75 parts by volume of methanol and 150 parts by volume of acetic acid of 15% strength with adequate mixing, the solution is extracted with 2 portions each of 100 parts by volume of hexane. The combined hexane extracts are extracted with 15 parts by volume of acetic acid of 15% strength. The latter extract is added to the above acetic acid phase which is then extracted with 3 portions each of 75 parts by volume and 1 portion of 50 parts by volume of ethylene chloride.

The first three extracts are combined and washed with 60 parts by volume of 2 N sodium carbonate solution and then with 60 parts by volume of distilled water. These washing solutions are saved and used for the washing of the 4th and final ethylene chloride extract. The combined ethylene chloride extracts are dried over sodium sulfate, filtered and evaporated in vacuo to a constant weight of a tan, frothy solid. One part by weight of this residue is dissolved in 1.5 parts by volume of warm methanol and the solution cooled to 5°C for 18 hours, whereby crystallization of a mixture containing principally reserpine sets in. After filtering this mixture and washing it with cool methanol, the filtrate is freed of solvent in vacuo.

Two parts by weight of the resulting red-brown solid froth are triturated with 2 portions each of 25 parts by volume of benzene and filtered each time. The benzene insoluble material is saved for further treatment. The benzene soluble fraction is poured on to a column of 40 parts by weight of activated alumina (Woelm, Activity Grade I) which is then eluted first with 3 portions each of 50 parts by volume of benzene and then with 6 portions each of 50 parts by volume of benzene-acetone (9:1), the first of which benzene-acetone portions had been used for extraction of the abovementioned benzene insoluble material. The second of the 6 benzene-acetone elution fractions on removal of the solvents gives a light tan solid froth which on crystallization from methanol gives colorless prismatic needles of slightly impure deserpidine. Rechromatographing of 1 part by weight of this substance on 20 parts by weight of activated alumina (Woelm, Activity Grade I) using benzene and benzene containing 0.1% methanol as eluting agents followed by crystallization from methanol gives colorless prismatic needles of pure deserpidine, melting at 228°-232°C. Deserpine obtained according to this example can be made up into pharmaceutical preparations.

References

Merck Index 2885
Kleeman & Engel p. 272
PDR pp. 515, 526, 543

OCDS Vol. 1 p. 320 (1977)

I.N. p. 296

REM p. 909

Ulshafer, P.R.; U.S. Patent 2,982,769; May 2, 1961; assigned to Ciba Pharmaceutical

DESIPRAMINE HYDROCHLORIDE

Therapeutic Function: Psychostimulant

Chemical Name: 10,11-dihydro-N-methyl-5H-dibenz-[b,f]azepine-5-propanamine hydrochloride

Common Name: —

Structural Formula:

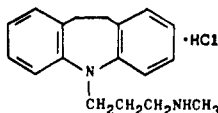

Chemical Abstracts Registry No.: 58-28-6; 50-47-5 (Base)

Trade Name	Manufacturer	Country	Year Introduced
Pertofran	Geigy	U.K.	1963
Norpramine	Merrell	U.S.	1964
Pertofrane	U.S.V.	U.S.	1965
Pertofran	Ciba Geigy	Switz.	1965
Pertofran	Ciba Geigy	W. Germany	1965
Pertofran	Ciba Geigy	France	1966
Nortimil	Chiesi	Italy	1971
Deprexan	Unipharm	Israel	—
Nebriol	Montpellier	Argentina	—
Norpolake	Lakeside	U.S.	—
Petylyl	Arzneimittelwerk Dresden	E. Germany	—
Sertofren	Geigy	—	—

Raw Materials

- o-Nitrotoluene
- Hydrogen
- N-(3-Chloropropyl)-N-methylbenzamine

Manufacturing Process

Oxidative coupling of o-nitrotoluene gives 4,4'-dinitrodibenzyl which is reduced with hydrogen to the diamine. The diamine is pyrolyzed to give dihydrobenzazepine. This is reacted with N-(3-chloropropyl)-N-methylbenzamine to give N-benzyl-desipramine. This is debenzylated by reductive cleavage and then reacted with HCl.

References

- Merck Index 2886
- Kleeman & Engel p. 273
- PDR pp. 1232, 1819
- OCDS Vol. 1 p. 402 (1977)
- DOT 9 (6) 218 (1973)

I.N. p. 296

REM p. 1094

British Patent 908,788; October 24, 1962; assigned to J.R. Geigy AG, Switzerland

Biel, J.H. and Judd, C.I.; U.S. Patent 3,454,554; July 8, 1969; assigned to Colgate-Palmolive Co.

DESMOPRESSIN

Therapeutic Function: Antidiuretic

Chemical Name: 1-(3-Mercaptopropionic acid)-8D-arginine vasopressin

Common Name: —

Structural Formula:

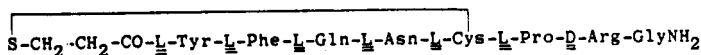

Chemical Abstracts Registry No.: 16679-58-6; 16789-98-3 (Diacetate)

Trade Name	Manufacturer	Country	Year Introduced
DAV	Ritter	Switz.	1974
DDAVP	Ferring	U.K.	1975
Minirin	Ferring	W. Germany	1976
DDAVP	U.S.V.	U.S.	1978
Desmopressin	Kyowa	Japan	1979
Minirin DDAVP	Valeas	Italy	1979
Adiuretin	Spofa	Czechoslovakia	—
Defirin	Ferring	Sweden	—
Desurin	Ferring	Sweden	—
Minirin	Protea	Australia	—
Stimate	Armour	U.S.	—

Raw Materials

β -Benzylmercaptopropionyl-L-tyrosyl-L-phenylalanyl-L-glutamyl-L-asparagyl-S-benzyl-L-cysteinyl-L-prolyl-N-tosyl-D-arginyl-glycinamide

Sodium

Ammonia

Acetic acid

Manufacturing Process

β -Benzylmercaptopropionyl-L-tyrosyl-L-phenylalanyl-L-glutamyl-L-asparagyl-S-benzyl-L-cysteinyl-L-prolyl-N-tosyl-D-arginyl-glycinamide (0.5 g) is reduced with sodium in liquid ammonia. The liquid ammonia is then evaporated and the residue dissolved in 5% aqueous acetic acid (800 ml). The solution is filtered to remove the undissolved portion and the filtrate is adjusted to a pH of 6.5 to 7 by addition of aqueous sodium hydroxide and it is then oxidized by known procedure, cf. Kimbrough, R.D., Jr.; Cash, W.D.; Branda, L.A.; Chan, W.Y.; and Du Vigneaud, V.; *J. Biol. Chem.* 238, 1411 (1963). The reaction mixture is thereupon adjusted to a pH of 4 to 4.5 by addition of acetic acid. The peptide is applied to a column of a carboxylate ion exchange resin, is eluted with 50% aqueous acetic acid and isolated by lyophilization (freeze-drying). The crude product is purified by known procedure using a carrier-free high-voltage electrophoresis, cf. Zaoral, M.; Sorm, F.; *Collection Czechoslov. Chem Commun.* 31, 310 (1966). Yield, 100 to 200 mg of 1-deamino-8-D-argine-vasopressin.

References

Merck Index 2888

Kleeman & Engel p. 274

PDR pp. 586, 1810

DOT 12 (1) 27 (1976) & 16 (10) 359 (1980)

I.N. p. 297

REM p. 958

Zaoral, M., Vavra, I., Machova, A. and Sorm, F.; U.S. Patent 3,497,491; February 24, 1970; assigned to Ceskoslovenska Akademie Ved. (Czechoslovakia)

Ferring, A.B.; British Patents 1,539,317 and 1,539,318; both dated January 31, 1979

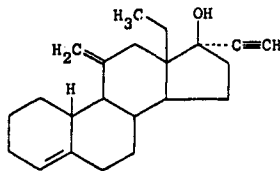
DESOGESTREL**Therapeutic Function:** Progestin**Chemical Name:** 13-Ethyl-11-methylene-18,19-dinorpregn-4-en-20-yn-17-ol**Common Name:** —**Structural Formula:****Chemical Abstracts Registry No.:** 54024-22-5

Trade Name	Manufacturer	Country	Year Introduced
Dicromil	Organon	W. Germany	1981
Marvelon	Organon	U.K.	1982

Raw Materials11,11-Methylene-18-methyl- Δ^4 -estren-17-one

Potassium acetylde

Sulfuric acid

Manufacturing Process

A solution of 1.0 g of 11,11-methylene-18-methyl- Δ^4 -estren-17-one in 33 ml tetrahydrofuran was added to a potassium-acetylde solution in tetrahydrofuran.

After 2 hours of stirring at 0°C to 5°C the reaction mixture was acidified with 2N H₂SO₄ and processed further.

By a chromatographic treatment on silica gel and crystallization from pentane 0.7 g of 11,11-methylene-17 α -ethynyl-18-methyl- Δ^4 -estren-17 β -ol with a melting point of 109°C to 110°C and an $[\alpha]_D$ of +55°C (CHCl₃) was obtained.

References

Merck Index 2890

DFU 2 (12) 829 (1977)

DOT 18 (8) 361 (1982) & 19 (10) 570 (1983)

I.N. p. 297

Van den Broek, A.J.; U.S. Patent 3,927,046; December 16, 1975; assigned to Akzona, Inc.

DESONIDE

Therapeutic Function: Antiinflammatory

Chemical Name: 11,21-Dihydroxy-16,17-[(1-methylethylidene)bis(oxy)]pregna-1,4-diene-3,20-dione

Common Name: Prednacinolone

Structural Formula:

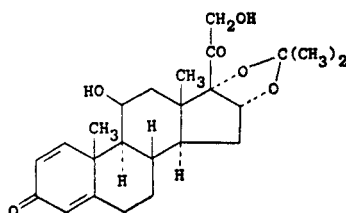

Chemical Abstracts Registry No.: 638-94-8

Trade Name	Manufacturer	Country	Year Introduced
Tridesilon	Dome	U.S.	1972
Tridesilon	Dome	U.K.	1972
Steroderm	De Angeli	Italy	1973
Tridesonit	Miles	France	1976
Tridesilon	Klinge	W. Germany	1978
Prenacid	Sifi	W. Germany	1979
Locapred	Alimedic	Switz.	1983
Sterax	Alcon	Switz.	1983
Apolar	A.L.	Norway	—
Locapred	Fabre	France	—
Prednol	Mustafa Nevzat	Turkey	—
Reticus	Farmila	Italy	—
Sine-Fluor	Made	Spain	—

Raw Materials

11 β ,16 α ,17 α ,21-Tetrahydroxy-1,4-pregnadiene-3,20-dione
Acetone

Manufacturing Process

Preparation of 11 β ,21-Dihydroxy-16 α ,17 α -Isopropylidenedioxy-1,4-Pregnadiene-3,20-Dione: A solution of 11 β ,16 α ,17 α ,21-tetrahydroxy-1,4-pregnadiene-3,20-dione (40 mg) in acetone (10 ml) containing hydrochloric acid (three drops; d 1.19) is boiled on the steam bath for two minutes and then allowed to stand for eighteen hours at room temperature. The reaction mixture is diluted with water (50 ml) and extracted with chloroform (3 x 25 ml), the combined extracts then being washed with water (30 ml) and dried over anhydrous sodium sulfate. The residue obtained by removal of solvent crystallized from ethyl acetate-petroleum ether as small plates (25 mg), melting point 257°-260°C.

References

Merck Index 2892

Kleeman & Engel p. 275

PDR p. 1261

OCDS Vol. 2 p. 179 (1980)

DOT 8 (6) 223 (1972)

I.N. p. 297

REM p. 972

Bernstein, S. and Allen, G.R., Jr.; U.S. Patent 2,990,401; June 27, 1961; assigned to American Cyanamid Company

Diassi, P.A. and Principe, P.A.; U.S. Patent 3,549,498; December 22, 1970; assigned to E.R. Squibb & Sons, Inc.

DESOXIMETASONE

Therapeutic Function: Antiinflammatory

Chemical Name: 9-fluoro-11 β ,21-dihydroxy-16 α -methylpregna-1,4-diene-3,20-dione

Common Name: Desoxymethasone

Structural Formula:

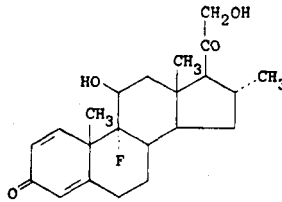

Chemical Abstracts Registry No.: 382-67-2

Trade Name	Manufacturer	Country	Year Introduced
Topicorte	Roussel	France	1968
Topisolon	Hoechst	W. Germany	1974
Flubason	Albert Pharma	Italy	1974
Topicort	Roussel	Italy	1974
Topisolon	Hoechst	Switz.	1974
Topicort	Hoechst	U.S.	1977
Actiderm	Hoechst	—	—
Decolian	Hoechst	—	—
Dermo-Hidrol	Hoechst	—	—
Esperson	Hoechst	—	—
Ibaril	Hoechst	—	—
Topifram	Roussel	France	—
Topisolon	Cassella-Riedel	W. Germany	—

Raw Materials

Bacterium *Curvularia lunata*
 16 α -Methyldesoxycorticosterone
 Bacterium *Bacillus lentus*

Glucose
 Acetic anhydride
 Hydrogen fluoride

Manufacturing Process

(a) *Production of 16 α -Methyl-4-Pregnene-11 β ,21-diol-3,20-Dione (=16 α -Methylcorticosterone)*: A fermenter of stainless steel having a 50 liter capacity is charged with 30 liters of a nutrient solution containing:

	Percent
Glucose (starch sugar)	4.4
Malt extract	1.0
NaNO ₃	0.3
KH ₂ PO ₄	0.1
KCl	0.05
MgSO ₄	0.05
FeSO ₄	0.002
Corn steep	0.5

sterilized for ½ hour at 120°C and after cooling, inoculated with a spore suspension of *Curvularia lunata* which is obtained by rinsing a seven day corn culture (15 grams corn) with approximately 100 cc of physiological sodium chloride solution.

After two days of culturing at 25°C under stirring (220 revolutions per minute) and ventilation (1.65 m³/hr), 18 liters of the obtained culture are removed under sterile conditions and introduced into a fermenter of the same size charged with 28.2 liters of a nutrient solution containing:

	Percent
Glucose (starch sugar)	4.4
Malt extract	1.0
NaNO ₃	0.3
KH ₂ PO ₄	0.1

After 24 hours cultivation under stirring and ventilation as described above, 7.5 grams of 16 α -methyldeoxycorticosterone, obtained by saponification of the corresponding 21-acetate and melting at 102°-104°C, in 200 cc of ethanol are added and fermented under the same conditions for 28 hours.

The course of the fermentation is tested by removal of samples, which are extracted with methyl isobutyl ketone. The extract is analyzed by paper chromatography in a system of dioxane + toluene/propylene glycol.

After the end of the fermentation (28 hours) the culture broth is filtered off by suction over a large suction filter. The mycel residue is washed with water several times. The filtrate is extracted three times, each time with 10 liters of methyl isobutyl ketone. The extract is concentrated under vacuum in a circulating evaporator and in a round flask carefully dried under vacuum. The residue is crystallized from acetone/isopropyl ether. The melting point is 157°-158°C (fermentation yield = 60%). The pure product yield obtained after a second crystallization and chromatography of the mother liquor on silica gel amounts to 53% of the theoretical.

(b) *16 α -Methyl-9 α -Fluoro- Δ^4 -Pregnene-11 β ,21-Diol-3,20-Dione*: 7.5 grams of 16 α -methyl-9 α -fluoro- Δ^4 -pregnene-21-ol-3,20-dione-21-acetate, obtained from Step (a) by acetylating with acetic anhydride in pyridine followed by reaction with HF in pyridine at 0°C, are fermented for 36 hours with *Curvularia lunata* (Mutant NRRL 2380), whereby the 21-acetate group is simultaneously saponified, and then further worked up. The residue is extracted with MIBK, subjected to chromatography on silica gel and there is obtained from chloroform/ethyl acetate (2:1) an eluate containing the 11 β -hydroxy compound, which is further dehydrogenated as the crude product.

(c) *16 α -Methyl-9 α -Fluoro- $\Delta^{1,4}$ -Pregnadiene-11 β ,21-Diol-3,20-Dione*: 16 α -methyl-9 α -fluoro- Δ^4 -pregnene-11 β ,21-diol-3,20-dione obtained as the crude product under Step (b) above,

is fermented with *Bacillus lentus* for 30 hours and further worked up. The residue is extracted with methyl isobutyl ketone and there is obtained as the crude product 16 α -methyl-9 α -fluoro- $\Delta^{1,4}$ -pregnadiene-11 β ,21-diol-3,20-dione.

References

Merck Index 2894

Kleeman & Engel p. 277

PDR p. 946

I.N. p. 297

REM p. 972

Kieslich, K., Kerb, U. and Raspe, G.; U.S. Patent 3,232,839; February 1, 1966; assigned to Schering AG, Germany

DEXAMETHASONE ACETATE

Therapeutic Function: Glucocorticoid

Chemical Name: 9-Fluoro-11 β ,17-dihydroxy-21-acetoxy-16 α -methylpregna-1,4-diene-3,20-dione

Common Name: —

Structural Formula:

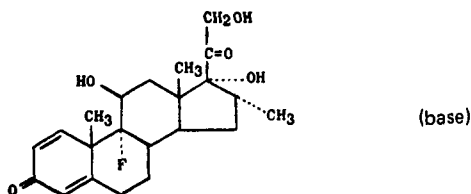

Chemical Abstracts Registry No.: 1177-87-3; 50-02-2 (Base)

Trade Name	Manufacturer	Country	Year Introduced
Dexacen	Central	U.S.	1977
Decadron-La	MS&D	U.S.	1974
Dalalone	O'Neal Jones	U.S.	1982
Decasterolone	Biopharma	Spain	—
Decoderm	Igoda	Spain	—
Delladec	O'Neal Jones	U.S.	—
Deronil	Essex Espana	Spain	—
Dexacortisyl	Roussel	—	—
Fortecortin	E. Merck	—	—
Panason	Norbrook	U.K.	—
Solurex	Hyrex	U.S.	—

Raw Materials

9 β ,11 β -Epoxy-17 α -hydroxy-21-acetoxy-16 α -methyl- $\Delta^{1,4}$ -pregnadiene-3,20-dione
Hydrofluoric acid

Manufacturing Process

The preparation of dexamethasone acetate is described in U.S. Patent 3,007,923 as follows. 1.5 cc of dimethylformamide and 1.5 cc of anhydrous hydrofluoric acid are admixed and

treated with 480 mg of 9 β ,11 β -epoxy-17 α -hydroxy-21-acetoxy-16 α -methyl- $\Delta^1,4$ -pregnadiene-3,20-dione (prepared according to E.P. Oliveto et al, *J. Am. Chem. Soc.*, 80, 44331, 1958). The steroid dissolves in about 15 minutes. The reaction mixture is shaken for two hours at a temperature between 0° and +5°C, and then poured into 75 cc of water containing in suspension, 7.5 grams of sodium bicarbonate. The mixture is vacuum filtered, the filter cake washed and then dried at 100°C, yielding 460 mg of crude hexadecadol contaminated with a small amount of the starting material. A single recrystallization from methylene chloride yields 370 mg of the pure product having a melting point of 170°C and 229°C. The mother liquor yields 62 mg of the starting material, and a remainder constituting a mixture of starting and final materials with little other contamination.

References

Merck Index 2906

Kleeman & Engel p. 278

PDR pp. 695, 928, 1156, 1286, 1569, 1606, 1723

OCDS Vol. 1 p. 199 (1977)

I.N. p. 299

REM p. 972

Fried, J.; U.S. Patent 2,852,511; September 16, 1958; assigned to Olin Mathieson Chemical Corporation

Muller, G., Bardoneschi, R. and Jolly, J.; U.S. Patent 3,007,923; November 7, 1961; assigned to Les Laboratoires Français de Chimiotherapie, France

DEXAMETHASONE-21-LINOLEATE

Therapeutic Function: Topical antiinflammatory

Chemical Name: 9 α -Fluoro-11 β ,17,21-trihydroxy-16 α -methylpregna-1,4-diene-3,20-dione-21-(octadeca-cis-9,cis-12-dienoate)

Common Name: —

Structural Formula:

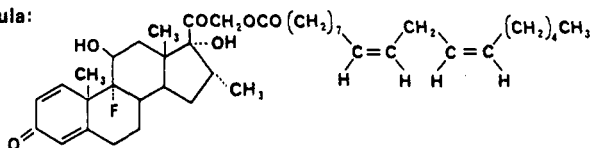

Chemical Abstracts Registry No.: 39026-39-6

Trade Name	Manufacturer	Country	Year Introduced
Topolyn	I.S.F.	Italy	1979

Raw Materials

9 α -Fluoro-11 β ,17,21-trihydroxy-16 α -methylpregna-1,4-diene-3,20-dione

Methane sulfonyl chloride

Potassium octadeca-cis-9,cis-13-dienoate

Manufacturing Process

To a stirred solution of 9 α -fluoro-11 β ,17,21-trihydroxy-16 α -methylpregna-1,4-diene-3,20-dione (10 g, 25.5 mmol) in 20 ml pyridine and 12 ml acetone at -10°C, a cold solution of methane sulfonyl chloride (3 ml, 38.5 mmol) in 8 ml acetone was added dropwise. The addi-

tion was completed within about 3 hours and the mixture was then left standing in the cold for a further 1.5 hours after which 200 ml cold water were added. The resulting precipitate was separated by filtration and washed with water to give 11.5 g (96% of theoretical yield) of dexamethasone 21-mesylate, melting point 208°C to 210°C (decomposition).

The dexamethasone 21-mesylate (11.5 g, 24.5 mmol) prepared as described was added in a nitrogen atmosphere to a stirred slurry of potassium octadeca-cis-9, cis-12-dienoate (7.81 g, 24.5 mmol) in 70 ml DMF. After stirring for 1.5 hours at 50°C and evaporating the solvent in vacuo at the same temperature, the residue was washed by slurring it into water and was then redissolved in methylene chloride, dried and the solvent evaporated. The residue was purified by chromatography on an inactivated (10% water) silica gel column (470 g) by using an ethyl acetate/hexane mixture (7:3) to give a very good yield of an oily product.

References

Merck Index 2906

DFU 1 (7) 316 (1976)

Kleeman & Engel p. 281

OCDS Vol. 1 p. 199 (1977)

I.N. p. 300

Piffer, G. and Pinza, M.; British Patent 1,292,785; October 11, 1972; assigned to I.S.F. SpA (Italy)

DEXAMETHASONE PHOSPHATE

Therapeutic Function: Glucocorticoid

Chemical Name: 9-Fluoro-11,17,21-trihydroxy-16-methylpregna-1,4-diene-3,20-dione-21-phosphate disodium salt

Common Name: —

Structural Formula:

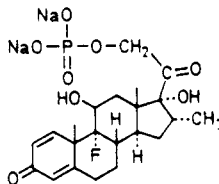

Chemical Abstracts Registry No.: 312-93-6; 2392-39-4 (Disodium salt)

Trade Name	Manufacturer	Country	Year Introduced
Decadron Phosphate	MS&D	U.S.	1959
Hexadrol Phosphate	Organon	U.S.	1965
Maxidex	Algon	U.S.	1975
Dexacen 4	Central	U.S.	1977
Acidexam	Aaciphar	Belgium	—
Cebedex	Chauvin-Blache	France	—
Cebefrasone	Chauvin-Blache	France	—
Chibro-Cardon	Chibret	France	—
Colvasone	Norbrook	U.K.	—
Cortcetine	Chauvin-Blache	France	—
Dalaron	O'Neal Jones	U.S.	—
Decaderm	Frosst	Australia	—

Trade Name	Manufacturer	Country	Year Introduced
Decadron	Banyu	Japan	—
Decalibour	MSD	France	—
Dekort	Deva	Turkey	—
Delladec	O'Neal Jones	U.S.	—
Desalark	Farm. Milanese	Italy	—
Dexacort	Ikapharm	Israel	—
Dexaderme	Chauvin-Blache	France	—
Dexa-Helvacort	Helvepharm	Switz.	—
Dexamed	Medice	W. Germany	—
Dexasone	Legere	U.S.	—
Eta-Cortilen	S.I.F.I.	Italy	—
Megacort	Lancet	Italy	—
Orgadrone	Sankyo	Japan	—
Penthasone	Pentagone	Canada	—
Savacort	Savage	U.S.	—
Soldesam	Farm. Milanese	Italy	—
Solone	Liade	Spain	—
Soludecadron	MSD	France	—
Solurex	Hyrex	U.S.	—
Spersadex	Dispersa	Switz.	—
Vasodex	Smith, Miller & Patch	Puerto Rico	—

Raw Materials

Phosphoric acid
 Triethylamine
 9 α -Fluoro-11 β ,17 α ,21-trihydroxy-16 α -methyl-1,4-pregnadiene-3,20-dione-21-methane sulfonate
 Sodium methoxide

Manufacturing Process

A solution of bis-triethylamine phosphate was prepared by slowly adding 2.36 ml of 85% phosphoric acid to 20 ml of acetonitrile containing 9.9 ml of triethylamine at 20°C. This solution was added to a stirred solution of 4.70 g of 9 α -fluoro-11 β ,17 α ,21-trihydroxy-16 α -methyl-1,4-pregnadiene-3,20-dione 21-methanesulfonate and 20 ml of acetonitrile. The mixture was heated under reflux for four hours and then evaporated under reduced pressure to a volume of 12 ml. This mixture was a concentrated solution of 9 α -fluoro-11 β ,17 α ,21-trihydroxy-16 α -methyl-1,4-pregnadiene-3,20-dione 21-phosphate triethylamine salt with some inorganic phosphate.

The mixture was cooled, 25 ml of methanol added, and the cooled mixture treated with 33 ml of 1.89N methanolic sodium methoxide solution. The precipitated inorganic phosphates were removed by suction filtration and washed thoroughly with methanol. The combined filtrates were evaporated under reduced pressure to a volume of 12 ml and treated with 30 ml of methanol. The resulting cloudy solution was clarified by filtration through diatomaceous earth. The volume of the filtrate was brought to 40 ml by the addition of methanol, and 120 ml of ether was added with stirring. The precipitated product, which was 9 α -fluoro-11 β ,17 α ,21-trihydroxy-16 α -methyl-1,4-pregnadiene-3,20-dione 21-phosphate sodium salt, was collected by suction filtration, and washed with acetone and then with ether. The weight of the air-dried material was 3.06 g.

References

Merck Index 2906
 Kleeman & Engel p. 281
 PDR p. 1033
 OCDS Vol. 1 p. 199 (1977)
 I.N. p. 300

REM p. 965

Chemerda, J.M., Tull, R.J. and Fisher, J.F.; U.S. Patent 2,939,873; June 7, 1960; assigned to Merck & Co., Inc.

DEXBROMPHENIRAMINE MALEATE

Therapeutic Function: Antihistaminic

Chemical Name: d-2-[4-bromo- α -(2-dimethylaminoethyl)benzyl]pyridine maleate

Common Name: —

Structural Formula:

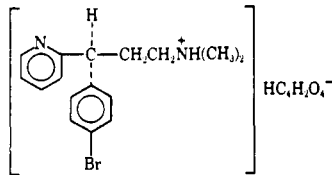

Chemical Abstracts Registry No.: 2391-03-9; 132-21-8 (Base)

Trade Name	Manufacturer	Country	Year Introduced
Disomer	White	U.S.	1959
Dexbrom	Zenith	U.S.	—
Disophrol	Schering	U.S.	—
Drixoral	Schering	U.S.	—
Ebalin	Allergopharma	W. Germany	—

Raw Materials

3-(2-Pyridyl)-3-p-bromophenyl-N,N-dimethylpropylamine (racemic)
 d-Phenylsuccinic acid
 Potassium carbonate
 Maleic acid

Manufacturing Process

The following is taken from U.S. Patent 3,061,517. Sixteen grams of racemic 3-(2-pyridyl)-3-p-bromophenyl-N,N-dimethylpropylamine and 9.7 grams of d-phenylsuccinic acid are dissolved in 150 ml of absolute alcohol and kept at room temperature until crystallization is effected. The crystals are filtered, washed with absolute ethyl alcohol, and recrystallized from the same solvent using 5 ml thereof per gram of solid. Three subsequent crystallizations from 80% alcohol give d-3-(2-pyridyl)-3-p-bromophenyl-N,N-dimethylpropylamine-d-phenylsuccinate; MP 152°-154°C; $[\alpha]_D^{25}$ 91 (concentration, 1% in dimethylformamide).

The free base, d-3-(2-pyridyl)-3-p-bromophenyl-N,N-dimethylpropylamine, is obtained from this salt with diethyl ether and aqueous potassium carbonate; $[\alpha]_D^{25}$ +42.7 (concentration, 1% in dimethylformamide). The free base is then reacted with maleic acid.

References

Merck Index 2907
 Kleeman & Engel p. 283
 PDR p. 1999
 OCDS Vol. 1 p. 77 (1977)

I.N. p. 302

REM p. 1132

Walter, L.A.; U.S. Patents 3,030,371; April 17, 1962; and 3,061,517; October 30, 1962; both assigned to Schering Corporation

DEXCHLORPHENIRAMINE MALEATE

Therapeutic Function: Antihistaminic

Chemical Name: d-2-[p-chloro- α -(2-dimethylaminoethyl)benzyl] pyridine maleate

Common Name: —

Structural Formula: See dexbrompheniramine maleate substituting -Cl for -Br.

Chemical Abstracts Registry No.: 2438-32-6; 25523-97-1 (Base)

Trade Name	Manufacturer	Country	Year Introduced
Polaramine	Schering	U.S.	1958
Celestamine	Cetrane	France	—
Destral	Tiber	Italy	—
Dexchlor	Schein	U.S.	—
Phenamin	Nyegaard	Norway	—
Polaramin	Aesca	Austria	—
Polaramin	Essex	Italy	—
Polaramine	Schering-Shionogi	Japan	—
Polaronil	Byk-Essex	W. Germany	—
Sensidyn	Medica	Finland	—

Raw Materials

3-(2-Pyridyl)-3-p-chlorophenyl-N,N-dimethylpropylamine
 d-Phenylsuccinic acid
 Potassium carbonate
 Maleic acid

Manufacturing Process

Twenty grams of d-phenylsuccinic acid and 28 grams of 3-(2-pyridyl)-3-p-chlorophenyl-N,N-dimethylpropylamine are dissolved in 400 ml of absolute ethyl alcohol and allowed to stand at room temperature until crystallization is effected. The crystals are filtered, washed with absolute ethyl alcohol and recrystallized from 300 ml of this solvent in the same manner. The crystals are recrystallized twice from 80% ethyl alcohol using 3.5 ml per gram of compound in the manner described above and pure d-3-(2-pyridyl)-3-p-chlorophenyl-N,N-dimethylpropylamine-d-phenylsuccinate is obtained, melting point 145°-147°C.

This salt is shaken with 100 ml of diethyl ether and 50 ml of 20% aqueous potassium carbonate; the ether layer is separated, dried over anhydrous potassium carbonate, filtered and the ether is removed in vacuo. The d-3-(2-pyridyl)-3-p-chlorophenyl-N,N-dimethylpropylamine so obtained is a mobile oil.

4.3 grams of the above base and 1.8 grams of maleic acid are dissolved in 20 ml isopropyl acetate and kept at room temperature until crystallization is complete. The crystals are filtered, washed with ethyl acetate and recrystallized from 15 ml of this solvent in the same manner. The crystalline d-3-(2-pyridyl)-3-p-chlorophenyl-N,N-dimethylpropylamine maleate so formed is then filtered off and dried. MP 113°-115°C from U.S. Patent 3,030,371.

References

Merck Index 2908

Kleeman & Engel p. 284

PDR pp. 1606, 1648

OCDS Vol. 1 p. 77 (1977)

I.N. p. 302

REM p. 1127

Walter, L.A.; U.S. Patents 3,061,517; October 30, 1962; and 3,030,371; April 17, 1962; both assigned to Schering Corporation

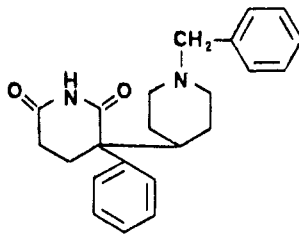
DEXETIMIDE**Therapeutic Function:** Anticholinergic**Chemical Name:** (+)-1-Benzyl-4-[(2,6-dioxo-3-phenyl)-3-piperidyl] piperidine**Common Name:** Dexbenzetimide; dextrobenzetimide; benzetimide**Structural Formula:**

(base)

Chemical Abstracts Registry No.: 21888-98-2

Trade Name	Manufacturer	Country	Year Introduced
Tremblex	Brocades	Italy	1981
Tremblex	Janssen	Switz.	—

Raw Materials

dl-1-Benzyl-4-(1,3-dicyano-1-phenylpropyl)piperidine HCl

Sulfuric acid

Hydrogen chloride

Manufacturing Process

400 parts glacial acetic acid are cooled to 10°C to 20°C. Then there are added first dropwise 300 parts concentrated sulfuric acid followed by portionwise addition of 50 parts dl-1-benzyl-4-(1,3-dicyano-1-phenylpropyl)-piperidine hydrochloride at the same temperature. After the addition is complete, the whole is heated to 125°C in the course of 15 to 20 minutes. This temperature is then maintained for 10 minutes. After cooling, the reaction mixture is poured into ice, alkalinized with NH₄OH at a temperature <20°C and extracted with chloroform. The chloroform layer is first washed twice with a K₂CO₃ 5% solution, and then washed twice with water, dried over MgSO₄, filtered and evaporated. The residue is dissolved in a mixture of 320 parts acetone and 600 parts diisopropylether, filtered and HCl gas is introduced into the filtrate. The solid hydrochloride is filtered off and dried, to yield 43 parts less pure 1-benzyl-4-(2,6-dioxo-3-phenyl-3-piperidyl)-piperidine hydrochloride, melting point 283°C to 294°C.

A sample of 4 parts is recrystallized from a boiling mixture of 80 parts isopropanol, 40 parts methanol and 500 parts water. The whole is filtered and after cooling the filtrate overnight at -20°C , 1-benzyl 4-(2,6-dioxo-3-phenyl-3-piperidyl)-piperidine hydrochloride is obtained, melting point 299°C to 301.5°C , as a white amorphous powder.

The dextro-isomer may be separated via the dextro-camphorsulfonate of the base.

References

Merck Index 2909

OCDS Vol. 2 p. 393 (1980)

DOT 9 (5) 170 (1975) & 9 (6) 247 (1975)

I.N. p. 302

Janssen, P.A.J.; U.S. Patent 3,125,578; March 17, 1964; assigned to Research Laboratorium Dr. C. Janssen NV (Belgium)

DEXPANTHENOL

Therapeutic Function: Gastrointestinal drug

Chemical Name: (R)-2,4-dihydroxy-N-(3-hydroxypropyl)-3,3-dimethylbutanamide

Common Name: Panthenol; pantothenyl alcohol

Structural Formula:

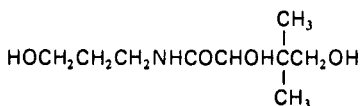

Chemical Abstracts Registry No.: 81-13-0

Trade Name	Manufacturer	Country	Year Introduced
Bepantheme	Roche	France	1951
Ilopan	Warren Teed	U.S.	1957
Cozyme	Travenol	U.S.	1958
Motilyn	Abbott	U.S.	1960
Beducene	Roche	—	—
Dexol	Legere	U.S.	—
Intrapan	Elkins-Sinn	U.S.	—
May-Vita	Mayrand	U.S.	—
Pantene	Shionogi	Japan	—
Pantenyl	Kay	U.S.	—
Panthenol-Drobena	Drobena	W. Germany	—
Panthoderm	U.S.V.	U.S.	—
Pantol	Toa-Eiyo-Yamanouchi	Japan	—
Thenalton	Fulton	Italy	—
Tonestat	A.V.P.	U.S.	—
Urupan	Merckle	W. Germany	—

Raw Materials

d(-)- α -Hydroxy- β,β -dimethyl- γ -butyric acid lactone
3-Hydroxypropylamine

Manufacturing Process

130 parts by weight of d(-)- α -hydroxy- β,β -dimethyl- γ -butyric-acid-lactone are dissolved in 150 parts by volume of methyl alcohol. 75 parts by weight of 3-hydroxypropylamine are added, in one portion, to the solution and the mixture is well stirred. While the reaction sets in, the temperature of the mixture gradually rises by itself to about 50°C and then drops again after about two hours. To cause completion of the reaction, the mixture is allowed to stand at room temperature for 24 hours. The so obtained (d+)- α,γ -dihydroxy- β,β -dimethyl-butyrac-acid-(3'-hydroxypropyl)-amide is freed from methyl alcohol in vacuo. It is a colorless, viscous oil, easily soluble in water. It boils under a pressure of 0.02 mm between 118° and 120°C.

References

Merck Index 2910

Kieeman & Engel p. 284

PDR pp. 563, 872, 1033, 1083

I.N. p. 302

REM p. 813

Schnider, O.; U.S. Patent 2,413,077; December 24, 1946; assigned to Hoffmann-La Roche Inc.

DEXTRAN 40

Therapeutic Function: Plasma extender

Chemical Name: Polymeric glucose (see structural formula) of molecular weight 40,000

Common Name: —

Structural Formula:

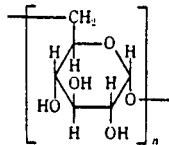

Chemical Abstracts Registry No.: 9004-54-0

Trade Name	Manufacturer	Country	Year Introduced
LMD 10%	Abbott	U.S.	1967
Rheomacrodex	Pharmacia	U.S.	1967
Fruindex	Polfa	Poland	—
Gentran 40	Travenol	U.S.	—
Lomodex 40	Fisons	U.K.	—
Longasteril	Fresenius	W. Germany	—
Perfadex	Pharmacia	Sweden	—
Plander R	Pierrel	Italy	—
Reohem	Zdravlje	Yugoslavia	—
Rheoslander	Roger Bellon	France	—
Rheotran	Pharmachem	U.S.	—
Soludeks	Pliva	Yugoslavia	—

Raw Materials

Sucrose
Bacterium *Leuconostoc mesenteroides*

Manufacturing Process

Sucrose is subjected to the action of the bacterium *Leuconostoc mesenteroides* B 512 and the crude, high-molecular weight dextran thus formed is hydrolyzed and fractionated to an average molecular weight of about 40,000 as measured by light-scattering techniques.

References

Merck Index 2911

PDR p. 1428

I.N. p. 303

REM p. 820

Grønwall, A.J.T. and Ingelman, B.G.A.; U.S. Patent 2,644,815; July 7, 1953; assigned to Aktiebolaget Pharmacia, Sweden

Shurter, R.A.; U.S. Patent 2,717,853; September 13, 1955; assigned to Commercial Solvents Corp.

Behrens, U. and Ringpfeil, M.; U.S. Patent 3,044,940; July 17, 1962; assigned to Vebserum-Werk Bernburg (W. Germany)

Novak, L.J. and Stoycos, G.S.; U.S. Patent 2,841,578; July 1, 1958; assigned to Commonwealth Eng. Co. of Ohio

Novak, L.J. and Witt, E.E.; U.S. Patent 2,972,567; February 21, 1961; assigned to Commonwealth Eng. Co. of Ohio

DEXTROAMPHETAMINE SULFATE

Therapeutic Function: Central stimulant

Chemical Name: (S)- α -methylbenzeneethanamine sulfate

Common Name: d- β -phenylisopropylamine sulfate

Structural Formula:

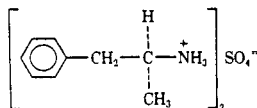

Chemical Abstracts Registry No.: 51-63-8

Trade Name	Manufacturer	Country	Year Introduced
Dexedrine Sulfate	SKF	U.S.	1944
Domofate	Haag	U.S.	1954
Dexalme	Meyer	U.S.	1954
Amsusatin	Key	U.S.	1954
Evrodex	Evron	U.S.	1955
Cendex	Dentral	U.S.	1956
D-Ate	Lemmon	U.S.	1957
Perke One	Ascher	U.S.	1966
Dexaspan	U.S.V.	U.S.	1969
Dexa Sequels	Lederle	U.S.	1970
Dexamplex	Lemmon	U.S.	1976
Adiparthrol	Syntex-Medical	Switz.	—

Trade Name	Manufacturer	Country	Year Introduced
Amfe-Dyn	Pharma-Dyn	Italy	—
d-Amfetasul	Pitman-Moore	U.S.	—
Curban	Pasadena	U.S.	—
Dexamine	Streuli	Switz.	—
Obetrol	Rexar	U.S.	—
Simpamina	Recordat	Italy	—
Stil-2	Castillon	Spain	—

Raw Materials

dI- α -Methylphenethylamine	Sodium hydroxide
d-Tartaric acid	Sulfuric acid

Manufacturing Process

Two mols, for example, 270 grams, of racemic α -methylphenethylamine base are reacted with one mol (150 grams) of d-tartaric acid, thereby forming dI- α -methylphenethylamine d-tartrate, a neutral salt. The neutral salt thus obtained is fully dissolved by the addition of sufficient, say about 1 liter, of absolute ethanol, and heating to about the boiling point. The solution is then allowed to cool to room temperature with occasional stirring to effect crystallization. The crystals are filtered off and will be found to contain a preponderance of the levo enantiomorph.

The residual solid in the mother liquors is repeatedly and systematically crystallized, yielding a further fraction of 1- α -methylphenethylamine d-tartrate which may be purified by recrystallization. d- α -Methylphenethylamine may be readily recovered from the mother liquors by the addition of tartaric acid thereto for the formation of acid tartrates and separation of d- α -methylphenethylamine d-bitartrate by crystallization.

The free base of either optical isomer may be obtained by addition to the d-tartrate in the case of the levo isomer and the d-bitartrate in the case of the dextro isomer of alkali in excess, as, for example, by the addition of an aqueous solution of caustic soda, which will cause the base to separate as an oil which may be recovered and purified by any well-known procedure. The base is exactly neutralized with sulfuric acid to give the sulfate.

References

- Merck Index 2918
 PDR pp. 1450, 1711
 OCDS Vol. 1 p. 70 (1977)
 I.N., p. 301
 REM p. 881
 Nabenhauer, F.P.; U.S. Patent 2,276,508; March 17, 1942; assigned to Smith, Kline & French Laboratories

DEXTROMETHORPHAN HYDROBROMIDE

Therapeutic Function: Antitussive

Chemical Name: d-3-Methoxy-N-methylmorphinan

Common Name: Racemethorphan hydrobromide

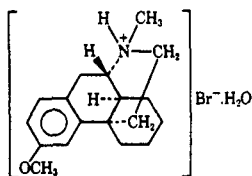
Structural Formula:**Chemical Abstracts Registry No.:** 510-53-2 (Base)

Trade Name	Manufacturer	Country	Year Introduced
Symptom 1	Parke Davis	U.S.	1977
Romilar HBR	Block	U.S.	1954
Methorate	Upjohn	U.S.	1958
Dormethan	Dorsey	U.S.	1958
Tusasade	Westerfield	U.S.	1964
Benylin	Parke Davis	U.S.	1978
Delsym	Pennwalt	U.S.	1982
Cremacoat	Vicks	U.S.	1983
Agrippol	Herd & Charton	Canada	—
Albatussin	Bart	U.S.	—
Ambenyl-D	Marion	U.S.	—
Balminil-DM	Rougier	Canada	—
Broncho-Grippol	Herd & Charton	Canada	—
Calmasan	Syntex-Pharm	Switz.	—
Calmerphan-L	Siegfried	Switz.	—
Cardec	Schein	U.S.	—
Codimal	Central	U.S.	—
Comtrex	Bristol-Myers	U.S.	—
Congespirin	Bristol-Myers	U.S.	—
Contratuss	Eri	Canada	—
Coryban D	Pfipharmecs	U.S.	—
Co Tylenol	McNeil	U.S.	—
Coughcon	Santen	Japan	—
Demo-Cineol	Sabex	Canada	—
Dextphan	Hishiyama	Japan	—
Extuson	Ferrosan	Denmark	—
Histalet DM	Reid-Rowell	U.S.	—
Husmedin	Toho	Japan	—
Hustenstilller	Roha	W. Germany	—
Hustep	S.S. Pharm	Japan	—
Kibon S	Sawai	Japan	—
Koffex	Rougier	Canada	—
Methorcon	Kowa	Japan	—
Neo-DM	Neo	Canada	—
Nycoff	Dover	U.S.	—
Pedia Care	McNeil	U.S.	—
Pulmex-DM	Therapex	Canada	—
Quelidrine	Abbott	U.S.	—
Rivodex	Rivopharm	Switz.	—
Robidex	Robins	U.S.	—
Scot-Tussin	Scot-Tussin	U.S.	—
Sedatuss	Trianon	Canada	—
Sedotus	Farge	Italy	—
Sisaal	Towa	Japan	—
Sorbutuss	Dalin	U.S.	—
St. Joseph Cough Syrup	Plough	U.S.	—
Testamin	Toyama	Japan	—
Triaminicol	Dorsey	U.S.	—

Trade Name	Manufacturer	Country	Year Introduced
Trimpus	Zensei	Japan	—
Tussar D.M.	U.S.V.	U.S.	—
Tussidy!	Tika	Sweden	—
Tussi-Organidin	Wallace	U.S.	—
Val-Atux	Farm, Milanese	Italy	—

Raw Materials

D,L-3-Hydroxy-N-methyl-morphinan	Sodium carbonate
Phenyl trimethyl ammonium chloride	Hydrogen bromide
D-Tartaric acid	

Manufacturing Process

The methylation of 51.4 parts by weight of D,L-3-hydroxy-N-methyl-morphinan is carried out with a methylating solution obtained from 51.5 parts by weight of phenyl-trimethyl-ammonium-chloride. The D,L-3-methoxy-N-methyl-morphinan is isolated in the form of its hydrobromide, which melts with 1 mol of water at 92°-94°C, without water at 239°-240°C. The base isolated from the aqueous solution by means of sodium carbonate melts at 81°-83°C.

27.1 parts by weight of D,L-3-methoxy-N-methyl-morphinan base are dissolved with 15.0 parts by weight of D-tartaric acid in 150 parts by volume of hot alcohol. The solution is cooled and seeded with (+)-3-methoxy-N-methyl-morphinan-tartrate. The (+) form which is difficultly soluble in alcohol separates, is filtered by suction and washed with a little alcohol.

[The (-) form may be crystallized from the residue obtained by concentrating the mother liquor, separating therefrom as much as possible of the (+) form and adding acetone.] The (+)-3-methoxy-N-methyl-morphinan-tartrate melts with 1 mol of water at 195°-196°C $[\alpha]_{D}^{20} = +30.6^{\circ}$ (c = 1.5 in water). The (+) base melting at 108°-109°C may be obtained from the tartrate by means of sodium carbonate. The corresponding hydrobromide melts at 122°-124°C $[\alpha]_{D}^{20} = +27.6^{\circ}$ (c = 1.5 in water).

References

Merck Index 8009

PDR pp. 552, 654, 688, 727, 784, 829, 847, 851, 993, 1074, 1084, 1404, 1447, 1454, 1562, 1606, 1662, 1824, 1868, 1886, 1972

I.N. p. 304

REM p. 870

Schnider, O. and Grussner, A.; U.S. Patent 2,676,177; April 20, 1954; assigned to Hoffmann-La Roche Inc.

DIAMTHAZOLE DIHYDROCHLORIDE

Therapeutic Function: Antifungal

Chemical Name: 6-(2-Diethylaminoethoxy)-2-dimethylaminobenzothiazole dihydrochloride

Common Name: Dimazole dihydrochloride

Structural Formula:

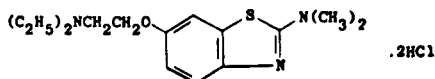

Chemical Abstracts Registry No.: 136-96-9; 95-27-2 (Base)

Trade Name	Manufacturer	Country	Year Introduced
Asterol	Roche	U.S.	1951
Athelor	Roche	—	—
Atelora	Roche	—	—
Aterola	Roche	—	—
Kesten	Roche	—	—
Mycotol	Syntofarma	Poland	—

Raw Materials

2-Dimethylamino-6-hydroxybenzothiazole	Sodium hydroxide
1-Diethylamino-2-chloroethane	Hydrogen chloride

Manufacturing Process

19.4 g of 2-dimethylamino-6-hydroxybenzothiazole (MP 245°C) were slugged in a 500 cc three-necked flask with 250 cc of chlorobenzene. Then 4.4 g of sodium hydroxide flakes were added and the mixture heated with agitation to 90°C, 4 cc of water were dropped in, and the mixture then heated slowly to the boil while about 500 cc of the water-containing chlorobenzene were distilled off. 50 cc of dry chlorobenzene were then added and the distillation was continued until about 30 cc of the chlorobenzene were distilled off. The residue was the sodium salt of thiazole in chlorobenzene. To the residue were added at 90°C, 15 g of fresh distilled 1-diethylamino-2-chloroethane. The mixture was then refluxed at 133°C for three hours, then cooled to 35°C. 75 cc of water and 5 cc of (40% by volume) sodium hydroxide solution were added and the mixture stirred for one hour. The chlorobenzene layer which contained the reaction product was separated from the aqueous layer in a separatory funnel. The chlorobenzene solution was then dried with sodium sulfate for twelve hours. It was then filtered and HCl gas was passed into the chlorobenzene solution until saturated, while cooling and stirring. The dihydrochloride precipitated as a white crystalline, sandy powder. The precipitate was filtered and washed on the funnel with benzene and finally washed with ether. The filter cake was dried at 80°C to 90°C. The 2-dimethylamino-6-(β -diethylaminoethoxy)-benzothiazole dihydrochloride thus obtained is a white crystalline powder, MP 240°C to 243°C. It can be recrystallized from ethanol and ether, or methanol or acetone.

The free base, which is an oil, can be obtained from the aqueous solution of the dihydrochloride by adding dilute sodium hydroxide or sodium carbonate solution. The base is soluble in ether, methanol, ethanol, benzene and the like, but slightly soluble in water.

References

- Merck Index 2955
 Kleeman & Engel p. 313
 I.N. p. 333
 Steiger, N. and Keller, O.; U.S. Patent 2,578,757; December 18, 1951; assigned to Hoffmann-La Roche, Inc.

DIATRIZOATE SODIUM

Therapeutic Function: Diagnostic aid (radiopaque medium)

Chemical Name: 3,5-Bis(acetylamino)-2,4,6-triiodobenzoic acid

Common Name: Amidotrizoate sodium

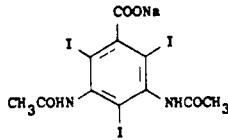
Structural Formula:

Chemical Abstracts Registry No.: 737-31-5 (Sodium salt); 117-96-4 (Base)

Trade Name	Manufacturer	Country	Year Introduced
Hypaque Sodium	Winthrop	U.S.	1955
MD-50	Mallinckrodt	U.S.	1980
Urovist Sodium	Berlex	U.S.	1983
Trignost	Teva	Israel	—
Urovison	Schering	W. Germany	—
Visotrast	Fahlberg-List	E. Germany	—

Raw Materials

3,5-Dinitrobenzoic acid	Iodine Monochloride
Hydrogen	Acetic anhydride
Sodium hydroxide	

Manufacturing Process

3,5-Dinitrobenzoic acid (15.9 g) was dissolved in an equivalent amount of sodium hydroxide solution, and the solution was diluted to 310 ml with water. The solution was refluxed with Raney nickel for fifteen minutes, filtered, and the filtrate was hydrogenated at elevated pressure using platinum oxide catalyst. After the amount of hydrogen calculated to reduce both nitro groups had been absorbed, the mixture was filtered, and the filtrate was acidified with an equal volume of concentrated hydrochloric acid. Iodine monochloride (17 ml) in 100 ml of 6N HCl was then added with stirring. The reaction mixture was allowed to stand for two and one-half hours at room temperature, then diluted with an equal amount of water with vigorous stirring, and the solid material was collected by filtration and recrystallized from dilute methanol, giving 18.5 g of 3,5-diamino-2,4,6-triiodobenzoic acid, MP about 135°C with decomposition. The 18.5 g of 3,5-diamino-2,4,6-triiodobenzoic acid was suspended in 150 ml of acetic anhydride containing 5 drops of 70% perchloric acid, and the mixture was heated on a steam bath for three and one-half hours. The reaction mixture was poured into 300 ml of ice water, and then heated on a steam bath until crystallization took place. The solid material was collected by filtration, dissolved in dilute sodium hydroxide solution, filtered, and hydrochloric acid was added to the filtrate to reprecipitate the acid product. The latter was again dissolved in sodium hydroxide and reprecipitated with acid, giving 9 g of 3,5-diacetamido-2,4,6-triiodobenzoic acid, MP above 250°C.

The acid may be used as the sodium salt or as the meglumate.

References

- Merck Index 2965
 Kleeman & Engel p. 38
 I.N. p. 68
 REM p. 1268
 British Patent 782,313; September 4, 1957; assigned to Mallinckrodt Chemical Works
 Larsen, A.A.; U.S. Patent 3,076,024; January 29, 1963; assigned to Sterling Drug, Inc.

DIAZEPAM

Therapeutic Function: Tranquilizer

Chemical Name: 7-chloro-1,3-dihydro-1-methyl-5-phenyl-2H-1,4-benzodiazepin-2-one

Common Name: —

Structural Formula:

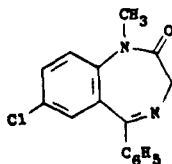

Chemical Abstracts Registry No.: 439-14-5

Trade Name	Manufacturer	Country	Year Introduced
Valium	Roche	Italy	1962
Valium	Roche	U.S.	1963
Valium	Roche	W. Germany	1963
Valium	Roche	U.K.	1963
Valium	Roche	France	1964
Novazam	Genevrier	France	1983
Aliseum	Zova	Italy	—
Amiprol	U.S. Vitamin	Argentina	—
Anksiyolin	Saglik	Turkey	—
Ansiolin	Scharper	Italy	—
Ansiolisina	Effepi	Italy	—
Anxium-5	Ethica	Canada	—
Anzepam	Arislo	India	—
Apaurin	Krka	Yugoslavia	—
Apozepam	A.L.	Norway	—
Armonil	Alet	Argentina	—
Assival	Assia	Israel	—
Atensine	Berk	U.K.	—
Avex	Spemsa	Italy	—
Bensedin	Galenika	Yugoslavia	—
Betapam	Be-Tabs	S. Africa	—
Calmpose	Ranbaxy	India	—
Canazepam	Paul Maney	Canada	—
Cercine	Takeda	Japan	—
Ceregular	Kaken	Japan	—
Condition	Nagataki	Japan	—
Diaceplex	Salvat	Spain	—
Dialag	Legap	Switz.	—
Diapam	Orion	Finland	—
Diapam	Dincel	Turkey	—
Diatran	Protea	S. Africa	—
Diaz	Taro	Israel	—
Diazem	Deva	Turkey	—
Diazemuls	Kabi Vitrum	Sweden	—
Diempax	Lafi	Brazil	—
Dipam	Alkaloid	Yugoslavia	—
Dizam	Pharmador	S. Africa	—
Domalium	Valderrama	Spain	—
Doval	Ormed	S. Africa	—
Drenian	Ern	Spain	—
Ducene	Sauter	Australia	—
Duksen	Kobanyai	Hungary	—
E-Pam	I.C.N.	Canada	—
Eridan	UCB-Smit	Italy	—

Trade Name	Manufacturer	Country	Year Introduced
Erital	Eri	Canada	—
Euphorin	Dojin	Japan	—
Eurosan	Mepha	Switz.	—
Evacalm	Unimed	U.K.	—
Faustan	Arzneimittelwerk Dresden	E. Germany	—
Grewacalm	Heilmittelwerke Wien	Austria	—
Githitan	Toyama	Japan	—
Horizon	Yamanouchi	Japan	—
Lamra	Merckle	W. Germany	—
Lembrol	Gerardo Ramon	Argentina	—
Levium	Sodelco	Neth.	—
Liberetas	Galup	Spain	—
Lizan	Nobel	Turkey	—
Meval	Medic	Canada	—
Neo-Calme	Neo	Canada	—
Nervium	Saba	Turkey	—
Neurolytril	Dorsch	W. Germany	—
Noan	Ravizza	Italy	—
Notense	Rio Ethicals	S. Africa	—
Novodipam	Novopharm	Canada	—
Pacipam	Cox	U.K.	—
Pacitran	Grossmann	Mexico	—
Pacitran	Lafi	Brazil	—
Pax	Lennon	S. Africa	—
Paxel	Elliott-Marion	Canada	—
Pro-Pam	Protea	Australia	—
Psychopax	Sigmapharm	Austria	—
Quetinil	Dompe	Italy	—
Quievita	Vita	Italy	—
Relivan	Scruple	S. Africa	—
Renborin	Nippon Chemiphar	Japan	—
Rival	Riva	Canada	—
Saromet	Sintyal	Argentina	—
Scriptopam	Propan-Lipworth	S. Africa	—
Sedapam	Duncan Flockhart	U.K.	—
Sedaril	Kodama	Japan	—
Sedipam	Medica	Finland	—
Seduxen	Gedeon Richter	Hungary	—
Serenack	Nordic	Canada	—
Serenamin	Medimpex	Hungary	—
Serenamin	Toyo Jozo	Japan	—
Serenzin	Sumitomo	Japan	—
Solis	Galen	U.K.	—
Somasedan	Celtia	Argentina	—
Sonacon	Delmar	Canada	—
Sonacon	Chugai	Japan	—
Stresolid	Dumex	Denmark	—
Stress-Pam	Sabex	Canada	—
Tensium	D.D.S.A.	U.K.	—
Tensopam	Pharmacal	Finland	—
Tranquase	Azuchemie	W. Germany	—
Tranquo-Puren	Klinge	W. Germany	—
Tranquo-Tabliten	Sanorania	W. Germany	—
Umbrium	Kwizda	Austria	—
Valibrin	Mulda	Turkey	—
Valitran	Firma	Italy	—
Vatran	Valeas	Italy	—

Trade Name	Manufacturer	Country	Year Introduced
Vival	A.L.	Norway	—
Vivol	Horner	Canada	—
Zepam	Aksu	Turkey	—

Raw Materials

2-Amino-5-chlorobenzophenone- β -oxime	Sodium hydroxide
Chloroacetyl chloride	Diazomethane
Phosphorus trichloride	

Manufacturing Process

Into a stirred, cooled (10°-15°C) solution of 26.2 grams (0.1 mol) of 2-amino-5-chlorobenzophenone β -oxime in 150 ml of dioxane were introduced in small portions 12.4 grams (0.11 mol) of chloroacetyl chloride and an equivalent amount of 3 N sodium hydroxide. The chloroacetyl chloride and sodium hydroxide were introduced alternately at such a rate so as to keep the temperature below 15°C and the mixture neutral or slightly alkaline. The reaction was completed after 30 minutes. The mixture was slightly acidified with hydrochloric acid, diluted with water and extracted with ether. The ether extract was dried and concentrated in vacuo. Upon the addition of ether to the oily residue, the product, 2-chloroacetamido-5-chlorobenzophenone β -oxime, crystallized in colorless prisms melting at 161°-162°C.

20 ml of 1 N sodium hydroxide were added to a solution of 6.4 grams (20 mmol) of 2-chloroacetamido-5-chlorobenzophenone β -oxime. After 15 hours the mixture was diluted with ice cold 1 N sodium hydroxide and extracted with ether. The ether extract was discarded. The alkaline solution was acidified with hydrochloric acid and extracted with methylene chloride. The methylene chloride solution was concentrated to a small volume and then diluted with petroleum ether to obtain 7-chloro-5-phenyl-3H-1,4-benzodiazepin-2(1H)-one 4-oxide.

To a stirred suspension of 10 grams (35 mmol) of 7-chloro-5-phenyl-3H-1,4-benzodiazepin-2(1H)-one 4-oxide in approximately 150 ml of methanol was added in portions an excess of a solution of diazomethane in ether. After about one hour, almost complete solution had occurred and the reaction mixture was filtered. The filtrate was concentrated in vacuo to a small volume and diluted with ether and petroleum ether. The reaction product, 7-chloro-1-methyl-5-phenyl-3H-1,4-benzodiazepin-2(1H)-one 4-oxide, crystallized in colorless prisms. The product was filtered off and recrystallized from acetone, MP 188°-189°C.

A mixture of 3 grams (0.01 mol) of 7-chloro-1-methyl-5-phenyl-3H-1,4-benzodiazepin-2(1H)-one 4-oxide, 30 ml of chloroform and 1 ml of phosphorus trichloride was refluxed for one hour. The reaction mixture was then poured on ice and stirred with an excess of 40% sodium hydroxide solution. The chloroform was then separated, dried with sodium sulfate, filtered and concentrated in vacuo. The residue was dissolved in methylene chloride and crystallized by the addition of petroleum ether. The product, 7-chloro-1-methyl-5-phenyl-3H-1,4-benzodiazepin-2(1H)-one, was recrystallized from a mixture of acetone and petroleum ether forming colorless plates melting at 125°-126°C.

The manufacturing procedure above is from U.S. Patent 3,136,815. Purification of diazepam is discussed in U.S. Patent 3,102,116.

References

- Merck Index 2967
- Kleeman & Engel p. 288
- PDR pp. 1506, 1517, 1999
- OCDS Vol. 1 p. 365 (1977) & 2 p. 452 (1980)
- DOT 9 (6) 236 (1973); 18 (8) 380 (1982) & 19 (3) 170 (1983)
- I.N. p. 309
- REM p. 1062

Chase, G.; U.S. Patent 3,102,116; August 27, 1963; assigned to Hoffmann-La Roche Inc.
 Reeder, E. and Sternbach, L.H.; U.S. Patent 3,109,843; November 5, 1963; assigned to Hoffmann-La Roche Inc.
 Reeder, E. and Sternbach, L.H.; U.S. Patent 3,136,815; June 9, 1964; assigned to Hoffmann-La Roche Inc.
 Reeder, E. and Sternbach, L.H.; U.S. Patent 3,371,085; February 27, 1968; assigned to Hoffmann-La Roche Inc.

DIAZOXIDE

Therapeutic Function: Antihypertensive

Chemical Name: 7-chloro-3-methyl-2H-1,2,4-benzothiadiazine 1,1-dioxide

Common Name: —

Structural Formula:

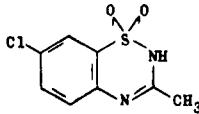

Chemical Abstracts Registry No.: 364-98-7

Trade Name	Manufacturer	Country	Year Introduced
Eudemine	Allen Hanburys	U.K.	1970
Hyperstat	Schering	U.S.	1973
Hypertonalum	Byk-Essex	W. Germany	1973
Hyperstat	Essex	Switz.	1973
Proglidem	Byk-Essex	W. Germany	1974
Proglidem	Cetrane	France	1974
Proglidem	Essex	Italy	1975
Hyperstat	Cetrane	France	1976
Diapressin	Medica	Finland	—
Proglidem	Aesca	Austria	—
Proglycem	Schering	U.S.	—

Raw Materials

Benzyl chloride	Thiourea
2,4-Dichloronitrobenzene	Chlorine
Ammonia	Iron
Ethyl orthoacetate	Orthoanilamide
Acetic anhydride	

Manufacturing Process

One route is described in U.S. Patent 2,986,573: Mix 63 grams of benzyl chloride, 38 grams of thiourea, 3 drops of concentrated ammonium hydroxide solution, and 250 ml of 95% ethanol. Reflux the mixture for 3 hours. Cool and add a solution containing 96 grams of 2,4-dichloro-nitrobenzene in 200 ml of ethanol. Heat the mixture to reflux and then add drop-wise a solution of 70 grams of potassium hydroxide in 500 ml of ethanol. Continue refluxing for 2 hours, and then cool and filter the solids produced. Wash the solid with aqueous ethanol and dry. There is thus produced 2-benzylthio-4-chloro-nitrobenzene. Sus-

pend 50 grams of 2-benzylthio-4-chloro-nitrobenzene in 1,000 ml of 33% aqueous acetic acid. Bubble chlorine gas through the suspension during a period of 2 hours, while maintaining the suspension at a temperature in the range of about 0°-5°C.

Extract the mixture 3 times with 400 ml each of chloroform, pool the extracts, and wash the chloroform solution with water. Dry the chloroform solution with anhydrous sodium sulfate and filter.

Evaporate the dried chloroform solution to a residue, add to the residue 400 ml of liquid ammonia, stir and allow the excess ammonia to evaporate, triturate the residue with hexane to form a crystalline solid, continue trituration with water, and filter the solid to yield substantially pure 2-sulfamyl-4-chloro-nitrobenzene. Recrystallize from aqueous methanol. Mix together 4.4 grams of ammonium chloride, 18 ml of methanol, 9 ml of water and 3.0 grams of 2-sulfamyl-4-chloro-nitrobenzene. Heat the mixture to reflux. Add portionwise 4.4 grams of iron filings during a period of about 1½ hours. Cool the mixture and filter. Concentrate the filtrate to a residue. Triturate the residue with 15 ml of water and filter the solid. Recrystallize the solid from aqueous methanol to yield substantially pure 2-sulfamyl-4-chloroaniline.

Heat a mixture of 6 grams of 2-sulfamyl-4-chloroaniline and 15 ml of ethyl orthoacetate at 100°-110°C for 1.5 hours. Cool and filter the solids. Recrystallize from aqueous ethanol yielding 3-methyl-7-chloro-1,2,4-benzothiadiazine-1,1-dioxide. This substance is a white crystalline solid melting at 330°C.

Another route is described in U.S. Patent 3,345,365: A mixture containing 10 grams of orthoanilamide, 10 cc of pyridine and 20 cc of acetic anhydride is heated for 3 hours at 50°-60°C and allowed to stand overnight. The solids obtained are filtered and crystallized from ethanol to yield 10.73 grams of N,N'-diacetyl-o-anilamide, MP 199°-200°C.

To a mixture of 3.0 grams of N,N'-diacetyl-o-anilamide and 20 ml of acetic acid is added a previously prepared solution of 1.5 grams of chlorine in 31 cc of acetic acid. The reaction mixture is allowed to stand at room temperature for 3 hours and is then evaporated to dryness on a steam bath under reduced pressure. The resulting solid residue is recrystallized from ethanol, yielding the intermediate N,N'-diacetyl-2-sulfamyl-4-chloroaniline. The intermediate compound is fused in an oil bath at 250-260°C for 15 minutes, cooled and the product so obtained is crystallized from 80% ethanol yielding 3-methyl-7-chloro-1,2,4-benzothiadiazine-1,1-dioxide, MP 330°C.

References

Merck Index 2975

Kleeman & Engel p. 290

PDR pp. 1130, 1630

OCDS Vol. 1 p. 355 (1977) & 2 p. 395 (1980)

DOT 9 (11) 458 (1973)

I.N. p. 310

REM p. 847

Topliss, J.G., Sperber, N. and Rubin, A.A.; U.S. Patent 2,986,573; May 30, 1961; assigned to Schering Corporation

Topliss, J.G., Sperber, N. and Rubin, A.A.; U.S. Patent 3,345,365; October 3, 1967; assigned to Schering Corporation

DIBEKACIN

Therapeutic Function: Antibacterial

Chemical Name: O-3-Amino-3-deoxy- α -D-glucopyranosyl-(1 \rightarrow 6)-O-[2,6-diamino-2,3,4,6-tetra-deoxy- α -D-erythrohexopyranosyl(1 \rightarrow 4)]-2-deoxy-D-streptomycin

Common Name: Dideoxykanamycin

Structural Formula:

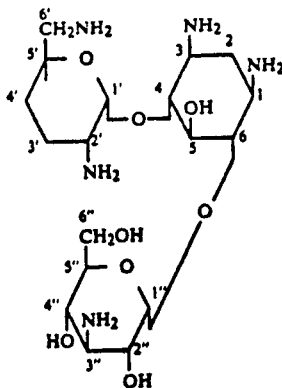

Chemical Abstracts Registry No.: 34493-98-6; 60594-69-6 (Sulfate)

Trade Name	Manufacturer	Country	Year Introduced
Panimycin	Meiji Seika	Japan	1975
Orbicin	Pfizer	W. Germany	1978
Kappabi	Farmitalia Erba	Italy	1980
Ioacine	Bristol	France	1981
Decabacin	Lefa	Spain	—
Debekacyl	Meiji	Japan	—
Duramycin	Pfizer-Roerig	—	—
Klobamicina	Admirall	Spain	—
Nipocin	Pliva	Yugoslavia	—
Panimycin	Gerardo Ramon	Argentina	—

Raw Materials

Penta-N-benzoyloxycarbonyl-2''-O-benzylsulfonyl-3',4'-dideoxy-3'-eno-kanamycin B
Sodium
Ammonia
Hydrogen

Manufacturing Process

Penta-N-benzoyloxycarbonyl-2''-O-benzylsulfonyl-3',4'-dideoxy-3'-eno-kanamycin B (61 mg) was dissolved in about 18 ml of liquid ammonia at -50°C , followed by addition of about 120 mg of metal sodium. The mixture was gently stirred at -50°C for 1 hour, followed by addition of methanol to consume up the excess of the metal sodium. The reaction mixture was allowed to slowly raise up to ambient temperature while permitting the ammonia to evaporate. The residue so obtained was dissolved in water, and the aqueous solution was admixed with 4 ml of a cation-exchange resin, Dowex 50WX2 (H cycle) (a product of Dow Chemical Co., U.S.A.) under stirring. The admixture comprising the resin was placed on the top of a column of 3.5 ml of the same resin. Dowex 50WX2, and the whole resin column was well washed with water and then eluted using 1 M aqueous ammonia as the developing solvent. The eluate was collected in fractions, and such fractions which gave positive reaction with ninhydrin were combined together and concentrated to dryness, affording 3',4'-dideoxy-3'-enokanamycin B in the form of its monocarbonate. The yield was 23.8 mg (97%).

The product (12.1 mg) obtained in the above step was dissolved in 0.3 ml of water, to which was then added a catalytic quantity (about 5 mg) of platinum oxide. Hydrogenation was made with hydrogen gas at a pressure of 3.5 kg/cm² for 1.5 hours. The reaction solution was filtered to remove the catalyst, and the filtrate was concentrated to dryness, giving the desired product 3',4'-dideoxykanamycin B in the form of its monocarbonate. The yield was 11.5 mg (95%). $[\alpha]_D^{25} + 110^\circ$ (c 1, water). The overall yield of 3',4'-dideoxykanamycin B based on the starting kanamycin B was 57%.

References

Merck Index 2976

Kleeman & Engel p. 290

DOT 12 (5) 211 (1976)

I.N. p. 311

Umezawa, H., Umezawa, S. and Tsuchiya, T.; U.S. Patent 4,169,939; October 2, 1979; assigned to Zaidan Hojin Biseibutsu Kagaku Kenkyu Kai (Japan)

DIBENZEPIN HYDROCHLORIDE

Therapeutic Function: Psychostimulant

Chemical Name: 10-[2-(dimethylamino)ethyl]-5,10-dihydro-5-methyl-11H-dibenzo[b,e]-[1,4] diazepin-11-one hydrochloride

Common Name: —

Structural Formula:

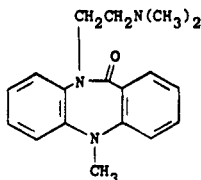

(base)

Chemical Abstracts Registry No.: 315-80-0; 4498-32-2 (Base)

Trade Name	Manufacturer	Country	Year Introduced
Noveril	Wander	Switz.	1965
Noveril	Wander	W. Germany	1965
Noveril	Sandoz	France	1967
Noveril	Wander	Italy	1968
Noveril	Wander	U.K.	1970
Noveril	Morishita	Japan	1975
Ansiopax	Andrade	Portugal	—
Deprex	Novo	—	—
Ecatriil	Sandoz	France	—
Neodit	Wander	—	—
Victoril	Unipharm	Israel	—

Raw Materials

5-Methyl-11-hydroxy-5H-dibenzo[b,e][1,4]-diazepine
Sodium amide
 β -Dimethylaminoethyl chloride
Hydrogen chloride

Manufacturing Process

4.48 grams of 5-methyl-11-hydroxy-5H-dibenzo-[b,e] [1,4]-diazepine and 0.86 gram of sodium amide were boiled for one hour in 50 ml of absolute dioxane. After adding a concentrated benzenic solution of β -dimethylamino-ethyl chloride freshly prepared from 3.75 grams of the hydrochloride with concentrated sodium hydroxide solution, taking up in benzene and drying the solution with potash, the mixture was boiled for 16 hours under reflux, whereupon the reaction mixture was concentrated to dryness and the residue distributed between ether and water. By exhaustive extraction of the basic fractions with dilute acetic acid, precipitation with ammonia, taking up the base in ether and working up the ethereal solution, there was obtained 5.05 grams (85% of the theoretical) of 5-methyl-10- β -dimethylamino-ethyl-10,11-dihydro-11-oxo-5H-dibenzo-[b,e] [1,4]-diazepine in the form of a viscous yellowish resin with the boiling point 185°C/0.01 mm Hg. The base was crystallized from acetone-petroleum ether, MP 116°-117°C. Melting point of the monohydrochloride (from ethanol-ether) 234°-240°C.

References

Merck Index 2979

Kleeman & Engel p. 291

OCDs Vol. 1 p. 405 (1977) & 2 pp. 424, 471 (1980)

DOT 2 (1) 4 (1966)

I.N. p. 311

British Patent 961,106; June 17, 1964; assigned to Dr. A. Wander AG, Switzerland

Schmutz, J. and Hunziker, F.; U.S. Patent 3,419,547; December 31, 1968; assigned to Dr. A. Wander, S.A. (Switzerland)

DIBUTOLINE SULFATE

Therapeutic Function: Anticholinergic

Chemical Name: Bis[Ethyl(2-hydroxyethyl)dimethylammonium] sulfate -bis(dibutylcarbamate)

Common Name: —

Structural Formula:

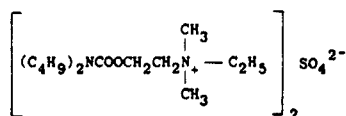

Chemical Abstracts Registry No.: 532-49-0

Trade Name	Manufacturer	Country	Year Introduced
Dibuline Sulfate	MSD	U.S.	1952

Raw Materials

β -Chloroethyl-di-n-butylcarbamate	Dimethylamine
Silver sulfate	Ethyl iodide

Manufacturing Process

About 55.5 g of β -chloroethyl-di-n-butylcarbamate and about 22.6 g of dimethylamine are placed in a container, firmly sealed, and heated at about 95°C for about 16 hours. To the re-

sulting crude mixture is added ethyl ether and the mixture filtered to remove dimethylamine hydrochloride formed during the course of the reaction. The ethereal solution is then extracted with 12 N hydrochloric acid. Under a fresh layer of ether and at a temperature under 10°C the aqueous acid extract is first neutralized with sodium carbonate and then made strongly alkaline with sodium hydroxide. The supernatant ethereal solution is then separated and dried over potassium hydroxide. The ethereal solution is finally concentrated and the residue obtained is fractionally distilled under vacuum. The β -dimethylaminoethyl-di-n-butylcarbamate is found to distill undecomposed at about 128°C to 130°C under approximately 2 mm pressure.

A mixture of about 100 g of β -dimethylaminoethyl-di-n-butylcarbamate and about 188 cc of ethyl iodide is held at about 25°C for two hours. The temperature is kept about 25°C by occasional cooling in an ice bath during the first half hour. About 1,600 cc of anhydrous ethyl ether is then added causing the precipitation of a dense white product. After standing for about 16 hours at 0°C the product is filtered off, washed thoroughly with anhydrous ether, and dried under diminished pressure at room temperature over sulfuric acid. The β -(dimethyl ethyl ammonium iodide)-ethyl-di-n-butylcarbamate thus obtained is a white crystalline powder, slightly hygroscopic with a melting point of about 76°C to 77°C.

A mixture of about 150 g of β -(dimethyl ethyl ammonium iodide)-ethyl-di-n-butylcarbamate, 90 g of silver sulfate, 750 cc of water and 750 cc of ethanol is stirred at about 30°C for approximately 45 minutes. The silver iodide formed is removed and the excess silver remaining in solution is removed by bubbling in hydrogen sulfide for five minutes followed by filtration to remove the precipitated silver sulfide. The filtrate is concentrated to a thick syrup under vacuum and about one liter of benzene is added which is distilled off with stirring to atmospheric pressure to remove the last traces of water. The residual benzene is removed under vacuum and the product granulated by stirring with one liter of anhydrous ether for two hours. The product is removed, washed with anhydrous ether, and dried under diminished pressure over phosphorous pentoxide at 25°C. The β -(dimethyl ethyl ammonium sulfate)-ethyl-di-n-butylcarbamate thus obtained is a very hygroscopic white solid having a melting point of about 166°C with decomposition.

References

Merck Index 3012

I.N. p. 313

Swan, K.C. and White, N.G.; U.S. Patent 2,432,049; December 2, 1947

DICHLORISONE ACETATE

Therapeutic Function: Topical antipruritic

Chemical Name: 9 α ,11 β -Dichloro-1,4-pregnadiene-17 α ,21-diol-3,20-dione -21-acetate

Common Name: —

Structural Formula:

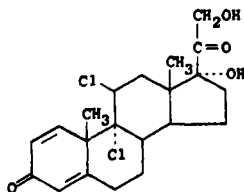

Chemical Abstracts Registry No.: 79-61-8; 7008-26-6 (Base)

Trade Name	Manufacturer	Country	Year Introduced
Diloderm	Schering	U.S.	1960
Astroderm	Aristochimica	Italy	—
Dermaren	Areu	Spain	—
Diclasone	Liberman	Spain	—
Disoderm	Schering	—	—

Raw Materials

1,4,9(11)-Pregnatriene-17 α ,21-diol-3,20-dione-21-acetate
N-Chlorosuccinimide

Manufacturing Process

A solution of 1.0 g of 1,4,9(11)-pregnatriene-17 α ,21-diol-3,20-dione-21-acetate and 5.0 g of lithium chloride in 40 ml of glacial acetic acid is treated with 0.410 g of N-chlorosuccinimide, followed by 0.104 g of anhydrous hydrogen chloride dissolved in 2.5 ml of tetrahydrofuran. The reaction mixture is stirred for 2 hours and poured into ice water. The crude product is filtered and washed with water to give 1.12 g of solid material, which is recrystallized from acetone-hexane to give substantially pure 9 α ,11 β -dichloro-1,4-pregnadiene-17 α ,21-diol-3,20-dione-21-acetate; MP 246°C to 253°C (dec.).

References

Merck Index 3030

Kleeman & Engel p. 292

OCDS Vol. 1 p. 203 (1977)

I.N. p. 314

Gould, D.H., Reimann, H. and Finckenor, L.E.; U.S. Patent 2,894,963; July 14, 1959; assigned to Schering Corp.

DICHLORPHENAMIDE

Therapeutic Function: Carbonic anhydrase inhibitor; glaucoma treatment

Chemical Name: 4,5-Dichloro-m-benzenedisulfonamide

Common Name: Diclofenamid

Structural Formula:

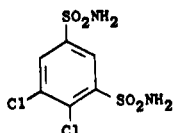

Chemical Abstracts Registry No.: 120-97-8

Trade Name	Manufacturer	Country	Year Introduced
Daranide	MSD	U.S.	1958
Oratrol	Alcon	U.S.	1960
Diclofenamid	Mann	W. Germany	1976
Antidrafi	I.S.F.	Italy	—
Barastonin	Santen	Japan	—
Fenamide	Farmigea	Italy	—
Glajust	Hotta	Japan	—

Trade Name	Manufacturer	Country	Year Introduced
Glaucol	Star	Finland	—
Glauconide	Llorens	Spain	—
Glaumid	S.I.F.I.	Italy	—
Hipotensor Oftalmico	C.M.C.	Spain	—
Netex	C.M.C.	Spain	—
Tensodilen	Frumtost	Spain	—

Raw Materials

Chlorosulfonic acid	O-Chlorophenol
Phosphorus pentachloride	Ammonia

Manufacturing Process

In a 2 liter round-bottomed flask equipped with stirrer and dropping funnel is placed 1,585 grams (880 cc; 13.6 mols) of chlorosulfonic acid. To this is added dropwise with stirring during 5 hours 218 grams (1.7 mols) of o-chlorophenol. The mixture is allowed to stand 1 hour at room temperature and then is heated 1 hour on a steam bath. The mixture is then poured on ice.

A product consisting largely of 5-chloro-4-hydroxybenzene-1,3-disulfonyl chloride separates as a gum which solidifies on standing for about 1 hour. The solid product is collected on a Buchner funnel, washed with water and thoroughly dried in air at room temperature.

A mixture of this crude product (approximately 302 grams, 0.92 mol) and 480 grams (2.3 mols) of phosphorus pentachloride is heated for 1 hour at 120°-140°C in a 2 liter round-bottomed flask. The resulting clear solution is poured on ice. 4,5-Dichlorobenzene-1,3-disulfonyl chloride separates immediately as a solid. It is collected by filtration and washed with water. While still moist, it is added in portions during about 20 minutes to 1 liter of concentrated ammonia water contained in a 3 liter beaker surrounded by a cold water bath. The reaction mixture is then allowed to stand for 1 hour without cooling after which it is heated on a steam bath for about 30 minutes while air is bubbled through it, in order to remove some of the excess ammonia. It is then filtered, acidified with concentrated hydrochloric acid and chilled.

The product separates as a gum from which the supernatant liquid is decanted, and the gum is triturated with 250 cc of water in order to induce crystallization. The crude product thus obtained is recrystallized from 3,200 cc of boiling water and then from 40% aqueous isopropyl alcohol yielding 4,5-dichlorobenzene-1,3-disulfonamide as a white solid, MP 228.5° to 229.0°C.

References

- Merck Index 3062
- Kleeman & Engel p. 294
- PDR p. 1155
- OCDS Vol. 1 p. 133 (1977)
- I.N. p. 316
- REM p. 936
- Schultz, E.M.; U.S. Patent 2,835,702; May 20, 1958; assigned to Merck & Co., Inc.

DICLOFENAC SODIUM

Therapeutic Function: Antiinflammatory

Chemical Name: 2-[(2,6-dichlorophenyl)amino]benzeneacetic acid monosodium salt

Common Name: —

Structural Formula:

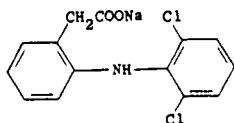

Chemical Abstracts Registry No.: 15307-79-6; 15307-86-5 (Base)

Trade Name	Manufacturer	Country	Year Introduced
Voltaren	Fujisawa	Japan	1974
Voltaren	Ciba Geigy	Italy	1975
Voltarene	Ciba Geigy	France	1976
Voltaren	Geigy	W. Germany	1976
Voltarol	Ciba Geigy	U.K.	1978
Adefuronic	Taiyo	Japan	—
Blesin	Sawai	Japan	—
Dichronic	Toyo	Japan	—
Docell	Nippon Kayaku	Japan	—
Irinatolon	Tatumi	Japan	—
Kriplex	Alfa Farm.	Italy	—
Neriodin	Teikoku	Japan	—
Shignol	Taisho	Japan	—
Sofarin	Nippon Chemiphar	Japan	—
Sorelmon	Towa Yakuhin	Japan	—
Thicataren	Isei	Japan	—
Tsudohmin	Toho	Japan	—
Valetan	Tobishi	Japan	—

Raw Materials

N-Chloroacetyl-N-phenyl-2,6-dichloroaniline
 Aluminum chloride
 Sodium hydroxide

Manufacturing Process

Four grams of N-chloroacetyl-N-phenyl-2,6-dichloroaniline and 4 grams of aluminum chloride are well mixed together and heated for 2 hours at 160°C. The melt is cooled and poured onto about 50 grams of ice while it is still warm. The oil which separates is dissolved in 50 ml of chloroform, the chloroform solution is washed with 10 ml of water, dried over sodium sulfate and concentrated under 11 torr. The residue is distilled. The 1-(2,6-dichlorophenyl)-2-indolinone melts at 126°-127°C.

A solution of 186 grams of 1-(2,6-dichlorophenyl)-2-indolinone in 660 ml of ethanol and 660 ml of 2 N sodium hydroxide solution is refluxed for 4 hours. The solution is then cooled and left to stand for 4 hours at 0°-5°C. The crystals which form are filtered off and recrystallized from water. The sodium salt of 2-(2,6-dichloroanilino)-phenylacetic acid melts at 283°-285°C. The yield is 97% of theoretical, according to U.S. Patent 3,558,690.

References

Merck Index 3066
 Kleeman & Engel p. 293
 OCDS Vol. 2 p. 70 (1980)
 DOT 9 (9) 369 (1973) & 11 (3) 106 (1975)
 I.N. p. 316

Sallmann, A. and Pfister, R.; U.S. Patent 3,558,690; January 26, 1971; assigned to Geigy Chemical Corporation

Sallmann, A. and Pfister, R.; U.S. Patent 3,652,762; March 28, 1972; assigned to Ciba-Geigy Corporation

DICLOXACILLIN SODIUM

Therapeutic Function: Antibacterial

Chemical Name: 6-[3-(2,6-dichlorophenyl)-5-methyl-4-isoxazolecarboxamido]-3,3-dimethyl-7-oxo-4-thia-1-azabicyclo[3.2.0]heptane-2-carboxylic acid sodium salt

Common Name: 3-(2,6-dichlorophenyl)-5-methyl-4-isoxazolylpenicillin

Structural Formula:

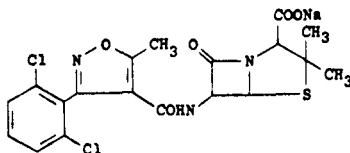

Chemical Abstracts Registry No.: 13412-64-1; 3116-76-5 (Acid)

Trade Name	Manufacturer	Country	Year Introduced
Dichlor-Stapenor	Bayer	W. Germany	1965
Dynapen	Bristol	U.S.	1968
Veracillin	Ayerst	U.S.	1968
Pathocil	Wyeth	U.S.	1968
Diclocil	Bristol	France	1968
Diclocil	Bristol	Italy	1971
Dycill	Beecham	U.S.	1975
Clocil	Bristol Banyu	Japan	—
Combipenix	Toyo Jozo	Japan	—
Constaphyl	Grunenthal	W. Germany	—
Diclex	Meiji	Japan	—
Diclo	Firma	Italy	—
Diclomax	Pulitzer	Italy	—
Diclozapen	Magis	Italy	—
Novapen	I.B.P.	Italy	—
Soldak	Ariston	Argentina	—
Staphicillin	Banyu	Japan	—
Totocillin	Bayer	W. Germany	—

Raw Materials

6-Aminopenicillanic acid
3-(2',6'-Dichlorophenyl)-5-methylisoxazole-4-carbonyl chloride
Sodium bicarbonate

Manufacturing Process

A suspension of 6-aminopenicillanic acid (216 grams) in water (2 liters) was adjusted to pH 6.8 by the addition of N aqueous sodium hydroxide (approximately 1 liter) and the resulting solution was stirred vigorously while a solution of 3-(2',6'-dichlorophenyl)-5-methylisoxazole-4-carbonyl chloride (290 grams) in acetone (1.5 liters) was added in one portion.

The temperature rose to 26°C and as reaction proceeded the free acid form of the penicillin separated as a white solid. After 30 minutes the suspension was cooled to 10°C and stirring was continued at this temperature for 1 hour more. The mixture was then cooled to 0°C, centrifuged, and the solid product washed with aqueous acetone (250 ml) and finally dried in an air oven at 30°C. The product (440 grams, 94%) had $[\alpha]_D^{20} + 106.3^\circ$ (c., 1 in EtOH) and was shown by alkalimetric assay to be 97.5% pure.

The salt was prepared by dissolving the free acid form of the penicillin in the equivalent amount of aqueous sodium bicarbonate and freeze drying the resulting solution. The hydrated salt so obtained was shown by alkalimetric assay to be 94% pure and to contain 6% water.

References

Merck Index 3068

Kleeman & Engel p. 295

PDR pp. 697, 993, 1606, 1967

OCDS Vol. 1 p. 413 (1977)

DOT 2 (2) 50 (1966)

I.N. p. 316

REM p. 1196

Naylor, J.H.C.; U.S. Patent 3,239,507; March 8, 1966; assigned to Beecham Group Limited, England

DICYCLOMINE HYDROCHLORIDE

Therapeutic Function: Antispasmodic

Chemical Name: (bicyclohexyl)-1-carboxylic acid 2-(diethylamino)ethyl ester hydrochloride

Common Name: Dicycloverin hydrochloride

Structural Formula:

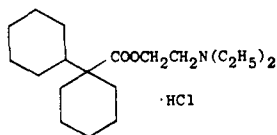

Chemical Abstracts Registry No.: 67-92-5; 77-19-0 (Base)

Trade Name	Manufacturer	Country	Year Introduced
Bentyl	Merrell National	U.S.	1950
Dyspas	Savage	U.S.	1974
Dicen	Mallard	U.S.	1980
Neoquess	O'Neal, Jones	U.S.	1981
A-Spas	Hyrex	U.S.	1983
Ametil	Corvi	Italy	—
Atumin	Merrell	W. Germany	—
Babyspasmil	Lacefa	Argentina	—
Benacol	Cenci	U.S.	—
Bentomine	Darby	U.S.	—
Bentylol	Inibsa	Spain	—
Clomin	S.C.S. Pharnalab.	S. Africa	—
Cyclobec	Pharbec	Canada	—
Dicycol	Ohio Medical	U.S.	—

Trade Name	Manufacturer	Country	Year Introduced
Esentil	Erba	Italy	—
Formulex	I.C.N.	Canada	—
Icramin	Toho Iyaku	Japan	—
Incron	Seiko	Japan	—
Kolantyl	Merrill	U.K.	—
Lomine	Riva	Canada	—
Mamiesan	Kyowa	Japan	—
Merbantal	Vitrum	Sweden	—
Merbenyl	Merrell	U.K.	—
Mydocalm	Lennon	S. Africa	—
Nomocramp	Salusa	S. Africa	—
Notensyl	C.T.S.	Israel	—
Or-Tyl	Ortega	U.S.	—
Panakiron	Sato	Japan	—
Protylol	Pro Doc	Canada	—
Spascol	Vangard	U.S.	—
Spasmoban	Trianon	Canada	—
Viscerol	Medic	Canada	—

Raw Materials

1-Phenylcyclohexane cyanide	Sulfuric acid
β -Diethylaminoethanol	Ethanol
Sodium	Hydrogen

Manufacturing Process

155 grams of 1-phenylcyclohexanecyanide, 350 cc of concentrated sulfuric acid and 1,130 cc of ethyl alcohol are refluxed vigorously for 48 hours. The remaining alcohol is then removed by vacuum distillation and the residue is poured into 1 liter of ice water. An oil separates which is extracted 3 times with 200 cc portions of petroleum ether, the extracts are combined and heated on a steam bath to remove the ether. The resulting crude ester may be used directly for the reesterification operation or it may be distilled to purify it first. A mixture of the ester so obtained, 155 grams of β -diethylaminoethanol and 800 cc of dry xylene are placed in a reaction vessel with about 2 grams of sodium. The vessel is heated in an oil bath at 150°-160°C. A xylene-ethanol azeotrope distills over at about 78°-82°C over a period of 2 to 3 hours. The distillate is cooled and shaken with about 3 times its volume of water, the decrease in volume of the distillate being considered a measure of the amount of alcohol formed. When 80-90% of the theoretical amount of alcohol is obtained in the distillate the reaction mixture is subjected to vacuum distillation to remove most of the xylene and unreacted diethylaminoethanol. The residue is poured into 500 cc of benzene which is then extracted 3 times with 500 cc portions of water.

The washed benzene layer is diluted with an equal volume of ether and alcoholic hydrochloric acid is added until the mixture is acid to Congo red. A white crystalline solid forms which is dissolved in 300-400 cc of alcohol and diluted with ether to the point where precipitation starts. A few drops of butanone are added, the solution is cooled to -10°C, and filtered to recover the crystals which separate. The product is obtained in the form of white needles melting at 159°-160°C, in good yield.

13 parts of β -diethylaminoethyl 1-phenylcyclohexanecarboxylate hydrochloride, 125 parts of glacial acetic acid and 0.3 part of Adams' catalyst are heated to 70°C and shaken with hydrogen at 50 lb pressure until 90-100% of the theoretical hydrogen is absorbed. The acetic acid is then removed by distillation and the residue recrystallized from butanone, giving the above product as a crystalline hydrochloride melting at 165°-166°C, in good yields. This product may also be prepared by reacting cyclohexyl bromide with cyclohexyl cyanide with the use of sodamide followed by alcoholysis and reesterification.

References

Merck Index 3083

Kleeman & Engel p. 295

PDR pp. 830, 986, 993

OCDS Vol. 1 p. 36 (1977)

I.N. p. 317

REM p. 915

Van Campen, M.G. Jr. and Tilford, C.H.; U.S. Patent 2,474,796; June 28, 1949; assigned to The Wm. S. Merrell Company

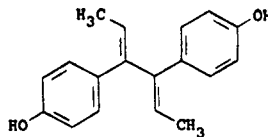
DIENESTROL**Therapeutic Function:** Estrogen**Chemical Name:** 4,4'-(1,2-diethylidene-1,2-ethanediyl)bisphenol**Common Name:** Dienoestrol**Structural Formula:****Chemical Abstracts Registry No.:** 84-17-3

Trade Name	Manufacturer	Country	Year Introduced
Synestrol	Schering	U.S.	1947
Cycladiene	Bruneau	France	1948
Agaldog	Vetoquinol	France	—
Bi-Star	Merit	U.S.	—
Dinestrol	Reid-Provident	U.S.	—
DV	Merrell Dow	U.S.	—
Estan	Schering	U.S.	—
Estraguard	Reid-Provident	U.S.	—
Farmacyrol	Farmarlyn	W. Germany	—
Follidene	Recordati	Italy	—
Hormofemin	Medo	U.K.	—
Lucidon	Westerfield	U.S.	—
Oestrovio	Stotzer	Switz.	—
Para-Dien	Klimitschek	Austria	—
Reginol	Merz	W. Germany	—
Sexadien	A.F.I.	Norway	—

Raw Materials

4-Hydroxypropiophenone	Sodium
Benzoyl chloride	Acetic anhydride
Potassium hydroxide	Acetyl chloride

Manufacturing Process

Preparation of $\gamma\delta$ -Bis-(4-Hydroxyphenyl)-Hexane- $\gamma\delta$ -Diol: A sodium amalgam is prepared containing 6 grams of sodium and 400 grams of mercury. The amalgam is covered with a solution of 20 grams of 4-hydroxypropiophenone in a mixture of 30 ml of 5 N sodium

hydroxide solution and 220 ml of water and the mixture is heated to 28°-30°C and stirred gently. The reduction is accompanied by development of heat and the temperature of the solution rises to 34°-35°C, and then falls slowly. After 5 hours the alkaline solution is separated from the mercury and diluted with 3 or 4 times its volume of water, when, in order to form the benzoyl derivatives of the products, the solution is vigorously stirred, while it is being cooled, with 20 ml of benzoyl chloride, the solution being kept at a temperature of 15°-20°C. When the reaction is completed, the benzoyl derivatives are filtered off, washed with water and recrystallized from a mixture of benzene and alcohol, when a product with a melting point of 195°-215°C is obtained.

Preparation of Dienoestrol: In order to obtain dienestrol, 14.6 grams of dry 4,4'-di-benzoate are refluxed with a mixture of 40 ml of acetic anhydride and 40 ml acetylchloride by heating in an oil-bath at about 90°C for 6 hours after which the bath temperature is increased to 120°C and heating continued for a further 18 hours, after which time the evolution of hydrogen chloride practically ceases. The mixture is allowed to cool for several hours and the crystals which separate are filtered off and recrystallized from an alcohol-benzene mixture when the product melts at 210°-222°C. This product is converted into dienestrol by adding 10.8 grams of it to 100 ml of 10% (w/v) alcoholic potassium hydroxide solution and then refluxing during 1 hour. After dilution with 200 ml of water and filtration from a small amount of insoluble material, dienestrol is precipitated from the alkaline solution by treatment with carbon dioxide. It is filtered off, washed with water and recrystallized from dilute alcohol after which it melts at 233°-234°C according to U.S. Patent 2,464,203.

References

Merck Index 3085

Kleeman & Engel p. 296

PDR pp. 1225, 1294

OCDS Vol. 1 p. 102 (1977)

I.N. p. 318

REM p. 988

Short, W.F. and Hobday, G.I.; U.S. Patent 2,464,203; March 15, 1949; assigned to Boots Pure Drug Company Limited, England

Adler, E.; U.S. Patent 2,465,505; March 29, 1949; assigned to Hoffmann-La Roche Inc.

DIETHYLCARBAMAZINE CITRATE

Therapeutic Function: Anthelmintic

Chemical Name: N,N-Diethyl-4-methyl-1-piperazine-carboxamide citrate

Common Name: —

Structural Formula:

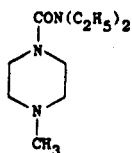

(base)

Chemical Abstracts Registry No.: 1642-54-2; 90-89-1 (Base)

Trade Name	Manufacturer	Country	Year Introduced
Hetrazan	Lederle	U.S.	1949

Trade Name	Manufacturer	Country	Year Introduced
Banocide	Burroughs-Wellcome	—	—
Difil	Evsco	U.S.	—
Filarcidin	Cidan	Spain	—
Filaribits	Norden	U.S.	—
Franocide	Burroughs-Wellcome	—	—
Loxuran	Egyt	Hungary	—
Notezine	Specia	—	—

Raw Materials

1-Methylpiperazine	Sodium hydroxide
Diethyl carbamyl chloride	Sodium carbonate

Manufacturing Process

To 50 cc of water was added 18 grams of 1-methyl piperazine dihydrochloride and 8.34 grams of sodium hydroxide. When solution had been effected the beaker was cooled to 10°C and with stirring, 4.17 grams of sodium hydroxide dissolved in 15 cc of water and 14 grams of diethyl carbamyl chloride were added simultaneously. When all had been added, the solution was extracted 3 times with ether which was then dried and filtered. The ether solution was saturated with dry hydrogen chloride. A yellow gum appeared which on trituration gave a white, hygroscopic solid which was filtered and dried in a drying pistol. The 1-methyl-4-piperazine-N,N-diethyl carboxamide hydrochloride had a melting point of 150°-155°C.

If the compound itself is desired, the salt is dissolved in water and the solution saturated with a mild alkali such as potassium carbonate. The product is then extracted with chloroform, dried, and after removal of the chloroform, distilled.

References

- Merck Index 3100
 OCDS Vol. 1 p. 278 (1977)
 I.N. p. 320
 REM p. 1235
 Kushner, S. and Brancone, L.; U.S. Patent 2,467,893; April 19, 1949; assigned to American Cyanamid Company
 Kushner, S. and Brancone, L.; U.S. Patent 2,467,895; April 19, 1949; assigned to American Cyanamid Company

DIETHYLPROPION HCl

Therapeutic Function: Anorexic

Chemical Name: 2-(Diethylamino)-1-phenyl-1-propanone

Common Name: Amfepramone

Structural Formula:

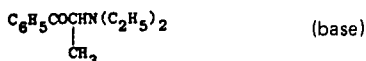

Chemical Abstracts Registry No.: 134-80-5; 90-84-6 (Base)

Trade Name	Manufacturer	Country	Year Introduced
Tenuate	Merrell National	U.S.	1959
Tepanil	Riker	U.S.	1959
Tenuate-Dospan	Merrell	France	1971
Adiposan	Phyteia	Switz.	1971
Anfamon	Ortscheit	W. Germany	—
Bonumin	Farmos	Finland	—
Brendalit	Dexter	Argentina	—
Delgamer	Merrell Dow	—	—
Derfon	Lafon	France	—
Dietec	Pharbec	Canada	—
Dietil-Retard	Trenker	Belgium	—
D.I.P.	Eri	Canada	—
Dobesin	Pharmacia	Sweden	—
Frekentine	Minerva-Chemie	Neth.	—
Lineal-Rivo	Rivopharm	Switz.	—
Linea Valeas	Valeas	Italy	—
Lipomin	Uriach	Spain	—
Liposlim	Pharma Farm. Spec.	Italy	—
Magrene	Ravasini	Italy	—
Menutil	Merrell Dow	—	—
Moderatan	Theranol	France	—
Nobesine-25	Nadeau	Canada	—
Nulobes	Disprovent	Argentina	—
Prefamone	Dexo	France	—
Regenon	Temmler	W. Germany	—
Regibon	Medic	Canada	—
Slim-Plus	Pharma-Plus	Switz.	—

Raw Materials

α -Bromopropiophenone
 Diethylamine
 Hydrogen chloride

Manufacturing Process

1,145 g of α -bromopropiophenone and 850 g of diethylamine are combined under stirring and heated on a water bath to boiling. The precipitate is filtered off under suction and washed with benzol. The filtrate is shaken up with aqueous hydrogen chloride, the aqueous solution made alkaline and etherified. The solution freed of the ether is fractionated. The boiling point (6 mm) is 140°C and the yield 800 g. The base is dissolved in acetic ester and precipitated with isopropanolic hydrogen chloride. After suction filtration and washing with ether the yield is found to be 750 g (80%) and the melting point 168°C.

References

Merck Index 3113
 Kleeman & Engel p. 37
 PDR pp. 991, 1453, 1606
 DOT 9 (6) 213 (1973)
 I.N. p. 66
 REM p. 891
 Schutte, J.; U.S. Patent 3,001,910; September 26, 1961; assigned to Firma Temmler-Werke (W. Germany)

DIETHYLSTILBESTROL

Therapeutic Function: Estrogen

Chemical Name: 4,4'-(1,2-Diethyl-1,2-ethenediyl)bisphenol

Common Name: DES

Structural Formula:

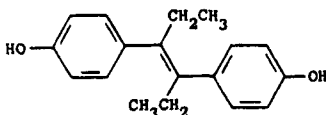

Chemical Abstracts Registry No.: 56-53-1

Trade Name	Manufacturer	Country	Year Introduced
DES	Amfre-Grant	U.S.	1946
Stilbetin	Squibb	U.S.	1950
Microest	Massengill	U.S.	1958
Vagestrol	Norwich Eaton	U.S.	1969
Acnestrol	Dermik	U.S.	—
Agostlben	Spofa	Czechoslovakia	—
Cyren A	Bayer	W. Germany	—
Desma	Tablicaps	U.S.	—
Des-Plex	Amfre-Grant	U.S.	—
Dicorvin	Amfre-Grant	U.S.	—
Distilbene	Ucepha	France	—
Estilbin	Dumex	Denmark	—
Estrosyn	Cooper	U.S.	—
Furacin-E	Eaton	U.S.	—
Gerex	Consul. Midland	U.S.	—
Makarol	Mallinckrodt	U.S.	—
Mase-Bestrol	Mason	U.S.	—
Menopax	Nicholas	U.K.	—
Micrest	Beecham	U.S.	—
Oestrogen	Holzinger	Austria	—
Oestrol	Veterinaria	Switz.	—
Oestromon	Merck	W. Germany	—
Pelestrol	Franklin	U.S.	—
Percutacrine	Besins-Iscovesco	France	—
Tylosterone	Lilly	U.S.	—

Raw Materials

p-Hydroxypropiophenone	Sodium
Sodium hydroxide	Hydrogen chloride

Manufacturing Process

50 parts by weight of p-hydroxypropiophenone are dissolved in 200 parts by weight of a 12.5% solution of caustic soda and shaken with 350 parts by weight of 3% sodium amalgam. The sodium salt of the pinacol thereby precipitating is reacted with glacial acetic acid, whereby the free pinacol is obtained (MP 205°C to 210°C, after purification 215°C to 217°C). The yield amounts to 95% of the theoretical. The pinacol is suspended in ether and gaseous hydrogen chloride introduced, whereby water separates and the pinacolin formed is dissolved in the ether, from which it is obtained by evaporation as a viscous oil (diacetate of MP 91°C). The yield is quantitative.

40 parts by weight of pinacolin are dissolved in ethyl alcohol and gradually treated with 80 parts by weight of sodium under reflux. The solution is decomposed with water and the pinacolin alcohol formed extracted from the neutralized solution with ether. The pinacolin alcohol is a viscous oil which is characterized by a dibenzoate of MP 172°C. The yield is 95% of the theoretical.

A solution of 30 parts by weight of pinacolin alcohol in ether is saturated with hydrogen chloride at room temperature and the ether solution then agitated with bicarbonate. After concentration by evaporation it leaves behind the crude diethylstilbestrol [α,β -(*p,p'*-dihydroxydiphenyl)- α,β -diethylethylene] which, when recrystallized from benzene, melts at 170°C to 171°C. The yield amounts to 75% of the calculated. The total yield of diethylstilbestrol, calculated on *p*-hydroxypropiophenone, is 68% of the theoretical.

References

Merck Index 3115

Kleeman & Engel p. 298

PDR p. 1045

OCDS Vol. 1 p. 101 (1977)

I.N. p. 321

REM p. 988

Adler, E., Gie, G.J. and von Euler, H.; U.S. Patent 2,421,401; June 3, 1947; assigned to Hoffmann-La Roche, Inc.

DIETHYLSTILBESTROL DIPHOSPHATE

Therapeutic Function: Estrogen; used in hormone therapy for prostate cancer

Chemical Name: 4,4'-(1,2-Diethyl-1,1-ethenediyl)bisphenol-bis(dihydrogen phosphate)

Common Name: Fosfestrol

Structural Formula:

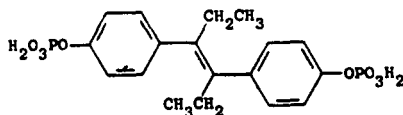

Chemical Abstracts Registry No.: 522-40-7; 23519-26-8 (Tetrasodium salt)

Trade Name	Manufacturer	Country	Year Introduced
Stilphostrol	Dome	U.S.	1955
ST 52	Lucien	France	1955
Cytonal	VEB Berlin-Chemie	E. Germany	—
Honvan	Asta	W. Germany	—
Honvan	Funk	Spain	—
Honvan	W.B. Pharm.	U.K.	—
Honvan	Noristan	S. Africa	—
Honvan	Schering	Italy	—
Honvan	Asta-Kyorin	Japan	—
Stilbetin	Squibb	—	—
Stibol	A.C.O.	Sweden	—

Raw Materials

α,α' -Diethyl-4,4'-dihydroxystilbene
Phosphorus oxychloride
Sodium bicarbonate

Manufacturing Process

A solution of 1 part of α,α' -diethyl-4,4'-dihydroxystilbene in 5 parts of pyridine is added drop

by drop to the strongly cooled solution of 2 parts of phosphorus-hydroxy chloride in 5 parts of pyridine. The mixture soon solidifies to a crystalline magma. It is allowed to stand in ice for ¼ hour and then for an hour at room temperature. The mass is then poured into an excess of saturated sodium bicarbonate solution. Unconsumed parent material is removed by extraction with ether. The aqueous solution is then mixed with 2N-hydrochloric acid, whereupon the primary phosphoric acid ester of α,α' -diethyl-4,4'-dihydroxystilbene of the formula

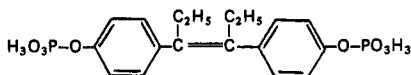

is precipitated in the form of a voluminous white powder. By recrystallization or reprecipitation this ester may be further purified.

References

Merck Index 4136

Kleeman & Engel p. 433

PDR p. 1261

OCDS Vol. 1 p. 101 (1977)

I.N. p. 321

REM p. 989

Miescher, K. and Heer, J.; U.S. Patent 2,234,311; March 11, 1941; assigned to Ciba Pharmaceutical Products, Inc.

DIFENOXINE

Therapeutic Function: Antiperistaltic

Chemical Name: 1-(3-Cyano-3,3-diphenylpropyl)-4-phenyl-4-piperidinecarboxylic acid

Common Name: Difenoxilic acid

Structural Formula:

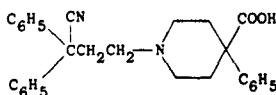

Chemical Abstracts Registry No.: 28782-42-5; 35607-36-4 (Hydrochloride)

Trade Name	Manufacturer	Country	Year Introduced
Lyspafena	Cilag Chemie	W. Germany	1980
Lyspafen	Protea	Australia	—

Raw Materials

t-Potassium butanolate

Ethyl-1-(3-cyano-3,3-diphenylpropyl)-4-phenylisonipecotat HCl

Acetic acid

Hydrogen chloride

Manufacturing Process

To a stirred solution of 5.52 parts of t-potassium butanolate in 60 parts of dimethylsulfoxide are added 1.7 parts of ethyl-1-(3-cyano-3,3-diphenylpropyl)-4-phenylisonipecotat hydro-

chloride and the whole is stirred on an oil bath (90°C) for 4 hours. The reaction mixture is cooled (30°C) and poured onto 180 parts of water with stirring. After two extractions with benzene, the aqueous phase is acidified with glacial acetic acid to pH 6.5 with stirring. The precipitated product is filtered off, washed with water, dried, dissolved in 50 parts of 0.4N potassium hydroxide and precipitated again with glacial acetic acid. The crude free base is filtered off and dissolved in a mixture of 2-propanol and chloroform and gaseous hydrogen chloride is introduced into the solution. The whole is filtered and the filtrate is evaporated. The residue is mixed with benzene and the latter is evaporated again. The residue is recrystallized from 2-propanol, yielding 1-(3-cyano-3,3-diphenylpropyl)-4-phenylisonipecotic acid hydrochloride.

References

Merck Index 3122

Kleeman & Engel p. 300

OCDS Vol. 2 p. 331 (1980)

DOT 10 (6) 205 (1974)

I.N. p. 323

Soudyn, W. and van Wijngaarden, I.; U.S. Patent 3,646,207; February 29, 1972; assigned to Janssen Pharmaceutica, N.V. (Belgium)

DIFLORASONE DIACETATE

Therapeutic Function: Topical corticosteroid antiinflammatory

Chemical Name: 6 α ,9 α -Difluoro-11 β ,17 α ,21-trihydroxy-16 β -methylpregna-1,4-diene-3,20-dione diacetate

Common Name: —

Structural Formula:

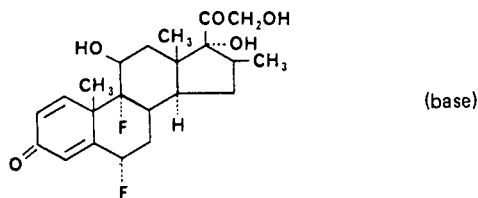

Chemical Abstracts Registry No.: 2557-49-5; 33654-31-7 (Diacetate)

Trade Name	Manufacturer	Country	Year Introduced
Florone	Upjohn	U.S.	1978
Florone	Upjohn	Switz.	1979
Maxiflor	Herbert	U.S.	1980
Florone	Upjohn	W. Germany	1981
Florone	Basotherm	W. Germany	1982
Flutone	Rorer	U.S.	—

Raw Materials

6 α -Fluoro-9 α -bromo-11 β ,17 α ,21-trihydroxy-16 α -methyl-1,4-pregnadiene-3,20-dione-21-acetate

Potassium acetate

Hydrogen fluoride

Orthoacetic acid trimethyl ester

Manufacturing Process

6 α -Fluoro-9 β -epoxy-17 α ,21-dihydroxy-16 α -methyl-1,4-pregnadiene-3,20-dione-21-acetate:

To a solution of 6.78 g of 6 α -fluoro-9 α -bromo-11 β ,17 α ,21-trihydroxy-16 α -methyl-1,4-pregnadiene-3,20-dione-21-acetate in 175 ml of acetone was added 6.78 g of potassium acetate and the resulting suspension was heated under reflux for a period of 17 hours. The mixture was then concentrated to approximately 60 ml volume at reduced pressure on the steam bath, diluted with water and extracted with methylene chloride. The methylene chloride extracts were combined, washed with water, dried over anhydrous sodium sulfate and evaporated. The residue was redissolved in methylene chloride and chromatographed over 500 g of Florisil anhydrous magnesium silicate. The column was eluted with 1 liter portions of hexanes (Skellysolve B) containing increasing proportions of acetone. There was so eluted 6 α -fluoro-9 β ,11 β -epoxy-16 α -methyl-17 α ,21-dihydroxy-1,4-pregnadiene-3,20-dione-21-acetate which was freed of solvent by evaporation of the eluates.

6 α ,9 α -Difluoro-11 β ,17 α ,21-trihydroxy-16 α -methyl-1,4-pregnadiene-3,20-dione-21-acetate:

To approximately 1.3 g of hydrogen fluoride contained in a polyethylene bottle and maintained at -60°C was added 2.3 ml of tetrahydrofuran and then a solution of 500 mg (0.0012 mol) of 6 α -fluoro-9 β ,11 β -epoxy-16 α -methyl-17 α ,21-dihydroxy-1,4-pregnadiene-3,20-dione-21-acetate in two ml of methylene chloride. The steroid solution was rinsed in with an additional 1 ml of methylene chloride. The light red colored solution was then kept at approximately -30°C for 1 hour and at -10°C for 2 hours. At the end of this period it was mixed cautiously with an excess of cold sodium bicarbonate solution and the organic material extracted with the aid of additional methylene chloride.

The combined extracts were washed with water, dried over anhydrous sodium sulfate and concentrated to approximately 35 ml. The solution was chromatographed over 130 g of Florisil anhydrous magnesium silicate. The column was developed with 260 ml portions of hexanes (Skellysolve B) containing increasing proportions of acetone. There was thus eluted 6 α ,9 α -difluoro-11 β ,17 α ,21-trihydroxy-16 α -methyl-1,4-pregnadiene-3,20-dione-21-acetate which was freed of solvent by evaporation of the eluate fractions.

6 α ,9 α -Difluoro-11 β ,17 α ,21-trihydroxy-16 α -methyl-1,4-pregnadiene-3,20-dione: 3.25 g of 6 α ,9 α -difluoro-11 β ,17 α ,21-trihydroxy-16 α -methyl-1,4-pregnadiene-3,20-dione-21-acetate was dissolved in 325 ml of methanol, previously purged of air-oxygen by passing nitrogen through it for 10 minutes and thereto was added a solution of 1.63 g of potassium bicarbonate in 30 ml of water, similarly purged of oxygen. The mixture was allowed to stand at room temperature for a period of 5 hours in a nitrogen atmosphere, thereupon neutralized with 2.14 ml of acetic acid in 40 ml of water. The mixture was concentrated to approximately one-third volume at reduced pressure on a 60° water bath. Thereupon 250 ml of water was added and the mixture chilled. The crystalline product was collected on a filter, washed with water and dried to give 6 α ,9 α -difluoro-11 β ,17 α ,21-trihydroxy-16 α -methyl-1,4-pregnadiene-3,20-dione.

The diflorasone is reacted with orthoacetic acid trimethyl ester in the presence of toluene sulfonic acid to give diflorasone diacetate.

References

- Merck Index 3124
- DFU 2 (4) 238 (1977)
- Kleeman & Engel p. 301
- PDR pp. 832, 932
- DOT 15 (4) 445 (1979)
- I.N. p. 324
- REM p. 972
- Lincoln, F.H., Schneider, W.P. and Spero, G.B.; U.S. Patent 3,557,158; January 19, 1971; assigned to The Upjohn Company
- Ayer, D.E., Schlagel, C.A. and Flynn, G.L.; U.S. Patent 3,980,778; September 14, 1976; assigned to The Upjohn Co.

DIFLUCORTOLONE VALERATE

Therapeutic Function: Antiinflammatory

Chemical Name: 6,9-Difluoro-11,21-dihydroxy-16-methylpregna-1,4-diene-3,20-dione valerate

Common Name: —

Structural Formula:

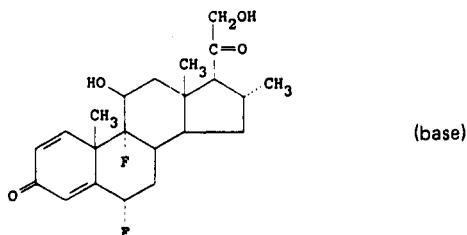

Chemical Abstracts Registry No.: 59198-70-8; 2607-06-9 (Base)

Trade Name	Manufacturer	Country	Year Introduced
Nerisone	Schering	U.K.	1976
Temetex	Roche	U.K.	1976
Temetex	Roche	W. Germany	1977
Nerisone	Schering	France	1979
Nerisona	Schering	Italy	1979
Temetex	Roche	Italy	1980
Nerisona	Schering	Japan	1981
Texmeten	Roche	Japan	1981
Travocort	Schering	W. Germany	—

Raw Materials

16 α -Methyl-6 α ,9 α -difluoro- Δ^4 -pregnene-11 β ,21-diol-3,20-dione-21-acetate
 Bacterium *Bacillus lentus*
 Valeric acid chloride

Manufacturing Process

16 α -methyl-6 α ,9 α -difluoro- Δ^4 -pregnene-11 β ,21-diol-3,20-dione-21-acetate (MP = 229°/232°-234°C (with decomposition) is dehydrogenated in 1,2-position by means of *Bacillus lentus*, Mutant MB 284, whereby the 21-acetate group is simultaneously saponified. (It is possible under the same conditions to start with the free 21-hydroxyl compound.)

For this purpose a fermenter made of stainless steel having a 50 liter capacity is charged with 30 liters of a nutrient solution of 0.1% yeast extract, 0.5% cornsteep and 0.2% glucose, heated for one-half hour at 120°C for sterilization purposes, and after cooling, inoculated with a bacterial suspension of *Bacillus lentus* MB 284.

After 24 hours of growth at 28°C under stirring (220 revolutions per minute) and aeration (1.65 m³/hr), 1.8 liters of the obtained culture is removed under sterile conditions and transferred with 28 liters of the same sterilized nutrient medium into a fermenter of the same size.

Simultaneously, 6 g of 16 α -methyl-6 α ,9 α -difluoro- Δ^4 -pregnene-11 β ,21-diol-3,20-dione-21-

acetate in 200 cc of dimethylformamide are added and the fermentation is continued for 50 hours under the same conditions.

The course of the fermentation is tested by removal of samples which are extracted with methyl isobutyl ketone. The extracts are analyzed by thin layer chromatography using a system of benzene/ethyl acetate (4:1).

After further working up there is obtained an oily crystalline residue which is subjected to chromatography on silica gel. The 16 α -methyl-6 α ,9 α -difluoro- $\Delta^{1,4}$ -pregnadien-11 β ,21-diol-3,20-dione is eluated with ethyl acetate-chloroform (1:2), it is recrystallized from ethyl acetate/ether and then formed to melt at 240°/242°-244°C. The yield is 60% of the theoretical. The product is reacted with valeric acid chloride to give the valerate ester.

References

Merck Index 3126

Kleeman & Engel p. 302

OCDS Vol. 2 p. 192 (1980)

DOT 12 (7) 259 (1976)

I.N. p. 324

Kieslich, K., Kerb, U. and Raspe, G.; U.S. Patent 3,426,128; February 4, 1969; assigned to Schering A.G. (West Germany)

DIFLUNISAL

Therapeutic Function: Analgesic, antiinflammatory

Chemical Name: 2',4'-Difluoro-4-hydroxy-[1,1'-biphenyl]-3-carboxylic acid

Common Name: Difluorophenyl salicylic acid

Structural Formula:

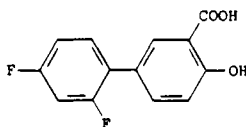

Chemical Abstracts Registry No.: 22494-42-4

Trade Name	Manufacturer	Country	Year Introduced
Dolobid	Morson	U.K.	1978
Unisal	Chibret	Switz.	1978
Dolobid	MSD	Italy	1979
Dolobis	MDS-Chibret	France	1981
Fluniget	Sharp & Dohme	W. Germany	1981
Dolobid	MSD	Canada	1982
Adomal	Malesci	Italy	1982
Dolobid	MSD	U.S.	1982
Citidol	C.T.	Italy	—
Diflonid	Dumex	Denmark	—
Diflunil	I.C.I.	—	—
Dugodol	Alkaloid	Yugoslavia	—

Trade Name	Manufacturer	Country	Year Introduced
Flovacil	Andromaco	Argentina	—
Fiustar	Firma	Italy	—
Reuflos	Scharper	Italy	—

Raw Materials

4-(2',4'-Difluorophenyl)phenol
Carbon dioxide

Manufacturing Process

A mixture of 10 g of 4-(2',4'-difluorophenyl)-phenol and 27.2 g of potassium carbonate is exposed to carbon dioxide at 1,300 psi and 175°C. The dark mass obtained from this carbonation is then dissolved in 300 ml of water and 200 ml of methylene chloride and the two layers separated. The water layer is then extracted with 100 ml of methylene chloride and then acidified with 2.5N hydrochloric acid. This mixture is then filtered and the cake dried in vacuo to yield 5.32 g of the crude product. The crude product is then recrystallized from benzene-methanol. An additional crystallization of this semipure material from benzene-methanol yields analytically pure 2-hydroxy-5-(2',4'-difluorophenyl)-benzoic acid (MP 210°-211°C).

References

Merck Index 3127

Kleeman & Engel p. 303

PDR p. 1171

OCDS Vol. 2 p. 85 (1980)

DOT 14 (7) 269 (1978)

I.N. p. 324

REM p. 1116

Ruyle, W.V., Jarett, L.H. and Matzuk, A.R.; U.S. Patent 3,714,226; January 30, 1973; assigned to Merck & Co., Inc.

DIFLUPREDNATE

Therapeutic Function: Antiinflammatory

Chemical Name: 21-(Acetyloxy)-6,9-difluoro-11-hydroxy-17-(1-oxobutoxy)pregna-1,4-diene-3,20-dione

Common Name: —

Structural Formula:

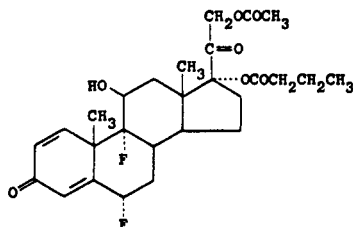

Chemical Abstracts Registry No.: 23674-86-4

Trade Name	Manufacturer	Country	Year introduced
Epitopic	Clin-Midy	France	1978

Raw Materials

6 α ,9 α -Difluoroprednisolone	Methyl orthobutyrate
Oxalic acid	Acetic anhydride

Manufacturing Process

Orthoesterification: A mixture of 1 g of 6 α ,9 α -difluoroprednisolone, 10 mg of p-toluene-sulfonic acid, 5 cc of dimethylformamide and 3 cc of methyl orthobutyrate is heated for 15 hours on an oil bath at 105°C while a slow stream of nitrogen is passed through the mixture so that the methanol produced as a by-product of the reaction, is distilled off. After addition of several drops of pyridine to neutralize the acid catalyst, the reaction mixture is evaporated under vacuum and there is obtained a solid residue which is taken up with methanol, and filtered. The product is recrystallized from a methylene chloride-methanol mixture to yield 682 mg of 6 α ,9 α -difluoroprednisolone 17 α ,21-methylorthobutyrate, also identified as 17 α ,21-(1'-methoxy)-n-butylidenedioxy-6 α ,9 α -difluoro- $\Delta^{1,4}$ -pregnadiene-11 β -ol-3,20-dione, MP 194°-198°C.

Upon chromatography of the mother liquor on a column of alumina another 338 mg of a crystalline mixture of the epimeric orthobutyrate are isolated.

Hydrolysis: A suspension of 1 g of the 6 α ,9 α -difluoroprednisolone 17 α ,21-methylorthobutyrate in 10 cc of methanol is treated with 2 cc of a 2 N aqueous solution of oxalic acid and heated on a water bath at 40°-50°C for about 5-10 minutes and, afterwards, the mixture is concentrated under vacuum. The residue is then shaken with water, the insoluble product is filtered off and then dried. The solid material is recrystallized from acetone-ether and 6 α ,9 α -difluoroprednisolone 17-butyrate is obtained, MP 193°-196°C.

Esterification: A solution of 500 mg of 6 α ,9 α -difluoroprednisolone 17-butyrate in 2.5 cc of pyridine is treated with 1.25 cc of acetic anhydride and the reaction mixture permitted to stand overnight at 0°C. The reaction mixture is then poured into ice water and the crystalline precipitate formed is filtered off and recrystallized from a methylene chloride-ether-petroleum ether mixture to yield 494 mg of 6 α ,9 α -difluoroprednisolone 17-butyrate, 21-acetate; MP 191°-194°C.

References

- Merck Index 3131
 Kleeman & Engel p. 303
 OCDS Vol. 2 p. 191 (1980)
 DOT 15 (1) 25 (1979)
 I.N. p. 325
 Ercoli, A. and Gardi, R.; U.S. Patent 3,780,177; December 18, 1973; assigned to Warner-Lambert Co.

DIHYDROSTREPTOMYCIN SULFATE

Therapeutic Function: Antibiotic

Chemical Name: O-2-Deoxy-2-(methylamino)- α -L-glucopyranosyl-(1 \rightarrow 2)-O-5-deoxy-3-C-(hydroxymethyl)- α -L-xylofuranosyl-(1 \rightarrow 4)-N,N'-bis(aminoiminomethyl)-D-streptamine

Common Name: —

Structural Formula:

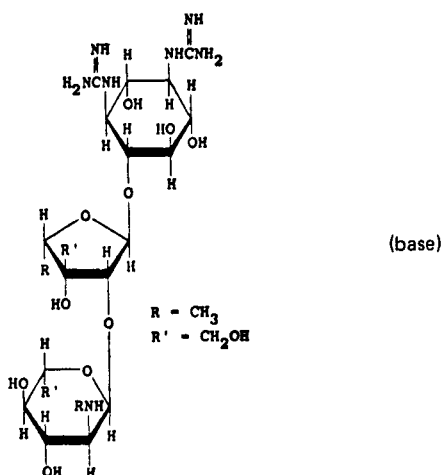

Chemical Abstracts Registry No.: 5490-27-7; 128-46-1 (Base)

Trade Name	Manufacturer	Country	Year Introduced
Dihydrostrepto	MSD	U.S.	1948
Abiocine	Lepetit	France	—
Didromycin	Specia	France	—
Didrothenat	Grunenthal	W. Germany	—
Diestreptopab	Martin Santos	Spain	—
Dihydro-Cidan Sulfato	Cidan	Spain	—
Dihydromycine	Specia	France	—
Dihydrostreptofor	Kwizda	Austria	—
Dihydrostreptomycin-Rafa	Rafa	Israel	—
Entera-Strept	Heyl	W. Germany	—
Estreptoluy	Miluy	Spain	—
Guanimycin	Allen & Hanburys	U.K.	—
Sanestrepto	Santos	Spain	—
Solvo-Strept	Heyl	W. Germany	—
Streptoral	Taro	Israel	—
Vibriomycin	Evans Medical	Australia	—

Raw Materials

Streptomycin sulfate
Hydrogen

Manufacturing Process

Dihydrostreptomycin sulfate may be prepared from streptomycin sulfate by catalytic hydrogenation (Merck, Pfizer, Cyanamid), electrolytic reduction (Schenley, Olin Mathieson), or by sodium borohydride reduction (Bristol), or by isolation from a fermentation process (Takeda).

References

Merck Index 3161
Kleeman & Engel p. 309
I.N. p. 328

Peck, R.L.; U.S. Patent 2,498,574; February 21, 1950; assigned to Merck & Co., Inc.
 Carboni, R.A. and Regna, P.P.; U.S. Patent 2,522,858; September 19, 1950; assigned to Chas. Pfizer & Co., Inc.
 Levy, G.B.; U.S. Patent 2,663,685; December 22, 1953; assigned to Schenley Industries, Inc.
 Dolliver, M.A. and Semenoff, S.; U.S. Patent 2,717,236; September 6, 1955; assigned to Olin Mathieson Chemical Corp.
 Sokol, H. and Popino, R.P.; U.S. Patent 2,784,181; March 5, 1957; assigned to American Cyanamid Co.
 Kaplan, M.A.; U.S. Patent 2,790,792; April 30, 1957; assigned to Bristol Laboratories, Inc.
 Tatsuoka, S., Kusaka, T., Miyake, A., Inoue, M., Shiraishi, Y., Iwasaki, H. and Imanishi, M.; U.S. Patent 2,950,277; August 23, 1960; assigned to Takeda Pharmaceutical Industries, Ltd.

DIHYDROTACHYSTEROL

Therapeutic Function: Blood calcium regulator

Chemical Name: 9,10-secoergosta-5,7,22-trien-3 β -ol

Common Name: Dichystrolum

Structural Formula:

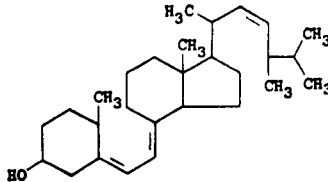

Chemical Abstracts Registry No.: 67-96-9

Trade Name	Manufacturer	Country	Year Introduced
Hytakerol	Winthrop	U.S.	1950
Calcamine	Sandoz	France	1949
D.H.T.	Roxane	U.S.	1983
A.T. 10	Bayer	W. Germany	—
Atecen	Merck	W. Germany	—
Dygratyl	Ferrosan	Denmark	—
Dihydral	Duphar	Belgium	—
Tachyrol	Duphar	Belgium	—
Tachystin	Ankerwerk	E. Germany	—

Raw Materials

Tachysterol
 Hydrogen

Manufacturing Process

The process of isolating chemically uniform crystalline dihydrotachysterol comprises subjecting the solution of the crude hydrogenation product of tachysterol in benzene to chromatographic adsorption by means of active aluminum oxide while collecting the components having a minor tendency of being adsorbed, subjecting the said components to a repeated chromatographic adsorption and converting the components having a minor tendency of

being adsorbed into its ester by treatment with acetic anhydride in pyridine solution, isolating the ester formed from the reaction mixture, subjecting its solution in benzene to chromatographic adsorption while collecting the components having a minor tendency of being adsorbed, recrystallizing these components, saponifying the crystalline ester and recrystallizing the dihydrotachysterol obtained.

References

Merck Index 3163

Kleeman & Engel p. 309

PDR p. 1570

I.N. p. 329

REM p. 978

von Werder, F.; U.S. Patent 2,228,491; January 14, 1941; assigned to Winthrop Chemical Company, Inc.

DILAZEP HYDROCHLORIDE

Therapeutic Function: Coronary vasodilator

Chemical Name: 3,4,5-trimethoxybenzoic acid diester with tetrahydro-1H-1,4-diazepine-1,4(5H)-dipropanol dihydrochloride

Common Name: —

Structural Formula:

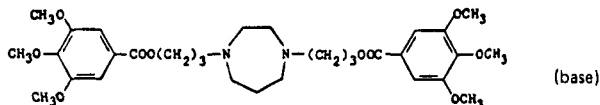

Chemical Abstracts Registry No.: 20153-98-4; 35898-87-4 (Base)

Trade Name	Manufacturer	Country	Year introduced
Cormelian	Asta	W. Germany	1972
Cormelian	Schering	Italy	1976
Comelian	Kowa	Japan	1979

Raw Materials

Bis(3-Hydroxypropyl)ethylene diamine
 1,3-Chlorobromopropane
 Triethylamine
 3,4,5-Trimethoxybenzoic acid chloride

Manufacturing Process

528.8 grams of bis-(3-hydroxypropyl)-ethylene diamine [K. Schlögl and R. Schlögl, *Monatshefte der Chemie* 95 (1964) page 935] are dissolved in a mixture of 1,500 cc of anhydrous ethyl alcohol and 1,250 grams of triethylamine. 520 grams of 1,3-chlorobromopropane are added thereto dropwise over a period of about 3 hours while stirring and heating the reaction mixture in an oil bath of 50°C. After completion of the addition, the oil bath is heated to 60°C for 20 minutes while stirring of the reaction mixture is continued. With increasing reaction time, triethylamine hydrochloride is precipitated. After completion of the reaction, the mixture is allowed to cool to room temperature.

Triethylamine hydrochloride is separated by filtration and the filter cake is washed with 100 cc of anhydrous ethyl alcohol. The alcohol and the excess of triethylamine is distilled off in a vacuum of a water pump. The residue represents a light-yellowish brown viscous oil which is extracted 3 times with 500 cc of anhydrous benzene each time with stirring at 40° to 60°C. The benzene is distilled off on a water bath at 60°C. Thus, an oil is obtained which solidifies to a hard mass after some hours. This mass is crushed and dried over P₂O₅ in an exsiccator. The compound represents N,N'-bis-(3-hydroxypropyl)homopiperazine. Yield: 128.5 grams. FP: 46°-47°C; BP_{0.02mm}: 141°-142°C.

21.6 grams of N,N'-bis-(3-hydroxypropyl)homopiperazine obtained as described and 63.8 grams of 3,4,5-trimethoxy benzoic acid chloride are dissolved in 600 parts by volume of anhydrous chloroform. The solution is heated to boiling for 5 hours. Thereafter, chloroform is distilled off in a vacuum. The residue is dissolved in water and the aqueous solution is washed with ether. Thereafter, the aqueous phase is rendered alkaline by the addition of soda lye and the separated oil base is extracted with ether. The ethereal solution is dried over Na₂SO₄. Ether is separated in a vacuum and the highly viscous residue is dissolved in 150 parts by volume of ethyl alcohol. The calculated equivalent amount of ethereal HCl is added thereto.

The soon crystallizing dihydrochloride is separated by filtration, dried and recrystallized from 120 parts by volume of ethanol. Thus, after drying for 3 days over P₂O₅, 40-50 grams (66-70% of the theoretical) of N,N'-bis-[(3,4,5-trimethoxy benzoyloxy)propyl] homopiperazine dihydrochloride containing 1 mol of water of crystallization is obtained. This product has a melting point at 194°-198°C.

References

Merck Index 3187

Kleeman & Engel p. 312

DOT 8 (7) 255 (1972)

I.N. p. 332

Arnold, H., Pahls, K., Rebling, R., Brock, N. and Lenke, H.-D.; U.S. Patent 3,532,685; October 6, 1970; assigned to Asta-Werke AG, Chemische Fabrik, Germany

DILTIAZEM HYDROCHLORIDE

Therapeutic Function: Coronary vasodilator

Chemical Name: cis-(+)-3-(acetyloxy)-5-[2-(dimethylamino)ethyl]-2,3-dihydro-2-(4-methoxyphenyl)-1,5-benzothiazepin-4(5H)-one hydrochloride

Common Name: —

Structural Formula:

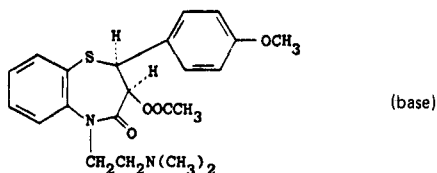

Chemical Abstracts Registry No.: 33286-22-5; 42399-41-7 (Base)

Trade Name	Manufacturer	Country	Year Introduced
Herbesser	Tanabe Seiyaku	Japan	1974
Tildiem	Dausse	France	1980

Trade Name	Manufacturer	Country	Year Introduced
Dilzem	Goedecke	W. Germany	1981
Cardizem	Marion	U.S.	1982
Cardizem	Nordic	Canada	1983
Tilazem	Parke Davis	—	—

Raw Materials

β -Diethylaminoethyl chloride	Acetic anhydride
Sodium ethoxide	Sodium bicarbonate
2-Aminothiophenol	Hydrogen chloride
4-Methoxybenzaldehyde	Ethyl chloroacetate

Manufacturing Process

β -Diethylaminoethyl chloride is condensed with 2-(4-methoxyphenyl)-3-hydroxy-2,3-dihydro-1,5-benzothiazepin-4(5H)-one in a first step. Then a mixture of 1.5 grams of 2-(4-methoxyphenyl)-3-hydroxy-5-(β -dimethylaminoethyl)-2,3-dihydro-1,5-benzothiazepin-4(5H)-one and 20 ml of acetic anhydride was heated on a water bath for 5 hours. The reaction mixture was evaporated under reduced pressure to remove acetic anhydride and the concentrated product was poured into ice water. The resulting mixture was made alkaline with sodium bicarbonate and extracted with chloroform. The chloroform layer was dried and evaporated to remove the solvent. The residue was dissolved in acetone, and an ethanol solution containing hydrogen chloride was added thereto producing 1.53 grams of 2-(4-methoxyphenyl)-3-acetoxy-5-(β -dimethylaminoethyl)-2,3-dihydro-1,5-benzothiazepin-4(5H)-one hydrochloride having a melting point from 187° to 188°C.

The starting material is made by reacting 4-methoxybenzaldehyde with ethyl chloroacetate; that product with sodium ethoxide; and that product with 2 aminothiophenol.

References

Merck Index 3189

Kleeman & Engel p. 312

PDR p. 1074

OCDS Vol. 3 p. 198 (1984)

DOT 10 (4) 127 (1974)

I.N. p. 333

REM p. 862

Kugita, H., Inoue, H., Ikezaki, M. and Takeo, S.; U.S. Patent 3,562,257; February 9, 1971; assigned to Tanabe Seiyaku Co., Ltd., Japan

DIMENHYDRINATE

Therapeutic Function: Antinauseant

Chemical Name: 8-chloro-3,7-dihydro-1,3-dimethyl-1H-purine-2,6-dione compound with 2-(diphenylmethoxy)-N,N'-dimethylethanamine (1:1)

Common Name: Chloranautine; O-benzhydryldimethylaminoethanol 8-chlorotheophyllinate

Structural Formula:

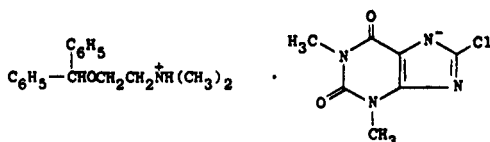

Chemical Abstracts Registry No.: 523-87-5

Trade Name	Manufacturer	Country	Year Introduced
Dramamine	Searle	U.S.	1949
Dramamine	Searle	France	1957
Dramocen	Central	U.S.	1977
Dimate	Totag	U.S.	1980
Dramaban	Mallard	U.S.	1983
Amalmare	Saita	Italy	—
Amosyt	Leo	Sweden	—
Andrumin	Ethnor	Australia	—
Antemin	Streuli	Switz.	—
Anti-Em	Adeka	Turkey	—
Antivomit	Farmos	Finland	—
Aviomarine	Polfa	Poland	—
Betadorm A	Woelm Pharma	W. Germany	—
Bontourist	Katwijk	Neth.	—
Calm-X	Republic	U.S.	—
Dimenest	Fellows-Testagar	U.S.	—
Dipendrate	Kenyon	U.S.	—
Dramarr	Quimia	Spain	—
Dramavir	Vir	Spain	—
Dramavol	Barlowe Cote	Canada	—
Dromyl	A.F.Z.	Norway	—
Dymenol	Dymond	Canada	—
Emedyl	Montavit	Austria	—
Epha	Woelm	W. Germany	—
Gravol	Horner	Canada	—
Gravol	Carter Wallace	U.K.	—
Hydrate	Hyrex	U.S.	—
Lomarin	Geymonat	Italy	—
Mareosan	Bescansa	Spain	—
Marolin	Andreu	Spain	—
Motion Aid	Vangard	U.S.	—
Nauseal	Eri	Canada	—
Nauseatol	Sabek	Canada	—
Neptusan	Benzon	Denmark	—
Novomina	Robisch	W. Germany	—
Novodiminate	Novopharm	Canada	—
Paranausine	Couvreur	Belgium	—
Pastillas Azules	Llano	Spain	—
Reidamine	Reid-Provident	U.S.	—
Removeine	Kerkhoff-Unicura	Neth.	—
Solbrine	Solac	France	—
Stada-Reisedragees	Stada	W. Germany	—
Travamin	Teva	Israel	—
Travamine	I.C.N.	Canada	—
Travel-Gum	Chemofux	Austria	—
Travin	Rondex	U.S.	—
Trawl	Chemofux	Austria	—
Troversin	Santuron	W. Germany	—
Valontan	Recordati	Italy	—
Vertirosan	Sigmapharm	Austria	—
Vomex	Endopharm	W. Germany	—
Voyal	Kwizda	Austria	—
Xamamina	Zambeletti	Italy	—

Raw Materials

8-Chlorotheophylline

β -Dimethylaminoethylbenzhydryl ether**Manufacturing Process**

58.8 grams of 8-chlorotheophylline and 70 grams of β -dimethylaminoethyl benzohydryl ether are dissolved in 150 cc of hot methanol. Then 5 grams of activated charcoal are added and the mixture is boiled for an hour. It is filtered hot and the filtrate cooled. The crystalline precipitate of β -dimethylaminoethyl benzohydryl ether 8-chlorotheophyllinate is collected on a filter, washed with ether and dried. It melts at 96°-99°C. It is dissolved in boiling ethyl acetate, filtered hot to remove any insoluble material, and then chilled. The salt so obtained melts at 102.5°-104°C after filtration, washing with ether and drying.

References

Merck Index 3195

Kleeman & Engel p. 314

PDR pp. 1669, 1989

I.N. p. 334

REM p. 808

Cusic, J.W.; U.S. Patent 2,499,058; February 28, 1950; assigned to G.D. Searle & Co.

Cusic, J.W.; U.S. Patent 2,534,813; December 19, 1950; assigned to G.D. Searle & Co.

DIMERCAPROL

Therapeutic Function: Heavy metal antidote

Chemical Name: 2,3-dimercapto-1-propanol

Common Name: 1,2-dithioglycerol

Structural Formula:

$$\text{SH}-\text{CH}_2-\underset{\text{SH}}{\text{CH}}-\text{CH}_2-\text{OH}$$

Chemical Abstracts Registry No.: 59-52-9

Trade Name	Manufacturer	Country	Year Introduced
Bal	Hynson/Westcott	U.S.	1944
Bal	Delalande	France	1950
Antoxol	Ferrosan	Denmark	—
Sulfactin	Homburg	W. Germany	—

Raw Materials

Glycerol 1,2-dibromohydrin

Sodium sulfide

Hydrogen

Manufacturing Process

1,2-Dithioglycerol is prepared in the following manner: 1,537 parts of sodium monosulfide nonahydrate and 411 parts of powdered sulfur are dissolved with stirring in 1,345 parts of water. Magnesium hydroxide is precipitated in the stirred sodium trisulfide solution by adding successively 97 parts of sodium hydroxide dissolved in 180 parts of water and then slowly 246 parts of magnesium chloride hexahydrate dissolved in 180 parts of water. The

magnesium hydroxide serves as a dispersing agent to maintain the resulting sulfide polymer in finely divided condition. The mixture is heated and stirred at 50°C while 1,329 parts of glycerol 1,2-dibromohydrin is added continuously during a period of 1.5 hours. The reaction is exothermic and external cooling is employed to maintain the temperature within the range of 50°-55°C. After the addition of the dibromohydrin is complete, the mixture is stirred and heated at 75°C for 6 hours.

The finely divided yellow sulfide polymer formed is then allowed to settle and the reaction liquor is separated by decantation. The product is washed by decantation five times with water and finally filtered by suction. The moist cake of polymer is then air dried. The yield is 988 parts including approximately 75 parts of magnesium hydroxide.

Thirty-two hundred fifty parts of the hydroxypropylene trisulfide containing magnesium hydroxide is charged into a steel autoclave equipped with a mechanical agitator. There is also charged into the autoclave 2,550 parts of dry dioxane and 350 parts of cobalt trisulfide catalyst pasted with 700 parts of dioxane. Hydrogen is charged into the autoclave to a pressure of 1,000 lb/in² and the autoclave is heated to a temperature of 125°C during 1.5 hours, agitation being employed during this operation. When the temperature reaches about 110°C the pressure commences to drop and is kept between the limits of 1,000 and 1,300 lb/in² by the addition of hydrogen. When the temperature reaches 125°C the pressure is raised to 1,700 lb/in² with hydrogen. The rate of hydrogenation increases as the temperature rises and the process is about complete when a temperature of 125°C is reached.

After the hydrogen absorption ceases, the autoclave is cooled, vented, and the reaction mixture is filtered to separate the catalyst. The filtrate is then heated on a steam bath at 60-80 mm pressure to remove the dioxane. The less volatile residue consists of 1,933 parts of crude dithioglycerol, a viscous oil.

1,2-Dithioglycerol is isolated from the oil by distillation from an oil heated pot through a short still. The distillation is carried out at a pressure of less than 1 mm and at a bath temperature of 120°-175°C, the dithioglycerol distilling over at a head temperature of 60°-65°C/0.2 mm or 75°-80°C/0.8 mm. Starting from 550 parts of crude dithioglycerol, 340 parts of distillate is obtained which contains 53% of mercapto sulfur and is nearly pure 1,2-dithioglycerol. The overall yield of dithioglycerol from the glycerol dibromohydrin is 48% of theoretical.

References

Merck Index 3198

Kleeman & Engel p. 315

PDR p. 948

I.N. p. 335

REM p. 1224

Peppel, W.J. and Signaigo, F.K.; U.S. Patent 2,402,665; June 25, 1946; assigned to E.I. du Pont de Nemours & Company

DIMETACRINE TARTRATE

Therapeutic Function: Antidepressant

Chemical Name: N,N,9,9-Tetramethyl-10(9H)acridinepropanamine tartrate

Common Name: —

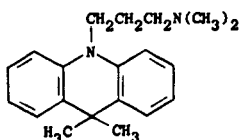
Structural Formula:

(base)

Chemical Abstracts Registry No.: 4757-55-5; 3759-07-7 (Base)

Trade Name	Manufacturer	Country	Year Introduced
Isotonil	Siegfried	W. Germany	1967
Isotonil	Nippon Chemiphar	Japan	1976
Isotonil	Triosol	Belgium	—
Linostil	Siegfried	Switz.	—

Raw Materials

5,5-Dimethylacridan	Sodium amide
1-Chloro-3-dimethylaminopropane	Tartaric acid

Manufacturing Process

A mixture of 10.0 g of 5,5-dimethylacridan, 2.0 g of pulverized sodium amide and 6.5 g of 1-chloro-3-dimethylaminopropane in 50 ml of xylene is heated at reflux with stirring for one hour. To the cooled reaction mixture is added one volume of water. The organic layer is separated and extracted several times with diluted lactic acid. The acidic extracts are combined, washed with ether and neutralized by alkali. The crude 10-(3'-dimethylaminopropyl)-5,5-dimethylacridan is isolated by ether extraction and purified by distillation in a high vacuum. The yield is 6.4 g BP 170°-180°C/0.005 mm. $n_D^{29} = 1.5990$.

43 g of the base I are dissolved in 229 ml of 1 N aqueous d-tartaric acid and the clear solution so obtained is evaporated to dryness under reduced pressure. The residue is dissolved in 150 ml of 90% ethanol which solution after cooling gives the tartaric acid salt of I in white needles. The salt contains 1 mol of tartaric acid per 1 mol of the base. MP 155°-156°C. Easily soluble in cold water.

References

Merck Index 3201

Kleeman & Engel p. 316

OCDS Vol. 1 p. 397 (1977)

DOT 4 (4) 150 (1968)

I.N. p. 335

British Patent 933,875; August 14, 1963; assigned to Kefalas S/A

Haring, M., Molnar, I. and Wagner-Jauregg, T.; U.S. Patent 3,284,454; November 8, 1966; assigned to Siegfried AG (Switzerland)

DIMETHICONE**Therapeutic Function:** Antiflatulent**Chemical Name:** Dimethylpolysiloxane**Common Name:** Simethicone

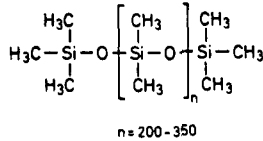
Structural Formula:

Chemical Abstracts Registry No.: 8050-81-5

Trade Name	Manufacturer	Country	Year Introduced
Silicote	Amer. Crit. Care	U.S.	1953
Aeropax	Green Cross	Japan	—
Bicolun	Warner	W. Germany	—
Ceolat	Kali-Chemie	W. Germany	—
Endo-Paractol	Homburg	W. Germany	—
Ganatone	Hokuriku	Japan	—
Gasace	Kanto	Japan	—
Gascon	Kissei	Japan	—
Gasless	Hishiyama	Japan	—
Gaspanon	Kotani	Japan	—
Gasteel	Fuso	Japan	—
Gaszeron	Nichiiko	Japan	—
Gersmin	Kowa	Japan	—
Harop	Toyo	Japan	—
Kestomatine	Lircal	Italy	—
Lefax	Asche	W. Germany	—
Margarte	Mohan	Japan	—
Mylicon	Parke Davis	Italy	—
Mylicon	Stuart	U.S.	—
Pleiazim	Guidotti	Italy	—
Polisilon	Midy	Italy	—
Polysilo	Toa	Japan	—
Silian	Lafare	Italy	—
Silies	Nippon Shoji	Japan	—
Silicogamma	I.B.P.	Italy	—
Sili-Met-San S	Nippon Shoji	Japan	—
Spalilin	Maruishi	Japan	—
Trimax	Winthrop	Italy	—
Unicare	United	U.S.	—

Raw Materials

Dimethyl diethoxy silane
 Trimethyl ethoxy silane
 Sodium hydroxide

Manufacturing Process

In a 5 liter three-necked flask, fitted with a reflux condenser, agitator and thermometer, were placed 1,393 g (9.41 mols) of redistilled $(\text{CH}_3)_2\text{Si}(\text{OEt})_2$ and 1,110 g (9.41 mols) of $(\text{CH}_3)_3\text{SiOEt}$. To this solution was added 254 g (14.11 mols) of water containing 7.5 g of NaOH (approximately 1 NaOH per 100 silicon atoms). This insured the formation of only straight chain polymers. The mixture was heated to 40°C and the temperature continued to rise for nearly an hour. After adding 50 cc (20% excess) more water, the mixture was refluxed for two hours and then allowed to stand overnight.

Alcohol was then distilled off, until the temperature reached 100°C. 1,706.6 g of distillate was collected. (Theory 1,430 g.) This alcohol was poured into four times its volume of water and an insoluble oil separated (457 g). The insoluble fraction was added back to the copoly-

mer residue from the distillation and 555 cc of 20% hydrochloric acid was added. The acid mixture was refluxed for two hours, and the silicon oils were carefully washed with distilled water until neutral. The yield was 1,420 g. (Theory 1,409 g.)

References

Merck Index 8374

Kleeman & Engel p. 317

PDR p. 1826

Rem p. 774

Hyde, J.F.; U.S. Patent 2,441,098; May 4, 1948; assigned to Corning Glass Works

DIMETHINDENE MALEATE

Therapeutic Function: Antihistaminic

Chemical Name: N,N-dimethyl-3-[1-(2-pyridinyl)ethyl]-1-H-indene-2-ethanamine maleate

Common Name: —

Structural Formula:

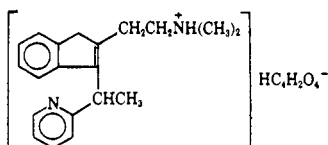

Chemical Abstracts Registry No.: 3614-69-5; 5636-83-9 (Base)

Trade Name	Manufacturer	Country	Year Introduced
Fenistil	Zyba	W. Germany	1961
Forhistal	Ciba	U.S.	1961
Fenostil	Zyba	U.K.	1963
Triten	Marion	U.S.	1971
Foristal	Ciba-Geigy-Takeda	Japan	—

Raw Materials

2-Ethylpyridine	Phenyl lithium
2-(2-Dimethylaminoethyl)-indan-1-one	Maleic acid

Manufacturing Process

26 grams of 2-ethylpyridine is added dropwise with cooling to 20°C and in an atmosphere of nitrogen to a stirred solution of 650 ml of an 0.37 molar solution of phenyl lithium in benzene. After two hours a solution of 10 grams of 2-(2-dimethylaminoethyl)-indan-1-one in 50 ml of dry ether is added over a period of five minutes while stirring and cooling to room temperature. After standing for 24 hours the organo-lithium compounds are decomposed by the addition of 50 ml of water with external cooling. After separating the water phase from the organic solution, the latter is washed several times with 50 ml of water, and then extracted with a mixture of 40 ml of concentrated hydrochloric acid and 100 ml of water.

The acidic solution, containing the 2-(2-dimethylaminoethyl)-1-[1-(2-pyridyl)-ethyl]-indan-1-ol is heated on the steam bath for thirty minutes to effect dehydration to the desired indene derivative. The solution is cooled, made strongly basic with an aqueous solution

of ammonia and then extracted with ether. The ether phase is dried over sodium sulfate, filtered, evaporated and the residue distilled.

At 15 mm pressure the excess of 2-ethylpyridine is removed, at 120°C/0.5 mm some unreacted 2-(2-dimethylaminoethyl)-indene distills and at 165°-175°C/0.5 mm the 2-(2-dimethylaminoethyl)-3-[1-(2-pyridyl)-ethyl]-indene is collected. It may be converted to an aqueous solution of the dihydrochloride by dissolving it in the appropriate amount of dilute hydrochloric acid.

To a solution of 1.0 gram of 2-(2-dimethylaminoethyl)-3-[1-(2-pyridyl)-ethyl]-indene in 10 ml of ethanol is added while stirring and heating 0.4 gram of maleic acid. On cooling the 2-(2-dimethylaminoethyl)-3-[1-(2-pyridyl)-ethyl]-indene maleate crystallizes, is filtered off, washed with a small amount of ethanol and recrystallized from ethanol, MP 158°C.

References

Merck Index 3205

Kleeman & Engel p. 320

REM p. 1127

Huebner, C.F.; U.S. Patent 2,970,149; January 31, 1961; assigned to Ciba Pharmaceutical Products, Inc.

DIMETHISOQUIN

Therapeutic Function: Topical anesthetic

Chemical Name: 2-[(3-butyl-1-isoquinolinyl)oxy]-N,N-dimethylethanamine

Common Name: Quinisocaine

Structural Formula:

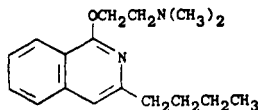

Chemical Abstracts Registry No.: 86-80-6; 2773-92-4 (Hydrochloride)

Trade Name	Manufacturer	Country	Year Introduced
Quotane	SKF	U.S.	1951
Quotane	Roger Bellon	France	1981
Isochinol	Chemipharm	W. Germany	—
Pruralgin	Pharmacia	Sweden	—
Pruralgin	Pharmacia	Italy	—

Raw Materials

β -Dimethylaminoethanol

Sodium

3-Butyl-1-chloroisoquinoline

Manufacturing Process

A mixture of 10.0 grams of β -dimethylaminoethanol and 1.9 grams of sodium in 90 cc of dry xylene was heated at 95°C for 5 hours. To the resulting solution was added at 30°C, 18 grams of 3-butyl-1-chloroisoquinoline. The solution, which turned very dark, was heated at 100°-125°C for 3.5 hours. The mixture was extracted with two 100 cc portions of 2 N

hydrochloric acid solution. The acid solution was made strongly alkaline with 40% potassium hydroxide solution and the oil which separated was taken into ether. The ether solution was washed with two 100 cc portions of water saturated with sodium chloride, and then dried over anhydrous sodium sulfate for 3 hours. The sodium sulfate was removed by filtration and the ether by distillation. Distillation of the residual oil gave a colorless liquid, BP 155°-157°C/3mm.

References

Merck Index 3208

Kleeman & Engel p. 799

OCDS Vol. 1 p. 18 (1977)

I.N. p. 835

REM p. 1055

Ulliot, G.E.; U.S. Patent 2,612,503; September 30, 1952; assigned to Smith, Kline & French Laboratories

DIMETHISTERONE

Therapeutic Function: Progestin

Chemical Name: 17 β -hydroxy-6 α -methyl-17-(1-propynyl)androst-4-en-3-one

Common Name: —

Structural Formula:

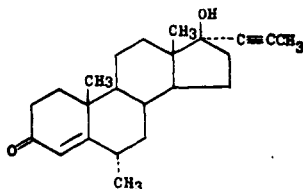

Chemical Abstracts Registry No.: 79-64-1

Trade Name	Manufacturer	Country	Year Introduced
Oracon	Mead Johnson	U.S.	1965
Secrosteron	Allen & Hanburys	U.K.	—
Secrosteron	Santen-Yamanouchi	Japan	—

Raw Materials

3,3-Ethylenedioxy-6 α -methylandrost-4-ene-3,17-dione

Propyl magnesium bromide

Acetic acid

Manufacturing Process

A solution of a Grignard reagent, employing 1-propyne (8 grams) was prepared. To this reagent there was added the 3,3 ethylenedioxy derivative (4 grams) of 6 α -methylandrost-4-ene-3,17-dione in tetrahydrofuran (100 ml), and the mixture heated under reflux for 3 hours. After decomposition of the complex with aqueous ammonium chloride, the product was isolated with ether and treated with 90% acetic acid (50 ml) for 30 minutes at 100°C. The product obtained by pouring the mixture into water and extracting with

ether was crystallized from aqueous methanol. 17 β -Hydroxy-6 α -methyl-17 α -(prop-1-ynyl)-androst-4-en-3-one formed plates MP 99° to 102°C.

References

Merck Index 3209

Kleeman & Engel p. 318

OCDS Vol. 1 pp. 176, 187 (1977)

DOT 4 (1) 7 (1968)

I.N. p. 336

Ellis, B., Petrow, V., Stansfield, M. and Stuart-Webb, I.A.; U.S. Patent 2,927,119; Mar. 1, 1960; assigned to The British Drug Houses Limited, England

Barton, S.P., Burn, D., Cooley, G., Ellis, B., Petrow, V. and Stuart-Webb, I.A.; U.S. Patent 2,939,819; June 7, 1960; assigned to The British Drug Houses Limited, England

DIMETHOXANATE

Therapeutic Function: Antitussive

Chemical Name: 10H-Phenothiazine-10-carboxylic acid 2-[2-(dimethylamino)ethoxy] ethyl ester

Common Name: —

Structural Formula:

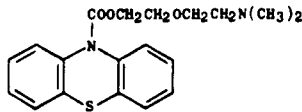

Chemical Abstracts Registry No.: 477-93-0; 518-63-8 (Hydrochloride)

Trade Name	Manufacturer	Country	Year Introduced
Cothera	Ayerst	U.S.	1957
Cotrane	Midypharm	France	1960
Cothera	Ayerst	Italy	1961
Atuss	Arcana	Austria	—
Perlatos	Farm. Milanese	Italy	—
Tossizid	Beolet	Italy	—

Raw Materials

Phenothiazine-10-carboxylic acid chloride

Dimethylaminoethoxyethanol

Hydrogen chloride

Manufacturing Process

5.23 g of phenothiazine-10-carboxylic acid chloride were suspended in 8 g of dimethylaminoethoxyethanol and heated, with stirring, under anhydrous conditions, first for 1 hour at a temperature of 50°-105°C, then for another hour at 108°-110°C. All the suspended acid chloride had dissolved after the final heating, and the solution was then allowed to cool slowly to 75°C over a period of one hour. Infrared examination of a sample showed that the esterification reaction was essentially complete after the second hour.

The reaction mixture was then poured on 1 liter of crushed ice, and the oily precipitate washed

repeatedly by decantation with ice water. It was then taken up in 75 ml of benzene, and again washed repeatedly with water until a pH of 8.2 in the washings indicated that substantially all of the excess β -dimethylaminoethoxyethanol had been removed. The benzene solution was then dried with anhydrous sodium sulfate, filtered, and the benzene evaporated in a current of dry nitrogen gas. The residual dark oil constituted the desired basic ester. β -Dimethylaminoethoxyethyl phenothiazine-10-carboxylate.

The basic ester may be dissolved in anhydrous ether and then precipitated by adding a slight excess of a solution of dry hydrogen chloride in ether and the hydrochloride salt may be isolated as an amorphous, glasslike product, which could be crystallized from anhydrous acetone or from methanol-ether. In this manner there was obtained as a stable, crystalline, colorless substance β -dimethylaminoethoxyethyl phenothiazine-10-carboxylate hydrochloride, one sample of which melted at 161°-163°C with decomposition.

References

Merck Index 3213

Kleeman & Engel p. 319

OCDS Vol. 1 p. 390 (1977)

I.N. p. 336

von Seemann, C.; U.S. Patent 2,778,824; January 22, 1957; assigned to American Home Products Corp.

DIMETHYL SULFOXIDE

Therapeutic Function: Topical antiinflammatory

Chemical Name: Sulfinylbis[methane]

Common Name: Methyl sulfoxide

Structural Formula: $(\text{CH}_3)_2\text{SO}$

Chemical Abstracts Registry No.: 67-68-5

Trade Name	Manufacturer	Country	Year Introduced
Rimso	Research Industries	U.S.	1978
Damul	Pharm. Werk Meuselbach	E. Germany	—
Deltan	Serum & Impfinstitut	Switz.	—
Demasorb	Squibb	—	—
Demesco	MSD	—	—
Demsodrox	Nezel	Spain	—
Dermialgida	Andromaco	Spain	—
Dipirartril	Pons	Spain	—
Dromisol	MSD	—	—
Hyadur	Grunenthal	—	—
Infiltrina	Heyden	W. Germany	—
Intran	Kwizda	Austria	—
Kemsol	Horner	Canada	—
Somipront	Mack	W. Germany	—

Raw Materials

Dimethyl sulfide

Oxygen

Nitrogen dioxide

Manufacturing Process

A current of oxygen at the rate of 370 ml/min was bubbled through a 30-cm layer of dimethyl sulfide maintained at 26.5°C, thereby producing a gaseous mixture containing the stoichiometric amount of oxygen required for the oxidation of the sulfide to sulfoxide. Nitric oxide at the rate of 30 ml/min was added to the gaseous mixture as it passed into the first of a series of four reaction chambers, each consisting of a glass tube 4.3 cm in diameter and 100 cm in length. The reaction started immediately, the temperature of the reaction mixture reached a maximum of about 75°C in the first two tubes where most of the reaction occurred, and the reaction slowed down in the last two tubes. The crude, yellow product, which dropped from the tubes, contained about 10% dimethyl sulfide, about 2% dissolved nitrogen dioxide, about 2% methane sulfonic acid, and some water. The crude product was refluxed at 100°C for 30 minutes and the escaping gas was passed into the first reaction chamber. The dimethyl sulfide was removed by then heating the product to 150°C, the methane sulfonic acid was neutralized by adding slaked lime, and the dimethyl sulfoxide was distilled in vacuum. The yield of pure dimethyl sulfoxide (BP 63°C at 6 mm Hg) was 85% of the theoretical yield from the evaporated dimethyl sulfide.

References

Merck Index 3255

PDR p. 1450

DOT 1 (3) 94 (1965)

I.N. p. 340

REM p. 1121

Smedslund, T.H.; U.S. Patent 2,581,050; January 1, 1952; assigned to A.B. Centrallaboratorium Helsinki

Coma, J.G. and Gerttula, V.G.; U.S. Patent 3,045,051; July 17, 1962; assigned to Crown Zellerbach Corp.

DIMETHYL TUBOCURARINE IODIDE

Therapeutic Function: Skeletal muscle relaxant

Chemical Name: 6,6',7',12'-tetramethoxy-2,2,2',2'-tetramethyltubocuraranium diiodide

Common Name: Metocurine iodide

Structural Formula:

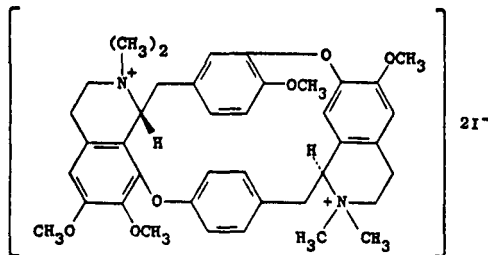

Chemical Abstracts Registry No.: 7601-55-0

Trade Name	Manufacturer	Country	Year Introduced
Metubine Iodide	Lilly	U.S.	1949
Mecostrin	Squibb	U.S.	—
Methyl Curarin	Ethicon	W. Germany	—

Raw Materials

Curare
Methyl iodide

Manufacturing Process

50 grams of crude, tarry curare as received in commerce and containing about 20% of d-tubocurarine are suspended in 400 cc of 0.5 N methanolic potassium hydroxide, and the mixture is boiled for ten minutes. The dark brown insoluble material is filtered off and the filtrate is treated with 50 cc of methyl iodide and refluxed gently for about 8 hours. An additional amount of 25 cc of methyl iodide is added to the reaction mixture and the refluxing is continued for 8 hours.

The reaction mixture is evaporated to a small volume, whereupon the d-tubocurarine dimethyl ether iodide precipitates. The precipitate is filtered off and dissolved in boiling water. The hot solution is treated with a small amount of decolorizing carbon, the carbon filtered off and the filtrate cooled to about 0°C. The dimethyl ether of d-tubocurarine iodide crystallizes in white crystals which melt at about 267°-270°C with decomposition.

References

Merck Index 6020

Kleeman & Engel p. 319

I.N. p. 340

REM p. 923

Bray, M.D.; U.S. Patent 2,581,903; January 8, 1952; assigned to Eli Lilly and Company

DINOPROST TROMETHAMINE

Therapeutic Function: Smooth muscle stimulant

Chemical Name: (5Z,9α,11α,13E,15S)-9,11,15-trihydroxyprosta-5,13-dien-1-oic acid tromethamine salt

Common Name: Prostaglandin F_{2α} tromethamine

Structural Formula:

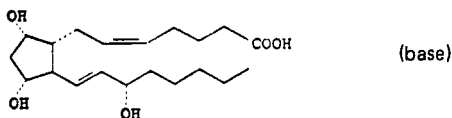

Chemical Abstracts Registry No.: 38562-01-5

Trade Name	Manufacturer	Country	Year Introduced
Prostin F2A	Upjohn	U.K.	1972
Prostin F2 Alpha	Upjohn	U.S.	1973
Prostalmon F	Ono	Japan	1974
Minprostin F2A	Upjohn	W. Germany	1975
Prostin F2 Alpha	Upjohn	Italy	1976
Pronalgon F	Sumitomo	Japan	1981
Amoglandin	Kabi Vitrum	Sweden	—
Enzaprost	Chinoin	Hungary	—
Enzaprost	Medica	Finland	—

Trade Name	Manufacturer	Country	Year Introduced
Lutalyse	Upjohn	—	—
Panacelan-F	Glaxo-Fuji	Japan	—
Zinoprost	Ono	Japan	—

Raw Materials

Tris(Hydroxymethyl)aminomethane
Prostaglandin F_{2α}

Manufacturing Process

A solution of tris(hydroxymethyl)aminomethane (1.645 grams) in 3.0 ml of water at 60°C is added with vigorous stirring to a solution of PGF_{2α} (5.00 grams) in 700 ml of acetonitrile which has just been brought to its boiling point. The vessel which contained the aqueous amine solution is rinsed with three 0.66 ml portions of water, each rinsing being added with vigorous stirring to the acetonitrile solution. The mixture is then cooled to 25°C by immersion of the vessel in cool water. At the cloud point, the vessel wall (glass) below the liquid surface is scratched vigorously with a glass rod. The mixture is then maintained at 25°C for 24 hours.

The resulting crystals are collected by filtration under nitrogen, washed on the filter with 50 ml of acetonitrile, and then dried by passing nitrogen at 50°C through the filter cake for one hour. Drying is completed in an oven at 70°C for 8 hours to give 5.965 grams of the tris(hydroxymethyl)aminomethane salt of PGF_{2α} in free flowing crystalline form; MP 100°-101°C.

References

Merck Index 7781

Kleeman & Engel p. 321

OCDS Vol. 1 pp. 27, 33 (1977)

DOT 10 (4) 132 (1974) & 19 (6) 318 (1983)

I.N. p. 343

REM p. 950

Morozowich, W.; U.S. Patent 3,657,327; April 18, 1972; assigned to The Upjohn Company

DINOPROSTONE

Therapeutic Function: Oxytocic; abortifacient

Chemical Name: 11,15-Dihydroxy-9-oxoprostano-5,13-dien-1-oic acid

Common Name: Prostaglandin E₂, PGE₂

Structural Formula:

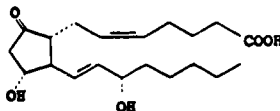

Chemical Abstracts Registry No.: 363-24-6

Trade Name	Manufacturer	Country	Year Introduced
Prostin E ₂	Upjohn	U.K.	1972

Trade Name	Manufacturer	Country	Year Introduced
Prostarmon E	Ono	Japan	1976
Prostin E ₂	Upjohn	U.S.	1977
Minprostín	Upjohn	W. Germany	1978

Raw Materials

Prostaglandin-A ₂	Hexamethyldisilazane
Trimethylchlorosilane	Hydrogen peroxide
Aluminum amalgam	

Manufacturing Process

Hexamethyldisilazane (1 ml) and trimethylchlorosilane (0.2 ml) are added with stirring to a solution of PGA₂ (250 mg) in 4 ml of tetrahydrofuran at 0°C under nitrogen. This mixture is maintained at 5°C for 15 hours. The mixture is then evaporated under reduced pressure. Toluene is added and evaporated twice. Then the residue is dissolved in 6 ml of methanol, and the solution is cooled to -20°C. Hydrogen peroxide (0.45 ml; 30% aqueous) is added. Then, 1 N sodium hydroxide solution (0.9 ml) is added dropwise with stirring at -20°C. After 2 hours at -20°C, an additional 0.3 ml of the sodium hydroxide solution is added with stirring at -20°C. After another hour in the range -10°C to -20°C, an additional 0.1 ml of the sodium hydroxide solution is added. Then, 1.5 ml of 1 N hydrochloric acid is added, and the mixture is evaporated under reduced pressure. The residue is extracted with ethyl acetate, and the extract is washed successively with 1 N hydrochloric acid and brine, dried with anhydrous sodium sulfate and evaporated. The residue is dissolved in 5 ml of diethyl ether. To this solution is added 0.5 ml of methanol and 0.1 ml of water. Amalgamated aluminum made from 0.5 g of aluminum metal is then added in small portions during 3 hours at 25°C. Then, ethyl acetate and 3 N hydrochloric acid are added, and the ethyl acetate layer is separated and washed successively with 1 N hydrochloric acid and brine, dried with anhydrous sodium sulfate, and evaporated. The residue is chromatographed on 50 g of acid-washed silica gel, eluting first with 400 ml of a gradient of 50-100% ethyl acetate in Skellysolve B, and then with 100 ml of 5% methanol in ethyl acetate, collecting 25 ml fractions. Fractions 9 and 10 are combined and evaporated to give 18 mg of 11β-PGE₂. Fractions 17-25 are combined and evaporated to give 39 mg of PGE₂.

References

- Merck Index 7780
 Kleeman & Engel p. 323
 OCDS Vol. 1 pp. 27, 30, 33, 35 (1977)
 DOT 9 (10) 432 (1979); 11 (10) 388 (1975) & 14 (2) 74 (1978)
 I.N. p. 343
 REM p. 947
 Pike, J.E. and Schneider, W.P.; U.S. Patent 3,948,981; April 6, 1976; assigned to The Upjohn Co.

DIOSMIN

Therapeutic Function: Bioflavonoid

Chemical Name: 5,7-Dihydroxy-2-(3-hydroxy-4-methoxyphenyl)-4H-1-benzopyran-4-one-7-rutinoside

Common Name: —

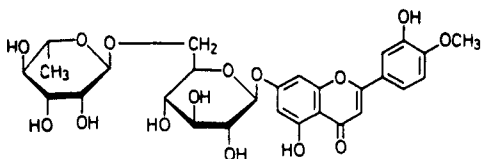
Structural Formula:

Chemical Abstracts Registry No.: 520-27-4

Trade Name	Manufacturer	Country	Year Introduced
Diosmil	Bellon	France	1971
Tovene	Kali-Chemie	W. Germany	1976
Dalfon	Servier	Italy	1977
Diosminil	Faes	Spain	—
Diovenor	Hommel	Switz.	—
Flebotropin	Bago	Argentina	—
Insuven	Lusofarmaco	Spain	—
Rioven	Hommel	Switz.	—
Varinon	Hommel	Switz.	—
Ven-Detrex	Hommel	Switz.	—
Venex	Lusofarmaco	Portugal	—
Venosmine	Hommel	Switz.	—
Venotrex	Hommel	Switz.	—
Venusmin	Hommel	Switz.	—

Raw Materials

Hesperidin	Acetic anhydride
Bromine	Sodium hydroxide
Acetic acid	

Manufacturing Process

A mixture of 72 g hesperidin, 288 ml acetic anhydride and 300 ml glacial acetic acid were boiled in reflux with 15 ml pyridine as the catalyst for 144 hours until during the control of the reaction the band disappeared at a wave length between 264 to 280 nm, and a new maximum appeared at 330 nm. Thereafter in a rotation evaporator the reaction mixture was concentrated by evaporation under vacuum conditions.

The residue was absorbed in 1,200 ml ethyl acetate, admixed with 20 ml ethanol and boiled for one hour under reflux action. The solution was filtered and compressed to dryness. The residue was dried in a vacuum drying cabinet. The yield amounted to 107.5 g.

35.8 g thereof were then dissolved in 280 ml glacial acetic acid and brominated with a solution of 6.05 g bromine in 30 ml glacial acetic acid. Thereafter the mixture compressed to dryness by means of the rotation evaporator, there being obtained a residue of 41.8 g. Such was dissolved in 150 ml methanol, admixed with a solution of 36 g sodium hydroxide in 180 ml water and stirred for one hour at 50°C.

The diosmin was precipitated out by adding 120 ml glacial acetic acid and stirring at 70°C for 30 minutes. The precipitate was filtrated in a suction filter or strainer, washed with methanol, water and again methanol and dried at 60°C in the drying cabinet. Raw yield: 17.0 g corresponding to 71% yield. Bromine content 0.51%.

10 g of the thus-obtained diosmin was dissolved in a solution of 24 g sodium hydroxide in 120 ml water, admixed with 100 ml methanol and 100 ml pyridine and stirred for one hour at 50°C. The diosmin was precipitated by the addition of 100 ml glacial acetic acid and stirred for 30 minutes at 70°C, filtered and washed with methanol and water and again methanol.

After drying at 60°C there was obtained a pure yield of 9.2 g diosmin (65% based upon the employed hesperidin) having a bromine content of 0.07%.

References

Merck Index 3300

Kleeman & Engel p. 324

DOT 12 (7) 263 (1976)

I.N. p. 344

Schmid, C., Glasbrenner, M. and Heusser, J.; U.S. Patent 4,078,137; March 7, 1978; assigned to Hommel A.G. (Switz.)

DIOXYLINE PHOSPHATE

Therapeutic Function: Vasodilator

Chemical Name: 1-(4-ethoxy-3-methoxybenzyl)-6,7-dimethoxy-3-methyl isoquinoline phosphate

Common Name: Dimoxyline

Structural Formula:

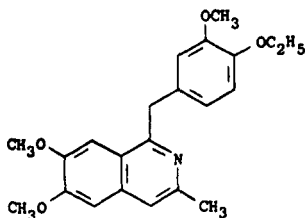

(base)

Chemical Abstracts Registry No.: 5667-46-9; 147-27-3 (Base)

Trade Name	Manufacturer	Country	Year Introduced
Paveril	Lilly	U.S.	1951
Paverona	Lilly	Japan	—

Raw Materials

1-(3',4'-Dimethoxyphenyl)-2-propanone

Hydroxylamine HCl

Ammonia

3-Methoxy-4-ethoxyphenyl acetic acid

Phosphorus oxychloride

Sodium hydroxide

Manufacturing Process

A mixture of 150 grams of 1-(3',4'-dimethoxyphenyl)-2-propanone and 70 grams of hydroxylamine hydrochloride in 125 cc of water is stirred while a solution of 51.3 grams of sodium carbonate in 150 cc of water is added over the course of 15 minutes, and while maintaining the reaction mixture at 30°-40°C. The reaction mixture is stirred for an additional two and one-half hour period at room temperature, and is then diluted with an equal volume of water and extracted three times with 300 cc portions of ether. The combined ether extracts are washed with water, dried over anhydrous magnesium sulfate, and the

ether is distilled off. The residue, comprising 1-(3',4'-dimethoxyphenyl)-2-propanone oxime, may be purified by fractional distillation in vacuo.

1-(3',4'-Dimethoxyphenyl)-2-propanone oxime thus prepared boiled at about 165-175°C at 0.6 mm pressure. Analysis showed the presence of 7.23% of nitrogen, compared with the calculated amount of 6.69%.

A solution of 151 grams of 1-(3',4'-dimethoxyphenyl)-2-propanone oxime in 200 cc of absolute ethanol is treated with 5 grams of Raney nickel catalyst and ammonia in an autoclave at about 25 atm of pressure and at 75°-100°C. The reduction is complete in about one-half hour and the reaction mixture is filtered and fractionated under reduced pressure to recover the α -methylhomoveratrylamine formed by the reduction. α -Methylhomoveratrylamine thus prepared boiled at 163°-165°C at 18 mm pressure.

A mixture of 39.0 grams (0.2 mol) of α -methylhomoveratrylamine and 42.0 grams (0.2 mol) of 3-methoxy-4-ethoxyphenylacetic acid is heated at 190°-200°C for one hour. The reaction mixture is poured into about 100 cc of petroleum ether, whereupon crystals of N-(α -methylhomoveratryl)-3-methoxy-4-ethoxyphenylacetamide separate. The precipitate is filtered off, and recrystallized from 50% methanol-water.

N-(α -methylhomoveratryl)-3-methoxy-4-ethoxyphenylacetamide thus prepared melted at about 135°-136°C. Analysis showed the presence of 68.05% carbon and 7.62% of hydrogen compared with the calculated amount of 68.19% carbon and 7.54% hydrogen.

A solution of 50 grams of N-(α -methylhomoveratryl)-3-methoxy-4-ethoxyphenylacetamide, prepared as set out above, in 200 cc of benzene, is treated with 8 cc of phosphorus oxychloride. The mixture is refluxed for about 3 hours, cooled and then is shaken with a solution composed of 15 grams of sodium hydroxide dissolved in 60 cc of water. The aqueous layer is removed, and the benzene solution is washed with water. The washed benzene solution is dried over anhydrous magnesium sulfate, filtered and evaporated to dryness. The low-melting solid residue is 6,7-dimethoxy-3-methyl-1-(3'-methoxy-4'-ethoxybenzyl)-dihydroisoquinoline base.

To a solution of 50 grams of 6,7-dimethoxy-3-methyl-1-(4'-ethoxy-3'-methoxybenzyl)-dihydroisoquinoline base in 200 ml of dry benzene are added 150 ml of decalin, and the mixture is distilled until its temperature reaches 180°C. 1.5 grams of 5% palladium on carbon are then added. The mixture is stirred under reflux for about 6 hours to dehydrogenate the dihydroisoquinoline. On cooling, the reaction mixture is diluted with petroleum ether and the precipitated 6,7-dimethoxy-3-methyl-1-(3'-methoxy-4'-ethoxybenzyl)-isoquinoline is filtered off and recrystallized from dilute ethanol.

6,7-Dimethoxy-3-methyl-1-(3'-methoxy-4'-ethoxybenzyl)isoquinoline thus prepared melted at 124°-125°C. Analysis showed the presence of 71.68% carbon and 7.07% hydrogen as compared with the calculated amount of 71.91% carbon and 6.85% hydrogen.

A solution of 5 grams of 6,7-dimethoxy-3-methyl-1-(4'-ethoxy-3'-methoxybenzyl)-isoquinoline in 100 cc of ethanol is treated with a solution of 1.5 grams of phosphoric acid in 10 cc of ethanol. 10 cc of water are added to effect complete solution, and the reaction mixture is then cooled and ether is added until precipitation of the salt is complete. The precipitate of 6,7-dimethoxy-3-methyl-1-(3'-methoxy-4'-ethoxybenzyl)-isoquinoline phosphate is filtered off and recrystallized from 85% ethanol by the addition of 2 volumes of ether.

References

Merck Index 3266

Kleeman & Engel p. 321

OCDS Vol. 1 p. 349 (1977)

I.N. p. 342

Shepard, E.R.; U.S. Patent 2,728,769; December 27, 1955; assigned to Eli Lilly and Co.

DIPHEMANIL METHYLSULFATE

Therapeutic Function: Antispasmodic

Chemical Name: 4-(diphenylmethylene)-1,1-dimethylpiperidinium methyl sulfate

Common Name: —

Structural Formula:

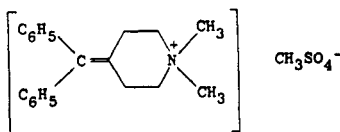

Chemical Abstracts Registry No.: 62-97-5

Trade Name	Manufacturer	Country	Year Introduced
Prantal	Schering	U.S.	1952
Prantal	Unicet	France	1958
Demotil	Pharmacia	Sweden	—
Prentol	Essex Espana	Spain	—

Raw Materials

Bromobenzene	Magnesium
4-Benzoyl-N-methylpiperidine	Sulfuric acid
Dimethyl sulfate	

Manufacturing Process

(A) *Preparation of Diphenyl-(N-Methyl-4-Piperidyl)Carbinol:* To a Grignard solution prepared from 4.9 grams of magnesium, 100 cc of ether and 31.4 grams of dry bromobenzene is added 18.5 grams of 4-benzoyl-N-methylpiperidine in 200 cc of dry ether. The reaction mixture is heated with stirring for 4 hours on the steam bath and then decomposed. The organic layer is separated and the aqueous layer extracted with benzene. The combined organic extracts are concentrated and the residue, diphenyl-(N-methyl-4-piperidyl)carbinol, recrystallized from benzene-petroleum ether, MP 130°-131°C. The Grignard complex may also be decomposed with ice and hydrochloric acid and the insoluble hydrochloride of the carbinol isolated directly.

(B) *Preparation of Diphenyl-(N-Methyl-4-Piperidylidene)Methane:* The carbinol can be dehydrated with 60% sulfuric acid. In general, to one part of the carbinol there is added 10 parts of 60% sulfuric acid. The mixture after heating for 6 hours is poured onto cracked ice, the solution made alkaline with dilute sodium hydroxide and the oily basic layer extracted with ether. The ether extracts after washing with water are dried over sodium sulfate, and after removing the ether, the residue is distilled in vacuo, MP 52°-53°C.

(C) *Preparation of Final Product:* The product from (B) is reacted with dimethyl sulfate in benzene to give the final product, MP 196°-197°C.

References

Merck Index 3313

Kleeman & Engel p. 325

I.N. p. 346

Sperber, N., Villani, F.J. and Papa, D.; U.S. Patent 2,739,968; March 27, 1956; assigned to Schering Corporation

DIPHENADIONE

Therapeutic Function: Anticoagulant

Chemical Name: 2-(diphenylacetyl)-1H-indene-1,3(2H)-dione

Common Name: 2-diphenylacetyl-1,3-diketohydrindene; 2-diphenylacetyl-1,3-indandione

Structural Formula:

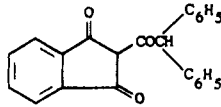

Chemical Abstracts Registry No.: 82-66-6

Trade Name	Manufacturer	Country	Year Introduced
Dipaxin	Upjohn	U.S.	1955
Didandin	Boots	—	—

Raw Materials

Dimethyl phthalate	Sodium
Diphenylacetone	Methanol

Manufacturing Process

A solution of sodium methoxide was prepared by adding 2.76 grams (0.12 mol) of sodium to 50 ml of absolute methanol and gently warming the mixture to effect complete solution of the sodium. To this was added 300 milliliters of dry benzene with vigorous stirring, whereafter excess methanol was removed by concentrating the mixture to a volume of about 100 ml. To the resulting sodium methoxide suspension was added a solution of 19.4 grams (0.1 mol) of dimethyl phthalate in 200 ml of dry benzene. The mixture was heated to boiling and a solution of 21 grams (0.1 mol) of diphenylacetone in 200 ml of dry benzene was added dropwise thereto. During addition approximately 200 ml of liquid, which consisted of benzene together with methanol formed during the course of the reaction, was distilled from the reaction mixture. After addition of the diphenylacetone, the mixture was heated under reflux for about 6 hours, cooled and stirred vigorously with 200 ml of 5% sodium hydroxide solution.

The light yellow solid which separated was collected by filtration; the filtrate was reserved for treatment as described below. Suspension in water of the solid, which weighed 12 grams, and acidification of the mixture with dilute hydrochloric acid produced a gum which soon crystallized. Recrystallization of this solid from ethanol gave 10.2 grams (30%) of 2-diphenylacetyl-1,3-indandione as a light yellow crystalline solid, which melted at 146°-147°C.

The filtrate mentioned above consisted of 3 layers. An oily layer which was present between the aqueous and benzene layers was separated, acidified and extracted with ether. The aqueous layer was likewise separated, acidified and extracted with ether. The extracts were combined, dried and evaporated to yield a heavy gum which was crystallized from ethanol to give an additional 2.5 grams of product which melted at 146°-147°C. The total yield of 2-diphenylacetyl-1,3-indandione was 12.7 grams (37%).

References

- Merck Index 3315
- Kleeman & Engel p. 326
- I.N. p. 346
- REM p. 1257
- Thomas, D.G.; U.S. Patent 2,672,483; March 16, 1954; assigned to The Upjohn Company

DIPHENHYDRAMINE HYDROCHLORIDE

Therapeutic Function: Antihistaminic

Chemical Name: 2-diphenylmethoxy-N,N-dimethylethanamine hydrochloride

Common Name: Benzhydramine hydrochloride

Structural Formula:

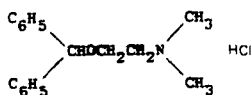

Chemical Abstracts Registry No.: 147-24-0; 58-73-1 (Base)

Trade Name	Manufacturer	Country	Year Introduced
Benadryl	Parke Davis	U.S.	1946
Benylin	Parke Davis	France	1964
Weldryl	Hauck	U.S.	1964
Sominex	Williams	U.S.	1982
Aleryl	Farmos	Finland	—
Alledryl	Teva	Israel	—
Allerdryl	I.C.N.	Canada	—
Allergan	Bouty	Italy	—
Allergin	Nyegaard	Norway	—
Allergina	De Angeli	Italy	—
Bax	McKesson	U.S.	—
Benadoi	Taisho	Japan	—
Benadozol	Hokuriku	Japan	—
Benapon	Dainippon	Japan	—
Benasin	Kanto	Japan	—
Benhydramil	Barlow Cote	Canada	—
Benocten	Medinova	Switz.	—
Benzantine	Teva	Israel	—
Benzehist	Pharmex	U.S.	—
Bidramine	Adams	Australia	—
Bromanil	Schein	U.S.	—
Broncho-Rivo	Rivopharm	Switz.	—
Carphenamine	Carroll	U.S.	—
Cathejell	Montavit	Austria	—
Dabylen	Schiefflin	U.S.	—
Dermistina	I.S.M.	Italy	—
Dermodrin	Montavit	Austria	—
Desentol	Leo	Sweden	—
Dibondrin	Montavit	Austria	—
Dihydral	SCS Pharmalab	S. Africa	—
Dimidril	Pliva	Yugoslavia	—
Dobacen	Hombberger	Switz.	—
Dolestan	Much	W. Germany	—
Drama Ject	Mayrand	U.S.	—
Draminol	Luar	U.S.	—
Drylistan	Sigmapharm	Austria	—
Expectoryn	Pharma-Plus	Switz.	—
Fenylhist	Mallard	U.S.	—
Histaxin	Chemofux	Austria	—
Hyrexin	Hyrex	U.S.	—
Insomnal	Welcker-Lyster	Canada	—

Trade Name	Manufacturer	Country	Year Introduced
Kendiphen	Key	U.S.	—
Lensen	Geneva	U.S.	—
Mandrax	I.S.H.	France	—
Medidryl	Medica	Finland	—
Nautamine	Delagrangé	France	—
Niramine	Rachelle	U.S.	—
Noctomin	Medichemie	Switz.	—
Phentamine	Restan	S. Africa	—
Pheramin	Kanoldt	W. Germany	—
Prodryl	Progress	U.S.	—
Restamin	Kowa	Japan	—
Reston	Kowa	Japan	—
Serundal D	Woelm	W. Germany	—
Somenox	Cooper	Switz.	—
Valdrene	Vale	U.S.	—
Vilbin	Felbena	Switz.	—
Ziradryl	Parke Davis	U.S.	—

Raw Materials

β -Dimethylaminoethanol	Sodium carbonate
Diphenylmethane	Bromine

Manufacturing Process

As described in U.S. Patent 2,421,714* (a) benzhydryl bromide is first prepared as follows: 840 parts by weight of diphenylmethane is heated to 130°C with stirring. In the presence of a 200 watt electric light 6 inches from the flask, 880 parts of bromine is added slowly. Liberation of HBr occurs and addition requires 1 hour and 45 minutes. The temperature is maintained at 130°C for an additional 30 minutes. A fine stream of air is blown in to remove HBr and Br₂ while the reaction mixture cools. Benzene (180 parts) is added and the solution used immediately in (b) below.

If pure benzhydryl bromide is desired the above reaction mixture is dissolved in ether, washed with water, sodium carbonate solution and finally with water. The ether is removed, benzene added and distilled off and the benzhydryl bromide distilled in vacuo. Yield 85%.

(b) 490 parts β -dimethylaminoethanol and 530 parts of anhydrous sodium carbonate are heated to 110°C with stirring. The addition of the benzene-benzhydryl bromide mixture is then begun. The temperature is raised to 120°-125°C. As reaction takes place carbon dioxide is evolved, the addition requires 1½ hours. The mixture is kept at 125°C for 5 hours additional time. After cooling, 3,000 parts of water is added and the mixture stirred until the inorganic salts are dissolved. The mixture is transferred to a large separatory funnel and 1,500 parts of ether added. The ether solution is washed several times with water and then the ether layer extracted with 1 to 4 hydrochloric acid. The acid solution is treated with 30 parts of Darco and 30 parts Filter-Cel and filtered.

The free base is liberated from the acid solution with 20% sodium hydroxide solution and taken up in ether. The ether layer is washed with water, saturated with NaCl and then shaken with solid potassium hydroxide. The ether is removed by distillation, 200 parts of benzene added and distilled off. The residue is distilled in vacuo and the fraction 150°-165°C/2 mm is collected and amounts to 433 parts. The hydrochloride salt is prepared by dissolving the free base in anhydrous ether and slowly adding an alcoholic solution of hydrogen chloride. The solid is recrystallized from absolute alcohol-ether mixture or isopropanol-ether mixture and has a MP of 161°-162°C.

References

Merck Index 3320
Kleeman & Engel p. 327

PDR pp. 695, 830, 872, 993, 1033, 1317, 1397, 1569, 1606, 1989, 1999

OCDS Vol. 1 p. 41 (1977)

I.N. p. 347

REM p. 1128

Martin, H., Hafliiger, F., Gatzl, K. and Grob, A.; U.S. Patent 2,397,799; April 2, 1946; assigned to J.R. Geigy AG, Switzerland

Rieveschl, G. Jr.; U.S. Patent 2,421,714; June 3, 1947; assigned to Parke, Davis & Co.

Rieveschl, G. Jr.; U.S. Patent 2,427,878; September 23, 1947; assigned to Parke, Davis & Company

DIPHENIDOL

Therapeutic Function: Antinauseant

Chemical Name: α,α -diphenyl-1-piperidinebutanol

Common Name: —

Structural Formula:

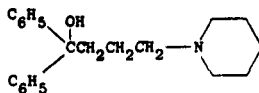

Chemical Abstracts Registry No.: 972-02-1

Trade Name	Manufacturer	Country	Year Introduced
Vontrol	SKF	U.S.	1967
Cephadol	Nippon Shinyaku	Japan	1974
Ansumin	S.S. Pharm	Japan	—
Antiul	Tokyo Hosei	Japan	—
Avomol	Landerlan	Spain	—
Celmidol	Tobishi	Japan	—
Cerachidol	Ono	Japan	—
Cerrosa	Toyo	Japan	—
Deanosarl	Isei	Japan	—
Degidole	Nihon Yakuhin	Japan	—
Difenidolin	Taiyo	Japan	—
Gipsydol	Nihon Yakuhin	Japan	—
Maniol	Morishita	Japan	—
Meranom	Hokuriku	Japan	—
Midnighton	Takata	Japan	—
Pineroro	Maruko	Japan	—
Promodor	Torii	Japan	—
Satanolon	Tatsumi	Japan	—
Sofalead	Nikken	Japan	—
Solnomin	Zensei	Japan	—
Tatimil	Mohan	Japan	—
Wansar	Hoei	Japan	—
Yesdol	Toho Iyaku	Japan	—
Yophadol	Horita	Japan	—

Raw Materials

Ethyl bromide
N-[1-Chloropropyl-(3)] piperidine

Magnesium
Benzophenone

Manufacturing Process

2.6 grams magnesium, activated by means of iodine, is introduced into 20 cc of absolute ether and is caused to react with 0.6 cc of ethyl bromide. While warming gently, 16.2 grams (0.1 mol) of N-[1-chloropropyl-(3)]-piperidine in 40 cc of absolute ether are added and, after adding a further 0.5 cc of ethyl bromide, 14.5 grams (0.08 mol) of benzophenone in 50 cc of anhydrous ether are added in portions. The magnesium is used up fairly quickly and, after 10 hours, only traces are left. In working up, both with hydrochloric acid and with ammonium chloride, the hydrochloride of diphenyl-3-piperidinopropyl carbinol is precipitated as a dense precipitate. It is purified by recrystallization from chloroform-ethyl acetate. MP 212°-214°C.

References

Merck Index 3323

Kleeman & Engel p. 300

PDR p. 1731

OCDS Vol. 1 p. 46 (1977)

DOT 3 (1) 32 (1967)

I.N. p. 323

REM p. 808

Miescher, K. and Marxer, A.; U.S. Patent 2,411,664; November 26, 1946; assigned to Ciba Pharmaceutical Products, Inc.

DIPHENOXYLATE HYDROCHLORIDE

Therapeutic Function: Antidiarrheal

Chemical Name: 1-(3-cyano-3,3-diphenylpropyl)-4-phenyl-4-piperidinecarboxylic acid ethyl ester hydrochloride

Common Name: —

Structural Formula:

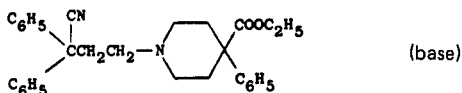

Chemical Abstracts Registry No.: 3810-80-8; 915-30-0 (Base)

Trade Name	Manufacturer	Country	Year Introduced
Lomotil	Searle	U.S.	1960
Diarsed	Clin-Comar-Byla	France	—
Protector	I.F.L.	Spain	—
Reasec	Janssen	W. Germany	—
Retardin	Benzon	Denmark	—
Retardin	Leo	Sweden	—
Sedistal	Abic	Israel	—

Raw Materials

4-Phenylisonepicotic acid ethyl ester
2,2-Diphenyl-4-bromobutyronitrile

Manufacturing Process

A mixture of 23 parts of the ethyl ester of 4-phenylisonipecotic acid and 15 parts of 2,2-diphenyl-4-bromobutyronitrile in 19 parts of xylene is heated for 24 hours at 100°-120°C and then cooled and filtered to remove the precipitate of the hydrobromide of the ethyl ester of 4-phenylisonipecotic acid. The filtrate is then extracted with dilute hydrochloric acid and the extract is rendered alkaline by addition of concentrated aqueous potassium hydroxide and extracted with ether. This ether extract is treated with gaseous hydrogen chloride. The resulting precipitate is collected on a filter. The hydrochloride of the ethyl ester of 2,2-diphenyl-4-(4'-carboxy-4'-phenyl-1'-piperidino) butyronitrile thus obtained melts at about 220.5-222°C. See *Meperidine hydrochloride* for synthesis of 4-phenyl-isonipecotic acid ethyl ester.

References

Merck Index 3325

Kleeman & Engel p. 328

PDR pp. 993, 1569, 1690, 1999

OCDS Vol. 1 p. 302 (1977) & 2 331 (1980)

I.N. p. 348

REM p. 813

Janssen, P.A.J.; U.S. Patent 2,898,340; August 4, 1959

Dryden, H.L. Jr. and Erickson, R.A.; U.S. Patent 4,086,234; April 25, 1978; assigned to G.D. Searle & Co.

DIPHENPYRAMIDE

Therapeutic Function: Antiinflammatory

Chemical Name: 2-(Diphenylacetyl-amino)-pyridine

Common Name: Difenpiramide

Structural Formula:

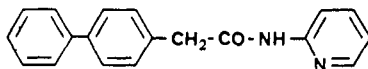

Chemical Abstracts Registry No.: 51484-40-3

Trade Name	Manufacturer	Country	Year Introduced
Difenax	Zambeletti	Italy	1977

Raw Materials

Diphenylacetic acid chloride

2-Aminopyridine

Manufacturing Process

23 g (0.1 mol) diphenylacetic acid chloride dissolved in 300 cc anhydrous ethyl ether are slowly added dropwise to a solution of 19 g (0.2 mol) 2-aminopyridine in 300 cc anhydrous ethyl ether. The reaction mixture is agitated and the temperature is kept at between 5°C and 10°C with an ice bath. After the addition has been completed, the agitation of the mixture is continued and the temperature is allowed to rise to 20°C to 25°C.

After leaving to stand for a few hours, the gummy precipitate solidifies and becomes filterable. After separating off the precipitate, the ether is evaporated under reduced pressure to a volume of about 100 cc.

The ether is left to stand at a low temperature below 10°C when the remaining portion of the product precipitates and is filtered off and added to the first precipitate. The product thus obtained is thoroughly washed, first in water and then in a solution of sodium bicarbonate, and then again in water. After drying in air, the product is crystallized from anhydrous ethanol or from acetone and water. The analytical data correspond to calculated values. Yield is 18 g; MP 122°C to 124°C.

References

Merck Index 3123

DFU 2 (12) 793 (1977)

I.N. p. 323

Molteni, L., Tenconi, F. and Tagliabue, R.; U.S. Patent 3,868,380; February 25, 1975

DIPHENYLPYRALINE HYDROCHLORIDE

Therapeutic Function: Antihistaminic

Chemical Name: 4-(diphenylmethoxy)-1-methylpiperidine hydrochloride

Common Name: —

Structural Formula:

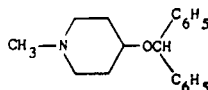

Chemical Abstracts Registry No.: 132-18-3; 147-20-6 (Base)

Trade Name	Manufacturer	Country	Year Introduced
Diafen	Riker	U.S.	1955
Hispril	Nopco	U.S.	1959
Lergoban	Riker	U.K.	1971
Allerzin	Virax	Australia	—
Anti-H10	S.M.B.	Belgium	—
Antinal	Arcana	Austria	—
Belfene	Bellon	France	—
Kolton Gelee	Promonta	W. Germany	—
Lysepoll	Lyssia	W. Germany	—
Pirazone	UCB-Smit	Italy	—

Raw Materials

1-Methyl-4-piperidinol
Benzhydryl bromide
Hydrogen chloride

Manufacturing Process

A mixture of 46 grams of 1-methyl-4-piperidinol (0.4 mol), 49.4 grams of benzhydryl bromide (0.2 mol) and 100 ml of xylene was refluxed for approximately 24 hours. The reaction mixture separated into two phases with the upper phase containing the desired

ether compound dissolved in xylene. The lower phase consisted of the hydrobromide salt of the excess 1-methyl-4-piperidinol. The upper phase was separated from the lower phase and the desired benzhydryl ether recovered in the crude state by distilling off the xylene under reduced pressure.

The crude benzhydryl ether was a clear reddish oil. It was dissolved in 75 ml of 20% hydrochloric acid and the aqueous acid solution then washed three times with 50 ml portions each of ethyl ether. The aqueous acid solution was then decolorized with activated carbon and thereafter slowly admixed with 75 ml of 28% aqueous ammonia. The benzhydryl ether separated as an oily material and was removed from the aqueous mixture by extraction with three 50 ml portions of ethyl ether.

On evaporation of the ethyl ether from the ethyl ether solution, the benzhydryl ether was recovered as a pale yellow oil. The benzhydryl ether was dissolved in 60 ml of isopropanol and the isopropanol solution acidified to a pH of 3 with dry hydrogen chloride-methanol solution. The acidic propanol solution was then diluted with ethyl ether until a faint turbidity was observed. In a short time, the crystalline hydrochloride salt of the benzhydryl ether separated from the propanol solution. The crystallized salt was recrystallized once from 75 ml of isopropanol with the aid of ethyl ether in order to further purify the material. A yield of the pure hydrochloride salt of 1-methylpiperidyl-4-benzhydryl ether of 24.5 grams was obtained. This was 39% of the theoretical yield. The pure material had a melting point of 206°C.

References

Merck Index 3347

Kleeman & Engel p. 328

PDR p. 1717

I.N. p. 349

REM p. 1128

Knox, L.H. and Kapp, R.; U.S. Patent 2,479,843; August 23, 1949; assigned to Nopco Chemical Company

DIPIVEFRIN

Therapeutic Function: Adrenergic (Ophthalmic)

Chemical Name: 2,2-Dimethylpropanoic acid 4-[1-hydroxy-2-(methylamino)ethyl]-1,2-phenylene ester

Common Name: Dipivalyl epinephrine

Structural Formula:

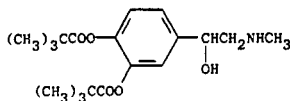

Chemical Abstracts Registry No.: 52365-63-6

Trade Name	Manufacturer	Country	Year Introduced
Propine	Allergan	W. Germany	1978
Propine	Allergan	U.S.	1980
D-Epifrin	Allergan	—	—
Diopine	Allergan	—	—
Glaucothil	Thilo	W. Germany	—
Vistapin	Pharm-Allergan	W. Germany	—

Raw Materials

α -Chloro-3',4'-dihydroxyacetophenone
 Methylamine
 Pivaloyl chloride
 Hydrogen

Manufacturing Process

First, 0.27 mol of α -chloro-3',4'-dihydroxyacetophenone are dissolved in 200 ml methanol with warming. Next, 100 ml of a 40% aqueous solution of methylamine is slowly added and the mixture stirred at 50°C to 55°C for 2 hours. The reaction mixture is then stirred an additional 24 hours at room temperature.

The crude product separates as a solid from the reaction medium and is recovered by filtration, and it is then washed thoroughly with ether and dissolved in 350 ml 1 N HCl. Then, approximately 250 ml of the aqueous solvent is removed with a rotary evaporator and the evaporation residue combined with 125 ml methanol and filtered through decolorizing charcoal. The product is precipitated as the HCl salt by the addition of 7 parts of acetone. The resulting crystalline material is removed by filtration dried at 40°C with vacuum, and has a melting point of about 242°C and is used without further purification.

Next, 25.3 g, 0.125 mol, of the above product are dissolved in 250 ml ethyl acetate and 0.125 mol perchloric acid as a 70% aqueous solution is slowly added thereto with continuous stirring. Then, an excess of pivaloyl chloride, 280 ml, is added and the mixture slowly warmed to reflux temperature. The reaction mixture is refluxed for about 5 hours and allowed to cool to room temperature with continuous stirring. The product is precipitated as the perchlorate salt by the addition of perchloric acid, HClO₄, in 500 ml ether. The product is isolated and purified by dissolving in 75 ml acetone and precipitating it with 150 to 200 ml of water.

To 20 g of the above compound dissolved in 300 ml 95% ethanol in a Parr reaction vessel is added 1.5 g Adams catalyst, platinum dioxide, and the mixture shaken under hydrogen at 50 psi for 1 hour at ambient temperature. The mixture is then filtered and the ethanol removed on a standard rotary evaporator. The resulting oil is dissolved in 200 ml ether and slowly added to 1,200 ml ether with continuous stirring. The product separates as crystals which are removed after 15 to 30 minutes by filtration. The compound melts at 146°C to 147°C and needs no further purification.

References

- Merck Index 3356
 Kleeman & Engel p. 329
 OCDS Vol. 3 p. 22 (1984)
 I.N. p. 350
 REM p. 891
 Hussain, A. and Truelove, J.E.; U.S. Patents 3,809,714; May 7, 1974; and 3,839,584; October 1, 1974; both assigned to Inter Rx Research Corp.
 Henschler, D., Wagner, J. and Hampel, H.; U.S. Patent 4,085,270; April 18, 1978; assigned to Chemisch-Pharmazeutische Fabrik Adolf Klinge & Co. (W. Germany)

DIPYRIDAMOLE

Therapeutic Function: Coronary vasodilator

Chemical Name: 2,2',2'',2'''-(4,8-dipiperidinopyrimido[5,4-d]pyrimidine-2,6-diyldinitrilo)-tetraethanol

Common Name: —

Structural Formula:

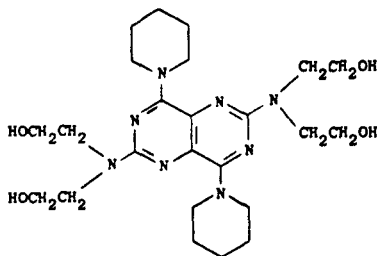

Chemical Abstracts Registry No.: 58-32-2

Trade Name	Manufacturer	Country	Year Introduced
Persantine	Boehr./Ingel.	U.S.	1961
Natyl	Nativelle	France	1961
Persantin	Boehr./Ingel.	U.K.	1961
Persantin	Thomae	W. Germany	1966
Agilease	Isei	Japan	—
Anginal	Yamanouchi	Japan	—
Atlantin	Dojin	Japan	—
Cardoxin	Rafa	Israel	—
Cleridium	Millot	France	—
Coribon	Radiumpharma	Italy	—
Coronamole	Nichiiko	Japan	—
Coronarine	Negma	France	—
Corosan	Saita	Italy	—
Coroxin	Malesci	Italy	—
Curantyl	Arzneimittelwerk Dresden	E. Germany	—
Dipyrida	Schurholz	W. Germany	—
Drisentin	Drifa	Turkey	—
Funciocardon	Krewel	W. Germany	—
Gulliostin	Taiyo	Japan	—
Isephanine	Kanto	Japan	—
Justpertin	Horita	Japan	—
Padicor	Padil	Italy	—
Penselin	Sawai	Japan	—
Peridamol	Lab. Franc. Therap.	France	—
Perkod	Generod	France	—
Permilitin	Zensei	Japan	—
Piroan	Towa	Japan	—
Prandiol	Botto	France	—
Protangix	Lefrancq	France	—
Royalcor	Morgan	Italy	—
Santhimon	Santen	Japan	—
Stenocor	Chemipharma	Italy	—
Stimolcardio	Phanthox & Burck.	Italy	—
Tinol	Teikoku	Japan	—
Trancocard	Benvegna	Italy	—
Trombostaz	Yurtoglo	Turkey	—
Viscor	Italsuisse	Italy	—

Raw Materials

Urea

Nitric acid

Acetoacetic ester

Hydrogen

Potassium cyanate
Phosphorus oxychloride

Diethanolamine
Piperidine

Manufacturing Process

Urea may be reacted with acetoacetic ester and that product nitrated to give 5-nitro-orotec acid That is hydrogenated, then reacted with urea and potassium cyanate to give tetrahydroxypyrimidopyrimidine. The tetrahydroxy compound is converted to the tetrachloro compound POCl₃. Reaction with diethanolamine and then with piperidine gives diprydamole.

References

- Merck Index 3366
- Kleeman & Engel p. 330
- PDR pp. 678, 830, 993, 1606, 1723, 1999
- OCDs Vol. 1 p. 428 (1977)
- I.N. p. 351
- REM p. 854
- Fischer, F.G., Roch, J and Kottler, A.; U.S. Patent 3,031,450; April 24, 1962; assigned to Dr. Karl Thomae GmbH, Germany

DISOPYRAMIDE PHOSPHATE

Therapeutic Function: Antiarrhythmia

Chemical Name: α-[2-[bis(1-Methylethyl)amino] ethyl] -α-phenyl-2-pyridineacetamide phosphate

Common Name: —

Structural Formula:

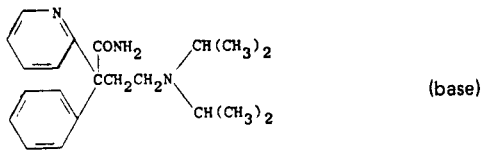

Chemical Abstracts Registry No.: 22059-60-5; 3737-09-5 (Base)

Trade Name	Manufacturer	Country	Year Introduced
Rythmodan	Cassenne	France	1969
Ritmodan	Maestretti	Italy	1970
Rhythmodan	Roussel	U.K.	1972
Norpace	Searle	U.K.	1976
Norpace	Searle	W. Germany	1977
Norpace	Searle	U.S.	1977
Rythmodul	Roussel	W. Germany	1977
Rythmodan	Hoechst-Roussel	Switz.	1978
Rythmodan	Roussel	Japan	1981
Dirytmim	Astra	Sweden	—
Disaloc	Medica	Finland	—
Rythmical	Unipharm	Israel	—
Rytmilen	Leiras	Finland	—

Raw Materials

Phenylacetonitrile	2-Bromopyridine
Diisopropylaminoethyl chloride	Sodium amide
Sulfuric acid	Sodium hydroxide
Phosphoric acid	

Manufacturing Process

To a solution of 35.3 parts of phenylacetonitrile and 47.6 parts of 2-bromopyridine in 175 parts of dry toluene is added 53.4 parts of sodamide slowly with stirring over a period of 45 minutes. The resultant mixture is stirred at 100°C for 2 hours before it is cooled and the excess sodamide is decomposed by the addition of water. The toluene layer is separated and washed with water to remove excess alkali. The toluene solution is extracted with 6 N hydrochloric acid and the acid extract is made alkaline and then extracted with toluene. The toluene solution is dried over sodium sulfate and the solvent is evaporated. Recrystallization of the residue from alcohol-hexane gives α -phenyl-2-pyridineacetonitrile melting at about 87°-88°C.

To a solution of 41 parts of α -phenyl-2-pyridineacetonitrile in 350 parts of dry toluene is added 9.2 parts of sodamide and the mixture is stirred and heated at 90°C for 30 minutes. Heating is stopped and a solution of 38.5 parts of 2-diisopropylaminoethyl chloride in 110 parts of dry toluene is added slowly over a period of 30 minutes. The mixture is stirred and refluxed for 6 hours before it is cooled and decomposed by the addition of water. The toluene layer is separated and washed with water and extracted with 6 N hydrochloric acid. The acid extract is made alkaline and extracted with toluene. The toluene solution is washed with water and dried and the solvent is evaporated. Distillation of the residue gives 4-diisopropylamino-2-phenyl-2-(2-pyridyl)-butyronitrile boiling at about 145°-160°C at 0.3 mm pressure.

A solution of 27.2 parts of 4-diisopropylamino-2-phenyl-2-(2-pyridyl)butyronitrile in 200 parts of concentrated sulfuric acid is heated on a steam bath for 4 hours and then poured onto ice. The resultant mixture is alkalized with 10 N sodium hydroxide, and the pH is adjusted to 6 by the addition of acetic acid. The solution is washed once with benzene before it is alkalized again with 10 N sodium hydroxide solution. The resultant mixture is extracted with benzene, and the solvent is evaporated from the benzene extract. The resultant residue is dissolved in ethanol and the alcohol solution is treated with charcoal and filtered. Evaporation of the solvent leaves a residue which is recrystallized from hexane to give 4-diisopropylamino-2-phenyl-2-(2-pyridyl)butyramide melting at about 94.5°-95°C. It may be converted to the phosphate with phosphoric acid.

References

- Merck Index 3378
 Kleeman & Engel p. 332
 PDR pp. 673, 830, 993, 1691
 OCDS Vol. 2 p. 81 (1980) & 3, 41 (1984)
 DOT 6 (6) 213 (1970)
 I.N. p. 352
 REM p. 858
 Cusic, J.W. and Sause, H.W.; U.S. Patent 3,225,054; December 21, 1965; assigned to G.D. Searle & Co.

DISTIGMINE BROMIDE

Therapeutic Function: Cholinesterase inhibitor

Chemical Name: 3,3'-[1,6-Hexanediylbis[(methylimino)carbonyl]oxy]bis-[1-methylpyridinium] dibromide

Common Name: Hexamarium bromide

Structural Formula:

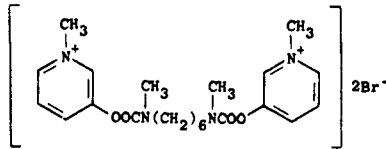

Chemical Abstracts Registry No.: 15876-67-2

Trade Name	Manufacturer	Country	Year Introduced
Ubretid	Hormonchemie	W. Germany	1966
Ubretid	Berk	U.K.	—
Ubretid	Lentia	W. Germany	—
Ubretid	Torii	Japan	—

Raw Materials

3-Oxypyridine
Sodium
Methanol
Hexamethylene-bis-(N-methyl carbamic acid chloride)
Methyl bromide

Manufacturing Process

2 parts of sodium are dissolved in 24 parts of methanol and to the solution of sodium methylate formed 8.25 parts of 3-oxypyridine and 90 parts of xylene (mixture of isomers) are added. Then the mixture is distilled in an atmosphere of nitrogen as protecting gas until the boiling point of xylene is reached and the methanol is completely removed. The remainder is brought together with a solution of 11.7 parts of hexamethylene-bis-(N-methyl carbamic acid chloride) in 45 parts of xylene and maintained 4 hours at a temperature of 80°C under vigorous stirring.

After having been cooled it is washed three times in water, three times in a 5% solution of caustic soda, and then another three times in water. The solution in xylene is dried over sodium sulfate and the xylene is completely distilled off in vacuo. Thus 11.0 parts of hexamethylene-bis-(N-methyl carbamic acid-3-pyridyl ester) are obtained.

7.3 parts of hexamethylene-bis-(N-methyl carbamic acid-3-pyridyl ester) are dissolved in 120 parts of acetone, then 22 parts of methyl bromide are added and the mixture is left to stand at room temperature until the reaction is finished, whereby crystals are precipitated. The reaction product after being drawn off and dried (9.9 parts) can be purified by dissolving in acetic acid and precipitating with methyl ethyl ketone. The hexamethylene-bis-(N-methyl carbamic acid-3-pyridyl ester bromomethylate) has a micro melting point between 147°C and 150°C.

References

Merck Index 3380
Kleeman & Engel p. 332
I.N. p. 353
Schmid, O.; U.S. Patent 2,789,981; April 23, 1957; assigned to Oesterreichische Stickstoffwerke A.G. (Austria)

DISULFIRAM

Therapeutic Function: Alcohol deterrent

Chemical Name: Tetraethylthioperoxydicarbonic diamide

Common Name: Tetraethyl thiuram disulfide

Structural Formula:

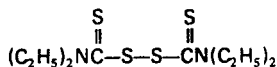

Chemical Abstracts Registry No.: 97-77-8

Trade Name	Manufacturer	Country	Year Introduced
Esperal	Millot Solac	France	1950
Antabuse	Ayerst	U.S.	1951
Abstenil	Sintesina	Argentina	—
Abstinyl	Pharmacia	Sweden	—
Antabus	Tosse	W. Germany	—
Antabuse	Ethnor	Australia	—
Antabuse	Crinos	Italy	—
Antabuse D	Tokyo Tanabe	Japan	—
Antietil	Italfarmaco	Italy	—
Antivitium	Reder	Spain	—
Aversan	A.F.I.	Norway	—
Nocbin	Tokyo Tanabe	Japan	—
Ro-Sulfiram	Robinson	U.S.	—
Tetidis	Krka	Yugoslavia	—

Raw Materials

Diethyl amine	Carbon bisulfide
Sodium hydroxide	Hydrogen peroxide

Manufacturing Process

Disulfiram may be made by the reaction of diethyl amine with carbon disulfide in the presence of sodium hydroxide. The $(C_2H_5)_2NCSSNa$ intermediate is oxidatively coupled using hydrogen peroxide to give disulfiram.

References

- Merck Index 3382
- Kleeman & Engel p. 333
- PDR pp. 611, 830, 1606
- OCDS Vol. 1 p. 223 (1977)
- DOT 10 (9) 324 (1974)
- I.N. p. 353
- REM p. 1070
- Adams, H.S. and Meuser, L.; U.S. Patent 1,782,111; November 18, 1930; assigned to The Naugatuck Chemical Company
- Bailey, G.C.; U.S. Patent 1,796,977; March 17, 1931; assigned to The Roessler & Hasslacher Chemical Company

DITAZOL

Therapeutic Function: Antiinflammatory

Chemical Name: 2,2'-[(4,5-diphenyl-2-oxazolyl)imino] diethanol

Common Name: Diethamphenazol

Structural Formula:

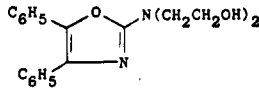

Chemical Abstracts Registry No.: 18471-20-0

Trade Name	Manufacturer	Country	Year Introduced
Ageroplas	Serona	Italy	1973

Raw Materials

2-Chloro-4,5-diphenyl oxazole
Diethanolamine

Manufacturing Process

A solution of 5.1 grams 2-chloro-4,5-diphenyl-oxazole, 6.3 grams diethanolamine and 50 ml absolute ethanol was refluxed for 4 hours. The solvent was stripped at 1 mm and the oily residue was added at 60°C to 100 ml 50% ethanol; by cooling the hydro-alcoholic solution, 4.5 grams of 2-bis(β-hydroxyethyl)amino-4,5-diphenyl-oxazole was obtained (yield, 69.5%). The product crystallized from ethyl ether + petroleum ether, with a MP of 96° to 98°C.

References

Merck Index 3386

DOT 10 (4) 135 (1974)

I.N. p. 354

Marchetti, E.; U.S. Patent 3,557,135; January 19, 1971; assigned to Istituto Farmacologico Serono SpA, Italy

DITHIAZANINE IODIDE

Therapeutic Function: Anthelmintic

Chemical Name: 3-Ethyl-2-[5-[3-ethyl-2-(3H)-benzothiazolynilidene]-1,3-pentadienyl]benzothiazolium iodide

Common Name: 3,3'-Diethylthiacarbocyanine iodide

Structural Formula:

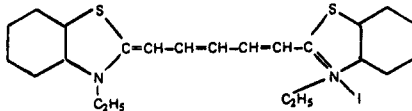

Chemical Abstracts Registry No.: 514-73-8

Trade Name	Manufacturer	Country	Year Introduced
Delvex	Lilly	U.S.	1958
Abminthic	Pfizer	U.S.	1959

Trade Name	Manufacturer	Country	Year Introduced
Dilombrin	Pfizer	—	—
D.I.M.	Mediphar	Congo	—
Elmizin	Bouty	Italy	—
Nectocyd	Pfizer	—	—
Ossiurene	A.M.S.A.	Italy	—
Partel	Lilly	—	—
Telmid	Lilly	—	—

Raw Materials

1-Methylbenzthiazole ethiodide
 β -Ethyl thioacrolein diethyl acetal

Manufacturing Process

3.05 g of 1-methylbenzthiazole ethiodide, 1.11 g of β -ethyl thioacrolein diethyl acetal and 15 cc of pyridine were mixed and boiled gently under reflux for 15 minutes. The reaction mixture was then poured into an aqueous solution of potassium iodide. The dye was precipitated and was filtered off, and washed with ethyl alcohol and ether. Recrystallization from methyl alcohol solution yielded the dye as green needles. Melting point 248°C with decomposition.

References

Merck Index 3388

OCDS Vol. 1 p. 327 (1977)

I.N. p. 354

Kendall, J.D. and Edwards, H.D.; U.S. Patent 2,412,815; December 17, 1946; assigned to Ilford, Ltd.

DIXYRAZINE

Therapeutic Function: Tranquilizer

Chemical Name: 2-[2-[4-[2-methyl-3-(10H-phenothiazin-10-yl)propyl]-1-piperazinyl]ethoxy]ethanol

Common Name: —

Structural Formula:

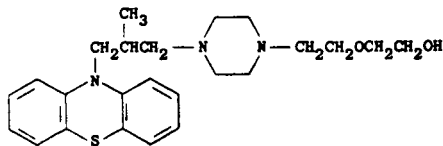

Chemical Abstracts Registry No.: 2470-73-7

Trade Name	Manufacturer	Country	Year Introduced
Esucos	UCB Chemie	W. Germany	1962
Esucos	UCB	Italy	1962
Esucos	UCB	France	1964
Esocalm	Assia	Israel	—
Roscal	Rosco	Denmark	—

Raw Materials

Phenothiazine
 Sodium amide
 1-Chloro-2-methyl-3-bromopropane
 1-[2-(2-Hydroxyethoxy)ethyl] piperazine

Manufacturing Process

To a suspension of sodamide in liquid ammonia and made from sodium in liquid ammonia, there is added fractionally and with stirring phenothiazine. After an hour there is added thereto, while maintaining the stirring, 1-chloro-2-methyl-3-bromopropane, then 700 cc of toluene. The ammonia is then driven off and heating under reflux is carried out for one hour.

After cooling, water is added and the solution then decanted. The toluene phase is then evaporated in vacuo to constant weight. The residue is constituted of 10-(2-methyl-3-chloro-propyl)-phenothiazine containing a certain quantity of phenothiazine which has not reacted. As this product is not readily soluble in petroleum ether, it is possible to eliminate it by extraction by means of this solvent.

By operating in this manner 10-(2-methyl-3-chloro-propyl)phenothiazine is obtained. A mixture of 10-(2-methyl-3-chloro-propyl)phenothiazine and 1-[2-(2-hydroxyethoxy)ethyl] piperazine is then heated at 110°-120°C for 20 hours. After cooling, the reaction product is dissolved in 200 cc of benzene and the solution washed several times with water.

The benzene phase is then extracted by dilute hydrochloric acid. The acid aqueous phase is decanted, it is made distinctly alkaline and then extracted with benzene. The benzene extract is dried and evaporated in vacuo. The condensation product could not be crystallized. It may be converted into the dihydrochloride which, after recrystallization from isopropanol, melts at 192°C.

References

Merck Index 3403
 Kleeman & Engel p. 334
 OCDS Vol. 1 p. 384 (1977)
 I.N. p. 356
 Morren, H.; British Patent 861,420; February 22, 1961

DOBESILATE CALCIUM

Therapeutic Function: Vasodilator

Chemical Name: 2,5-dihydroxybenzenesulfonic acid calcium salt

Common Name: Hydroquinone calcium sulfonate

Structural Formula:

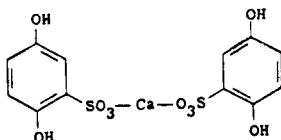

Chemical Abstracts Registry No.: 20123-80-2

Trade Name	Manufacturer	Country	Year Introduced
Doxium	Carrion	France	1971
Dexium	Delalande	W. Germany	1971
Doxium	Delalande	Italy	1973
Dobesiphar	Farmila	Italy	—
Doxi-OM	O.M.	Switz.	—
Doxytrex	O.M.	Switz.	—
Romiven	Roche	—	—

Raw Materials

1,4-Benzoquinone
Calcium bisulfite

Manufacturing Process

To an ether solution of 108 grams 1,4-benzoquinone, maintained below 0°C, one adds an also very cold solution of 102 grams of pure calcium bisulfite as a 50% solution in distilled water. The addition is made carefully so as to maintain a very low temperature (0° to 4°C) in the vessel, and under stirring so as to mix the water and ether phase.

At the end of the addition, an almost colorless ether layer swims on the surface of the strongly colored water layer. After removal of the ether layer, the water layer is concentrated to dryness under vacuum and a stream of an inert gas. An earthy precipitate is formed, which after recrystallization yields 100 grams of hydroquinone calcium sulfonate, which decomposes without melting above 250°C.

The product consists of very small crystals having a powdery aspect and a pink color which deepens on contact with air. This product is very soluble in water and alcohol, and insoluble in ether.

References

Merck Index 3406

Kleeman & Engel p. 135

I.N. p. 356

Esteve-Subirana, A.; U.S. Patent 3,509,207; April 28, 1970; assigned to Laboratories Om Societe Anonyme, Switzerland

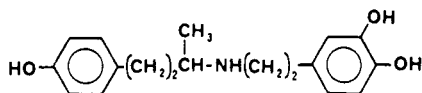
DOBUTAMINE**Therapeutic Function:** Cardiotoxic**Chemical Name:** 3,4-Dihydroxy-N-[3-(4-hydroxyphenyl)-1-methylpropyl]-β-phenethylamine**Common Name:** —**Structural Formula:****Chemical Abstracts Registry No.:** 34368-04-2; 52663-81-4 (Hydrochloride)

Trade Name	Manufacturer	Country	Year Introduced
Dobutrex	Lilly	U.K.	1977
Dobutrex	Lilly	U.S.	1978
Dobutrex	Lilly	W. Germany	1978
Dobutrex	Shionogi	Japan	1982
Dobutrex	Lilly	Italy	1983
Dobuject	Leiras	Finland	—
Inotrex	Lilly	—	—

Raw Materials

4-(p-Methoxyphenyl)-3-buten-2-one	Hydrogen
Homoveratrylamine	Hydrogen bromide
Acetic acid	Hydrogen chloride

Manufacturing Process

In a stainless steel hydrogenation bottle were placed 17.6 g (0.1 mol) of 4-(p-methoxyphenyl)-3-buten-2-one, 80 ml of ethyl acetate, and 1 g of Raney nickel catalyst. The hydrogenation bottle was attached to a Paar low-pressure hydrogenation apparatus and the solution was hydrogenated under an initial hydrogen pressure of 50 psi. The hydrogenation was carried out at room temperature and after about 12 hours one equivalent of hydrogen had been absorbed. The catalyst was filtered from the reduction mixture and 18.1 g (0.1 mol) of homoveratrylamine were added to the reduction mixture.

To the reduction mixture was then added 3.5 g of 5% palladium on carbon catalyst and the mixture was hydrogenated under a hydrogen pressure of 50 psi at room temperature for 12 hours. The catalyst was removed by filtration and the filtrate was evaporated to a small volume. The concentrated filtrate was dissolved in diethyl ether and the ethereal solution was saturated with anhydrous hydrogen chloride. The reduction product, 3,4-dimethoxy-N-[3-(4-methoxyphenyl)-1-methyl-n-propyl] phenethylamine was precipitated as the hydrochloride salt. The salt was filtered and recrystallized from ethanol melting at about 147°C to 149°C.

To a solution of 101.2 g of the trimethoxy secondary amine, obtained as described above, in 3,060 ml of glacial acetic acid was added 1,225 ml of 48% hydrobromic acid and the reaction mixture heated at the reflux temperature for 4 hours. The reaction mixture was then cooled and evaporated to a small volume. The crystalline residue which formed was filtered and dried in vacuo. The dried crystalline residue was then triturated with ethyl acetate and re-dried to yield 97.3 g of crude crystalline material. The crude product was dissolved in 970 ml of warm water to obtain a yellow solution. To the solution was added successively by dropwise addition 75 ml of 1 N and 75 ml of 2 N hydrochloric acid. Following the dropwise addition, the solution was allowed to stir with ice cooling. The impurities which precipitated were removed by filtration through a gauze filter. Concentrated hydrochloric acid was then added dropwise. When approximately 50 to 75 ml of the concentrated acid had been added with ice bath cooling a pale yellow oil precipitated along with a white solid precipitate. With continued stirring of the cold solution, the pale yellow oil crystallized.

The cold solution was then allowed to stand overnight and all crystalline material filtered through a sintered glass filter. The filtrate was treated with an additional 300 ml of concentrated hydrochloric acid to yield a heavy white precipitate. The precipitate was filtered, dried and combined with the initial precipitate obtained as described above. The combined precipitated product, 3,4-dihydroxy-N-[3-(4-hydroxyphenyl)-1-methyl-n-propyl]- β -phenethylamine hydrochloride, had a melting point of about 184°C to 186°C after recrystallization from boiling 4 N hydrochloric acid.

References

- Merck Index 3407
- DFU 2 (9) 579 (1977)
- Kleeman & Engel p. 334

PDR p. 1047

OCDS Vol. 2 p. 53 (1980)

DOT 14 (10) 433 (1978)

I.N. p. 357

REM p. 882

Tuttle, R.R. and Mills, J.; U.S. Patent 3,987,200; October 19, 1976; assigned to Eli Lilly & Co.

DOCUSATE CALCIUM

Therapeutic Function: Stool softener

Chemical Name: Sulfobutanedioic acid 1,4-bis(2-ethylhexyl)ester calcium salt

Common Name: Dioctyl calcium sulfosuccinate

Structural Formula:

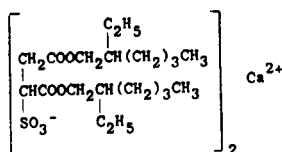

Chemical Abstracts Registry No.: 128-49-4

Trade Name	Manufacturer	Country	Year Introduced
Surfak	Hoechst	U.S.	1959
Regulol	Schering	U.S.	1981
Doxidan	Hoechst	—	—
Dioctocal	Schein	U.S.	—

Raw Materials

Dioctyl sodium sulfosuccinate
Calcium chloride

Manufacturing Process

88 g of dioctyl sodium sulfosuccinate is first dissolved in 100 cc of isopropanol and 25 g of calcium chloride is dissolved in 50 cc of methanol. The solutions are then mixed and stirred for about 3 hours and then cooled with ice. The sodium chloride which precipitates in the cool mixture is removed by filtration and most of the alcohol is evaporated from the resulting filtrate with heat. The liquid remaining is poured into 88 cc of water, and the resulting precipitate washed with water until free of chloride ion. The washed calcium salt is then dried.

References

Merck Index 3408

PDR pp. 938, 945, 1606

I.N. p. 357

REM p. 805

Klotz, L.J.; U.S. Patent 3,035,973; May 22, 1962; assigned to Lloyd Brothers, Inc.

DOMIPHEN BROMIDE

Therapeutic Function: Topical antiinfective

Chemical Name: N,N-Dimethyl-N-(2-phenoxyethyl)-1-dodecanaminium bromide

Common Name: Phenododecinium bromide

Structural Formula:

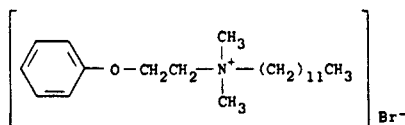

Chemical Abstracts Registry No.: 538-71-6

Trade Name	Manufacturer	Country	Year Introduced
Bradosol	Ciba	U.S.	1958
Bradex-Vioform	Ciba	W. Germany	—
Brado	Ciba-Geigy-Takeda	Japan	—
Bradoral	Ciba	Italy	—
Neo-Bradoral	Ciba	Switz.	—
Oradol	Ciba-Geigy-Takeda	Japan	—

Raw Materials

β -Phenoxyethyl dimethylamine
Dodecyl bromide

Manufacturing Process

7 parts of β -phenoxyethyl-dimethylamine are heated for 2 hours on the boiling water-bath with 11 parts of dodecyl bromide. A good yield of β -phenoxy-ethyl-dimethyl-dodecyl-ammonium bromide is obtained which, after recrystallization from acetone, melts at 112°C. It is a white crystalline powder which dissolves easily in water to give a neutral reaction.

References

Merck Index 3424

Kleeman & Engel p. 335

I.N. p., 359

Hartmann, M. and Bosshard, W.; U.S. Patent 2,581,336; January 8, 1952; assigned to Ciba Pharmaceutical Products, Inc.

DOMPERIDONE

Therapeutic Function: Antiemetic

Chemical Name: 5-Chloro-1-[1-[3-(2,3-dihydro-2-oxo-1H-benzimidazol-1-yl)-propyl] 4-piperidiny] -1,3-dihydro-2H-benzimidazol-2-one

Common Name: —

Structural Formula:

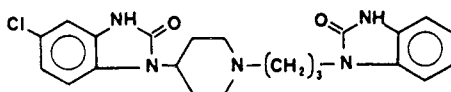

Chemical Abstracts Registry No.: 57808-66-9

Trade Name	Manufacturer	Country	Year Introduced
Motilium	Cilag	Switz.	1979
Motilium	Janssen	W. Germany	1979
Motilium	Janssen	Italy	1981
Motilium	Janssen	U.K.	1982
Nauselin	Kyowa Hakko	Japan	1982
Motilium	Janssen-Le Brun	France	1983
Euciton	Roux-Ocefa	Argentina	—
Moperidona	Sidus	Argentina	—

Raw Materials

- 1-(3-Chloropropyl)-1,3-dihydro-2H-benzimidazol-2-one
5-Chloro-1,3-dihydro-1-(4-piperidiny)-2H-benzimidazol-2-one

Manufacturing Process

A mixture of 2.3 parts of 1-(3-chloropropyl)-1,3-dihydro-2H-benzimidazol-2-one, 2.5 parts of 5-chloro-1,3-dihydro-1-(4-piperidiny)-2H-benzimidazol-2-one, 3.2 parts of sodium carbonate, 0.1 part of potassium iodide and 80 parts of 4-methyl-2-pentanone is stirred and refluxed for 24 hours. The reaction mixture is cooled to room temperature and water is added. The undissolved product is filtered off and purified by column chromatography over silica gel using a mixture of trichloromethane and 10% methanol as eluent. The pure fractions are collected and the eluent is evaporated. The residue is crystallized from 4-methyl-2-pentanone. The product is filtered off and recrystallized from a mixture of N,N-dimethylformamide and water, yielding 1.3 parts (30%) of 5-chloro-1-[1-[3-(1,3-dihydro-2-oxo-2H-benzimidazol-1-yl)propyl]-4-piperidiny]-1,3-dihydro-2H-benzimidazol-2-one; MP 242.5°C.

References

- Merck Index 3425
DFU 2 (10) 661 (1977)
Kleeman & Engel p. 335
OCDS Vol. 3 p. 174 (1984)
DOT 17 (1) 19 (1981)
I.N. p. 360
Vanderberk, J., Kennis, L.E.J., Van der Aa, M.J.M.C. and Van Heertum, A.H.M.T.; U.S. Patents 4,066,772; January 3, 1978; 4,110,333; August 29, 1978; 4,126,687; November 21, 1978; 4,126,688; November 21, 1978; 4,160,836; July 10, 1979 and 4,175,129; November 20, 1979; all assigned to Janssen Pharmaceutica NV (Belgium)

DOXAPRAM HYDROCHLORIDE

Therapeutic Function: Respiratory stimulant

Chemical Name: 1-ethyl-4-(2-morpholinoethyl)-3,3-diphenyl-2-pyrrolidinone hydrochloride monohydrate

Common Name: —

Structural Formula:

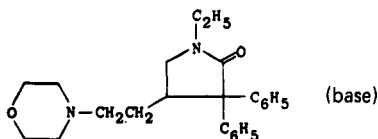

Chemical Abstracts Registry No.: 7081-53-0; 309-29-5 (Base)

Trade Name	Manufacturer	Country	Year Introduced
Dopram	Robins	U.S.	1965
Doxapril	Farmalabor	Italy	1967
Dopram	Martinet	France	1969
Dopram	Robins	U.K.	1971
Dopram	Kissei	Japan	1976
Dopram	Brenner	W. Germany	1977
Stimulexin	Robins	U.S.	—

Raw Materials

Diphenylacetonitrile	Sodium amide
1-Ethyl-3-chloropyrrolidine	Sulfuric acid
Morpholine	Hydrogen chloride

Manufacturing Process

(A) *Preparation of α -(1-Ethyl-3-Pyrrolidyl)- α,α -Diphenylacetonitrile:* A suspension of the sodium salt of diphenylacetonitrile was formed by the dropwise addition at 50°C of 193 grams (1.0 mol) of diphenylacetonitrile to a stirred suspension of 43 grams (1.1 mols) of sodium amide in 1 liter of dry toluene. After addition was complete, the mixture was refluxed for 4 hours and then, to the refluxing mixture, 1.0 mol of 1-ethyl-3-chloropyrrolidine was added at a rapid dropwise rate with continuous stirring. After addition was complete, stirring and refluxing were continued for 3 hours. The mixture was then cooled and extracted with one normal hydrochloric acid. The aqueous layer together with an oil layer were separated, made basic with dilute sodium hydroxide, and extracted with ether. The ethereal solution was dried over sodium sulfate and concentrated and the residue was distilled in vacuo. The material crystallized from a 4:1 ethanol-water mixture.

(B) *Preparation of 4-(β -Chloroethyl)-3,3-Diphenyl-1-Ethyl-2-Pyrrolidinone:* A solution of α,α -diphenyl- α -(1-ethyl-3-pyrrolidyl)-acetonitrile in 70% sulfuric acid was heated at 130°-140°C for 48 hours, poured onto ice, made basic with sodium hydroxide, and extracted with chloroform. The chloroform solution was acidified with hydrogen chloride gas, dried over sodium sulfate and concentrated. The residue was refluxed in 500 ml of thionyl chloride for 3 hours; the resulting solution was concentrated in vacuo; and the residue was crystallized from isopropyl ether.

(C) *Preparation of Doxapram Hydrochloride [3,3-Diphenyl-1-Ethyl-4-(2-Morpholino-Ethyl)-2-Pyrrolidinone Hydrochloride Monohydrate]:* A solution of 25 grams (0.076 mol) of 4-(2-chloroethyl)-3,3-diphenyl-1-ethyl-2-pyrrolidinone and 13.3 grams (0.153 mol) of morpholine in 500 ml of absolute ethanol was heated at 95°-120°C for 21 hours in a closed system and concentrated in vacuo. The residue was dissolved in 300 ml of two normal hydrochloric acid and extracted with 150 ml of ethyl acetate. A solid crystallized (13 g) during the extraction and was removed by filtration. MP 217°-219°C. The acid extracts were made basic with sodium hydroxide and extracted with ether, and the ether solution was concentrated in vacuo and the residue was suspended in six normal hydrochloric acid. Additional crystalline product formed and was recrystallized from two normal hydrochloric acid. Yield, 10 grams; MP 217°-219°C. Total yield, 23 grams (70%).

References

- Merck Index 3433
- Kleeman & Engel p. 337
- PDR p. 1456
- OCDS Vol. 2 p. 236 (1980)
- DOT 2 (2) 55 (1966)
- I.N. p. 362
- REM p. 867

Lunsford, C.D. and Cale, A.D. Jr.; U.S. Patent 3,192,230; June 29, 1965; assigned to A.H. Robins Company, Inc.

DOXEPIN HYDROCHLORIDE

Therapeutic Function: Tranquilizer

Chemical Name: N,N-dimethyl-3-dibenz[b,e]oxepin-11-(6H)-ylidene-1-propanamine hydrochloride

Common Name: —

Structural Formula:

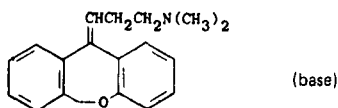

Chemical Abstracts Registry No.: 1229-29-4; 1668-19-5 (Base)

Trade Name	Manufacturer	Country	Year Introduced
Sinequan	Pfizer	U.S.	1969
Sinequan	Pfizer	U.K.	1969
Aponal	Boehr./Mann.	W. Germany	1970
Sinequan	Pfizer	W. Germany	1970
Sinequan	Pfizer	Italy	1971
Sinequan	Pfizer	France	1971
Adapin	Pennwalt	U.S.	1973
Doksapan	Eczacıbası	Turkey	—
Dolat	Yurtoglu	Turkey	—
Doxal	Orion	Finland	—
Doxedyn	Medica	Finland	—
Gilex	Ikapharm	Israel	—
Novoxapin	Ester	Spain	—
Quitaxon	Phartec	France	—
Toruan	Boehr./Mann.	—	—

Raw Materials

1,3-Dibromopropane	Triphenyl phosphine
Dimethylamine	Hydrogen bromide
6,11-Dihydrodibenz-(b,e)oxepin-11-one	Butyl lithium

Manufacturing Process

(A) Preparation of 3-Bromopropyltriphenylphosphonium Bromide: Triphenylphosphine, 1.0 kg, and 770 grams of 1,3-dibromopropane are dissolved in 2.0 liters of xylene and the solution is stirred under a nitrogen atmosphere at 130°C. After 20 hours the mixture is cooled, and the crystalline product, which precipitates, is collected and washed with 20 liters of benzene. After drying in vacuo the product weighs 1,578 grams, MP 229°-230°C; titration for bromide ion: Found, 17.1%; calculated, 17.2%.

(B) Preparation of 3-Dimethylaminopropyltriphenylphosphonium Bromide Hydrobromide: A solution of 595 grams of anhydrous dimethylamine and 1,358 grams of 3-bromopropyl-

triphenylphosphonium bromide in 4 liters of ethanol is warmed to 70°C until solution is complete and the solution then is allowed to stand at room temperature for 20 hours. Volatile components are removed by distillation in a vacuum and the residue is suspended in 2.0 liters of ethanol and is redistilled to remove excess amine. The residue is dissolved in 3.0 liters of warm ethanol and gaseous hydrogen bromide is passed into the solution until the mixture is acidic. After filtration the solution is concentrated to a volume of 3.0 liters, is cooled, whereupon the product precipitates, and the precipitate is collected; it weighs 1,265 grams, MP 274°-281°C. Recrystallization from ethanol raises the MP to 280.5°-282.5°C. Bromide ion titration: Found, 31.2%; calculated 31.3%.

(C) Preparation of Doxepin: 1,530 grams of the product from step (B) is suspended in 4.5 liters dry tetrahydrofuran and 6.0 mols of butyl lithium in heptane is added during 1 hour. After an additional 30 minutes, 483 grams of 6,11-dihydrodibenz-(b,e)oxepin-11-one, prepared as described in Belgian Patent 641,498, is added to the deep red solution and the reaction was maintained at reflux for 10 hours. Water, 500 ml, is added at room temperature and the solvent is removed in vacuo. The crude residue is treated with 10% hydrochloric acid until acidic (pH 2) and then 1.5 liters benzene is added. After stirring, the mixture separates into 3 phases (an insoluble hydrochloride salt product phase, an aqueous phase and an organic phase).

The benzene layer is removed by decantation and the remaining mixture is rendered basic with 10% sodium hydroxide solution and is extracted with three 1,500 ml portions of benzene. The benzene extracts are washed, then dried with anhydrous sodium sulfate and concentrated in a vacuum leaving a residue of 1,530 grams, gas and thin layer chromatography analysis show this to be a cis/trans mixture (approx. 4:1) of 11-dimethylamino-propylidene-6,11-dihydrodibenz-(b,e)oxepin (90% yield). This mixture has substantially more activity pharmacologically than the cis/trans mixture obtained by the Grignard route disclosed in the Belgian Patent 641,498. This base is then converted to the hydrochloride with HCl.

References

- Merck Index 3434
 Kleeman & Engel p. 338
 PDR pp. 1397, 1530
 OCDS Vol. 1 p. 404 (1977)
 DOT 6 (2) 53 (1970)
 I.N. p. 362
 REM p. 1094
 Chas. Pfizer & Co., Inc.; British Patent 1,085,406; October 4, 1967
 Bloom, B.M. and Tretter, J.R.; U.S. Patent 3,420,851; January 7, 1969; assigned to Chas. Pfizer & Co., Inc.
 Stach, K.; U.S. Patent 3,438,981; April 15, 1969; assigned to C.F. Boehringer & Soehne GmbH (Germany)

DOXORUBICIN

Therapeutic Function: Cancer chemotherapy

Chemical Name: (8S-cis)-10-[(3-amino-2,3,6-trideoxy- α -L-lyxo-hexopyranosyl)oxy]-7,8,9,10-tetrahydro-6,8,11-trihydroxy-8-(hydroxyacetyl)-1-methoxy-5,12-naphthacenedione

Common Name: 14-Hydroxydaunomycin

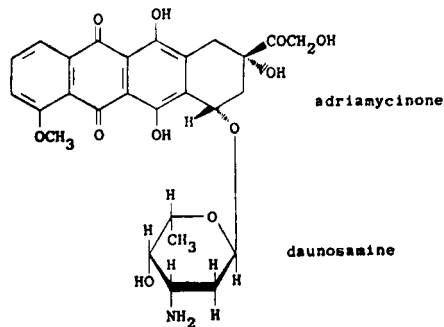
Structural Formula:

Chemical Abstracts Registry No.: 23214-92-8; 25316-40-9 (Hydrochloride)

Trade Name	Manufacturer	Country	Year Introduced
Adriblastina	Farmitalia	Italy	1971
Adriamycin	Farmitalia	U.K.	1971
Adriblastina	Farmitalia	W. Germany	1972
Adriablastine	Roger Bellon	France	1974
Adriacin	Kyowa Hakko	Japan	1974
Adriamycin	Adria	U.S.	1974

Raw Materials

Glucose
Bacterium *Streptomyces peucetius* var. *caesius*

Manufacturing Process

Two 300 ml Erlenmeyer flasks, each containing 60 ml of the following culture medium for the vegetative phase, were prepared: peptone 0.6%; dry yeast 0.3%; hydrated calcium carbonate 0.2%; magnesium sulfate 0.01%; the pH after sterilization was 7.2. Sterilization has been effected by heating in autoclave to 120°C for 20 minutes. Each flask was inoculated with a quantity of mycelium of the mutant F.1.106 (the new strain thus obtained has been given the code F.1.106 of the Farmitalia microbiological collection and has been called *Streptomyces peucetius* var. *caesius*) corresponding to 1/5 of a suspension in sterile water of the mycelium of a 10 day old culture grown in a big test tube on the following medium: saccharose 2%; dry yeast 0.1%; bipotassium phosphate 0.2%; sodium nitrate 0.2%; magnesium sulfate 0.2%; agar 2%; tap water up to 100%. The flasks were then incubated at 28°C for 48 hours on a rotary shaker with a stroke of 30 mm at 220 rpm.

2 ml of a vegetative medium thus grown were used to inoculate 300 ml Erlenmeyer flasks with 60 ml of the following medium for the productive phase: glucose 6%; dry yeast 2.5%; sodium chloride 0.2%; bipotassium phosphate 0.1%; calcium carbonate 0.2%; magnesium sulfate 0.01%; ferrous sulfate 0.001%; zinc sulfate 0.001%; copper sulfate 0.001%; tap water to 100%. The glucose was previously sterilized separately at 110°C for 20 minutes. The resulting pH was 7. This was sterilized at 120°C for 20 minutes and incubated at 28°C under the same conditions by stirring, as for the vegetative media.

The maximum concentration of the antibiotic was reached on the 6th day of fermentation. The quantity of adriamycin produced at this time corresponds to a concentration of 15 µg/ml.

References

Merck Index 3435
Kleeman & Engel p. 338

PDR p. 557

DOT 8 (4) 132 (1972) & 16 (5) 170 (1980)

I.N. p. 362

REM p. 1149

Arcamone, F., Cassinelli, G., di Marco, A. and Gaetani, M.; U.S. Patent 3,590,028; June 29, 1971; assigned to Societa Farmaceutici Italia, Italy

Smith, T.H., Fujiwara, A.N., Henry, D.W. and Lee, W.W.; U.S. Patent 4,012,448; March 15, 1977; assigned to Stanford Research Institute

Arcamone, F., di Marco, A. and Penco, S.; U.S. Patents 4,058,519; November 15, 1977; and 4,098,798; July 4, 1978; both assigned to Societa Farmaceutici Italia S.p.A. (Italy)

DOXYCYCLINE

Therapeutic Function: Antibiotic

Chemical Name: 4 α S-(dimethylamino)-1,4,4 α ,5,5 α ,6,11,12 α -octahydro-3,5 α ,10,12,12 α -pentahydroxy-6 α -methyl-1,11-dioxo-2-naphthacene-carboxamide

Common Name: 6-deoxy-5-oxytetracycline

Structural Formula:

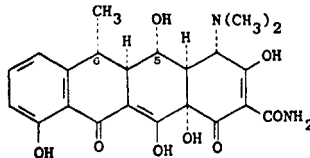

Chemical Abstracts Registry No.: 564-25-0

Trade Name	Manufacturer	Country	Year Introduced
Cyclidox	Protea	Australia	—
Doxitard	Mack	W. Germany	—
Doxy	Wolff	W. Germany	—
Doxy 200	Engelhard	W. Germany	—
Doxylin	A.L.	Norway	—
Doxy-Puren	Klinge	W. Germany	—
Doxyremed	Remed Econerica	W. Germany	—
Dumoxin	Dumex	Denmark	—
Dura Doxal	Durachemie	W. Germany	—
Geobiotico	Asia	Spain	—
Hiramycin	Pliva	Yugoslavia	—
Liviatin	Juste	Spain	—
Medomycin	Medica	Finland	—
Mespatin	Merckle	W. Germany	—
Novelciclina	Lifasa	Spain	—
Tenutan	Chinoïn	Hungary	—

Raw Materials

Methacycline
Hydrogen

Manufacturing Process

Hydrogen was introduced into a standard hydrogenation vessel containing 10 grams 6-deoxy-6-demethyl-6-methylene-5-oxytetracycline hydrochloride (methacycline), 150 ml methanol and 5 grams 5% rhodium on carbon. The pressure was maintained at 50 psi while agitating at room temperature for 24 hours. The catalyst was then filtered off, the cake washed with methanol and the combined filtrates were evaporated to dryness. The dry solids were slurried in ether, filtered and the cake dried. The resulting solids exhibited a bioactivity of 1,345 units per mg versus *K. pneumoniae*.

Water (35 ml) was employed to dissolve 8.5 grams of the above product and the pH was adjusted to 6.0 with triethylamine, sufficient dimethyl formamide being added to maintain the solids in solution. Cellulose powder (2 kg) was slurried in water-saturated ethyl acetate and packed into a tower of about 3½ inches diameter, to a height of 3 ft. The product solution was then chromatographed over this column, developing with about 12 liters water-saturated ethyl acetate. The first product fraction to come from the tower yielded 1.85 grams 6-epi-6-deoxy-5-oxytetracycline. The next fraction contained 2.0 grams of 6-deoxy-6-demethyl-6-methylene-5-oxytetracycline. The third fraction yielded 0.8 grams 6-deoxy-5-oxytetracycline.

References

Merck Index 3436

Kleeman & Engel p. 339

PDR p. 1424

DOT 3 (3) 114 (1967) & 4 (3) 102 (1968)

I.N. p. 363

REM p. 1205

Blackwood, R.K., Rennhard, H.H., Beereboom, J.J. and Stephens, C.R. Jr.; U.S. Patent 3,200,149; August 10, 1965; assigned to Chas. Pfizer & Co., Inc.

DROMOSTANOLONE PROPIONATE

Therapeutic Function: Cancer chemotherapy

Chemical Name: 2 α -methyl-17 β -(1-oxopropoxy)-5 α -androstan-3-one

Common Name: 2-methylidihydrotestosterone propionate

Structural Formula:

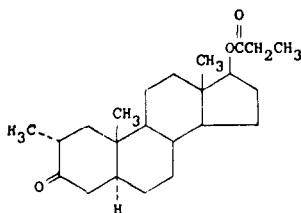

Chemical Abstracts Registry No.: 521-12-0; 58-19-5 (Base)

Trade Name	Manufacturer	Country	Year Introduced
Drolban	Lilly	U.S.	1961
Masterone	Recordati	Italy	1962
Masterid	Gruenthal	W. Germany	1969

Trade Name	Manufacturer	Country	Year Introduced
Permastril	Cassenne	France	1969
Masteril	Syntex	U.K.	—
Mastisol	Shionogi	Japan	—
Metormon	I.F.L.	Spain	—

Raw Materials

Dihydrotestosterone	Ethyl formate
Sodium hydride	Propionic anhydride

Manufacturing Process

A suspension of 10 grams of dihydrotestosterone in 500 cc of anhydrous benzene free of thiophene was mixed with 10cc of ethyl formate and 3 grams of sodium hydride and the mixture was stirred for 5 hours under an atmosphere of nitrogen and at a temperature of approximately 25°C. The resulting suspension was filtered, the resulting mixture of the sodium salt of the hydroxymethylene compound and the excess of sodium hydride was washed with benzene and dried. This mixture was slowly added to a vigorously stirred solution of 20 cc of concentrated hydrochloric acid in 500 cc of water, and the stirring was continued for 30 minutes at the end of which the precipitate was collected and well washed with distilled water. After drying in vacuo, there was obtained 9.7 grams of 2-hydroxymethylene-dihydrotestosterone.

A mixture of 1 gram of 2-hydroxymethylene-dihydrotestosterone, 10 cc of pyridine and 2 cc of propionic anhydride was allowed to react at room temperature for 16 hours and then poured into water. The resulting suspension was heated for 1 hour on the steam bath to hydrolyze the excess of propionic anhydride, cooled and extracted with methylene dichloride. The extract was consecutively washed with dilute hydrochloric acid, sodium bicarbonate solution and water, dried over anhydrous sodium sulfate and evaporated to dryness under vacuum. There was thus obtained the dipropionate of 2-hydroxymethylene-dihydrotestosterone which was treated with hydrogen, in methanol solution.

When the uptake of hydrogen ceased, the catalyst was filtered and the solution was evaporated to dryness under vacuum. The residue was dissolved in a mixture of benzene-hexane, transferred to a chromatographic column with neutral alumina and the product was eluted with mixtures of benzene-hexane, gradually increasing the proportion of benzene in the mixture. Crystallization of the eluates from acetone-hexane yielded the propionate of 2 α -methyl-dihydrotestosterone.

References

- Merck Index 3443
- Kleeman & Engel p. 342
- OCDS Vol. 1 p. 173 (1977)
- I.N. p. 366
- REM p. 998
- Ringold, H.J. and Rosenkranz, G.; U.S. Patent 2,908,693; October 13, 1959; assigned to Syntex SA, Mexico
- Ringold, H.J. and Rosenkranz, G.; U.S. Patent 3,118,915; January 21, 1964; assigned to Syntex Corporation, Panama

DROPERIDOL

Therapeutic Function: Tranquilizer

Chemical Name: 1-[1-[4-(4-fluorophenyl)-4-oxobutyl]-1,2,3,6-tetrahydro-4-pyridinyl]-1,3-dihydro-2H-benzimidazol-2-one

Common Name: Dehydrobenzperidol

Structural Formula:

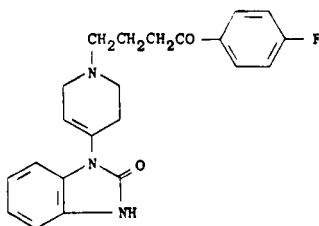

Chemical Abstracts Registry No.: 548-73-2

Trade Name	Manufacturer	Country	Year Introduced
Dehydrobenzperidol	Janssen	W. Germany	1963
Sintodian	Carlo Erba	Italy	1965
Droleptan	Janssen	U.K.	1965
Droleptan	Janssen	France	1966
Inapsine	Mc Neil	U.S.	1970
Thalamonal	Sankyo	Japan	1972
Dridol	Leo	Sweden	—
Halkan	Thekan	France	—
Leptofen	Erba	Italy	—
Neurolidol	Abic	Israel	—

Raw Materials

γ -Chloro-4-fluorobutyrophenone
1-(1,2,3,6-Tetrahydro-4-pyridyl)-2-benzimidazolinone

Manufacturing Process

A mixture of 10 parts of γ -chloro-4-fluorobutyrophenone, 5.5 parts of 1-(1,2,3,6-tetrahydro-4-pyridyl)-2-benzimidazolinone, 4 parts of sodium carbonate, and 0.1 part of potassium iodide in 176 parts of 4-methyl-2-pentanone is stirred and refluxed for 64 hours. The cooled reaction mixture is filtered and the solvent is evaporated from the filtrate to leave an oily residue which is dissolved in toluene. The toluene solution is filtered and the solvent is evaporated. The resultant residue is recrystallized from a mixture of 32 parts of ethyl acetate and 32 parts of diisopropyl ether to give 1-[1-[(4-fluorobenzoyl)propyl]-1,2,3,6-tetrahydro-4-pyridyl]-2-benzimidazolinone hydrate melting at about 145°-146.5°C.

References

Merck Index 3444

Kleeman & Engel p. 341

PDR p. 954

OCDS Vol. 1 p. 308 (1977)

DOT 9 (6) 235 (1973)

I.N. p. 365

REM p. 1087

Janssen, P.A.J. and Gardocki, J.F.; U.S. Patent 3,141,823; July 21, 1964; assigned to Research Laboratorium Dr. C. Janssen NV, Belgium

Janssen, P.A.J.; U.S. Patent 3,161,645; December 15, 1964; assigned to Research Laboratorium Dr. C. Janssen NV, Belgium

DROPRENILAMINE HCl

Therapeutic Function: Coronary vasodilator

Chemical Name: N-(2-Cyclohexyl-1-methylethyl)-γ-phenylbenzene-propanamine

Common Name: —

Structural Formula:

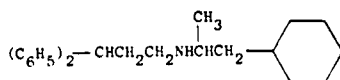

Chemical Abstracts Registry No.: 57653-27-7 (Base)

Trade Name	Manufacturer	Country	Year Introduced
Valcor	Maggioni	Italy	1979

Raw Materials

3,3-Diphenylpropylamine
Cyclohexylacetone
Hydrogen

Manufacturing Process

The flask of a Parr hydrogenation apparatus was charged with 10.5 g of 3,3-diphenylpropylamine, 7.7 g of cyclohexylacetone, 50 ml methanol and 150 mg of platinum dioxide. Hydrogen at a pressure of 3 atmospheres was introduced and the mixture stirred. Upon absorption of the theoretical amount of hydrogen, stirring is discontinued, the catalyst is filtered off and the solution is evaporated to dryness. The residue is taken up with ether and the hydrochloride is precipitated with HCl in alcoholic solution. The product, as collected on a filter and washed with ether, is recrystallized from isopropanol. Yield: 17 g (92.5% of theory). MP: 175°C to 177°C.

References

- Merck Index 3445
DFU 2 (11) 720 (1977)
OCDS Vol. 3 p. 47 (1984)
I.N. p. 366
Carissimi, M., Ravenna, F. and Picciola, G.; British Patent 1,461,240; January 13, 1977; assigned to Maggioni & Co. S.p.A. (Italy)

DYCLONINE HYDROCHLORIDE

Therapeutic Function: Topical anesthetic

Chemical Name: 1-(4-butoxyphenyl)-3-(1-piperidinyl)-1-propanone hydrochloride

Common Name: —

Structural Formula:

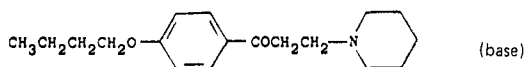

Chemical Abstracts Registry No.: 536-43-6; 586-60-7 (Base)

Trade Name	Manufacturer	Country	Year Introduced
Dyclone	Dow	U.S.	1956
Resolve	Merrell Dow	U.S.	1980
Epicain Ace	S.S. Pharm.	Japan	—
Epirocain	Eisai	—	—

Raw Materials

p-n-Butoxyacetophenone	Paraformaldehyde
Piperidine hydrochloride	Hydrogen chloride

Manufacturing Process

A mixture of 17.6 grams of p-n-butoxyacetophenone, 12.1 grams of piperidine hydrochloride, 4.5 grams paraformaldehyde, 0.25 cc concentrated hydrochloric acid, 52.5 cc nitroethane, 7.5 cc of 95% ethanol, and 15 cc of toluene was boiled under reflux for one hour, removing water formed in the reaction by means of a condensate trap. The mixture was then cooled. The crystals which formed were collected by filtration, washed with anhydrous ether and recrystallized from methyl ethyl ketone. The crystals thus obtained, which melted at 174°-175°C, were shown by analysis to be 4-n-butoxy-beta-piperidinopropiophenone hydrochloride.

References

Merck Index 3459

Kleeman & Engel p. 343

PDR p. 592

I.N. p. 369

REM p. 1056

Bockstahler, E.R.; U.S. Patent 2,771,391; November 20, 1956; assigned to Allied Laboratories, Inc.

Florestano, H.J., Jeffries, S.F., Osborne, C.E. and Bahler, M.E.; U.S. Patent 2,868,689; January 13, 1959; assigned to Allied Laboratories, Inc.

DYDROGESTERONE

Therapeutic Function: Progestin

Chemical Name: 9 β ,10 α -pregna-4,6-diene-3,20-dione

Common Name: 10 α -isopregnenone; 6-dehydro-retro-progesterone

Structural Formula:

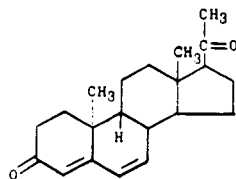

Chemical Abstracts Registry No.: 152-62-5

Trade Name	Manufacturer	Country	Year Introduced
Duphaston	Duphar	U.K.	1961
Duphaston	Duphar	France	1962
Duphaston	Philips Roxane	U.S.	1962
Dufaston	I.S.M.	Italy	1963
Duphaston	Thomae Duphar	W. Germany	1966
Gynorest	Mead Johnson	U.S.	1968
Duphaston	Ethnor	Australia	—
Terolut	Ferrosan	Denmark	—

Raw Materials

Retroprogesterone
Chloranil

Manufacturing Process

A solution of 7.5 grams of retroprogesterone in 500 ml of freshly distilled tertiary butyl alcohol was refluxed with 12.75 grams of finely powdered chloranil, while stirring, for 5 hours in a nitrogen atmosphere. After cooling, 2 liters of water were added and extraction was performed three times with 200 ml of methylene dichloride. The combined extracts were then diluted with 1 liter of petroleum ether (40°-60°C) washed successively with 100 ml of diluted Na₂SO₄, four times with 75 ml of 1 N NaOH, and then water to neutral reaction.

By drying this solution on Na₂SO₄ and evaporating to dryness (last part in vacuo) 3.7 grams of crystalline residue was obtained. This residue was then dissolved in benzene. Filtration in benzene filtered through 35 grams of alumina (according to Brockmann was done and then the alumina was eluted with benzene. Evaporation of the benzene yielded 3.11 grams of crystalline residue. By crystallization with 15 ml of acetone at room temperature (at lower temperatures a by-product crystallized out) 900 mg of crystals, with a melting point of 165°-170°C were obtained. Transfer of the acetone mother liquor into a mixture of ethanol and hexane yielded 1.7 grams of a solid substance with a melting point of 130° to 145°C. This solid was then recrystallized with acetone at room temperature, yielding 600 mg of a solid with a melting point of 166° to 171°C. The two fairly pure fractions (600 mg and 900 mg) yielded, after crystallization with a mixture of acetone and hexane, finally 1.0 gram of 6-dehydroretroprogesterone, melting point 169° to 170°C. From the mother liquors an additional fraction of 0.44 gram with a melting point of 168° to 169°C was obtained.

References

Merck Index 3460

Kleeman & Engel p. 343

I.N. p. 369

Reerink, E.H., Westerhof, P. and Scholer, H.F.L.; U.S. Patent 3,198,792; August 3, 1965; assigned to North American Philips Company, Inc.

DYPHYLLINE

Therapeutic Function: Smooth muscle relaxant

Chemical Name: 7-(2,3-Dihydroxypropyl)-3,7-dihydro-1,3-dimethyl-1H-purine-2,6-dione

Common Name: (1,2-Dihydroxy-3-propyl)theophylline; diprophylline

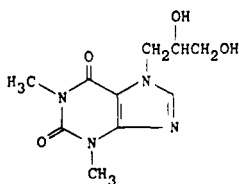
Structural Formula:

Chemical Abstracts Registry No.: 479-18-5

Trade Name	Manufacturer	Country	Year Introduced
Neophylline	Lemmon	U.S.	1948
Neutraphylline	Houde	France	1949
Droxine La	Dermik	U.S.	1979
Diprophyline	Wakodo Seiyaku	Japan	1981
Oxystat	Hyrex	U.S.	1983
AFI-Phyllin	A.F.I.	Norway	—
Aristophyllin	Kwizda	Austria	—
Astamasit	Showa	Japan	—
Asthmolysin	Kade	W. Germany	—
Astrophyllin	Astra	—	—
Austrophyllin	Petrasch	Austria	—
Coeurophylline	Barlow Cote	Canada	—
Corphyllin	Nippon Shinyaku	Japan	—
Difilina	Liade	Spain	—
Dilor	Savage	U.S.	—
Diasthmol	Trima	Israel	—
Dyflex	Econo-Rx	U.S.	—
Diurophylline	Monal	France	—
Dihydrophylline	Tokyo Hosei	Japan	—
Lufyllin	Mallinckrodt	U.S.	—
Neophyllin-M	Eisai	Japan	—
Neospect	Lemmon	U.S.	—
Neophylline	Lemmon	U.S.	—
Neo-Vasophylline	Katwijk	Neth.	—
Prophyllin	Streuli	Switz.	—
Protrophylline	Rougier	Canada	—
Rominophyllin	Grelan	Japan	—
Silbephylline	Berk	U.K.	—
Sintofillina	Sintetica	Switz.	—
Solufyllin	Pharmacia	Sweden	—
Theourin	Kanto	Japan	—
Thefylan	Pharmacia	Sweden	—

Raw Materials

Theophylline
Sodium hydroxide
1-Chloro-2,3-dihydroxypropane

Manufacturing Process

180 grams of theophylline is dissolved in 500 cc of boiling water. To this solution is added 40 grams of sodium hydroxide or 56 grams of potassium hydroxide slowly and with constant stirring.

When solution is complete, 120 grams of 1-chloro-2,3-dihydroxypropane is slowly added. The thus provided mixture is brought to boiling and heating is continued until a temperature of 110°C is reached.

The resultant liquid is evaporated under reduced pressure to remove all traces of water. The resulting syrupy liquid is allowed to stand with occasional stirring until crystallization takes place. The compound is purified by recrystallization from alcohol. The product melts at 155°-157°C.

References

Merck Index 3465

Kleeman & Engel p. 329

PDR pp. 1603, 1877

I.N. p. 350

REM p. 872

Jones, J.W. and Maney, P.V.; U.S. Patent 2,575,344; November 20, 1951; assigned to the State of Iowa

E

ECHOTHIOPATE IODIDE

Therapeutic Function: Cholinergic (ophthalmic)

Chemical Name: 2-[(diethoxyphosphinyl)thio]-N,N,N-trimethylethanaminium iodide

Common Name: O,O-diethyl-S-β-dimethylaminoethyl thiophosphate methyl iodide

Structural Formula:

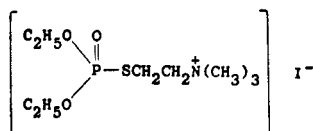

Chemical Abstracts Registry No.: 513-10-0

Trade Name	Manufacturer	Country	Year Introduced
Phospholine iodide	Ayerst	U.S.	1959
Phospholine iodide	Promedica	France	1966
Echioidide	Alcon	U.S.	1977
Phospholine iodide	Santen	Japan	—
Phospholine iodide	Ayerst	U.K.	—
Phospholine iodide	Chinoïn	Italy	—

Raw Materials

β-Dimethylaminoethyl mercaptan hydrochloride
Sodium
Diethylchlorophosphate
Methyl iodide

Manufacturing Process

The reaction is carried out in an atmosphere of nitrogen. To a solution of 4.60 grams sodium (0.20 mol) in 60 cc of methanol is added 14.17 grams β-dimethylaminoethyl mercaptan hydrochloride (0.10 mol), rinsed in with 10 cc methanol. Solvent is removed at a water-pump vacuum while blowing with a slow stream of nitrogen to 100°C/20 mm. To the residue suspended in 150 cc benzene and cooled in an ice bath is added 17.25 grams diethylchlorophosphate (0.10 mol) in 3 portions at 10-minute intervals. After each addition, the temperature increases from about 4° to about 14°C and then falls. The mixture is stirred in an ice bath for one-half hour and while warming to room temperature during 2 hours is washed with 35 and 5 cc portions of water with two 10 cc portions of saturated brine and is dried over calcium sulfate and filtered.

After removal of solvent by distillation under reduced pressure to 55°C/20 mm, the residue is 23.0 grams crude base (95% theory) as a pale yellow liquid. A sample of the crude base distills with some decomposition at 105° to 112°C/0.8 mm.

A sample of distilled base in cold isopropanol is treated with excess methyl iodide, left at room temperature overnight, diluted with 5 volumes of ethyl acetate and filtered from the methiodide salt. This is purified by crystallization from mixtures of isopropanol and ethyl acetate, filtering hot to remove an impurity of low solubility. The pure methiodide is obtained as a white solid, MP 124° to 124.5°C, containing 99 mol percent thiol isomer.

References

Merck Index 3481

Kleeman & Engel p. 345

PDR p. 632

I.N. p. 371

REM p. 898

Fitch, H.M.; U.S. Patent 2,911,430; November 3, 1959; assigned to Campbell Pharmaceuticals, Inc.

ECONAZOLE NITRATE

Therapeutic Function: Antifungal

Chemical Name: 1-(2-[(4-chlorophenyl)methoxy]-2-(2,4-dichlorophenyl)ethyl)-1H-imidazole nitrate

Common Name: —

Structural Formula:

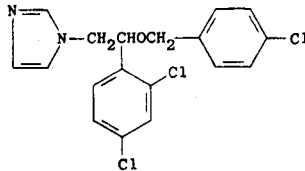

(base)

Chemical Abstracts Registry No.: 24169-02-6; 27220-47-9 (Base)

Trade Name	Manufacturer	Country	Year Introduced
Pevaryl	Cilag Chemie	France	1976
Pevaryl	Cilag	Italy	1978
Ecostatín	Fair Labs	U.K.	1978
Pevaryl	Cilag Chemie	W. Germany	1978
Skilar	Italchemie	Italy	1979
Paravale	Otsuka	Japan	1981
Spectazole	Ortho	U.S.	1983
Epi-Pevaryl	Cilag	W. Germany	—
Gyno-Pevaryl	Cilag	W. Germany	—
Ifenec	Italfarmaco	Italy	—
Micoespec	Centrum	Spain	—
Micofugal	Ion	Italy	—
Micogyn	Crosara	Italy	—
Mycopevaryl	Cilag	—	—

Raw Materials

α -(2,4-Dichlorophenyl)-imidazole-1-ethanol
Sodium hydride

p-Chlorobenzyl chloride
Nitric acid

Manufacturing Process

A suspension of 10.3 parts of α -(2,4-dichlorophenyl)-imidazole-1-ethanol and 2.1 parts of sodium hydride in 50 parts of dry tetrahydrofuran is stirred and refluxed for 2 hours. After this reaction-time, the evolution of hydrogen is ceased. Then there are added successively 60 parts dimethylformamide and 8 parts of p-chlorobenzylchloride and stirring and refluxing is continued for another two hours. The tetrahydrofuran is removed at atmospheric pressure. The dimethylformamide solution is poured onto water. The product, 1-[2,4-dichloro- β -(p-chlorobenzoyloxy)phenethyl] imidazole, is extracted with benzene. The extract is washed with water, dried, filtered and evaporated in vacuo. From the residual oily free base, the nitrate salt is prepared in the usual manner in 2-propanol by treatment with concentrated nitric acid, yielding, after recrystallization of the crude solid salt from a mixture of 2-propanol, methanol and diisopropylether, 1-[2,4-dichloro- β -(p-chlorobenzoyloxy)phenethyl] imidazole nitrate; MP 162°C.

References

Merck Index 3482

Kleeman & Engel p. 345

PDR p. 1309

OCDS Vol. 2 p. 249 (1980)

DOT 11 (8) 310 (1975)

I.N. p. 371

REM p. 1227

Godefroi, E.F. and Heeres, J.; U.S. Patent 3,717,655; February 20, 1973; assigned to Janssen Pharmaceutica NV, Belgium

ECTYLUREA

Therapeutic Function: Sedative

Chemical Name: (Z)-N-(Aminocarbonyl)-2-ethyl-2-butenamide

Common Name: Ethylcrotonylurea

Structural Formula:

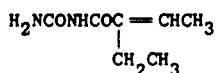

Chemical Abstracts Registry No.: 95-04-5

Trade Name	Manufacturer	Country	Year Introduced
Nostyn	Ames	U.S.	1956
Levanil	Upjohn	U.S.	1959
Cronil	Farmigea	Italy	—
Distasol	Locatelli	Italy	—
Ektyl	A.C.O.	Sweden	—
Neuroprocin	Minerva-Chemie	Neth.	—

Raw Materials

2-Bromo-2-ethylbutyryl urea (carbromal)
Silver oxide

Manufacturing Process

54 g of carbromal (2-bromo-2-ethylbutyryl-urea) in 600 cc of isopropanol was stirred and refluxed for 3 hours with 27.8 g of anhydrous silver oxide. The reaction mixture was filtered and the silver residue was extracted with 100 cc of boiling isopropanol. The filtered and dried solids which separated weighed 22.5 g and melted at 189°C to 190.5°C. Concentration of the filtrate yielded an additional 3.3 g of product which melted at 160°C to 170°C. These two crops were separately obtained as white needles by crystallization from alcohol and exhibited slight solubility in water. The first crop gave 21.7 g of 2-ethyl-cis-crotonyl-urea with a melting point of 191°C to 193°C, and the second crop gave 0.9 g with a melting point of 191°C to 193°C for a total yield of 42.4 g or 63% of the theoretical.

References

Merck Index 3484

OCDS Vol. 1 p. 221 (1977)

I.N. p. 372

Faucher, O.E.; U.S. Patents 2,854,379; September 30, 1958; and 2,931,832; April 5, 1960; both assigned to Miles Laboratories, Inc.

EDETATE DISODIUM

Therapeutic Function: Pharmaceutic aid (chelating agent)

Chemical Name: N,N'-1,2-Ethanediybis[N-(carboxymethyl)glycine] disodium salt

Common Name: EDTA disodium

Structural Formula:

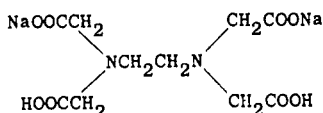

Chemical Abstracts Registry No.: 139-33-3

Trade Name	Manufacturer	Country	Year Introduced
Endrate Disodium	Bersworth	U.S.	1959
Cheladrate	Pharmex	U.S.	—
Diso-Tate	O'Neal, Jones	U.S.	—
Idranal	Riedel de Hahn	W. Germany	—
Komplexon III	Chemische Fabrik	Switz.	—
Uni Wash	United	U.S.	—

Raw Materials

Ethylene diamine	Sodium cyanide
Formaldehyde	Sodium hydroxide

Manufacturing Process

10 mols of ethylene diamine as a 30% aqueous solution and 4 mols of solid caustic soda are placed in a steam heated kettle supplied with an agitator. 8 mols of sodium cyanide as a concentrated water solution (about 30%) are added and the solution heated to 60°C. About a 10 inch vacuum is applied to bring the liquid to incipient boiling. Formaldehyde (7.5 mols of 37% to 40% aqueous solution) is slowly added, the temperature being held at 60°C, and the

solution vigorously stirred. Then, when the evolution of ammonia has substantially stopped, an additional 8 mols of sodium cyanide, followed by 8 mols of formaldehyde are added as before. This is continued until 40 mols of cyanide and 40 mols of formaldehyde have been added. Then at the end about 2 mols more of formaldehyde are added, making 42 mols in all, to remove any last traces of cyanide. About 8 to 10 hours are required to complete the reaction. The resulting product, referred to herein as the crude reaction product, is essentially an aqueous solution of the sodium salt of ethylene diamine tetracetic acid.

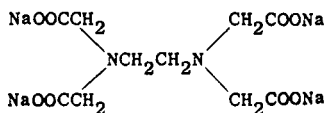

To 1,000 g of the crude reaction product are added 264 g of ethylene diamine tetracetic acid. The mixture is preferably heated to incipient boiling to increase the rate of reaction, and then the mixture is allowed to cool and crystallize. The crystals formed are filtered off, washed with the smallest possible amount of ice water, and dried to a constant weight, which is 452 g. A representative sample of the product so prepared showed, upon analysis, 13.26% sodium against a theoretical of 13.70% for the disodium salt. The dialkali salt has a pH of about 5.3 and behaves like a weak acid, displacing CO_2 from carbonates and reacting with metals to form hydrogen. It is a white crystalline solid.

References

Merck Index 3487

PDR p. 1826

I.N. p. 21

REM p. 838

Bersworth, F.C.; U.S. Patent 2,407,645; September 17, 1946; assigned to The Martin Dennis Co.

EDROPHONIUM CHLORIDE

Therapeutic Function: Cholinergic

Chemical Name: N-ethyl-3-hydroxy-N,N-dimethylbenzaminium chloride

Common Name: —

Structural Formula:

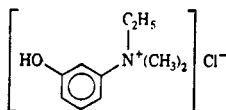

Chemical Abstracts Registry No.: 116-38-1

Trade Name	Manufacturer	Country	Year Introduced
Tensilon	Roche	U.S.	1951
Tensilon	Roche	U.K.	—
Antirex	Kyorin	Japan	—

Raw Materials

m-Dimethylaminophenol
Sodium hydroxide
Hydrogen chloride

Ethyl iodide
Silver nitrate

Manufacturing Process

A solution made up of 10 grams of m-dimethylaminophenol, 50 cc of acetone and 13 grams of ethyl iodide was heated at 50°C for five hours. On addition of ether to the cooled solution, (3-hydroxyphenyl)ethyl dimethylammonium iodide precipitated as an oil which soon crystallized. Upon recrystallization from isopropanol the compound had a MP of 113° to 115°C.

A slight excess of a 10% sodium hydroxide solution was added to a solution of 23 grams of silver nitrate in 300 cc of water. The precipitated silver oxide was washed free of silver ion with distilled water. To a suspension of the silver oxide in 200 cc of water, a solution of 25 grams of (3-hydroxyphenyl)ethyl dimethylammonium iodide in 300 cc of water was added. The precipitate of silver iodide was removed by filtration and the filtrate concentrated to a volume of about 100 cc in vacuo. The remainder of the water was removed by lyophilization. (3-hydroxyphenyl)ethyl dimethylammonium hydroxide was obtained as a hygroscopic, amorphous solid.

A solution of 5 grams of (3-hydroxyphenyl)ethyl dimethylammonium hydroxide in about 200 cc of water was neutralized with dilute hydrochloric acid. On concentration to dryness in vacuo, (3-hydroxyphenyl)ethyl dimethylammonium chloride crystallized. The compound was recrystallized from isopropanol; MP 162° to 163°C (with decomposition).

References

Merck Index 3492

Kleeman & Engel p. 346

PDR pp. 1504, 2009

I.N. p. 372

REM p. 899

Terrell, R.C.; U.S. Patents 3,469,011; September 23, 1969 and 3,527,813; September 8, 1970; both assigned to Air Reduction Company, Incorporated

EMYLCAMATE

Therapeutic Function: Tranquilizer

Chemical Name: 3-Methyl-3-pentanol carbamate

Common Name: —

Structural Formula:

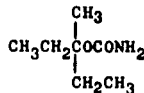

Chemical Abstracts Registry No.: 78-28-4

Trade Name	Manufacturer	Country	Year Introduced
Striatin	MSD	U.S.	1960

Raw Materials

3-Methyl-3-pentanol
Trichloroacetic acid

Potassium cyanate
Sodium carbonate

Manufacturing Process

30.5 g of 3-methyl-3-pentanol, 8.1 g of potassium cyanate and 16.3 g of trichloroacetic acid are heated while stirring at 45°C to 50°C for 24 hours, neutralized by successive addition of anhydrous sodium carbonate. The precipitate is removed from the reaction mixture. Unreacted 3-methyl-3-pentanol is distilled off and the residue is added to a small volume of distilled water. After precipitation and filtration the resulting 3-methyl-3-pentanol carbamate is dried and recrystallized from petroleum ether. MP 54°C to 55°C.

References

Merck Index 3528

I.N. p. 376

Melander, B.O. and Hanshoff, G.; U.S. Patent 2,972,564; February 21, 1961; assigned to A/B Kabi (Sweden)

ENDRALAZINE

Therapeutic Function: Hypotensive

Chemical Name: 6-Benzoyl-3-hydrazino-5,6,7,8-tetrahydropyrido[4,3-c]pyridazine

Common Name: —

Structural Formula:

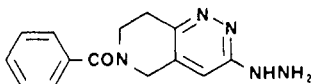

Chemical Abstracts Registry No.: 39715-02-1

Trade Name	Manufacturer	Country	Year Introduced
Miretilan	Sandoz	Switz.	1981
Miretilan	Sandoz	W. Germany	1982

Raw Materials

2,3,4,4a,5,6,7,8-Octahydro-3-oxo-6-pyrido[4,3-c]pyridazine-carboxylic acid ethyl ester

Bromine

Hydrogen chloride

Phosphorus oxychloride

Benzoyl chloride

Maleic acid

Hydrazine

Manufacturing Process

(a) *6-Carboxy-5,6,7,8-tetrahydro-3(2H)pyrido[4,3-c]pyridazinone*: Produced from 450.5 g of 2,3,4,4a,5,6,7,8-octahydro-3-oxo-6-pyrido[4,3-c]pyridazinecarboxylic acid ethyl ester and 320 g of bromine. The bromine is added dropwise to a boiling solution of the ester in 200 cc of chloroform over one hour and the mixture is stirred for another hour at the same temperature. 1 kg of ice water is added to the mixture, the chloroform portion is separated, and the acid aqueous phase is again extracted with 500 cc of chloroform. The semicrystalline crude product obtained after concentrating the chloroform phase, is recrystallized with 250 cc of absolute ethanol, melting point 165°C to 168°C (decomp.).

A solution of 223.2 g of 6-carbethoxy-5,6,7,8-tetrahydro-3(2H)pyrido[4,3-c]pyridazinone in 1 liter of concentrated hydrochloric acid is heated to the boil at reflux for 22 hours while stirring. The mixture is concentrated in a vacuum, and the resulting crude crystalline hydrochloride of 5,6,7,8-tetrahydro-3(2H)pyrido[4,3-c]pyridazinone, having a melting point of 307°C to 310°C (decomposed from methanol), is suspended in 0.75 liter of methanol, and 0.4 liter of triethylamine is slowly added to the suspension. After stirring for 15 minutes and cooling the violet suspension, the crude base is obtained. 25 g of the crude base are recrystallized from 300 cc of methanol, mixed with 10 cc of concentrated ammonia and 40 cc of water, with the addition of a small amount of coal. 5,6,7,8-Tetrahydro-3(2H)pyrido[4,3-c]pyridazinone has a melting point of 223°C to 225°C (decomp.).

(b) 3-Chloro-5,6,7,8-tetrahydropyrido[4,3-c]pyridazine: Produced from 30.3 g of 5,6,7,8-tetrahydro-3(2H)pyrido[4,3-c]pyridazinone suspended in 250 cc of phosphorus oxychloride. The suspension is heated to the boil while stirring. The resulting solution is stirred for 1 hour at the boil and then concentrated to an oil in a vacuum. 150 cc of ice water and 40 cc of concentrated ammonia solution are added to this oil, and the mixture is extracted twice with a total of 300 cc of chloroform. The chloroform phase is concentrated in a vacuum.

(c) The crude unstable base is converted into the maleate for working up. This is effected by boiling 24.8 g of the base in 150 cc of methanol with 17.5 g of maleic acid. Upon cooling the solution, the crude maleate is obtained, which is recrystallized from methanol with the addition of a small amount of coal. 3-Chloro-5,6,7,8-tetrahydropyrido[4,3-c]pyridazine maleate has a melting point of 162°C to 164°C (decomp.).

A mixture of 12.6 g of benzoyl chloride in 100 cc of ethylene chloride is added dropwise to a suspension of 25.6 g of 3-chloro-5,6,7,8-tetrahydropyrido[4,3-c]pyridazine maleate in 250 cc of ethylene chloride and 21.8 g of triethylamine within 18 minutes at room temperature while stirring. The mixture is stirred at room temperature for a further 14 hours, 200 cc of water are added, the organic phase is separated and concentrated to an oil in a vacuum. Upon adding ether/dimethoxyethane to this oil, crude 6-benzoyl-3-chloro-5,6,7,8-tetrahydropyrido[4,3-c]pyridazine is obtained. After recrystallization from absolute ethanol with the addition of a small amount of coal, the compound has a melting point of 125°C to 127°C (decomp.). Displacement of the halogen with hydrazine leads to the formation of endralazine.

References

- Merck Index 3538
 DFU 3 (5) 375 (1978)
 OCDS Vol. 3 p. 232 (1984)
 I.N. p. 378
 Schenker, E.; U.S. Patent 3,838,125; September 24, 1974; assigned to Sandoz Ltd.
 Schenker, E.; U.S. Patent 3,954,754; May 4, 1978; assigned to Sandoz, Ltd.

ENFLURANE

Therapeutic Function: Anesthetic

Chemical Name: 2-chloro-1-(difluoromethoxy)-1,1,2-trifluoroethane

Common Name: —

Structural Formula: CHF₂OCF₂CHFCl

Chemical Abstracts Registry No.: 13838-16-9

Trade Name	Manufacturer	Country	Year Introduced
Ethrane	Ohio Medical	U.S.	1972
Ethrane	Abbott	Italy	1974
Ethrane	Deutsche Abbott	W. Germany	1975
Ethrane	Abbott	U.K.	1977
Ethrane	Abbott	France	1978
Ethrane	Dainippon	Japan	1981
Aerrane	Ohio Medical	U.K.	1983
Alyrane	Ohio Medical	—	—
Efrane	Abbott	—	—
Inheltran	Abbott	—	—

Raw Materials

2-Methoxy-2,2-difluoro-1-chloro-1-fluoroethane
Chlorine
Hydrogen fluoride

Manufacturing Process

Preparation of the Intermediate $\text{CHCl}_2\text{OCF}_2\text{CHFCl}$: To a 3-necked round-bottomed flask fitted with a Dry Ice condenser, a fritted glass gas inlet tube, a thermometer and a stirrer, was charged 1,180 grams (8 mols) of $\text{CH}_3\text{OCF}_2\text{CHFCl}$. After flushing the system with nitrogen, chlorine gas was added via the inlet tube while the reaction was stirred and illuminated with a 300 watt incandescent lamp. The chlorination was rapid and exothermic and the reactor was cooled to hold the temperature between 30° and 35°C. The effluent gases were led from the top of the condenser to a water scrubber which was titrated at intervals with standard base. When a total of 1.45 mols of HCl per mol of ether was titrated the reaction was stopped. The crude product obtained weighed 1,566 grams which corresponded to the addition of 1.41 mols of chlorine per mol of the starting ether. The product was flash distilled to yield 1,480 grams of product which had the following composition as determined by vapor phase chromatography: 45.3% $\text{CH}_2\text{ClOCF}_2\text{CHFCl}$; 50.5% $\text{CHCl}_2\text{OCF}_2\text{CHFCl}$, plus a small amount of $\text{CH}_2\text{ClOCF}_2\text{CFCl}_2$; 1.8% $\text{CHCl}_2\text{OCF}_2\text{CFCl}_2$ and 2.1% $\text{CCl}_3\text{OCF}_2\text{CHFCl}$.

Fractional distillation of this mixture using a 5 x 120 cm column packed with ¼" Penn State packing yielded 670 grams of product containing 95% $\text{CH}_2\text{ClOCF}_2\text{CHFCl}$ and 5% $\text{CHCl}_2\text{OCF}_2\text{CHFCl}$; BP 55° to 60°C at 100 mm, $n_D^{20} = 1.3748$ to 1.3795; and 670 grams of $\text{CHCl}_2\text{OCF}_2\text{CHFCl}$ (95% pure, containing 5% $\text{CH}_2\text{ClOCF}_2\text{CFCl}_2$); BP 60°C at 100 mm, $n_D^{20} = 1.3870$ to 1.3875. The still bottoms were comprised mostly of $\text{CCl}_3\text{OCF}_2\text{CHFCl}$ and $\text{CHCl}_2\text{OCF}_2\text{CFCl}_2$.

Preparation of $\text{CHF}_2\text{OCF}_2\text{CHFCl}$: To a mixture of 2,172 grams (10 mols) $\text{CHCl}_2\text{OCF}_2\text{CHFCl}$ prepared as described above (containing approximately 5% $\text{CH}_2\text{ClOCF}_2\text{CFCl}_2$) and 40 grams (2% by weight) SbCl_5 was added anhydrous hydrogen fluoride while the temperature was maintained at 0±5°C. The reaction was carried out in a 3-necked stainless steel flask fitted with a stainless steel stirrer, a thermocouple well and a copper Dry Ice condenser. The amount of hydrogen fluoride added was measured by titration of the HCl given off. At the end of the reaction (total HCl evolved: 1.98 mols per mol of starting ether) the mixture was poured into water and the organic layer (1,803 grams, $n_D^{20} = 1.3080$) recovered. The crude product was flash distilled in a 60 x 2 cm column packed with ¼" Penn State packing giving 1,594 grams of substantially pure $\text{CHF}_2\text{OCF}_2\text{CHFCl}$, BP 56° to 57°C. By further distillation 1,450 grams of the pure ether were obtained, BP 56.5°C, $n_D^{20} = 1.3030$ as described in each of the patents cited as references.

References

Merck Index 3541
Kleeman & Engel p. 346
DOT 9 (5) 173 (1973) & 11 (9) 347 (1975)
I.N. p. 378

REM p. 1041

Terrell, R.C.; U.S. Patents 3,469,011; September 23, 1969 and 3,527,813; September 8, 1970; both assigned to Air Reduction Company, Incorporated

ENVIOMYCIN

Therapeutic Function: Antitubercular

Chemical Name: 1-(L-Threo-3,6-diamino-4-hydroxyhexanoic acid)-6-[L-2-(2-amino-1,4,5,6-tetrahydro-4-pyrimidinyl)glycine]viomycin

Common Name: Tuberactinomycin-N

Structural Formula:

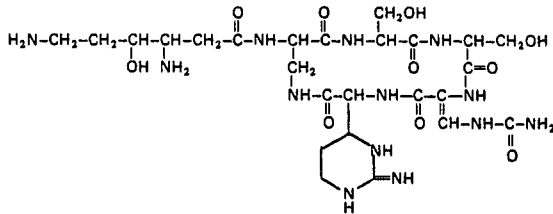

Chemical Abstracts Registry No.: 33103-22-9

Trade Name	Manufacturer	Country	Year Introduced
Tuberactin	Toyo Jozo	Japan	1975
TUM	Toyo Jozo	Japan	—

Raw Materials

Bacterium *Streptomyces griseoverticillatus* var. *tuberceticus*
Glucose

Manufacturing Process

Two liters of an aqueous medium consisting of glucose 3%, starch 2%, soybean meal 3% and sodium chloride 1.5% were equally divided and introduced into twenty 500-ml Erlenmeyer flasks, adjusted to pH 6, sterilized at 120°C for 30 minutes, inoculated with *Streptomyces griseoverticillatus* var. *tuberceticus* N6-130 and then rotatively shake-cultured (radius 2.5 cm, 330 rpm) at 30°C for 7 days, obtaining 1.5 liter of cultured broth containing 2,360 mcg/ml of tuberactinomycin-N.

Filtered broth was passed at 2.5 ml/min through a resin column (2.5 cm diameter, 28 cm length) packed with 150 ml of ion exchange resin Amberlite IRC-50 sodium type (Rohm and Haas Co., U.S.A.). The column was washed with water, eluted with 0.5N HCl at a flow rate 1.3 ml/min. The eluates were fractionated each 10 ml and tuberactinomycin-N activity was found at fractions No. 45-63 observed by ultraviolet absorption method and bioassay.

The thus yielded active fraction, about 200 ml, was neutralized with sodium hydroxide, concentrated to about 15 ml in vacuo, separating the precipitated inorganic salts therefrom. After decolorization with active carbon, 150 ml of methanol was added, the mixture was allowed to stand overnight at 5°C and the precipitate was collected by filtration. The precipitate was washed with methanol and dried in vacuo to yield crude tuberactinomycin-N hydrochloride (yield, 3.07 g; purity, 71.5%; recovery, 62%).

References

Merck Index 3551

Kleeman & Engel p. 347

DOT 13 (1) 21 (1977)

I.N. p. 988

Abe, J., Watanabe, T., Nagata, A., Ando, T., Take, T., Izumi, R., Noda, T. and Matsuura, K.; U.S. Patent 3,892,732; July 1, 1975; assigned to Toyo Jozo K.K. (Japan)

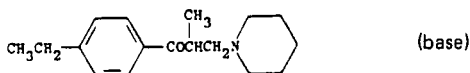
EPERISONE HCl**Therapeutic Function:** Muscle relaxant**Chemical Name:** 1-(4-Ethylphenyl)-2-methyl-3-(1-piperidinyl)-1-propanone hydrochloride**Common Name:** —**Structural Formula:****Chemical Abstracts Registry No.:** 64840-90-0 (Base)

Trade Name	Manufacturer	Country	Year Introduced
Myonal	Eisai	Japan	1983

Raw Materials4-Ethyl-propiophenone
Piperidine hydrochlorideParaformaldehyde
Hydrogen chloride**Manufacturing Process**

To 60 ml of isopropanol, there are introduced 120 g of 4-ethyl-propiophenone, 28.8 g of p-formaldehyde and 107 g of piperidine hydrochloride, and the resulting mixture is heated to reflux on an oil bath with stirring. The heating is continued, and when the reaction mixture solidifies, the state being a sign of completion of the reaction, there are added 500 ml of acetone thereto. The solidified mass is pulverized by crush, recovered by filtration and washed with acetone. 144 g of the crude dry crystalline substance is thus obtained, which is the hydrochloride of the purposed product. The hydrochloride is recrystallized from isopropanol, and there are obtained the crystalline needles having the melting point of 170°C to 172°C.

References

Merck Index 3555

DFU 7 (12) 907 (1982)

DOT 19 (10) 583 (1983)

Morita, E. and Kanai, T.; U.S. Patent 3,995,047; November 30, 1976; assigned to Eisai Co., Ltd. (Japan)

EPICILLIN**Therapeutic Function:** Antibacterial

Chemical Name: 6-[D-2-amino-2-(1,4-cyclohexadien-1-yl)acetamido]-3,3-dimethyl-7-oxo-4-thia-1-azabicyclo[3.2.0] heptane-2-carboxylic acid

Common Name: D- α -amino-(1,4-cyclohexadien-1-yl)methylpenicillin

Structural Formula:

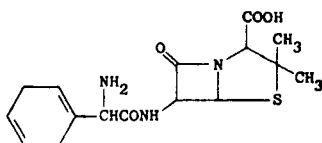

Chemical Abstracts Registry No.: 26774-90-3

Trade Name	Manufacturer	Country	Year Introduced
Dexacilline	Squibb	France	1974
Spectacillin	Sandoz	W. Germany	1975
Dexacillin	Squibb	Italy	1977
Florispec	Squibb	—	—
Omnisan	Squibb	—	—
Spectacillin	Biochemie	Austria	—

Raw Materials

D-Phenylglycine	Lithium
Ammonia	Methyl acetoacetate
6-Amino penicillanic acid	

Manufacturing Process

See Cephradine for preparation of D-2-amino-2-(1,4-cyclohexadienyl)acetic acid and then its methyl acetoacetic ester enamine as the starting material.

358 mg of 6-aminopenicillanic acid (APA) (1.66 mmol) are stirred well in 2.5 ml of water while 0.23 ml triethylamine is gradually added with the pH kept under 8.0. Final pH is 7.4; 0.85 ml acetone is added and the solution kept at -10°C .

469 mg methyl acetoacetate enamine of D-2-amino-2-(1,4-cyclohexadienyl)acetic acid sodium salt (1.715 mmol) are stirred in 4.25 ml acetone at -20°C . A microdrop of N-methylmorpholine is added followed by the slow addition of 198 mg of ice cold ethyl chloroformate. Water, 0.43 ml, is added at this point and a turbid solution results. The reaction mixture is stirred for 10 minutes at -20°C .

The turbid solution of mixed anhydride is then added to the 6-APA solution. A complete solution is observed. The solution is stirred for 30 minutes at -10°C , then raised to room temperature, acidified to pH 2.0 with diluted HCl and, with good stirring, the pH is kept at that level for 10 minutes.

The solution is then extracted with 5 ml xylene. The aqueous layer is layered with 5 ml methyl isobutyl ketone and the pH adjusted to 5.0 with 1 N NaOH and chilled overnight. The resulting crystals are filtered off, washed with water and air dried. Yield, 272 mg (44%), decomposes at 202°C .

References

- Merck Index 3563
- Kleeman & Engel p. 348
- DOT 9 (3) 101 (1973)
- I.N. p. 381
- REM p. 1201

Weisenhorn, F.L., Dolfini, J.E., Bach, G.G. and Bernstein, J.; U.S. Patent 3,485,819; Dec. 23, 1969; assigned to E.R. Squibb & Sons, Inc.

EPIMESTROL

Therapeutic Function: Anterior pituitary activator

Chemical Name: 3-Methoxyestra-1,3,5(10)-triene-16,17-diol

Common Name: —

Structural Formula:

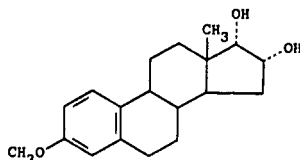

Chemical Abstracts Registry No.: 7004-98-0

Trade Name	Manufacturer	Country	Year Introduced
Stimovul	Organon	W. Germany	1976
Stimovul	Ravasini	Italy	1980
Alene	Organon	—	—

Raw Materials

16-Keto-17(α)-hydroxyestratrienol-3-methyl
Sodium amalgam

Manufacturing Process

Reduction of 16-keto-17(α)-hydroxyestratrienol-3-methyl to 16,17-dihydroxyestratrienol-3-methyl ether: A solution of 800 mg of the alpha ketol methyl ether in 100 cc of ethanol and 10 cc of acetic acid was carefully maintained at 40°C (water bath), and 200 g of freshly prepared sodium amalgam (2%) were added in small pieces with efficient swirling. Before all of the amalgam had been added, a precipitation of sodium acetate occurred, and at this point an additional 100 cc of 50% acetic acid were added. After all the reducing agent had been added, the mixture was transferred to a separatory funnel with ether and water. The mercury plus aqueous phase was separated, after partitioning, from the ether; the latter may be further washed with water, with 0.5 N sodium hydroxide, and again with water to purify the alpha glycol. Evaporation of the ethereal phase yielded a crystalline residue of the isomeric transoid 16(β),17(α)-dihydroxy-steroid-3-methyl ether and cisoid 16(α),17(α)-dihydroxy-steroid-3-methyl ether.

References

Merck Index 3566
Kleeman & Engel p. 348
OCDS Vol. 2 p. 13 (1980)
DOT 13 (5) 191 (1977)
I.N. p. 381
Huffman, M.N.; U.S. Patent 2,584,271; February 5, 1952; assigned to G.D. Searle & Co.

EPINEPHRYL BORATE

Therapeutic Function: Antiglaucoma drug

Chemical Name: 4-[1-hydroxy-2-(methylamino)ethyl]-1,2-benzenediol borate

Common Name: Methylaminoethanolcatechol borate; adrenalin borate

Structural Formula:

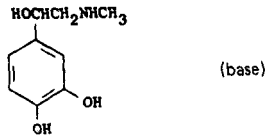

Chemical Abstracts Registry No.: —

Trade Name	Manufacturer	Country	Year Introduced
Eppy	Barnes-Hind	U.S.	1961
Epinal	Alcon	U.S.	—

Raw Materials

Epinephrine
Boric acid

Manufacturing Process

Epinephrine may be made by isolation from animal adrenal glands or may be synthesized as described by Payne in *Ind. Chemist*, 37, 523 (1961).

It has been found that epinephrine solutions having a physiological pH and which are stable for months in storage can be prepared by combining with the epinephrine a small amount of sodium bisulfite, boric acid, and oxine (8-hydroxy-quinoline) hereinafter called 8-quinolinol and adjusting the pH with an alkali, such as sodium hydroxide, to the desired pH.

It has been found that from 0.001 to 0.1% of 8-quinolinol can be used. From 0.2 to 5% boric acid may be used. The amount of sodium bisulfite can be varied from 0.1 to 1%. The solutions can contain from 0.1 to 4% epinephrine. The pHs of the solutions can be adjusted to any value within the physiological range, i.e., from 6.5 to 8.5 using any convenient alkali such as sodium hydroxide.

References

Merck Index 3567

Kleeman & Engel p. 349

I.N. p. 382

REM p. 884

Riegelman, S.; U.S. Patent 3,149,035; September 15, 1964; assigned to The Regents of the University of California

EPIRIZOLE

Therapeutic Function: Antiinflammatory, analgesic, antipyretic

Chemical Name: 4-methoxy-2-(5-methoxy-3-methylpyrazol-1-yl)-6-methylpyrimidine

Common Name: Mepirizole

Structural Formula:

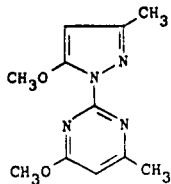

Chemical Abstracts Registry No.: 18694-40-1

Trade Name	Manufacturer	Country	Year Introduced
Mebron	Daiichi Seiyaku	Japan	1970
Mebron	Daiichi Seiyaku	Italy	1979
Daicon	I.B.I.	Italy	1979
Analock	Taito Pfizer	Japan	—
Mepiral	Rober	Spain	—

Raw Materials

4-Methyl-6-methoxy-2-pyrimidinyl-hydrazine
Ethyl acetoacetate
Diazomethane

Manufacturing Process

A mixture of 16.3 g of 4-methyl-6-methoxy-2-pyrimidinyl-hydrazine, 13.7 g of ethyl acetoacetate and 16.3 ml of methanol was refluxed 2 hours on a water bath. After a mixture of 4.7 g of sodium hydroxide, 4.7 ml of water and 27 ml of methanol was added dropwise thereto at about 50°C, the reaction mixture was refluxed for 2 hours more, then methanol was distilled off and the residue was dissolved in 130 ml of water. The solution was adjusted to pH 6 with acetic acid. The precipitate was filtered, washed with water and dried to give 24 g (yield: 95.3%) of crystals, MP 97° to 98°C. Recrystallization from ligroin gave 1-(4'-methyl-6'-methoxy-2'-pyrimidinyl)-3-methyl-3-pyrazoline-5-one, MP 102° to 103°C.

To a solution of 4.76 g of 1-(4'-methyl-6'-methoxy-2'-pyrimidinyl)-3-methyl-3-pyrazoline-5-one in 200 ml of ether was added an ether solution containing 6 molar equivalents of diazomethane and the reaction mixture was allowed to stand at room temperature for 20 hours. After distilling off the solvent, the residue was dissolved in 160 ml of water, made alkaline (pH 10) with sodium hydroxide solution and extracted three times with 140 ml of benzene. The extract was washed with a small amount of water, dried over sodium sulfate and evaporated to give a crystalline mass. Recrystallization from isopropylether gave 1-(4'-methyl-6'-methoxy-2'-pyrimidinyl)-3-methyl-5-methoxypyrazole (3.96 g, 84%) as colorless prisms, MP 90° to 92°C.

References

Merck Index 3571

Kleeman & Engel p. 349

OCDS Vol. 3 p. 152 (1984)

I.N. p. 382

Naito, T., Oshima, Y., Yoshikawa, T., Kasahara, A., Dohmori, R., Nakai, Y. and Tsukada, W.; South African Patent Application 67/4936; January 19, 1968; assigned to Daiichi Seiyaku Company Limited, Japan

EPITIOSTANOL

Therapeutic Function: Antineoplastic

Chemical Name: 2,3-Epithioandrostan-17-ol

Common Name: Epithioandrostanol

Structural Formula:

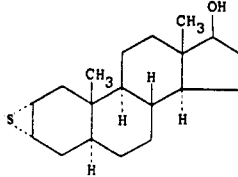

Chemical Abstracts Registry No.: 2363-58-8

Trade Name	Manufacturer	Country	Year Introduced
Thiodrol	Shionogi	Japan	1977

Raw Materials

2 β -Thiocyanato-3 α -methanesulfonyloxy-5 α -androstan-17 β -ol-17-acetate
Potassium hydroxide

Manufacturing Process

A solution of 2 β -thiocyanato-3 α -methanesulfonyloxy-5 α -androstan-17 β -ol 17-acetate (0.82 part by weight) and potassium hydroxide (0.9 part by weight) in diglyme (20 parts by volume) is refluxed on a water bath for 24 hours while stirring. To the reaction mixture, there is added water, and the separated substance is collected by filtration and crystallized from hexane to give 2 β ,3 β -epithio-5 α -androstan-17 β -ol (0.60 part by weight) as crystals melting at 132.5°C to 134°C.

References

Merck Index 3573

Kleeman & Engel p. 350

DOT 14 (7) 274 (1978)

I.N. p. 383

Komeno, T.; U.S. Patent 3,230,215; January 18, 1966; assigned to Shionogi & Co., Ltd.

EPRAZINONE HCl

Therapeutic Function: Antitussive

Chemical Name: 3-[4-(2-Ethoxy-2-phenylethyl)-1-piperaziny]-2-methyl-1-phenyl-1-propanone

Common Name: —

Structural Formula:

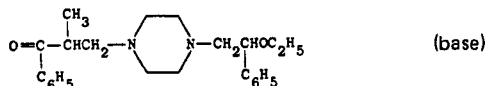

Chemical Abstracts Registry No.: 10402-53-6; 10402-90-1 (Base)

Trade Name	Manufacturer	Country	Year Introduced
Mucitux	Riom	France	1969
Resplen	Chugai	Japan	1974
Eftapan	Merckle	W. Germany	1977
Mucitux	Recordati	Italy	1981
Mukolen	Krka	Yugoslavia	—
Vopop	Lando	Argentina	—

Raw Materials

1-(2-Phenyl-2-ethoxy)piperazine dihydrochloride
 Propiophenone
 Trioxyethylene
 Hydrogen chloride

Manufacturing Process

61.4 g of 0.2 M of 1-(2-phenyl-2-ethoxy)piperazine dihydrochloride, 33.5 g (0.25 M) propiophenone, 75 g (0.25 M) trioxyethylene, 120 ml of ethanol and 0.4 ml of concentrated HCl are heated under reflux for 4 to 5 hours. The product is allowed to crystallize, then filtered and washed with alcohol. It is dried and recrystallized from methanol containing 10% H₂O.

There is thus obtained 60 g of a white crystalline powder soluble in water. Yield: 66%. Melting point: 160°C.

References

Merck Index 3575
 Kleeman & Engel p. 350
 OCDS Vol. 1 p. 64 (1977)
 I.N. p. 384
 Mauvernay, R.Y.; U.S. Patent 3,448,192; June 3, 1969

EPROZINOL

Therapeutic Function: Bronchodilator

Chemical Name: 4-(β-methoxyphenethyl)-α-phenyl-1-piperazinepropanol

Common Name: —

Structural Formula:

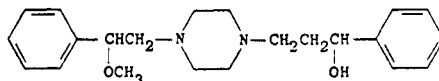

Chemical Abstracts Registry No.: 32665-36-4

Trade Name	Manufacturer	Country	Year Introduced
Eupneron	Lyocentre	France	1973
Brovel	Lepetit	Italy	1978

Raw Materials

Styrene

t-Butyl hypobromite

Methanol
Acetophenone
Sodium borohydride

Piperazine
Trioxymethylene

Manufacturing Process

Stage 1: Preparation of 2-Phenyl-2-Methoxy-Ethyl Bromide – 1.3 moles of tert-butyl hypobromite is added slowly and with agitation to a mixture of 107 grams (1 mol) of vinylbenzene (styrene) and 250 ml of methanol (99%), kept at -10°C . When the addition of the reactant is finished, the mixture is allowed to return to ambient temperature, it is washed in water and dried on anhydrous Na_2SO_4 . Rectification is effected in vacuo in order to obtain a colorless liquid $\text{BP}_{12} = 113^{\circ}\text{C}$, $\text{BP}_{2-5} = 84^{\circ}\text{C}$, $n_{\text{D}}^{20.6} = 1.5429$, yield = 76%.

Stage 2: Preparation of 1-[2-Phenyl-2-Methoxy]-Ethyl-Piperazine – 210 grams of 2-phenyl-2-methoxy-ethyl bromide and 260 grams of anhydrous piperazine are heated for 5 to 6 hours to reflux in 600 ml of ethanol, 500 ml of ethanol is then distilled off and finally the solvent is removed in vacuo. The residue is taken up in 250 ml of benzene and the piperazine hydrobromide is filtered off. The benzene is removed in vacuo. The oily residue is taken up by 450 ml of water and acidification is effected up to $\text{pH} = 1$ by concentrated HCl. The aqueous solution is filtered; the latter is then made alkaline by 50% aqueous NaOH. The liberated base is decanted, the alkaline aqueous solution is washed twice by 150 ml ether. After distillation of the ether, the previously decanted oil is added to the residue and distillation is effected in vacuo. Thus, 135 grams of a colorless viscous oil, becoming carbonated in air, is obtained. $\text{BP}_{14} = 166^{\circ}\text{C}$, $n_{\text{D}}^{20} = 1.5321$, yield = 61%.

Stage 3: Preparation of 1-[2-Phenyl-2-Methoxy]-Ethyl-4-[2-Benzoyl-Ethyl]-Piperazine Dihydrochloride – There are heated to reflux and with agitation for 6 hours, 166 grams 1-[2-phenyl-2-methoxy]-ethyl-piperazine, 400 ml ethanol (96°), 260 ml absolute ethanol with 23% HCl gas, 112 grams acetophenone, 32 grams trioxymethylene and 0.8 ml concentrated aqueous HCl. After cooling, the product crystallizes. Recrystallization is effected in ethanol (96°) (1.400 liters for the quantity indicated). 246 grams of a white crystalline powder is thus obtained, slightly soluble in water and alcohol. MP (instant) = 168°C with decomposition, yield 77%.

Stage 4: Preparation of 1-[2-Phenyl-2-Methoxy]-Ethyl-4-[3-Phenyl-3-Hydroxypropyl]-Piperazine Dihydrochloride – In a double-neck flask equipped with a thermometer and a mechanical stirrer, there is placed in suspension in 800 ml of methanol, 233 grams of 1-[2-phenyl-2-methoxy]-ethyl-4-[2-benzoyl-ethyl]-piperazine dihydrochloride (0.55 mol). It is cooled to approximately 5°C , and 46 grams of NaOH pellets dissolved in 80 ml of H_2O are added. When the temperature is about 5°C , one addition of 29.2 grams of sodium borohydride in 40 ml H_2O is made. The ice-bath is then removed and stirring continued at ambient temperature for 6 hours.

Cooling is effected in the ice-bath while slowly adding concentrated HCl up to a pH of 2, while maintaining the temperature around 5°C . It is filtered and an equal volume of H_2O is added. If the solution is cloudy it is washed in ether. It is alkalinized by aqueous NaOH (40%), and the oil formed is extracted with ether. The ether phase is washed with water saturated with NaCl, then it is dried over anhydrous Na_2SO_4 .

After evaporation of the solvent, a very thick, colorless oil is obtained. This base is dissolved by 200 ml of absolute ethanol and the quantity of HCl to obtain the dihydrochloride is added. It is left for a few hours over ice, dried, washed with approximately 100 ml of anhydrous ether in order to obtain 190 to 195 grams of 1-[2-phenyl-2-methoxy]-ethyl-4-[3-phenyl-3-hydroxy]-propyl-piperazine dihydrochloride after drying at 60°C in vacuo. The yield is 80%. It is recrystallized from absolute ethanol. The product is in the form of white crystalline powder, soluble in water, slightly soluble in alcohol, insoluble in ethyl acetate.

References

Merck Index 3576

Kleeman & Engel p. 351

OCDS Vol. 2 p. 44 (1980)

DOT 9 (5) 177 (1973)

I.N. p. 384

Saunders, H.E. and Mauverney, R.-Y.; British Patent 1,188,505; April 15, 1970

ERYTHROMYCIN

Therapeutic Function: Antibacterial

Chemical Name: See structural formula

Common Name: —

Structural Formula:

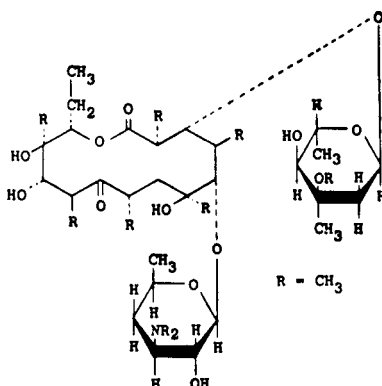

Chemical Abstracts Registry No.: 114-07-8

Trade Name	Manufacturer	Country	Year Introduced
Ilotycin	Dista	U.S.	1952
Erythrocin	Abbott	U.S.	1952
E-Myacin	Upjohn	U.S.	1953
Robimycin	Robins	U.S.	1972
Kesso-Myacin	McKesson	U.S.	1973
Staticin	Westwood	U.S.	1980
Eryc	Faulding	U.S.	1980
I/T/S Ilotycin	Lilly	U.S.	1980
Ery Derm	Abbott	U.S.	1980
A/T/S	Hoechst	U.S.	1981
Ery-Tab	Abbott	U.S.	1981
T.Stat	Westwood	U.S.	1983
Erymax	Allergan	U.S.	1983
Abomacetin	Mochida	Japan	—
Adamycin	Lederle	—	—
Aknemycin	Hermal	W. Germany	—
Benzamycin	Dermik	U.S.	—
Bisolvanat	Thomae	W. Germany	—

Trade Name	Manufacturer	Country	Year Introduced
Clafanone	Roche	—	—
Dowmycin	Merrell-Dow	—	—
Endoeritrin	Lopez-Brea	Spain	—
Eritrobios	Nuovo Cons. Sanit. Naz.	Italy	—
Eritonormo	Normon	Spain	—
Erycinum	Schering	W. Germany	—
Ery-Max	Astra	Sweden	—
Erythro ST	Nippon Kayaku	Japan	—
Estromycin	Orion	Finland	—
Ilosone	Lilly	Italy	—
Marocid	Lifepharma	Italy	—
Mistral	Dessy	Italy	—
Orizina	Perga	Spain	—
Pediamycin	Ross	U.S.	—
Polarmicina	Medipolar	Sweden	—
Reciomycin	Recip	Sweden	—
Retcin	D.D.S.A.	U.K.	—
Rivotrocin	Rivopharm	Switz.	—
RP-Mycin	Reid-Provident	U.S.	—
Taimoxin-F	Taiyo	Japan	—
Ytrocin	Lederle	—	—

Raw Materials

Bacterium *Streptomyces erythreus*
 Starch
 Soybean meal

Manufacturing Process

An inoculum broth is prepared having the following composition: 32 pounds starch; 32 pounds soybean meal; 10 pounds corn steep solids; 10 pounds sodium chloride; 6 pounds calcium carbonate; and 250 gallons water.

The broth is placed in an iron tank of 350 gallon capacity and is sterilized by heating it under pressure at a temperature of about 120°C for 30 minutes. The sterilized broth is cooled and inoculated aseptically with spores of *Streptomyces erythreus*, NRRL 2338. The organism is grown in the broth at about 26°C for a period of 45 hours. During the growth period the broth is stirred and aerated with sterile air in the amount of about 0.5 volume of air per volume of culture broth per minute.

In a 1,600-gallon iron tank is placed a fermentation broth having the following composition: 153 pounds starch; 153 pounds soybean meal; 51 pounds corn steep solids; 33 pounds calcium carbonate; 51 pounds sodium chloride; and 1,200 gallons water.

The culture broth is sterilized by heating it under pressure at about 120°C for about 30 minutes. The broth is cooled and the above inoculant culture is added aseptically. The organism is grown in the broth for 4 days at a temperature of 26°C. During the growth period the broth is stirred and sterile air is blown through the broth at a rate of about 0.5 volume of air per volume of broth per minute. At the end of the growth period the broth shows an antibiotic activity equivalent to about 150 mcg of erythromycin per ml of broth.

The culture broth (about 1,100 gallons in volume) is adjusted to pH 9.5 with 40% sodium hydroxide solution and is filtered to remove the mycelium, the filtration being assisted by use of 3% of Hyflo Super-Cel, a filter aid, (sold by Johns-Manville Company). The clear filtrate is extracted with amyl acetate in a Podbielniak extractor using a ratio of 1 volume of amyl acetate to 6 volumes of clarified broth. The amyl acetate extract is in turn extracted batchwise with water brought to about pH 5 by the addition of sulfuric acid. Two

extractions are carried out, the first with ½ volume and the second with ¼ volume of water adjusted to pH 5 with sulfuric acid. The aqueous extracts are combined and adjusted to pH 8.0 with sodium hydroxide solution.

The alkaline solution is concentrated in vacuo to a volume of about 30 gallons and the solution is then adjusted to pH 9.5 by the addition of aqueous sodium hydroxide and is allowed to stand. Erythromycin separates as a crystalline material. The crystals are filtered off, the mother liquor is adjusted to about pH 8 by the addition of dilute sulfuric acid and is concentrated in vacuo to a volume of about 30 gallons. The solution is adjusted to about pH 9.5 and allowed to stand, whereupon an additional amount of erythromycin separates in crystalline form. The total amount of erythromycin obtained is about 256 grams. The erythromycin is purified by several recrystallizations from aqueous acetone (2:1 mixture), according to U.S. Patent 2,653,899.

References

Merck Index 3624

Kleeman & Engel p. 353

PDR pp. 516, 831, 840, 888, 930, 935, 1307, 1345, 1429, 1557, 1606, 1895

I.N. p. 387

REM p. 1189

Clark, R.J. Jr.; U.S. Patent 2,823,203; February 11, 1958; assigned to Abbott Laboratories
 Friedland, W.C., Denison, F.W. Jr. and Peterson, M.H.; U.S. Patent 2,833,696; May 6, 1958;
 assigned to Abbott Laboratories

Bunch, R.L. and McGuire, J.M.; U.S. Patent 2,653,899; September 29, 1953; assigned to Eli Lilly and Company

ERYTHROMYCIN ESTOLATE

Therapeutic Function: Antibacterial

Chemical Name: Erythromycin propionate lauryl sulfate

Common Name: —

Structural Formula:

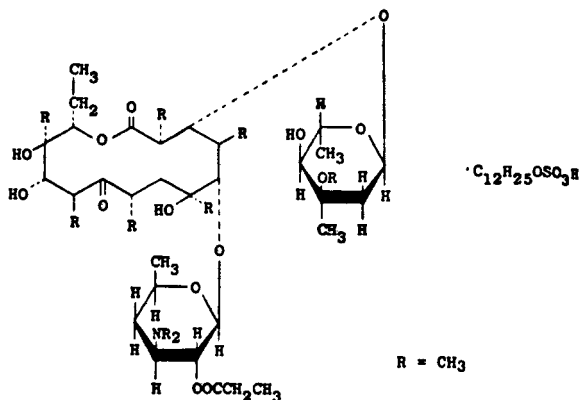

Chemical Abstracts Registry No.: 3521-62-8

Trade Name	Manufacturer	Country	Year Introduced
Ilosone	Dista	U.S.	1958
Biomicon	Isa	Brazil	—
Chemthromycin	Chemo-Drug	Canada	—
Cimetrin	Cimex	Switz.	—
Dreimicina	Dreikehl	Spain	—
Endoeritrin	Lopez-Brea	Spain	—
Erimec	Isola-Ibi	Italy	—
Eriscel	Rachelle	U.S.	—
Eritrazon	Cipan	Portugal	—
Eritrobiotic	Panther-Osfa	Italy	—
Eritrocin	Maipe	Spain	—
Eritrodes	Dessy	Italy	—
Eritroveinte	Madariaga	Spain	—
Erito-Wolf	Incasa-Wolff	Spain	—
Ermysin	Farmos	Finland	—
Ery-Toxinal	Pharma-Selz	W. Germany	—
Erytrarco	Arco	Switz.	—
Erythromyctine	Barlowe Cote	Canada	—
Erytro-Prot	Proto	Switz.	—
Laurilin	Deva	Turkey	—
Lauromicina	Dukron	Italy	—
Lubomycine	Polfa	Poland	—
Manilina	Lepetit	Italy	—
Neo-Erycinum	Schering	W. Germany	—
Neo-Itolylin	Lilly	—	—
Novorythro	Novopharm	Canada	—
Propiocine	Roussel	France	—
Proterytrin	Proter	Italy	—
Ritromin	Cophar	Switz.	—
Stellamicina	Pierrel	Italy	—
Togiren	Schwarzhaupt	W. Germany	—

Raw Materials

Monopropionylerythromycin
Sodium lauryl sulfate

Manufacturing Process

16.7 grams of monopropionylerythromycin are dissolved in 50 ml of warm acetone. To the solution are added 6.4 grams of sodium lauryl sulfate dissolved in 50 ml of distilled water containing 2 ml of glacial acetic acid. The white crystalline precipitate of monopropionylerythromycin lauryl sulfate which separates is filtered off and dried. It melts at about 135° to 137°C.

References

Merck Index 3625
Kleeman & Engel p. 354
PDR pp. 830, 838, 993, 1606
I.N. p. 388
REM p. 1191
Bray, M.D. and Stephens, V.C.; U.S. Patent 3,000,874; September 19, 1961; assigned to Eli Lilly and Company

ERYTHROMYCIN GLUCEPTATE

Therapeutic Function: Antibacterial

Chemical Name: Erythromycin glucoheptonic acid salt

Common Name: —

Structural Formula: See Erythromycin for structure of base

Chemical Abstracts Registry No.: 23067-13-2

Trade Name	Manufacturer	Country	Year Introduced
Ilotycin Glucoptate	Dista	U.S.	1954
Erycinum	Schering	—	—
Ilotycin Otic	Lilly	—	—

Raw Materials

Erythromycin
d-Glucoheptonic acid lactone

Manufacturing Process

A solution of 10 grams of d-glucoheptonic acid lactone in 50 ml of distilled water is warmed on a steam bath for about 2 hours to hydrolyze the lactone to the acid. The mixture is cooled and 100 ml of 95% ethanol are added. To the solution of glucoheptonic acid are added about 37 grams of erythromycin and the volume of the reaction mixture is brought to 200 ml by the addition of 95% ethanol. The reaction mixture is stirred for about 2 hours and is filtered through a porcelain filter candle of porosity 02. To provide a sterile product, aseptic technique is used throughout the remainder of the procedure. To the filtered solution are added slowly and with stirring about 1,200 ml of anhydrous ether, to cause precipitation of erythromycin d-glucoheptonate and to keep in solution any excess of unreacted erythromycin. The precipitated erythromycin salt is removed by filtration through a sintered glass funnel, is washed with anhydrous ether and is dried in vacuo. Erythromycin d-glucoheptonate melts over a range of about 95° to 140°C.

References

Merck Index 3626

Kleeman & Engel p. 355

PDR p. 841

I.N. p. 388

REM p. 1190

Shepler, J.T.; U.S. Patent 2,852,429; September 16, 1958; assigned to Eli Lilly and Co.

ERYTHROMYCIN LACTOBIONATE

Therapeutic Function: Antibacterial

Chemical Name: Erythromycin lactobionate

Common Name: —

Structural Formula: See Erythromycin for structure of base.

Chemical Abstracts Registry No.: 3847-29-8

Trade Name	Manufacturer	Country	Year Introduced
Erythrocin Lactobionate	Abbott	U.S.	1954
Erythrocin Piggyback	—	U.S.	—
Laurylin	Pierrel	Italy	—
Laurylin	Douglas	New Zealand	—
Lubomycline L	Pofa	Poland	—
Proterytrin IV	Proter	Italy	—

Raw Materials

Erythromycin
Lactobiono-delta-lactone

Manufacturing Process

A solution of erythromycin free base is prepared by dissolving 8.0 grams of erythromycin in 25 cc of acetone. 4.0 grams of lactobiono-delta-lactone is dissolved in 25 cc of water. The free lactobionic acid is formed in this solution and it has the molecular formula $C_{12}H_{22}O_{12}$. The two solutions are mixed and evaporated to a gummy residue. This residue is dissolved in 60 cc of water and the solution is frozen and dried in vacuum by lyophilization. The dried residue of erythromycin lactobionate is a white amorphous powder and weighs 11.7 grams. The reaction product has an activity against *B. subtilis* of 420 units per milligram. Its solubility in water is about 200 mg/cc and the melting point of the white powdery reaction product is 145° to 150°C.

References

Merck Index 3627
Kleeman & Engel p. 356
PDR pp. 519, 872
I.N. p. 388
REM p. 1190
Hoffhine, C.E. Jr.; U.S. Patent 2,761,859; September 4, 1956; assigned to Abbott Laboratories

ERYTHROMYCIN STEARATE

Therapeutic Function: Antibacterial

Chemical Name: Erythromycin stearate

Common Name: —

Structural Formula: See Erythromycin for structure of base

Chemical Abstracts Registry No.: 643-22-1

Trade Name	Manufacturer	Country	Year Introduced
Erythrocin Stearate	Abbott	U.S.	1952
Bristamycin	Bristol	U.S.	1971
Ethril	Squibb	U.S.	1972
Erypar	Parke Davis	U.S.	1972
SK-Erythromycin	SKF	U.S.	1972
Qidmycin	Mallinckrodt	U.S.	1973
Pfizer-E	Pfizer	U.S.	1973
Dowmycin-E	Merrell Dow	U.S.	1974

Trade Name	Manufacturer	Country	Year Introduced
Erythromycin Stearate	Lederle	U.S.	1975
Wyamycin-S	Wyeth	U.S.	1978
Abbotcine	Abbott	France	—
Cimetrin	Cimex	Switz.	—
Dura Erythromycin	Durachemie	W. Germany	—
Emisin	Saba	Turkey	—
E-Mycin	Protea	Australia	—
Eratrex	Bristol	—	—
Erisul	Liba	Turkey	—
Eritral	Helvepharm	Switz.	—
Eritro	Ilitas	Turkey	—
Eritrolag	Lagap	Switz.	—
Ermysin S	Farmos	Finland	—
Erostin	Knoll	Australia	—
Erymycin	Squibb	—	—
Eryprim	Scarium	Switz.	—
Erythran	Spirig	Switz.	—
Erythrocin	Dainippon	Japan	—
Erythro-S	Sanko	Japan	—
Erythro-Teva	Teva	Israel	—
Ethryn	Faulding	Australia	—
Helvemycin	Helvepharm	Switz.	—
Resibion	Leiras	Finland	—
Rossomicina	Pulitzer	Italy	—
Servitrocin	Servipharm	Switz.	—
Torlamicina	Torlan	Spain	—
Wemid	Bernabo	Argentina	—

Raw Materials

Erythromycin
 Stearoyl Chloride
 1-Ethylpiperidine

Manufacturing Process

To a well-stirred solution of 3.18 grams (10.5 mmol) of stearoyl chloride and 1.24 grams (11.0 mmol) of 1-ethylpiperidine in 50 ml of methylene chloride is added 7.20 grams (10.0 mmol) of erythromycin. After a short time complete solution is obtained and stirring is then discontinued. The solution is allowed to stand overnight. The solution is diluted to 250 ml by the addition of methylene chloride and washed three times with 100 ml portions of water followed by two washes with 5% sodium bicarbonate solution. The organic layer is dried over anhydrous sodium sulfate and filtered, the solvent being removed under diminished pressure. The product is dried to constant weight at room temperature in a vacuum desiccator.

References

Merck Index 3629
 Kleeman & Engel p. 356
 PDR pp. 521, 993, 1346, 1723, 1999
 I.N. p. 388
 REM p. 1191
 Booth, R.E., Dale, J.K. and Murray, M.F.; U.S. Patent 2,862,921; December 2, 1958; assigned to The Upjohn Company

ESTAZOLAM

Therapeutic Function: Hypnotic, sedative

Chemical Name: 8-chloro-6-phenyl-4H-[1,2,4]-triazolo[4,3-a][1,4] benzodiazepine

Common Name: —

Structural Formula:

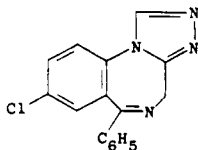

Chemical Abstracts Registry No.: 29975-16-4

Trade Name	Manufacturer	Country	Year Introduced
Eurodin	Takeda	Japan	1975
Nuctalon	Cassenne-Takeda	France	1978
Esilgan	Cyanamid	Italy	1983
Domnamid	Lundbeck	—	—

Raw Materials

7-Chloro-1,3-dihydro-5-phenyl-2H-1,4-benzodiazepine-2-thione
Formic acid hydrazide

Manufacturing Process

A mixture of 5.74 grams (0.020 mol) of 7-chloro-1,3-dihydro-5-phenyl-2H-1,4-benzodiazepine-2-thione, 3.6 grams (0.060 mol) of formic acid hydrazide and 200 ml of 1-butanol was refluxed for 3.75 hours with a slow stream of nitrogen bubbling through the mixture. The mixture was concentrated, the residue was suspended in water and the suspension was filtered. The filter cake consisted principally of unchanged starting material. The filtrate was concentrated, ethyl acetate and Skellysolve B hexanes being added during the concentration, giving crude product (2.54 grams), MP 220.5° to 225°C. Recrystallization of this material from ethyl acetate-Skellysolve B hexanes gave 8-chloro-6-phenyl-4H-s-triazolo[4,3-a][1,4] benzodiazepine, MP 228° to 229°C.

References

Merck Index 3645

Kleeman & Engel p. 357

DOT 11 (5) 185, 211 (1975) & 12 (9) 353 (1976)

I.N. p. 390

Hester, J.B. Jr.; U.S. Patent 3,701,782; October 31, 1972; assigned to The Upjohn Co.

ESTRADIOL CYPIONATE

Therapeutic Function: Estrogen

Chemical Name: Estradiol 17 β -cyclopentanepropionate

Common Name: —

Structural Formula:

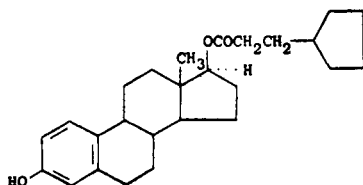

Chemical Abstracts Registry No. 313-06-4

Trade Name	Manufacturer	Country	Year Introduced
Depo-Estradiol	Upjohn	U.S.	1952
Depa-Estradiol	Upjohn	U.S.	1952
Cicloestradiolo	Farmigea	Italy	—
Depoestra	Tennessee Pharm.	U.S.	—
Depogen	Hyrex	U.S.	—
E-Cypionate	Legere	U.S.	—
E-Ionate	Reid-Provident	U.S.	—
Estro-Cyp	Keene Pharm.	U.S.	—
Estrofem	Pasadena	U.S.	—
Estromed-PA	Medics	U.S.	—
Femovirin	Hoechst	—	—
Neoginon Depositem	Lusofarmaco	Italy	—
Oestradiol-Retard	Hepatrol	France	—
Pertradiol	Dexter	Spain	—
Spendepiol	Spencer-Mead	U.S.	—
T-E Cypionate	Legere	U.S.	—

Raw Materials

Estradiol-17 β
 Cyclopentanepropionyl chloride
 Potassium carbonate

Manufacturing Process

A solution of 80.0 grams (0.294 mol) of estradiol-17 β in 860 ml of pyridine was cooled in an ice-bath and 130.0 grams (0.81 mol) of cyclopentanepropionyl chloride was added dropwise with stirring during a period of about 20 minutes. The ice-bath was removed, stirring was continued for 1 hour and the reaction mixture was allowed to stand at room temperature overnight. The mixture was warmed on a steam bath and stirred for about 45 minutes, cooled and poured slowly onto about 1,000 grams of ice to which had been added 330 ml of concentrated sulfuric acid. The precipitated product was extracted with 400 to 500 ml of ether, and the extract was washed successively with two 100-ml portions of cold 1 N sulfuric acid, two 100-ml portions of saturated sodium carbonate solution and water until the pH was 7 and dried over anhydrous sodium sulfate. After removal of the drying agent, the solution was concentrated to a volume of about 250 ml and an equal volume of methanol was added.

After chilling overnight a total of 120.0 grams (78.5%) of estradiol 3,17 β -dicyclopentanepropionate was obtained which melted at 87° to 90°C. A sample recrystallized from ether-methanol for analysis melted at 90.5° to 91.5°C.

To a solution of 2.5 grams (18.1 mmol) of potassium carbonate in 25 ml of water was added 225 ml of methanol followed by 5.0 grams (9.6 mmol) of estradiol 3,17 β -dicyclopentanepropionate. The mixture was stirred for 2½ hours at 20±2°C during which time some precipitation occurred. The mixture was poured into 700 ml of water with efficient stirring and the precipitated solid was removed by filtration, washed with water and dried.

Recrystallization of the crude product from 80% methanol gave 3.16 grams (83%) of estradiol 17 β -cyclopentanepropionate melting at 148° to 151°C. Recrystallization from benzene-petroleum ether raised the MP to 151° to 152°C.

References

- Merck Index 3651
 Kleeman & Engel p. 360
 PDR p. 1033
 OCDS Vol. 1 p. 162 (1977)
 I.N. p. 391
 REM p. 986
 Ott, A.C.; U.S. Patent 2,611,773; September 23, 1952; assigned to The Upjohn Company

ESTRADIOL VALERATE

Therapeutic Function: Estrogen

Chemical Name: Estradiol valerate

Common Name: —

Structural Formula: See Estradiol Cypionate for form of salt

Chemical Abstracts Registry No.: 979-32-8

Trade Name	Manufacturer	Country	Year Introduced
Delestrogen	Squibb	U.S.	1954
Lastrogen	Key	U.S.	1961
Reposo-E	Canfield	U.S.	1961
Estraval PA	Tutag	U.S.	1970
Androtardyl-Oestradiol	S.E.P.P.S.	France	—
Ardefem	Burgin-Arden	U.S.	—
Atladiol	I.C.I.	U.S.	—
Depogen	Sig	U.S.	—
Diol-20	Blaine	U.S.	—
Dioval	Keene	U.S.	—
Ditate	Savage	U.S.	—
Dura-Estate	Ries	U.S.	—
Dura-Estradiol	Myers-Carter	U.S.	—
Duratrad	Ascher	U.S.	—
Estate	Savage	U.S.	—
Estral-L	Pasadena	U.S.	—
Femogen	Fellows	U.S.	—
Femogex	Stickley	Canada	—
Menaval	Legere	U.S.	—
Oestrogynal	Asche	W. Germany	—
Ostrin Depo	I.E. Kimya	Turkey	—
Pelanin	Mochida	Japan	—
Primogyn-Depot	Schering	W. Germany	—
Progynon Depot	Schering	W. Germany	—
Progynova	Schering	W. Germany	—
Repestragen	Spencer-Mead	U.S.	—
Repo-Estra	Central	U.S.	—
Retestrin	Rocky Mountain	U.S.	—
Span-Est	Scrip	U.S.	—

Trade Name	Manufacturer	Country	Year Introduced
Testaval	Legere	U.S.	—
Valergen	Hyrex	U.S.	—

Raw Materials

Estradiol
 n-Valeric anhydride
 Potassium carbonate

Manufacturing Process

2.3 parts of estradiol are mixed with 12 parts of pyridine and 10 parts of n-valeric anhydride and the mixture is heated for some time at 115°C in the oil bath. The cooled solution is mixed with 250 parts of water, whereupon an oil separates; this is extracted with ether. The separated ethereal solution is washed successively with N sulfuric acid, water, N sodium carbonate solution and water and then dried. The ether is then removed and the residue purified by distillation in a high vacuum. The estradiol di-n-valerate forms a yellowish oil according to U.S. Patent 2,205,627.

1 part of estradiol-3,17-n-divalerianate (boiling point at 0.01 mm = 220° to 230°C bath temperature; made, e.g., by the action of n-valeric anhydride on a solution of estradiol in pyridine) is mixed with 50 parts of a solution of 0.5% strength of potassium carbonate in methyl alcohol of 95% strength, and the whole is stirred for some time at 20°C. The oily n-di-valerianate passes gradually into solution. The solution is neutralized and the precipitate is produced by the addition of about 200 parts of water. This finely crystalline product is filtered and washed successively with water, dilute sodium carbonate solution and again with water. It may be further purified by crystallization from a mixture of methyl alcohol and water. The estradiol-17-mono-n-valerianate melts at 144° to 145°C according to U.S. Patent 2,233,025.

References

Kleeman & Engel p. 655

PDR pp. 1033, 1604

OCDS Vol. 1 p. 162 (1977)

I.N. p. 391

REM p. 986

Miescher, K. and Scholz, C.; U.S. Patent 2,205,627; June 25, 1940; assigned to the Society of Chemical Industry in Basle, Switzerland

Miescher, K. and Scholz, C.; U.S. Patent 2,233,025; February 25, 1941; assigned to Ciba Pharmaceutical Products, Incorporated

ESTRAMUSTINE PHOSPHATE

Therapeutic Function: Cancer chemotherapy

Chemical Name: Estradiol-3-N-bis(β-chloroethyl)carbamate

Common Name: —

Structural Formula:

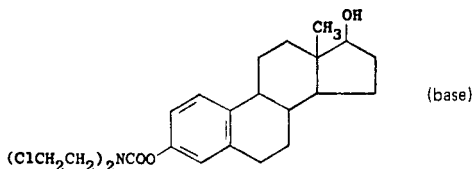

Chemical Abstracts Registry No.: 4891-15-0

Trade Name	Manufacturer	Country	Year Introduced
Estracyt	Bastian-Werk	W. Germany	1973
Estracyt	Lundbeck	U.K.	1977
Estracyt	Roche	France	1981
Estracyt	Roche	Italy	1981
Emcyt	Roche	U.S.	1982
Estracyt	Abello	Spain	—
Estracyt	Leo	Sweden	—

Raw Materials

Bis(β -Chloroethyl)amine	Phosgene
Phosphorus oxychloride	Estradiol

Manufacturing Process

A solution in dry benzene of 82 grams of bis(β -chloroethyl)amine freshly liberated from its hydrochloride is added gradually to a solution of 36 grams of carbonyl chloride (phosgene) in benzene at a temperature below 10°C. The mixture is mechanically stirred for 3 hours, the precipitate of bis(β -chloroethyl)amine hydrochloride is removed by filtration and the benzene is distilled off on a water bath. The residue is distilled in vacuo and the N-chloroformyl-bis(β -chloroethyl)amine is obtained as a pale yellow oil with a BP of 114° to 116°C at 1 mm Hg.

To a solution of 16.35 grams of estradiol in 75 ml of dry pyridine, 21.00 grams of the abovementioned chloroformyl-bis(β -chloroethyl)amine are added while stirring and cooling with ice-water.

The reaction mixture is allowed to stand at room temperature for 60 to 70 hours under the exclusion of air humidity. Then the excess of the chloroformyl compound is hydrolyzed with crushed ice. Ethyl acetate is added and after shaking, the ethyl acetate solution is separated and washed with water, dried over sodium sulfate and evaporated in vacuo to dryness.

The residue is the 3-N-bis(β -chloroethyl)carbamate of estradiol. The compound melts at 101° to 103°C after recrystallization from isopropyl ether plus hexane (1:1).

To a solution of 2.3 ml of phosphorus oxychloride in 50 ml of dry pyridine is added a solution of 2.2 grams of 3-N-bis(β -chloroethyl)carbamate of estradiol while stirring and at a temperature of about -10°C. The reaction mixture is allowed to stand at about 0°C for 1½ hours, whereupon it is hydrolyzed by pouring it into ice-water. The main part of the pyridine is evaporated in vacuo, whereupon the residue is poured into 100 ml of cold 3.5 N hydrochloric acid with stirring. The precipitate thus obtained is isolated and washed with 0.1 N hydrochloric acid and water.

The compound, which consists of the 17-phosphate of estradiol-3-N-bis(β -chloroethyl)carbamate, melts under decomposition at about 155°C. It is soluble in an aqueous solution of alkali.

References

- Merck Index 3653
- Kleeman & Engel p. 361
- PDR p. 1483
- OCDS Vol. 3 p. 83 (1984)
- DOT 8 (11) 415 (1972)
- I.N. p. 392
- REM p. 1155

Fex, H.J., Hogberg, K.B., Konyves, I. and Kneip, P.H.O.J.; U.S. Patent 3,299,104; Jan. 17, 1967; assigned to Leo AB, Sweden

ESTRIOL SUCCINATE

Therapeutic Function: Estrogen

Chemical Name: Estra-1,3,5(10)-triene-3,16 α ,17 β -triol succinate

Common Name: 16 α -hydroxyestradiol

Structural Formula:

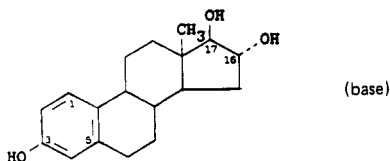

Chemical Abstracts Registry No.: 514-68-1

Trade Name	Manufacturer	Country	Year Introduced
Hemostyptanon	Endopancrine	France	1966
Orgastypin	Organon	W. Germany	—
Ovestin	Ravasini	Italy	—
Synapause	Nourypharma	W. Germany	—
Synapause	Organon	France	—
Synapasa	Erco	Denmark	—

Raw Materials

Estriol
Succinic acid anhydride

Manufacturing Process

A mixture consisting of 8 grams of estriol, 20 grams of succinic acid anhydride and 60 ml of pyridine is heated at 90°C for 4 hours, after which the reaction mixture is poured into water. The aqueous solution is extracted with ether, the ether layer is separated, washed with diluted sulfuric acid and after that with water until neutral, then evaporated to dryness to obtain 14 grams of an amorphous substance. Melting point 82° to 86°C. This drying residue proves to consist of a mixture of estriol disuccinate and estriol monosuccinate, which are separated by repeated crystallization from a mixture of methanol and water.

References

Merck Index 3654
Kleeman & Engel p. 362
I.N. p. 392
Organon Laboratories Limited, England; British Patent 879,014; October 4, 1961

ETHACRYNIC ACID

Therapeutic Function: Diuretic

Chemical Name: [2,3-dichloro-4-(2-methylene-1-oxobutyl)phenoxy] acetic acid

Common Name: —

Structural Formula:

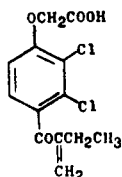

Chemical Abstracts Registry No.: 58-54-8

Trade Name	Manufacturer	Country	Year Introduced
Hydromedin	MSD	W. Germany	1966
Edecrin	MSD	U.K.	1966
Edecrin	MSD	U.S.	1967
Edecrin	MSD	Italy	1967
Edecrine	MSD	France	1968
Crinuryl	Assia	Israel	—
Edecril	Merck-Banyu	Japan	—
Reomax	Bioindustria	Italy	—
Taladren	Malesci	Italy	—

Raw Materials

2,3-Dichlorophenoxyacetic acid	n-Butyryl chloride
Aluminum chloride	Paraformaldehyde
Dimethylamine hydrochloride	

Manufacturing Process

Step A: Preparation of 2,3-Dichloro-4-Butyrylphenoxy Acid — The product is prepared using the following ingredients: 22.1 grams (0.1 mol) 2,3-dichlorophenoxyacetic acid; 21.3 grams (0.2 mol) n-butyryl chloride; and 53.3 grams (0.4 mol) powdered aluminum chloride.

The 2,3-dichlorophenoxyacetic acid and n-butyryl chloride are placed in the reaction vessel and stirred while the aluminum chloride is added portionwise over a 45-minute period. The mixture then is heated on the steam bath for 3 hours and allowed to cool to room temperature. The gummy product obtained is added to a mixture of 300 ml of crushed ice and 30 ml concentrated hydrochloric acid. The resulting mixture is extracted with ether and the extract evaporated at reduced pressure. The residue is suspended in boiling water and dissolved by addition of a minimum quantity of 40% sodium hydroxide. After treatment with decolorizing charcoal and filtering, the hot filtrate is made acid to Congo red paper and chilled in ice.

The oil that separates is extracted with ether, the extract dried over anhydrous sodium sulfate and then evaporated at reduced pressure. The residue is dissolved in boiling benzene (75 ml) treated with decolorizing charcoal, filtered, treated with boiling cyclohexane (275 milliliters) and cooled to give 22.3 grams of 2,3-dichloro-4-butyrylphenoxyacetic acid. After several recrystallizations from a mixture of benzene and cyclohexane, then from methylcyclohexane, next from a mixture of acetic acid and water, and finally from methylcyclohexane, the product melts at 110° to 111°C (corr).

Step B: Preparation of 2,3-Dichloro-4-[2-(Dimethylaminomethyl)Butyryl]Phenoxyacetic Acid Hydrochloride — In a 100 ml round flask equipped with an outlet tube suitable for

application of intermittent suction, an intimate mixture of 5.20 grams (0.0179 mol) 2,3-dichloro-4-butyrylphenoxyacetic acid; 0.63 gram (0.0209 mol) paraformaldehyde; 1.59 grams (0.0195 mol) dry dimethylamine hydrochloride; and 4 drops acetic acid is heated on the steam bath for about 1.5 hours during which period suction is applied for about 1 minute intervals five or six times. Upon cooling, a solid is obtained.

The crude reaction product is triturated with ether to give 5.8 grams (85%) of 2,3-dichloro-4-[2-dimethylaminomethyl]butyryl]phenoxyacetic acid hydrochloride in the form of a white solid. After two recrystallizations from a mixture of methanol and ether, the product melts at 165° to 167°C.

Step C: Preparation of 2,3-Dichloro-4-(2-Methylenebutyryl)Phenoxyacetic Acid — The Mannich compound obtained as described above is treated with aqueous sodium bicarbonate to form 2,3-dichloro-4-(2-methylenebutyryl)phenoxyacetic acid, MP 115° to 118°C. Two recrystallizations from a mixture of benzene and cyclohexane give white solid material melting at 118.5° to 120.5°C.

References

Merck Index 3664

Kleeman & Engel p. 364

PDR p. 1173

OCDS Vol. 1 p. 120 (1977) & 2, 103 (1980)

DOT 2 (1)14 (1966)

I.N. p. 22

REM p. 942

Schultz, E.M. and Sprague, J.M.; U.S. Patent 3,255,241; June 7, 1966; assigned to Merck & Co., Inc.

ETHAMBUTOL HYDROCHLORIDE

Therapeutic Function: Antitubercular

Chemical Name: (R)-2,2'-(1,2-ethanediyldiimino)bis-1-butanol dihydrochloride

Common Name: —

Structural Formula:

$$\text{CH}_3\text{CH}_2\overset{\text{CH}_2\text{OH}}{\underset{|}{\text{C}}}\text{HNHCH}_2\text{CH}_2\text{NHCH}\overset{\text{CH}_2\text{OH}}{\underset{|}{\text{C}}}\text{CH}_2\text{CH}_3 \cdot 2\text{HCl}$$

Chemical Abstracts Registry No.: 74-55-5 (Base)

Trade Name	Manufacturer	Country	Year Introduced
Myambutol	Lederle	U.S.	1967
Myambutol	Cyanamid	W. Germany	1967
Myambutol	Lederle	U.K.	1967
Miambutol	Cyanamid	Italy	1967
Myambutol	Lederle	France	1970
Abbutol	Abbott	—	—
Afimocil	Prodes	Spain	—
Anvital	Cheminova Espanola	Spain	—
Cidanbutol	Cidan	Spain	—
Dexambutol	Sobio	France	—
Ebutol	Kaken	Japan	—
EMB-Fatol	Saarstickstoff-Fatol	W. Germany	—

Trade Name	Manufacturer	Country	Year Introduced
Embutol	Saba	Turkey	—
Esanbutol	Lederle	Japan	—
Etambrin	Lopez-Brea	Spain	—
Etambutol Beta	Beta	Argentina	—
Etambutyl	Stholl	Italy	—
Etapiam	Piam	Italy	—
Etbutol	Leiras	Finland	—
Etibi	Zoja	Italy	—
Etibi	Gerot	Austria	—
Farmabutol	Farmabion	Spain	—
Fimbutol	Sanomed	Spain	—
Inagen	Morgens	Spain	—
Mycobutol	I.C.I.	Italy	—
Olbutam	Carlo Erba	Italy	—
Oributol	Orion	Finland	—
Stambutol	Pharmacial	Finland	—
Sural	Chinoïn	Hungary	—
Syntomen	VEB Berun-Chemie	E. Germany	—
Tambutol	Atabay	Turkey	—
Tisiobutol	Capitol	Spain	—
Tuberol	Deva	Turkey	—

Raw Materials

2-Amino-1-butanol
Hydrogen chloride

Ethylene dichloride
Sodium hydroxide

Manufacturing Process

To 27 grams (2.55 mols) of 2-amino-1-butanol was added 100 grams (1.0 mol) of ethylene dichloride. The mixture was heated at reflux and in a few minutes, the exothermic reaction required the removal of exterior heating. After 10 minutes, exterior heating was recommenced for an additional 20 minutes. The hot mixture was then treated with 300 ml of methanol and then cautiously with 84 grams (2.1 mols) of sodium hydroxide in 80 ml of water. The precipitated sodium chloride was removed by filtration. The excess 2-amino-1-butanol distilled as light yellow oil at 83° to 87°C/13 mm. The viscous residue distilled at 165° to 170°C/0.6 mm as a light yellow oil which tended to solidify in the air condenser; yield, 108 grams.

Recrystallization by dissolving in 80 ml of hot ethanol, adding about 150 ml of petroleum ether (BP 90° to 100°C) and cooling at 5°C overnight, gave 64 grams of white crystals melting at 128° to 132.5°C. This, on recrystallization from 100 ml of 95% ethanol, gave 35 grams of white crystals melting at 134.5° to 136°C and a second crop of 10 grams melting at 132.5° to 134°C which is the meso base. Its dihydrochloride melts at 202° to 203°C.

From the ethanolic filtrates upon addition of 130 ml of about 4 N ethanolic hydrochloric acid and cooling, there was obtained 55 grams of white crystals melting at 176.5° to 178°C and a second crop of 10 grams melting at 171.5° to 174.5°C. This is the dl racemate dihydrochloride.

References

Merck Index 3666
Kleeman & Engel p. 367
PDR p. 1020
OCDS Vol. 1 p. 222 (1977)
DOT 3 (4) 133 (1967)
I.N. p. 395
REM p. 1214

Wilkinson, R.G. and Shepherd, R.G.; U.S. Patent 3,297,707; January 10, 1967; assigned to American Cyanamid Company

ETHAMIVAN

Therapeutic Function: Central and respiratory stimulant

Chemical Name: N,N-Diethyl-4-hydroxy-3-methoxybenzamide

Common Name: Vanillic acid diethylamide

Structural Formula:

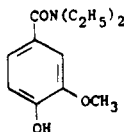

Chemical Abstracts Registry No.: 304-84-7

Trade Name	Manufacturer	Country	Year Introduced
Emivan	U.S.V.	U.S.	1961
Corivanil	Sirt-B.B.P.	Italy	—
Romecor	Benvegna	Italy	—
Vandid	Riker	U.K.	—
Vandid	Lentia	W. Germany	—

Raw Materials

Vanillinic acid
Diethylamine
Phosphorus pentoxide

Manufacturing Process

4 g of vanillinic acid are mixed with 3.6 g of diethylamine, after cooling 2.2 g of phosphorus pentoxide and the same amount of glass powder are added, and then reacted with xylene until a thin paste has been formed. The latter is boiled for some hours in the reflux cooler, moisture being excluded. Decantation follows, and the residue is dissolved by means of a warm solution of potassium carbonate until only glass powder or small amount of impurities remain undissolved, and then the xylene solution is shaken up therewith. The xylene solution is then separated, the aqueous layer is again extracted with ether, and the ether extract is combined with the xylene solution. The mixture is then distilled under the lowest possible pressure, collecting the fraction between 170°C and 250°C (referred to 10 Torr), and purifying it by further fractionation. In this way a slightly yellowish oil is obtained, which crystallizes after some time. By dissolving in ligroin and crystallizing, pure vanillinic acid diethylamide is obtained in the form of white needles; MP 95°C to 95.5°C.

References

Merck Index 3667

Kleeman & Engel p. 365

OCDS Vol. 2 p. 94 (1980)

Kratzl, K. and Kvasnicka, E.; U.S. Patent 2,641,612; June 9, 1953; assigned to Oesterreichische Stickstoffwerke A.G. (Austria)

ETHAMSYLATE

Therapeutic Function: Hemostatic

Chemical Name: 2,5-dihydroxybenzenesulfonic acid compound with N-ethylethanamine

Common Name: Diethylammonium cyclohexadien-4-ol-1-one-4-sulfonate

Structural Formula:

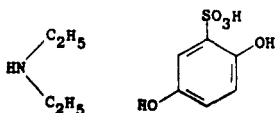

Chemical Abstracts Registry No.: 88-46-0

Trade Name	Manufacturer	Country	Year Introduced
Dicynone	Delalande	France	1965
Dicynene	Delalande	Italy	1967
Altodor	Delalande	W. Germany	1967
Dicynene	Delalande	U.K.	1971
Aglumin	Eisai	Japan	—
Dicynone	Torii	Japan	—
Eselin	Ravizza	Italy	—

Raw Materials

Diethylamine bisulfite
1,4-Benzoquinone

Manufacturing Process

163 grams of pure diethylamine bisulfite are added to an ethyl alcohol solution of 108 grams of 1,4-benzoquinone at a temperature not above 5°C and under continuous stirring. After reaction, the alcohol is removed by distilling under vacuum. The product is recrystallized from ethyl alcohol at 80°C. Yield: 198 grams of diethylammonium cyclohexadienol-4-one-1-sulfonate-4. MP 125°C.

References

Merck Index 3669

Kleeman & Engel p. 366

Laboratories OM Societe Anonyme, Switzerland; British Patent 895,709; May 9, 1962

ETHCLORVYNOL

Therapeutic Function: Sedative, hypnotic

Chemical Name: 1-chloro-3-ethyl-1-penten-4-yl-3-ol

Common Name: Ethyl β-chlorovinyl ethynyl carbinol

Structural Formula:

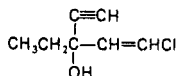

Chemical Abstracts Registry No.: 113-18-8

Trade Name	Manufacturer	Country	Year Introduced
Placidyl	Abbott	U.S.	1965
Arvynol	Pfizer	U.K.	—
Arvynol	Taito Pfizer	Japan	—
Nostel	Dainippon	Japan	—
Roeridorm	Pfizer-Roerig	—	—
Serenesil	Abbott	U.K.	—

Raw Materials

Acetylene
Lithium
Ethyl β -chlorovinyl ketone

Manufacturing Process

Acetylene was passed into a stirred solution of 3.05 grams (0.44 mol) of lithium in 300 ml of liquid ammonia until the blue color exhibited by the mixture had disappeared. Ethyl β -chlorovinyl ketone (47.4 grams; 0.40 mol) dissolved in 50 ml dry ether was then added to the resulting solution of lithium acetylide over a period of 20 minutes, during which the color deepened through yellow to reddish-brown. The mixture was stirred under reflux maintained with a Dry Ice condenser for 2 hours. Thereafter, dry ether (200 ml) was added and the ammonia was permitted to evaporate with stirring overnight.

The residue was poured into a slurry of ice and water containing 30 grams (0.50 mol) of acetic acid. After separating the ether layer, the aqueous layer was washed with two 200 milliliter portions of ether. The combined ether extracts were washed with saturated sodium bicarbonate solution, dried over anhydrous magnesium sulfate and evaporated in a stream of pure nitrogen. Three successive distillations of the residue gave 46.3 grams (80.2% yield) of a colorless liquid, boiling point 28.5° to 30°C at 0.1 mm Hg.

References

Merck Index 3677

Kleeman & Engel p. 369

PDR p. 551

I.N. p. 396

REM p. 1070

Bayley, A. and McLamore, W.M.; U.S. Patent 2,746,900; May 22, 1956; assigned to Chas. Pfizer & Co., Inc.

ETHIAZIDE

Therapeutic Function: Diuretic

Chemical Name: 6-chloro-3-ethyl-3,4-dihydro-2H-1,2,4-benzothiadiazine-7-sulfonamide 1,1-dioxide

Common Name: Acthiazidum

Structural Formula:

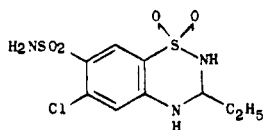

Chemical Abstracts Registry No.: 1824-58-8

Trade Name	Manufacturer	Country	Year Introduced
Ethiazide	Tokyo Tanabe	Japan	1970
Hypertane	Medo-Chemicals	U.K.	—

Raw Materials

5-Chloro-2,4-disulfamylaniline
Propionaldehyde

Manufacturing Process

A mixture of 2.9 grams of 5-chloro-2,4-disulfamyl-aniline in 20 ml of anhydrous diethylene-glycol dimethylether, 0.44 gram of propionaldehyde and 0.5 ml of a solution of hydrogen chloride in ethyl acetate (109.5 grams hydrogen chloride per 1,000 ml) is heated to 80° to 90°C and maintained at that temperature for 1 hour. The reaction mixture is concentrated under reduced pressure; on addition of water, the product separates and is then recrystallized from ethanol or aqueous ethanol to yield the desired 6-chloro-3-ethyl-7-sulfamyl-3,4-dihydro-1,2,4-benzothiadiazine-1,1-dioxide, MP 269° to 270°C.

References

Merck Index 3681
Kleeman & Engel p. 370
OCDS Vol. 1 p. 358 (1977)
I.N. p. 397
Ciba Limited, Switzerland; British Patent 861,367; February 22, 1961

ETHINAMATE

Therapeutic Function: Sedative

Chemical Name: 1-ethynylcyclohexanol carbamate

Common Name: —

Structural Formula:

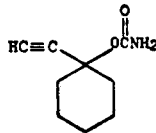

Chemical Abstracts Registry No.: 126-52-3

Trade Name	Manufacturer	Country	Year Introduced
Valmid	Dista	U.S.	1955
Valamin	Schering	W. Germany	—

Raw Materials

1-Ethynyl-1-cyclohexanol
Phosgene
Ammonia

Manufacturing Process

A solution of 34 cc (0.5 mol) of liquid phosgene in 150 cc of absolute ether is reacted while cooling with a mixture of sodium chloride and ice, first with 62 grams (0.5 mol) of 1-ethinyl cyclohexanol-1 and then with 64 cc (0.5 mol) of quinoline. The precipitated quinoline chlorohydrate is filtered off and the filtrate is reacted with ammonia in ether. In this manner 45 grams of the carbamic acid ester of 1-ethinyl cyclohexanol are obtained. Yield: 53% of the theoretical yield. The ester boils at 108° to 110°C/3 mm and on recrystallization from cyclohexane, yields colorless needles melting at 94° to 96°C.

References

Merck Index 3682

Kleeman & Engel p. 370

PDR p. 846

I.N. p. 397

REM p. 1070

Junkmann, K. and Pfeiffer, H.; U.S. Patent 2,816,910; December 17, 1957; assigned to Schering AG, Germany

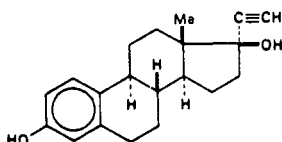
ETHINYLESTRADIOL**Therapeutic Function:** Estrogen**Chemical Name:** 19-Nor-17 α -pregna-1,3,5(10)-trien-20-yne-3,17-diol**Common Name:** 17-Ethinylestradiol**Structural Formula:****Chemical Abstracts Registry No.:** 57-63-6

Trade Name	Manufacturer	Country	Year Introduced
Estinyl	Schering	U.S.	1944
Lynoral	Organon	U.S.	1945
Eticyclol	Ciba	U.S.	1947
Ethinyl Oestradiol	Roussel	France	1950
Diogyn-E	Pfizer	U.S.	1953
Provest	Upjohn	U.S.	1964
Norlestrin	Parke Davis	U.S.	1964
Oracon	Mead Johnson	U.S.	1965
Feminone	Upjohn	U.S.	1970
Demulen	Searle	U.S.	—
Duramen	Leo	Sweden	—
Edrol	Virax	Australia	—
Ertonyl	Schering	—	—
Estigyn	Allen & Hanburys	U.K.	—
Etifollin	Nyegaard	Norway	—
Etivex	Leo	Sweden	—
Farmacyrol	Farmacyn	W. Germany	—
Follikoral	Arcana	Austria	—

Trade Name	Manufacturer	Country	Year Introduced
Gynetone	Schering	U.S.	—
Gynolett	Labopharma	W. Germany	—
Gynoral	Teva	Israel	—
Kolpi Gynaedron	Artesan	W. Germany	—
Metroval	Kwizda	Austria	—
Oradiol	Van Pelt & Brown	U.S.	—
Orestralyln	McNeil	U.S.	—
Ovahormon	Teikoku Zoki	Japan	—
Ovex	Ratiopharm	W. Germany	—
Progynon	Schering	W. Germany	—
Turisteron	Jenapharm	E. Germany	—
Ylestrol	Ferndale	U.S.	—

Raw Materials

Ammonia	Potassium
Acetylene	Estrone

Manufacturing Process

In about 250 cc of liquid ammonia (cooled with dry ice and acetone) are dissolved about 7.5 g of potassium and into the solution acetylene is passed until the blue color has disappeared (about 3 hours). Then slowly a solution or suspension of 3 g of estrone in 150 cc of benzene and 50 cc of ether is added. The freezing mixture is removed, the whole allowed to stand for about 2 hours and the solution further stirred overnight. Thereupon the reaction solution is treated with ice and water, acidified with sulfuric acid to an acid reaction to Congo red and the solution extracted five times with ether. The combined ether extracts are washed twice with water, once with 5% sodium carbonate solution and again with water until the washing water is neutral. Then the ether is evaporated, the residue dissolved in a little methanol and diluted with water. The separated product is recrystallized from aqueous methanol. The yield amounts to 2.77 g. The 17-ethinyl-estradiol-3,17 thus obtained melts at 142°C to 144°C.

References

Merck Index 3683

Kleeman & Engel p. 371

PDR pp. 1104, 1297, 1358, 1372, 1616, 1680, 1793, 1952, 1960, 1965, 1983

I.N. p. 397

REM p. 987

Inhoffen, H.H. and Hohlweg, W.; U.S. Patent 2,265,976; December 9, 1941; assigned to Schering Corp.

ETHIONAMIDE

Therapeutic Function: Antitubercular

Chemical Name: 2-ethyl-4-pyridinecarbothioamide

Common Name: Ethyl isonicotinic thioamide

Structural Formula:

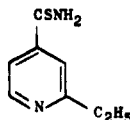

Chemical Abstracts Registry No.: 536-33-4

Trade Name	Manufacturer	Country	Year Introduced
Trecator	Theraplix	France	1959
Trecator-SC	Ives	U.S.	1962
Ethimide	Tanabe	Japan	—
Ethinamin	Takeda	Japan	—
Ethiocidan	Cidan	Spain	—
Iridocin	Bayer	—	—
Itiocide	Kyowa	Japan	—
Nicotion	Leiras	Finland	—
Rigenicid	Gedeon Richter	Hungary	—
Sertinon	Daiichi	Japan	—
Teberus	Dainippon	Japan	—
Thiomid	Nikken	Japan	—
Thioniden	Kaken	Japan	—
Trescatyl	May & Baker	U.K.	—
Tubenamide	Seiko	Japan	—
Tubermin	Meiji	Japan	—
Tuberoid	Sankyo	Japan	—
Tuberoson	Shionogi	Japan	—

Raw Materials

Methyl ethyl ketone	Ammonia
Ethyl oxalate	Cyanacetamid
Hydrogen chloride	Ethanol
Phosphorus oxychloride	Hydrogen
Phosphorus pentoxide	Hydrogen sulfide

Manufacturing Process

Ethyl Propionyl-Pyruvate: 36 grams of methyl ethyl ketone and 73 grams of ethyl oxalate are condensed in the presence of sodium ethylate, the reaction mixture being refluxed in an alcoholic medium. 28 grams of the desired product having a boiling point of 100° to 105°C/6 mm are obtained.

3-Cyano-4-Carboxy-6-Ethyl-2-Pyridone: 205 cc of 60% alcohol, 22 grams of the product just obtained, 11 grams of cyanacetamide and 4.5 cc of piperidine are refluxed. 19 grams of product having a melting point of 211°C are obtained.

4-Carboxy-6-Ethyl-2-Pyridone: 30 grams of the cyanopyridone just obtained are refluxed with concentrated hydrochloric acid. 13.5 grams of product having a melting point of 308°C are obtained.

2-Chloro-4-Carboxy-6-Ethyl-Pyridine: 26 grams of the product just obtained are treated with 81 grams of phosphorus pentachloride in 45 cc of phosphorus oxychloride. The phosphorus oxychloride is distilled off in a vacuum and the residue is treated with absolute alcohol. After distillation there are obtained 24 grams of product having a boiling point of 127° to 131°C/8 mm.

Ethyl-2-Ethyl-Isonicotinate: 10 grams of the ester just obtained dissolved in 80 cc of absolute alcohol containing 5.5 grams of potassium acetate are hydrogenated catalytically on 5% palladium black. 8 grams of product having a boiling point of 120° to 124°C/14 mm are obtained.

2-Ethyl-Isonicotinic-Amide: 20 grams of the ether just obtained are agitated with 25 cc of concentrated ammonia. 11 grams of product having a melting point of 131°C are obtained.

2-Ethyl-Isonicotinic Nitrile: The 11 grams of the amide just obtained are treated with 15 grams of phosphorus anhydride at 160° to 180°C in a vacuum. 6 grams of a liquid residue are obtained.

α-Ethyl-Isonicotinic Thioamide: The 6 grams of the liquid just obtained, in solution in 15 cc of absolute alcohol containing 2 grams of triethanolamine, are treated with hydrogen sulfide. 6.5 grams of the desired product having a melting point of 166°C are obtained.

References

Merck Index 3686

Kleeman & Engel p. 371

PDR p. 1982

OCDS Vol. 1 p. 255 (1977)

I.N. p. 397

REM p. 1216

Chimie et Atomistique, France; British Patent 800,250; August 20, 1958

ETHOHEPTAZINE

Therapeutic Function: Analgesic

Chemical Name: Hexahydro-1-methyl-4-phenylazepine-4-carboxylic acid ethyl ester

Common Name: —

Structural Formula:

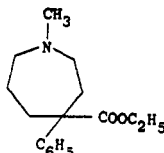

Chemical Abstracts Registry No.: 77-15-6

Trade Name	Manufacturer	Country	Year Introduced
Zactane	Wyeth	U.S.	1957
Equagesic	Wyeth	U.S.	—
Mepro	Schein	U.S.	—
Panalgin	Padil	Italy	—
Zactipar	Wyeth	U.K.	—
Zactirin	Banyo	Japan	—

Raw Materials

Phenylacetoneitrile	N-(2-Chloroethyl)dimethylamine
Sodium amide	Trimethylene bromide
Sulfuric acid	Ethanol

Manufacturing Process

As a starting material, phenylacetoneitrile was reacted with N-(2-chloroethyl)dimethylamine. This then underwent the following reaction sequence.

Preparation of 1-Dimethylamino-3-Cyano-3-Phenyl-6-Bromohexane: 65.8 grams (0.35 mol) of 2-phenyl-4-dimethylaminobutyronitrile in 350 cc of absolute ether was dripped into a stirred suspension of 17.5 grams (0.45 mol) of sodamide in 350 cc of absolute ether during 1 hour, keeping the reaction mixture under a dry nitrogen atmosphere. The mixture was stirred an additional hour at room temperature and then 1 hour at reflux temperature. The mixture was diluted with 250 cc of absolute ether, cooled in an ice bath, then, while stirring, a solution of 74.7 grams (0.37 mol) of trimethylene bromide in 250 cc of absolute ether added at once. The yellow suspension continued to be stirred at ice-bath temperature for 1 hour, then at room temperature for 1 hour, and finally at reflux temperature for 3 hours. The mixture was cooled and the sodium bromide, which had precipitated in quantitative yield, was filtered off and washed with ether. The light yellow ethereal filtrate contained the product. This compound could be stored for some time in a hydrocarbon solvent, e.g., n-heptane, at +5°C.

Preparation of 4-Phenyl-4-Cyano-N-Methyl Azacycloheptane Methobromide: A 0.1 M nitrobenzene solution of 1-dimethylamino-3-cyano-3-phenyl-6-bromohexane was kept at 100°C for 1 hour whereby the quaternary salt precipitated out; MP 246° to 247°C.

Preparation of 4-Phenyl-4-Cyano-N-Methyl Azacycloheptane: 6.2 grams (0.02 mol) of the methobromide quaternary salt was suspended in 150 cc of tetralin. While vigorously stirring, the mixture was heated to its reflux temperature, whereupon the solid began to disintegrate and go into solution. The stirring and refluxing was continued 1 hour, then the mixture cooled, water added, and the layers separated. The tetralin solution was extracted with 3 M aqueous hydrochloric acid, the acid extract washed with ether, then made alkaline with aqueous sodium hydroxide and extracted with ether. The ether extracts were dried, filtered, and the solvent distilled off. Vacuum distillation of the liquid residue gave the tertiary amine, BP 119° to 121°C/0.25 mm.

Preparation of 4-Phenyl-4-Carboxy-N-Methyl Azacycloheptane: A solution of 8.4 grams (0.04 mol) of the cyclic aminonitrile in 10.6 grams concentrated sulfuric acid and 2.6 grams water was kept at 110° to 120°C (bath temperature) for 3 hours. Then, while repeatedly adding absolute ethanol, 95% aqueous ethanol was slowly distilled off during 16 hours. The reaction mixture was concentrated to 50 cc, cooled, poured into 200 cc of a cold saturated aqueous solution of sodium carbonate and extracted with ether. The ether extract after drying and filtering yielded, by distillation, the aminoester, BP 122° to 124°C/0.3 mm.

References

Merck Index 3691

Kleeman & Engel p. 373

PDR p. 1606

OCDs Vol. 1 p. 303 (1977)

I.N. p. 398

REM p. 1116

Diamond, J. and Bruce, W.F.; U.S. Patent 2,666,050; January 12, 1954; assigned to American Home Products Corporation

ETHOPROPAZINE HYDROCHLORIDE

Therapeutic Function: Antiparkinsonian

Chemical Name: N,N-diethyl- α -methyl-10H-phenothiazine-10-ethanamine hydrochloride

Common Name: Profenamin

Structural Formula:

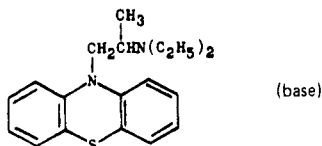

Chemical Abstracts Registry No.: 1094-08-2; 522-00-9 (Base)

Trade Name	Manufacturer	Country	Year Introduced
Parsidol	Warner Lambert	U.S.	1954
Parkin	Yoshitomi	Japan	1973
Parsidol	Sevenet	France	1981
Dibutil	Bayer	—	—
Lysivane	May & Baker	U.S.	—
Parsitan	Rhone-Poulenc	Canada	—
Parsotil	Rhodia Iberica	Spain	—
Rodipal	Deutsches Hydrierwerk	E. Germany	—

Raw Materials

Phenthiazine	Magnesium
Methyl iodide	Hydrogen chloride
2-Chloro-1-diethylamino propane	

Manufacturing Process

6.2 grams of phenthiazine in 100 cc of warm dry benzene was added during 1 hour with stirring, and in an atmosphere of hydrogen, to the Grignard reagent prepared from 1 gram of magnesium, 6.2 grams of methyl iodide, and 20 cc of dry ether. After boiling for 30 minutes, a solution of 6.6 grams of 2-chloro-1-diethylamino propane in 10 cc of dry benzene was added during 1 hour to the boiling solution, and heating was maintained for a further 1.5 hours.

The reaction mixture was then cooled and treated with aqueous ammonium chloride and chloroform added to dissolve an oil at the interface of the benzene and aqueous layers. The chloroform-benzene extract was extracted with 2 N hydrochloric acid and the acid extract was basified at 5° to 10°C with 50% aqueous sodium hydroxide.

There was obtained a mixture of N-(2'-diethylamino-2'-methylethyl)phenthiazine and N-(2'-diethylamino-1'-methylethyl)phenthiazine in the form of a viscous yellow oil, BP 202° to 205°C/2 mm. This oil was treated in ethereal solution with ethereal hydrogen chloride and gave a white solid which was fractionally crystallized from ethylene dichloride. The less soluble fraction, N-(2'-diethylamino-2'-methylethyl)phenthiazine hydrochloride formed colorless rhombs, MP 223° to 225°C. The more soluble N-(2'-diethylamino-1'-methylethyl)-phenthiazine hydrochloride was obtained as colorless prismatic needles, MP 166° to 168°C.

References

Merck Index 3696

Kleeman & Engel p. 765

PDR p. 1380

OCDS Vol. 1 p. 373 (1977)

I.N. p. 807

REM p. 932

Berg, S.S. and Ashley, J.N.; U.S. Patent 2,607,773; August 19, 1952; assigned to Societe des Usines Chimiques Rhone-Poulenc, France

ETHOSUXIMIDE

Therapeutic Function: Anticonvulsant

Chemical Name: 3-ethyl-3-methyl-2,5-pyrrolidinedione

Common Name: —

Structural Formula:

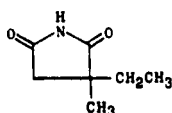

Chemical Abstracts Registry No.: 77-67-8

Trade Name	Manufacturer	Country	Year Introduced
Zarontin	Parke Davis	U.S.	1960
Suxinutin	Parke Davis	W. Germany	1960
Zarontin	Parke Davis	U.K.	1960
Zarontin	Parke Davis	France	1965
Zarontin	Parke Davis	Italy	1966
Asamid	Pliva	Yugoslavia	—
Emeside	Lab. For Appl. Biol.	U.K.	—
Epileo-Petitmal	Eisai	Japan	—
Ethymal	Hillel	Israel	—
Etomal	Orion	Finland	—
Petinamide	Gerot	Austria	—
Petnidan	Desitin	W. Germany	—
Pyknolepsinum	ICI Pharma	W. Germany	—
Simatin	Geistlich	Switz.	—

Raw Materials

Ethyl cyanoacetate	Methyl ethyl ketone
Hydrogen cyanide	Sodium hydroxide
Sulfuric acid	Ammonia

Manufacturing Process

α -Ethyl- α -methylsuccinimide is known in the prior art as a chemical entity, having been prepared according to the method described by Sircar, *J. Chem. Soc.*, 128:600 (1927), and characterized in *J. Chem. Soc.*, 128:1254 (1927).

In its manufacture, methyl ethyl ketone is condensed with ethylcyanoacetate to give ethyl-2-cyano-3-methyl-2-pentenoate. That, in turn, adds HCN to give ethyl-2,3-dicyano-3-methyl-pentanoate. Saponification and decarboxylation gives 2-methyl-2-ethyl succinonitrile. Heating with aqueous NH_3 gives the diamide which loses NH_3 and cyclizes to ethosuximide.

References

- Merck Index 3697
- Kleeman & Engel p. 373
- PDR p. 1396
- OCDS Vol. 1 p. 228 (1977)
- I.N. p. 398
- REM p. 1078
- Miller, C.A. and Long, L.M.; U.S. Patent 2,993,835; July 25, 1961; assigned to Parke, Davis and Company

ETHOTOIN

Therapeutic Function: Anticonvulsant

Chemical Name: 3-ethyl-5-phenyl-2,4-imidazolidinedione

Common Name: 3-ethyl-5-phenylhydantoin

Structural Formula:

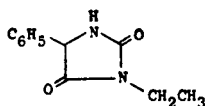

Chemical Abstracts Registry No.: 86-35-1

Trade Name	Manufacturer	Country	Year Introduced
Peganone	Abbott	U.S.	1957
Accenon	Dainippon	Japan	—

Raw Materials

Benzaldehyde cyanohydrin	Urea
Hydrogen chloride	Ethyl iodide

Manufacturing Process

Benzaldehyde cyanohydrin is reacted with urea to displace the hydroxyl group of the cyanohydrin. That intermediate is treated with HCl to convert the urea nitrogen to a nitrile. The resultant imine is hydrolyzed to the phenylhydantoin. Alkylation with ethyl iodide gives ethotoin, as described by A. Pinner in *Chem. Ber.* 21, 2325 (1888).

References

Merck Index 3698

Kleeman & Engel p. 374

PDR p. 546

OCDS Vol. 1 p. 245 (1977)

I.N. p. 398

REM p. 1083

Close, W.J.; U.S. Patent 2,793,157; May 21, 1957; assigned to Abbott Laboratories

ETHOXZOLAMIDE

Therapeutic Function: Diuretic

Chemical Name: 6-ethoxy-2-benzothiazolesulfonamide

Common Name: —

Structural Formula:

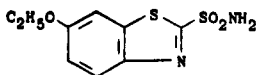

Chemical Abstracts Registry No.: 452-35-7

Trade Name	Manufacturer	Country	Year Introduced
Cardrase	Upjohn	U.S.	1957
Ethamide	Allergan	U.S.	1967
Glaucotensil	Farmila	Italy	—
Redupressin	Thilo	W. Germany	—
Poenglausil	Poen	Argentina	—

Raw Materials

6-Ethoxybenzothiazole-2-thiol	Ammonia
Sodium hypochlorite	Potassium permanganate

Manufacturing Process

Preparation of 6-Ethoxybenzothiazole-2-Sulfenamide: A solution prepared by dissolving 21.0 grams (0.1 mol) of 6-ethoxybenzothiazole-2-thiol, Sebrell and Boord, *J. Am. Chem. Soc.* 45: 2390 to 2399 (1923), in 75 ml of water containing 5 grams of sodium hydroxide, and 75 ml of 10% sodium hypochlorite solution were added simultaneously to 300 ml of concentrated ammonium hydroxide which was cooled to 0°C, and vigorously stirred. During the addition the temperature was not allowed to rise above 5°C. The resulting solid was recovered by filtration, washed thoroughly with water, and dried at room temperature under reduced pressure. There was obtained 21 grams of 6-ethoxybenzothiazole-2-sulfenamide melting at 132° to 155°C (decomposition). Recrystallization from ethyl acetate gave a product melting at 140.5° to 143°C (decomposition).

Preparation of 6-Ethoxybenzothiazole-2-Sulfonamide: A solution of 3.39 grams (0.015 mol) of the sulfenamide in 100 ml of acetone was treated dropwise, with stirring, with a solution of 3.5 grams of potassium permanganate in 100 ml of water. The temperature rose to 42°C. After stirring an additional 10 minutes the reaction mixture was filtered to remove manganese dioxide, the latter was washed with 100 ml of warm water, and the combined filtrates were concentrated under reduced pressure to remove acetone. The residual solution was treated with charcoal, filtered and acidified with concentrated hydrochloric acid. After standing in the refrigerator for 4 hours the solid sulfonamide was recovered by filtration, washed with water and dried. There was obtained 2.37 grams of 6-ethoxybenzothiazole-2-sulfonamide melting at 180° to 190°C. Recrystallization from ethyl acetate-Skellysolve B gave 1.25 grams of material melting at 188° to 190.5°C.

References

- Merck Index 3704
 Kleeman & Engel p. 374
 OCDS Vol. 1 p. 327 (1977)
 DOT 14 (6) 207 (1978)
 I.N. p. 399
 Korman, J.; U.S. Patent 2,868,800; January 13, 1959; assigned to The Upjohn Company

ETHYL BISCOUMACETATE

Therapeutic Function: Anticoagulant

Chemical Name: 4-Hydroxy- α -(4-hydroxy-2-oxo-2H-1-benzopyran-3-yl)-2-oxo-2H-1-benzopyran-3-acetic acid ethyl ester

Common Name: —

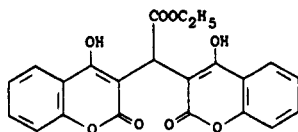
Structural Formula:

Chemical Abstracts Registry No.: 548-00-5

Trade Name	Manufacturer	Country	Year Introduced
Tromexan	Geigy	U.S.	1950
Biscouron	Ayerst	—	—
Stabilene	Auclair	France	—

Raw Materials

Benzotetronic acid
Glyoxylic acid ethyl ester ethyl alcoholate

Manufacturing Process

7 g of benzotetronic acid are dissolved in 750 cc of water at boiling temperature and thereafter 10.5 g of glyoxylic acid ethyl ester ethyl alcoholate are added. After a short while the liquid becomes turbid and gradually a white deposit is separated. The deposit is filtrated and dried in vacuo. The melting point is 172°C to 174°C; after recrystallization from methyl alcohol 153°C to 154°C.

The crude product is dissolved in sodium lye, filtrated by means of animal charcoal precipitated by means of hydrochloric acid, and recrystallized from methyl alcohol. The melting point is 153°C to 154°C.

References

Merck Index 3719

Kleeman & Engel p. 375

I.N. p. 400

Rosicky, J.; U.S. Patent 2,482,511; September 20, 1949; assigned to Spojene Farmaceuticke Zovody (Czechoslovakia)

ETHYLESTRENOL

Therapeutic Function: Anabolic

Chemical Name: 19-nor-17 α -pregn-4-en-17-ol

Common Name: 17 α -ethyl-17 β -hydroxy-19-norandrostene

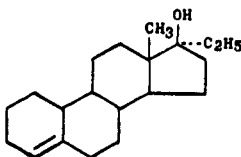
Structural Formula:

Chemical Abstracts Registry No.: 965-90-2

Trade Name	Manufacturer	Country	Year Introduced
Maxibolin	Organon	U.S.	1964
Durabolin	Organon	—	—
Orabolin	Organon	U.K.	—
Orgabolin	Organon-Sankyo	Japan	—
Orgaboline	Organon	France	—

Raw Materials

17 α -Ethyloestradiol-3-ethylether
Lithium
Ethylamine

Manufacturing Process

4.5 grams of lithium cut to small pieces are added to 435 ml of dry ethylamine which is cooled in ice. After the solution turns blue 9 grams of 17 α -ethyloestradiol-3-ethylether dissolved in 900 ml of dry ether are added.

Subsequently, the reaction mixture is stirred at a temperature of 0° to 5°C for 20 hours, after which 50 ml of absolute ethanol are added. Then the ethylamine is distilled off at low pressure. To the remaining solution 50 ml of ether and 50 ml of water are added. The water layer is separated and extracted a few times with ether. The collected ether extracts are added to the ethereal layer, after which this ethereal solution is washed with a 2 N hydrochloric acid solution, subsequently with a saturated sodium bicarbonate solution, and then with water. The ethereal solution is then dried on sodium sulfate and finally evaporated to dryness.

The crude product is distributed between equal parts of petroleum ether and 70% methanol. From the petroleum ether layer 5.6 grams of Δ^4 -17 α -ethyl-17 β -hydroxy-19-nor-androstene with a melting point of about 50°C are obtained.

References

- Merck Index 3750
Kleeman & Engel p. 375
PDR p. 1286
OCDS Vol. 1 p. 170 (1977)
I.N. p. 400
REM p. 1001
Szpilfogel, S.A. and de Winter, M.S.; U.S. Patent 2,878,267; March 17, 1959; assigned to Organon Inc.
Szpilfogel, S.A., Hanegraaf, J.A. and van Dijck, L.A.; U.S. Patent 3,112,328; Nov. 26, 1963 assigned to Organon Inc.

ETHYNODIOL DIACETATE

Therapeutic Function: Progestin; oral contraceptive ingredient

Chemical Name: 3 β ,17 β -diacetoxy-17 α -ethynyl-4-estrene

Common Name: —

Structural Formula:

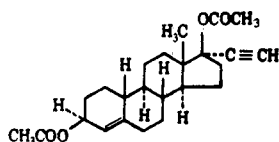

Chemical Abstracts Registry No.: 297-76-7

Trade Name	Manufacturer	Country	Year Introduced
Lutometrodol	Searle	France	1965
Ovulen	Searle	U.S.	1966
Femulen	Searle	Italy	1971
Femulen	Searle	U.K.	1973
Alfames E	Dr. Kade	W. Germany	—
Conova	Searle	U.K.	—
Demulen	Searle	U.S.	—
Luteonorm	Seronol	Italy	—
Metrodiol	Byla	France	—
Metruilen	Searle	U.S.	—
Ovamin	Searle	U.K.	—

Raw Materials

17 α -Ethylnyl-19-norandrost-4-ene-3 β ,17 β -diol (ethynodiol)
Acetic anhydride

Manufacturing Process

A mixture of 30 parts of 17 α -ethynyl-19-norandrost-4-ene-3 β ,17 β -diol, 360 parts of dry pyridine, and 111 parts of acetic anhydride, under nitrogen, is stirred and heated at the reflux temperature for about 5 hours. This reaction mixture is cooled, then poured into approximately 3,500 parts of cold water and the resulting aqueous mixture is stirred at room temperature for about 0.5 hour. The precipitate which forms is collected by filtration, then is washed on the filter with water and dried in air. This solid material is extracted into ether, and the ether solution is washed successively with 10% aqueous hydrochloric acid and 5% aqueous sodium bicarbonate.

Drying over anhydrous sodium sulfate containing decolorizing carbon followed by removal of the solvent by distillation at reduced pressure affords an oil which solidifies on standing. Recrystallization of that solid by dropwise dilution with water of a methanol solution affords 17 α -ethynyl-19-norandrost-4-ene-3 β ,17 β -diol 3,17-diacetate, melting at about 126° to 127°C.

References

Merck Index 3807
Kleeman & Engel p. 384
PDR p. 1680
OCDS Vol. 1 pp. 165, 186 (1977)
DOT 4 (1) 9 (1966)
REM p. 991
Klimstra, P.D.; U.S. Patent 3,176,013; March 30, 1965; assigned to G.D. Searle & Co.

ETIDOCAINE HCl

Therapeutic Function: Local anesthetic

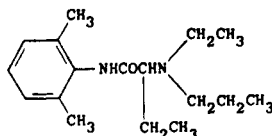
Chemical Name: N-(2,6-Dimethylphenyl)-2-(ethylpropylamino)butanamide**Common Name:** —**Structural Formula:****Chemical Abstracts Registry No.:** 36637-19-1; 36637-18-0 (Base)

Trade Name	Manufacturer	Country	Year Introduced
Duranest	Astra	U.S.	1976
Duranest	Astra	W. Germany	1976
Duranest	Bellon	France	1977

Raw Materials

2-Bromobutyric acid	Sulfonyl chloride
2,6-Xylidine	Potassium iodide
n-Propylamine	Diethyl sulfate
Hydrogen chloride	

Manufacturing Process

α -(n-Propylamino)-n-butyl-2,6-xylidide (0.243 mol) and freshly distilled diethyl sulfate (1.6 mols) were mixed in a flask equipped with reflux condenser, drying tube and stirrer. The mixture was stirred for 5 hours at 90°C. After cooling, water (110 ml) was added with stirring for 15 minutes followed by 4 M HCl (110 ml). The solution was washed with ether (3 X 100 ml) and made alkaline with 7 M NaOH to pH 10-11. The freed base was taken up in ether (3 X 100 ml); the extracts were dried over sodium sulfate, filtered and evaporated. The residue was dissolved in absolute ether (200 ml) and the hydrochloride prepared by addition of ethereal hydrogen chloride. The precipitate was filtered, washed with ether, and recrystallized twice from absolute ethanol/ether and from isopropanol/isopropylether; MP 203°C to 203.5°C; yield: 0.126 mol (52%).

The starting material is prepared by reacting 2-bromobutyric acid with sulfonyl chloride to give the acid chloride. It is then reacted with 2,6-xylidine, then with potassium iodide followed by n-propylamine.

References

Merck Index 3811

Kleeman & Engel p. 376

PDR p. 591

OCDS Vol. 2 p. 95 (1980)

I.N. p. 403

REM p. 1051

Adams, H.J.F., Kronberg, G.H. and Takman, B.H.; U.S. Patent 3,812,147; May 21, 1974; assigned to Astra Pharmaceutical Products, Inc.

ETIDRONATE DISODIUM**Therapeutic Function:** Bone calcium regulator

Chemical Name: (1-Hydroxyethylidene)bisphosphonic acid disodium salt

Common Name: —

Structural Formula:



Chemical Abstracts Registry No.: 7414-83-7; 2809-21-4 (Base)

Trade Name	Manufacturer	Country	Year Introduced
Etidron	Gentili	Italy	1977
Didronel	Procter & Gamble	U.S.	1978
Didronel	Gist Brocade	U.K.	1980
Didronel	Procter & Gamble	Switz.	1980
Didronel	Beytout	France	1982
Diphos	Boehr./Mann.	W. Germany	1982
Difosfen	Rubio	Spain	—
Diphosphonat	Procter & Gamble	U.S.	—

Raw Materials

Phosphorous acid
Acetic anhydride
Sodium hydroxide

Manufacturing Process

Phosphorous acid was premixed with acetic acid to form a 50 wt % solution of phosphorous acid dissolved in acetic acid. The acids were mixed on a molar basis of 1.36:1, acetic acid to phosphorous acid, and this corresponded on a mol percentage basis to 57.6% acetic acid and 42.4% phosphorous acid. Acetic anhydride was continuously metered into a stream of the phosphorous acid-acetic acid mixture to form the reaction solution. The acetic anhydride was metered into the acid mixture at a mol ratio of 1.33 mols of acetic anhydride per mol of phosphorous acid. The metering rates were 18.5 lb/hr of the phosphorous acid/acetic acid premixed solution and 15.1 lb/hr acetic anhydride. The reaction solution was continuously passed through a heat exchanger where it was heated to 190°F then it was continuously fed into a two stage back-mix reaction zone where due to the heat of reaction the temperature rose to 275°F. The average residence in the reaction zone was 27 min. The reaction zone consisted of two back-mix reactors each having a capacity of 7.5 pounds of the reaction solution. A stream of reaction solution was continuously withdrawn from the second reactor and continuously mixed with a stream of water which was being metered at a rate of 2 lb/hr. This amount of water corresponded to 18% excess over the theoretical amount necessary to hydrolyze all of the acetyl-containing compounds in the reaction solution to free acids. The hydrolyzed solution was continuously passed through a heat exchanger and cooled to room temperature after which the solution was continuously passed to a crystallizer where, with agitation, the ethane-1-hydroxy-1,1-diphosphonic acid crystallized. The slurry was then filtered and the crystals were recovered and dried. Analysis of the product showed a conversion rate of phosphorous acid to ethane-1-hydroxy-1,1-diphosphonic acid of 86%. Sodium hydroxide may be used to give the disodium salt.

References

Merck Index 3812
Kleeman & Engel p. 377
PDR p. 1275
DOT 4 (3) 104 (1978)
I.N. p. 23

REM p. 979

Rogovin, L., Brawn, D.P. and Kalberg, J.N.; U.S. Patent 3,400,147; September 3, 1968; assigned to The Procter & Gamble Co.

ETIFELMINE

Therapeutic Function: Central stimulant; antihypotensive

Chemical Name: 2-Diphenylmethylenebutylamine

Common Name: —

Structural Formula:

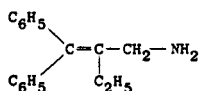

Chemical Abstracts Registry No.: 341-00-4

Trade Name	Manufacturer	Country	Year Introduced
Etifelmine	Giulini	W. Germany	1963
Tensinase D	Chemiphar	Japan	1975
Gilutensin	Giulini	W. Germany	—

Raw Materials

2-Ethyl-3-hydroxy-3,3-diphenyl propionitrile
 Hydrogen
 Hydrogen chloride

Manufacturing Process

(a) Preparation of 2-ethyl-3-hydroxy-3,3-diphenyl-propylamine: 10 g of 2-ethyl-3-hydroxy-3,3-diphenyl-propionitrile are dissolved in 200 ml of methanol. 10 ml of acetic acid are added to the mixture, and the mixture is hydrogenated in the presence of platinum as catalyst. After the hydrogen uptake or consumption has ceased, the reaction is interrupted, the catalyst is filtered off and the filtrate is evaporated in vacuo to dryness. The residue is dissolved in water and, after the addition of 1 ml of hydrochloric acid, the solution extracted with ether. The acidified ether-phase is discarded. The aqueous phase is made alkaline with ammonia, whereby the base crystallizes out. The crystals are recovered and recrystallized from methanol. The melting point of the 2-ethyl-3-hydroxy-3,3-diphenyl-propylamine thereby obtained is 132°C.

(b) Preparation of 2-ethyl-3,3-diphenyl-1-amino-propene-(2)-hydrochloride: 5 g of 2-ethyl-3-hydroxy-3,3-diphenyl-propylamine are dissolved in 50 ml of acetic acid. Gaseous hydrogen chloride is passed through the solution for 10 minutes, and thereafter the solution is boiled for one hour under reflux. The solution is then distilled to dryness. The residue is dissolved in water and the acidified solution extracted with ether. The aqueous phase is separated, made alkaline with ammonia and extracted with ether. The ether phase is dried over sodium sulfate, the ether distilled off and the residue is dissolved in methanolic hydrogen chloride. On the addition of absolute ether, the hydrochloride of 2-ethyl-3,3-diphenyl-1-amino-propene-(2) is crystallized out. The crystalline substance thereby obtained has a melting point of 232°C.

References

Merck Index 3813

Kleeman & Engel p. 377

I.N. p. 403

Gebruder Giuliani, G.m.b.H.; British Patent 936,041; September 4, 1963

ETIFOXINE

Therapeutic Function: Tranquilizer

Chemical Name: 2-Ethylamino-4-methyl-4-phenyl-6-chloro-4H-3,1-benzoxazine

Common Name: —

Structural Formula:

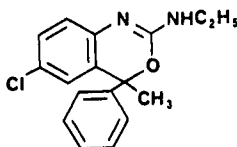

Chemical Abstracts Registry No.: 21715-46-8

Trade Name	Manufacturer	Country	Year Introduced
Stresam	Beaufour	France	1971

Raw Materials

5-Chloro-2-amino- α -methyl- α -phenylbenzyl alcohol
 Ethyl mustard oil (ethyl isothiocyanate)
 Mercury oxide

Manufacturing Process

(a) A solution of 50 g of 5-chloro-2-amino- α -methyl- α -phenylbenzyl alcohol in 150 ml of ether is mixed with 35 g of ethyl mustard oil and kept for 48 hours at room temperature. Part of the solvent is then distilled off under reduced pressure and the crystalline residue is filtered to yield 53 g (= 79% of theory) of pure 5-chloro-2-(ω -ethylthioureido)- α -methyl- α -phenylbenzyl alcohol melting at 101°C to 103°C. On crystallization from benzene + petroleum ether a higher-melting modification melting at 112°C to 114°C is sometimes obtained.

(b) 33.5 g of the thiourea derivative obtained under (a) are mixed with 43 g of mercury oxide in 300 ml of ethanol and stirred and refluxed for 30 minutes. The reaction mixture is filtered hot and the solvent is evaporated, to yield 2-ethyl-amino-4-methyl-4-phenyl-6-chloro-4H-3,1-benzoxazine as an almost colorless oil which soon solidifies in crystalline form. Recrystallization from petroleum ether furnishes 26 g (= 87% of theory) of colorless crystals melting at 90°C to 92°C.

References

Merck Index 3814

DFU 6 (9) 550 (1981)

DOT 9 (6) 242 (1973)

Kuch, H., Schmitt, K., Seidl, G. and Hoffmann, I.; U.S. Patent 3,725,404; April 3, 1973; assigned to Farbwerke Hoechst AG

ETILEFRINE PIVALATE HYDROCHLORIDE

Therapeutic Function: Adrenergic

Chemical Name: 1-(3'-Pivaloyloxyphenyl)-2-ethylaminoethanol-1 hydrochloride

Common Name: —

Structural Formula:

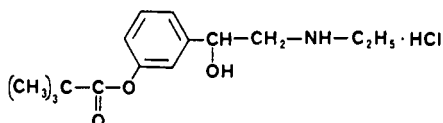

Chemical Abstracts Registry No.: 943-17-9; 709-55-7 (Base)

Trade Name	Manufacturer	Country	Year Introduced
Circupon	Troponwerke	W. Germany	1972
Amphodyn	Klinge	W. Germany	—
Effortil	Boehr/Ingel	W. Germany	—
Ethyfron	Sawai	Japan	—
Eti-Puren	Klinge	W. Germany	—
Hishiherin-S	Hishiyama	Japan	—
Hyrina	Seiko	Japan	—
Presotona	Erco	Denmark	—
Pulsamin	Teikoku	Japan	—
Soledoton M	Soledum	W. Germany	—
Theoral	S.S. Pharm.	Japan	—
Tonus-Forte	Sanorania	W. Germany	—
Tri-Effortil	Boehr/Ingel.	W. Germany	—

Raw Materials

1-(3'-Hydroxyphenyl)-2-(N-benzylaminomethyl)ethan-1-one
 Pivalic anhydride
 Hydrogen

Manufacturing Process

30 parts of 1-(3'-hydroxyphenyl)-2-(N-benzylaminomethyl)ethan-1-one are mixed with 100 parts of pyridine and 30 parts of pivalic anhydride and dissolved while warming. After heating for 1 hour under reflux, the acylation is complete. After concentrating the reaction solution, the product is precipitated from acetone/ether. Yield: 96.4% of 1-(3'-pivaloyloxyphenyl)-2-(N-benzylaminomethyl)ethan-1-one.

3 parts of palladium/charcoal (10% strength) are prehydrogenated in water, thereafter 10 parts of 1-(3'-pivaloyloxyphenyl)-2-(N-benzylaminoethyl)ethan-1-one, dissolved in a 10-fold amount of water, are added dropwise at room temperature and hydrogenation is carried out until 1 mol of hydrogen has been taken up. After filtering off the catalyst, a further 3 parts of palladium/charcoal are added and hydrogenation is carried out until a further mol of hydrogen has been taken up. The catalyst is separated off and after removal of the solvent the hydrogenation product is reprecipitated from acetone/petroleum ether and from methanol/ether until it is pure according to thin layer chromatography. Yield: 38.8% of 1-(3'-pivaloyloxyphenyl)-2-ethylaminoethanol-1 hydroxide, melting point 208°C to 209°C.

References

Merck Index 3815
 DFU 4 (6) 413 (1979)

Kleeman & Engel p. 378

I.N. p. 403

Chemisch-Pharmazeutische Fabrik, Adolf Kilinge and Co.; British Patent 1,358,973; July 3, 1974

ETIROXATE

Therapeutic Function: Antihyperlipoproteinemic

Chemical Name: O-(4-Hydroxy-3,5-diiodophenyl)-3,5-diiodo- α -methyl tyrosine ethyl ester

Common Name: —

Structural Formula:

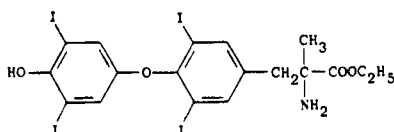

Chemical Abstracts Registry No.: 17365-01-4

Trade Name	Manufacturer	Country	Year Introduced
Skleronorm	Gruenthal	W. Germany	1977

Raw Materials

α -Methylthyroxine

Ethanol

Manufacturing Process

7.91 g of α -methyl thyroxine are suspended in 150 cc of ethanol. While heating, the solution is saturated with dry hydrogen chloride. Thereafter, the solvent is distilled off at reduced pressure. The residue is dissolved in a mixture of ethanol and water (1:1). Adding a 5% solution of sodium hydrogen carbonate in water, the ethyl ester of α -methyl thyroxine precipitates; melting point: 156°C to 157°C after recrystallization from ethanol. The yield is 6.05 g, i.e., 74% of the theoretical yield.

References

Merck Index 3820

Kleeman & Engel p. 378

DOT 13 (5) 197 (1977)

I.N. p. 404

Kummer, H. and Beckmann, R.; U.S. Patent 3,930,017; December 30, 1975

ETODROXIZINE

Therapeutic Function: Hypnotic

Chemical Name: 2-[2-[2-[4-(p-chloro- α -phenylbenzyl)-1-piperaziny] ethoxy] ethoxy] ethanol

Common Name: —

Structural Formula:

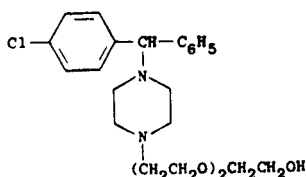

Chemical Abstracts Registry No.: 17692-34-1

Trade Name	Manufacturer	Country	Year Introduced
Vesparax	UCB Chemie	W. Germany	1973
Drimyl	Cassenne	France	—
Indunox	UCB	—	—

Raw Materials

1-(2'-Hydroxyethyl)piperazine	Thionyl chloride
p-Chlorobenzhydryl chloride	Potassium carbonate
Diethylene glycol	

Manufacturing Process

A mixture of 1.5 mols of 1-(2'-hydroxyethyl)piperazine and 1 mol of p-chlorobenzhydryl chloride is heated at 150°C for 15 minutes. The substance is dissolved in water, basified by caustic soda and extracted with benzene.

By purifying the benzene extract in vacuo, a 75% yield is obtained of 1-p-chlorobenzhydryl-4-(2'-hydroxyethyl)piperazine which has a boiling point of 205°C/0.02 mm Hg.

0.2 mol of 1-p-chlorobenzhydryl-4-(2'-hydroxyethyl)piperazine is dissolved in 300 cc of dry benzene and a solution of 36 grams of thionyl chloride in 100 cc of dry benzene is added cold with agitation. Reflux heating is then carried out until sulfur dioxide has ceased to be evolved.

The solvent is evaporated in vacuo, the residue is dissolved in anhydrous acetone and the hydrochloride formed is filtered. The corresponding base is liberated by treating the aqueous solution of this hydrochloride with an excess of potassium carbonate. A benzene extraction is effected and the benzene solution of the base is dried over potassium carbonate.

This benzene solution is then added to an equimolecular solution of the monosodium derivative of diethyleneglycol in a considerable excess of diethyleneglycol. The benzene is removed by distillation and the residue is heated in a boiling water-bath with agitation for 3 hours.

The excess diethyleneglycol is removed in vacuo and the residue dissolved in water and then in benzene. The benzene extract is washed several times in water, then purified in vacuo. The 1-p-chlorobenzhydryl-4-(2'-[2''-(2'''-hydroxyethoxy)-ethoxy]-ethyl)piperazine obtained distills at 250°C/0.01 mm Hg.

References

Merck Index 3823

Kleeman & Engel p. 379

I.N. p. 404

Morren, H.; British Patent 817,231; July 29, 1959

ETOFENAMATE

Therapeutic Function: Antiinflammatory

Chemical Name: 2-[[3-(Trifluoromethyl)phenyl]amino]benzoic acid-2-(2-hydroxyethoxy)-ethyl ester

Common Name: —

Structural Formula:

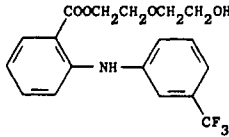

Chemical Abstracts Registry No.: 30544-47-9

Trade Name	Manufacturer	Country	Year Introduced
Rheumon	Troponwerke	W. Germany	1977
Rheumon	Bayer	Switz.	1979
Bayrogel	Bayro Pharm	Italy	1980
Flogoprofen	Wassermann	Spain	—

Raw Materials

N-(3-Trifluoromethylphenyl)anthranilic acid
2-(2-Chloroethoxy)ethanol

Manufacturing Process

16.0 g (0.05 mol) of the potassium salt of N-(3-trifluoromethylphenyl)-anthranilic acid are dissolved in 60 ml of dimethylformamide and heated to 110°C, and 6.2 g (0.05 mol) of 2-(2-chloroethoxy)-ethanol are slowly added. The reaction mixture is then heated to boiling for 2 hours. The precipitated potassium chloride is filtered off and the solvent is removed by evaporation. The residue is separated over a column with 400 g of silica gel (particle size 0.05 to 0.2 mm), using a 1:1 mixture of cyclohexane and glacial acetic acid as eluting agent. 16.0 g of the 2-(2-hydroxyethoxy)-ethyl ester of N-(3-trifluoromethylphenyl)-anthranilic acid are obtained in the form of a pale yellow oil which does not crystallize and cannot be distilled.

References

- Merck Index 3824
Kleeman & Engel p. 380
DOT 14 (1) 9 (1978)
I.N. p. 404
Boltze, K.H., Brendler, O. and Lorenz, D.; U.S. Patent 3,692,818; September 19, 1972; assigned to Troponwerke Dinklage & Co. (W. Germany)

ETOFIBRATE

Therapeutic Function: Hypolipemic

Chemical Name: 2-Hydroxyethylnicotinate-2-(p-chlorophenoxy)-2-methyl propionate

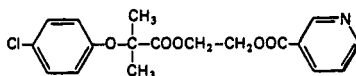
Common Name: —**Structural Formula:****Chemical Abstracts Registry No.:** 31637-97-5

Trade Name	Manufacturer	Country	Year Introduced
Lipo-Merz	Merz	W. Germany	1974
Noflevan	Alter	Spain	—

Raw Materials

2-(p-Chlorophenoxy)-2-methylpropionic acid
Ethylene oxide
Nicotinic acid

Manufacturing Process

A stream of ethylene oxide is passed through a solution of 107 g of 2-(p-chlorophenoxy)-2-methylpropionic acid and 2 g of zinc chloride in 200 ml of toluene, previously heated to between 55°C and 60°C, until 24 g of the gas have been dissolved. The reaction is allowed to continue for five hours, with gentle stirring. After this time has elapsed, the solution is cooled and washed successively with water, dilute ammonia and water until its pH becomes neutral. It is dried over anhydrous sodium sulfate, the solvent is separated off under vacuum, and the resulting liquid is the monoglycol ester of 2-(p-chlorophenoxy)-2-methylpropionic acid.

The product thus prepared is sufficiently pure to be used in the subsequent reaction. In this way, 107 g of the ester are prepared, which represents a yield of 83%.

To a solution of 93.8 g of the monoglycol ester in 500 ml of benzene, there are added 55 g of nicotinic acid chloride and 25 g of trimethylamine dissolved in 200 ml of benzene. The solution is stirred gently at a temperature of 60°C for two hours. After this time, the solution is cooled and washed successively with water, dilute hydrochloric acid, dilute ammonia and water until neutrality, it is dried over anhydrous sodium sulfate, and the solvent is evaporated under vacuum: in this way 110 g of glycol 2-(p-chlorophenoxy)-2-methylpropionate nicotinate is prepared, which represents a yield of 84%. The product is a slightly yellow oil having a refraction index of $n_D^{20} = 1.5422$ and which is distilled with decomposition at 214°C at a pressure of 0.3 mm.

References

Kleeman & Engel p. 380

DOT 11 (2) 459 (1975)

I.N. p. 405

Letelier, C.S. and Grafulla, F.C.; U.S. Patent 4,028,369; June 7, 1977; assigned to Alter S.A. (Spain)

ETOFYLLINE CLOFIBRATE**Therapeutic Function:** Hypolipemic**Chemical Name:** 1-(Theophyllin-7-yl)ethyl 2-(p-chlorophenoxy)isobutyrate

Common Name: Theofibrate

Structural Formula:

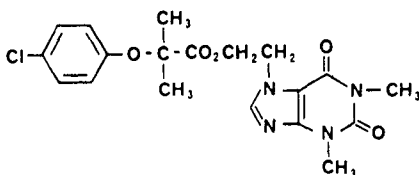

Chemical Abstracts Registry No.: 519-37-9 (Base)

Trade Name	Manufacturer	Country	Year Introduced
Duolip	Merckle	W. Germany	1981
Duolip	Mepha	Switz.	1981

Raw Materials

2-(p-Chlorophenoxy)isobutyric acid
7-Hydroxyethyltheophylline

Manufacturing Process

107.3 g (0.5 mol) 2-(p-chlorophenoxy) isobutyric acid and 56.0 g (0.25 mol) 7-hydroxyethyltheophylline were suspended together in 250 ml xylene. They were heated together for 15 hours in a water separator following the addition of 1.5 g p-toluenesulfonic acid. The solution was next agitated with dilute sodium bicarbonate solution (0.5 mol NaHCO₃), water washed and evaporated in a rotary evaporator.

The residue was then crystallized from isopropanol, yielding 58.0 g (55% yield) of 1-(7-theophyllinyl)-2-ethyl [2-(p-chlorophenoxy)-isobutyrate]. The compound had a melting point of 131°C to 132°C.

References

Merck Index 9113
DFU 2 (12) 800 (1977)
Kleeman & Engel p. 381
DOT 17 (9) 370 (1981)
I.N. p. 405
Metz, G. and Specker, M.; U.S. Patent 3,984,413; October 5, 1976; assigned to L. Merckle K.G. (W. Germany)

ETOMIDATE HYDROCHLORIDE

Therapeutic Function: Intravenous hypnotic

Chemical Name: 1-(1-Phenylethyl)-5-(ethoxy-carbonyl)imidazole hydrochloride

Common Name: —

Structural Formula:

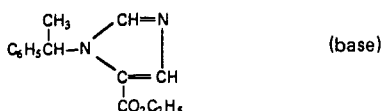

Chemical Abstracts Registry No.: 33125-97-2 (Base)

Trade Name	Manufacturer	Country	Year Introduced
Hypnomidate	Janssen	W. Germany	1977
Hypnomidate	Janssen	U.K.	1979
Amidate	Abbott	U.S.	1983
Radenarcon	Arzneimittelwerk Dresden	E. Germany	—

Raw Materials

dl-1-Phenylethylamine	Ethyl chloroacetate
Formic acid	Sodium
Potassium thiocyanate	Nitric acid
Sodium carbonate	

Manufacturing Process

To a mixture of 1,115 parts dl-1-phenylethylamine and 950 parts dimethylformamide are added successively 655 parts triethylamine and 1,130 parts ethyl chloroacetate. After the addition is complete, the whole is stirred overnight. Then there are added 5,600 parts anhydrous ether and the whole is filtered.

The filtrate is washed four times with water, dried and evaporated, yielding dl-N-[(ethoxycarbonyl)methyl]-1-phenylethylamine. This residue is dissolved in 4,800 parts xylene while refluxing and to this solution are added 450 parts formic acid. After boiling for a few hours, the mixture is cooled and washed successively three times with a 20% solution of formic acid, water, sodium hydrogen carbonate solution.

The organic layer is then dried, filtered and evaporated. The oily residue is distilled in vacuo, yielding 1,600 parts dl-N-formyl-N-[(ethoxycarbonyl)methyl]-1-phenylethylamine (boiling point 160°C to 170°C at 0.8 mm pressure). 30 parts of a sodium dispersion, 50% in paraffin oil are added to 450 parts tetrahydrofuran and the whole is slowly heated to a temperature of 40°C, while stirring. While maintaining this temperature (cooling on a water bath is necessary) there are added portionwise 30 parts ethanol.

After the addition is complete, the whole is cooled on an ice bath and there is added dropwise a solution of 144 parts dl-N-formyl-N-[(ethoxycarbonyl)methyl]-1-phenylethylamine in 133 parts ethyl formate. After the addition is complete, the mixture is stirred overnight at room temperature.

Then there are added 160 parts ether. After stirring for 5 minutes the mixture is poured into 1,500 parts water. The aqueous layer is separated, washed twice with 80 parts diisopropyl ether and then there are added successively 114 parts concentrated hydrochloric acid and 90 parts potassium thiocyanate in 200 parts water. The mixture is stirred for 24 hours, whereupon an oil is separated.

After the addition of 750 parts water, a crystalline product is precipitated. The mixture is further stirred overnight. The solid is then filtered off and recrystallized from a mixture of ethanol and water (1:1 by volume) to yield dl-1-(1-phenylethyl)-2-mercapto-5-(ethoxycarbonyl)imidazole; its melting point is 129.8°C to 130.8°C.

To a stirred mixture of 140 parts nitric acid ($d = 1.37$), 1 part sodium nitrate and 240 parts water are added portionwise 89 parts dl-1-(1-phenylethyl)-2-mercapto-5-(ethoxycarbonyl)imidazole. After the addition is complete, the whole is stirred for 2 hours at room temperature. The free base is liberated by addition of solid sodium carbonate and the whole is extracted with 120 parts anhydrous ether while heating. The aqueous layer is separated and extracted twice with 80 parts anhydrous ether.

The combined extracts are dried over magnesium sulfate, filtered and to the filtrate is added

2-propanol previously saturated with gaseous hydrogen chloride. The precipitated salt is filtered off, dried for 2 days at 60°C, to yield dl-1-(1-phenylethyl)-5-(ethoxycarbonyl)imidazole hydrochloride. It has a melting point 142°C to 142.8°C.

References

Merck Index 3828

DFU 1 (10) 461 (1976)

Kleeman & Engel p. 381

OCDS Vol. 3 p. 135 (1984)

DOT 15 (11) 475 (1979)

I.N. p. 405

REM p. 1044

Godefroi, E.F. and Van Der Eijcken, C.A.M.; U.S. Patent 3,354,173; November 21, 1967; assigned to Janssen Pharmaceutica NV (Belgium)

ETOMIDOLINE

Therapeutic Function: Muscle relaxant

Chemical Name: 2-Ethyl-2,3-dihydro-3-[[4-[2-(1-piperidinyloxy)phenyl]amino]-1H-isoindol-1-one

Common Name: —

Structural Formula:

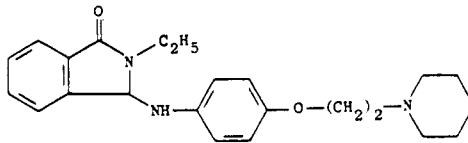

Chemical Abstracts Registry No.: —

Trade Name	Manufacturer	Country	Year Introduced
Smedolin	Yamanouchi	Japan	1976
Amidoline	Erba	Italy	—

Raw Materials

1-oxo-3-(Aminophenyl-p-ethoxypiperidino)isoindoline
Sodium hydride
Ethyl iodide

Manufacturing Process

31.3 g of 1-oxo-3-(aminophenyl-p-ethoxypiperidino)-isoindoline (0.0892 mol) are dissolved in 500 ml of anhydrous N,N-dimethylformamide. To this solution 5.75 g of NaH (0.105 mol) and 7.24 ml of CH₂CH₂I (0.0945 mol) are added and the resulted mixture is heated at 70°C for 1 hour, and then poured into an excess of water. 1-oxo-2-ethyl-3-(aminophenyl-p-ethoxypiperidino)-isoindoline (MP 106°C to 107°C) is obtained by crystallization with ligroin.

1-oxo-2-ethyl-3-(liminophenyl-p-ethoxypiperidino)-isoindoline (MP 103°C to 104°C) is obtained as a byproduct with the above compound. This latter compound was reduced to produce 1-oxo-2-ethyl-3-(aminophenyl-p-ethoxypiperidino)-isoindoline.

References

Merck Index 3829

I.N. p. 406

Giraldi, P.N. and Mariotti, V.; U.S. Patent 3,624,206; November 30, 1971; assigned to Carlo Erba S.p.A. (Italy)

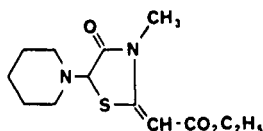
ETOZOLIN**Therapeutic Function:** Diuretic**Chemical Name:** 2-Carboethoxymethylene-3-methyl-5-piperidino-thiazolidin-4-one ester**Common Name:** —**Structural Formula:****Chemical Abstracts Registry No.:** 73-09-6

Trade Name	Manufacturer	Country	Year Introduced
Elkapin	Goedecke	W. Germany	1977
Elkapin	Goedecke	Italy	1983
Etopinil	Wassermann	Spain	—

Raw Materials

2-Carboethoxymethylene-3-methyl-4-thiazolidinone
 Bromine
 Piperidine

Manufacturing Process

To a stirred solution of 20 g (0.1 mol) 2-carboethoxymethylene-3-methyl-4-thiazolidinone in 120 ml chloroform is added, dropwise, a solution of 5 ml (0.1 mol) bromine in 20 ml chloroform. The solvent is removed by distillation and the residue crystallized from methanol to yield 18 g (65%) of 2-carboethoxymethylene-3-methyl-5-bromo-4-thiazolidinone, MP 76°C.

To a solution of 28 g (0.1 mol) 2-carboethoxymethylene-3-methyl-5-bromo-4-thiazolidinone prepared as described in 200 ml benzene is added (0.2 mol) piperidine and the mixture is allowed to stand for 3 hours at 25°C. The resulting suspension is filtered to remove the precipitated piperidine hydrobromide and the filtrate is evaporated to dryness. The residue is taken up in ether, filtered and the filtrate saturated with dry hydrogen chloride to yield the hydrochloride salt of 2-carboethoxymethylene-3-methyl-5-piperidino-4-thiazolidinone, MP 158°C to 159°C.

References

Merck Index 3835

DFU 3 (4) 282 (1978)

Kleeman & Engel p. 383

DOT 14 (6) 239 (1978)

I.N. p. 407

Satzinger, G.; U.S. Patent 3,072,653; January 8, 1963; assigned to Warner-Lambert Pharmaceutical Co.

ETRETINATE

Therapeutic Function: Antipsoriasis (and antitumor)

Chemical Name: Ethyl all-trans-9-(4-methoxy-2,3,6-trimethylphenyl)-3,7-dimethyl-2,4,6,8-nonatetraenoate

Common Name: —

Structural Formula:

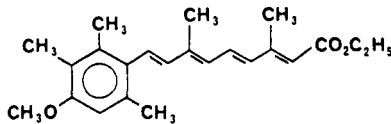

Chemical Abstracts Registry No.: —

Trade Name	Manufacturer	Country	Year Introduced
Tigason	Roche	U.K.	1981
Tigason	Roche	Switz.	1982
Tigason	Roche	France	1983
Tigason	Roche	W. Germany	1983
Tigason	Roche	Sweden	1983
Tigason	Sauter	Switz.	—

Raw Materials

- 5-(4-Methoxy-2,3,6-trimethylphenyl)-3-methylpenta-2,4-diene-1-triphenylphosphonium bromide
- Sodium hydride
- 3-Formylcrotonic acid butyl ester
- Potassium hydroxide
- Ethyl iodide
- Potassium carbonate

Manufacturing Process

228 g of 5-(4-methoxy-2,3,6-trimethylphenyl)-3-methylpenta-2,4-diene-1-triphenylphosphonium bromide are introduced under nitrogen gassing into 910 ml of dimethylformamide and treated with cooling at 5°C to 10°C within 20 minutes with 17.5 g of a suspension of sodium hydride (about 50% by weight) in mineral oil. The mixture is stirred for 1 hour at about 10°C, then treated at 5°C to 8°C dropwise with 61.8 g of 3-formylcrotonic acid butyl ester, heating for 2 hours at 65°C, subsequently introduced into 8 liters of ice water, and, after the addition of 300 g of sodium chloride, thoroughly extracted with a total of 18 liters of hexane. The extract is washed 5 times with 1 liter of methanol/water (6:4 parts by volume) each time and 2 times with 1.5 liter of water each time, dried over sodium sulfate and evaporated under reduced pressure to leave 9-(4-methoxy-2,3,6-trimethylphenyl)-3,7-dimethylnona-2,4,6,8-tetraen-1-oic acid butyl ester, MP 80°C to 81°C as the residue.

125.8 g of 9-(4-methoxy-2,3,6-trimethylphenyl)-3,7-dimethylnona-2,4,6,8-tetraen-1-oic acid

butyl ester are introduced into 2,000 ml of abs. ethanol and treated with a solution of 125.8 g of potassium hydroxide in 195 ml of water. The mixture is heated to boiling under nitrogen gassing for 30 minutes, then cooled, introduced into 10 liters of ice water and, after the addition of about 240 ml of concentrated hydrochloric acid (pH 2-4), thoroughly extracted with a total of 9 liters of methylene chloride. The extract is washed with about 6 liters of water to neutrality, dried over calcium chloride and evaporated under reduced pressure. The residue is taken up in 700 ml of hexane. The precipitated 9-(4-methoxy-2,3,6-trimethylphenyl)-3,7-dimethyl-nona-2,4,6,8-tetraen-1-oic acid melts at 228°C to 230°C.

60 g of 9-(4-methoxy-2,3,6-trimethylphenyl)-3,7-dimethyl-nona-2,4,6,8-tetraen-1-oic acid are dissolved in 1,000 ml of acetone. After the addition of 128 g of ethyl iodide and 128 g of potassium carbonate, the solution is stirred under nitrogen gassing for 16 hours at 55°C to 60°C and subsequently evaporated under reduced pressure. The residue is dissolved in 1,300 ml of petroleum ether (BP 80°C to 105°C). The 9-(4-methoxy-2,3,6-trimethylphenyl)-3,7-dimethyl-nona-2,4,6,8-tetraen-1-oic acid ethyl ester crystallizing out at -20°C, melts at 104°C to 105°C.

References

Merck Index 3836

DFU 2 (3) 199 (1977) (As Ro 10/9359) & 4 (12) 911 (1979) (As Etretinate)

DOT 18 (3) 120 (1982)

I.N. p. 407

Bollag, W., Ruegg, R. and Ryser, G.; U.S. Patent 4,105,681; August 8, 1978; assigned to Hoffmann-La Roche, Inc.

Bollag, W., Ruegg, R. and Ryser, G.; U.S. Patent 4,215,215; July 29, 1980; assigned to Hoffmann-La Roche, Inc.

ETRYPTAMINE

Therapeutic Function: Central stimulant

Chemical Name: α -Ethyl-1H-indole-3-ethanamine

Common Name: —

Structural Formula:

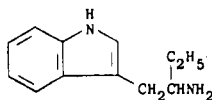

Chemical Abstracts Registry No.: 2235-90-7

Trade Name	Manufacturer	Country	Year Introduced
Monase	Upjohn	U.S.	1961

Raw Materials

3-(2'-Ethyl-2'-nitrovinyl)indole
Hydrogen

Manufacturing Process

A mixture of 5 parts of 3-(2'-ethyl-2'-nitrovinyl)indole in 80 parts of ethanol saturated with ammonia gas is shaken in an atmosphere of hydrogen at 100 atmospheres pressure and at 20°C

in the presence of 1 part of a 5% palladium on carbon catalyst until the theoretical amount of hydrogen is absorbed. The catalyst is removed by filtration. The ethanol and ammonia are then removed from the filtrate by distillation under reduced pressure. The residual oil is dissolved in 170 parts of dry ether, 50 parts of potassium hydroxide pellets are added and the solution is kept at 18°C to 22°C for 2 hours. The mixture is filtered and hydrogen chloride is passed into the filtrate to precipitate crude α -ethyltryptamine hydrochloride. This is purified by crystallization from methanol/ethyl acetate and it then has a MP of 221°C.

References

Merck Index 3837

I.N. p. 407

Young, E.H.P.; British Patent 933,786; August 14, 1963; assigned to Imperial Chemical Industries Ltd.

EXALAMIDE

Therapeutic Function: Antifungal

Chemical Name: 2-(Hexyloxy)benzamide

Common Name: —

Structural Formula:

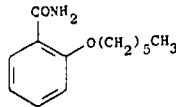

Chemical Abstracts Registry No.: 53370-90-4

Trade Name	Manufacturer	Country	Year Introduced
Hyperan	S.S. Pharm	Japan	1980

Raw Materials

Salicylamide	Sodium
Ethanol	n-Hexyl bromide

Manufacturing Process

4.6 g sodium were dissolved in 150 ml ethanol and 27.4 g (0.2 mol) salicylamide added. The solution was refluxed gently and 24.6 g (0.2 mol) n-hexyl-bromide added gradually. The mixture was refluxed for six hours, the precipitated sodium bromide filtered off, and most of the alcohol removed by distillation. Water was then added to the residue, and the 2-n-hexyloxybenzamide filtered off. It crystallized from 50% aqueous ethanol in colorless crystals, MP 71°C.

References

Merck Index 3858

DOT 16 (8) 246 (1980)

I.N. p. 410

MacRae, F.J. and Seymour, D.E.; British Patent 726,786; June 5, 1952; assigned to Herts Pharmaceuticals Ltd.

EXIPROBEN

Therapeutic Function: Choleric

Chemical Name: 2-[3-(Hexyloxy)-2-hydroxypropoxy] benzoic acid

Common Name: —

Structural Formula:

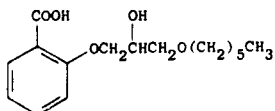

Chemical Abstracts Registry No.: 26281-69-6

Trade Name	Manufacturer	Country	Year Introduced
Droctil	Ciba Geigy	Italy	1971
Etopalin	Ciba Geigy	—	—

Raw Materials

p-Hydroxybenzoic acid methyl ester	Sodium hydroxide
3-Hexoxy-2-hydroxy-1-chloropropane	Hydrogen chloride

Manufacturing Process

p-Hydroxy-benzoic acid methyl ester was subjected to a condensation reaction with 3-hexoxy-2-hydroxy-1-chloropropane in the presence of sodium ethylate and ethanol as a solvent, yielding p-(3-hexoxy-2-hydroxy)-propoxy-benzoic acid methyl ester.

62 g of this intermediate product were admixed with 250 cc of 2N sodium hydroxide and the resulting mixture was refluxed for three hours. The reaction mixture was allowed to cool and was made acid with concentrated hydrochloric acid while cooling it on ice. An oil separated out which was extracted with ether. The ether extract solution was dried over sodium sulfate and then the ether was distilled off, leaving a crystalline mass as a residue. The crystalline product was recrystallized from a mixture of benzene and petroleum ether, yielding a compound having a MP of 68°C.

References

Merck Index 3860

I.N. p. 410

Ohnacker, G.; U.S. Patent 3,198,827; August 3, 1965; assigned to Boehringer Ingelheim G.m.b.H. (Germany)

F

FAZIDINIUM BROMIDE

Therapeutic Function: Skeletal muscle relaxant

Chemical Name: 1,1'-Azobis[3-methyl-2-phenylimidazo[1,2-a]pyridinium] dibromide

Common Name: —

Structural Formula:

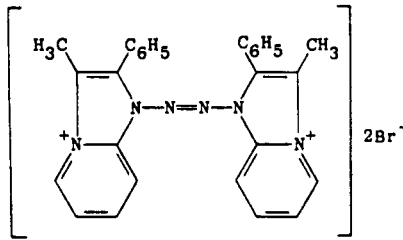

Chemical Abstracts Registry No.: 49564-56-9

Trade Name	Manufacturer	Country	Year Introduced
Fazadon	Duncan Flockhart	U.K.	1976
Fazadon	Glaxo	Italy	1981

Raw Materials

2-(2-Acetylhydrazino)pyridine	Hydrogen bromide
2-Bromopropiophenone	Bromine

Manufacturing Process

(a) 1-Acetamido-3-methyl-2-phenylimidazo[1,2-a]pyridinium bromide—A mixture of 2-(2-acetylhydrazino)pyridine (2 g) and 2-bromopropiophenone (2.84 g), in ethanol (10 ml) was heated in an open flask in a bath at 160°C to 170°C until the ethanol had evaporated; the residual melt was then heated for a further 0.25 hour. After cooling, the residual gum was triturated with acetone and the resulting solid (2.8 g) recrystallized from ethanol-ether giving the *bromide* as colorless prisms, MP 232°C to 234°C.

(b) 1-Amino-3-methyl-2-phenylimidazo[1,2-a]pyridinium bromide—A solution of the acetamido compound (2.78 g) in 24% hydrobromic acid (12 ml) was boiled under reflux for 1 hour. The solution was then evaporated under reduced pressure and the residue dissolved in methanol. Addition of ether precipitated the *bromide* which crystallized from ethanol as colorless prisms, MP 243°C to 244°C (1.7 g).

(c) 1,1'-Azobis[3-methyl-2-phenyl-1H-imidazo[1,2-a]pyridinium] dibromide—A warm (50°C) solution of the N-amino compound (0.6 g) in water (10 ml) was treated with saturated bro-

mine water (70 ml) and the precipitated orange solid filtered off and washed with water. The orange solid was sucked dry and then boiled with acetone (30 ml) until the suspended solid became yellow. Absolute acetone (10 ml) was then added and the solution filtered giving the *dibromide* (0.57 g) which crystallized from water as the yellow dihydrate, MP 215°C to 219°C (softened at 196°C).

References

Merck Index 3878

DFU 1 (10) 466 (1976)

DOT 13 (3) 98 (1977)

I.N. p. 413

Jack, D. and Glover, E.E.; U.S. Patents 3,773,746; November 20, 1973 and 3,849,557; November 19, 1974; both assigned to Allen & Hansburys Ltd.

FEBANTEL

Therapeutic Function: Anthelmintic

Chemical Name: Dimethyl[2-(2-methoxyacetamido)-4-phenylthiophenyl]-imidacarbonyl]-dicarbamate

Common Name: —

Structural Formula:

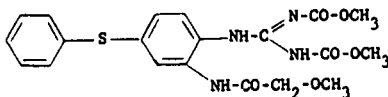

Chemical Abstracts Registry No.: 58306-30-2

Trade Name	Manufacturer	Country	Year Introduced
Rintal	Bayer	W. Germany	1979

Raw Materials

2-Amino-5-phenylthiomethoxyacetanilide

N,N'-Bis-methoxycarbonylisoithiourea-S-methyl ether

Manufacturing Process

2-Amino-5-phenylthiomethoxyacetanilide in methanol solution is heated with N,N'-bis-methoxycarbonyl-isoithiourea-S-methyl ether with the addition of a catalytic amount of p-toluene-sulfonic acid for three hours with stirring under reflux. The mixture is then filtered hot and after cooling the febantel product crystallizes out. It is filtered off, rinsed with ether and dried under high vacuum to give the final product, melting at 129°C to 130°C.

References

Merck Index 3879

DFU 3 (5) 377 (1978)

I.N. p. 413

Kolling, H., Thomas, H., Widdig, A. and Wollweber, H.; U.S. Patent 4,088,780; May 9, 1978; assigned to Bayer AG

FEBUPROL

Therapeutic Function: Choleric agent

Chemical Name: 3-n-Butoxy-1-phenoxy-2-propanol

Common Name: —

Structural Formula:

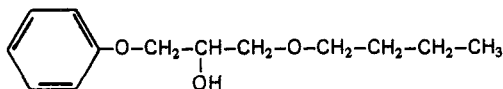

Chemical Abstracts Registry No.: 3102-00-9

Trade Name	Manufacturer	Country	Year Introduced
Valbil	Rohm Pharma	W. Germany	1981
Valbil	Klinge	W. Germany	—

Raw Materials

n-Butylglycidyl ether
Phenol
Potassium hydroxide

Manufacturing Process

Initially, 4.5 g (0.08 mol) pulverized potassium hydroxide was dissolved in 300 ml isopropanol in a 500 ml four-neck flask equipped with stirrer, intensive cooler, dropping funnel and feed pipe for the gas treatment with nitrogen.

Then, 52.0 g (0.4 mol) n-butylglycidyl ether and 41.4 g (0.44 mol) phenol was added thereto, whereafter the material was heated to boiling under nitrogen. The material was stirred, about 8.5 hours, until no glycidyl ether could be determined, e.g., by gas chromatography.

After the suspension was cooled under nitrogen, the solvent was distilled off under vacuum. The residue was taken up in 200 ml water and the milky emulsion extracted exhaustively with ether. From the organic phase, the excess butylglycidyl ether was extracted with diluted potassium hydroxide solution. The ether phase was washed neutral with water and the solvent removed after drying with sodium sulfate. The remaining oily residue was distilled under vacuum; there was obtained a colorless liquid of BP 123.5°C/0.07 mm. Yield: 81.8 g (91.1% of the theory).

References

Merck Index 3882

DFU 3 (3) 191 (1978)

DOT 19 (12) 683 (1983)

I.N. p. 413

Hoffmann, H., Wagner, J., Hofrichter, G. and Grill, H.; U.S. Patent 3,839,587; October 1, 1974; assigned to Chemisch-Pharmazeutische Fabrik Adolf Klinge and Co.

FELYPRESSIN

Therapeutic Function: Vasoconstrictor

Chemical Name: Vasopressin 2-(L-phenylalanine)-8-L-lysine

Common Name: —

Structural Formula: $\text{Cys-Phe-Phe-Gln-Asn-Cys-Pro-Lys-GlyNH}_2$

Chemical Abstracts Registry No.: 56-59-7

Trade Name	Manufacturer	Country	Year Introduced
Octapressin	Sandoz	W. Germany	1967
Octapressin	Sandoz	Japan	1971
Colupressine	Joullie	France	—

Raw Materials

N-Carbobenzoxyl-L-prolyl- ϵ -N-p-toluenesulfonyl-L-lysyl-glycinamide
 N-Carbobenzoxyl-L-glutaminyll-L-asparaginyll-S-benzyl-L-cysteinyl-azide
 N-Carbobenzoxyl-S-benzyl-L-cysteinyl-L-phenylalanyl azide
 Oxygen
 Ammonia
 Acetic acid
 Hydrogen bromide

Manufacturing Process

Preparation of N-Carbobenzoxyl-L-Glutaminyll-L-Asparaginyll-S-Benzyl-L-Cysteinyl-L-Prolyl- ϵ -N-p-Toluenesulfonyll-L-Lysylglycinamide: 200 parts by weight of N-carbobenzoxyl-L-prolyl- ϵ -N-p-toluenesulfonyll-L-lysyl-glycinamide are dissolved in 1,000 parts by volume of anhydrous acetic acid which has been saturated with HBr, the mixture allowed to stand for 1 hour at 20°C and then evaporated under reduced pressure at below 40°C. The residue from this evaporation is carefully washed with diethyl ether and then added to a solution of 185 parts by weight of N-carbobenzoxyl-L-glutaminyll-L-asparaginyll-S-benzyl-L-cysteinyl-azide and 48 parts by volume of triethylamine in 1,500 parts by volume of dimethylformamide. The mixture is allowed to stand overnight at 20°C and the mixture is then poured into twice its volume of acetone. The precipitate which settles out is filtered off, washed with water, and recrystallized from dimethylformamide-acetone. There are thus obtained 190 parts by weight of N-carbobenzoxyl-L-glutaminyll-L-asparaginyll-S-benzyl-L-cysteinyl-L-prolyl- ϵ -N-p-toluenesulfonyll-L-lysyl-glycinamide; MP 165°C (decomposition).

Preparation of N-Carbobenzoxyl-S-Benzyl-L-Cysteinyl-L-Phenylalanyl-L-Phenylalanyl-L-Glutaminyll-L-Asparaginyll-S-Benzyl-L-Cysteinyl-L-Prolyl- ϵ -N-p-Toluenesulfonyll-L-Lysyl-Glycinamide: 50 parts by weight of N-carbobenzoxyl-L-glutaminyll-L-asparaginyll-S-benzyl-L-cysteinyl-L-prolyl- ϵ -N-p-toluenesulfonyll-L-lysyl-glycinamide are dissolved in 400 parts by volume of anhydrous acetic acid which is saturated with HBr, and the mixture allowed to stand for 1 hour at 20°C. After evaporating off the solvent under reduced pressure at a temperature of 35°C (or another temperature below 40°C), the residue is carefully washed with diethyl ester, whereupon a solution of 32 parts by weight of N-carbobenzoxyl-S-benzyl-L-cysteinyl-L-phenylalanyl-L-phenylalanyl-azide and 70 parts by volume of triethylamine in 500 parts by volume of dimethylformamide is added.

The mixture is allowed to stand for 2 days at 20°C, after which twice its volume of ethyl-acetate is added and the resultant precipitate then washed with warm methanol. There are obtained 45 parts by weight of N-carbobenzoxyl-S-benzyl-L-cysteinyl-L-phenylalanyl-L-phenylalanyl-L-glutaminyll-L-asparaginyll-S-benzyl-L-cysteinyl-L-prolyl- ϵ -N-p-toluenesulfonyll-L-lysyl-glycinamide; MP 222°C.

Preparation of L-Cysteinyl-L-Phenylalanyl-L-Phenylalanyl-L-Glutaminyll-L-Asparaginyll-L-

Cysteinyl-L-Prolyl-L-Lysyl-Glycinamide: Metallic potassium is stirred into a solution of 10 parts by weight of N-carbobenzoxy-S-benzyl-L-cysteinyl-L-phenylalanyl-L-phenylalanyl-L-glutaminy-L-asparaginy-L-S-benzyl-L-cysteinyl-L-prolyl-ε-N-p-toluenesulfonyl-L-lysyl-glycinamide in 2,500 parts of dry liquid ammonia at boiling temperature of the solution, until a stable blue coloration appears. After the addition of 1.8 parts by weight of ammonium chloride, the solution is evaporated to dryness. The residue of this evaporation contains the desired L-cysteinyl-L-phenylalanyl-L-phenylalanyl-L-glutaminy-L-asparaginy-L-cysteinyl-L-prolyl-L-lysyl-glycinamide.

Preparation of Felypressin: The aforesaid residue, containing the L-cysteinyl-L-phenylalanyl-L-phenylalanyl-L-glutaminy-L-asparaginy-L-cysteinyl-L-prolyl-L-lysyl-glycinamide, is dissolved in 20,000 parts by volume of 0.01 normal acetic acid and is then oxidized by passing air into the solution at a pH of 6.5 to 8.0 for 1 hour. The solution, which contains Felypressin, is adjusted to a pH of 4.0 to 5.0, whereupon 100 parts by weight of sodium chloride are added and the mixture evaporated to dryness, yielding a dry powder of good stability. It can be stored, and yields a clear solution, e.g., in water or other appropriate solvent. The solution may be used directly or, if desired, after dilution with water or a sodium chloride solution.

References

Merck Index 3885

Kleeman & Engel p. 385

I.N. p. 414

Boissonnas, R. and Guttmann, S.; U.S. Patent 3,232,923; February 1, 1966; assigned to Sandoz AG, Switzerland

FENBENDAZOLE

Therapeutic Function: Anthelmintic

Chemical Name: 5-Phenylmercapto-benzimidazole-2-methyl-carbamate

Common Name: —

Structural Formula:

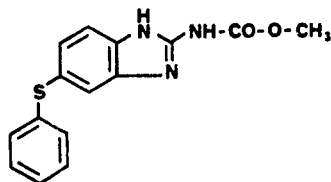

Chemical Abstracts Registry No.: 43210-67-9

Trade Name	Manufacturer	Country	Year Introduced
Panacur	Hoechst	W. Germany	1980

Raw Materials

S-Methyl thiourea

Chloroformic acid methyl ester

3,4-Diamino-diphenyl-thioether

Manufacturing Process

20.9 g of S-methyl-thiourea were dissolved in 27 ml of water with 13.5 ml of chloroformic acid methyl ester. Then, 45.7 ml of 25% sodium hydroxide solution were added dropwise, while stirring, at a temperature of 5°C to 10°C. After having stirred for 20 minutes, the reaction mixture was combined with 27 ml of glacial acetic acid, 100 ml of water and 29 g of 3,4-diamino-diphenyl-thioether. Stirring was continued for 90 minutes at a temperature of 85°C, during which time methyl-mercaptan was separated. After having allowed the whole to cool and stand overnight, the 5-phenylmercapto-benzimidazole-2-methyl-carbamate that had formed was filtered off with suction. After recrystallization from a mixture of glacial acetic acid and methanol, 14 g of 4-phenylmercapto-benzimidazole-2-methyl-carbamate melting at 233°C were obtained.

References

Merck Index 3891

OCDS Vol. 3 p. 176 (1984)

DOT 14 (1) 45 (1978)

I.N. p. 414

Loewe, H., Urbanietz, J., Kirsch, R. and Duwel, D.; U.S. Patent 3,984,561; October 5, 1976; assigned to Hoechst AG

Loewe, H., Urbanietz, J., Kirsch, R. and Duwel, D.; U.S. Patent 3,954,791; May 4, 1976; assigned to Hoechst AG

FENBUFEN

Therapeutic Function: Antiinflammatory

Chemical Name: 3-(4-Biphenylcarbonyl)propionic acid

Common Name: —

Structural Formula:

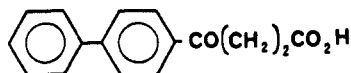

Chemical Abstracts Registry No.: 36330-85-5

Trade Name	Manufacturer	Country	Year Introduced
Cinopal	Cyanamid	Italy	1976
Lederfen	Cyanamid	W. Germany	1979
Lederfen	Lederle	U.K.	1979
Cinopal	Opopharma	Switz.	1979
Napanol	Lederle	Japan	1980
Cinopal	Cyanamid	France	1971
Bufemid	Lederle	—	—

Raw Materials

Biphenyl

Succinic anhydride

Aluminum chloride

Manufacturing Process

135 g of aluminum chloride is dissolved in 500 ml of nitrobenzene, the solution being held

below 10°C by external cooling. A finely ground mixture of 50 g of succinic anhydride and 75 g of biphenyl is added to the stirred solution, the temperature being held below 10°C. It is then held at room temperature for four days. After pouring the reaction mixture into a solution of 150 ml of concentrated hydrochloric acid in 1 liter of ice water, the nitrobenzene is removed by steam distillation. The solid is collected, dissolved in 4 liters of 3% hot sodium carbonate solution, clarified, and reprecipitated by the addition of excess 6N sulfuric acid solution. The crude product is collected, dried, and recrystallized from ethanol to give the pure subject compound, MP 185°C to 187°C.

References

Merck Index 3893

DFU 1 (1) 26 (1976)

Kleeman & Engel p. 386

OCDS Vol. 2 p. 126 (1980)

DOT 13 (4) pp. 133, 136 (1977)

I.N. p. 416

Tomcufoik, A.S., Child, R.G. and Sloboda, A.E.; U.S. Patent 3,784,701; January 8, 1974; assigned to American Cyanamid Co.

FENDILINE HYDROCHLORIDE

Therapeutic Function: Coronary vasodilator

Chemical Name: γ -phenyl-N-(1-phenylethyl)benzenepropanamine hydrochloride

Common Name: N-(1-phenylethyl)-3,3-diphenyl-propylamine

Structural Formula:

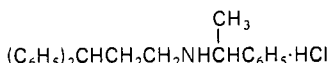

Chemical Abstracts Registry No.: 13636-18-5; 13042-18-7 (Base)

Trade Name	Manufacturer	Country	Year Introduced
Sensit	Thiemann	W. Germany	1974
Sensit F	Ravasini	Italy	1981
Difmecor	UCM-Difme	Italy	—
Fendilar	Spa	Italy	—

Raw Materials

γ,γ -Diphenylpropylamine	Hydrogen
Acetophenone	Hydrogen chloride

Manufacturing Process

21.13 grams of γ,γ -diphenyl-propylamine and 12.01 grams of acetophenone are hydrogenated in 200 ml of methanol at 55°C and a pressure of 10 atmospheres in the presence of palladium charcoal. On filtration of the catalyst the solution is concentrated and the remainder is distilled in vacuo at a pressure of 0.3 Hg mm. The main distillate is collected at 206° to 210°C. 25.38 grams of N-[1'-phenylethyl-(1'')] -1,1-diphenyl-propyl-(3)-amine are obtained.

The product is dissolved in 134 ml of 96% ethanol whereupon 26.8 ml of concentrated hydrochloric acid and 201 ml of water are added while cooling with ice-water. The pre-

cipitate is filtered off and dried in vacuo at 100°C. 22.98 grams of N-[1¹-phenylethyl-(1¹)]-1,1-diphenyl-propyl-(3)-amine hydrochloride are obtained. MP 200° to 201°C. On recrystallization from 285 ml of a 2:1 mixture of water and 96% ethanol the melting point remains unchanged.

References

Merck Index 3903

Kleeman & Engel p. 389

DOT 10 (12) 337 (1974)

I.N. p. 417

Harsányi, K., Korbonits, D., Takáts, K., Tardos, L. and Leszkovszky, G.; U.S. Patent 3,262,977; July 26, 1966; assigned to Chinoin Gyógyszer-és Vegyeszeti Termékek, Hungary

FENETHYLLINE HCl

Therapeutic Function: Central stimulant

Chemical Name: 3,7-Dihydro-1,3-dimethyl-7-[2-[(1-methyl-2-phenylethyl)amino]ethyl]-1H-purine-2,6-dione

Common Name: Theophyllineethylamphetamine

Structural Formula:

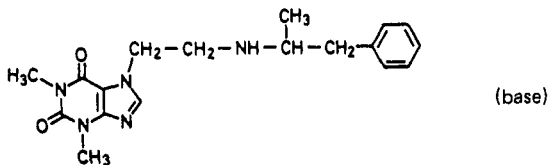

Chemical Abstracts Registry No.: 1892-80-4; 3736-08-1 (Base)

Trade Name	Manufacturer	Country	Year Introduced
Captagon	Homburg	W. Germany	1961
Gelosedine	Bayer	France	1964
Captagon	Gerda	France	—
Fitton	Teva	Israel	—

Raw Materials

7-(β-Chloroethyl)-theophylline
 α-Methyl-β-phenyl ethylamine
 Hydrogen chloride

Manufacturing Process

1 mol of 7-(β-chloroethyl)-theophylline and 2½ mols of α-methyl-β-phenyl ethylamine are heated for 6 hours in an oil bath, if necessary with addition of alcohol or toluene. The reaction mixture is diluted with alcohol and acidified with alcoholic hydrochloric acid. The crystalline mass formed is filtered with suction and extracted by boiling with alcohol. A product having a melting point of 237°C to 239°C is formed. With prolonged extraction by boiling with alcohol, the melting point of the mass falls, preferably due to a change in modification, to 227°C to 229°C. However, analysis shows that both products are the pure condensation product.

Instead of the chloroethyl theophylline, it is also possible to use the corresponding bromine derivative. It was found that in this way the process is facilitated and the yield is improved.

References

Merck Index 3906

Kleeman & Engel p. 390

OCDS Vol. 1 p. 425 (1977)

I.N. p. 418

Kohlstaedt, E. and Klingler, K.H.; U.S. Patent 3,029,239; April 10, 1962; assigned to Chemiewerke Homburg

FENIPENTOL

Therapeutic Function: Choleric

Chemical Name: α -Butylbenzenemethanol

Common Name: Phenylpentanol

Structural Formula:

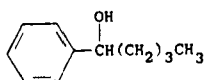

Chemical Abstracts Registry No.: 583-03-9

Trade Name	Manufacturer	Country	Year Introduced
Pancoral	Eisai	Japan	1973
Euralan	Bedrial	France	1974
Billicol	Violoni-Farmavigor	Italy	—
Cholipin	Boehr. Ingel.	Italy	—
Critichol	Angelini	Italy	—
Epatolark	Farm. Mil.	Italy	—
Eprox	Off	Italy	—
Fabil-Valeas	Valeas	Italy	—
Florobil	Scalari	Italy	—
Kol	Mitim	Italy	—
Liverpen	Guidil	Italy	—
Pentabil	Off	Italy	—
Suiclisin	Nikken	Japan	—

Raw Materials

Benzaldehyde

Butyl bromide

Magnesium

Manufacturing Process

The 1-phenyl-pentanol-(1) may be prepared in any convenient manner. Benzaldehyde may be reacted with n-butyl-magnesium bromide, and after purification 1-phenyl-pentanol-(1) is obtained in the form of a colorless oil at room temperature.

References

Merck Index 3909

Kleeman & Engel p. 391

DOT 10 (6) 203 (1974)

I.N. p. 418

Scheffler, H. and Engelhorn, R.; U.S. Patent 3,084,100; April 2, 1963; assigned to Dr. Karl Thomae G.m.b.H.

FENOFIBRATE

Therapeutic Function: Antihyperlipoproteinemic

Chemical Name: 2-[4-(4-Chlorobenzoyl)phenoxy]-2-methylpropanoic acid-1-methylethyl ester

Common Name: Procetofen

Structural Formula:

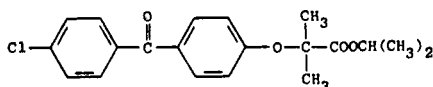

Chemical Abstracts Registry No.: 49562-28-9

Trade Name	Manufacturer	Country	Year Introduced
Lipantyl	Fournier	France	1975
Lipanthyl	Fournier	Switz.	1975
Lipanthyl	Pharma Holz	W. Germany	1978
Lipanthyl	Nativelle	Italy	1979
Lipidax	UCB-Smit	Italy	1979
Ankebin	Volpino	Argentina	—
Elasterin	Phoenix	Argentina	—
Fenobrate	Gerardo Ramon	Argentina	—
Fenolibis	L.I.B.S.	France	—
Lipanthyl	Falorni	Italy	—
Lipidil	ibirn	Italy	—
Lipoclar	Farmacosmici	Italy	—
Lipofene	Selvi	Italy	—
Liposit	S.I.T.	Italy	—
Nolipax	Biomedica Foscama	Italy	—
Procetoken	Bernabo	Argentina	—
Protolipan	Millet	Argentina	—
Sedufen	Microsules	Argentina	—

Raw Materials

4-Hydroxy-4'-chlorobenzophenone	Acetone
Sodium hydroxide	Chloroform
Thionyl chloride	Isopropanol

Manufacturing Process

(a) *Preparation of p-(4-chlorobenzoyl)-phenoxyisobutyric acid:* 1 mol of 4-hydroxy-4'-chlorobenzophenone is dissolved in anhydrous acetone and then 5 mols of powdered sodium hydroxide is added. The corresponding sodium phenoxide precipitates. Refluxing is effected, and then, 1.5 mols of CHCl_3 diluted with anhydrous acetone is added and the resulting mixture is refluxed for 10 hours. After cooling, water is added, the acetone is evaporated, the

aqueous phase is washed with ether and acidified and the organic phase is redissolved in ether and extracted into a solution of bicarbonate. The bicarbonate solution is then acidified to obtain the desired acid, having a melting point of 185°C, with a yield of 75%.

(b) *Preparation of fenofibrate*: 1 mol of the acid obtained is converted into its acid chloride using thionyl chloride (2.5 mols). 1 mol of the acid chloride is then condensed with 1.05 mol of isopropyl alcohol in the presence of 0.98 mol of pyridine in an inert solvent such as benzene.

Since traces of SO₂ (which has a bad smell) may be obtained from the thionyl chloride, it is preferable to avoid this disadvantage by carrying out the esterification directly.

References

Merck Index 3912

Kleeman & Engel p. 392

I.N. p. 419

Mieville, A.; U.S. Patent 3,907,792; September 23, 1975

FENOPROFEN

Therapeutic Function: Antiinflammatory

Chemical Name: α -methyl-3-phenoxybenzeneacetic acid

Common Name: m-phenoxyhydratropic acid

Structural Formula:

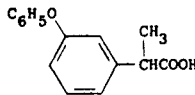

Chemical Abstracts Registry No.: 31879-05-7

Trade Name	Manufacturer	Country	Year Introduced
Fenopron	Dista	U.K.	1974
Feprona	Lilly	W. Germany	1975
Nalfon	Dista	U.S.	1976
Fepron	Lilly	Italy	1978
Nalgesic	Lilly	France	1979
Fenopron	Yamanouchi	Japan	1982
Fenoprex	Lilly	—	—
Progesic	Lilly	—	—

Raw Materials

m-Hydroxyacetophenone	Bromobenzene
Potassium carbonate	Copper
Sodium borohydride	Sodium cyanide
Phosphorus tribromide	Sodium hydroxide

Manufacturing Process

3-Phenoxyacetophenone: A mixture consisting of 908 grams (6.68 mols) of m-hydroxyacetophenone, 4,500 grams (28.6 mols) of bromobenzene, 996 grams (7.2 mols) of anhydrous potassium carbonate, and 300 grams of copper bronze was heated under reflux with

stirring until water evolution was complete, using a Dean-Stark water separator. The mixture was then stirred and refluxed for 24 hours. After cooling to room temperature, the reaction was diluted with an equal volume of CHCl_3 and filtered. The filtrate was washed with 5% HCl, then with 5% NaOH, with water, dried over Na_2SO_4 and evaporated in vacuo. The residual oil was distilled through a 15 cm Vigreux column, yielding 918 grams of 3-phenoxy-acetophenone, BP 120° to 121°C (0.09 mm).

α -Methyl-3-Phenoxybenzyl Alcohol: A stirred solution of 700 grams of m-phenoxyacetophenone in 3,000 ml anhydrous methanol was cooled to 0°C in an ice-acetone bath. Sodium borohydride, 136 grams (3.6 mols) was added to this solution in small portions at such a rate that the temperature never rose above 10°C . After borohydride addition was complete, the reaction mixture was allowed to warm to room temperature and stirred for 18 hours. It was then stirred and refluxed for 8 hours. About 400 ml of methanol was distilled out and the remaining solution was evaporated to about one-third its original volume in vacuo and poured into ice water. This mixture was extracted twice with ether, acidified with 6 N HCl, and again extracted with ether. The ether extracts were combined, washed with saturated NaCl solution, dried over anhydrous sodium sulfate, and evaporated in vacuo. The residual oil was distilled through a 15 cm Vigreux column, yielding 666 grams of α -methyl-3-phenoxybenzyl alcohol, BP 132° to 134°C (0.35 mm), $n_D^{25} = 1.5809$.

α -Methyl-3-Phenoxybenzyl Bromide: A stirred solution of 1,357 grams of α -methyl-3-phenoxybenzyl alcohol in 5,000 ml anhydrous CCl_4 (predried over molecular sieve) was cooled to 0°C . To this was added 1,760 grams PBr_3 , stirring and cooling being maintained at such a rate that the temperature remained at 0° to 5°C , during the addition. The reaction mixture was then allowed to warm to room temperature and was stirred at room temperature overnight (ca 12 hours). The reaction mixture was then poured into ice water and the organic phase separated. The aqueous phase was extracted with CCl_4 and the combined extracts were washed three times with water, dried over anhydrous sodium sulfate and evaporated to dryness in vacuo to yield 1,702 grams of α -methyl-3-phenoxybenzyl bromide as a heavy viscous oil, $n_D^{25} = 1.5993$.

2-(3-Phenoxyphenyl)Propionitrile: A well-stirred suspension of 316 grams of 98% sodium cyanide in 5,000 ml of anhydrous dimethyl sulfoxide (previously dried over molecular sieve) was warmed to 55° to 60°C and maintained at this temperature while 1,702 grams of α -methyl-3-phenoxybenzyl bromide was slowly added. After the bromide addition was completed, the temperature was raised to 75°C and the mixture stirred at this temperature for 1.5 hours. The mixture was then allowed to cool to room temperature and was stirred overnight at room temperature and then poured into ice water. The resulting aqueous suspension was extracted twice with ethyl acetate, and then with ether. The organic extract was washed twice with a sodium chloride solution, once with water, and dried over anhydrous sodium sulfate. Evaporation of the solvent in vacuo left an oily residue which was distilled through a 15 cm Vigreux column to yield 1,136 grams of 2-(3-phenoxyphenyl)-propionitrile, BP 141° to 148°C (0.1 mm), $n_D^{25} = 1.5678$.

2-(3-Phenoxyphenyl)Propionic Acid: A mixture of 223 grams of 2-(3-phenoxyphenyl)-propionitrile and 400 grams of sodium hydroxide in 1,600 ml of 50% ethanol was refluxed with stirring for 72 hours. After cooling to room temperature, the reaction mixture was poured into ice water. The resulting solution was washed with ether, acidified with concentrated HCl, and extracted with ether. The ether extract was washed with water, dried over anhydrous sodium sulfate, and evaporated to dryness in vacuo. The residual oil was distilled to yield 203.5 grams (84%) of 2-(3-phenoxyphenyl)propionic acid as a viscous oil; BP 168° to 171°C (0.11 mm), $n_D^{25} = 1.5742$.

References

- Merck Index 3913
- Kleeman & Engel p. 392
- PDR p. 843
- OCDS Vol. 2 p. 67 (1980)

DOT 8 (1) 34 (1972) & 9 (9) 373 (1973)

I.N. p. 419

REM p. 1116

Marshall, W.S.; U.S. Patent 3,600,437; August 17, 1971; assigned to Eli Lilly and Company

FENOTEROL HYDROBROMIDE

Therapeutic Function: Bronchodilator

Chemical Name: 3,5-dihydroxy- α -[[(p-hydroxy- α -methylphenethyl)amino] methyl] benzyl alcohol hydrobromide

Common Name: —

Structural Formula:

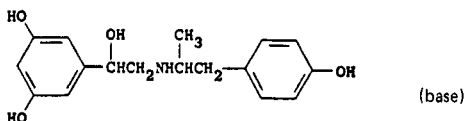

Chemical Abstracts Registry No.: 1944-12-3; 13392-18-2 (Base)

Trade Name	Manufacturer	Country	Year Introduced
Berotec	Boehr. Ingel.	W. Germany	1972
Berotec	W.B. Pharm	U.K.	1977
Dosberotec	Boehr. Ingel.	Italy	1980
Berotec	Boehr. Ingel.	Switz.	1982
Airum	Promeco	Argentina	—
Berotec	Fher	Spain	—
Partusisten	Boehr. Ingel.	—	—

Raw Materials

3,5-Diacetoxy acetophenone	Hydrogen chloride
1-p-Methoxyphenyl-2-benzylamino propane	Bromine
Hydrogen bromide	Hydrogen

Manufacturing Process

441 grams (1.4 mols) of 3,5-diacetoxy- α -bromo-acetophenone (MP 66°C), prepared by bromination of 3,5-diacetoxy-acetophenone, were added to a solution of 714 grams (2.8 mols) of 1-p-methoxyphenyl-2-benzylamino-propane in 1,000 cc of benzene, and the resulting solution mixture was refluxed for 1 hour. The molar excess of 1-p-methoxy-phenyl-2-benzylamino-propane precipitated out as its hydrobromide. After separation of the precipitated hydrobromide of the amino component, the hydrochloride of 1-p-methoxy-phenyl-2-(β -3',5'-diacetoxyphenyl- β -oxo)-ethyl-benzylamino-propane was precipitated from the reaction solution by addition of an ethanolic solution of hydrochloric acid. The precipitate was separated and, without further purification, was deacetylated by boiling it in a mixture of 2 liters of aqueous 10% hydrochloric acid and 1.5 liters of methanol.

The resulting solution was filtered through animal charcoal and, after addition of 2 liters of methanol, it was debenzylated by hydrogenation at 60°C over palladinized charcoal as a catalyst. After removal of the catalyst by filtration, the filtrate was concentrated by evaporation, whereupon the hydrochloride of 1-p-methoxyphenyl-2-(β -3',5'-dihydroxyphenyl- β -oxo)-ethylamino-propane (MP 244°C) crystallized out. For the purpose of demethylation,

the 350 grams of the hydrochloride thus produced were refluxed for 2 hours with 3.5 liters of aqueous 48% hydrobromic acid. Upon cooling of the reaction solution, 320 grams of 1-p-hydroxyphenyl-2-(β -3',5'-dihydroxyphenyl- β -oxo)-ethylamino-propane hydrobromide (MP 220°C) crystallized out.

220 grams of 1-p-hydroxyphenyl-2-(β -3',5'-dihydroxyphenyl- β -oxo)-ethylamino-propane hydrobromide were dissolved in 1 liter of methanol, the resulting solution was boiled with activated charcoal, the charcoal was filtered off and the filtrate was hydrogenated in the presence of Raney nickel at 60°C and 5 atmospheres gauge. Thereafter, the catalyst was filtered off, the methanolic solution was admixed with a small amount of concentrated hydrobromic acid, and the mixture was evaporated to dryness in vacuo. The residue was stirred with acetone, the mixture was vacuum filtered and the filter cake was recrystallized from a mixture of methanol and ether. The 1-p-hydroxyphenyl-2-(β -3',5'-dihydroxyphenyl- β -hydroxy)-ethylamino-propane hydrobromide thus obtained had a melting point of 222° to 223°C.

References

Merck Index 3914

Kleeman & Engel p. 393

OCDS Vol. 2 p. 38 (1980)

DOT 8 (1) 36 (1972), 9 (1) 21 (1973) & 11 (1) 20 (1975)

I.N. p. 419

Zeile, K., Thoma, O. and Mentrup, A.; U.S. Patent 3,341,593; September 12, 1967; assigned to Boehringer Ingelheim GmbH, Germany

FENOXEDIL

Therapeutic Function: Vasodilator

Chemical Name: 2-(4-butoxyphenoxy)-N-(2,5-diethoxyphenyl)-N-[2-(diethylamino)ethyl]-acetamide

Common Name: —

Structural Formula:

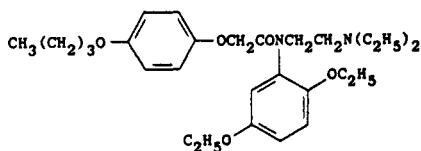

Chemical Abstracts Registry No.: 54063-40-0; 27471-60-9 (Hydrochloride)

Trade Name	Manufacturer	Country	Year Introduced
Suplexedil	Hepatrol	France	1974

Raw Materials

2,5-Diethoxyaniline	Triethylamine
4-Butoxyphenoxy acetyl chloride	Sodium amide
2-Diethylamino-1-chloroethane	

Manufacturing Process

420 grams of 2,5-diethoxy aniline are dissolved in 4 liters of dichloroethane and 230 grams

of triethylamine are added. The mixture is heated, while stirring, with 845 grams of 4-butoxy phenoxy acetyl chloride. The temperature increases towards 40°C. The mixture is then heated for 2 hours at 80°C. After cooling the product is washed with normal hydrochloric acid, then with water, then with normal sodium carbonate and finally with water.

The organic phase is dried over sodium sulfate, filtered, the dichloroethane is evaporated off and the residue is crystallized from ethyl alcohol (95%). The product is dried in the oven and there is thus obtained about 800 grams (yield 90%) of the N-(2,5-diethoxyphenyl)-4-butoxy phenoxy acetamide, MP 101°C.

A vessel provided with a mechanical agitator, a thermometer and a refrigerant, is charged with 49.2 grams of sodamide (90%) in suspension in 300 ml of anhydrous toluene, and a solution of 465 grams of amide obtained as above in 2 liters of anhydrous toluene. The solution is poured in, little by little during 1.5 hours with slight warming. The mixture is maintained for 1 hour at 80°C during which ammonia is evolved. It is cooled to 45°C, there is added, in a single quantity, 170 grams of 2-diethyl-amino-1-chloroethane and the temperature is raised slowly to 100°C and is maintained there for 10 hours.

The mixture is cooled, the organic phase washed with water and dried over sodium sulfate. The toluene is evaporated and the residue taken up in 2 liters of normal acetic acid, with cooling. It is allowed to crystallize in the cold, filtered to remove the insoluble portion and the base precipitated from the filtrate by the addition of sodium carbonate; this is extracted with dichloroethane and the organic phase dried over sodium sulfate. After evaporation of the solvent an oil is distilled, BP 225° to 230°C/0.1 mm, weight 340 grams, yield 58%. The hydrochloride prepared by the action of gaseous hydrogen chloride on this oil in ethyl ether melts at 140°C.

References

Merck Index 3916

Kleeman & Engel p. 395

DOT 11 (2) 58 (1975)

I.N. p. 420

Thuillier, G. and Geffroy, F.; U.S. Patent 3,818,021; June 18, 1974; assigned to CERPHA (Centre Europeen de Recherches Pharmacologiques), France

FENPROPOREX

Therapeutic Function: Anorexic

Chemical Name: 3-[(1-Methyl-2-phenylethyl)amino]propanenitrile

Common Name: N-2-Cyanoethylamphetamine

Structural Formula:

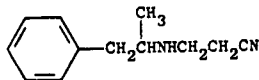

Chemical Abstracts Registry No.: 15686-61-0

Trade Name	Manufacturer	Country	Year Introduced
Fenproporex	Chephasaar	W. Germany	1975

Trade Name	Manufacturer	Country	Year Introduced
Fenproporex	Bottu	France	1977
Desobesi	Luer	Brazil	—
Fenorex	Biosintetica	Brazil	—
Lineal	Roussel	—	—
Lipolin	ICN-Usafarma	Brazil	—
Perphoxene	Bottu	France	—
Perphoxene	Siegfried	Switz.	—
Tegisec	Roussel	—	—

Raw Materials

Acrylonitrile
 α -Methyl- β -phenylethylamine
 Hydrogen chloride

Manufacturing Process

(a) 22 g of acrylonitrile and 27 g of racemic α -methyl- β -phenylethylamine were introduced into a 100 ml round-bottomed flask and left standing for 13 hours at ambient temperature, and then the mixture was boiled under reflux for 12½ hours. The excess acrylonitrile was then evaporated in vacuo and the residue distilled. 27.3 g (yield: 72.6%) of racemic N-(β -cyanoethyl)- α -methyl- β -phenylethylamine were obtained as an oily liquid, BP = 126°C to 127°C/2 mm Hg.

(b) 22 g of the base obtained in (a) were dissolved in 80 ml of anhydrous diethyl ether and an ethereal solution of hydrochloric acid added until the pH value was 1. The salt was filtered off, dried and washed with 10 ml of diethyl ether. 18 g (yield: 68%) of N-(β -cyanoethyl)- α -methyl- β -phenylethylamine hydrochloride were obtained, after recrystallization from absolute ethanol, as a white, microcrystalline, odorless powder having a bitter, acid taste; it was fairly soluble in water, ether and benzene. MP = 146°C on a Kofler block.

References

Merck Index 3922

DOT 9 (6) 213 (1973)

I.N. p. 420

Rohrbach, P. and Blum, J.; U.S. Patent 3,485,924; December 23, 1969; assigned to Manufacturers J.R. Bottu (France)

FENSPIRIDE

Therapeutic Function: Bronchodilator

Chemical Name: 8-(2-phenylethyl)-1-oxa-3,8-diazaspiro[4.5] decan-2-one

Common Name: Decaspiride

Structural Formula:

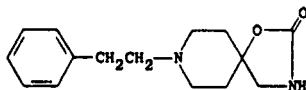

Chemical Abstracts Registry No.: 5053-06-5; 5053-08-7 (Hydrochloride)

Trade Name	Manufacturer	Country	Year Introduced
Viarespan	Servier	France	1969
Respiride	Schiapparelli	Italy	1979
Abronquill	Soubeiran Chobet	Argentina	—
Decaspir	Pulitzer	Italy	—
Espiran	Fardeco	Italy	—
Fendel	Sidus	Argentina	—
Fluiden	Lafare	Italy	—
Pneumorel	Biopharma	France	—
Teodelin	Cuatrecasas-Darkey	Spain	—

Raw Materials

1-(2-Phenylethyl)-4-piperidone	Potassium cyanide
Lithium aluminum hydride	Diethyl carbonate

Manufacturing Process

A solution of 192 g of 1-phenethyl-4-hydroxy-4-aminomethyl piperidine in 800 cc of diethyl carbonate is heated for 2½ hours to reflux at about 80°C in the presence of sodium methylate (prepared for immediate use from 2 g of sodium). After this time, the ethyl alcohol formed during the reaction is slowly distilled while the maximum temperature is reached. The excess ethyl carbonate is distilled under reduced pressure. A crystallized residue is then obtained, which is stirred with 400 cc of water and 400 cc of ether. The solution is filtered and 125 g (77.6%) of practically pure product melting at 232°C to 233°C, are obtained.

The starting material was prepared in a yield of 58% by reduction of the corresponding cyano-hydrin. It in turn was prepared from 1-(2-phenylethyl)-4-piperidone and potassium cyanide to give the cyanohydrin which was reduced by lithium aluminum hydride.

References

- Merck Index 3924
 Kleeman & Engel p. 397
 OCDS Vol. 2 p. 291 (1980)
 DOT 5 (4) 130 (1969)
 I.N. p. 421
 Regnier, G., Canevari, R. and Le Douarec, J.-C.; U.S. Patent 3,399,192; August 27, 1968;
 assigned to Science Union et Cie, Societe Francaise de Recherche Medicale, France

FENTANYL

Therapeutic Function: Narcotic analgesic

Chemical Name: N-phenyl-N-[1-(2-phenylethyl)-4-piperidinyl]propanamide

Common Name: —

Structural Formula:

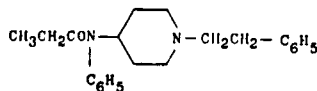

Chemical Abstracts Registry No.: 437-38-7

Trade Name	Manufacturer	Country	Year Introduced
Fentanyl	Janssen	W. Germany	1963
Sublimaze	Janssen	U.K.	1965
Fentanest	Carlo Erba	Italy	1965
Sublimaze	McNeil	U.S.	1968
Fentanest	Sankyo	Japan	1972
Fentanyl Le Brun	Le Brun	France	1973
Beatryl	Abic	Israel	—
Haldid	Janssen	—	—
Innovar	McNeil	U.S.	—
Leptanal	Leo	Sweden	—
Thalamonal	Janssen	W. Germany	—

Raw Materials

1-Benzyl-4-piperidone	Aniline
Lithium aluminum hydride	Propionic anhydride
β -Phenylethyl chloride	Hydrogen

Manufacturing Process

To the stirred solution of 5 parts of N-(4-piperidyl)propionanilide, 6.85 parts sodium carbonate, 0.05 part potassium iodide in 120 parts hexone is added portionwise a solution of 3.8 parts β -phenylethyl chloride in 24 parts 4-methyl-2-pentanone. The mixture is stirred and refluxed for 27 hours. The reaction mixture is filtered while hot, and the filtrate is evaporated. The oily residue is dissolved in 160 parts diisopropyl ether and the solution is filtered several times until clear, then concentrated to a volume of about 70 parts. The residue is then cooled for about 2 hours at temperatures near 0°C to yield N-[1-(β -phenylethyl)-4-piperidyl]propionanilide, melting at about 83° to 84°C as described in U.S. Patent 3,141,823.

The starting material is prepared by reacting 1-benzyl-4-piperidone with aniline, reducing the condensation product with lithium aluminum hydride, reacting the product thus obtained with propionic anhydride, then hydrogen.

References

- Merck Index 3926
- Kleeman & Engel p. 397
- PDR pp. 954, 957
- OCDS Vol. 1 pp. 299, 306, 309 (1977) & 3 p. 116 (1984)
- DOT 1 (1) 1 (1965)
- I.N. p. 421
- REM p. 1108
- Janssen, P.A.J. and Gardocki, J.F.; U.S. Patent 3,141,823; September 4, 1962; assigned to Research Laboratorium Dr. C. Janssen NV, Belgium
- Janssen, P.A.J.; U.S. Patent 3,164,600; January 5, 1965; assigned to Research Laboratorium Dr. C. Janssen, NV, Belgium

FENTIAZAC

Therapeutic Function: Analgesic, antipyretic and antiinflammatory

Chemical Name: 4-(p-Chlorophenyl)-2-phenyl-thiazol-5-yl-acetic acid

Common Name: —

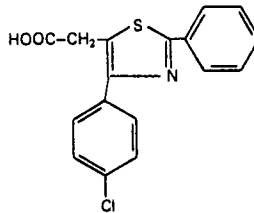
Structural Formula:

Chemical Abstracts Registry No.: 18046-21-4

Trade Name	Manufacturer	Country	Year Introduced
Norvedan	LPB	Italy	1975
Norvedan	Nippon Chemiphar	Japan	1982
Donorest	Wyeth	Japan	1982
Domureuma	Medici Domus	Italy	—
Flogene	Polifarma	Italy	—

Raw Materials

Methyl 3-(p-chlorobenzoyl)-3-bromopropionate
 Potassium thioacetate
 Potassium hydroxide
 Benzonitrile
 Acetic acid

Manufacturing Process

13.6 g methyl 3-(p-chlorobenzoyl)-3-bromopropionate in 30 ml methanol are added to a solution of 5.6 g potassium thioacetate in 30 ml methanol. Immediate precipitation of KBr is observed. The suspension is refluxed for 10 minutes.

It is cooled to ambient temperature, filtered, and the methanol is evaporated to dryness. 13.2 g methyl 3-(p-chlorobenzoyl)-3-thioacetylpropionate in the form of a chromatographically pure orange-colored oil are obtained.

A suspension of 13.2 g methyl 3-(p-chlorobenzoyl)-3-thioacetylpropionate is agitated in 500 ml of a 2N aqueous solution of KOH for 6 hours at ambient temperature in an atmosphere of nitrogen, followed by extraction with ethyl ether. The aqueous phase, adjusted to a pH equal to 2 with 2N HCl, is extracted with ethyl ether which was washed with water, dried over Na_2SO_4 , and finally evaporated to dryness.

9.8 g of crude 3-(p-chlorobenzoyl)-3-mercaptopropionic acid are obtained. By recrystallizing from isopropyl ether there are obtained 8.6 g of pure product, MP 96°C to 97°C (yield: 79%).

1.7 ml benzonitrile and 5.05 ml diethylamine are added to a solution of 4 g 3-(p-chlorobenzoyl)-3-thiol-propionic acid in 50 ml ethanol. The solution is agitated at ambient temperature for 60 minutes in an atmosphere of nitrogen. It is then evaporated to a syrupy consistency and 60 ml 50% aqueous acetic acid are added, whereupon the mixture is refluxed for 60 minutes. It is evaporated to a small volume, adjusted to a pH equal to 8 with a saturated solution of sodium bicarbonate and then extracted with ethyl ether. The aqueous phase is acidified with 2N HCl (Congo red), and then again extracted with ethyl ether. It is dried over Na_2SO_4 and evaporated to dryness. The evaporation residue is recrystallized from benzene and 4 g 4-(p-chlorophenyl)-2-phenyl-thiazol-5-yl-acetic acid are obtained (MP = 152°C to 154°C, yield - 74.3%).

References

Merck Index 3928

DOT 11 (9) 351 (1975) & 15 (7) 325 (1979)

I.N. p. 421

Laboratorio Prodotti Biologici Braglia SpA; British Patent 1,380,507; January 15, 1975
Brown, K.; U.S. Patent 3,476,766; November 4, 1969; assigned to John Wyeth & Brother Ltd.

FENTONIUM BROMIDE

Therapeutic Function: Anticholinergic; antispasmodic

Chemical Name: [3(S)-Endo]-8-[2-[1,1'-biphenyl] 4-yl-2-oxaethyl]-3-(2-hydroxy-1-oxo-2-phenylpropoxy)-8-methyl-8-azoniabicyclo[3.2.1] octane bromide

Common Name: —

Structural Formula:

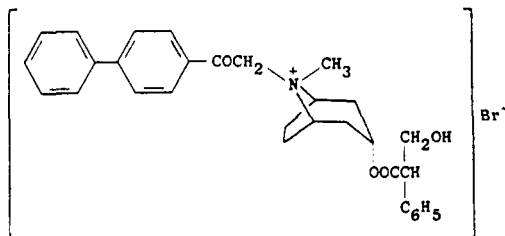

Chemical Abstracts Registry No.: 5868-06-4

Trade Name	Manufacturer	Country	Year Introduced
Hoelcesium	Zambon	Italy	1972
Ulcesium	Inpharzam	W. Germany	1978
Dicasten	Fher	Spain	—
Ketoscilium	Zambon	Italy	—

Raw Materials

p-Phenylphenacyl bromide
1-Hyoscyamine

Manufacturing Process

5.50 g (0.02 mol) of p-phenylphenacyl bromide were dissolved in 56 cc of anhydrous acetone previously heated to about 40°C. This solution was added, with stirring, to a solution of 5.70 g (0.02 mol) of 1-hyoscyamine in 43 cc of anhydrous acetone; the reaction solution was maintained at 45°C and stirred for about six hours.

After standing overnight in the refrigerator, the precipitate was collected by filtration and dried in vacuo at 60°C. Yield: 10.2 g; MP = 193°C to 194°C.

References

Merck Index 3930

Kleeman & Engel p. 398

I.N. p. 422

Teotino, U. and Della Bella, D.; U.S. Patent 3,356,682; December 5, 1967 and U.S. Patent 3,436,458; April 1, 1969; both assigned to Whitefin Holding S.A. (Switz.)

FEPRAZONE

Therapeutic Function: Antiinflammatory

Chemical Name: 1,2-Diphenyl(3,5-dioxo-4-(3'-methyl-2'-butenyl)-pyrazolidine

Common Name: Phenylprenazone, prenazone

Structural Formula:

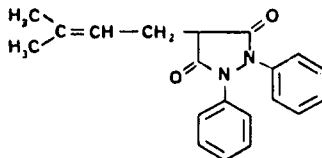

Chemical Abstracts Registry No.: 30748-29-9

Trade Name	Manufacturer	Country	Year Introduced
Zepelin	De Angeli	Italy	1972
Methrazone	W.B. Pharm.	U.K.	1977
Zepelin	Boehr. Ingel.	W. Germany	1980
Zontal	Fujisawa	Japan	1983
Analud	Unifa	Argentina	—
Brotazona	Escaned	Spain	—
Danfenona	Larma	Spain	—
Grisona	Cusi	Spain	—
Metrazone	Boehr. Ingel.	Spain	—
Naloven	De La Cruz	Spain	—
Nazona	Reig Jofre	Spain	—
Nilatin	Llenas	Spain	—
Prenazon	Inexfa	Spain	—
Rangozona	Mazuelos	Spain	—
Represil	Cecef	Spain	—
Tabrien	Callol	Spain	—
Zepelin	Bender	Austria	—
Zoontal	Boehr. Ingel.	—	—

Raw Materials

Hydrazobenzene	Sodium
Diethyl-3-methyl-2-butenyl malonate	Ethanol

Manufacturing Process

43.8 g (0.237 mol) of hydrazobenzene are added to a solution of sodium ethylate obtained by dissolving 6.55 g (0.285 mol) of sodium in 125 ml of anhydrous ethanol. 59.6 g (0.2612 mol) of diethyl 3-methyl-2-butenyl malonate are then added, with stirring, at the reflux temperature.

The reaction mixture is refluxed for 1 hour, then the solvent is slowly distilled off, the distillation being completed in vacuo. The solid residue so obtained is dissolved in 400 ml of water and washed with ether. The solution is acidified with 10% HCl and the 1,2-diphenyl-3,5-dioxo-4-(3'-methyl-2'-butenyl)-pyrazolidine which separates is purified by crystallization from ethanol (MP 155°C to 156°C).

References

Merck Index 3934

DOT 8 (10) 330 (1972)

I.N. p. 422

Casadio, S. and Pala, G.; U.S. Patent 3,703,528; November 21, 1972; assigned to Instituto de Angeli S.p.A.

FERROCHOLINATE

Therapeutic Function: Hematinic

Chemical Name: [hydrogen citrato(3—)] triaquoiron, choline salt

Common Name: Iron choline citrate

Structural Formula:

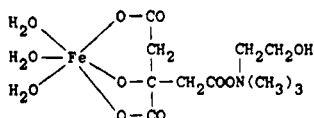

Chemical Abstracts Registry No.: 1336-80-7

Trade Name	Manufacturer	Country	Year Introduced
Ferrolip	Flint	U.S.	1953
Chel-Iron	Kinney	U.S.	1957

Raw Materials

Choline dihydrogen citrate	Ferric hydroxide
Tricholine citrate	Ferric citrate

Manufacturing Process

As described in U.S. Patent 2,575,611, 107 parts of freshly prepared ferric hydroxide are added to 295 parts of choline dihydrogen citrate dissolved in 200 parts of distilled water and heated to approximately 80°C until a homogeneous solution occurs. The resulting reddish brown solution may be used as such or it may be dried by evaporating the water. The dried product is a reddish brown, amorphous solid presenting a glistening surface upon fracture. The dry product is somewhat hygroscopic and is freely soluble in water to give a stable solution. The following paragraph gives an alternative preparation.

One mol of tricholine citrate is dissolved in 6,000 ml of water and two mols of ferric citrate in solid form are added thereto. The reaction mass is then agitated until solution is effected, and until the reaction mass changes from brown to green. Water is removed either under vacuum, or as an azeotrope with benzene or toluene or by heating to a temperature of 110° to 115°C. There is thus obtained a gummy viscous mass which is treated with methanol, about five gallons, whereupon it solidifies, i.e., changes, into a green crystalline compound. Following the treatment with methanol, the mass is filtered and the green compound dried at about 70°C, according to U.S. Patent 2,865,938.

References

Merck Index 3970

I.N. p. 423

Bandelin, F.J.; U.S. Patent 2,575,611; November 20, 1951; assigned to Flint Eaton and Company

Rosenfelder, W.J.; U.S. Patent 2,865,938; December 23, 1958

FERROGLYCINE SULFATE

Therapeutic Function: Hematinic

Chemical Name: Ferroglycine sulfate

Common Name: —

Structural Formula: $(\text{FeSO}_4)_x(\text{NH}_2\text{CH}_2\text{COOH})_y$

Chemical Abstracts Registry No.: 17169-60-7

Trade Name	Manufacturer	Country	Year Introduced
Ferronord	Cooper	U.S.	1956
Fe-Cap	MCP Pure Drugs	U.K.	1970
Bonafer	Remeda	Finland	—
Ferrochel	C.F.C.	Australia	—
Ferrocontin	Napp	U.K.	—
Ferrosanol	Sanol	W. Germany	—
Glycifer	Pharmacia	Sweden	—
Orferon	Pliva	Yugoslavia	—
Plesmet	Napp	U.K.	—

Raw Materials

Ferrous sulfate
Glycine

Manufacturing Process

10.0 g of ferrous sulfate and 2.7 g of glycine are thoroughly mixed and carefully heated under nitrogen to 70°C. Reaction occurs rapidly, and the complex compound is obtained as soon as the color turns uniformly light-brown. After cooling to 20°C, 12.7 g of ferrous sulfate-glycine complex are obtained, which contains 100 mg Fe^{++} -ions per 0.63 g.

References

Merck Index 3972

I.N. p. 12

Rummel, W.; U.S. Patent 2,877,253; March 10, 1959; assigned to Dr. Schwarz Arzneimittel-fabrik GmbH, Germany

Rummel, W.; U.S. Patent 2,957,806; October 25, 1960; assigned to Dr. Schwarz Arzneimittel-fabrik GmbH, Germany

FERROUS FUMARATE

Therapeutic Function: Hematinic

Chemical Name: Ferrous fumarate

Common Name: —

Structural Formula: $\text{FeC}_4\text{H}_2\text{O}_4$ (exact structure unknown)

Chemical Abstracts Registry No.: 141-01-5

Trade Name	Manufacturer	Country	Year Introduced
Toleron	Mallinckrodt	U.S.	1957
Ircon	Key	U.S.	1960
Tolferain	Ascher	U.S.	1961
Feostat	Westerfield	U.S.	1962
Ferlon	Madland	U.S.	1964
Eldec	Parke-Davis	U.S.	—
Ercofer	Erco	Denmark	—
Fem-Iron	Williams	U.S.	—
Feosol	Menley & James	U.S.	—
Feostim	Westerfield	U.S.	—
Fero-Folic	Abbott	U.S.	—
Fero-Grad	Abbott	U.S.	—
Feroton	Paul Maney	Canada	—
Ferro-Delalande	Delalande	France	—
Ferrofume	Nordic	Canada	—
Ferrolina	Chemie Linz	Austria	—
Ferronat	Galena	Czechoslovakia	—
Ferrone	Wolfs	Belgium	—
Ferrum Hausmann	Hausmann	Switz.	—
Fersaday	Glaxo	—	—
Fersamal	Glaxo	—	—
Ferumat	Continental Pharma	Belgium	—
Firon	Beard Glynn	U.S.	—
Fumafer	Erco	Denmark	—
Fumafer	Aktiva	Sweden	—
Fumasorb	Marion	U.S.	—
Fumiron	Knoll	W. Germany	—
Hematon	Nova	Canada	—
Heptuna	Roerig	U.S.	—
Iberet	Abbott	U.S.	—
Ircon	Lakeside	U.S.	—
Irospan	Fielding	U.S.	—
Mevanin	Beutlich	U.S.	—
Neo-Fer	Nyegaard	Norway	—
Novofumar	Novopharm	Canada	—
Palafer	Beecham	—	—
Pramet	Ross	U.S.	—
Soparon	Sopar	Belgium	—
Tolifer	Elliott-Marion	Canada	—

Raw Materials

Fumaric acid
Sodium carbonate
Ferrous sulfate

Manufacturing Process

Sodium carbonate (53.5 pounds of $\text{Na}_2\text{CO}_3 \cdot \text{H}_2\text{O}$) was dissolved in water (40 to 45 gallons)

and fumaric acid (50 pounds) was added slowly. During the addition the solution was stirred and heated. The resulting solution of sodium fumarate, having a pH of 6.8, was added slowly with mixing to a solution of ferrous sulfate (118 pounds $\text{FeSO}_4 \cdot 7\text{H}_2\text{O}$ in 33 gallons of water) having a pH of 3.3, both solutions being maintained at or near boiling temperature during the mixing. The resulting slurry of reddish-brown anhydrous ferrous fumarate was filtered and washed in a centrifuge and dried in a tray drier (15 hours at 110°C). Yield: 63 pounds, 86% of theory. Calculated for $\text{FeC}_4\text{H}_2\text{O}_4$: Fe, 32.9%. Found: Fe, 32.6%. Only 0.2% of ferric iron (Fe^{+++}) was found.

References

Merck Index 3981

PDR pp. 524, 673, 876, 993, 1131, 1344, 1526, 1559, 1569

I.N. p. 447

REM p. 840

Bertsch, H.C. and Lemp, J.F.; U.S. Patent 2,848,366; August 19, 1958; assigned to Mallinckrodt Chemical Works

FIBRINOLYSIN

Therapeutic Function: Thrombolytic enzyme

Chemical Name: Complex protein, molecular weight about 75,000

Common Name: —

Structural Formula: See chemical name

Chemical Abstracts Registry No.: 9001-90-5

Trade Name	Manufacturer	Country	Year Introduced
Actase	Ortho	U.S.	1959
Thrombolysin	MSD	U.S.	1960
Elastase	Parke Davis	U.S.	1960
Lyovac	MSD	U.S.	—
Thromboclase	Choay	France	—

Raw Materials

Human blood plasma
Calcium chloride

Oxalic acid
Ammonium sulfate

Manufacturing Process

A 5 gallon drum of frozen plasma oxalated with a known anticoagulant quantity and proportion of oxalic acid and sodium oxalate as described in U.S. Patent 2,394,566 is permitted to stand at room temperature (24° to 26°C) for 24 hours after which the remaining unmelted portion is broken up with an ice pick and a stainless steel warming coil containing running warm water at about 40°C is inserted into the mixture and the mixture stirred. The remaining frozen material is rapidly melted. The warming is then continued with vigorous agitation.

When the temperature of the plasma reaches about 5° to 8°C , the calculated quantity of calcium chloride solution is added in amount which is from 0.2 to 0.3% in excess of that needed to react with and precipitate the anticoagulant. The temperature of the plasma is allowed to rise to about 24°C . At 18° to 24°C strands of fibrin begin to appear and the

vigor of stirring is increased to prevent a gel of fibrin from forming. Stirring is continued for 30 minutes after the fibrin is whipped out to allow for complete conversion of all prothrombin to thrombin and for the antithrombin to completely destroy all thrombin. At the end of this time the stirring is stopped, the fibrin allowed to rise to the surface and the clear serum siphoned off.

If, through failure to stir with enough vigor, a gel forms instead of strands of fibrin, when the temperature reaches about 18°C, the serum can also be obtained from the fibrin by working and kneading the gel in a cheesecloth bag while draining off the clear serum. However, this method is time-consuming and it is preferred to prevent gel formation by very vigorous stirring of the mixture.

The clear serum of this example is an amber liquid free from prothrombin, thrombin, fibrinogen and fibrin. It contains profibrinolysin and is excellently suited to further purification by salt precipitation fractionation, as given below.

The special serum is brought to a temperature of about 4° to 6°C (preferably 5°C) and saturated ammonium sulfate solution added drop by drop with constant stirring to about 24 to 26% of saturation (preferably 25%). The precipitated protein impurities are then centrifuged off and the supernatant brought to about -1° to +1°C (preferably 0°C). The degree of its saturation is then brought to about 28 to 31% of saturation (preferably 29%) by further addition of ammonium sulfate solution with stirring. This further degree of saturation precipitates the profibrinolysin which is collected by centrifugation and separated from soluble impurities. By washing the profibrinolysin several times with ammonium sulfate solution of a strength which is 29% of saturation a practically white solid is obtained which can be freeze-dried (frozen and dried under reduced pressure) to give a dry, white, product containing purified profibrinolysin free from thromboplastin, prothrombin, thrombin, fibrinogen and fibrin, (from U.S. Patent 2,624,691), which is then activated to fibrinolysin.

References

Merck Index 4001

Kleeman & Engel p. 400

PDR p. 1343

I.N. p. 424

REM p. 1038

Loomis, E.C.; U.S. Patent 2,624,691; January 6, 1953; assigned to Parke, Davis & Co.

Singer, H.O.; U.S. Patent 3,136,703; June 9, 1964; assigned to Ortho Pharmaceutical Corp.

Hink, J.H. Jr. and McDonald, J.K.; U.S. Patent 3,234,106; February 8, 1966; assigned to Cutter Laboratories, Inc.

FLAVOXATE HYDROCHLORIDE

Therapeutic Function: Antispasmodic

Chemical Name: 3-methyl-4-oxo-2-phenyl-4H-1-benzopyran-8-carboxylic acid 2-piperidinoethyl ester hydrochloride

Common Name: 2-piperidinoethyl 3-methylflavone-8-carboxylate

Structural Formula:

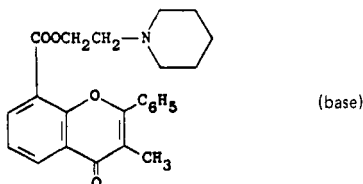

Chemical Abstracts Registry No.: 3717-88-2; 15301-69-6 (Base)

Trade Name	Manufacturer	Country	Year Introduced
Urispas	SKF	U.S.	1971
Urispas	Syntex	U.K.	1971
Genurin	Recordati	Italy	1973
Spasuret	Asche	W. Germany	1978
Bladderon	Nippon Shinyaku	Japan	1979
Urispas	Negma	France	1981
Spasmal	Ikapharm	Israel	—
Urispadol	Pharmacia	Sweden	—
Urispan	Byk Gulden	—	—
Urispas	Protea	Australia	—

Raw Materials

Salicylic acid	Propionyl chloride
Aluminum chloride	Benzoic anhydride
Thionyl chloride	Piperidinoethanol

Manufacturing Process

A mixture of 13.3 grams of anhydrous aluminum chloride and 100 ml of carbon disulfide is added to 19.4 grams of 2-propionyloxybenzoic acid (prepared from the reaction of propionyl chloride and 2-hydroxybenzoic acid). After an initial evolution of hydrogen chloride, the solvent is removed by distillation and the mixture is heated at 150° to 160°C for 4 hours. The cooled reaction mixture is treated with ice and hydrochloric acid and the product, 2-hydroxy-3-carboxypropiophenone, is obtained from the oily residue by distillation in vacuo.

A mixture of 1.9 grams of 2-hydroxy-3-carboxypropiophenone, 5.0 grams of sodium benzoate and 20.0 grams of benzoic anhydride is heated at 180° to 190°C for 6 hours. A solution of 15.0 grams of potassium hydroxide in 50 ml of ethanol and 20 ml of water is added and refluxed for 1 hour. The mixture is evaporated and the residue after addition of water yields 3-methylflavone-8-carboxylic acid.

To a suspension of 12.0 grams of 3-methylflavone-8-carboxylic acid in 200 ml of anhydrous benzene is added 10.0 grams of thionyl chloride. The mixture is refluxed for 2 hours during which the suspended solid goes into solution. The solvent is completely removed by distillation, the residue extracted with benzene and the extract evaporated to dryness. The product, 3-methylflavone-8-carboxylic acid chloride, is recrystallized from ligroin to give crystals melting at 155° to 156°C.

To 11.0 grams of 3-methylflavone-8-carboxylic acid chloride dissolved in 150 ml of anhydrous benzene is added at room temperature 4.8 grams of piperidinoethanol and the mixture refluxed for 2 to 3 hours. The separated solid is filtered, washed with benzene and dried. The product, piperidinoethyl 3-methylflavone-8-carboxylate hydrochloride is obtained as a colorless crystalline solid, MP 232° to 234°C, (from U.S. Patent 2,921,070).

References

- Merck Index 4018
- Kleeman & Engel p. 400
- PDR p. 1731
- OCDS Vol. 2 p. 392 (1980)
- DOT 7 (5) 171 (1971)
- I.N. p. 426
- REM p. 920
- Da Re, P.; U.S. Patent 2,921,070; January 12, 1960; assigned to Recordati-Laboratorio Farmacologico SpA, Italy

Da Re, P.; U.S. Patent 3,350,411; October 31, 1967; assigned to Societe d'Exploitation Chimiques et Pharmaceutiques Seceph SA, Switzerland

FLECAINIDE

Therapeutic Function: Antiarrhythmic

Chemical Name: N-(2-Piperidylmethyl)-2,5-bis(2,2,2-trifluoroethoxy)benzamide

Common Name: —

Structural Formula:

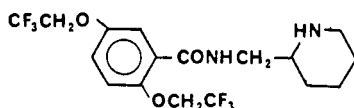

Chemical Abstracts Registry No.: 54143-55-4

Trade Name	Manufacturer	Country	Year Introduced
Tambocor	Kettelhack	W. Germany	1982
Tambocor	Riker	U.K.	1983

Raw Materials

2-Aminomethylpiperidine
 2,2,2-Trifluoroethyl-2,5-bis(2,2,2-trifluoroethoxy)benzoate
 Hydrogen chloride

Manufacturing Process

Under a nitrogen atmosphere 2-aminomethylpiperidine (0.249 mol, 28.4 g) is treated dropwise over 25 minutes with 2,2,2-trifluoroethyl 2,5-bis(2,2,2-trifluoroethoxy)benzoate (0.0249 mol, 10.0 g). After 3 hours 50 ml of benzene is added to the thick mixture and stirred for about 40 hours at 45°C. The mixture is then concentrated under vacuum with heating to remove the volatile components. The residue solidifies after cooling, is steam distilled for further purification and is separated by filtration and extracted into dichloromethane. The dichloromethane solution is washed with saturated sodium chloride solution, and the organic layer is dried over anhydrous magnesium sulfate. The magnesium sulfate is removed by filtration and 4 ml of 8.4 N hydrogen chloride in isopropanol is added to the dichloromethane solution with stirring.

After 2 hours the mixture is cooled to about 0°C and the crude product is collected by filtration, washed with diethyl ether and dried in a vacuum oven. After treatment with decolorizing charcoal and recrystallization from an equivolome mixture of isopropanol and methanol, the product, 2,5-bis(2,2,2-trifluoroethoxy)-N-(2-piperidylmethyl)benzamide hydrochloride has a MP of 228°C to 229°C.

References

Merck Index 4019
 DFU 2 (9) 586 (1977)
 OCDS Vol. 3 p. 59 (1984)
 DOT 18 (10) 549 (1974), 19 (2) 112 & (5) 252 (1983)
 I.N. p. 426
 Banitt, E.H. and Brown, W.R.; U.S. Patent 3,900,481; August 19, 1975; assigned to Riker Laboratories, Inc.

FLOCTAFENINE

Therapeutic Function: Analgesic

Chemical Name: 2-[[8-(trifluoromethyl)-4-quinolinyl] amino] benzoic acid 2,3-dihydroxypropyl ester

Common Name: —

Structural Formula:

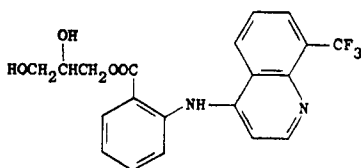

Chemical Abstracts Registry No.: 23779-99-9

Trade Name	Manufacturer	Country	Year Introduced
Idarac	Diamant	France	1976
Idarac	Roussel Maestretti	Italy	1977
Idarac	Albert Roussel	W. Germany	1978
Floktin	Yurtoglu	Turkey	—
Idalon	Roussel	—	—

Raw Materials

o-Trifluoromethylaniline
 Ethoxymethylene ethyl malonate
 Phosphorus oxychloride
 Methyl anthranilate
 2,2-Dimethyl-4-hydroxymethyl-1,3-dioxolane
 Sodium hydride
 Hydrogen chloride

Manufacturing Process

Step A: Ortho-Trifluoromethylanilinomethylene Ethyl Malonate — A mixture of 54.8 grams of ortho-trifluoromethylaniline and 73.5 grams of ethoxymethylene ethyl malonate was heated to 120°C under an inert atmosphere and maintained for 1 hour at this temperature while distilling off the ethanol formed. The mixture was cooled and the elimination of ethanol was completed by distillation under reduced pressure. The mixture was cooled to obtain 115 grams of ortho-trifluoromethylanilinomethylene ethyl malonate which was used as is for the following stage. A sample of the product was crystallized from petroleum ether (BP = 65° to 75°C) to obtain a melting point of 94°C.

Step B: 3-Carboxy-4-Hydroxy-8-Trifluoromethylquinoline — A mixture of 113 grams of crude ortho-trifluoromethylanilinomethylene ethyl malonate from Step A, and 115 cc of phenyl oxide was heated rapidly under an inert atmosphere. At about 195°C, the ethanol formed began to distill off. At the end of about 30 minutes, the interior temperature reached 250°C and the reaction mixture was heated to reflux. Reflux was maintained for 1 hour and the mixture was then cooled, 25 cc of acetone were added and the mixture was allowed to crystallize. The mixture was filtered and the crystals thus formed were washed and dried to obtain 71.5 grams of 3-carboxy-4-hydroxy-8-trifluoromethylquinoline with a melting point of 210° to 214°C, which was used as is for the following stage. A sample of this product was crystallized from ethanol to show a melting point of 216°C.

Step C: 3-Carboxy-4-Hydroxy-8-Trifluoromethylquinoline – 70 grams of crude 3-carboxy-4-hydroxy-8-trifluoromethylquinoline, obtained in Step B, were introduced under an inert atmosphere into a mixture of 300 cc of water and 100 cc of aqueous 10 N solution of sodium hydroxide. The reaction mixture was heated to reflux and maintained there for 2 hours and forty-five minutes. The solution obtained was poured over a mixture of water, ice and 100 cc of aqueous 11.8 N solution of hydrochloric acid. The precipitate thus formed was isolated by filtration, washed with water and introduced into a solution of 20 grams of sodium bicarbonate in 2 liters of water.

The mixture was heated to 90°C and filtered to remove slight persisting insolubles. The filtrate was acidified with acetic acid to bring the pH to about 5.5 and the precipitate formed was isolated by filtration, washed and dried to obtain 58 grams of 3-carboxy-4-hydroxy-8-trifluoromethylquinoline having a melting point of 290° to 292°C, which was used as is for the following stage. A sample of the product was crystallized from hot and cold acetone, treated with charcoal to obtain pure 3-carboxy-4-hydroxy-8-trifluoromethylquinoline having a melting point of 292°C.

Step D: 4-Hydroxy-8-Trifluoromethylquinoline – Under an inert atmosphere, 56.5 grams of crude 3-carboxy-4-hydroxy-8-trifluoromethylquinoline, obtained in Step C were introduced into 110 cc of phenyl oxide. The reaction mixture was rapidly heated to reflux and maintained at reflux for an hour and fifteen minutes. The reaction mixture was cooled to about 50°C and 20 cc of isopropyl ether were added thereto. The mixture was cooled to 20°C and allowed to crystallize. The precipitate formed was isolated by filtration, washed and dried to obtain 45.8 grams of 4-hydroxy-8-trifluoromethylquinoline having a melting point of 180°C. A sample of this product was crystallized from acetone, treated with charcoal to obtain pure 4-hydroxy-8-trifluoromethylquinoline having a melting point of 180°C.

Step E: 4-Chloro-8-Trifluoromethylquinoline – 44.3 grams of crude 4-hydroxy-8-trifluoromethylquinoline obtained in Step D were introduced in small amounts into 130 cc of phosphorus oxychloride and then the reaction mixture was held for 15 minutes at ambient temperature and heated to reflux and maintained at reflux for 1 hour. The mixture was cooled and excess phosphorus oxychloride was removed by distillation under reduced pressure. Water, ice, and then 80 cc of aqueous solution of ammonia at 22°Bé were added to the residue and the mixture was stirred and the aqueous phase was extracted with ether. The ethereal extracts were washed with a dilute aqueous solution of ammonia, then with water, dried, treated with charcoal and concentrated to dryness to obtain 45.4 grams of 4-chloro-8-trifluoromethylquinoline having a melting point of 78°C, which was used as is for the preparation of 4-(ortho-methoxycarbonylphenylamino)-8-trifluoromethylquinoline. A sample of crude 4-chloro-8-trifluoromethylquinoline was crystallized from petroleum ether (BP = 65° to 75°C) to get a product with a melting point of 78°C.

Step F: 4-(Ortho-Methoxycarbonyl)-Phenylamino-8-Trifluoromethylquinoline – Into 100 cc of aqueous 2 N solution of hydrochloric acid, 23.15 grams of crude 4-chloro-8-trifluoromethylquinoline, obtained in Step E, then 15.85 grams of methyl anthranilate were introduced. The reaction mixture was heated to reflux and maintained there for 50 minutes. The mixture was cooled and the crystallation developed. The precipitate formed was recovered by filtration and introduced into 300 cc of a saturated aqueous solution of sodium bicarbonate. The mixture was agitated, methylene chloride was added and the mixture agitated and filtered to remove persisting insolubles. The organic phase was separated by decantation, washed with water and concentrated to dryness. The residue was crystallized from methanol to obtain 21.3 grams of 4-(ortho-methoxy-carbonylphenylamino)-8-trifluoromethylquinoline with a melting point of 176°C.

Step G: 4-[Ortho-(2',3'-Dihydroxypropyloxycarbonyl)-Phenyl]-Amino-8-Trifluoromethylquinoline Acetonide – 100 cc of toluene were added to 80 cc of 2,2-dimethyl-4-hydroxy-methyl-1,3-dioxolane and the toluene was distilled off under reduced pressure to eliminate the water present. To the anhydrous 2,2-dimethyl-4-hydroxymethyl-1,3-dioxolane thus obtained, 0.25 gram of an oily 50% suspension of sodium hydride and then 21.3 grams of 4-

(ortho-methoxycarbonylphenylamino)-8-trifluoromethylquinoline were added under inert atmosphere. The mixture was agitated for 5 hours at 85°C under a vacuum of 50 to 100 mm of mercury. After cooling, an aqueous solution of sodium chloride was added to the reaction mixture and it was stirred. The aqueous phase was extracted with methylene chloride and the methylene chloride extracts were washed with water, dried and concentrated to dryness by distillation under reduced pressure.

The residue was washed with petroleum ether (BP 65° to 75°C), dried and crystallized from isopropyl ether to obtain 23.8 grams of 4-[ortho-(2',3'-dihydroxypropyloxycarbonyl)-phenyl]-amino-8-trifluoromethylquinoline acetone having a melting point of 108°C.

Step H: Preparation of 4-[Ortho-(2',3'-Dihydroxypropyloxycarbonyl)-Phenyl]-Amino-8-Trifluoromethylquinoline — Into a mixture of 60 cc of water and 12 cc of aqueous solution of 22°Bé hydrochloric acid there was introduced 19.8 grams of 4-[ortho-(2',3'-dihydroxypropyloxycarbonyl)-phenyl]-amino-8-trifluoromethylquinoline acetone (obtained in Step G) and the temperature of the reaction mixture was raised to 95°C and maintained at this temperature for 15 minutes. The mixture was cooled to 0°C and crystallization was allowed. The crude hydrochloride was recovered by filtration, washed and introduced into a mixture of 60 cc of dimethylformamide, 40 cc of water and 10 cc of triethylamine.

Dissolution and the crystallization occurred and the precipitate was recovered by filtration and was washed and dried to obtain 16 grams of crude base having a melting point of 179° to 180°C. The crude base was crystallized from methanol with treatment with charcoal to obtain 11.95 grams of 4-[ortho-(2',3'-dihydroxypropyloxycarbonyl)-phenyl]-amino-8-trifluoromethylquinoline with a melting point of 179° to 180°C. The product is soluble in ether, chloroform and methylene chloride and insoluble in water.

References

Merck Index 4021

DFU 1 (2) 59 (1976)

Kleeman & Engel p. 401

OCDS Vol. 3 p. 184 (1984)

DOT 13 (4) 143 (1977)

I.N. p. 427

Allais, A. and Meier, J.; U.S. Patent 3,644,368; February 22, 1972; assigned to Roussel-UCLAF, France

FLORANTYRONE

Therapeutic Function: Hydrocholeretic

Chemical Name: γ -Oxo-8-fluoranthenebutanoic acid

Common Name: —

Structural Formula:

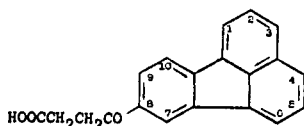

Chemical Abstracts Registry No.: 519-95-9

Trade Name	Manufacturer	Country	Year Introduced
Zanchol	Searle	U.S.	1957
Bilyn	Janus	Italy	—
Cistoplex	Borromeo	Italy	—
Idroepar	Beolet	Italy	—
Zanchol	Dainippon	Japan	—

Raw Materials

Fluoranthene
Succinic anhydride

Manufacturing Process

50 g of fluoranthene and 26 g of succinic anhydride in 500 cc of nitrobenzene were treated at 0°C to 5°C with 75 g of anhydrous aluminum chloride. The temperature was held at 0°C for 4 hours and then allowed gradually to come to room temperature. The reaction mixture was allowed to stand for 16 hours. The reaction mixture was then worked up. In so doing, the reaction mixture was decomposed with dilute HCl, the nitrobenzene was removed by steam distillation and the residue after filtration was dissolved in hot sodium carbonate solution and filtered free of a small amount of nonacidic material. Precipitation from solution with HCl gave a light yellow product which crystallized from a 50-50 mixture of dioxane-alcohol as fine platelets which melted at 192°C to 194°C and showed a neutral equivalent of 308 which corresponds closely to the theoretical value of 302 for β -fluoranthoylpropionic acid.

25 g of the crude acid was dissolved in 100 cc of water containing 13 g of sodium carbonate. On cooling a thick syrup was obtained. On dilution to 1 liter precipitation started and after standing 16 hours, the solid which separated was filtered (filtrate treated as below), suspended in water, acidified with HCl and filtered. Crystallization from alcohol gave a light yellow material melting at 199°C to 200°C and having a neutral equivalent of 303.

The filtrate mentioned above, upon acidification thereof with HCl gave a darker acid which melted over a wide range, but had a neutral equivalent which also corresponds to that of β -fluoranthoylpropionic acid.

References

Merck Index 4023
Kleeman & Engel p. 403
I.N. p. 427
Fancher, O.E.; U.S. Patent 2,560,425; July 10, 1951; assigned to Miles Laboratories, Inc.

FLOREDIL HYDROCHLORIDE

Therapeutic Function: Coronary stabilizer

Chemical Name: 1-(3',5'-Diethoxyphenoxy)-2-morpholinoethane hydrochloride

Common Name: —

Structural Formula:

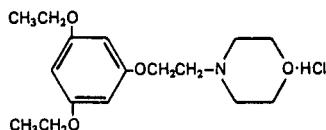

Chemical Abstracts Registry No.: 53731-36-5 (Base)

Trade Name	Manufacturer	Country	Year Introduced
Carfonal	Lafon	France	1973

Raw Materials

Sodium
Ethanol
3,5-Diethoxyphenol
1-Chloro-2-morpholinoethane hydrochloride

Manufacturing Process

Starting from 2.3 g (0.1 g atom) of sodium in 60 cc ethanol, 9.1 g (0.05 mol) of 3,5-diethoxyphenol in 25 cc of ethanol, and 9.3 g (0.05 mol) of 1-chloro-2-morpholinoethane hydrochloride in 15 cc of ethanol, 12 g (yield 72.4%) of white crystals melting at 183°C to 184°C were obtained after recrystallization from 50 cc of boiling isopropanol, which were soluble in water, slightly soluble in ethanol, and insoluble in hydrocarbons.

References

Merck Index 4024
Kleeman & Engel p. 403
DOT 9 (7) 285 (1973)
I.N. p. 428
Lafon, L.; British Patent 1,262,785; February 9, 1972; assigned to Orsymonde

FLOXACILLIN

Therapeutic Function: Antibacterial

Chemical Name: 6-[3-(2-chloro-6-fluorophenyl)-5-methyl-4-isoxazolecarboxamido]-3,3-dimethyl-7-oxo-4-thia-1-azabicyclo[3.2.0]heptane-2-carboxylic acid

Common Name: Flucloxacillin; 3-(2-chloro-6-fluorophenyl)-5-methyl-4-isoxazolympenicillin

Structural Formula:

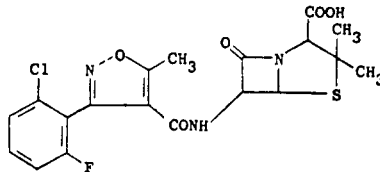

Chemical Abstracts Registry No.: 5250-39-5

Trade Name	Manufacturer	Country	Year Introduced
Floxapen	Beecham	U.K.	1970
Clupen	Fujisawa	Japan	1970
Staphylex	Beecham	W. Germany	1972
Flupen	Alfa	Italy	1974
Flofen	C.S.L.	Australia	—
Fluclox	Ayerst	—	—

Trade Name	Manufacturer	Country	Year Introduced
Heracillin	Astra	—	—
Penplus	Farma Labor	Italy	—

Raw Materials

2-Chloro-6-fluorobenzaldoxime	Chlorine
Methyl acetoacetate	Sodium methoxide
6-Amino-penicillanic acid	Thionyl chloride
Sodium hydroxide	

Manufacturing Process

3-(2-chloro-6-fluorophenyl)-5-methylisoxazole-4-carboxylic acid, MP 206° to 207°C, was obtained by chlorinating 2-chloro-6-fluorobenzaldoxime, then condensing the resulting hydroxamoyl chloride with methyl acetoacetate in methanolic sodium methoxide and hydrolyzing the resulting ester with hot alkali. The acid chloride resulted from treatment of the acid with thionyl chloride.

A suspension of 6-aminopenicillanic acid (36.4 grams) in water was adjusted to pH 7.2 by the addition of N aqueous sodium hydroxide and the resulting solution was treated with a solution of 3-(2-chloro-6-fluorophenyl)-5-methylisoxazole-4-carbonyl chloride (46.1 grams) in isobutyl methyl ketone. The mixture was stirred vigorously for 1½ hours and then filtered through Dicalite. The layers were separated and the isobutyl methyl ketone layer was shaken with saturated brine. Then, precipitation of the sodium salt only took place after dilution of the mixture with ether. In this way there was obtained 60.7 grams of the penicillin sodium salt having a purity of 88% as determined by alkalimetric assay.

References

Merck Index 4025

Kleeman & Engel p. 405

OCDS Vol. 1 p. 413 (1977)

DOT 7 (1) 18 (1971)

I.N. p. 429

REM p. 1201

Nayler, J.H.C.; U.S. Patent 3,239,507; March 8, 1966; assigned to Beecham Group Limited, England

FLOXURIDINE

Therapeutic Function: Antiviral; cancer chemotherapy

Chemical Name: 2'-deoxy-5-fluorouridine

Common Name: —

Structural Formula:

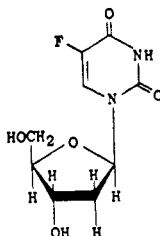

Chemical Abstracts Registry No.: 50-91-9

Trade Name	Manufacturer	Country	Year Introduced
FUDR	Roche	U.S.	1971

Raw Materials

Bacterium <i>Streptococcus fecalis</i>	5-Fluorouracil
Nutrient medium	Thymidine

Manufacturing Process

Cells of *Streptococcus fecalis* (ATCC-8043) were grown in the AOAC folic acid assay medium [Lepper, *Official and Tentative Methods of the Association of Official Agricultural Chemists*, Washington, D.C., 7th edition, 784 (1950)], supplemented with 2 mg per liter of thymine; following the teachings of Prusoff, *Proc. Soc. Exp. Biol. & Med.* 85, 564 (1954). After 20 hours of incubation at 37°C, the cells were harvested by centrifugation. The collected cells were washed three times with four volumes of potassium phosphate buffer solution (M/15 aqueous KH₂PO₄ solution, adjusted to pH 8.0 by addition of 2 N aqueous KOH) and the wet cells were weighed. The cells were finally suspended in the above potassium phosphate buffer solution and ground in a glass tissue homogenizer.

An amount of enzyme preparation equivalent to 900 mg of wet cells was made up to 25 ml with the above potassium phosphate buffer solution. 150 mg (1.15 mmol) of 5-fluorouracil and 1.0 gram of thymidine (4.12 mmol) were dissolved in 15 ml of the above potassium phosphate buffer solution. The mixture was incubated at 37°C for 18 hours. After this time, enzyme action was stopped by the addition of four volumes of acetone and one volume of peroxide-free diethyl ether. The precipitated solids were removed by filtration, and the filtrate was evaporated under nitrogen at reduced pressure until substantially all volatile organic solvent had been removed. About 20 ml of aqueous solution, essentially free of organic solvent, remained. This solution was diluted to 100 ml with distilled water.

Ten microliters of this solution were submitted to descending chromatography on a paper buffered with 0.2 N KH₂PO₄ (pH 7.8), using a solvent mixture of tertiary amyl alcohol:water:n-butyl ether (80:13:7 by volume). A spot visible under ultraviolet light and having R_f = 0.55 was leached with 0.1 N HCl and assayed for deoxyribose by the method of Stumpf, *J. Biol. Chem.* 169, 367 (1947). This analysis indicated the presence of a minimum of 85.5 mg (0.35 mmol) of 2'-deoxy-5-fluorouridine in the protein-free reaction mixture according to U.S. Patent 2,885,396. An alternate route from 5-fluorouracil via the mercury derivative, through toluoyl deoxyuridines and then toluoyl removal to give floxuridine is described in U.S. Patent 3,041,335.

References

- Merck Index 4026
- PDR p. 1485
- DOT 8 (2) 63 (1972)
- I.N. p. 428
- REM p. 1155
- Heidelberg, C. and Duschinsky, R.; U.S. Patent 2,885,396; May 5, 1959
- Hoffer, M.; U.S. Patent 2,949,451; August 16, 1960; assigned to Hoffmann-La Roche Inc.
- Duschinsky, R., Farkas, W.G. and Heidelberg, C.; U.S. Patent 2,970,139; January 31, 1961
- Hoffer, M.; U.S. Patent 3,041,335; June 26, 1962; assigned to Hoffmann-La Roche Inc.

FLUAZACORT

Therapeutic Function: Antiinflammatory

Chemical Name: 21-(Acetyloxy)-9-fluoro-11-hydroxy-2'-methyl-5'H-pregna-1,4-diene-[17,16-d] oxazole-3,20-dione

Common Name: Fluzacortenol acetate

Structural Formula:

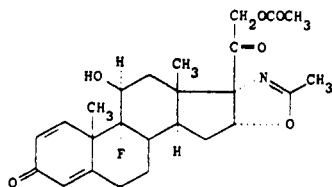

Chemical Abstracts Registry No.: 19888-56-3

Trade Name	Manufacturer	Country	Year Introduced
Azacortid	Richter	Italy	1975
Azacortid	Lepetit	France	1981

Raw Materials

Pregna-1,4,9(11)-triene-21-ol-3,20-dione-[17 α ,16 α -d]-2'-methyloxazoline-21-acetate
 N-Bromoacetamide
 Sodium hydroxide
 Hydrogen fluoride

Manufacturing Process

To a solution of 2.4 g of pre-gna-1,4,9(11)-triene-21-ol-3,20-dione-[17 α ,16 α -d]-2'-methyloxazoline 21-acetate in 24 ml of tetrahydrofuran, 12.8 ml of 0.46N perchloric acid are added at 15°C under stirring. N-bromoacetamide (1.1 g) is then added to the mixture which is kept far from light, and stirred for 4 hours at room temperature. After lowering the temperature to 10°C, a saturated solution of sodium bisulfite is added in order to decolorize the mixture, which is then poured into 120 ml of ice water. A product separates, which is collected by filtration, washed with water and then dried, thus obtaining 2.81 g of crude 9 α -bromo-pregna-1,4-diene-11 β ,21-diol-3,20-dione-[17 α ,16 α -d]-2'-methyloxazoline 21-acetate (yield 93%), MP 175°C to 176°C. An amount of 2.75 g of 9 α -bromo-pregna-1,4-diene-11 β ,21-diol-3,20-dione-[17 α ,16 α -d]-2'-methyloxazoline 21-acetate is dissolved under nitrogen in 137 ml of a mixture methanol:chloroform (3:2). The solution is put in ice bath and 5.5 ml of 1N NaOH are then added within 10 minutes followed by 5.5 ml within the next 40 minutes. A strong stirring is provided for 2 hours and the temperature is kept between 0°C and 5°C, then the pH is adjusted to 7 to 8 with glacial acetic acid. The solvent is evaporated in vacuo to 20 ml of volume of solution, that is poured into ice water (130 ml). The product is collected by filtration, washed with water and dried. Yield: 1.6 g (80%), MP 221°C to 222°C. It is pre-gna-1,4-diene-9 β ,11 β -epoxy-21-ol-3,20-dione-[17 α ,16 α -d]-2'-methyloxazoline.

An amount of 1 g of the above product is dissolved in 9.4 ml of a mixture obtained by mixing 4.67 ml of hydrofluoric acid with 8.5 ml of tetrahydrofuran at the temperature of 0°C. This solution is stirred for 20 hours at the same temperature, then under strong stirring and cooling 20 ml of tetrahydrofuran are added. The solution is subsequently neutralized by the addition of 24 g of sodium bicarbonate followed by 1 g of sodium sulfate. The inorganic substance is collected and washed with ethyl acetate. The filtrate is evaporated to dryness and the product is crystallized from acetone: 0.65 g (yield 61%) of pre-gna-1,4-dien-9 α -fluoro-11 β ,21-diol-3,20-dione-[17 α ,16 α -d]-2'-methyloxazoline are obtained, MP 241°C to 244°C [α]_D = +83.5 (c. 0.5, CHCl₃). The 21-acetate has MP 252°C to 255°C [α]_D = +54.8 (c. 0.5, CHCl₃).

References

Merck Index 4028

Kleeman & Engel p. 404

DOT 12 (10) 396 (1976)

I.N. p. 428

Nathansohn, G., Winters, G. and Testa, E.; U.S. Patent 3,461,119; August 12, 1969; assigned to Lepetit S.p.A. (Italy)

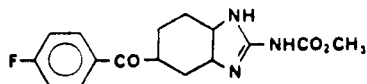
FLUBENDAZOLE**Therapeutic Function:** Anthelmintic**Chemical Name:** Methyl-N-[5(6)-p-fluorobenzoyl-2-benzimidazolyl] carbamate**Common Name:** —**Structural Formula:****Chemical Abstracts Registry No.:** 31430-15-6

Trade Name	Manufacturer	Country	Year Introduced
Fluvermal	Janssen Le Brun	France	1980
Flubenol	Janssen	W. Germany	1982
Flumoxane	Le Brun	France	—

Raw Materials

Fluorobenzene	Aluminum chloride
4-Chloro-3-nitrobenzoyl chloride	Ammonia
Hydrogen	Methyl chloroformate
S-Methylthiourea sulfate	

Manufacturing Process

To a stirred and cooled (ice bath) suspension of 25 parts of aluminum chloride in 52 parts of fluorobenzene is added dropwise a solution of 27.5 parts of 4-chloro-3-nitrobenzoyl chloride in 52 parts of fluorobenzene. Upon completion, stirring is continued overnight at room temperature. The reaction mixture is poured onto water and the product is extracted with methylene chloride. The extract is washed successively with sodium hydrogen carbonate solution and water, dried, filtered and evaporated in vacuo. The solid residue is crystallized from 2-propanol, yielding 4-chloro-4'-fluoro-3-nitrobenzophenone; MP 97.9°C.

A mixture of 24.5 parts of 4-chloro-4'-fluoro-3-nitrobenzophenone, 72 parts of methanol, 13 parts of sulfolane and 3.12 parts of ammonia is heated in a sealed tube for 20 hours at 120°C. To the reaction mixture is added successively 50 parts of water and 25 parts of a diluted hydrochloric acid solution and the whole is stirred and refluxed for 5 minutes. The reaction mixture is cooled and the precipitated product is filtered off. It is washed with 2-propanol and recrystallized from 640 parts of toluene, yielding 4-amino-4'-fluoro-3-nitrobenzophenone; MP 199°C.

A mixture of 14.5 parts of 4-amino-4'-fluoro-3-nitrobenzophenone, 160 parts of methanol,

6 parts of concentrated hydrochloric acid solution and 0.5 part of platinum oxide is hydrogenated at normal pressure and at room temperature. After the calculated amount of hydrogen is taken up, hydrogenation is stopped. The catalyst is filtered off and the filtrate is evaporated. The residue is washed with 2-propanol and dried, yielding 3,4-diamino-4'-fluorobenzophenone hydrochloride; MP 226°C to 230.5°C.

A mixture of 8.9 parts of S-methylisothiurea sulfate, 6.05 parts of methyl chloroformate in 7 parts of water is cooled, and at a temperature of 5°C to 10°C, sodium hydroxide solution 25% is added until pH equals 8. Then there are added successively 6.4 parts of acetic acid, 2.6 parts of sodium acetate and 8.9 parts of 3,4-diamino-4'-fluorobenzophenone hydrochloride and the whole is stirred while heating at 85°C for 45 minutes (during this reaction time, water and 2-propanol is added). The precipitated product is filtered off, washed with methanol and recrystallized from a mixture of 200 parts of acetic acid and 80 parts of methanol, yielding methyl N-[5(6)-p-fluorobenzoyl-2-benzimidazolyl] carbamate; MP >260°C.

References

Merck Index 4030

DFU 3 (10) 739 (1978)

Kleeman & Engel p. 404

OCDS Vol. 2 p. 354 (1980)

DOT 16 (9) 307 (1980) & 17 (6) 259 (1981)

I.N. p. 428

Van Gelder, J.L.H., Roevens, L.F.C. and Raeymaekers, A.H.M.; U.S. Patent 3,657,267; April 18, 1972; assigned to Janssen Pharmaceutica NV

FLUCLORONIDE

Therapeutic Function: Glucocorticoid

Chemical Name: 9,11β-dichloro-6α-fluoro-21-hydroxy-16α,17[(1-methylethylidene)bis(oxy)]-pregna-1,4-diene-3,20-dione

Common Name: Fluclorolone acetonide

Structural Formula:

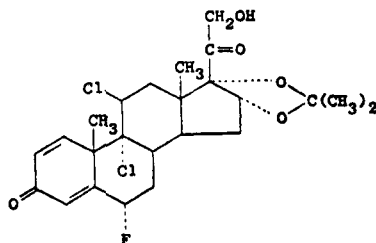

Chemical Abstracts Registry No.: 3693-39-8

Trade Name	Manufacturer	Country	Year Introduced
Topilar	Syntex	U.K.	1971
Topilar	Syntex Daltan	France	1979
Gutanit	I.F.L.	Spain	—
Synemol	Syntex	—	—

Raw Materials

6 α -Fluoro-16 α -hydroxycortisone-21-acetate
 Acetic anhydride
 Methane sulfonyl chloride
 Chlorine
 Selenium dioxide
 Potassium hydroxide
 Acetone

Manufacturing Process

To 6 α -fluoro-16 α -hydroxy-hydrocortisone 21-acetate, described by Mills et al, *J. Am. Chem. Soc.*, volume 81, pages 1264 to 1265, March 5, 1959, there was added acetic anhydride in dry pyridine. The reaction mixture was left at room temperature overnight and was then poured with stirring into ice water. The resulting precipitate was filtered, washed with water and crystallized from acetone-hexane to give 6 α -fluoro-16 α -hydroxy-hydrocortisone-16 α ,21-diacetate. This was reacted with methane-sulfonyl chloride in dimethyl formamide in the presence of pyridine at 80°C for 1 hour. The mixture was cooled, diluted with water and extracted with ethyl acetate. The extract was washed with water, dried over anhydrous sodium sulfate and the ethyl acetate was evaporated. By recrystallization of the residue from acetone-hexane there was obtained 6 α -fluoro- $\Delta^{4,9(11)}$ -pregnadiene-16 α ,17 α ,21-triol-3,20-dione 16 α ,21 diacetate.

This was reacted with chlorine to give the dichloropregnene compound, then with selenium dioxide to give the dichloropregnadiene compound. By hydrolysis with methanolic potassium hydroxide there was obtained the free 6 α -fluoro-9 α ,11 β -dichloro- $\Delta^{1,4}$ -pregnadiene-16 α ,17 α ,21-triol-3,20-dione. By treatment with acetone in the presence of perchloric acid, the 16,17-acetonide of 6 α -fluoro-9 α ,11 β -dichloro- $\Delta^{1,4}$ -pregnadiene 16 α ,17 α ,21-triol-3,20-dione was formed.

References

Merck Index 4033
 Kleeman & Engel p. 405
 OCDS Vol. 2 p. 198 (1980)
 DOT 7 (4) 130 (1971)
 I.N. p. 429
 Bowers, A.; U.S. Patent 3,201,391; August 17, 1965; assigned to Syntex Corporation, Panama

FLUCYTOSINE

Therapeutic Function: Antifungal

Chemical Name: 5-fluorocytosine

Common Name: —

Structural Formula:

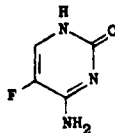

Chemical Abstracts Registry No.: 2022-85-7

Trade Name	Manufacturer	Country	Year Introduced
Ancobon	Roche	U.S.	1972
Ancotil	Roche	France	1974
Alcobon	Roche	U.K.	1974
Ancotil	Roche	W. Germany	1975
Ancotil	Roche	Japan	1979
Ancotil	Roche	Italy	1982

Raw Materials

5-Fluorouracil	Phosphorus oxychloride
Hydrogen chloride	Ammonia

Manufacturing Process

The preparation of 5-fluorouracil is given under "Fluorouracil." As described in U.S. Patent 3,040,026, 5-fluorouracil is then subjected to the following steps to give flucytosine.

Step 1: 2,4-Dichloro-5-Fluoropyrimidine — A mixture of 104 grams (0.8 mol) of 5-fluorouracil, 1,472 grams (9.6 mols) of phosphorus oxychloride and 166 grams (1.37 mols) of dimethylaniline was stirred under reflux for 2 hours. After cooling to room temperature, phosphorus oxychloride was removed by distillation at 18 to 22 mm and 22° to 37°C. The residue was then poured into a vigorously stirred mixture of 500 ml of ether and 500 gram of ice. After separating the ether layer, the aqueous layer was extracted with 500 ml, then 200 ml of ether. The combined ether fractions were dried over sodium sulfate, filtered, and the ether removed by vacuum distillation at 10° to 22°C. The residue, a yellow solid melting at 37° to 38°C, weighed 120 grams corresponding to a 90% yield. Vacuum distillation of 115 grams of this material at 74° to 80°C (16 mm) gave 108 grams of white solid melting at 38° to 39°C corresponding to an 84.5% yield.

Step 2: 2-Chloro-4-Amino-5-Fluoropyrimidine — To a solution of 10.0 grams (0.06 mol) of 2,4-dichloro-5-fluoropyrimidine in 100 ml of ethanol, 25 ml of concentrated aqueous ammonia were slowly added. A slightly opalescent solution resulted. The temperature gradually rose to 35°C. The solution was then cooled in ice to 18°C and thereafter remained below 30°C. After three hours, a Volhard titration showed that 0.0545 mol of chlorine was present in ionic form. Storage in a refrigerator overnight resulted in some crystallization of ammonium chloride. A white sludge, resulting from the evaporation of the reaction mixture at 40°C, was slurried with 75 ml of water, filtered and washed free of chloride. After drying in vacuo, the product melted at 196.5° to 197.5°C, yield 6.44 grams. Evaporation of the mother liquors yielded a second crop of 0.38 gram, raising the total yield to 6.82 grams (79.3%).

Step 3: 5-Fluorocytosine — A slurry of 34.0 grams (0.231 mol) of 2-chloro-4-amino-5-fluoropyrimidine in 231 ml of concentrated hydrochloric acid was heated in a water bath at 93° to 95°C for 125 minutes. The reaction was followed by means of ultraviolet spectrophotometry using the absorption at 245, 285, and 300 m μ as a guide. The absorption at 300 m μ rose to a maximum after 120 minutes and then dropped slightly. The clear solution was cooled to 25°C in an ice bath, then evaporated to dryness under vacuum at 40°C. After slurrying with water three times and reevaporating, the residue was dissolved in 100 milliliters of water. To this solution, cooled in ice, 29 ml of concentrated ammonia were added dropwise. The resulting precipitate was filtered, washed free of chloride with water, then with alcohol and ether. After drying in vacuo at 65°C, the product weighed 22.3 grams. An additional 6.35 grams was obtained by evaporation of the mother liquor, thus yielding a total of 28.65 grams (96.0%).

References

Merck Index 4035

Kleeman & Engel p. 406

PDR p. 1472

DOT 8 (11) 418 (1972)

I.N. p. 429

REM p. 1227

Heidelberger, C. and Duschinsky, R.; U.S. Patent 2,802,005; August 6, 1957

Duschinsky, R. and Heidelberger, C.; U.S. Patent 2,945,038; July 12, 1960; assigned to Hoffmann-La Roche Inc.

Duschinsky, R.; U.S. Patent 3,040,026; June 19, 1962; assigned to Hoffmann-La Roche Inc.

Berger, J. and Duschinsky, R.; U.S. Patent 3,368,938; February 13, 1968; assigned to Hoffmann-La Roche Inc.

FLUDIAZEPAM HYDROCHLORIDE

Therapeutic Function: Anxiolytic

Chemical Name: 1-Methyl-7-chloro-5-(o-fluorophenyl)-1,3-dihydro-2H-1,4-benzodiazepine-2-one hydrochloride

Common Name: —

Structural Formula:

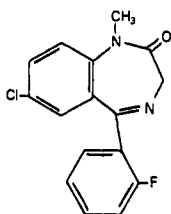

(base)

Chemical Abstracts Registry No.: 3900-31-0 (Base)

Trade Name	Manufacturer	Country	Year Introduced
Erispan	Sumitomo	Japan	1981

Raw Materials

2-Aminomethyl-1-methyl-5-chloro-3-(o-fluorophenyl)indole HCl
 Chromic anhydride
 Ammonia
 Hydrogen chloride

Manufacturing Process

A solution of 60 g of chromic anhydride in 40 ml of water was added dropwise to a suspension of 60 g of 2-aminomethyl-1-methyl-5-chloro-3-(o-fluorophenyl)indole hydrochloride in 600 ml of acetic acid. The mixture was stirred at room temperature overnight. To the reaction mixture was added 1.1 liters of ether and 1 liter of water and then 800 ml of 28% ammonium hydroxide, in small portions. The ethereal layer separated, washed with water, dried, and concentrated under reduced pressure. The residue (51.8 g) was dissolved in 100 ml of ethanol, and 100 ml of 20% ethanolic hydrogen chloride was added to the solution and the mixture was cooled. The precipitate was collected by filtration to yield 46.5 g of 1-methyl-7-chloro-5-(o-fluorophenyl)-1,3-dihydro-2H-1,4-benzodiazepine-2-one hydrochloride, melt-

ing point 218°C (decomposed). Recrystallization from ethanol raised the melting point to 218.5°C to 219°C (decomposed).

References

Merck Index 4036

DFU 6 (12) 774 (1981)

DOT 18 (2) 68 (1982)

I.N. p. 430

Yamamoto, H., Inaba, S., Okamoto, T., Hirohashi, T., Ishizumi, K., Yamamoto, M., Maruyama, I., Mori, K. and Kobayashi, T.; U.S. Patents 3,723,461; March 27, 1973; 3,828,027; August 6, 1974 and 3,925,364; December 9, 1975; all assigned to Sumitomo Chemical Co., Ltd.

FLUDROCORTISONE ACETATE

Therapeutic Function: Antiinflammatory

Chemical Name: 9-fluoro-11 β ,17,21-trihydroxy-pregn-4-ene-3,20-dione acetate

Common Name: —

Structural Formula:

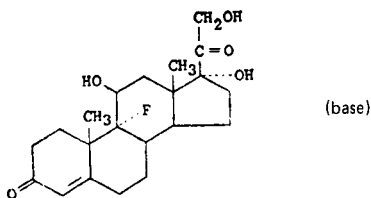

Chemical Abstracts Registry No.: 514-36-3; 127-31-1 (Base)

Trade Name	Manufacturer	Country	Year Introduced
Alflorone Acetate	MSD	U.S.	1954
Florinef Acetate	Squibb	U.S.	1955
F-Cortef Acetate	Upjohn	U.S.	1955
Alfa-Fluorone	Ausonias	Italy	—
Alfanonidrone	Difer	Italy	—
Astonin	Merck	W. Germany	—
Blephaseptyl	Chauvin-Blache	France	—
Cortineff	Poifa	Poland	—
Florotic	Squibb	U.S.	—
Fludrocortone	MSD	—	—
Myconef	Squibb	U.S.	—
Panotile	Inpharzam	W. Germany	—
Panotile	Arsac	France	—
Schlerofluron	Schering	W. Germany	—

Raw Materials

Hydrocortisone acetate
Hypobromous acid

Phosphorus oxychloride
Hydrogen fluoride

Manufacturing Process

Hydrocortisone acetate is first reacted with phosphorus oxychloride in pyridine to give the

corresponding olefin. Then a sequence consisting of hypobromous acid addition, ring closure to the epoxide and ring opening with hydrogen fluoride gives fludrocortisone acetate. Preparation of a crystalline product is described then in U.S. Patent 2,957,013.

References

Merck Index 4037

Kleeman & Engel p. 407

OCDS Vol. 1 p. 192 (1977)

DOT 7 (6) 203 (1971)

I.N. p. 430

REM p. 965

Graber, R.P. and Snoddy, C.S. Jr.; U.S. Patent 2,957,013; October 18, 1960; assigned to Merck & Co., Inc.

FLUMEQUINE

Therapeutic Function: Antibacterial

Chemical Name: 9-Fluoro-6,7-dihydro-5-methyl-1-oxo-1H,5H-benzo[*i,j*]quinolizine-2-carboxylic acid

Common Name: —

Structural Formula:

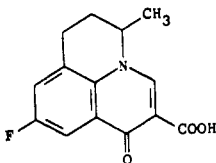

Chemical Abstracts Registry No.: 42385-25-6

Trade Name	Manufacturer	Country	Year Introduced
Apurone	Riker	France	1977
Uribact	Diethelm	Switz.	1983
Flumural	Spa	Italy	—

Raw Materials

6-Fluoro-2-methyltetrahydroquinoline
 Diethyl ethoxymethylenemalonate
 Polyphosphoric acid
 Sodium hydroxide

Manufacturing Process

6-Fluoro-2-methyltetrahydroquinoline (32.2 g, 0.2 mol) is mixed with diethyl ethoxymethylenemalonate, and the mixture is heated at 125°C to 130°C for 3 hours. Polyphosphoric acid (200 g) is added, and the solution is gradually heated to 115°C to 120°C in an oil bath with occasional stirring. The temperature is maintained for 1 hour, then the mixture is poured into 600 ml of water and neutralized with 40% sodium hydroxide solution. The product ester which precipitates is separated by filtration, washed with water and suspended in 2 liters of 10% sodium hydroxide solution. The mixture is heated on the steam bath for 1 hour, treated

with decolorizing charcoal, filtered, then neutralized with concentrated hydrochloric acid. The solid product is isolated by filtration of the hot solution, washed with water and recrystallized from dimethylformamide.

References

Merck Index 4041

Kleeman & Engel p. 411

OCDS Vol. 3 p. 186 (1984)

DOT 11 (10) 410 & 14 (8) 365 (1978)

I.N. p. 431

Gerster, J.F.; U.S. Patent 3,896,131; July 22, 1975; assigned to Riker Laboratories, Inc.

FLUMETHASONE

Therapeutic Function: Glucocorticoid; antiinflammatory

Chemical Name: 6,9-Difluoro-11,17,21-trihydroxy-16-methylpregna-1,4-diene-3,20-dione

Common Name: 6 α -Fluorodexamethasone

Structural Formula:

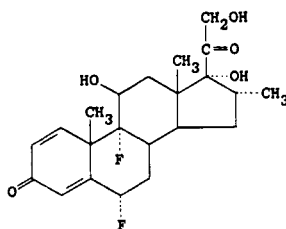

Chemical Abstracts Registry No.: 2135-17-3

Trade Name	Manufacturer	Country	Year Introduced
Locacorten	Ciba	W. Germany	1964
Locorten	Ciba	Italy	1965
Locorten	Ciba	U.K.	1965
Locorten	Ciba-Geigy	Japan	1970
Locorten	Ciba-Geigy	U.S.	1970
Gerson	VEB Leipziger	E. Germany	—
Loriden	Polfa	Poland	—
Topicorten	Trima	Israel	—

Raw Materials

6 α -Fluoro-9 β ,11 β -epoxy-16 α -methyl-17 α ,21-dihydroxy-1,4-pregnadiene-3,20-dione-21-acetate

Hydrogen fluoride

Manufacturing Process

To approximately 1.3 g of hydrogen fluoride contained in a polyethylene bottle and maintained at -60°C was added 2.3 ml of tetrahydrofuran and then a solution of 500 mg (0.0012 mol) of 6 α -fluoro-9 β ,11 β -epoxy-16 α -methyl-17 α ,21-dihydroxy-1,4-pregnadiene-3,20-dione

21-acetate in 2 ml of methylene chloride. The steroid solution was rinsed in with an additional 1 ml of methylene chloride. The light red colored solution was then kept at approximately -30°C for 1 hour and at -10°C for 2 hours. At the end of this period it was mixed cautiously with an excess of cold sodium bicarbonate solution and the organic material extracted with the aid of additional methylene chloride. The combined extracts were washed with water, dried over anhydrous sodium sulfate and concentrated to approximately 35 ml. The solution was chromatographed over 130 g of Florisil anhydrous magnesium silicate. The column was developed with 260 ml portions of hexanes (Skellysolve B) containing increasing proportions of acetone. There was thus eluted $6\alpha,9\alpha$ -difluoro- $11\beta,17\alpha,21$ -trihydroxy- 16α -methyl- $1,4$ -pregnadiene- $3,20$ -dione 21-acetate which was freed of solvent by evaporation of the eluate fractions.

References

Merck Index 4042

Kleeman & Engel p. 411

OCDS Vol. 1 p. 200 (1977)

I.N. p. 431

REM p. 965

Lincoln, F.H., Schneider, W.P. and Spero, G.B.; U.S. Patent 3,557,158; January 19, 1971; assigned to The Upjohn Co.

FLUMETHIAZIDE

Therapeutic Function: Carbonic anhydrase inhibitor

Chemical Name: 6-(Trifluoromethyl)-2H-1,2,4-benzothiadiazine-7-sulfonamide-1,1-dioxide

Common Name: Trifluoromethylthiazide

Structural Formula:

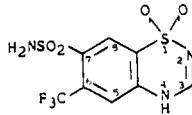

Chemical Abstracts Registry No.: 148-56-1

Trade Name	Manufacturer	Country	Year Introduced
Ademol	Squibb	U.S.	1959

Raw Materials

3-Trifluoromethylaniline	Chlorosulfonic acid
Ammonia	Formic acid

Manufacturing Process

Chilled 3-trifluoromethylaniline (32.2 g) is added dropwise over a 45-minute period to 150 ml of chlorosulfonic acid with stirring and cooling. The ice bath is removed and 140 g of sodium chloride is added over 3 hours. The mixture is heated on a water bath for 30 minutes, then gradually up to 160°C over 6 hours. The cooled reaction mixture is diluted with 500 ml of an ice water slurry and taken into ether. The ether is dried and evaporated to leave 5-trifluoromethylamine-2,4-disulfonyl chloride.

The crude residue is heated on the steam bath for 1 hour with 75 ml of concentrated ammonium

hydroxide. Cooling and filtration gives 2,4-disulfamyl-5-trifluoromethylaniline, MP 241°C to 243°C.

This intermediate is treated with an excess of 98% formic acid at steam bath temperature for 3 hours. Evaporation and dilution with water gives 7-sulfamyl-6-trifluoromethyl-1,2,4-benzothiadiazine-1,1-dioxide, MP 304°C to 308°C.

References

Merck Index 4043

OCDS Vol. 1 p. 355 (1977) & 2 p. 355 (1980)

I.N. p. 431

Smith Kline & French Laboratories; British Patent 861,809; March 1, 1961

FLUNARIZINE HCl

Therapeutic Function: Vasodilator

Chemical Name: 1-[Bis(4-fluorophenyl)methyl]-4(3-phenyl-2-propenyl)piperazine

Common Name: —

Structural Formula:

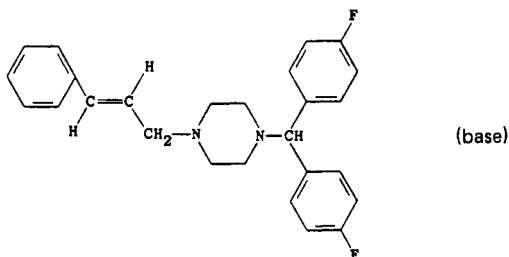

Chemical Abstracts Registry No.: 30484-77-6; 52468-60-7 (Base)

Trade Name	Manufacturer	Country	Year Introduced
Sibelium	Janssen	W. Germany	1977
Sibelium	Janssen	Switz.	1980
Issium	Farmochimica	Italy	1981
Fluxarten	Zambeletti	Italy	1981
Dinaplex	Sidus	Argentina	—
Flugerol	Italfarmaco	Italy	—
Flunagen	Gentili	Italy	—
Gradient Polifarma	Polifarma	Italy	—
Mondus	Labinca	Argentina	—

Raw Materials

Di-(p-Fluorophenyl)chloromethane
1-Cinnamylpiperazine
Sodium carbonate

Manufacturing Process

A mixture of 14.3 parts of di-(p-fluorophenyl)-chloromethane, 10.1 parts of 1-cinnamyl-piperazine, 12.7 parts of sodium carbonate, a few crystals of potassium iodide in 200 parts of 4-methyl-2-pentanone is stirred and refluxed for 21 hours. The reaction mixture is cooled

and 50 parts of water are added. The organic layer is separated, dried, filtered and evaporated. The oily residue is dissolved in 480 parts of anhydrous diisopropyl ether. This solution is boiled with activated charcoal, filtered and to the clear filtrate is added an excess of 2-propanol, previously saturated with gaseous hydrogen chloride. The precipitated salt is filtered off and recrystallized from a mixture of 2-propanol and ethanol, yielding 1-cinnamyl-4-(di-p-fluorobenzhydryl)piperazine dihydrochloride, MP 251.5°C.

References

Merck Index 4045

Kleeman & Engel p. 412

OCDS Vol. 2 p. 31 (1980)

DOT 14 (3) 109 (1978)

I.N. p. 432

Janssen, P.A.J.; U.S. Patent 3,773,939; November 20, 1973; assigned to Janssen Pharmaceutica N.V.

FLUNISOLIDE

Therapeutic Function: Antiinflammatory

Chemical Name: 16 α ,17 α -Isopropylidenedioxy-6 α -fluoro-1,4-pregnadiene-11 β ,21-diol-3,20-dione

Common Name: —

Structural Formula:

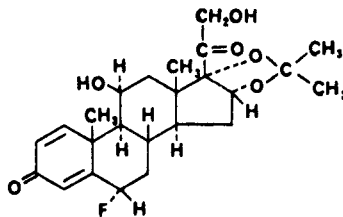

Chemical Abstracts Registry No.: 3385-03-3

Trade Name	Manufacturer	Country	Year Introduced
Syntaris	Syntex	U.K.	1978
Syntaris	Syntex	W. Germany	1979
Syntaris	Syntex	Switz.	1980
Nasalide	Syntex	U.S.	1981
Syntaris	Recordati	Italy	1982
Lunis	Valeas	Italy	1983
Aero Bid	Key	U.S.	—
Bronalide	Krewel	W. Germany	—
Lobilan Nasal	Astra	—	—
Lokilan Nasal	Syntex	—	—
Rhinalar	Syntex	—	—

Raw Materials

6 α -Fluoroprednisolone

Bacterium *Streptomyces roseochromogenus*

Acetone

Perchloric acid

Manufacturing Process

(a) *Preparation of 6 α -fluoro-16 α -hydroxyprednisolone*: 1.9 liters of whole mash containing 400 mg of 6 α -fluoroprednisolone (6 α -fluoro-11 β ,17 α ,21-trihydroxy-1,4-pregnadiene-3,20-dione) acted upon by *Streptomyces roseochromogenus* AE-751 (or Waksman No. 3689) is filtered and the filtrate extracted three times with 2 liter portions of ethyl acetate. The mycelium is extracted with 500 ml of ethyl acetate and the mixture filtered. The combined ethyl acetate extracts are washed with 200 ml of water and concentrated to a residue. The residue is subjected to partition chromatograph using a 200 g column of diatomaceous earth moistened with the lower phase of an equilibrated solvent system composed of 1 volume of water, 5 volumes of dioxane, and 3 volumes of cyclohexane. The upper phase is used to develop the column and the activity of the eluent is followed by measuring the ultraviolet absorbance at 240 m μ . The cuts containing most of the activity are concentrated to a syrupy residue and triturated with acetone. Crystals (25 mg) form and recrystallization gives a product with a MP of 226°C to 230°C.

(b) *Preparation of 16 α ,17 α -isopropylidenedioxy-6 α -fluoro-1,4-pregnadiene-11 β ,21-diol-3,20-dione*: 15 mg of crystalline 6 α -fluoro-11 β ,16 α ,17 α ,21-tetrahydroxy-1,4-pregnadiene-3,20-dione [6 α -fluoro-16 α -hydroxyprednisolone described in U.S. Patent 2,838,546 and prepared as described in (a) above] is dissolved in 2 ml of acetone and 0.02 ml of 70% perchloric acid is added. The solution is allowed to stand 1 hour. Then 0.5 ml of saturated sodium bicarbonate solution is added and the solution concentrated under reduced pressure to about 1 ml. The solution is allowed to stand overnight and the crystals which form are filtered, washed with ether and recrystallized from acetone-hexane. The crystals are the 16 α ,17 α -isopropylidene derivative of 6 α -fluoro-16 α -hydroxyprednisolone.

References

- Merck Index 4046
 DFU 3 (2) 81 (1979)
 Kleeman & Engel p. 413
 PDR pp. 966, 1803
 OCDS Vol. 2 p. 181 (1980)
 DOT 16 (8) 252 (1980)
 I.N. p. 432
 REM p. 972
 American Cyanamid Co.; British Patent 933,867; August 14, 1963

FLUNITRAZEPAM

Therapeutic Function: Hypnotic

Chemical Name: 5-(2-fluorophenyl)-1,3-dihydro-1-methyl-7-nitro-2H-1,4-benzodiazepin-2-one

Common Name: —

Structural Formula:

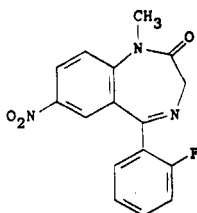

Chemical Abstracts Registry No.: 1622-62-4

Trade Name	Manufacturer	Country	Year Introduced
Roipnol	Roche	Italy	1976
Rohypnol	Roche	France	1978
Rohypnol	Roche	W. Germany	1979
Rohypnol	Sauter	U.K.	1982
Hypnodorm	Teva	Israel	—
Hipnosedon	Roche	—	—
Narcozep	Roche	France	—

Raw Materials

p-Chloroaniline	Hydrogen
o-Fluorobenzoyl chloride	Bromoacetyl bromide
Ammonia	Potassium nitrate
Sulfuric acid	Sodium hydride
Methyl iodide	

Manufacturing Process

A mixture of 176 grams of orthofluorobenzoyl chloride and 64 grams of para-chloroaniline was stirred and heated to 180°C, at which temperature 87 grams of zinc chloride was introduced, the temperature raised to 200° to 205°C and maintained there for 40 minutes. The golden colored melt was quenched by the careful addition of 500 ml of 3 N hydrochloric acid and the resulting mixture refluxed for 5 minutes. The acid solution was decanted and the process repeated three times to remove all orthofluorobenzoic acid. The grey granular residue was dissolved in 300 ml of 75% (v/v) sulfuric acid and refluxed for 40 minutes to complete hydrolysis. The hot solution was poured over 1 kg of ice and diluted to 2 liters with water. The organic material was extracted with four 300 ml portions of methylene chloride, and the combined extracts subsequently washed with two 500 ml portions of 3 N hydrochloric acid to remove traces of para-chloroaniline, three 500 ml portions of 5 N sodium hydroxide solution to remove orthofluorobenzoic acid, and finally two 200 ml portions of saturated brine solution.

The combined methylene chloride extracts were dried over anhydrous sodium sulfate and the solvent removed to give the crude 2-amino-5-chloro-2'-fluorobenzophenone which upon recrystallization from methanol formed yellow needles melting at 94° to 95°C.

50.0 grams of 2-amino-5-chloro-2'-fluorobenzophenone in 300 cc of tetrahydrofuran was hydrogenated at atmospheric pressure in the presence of 10 grams of charcoal (Norite), 30.0 grams of potassium acetate and 2.5 cc of a 20% palladous chloride solution (20% by weight of palladium). After an initiation period varying from 10 minutes to an hour, hydrogen uptake was rapid and stopped completely after the absorption of the theoretical amount.

Filtration of the catalyst over a Hyflo pad and removal of the solvent left a yellow crystalline residue. The crude mixture of ketone and potassium acetate was partitioned between methylene chloride (300 cc) and water (1 liter). The layers were separated and the water layer washed with methylene chloride (3 x 50 cc). The organic layers were combined, washed with 3 N sodium hydroxide solution (2 x 50 cc), water (3 x 100 cc), dried over anhydrous sodium sulfate and filtered. The solvent was removed and the product recrystallized from ethanol to give 2-amino-2'-fluorobenzophenone as yellow prisms melting at 126° to 128°C.

A solution of 21.5 grams of 2-amino-2'-fluorobenzophenone in 500 cc of ether was treated with 20 cc of a 20% (v/v) solution of bromoacetyl bromide in ether. The mixture was shaken and allowed to stand for 5 minutes and then washed with water (20 cc). The proc-

ess was repeated five times. The final solution was washed thoroughly with water (5 x 500 cc) and concentrated to 100 cc. The crystals were filtered and recrystallized from methanol to give 2-bromacetamido-2'-fluorobenzophenone as white needles melting at 117° to 118.5°C.

A solution of 23.7 grams of 2-bromoacetamido-2'-fluorobenzophenone in tetrahydrofuran (100 cc) was added to liquid ammonia (approximately 500 cc) and allowed to evaporate overnight. The residue was treated with water (1 liter) and the crystals filtered off and refluxed in toluene (100 cc) for 30 minutes. The mixture was treated with decolorizing carbon (Norite) and filtered over Hyflo. The solution was concentrated to a small volume (25 cc) cooled, diluted with 20 cc of ether and allowed to stand. The product was recrystallized from acetone/hexane to give 5-(2-fluorophenyl)-3H-1,4-benzodiazepin-2(1H)-one as white needles melting at 180° to 181°C.

23.8 grams of 5-(2-fluorophenyl)-3H-1,4-benzodiazepin-2(1H)-one was dissolved in 50 cc of concentrated sulfuric acid at 0°C. To the resulting mixture there was then added dropwise with stirring a solution of 7.1 grams of potassium nitrate in 20 cc of concentrated sulfuric acid. The mixture was stirred for 2½ hours at 0°C and then diluted with 300 grams of ice. The resulting solution was made alkaline with concentrated ammonium hydroxide solution, keeping the temperature at 0°C. The formed suspension was extracted thoroughly with methylene chloride (6 x 100 cc). The organic layers were combined, washed with saturated brine solution, dried over anhydrous sodium sulfate and filtered. Removal of the solvent yielded a brown gum which was taken up in a small amount of methylene chloride and filtered through a pad of grade I alumina. The alumina was eluted with methylene chloride, the solvent removed, and the residue crystallized from acetone/hexane to yield 7-nitro-5-(2-fluorophenyl)-3H-1,4-benzodiazepin-2(1H)-one as white needles melting at 210° to 211°C.

20.2 grams of the abovementioned 7-nitro-5-(2-fluorophenyl)-3H-1,4-benzodiazepin-2(1H)-one was dissolved in 60 cc of N,N-dimethyl formamide to which was then added 3.49 grams of a 50% suspension of sodium hydride in heavy mineral oil. The mixture was allowed to stir for 15 minutes in the cold, 11.2 grams of methyl iodide was added and the solution was stirred for a further 20 minutes. Solvent was removed under reduced pressure to give an oil which was partitioned between water and methylene chloride (1 liter/300 cc), the water layer was extracted with methylene chloride (5 x 200 cc), the organic layers combined and washed with water (2 x 100 cc), 3N hydrochloric acid (1 x 50 cc), water (3 x 100 cc), dried over anhydrous sodium sulfate and filtered.

Removal of the solvent gave an oil which was taken up in ether and filtered through a pad of Woelm grade I alumina. The eluent was concentrated and the residue was crystallized from methylene chloride/hexane yielding 1-methyl-7-nitro-5-(2-fluorophenyl)-3H-1,4-benzodiazepin-2(1H)-one as pale yellow needles melting at 166° to 167°C.

References

Merck Index 4047

Kleeman & Engel p. 413

OCDS Vol. 2 p. 406 (1980)

DOT 11 (5) pp. 177,211 (1975) & 19 (3) p. 163 (1983)

I.N. p. 432

REM p. 1064

Kariss, J. and Newmark, H.L.; U.S. Patent 3,116,203; December 31, 1963; assigned to Hoffmann-La Roche Inc.

Kariss, J. and Newmark, H.L.; U.S. Patent 3,123,529; March 3, 1964; assigned to Hoffmann-La Roche Inc.

Keiler, O., Steiger, N. and Sternbach, L.H.; U.S. Patent 3,203,990; August 31, 1965; assigned to Hoffmann-La Roche Inc.

FLUOCINOLONE ACETONIDE

Therapeutic Function: Glucocorticoid; antiinflammatory

Chemical Name: 6 α ,9-difluoro-11 β ,21-dihydroxy-16 α ,17-[[1-methylethylidene)bis(oxy)]-pregna-1,4-diene-3,20-dione

Common Name: —

Structural Formula:

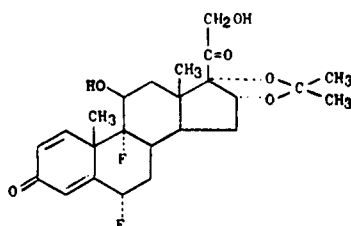

Chemical Abstracts Registry No.: 67-73-2

Trade Name	Manufacturer	Country	Year Introduced
Synalar	Syntex	U.S.	1961
Synalar	Cassenne	France	1961
Synalar	I.C.I.	U.K.	1961
Localyn	Recordati	Italy	1963
Fellin	Gruenthal	W. Germany	1964
Synemol	Syntex	U.S.	1975
Fluonid	Herbert	U.S.	1983
Fluotrex	Savage	U.S.	1983
Alfabios	Iton	Italy	—
Alvadermo	Alvarez-Gomez	Spain	—
Benamizol	Mohan Yakuhin	Japan	—
Biscosol	Onta Seiyaku	Japan	—
Boniderma	Bonicontra	Italy	—
Coderma	Biotrading	Italy	—
Co-Fluosin	Sanchez-Covisa	Spain	—
Cordes F	Ichthyol	W. Germany	—
Cortalar	Bergamon	Italy	—
Cortiderma	Gazzini	Italy	—
Cortiphate	Tokyo Tanabe	Japan	—
Cortiespec	Centrum	Spain	—
Cortoderm	Lennon	S. Africa	—
Dermacort	P.S.N.	Italy	—
Dermaisom	Isom	Italy	—
Dermalar	Teva	Israel	—
Dermaplus	Ripari-Gero	Italy	—
Dermil	Cifa	Italy	—
Dermobeta	Amelix	Italy	—
Dermobiomar	Dermologia Marina	Spain	—
Dermofil	N.C.S.N.	Italy	—
Dermo Framan	Oftalmiso	Spain	—
Dermolin	Lafare	Italy	—
Dermomagis	Magis	Italy	—
Dermophyl	Rougier	Canada	—
Dermotergol	Wolner	Spain	—

Trade Name	Manufacturer	Country	Year Introduced
Doricum	Farmila	Italy	—
Ekaton	Pharma Farm. Spec.	Italy	—
Esacinone	Lisapharma	Italy	—
Esilon	S.I.T.	Italy	—
Flucinar	Poifa	Poland	—
Flucort	Syntex-Tanabe	Japan	—
Fluocinil	Coli	Italy	—
Fluocinone	Panther-Osfa	Italy	—
Fluocit	C.T.	Italy	—
Fluoderm	Unipharm	Israel	—
Fluodermol	Medosan	Italy	—
Fluogisol	Washington	Italy	—
Fluolar	Riva	Canada	—
Fluomix	Savoma	Italy	—
Fluonide Dermica	Janus	Italy	—
Fluordima	Intersint	Italy	—
Fluoskin	Dessy	Italy	—
Fluovitef	Italfarmaco	Italy	—
Flupollon	Kaigai	Japan	—
Flupollon	Ohta	Japan	—
Fluvean	Kowa	Japan	—
Fluzon	Taisho	Japan	—
Gelargin	Leciva	Czechoslovakia	—
Gelidina	I.F.L.	Spain	—
Intradermo	Pental	Spain	—
Isnaderm	Isnardi	Italy	—
Isoderma	Isola-Ibi	Italy	—
Jellin	Gruenthal	—	—
Meclocloderm	I.C.I.	Italy	—
Monoderm	Pharbil	Neth.	—
Omniderm	Face	Italy	—
Oxidermiol Fuerte	Mazuelos	Spain	—
Percutina	Mitim	Italy	—
Prodermin	Eufarma	Italy	—
Radiocin	Radiopharma	Italy	—
Roliderm	Neopharmed	Italy	—
Sterolone	Francia	Italy	—
Straderm	I.T.A.	Italy	—
Synandone	I.C.I.	U.K.	—
Tefunote	Taiyo	Japan	—
Topifluor	Tiber	Italy	—
Ultraderm	Ecobi	Italy	—
Ungovac	I.C.N.	—	—

Raw Materials

6 α -Fluoro-16 α -hydroxy-hydrocortisone	Hydrogen fluoride
Acetic anhydride	Selenium dioxide
Methane sulfonyl chloride	Potassium hydroxide
N-Bromoacetamide	

Manufacturing Process

A mixture of 1.2 grams of 6 α -fluoro-16 α -hydroxy-hydrocortisone, 4 cc of acetic anhydride and 8 cc of pyridine was heated at 60°C for 2 hours and then kept at room temperature for 2 hours. Ice and water were added and the solid was collected, washed with water, dried and recrystallized from methylene chloride-methanol, thus giving 1.05 grams of the

16,21-diacetate of 6 α -fluoro-16 α -hydroxy-hydrocortisone (solvated) of MP 182° to 187°C; concentration of the mother liquors afforded an additional 130 mg of the same compound, MP 184° to 187°C. By recrystallization from the same solvents there was obtained the compound with a lower constant melting point of 175° to 177°C.

2.94 grams of the 16,21-diacetate of 6 α -fluoro-16 α -hydroxy-hydrocortisone was mixed with 60 cc of dimethylformamide, 3.6 cc of pyridine and 2.4 cc of methane-sulfonyl chloride was heated on the steam bath for 2 hours. The diacetate of 6 α -fluoro-16 α -hydroxy-hydrocortisone had been prepared as set forth above, and further dried by azeotropic distillation with benzene; the dimethylformamide had been previously distilled. After the 2 hours on the steam bath the mixture was cooled and poured into saturated aqueous sodium bicarbonate solution; the product was extracted with methylene chloride, the extract was washed with water, dried over anhydrous sodium sulfate and the solvent was evaporated.

The residue was chromatographed on 90 grams of silica gel eluting the product with methylene chloride-acetone (9:1) and then recrystallizing from methylene chloride-methanol. There was thus obtained 1.6 grams of the 16,21-diacetate of 6 α -fluoro- $\Delta^{4,9(11)}$ -pregnadiene-16 α -, 17 α -,21-triol-3,20-dione with MP 110° to 114°C; the analytical sample melted at 115° to 117°C, $[\alpha]_D^{23.5}$ (chloroform), λ max. 234 to 236 μ m, $\log \epsilon$ 4.18.

A mixture of 1.38 grams of the above compound and 15 cc of dioxane was treated with 1.9 cc of a 0.5 N aqueous solution of perchloric acid and 600 mg of N-bromoacetamide, adding the latter in the dark, in three portions, in the course of half an hour and under continuous stirring. It was then stirred for a further 1 $\frac{3}{4}$ hours in the dark, then the excess of reagent was decomposed by the addition of aqueous sodium bisulfite solution and ice water was added; the product was extracted with methylene chloride, washed with water, dried over anhydrous sodium sulfate and the solvent was evaporated under reduced pressure, thus giving a yellow oil consisting of the 16,21-diacetate of 6 α -fluoro-9 α -bromo-16 α -hydroxy-hydrocortisone which was used for the next step without further purification.

The above crude bromohydrin was mixed with 2.5 grams of potassium acetate and 60 cc of acetone and refluxed for 6 hours, at the end of which the acetone was distilled, water was added to the residue and the product was extracted with methylene chloride. The extract was washed with water, dried over anhydrous sodium sulfate and the solvent was evaporated. Recrystallization of the residue from methanol furnished 800 mg of the 16,21-diacetate of 6 α -fluoro-9 β ,11 β -oxido- Δ^4 -pregnene-16 α -,17 α -,21-triol-3,20-dione with MP 120° to 124°C; by chromatography of the mother liquors on silica gel there was obtained 180 milligrams more of the same compound with MP 117° to 119°C. The analytical sample was obtained by recrystallization from methanol; it showed MP 125° to 127°C.

To a solution of 1.6 grams of anhydrous hydrogen fluoride in 2.85 grams of tetrahydrofuran and 10 cc of methylene chloride cooled to -60°C was added a solution of 650 mg of the 16,21-diacetate of 6 α -fluoro-9 β ,11 β -oxido- Δ^4 -pregnene-16 α -,17 α -,21-triol-3,20-dione in 20 cc of methylene chloride and the mixture was kept at -10°C for 72 hours. It was then poured into saturated aqueous sodium bicarbonate solution and the organic layer was separated, washed with water, dried over anhydrous sodium sulfate and evaporated. The residue was reacylated by heating with 3 cc of acetic anhydride and 6 cc of pyridine for 1 hour on the steam bath. The reagents were evaporated under reduced pressure and the residue was chromatographed on 30 grams of silica gel. Upon elution with methylene chloride-acetone (9:1) and recrystallization of the residue from methylene chloride-methanol there was obtained 290 mg of the 16,21-diacetate of 6 α ,9 α -difluoro-16 α -hydroxy-hydrocortisone which melted with loss of solvent at 140° to 150°C. Recrystallization from acetone-hexane afforded the analytical sample which was dried at 130°C; it then showed a MP of 182° to 185°C.

A mixture of 290 mg of the 16,21-diacetate of 6 α ,9 α -difluoro-16 α -hydroxy-hydrocortisone, 30 cc of t-butanol, 0.5 cc of pyridine and 150 mg of selenium dioxide was refluxed for 53 hours under an atmosphere of nitrogen and cooled; ethyl acetate was added and filtered through celite; the solvent was evaporated to dryness under reduced pressure, the residue

was triturated with water, the solid was collected by filtration, washed with water and dried. The product was then chromatographed on 10 grams of silica gel. The solid fractions eluted with acetone-methylene chloride (1:19) were recrystallized from methylene chloride, thus affording 68 mg of the 16,21-diacetate of 6 α ,9 α -difluoro-16 α -hydroxy-prednisolone; MP 212° to 215°C.

A mixture of 430 mg of the 16,21-diacetate of 6 α ,9 α -difluoro-16 α -hydroxy-prednisolone, 15 cc of methanol and 2.2 cc of a 4% aqueous solution of potassium hydroxide was stirred at 0°C in an atmosphere of nitrogen; the material entered rapidly in solution and reprecipitated after 30 minutes. The mixture was then stirred for 1 hour more at 0°C and under an atmosphere of nitrogen, then neutralized with acetic acid and the methanol was distilled under reduced pressure. The residue was triturated with water, the solid was collected, washed with water, dried and recrystallized from ethyl acetate-methanol, thus giving 285 milligrams of the free 6 α ,9 α -difluoro-16 α -hydroxy-prednisolone, MP 258° to 260°C; the analytical sample showed MP 266° to 268°C.

References

Merck Index 4050

Kleeman & Engel p. 414

PDR pp. 888, 930, 1429, 1606, 1800

I.N. p. 433

REM p. 966

Mills, J.S. and Bowers, A.; U.S. Patent 3,014,938; December 26, 1961; assigned to Syntex SA, Mexico

FLUOCINONIDE

Therapeutic Function: Antiinflammatory; glucocorticoid

Chemical Name: 21-(acetyloxy)-6 α ,9-difluoro-11 β -hydroxy-16 α ,17-[(1-methylethylidene)-bis(oxy)]pregna-1,4-diene-3,20-dione

Common Name: Fluocinolone acetonide acetate

Structural Formula:

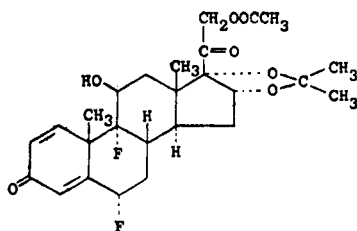

Chemical Abstracts Registry No.: 356-12-7

Trade Name	Manufacturer	Country	Year Introduced
Topsyn	Recordati	Italy	1970
Lidex	Syntex	U.S.	1971
Metosyn	I.C.I.	U.K.	1971
Topsym	Gruenthal	W. Germany	1971
Topsyne	Cassenne	France	1971

Trade Name	Manufacturer	Country	Year Introduced
Topsyn	Tanabe	Japan	1975
Bestasone	Kodama	Japan	—
Cusigel	Cusi	Spain	—
Flu 21	Lanat	Italy	—
Fludex	San Carlo	Italy	—
Fluzon	Taisho	Japan	—
Novoter	Cusi	Spain	—
Supracort	Teva	Israel	—

Raw Materials

6 α -Fluoro-triamcinolone	Acetone
Perchloric acid	Acetic anhydride

Manufacturing Process

To a suspension of 500 mg of 6 α -fluoro-triamcinolone in 75 ml of acetone is added 0.05 milliliters of 72% perchloric acid and the mixture agitated at room temperature for 3 hours. During this period the crystals gradually dissolve and the clear solution is neutralized with dilute bicarbonate and the acetone removed in vacuo. The resulting crystalline suspension is filtered and the crystals washed with water. The dried material is recrystallized from 95% alcohol to give the pure acetone.

A solution of 50 mg of 6 α -fluoro-triamcinolone acetone in 1 ml of pyridine and 1 ml of acetic anhydride is allowed to stand at room temperature for 18 hours. Removal of the reagents in vacuo gives a crystalline residue which after crystallization from acetone-hexane gives the pure 16 α ,17 α -isopropylidene 6 α -fluoro-triamcinolone 21 acetate (fluocinonide), as described in U.S. Patent 3,197,469.

References

Merck Index 4051

Kleeman & Engel p. 415

PDR p. 1800

DOT 7 (6) 207 (1971)

I.N. p. 433

REM p. 966

Ringold, H.J. and Rosenkranz, G.; U.S. Patent 3,124,571; March 10, 1964; assigned to Syntex Corporation, Panama

Ringold, H.J., Zderic, J.A., Djerassi, C. and Bowers, A.; U.S. Patent 3,126,375; March 24, 1964; assigned to Syntex Corporation, Panama

Fried, J.; U.S. Patent 3,197,469; July 27, 1965; assigned to Pharmaceutical Research Products, Inc.

FLUOCORTIN BUTYL

Therapeutic Function: Antiinflammatory

Chemical Name: 6-Fluoro-11-hydroxy-16-methyl-3,20-dioxopregna-1,4-dien-21-oic acid butyl ester

Common Name: —

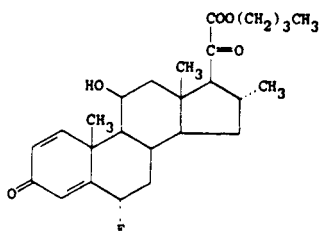
Structural Formula:

Chemical Abstracts Registry No.: 41767-29-7; 33124-50-40 (Base)

Trade Name	Manufacturer	Country	Year Introduced
Vaspit	Schering	W. Germany	1977
Vaspit	Schering	Switz.	1978
Vaspit	Schering	Italy	1981
Vaspid	Schering	Australia	—

Raw Materials

6 α -Fluoro-11 β ,21-dihydroxy-16 α -methyl-1,4-pregnadiene-3,20-dione
 Cupric acetate
 Methanol
 Manganese dioxide
 Butanol

Manufacturing Process

(a) A solution of 11.3 g of 6 α -fluoro-11 β ,21-dihydroxy-16 α -methyl-1,4-pregnadiene-3,20-dione in 500 ml of absolute methanol is mixed with 3.0 g of copper (II) acetate in 500 ml of absolute methanol. The solution is agitated at room temperature for 170 hours, then clarified by filtration, and concentrated under vacuum. The residue is mixed with 10% ammonium hydroxide solution and extracted with methylene chloride. The organic phase is washed several times with water, dried over sodium sulfate, and concentrated under vacuum. The residue is chromatographed on 1.3 kg of silica gel. After recrystallization from acetone-hexane, with 6-7% acetone-methylene chloride, 1.40 g of the methyl ester of 6 α -fluoro-11 β ,20 α -dihydroxy-3-oxo-16 α -methyl-1,4-pregnadiene-21-oic acid is obtained, MP 191°C to 192°C.

(b) 2.1 g of a mixture of the methyl ester of 6 α -fluoro-11 β ,20 α -dihydroxy-3-oxo-16 α -methyl-1,4-pregnadiene-21-oic acid and the methyl ester of 6 α -fluoro-11 β ,20 β -dihydroxy-3-oxo-16 α -methyl-1,4-pregnadiene-21-oic acid is dissolved in 20 ml of methylene chloride. The solution is mixed with 20 g of active manganese(IV) oxide ("precipitation active for synthesis purposes" by Merck, A.G.) and refluxed for 6 hours. Then, the reaction mixture is filtered off from the manganese(IV) oxide. The filtrate is evaporated and the residue is recrystallized from acetone-hexane, thus obtaining 450 mg of the methyl ester of 6 α -fluoro-11 β -hydroxy-3,20-dioxo-16 α -methyl-1,4-pregnadiene-21-oic acid, MP 182°C to 184°C.

(c) A solution of 250 mg of the methyl ester of 6 α -fluoro-11 β ,20 α -dihydroxy-3-oxo-16 α -methyl-1,4-pregnadiene-21-oic acid in 3 ml of methylene chloride is mixed with 2.5 g of active manganese(IV) oxide and stirred for 45 minutes at room temperature. The manganese(IV) oxide is removed by filtration, the filtrate is evaporated to dryness, and the residue is recrystallized from acetone-hexane, thus producing 145 mg of the methyl ester of 6 α -fluoro-11 β -hydroxy-3,20-dioxo-16 α -methyl-1,4-pregnadiene-21-oic acid, MP 188°C.

(d) 4.3 g of the methyl ester of 6 α -fluoro-11 β ,20 β -dihydroxy-3-oxo-16 α -methyl-1,4-pregnadiene-21-oic acid is dissolved, with the addition of 50 g of active manganese(IV) oxide, in 50 ml of isopropanol. The reaction mixture is agitated at room temperature for 25 hours and filtered off from the manganese(IV) oxide. After evaporation of the solvent, the residue

is recrystallized twice from hexane-acetone. Yield: 1.3 g of the methyl ester of 6 α -fluoro-11 β -hydroxy-3,20-dioxo-16 α -methyl-1,4-pregnadiene-21-oic acid, MP 189°C to 191°C.

(e) 500 mg of 6 α -fluoro-11 β -hydroxy-3,20-dioxo-16 α -methyl-1,4-pregnadiene-21-oic acid is dissolved in 100 ml of absolute ether, and mixed with 7 ml of butanol and 1.5 ml of dicyclohexyl carbodiimide. After 18 hours of agitation at room temperature, the reaction mixture is vacuum-filtered from the thus-precipitated dicyclohexyl urea. The filtrate is concentrated, and the crude product is chromatographed on silica gel. With 9–11% acetone-hexane, after recrystallization from acetone-hexane, 256 mg of the butyl ester of 6 α -fluoro-11 β -hydroxy-3,20-dioxo-16 α -methyl-1,4-pregnadiene-21-oic acid is obtained, MP 185°C to 187°C.

References

Merck Index 4052

DFU 2 (10) 669 (1977)

Kleeman & Engel p. 416

DOT 13 (12) 528 (1977) & 17 (9) 388 (1981)

I.N. p. 434

Laurent, H., Wiechert, R., Prezewowsky, K., Hofmeister, H., Gerhards, E., Kolb, K.H. and Mengel, K.; U.S. Patent 3,824,260; July 16, 1974; assigned to Schering A.G. (West Germany)

FLUOCORTOLONE

Therapeutic Function: Glucocorticoid

Chemical Name: 6 α -fluoro-11 β ,21-dihydroxy-16 α -methylpregna-1,4-diene-3,20-dione

Common Name: —

Structural Formula:

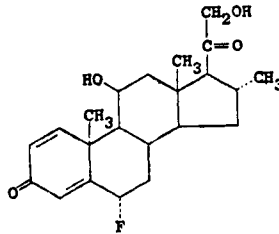

Chemical Abstracts Registry No.: 152-97-6

Trade Name	Manufacturer	Country	Year Introduced
Ultralan	Schering	W. Germany	1965
Ultralan	Schering	Italy	1974
Ficoid	Fisons	U.K.	—
Myco-Ultralan	S.E.P.P.S.	France	—
Syracort	Beiersdorf	W. Germany	—
Ultrason	Schering	W. Germany	—

Raw Materials

16 α -Methyl- Δ^5 -pregnene-3 β ,21-diol-20-one-21-acetate
N-Bromoacetamide

Hydrogen fluoride
 Chromic acid
 Bacterium *Curvularia lunata*
 Acetic anhydride
 Bacterium *Corynebacterium simplex*

Manufacturing Process

(a) *16 α -Methyl-6 α -Fluoro- Δ^4 -Pregnene-11 β ,21-Diol-3,20-Dione*: 16 α -methyl-6 α -fluoro- Δ^4 -pregnene-21-ol-3,20-dione-21-acetate (MP 132°/134° to 138°C, UV_{e₂₃₈} = 15,000) is hydroxylated with *Curvularia lunata* in 11 β -position using the fermentation method whereby the 21-acetate group is simultaneously saponified. The hitherto unknown starting material 16 α -methyl-6 α -fluoro- Δ^4 -pregnene-21-ol-3,20-dione-21-acetate is obtained from 16 α -methyl- Δ^5 -pregnene-3 β ,21-diol-20-one-21-acetate, MP 152° to 154°C, by the addition of bromofluorine (from N-bromacetamide and hydrogen fluoride) onto the 5–6 double bond, oxidation of the 3 β -hydroxyl group with chromic acid, introduction of the Δ^4 -double bond by splitting of the hydrogen bromide and acid isomerization of the 6 β -fluoro substituent to the 16 α -methyl-6 α -fluoro- Δ^4 -pregnene-21-ol-3,20-dione-21-acetate. By chromatographic purification on silica gel the 16 α -methyl-6 α -fluoro- Δ^4 -pregnene-11 β ,21-diol-3,20-dione is: MP 166°/167° to 171°C.

(b) *16 α -Methyl-6 α -Fluoro- Δ^4 -Pregnene-11 β ,21-Diol-3,20-Dione-21-Acetate*: By reaction of the compound of (a) with acetic anhydride in pyridine at room temperature, the acetate is obtained and recrystallized from ethyl acetate, MP 248°/249° to 251°C.

(c) *16 α -Methyl-6 α -Fluoro- $\Delta^{1,4}$ -Pregnadiene-11 β ,21-Diol-3,20-Dione*: 16 α -methyl-6 α -fluoro- Δ^4 -pregnene-11 β ,21-diol-3,20-dione is dehydrogenated with *Corynebacterium simplex*. The extraction residue is subjected to chromatography on silica gel and after recrystallization there is obtained from methylene chloride-isopropyl ether 16 α -methyl-6 α -fluoro- $\Delta^{1,4}$ -pregnadiene-11 β ,21-diol-3,20-dione, MP 180°/181° to 182°C.

References

- Merck Index 4053
 Kleeman & Engel p. 417
 OCDS Vol. 1 p. 204 (1977)
 I.N. p. 434
 Kieslich, K., Kerb, U. and Raspe, G.; U.S. Patent 3,426,128; February 4, 1969; assigned to Schering AG, Germany

FLUOROMETHOLONE

Therapeutic Function: Glucocorticoid; antiinflammatory

Chemical Name: 9-fluoro-11 β ,17-dihydroxy-6 α -methylpregna-1,4-diene-3,20-dione

Common Name: —

Structural Formula:

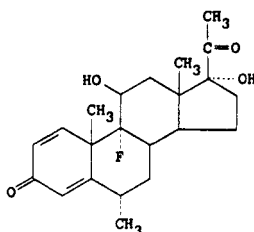

Chemical Abstracts Registry No.: 426-13-1

Trade Name	Manufacturer	Country	Year Introduced
Oxylone	Upjohn	U.S.	1959
Efflumidex	Pharm-Allergan	W. Germany	1975
FML Liquifilm	Allergan	U.K.	1977
Fluaton	Tubi Lux	Italy	1977
Flumerol	Sumitomo	Japan	1971
Flucon	Alcon	France	1983
Cortilet	Hoechst	—	—
Cortisdin	Isdin	Spain	—
Delmeson	Hoechst	W. Germany	—
Ehrtolan	Albert-Roussel	W. Germany	—
Flu-Base	Kowa	Japan	—
Fiumetholon	Santen	Japan	—
Flumetol	Farmila	Italy	—
Fluoderm	B.D.H.	U.K.	—
Fluolon	Lundbeck	—	—
Loticort	Hoechst	Italy	—
Okilon	Summitomo	Japan	—
Regresin	Hoechst	—	—
Trilcin	B.D.H.	U.K.	—
Ursnon	Nippon Chemiphar	Japan	—

Raw Materials

1-Dehydro-6 α -methyl-9 α -fluorohydrocortisone
 Methanesulfonyl chloride
 Sodium iodide
 Sodium thiosulfate

Manufacturing Process

The following description is taken from U.S. Patent 2,867,637.

(a) *Preparation of 6 α -Methyl-9 α -Fluoro-11 β ,17 α ,21-Trihydroxy-1,4-Pregnadiene-3,20-Dione 21-Methanesulfonate:* A solution was prepared containing 250 mg of 1-dehydro-6 α -methyl-9 α -fluorohydrocortisone [G.B. Spero et al, *J. Am. Chem. Soc.* 79, 1515 (1957)] in 6 ml of pyridine. This solution was cooled to 0°C and treated with 0.25 ml of methanesulfonyl chloride. Thereafter the solution was allowed to stir at a temperature between 0° and 5°C for a period of 18 hours. Thereafter ice and 2 ml of water were added, followed by 30 ml of sufficient dilute (5%) hydrochloric acid to neutralize the pyridine. The mixture was then filtered, the precipitate washed with water and dried to give 197 mg of crude 6 α -methyl-9 α -fluoro-11 β ,17 α ,21-trihydroxy-1,4-pregnadiene-3,20-dione 21-methanesulfonate of MP 165° to 185°C.

(b) *Preparation of 6 α -Methyl-9 α -Fluoro-11 β ,17 α -Dihydroxy-21-Iodo-1,4-Pregnadiene-3,20-Dione:* The crude 197 mg of methanesulfonate of 6 α -methyl-9 α -fluoro-11 β ,17 α ,21-trihydroxy-1,4-pregnadiene-3,20-dione was dissolved in 5 ml of acetone and treated with a solution of 197 mg of sodium iodide in 5 ml of acetone. The mixture was heated under reflux with stirring for a period of 15 minutes. The heating was then discontinued and the mixture concentrated to dryness at reduced pressure to give 6 α -methyl-9 α -fluoro-11 β ,17 α -dihydroxy-21-iodo-1,4-pregnadiene-3,20-dione.

(c) *Preparation of 6 α -Methyl-9 α -Fluoro-11 β , 17 α -Dihydroxy-1,4-Pregnadiene-3,20-Dione:* The crude 6 α -methyl-9 α -fluoro-11 β , 17 α -dihydroxy-21-iodo-1,4-pregnadiene-3,20-dione was slurried with 5 ml of acetic acid and stirred for a period of 45 minutes. Thereafter was added a solution of 250 mg of sodium thiosulfate pentahydrate in 5 ml of water causing the iodine color to disappear. Additional water was added (30 ml) and the reac-

tion mixture was filtered. The resulting solid precipitate was washed with water and dried to give 146 mg of crude 6 α -methyl-9 α -fluoro-11 β ,17 α -dihydroxy-1,4-pregnadiene-3,20-dione.

The crude material was then chromatographed by dissolving 120 mg of 6 α -methyl-9 α -fluoro-11 β ,17 α -dihydroxy-1,4-pregnadiene-3,20-dione in 300 ml of methylene chloride and allowing the thus obtained solution to be absorbed by a chromatographic column containing 10 grams of Florisil anhydrous magnesium silicate. The column was developed taking fractions of 20 ml each as follows:

Fraction	Solvent
1- 5	Skellysolve B-hexane-5% acetone
6-10	Skellysolve B-hexane-10% acetone
11-15	Skellysolve B-hexane-15% acetone
16-20	Skellysolve B-hexane-20% acetone
21-25	Skellysolve B-hexane-30% acetone
26-28	Acetone

Fractions 11 through 24 inclusive were combined, evaporated and twice recrystallized from acetone to give pure 6 α -methyl-9 α -fluoro-11 β ,17 α -dihydroxy-1,4-pregnadiene-3,20-dione of melting point 292° to 303°C.

References

Merck Index 4081

Kleeman & Engel p. 418

OCDS Vol. 1 p. 203 (1977)

I.N. p. 435

REM p. 966

Fried, J.; U.S. Patent 2,852,511; September 16, 1958; assigned to Olin Mathieson Chemical Corporation

Lincoln, F.H. Jr., Schneider, W.P. and Spero, G.B.; U.S. Patent 2,867,637; January 6, 1959; assigned to The Upjohn Company

Lincoln, F.H. Jr., Schneider, W.P. and Spero, G.B.; U.S. Patent 2,867,638; January 6, 1959; assigned to The Upjohn Company

Magerlein, B.J., Kagan, F. and Schlagel, C.A.; U.S. Patent 3,038,914; June 12, 1962; assigned to The Upjohn Company

FLUOROURACIL

Therapeutic Function: Cancer chemotherapy

Chemical Name: 5-fluoro-2,4(1H,3H)-pyrimidinedione

Common Name: 5-fluorouracil

Structural Formula:



Chemical Abstracts Registry No.: 51-21-8

Trade Name	Manufacturer	Country	Year Introduced
Efudex	Roche	U.S.	1962

Trade Name	Manufacturer	Country	Year Introduced
Efudix	Roche	France	1963
Efudix	Roche	W. Germany	1966
Fluoroplex	Herbert	U.S.	1970
Efudix	Roche	U.K.	1972
Adrucil	Adria	U.S.	1977
Arumel	SS Pharmaceutical	Japan	—
Benton	Toyo Jozo	Japan	—
Carzonal	Tobishi	Japan	—
Cinco-Fu	Montedison	W. Germany	—
Flacule	Nippon Kayaku	Japan	—
Fluoroblastin	Erba	Italy	—
Fluorotop	Abic	Israel	—
Fluorouracil	Roche	U.S.	—
Kecimeton	Tatsumi	Japan	—
Lifril	Kissei	Japan	—
Timadin	Torii	Japan	—
Ulosagen	Kyowa Yakunin Osaka	Japan	—
Ulup	Maruko	Japan	—
Verrumal	Hermal	W. Germany	—

Raw Materials

Sodium fluoroacetate	Diethyl sulfite
Potassium ethylate	Ethyl formate
S-Methylisothiuronium sulfate	Sodium methoxide
Hydrogen chloride	

Manufacturing Process

A mixture of 200 grams (2 mols) of dry sodium fluoroacetate and 442 grams (2.86 mols) of diethyl sulfite was refluxed for 3½ hours in an oil bath. The reaction mixture was then distilled through a fractionating column, yielding 177.3 grams of crude ethyl fluoroacetate, having a boiling range of 116° to 120°C. The material was redistilled through a fractionating column, yielding purified ethyl fluoroacetate boiling at 114° to 118°C.

In a 2-liter, 3-neck, round bottom flask, provided with stirrer, dropping funnel and reflux condenser, was placed 880 ml of absolute diethyl ether, and 47.6 grams (1.22 mols) of potassium, cut into 5 mm pieces, was suspended therein. 220 ml of absolute ethanol was added dropwise, while stirring, whereby the heat of reaction produced refluxing. In order to obtain complete dissolution of the potassium, the mixture was finally refluxed on a steam bath. The reaction mixture was then cooled in an ice bath, and a mixture of 135 grams (1.22 mols) of ethyl fluoroacetate and 96.4 grams (1.3 mols) of freshly distilled ethyl formate was added dropwise, while stirring and cooling, over a period of 2½ hours. Upon completion of the addition of the ethyl formate, the reaction mixture was stirred for an additional hour while cooling, and then was allowed to stand overnight at room temperature.

At the end of this time the crystalline precipitate which had formed was filtered off with suction, washed with diethyl ether, and dried in a vacuum desiccator. The product comprised essentially the potassium enolate of ethyl fluoromalonaldehyde (alternative nomenclature, the potassium salt of fluoromalonaldehydic acid ethyl ester).

A mixture of 103.6 grams (0.6 mol) of the freshly prepared potassium enolate of ethyl fluoromalonaldehyde, 83.4 grams (0.3 mol) of S-methylisothiuronium sulfate and 32.5 grams (0.6 mol) of sodium methoxide was refluxed with stirring in 1,500 ml of absolute methanol. At first the reactants dissolved to a great extent, but very shortly thereafter precipitation occurred. The reaction mixture was refluxed for 2 hours and at the end of this time was evaporated to dryness in vacuo. The residue was treated with 280 ml of water; incomplete dissolution was observed.

The mixture obtained was clarified by filtering it through charcoal. The filtrate was acidified (to a slight Congo red acid reaction) by adding concentrated aqueous hydrochloric acid, containing 37% by weight HCl (48 ml required). The material which crystallized from the acidified solution was filtered off, washed free of sulfates with water and dried at 100°C, yielding crude S-methyl ether of 2-thio-5-fluorouracil, having a melting range from 202° to 221°C. The latter material was recrystallized by dissolving it in 2,035 ml of boiling ethyl acetate and cooling to -20°C, yielding S-methyl ether of 2-thio-5-fluorouracil, MP 230° to 237°C, in a sufficient state of purity that it could be used directly for the next step. A sample of the material was recrystallized from water (alternatively, from ethyl acetate) thereby raising the melting point to 241° to 243°C. For analysis the material was further purified by subliming it in vacuo at 140° to 150°C/0.1 mm.

A solution of 10.0 grams of purified S-methyl ether of 2-thio-5-fluorouracil, MP 230° to 237°C, in 150 ml of concentrated aqueous hydrochloric acid (containing approximately 37% by weight HCl) was refluxed under nitrogen for 4 hours. The reaction mixture was then evaporated in vacuo. The crystalline brownish residue was recrystallized from water. The resulting recrystallized product was further purified by sublimation in vacuo at 190° to 200°C (bath temperature)/0.1 mm pressure. There was obtained 5-fluorouracil, in the form of colorless or pinkish-tan crystals, MP 282° to 283°C (with decomposition).

References

Merck Index 4088

Kleeman & Engel p. 419

PDR pp. 559, 931, 1483

OCDS Vol. 3 p. 155 (1984)

DOT 9 (12) 495 (1973) & 16 (5) 174 (1980)

I.N. p. 436

REM p. 1149

Heidelberger, C. and Duschinsky, R.; U.S. Patent 2,802,005; August 6, 1957

Heidelberger, C. and Duschinsky, R.; U.S. Patent 2,885,396; May 5, 1959

FLUOXYMESTERONE

Therapeutic Function: Androgen

Chemical Name: 9-fluoro-11 β ,17 β -dihydroxy-17-methylandro-4-en-3-one

Common Name: —

Structural Formula:

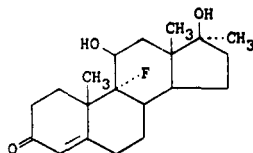

Chemical Abstracts Registry No.: 76-43-7

Trade Name	Manufacturer	Country	Year Introduced
Halotestin	Upjohn	U.S.	1957
Ora-Testryl	Squibb	U.S.	1958
Ultandren	Ciba	U.S.	1958
Halotestin	Upjohn	France	1961

Android-F	Brown	U.S.	1981
Afluteston	Arcana	Austria	—
Androsterolo	Pierrel	Italy	—
Oralsterone	Bouty	Italy	—
Testoral	Midy	Italy	—
U-Gono	Upjohn	—	—

Raw Materials

11 α -Hydroxy-17-methyltestosterone	N-Bromoacetamide
p-Toluene sulfonyl chloride	Sodium hydroxide
Hydrogen fluoride	

Manufacturing Process

The following description is taken from U.S. Patent 2,793,218.

(a) Preparation of 9(11)-Dehydro-17-Methyltestosterone: A warm solution of 1 gram of 11 α -hydroxy-17-methyltestosterone (U.S. Patent 2,660,586) in 2 ml of dry pyridine was mixed with 1 gram of para-toluenesulfonyl chloride. The mixture was maintained at room temperature for 18 hours and then poured into 25 ml of water. The mixture was stirred until the precipitated oil solidified. The solid was filtered, washed with water and dried to give 1.41 grams of 11 α -(p-toluenesulfonyloxy)-17 α -methyl-17 β -hydroxy-4-androsten-3-one which melted at 144° to 148°C with decomposition and, after crystallization from a mixture of methylene chloride and hexane hydrocarbons, melted at 141° to 144°C with decomposition.

A mixture of 1 gram of the thus-produced 11 α -(p-toluenesulfonyloxy)-17 α -methyl-17 β -hydroxy-4-androsten-3-one, 0.2 gram of sodium formate, 0.57 ml of water and 14 ml of absolute ethanol was heated at its refluxing temperature for 19 hours. The solution was cooled and then poured onto 50 grams of a mixture of ice and water with stirring. The resulting precipitate was filtered and dried to give 0.59 gram of 9(11)-dehydro-17-methyltestosterone which melted at 156° to 160°C and, after crystallization from a mixture of methylene chloride and hexane hydrocarbons, melted at 167° to 170°C.

(b) Preparation of 9 α -Bromo-11 β -Hydroxy-17-Methyltestosterone: To a solution of 1 gram of 9(11)-dehydro-17-methyltestosterone in 50 ml of acetone was added dropwise, with stirring, at 15°C, 1 gram of N-bromoacetamide dissolved in 25 ml of water. A solution of 20 ml of 0.8N perchloric acid was then slowly added at the same temperature. After 20 minutes, there was added a sufficient amount of a saturated aqueous solution of sodium sulfite to discharge the yellow color of the solution. The resulting mixture was then diluted with 100 ml of water thereby precipitating 1 gram of 9 α -bromo-11 β -hydroxy-17-methyltestosterone as needles melting at 153° to 155°C.

(c) Preparation of 9,11 β -Epoxy-17-Methyltestosterone: A suspension of 1 gram of 9 α -bromo-11 β -hydroxy-17-methyltestosterone in 30 ml of methanol was titrated with 1 M equivalent of 0.1 N aqueous sodium hydroxide. The resulting mixture was diluted with 50 ml of water and then chilled to about 0°C thereby precipitating 0.64 gram of 9,11 β -epoxy-17-methyltestosterone melting at 170° to 176°C which, after crystallization from dilute methanol, melted at 65° to 172°C (with sublimation).

(d) Preparation of 9 α -Fluoro-11 β -Hydroxy-17-Methyltestosterone: To a solution of 0.5 gram of 9,11 β -epoxy-17-methyltestosterone in 10 ml of methylene chloride was added 2 ml of 48% aqueous hydrofluoric acid. The mixture was stirred at room temperature for 5 hours and then cautiously poured with stirring into a mixture of 6 grams of sodium bicarbonate in a mixture of ice and water. The precipitated steroid was extracted with methylene chloride, the extract washed with water and then dried. The solvent was distilled from the dried solution and the residue crystallized from methylene chloride to give 148 mg of 9 α -fluoro-11 β -hydroxy-17-methyltestosterone melting at 265°C with decomposition.

References

Merck Index 4091

Kleeman & Engel p. 420

PDR pp. 730, 1606, 1844

OCDS Vol. 1 p. 175 (1977)

I.N. p. 437

REM p. 998

Herr, M.E.; U.S. Patent 2,793,218; May 21, 1957; assigned to The Upjohn Company

Herr, M.E.; U.S. Patent 2,813,881; November 19, 1957; assigned to The Upjohn Company

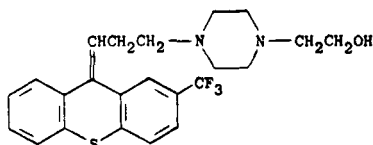
FLUPENTIXOL**Therapeutic Function:** Tranquilizer**Chemical Name:** 4-[3-[2-(trifluoromethyl)-9H-thioxanthen-9-ylidene]propyl]-1-piperazine-ethanol**Common Name:** —**Structural Formula:****Chemical Abstracts Registry No.:** 2709-56-0; 2413-38-9 (Dihydrochloride)

Trade Name	Manufacturer	Country	Year Introduced
Emergil	Labaz	France	1971
Siplarol	Erba	Italy	1972
Metamin	Takeda	Japan	1973
Depixol	Lundbeck	U.K.	—
Fluanxol	Labaz	France	—

Raw Materials

2-Benzoyloxyethanol	Ethyl bromide
p-Toluene sulfonyl chloride	Magnesium
N-Ethoxycarbonylpiperazine	Hydrogen chloride
2-Trifluoromethyl-9-xanthenone	Thionyl chloride
3-Bromopropanol	Potassium hydroxide

Manufacturing Process

A mixture of 200 grams of 2-benzoyloxyethanol in 2 liters of pyridine at -5°C is treated with 275 grams of p-toluenesulfonyl chloride and the resulting mixture is stirred at 0°C for 2 hours. Water is added slowly at 0° to 5°C . Extracting with chloroform, washing the extract with dilute hydrochloric acid, water and potassium bicarbonate, and evaporating the solvent leaves benzoyloxyethyl p-toluenesulfonate.

A mixture of 186 grams of the above prepared p-toluenesulfonate, 106 grams of N-ethoxycarbonylpiperazine, 44 grams of potassium carbonate and 800 ml of toluene is refluxed

for 21 hours, then filtered and extracted with dilute hydrochloric acid. The extract is basified with sodium hydroxide and extracted into chloroform. Evaporation of the chloroform and distillation of the residue in vacuo gives 1-benzoyloxyethyl-4-ethoxy-carbonyl-piperazine, BP 153° to 156°C (0.15 mm).

Hydrolysis and decarboxylation of this ester (188 grams) is accomplished by refluxing with 155 grams of potassium hydroxide, 155 ml of water and 1,550 ml of ethanol for four days. Filtering, concentrating, adding water to the residue, acidifying with hydrochloric acid, heating to 90°C, saturating with potassium carbonate, extracting into chloroform, evaporating and distilling the chloroform gives N-benzoyloxyethylpiperazine.

A mixture of 50 grams of the above prepared piperazine, 30.1 grams of sodium carbonate and 200 ml of benzene is heated to reflux and treated with 39.5 grams of 3-bromopropanol over 1.5 hours. The resulting mixture is refluxed for 2 hours, then filtered, extracted with dilute hydrochloric acid, basified, extracted with benzene, and the extracts are concentrated and distilled to give 1-benzoyloxyethyl-4-(3-hydroxypropyl)-piperazine, BP 188° to 190°C (0.15 mm). The free base is converted to the dihydrochloride salt by treatment of an alcoholic solution with ethereal hydrogen chloride to separate the salt.

Thionyl chloride (67 grams) is added over 15 minutes to a mixture of 39.5 grams of the above prepared dihydrochloride salt and 400 ml of chloroform. Refluxing for 4 hours, cooling and filtering yields the dihydrochloride salt of 1-benzoyloxyethyl-4-(3-chloropropyl)-piperazine, MP 201° to 202°C. The salt in aqueous solution is basified. Extraction with ether and evaporation of the solvent yields the free base.

Magnesium (1.3 grams) in 8 ml of refluxing tetrahydrofuran is treated with 1 ml of ethyl bromide. A solution of 22.7 grams of 1-benzoyloxyethyl-4-(3-chloropropyl)-piperazine in 50 ml of tetrahydrofuran is added slowly and the mixture is refluxed for 1 hour.

A solution of 13.2 grams of 2-trifluoromethyl-9-xanthenone in tetrahydrofuran is added over 1 hour to 16.0 grams of 3-(4-benzoyloxyethyl-1-piperazinyl)propylmagnesium chloride, prepared as above, in tetrahydrofuran while gently refluxing. Refluxing is continued for 2 hours. Concentrating, pouring the residue into ammonium chloride, ice and water, extracting with ether, evaporating the extracts and treating the residue with concentrated hydrochloric acid at 95°C for 1 hour gives a mixture of cis and trans 9-[3-(4-hydroxyethyl-1-piperazinyl)propylidene]-2-trifluoromethylxanthenone dihydrochloride. Fractional crystallization from ethanol-ether separates the isomers. The free bases are obtained by neutralizing an aqueous solution of the dihydrochloride, extracting into ether and evaporating the ether in vacuo.

References

Merck Index 4092

Kleeman & Engel p. 421

DOT 4 (4) 155 (1968) & 9 (6) 229 (1973)

I.N. p. 437

Smith Kline & French Laboratories; British Patent 925,538; May 8, 1963

Craig, P.N. and Zirkle, C.L.; U.S. Patent 3,282,930; November 1, 1966; assigned to Smith Kline & French Laboratories

FLUPHENAZINE HYDROCHLORIDE

Therapeutic Function: Tranquilizer

Chemical Name: 4-[3-[2-(trifluoromethyl)-10H-phenothiazin-10-yl] propyl]-1-piperazine-ethanol dihydrochloride

Common Name: —

Structural Formula:

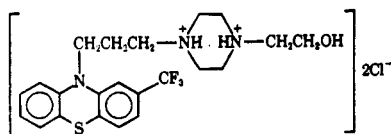

Chemical Abstracts Registry No.: 146-56-5; 69-23-8 (Base)

Trade Name	Manufacturer	Country	Year Introduced
Prolixin	Squibb	U.S.	1959
Permitil	Schering	U.S.	1959
Anatensol	Squibb	Italy	—
Anatensol	Showa	Japan	—
Calmansial	Squibb	—	—
Dapotum	Heyden	W. Germany	—
Eutimox	Soc. Gen. De Farmacia	Spain	—
Flumezine	Yoshitomi	Japan	—
Lyogen	Byk Gulden	W. Germany	—
Lyorodin	Deutsches Hydrierwerk	E. Germany	—
Modecate	Squibb	France	—
Moditen	Squibb	France	—
Motipress	Squibb	U.K.	—
Omca	Heyden	W. Germany	—
Pacinol	Schering	—	—
Seditin	Taro	Israel	—
Selecten	Unipharm	Israel	—
Sevinol	Schering-Shionogi	Japan	—
Siqualine	Iquinosa	Spain	—
Siqualone	Astra	Sweden	—
Trancin	Schering	—	—

Raw Materials

2-Trifluoromethylphenothiazine	Sodium amide
1-(3'-Hydroxypropyl)piperazine	Methyl formate
Thionyl chloride	Sodium hydroxide
β -Bromoethyl acetate	Hydrogen chloride

Manufacturing Process

A suspension of 69.0 grams of 2-trifluoromethylphenothiazine in 1 liter of toluene with 10.9 grams of sodium amide is heated at reflux with high speed stirring for 15 minutes. A solution of 54.1 grams of 1-formyl-4-(3'-chloropropyl)-piperazine, [prepared by formylating 1-(3'-hydroxypropyl)-piperazine by refluxing in an excess of methyl formate, purifying the 1-formyl-4-(3'-hydroxypropyl)-piperazine by vacuum distillation, reacting this compound with an excess of thionyl chloride at reflux and isolating the desired 1-formyl-4-(3'-chloropropyl)-piperazine by neutralization with sodium carbonate solution followed by distillation] in 200 ml of toluene is added. The reflux period is continued for 4 hours. The cooled reaction mixture is treated with 200 ml of water. The organic layer is extracted twice with dilute hydrochloric acid. The acid extracts are made basic with ammonia and extracted with benzene. The volatiles are taken off in vacuo at the steam bath to leave a dark brown oil which is 10-[3'-(N-formylpiperazinyl)-propyl]-2-trifluoromethylphenothiazine. It can be distilled at 260°C at 10 microns, or used directly without distillation if desired.

A solution of 103.5 grams of 10-[3'-(N-formylpiperazinyl)-propyl]-2-trifluoromethylphenothiazine in 400 ml of ethanol and 218 ml of water containing 26 ml of 40% sodium hy-

droxide solution is heated at reflux for 2 hours. The alcohol is taken off in vacuo on the steam bath. The residue is swirled with benzene and water. The dried benzene layer is evaporated in vacuo. The residue is vacuum distilled to give a viscous, yellow oil, 10-(3'-piperazinypropyl)-2-trifluoromethylphenothiazine, distilling at 210° to 235°C at 0.5 to 0.6 mm.

A suspension of 14.0 grams of 10-(3'-piperazinypropyl)-2-trifluoromethylphenothiazine, 6.4 grams of β -bromoethyl acetate and 2.6 grams of potassium carbonate in 100 ml of toluene is stirred at reflux for 16 hours. Water (50 ml) is added to the cooled mixture. The organic layer is extracted into dilute hydrochloric acid. After neutralizing the extracts and taking the separated base up in benzene, a viscous, yellow residue is obtained by evaporating the organic solvent in vacuo. This oil is chromatographed on alumina. The purified fraction of 7.7 grams of 10-[3'-(N-acetoxyethylpiperaziny)-propyl]-2-trifluoromethylphenothiazine is taken up in ethyl acetate and mixed with 25 ml of alcoholic hydrogen chloride. Concentration in vacuo separates white crystals of the dihydrochloride salt, MP 225° to 227°C.

A solution of 1.0 gram of 10-[3'-(N-acetoxyethylpiperaziny)-propyl]-2-trifluoromethylphenothiazine in 25 ml of 1 N hydrochloric acid is heated at reflux briefly. Neutralization with dilute sodium carbonate solution and extraction with benzene gives the oily base, 10-[3'-(N- β -hydroxyethylpiperaziny)-propyl]-2-trifluoromethylphenothiazine. The base is reacted with an excess of an alcoholic hydrogen chloride solution. Trituration with ether separates crystals of the dihydrochloride salt, MP 224° to 226°C, (from U.S. Patent 3,058,979).

References

Merck Index 4094

Kleeman & Engel p. 423

PDR pp. 1646, 1759

OCDS Vol. 1 p. 383 (1977)

DOT 3 (1) 60 (1967) & 9 (6) 228 (1973)

I.N. p. 438

REM p. 1088

Ulliot, G.E.; U.S. Patent 3,058,979; October 16, 1962; assigned to Smith Kline & French Laboratories

FLUPREDNIDENE ACETATE

Therapeutic Function: Topical antiinflammatory

Chemical Name: 21-(acetyloxy)-9-fluoro-11 β ,17-dihydroxy-16-methylenepregna-1,4-diene-3,20-dione

Common Name: 16-methylene-9 α -fluoroprednisolone 21-acetate

Structural Formula:

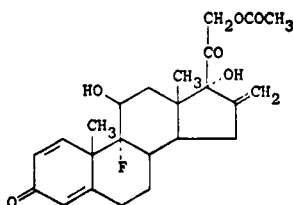

Chemical Abstracts Registry No.: 1255-35-2

Trade Name	Manufacturer	Country	Year Introduced
Etacortin	Hermal	W. Germany	1968
Decoderm	Bracco	Italy	1972
Decoderme	Merck-Clevenot	France	1974
Decoderm	Merck	U.K.	—
Candio-Hermal	Hermal	W. Germany	—
Corticoderm	Merck	W. Germany	—
Crino-Hermal	Hermal	W. Germany	—
Emcortina	Merck	U.S.	—

Raw Materials

9 α -Fluoro-11 β ,17 α ,21-trihydroxy-16 α -methyl-1,4-pregnadiene-3,20-dione
 Semicarbazide
 Acetic anhydride
 t-Butyl hydroperoxide
 Hydrogen bromide

Manufacturing Process

Preparation of 3,20-Disemicarbazone of 9 α -Fluoro-11 β ,17 α ,21-Trihydroxy-16 α -Methyl-1,4-Pregnadiene-3,20-Dione: A mixture of 1.00 gram of 9 α -fluoro-11 β ,17 α ,21-trihydroxy-16 α -methyl-1,4-pregnadiene-3,20-dione, 750 mg of semicarbazide base, 280 mg of semicarbazide hydrochloride in 20 ml of methanol and 10 ml of dimethylformamide is refluxed for 20 hours under nitrogen. The mixture is cooled to 20°C and 100 ml of water is added with stirring. The precipitated 3,20-disemicarbazone of 9 α -fluoro-11 β ,17 α ,21-trihydroxy-16 α -methyl-1,4-pregnadiene-3,20-dione is filtered, washed with water, and dried in air; MP over 300°C.

Preparation of 9 α -Fluoro-11 β ,21-Dihydroxy-16-Methyl-1,4,16-Pregnatriene-3,20-Dione 21-Acetate: A solution of 500 mg of the 3,20-disemicarbazone of 9 α -fluoro-11 β ,17 α ,21-trihydroxy-16 α -methyl-1,4-pregnadiene-3,20-dione in 10 ml of acetic acid and 0.5 ml acetic anhydride is refluxed under nitrogen for one hour to produce the corresponding 3,20-disemicarbazone of 11 β ,21-dihydroxy-16-methyl-1,4,16-pregnatriene-3,20-dione 21-acetate. The reaction mixture is cooled, 13 ml of water is added and the mixture heated on the steam bath for 5 hours. It is then concentrated in vacuo nearly to dryness and water and chloroform added. The mixture is thoroughly extracted with chloroform, and the chloroform extract washed with excess aqueous potassium bicarbonate and saturated salt solution and dried over magnesium sulfate. Chromatography of the residue on neutral alumina and crystallization of pertinent benzene-chloroform fractions gives 9 α -fluoro-11 β ,21-dihydroxy-16-methyl-1,4,16-pregnatriene-3,20-dione 21-acetate; MP 228° to 233°C.

Preparation of 9 α -Fluoro-11 β ,21-Dihydroxy-16 β -Methyl-16 α ,17 α -Oxido-1,4-Pregnadiene-3,20-Dione 21-Acetate: To a stirred solution of 500 mg of 9 α -fluoro-11 β ,21-dihydroxy-16-methyl-1,4,16-pregnatriene-3,20-dione 21-acetate in 5 ml of benzene and 5 ml of chloroform are added 0.50 ml of t-butyl hydroperoxide and 0.1 ml of a 35% methanolic solution of benzyl-trimethyl ammonium hydroxide. After 18 hours at room temperature, water is added and the mixture thoroughly extracted with chloroform. The chloroform extract is washed with saturated aqueous sodium chloride and dried over magnesium sulfate. Evaporation of the solvent and crystallization of the residue from acetone-ether gives 9 α -fluoro-11 β ,21-dihydroxy-16 β -methyl-16 α ,17 α -oxido-1,4-pregnadiene-3,20-dione 21-acetate.

Preparation of 9 α -Fluoro-11 β ,17 α ,21-Trihydroxy-16-Methylene-1,4-Pregnadiene-3,20-Dione 21-Acetate: To a stirred solution of 600 mg of 9 α -fluoro-11 β ,21-dihydroxy-16 β -methyl-16 α ,17 α -oxido-1,4-pregnadiene-3,20-dione 21 acetate in 10 ml of acetic acid maintained at 10° to 15°C is added 3 ml of cold 10% hydrogen bromide in acetic acid. After 30 min-

utes the mixture is concentrated to dryness in vacuo (temperature 15°C) and the residue chromatographed on neutral alumina. Combination of pertinent benzene-chloroform fractions and crystallization leads to the desired 9 α -fluoro-11 β ,17 α ,21-trihydroxy-16-methylene-1,4-pregnadiene-3,20-dione 21 acetate.

References

Merck Index 4095

Kleeman & Engel p. 423

DOT 4 (2) 80 (1968)

I.N. p. 439

Wendler, N.L. and Taub, D.; U.S. Patent 3,065,239; November 20, 1962; assigned to Merck & Co., Inc.

Taub, D. and Wendler, N.L.; U.S. Patent 3,068,224; December 11, 1962; assigned to Merck & Co., Inc.

Taub, D., Wendler, N.L. and Hoffsommer, R.D. Jr.; U.S. Patent 3,068,226; December 11, 1962; assigned to Merck & Co., Inc.

Wendler, N.L., Taub, D. and Hoffsommer, R.D. Jr.; U.S. Patent 3,136,760; June 9, 1964; assigned to Merck & Co., Inc.

FLUPREDNISOLONE

Therapeutic Function: Glucocorticoid; antiinflammatory

Chemical Name: 6 α -fluoro-11 β ,17 α ,21-trihydroxypregna-1,4-diene-3,20-dione

Common Name: 6 α -fluoroprednisolone

Structural Formula:

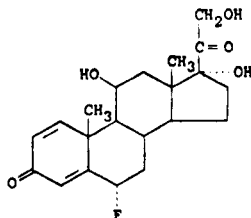

Chemical Abstracts Registry No.: 53-34-9

Trade Name	Manufacturer	Country	Year Introduced
Alphadrol	Upjohn	U.S.	1961
Decoderme	Merck-Clevenot	France	—
Etadrol	Farmitalia	Italy	—
Isopredon	Hoechst	W. Germany	—
Selectren	Albert Pharma	Spain	—

Raw Materials

5 α ,11 β ,17 α -Trihydroxy-6 β -fluoro-21-acetoxypregnan-3,20-dione-3-ethylene ketal
Sulfuric acid
Sodium bicarbonate
Acetic acid

Bacterium Septomyxa affinis
Acetic anhydride
Hydrogen chloride

Manufacturing Process

5 α ,11 β ,17 α -Trihydroxy-6 β -Fluoro-21-Acetoxyallopregnane-3,20-Dione: A solution of 0.47 gram of 5 α ,11 β ,17 α -trihydroxy-6 β -fluoro-21-acetoxyallopregnane-3,20-dione 3-ethylene ketal in 35 ml of acetone and 4 ml of 1 N sulfuric acid solution was gently boiled on the steam bath for 10 minutes, cooled and neutralized with dilute sodium bicarbonate solution. Addition of water and cooling gave 0.33 gram of 5 α ,11 β ,17 α -trihydroxy-6 β -fluoro-21-acetoxyallopregnane-3,20-dione, MP 230° to 240°C.

6 β -Fluoro-11 β ,17 α -Dihydroxy-21-Acetoxy-4-Pregnene-3,20-Dione (6 β -Fluorohydrocortisone Acetate): A solution of 100 mg of 5 α ,11 β ,17 α -trihydroxy-6 β -fluoro-21-acetoxyallopregnane-3,20-dione in 4.9 ml of acetic acid and 0.1 ml of water was refluxed for a period of 1 hour, cooled, diluted with 50 ml of water and evaporated to dryness under reduced pressure. The residue was chromatographed over Florisil (synthetic magnesium silicate) to give one fraction (77 mg) eluted with methylene chloride plus 10% acetone. Crystallization from acetone-Skellysolve B-hexanes gave 38 mg of 6 β -fluoro-11 β ,17 α -dihydroxy-21-acetoxy-4-pregnene-3,20-dione (6 β -fluorohydrocortisone acetate), MP 210° to 218°C.

6 β -Fluoro-11 β ,17 α -Dihydroxy-21-Acetoxy-1,4-Pregnadiene-3,20-Dione: A medium consisting of 1% dextrose hydrate, 2% cornsteep liquor of 60% solids and Kalamazoo tap water was adjusted to pH 4.9 with sodium hydroxide. The medium was steam sterilized at 15 pounds pressure for 30 minutes, cooled, and then inoculated with a 24-hour growth, from spores, of *Septomyxa affinis*, ATCC 6737. The medium was agitated, sparged with sterile air at the rate of one-tenth volume of air per volume of medium per minute. At the end of 24 hours of fermentation at room temperature, the pH was about 7.4.

To this culture there was added a solution of 6 β -fluoro-11 β ,17 α -dihydroxy-21-acetoxy-4-pregnene-3,20-dione (6 β -fluorohydrocortisone acetate), dissolved in diethylformamide. The solution was prepared by dissolving five parts of the steroid in 100 parts of the solid and adding about 10 cm of the solution per liter of the medium. Fermentation was continued for a period of 48 hours whereupon the mycelium and beer were extracted thoroughly with methylene chloride. The extract was washed with sodium bicarbonate solution and then with water, dried and concentrated in vacuo to a slightly viscous residue. The residue, after reacylation with acetic anhydride in pyridine, was fractionated chromatographically and 6 β -fluoro-11 β ,17 α -dihydroxy-21-acetoxy-1,4-pregnadiene-3,20-dione was recovered as a light-colored crystalline solid. Isomerization to the 6 α -fluoro product is effected by streaming dry HCl into a cold chloroform/ethanol solution of the 6 β -epimer.

References

- Merck Index 4096
Kleeman & Engel p. 425
I.N. p. 439
REM p. 972
Hogg, J.A. and Spero, G.B.; U.S. Patent 2,841,600; July 1, 1958; assigned to The Upjohn Company

FLURANDRENOLIDE

Therapeutic Function: Glucocorticoid; antiinflammatory

Chemical Name: 6 α -Fluoro-11 β ,21-dihydroxy-16 α ,17-[[1-methylethylidene]bis(oxy)]pregn-4-ene-3,20-dione

Common Name: Flurandrenolone; fludroxycortide

Structural Formula:

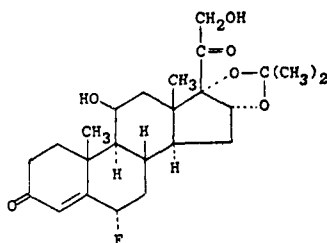

Chemical Abstracts Registry No.: 1524-88-5

Trade Name	Manufacturer	Country	Year Introduced
Haelan	Lilly	U.K.	1962
Sermaka	Lilly	W. Germany	1964
Haelan	Lilly	Italy	1964
Haelan	Lilly	France	1966
Cortide Tape	Nichiban	Japan	1981
Cordran	Lilly	U.S.	—
Drenison	Dainippon	Japan	—
Drenison	Lilly	U.K.	—
Drocort	Lilly	—	—
Sermaform	Lilly	W. Germany	—

Raw Materials

6 α -Fluoro-16 α -hydroxycortisol
 Acetone
 Perchloric acid

Manufacturing Process

6 α -Fluoro-16 α -hydroxycortisol is condensed with acetone by treating the solution in acetone with 70% perchloric acid.

References

- Merck Index 4099
 Kleeman & Engel p. 408
 PDR p. 837
 OCDS Vol. 2 p. 180 (1980)
 I.N. p. 430
 REM p. 967
 Casas-Campillo, C.; U.S. Patent 3,119,748; January 28, 1964; assigned to Syntex Corporation, Panama
 Ringold, H.J., Zderic, J.A., Djerassi, C. and Bowers, A.; U.S. Patent 3,126,375; March 24, 1964; assigned to Syntex Corporation, Panama

FLURAZEPAM

Therapeutic Function: Hypnotic

Chemical Name: 7-chloro-1-[2-(diethylamino)ethyl]-5-(o-fluorophenyl)-1,3-dihydro-2H-1,4-benzodiazepin-2-one

Common Name: —

Structural Formula:

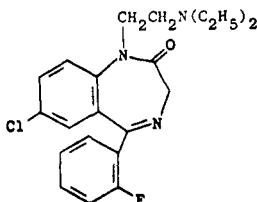

Chemical Abstracts Registry No.: 17617-23-1; 1172-18-5 (Hydrochloride)

Trade Name	Manufacturer	Country	Year Introduced
Dalmane	Roche	U.S.	1970
Flunox	Boehr. Biochem.	Italy	1973
Dalmadorm	Roche	W. Germany	1974
Dalmane	Roche	U.K.	1974
Dalmadorm	Roche	Italy	1974
Dalmate	Roche	Japan	1975
Benozil	Kyowa Hakko	Japan	1975
Flunox	Robin	Italy	1975
Insumin	Kyorin	Japan	1979
Benodil	Kyowa	Japan	—
Felison	Sigurta	Italy	—
Fluzepam	Krka	Yugoslavia	—
Lunipax	Beecham	—	—
Natam	Unifa	Argentina	—
Novoflupam	Novopharm	Canada	—
Remdue	Biomedica Foscama	Italy	—
Somlan	Sintyal	Argentina	—
Sompan	I.C.N.	Canada	—
Valdorm	Valeas	Italy	—

Raw Materials

5-(2-Fluorophenyl)-7-chloro-2,3-dihydro-1H-benzodiazepinone(2)
Sodium methoxide
Diethylaminoethyl chloride

Manufacturing Process

13 grams of 5-(2-fluorophenyl)-7-chloro-2,3-dihydro-1H-1,4-benzodiazepinone-(2) were dissolved in 100 ml of N,N-dimethylformamide and treated with 10.3 ml of a solution of sodium methoxide in methanol containing 54 mmol or 2.95 grams of sodium methoxide. The resulting solution was stirred at about 20°C for 1 hour and then cooled in an ice-salt mixture to 0°C. A solution of diethylamino-ethyl chloride was prepared by dissolving 13.8 grams of diethylamino-ethyl chloride hydrochloride in cold dilute sodium hydroxide solution and extracting the base four times with 50 ml of toluene each time. The toluene extracts were combined, dried over anhydrous sodium sulfate, filtered and added to the reaction mixture.

The mixture was allowed to stand for 70 hours and then concentrated to a small volume under reduced pressure. The residue was dissolved in 100 ml of methylene chloride,

washed with 75 ml of water, three times with 50 ml of saturated brine solution each time and filtered over neutral alumina (grade 1). The filtrate was evaporated to dryness and the resulting colorless oil taken up in ether, which was then saturated with hydrogen chloride. The pale yellow precipitate was filtered off and recrystallized from methanol/ether yielding 1-[2-(diethylamino)ethyl]-5-(2-fluorophenyl)-7-chloro-2,3-dihydro-1 H-1,4-benzodiazepinone-(2) dihydrochloride as pale yellow rods melting at 190° to 220°C with decomposition, (from British Patent 1,040,548).

References

Merck Index 4100

Kleeman & Engel p. 426

PDR p. 1509

DOT 9 (6) 237 (1973) & 6 (6) 217 (1970)

I.N. p. 440

REM p. 1062

F. Hoffmann-La Roche & Co., AG, Switzerland; British Patent 1,040,547; Sept. 1, 1966

F. Hoffmann-La Roche & Co., AG, Switzerland; British Patent 1,040,548; Sept. 1, 1966

Fryer, R. and Sternbach, L.H.; U.S. Patent 3,567,710; March 2, 1971; assigned to Hoffman-La Roche, Inc.

FLURBIPROFEN

Therapeutic Function: Antiinflammatory

Chemical Name: 2-(2-Fluoro-4-biphenyl)propionic acid

Common Name: —

Structural Formula:

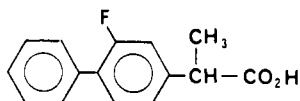

Chemical Abstracts Registry No.: 5104-49-4

Trade Name	Manufacturer	Country	Year Introduced
Froben	Boots	U.K.	1977
Froben	Boots	Switz.	1978
Froben	Kakenyaku Kako	Japan	1979
Froben	Boots	France	1979
Froben	Thomae	W. Germany	1980
Froben	Formenti	Italy	1981
Ansaid	Upjohn	—	—
Cebutid	Boots-Dacour	France	—
Flugalin	Galenika	Yugoslavia	—

Raw Materials

3-Acetyl-2-fluorobiphenyl	Sulfur
Morpholine	Ethanol
Diethyl carbonate	Dimethyl sulfate

Manufacturing Process

A mixture of 3-acetyl-2-fluorobiphenyl, MP 95°C to 96°C, (73.5 g) [prepared from 4-bromo-

3-nitroacetophenone (Oelschläge, Ann., 1961, 641, 81) via 4-acetyl-2-nitrobiphenyl, MP 106°C to 108°C (Ullman reaction), 4-acetyl-2-aminobiphenyl, MP 124°C to 125°C (reduction), and finally the Schiemann reaction], sulfur (17.4 g) and morpholine (87 ml) was refluxed for 16.5 hr, and then the resulting thiomorpholide was hydrolyzed by refluxing with glacial acetic acid (340 ml) concentrated sulfuric acid (54 ml) and water (78 ml) for 24 hr. The cooled solution was diluted with water, and the precipitated crude 2-fluoro-4-biphenylacetic acid was collected. (A sample was purified by recrystallization to give MP 143°C to 144.5°C; Found (%): C, 73.2; H, 4.8. C₁₄H₁₁FO₂ requires C, 73.1; H, 4.8.)

A sodium carbonate solution of the crude acetic acid was washed with ether and then acidified with hydrochloric acid; the required acid was isolated via an ether extraction and was esterified by refluxing for 6 hr with ethanol (370 ml) and concentrated sulfuric acid (15 ml). Excess alcohol was distilled, the residue diluted with water and the required ester isolated in ether. Distillation finally gave ethyl 2-fluoro-4-biphenylacetate, BP 134°C to 136°C/0.25 mm.

This ester (70 g) and diethyl carbonate (250 mg) were stirred at 90°C to 100°C while a solution of sodium ethoxide [from sodium (7.8 g) and ethanol (154 ml)] was added over 1 hr. During addition, ethanol was allowed to distill and after addition distillation was continued until the column heat temperature reached 124°C. After cooling the solution to 90°C, dimethyl sulfate (33 ml) was followed by a further 85 ml of diethyl carbonate. This solution was stirred and refluxed for 1 hr and then, when ice cool, was diluted with water and acetic acid (10 ml). The malonate was isolated in ether and fractionally distilled to yield a fraction boiling at 148°C to 153°C/0.075 mm, identified as the alpha-methyl malonate. This was hydrolyzed by refluxing for 1 hr at 2.5N sodium hydroxide (350 ml) and alcohol (175 ml), excess alcohol was distilled and the residual suspension of sodium salt was acidified with hydrochloric acid to give a precipitate of the alpha-methyl malonic acid. This was decarboxylated by heating at 180°C to 200°C for 30 minutes and recrystallized from petroleum ether (BP 80°C to 100°C) to give 2-(2-fluoro-4-biphenyl)propionic acid, MP 110°C to 111°C.

References

- Merck Index 4101
 DFU 1 (7) 323 (1976)
 Kleeman & Engel p. 427
 DOT 9 (9) 377 (1973) & 14 (9) 407 (1978)
 I.N. p. 440
 Adams, S.S., Bernard, J., Nicholson, J.S. and Blancafort, A.R.; U.S. Patent 3,755,427; Aug. 28, 1973; assigned to The Boots Company Ltd.

FLUROTHYL

Therapeutic Function: Central stimulant; convulsant

Chemical Name: 1,1'-oxybis[2,2,2-trifluoroethane]

Common Name: Hexafluorodiethyl ether; bis(trifluoroethyl) ether

Structural Formula: CF₃CH₂OCH₂CF₃

Chemical Abstracts Registry No.: 333-36-8

Trade Name	Manufacturer	Country	Year Introduced
Indoklon	Ohio Medical	U.S.	1964

Raw Materials

2,2,2-Trifluoroethanol

Sodium
p-Toluene sulfonyl chloride

Manufacturing Process

23 parts of sodium metal were placed in 300 parts of dry dioxane in a reactor equipped with an agitator and reflux condenser. The dioxane was heated to reflux while stirring. 150 parts of 2,2,2-trifluoroethanol were added very slowly in the period of about 1 hour, or until the sodium was all reacted, to form sodium 2,2,2-trifluoroethylate. 250 parts of 2,2,2-trifluoroethyl p-toluenesulfonate prepared by reacting 2,2,2-trifluoroethanol with p-toluenesulfonyl chloride were placed in another reactor and heated to about 160° to 185°C. The solution of sodium 2,2,2-trifluoroethylate in dioxane was added very slowly over a period of about 1½ hours. Bis(2,2,2-trifluoroethyl) ether formed continuously and distilled from the reactor with the dioxane into a cooled receiving vessel. The condensed effluent from the reactor was fractionally distilled, yielding 46.5 parts of products boiling at 55° to 73°C.

The crude product was washed successively with concentrated HCl, 62% H₂SO₄, concentrated H₂SO₄ and 5% NaOH solution. It was dehydrated over a drying agent and then refractionated in a still. 20 parts of bis(2,2,2-trifluoroethyl) ether were recovered (BP 62.5° to 63.5°C).

References

Merck Index 4103
Kleeman & Engel p. 428
I.N. p. 440
REM p. 1138
Olin, J.F.; U.S. Patent 3,363,006; January 9, 1968; assigned to Pennsalt Chemicals Corp.

FLUROXENE

Therapeutic Function: Inhalation anesthetic

Chemical Name: (2,2,2-trifluoroethoxy)ethene

Common Name: 2,2,2-trifluoroethyl vinyl ether

Structural Formula: CF₃CH₂OCH=CH₂

Chemical Abstracts Registry No.: 406-90-6

Trade Name	Manufacturer	Country	Year Introduced
Fluoromar	Ohio Medical	U.S.	1961

Raw Materials

2,2,2-Trifluoroethanol
Potassium
Acetylene

Manufacturing Process

The following process description is taken from U.S. Patent 2,830,007.

270 grams 2,2,2-trifluoroethanol was added slowly to 15 grams of a cooled suspension of

potassium metal in 250 ml of ethyl ether with stirring. When all the potassium metal had reacted, the resulting solution was fractionally distilled in order to remove the ethyl ether. The residue was placed in a bomb and the air was removed from the bomb by flushing with acetylene. The bomb was sealed and heated to 150°C. Acetylene was then introduced at 245 to 260 psi and the gas pressure was maintained for a period of 5 hours under mechanical agitation throughout the reaction. At the end of this time, heating was discontinued, the flow of acetylene was shut off and the bomb was allowed to cool to room temperature. The excess pressure in the bomb was reduced to atmospheric pressure by venting any gases through a dry ice cooled trap.

The reaction mixture comprising 2,2,2-trifluoroethyl vinyl ether, 2,2,2-trifluoroethanol and potassium 2,2,2-trifluoroethylate was fractionally distilled, whereupon crude 2,2,2-trifluoroethyl vinyl ether was obtained which boiled at 42° to 45°C at 760 mm. More 2,2,2-trifluoroethyl vinyl ether was obtained when the distillation residue was returned to the bomb and reacted with acetylene in the same manner as hereinabove described.

The alkali metal hydroxides, instead of the alkali metals per se, can be employed to produce the alkali metal 2,2,2-trifluoroethanolate. However, this introduces water in the reaction mixture which requires removal prior to vinylation with acetylene. The crude products, on further distillation, yielded 2,2,2-trifluoroethyl vinyl ether having a boiling point of 43.1°C at 759 mm.

References

Merck Index 4104

Kleeman & Engel p. 428

I.N. p. 440

REM p. 1042

Shukys, J.G.; U.S. Patent 2,830,007; April 8, 1958; assigned to Air Reduction Company

Townsend, P.W.; U.S. Patent 2,870,218; January 20, 1959; assigned to Air Reduction Co.

FLUSPIRILENE

Therapeutic Function: Tranquilizer

Chemical Name: 8-[4,4-bis(p-fluorophenyl)butyl]-1-phenyl-1,3,8-triazaspiro[4.5]decan-4-one

Common Name: —

Structural Formula:

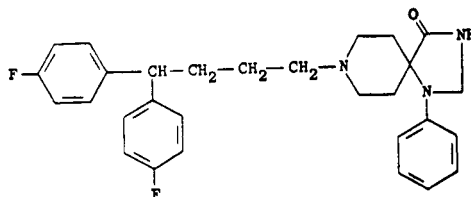

Chemical Abstracts Registry No.: 1841-19-6

Trade Name	Manufacturer	Country	Year Introduced
Imap	Janssen	W. Germany	1972
Redeptin	SKF	U.K.	1975
Imap	McNeil	U.S.	—

Raw Materials

Cyclopropyl di-(4-fluorophenyl)carbinol
 Thionyl chloride
 Hydrogen
 1-Phenyl-4-oxo-1,3,8-triazaspiro(4,5)-decane

Manufacturing Process

To a solution of 130 parts cyclopropyl-di-(4-fluorophenyl)-carbinol in 240 parts benzene are added dropwise 43 parts thionylchloride. The whole is refluxed until no more gas is evolved. The reaction mixture is then evaporated. The residue is distilled in vacuo, yielding 4-chloro-1,1-di-(4-fluorophenyl)-1-butene, boiling point 165° to 167°C at 6 mm pressure; $n_D^{20} = 1.5698$; $d_{20}^{20} = 1.2151$.

A solution of 61 parts 4-chloro-1,1-di-(4-fluorophenyl)-1-butene in 400 parts 2-propanol is hydrogenated at normal pressure and at room temperature in the presence of 5.5 parts palladium-on-charcoal catalyst 10% (exothermic reaction, temperature rises to about 30°C). After the calculated amount of hydrogen is taken up, hydrogenation is stopped. The catalyst is filtered off and the filtrate is evaporated. The oily residue is distilled in vacuo, yielding 1-chloro-4,4-di-(4-fluorophenyl)-butane, boiling point 166° to 168°C at 6 mm pressure; $n_D^{20} = 1.5425$; $d_{20}^{20} = 1.2039$.

A mixture of 7.3 parts 1-chloro-4,4-di-(4-fluorophenyl)-butane, 5.1 parts 1-phenyl-4-oxo-1,3,8-triazaspiro(4,5)-decane, 4 parts sodium carbonate, a few crystals of potassium iodide in 200 parts 4-methyl-2-pentanone is stirred and refluxed for 60 hours. After cooling the reaction mixture is treated with water. The organic layer is separated, dried, filtered and evaporated. The solid residue is recrystallized from 80 parts 4-methyl-2-pentanone, yielding 1-phenyl-4-oxo-8-[4,4-di-(4-fluorophenyl)-]butyl-1,3,8-triazaspiro(4,5)decane, melting point 187.5° to 190°C.

References

Merck Index 4105

Kleeman & Engel p. 428

OCDS Vol. 2 p. 292 (1980)

DOT 9 (6) 235 (1973)

I.N. p. 441

Janssen, P.A.J.; U.S. Patent 3,238,216; March 1, 1966; assigned to Research Laboratorium Dr. C. Janssen NV, Belgium

FLUTAMIDE

Therapeutic Function: Antiandrogen

Chemical Name: 2-Methyl-N-[4-nitro-3-(trifluoromethyl)phenyl]-propanamide

Common Name: Niftolid

Structural Formula:

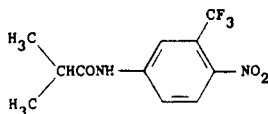

Chemical Abstracts Registry No.: 13311-84-7

Trade Name	Manufacturer	Country	Year Introduced
Flugerel	Byk Essex	W. Germany	1983
Drogenil	Schering	Chile	1983

Raw Materials

4-Nitro-3-trifluoromethylaniline
Isobutryl chloride

Manufacturing Process

To a stirred, cooled solution of 100 g of 4-nitro-3-trifluoromethylaniline in 400 ml of pyridine, slowly and in a dropwise fashion, add 54 g of isobutryl chloride and then heat the reaction mixture on a steam bath for 1.5 hours. Cool and pour the resulting mixture into ice water, filter and water-wash the crude anilide and crystallize the product of this example from benzene to obtain analytically pure material, MP 111.5°C to 112.5°C.

References

Merck Index 4106
DFU 1 (3) 108 (1976)
OCDS Vol. 3 p. 57 (1984)
I.N. p. 441
Gold, E.H.; U.S. Patent 3,847,988; November 12, 1974; assigned to Schering Corp.

FLUVOXAMINE MALEATE

Therapeutic Function: Antidepressant

Chemical Name: 5-Methoxy-4'-trifluoromethylvalerophenone O-(2-aminoethyl)oxime maleate (1:1)

Common Name: —

Structural Formula:

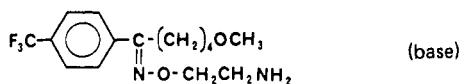

Chemical Abstracts Registry No.: 54739-18-3 (Base)

Trade Name	Manufacturer	Country	Year Introduced
Floxyfral	Kali-Duphar	Switz.	1983
Solvay	Kali-Duphar	W. Germany	1983
Floxyfral	Duphar	U.K.	—

Raw Materials

5-Methoxy-4'-trifluoromethylvalerophenone
2-Aminoxyethylamine dihydrochloride
Maleic anhydride

Manufacturing Process

20.4 mmol (5.3 g) of 5-methoxy-4'-trifluoromethylvalerophenone (MP 43°C to 44°C), 20.5 mmol (3.1 g) of 2-aminoxyethylamine dihydrochloride and 10 ml of pyridine were refluxed

for 15 hr in 20 ml of absolute ethanol. After evaporating the pyridine and the ethanol in vacuo, the residue was dissolved in water. This solution was washed with petroleum ether and 10 ml of 50% sodium hydroxide solution were then added. Then three extractions with 40 ml of ether were carried out. The ether extract was washed successively with 20 ml of 5% sodium bicarbonate solution and 20 ml of water. After drying on sodium sulfate, the ether layer was evaporated in vacuo. Toluene was then evaporated another three times (to remove the pyridine) and the oil thus obtained was dissolved in 15 ml of absolute ethanol. An equimolar quantity of maleic acid was added to the solution and the solution was then heated until a clear solution was obtained. The ethanol was then removed in vacuo and the residue was crystallized from 10 ml of acetonitrile at +5°C. After sucking off and washing with cold acetonitrile, it was dried in air. The MP of the resulting compound was 120°C to 121.5°C.

References

Merck Index 4108

DFU 3 (4) 288 (1978)

I.N. p. 441

Welle, H.B.A. and Claassen, V.; U.S. Patent 4,085,225; April 18, 1978; assigned to U.S. Phillips Corp.

FOLIC ACID

Therapeutic Function: Treatment of B vitamin (folacin) deficiency

Chemical Name: N-[4-[[[2-amino-1,4-dihydro-4-oxo-6-pteridiny]methyl] amino] benzoyl]-L-glutamic acid

Common Name: Pteroylglutamic acid

Structural Formula:

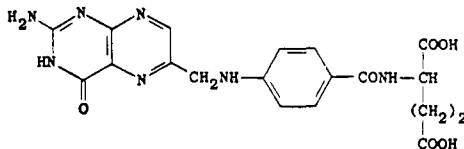

Chemical Abstracts Registry No.: 59-30-3

Trade Name	Manufacturer	Country	Year Introduced
Folvite	Lederle	U.S.	1946
Foldine	Specia	France	1947
Follicet	Mission	U.S.	1981
Acfol	Torlan	Spain	—
Cefol	Abbott	U.S.	—
Cevi-Fer	Geriatric	U.S.	—
Cytofol	Lappe	W. Germany	—
Eldec	Parke-Davis	U.S.	—
Eldercaps	Mayrand	U.S.	—
Enviro-Stress	Vitaline	U.S.	—
Fefol	SKF	U.K.	—
Feosol	Menley & James	U.S.	—
Fero-Folic	Abbott	U.S.	—
Ferrocop	Consolidated	U.K.	—
Ferrograd	Abbott	U.K.	—

Trade Name	Manufacturer	Country	Year Introduced
Ferromyn	Calmic	U.K.	—
Filibon	Lederle	U.S.	—
Folacid	U.C.B.	—	—
Folacin	Kabi-Vitrum	Sweden	—
Folaemin	O.P.G.	Neth.	—
Folamin	Becker	Austria	—
Folan	Farmakos	Yugoslavia	—
Folasic	Adams	Australia	—
Folbiol	I.E. Kimya Evi	Turkey	—
Folettes	Fawns & McAllan	Australia	—
Folex	Rybar	U.K.	—
Folical	Shionogi	Japan	—
Foliamin	Takeda	Japan	—
Folicet	Mission	U.S.	—
Folico	Mitim	Italy	—
Folina	Tosi	Italy	—
Folirivo	Rivopharm	Switz.	—
Hemocyte	U.S. Pharm.	U.S.	—
Hemostyl	Roussel	—	—
Iberet	Abbott	U.S.	—
Ircon	Key	U.S.	—
Irofol	Abbott	U.K.	—
Iromin	Mission	U.S.	—
Lipo	Legere	U.S.	—
May-Vita	Mayrand	U.S.	—
Mega-B	Arco	U.S.	—
Megadose	Arco	U.S.	—
Methiofoline	Hepatrol	France	—
Mevanin	Beutlich	U.S.	—
Niferex	Central	U.S.	—
Nifolin	Ferrosan	Denmark	—
Novofolac	Novopharm	Canada	—
Nu-Iron	Mayrand	U.S.	—
Pramet	Ross	U.S.	—
Pramilet	Ross	U.S.	—
Pregaday	Glaxo	U.K.	—
Prenate	Bock	U.S.	—
Pronemia	Lederle	U.S.	—
Stuartnatal	Stuart	U.S.	—
Trinsicon	Glaxo	U.S.	—
Vicon	Glaxo	U.S.	—
Vitafol	Everett	U.S.	—
Zenate	Reid-Rowell	U.S.	—
Zincvit	R.A.M. Labs	U.S.	—

Raw Materials

1,3,3-Trichloroacetone	Bromine
2,4,5-Triamino-6-hydroxypyrimidine HCl	Sodium bisulfite
p-Aminobenzoylglutamic acid	

Manufacturing Process

The following description is taken from U.S. Patent 2,956,057.

100 grams of 1,3,3-trichloroacetone are heated on a boiling water bath and 95 grams of bromine are added thereto in drops while being stirred and the stirring is continued for about 1 hour. The resulting reaction solution is distilled under reduced pressure. 115

grams of 1-bromo-1,3,3-trichloroacetone are obtained having a boiling point of 85° to 95°C/17 mm (Hg).

For the preparation of the hydrate, 100 grams of water are added to 100 grams of 1-bromo-1,3,3-trichloroacetone, which is agitated and cooled. A white scaly crystal of hydrate of 1-bromo-1,3,3-trichloroacetone is obtained (100 grams), having a melting point of 52° to 53°C.

8.9 grams of 2,4,5-triamino-6-hydroxypyrimidine hydrochloride and 8 grams of p-aminobenzoylglutamic acid are dissolved in 400 cc warm water, which is cooled at 35° to 27°C and adjusted to pH 4 by using 20% caustic soda solution. To this solution was simultaneously added dropwise a solution obtained by dissolving 13.4 grams of 1-bromo-1,3,3-trichloroacetone hydrate in 90 cc of 50% methanol and 24 grams of 35% aqueous sodium bisulfite solution over a period of approximately 2 hours. During this period, in order to maintain the pH value of the reaction solution at 4 to 5, 20% caustic soda solution is added from time to time. The precipitate, formed by stirring for 5 hours after dropping was finished, is filtered, and the filtrated precipitate is refined; 5.6 grams of pure pteroylglutamic acid is obtained.

References

Merck Index 4110

Kleeman & Engel p. 430

PDR pp. 508, 524, 581, 673, 785, 830, 875, 905, 916, 969, 1010, 1033, 1050, 1083, 1131, 1264, 1344, 1441, 1449, 1559, 1786, 1808, 1869

I.N. p. 24

REM pp. 1014, 1023

Sletzing, M. and Tishler, M.; U.S. Patent 2,786,056; March 19, 1957; assigned to Merck & Co., Inc.

Sletzing, M. and Tishler, M.; U.S. Patent 2,816,109; December 10, 1957; assigned to Merck & Co., Inc.

Sletzing, M. and Tishler, M.; U.S. Patent 2,821,527; January 28, 1958; assigned to Merck & Co., Inc.

Sletzing, M. and Tishler, M.; U.S. Patent 2,821,528; January 28, 1958; assigned to Merck & Co., Inc.

Kawanishi, S.; U.S. Patent 2,956,057; October 11, 1960; assigned to Kongo Kagaku K.K., Japan

FOMINO BEN HCl

Therapeutic Function: Antitussive; respiratory stimulant

Chemical Name: 3'-Chloro- α -[methyl[(morpholinocarbonyl)methyl] amino] -o-benzotolidide

Common Name: —

Structural Formula:

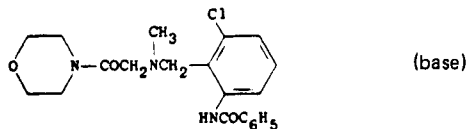

Chemical Abstracts Registry No.: 18053-32-2; 18053-31-1 (Base)

Trade Name	Manufacturer	Country	Year Introduced
Noleptan	Thomae	W. Germany	1973
Terion	Lusofarmaco	Italy	1979
Noleptan	Tanabe Seiyaku	Japan	1983
Deronyl	Arzneimittelwerk Dresden	E. Germany	—
Finaten	Finadiet	Argentina	—
Oleptan	Bender	Austria	—
Tussirama	Serpero	Italy	—

Raw Materials

6-Chloro-2-dibenzoylamino-benzyl bromide	Morpholine
Sarcosine methyl ester	Hydrogen chloride
Ethyl chloroformate	

Manufacturing Process

(a) A mixture consisting of 9.75 g of 6-chloro-2-dibenzoylamino-benzyl bromide, 2.34 g of sarcosine methyl ester, 3.18 ml of triethylamine and 250 ml of chloroform was refluxed for five hours. Thereafter, an addition 0.5 g of sarcosine methyl ester was added, and the mixture was again refluxed for five hours. Subsequently, the chloroform was evaporated in vacuo, the residue was taken up in ethylacetate, the insoluble matter was separated by filtration, and the filtrate was again evaporated in vacuo. The residual oil was dissolved in methanol, the solution was admixed with 25 ml of 2 N sodium hydroxide, and the mixture was allowed to stand overnight at about 20°C. Thereafter, the methanol was evaporated in vacuo, and the residual aqueous solution was adjusted to pH 2 with 2 N hydrochloric acid, then extracted with ethyl acetate and then adjusted to pH 6 with 2 N sodium hydroxide. The crystalline product precipitated thereby was collected by vacuum filtration and recrystallized from water, yielding N-(2-benzoylamino-6-chloro-benzyl)-N-methyl-glycine, MP 150°C to 152°C.

(b) 80.7 g of N-(2-benzoylamino-6-chlorobenzyl)-N-methyl-glycine and 38 ml of triethylamine were dissolved in 1 liter of dry chloroform. While stirring the resulting solution at -15°C to -5°C, 23.4 ml of ethyl chloroformate were rapidly added dropwise, and the mixture was stirred for 40 minutes more at -15°C to -5°C. Thereafter, 50 ml of morpholine were added all at once, and the mixture was allowed to stand at 20°C for 20 hours. Subsequently, the chloroformic reaction solution was washed three times with brine, dried over magnesium sulfate and evaporated in vacuo, and the oily residue was taken up in ether, whereupon it crystallized. The crystalline product was recrystallized from methanol, yielding N-(2-benzoylamino-6-chloro-benzyl)-N-methyl-glycine-morpholide, MP 122.5°C to 123°C, of the formula

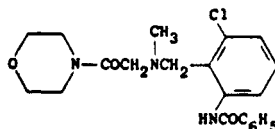

The product was dissolved in isopropanol, and the solution was acidified with anhydrous hydrochloric acid, yielding the hydrochloride, MP 206°C to 208°C (decomp.).

References

Merck Index 4124

Kleeman & Engel p. 432

DOT 9 (7) 288 (1973)

I.N. p. 442

Kruger, G., Zipp, O., Keck, J., Nickl, J., Machleidt, H., Ohnacker, G., Engelhorn, R. and Puschmann, S.; U.S. Patent 3,661,903; May 9, 1972; assigned to Boehringer Ingelheim G.m.b.H. (W. Germany)

FOMOCAINE

Therapeutic Function: Local anesthetic

Chemical Name: 4-[3-[4-(phenoxyethyl)phenyl]propyl]morpholine

Common Name: —

Structural Formula:

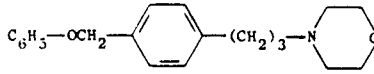

Chemical Abstracts Registry No.: 17692-39-6

Trade Name	Manufacturer	Country	Year Introduced
Erbocain	Heilit	W. Germany	1967
Panacain	Hermal	W. Germany	—

Raw Materials

γ -(4-Chloromethylphenyl)propyl chloride
Sodium phenolate
Morpholine

Manufacturing Process

64 parts of dry sodium phenolate are dissolved in 300 parts of methylisobutyl ketone by heating at 110°C. 103 parts of γ -(4-chloromethylphenyl)propyl chloride are added dropwise with agitation, and the mixture is maintained at 110°C for a period of 4 hours with constant agitation. After cooling, the reaction mixture is washed 2 or 3 times with 100 parts of water and the methylisobutyl ketone is distilled off under reduced pressure. The residue is taken up in 200 parts of petroleum-ether and γ -(4-phenoxyethylphenyl)propyl chloride is crystallized by addition of ice water. The crystals are filtered off employing a suction pump and dried at 100°C in vacuo (10 mm Hg) for 1 to 2 hours. The γ -(4-phenoxyethylphenyl)propyl chloride melts at 55°C to 56°C after recrystallization from petroleum-ether.

130 parts of γ -(4-phenoxyethylphenyl)propyl chloride are heated under reflux at 140°C for 24 hours with 130 parts of morpholine. The reaction mixture is treated to give N-(γ -phenoxyethylphenyl)propyl]-morpholine, which forms colorless crystals melting at 52°C to 53°C when crystallized from n-heptane.

References

Merck Index 4115

I.N. p. 442

Chemische Fabrik Promonta G.m.b.H.; British Patent 786,128; November 13, 1957

FONAZINE MESYLATE

Therapeutic Function: Analgesic

Chemical Name: 10-[2-(dimethylamino)propyl]-N,N-dimethylphenothiazine-2-sulfonamide methane sulfonate

Common Name: Dimethothiazine

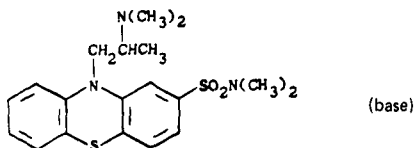
Structural Formula:

Chemical Abstracts Registry No.: 7455-39-2; 7456-24-8 (Base)

Trade Name	Manufacturer	Country	Year Introduced
Migristene	Rhone Poulenc	France	1965
Migristene	Rhone Poulenc	W. Germany	1967
Migristene	Rhone Poulenc	U.K.	1968
Migristene	Rhone Poulenc	Italy	1972
Migristen	Shionogi	Japan	1973
Alius	Scharper	Italy	—
Banistyl	May & Baker	U.K.	—
Bistermin	Toyo Shinyaku	Japan	—
Calsekin	Kanto	Japan	—
Demethothiazine	Mohan	Japan	—
Normelin	Sawai	Japan	—
Serevirol	Fuji Zoki	Japan	—

Raw Materials

3-Dimethylsulfamoylphenothiazine
Sodium amide
1-Dimethylamino-2-chloropropane
Hydrogen chloride
Methane sulfonic acid

Manufacturing Process

A solution of 3-dimethylsulfamoylphenothiazine (10 grams) in xylene (100 cc) is heated under reflux for 3 hours with sodamide (1.5 grams). A solution of 1-dimethylamino-2-chloropropane (4.4 grams) in anhydrous xylene (30 cc) is then added and heating under reflux continued for 4 hours. After cooling the suspension obtained is agitated with water (50 cc) and ether (30 cc). The aqueous layer is separated and the basic products are extracted from the organic phase with 10% hydrochloric acid. The xylene layer is discarded and, after the combined acid solutions have been made alkaline with sodium carbonate, the base is extracted with chloroform. The chloroform solutions are then washed with water and dried over anhydrous potassium carbonate. After evaporation of the solvent under reduced pressure there is obtained a crude resinous base (9.7 grams).

On the addition of ethereal hydrogen chloride to a solution of the base in isopropanol and recrystallization from anhydrous ethanol of the salt formed, there is obtained 3-dimethylsulfamoyl-10-(2-dimethylaminopropyl)phenothiazine hydrochloride (2.1 grams), MP 214°C with decomposition. After dissolving the product in anhydrous ethanol and adding methanesulfonic acid there is obtained fonazine mesylate.

References

Merck Index 4116
Kleeman & Engel p. 320
DOT 3 (2) 57 (1967) & 9 (6) 226 (1973)
I.N. p. 341

Societe des Usines Chimiques Rhone-Poulenc, France; British Patent 814,512; June 3, 1959

FORMOCORTAL ACETATE

Therapeutic Function: Glucocorticoid; antiinflammatory

Chemical Name: 3-(2-chloroethoxy)-9-fluoro-11 β ,16 α ,17,21-tetrahydroxy-20-oxopregna-3,5-diene-6-carboxaldehyde, cyclic 16,17-acetal-21-acetate

Common Name: —

Structural Formula:

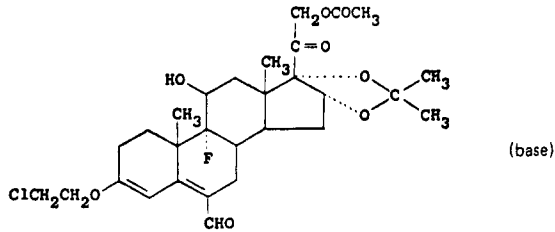

Chemical Abstracts Registry No.: 2825-60-7 (Base)

Trade Name	Manufacturer	Country	Year Introduced
Fluderma	Farmitalia	Italy	1970
Deflamene	Pharmitalia	U.K.	1971
Deidral	Montedison	W. Germany	—
Formaftil	Farmigea	Italy	—

Raw Materials

9 α -Fluoro-4-pregnene-11 β ,16 α ,17 α ,21-tetrol-3,20-dione-21-acetate-16 α ,17 α -acetonide
 Ethylene glycol
 Ethyl orthoformate
 Trichloroethylene
 Phosphorus oxychloride

Manufacturing Process

4.8 grams of 9 α -fluoro-4-pregnene-11 β ,16 α ,17 α ,21-tetrol-3,20-dione-21-acetate-16 α ,17 α -acetonide, melting at 248° to 250°C and prepared by acetylation of the corresponding 21-alcohol (*J. Amer. Chem. Soc.*, 1959, 81, page 1689), were refluxed for 20 hours with 80 cc of dioxane, 5.2 cc of ethylene glycol, 4.8 cc of ethyl orthoformate and 60 mg of p-toluenesulfonic acid. After cooling, 0.6 cc of pyridine were added and the mixture was concentrated in vacuo, diluted with ethyl acetate, poured into a separatory funnel, and washed with water, with a solution of 5% aqueous sodium bicarbonate and then with water to neutrality. After distilling off the solvent, a residue of 5.5 grams remained, which was dissolved in benzene and chromatographed over 100 grams of Florisil (chromatographic adsorbent). 3 grams of 9 α -fluoro-5-pregnene-11 β ,16 α ,17 α ,21-tetrol-3,20-dione-21-acetate-3-ethyleneketal-16 α ,17 α -acetonide, melting at 145° to 147°C, were collected from the fractions eluted with benzene-ether 9:1.

1 gram of this 9 α -fluoro-5-pregnene-11 β ,16 α ,17 α ,21-tetrol-3,20-dione-21-acetate-3-ethyleneketal-16 α ,17 α -acetonide in 2 cc of dimethylformamide and 2 cc of trichloroethylene was heated for 3 hours on an oil bath at 70°C with the reagent obtained from 0.5 cc of dimethylformamide in 4 cc of trichloroethylene with 0.5 cc phosphorus oxychloride. After cooling to 0°C, 1 gram of sodium acetate dissolved in 3 cc of water were slowly added with stirring. The mixture was extracted with ethyl acetate and the extracts were washed with

water, with a 5% aqueous solution of sodium bicarbonate and then with water to neutrality. On distillation of the solvent 1.1 grams of a residue was obtained from which, after dissolution in ether and precipitation with petroleum ether, 0.500 gram of 3-(2'-chloroethoxy)-6-formyl-9 α -fluoro-3,5-pregnadien-11 β ,16 α ,17 α ,21-tetrol-20-one-21-acetate-16 α ,17 α -acetonide, melting at 180° to 182°C were obtained.

References

Merck Index 4126

Kleeman & Engel p. 433

OCDS Vol. 2 p. 189 (1980)

DOT 7 (1) 21 (1971)

I.N. p. 443

Camerino, B., Patelli, B. and Sciaky, R.; U.S. Patent 3,314,945; April 18, 1967; assigned to Societa Farmaceutici Italia, Italy

FOSFOMYCIN

Therapeutic Function: Antibiotic

Chemical Name: (Cis-1,2-epoxypropyl)phosphonic acid

Common Name: Fosfonomycin

Structural Formula:

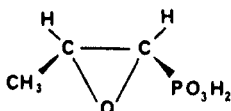

Chemical Abstracts Registry No.: 23155-02-4

Trade Name	Manufacturer	Country	Year Introduced
Fosfocin	Crinos	Italy	1977
Fosfocine	Clin Midy	France	1980
Fosfocin	Boehr. Mann.	W. Germany	1980
Fosmicin	Meiji Seika	Japan	1981
Fosfocine	Boehr. Mann.	Switz.	1983
Biocin	Ibirm	Italy	—
Faremicin	Lafare	Italy	—
Fonofos	Pulitzer	Italy	—
Fosfogram	Firma	Italy	—
Fosfotricina	Italfarmaco	Italy	—
Francital	Francia	Italy	—
Lancetina	Lancet	Italy	—
Lofoxin	Locatelli	Italy	—
Palmofen	Zambon	Italy	—
Prionicina	San Carlo	Italy	—
Selemicina	Italchemi	Italy	—
Valemicina	Valeas	Italy	—

Raw Materials

Acetaldehyde	Hydroxymethylphosphonic acid
t-Butyl hypochlorite	Zinc-copper couple

Manufacturing Process

(A) *The preparation of [(1-chloroethoxy)chloromethyl] phosphonic acid:* Acetaldehyde (1.1 mol) and hydroxymethylphosphonic acid (1 mol) in 500 ml of benzene are saturated with hydrogen chloride gas at 10°C to 15°C. The mixture is aged at 25°C for 24 hr, the solvent distilled out in vacuo and the residue flushed three times with benzene to remove all traces of hydrogen chloride. The residue is taken up in benzene (500 ml), treated with tert-butyl hypochlorite (0.8 mol) and azobisisobutyronitrile (0.8 mm) at 40°C until titration shows the absence of hypochlorite and the solution is then evaporated to yield [(1-chloroethoxy)chloromethyl] phosphonic acid in the form of an oil.

(B) *The preparation of (cis-1,2-epoxypropyl)phosphonic acid:* [(1-chloroethoxy)chloromethyl] phosphonic acid (1.0 g) is added with stirring to tetrahydrofuran (50 ml) to which has been added a crystal of iodine and a zinc-copper couple (15.0 g). The mixture is then heated under reflux for 24 hr and the resulting solution filtered to yield (cis-1,2-epoxypropyl)-phosphonic acid.

There is also a fermentation route to Fosfomycin as noted by Kleeman & Engel.

References

Merck Index 4137

Kleeman & Engel p. 434

DOT 9 (7) 294 (1973)

I.N. p. 444

REM p. 1212

Christensen, B.G. and Firestone, R.A.; U.S. Patent 3,632,691; January 4, 1972; assigned to Merck & Co., Inc.

Firestone, R.A. and Sletzing, M.; U.S. Patent 3,584,014; June 8, 1971; assigned to Merck & Co., Inc.

Firestone, R.A. and Glamkowski, E.J.; U.S. Patent 3,632,609; January 4, 1972; assigned to Merck & Co., Inc.

Firestone, R.A.; U.S. Patent 3,637,765; January 25, 1972; assigned to Merck & Co., Inc.

Glamkowski, E.J. and Sletzing, M.; U.S. Patent 3,637,766; January 25, 1972; assigned to Merck & Co., Inc.

Poliak, P.I., Wendler, N.L. and Christensen, B.G.; U.S. Patent 3,649,619; March 14, 1972; assigned to Merck & Co., Inc.

FRUCTOSE

Therapeutic Function: Fluid and nutrient replenisher

Chemical Name: Fructose

Common Name: Levulose and fruit sugar

Structural Formula:

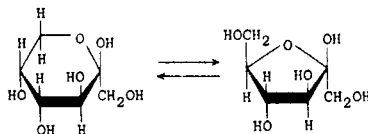

Chemical Abstracts Registry No.: 57-48-7

Trade Name	Manufacturer	Country	Year Introduced
Levugen	Baxter	U.S.	1953
Fructosteril	Fresenius	W. Germany	—
Inulon	Boehr. Mann.	W. Germany	—
Laevoral	Laevosan	Austria	—
Laevosan	Laevosan	Austria	—
Laevuflex	Geistlich	U.K.	—
Levulose	Biosedra	France	—
Levupan	Sirt-B.B.P.	Italy	—

Raw Materials

Bacterium *Leuconostoc mesenteroides*
 Sucrose
 Corn steep liquor

Manufacturing Process

200 gal of medium containing 2% sucrose, 2% corn steep liquor solids, 0.1% potassium dihydrogen phosphate, and traces of mineral salts, was inoculated with *Leuconostoc mesenteroides* NRRL B-512 and incubated at 25°C. During growth, alkali was added automatically as needed to maintain the pH between 6.6 and 7.0. Fermentation was completed in 11 hours and the culture was immediately adjusted to pH 5 to maintain enzyme stability. Bacterial cells were removed by filtration and yielded a culture filtrate containing 40 dextransucrase units per ml, where one unit is the amount of dextransucrase which will convert 1 mg of sucrose to dextran, as determined by the amount of fructose liberated, measured as reducing power in 1 hour.

10 gal of the above culture filtrate was diluted to 40 gal with water, 33.3 lb of sucrose was added to give a 10% solution, and toluene was added as a preservative. Dextran synthesis was complete before 22 hours, and dextran was harvested at 24 hours by the addition of alcohol to be 40% on a volume basis.

The alcoholic supernatant liquor obtained was evaporated to recover the alcohol and yielded a thick syrup, rich in fructose. Analysis showed the syrup to contain 50.1% of reducing sugar, calculated as monosaccharide and to have an optical rotation equivalent to 35.1% fructose. The percentages are expressed on a weight/volume basis, and reducing power was determined by the method of Somogyi, *Jour. Biol. Chem.* 160, 61 (1945). A portion (4.3 liters) of the syrup was cooled to 3°C. One-tenth of this volume was treated by slow regular addition, with rapid stirring, of a 6-fold volume of cold 20% calcium oxide suspension. A second portion was treated in the same manner, and this process was continued until the entire volume of crude fructose syrup had been utilized. The reaction mixture became thick with a white sediment containing a profusion of microscopic needlelike crystals of calcium levulate. Stirring was continued for 2 hours.

The calcium levulate precipitate was separated from the reaction mixture by filtration and washed with cold water. The precipitate was suspended in water to give a thick slurry, and solid carbon dioxide added until the solution was colorless to phenolphthalein. A heavy precipitate of calcium carbonate was now present and free fructose remained in the solution. The calcium carbonate precipitate was removed by filtration, and the filtered solution was found to contain 1,436 g of fructose as determined by optical rotation. A small amount of calcium bicarbonate was present as an impurity in solution and was removed by the addition of oxalic acid solution until a test for both calcium and oxalic acid was negative. The insoluble calcium oxalate precipitate was removed by filtration.

The fructose solution was decolorized by treatment with activated charcoal and concentrated under vacuum to a thick syrup. Two volumes of hot 95% ethyl alcohol were added, and the solution was heated to a boil and filtered to remove a small amount of insoluble material. After cooling, three volumes of ethyl ether were added, and the solution was allowed to stand overnight in the refrigerator. Fructose separated from the solution as a thick syrup and was

separated from the supernatant liquid by decantation. The syrup was seeded with fructose crystals and after standing in the cold for 4 days, became a crystalline mass of fructose. The yield of dry fructose was 928 g. Additional recoverable quantities of fructose are present in the crystallization mother liquor. In continuous operation this mother liquor may be recycled for addition to subsequent quantities of fructose syrup and the combined liquors crystallized as in the foregoing example.

References

Merck Index 4149

I.N. p. 445

REM p. 1029

Koepsell, H.J., Jackson, R.W. and Hoffman, C.A.; U.S. Patent 2,729,587; January 3, 1956; assigned to the Secretary of Agriculture

Cantor, S.M. and Hobbs, K.C.; U.S. Patent 2,354,664; August 1, 1944; assigned to Corn Products Refining Co.

FUMAGILLIN

Therapeutic Function: Antibiotic

Chemical Name: 2,4,6,8-Decatetraenedioic acid mono[5-methoxy-4-[2-methyl-3-(methyl-2-butenyl)oxiranyl]-1-oxaspiro[2.5]oct-6-yl] ester

Common Name: —

Structural Formula:

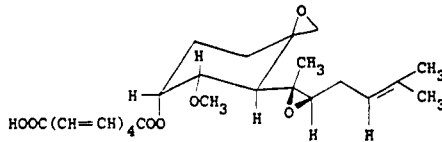

Chemical Abstracts Registry No.: 23110-15-8

Trade Name	Manufacturer	Country	Year Introduced
Fugillin	Upjohn	U.S.	1953
Fumidil	Abbott	U.S.	1953

Raw Materials

Corn steep liquor
Bacterium *Aspergillus fumigatus*

Manufacturing Process

A fermentation medium comprising 4,600 gal of sterile corn steep-glucose-calcium carbonate medium in a 6,000-gal fermentation tank is adjusted to pH 6.0 with sodium carbonate prior to sterilization and thereafter inoculated with 200 gal of vegetative inoculum of *Aspergillus fumigatus* NRRL 2436. The inoculated medium is incubated for approximately 108 hours at a temperature of 26°C and agitated by an impeller rotating at 114 rpm and aerated at a rate of 500 cfm. An antifoam agent of the type used in penicillin fermentation is used as required.

The clarified liquid obtained from the fermentation medium (beer) by filtration in any of the

usual apparatus for removing mycelia and suspended solids from fermentation beers, after first adjusting the pH of the contents of the fermentation tank to above about pH 7.0 and preferably to between pH 7.5 and pH 8.5 with, for example, the addition of an alkaline material such as sodium carbonate, is intimately mixed with hexane with a Podbielniak extractor and the hexane layer containing undesirable fatty material discarded. The pH of the defatted liquid is adjusted to about pH 3 by the addition of H₂SO₄, and the defatted liquid is extracted with chloroform. The chloroform is removed under reduced pressure without external heating. After the removal of all of the chloroform the residual syrup is dissolved in acetone. The acetone solution is cooled to 5°C whereupon a small quantity of brown precipitate separates which is removed by filtration. The precipitate is washed with acetone and the washings added to the original filtrate. A portion of the above acetone solution is concentrated under reduced pressure at room temperature under an atmosphere of nitrogen. The resulting thick suspension is placed in a 1-liter centrifuge cup, under nitrogen, and cooled at -30°C for 18 hours. The suspension is centrifuged for 1 hour at 1,500 to 1,700 rpm. The supernatant liquid is decanted from the residual solids which are washed 5 times at room temperature with several portions of tert-butanol. A residual solid material remains after the wash and after drying at room temperature. This material, after recrystallization from a mixture of equal parts of water and of methanol has a MP of 190°C to 192°C.

References

Merck Index 4164

Kleeman & Engel p. 434

I.N. p. 447

Peterson, M.H., Goldstein, A.W. and Denison, F.W. Jr.; U.S. Patent 2,803,586; August 20, 1957; assigned to Abbott Laboratories

FURALTADONE

Therapeutic Function: Antibacterial

Chemical Name: 5-(4-Morpholinylmethyl)-3-[[[5-nitro-2-furanyl)methylene] amino]-2-oxazolidinone

Common Name: Furmethanol and nitrofurmethone

Structural Formula:

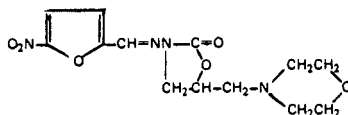

Chemical Abstracts Registry No.: 139-91-3

Trade Name	Manufacturer	Country	Year Introduced
Altafur	Norwich Eaton	U.S.	1959
Altabactina	Esteve	Spain	—
Darifur	Norwich Eaton	U.S.	—
Furasol	SKF	U.S.	—
Medifuran	Hess & Clark	U.S.	—
Valsyn	Pharmacia	Sweden	—

Raw Materials

3-(N-Morpholinyl)-1,2-epoxypropane

Sodium

Hydrazine hydrate
5-Nitro-2-furaldehyde

Diethyl carbonate
Hydrogen chloride

Manufacturing Process

11.17 g (0.78 mol) 3-(N-morpholinyl)-1,2-epoxypropane, BP 76.5°C to 78°C, 3.9 mm, prepared by Eisleb's method for 3-(1-piperidyl)-1,2-epoxypropane (U.S. Patent 1,790,042) is added dropwise in 12 minutes to 19.5 g (0.39 mol) 100% hydrazine hydrate, which has been warmed to 85°C on the steam bath, and is being mechanically stirred. The heat of the reaction maintains the internal temperature at 90°C to 100°C without further external heating. The reaction mixture is then warmed on the steam bath for an additional two hours (90°C to 95°C). The excess hydrazine hydrate is removed in vacuo. The residue of viscous 1-hydrazino-3-morpholinyl-2-propanol is not distilled, but is mixed with 10.16 g (0.086 mol) diethyl carbonate and a solution of 0.3 g sodium metal in 15 ml methyl alcohol. The mixture is refluxed about 2 hours under a 15 cm Widmer column, the alcohol being removed leaving a thick, green liquid residue, which is cooled and the precipitate which forms is removed by filtration and washed well with ether. Yield 82%, MP 114°C to 116°C. Recrystallization from isopropanol gives purified 3-amino-5-(N-morpholinyl)-methyl-2-oxazolidone, MP 120°C as the intermediate.

It is not necessary that the intermediate be separated from the reaction medium in the preparation of the end product. Instead, the reaction mixture, after cooling, is treated with 200 ml of water acidified with 42 ml 10% hydrochloric acid solution, and filtered. To the clear, light yellow filtrate is added dropwise a solution of 9.8 g (0.07 mol) 5-nitro-2-furaldehyde in 100 ml ethyl alcohol. An orange solution of the hydrochloride results. The free base is precipitated as yellow plates by making the solution basic with saturated sodium carbonate solution. 14 g of the compound is filtered off by suction, washed with alcohol, and dried. The yield, MP 204°C to 205°C (dec.), is 53% of theoretical based on 3-(N-morpholinyl)-1,2-epoxy-propane. Recrystallization from 95% alcohol (75% recovery) raises the melting point to 206°C (dec.).

The hydrochloride salt is isolated quantitatively by suspending the base in alcohol and adding sufficient aqueous concentrated HCl solution. The precipitate becomes pale yellow, is filtered off, and recrystallized from 80% alcohol. The MP range is about 223°C to 228°C (dec.).

References

Merck Index 4170

OCDS Vol. 1 p. 229 (1977)

I.N. p. 448

Gever, G.; U.S. Patent 2,802,002; August 6, 1957; assigned to The Norwich Pharmacal Co.

FURAZABOL

Therapeutic Function: Anticholesteremic

Chemical Name: 17 α -methyl-5 α -androstand[2,3-c]-[1,2,5]oxadiazol-17 β -ol

Common Name: —

Structural Formula:

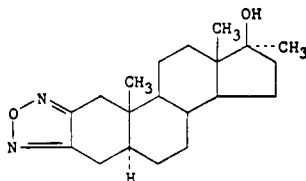

Chemical Abstracts Registry No.: 1239-29-8

Trade Name	Manufacturer	Country	Year Introduced
Miotolon	Daiichi	Japan	1969

Raw Materials

2,3-Dihydroxyimino-17 α -methyl-5 α -androstan-17 β -ol
Ethylene glycol

Manufacturing Process

A mixture of 2.0 grams of 2,3-dihydroxyimino-17 α -methyl-5 α -androstan-17 β -ol, 5 ml of piperidine and 10 ml of ethylene glycol was heated at a temperature between 180° and 190°C for 30 minutes. After the resulting product was cooled, water was added thereto, and the separated product was filtered, washed with water and dried. The product was dissolved in benzene and passed through a column of alumina. The column was washed with ether, and the eluted fractions were collected and condensed. Subsequently, the residue was recrystallized from ether or aqueous methanol to produce 1.53 grams of 17 β -hydroxy-17 α -methyl-5 α -androstan-2,3-dione which has a melting point of 152°C.

References

Merck Index 4174

Kleeman & Engel p. 435

I.N. p. 448

Ohta, G., Takegoshi, T., Onodera, T., Kasahara, A., Oshima, Y., Shimizu, M. and Ueno, K.; U.S. Patent 3,245,988; April 12, 1966; assigned to Daiichi Seiyaku KK, Japan

FURAZOLIDONE

Therapeutic Function: Topical antiinfective

Chemical Name: 3-[[5-nitro-2-furanyl)methylene]-amino]-2-oxazolidinone

Common Name: —

Structural Formula:

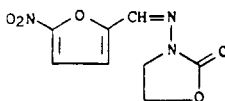
**Chemical Abstracts Registry No.:** 67-45-8

Trade Name	Manufacturer	Country	Year Introduced
Tricofuron	Norwich Eaton	U.S.	1955
Furoxone	Norwich Eaton	U.S.	1958
Furoxane	Oberval	France	1963
Colivan	Croce Bianca	Italy	—
Diefuron	Arnaldi	Italy	—
Dialidene	S.A.M.	Italy	—
Enteroxon	Bieffe	Italy	—
Furall	Farnam	U.S.	—
Furazon	Daiko Seiyaku	Japan	—
Giarlam	Laquifa	Portugal	—

Trade Name	Manufacturer	Country	Year Introduced
Ginvel	Fujita	Japan	—
Intefuran	Crosara	Italy	—
Medaron	Yamanouchi	Japan	—
Nifulidone	Abic	Israel	—
Nifuran	Pharmamed	E. Germany	—
Sclaventerol	Sciavo	U.S.	—
Trifurox	Pharmacia	Sweden	—
Viofuragyn	Violani-Farmavigor	Italy	—

Raw Materials

N-(Benzylidene)-3-amino-2-oxazolidone
5-Nitro-2-furaldehyde diacetate

Manufacturing Process

In 212 cc of water are mixed 21.2 grams (0.112 mol) of N-(benzylidene)-3-amino-2-oxazolidone, 8.93 grams of concentrated sulfuric acid, and 30.1 grams (0.124 mol) of 5-nitro-2-furaldehyde diacetate. This mixture is heated to effect the hydrolysis of N-(benzylidene)-3-amino-2-oxazolidone, steam distillation of the benzaldehyde and hydrolysis of 5-nitro-2-furaldehyde diacetate. Approximately 1½ hours are required for this reaction to take place. When the bulk of the benzaldehyde has been removed, 50 cc of 99% isopropanol are added, the reaction mixture is refluxed a short time, and the crystals of N-(5-nitro-2-furfurylidene)-3-amino-2-oxazolidone are filtered from the hot suspension. The product is washed with water and isopropanol and dried; a yield of 23.3 grams, 92.8% based on N-(benzylidene)-3-amino-2-oxazolidone of MP 254° to 256°C is obtained, according to U.S. Patent 2,759,931.

References

Merck Index 4175

Kleeman & Engel p. 435

PDR p. 1279

OCDS Vol. 1 p. 229 (1977)

I.N. p. 448

Drake, G.D., Gever, G. and Hayes, K.J.; U.S. Patent 2,759,931; August 21, 1956; assigned to The Norwich Pharmacal Company

Gever, G. and O'Keefe, C.J.; U.S. Patent 2,927,110; March 1, 1960; assigned to The Norwich Pharmacal Company

FUROSEMIDE

Therapeutic Function: Diuretic

Chemical Name: 5-(aminosulfonyl)-4-chloro-2-[(2-furanyl)methyl]amino] benzoic acid

Common Name: —

Structural Formula:

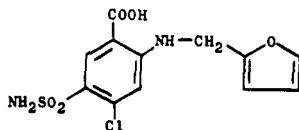

Chemical Abstracts Registry No.: 54-31-9

Trade Name	Manufacturer	Country	Year Introduced
Lasix	Hoechst	W. Germany	1964
Lasix	Hoechst	U.K.	1964
Lasilix	Hoechst	France	1965
Lasix	Hoechst	Italy	1965
Lasix	Hoechst	U.S.	1966
Eutensin	Hoechst	Japan	1981
Aisemide	Hotta	Japan	—
Accent	Toyama	Japan	—
Arasemide	Arakawa	Japan	—
Beronald	Kowa	Japan	—
Desal	Biofarma	Turkey	—
Desdemini	Vitacain	Japan	—
Disal	Med-Tech	U.S.	—
Diumide	Napp	U.K.	—
Diural	A.L.	Norway	—
Diuresal	Lagap	Switz.	—
Diurix	Helvepharm	Switz.	—
Diurolasa	Lasa	Spain	—
Diusemide	Nakataki	Japan	—
Diuzol	Wakamoto	Japan	—
Dryptal	Berk	U.K.	—
Errolon	Disprovent	Argentina	—
Franyl	Seiko Eiyō	Japan	—
Frusemin	Toho	Japan	—
Frusetic	Unimed	U.S.	—
Frusid	D.D.S.A.	U.K.	—
Fulsix	Tatsumi	Japan	—
Fuluvamide	Kanto	Japan	—
Furantral	Polfa	Poland	—
Furantril	Farmakhim	Bulgaria	—
Furesis	Farmos	Finland	—
Furetic	Script Intal	S. Africa	—
Furex	Siegfried	Switz.	—
Furfan	Nippon-Roussel-Chugai	Japan	—
Furix	Benzon	Denmark	—
Furix	Medica	Finland	—
Furomex	Orion	Finland	—
Furopuren	Klinge	W. Germany	—
Furosedon	Santen	Japan	—
Furoside	I.C.N.	Canada	—
Fusid	Teva	Israel	—
Hydro-Rapid	Sanorania	W. Germany	—
Impugan	Dumex	Denmark	—
Katlex	Iwaki	Japan	—
Kutrix	Kyowa	Japan	—
Lizik	Aksu	Turkey	—
Lowpston	Maruro	Japan	—
Macasirool	Hishiyama	Japan	—
Mirfat	Merckle	W. Germany	—
Moilarorin	Toho	Japan	—
Nephron	Alet	Argentina	—
Nicorol	Lundbeck	—	—
Oedemex	Mepha	Switz.	—
Panseman	Ono	Japan	—
Polysquall	Tokyo Hosei	Japan	—
Profemin	Toa Eiyō	Japan	—

Trade Name	Manufacturer	Country	Year Introduced
Promedes	Fuso	Japan	—
Protargen	Ohta	Japan	—
Puresis	Lennon	S. Africa	—
Radiamin	Nippon Shinyaku	Japan	—
Radonna	Nippon Kayaku	Japan	—
Rasisemid	Kodama	Japan	—
Rosemid	Toyo	Japan	—
Sigasalur	Siegfried	Switz.	—
Transit	Inca	Argentina	—
Trofurit	Chinoi	Hungary	—
Uremide	Protea	Australia	—
Urex	Mochida	Japan	—
Urex	Fawns & McAllan	Australia	—

Raw Materials

3-Sulfamyl-4,6-dichlorobenzoic acid
Furfurylamine

Manufacturing Process

10.8 grams of 3-sulfamyl-4,6-dichlorobenzoic acid (0.04 mol) and 11.7 grams of furfurylamine (0.12 mol) are heated in 30 cc of diethyleneglycol-dimethylether for 6 hours under reflux. When pouring the reaction mixture into 300 cc of 1 N hydrochloric acid, the reaction product is immediately separated off in the form of crystals. The light-yellow crude product is purified by dissolving it in 100 cc of warm 1 N sodium bicarbonate solution, precipitation by means of hydrochloric acid and subsequent recrystallization from ethanol/water, with addition of charcoal. Colorless prisms are obtained which decompose at 206°C while adopting a brown coloration, and with evolution of gas.

References

Merck Index 4186

Kleeman & Engel p. 436

PDR pp. 592, 872, 939, 993, 1349, 1606, 1723, 1999

OCDS Vol. 1 p. 134 (1977) & 2, 87 (1980)

DOT 1 (1) 5 (1965)

I.N. p. 450

REM p. 943

Stürm, K., Siedel, W. and Weyer, R.; U.S. Patent 3,058,882; October 16, 1962; assigned to Farbwerke Hoechst AG, Germany

FURSULTIAMINE

Therapeutic Function: Enzyme cofactor vitamin

Chemical Name: N-[(4-Amino-2-methyl-5-pyrimidinyl)methyl] -N'-[4-hydroxy-1-methyl-2-[(tetrahydrofurfuryl)dithio] -1-butanyl] formamide

Common Name: Thiamine tetrahydrofurfuryl disulfide

Structural Formula:

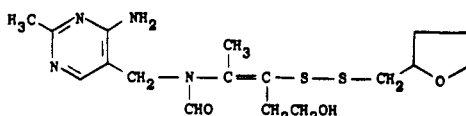

Furfural

Methyl iodide

Manufacturing Process

Furfuryl dimethyl amine is first produced. This may conveniently be accomplished by employing the Leuckart synthesis known to those skilled in the art, which involves the use of an aldehyde or a ketone, and formate of ammonia or an amine, or corresponding formamide derived by dehydration of formate of ammonia or an amine.

For example, 5 mols of dimethyl amine and 5 mols of formic acid and water are distilled to 135°C; distilling off most of the water. To the remaining liquid, consisting for the most part of the formyl derivative of dimethyl amine, 1 mol of furfural mixed with 1 mol of formic acid is slowly added with heating, the temperature being maintained at 150°C to 170°C, until the reaction is complete. The mixture is then distilled into a receiver. The course of this reaction may be illustrated as follows:

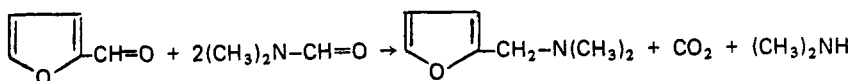

Part of the formic acid used in the above reaction functions to react with the dimethyl amine liberated in the reaction.

After the furfural has all been added and the reaction has subsided, the residue is cooled, diluted with water, made strongly alkaline and distilled until all volatile substances are removed. The distillate is then made acid with formic acid and distilled with steam as long as nonbasic substances are carried over by the steam. The residue is then made strongly basic with caustic soda and the volatile amines again distilled with steam. The distillate is then treated with strong alkali and then extracted with ether to extract the base. The extract is dried by the addition of caustic potash, the ether removed and the residual amine purified by distillation. Furfuryl dimethyl amine boils over the range 145°C to 150°C.

To obtain the quaternary salt, furfuryl dimethyl amine so prepared is dissolved in dry benzene and to the solution is added slightly more than one equivalent of methyl iodide. Inducement of crystallization of the quaternary salt which separates may be effected as, for example, by scratching the side of the vessel containing the mixture or seeding with a small quantity of the crystalline quaternary salt.

References

Merck Index 4190

I.N. p. 451

Nabenhauer, F.P.; U.S. Patent 2,185,220; January 2, 1940; assigned to Smith Kline & French Laboratories

FUSAFUNGINE**Therapeutic Function:** Antibacterial**Chemical Name:** See note under Structural Formula**Common Name:** —**Structural Formula:** Complex Antibiotic**Chemical Abstracts Registry No.:** 1393-87-9

Trade Name	Manufacturer	Country	Year Introduced
Locabiotol	Servier	France	1963
Locabiotol	Servier	U.K.	1964
Locabiotol	Stroder	Italy	1973
Locabiosol	Pharmacodex	W. Germany	1973
Fusaloyos	Servier	France	—
Fusarine	Couchoud	—	—

Raw Materials

Glucose
Bacterium *Fusarium lateritium*

Manufacturing Process

In a 5-liter round flask provided with two tubes, one of which is adapted for subsequent connection to a source of sterile air, 2 liters of fermentation medium are prepared according to the following formulation:

	Percentage
Peptone	1.
Crude glucose	3.
Sodium nitrate	0.1
Monoxygen potassium phosphate	0.1
Magnesium sulfate	0.05
Potassium chloride	0.05
Water, balance to	100.

Both openings of the flask are stopped with cotton wool and the medium is sterilized by placing it in an autoclave for 30 minutes at 120°C. The flask is then cooled to 29°C to 30°C and a small sample is taken to check the sterility and the pH value which should be approximately 5.

The spores from an inclined culture of *Fusarium lateritium* Wr, CSB 119.63 on a gelose medium are extracted with sterilized distilled water to obtain a suspension containing about 600,000 spores per ml. This suspension is then used to seed the medium prepared as earlier described. The contents of the flask are left to incubate at 27°C. Sterile air is injected into the liquid to effect thorough agitation and uniform supply of oxygen into the medium.

After 55 hours of fermentation, the contents of the round flask is transferred under aseptic conditions into a metal reactor of about 100 liters capacity containing 60 liters of sterile medium prepared as follows:

	Percentage
Peptone	0.5
Saccharose	4.
Ammonium nitrate	0.5
Dihydrogen potassium phosphate	0.1
Potassium chloride	0.5
Magnesium sulfate	0.5
Ferric sulfate	0.002
Water, balance to	100.

The culture is incubated at a temperature of 28°C in the reactor for 60 hours with mechanical agitation and constant aeration. The resulting broth is seeded into 600 liters of a sterile culture medium contained in a metal fermenting vat 1,800 liters in capacity and prepared according to the following formulation:

	Percentage
Saccharose	5.
Cerelose*	0.5
Ammonium nitrate	1.
Sodium chloride	0.3
Magnesium sulfate	0.25
Potassium chloride	0.03
Bacon oil (axonge oil)	0.1
Water, balance to	100.
*Trade Mark	

The culture is incubated for 55 hours at 28°C with constant forced aeration and agitation, and the broth is seeded into the production medium. In a fermentation vat 12 cubic meters in capacity provided with suitable stirring means, a temperature-control jacket, sterile air-injecting and dispersing means, and means for automatically injecting sterile antifoaming agent if required, there are prepared 6 cubic meters of a culture medium of the following formulation:

	Percentage
Saccharose	5.5
Cerelose*	0.5
Ammonium nitrate	1.
Sodium chloride	0.3
Dihydrogen potassium phosphate	0.5
Magnesium sulfate	0.25
Water, balance to	100.
*Trade Mark	

The medium is sterilized by heating it at 120°C for 40 minutes and is then cooled to 30°C. After seeding, the medium is incubated for about 60 hours, the temperature being maintained at 30°C. Throughout the period of fermentation, agitation is maintained at a rate of 20-40 rpm and sterile air is injected into the bottom of the vat at a rate of 4.8 cubic meters per minute by means of the air-dispersing device. Fermentation is arrested when about 90% of the carbohydrates have been consumed. The average Fusafungine content in the fermentation broth is then found to be about 0.5 to 0.8 grams per liter. The fermented broth is filtered under pressure and the content of the filter-press frames is washed with 2 cubic meters of water, then the filter cake is partially dried in a blast of compressed air. The mycelium is then dried in a ventilated oven at 70°C for 30 hours, dried and ground.

The yield obtained is 88 kilograms of dry product, containing 5.71% of Fusafungine. This is extracted from the crude product as follows: the dry powder is suspended in 836 liters of methanol, and 44 liters of an acetic buffer at pH 4.25 (0.05M) is added. The mixture is agitated for one hour at ordinary temperature, then drained to separate the exhausted powder from the methanol solution. This solution is transferred into an evaporator in which its volume is reduced to 200 liters. 100 liters of hexane are added, followed by 200 liters of water with agitation. After 15 minutes agitation, the mixture is allowed to stand for 30 minutes and the underlying phase is drawn off. The hexane extract is exhausted with three 25-liter batches of a methanol/water mixture, 3/1 by volume. The methanol mixture is then concentrated to 12.5 liters under reduced pressure. In this concentration step, the methanol is evaporated so that the water content of the residue increases regularly and the Fusafungine precipitates.

The resulting suspension is placed in a round flask equipped with a scraper-agitator device, and agitation is effected for 48 hours in an ice water bath. The antibiotic is isolated from the mother liquor by filtration through a Buchner filter. The filter cake is washed with 5 liters of a methyl alcohol and water mixture (1/2.5 by volume) cooled to 4°C. After drying in an oven at reduced pressure, 2.805 kilograms of a greyish-yellow crude product is obtained.

This crude product is dissolved in 140 liters anhydrous undenatured methyl alcohol, then 100 grams of discoloring carbon black, and 100 grams of a filtering aid are added. The mixture is agitated 30 minutes. The carbon black, filtering agent and insoluble impurities are filtered out. The filter cake is washed with 14 liters of methyl alcohol. The filtrate is placed in a receiving vessel, and 280 liters of distilled water at 70°C temperature are poured in with agitation. While continuing to agitate slowly, the mixture is allowed to cool gradually to a temperature of about 35°C. Crystallization is then initiated by adding a few crystals of pure Fusafungine, and agitation is continued for another 12 hours. The crystallization is allowed to proceed for 48 hours at +4°C. The pure Fusafungine crystals are collected by filtration. The filter cake is washed with 10 liters of methanol/water (1/2 by volume) mixture preliminarily cooled to +4°C and then with 20 liters of distilled water. The crystals are dried in an oven at 40°C under reduced pressure. A yield of 2.110 kilograms of pure Fusafungine antibiotics has thus been obtained.

References

Merck Index 4191

I.N. p. 451

Servier, J.; British Patent 1,018,626; January 26, 1966; assigned to Biofarma (France)

G

GALLAMINE TRIETHIODIDE

Therapeutic Function: Skeletal muscle relaxant

Chemical Name: 2,2',2''-[1,2,3-benzenetriyltris(oxy)] tris[N,N,N-triethylethanaminium] triiodide

Common Name: Benzcurine iodide

Structural Formula:

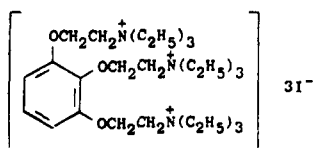

Chemical Abstracts Registry No.: 65-29-2

Trade Name	Manufacturer	Country	Year Introduced
Flaxedil	Davis/Geck	U.S.	1951
Flaxedil	May & Baker	U.K.	—
Flaxedil	Rhodia Iberica	Spain	—
Relaxan	Gea	Denmark	—
Sincurarina	Carlo Erba	Italy	—
Tricuran	Deutsches Hydrierwerk	E. Germany	—

Raw Materials

Pyrogallol	Sodium amide
Diethylaminochloroethane	Ethyl iodide

Manufacturing Process

12.6 grams of pyrogallol are dissolved in 100 cc of hot toluene. 14 grams of sodamide (85%) are added to the solution at about 100°C in 5 portions over a period of 15 minutes, with agitation. There are then added with agitation, over a period of 30 minutes, 100 cc of a toluene solution containing 474 grams of diethylaminochloroethane per liter of toluene.

The mixture is then heated for 1 hour, the toluene being refluxed, whereafter it is left to cool, 50 cc of water are added and, after decanting, the solution is again washed with two quantities of 50 cc of water. The toluene solution is dried over potassium carbonate and distilled in vacuo. There is thus obtained 28 grams of 1.2.3-tri-(β-diethylaminoethoxy)-benzene, boiling at 206°C under 1 mm pressure.

20 grams of 1.2.3-tri-(β-diethylaminoethoxy)-benzene is heated for 5 hours under reflux on the water bath with 30 grams of ethyl iodide. The hot mixture is dissolved in 50 cc of

water, filtered after addition of 2 grams of decolorizing black, evaporated to dryness on the water bath and recrystallized from 120 cc of alcohol. The product can be further recrystallized in mixtures of acetone and water.

The triethiodide of 1,2,3-tri-(β -diethylaminoethoxy)-benzene is thus obtained as white crystals which, after drying, have a rather indefinite melting point at about 152° to 153°C, (Maquenne block).

References

Merck Index 4214

Kleeman & Engel p. 437

I.N. p. 454

REM p. 923

Fourneau, E.; U.S. Patent 2,544,076; March 6, 1951; assigned to Societe des Usines Chimiques Rhone-Poulenc, France

GEMEPROST

Therapeutic Function: Prostaglandin; cervical softener

Chemical Name: 11,15-Dihydroxy-16,16-dimethyl-9-oxoprost-2,13-dien-1-ol acid methyl ester

Common Name: —

Structural Formula:

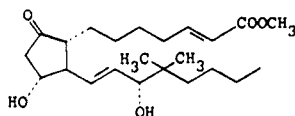

Chemical Abstracts Registry No.: 64318-79-2

Trade Name	Manufacturer	Country	Year Introduced
Preglandin	Ono	Japan	1982

Raw Materials

Ethyl 9 α -hydroxy-11 α ,15 α -bis(2-tetrahydropyranyloxy)-16,16-dimethyl-prosta-trans-2,trans-13-dienoate
 Potassium hydroxide
 Manganese sulfate
 Acetic acid

Manufacturing Process

Synthesis of 9-oxo-11 α ,15 α -bis-(2-tetrahydropyranyloxy)-16,16-dimethyl-prosta-trans-2,trans-13-dienoic acid: 4 g of ethyl 9 α -hydroxy-11 α ,15 α -bis-(2-tetrahydropyranyloxy)-16,16-dimethyl-prosta-trans-2,trans-13-dienoate were dissolved in 130 ml of a mixture of ethanol-water (3:1), mixed with 3.9 g of potassium hydroxide and stirred at 25°C for 2 hours. The reaction mixture was acidified with aqueous solution of oxalic acid to pH 5, and diluted with 100 ml of water, extracted with ethyl acetate. The extracts were washed with water, dried over sodium sulfate and concentrated under reduced pressure to obtain 3.88 g of 9 α -hydroxy-11 α ,15 α -bis-(2-tetrahydropyranyloxy)-16,16-dimethyl-prosta-trans-2,trans-13-dienoic acid.

The obtained compound 2.46 g were dissolved in 72 ml of diethyl ether and stirred at 3°C. To which a solution of manganese sulfate (15 g), 3.1 g of chromium trioxide, 72 ml of water and 3.5 ml of sulfuric acid was added. After stirring for 3.5 hours at 3°C, extracted with diethyl ether. The organic layer was washed with water, dried over sodium sulfate and concentrated under reduced pressure. The residue was purified by column chromatography on silica gel using ethyl acetate-benzene (1:1) as eluent to give 2.35 g of the title compound.

Synthesis of 16,16-dimethyl-trans- Δ^2 -PGE₁: 2.35 g of the bis-tetrahydropyranyl ether were dissolved in 6 ml of tetrahydrofuran and 60 ml of 65%-acetic acid aqueous solution and the solution stirred at 60°C to 70°C for 20 minutes. The reaction mixture was extracted with ethyl acetate, and the organic layer was washed with water, dried and concentrated under reduced pressure. The residue was purified by column chromatography on silica gel using ethyl acetate-cyclohexane (2:3) as eluent to yield 270 mg of the title compound.

References

Merck Index 4245

DFU 4 (2) 911 (1979)

DOT 19 (7) 414 (1983)

I.N. p. 456

Hayashi, M., Kori, S. and Wakasata, H.; U.S. Patent 4,052,512; October 4, 1977; assigned to Ono Pharmaceutical Co. (Japan)

GEMFIBROZIL

Therapeutic Function: Hypocholesterolemic agent

Chemical Name: 2,2-Dimethyl-5-(2,5-xilyloxy)valeric acid

Common Name: —

Structural Formula:

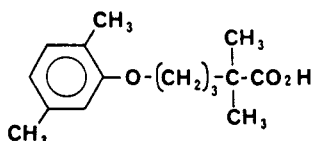

Chemical Abstracts Registry No.: 25812-30-0

Trade Name	Manufacturer	Country	Year Introduced
Lopid	Warner Lambert	U.S.	1982
Organolipid	Godecke	W. Germany	1982

Raw Materials

Isobutyric acid

3-(2,5-Xylyloxy)propyl bromide

n-Butyl lithium

Manufacturing Process

With stirring, 44.1 g of isobutyric acid is added to a mixture of 51.0 g of diisopropylamine, 23.2 g of a 57% sodium hydride dispersion in mineral oil, and 350 ml of tetrahydrofuran. When gas evolution subsides, the mixture is heated at reflux for 15 minutes, cooled to 0°C, and treated with 345 ml of a 1.45M solution of n-butyllithium in heptane. After 5 hr, the

mixture is warmed one-half hour at 30°C, cooled to 0°C, and treated with 122.0 g of 3-(2,5-xilyloxy)propyl bromide. After one more hour, it is stirred with 500 ml of water and the aqueous phase is separated and acidified with 150 ml of 6 N hydrochloric acid. The acidic mixture is extracted with ether and the ether extract is washed with saturated sodium chloride solution, dried over magnesium sulfate, concentrated almost to dryness, and distilled in vacuo. A distillate of 2,2-dimethyl-5-(2,5-xilyloxy)valeric acid is collected at boiling point 158°C to 159°C at 0.02 mm of Hg; melting point 61°C to 63°C following crystallization from hexane.

The same product is obtained by substituting 4.4 g of lithium hydride for the sodium hydride in the above procedure.

The same product is also obtained in the following manner. A mixture of 26.4 g of isobutyric acid, 6.0 g of magnesium oxide powder, and 250 ml of toluene is stirred and heated at reflux with continuous removal of the water formed in the reaction. When water formation ceases, the resulting mixture containing magnesium isobutyrate is concentrated to one-half its original volume, cooled in an ice bath, and treated with 31.0 g of diisopropylamine in 200 ml of dry tetrahydrofuran and then with 179 ml of 1.68 M n-butyllithium in heptane while the temperature is maintained below 10°C. After 15 more minutes, the mixture is warmed at 30°C for one-half hour, cooled to 0°C to 10°C, and treated with 75.0 g of 3-(2,5-xilyloxy)-propyl bromide. The mixture is then stirred for 18 hr at room temperature and diluted with 125 ml of 6 N hydrochloric acid and 250 ml of water. The organic phase is separated, concentrated, and the residue distilled in vacuo to give 2,2-dimethyl-5-(2,5-xilyloxy)valeric acid.

References

Merck Index 4246

DFU 1 (11) 520 (1976)

PDR p. 1364

OCDS Vol. 3 p. 45 (1984)

DOT 18 (11) 582 (1982)

I.N. p. 456

REM p. 864

Creger, P.L.; U.S. Patent 3,674,836; July 4, 1972; assigned to Parke, Davis & Co.

GENTAMICIN SULFATE

Therapeutic Function: Antibacterial

Chemical Name: See structural formula

Common Name: —

Structural Formula:

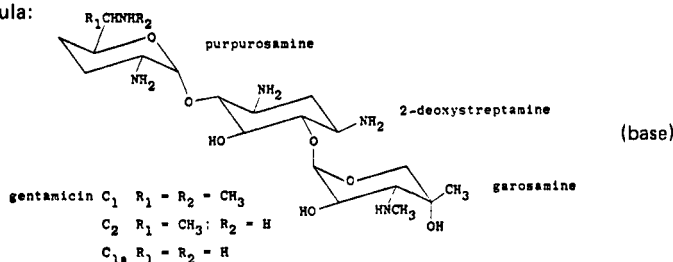

Chemical Abstracts Registry No.: 1405-41-0; 1403-66-3 (Base)

Trade Name	Manufacturer	Country	Year Introduced
Garamycin	Schering	U.S.	1966
Garramycin	Kirby-Warrick	U.K.	1966
Refobacin	Merck	W. Germany	1967
Gentalyn	Essex	Italy	1967
Gentalline	Unicet	France	1968
Genoptic	Allergan	U.S.	1979
U-Gencin	Upjohn	U.S.	1980
Bristagen	Bristol	U.S.	1980
Apogen	Beecham	U.S.	1980
Jenamycin	Hauck	U.S.	1982
Gentafair	Pharmafair	U.S.	1983
Biogen	Cusi	Spain	—
Biomargen	Biologia Marina	Spain	—
Cidomycin	Roussel	U.K.	—
Duramycin	Durachemie	W. Germany	—
Espectrosina	Centrum	Spain	—
Gensumycin	Roussel	—	—
Genta	I.E. Kimya Evi	Turkey	—
Genta-Gobens	Normon	Spain	—
Gentabac	Infan	Mexico	—
Gentacin	Schering-Shionogi	Japan	—
Gentadavur	Davur	Spain	—
Gentamedical	Medical	Spain	—
Gentamicin-Pos	Ursapharm	W. Germany	—
Gentamin	Medix	Spain	—
Gentamina	Essex	Argentina	—
Gentamival	Valles Mestre	Spain	—
Gentamorgens	Morgens	Spain	—
Gentamytrex	Mann	W. Germany	—
Gentaroger	Roger	Spain	—
Gentasillin	Nobel	Turkey	—
Gentibioptal	Farmila	Italy	—
Genticina	Antibioticos	Spain	—
Genticol	S.I.F.I.	Italy	—
Gento	Bryan	Spain	—
Gentona	Asla	Spain	—
Gent-Ophtal	Winzer	W. Germany	—
Getamisin	Deva	Turkey	—
Gevramycin	Essex Espana	Spain	—
Glevomicina	Bago	Argentina	—
G-Mycin	Neofarma	Finland	—
Miramycin	Teva	Israel	—
Ophtagram	Chauvin-Blache	France	—
Plurisemina	Northia	Argentina	—
Ribomicin	Farmigea	Italy	—
Sulgemycin	Larma	Spain	—
Sulmycin	Byk Essex	W. Germany	—

Raw Materials

Bacterium *Micromonospora purpurea*
Soybean meal

Manufacturing Process

Germination Stage: A lyophilized culture of *M. purpurea* is added to a 300 ml shake flask

containing 100 ml of the following sterile medium: 3 grams bacto-beef extract; 5 grams tryptose; 1 gram dextrose; 24 grams starch (soluble); 5 grams yeast extract; and 1,000 ml tap water. The flask and its contents are incubated for 5 days at 37°C on a rotary shaker (280 rpm, 2 inch stroke).

Inoculum Preparation Stage: Two batches of inoculum of about 50 gallons each are prepared by the following method: A 25 ml inoculum (from the germination stage) is transferred to each of four 2-liter flasks, each containing 500 ml of the sterile medium utilized for germination. The flasks and contents are incubated for 5 days at 28°C on a rotary shaker (280 rpm, 2 inch stroke).

The contents of the flasks are pooled, a 25 ml inoculum (taken from the pool) is added to each of twenty 2-liter flasks, each containing 500 ml of the following sterile medium: 30 grams soybean meal; 40 grams dextrose (cerelose); 1 gram calcium carbonate; 1,000 milliliters tap water. The flasks and their contents are incubated for 3 to 5 days at 28°C on a rotary shaker (280 rpm, 2 inch stroke). The broth is pooled and aseptically transferred into a sterile inoculum flask having a side arm (total volume, about 10 liters).

The 10 liters of inoculum is aseptically transferred to a 65-gallon fermenter containing 50 gallons of the following sterile medium: 600 grams bacto-beef extract; 1,000 grams bacto-tryptose; 200 grams dextrose (cerelose); 4,800 grams starch (soluble); 1,000 grams yeast extract; 100 ml antifoamer GE 60 (General Electric Co. brand of silicone defoamer), or other defoamer; and tap water, qs to 50 gallons.

The pH is adjusted to 6.9 to 7.0 before sterilization and aerobic fermentation is effected for 24 hours (until the packed cell volume is about 10 to 15%) under the following conditions: temperature, 37°C; sterile air input, 54 ft³/min; pressure, 7 psi; and agitation, 180 rpm.

Fermentation Stage: One 50-gallon batch of inoculum is aseptically transferred to a 675-gallon fermenter (fermenter A) containing the following medium: 54.0 kg soybean meal; 72.0 kg cerelose; 9.0 kg calcium carbonate; 300 ml antifoamer GE 60; and 450 gallons soft water. The other 50-gallon batch of inoculum is aseptically transferred to a similar fermenter (fermenter B) containing the same medium as fermenter A with the addition of 200 mg of CoCl₂·6H₂O. Fermentation is effected in each fermenter at 35°C while agitating at 120 rpm with air input at 7 psi and 15 ft³/min. At various times, samples of the fermented broth are withdrawn and assayed for antibiotic production by the disc assay method. The following table shows the increase in yield effected by the presence of cobalt, (as described in U.S. Patent 3,136,704).

Fermentation Time (hours)	Yield of Gentamicin (units/ml)	
	Fermenter A (no cobalt)	Fermenter B (cobalt present)
24	9.3	13
40	34	133
48	49	185
60	70	332
72	77	440
96	75	420

The conversion of the broth to gentamicin sulfate is described in U.S. Patent 3,091,572.

References

Merck Index 4251
 Kleeman & Engel p. 438
 PDR pp. 872, 888, 1397, 1429, 1606, 1621
 DOT 2 (3) 99 (1966) & 17 (3) 106 (1981)
 I.N. p. 457

REM p. 1180

Luedemann, G.M. and Weinstein, M.J.; U.S. Patent 3,091,572; May 28, 1963; assigned to Schering Corporation

Charney, W.; U.S. Patent 3,136,704; June 9, 1964; assigned to Schering Corporation

GEPEFRIN

Therapeutic Function: Antihypotensive

Chemical Name: 3-(2-Aminopropyl)phenol

Common Name: Alpha-methyltyramine

Structural Formula:

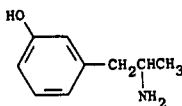

Chemical Abstracts Registry No.: 18840-47-6

Trade Name	Manufacturer	Country	Year Introduced
Pressionorm	Helopharm	W. Germany	1981

Raw Materials

D-(+)-1-(3-methoxyphenyl)-2-aminopropane
Hydrogen chloride

Manufacturing Process

Hydrolysis of D-(+)-1-(3-methoxyphenyl)-2-aminopropane: 2.42 mols (40 g) of the compound are dissolved in 6N hydrochloric acid in a bomb tube consisting of stainless steel and having a capacity of 500 ml. Hydrogen chloride gas is passed into the ice-cooled solution until this is saturated. The solution is then heated to 130°C for 2 hours in an air bath. After cooling and driving off the hydrochloric acid at a slightly elevated temperature, the hydrochloride of the 3-hydroxyphenyl derivative is present in the form of a yellowish syrup.

The free base can be liberated from the hydrochloride by extracting a butanol solution of the hydrochloride several times with sodium bicarbonate solution. After recrystallization from isopropanol/ligroin, the yield of D-(+)-1-(3-hydroxyphenyl)-2-aminopropane amounts to 33.0 g, corresponding to 90.1% of theory relative to the D-form. Melting point = 152°C to 154°C.

References

Merck Index 4262

I.N. p. 458

Helopharm W. Petrik & Co., K.G.; British Patent 1,527,479; October 4, 1978

GLAFENINE

Therapeutic Function: Analgesic

Chemical Name: 2-[(7-Chloro-4-quinolinyl)amino] benzoic acid 2,3-dihydroxy-propyl ester

Common Name: Glycerylaminophenaquine

Structural Formula:

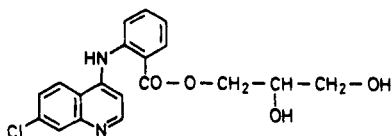

Chemical Abstracts Registry No.: 3820-67-5

Trade Name	Manufacturer	Country	Year Introduced
Glifanan	Roussel	France	1965
Glifanan	Albert Roussel	W. Germany	1968
Adalgur	Roussel	France	—
Glifan	Roussel-Maestretti	Italy	—
Glifan	Nippon Roussel-Chugai	Japan	—

Raw Materials

2,2-Dimethyl-4-hydroxymethyl-1,3-dioxolane
 o-Nitrobenzoyl chloride
 Hydrogen
 4,7-Dichloroquinoline

Manufacturing Process

Step A: Preparation of (2,3-isopropylidenedioxy)-propyl o-nitrobenzoate—59.6 g of 2,2-dimethyl-4-hydroxymethyl-1,3-dioxolane were dissolved under agitation in 60 cc of anhydrous pyridine. The solution was cooled to +5°C and 86.5 g of o-nitrobenzoyl chloride (prepared by Leckermann et al., *Ber.* vol. 80, p. 488, 1947) were slowly introduced into it. The reaction mixture was agitated for a period of two hours at room temperature and then was poured into 500 cc of ether. The mixture was filtered and the filtrate was washed successively with 0.5 N sulfuric acid solution, with aqueous sodium bicarbonate solution and finally with water until the wash waters were neutral. The washed solution was dried over sodium sulfate and filtered again. The filtrate was distilled to dryness under vacuum to obtain 116.5 g (being a yield of 92%) of (2,3-isopropylidenedioxy)-propyl o-nitrobenzoate in the form of a yellow oil which distilled at 178°C to 180°C at a pressure of 1 mm.

Step B: Preparation of (2,3-isopropylidenedioxy)-propyl anthranilate—80 g of (2,3-isopropylidenedioxy)-propyl o-nitrobenzoate, obtained as described in Step A, were subjected to hydrogenation for a period of one hour in 800 cc of absolute alcohol in the presence of 2 g of palladized carbon black as catalyst. The reaction mixture was filtered and the filtrate was evaporated under vacuum to obtain 70.5 g (being a yield of 98.5%) of (2,3-isopropylidenedioxy)-propyl anthranilate in the form of a yellow oil which distilled at 159°C to 160°C under 0.5 mm of pressure.

Step C: Preparation of the α -monoglyceride of 4-(2'-carboxyphenylamino)-7-chloroquinoline—A mixture of 48 g of (2,3-isopropylidenedioxy)-propyl anthranilate, 36 g of 4,7-dichloroquinoline, 36 cc of concentrated hydrochloric acid and 300 cc of water was agitated while heating to reflux for a period of two hours. The reaction mixture was filtered and the filtrate was allowed to stand at a temperature of 0°C for a period of three hours. The hydrochloride salt was then vacuum filtered and the salt was taken up in 600 cc 50% methanol at reflux. The solution was made alkaline by the addition of 120 cc of ammonia solution and iced for a period of one hour. The crystalline precipitate obtained was vacuum filtered, washed with water and dried to obtain 38.5 g (being a yield of 56%) of the α -monoglyceride of 4-(2'-carboxyphenylamino)-7-chloroquinoline having a melting point of 165°C.

The product occurred in the form of pale yellow prisms and was insoluble in water, ether, benzene, diluted alcohols, olive oil and chloroform, slightly soluble in absolute alcohol, dioxane, tetrahydrofuran and acetone, and soluble in dilute aqueous acids and alkalis.

References

Merck Index 4293

Kleeman & Engel p. 441

OCDS Vol. 1 p. 342 (1977)

DOT 2 (4) 139 (1966)

I.N. p. 460

Allais, A. and Meier, J.; U.S. Patent 3,232,944; February 1, 1966; assigned to Roussel-Uclaf S.A. (France)

GLAUCARUBIN

Therapeutic Function: Amebicide

Chemical Name: 11,20-Epoxy-1,2,11,12-tetrahydroxy-15-(2-hydroxy-2-methyl-1-oxobutoxy)picras-3-ene-16-one

Common Name: α -Kirondrin

Structural Formula:

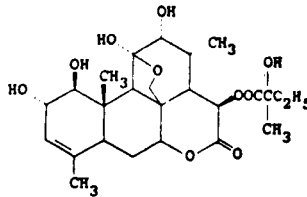

Chemical Abstracts Registry No.: 1448-23-3

Trade Name	Manufacturer	Country	Year Introduced
Glarubin	Massengill	U.S.	1959

Raw Materials

Aceituno meal
Water

Manufacturing Process

The preparation of pure glaucarubin from Aceituno meal is conveniently carried out by extracting the Aceituno meal with water, using about 100 gallons of the water per hundred pounds of meal. If the meal is in the form of a relatively solid cake, it should be soaked in the water for a time to cause disintegration. The temperature of the water is then raised to about 70°C for the actual extraction, and the mixture is moderately agitated, while maintaining a temperature of about 70°C for a period of about three hours, until extraction is substantially complete. If desired, the extraction may be conducted at lower temperatures down to about room temperature although at such lower temperatures, the extraction is much slower and less efficient at temperatures substantially higher than 70°C, there may be partial destruction or decomposition of the product being recovered.

The slurry or extraction mixture is filtered while hot, and the resulting filter cake is washed

with about five to ten gallons of hot water; the primary filtrate and wash water are combined and held for further processing. In order to insure complete extraction of the desired material, the filter cake is again extracted with about 100 gallons of water at 70°C. Although not essential, it is desirable to add to the second extraction a small quantity of acetic acid. The acetic acid appears to aid in obtaining a complete and thorough extraction. After extraction for about three hours with agitation at a temperature of about 70°C, the slurry is again filtered and the cake washed as before with about five to ten gallons of hot water. The resulting filtrate and wash are then combined with the primary filtrate and wash.

The combined filtrates or total aqueous extracts are cooled to about room temperature and filtered to remove any residual solids from solution. The clarified aqueous extract is then concentrated to about 70 gallons at a temperature below about 50°C, thus reducing the volume to about one-third the original volume. The resulting concentrate is cooled to room temperature or below and filtered to remove any tar or gum that may have separated. The presence of tar or gum at this stage of the process will vary depending upon the starting material and the manner in which the primary extraction has been carried out. It has been found, however, that unless any tar or gum present in the initial extract is removed by the procedure described, it will seriously interfere with the further concentration and crystallization steps hereinafter described.

After removal of such tar or gum, the concentrate is further evaporated at a temperature below about 50°C to about one-fourth the volume, i.e., 70 gallons is concentrated to about 15 to 20 gallons. This concentrate is cooled to a temperature of about 0°C to 5°C and allowed to stand for an extended period, such as overnight, whereupon there is a separation of crude crystalline glaucarubin therefrom. The crude crystals thus formed are removed by filtration and the mother liquors again concentrated to about one-half volume and cooled to permit separation of a second batch of crude glaucarubin crystals. The two batches of crude glaucarubin crystals are combined and dried preparatory to further purification.

The crude glaucarubin crystals obtained as above described from 100 pounds of Aceituno meal are slurried with about seven-and-one-half gallons of anhydrous methanol and refluxed until the crystals dissolve. The hot solution is then filtered and the resulting filter cake washed with methanol. The filter cake is then again extracted with an additional seven-and-one-half gallon quantity of anhydrous methanol in the manner described, and filtered. The methanol filtrates and washes are combined and concentrated at atmospheric pressure until crystals begin to appear, i.e., generally after concentration to about one-fifteenth volume. The solution is then cooled to about 0°C to 5°C and allowed to stand for crystallization to go substantially to completion. The resulting crystals are filtered off and the mother liquors are further concentrated and cooled to collect a second crop of crystals. The two crops of crystals are then combined and may be further purified by redissolving in methanol, filtering through activated charcoal, and recrystallizing after concentration of the methanol filtrate.

The purified crystalline glaucarubin thus obtained is colorless and odorless and is estimated to have a purity of about 96% to 97%. It has the formula $C_{25}H_{36}O_{10}$ and melts at 262°C to 263°C with decomposition (capillary tube).

References

Merck Index 4295

I.N. p. 460

Shafer, H.M.; U.S. Patent 2,864,745; December 16, 1958; assigned to Merck & Co., Inc.

GLAZIOVINE

Therapeutic Function: Tranquilizer

Chemical Name: (\pm)-[Hydroxy-6-methoxy-5-methyl-11H-cyclopenta[*i,j*]-isoquinoline]-7-spiro-1'(2,5-cyclohexadiene-4-one)

Common Name: —

Structural Formula:

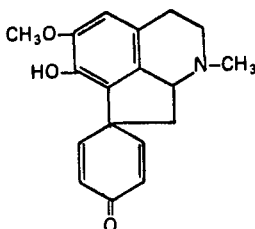

Chemical Abstracts Registry No.: 17127-48-9

Trade Name	Manufacturer	Country	Year Introduced
Suavedol	Simes	Italy	1976

Raw Materials

p-Benzyloxyphenylacetic acid	Formaldehyde
3-Methoxy-4-hydroxyphenethylamine	Sodium nitrite
Phosphorus oxychloride	Sulfuric acid
Sodium borohydride	Nitric acid
Hydrogen	

Manufacturing Process

The thermal condensation of p-benzyloxyphenylacetic acid and of 3-methoxy-4-hydroxyphenethylamine occurs and gives, with a yield of 86% to 92%, the N-(3-methoxy-4-hydroxyphenethyl)-p-benzyloxyphenylacetamide; from this latter, by cyclization according to Bischler-Napieralski with phosphorus oxychloride in acetonitrile, followed by reduction with sodium borohydride, there is obtained with a yield of 75% to 80% the 1-(p-benzyloxybenzyl)-6-methoxy-7-hydroxy-1,2,3,4-tetrahydroisoquinoline, which is methylated with formaldehyde and formic acid giving 1(p-benzyloxybenzyl)-2-methyl-6-methoxy-7-hydroxy-1,2,3,4-tetrahydroisoquinoline with a yield of 90%.

This intermediate is then nitrated with 65% nitric acid. The nitro compound is then hydrogenated to give a hydroxybenzylamino compound.

A solution of 94.2 g of 1-(p-hydroxybenzyl)-2-methyl-6-methoxy-7-hydroxy-8-amino-1,2,3,4-tetrahydroisoquinoline in 3 liters of 1N sulfuric acid is supplemented, with stirring, between 0°C and 5°C, with 21 grams of sodium nitrite. The diazonium sulfate solution thus obtained is made alkaline with 2.5 liters of 2N sodium hydroxide: the diazo-oxide which is separated at the outset as a yellow precipitate is redissolved by the excess alkali, the solution is diluted to 10 liters with deaerated water and subjected, in a nitrogen atmosphere at 15°C in a Pyrex glass apparatus, to the radiations of a 2,000 W high-pressure mercury vapor lamp until the yellow hue is discharged (about 30 to 40 minutes). The solution is brought to a pH of 8.6 with hydrochloric acid and is stirred with 1.5 liters of chloroform. The two phases are filtered, the chloroform is separated and the aqueous phase is extracted four times with 1.5 liters of chloroform. The extracts are evaporated under reduced pressure to a small volume and percolated through a chromatographic column containing 1.3 kilograms of neutral alumina (activity rating IV of the Brockmann scale). The column is then further eluted with chloroform. The eluates are evaporated under reduced pressure and the residue is recrystallized from ethyl acetate. There are thus obtained 40.2 grams (yield 45% of theory) of pure (\pm)-glaziovine, having a melting point of 220°C to 222°C.

References

Kleeman & Engel p. 442

DOT 13 (1) 24 (1977)

I.N. p. 460

Casagrande, C. and Canonica, L.; U.S. Patent 3,886,166; May 27, 1975; assigned to Siphar S.A. (Switz.)

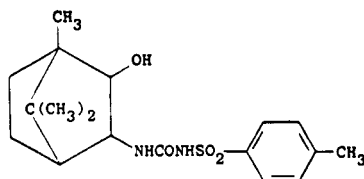
GLIBORNURIDE**Therapeutic Function:** Oral hypoglycemic**Chemical Name:** [1S-(endo,endo)]-N-[[[3-hydroxy-4,7,7-trimethylbicyclo[2.2.1]hept-2-yl]-amino] carbonyl]-4-methylbenzenesulfonamide**Common Name:** 1-(p-toluenesulfonyl)-3-(2-endo-hydroxy-3-endo-D-bornyl)urea**Structural Formula:****Chemical Abstracts Registry No.:** 26944-48-9

Trade Name	Manufacturer	Country	Year Introduced
Glutril	Roche	W. Germany	1972
Glutril	Roche	France	1973
Glutril	Roche	U.K.	1975
Glitrim	Roche	—	—
Gluborid	Gruenthal	W. Germany	—
Glytril	Roche	—	—
Logiston	Laake	Finland	—

Raw Materials

3-Endo-aminoborneol HCl
o-Methyl-N-p-toluene sulfonyl urea

Manufacturing Process

2.1 grams of 3-endo-aminoborneol hydrochloride and 2.4 grams of O-methyl-N-p-toluene-sulfonyl-urea are heated at 125°C for 3 hours with 2 ml of dimethylformamide. After cooling, the reaction mixture is stirred with 100 ml of water for 10 minutes, while a pH of 3.5 is maintained by the addition of a few drops of dilute hydrochloric acid. The precipitate is removed by filtration, washed with water and suspended in 100 ml of water. The suspension is dissolved by the addition of 20 ml of 1 N caustic soda. The alkaline solution is extracted with ether, acidified with dilute hydrochloric acid and filtered. The precipitate is washed with water and recrystallized from alcohol/water to yield 1-(p-toluenesulfonyl)-3-(2-endo-hydroxy-3-endo-bornyl)-urea having a melting point of 193° to 195°C.

References

Merck Index 4299

Kleeman & Engel p. 443
 OCDS Vol. 2 p. 117 (1980)
 DOT 8 (3) 88 (1972)
 I.N. p. 461

Bretschneider, H., Grassmayr, K., Hohenlohe-Oehringen, K. and Grussner, A.; U.S. Patent 3,654,357; April 4, 1972; assigned to Hoffmann-La Roche Inc.

GLICLAZIDE

Therapeutic Function: Oral hypoglycemic

Chemical Name: 1-(hexahydrocyclopenta[c] pyrrol-2(1H)-yl)-3-(p-tolylsulfonyl)urea

Common Name: N-(4-methylbenzenesulfonyl)-N'-(3-azabicyclo[3.3.0]-3-octyl)urea

Structural Formula:

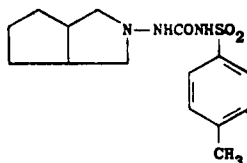

Chemical Abstracts Registry No.: 21187-98-4

Trade Name	Manufacturer	Country	Year Introduced
Diamicron	Servier	France	1972
Diamicron	Servier	Italy	1977
Diamicron	Servier	Switz.	1979
Diamicron	Pharmacodex	W. Germany	1980
Diamicron	Servier	U.K.	1980
Dramion	Maggioni	Italy	—

Raw Materials

4-Methylbenzenesulfonyl urethane
 N-Amino-3-azabicyclo(3.3.0)octane

Manufacturing Process

To a suspension containing 4.86 parts of 4-methylbenzenesulfonyl urethane (MP 80° to 82°C) and 36 parts of anhydrous toluene there are rapidly added 2.5 parts of N-amino-3-azabicyclo(3.3.0)octane (BP/18 mm = 86°C). The reaction mixture is heated under reflux for 1 hour. The resulting clear solution crystallizes on cooling. The crystals are filtered, washed with 2 parts of toluene, then recrystallized from anhydrous ethanol. There are obtained 3.8 parts of the desired product, MP 180° to 182°C.

References

Merck Index 4300
 Kleeman & Engel p. 444
 DOT 8 (4) 136 (1972)
 I.N. p. 461

Beregi, L., Hugon, P. and Duhault, J.; U.S. Patent 3,501,495; March 17, 1970; assigned to Science Union et Cie, Societe Francaise de Recherche Medicale, France

GLIPIZIDE

Therapeutic Function: Oral hypoglycemic

Chemical Name: 1-cyclohexyl-3-[[p-[2-(5-methylpyrazinecarboxamido)ethyl] phenyl] -sulfonyl] urea

Common Name: Glydiazinamide

Structural Formula:

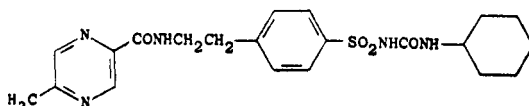

Chemical Abstracts Registry No.: 29094-61-9

Trade Name	Manufacturer	Country	Year Introduced
Minidiab	Carlo Erba	Italy	1973
Glibenese	Pfizer	France	1974
Glibenese	Pfizer	U.K.	1975
Minodiab	Farmitalia	U.K.	1975
Glibenese	Pfizer	W. Germany	1977
Glucotrol	Roerig	U.S.	—
Melizid	Medica	Finland	—
Mindiab	Aesca	Austria	—
Minibetic	Ikapharm	Israel	—

Raw Materials

5-Methylpyrazine-2-carboxylic acid
p-(β-Aminoethyl)benzenesulfonamide

Thionyl chloride
Cyclohexyl isocyanate

Manufacturing Process

5-Methyl pyrazine-2-carboxylic acid is refluxed with thionyl chloride in anhydrous benzene for approximately 12 hours. Benzene and thionyl chloride excess is removed by distillation. Then some anhydrous dioxane is added and this acid chloride solution is allowed to drop into p-(β-aminoethyl)-benzenesulfonamide suspension in dioxane and anhydrous pyridine. The resulting mixture is then refluxed for 3 hours. Dioxane is removed by distillation and then the residue is washed with water and acetic acid. The raw acylated sulfonamide is then filtered and crystallized from 95% ethanol, thus obtaining a product of MP 200° to 203°C.

This product is then reacted with cyclohexyl isocyanate to give glipizide.

References

Merck Index 4302

Kleeman & Engel p. 444

PDR p. 1525

OCDS Vol. 2 p. 117 (1980)

DOT 8 (11) 435 (1972) & 9 (11) 463 (1973)

I.N. p. 462

REM p. 977

Ambrogi, V. and Logemann, W.; U.S. Patent 3,669,966; June 13, 1972; assigned to Carlo Erba SpA, Italy

GLIQUIDONE

Therapeutic Function: Oral hypoglycemic

Chemical Name: N-[(cyclohexylamino)carbonyl]-4-[2-(3,4-dihydro-7-methoxy-4,4-dimethyl-1,3-dioxo-2(1H)-isoquinolinyl)ethyl] benzenesulfonamide

Common Name: Gliquidor

Structural Formula:

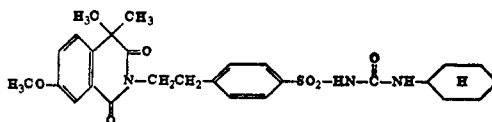

Chemical Abstracts Registry No.: 33342-05-1

Trade Name	Manufacturer	Country	Year Introduced
Glurenorm	Thomae	W. Germany	1975
Glurenorm	Winthrop	U.K.	1979
Glurenor	Boehr. Ingel.	—	—

Raw Materials

1,2,3,4-Tetrahydro-4,4-dimethyl-7-methoxy-isochromane-1,3-dione
 4-Aminosulfonyl-phenyl-(2)-ethylamine
 Potassium-t-butylate
 Cyclohexyl isocyanate

Manufacturing Process

A mixture consisting of 4 grams of 1,2,3,4-tetrahydro-4,4-dimethyl-7-methoxy-isochromane-dione-(1,3) (MP 95° to 97°C), 2.53 grams of 4-aminosulfonyl-phenyl-(2)-ethylamine and 150 ml of xylene was heated for 2 hours at its boiling point in an apparatus provided with a water separator. Thereafter, the reaction mixture was allowed to cool and was then vacuum-filtered, and the filter cake was recrystallized from n-propanol in the presence of activated charcoal. 2.9 grams (58% of theory) of 1,2,3,4-tetrahydro-4,4-dimethyl-2-[p-aminosulfonylphenyl-(2)-ethyl]-7-methoxy-isoquinolinedione-(1,3), MP 203° to 205°C, of the formula below were obtained.

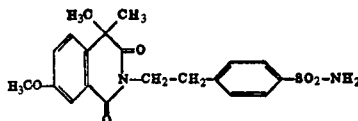

32.2 grams of 1,2,3,4-tetrahydro-4,4-dimethyl-2-[p-aminosulfonylphenyl-(2)-ethyl]-7-methoxy-isoquinolinedione-(1,3) were dissolved in 700 ml of dimethylformamide, 9.1 grams of potassium tert-butylate were added to the solution, and, while cooling the mixture with ice, 14.9 grams of cyclohexyl isocyanate were added dropwise thereto.

Subsequently, the reaction mixture was stirred for 5 hours on an ice bath and was then allowed to stand overnight at -2°C. Thereafter, the reaction solution was admixed with water, the precipitate formed thereby was separated by vacuum-filtration, the filtrate was admixed with more water, and the aqueous solution was acidified with 2 N hydrochloric acid. A greasy substance precipitated out which crystallized after a brief period of contact with boiling methanol. 2.6 grams (85% of theory) of 1,2,3,4-tetrahydro-2-[p-(N¹-cyclo-

hexyl-ureido-N-sulfonyl-phenethyl]-4,4-dimethyl-7-methoxy-isoquinolinedione-(1,3), MP 180° to 182°C, were obtained.

References

Merck Index 4303

Kleeman & Engel p. 445

DOT 11 (7) 281 (1975) & 16 (2) 47 (1980)

I.N. p. 462

Kutter, E., Griss, G., Grell, W. and Kleemann, M.; U.S. Patent 3,708,486; January 2, 1973; assigned to Boehringer Ingelheim GmbH, Germany

GLISOXEPID

Therapeutic Function: Oral hypoglycemic

Chemical Name: N-[2-[4-[[[(hexahydro-1H-azepin-1-yl)amino] carbonyl] amino] sulfonyl]-phenyl] ethyl]-5-methyl-3-isoxazolecarboxamide

Common Name: —

Structural Formula:

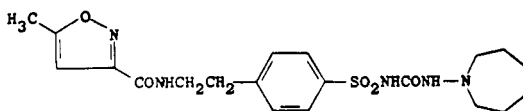

Chemical Abstracts Registry No.: 25046-79-1

Trade Name	Manufacturer	Country	Year Introduced
Pro-Diaban	Bayer	W. Germany	1974
Pro-Diaban	Schering	W. Germany	1974
Glysepin	Bayer	Italy	1978
Glucoben	Farmades	Italy	1979

Raw Materials

5-Methyl-isoxazole-(3)-carboxylic acid chloride

4-(β-Aminoethyl)benzene sulfonamide hydrochloride

Chloroformic acid methyl ester

N-Amino-hexamethylene imine

Manufacturing Process

There is obtained from 4-[β-[5-methyl-isoxazolyl-(3)-carboxamido]-ethyl]-benzene-sulfonamide (prepared from 5-methyl-isoxazole-(3)-carboxylic acid chloride and 4-(β-aminoethyl)-benzene-sulfonamide hydrochloride, MP 213° to 214°C in pyridine) and chloroformic acid methyl ester, in a yield of 69%, the compound N-[[4-[β-[5-methyl-isoxazolyl-(3)-carboxamido]-ethyl]]-benzene-sulfonyl]-methyl-urethane in the form of colorless crystals of MP 173°C.

From the sulfonyl-urethane described above and N-amino-hexamethylene-imine, there is obtained, in a yield of 70%, the compound 4-[[4-[β-[5-methyl-isoxazolyl-(3)-carboxamido]-ethyl]-benzene-sulfonyl]]-1,1-hexamethylene-semicarbazide in the form of colorless crystals of MP 189°C.

References

Merck Index 4304

Kleeman & Engel p. 445

DOT 10 (10) 257 (1974) & 16 (1) 15 (1980)

I.N. p. 462

Plumpe, H. and Puls, W.; U.S. Patent 3,668,215; June 6, 1972; assigned to Farbenfabriken Bayer AG, Germany

GLUCAGON**Therapeutic Function:** Antidiabetic**Chemical Name:** Polypeptide of molecular weight approximately 3,550; see Structural Formula**Common Name:** Hg-Factor; HGF

Structural Formula:

$$\overset{1}{\text{His}}-\text{Ser}-\text{Gln}-\text{Gly}-\text{Thr}-\text{Phe}-\text{Thr}-\text{Ser}-\text{Asp}-\text{Tyr}-\text{Ser}-\text{Lys}-\text{Tyr}-\overset{15}{\text{Leu}}-\overset{16}{\text{Ser}}-\overset{18}{\text{Arg}}-\overset{19}{\text{Ala}}-\overset{20}{\text{Gln}}-\overset{21}{\text{Asp}}-\overset{22}{\text{Phe}}-\overset{23}{\text{Val}}-\overset{24}{\text{Gln}}-\overset{25}{\text{Tyr}}-\overset{26}{\text{Leu}}-\overset{27}{\text{Met}}-\overset{28}{\text{Asn}}-\overset{29}{\text{Thr}}$$
Chemical Abstracts Registry No.: 9007-92-5

Trade Name	Manufacturer	Country	Year Introduced
Glucagon	Lilly	U.S.	1960
Glukagon	Lilly	W. Germany	1962
Glucagon	Novo	Italy	1964
Glucagon	Novo	France	1966
Glucagon Novo	Kodama	Japan	1977

Raw Materials

Pancreatic gland material
Acetone

Manufacturing Process

The process comprises treating pancreatic gland material having hyperglycemic activity in aqueous solution at pH 3-4 with 3-4 volumes of acetone to precipitate the hyperglycemic activity material, separating the precipitate and dialyzing the precipitate to remove inorganic salts and dialyzable low molecular weight impurities, and crystallizing the undialyzed hyperglycemic activity material from aqueous glycine buffer.

References

Merck Index 4307

PDR p. 1050

I.N. p. 463

REM p. 974

Eli Lilly & Co.; British Patent 762,885; December 5, 1956

GLUTETHIMIDE**Therapeutic Function:** Sedative, hypnotic

Chemical Name: 3-ethyl-3-phenyl-2,6-piperidinedione

Common Name: 3-ethyl-3-phenyl-2,6-dioxopiperidine

Structural Formula:

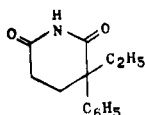

Chemical Abstracts Registry No.: 77-21-4

Trade Name	Manufacturer	Country	Year Introduced
Doriden	U.S.V.	U.S.	1955
Doridene	Ciba Geigy	France	1956
Alfimid	Pliva	Yugoslavia	—
Elrodorm	Deutsches Hydrierwerk	E. Germany	—
Glimid	Polfa	Poland	—
Glutethimide	Danbury	U.S.	—
Rigenox	Gedeon Richter	—	—

Raw Materials

α -Phenylbutyric acid nitrile	Sodium hydroxide
Methyl acrylate	Acetic acid
Sulfuric acid	

Manufacturing Process

The 2-phenyl-2-ethyl-pentane-1,5-diacid-mono-nitrile-(1) of melting point 72° to 76°C, used as starting material in this process, can be produced for example from α -phenyl-butyrlic acid nitrile by condensation with acrylic acid methyl ester and subsequent hydrolysis of the thus-obtained 2-phenyl-2-ethyl-pentane-1,5-diacid-monomethyl ester-mono-nitrile-(1) of boiling point 176° to 185°C under 12 mm pressure.

140 parts by weight of 2-phenyl-2-ethyl-pentane-1,5-diacid-mono-nitrile-(1) are dissolved in 200 parts by volume of glacial acetic acid and, at an initial temperature of 60°C, 100 parts by volume of concentrated sulfuric acid added in portions. In this operation the temperature of the reaction mixture rises to 100°C. The whole is finally maintained for a short time on the boiling water bath, then cooled and poured on ice and neutralized with alkali to a pH of 6. Extraction with chloroform is then effected and the chloroform extract washed with dilute caustic soda solution, dried over calcium chloride, the chloroform evaporated and the residue crystallized from ethyl acetate with addition of ligroin. The obtained 3-phenyl-3-ethyl-2,6-dioxo-piperidine melts at 78° to 81°C.

References

Merck Index 4338

Kleeman & Engel p. 446

PDR pp. 830, 1606, 1812

OCDS Vol. 1 p. 257 (1977)

I.N. p. 466

REM p. 1071

Hoffmann, K. and Tagmann, E.; U.S. Patent 2,673,205; March 23, 1954; assigned to Ciba Pharmaceutical Products, Inc.

GLYBUZOLE

Therapeutic Function: Oral hypoglycemic

Chemical Name: N-(5-tert-Butyl-1,3,4-thiadiazol-2-yl)benzenesulfonamide

Common Name: Desaglybuzole

Structural Formula:

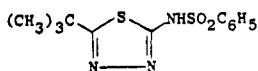

Chemical Abstracts Registry No.: 1492-02-0

Trade Name	Manufacturer	Country	Year Introduced
Glucose	Kyowa Hakko	Japan	1972

Raw Materials

2-Amino-5-tert-butyl-1,3,4-thiadiazole
Benzene sulfonyl chloride

Manufacturing Process

15.7 g of 2-amino-5-tert-butyl-1,3,4-thiadiazole (0.1 mol) and 17.6 g of benzene sulfonyl chloride (0.1 mol) were dissolved in 150 ml dry pyridine and heated over steam for 4 hr. The pyridine was removed by distillation under reduced pressure and the residue treated with 50 ml 2 N HCl. The solid product, MP 162° to 163°C, was filtered off and recrystallized once from benzene and twice from 50% aqueous EtOH.

References

Merck Index 4341

Kleeman & Engel p. 447

I.N. p. 466

MacRae, F.J. and Drain, D.J.; British Patent 822,947; November 4, 1959; assigned to T.J. Smith & Nephew Limited

GLYCOPYRROLATE

Therapeutic Function: Antispasmodic

Chemical Name: 3-[(Cyclopentylhydroxyphenylacetyl)oxy]-1,1-dimethylpyrrolidinium bromide

Common Name: Glycopyrrolonium bromide

Structural Formula:

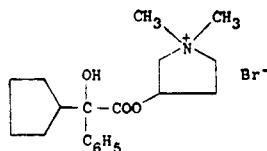

Chemical Abstracts Registry No.: 596-51-0

Trade Name	Manufacturer	Country	Year Introduced
Robinul	Robins	U.S.	1961
Robinul	Robins	U.K.	1962
Robinul	Kaken	Japan	1975
Robinul	Brenner	W. Germany	1975
Asecryl	Martinet	France	—
Gastrodyn	Medica	Finland	—
Nodapton	Geistlich	Switz.	—
Robanul	Lasa	Spain	—
Tarodyl	Lundbeck	—	—

Raw Materials

Methyl α -cyclopentyl mandelate	Sodium
1-Methyl-3-pyrrolidinol	Hydrogen chloride
Methyl bromide	

Manufacturing Process

A mixture of 42.5 grams (0.17 mol) of methyl α -cyclopentyl mandelate and 18 grams (0.175 mol) of 1-methyl-3-pyrrolidinol in 500 ml of heptane was refluxed under a Dean & Stark moisture trap, with the addition of four 0.1 gram pieces of sodium at 1-hour intervals. After 5 hours' refluxing the solution was concentrated to one-half volume, and extracted with cold 3 N HCl. The acid extract was made alkaline with aqueous sodium hydroxide and extracted with ether which was washed, dried over sodium sulfate, filtered and concentrated. The residue was fractionated at reduced pressure. Yield 33 grams (64%); BP 151° to 154°C/0.2 mm, $n_D^{23} = 1.5265$.

The hydrochloride salt was precipitated as an oil from an ethereal solution of the base with ethereal hydrogen chloride. It was crystallized from butanone; MP 170° to 171.5°C.

The methyl bromide quaternary was prepared by saturating a solution of the base in dry ethyl acetate with methyl bromide. After standing for 9 days the resulting crystalline solid was filtered and recrystallized from butanone and from ethyl acetate; MP 193° to 194.5°C.

References

- Merck Index 4365
 Kleeman & Engel p. 448
 PDR pp. 830, 1466
 DOT 18 (3) 128 (1982)
 I.N. p. 467
 REM p. 915
 Lunsford, C.D.; U.S. Patent 2,956,062; October 11, 1960; assigned to A.H. Robins Co., Inc.

GLYMIDINE

Therapeutic Function: Antidiabetic

Chemical Name: N-[5-(2-Methoxyethoxy)-2-pyrimidinyl] benzenesulfonamide

Common Name: Glycodiazine

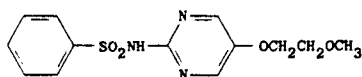
Structural Formula:**Chemical Abstracts Registry No.:** 339-44-6

Trade Name	Manufacturer	Country	Year Introduced
Redul	Bayer/Schering	W. Germany	1964
Gondafon	Schering	U.K.	1966
Gondafon	Schering	Italy	1968
Glycanol	Bayer	Italy	—
Glyconormal	Bayer	France	—
Lycanol	Bayer	Japan	—

Raw Materials

Methoxyethoxyacetaldehyde-di-methoxyethyl acetal
 Phosphorus pentachloride
 Dimethylformamide
 Sodium hydroxide
 Guanidine nitrate
 Benzene sulfonyl chloride

Manufacturing Process

210 g phosphorus pentachloride are gradually added to 252 g methoxyethoxyacetaldehyde-di-methoxyethylacetal with agitation. The mixture is externally cooled with ice to hold the reaction temperature below 25°C. Moisture is carefully excluded. After addition of the condensation agent is completed, the reaction mixture is further agitated at room temperature for 30 minutes. 225 ml dimethylformamide are then added drop by drop while the reaction temperature is held at 20°C to 25°C by external cooling of the reaction vessel with ice. When the dimethylformamide has been added, the temperature is raised to 60°C, and this temperature is maintained for 70 minutes.

The temperature is again lowered to 20°C to 25°C and maintained at this value by cooling with ice while 500 ml methanol are added drop by drop. The resulting solution is admixed drop by drop to a suspension of 240 g powdered caustic soda in 800 ml methanol at 20°C to 25°C. After mixing is completed, stirring is continued for 30 minutes at room temperature. The solution now contains inorganic salts and β -dimethylamino- α -methoxyethoxyacrolein.

200 g guanidine nitrate and thereafter 70 g sodium hydroxide are added to the solution. The methanol is evaporated with agitation. The residue is dissolved in 1.5 liters water and is repeatedly extracted with chloroform. The combined chloroform extracts are evaporated to dryness, and the residue is recrystallized from carbon tetrachloride. 80 g of 2-amino-5-methoxyethoxypyrimidine of MP 80°C to 81°C are obtained.

This material is then dissolved in pyridine. Benzenesulfonylchloride is added and the resulting mixture is heated two hours to 60°C. It is then poured into 300 ml water. The precipitate formed thereby is filtered off and dissolved in dilute ammonium hydroxide. The solution is purified with charcoal, and filtered. The filtrate is acidified with acetic acid to give glymidine.

62 g 2-benzenesulfonamido-5-methoxyethoxypyrimidine are dissolved jointly with 8 g sodium hydroxide in 250 ml ethanol. The solution is evaporated to dryness, and the residue is suspended in 300 ml acetone. The sodium salt of 2-benzenesulfonamido-5-methoxyethoxypyrimidine may be filtered off, washed with acetone, and dried. The yield of glymidine sodium is about 60 g, the MP 220°C to 223°C.

References

Merck Index 4371

Kleeman & Engel p. 448

OCDS Vol. 1 p. 125 (1977)

DOT 1 (2) 72 (1965) & 2 (3) 104 (1966)

I.N. p. 468

Priewe, H. and Gutsche, K.; U.S. Patent 3,275,635; September 27, 1966; assigned to Schering A.G. (W. Germany)

GRAMICIDIN**Therapeutic Function:** Antibacterial**Chemical Name:** Gramicidin D**Common Name:** —

Structural Formula: $\text{HCO}-\text{Val}-\text{Gly}-\text{Ala}-\text{Leu}-\text{Ala}-\text{Val}-\text{Val}-\text{Val}-\left[\begin{array}{c} \text{Trp}-\text{Leu} \\ \text{(L) (D)} \end{array} \right]_3-\text{Trp}-\text{NHCH}_2\text{CH}_2\text{OH}$

Chemical Abstracts Registry No: 113-73-5

Trade Name	Manufacturer	Country	Year Introduced
Gramoderm	Schering	U.S.	1949
Mytrex	Savage	U.S.	—
Neosporin	Burroughs-Wellcome	U.S.	—
Nyst-Olone	Schein	U.S.	—
Tri-Thalamic	Schein	U.S.	—

Raw Materials

Tyrothricin fermentation liquor	Ethanol
Pentane	Benzene
Acetone	

Manufacturing Process

5 lb of acid precipitated solid (Hotchkiss, *Advances in Enzymology*, pages 157-158) from 30 gal of tyrothricin fermentation liquor containing about 40 g (2%) of tyrothricin were extracted with 12 liters of absolute ethyl alcohol and filtered. The filtrate was evaporated in vacuo to 1 liter, and the concentrate extracted twice with 1 liter of pentane. The pentane layers were discarded.

40 g of decolorizing charcoal were added to the pentane-extracted filtrate and filtered off.

To 500 ml of the charcoal-treated filtrate were added 200 ml benzene and 300 ml water, the whole shaken thoroughly, centrifuged, and the benzene layer separated. This treatment of the charcoal-treated filtrate was repeated twice, all benzene fractions were combined and evaporated in vacuo.

200 ml of absolute acetone were added to the residue and concentrated by boiling to 150 ml. The concentrate was refrigerated overnight. The crystals which had formed in the concentrate were filtered off, and the mother liquor concentrated first to 50 ml and then to 25 ml,

the two concentrates refrigerated overnight, and the formed crystals filtered off. Total yield of crystalline gramicidin was 3.85 g = 19.2% of estimated tyrothricin in the initial material.

The combined crystal crops were redissolved in 50 ml absolute acetone, and the solution refrigerated overnight. After filtering, the formed crystals were dried in vacuo. The total yield of crystalline gramicidin thus obtained was 2.5 g.

References

Merck Index 4405

PDR pp. 758, 1604, 1606

I.N. p. 470

REM p. 1203

Baron, A.L.; U.S. Patent 2,534,541; December 19, 1950; assigned to S.B. Penick & Co.

GRISEOFULVIN

Therapeutic Function: Antifungal

Chemical Name: (2S-trans)-7-chloro-2',4,6-trimethoxy-6'-methylspiro[benzofuran-2(3H)-1'-[2] cyclohexene]-3,4'-dione

Common Name: —

Structural Formula:

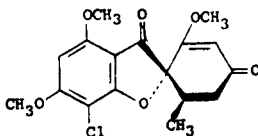

Chemical Abstracts Registry No.: 126-07-8

Trade Name	Manufacturer	Country	Year Introduced
Grifulvin	McNeil	U.S.	1959
Fulvicin	Schering	U.S.	1959
Grisactin	Ayerst	U.S.	1959
Fulcine Forte	I.C.I.	France	1972
Gris-Peg	Dorsey	U.S.	1975
Delmofulvina	Coli	Italy	—
Fulcin	Cepharma	Italy	—
Fungivin	Nyegaard	Norway	—
Gricin	Arzneimittelwerk Dresden	E. Germany	—
Grifulin	Teva	Israel	—
Grifulvin	Yamanouchi	Japan	—
Grisefuline	Clin-Comar-Byla	France	—
Grisetin	Nippon Kayaku	Japan	—
Grisovin	Fujisawa	Japan	—
Guservin	Chugai	Japan	—
Lamoryl	Lovens	Denmark	—
Likuden	Hoechst	W. Germany	—

Raw Materials

Bacterium *Penicillium patulum*
Corn steep liquor

Manufacturing Process

Corn steep liquor nitrogen	0.40% w/v
KH ₂ PO ₄	0.40% w/v
CaCO ₃	0.40% w/v
KCl	0.20% w/v
Mobilpar S	0.0275% v/v
White mineral oil	0.0275% v/v
H ₂ SO ₄	0.0125% v/v
Preinoculation volume	800 gal
Fermentation temperature	25°C
Inoculum volume	10%

The experiment was carried out on the 1,000 gallon scale. Three impellers 1'8" diameter at 220 rpm were employed. The air rates were 0 to 5 hours, 40 cfm, 5 to 10 hours, 80 cfm and after 10 hours, 125 cfm. The inoculum rate was 10% v/v. It was prepared by the standard inoculum development technique on the following medium:

Corn steep liquor nitrogen	0.30% w/v
Brown sugar	2.0% w/v
Chalk	1.0% w/v
Maize oil	1.0% v/v
Hodag MF	0.033% v/v

This was inoculated with a spore suspension of *P. patulum* (1 liter containing 3-5 x 10⁷ spores/ml) and grown at 25°C in 100 gallon tank. The inoculum is transferred at 40 hours or when the mycelial volume (after spinning 10 minutes at 3,000 rpm) exceeds 25%. The fermentation is conducted as near to the ideal pH curve as possible by addition of crude glucose, according to U.S. Patent 3,069,328.

References

- Merck Index 4420
 Kleeman & Engel p. 449
 PDR pp. 621, 931, 1307, 1620
 OCDS Vol. 1 p. 314 (1977)
 I.N. p. 471
 REM p. 1228
 Hockenhull, D.J.D.; U.S. Patent 3,069,328; December 18, 1962; assigned to Glaxo Laboratories Limited, England
 Dorey, M.J., Mitchell, I.L.S., Rule, D.W. and Walker, C.; U.S. Patent 3,069,329; Dec. 18, 1962; assigned to Glaxo Laboratories Limited, England

GUAIFENESIN

Therapeutic Function: Expectorant

Chemical Name: 3-(2-Methoxyphenoxy)-1,2-propanediol

Common Name: Guaiacol glyceryl ether

Structural Formula:

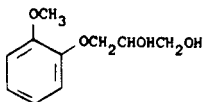

Chemical Abstracts Registry No.: 93-14-1

Trade Name	Manufacturer	Country	Year Introduced
GG Cen	Central	U.S.	1975
Breonasin	Breon	U.S.	1980
Cremacoat	Vicks	U.S.	1983
Ambenyl	Marion	U.S.	—
Asbron G	Sandoz	U.S.	—
Balminil	Rougier	Canada	—
Bromphen	Schein	U.S.	—
Bronchol	Streuli	Switz.	—
Broncovanil	Scharper	Italy	—
Brondecon	Parke Davis	U.S.	—
Bronkolixir	Winthrop-Breon	U.S.	—
Bronkotuss	Hyrex	U.S.	—
Congess	Fleming	U.S.	—
Cortussin	Xttrium	U.S.	—
Corutrol	Dow	U.S.	—
Coryban	Pfipharmecs	U.S.	—
Deconsel	Adams	U.S.	—
Detussin	Schein	U.S.	—
Dilaudid	Knoll	U.S.	—
Dilur-G	Savage	U.S.	—
Donatussin	Laser	U.S.	—
Dorcol	Dorsey	U.S.	—
Dura-Vent	Dura	U.S.	—
Entex	Norwich-Eaton	U.S.	—
Entuss	Hauck	U.S.	—
Fedahist	Rorer	U.S.	—
Gaiaspect	Eri	Canada	—
Guajacuran	Spofa	Czechoslovakia	—
Guajasyll	Mepha	Switz.	—
Guiatuss	Schein	U.S.	—
Gvaja	Lek	Yugoslavia	—
Head & Chest	Procter & Gamble	U.S.	—
Histalet	Reid-Rowell	U.S.	—
Humibid	Adams	U.S.	—
Hustosil	Kyoto	Japan	—
Hycotuss	Du Pont	U.S.	—
Hytuss	Hyrex	U.S.	—
Lufyllin	Wallace	U.S.	—
Mucostop	Verla	W. Germany	—
Mudrane	Poythess	U.S.	—
Naldecon	Bristol	U.S.	—
Neo-Spec	Neo	Canada	—
Novahistine	Lakeside	U.S.	—
Nucofed	Beecham	U.S.	—
Quibron	Mead Johnson	U.S.	—
Reorganin	Brunnengraber	U.S.	—
Resyl	Ciba	Italy	—
Robitussin	Robins	U.S.	—
Ru-Tuss	Boots	U.S.	—
Scot-Tussin	Scot-Tussin	U.S.	—
Sinufed	Hauck	U.S.	—
Sorbutuss	Dalín	U.S.	—
Triaminic	Dorsey	U.S.	—
Tussar	U.S.V.	U.S.	—
Tussend	Merrell-Dow	U.S.	—
Zephrex	Bock	U.S.	—

Raw Materials

o-Methoxyphenol (guaiacol)
Glycidol

Manufacturing Process

A mixture of o-methoxyphenol (57 g), glycidol (32 g) and pyridine (1 g) is warmed to 95°C at which temperature a vigorous reaction takes place. The reaction mixture is cooled to prevent the temperature rising above 110°C. When the exothermic reaction has subsided the reactants are heated at 95°C for one hour longer and then distilled under low pressure. The main fraction boils in the range 176°C to 180°C/0.5 mm. It crystallizes on cooling. Recrystallization from benzene gives the pure product, MP 78.5°C to 79.0°C.

References

Merck Index 4432

Kleeman & Engel p. 449

OCDS Vol. 1 p. 118 (1977)

I.N. p. 472

REM p. 868

Bradley, W. and Forrest, J.; British Patent 628,497; August 30, 1949; assigned to British Drug Houses, Ltd.

GUANABENZ

Therapeutic Function: Antihypertensive

Chemical Name: 2-[(2,6-Dichlorophenyl)methylene]hydrazinecarboximidamide

Common Name: —

Structural Formula:

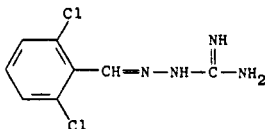

Chemical Abstracts Registry No.: 5051-62-7

Trade Name	Manufacturer	Country	Year Introduced
Wytensin	Wyeth	U.S.	1982
Rexitene	L.P.B.	Italy	—

Raw Materials

2,6-Dichlorobenzaldehyde
Aminoguanidine bicarbonate

Manufacturing Process

A mixture of 14.0 g of 2,6-dichlorobenzaldehyde, 10.8 g of aminoguanidine bicarbonate and 100 ml of pyridine was refluxed for 3 hours. The reaction mixture was poured into water and the crystalline precipitate filtered off; MP 225°C to 227°C.

References

- Merck Index 4436
 DFU 1 (11) 523 (1976)
 Kleeman & Engel p. 451
 PDR p. 1997
 OCDS Vol. 2 p. 123 (1980)
 DOT 15 (11) 481 (1979)
 I.N. p. 473
 REM p. 846
 Yates, J. and Haddock, E.; British Patent 1,019,120; February 2, 1966; assigned to Shell International Research Maatschappij N.V. (Netherlands)

GUANADREL SULFATE

Therapeutic Function: Antihypertensive

Chemical Name: (1,4-Dioxaspiro[4.5] decan-2-ylmethyl)guanidine sulfate

Common Name: —

Structural Formula:

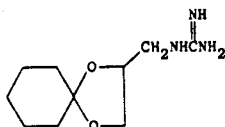

(base)

Chemical Abstracts Registry No.: 40580-59-4 (Base)

Trade Name	Manufacturer	Country	Year Introduced
Hylorel	Pennwalt	U.S.	1983
Hycoral	Pennwalt	W. Germany	1983
Anarel	Cutter	U.S.	—

Raw Materials

- 1,4-Dioxaspiro[4.5] decane-2-methylamine
 2-Methyl-2-thiopseudourea sulfate

Manufacturing Process

A mixture of 10.5 g of 1,4-dioxaspiro[4.5] decane-2-methylamine and 8.6 g of 2-methyl-2-thiopseudourea sulfate in 40 ml of water was heated on the steam bath for 4 hours during which 2.0 g of methylmercaptan was collected in a dry ice bath connected to the reaction flask through a water cooled reflux condenser. The reaction mixture was then evaporated at 15 mm pressure to a solid residue which was then dissolved in 80 ml of 50/50 methanol-ethanol. The solution was filtered and evaporated to approximately 50 ml volume and allowed to cool and crystallize, giving a crop melting at 213.5°C to 215°C of 1,4-dioxaspiro[4.5] decan-2-ylmethyl-guanidine sulfate.

References

- Merck Index 4438
 Kleeman & Engel p. 451
 PDR p. 1398

OCDS Vol. 1 p. 400 (1977)

DOT 16 (4) 140 (1980)

I.N. p. 473

REM p. 907

Hardie, W.R. and Aaron, J.E.; U.S. Patent 3,547,951; December 15, 1970

GUANETHIDINE SULFATE

Therapeutic Function: Antihypertensive

Chemical Name: [2-(hexahydro-1(2H)-azocinyl)ethyl] guanidine sulfate

Common Name: —

Structural Formula:

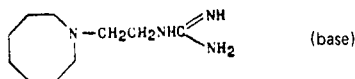

Chemical Abstracts Registry No.: 60-02-6; 55-65-2 (Base)

Trade Name	Manufacturer	Country	Year Introduced
Ismelin	Ciba	U.S.	1960
Ismelin	Ciba	W. Germany	1960
Ismelin	Ciba	U.K.	1960
Ismelin	Ciba	Italy	1961
Ismeline	Ciba Geigy	France	1963
Abapresin	Polfa	Poland	—
Antipres	Protea	Australia	—
Dopom	Galter	Italy	—
Ganda	Smith & Nephew	U.K.	—
Iporal	Euro-Labor	Portugal	—
Ipotidina	Francia	Italy	—
Izobarin	Pliva	Yugoslavia	—
Normalin	Taro	Israel	—
Pressedin	Chiesi	Italy	—
Santotensin	Egyt	Hungary	—
Visutensil	I.S.F.	Italy	—

Raw Materials

Chloroacetyl guanide	Heptamethyleneimine
Lithium aluminum hydride	Sulfuric acid

Manufacturing Process

13.6 grams of chloroacetyl guanide is added while stirring to a solution of 22.6 grams of heptamethyleneimine in 200 ml of benzene. After warming for 1 hour, and then cooling, the solution is filtered and the filtrate concentrated under reduced pressure. The residue, containing the 2-(1-N,N-heptamethylene-imino)-acetic acid guanide, is suspended in tetrahydrofuran and added to a refluxing solution of 6 grams of lithium aluminum hydride in tetrahydrofuran. After completion of the reaction, the excess of lithium aluminum hydride is decomposed by adding water, then aqueous sodium hydroxide. The solid material is filtered off, the filtrate is acidified with sulfuric acid and the 2-(1-N,N-heptamethylene-imino)-ethyl-guanidine sulfate can be recovered and recrystallized from aqueous ethanol, MP 276° to 281°C (with decomposition).

References

Merck Index 4441

Kleeman & Engel p. 452

PDR p. 797

OCDS Vol. 1 p. 282 (1977) & 2, 100 (1980)

DOT 16 (4) 137 (1980)

I.N. p. 474

Mull, R.P.; U.S. Patent 2,928,829; March 15, 1960; assigned to Ciba Pharmaceutical Products, Inc.

Mull, R.P.; U.S. Patent 3,006,913; October 31, 1961; assigned to Ciba Pharmaceutical Products, Inc.

Mull, R.P.; U.S. Patent 3,055,882; September 25, 1962; assigned to Ciba Corporation

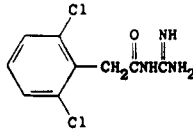
GUANFACINE**Therapeutic Function:** Antihypertensive**Chemical Name:** N-(Aminoiminomethyl)-2,6-dichlorobenzeneacetamide**Common Name:** —**Structural Formula:****Chemical Abstracts Registry No.:** 29110-47-2; 29110-48-3 (Hydrochloride)

Trade Name	Manufacturer	Country	Year Introduced
Estulic	Sandoz	Switz.	1980
Estulic	Sandoz	U.K.	1980
Estulic	Sandoz	W. Germany	1980
Estulic	Wander	France	1981
Estulic	Sandoz	France	1981
Hipertensal	Finadiet	Argentina	—

Raw Materials

2,6-Dichlorophenylacetic acid chloride

Guanidine

Hydrogen chloride

Manufacturing Process

2,6-Dichlorophenyl-acetyl-guanidine: A solution of 3.245 g (0.055 mol) of guanidine in isopropanol is added to a solution of 11.7 g (0.05 mol) of 2,6-dichlorophenyl-acetic acid ethyl ester (BP 142°C to 143°C/12 mm of Hg) in 20 cc of isopropanol. The reaction mixture is allowed to stand overnight and is subsequently concentrated by evaporation. After recrystallizing the residue from methanol/ether 2,6-dichlorophenyl-acetyl-guanidine is obtained in the form of white grains having a MP of 225°C to 227°C.

2,6-Dichlorophenyl-acetyl-guanidine hydrochloride: A solution of 5.6 g (0.025 mol) of 2,6-dichlorophenylacetic acid chloride (BP 137°C to 138°C/12 mm of Hg) in 10 cc of toluene is

added dropwise to a mixture of 4.5 g (0.076 mol) of guanidine and 60 cc of toluene. The reaction mixture is allowed to stand at room temperature for 20 minutes, is then heated on a steam bath for 2 hours and is subsequently cooled. The resulting precipitate is filtered off and washed twice with 25 cc amounts of water in order to separate the guanidine hydrochloride. The residue (2,6-dichlorophenyl-acetyl-guanidine) is washed with chloroform for further purification and is then dissolved in 50 cc of isopropanol. The pH-value of the solution is adjusted to 6 with ethanolic hydrochloric acid and the solution is cooled. The resulting white needles are again washed with chloroform. The resulting 2,6-dichlorophenyl-acetyl-guanidine hydrochloride has a MP of 213°C to 216°C.

References

Merck Index 4442

DFU 2 (4) 278 (1977)

OCDS Vol. 3 p. 40 (1984)

DOT 16 (12) 416 (1980)

I.N. p. 474

REM p. 846

Bream, J.B. and Picard, C.W.; U.S. Patent 3,632,645; January 4, 1972; assigned to Dr. A. Wander S.A. (Switz.)

GUANOXABENZ HYDROCHLORIDE

Therapeutic Function: Antihypertensive

Chemical Name: 1-(2,6-Dichlorobenzylideneamino)-3-hydroxyguanidine hydrochloride

Common Name: —

Structural Formula:

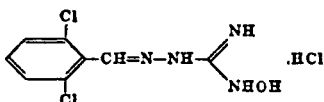

Chemical Abstracts Registry No.: 24047-25-4 (Base)

Trade Name	Manufacturer	Country	Year Introduced
Benezrial	Houde	France	1978

Raw Materials

S-Methylisothiosemicarbazide hydroiodide

Hydroxylamine hydrochloride

2,6-Dichlorobenzaldehyde

Manufacturing Process

2 N sodium hydroxide solution (5 ml) is added to a stirred suspension of S-methylisothiosemicarbazide hydroiodide (2.33 g) and hydroxylamine hydrochloride (0.70 g) in water (6 ml) and stirred for 48 hours. The solution is evaporated in vacuo to provide 1-amino-3-hydroxyguanidine. One-third of the residue is dissolved in 16 ml of ethanol and 2,6-dichlorobenzaldehyde (0.6 g) is added to this solution. The reaction mixture is then stirred for 48 hours. The solution is then evaporated in vacuo and the residue dissolved in ether (30 ml) and in hydrochloric acid (30 ml). The aqueous phase is rendered alkaline with 2 N sodium carbonate solution and extracted with ether. The ether layer is dried with sodium sulfate and evaporated.

The residue is dissolved in ether and excess dry hydrogen chloride is passed into the solution.

The resultant mixture is evaporated in vacuo and the residue triturated with methylene chloride to afford a crude product. Recrystallization from ethanol-ether (1:3) provides 1-(2,6-dichlorobenzylideneamino)-3-hydroxyguanidine hydrochloride; MP 173°C to 175°C. When the above process is carried out and S-benzylisothiosemicarbazide hydroiodide is used in place of S-methylisothiosemicarbazide hydroiodide, the identical product is again obtained.

References

Merck Index 4449

Kleeman & Engel p. 453

OCDS Vol. 2 p. 123 (1980)

DOT 14 (6) 244 (1978)

I.N. p. 474

Houlihan, W.G. and Manning, R.E.; U.S. Patent 3,591,636; July 6, 1971; assigned to Sandoz-Wander, Inc.

H

HALAZEPAM

Therapeutic Function: Tranquilizer

Chemical Name: 7-Chloro-1,3-dihydro-5-phenyl-1-(2,2,2-trifluoroethyl)-2H-1,4-benzodiazepine-2-one

Common Name: —

Structural Formula:

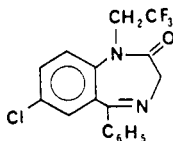

Chemical Abstracts Registry No.: 23092-77-3

Trade Name	Manufacturer	Country	Year Introduced
Paxipam	Schering	U.S.	1981

Raw Materials

7-Chloro-1,3-dihydro-5-phenyl-2H-1,4-benzodiazepine-2-one
Sodium
Methanol
2,2,2-Trifluoroethyl iodide

Manufacturing Process

Prepare a solution of sodium methylate by dissolving 3.9 g of sodium metal in 500 ml of methanol. Add 39.0 g of 7-chloro-1,3-dihydro-5-phenyl-2H-1,4-benzodiazepine-2-one. Evaporate the reaction mixture to a residue and dissolve the residue in 170 ml of dimethylformamide. Add 30 g of 2,2,2-trifluoroethyl iodide and stir at room temperature for ½ hour, then heat to 60°C to 70°C for an additional 7 hours. Add 19 g of 2,2,2-trifluoroethyl iodide and resume the heating and stirring at 60°C to 70°C for an additional 16 hours. Filter off the solids and evaporate the filtrate to a residue in vacuo. Triturate the residue with water and extract with ethyl ether. Wash the ethereal extract with water, dry over anhydrous sodium sulfate and evaporate the solvent to a residue.

Extract the residue with ethyl ether and filter. Concentrate the ethereal extract to a residue. Dissolve the residue in benzene and chromatograph on 300 g of alumina contained in a glass column 1.5 inches in diameter to give the crude product. Elute with benzene. Crystallize this product from acetone-petroleum ether to obtain the product.

References

Merck Index 4472

DFU 3 (2) 109 (1978)

PDR p. 1645

DOT 9 (6) 237 (1973), 11 (5) 191, 211 (1975) & 18 (8) 367 (1982)

I.N. p. 476

REM p. 1062

Topfiss, J.G.; U.S. Patents 3,429,874; Feb. 25, 1969 and 3,641,147; Feb. 8, 1972; both assigned to Schering Corp.

HALCINONIDE

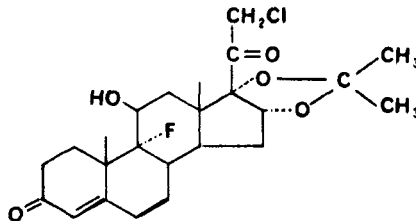
Therapeutic Function: Topical corticosteroid**Chemical Name:** 21-Chloro-9 α -fluoro- Δ^4 -pregnene-11 β ,16 α ,17 α -triol-3,20-dione 16,17-acetonide**Common Name:** —**Structural Formula:****Chemical Abstracts Registry No.:** 3093-35-4

Trade Name	Manufacturer	Country	Year Introduced
Halog	Squibb	U.S.	1974
Halciderm	Squibb	U.K.	1974
Halciderm	Squibb	Italy	1976
Halog	Von Heyden	W. Germany	1977
Halog	Squibb	France	1979
Halciderm	Squibb	U.S.	1980
Adcortin	Sankyo	Japan	1982
Beta Corton	Spirig	Switz.	—
Dihalog	Heyden	W. Germany	—
Halcimat	Heyden	W. Germany	—
Halcort	Fair	U.K.	—
Volog	Squibb	—	—

Raw Materials

16 α -Hydroxy-9 α -fluorohydrocortisone acetonide
 Methane sulfonyl chloride
 Lithium chloride

Manufacturing Process

(A) *16 α -Hydroxy-9 α -fluorohydrocortisone acetonide 21-mesylate:* To a solution of 1.5 g of 16 α -hydroxy-9 α -fluorohydrocortisone acetonide in 15 ml of dry pyridine is added at 0°C, 1.5 ml of methane-sulfonyl chloride. After standing in the refrigerator for 2½ hours, excess methane-sulfonyl chloride is destroyed by the addition of a small amount of ice, after which

ice-water is added slowly to precipitate the reaction product. After ½ hour in the refrigerator the material is filtered off, washed thoroughly with water and dried in vacuo. The resulting crude material after recrystallization from acetone-hexane gives the pure 21-mesylate of the following properties: melting point about 225°C to 227°C (decomposition); $[\alpha]_D^{23} +112^\circ$ (c, 0.5 in chloroform).

(B) *21-Chloro-9 α -fluoro- Δ^4 -pregnene-11 β ,16 α ,17 α -triol-3,20-dione 16,17-acetonide*: A solution of 200 mg of the acetonide 21-mesylate from part (A) and 900 mg of lithium chloride in 25 ml of dimethylformamide is kept at 100°C for 24 hours. The mixture is poured on ice, extracted with chloroform and the chloroform extract washed with water and dried over sodium sulfate. Evaporation of the solvent in vacuo furnishes the crystalline chloride, which after recrystallization from acetone-ethanol has a melting point about 276°C to 277°C.

References

Merck Index 4474

Kleeman & Engel p. 454

PDR p. 1745

OCDS Vol. 2 p. 187 (1980)

DOT 10 (11) 305 (1974)

I.N. p. 477

REM p. 972

Difazio, L.T. and Augustine, M.A.; U.S. Patent 3,892,857; July 1, 1975; assigned to E.R. Squibb & Sons, Inc.

HALOPERIDOL

Therapeutic Function: Antidyskinetic; antipsychotic

Chemical Name: 4-[4-(4-Chlorophenyl)-4-hydroxy-1-piperidinyl]-1-(4-fluorophenyl)-1-butanone

Common Name: —

Structural Formula:

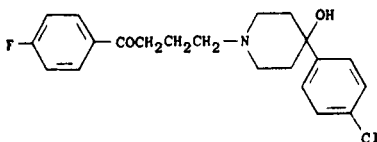

Chemical Abstracts Registry No.: 52-86-8

Trade Name	Manufacturer	Country	Year Introduced
Haldol	Janssen Le Brun	France	1960
Haldol	McNeil	U.S.	1967
Serenace	Searle	U.K.	1969
Fortunan	Steinhard	U.K.	1983
Bioperidolo	Firma	Italy	—
Brotopon	Pfizer Taito	Japan	—
Einalon S	Maruko	Japan	—
Eukystol	Merckle	W. Germany	—
Halidol	Abic	Israel	—
Halo Just	Horita	Japan	—
Haloperidol	Mohan	Japan	—
Halosten	Shionogi	Japan	—

Trade Name	Manufacturer	Country	Year Introduced
Keselan	Sumitomo	Japan	—
Linton	Yoshitomi	Japan	—
Pacedol	Protea	Australia	—
Peluces	Isei	Japan	—
Peridor	Unipharm	Israel	—
Selezyme	Sawai	Japan	—
Serenace	Dainippon	Japan	—
Serenase	Lusofarmaco	Italy	—
Serenase	Orion	Finland	—
Sigaperidol	Siegfried	Switz.	—
Vesadol	Le Brun	France	—

Raw Materials

4-(4-Chlorophenyl)piperidin-4-ol hydrochloride
 1,1-Dimethoxy-1-(4-fluorophenyl)-4-chlorobutane
 Hydrogen chloride
 Ammonia

Manufacturing Process

A stirred slurry of 120.0 parts 4-(4-chlorophenyl)-piperidin-4-ol hydrochloride and 40.0 parts of potassium iodide in 500 parts of water is warmed to a temperature of about 35°C under a nitrogen atmosphere. Then, 70.0 parts of potassium hydroxide is added. After further heating to about 55°C, 138.0 parts of 1,1-dimethoxy-1-(4-fluorophenyl)-4-chlorobutane is added. The temperature is then raised to about 102°C and heating continued for 3.5 hours. After cooling to about 75°C, 785 parts of toluene is added to the reaction mixture and stirred for about 5 minutes. An additional 320 parts of toluene is added and the water and organic layers separated. 102 parts of methanol is used to rinse the flask and added to the organic layer to provide a solution of 4-(4-chlorophenyl)-1-[4-(4-fluorophenyl)-4,4-dimethoxybutyl]-piperidin-4-ol. Then, 59 parts of concentrated hydrochloric acid is added to a stirred solution of the organic layer to precipitate a solid. The solid is filtered, rinsed twice with 550 parts by volume portions of a 10:9:1 acetone-toluene-methanol mixture, twice with 400 parts by volume portions of a 10:1 acetone-methanol mixture, and air-dried. The dried solid is then dissolved in 1,950 parts of methanol with gentle heating on a steam bath. The resulting solution is filtered and 300 parts by volume of concentrated ammonium hydroxide is added. Heating is continued to reflux and maintained thereat for about 1 hour. Then, 2,520 parts of water is added and the slurry stirred at about 75°C for 1.5 hours. After cooling to about 25°C, the solid is filtered, washed twice with 600 parts by volume portions of a 3:1 mixture of water-methanol, and air-dried. The resulting product, 4-[4-(4-chlorophenyl)-4-hydroxypiperidino]-4'-fluorobutyrophenone, is obtained in 32.5% yield. This product melts at about 148.5°C to 150.5°C.

References

Merck Index 4480
 Kleeman & Engel p. 454
 PDR p. 1089
 OCDS Vol. 1 p. 306 (1977)
 DOT 9 (6) 234 (1973)
 I.N. p. 478
 REM p. 1088
 Dryden, H.L. Jr. and Erickson, R.A.; U.S. Patent 4,086,234; April 25, 1978; assigned to G.D. Searle & Co.

HALOPREDONE ACETATE

Therapeutic Function: Topical antiinflammatory

Chemical Name: 17,21-Bis(acetyloxy)-2-bromo-6,9-difluoro-11-hydroxypregna-1,4-diene-3,20-dione

Common Name: —

Structural Formula:

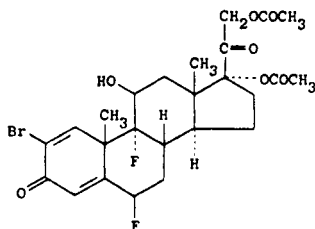

Chemical Abstracts Registry No.: 57781-14-3; 57781-15-4 (Base)

Trade Name	Manufacturer	Country	Year Introduced
Topicon	Pierrel	Italy	1983

Raw Materials

2-Bromo-6 β -fluoro-17 α ,21-dihydroxy-9 β ,11 β -oxido-pregna-1,4-diene-3,20-dione-17,21-diacetate
Hydrogen fluoride

Manufacturing Process

100 ml of a 70% hydrofluoric acid aqueous solution were cooled to -10°C in a polyethylene flask equipped with electromagnetic stirrer. 10 g of 2-bromo-6 β -fluoro-17 α ,21-dihydroxy-9 β ,11 β -oxido-pregna-1,4-diene-3,20-dione-17,21-diacetate were added under stirring during 15 minutes. After $\frac{1}{2}$ hour the reaction mixture was precipitated in water and ammonia. The solid was collected by filtration, washed with water and dried to a constant weight, giving about 9.5 g of 2-bromo-6 β ,9 α -difluoro-11 β ,17 α ,21-trihydroxypregna-1,4-diene-3,20-dione-17,21-diacetate.

References

Merck Index 4481
DFU 1 (11) 526 (1976)
Kleeman & Engel p. 456
OCDS Vol. 3 p. 99 (1984)
I.N. p. 478
Riva, M. and Toscano, L.; U.S. Patent 4,272,446; June 9, 1981; assigned to Pierrel S.p.A. (Italy)

HALOPROGIN

Therapeutic Function: Antibacterial

Chemical Name: 3-iodo-2-propynyl 2,4,5-trichlorophenyl ether

Common Name: 2,4,5-trichlorophenyl γ -iodopropargyl ether

Structural Formula:

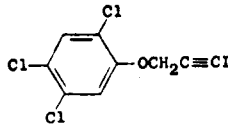

Chemical Abstracts Registry No.: 777-11-7

Trade Name	Manufacturer	Country	Year Introduced
Halotex	Westwood	U.S.	1972
Mycanden	Schering	W. Germany	1975
Mycilan	Schering	France	1978
Mycilan	Theraplix	France	—
Polik	Meiji	Japan	—

Raw Materials

2,4,5-Trichlorophenyl propargyl ether
Cuprous chloride
Iodine

Manufacturing Process

4.7 grams of 2,4,5-trichlorophenyl propargyl ether (MP 64° to 65°C) are added to an aqueous solution of cupro-ammonium complex salt which has been prepared by warming a mixture of 4.0 grams of cuprous chloride, 11.0 grams of ammonium carbonate and 20 cc of water to 50°C. The resulting admixture is shaken vigorously. The cuprous acetylide deposited is filtered, washed with water and suspended in 100 cc of water, and the suspension is mixed under agitation with a solution of 5.0 grams of iodine and 5.0 grams of potassium iodide in 15 cc of water. The mixture is stirred for a period of 1 hour. The precipitate is filtered, washed with water and extracted with ether. After the drying of the ethereal extract, the solvent is distilled off. Recrystallization of the residue from n-hexane gives about 5.6 grams of 2,4,5-trichlorophenyl iodopropargyl ether, MP 114° to 115°C.

References

Merck Index 4483
Kleeman & Engel p. 456
PDR p. 1891
DOT 8 (8) 292 (1972)
I.N. p. 478
REM p. 1228
Seki, S., Nomiya, B. and Ogawa, H.; U.S. Patent 3,322,813; May 30, 1967; assigned to Meiji Seika Kaisha, Ltd., Japan

HALOTHANE

Therapeutic Function: Inhalation anesthetic

Chemical Name: 2-bromo-2-chloro-1,1,1-trifluoroethane

Common Name: —

Structural Formula: F₃CCHBrCl

Chemical Abstracts Registry No.: 151-67-7

Trade Name	Manufacturer	Country	Year Introduced
Fluothane	Ayerst	U.S.	1958
Fluopan	Propan-Lipworth	S. Africa	—
Fluothane	I.C.I.	U.K.	—
Halan	Arzneimittelwerk Dresden	E. Germany	—
Halothan Hoechst	Hoechst	W. Germany	—
Halovis	Vister	Italy	—
Narcotan	Spofa	Czechoslovakia	—
Rhodialothan	Rhodia Pharma	W. Germany	—
Somnothane	Hoechst	—	—

Raw Materials

1,1,1-Trifluoro-2-chloroethane
Bromine

Manufacturing Process

According to U.S. Patent 2,849,502, the apparatus used consisted of a 2" x 24" silica tube packed with silica chips and enclosed in a vertical electric furnace. 1,1,1-trifluoro-2-chloroethane as vapor and bromine as liquid were introduced into a narrow tube passing down the inside of the reaction tube. The mixed reactants then passed up through the reaction tube which was maintained at a temperature of about 465°C. The reaction products were passed through a water-cooled condenser which condensed out most of the desired 1,1,1-trifluoro-2-bromo-2-chloroethane along with any high boiling by-products and unchanged bromine.

This condensate was washed with dilute caustic soda solution and dried over calcium chloride. The exit gases from this condenser were scrubbed with water and dilute caustic soda solution, dried and passed to a condenser cooled with a mixture of solid carbon dioxide and trichloroethylene which caused the unchanged 1,1,1-trifluoro-2-chloroethane to condense. This second condensate was then combined with the first and the mixture was fractionally distilled.

During a run of 2 hours 620 grams of 1,1,1-trifluoro-2-chloroethane and 630 grams of bromine were fed to the reactor and the product was worked up as described above. On fractional distillation there was obtained a first cut up to 50°C consisting of unchanged 1,1,1-trifluoro-2-chloroethane, then a middle cut between 50° and 52°C consisting of substantially pure 1,1,1-trifluoro-2-bromo-chloroethane and a higher boiling residue that contained a further quantity of the desired product together with some 1,1,1-trifluoro-2,2-dibromo-2-chloroethane. On redistillation of the middle fraction pure 1,1,1-trifluoro-2-bromo-2-chloroethane was obtained with BP 50° to 50.5°C.

References

Merck Index 4486

Kleeman & Engel p. 457

PDR p. 620

I.N. p. 479

REM p. 1042

Suckling, C.W. and Raventos, J.; U.S. Patent 2,849,502; August 26, 1958; assigned to Imperial Chemical Industries Limited, England

Suckling, C.W. and Raventos, J.; U.S. Patent 2,921,098; January 12, 1960; assigned to Imperial Chemical Industries, Limited, England

Scherer, O. and Kuhn, H.; U.S. Patent 2,959,624; November 8, 1960; assigned to Farbwerke Hoechst AG vormalis Meister Lucius & Bruning, Germany

McGinty, R.L.; U.S. Patent 3,082,263; March 19, 1963; assigned to Imperial Chemical Industries Limited, England

HEPARIN

Therapeutic Function: Anticoagulant

Chemical Name: See structural formula

Common Name: —

Structural Formula:

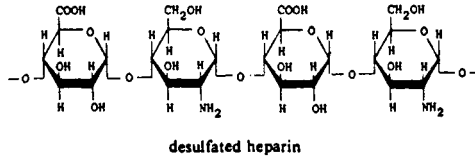

Chemical Abstracts Registry No.: 9005-49-6

Trade Name	Manufacturer	Country	Year Introduced
Heparin	Upjohn	U.S.	1942
Heprinar	Armour	U.S.	1976
Chemyparin	S.I.T.	Italy	—
Clearane	Jamco	Italy	—
Disebrin	Tubi Lux Pharma	Italy	—
Embolex	Sandoz	U.S.	—
Endoprin	Endo	U.S.	—
Eparina	Vister	Italy	—
Eparinoral	Bruco	Italy	—
Eparinavis	Vis	Italy	—
Fioricet	Sandoz	U.S.	—
Hamocura	Nordmark	W. Germany	—
Hepacort Plus	Rona Labs	U.K.	—
Hepa Gel	Spirig	Switz.	—
Heparin-Pos	Ursapharm	W. Germany	—
Heparin Sodium	Tokyo Tanabe	Japan	—
Heparinin	Sankyo	Japan	—
Hepathromb	Arzneimittelwerk Dresden	E. Germany	—
Hep-Lock	Elkins-Sinn	U.S.	—
Hepsal	Weddel	U.K.	—
Liquaemin	Organon	U.S.	—
Minihep	Leo	U.K.	—
Percase	Solac	France	—
Praecivenin	Pfleger	W. Germany	—
Pularin	Evans	U.K.	—
Thrombareduct	Azuchemie	W. Germany	—
Thromophob	Nordmark	W. Germany	—
Thrombo-Vetren	Promonta	W. Germany	—

Raw Materials

Beef intestine	Water
Chloroform	Toluene

Manufacturing Process

5,000 pounds of beef intestine was introduced into a stainless steel reactor, jacketed with thermostated water and steam. 200 gallons of water and 10 gallons of chloroform were added. The mixture was agitated, the temperature was raised to 90°F and the agitation

stopped. 5 gallons of toluene was added and the vessel closed. Autolysis was continued for 17 hours.

The extractant solution, consisting of 30 gallons of glacial acetic acid, 35 gallons of 30% aqueous ammonia, 50% sodium hydroxide to adjust the pH to 9.6 at 80°F and water to make 300 gallons, was added to the tissue. With agitation, the temperature was raised to 60°C and held there for 2 hours. Then steam was applied and the temperature was raised to boiling. 200 pounds of coarse filter aid (perlite) was added and the mixture filtered through a string discharge vacuum filter. The cake was washed with 200 gallons of hot water on the filter.

The filtrate was allowed to stand overnight and the fat skimmed off the top. After cooling to 100°F, the filtrate was transferred to a tank with thermostated water and the temperature set at 95° to 100°F. 24 gallons of pancreatic extract, prepared as described above, was added in 4-gallon increments every 12 hours for 3 days. The batch was brought to a boil and cooled to room temperature.

The batch was then filtered into a vessel and assayed for heparin content. 40,000,000 units were found in 1,000 gallons of filtrate. 20 kg of n-octylamine was added and 105 pounds of glacial acetic acid was added to bring the pH to 6.5. 20 gallons of methyl isobutyl ketone was added and the whole mixture was vigorously agitated for 1 hour. The mixture was then allowed to stand overnight. The clear, aqueous phase was drained off and discarded. The grayish-brown interphase was then removed, together with a small amount of the ketone phase, and transferred into a small kettle. The interphase volume was 7 gallons.

30 gallons of methanol was added and the mixture warmed to 120°F and then the pH was adjusted to 9.0. The mixture was then allowed to settle overnight. The solids were collected with vacuum and washed with 5 gallons of methanol. The cake was then suspended in 5 gallons of water and the heparin precipitated with 10 gallons of methanol. The solids were collected under vacuum. The dry weight of the cake was 1,000 grams and the total units were 38,000,000, according to U.S. Patent 2,884,358.

References

Merck Index 4543

Kleeman & Engel p. 458

PDR pp. 872, 887, 1286, 1581, 1845, 1949

I.N. p. 481

REM p. 828

Bush, J.A., Freeman, L.D. and Hagerty, E.B.; U.S. Patent 2,884,358; April 28, 1959; assigned to Southern California Gland Company

Nomine, G., Penasse, L. and Barthelemy, P.; U.S. Patent 2,989,438; June 20, 1961; assigned to UCLAF, France

Toccaceli, N.; U.S. Patent 3,016,331; January 9, 1962; assigned to Ormonoterapia Richter SpA, Italy

HEPRONICATE

Therapeutic Function: Peripheral vasodilator

Chemical Name: Nicotinic acid triester with 2-hexyl-2-(hydroxymethyl)-1,3-propanediol

Common Name: —

Structural Formula:

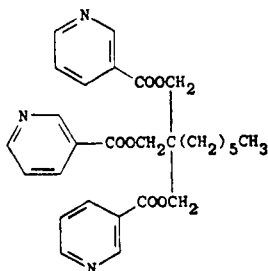

Chemical Abstracts Registry No.: 7237-81-2

Trade Name	Manufacturer	Country	Year Introduced
Megrin	Yoshitomi	Japan	1972

Raw Materials

2-Hexyl-2-(hydroxymethyl)-1,3-propanediol
 Nicotinic acid
 p-Toluene sulfonyl chloride

Manufacturing Process

In 50 ml of pyridine were dissolved 50 grams of nicotinic acid and 50 grams of p-toluene-sulfonyl chloride. While stirring, the mixture gradually became hot and colorless, and finally solidified. To the mixture was added dropwise a solution of 19 grams of 2-hexyl-2-(hydroxymethyl)-1,3-propanediol in 400 ml of pyridine at a temperature below 80°C. The mixture was heated at 115° to 125°C on an oil bath for 1 hour. After cooling, the mixture was poured into 300 ml of ice water, and extracted with toluene. The toluene layer was washed in sequence with water, aqueous sodium carbonate and water, dried over potassium carbonate, and then the toluene was distilled off. The oily residue was crystallized from ethanol to give 30 grams of 2-hexyl-2-(hydroxymethyl)-1,3-propanediol tri-nicotinate, melting at 94° to 96°C. The yield was 59.5%.

References

Merck Index 4545

Kleeman & Engel p. 459

DOT 8 (8) 314 (1972)

I.N. p. 482

Nakanishi, M., Kobayashi, R. and Arimura, K.; U.S. Patent 3,384,642; May 21, 1968; assigned to Yoshitomi Pharmaceutical Industries, Ltd., Japan

HEPTABARBITAL**Therapeutic Function:** Hypnotic; sedative**Chemical Name:** 5-(1-Cyclohepten-1-yl)-5-ethyl-2,4,6(1H,3H,5H)-pyrimidinetrione**Common Name:** —

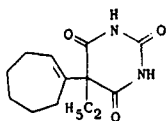
Structural Formula:

Chemical Abstracts Registry No.: 509-86-4

Trade Name	Manufacturer	Country	Year Introduced
Medomine	Ciba Geigy	France	1948
Medomin	Geigy	U.S.	1955

Raw Materials

Cycloheptanone	Sodium
Cyanoacetic acid methyl ester	Ethanol
Ethyl bromide	Urea
Hydrogen chloride	

Manufacturing Process

112 g of cycloheptanone (suberone) are mixed with 130 g of cyanoacetic acid methyl ester, 2 g of piperidine are added, and the mixture is heated on the water bath at 60°C for several hours until no more water separates from the reaction mixture. The water layer is removed, and the remainder is subjected to distillation in vacuo. The fraction distilling at 160°C to 175°C under a pressure of 20 mm is collected separately; it consists of cycloheptenyl-cyanoacetic acid methyl ester. The first fractions can be subjected to a fresh condensing reaction after addition of more piperidine.

The cycloheptenyl-cyanoacetic acid methyl ester so obtained is a colorless liquid boiling at 174°C under a pressure of 20 mm.

Into this compound, an ethyl radical is introduced at the same C-atom to which the cycloheptenyl radical is connected. This is done, for example, in the following way:

19.3 g of the above ester are added to a solution of 2.3 g of sodium in 40 cc of absolute ethyl alcohol. To this mixture, 13.0 g of ethyl bromide are gradually added while cooling, and the reaction mixture is heated under reflux on a water bath until it has become neutral. The mixture is then taken up in water, the aqueous layer is separated and the cycloheptenyl-ethyl-cyanoacetic acid methyl ester so formed distills at 169°C to 170°C under a pressure of 20 mm.

22.1 g of this latter substance are dissolved in a solution of 4.6 g of sodium in 100 cc of absolute ethyl alcohol. 12 g of urea are further added thereto, and the whole solution is heated to about 80°C for about eight hours. The alcohol is then distilled off in vacuo, the residue is dissolved in cold water, and from this solution, C-C-cycloheptenyl-ethyl barbituric acid is obtained by saponification with diluted hydrochloric acid. The crude product is recrystallized from diluted ethyl alcohol and forms colorless needles of faintly bitter taste and melting point 174°C.

The sodium salt of this acid may be prepared by dissolving 2.5 g of the acid in a solution of 0.23 g of sodium in 20 cc of ethyl alcohol, and the salt forms, after evaporating the alcohol, a colorless, water-soluble powder.

References

- Merck Index 4546
 Kleeman & Engel p. 459
 OCDS Vol. 1 pp. 269, 272 (1977)
 I.N. p. 482
 Taub, W.; U.S. Patent 2,501,551; March 21, 1950

HETACILLIN POTASSIUM

Therapeutic Function: Antibacterial

Chemical Name: 6-(2,2-dimethyl-5-oxo-4-phenyl-1-imidazolidinyl)-3,3-dimethyl-7-oxo-4-thia-1-azabicyclo[3.2.0]heptane-2-carboxylic acid potassium salt

Common Name: Phenazacillin

Structural Formula:

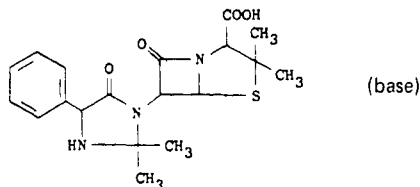

Chemical Abstracts Registry No.: 5321-32-4; 3511-16-8 (Base)

Trade Name	Manufacturer	Country	Year Introduced
Natacillin	Bristol-Banyu	Japan	1970
Versapen	Bristol	Italy	1970
Versapen	Bristol	France	1970
Versapen	Bristol	U.S.	1971
Hetabiotic	Bristol-Myers	—	—
Hetacin-K	Bristol	—	—
Penplenum	Bristol	W. Germany	—
Uropen	Bristol	—	—

Raw Materials

α -Aminobenzylpenicillin
Acetone

Manufacturing Process

To 100 grams of α -aminobenzylpenicillin slurried in 2,500 ml of acetone is added 200 ml of a 22% solution of potassium ethylhexanoate in dry n-butanol and the mixture is warmed to 45°C whereupon the acid dissolves. After the mixture is agitated for 1 hour at 40° to 45°C, the product begins to crystallize out. Agitation is continued for 4 hours at 45°C after which the product, the potassium salt of hetacillin, is collected by filtration, washed with 500 ml of dry acetone, dried for 17 hours at 40°C and found to weigh 70.0 grams.

References

Merck Index 4564
Kleeman & Engel p. 460
OCDS Vol. 1 p. 414 (1977)
DOT 3 (1) 12 (1967)
I.N. p. 483
REM p. 1200
Johnson, D.A. and Panetta, C.A.; U.S. Patent 3,198,804; August 3, 1965; assigned to Bristol-Myers Company

HEXACHLOROPHENE

Therapeutic Function: Topical antiinfective

Chemical Name: 2,2'-methylenebis(3,4,6-trichlorophenol)

Common Name: —

Structural Formula:

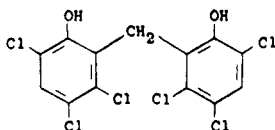

Chemical Abstracts Registry No.: 70-30-4

Trade Name	Manufacturer	Country	Year Introduced
Gamophen	Ethicon	U.S.	1950
Phisohex	Winthrop	U.S.	1954
Germa-Medica	Huntington	U.S.	1979
Hexascrub	Prof. Disposables	U.S.	1980
Pre-Op	Davis & Geck	U.S.	1980
Turgex	Xttrium	U.S.	1981
Coopaphene	McDougall & Robertson	U.K.	—
Dermadex	Alconox	U.S.	—
Dermohex	Hartz	Canada	—
G-11	Givaudan	Switz.	—
Germibon	Gamir	Spain	—
Heksaden	Deva	Turkey	—
Hexal	Fischer	Israel	—
Solu-Heks	Mustafa Nevzat	Turkey	—
Soy-Dome	Dome	U.S.	—
Ster-Zac	Hough	U.K.	—
Wescohex	West	U.S.	—
Westasept	West	U.S.	—

Raw Materials

2,4,5-Trichlorophenol
Paraformaldehyde

Manufacturing Process

A mixture of 198 grams of 2,4,5-trichlorophenol and 18.8 grams of paraformaldehyde was heated to 65°C and well stirred. 65 grams of oleum 20% was added dropwise and the addition was so regulated that the temperature increased, without the application of external heat, until it reached 135°C at the end of the acid addition, which took 10 to 15 minutes. The contents of the reaction vessel were stirred for 2 minutes more and then allowed to run into a solution of 100 grams of sodium hydroxide in 1,000 cc of water.

The reaction flask was washed with a solution of 25 grams of sodium hydroxide in 250 cc of water. The combined alkaline solutions were heated to boiling for 5 minutes. A small amount (6 grams) of alkali-insoluble material remained and was filtered off. Sulfuric acid (62% H₂SO₄ content) was then added at room temperature dropwise under stirring to the filtrate until a pH of 10.3 was reached. This required about 80 grams of the acid. The monosodium salt of bis-(3,5,6-trichloro-2-hydroxyphenyl) methane precipitated out of solution and was filtered and then washed with 200 cc of water. The salt was then sus-

pended in 2,000 cc of water and sulfuric acid (62% H₂SO₄ content) was added under stirring until the contents were acid to Congo red paper. This required about 30 grams of the acid.

The resulting bis-(3,5,6-trichloro-2-hydroxyphenyl) methane was filtered, washed with water until acid-free and dried to constant weight at 100°C (170 grams, MP 154° to 158°C). Crystallization of the 170 grams of dried bis-(3,5,6-trichloro-2-hydroxyphenyl) methane from 300 grams toluene yielded a first crop amounting to 105 grams of substantially pure bis-(3,5,6-trichloro-2-hydroxyphenyl) methane, having a MP of 161° to 163°C (from U.S. Patent 2,435,593).

References

Merck Index 4574

Kleeman & Engel p. 461

PDR p. 1926

I.N. p. 484

REM p. 1161

Gump, W.S.; U.S. Patent 2,250,480; July 29, 1941; assigned to Burton T. Bush, Inc.

Luthy, M. and Gump, W.S.; U.S. Patent 2,435,593; February 10, 1948; assigned to Burton T. Bush, Inc.

Gump, W.S., Luthy, M. and Krebs, H.G.; U.S. Patent 2,812,365; November 5, 1957; assigned to The Givaudan Corporation

HEXAMETHONIUM BROMIDE

Therapeutic Function: Antihypertensive

Chemical Name: N,N,N,N',N',N'-Hexamethyl-1,6-hexanediaminium bromide

Common Name: —

Structural Formula: (CH₃)₃N⁺(CH₂)₆N⁺(CH₃)₃·2Br⁻

Chemical Abstracts Registry No.: 60-26-4 (Hexamethonium)

Trade Name	Manufacturer	Country	Year Introduced
Bistrium	Squibb	U.S.	1951
Hexanium	Adrian-Marinier	France	—
Methobromin	Yamanouchi	Japan	—
Vegolysen	May & Baker	—	—

Raw Materials

Hexamethylene diamine	Dimethyl sulfate
Sodium hydroxide	Hydrogen bromide

Manufacturing Process

Hexamethylene diamine (116 g), sodium carbonate (466 g), and water (800 ml) were heated to 60°C, and dimethyl sulfate (830 g) added with stirring over 1½ hours keeping the temperature below 90°C. The reaction mixture was then stirred at 90°C for 2 hours, then cooled to 20°C, acetone (1,200 ml) added and the whole cooled to 0°C.

The solid formed was removed by filtration and washed with acetone (150 ml). Filtrate and washings were diluted with water to 4 liters and heated to 60°C under reflux. To this was

added a solution prepared from embonic acid (388 g), sodium hydroxide (80 g) and water (5 liters), the whole refluxed for 10 minutes and thereafter allowed to cool overnight.

The resultant embonate (530 g) was filtered off, washed twice with a solution of acetone (75 ml) in water (425 ml), and dried at 100°C to give an amorphous yellow powder, MP 290°C to 291°C (with decomp.). 588 g of the embonate was dissolved in boiling water (4 liters).

Hydrobromic acid 50% w/w (325 g) diluted with water (2 liters) was added slowly at the boil and the precipitated embonic acid removed by filtering hot and washing twice with hot water (1 liter). The filtrate and washings were evaporated to dryness in a steam pan and the residue recrystallized from ethyl alcohol (1,200 ml), to yield the dibromide (320 g).

References

Merck Index 4582

Kleeman & Engel p. 462

I.N. p. 485

Barber, H.J.; U.S. Patent 2,641,610; June 9, 1953; assigned to May & Baker, Ltd. (U.K.)

HEXESTROL

Therapeutic Function: Estrogen

Chemical Name: 4,4'-(1,2-diethyl-1,2-ethanediyl)bisphenol

Common Name: dihydrodiethylstilbestrol; hexoestrol

Structural Formula:

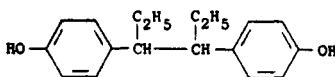

Chemical Abstracts Registry No.: 84-16-2

Trade Name	Manufacturer	Country	Year Introduced
Estra Plex	Rowell	U.S.	1956
Cycloestrol	Bruneau	France	—
Estrene	Lepetit	—	—
Femirogen	Fuso	Japan	—
Folliplex	Recip	Sweden	—
Hexron	Teikoku Zori	Japan	—
Hormoestrol	Siegfried	W. Germany	—
Syntex	Pharmacia	Sweden	—
Synthovo	Boots	U.K.	—

Raw Materials

p-Hydroxypropiophenone	Sodium amalgam
Hydrogen chloride	Hydrogen iodide
Phosphorus (Red)	

Manufacturing Process

50 parts by weight of p-hydroxy-propiophenone are dissolved in 200 parts by weight of a 12.5% solution of caustic soda and shaken with 350 parts by weight of 3% sodium amalgam. The sodium salt of the pinacol thereby precipitating is reacted with glacial acetic acid, whereby

the free pinacol is obtained (MP 205°C to 210°C, after purification 215°C to 217°C). The yield amounts to 95% of the theoretical. The pinacol is suspended in ether and gaseous hydrogen chloride introduced, whereby water separates and the pinacolin formed is dissolved in the ether, from which it is obtained by evaporation as a viscous oil (diacetate of MP 91°C). The yield is quantitative.

40 parts by weight of pinacolin are dissolved in ethyl alcohol and gradually treated with 80 parts by weight of sodium under reflux. The solution is decomposed with water and the pinacolin alcohol formed extracted from the neutralized solution with ether. The pinacolin alcohol is a viscous oil which is characterized by a dibenzoate of MP 172°C. The yield is 95% of the theoretical.

30 parts by weight of pinacolin alcohol are dissolved in 25 parts by weight of glacial acetic acid and heated for 30 minutes to 135°C to 140°C after having added 20 parts by weight of hydriodic acid (specific gravity = 1.94) and 5 parts by weight of red phosphorus. The whole is filtered, the solution poured into water, extracted with ether and the ether solution washed with bicarbonate. The oil remaining after distilling off the ether is taken up in chloroform, whereby hexoestrol [α,β -(*p,p*-dihydroxy-diphenyl)- α,β -diethyl-ethane] crystallizes out. MP after recrystallization from benzene: 185°C. Yield: 20%.

References

Merck Index 4593

DFU 8 (5) 413 (1983)

Kleeman & Engel p. 466

OCDS Vol. 1 p. 102 (1977)

I.N. p. 486

Wallis, E.S. and Bernstein, S.; U.S. Patent 2,357,985; September 12, 1944; assigned to Research Corporation

Adler, E., Gie, G.J. and von Euler, H.; U.S. Patent 2,421,401; June 3, 1947; assigned to Hoffmann-La Roche, Inc.

HEXETIDINE

Therapeutic Function: Antifungal

Chemical Name: 1,3-Bis(2-ethylhexyl)hexahydro-5-methyl-5-pyrimidinamine

Common Name: —

Structural Formula:

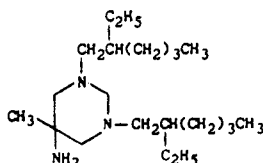

Chemical Abstracts Registry No.: 141-94-6

Trade Name	Manufacturer	Country	Year Introduced
Sterisil	Warner Lambert	U.S.	1956
Oraseptic	Parke Davis	Italy	1960
Hextril	Substantia	France	1961

Trade Name	Manufacturer	Country	Year Introduced
Hexoral	Goedecke	W. Germany	1967
Oraldene	Warner	France	1969
Oraldene	Warner	U.K.	1969
Bactidol	Warner-Chilcott	—	—
Bucosept	La Campana	Mexico	—
Collu-Hextril	Substantia	France	—
Drossadin	Drossapharm	Switz.	—
Glypesin	Stada	W. Germany	—
Sterisol	Warner-Chilcott	—	—

Raw Materials

Nitroethane	2-Ethylhexylamine
Formaldehyde	Hydrogen

Manufacturing Process

Nitroethane and formaldehyde are first reacted to give 2-methyl-2-nitro-1,3-propanediol. This is reacted with 2-ethylhexylamine and formaldehyde to give 5-nitro-1,3-bis(2-ethylhexyl)-5-methyl-hexahydropyrimidine.

To a hydrogenation apparatus containing 500 ml of methanol and 10 g of Raney nickel catalyst were continuously added over a period of one hour, 240 g of 5-nitro-1,3-bis(2-ethylhexyl)-5-methylhexahydropyrimidine. During the one-hour period, the resulting mixture was hydrogenated at approximately 1,000 pounds per square inch utilizing room temperature as the initial temperature and gradually increasing the temperature to about 70°C. At the end of the one-hour period, hydrogenation was stopped. The reaction mixture was first filtered to remove the catalyst and was then distilled at atmospheric pressure at a temperature of 70°C to remove methanol. 197.5 g of 5-amino-1,3-bis(2-ethylhexyl)-5-methylhexahydropyrimidine were collected.

References

Merck Index 4597

Kleeman & Engel p. 463

I.N. p. 487

Bell, W.O. and Neckar, A.E.; U.S. Patent 3,054,797; September 18, 1962; assigned to Commercial Solvents Corp.

HEXOBENDINE

Therapeutic Function: Vasodilator

Chemical Name: 3,4,5-Trimethoxybenzoic acid 1,2-ethanediylbis-[(methylimino)-3,1-propanediyl] ester

Common Name: —

Structural Formula:

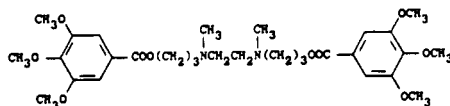

Chemical Abstracts Registry No.: 54-03-5; 50-62-4 (Dihydrochloride)

Trade Name	Manufacturer	Country	Year Introduced
Reoxyl	Hormonchemie	W. Germany	1966
Ustimon	Merck Clevenot	France	1969
Flussicor	Farmalabor	Italy	1971
Andiamine	Polfa	Poland	—
Hityl	Biosedra	France	—
Instenon	Byk Gulden	W. Germany	—

Raw Materials

Methyl acrylate	N,N'-Dimethylethylenediamine
Lithium aluminum hydride	3,4,5-Trimethoxybenzoyl chloride

Manufacturing Process

Methyl acrylate and N,N'-dimethylethylenediamine are first reacted and that product reduced with lithium aluminum hydride to give a compound A.

To a solution of 13 parts of compound A and 12 parts by volume of absolute pyridine in 80 parts by volume of absolute dioxane there are added dropwise and under constant stirring 35 parts of 3,4,5-trimethoxybenzoyl chloride dissolved in 70 parts by volume of absolute dioxane in the course of 30 minutes. The mixture is stirred for a further 3 hours at a temperature of 100°C and the excess solvent is then evaporated in vacuo. The residue of the evaporation is treated with ethyl acetate and saturated sodium carbonate solution, whereafter the organic phase is separated, treated with water, dried with sodium sulfate and the solvent is removed in vacuo. The residue thus obtained is taken up in ether and separated from 4 parts of insoluble trimethoxybenzoic acid anhydride by filtration. After evaporation of the ether there are obtained 32.5 parts of N,N'-dimethyl-N,N'-bis-[3-(3,4,5-trimethoxybenzoxy)-propyl] ethylene diamine, corresponding to a yield of 86% of the theoretical. MP: 75°C to 77°C.

The di-tertiary base thus obtained is dissolved in ether and the solution is saturated with hydrogen chloride gas. After isolation and reprecipitation from methanol-ether there is obtained the dihydrochloride melting at 170°C to 174°C.

References

- Merck Index 4600
 Kieeman & Engel p. 464
 OCDS Vol. 2 p. 92 (1980)
 I.N. p. 487
 Kraupp, O. and Schlogl, K.; U.S. Patent 3,267,103; August 16, 1966; assigned to Oesterreichische Stickstoffwerke AG (Austria)

HEXOCYCLIUM METHYL SULFATE

Therapeutic Function: Antispasmodic

Chemical Name: 4-(2-cyclohexyl-2-hydroxy-2-phenylethyl)-1,1-dimethylpiperazinium methyl sulfate

Common Name: —

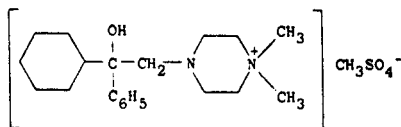
Structural Formula:**Chemical Abstracts Registry No.:** 115-63-9

Trade Name	Manufacturer	Country	Year Introduced
Tral	Abbott	U.S.	1957
Traline	Abbott	France	1959

Raw Materials

N-Phenacyl-N'-methylpiperazine	Magnesium
Cyclohexyl bromide	Dimethyl sulfate

Manufacturing Process

In a 2-liter, 3-necked, round-bottomed flask equipped with a stirrer, dropping funnel, and a condenser protected with a calcium chloride drying tube is placed 13.7 grams (0.57 mol) of magnesium turnings and the magnesium is covered with 200 cc of anhydrous ether. A crystal of iodine is added to the flask and 92.9 grams (0.57 mol) of cyclohexyl bromide dissolved in 300 cc of anhydrous ether is added dropwise with stirring while the reaction proceeds. After the addition of the cyclohexyl bromide is completed, the resulting mixture is stirred and heated on a steam bath for 3 hours. The mixture is cooled to room temperature and 49.5 grams (0.227 mol) of N-phenacyl-N'-methylpiperazine dissolved in 50 cc of anhydrous ether is added dropwise and the resulting mixture is stirred and re-fluxed for about 16 hours.

The reaction mixture is cooled and 50 grams of ammonium chloride dissolved in 200 cc of water is added dropwise thereto with stirring. The decomposed Grignard complex is then filtered. Benzene is added to the ether filtrate and the solvents are removed therefrom on a steam bath. The residue is fractionated and the base, N-(β-cyclohexyl-β-hydroxy-β-phenyl-ethyl)N'-methylpiperazine, is obtained as a liquid having a boiling point of 196° to 203°C at a pressure of 4.0 mm.

To 3.8 grams of the base dissolved in 35 cc of ethyl alcohol is added 1.6 grams of dimethyl sulfate. The solution is allowed to stand at room temperature for about 12 hours. The salt formed is filtered, recrystallized from ethyl alcohol, and is found to have a melting point of 203° to 204°C.

References

- Merck Index 4601
 Kleeman & Engel p. 465
 PDR p. 553
 I.N. p. 488
 REM p. 918
 Weston, A.W.; U.S. Patent 2,907,765; October 6, 1959; assigned to Abbott Laboratories

HEXOPRENALINE**Therapeutic Function:** Bronchodilator**Chemical Name:** 4,4'-[1,6-hexanediybis(imino(1-hydroxy-2,1-ethanediy))] bis-1,2-benzene-diol

Common Name: N,N'-bis[2-(3,4-dihydroxyphenyl)-2-hydroxyethyl] hexamethylenediamine

Structural Formula:

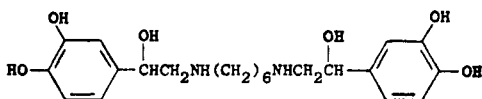

Chemical Abstracts Registry No.: 3215-70-1

Trade Name	Manufacturer	Country	Year Introduced
Etoscol	Byk-Gulden	W. Germany	1973
Hexoprenaline	Morishita	Japan	1976
Leanol	Yoshitomi	Japan	1976
Bronalin	Byk Liprandi	Argentina	—
Gynipral	Chemie Linz	Austria	—
Ipradol	Chemie Linz	Austria	—
Prelin	Farmos	Finland	—

Raw Materials

Chloroaceto pyrocatechol
N,N'-Dibenzylhexamethylene diamine
Hydrogen

Manufacturing Process

The N,N'-dibenzyl-N,N'-bis[2-(3',4'-dihydroxyphenyl)-2-oxoethyl]-hexamethylene-diamine-dichlorohydrate-monohydrate used as the starting material was prepared as follows: 2 mols of chloroaceto pyrocatechin were dissolved in 2,000 cc of acetone and heated to boiling with 2 mols of N,N'-dibenzylhexamethylene-diamine for 12 hours, almost the theoretical quantity of N,N'-dibenzylhexamethylene-diamine-dichlorohydrate being precipitated and removed by suction after cooling. Excess HCl was added to the filtrate, approximately 66% of the theoretically possible quantity of crude dichlorohydrate of the N,N'-dibenzyl-N,N'-bis[2-(3',4'-dihydroxyphenyl)-2-oxoethyl]-hexamethylene-diamine being precipitated. The product was cleaned by recrystallization from water with the addition of animal charcoal. After drying the substance contained water of crystallization at ambient temperature, MP 206° to 209.5°C.

Five grams of N,N'-dibenzyl-N,N'-bis[2-(3',4'-dihydroxyphenyl)-2-oxoethyl]-hexamethylene-diamine-dichlorohydrate as a monohydrate were hydrogenated under considerable agitation by means of 2.0 grams of 10% palladium-carbon, with hydrogen in a mixture of 270 cc of methanol and 50 cc of water at 45°C and normal pressure. After about 4 hours the theoretical quantity of hydrogen (4 mols of hydrogen per 1 mol of substance) was absorbed for the splitting off of the two benzyl radicals and the reduction of the two carbonyl groups to carbinol groups, and the hydrogenation came to a stop.

After separation of the catalyst the product was concentrated until dry, the residue was triturated with acetone, the resulting crystallizate was removed by suction and washed with acetone. The yield of N,N'-bis[2-(3',4'-dihydroxyphenyl)-2-hydroxyethyl]-hexamethylene-diamine-dichlorohydrate was 3.3 grams, i.e., 92% of the theoretical value. A quantity of 2.8 grams having a melting point of 197.5° to 198°C was obtained by precipitation from a mixture of methanol-ether.

Free N,N'-bis[2-(3',4'-dihydroxyphenyl)-2-hydroxyethyl]-hexamethylene-diamine can be separated from these salts by the addition of the equivalent quantity of caustic alkali solution. It has a melting point of 162° to 165°C and contains half a mol of water of crystallization.

N,N'-bis[2-(3',4'-dihydroxyphenyl)-2-hydroxyethyl]-hexamethylene-diamine-sulfate (MP

222° to 228°C) can be obtained by reacting the base with the equivalent quantity of sulfuric acid in an alcohol solution, followed by concentration and precipitation from water-alcohol solution.

References

Merck Index 4603

Kleeman & Engel p. 466

I.N. p. 488

Schmid, O., Lerchenthal, H.S.-M., Zolss, G., Gratz, R. and Wismayr, K.; U.S. Patent 3,329,709; July 4, 1967; assigned to Oesterreichische Stickstoffwerke AG, Austria

HEXYLCAINE HYDROCHLORIDE

Therapeutic Function: Local anesthetic

Chemical Name: 1-cyclohexylamino-2-propylbenzoate hydrochloride

Common Name: —

Structural Formula:

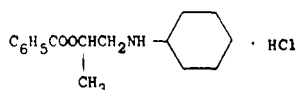

Chemical Abstracts Registry No.: 532-76-3; 532-77-4 (Base)

Trade Name	Manufacturer	Country	Year Introduced
Cyclaine	MSD	U.S.	1952

Raw Materials

1-Cyclohexylamino-2-propanol

Benzoyl chloride

Hydrogen chloride

Manufacturing Process

A solution of 0.1 mol of 1-cyclohexylamino-2-propanol in 30 grams of chloroform was saturated with dry hydrogen chloride gas, with cooling. A solution of 0.1 mol of benzoyl chloride in 30 grams of chloroform was added and the solution was heated in a bath at 50° to 55°C for four days under a reflux condenser protected from atmospheric moisture. Then the solvent was removed by vacuum distillation while the mixture was warmed on a water bath. Benzene was then added to the syrupy residue and the reaction product crystallized out after the benzene was removed by vacuum distillation.

The crystallized solid residue was washed with anhydrous ether to remove any unreacted benzoyl chloride. The 1-cyclohexylamino-2-propyl benzoate hydrochloride obtained was purified by two recrystallizations from absolute alcohol. It melted at 177° to 178.5°C.

References

Merck Index 4605

Kleeman & Engel p. 467

OCDS Vol. 1 p. 12 (1977)

I.N. p. 488

REM p. 1056

Cope, A.C.; U.S. Patent 2,486,374; November 1, 1949; assigned to Sharp & Dohme, Inc.

HOMOFENAZINE

Therapeutic Function: Tranquilizer

Chemical Name: Hexahydro-4-[3-[2-(trifluoromethyl)phenothiazin-10-yl]propyl]-1H-1,4-diazepine-1-ethanol

Common Name: —

Structural Formula:

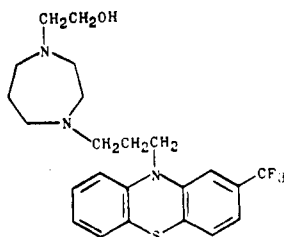

Chemical Abstracts Registry No.: 3833-99-6

Trade Name	Manufacturer	Country	Year Introduced
Pasaden	Homburg	Italy	1972
Oldagen	Purissimus	Argentina	—

Raw Materials

3-Trifluoromethyl-phenothiazine	Sodium amide
3-Bromopropyl-homopiperazine	2-Chloroethanol

Manufacturing Process

35 parts of 3-trifluoromethyl-phenothiazine in 200 parts of toluene were reacted with 6.1 parts soda amide and then with 28.8 parts of 3-bromopropyl-homopiperazine. After a 2 hour reaction period the reaction mixture was washed with water twice and then extracted with dilute HCl, the resulting extract alkalinized with excess K_2CO_3 and the precipitated base taken up in ether. After drying the ether extract and evaporation of the ether, the residue was distilled. 20.3 parts of 3-trifluoromethyl-10-(3'-homopiperazino)-propyl-phenothiazine having a boiling point of 225° to 230°C at 1 mm Hg pressure were obtained.

20 parts of 3-trifluoromethyl-10-(3'-homopiperazino)-propyl-phenothiazine in 100 parts of butanol were refluxed for 4 hours together with 5.5 parts of 2-chloroethanol and 11 parts potassium carbonate. The reaction mixture was diluted with 200 parts of ether, then washed three times with water and dried with potassium carbonate. After evaporation of the solvent the residue was distilled under a vacuum of 1 mm Hg. 17.5 parts of 3-trifluoromethyl-10-[3'-(4''-(2''-hydroxyethyl)-homopiperazino)-propyl]-phenothiazine distilled over at 230° to 240°C. The difumarate of this base had a melting point of 148°C.

References

- Merck Index 4633
 Kleeman & Engel p. 468
 I.N. p. 492
 Schuler, W.A., Beschke, H. and von Schlichtergroll, A.; U.S. Patent 3,040,043; June 19, 1962; assigned to Deutsche Gold- und Silber-Scheideanstalt vormals Roessler, Germany

HYDRALAZINE HYDROCHLORIDE

Therapeutic Function: Antihypertensive

Chemical Name: 1(2H)-phthalazinone hydrazone hydrochloride

Common Name: 1-hydrazinophthalazine hydrochloride

Structural Formula:

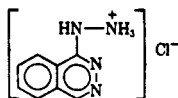

Chemical Abstracts Registry No.: 304-20-1; 86-54-4 (Base)

Trade Name	Manufacturer	Country	Year Introduced
Apresoline HCl	Ciba	U.S.	1952
Lopres	Tutag	U.S.	1971
Aiselazine	Hotta	Japan	—
Alphress	Unipharm	Israel	—
Anaspasmin	Vitacain	Japan	—
Aprelazine	Kaigai	Japan	—
Apresazide	Ciba	U.S.	—
Aprezine	Kanto	Japan	—
Basedock D	Sawai	Japan	—
Deselazine	Kobayashi	Japan	—
Diucholin	Toyama	Japan	—
Dralzine	Lemmon	U.S.	—
Homoton	Horii	Japan	—
Hydrapres	Rubio	Spain	—
Hydrapress	Isei	Japan	—
Hydroserpine	Zenith	U.S.	—
Hypatol	Yamanouchi	Japan	—
Hyperazine	Seiko	Japan	—
Hypos	Nippon Shinyaku	Japan	—
Ipolina	Lafare	Italy	—
Lopress	Reid Provident	U.S.	—
Pressfall	Nissin	Japan	—
Prospectin	Maruishi	Japan	—
Ser-Ap-Es	Ciba	U.S.	—
Serpasil	Ciba	U.S.	—
Solesorin	Hishiyama	Japan	—
Supres	Protea	Australia	—
Tetrasoline	Maruko	Japan	—
Unipres	Reid-Rowell	U.S.	—

Raw Materials

Phthalazone	Phosphorus oxychloride
Hydrazine hydrate	Hydrogen chloride

Manufacturing Process

30 parts by weight of phthalazone are converted to 1-chlorophthalazine by the method described in *Ber. d. deutsch. chem. Ges.*, vol 26, page 521 (1893). The freshly obtained yet moist chloro compound is heated on the water bath for two hours in a mixture of 100 parts by volume of ethyl alcohol and 90 parts by volume of hydrazine hydrate. Preferably after filtering, 1-hydrazino-phthalazine crystallizes out in yellow needles on cooling.

It is filtered with suction and washed with cold ethyl alcohol. The compound is crystallized from methyl alcohol, and melts, when rapidly heated, at 172° to 173°C. On warming in alcoholic or aqueous hydrochloric acid, the hydrochloride of MP 273°C (with decomposition) is obtained.

References

Merck Index 4661

Kleeman & Engel p. 468

PDR pp. 789, 812, 830, 993, 1449, 1600, 1999

OCDS Vol. 1 p. 353 (1977)

I.N. p. 494

REM p. 847

Hartmann, M. and Druey, J.; U.S. Patent 2,484,029; October 11, 1949; assigned to Ciba Pharmaceutical Products, Inc.

HYDROCHLOROTHIAZIDE

Therapeutic Function: Diuretic

Chemical Name: 6-chloro-3,4-dihydro-2H-1,2,4-benzothiadiazine-7-sulfonamide-1,1-dioxide

Common Name: Chlorosulthiadil

Structural Formula:

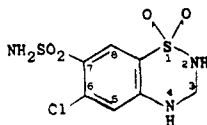

Chemical Abstracts Registry No.: 58-93-5

Trade Name	Manufacturer	Country	Year Introduced
Hydrodiuril	MSD	U.S.	1959
Oretic	Abbott	U.S.	1959
Esidrix	Ciba	U.S.	1959
Esidrex	Ciba Geigy	France	1960
Thiuretic	Parke Davis	U.S.	1974
Lexxor	Lemmon	U.S.	1974
Aldactazide	Searle	U.S.	—
Aldoril	MSD	U.S.	—
Apresazide	Ciba	U.S.	—
Apresoline	Ciba	U.S.	—
Catiazida	Infale	Spain	—
Chemhydrazide	Chemo-Drug	Canada	—
Clothia	Iwaki	Japan	—
Chlorzide	Foy	U.S.	—
Deidran	Pharma.Farm.Spec.	Italy	—
Delco-Retic	Delco	U.S.	—
Dichlorosal	Teva	Israel	—
Dichlotride	Merck-Banyu	Japan	—
Didral	Caber	Italy	—
Dihydran	A.F.I.	Norway	—
Diidrotiazide	Omikron-Gagliardi	Italy	—
Direma	Distillers	U.K.	—

Trade Name	Manufacturer	Country	Year Introduced
Dithiazid	Arcana	Austria	—
Diuchlor H	Medic	Canada	—
Diurogen	Gentili	Italy	—
Diursana H	Santos	Spain	—
Dixidrasi	Vaillant	Italy	—
Dyazide	SKF	U.S.	—
Esoidrina	Bouty	Italy	—
Esimil	Ciba	U.S.	—
HHR	Schein	U.S.	—
Hidrosaluretil	Gayoso Wellcome	Spain	—
Hyclosid	Pharmacal	Finland	—
Hydoril	Cenci	U.S.	—
Hydrazide	Powell	Canada	—
Hydrex	Orion	Finland	—
Hydrite	Verdun	Canada	—
Hydro-D	Halsey	U.S.	—
Hydrodiuretex	Barlow Cote	Canada	—
Hydropres	MSD	U.S.	—
Hydroserpine	Schein	U.S.	—
Hydrozide	Elliott-Marion	Canada	—
Hytrid	Leiras	Finland	—
Idrodiuvis	Vis	Italy	—
Inderide	Ayerst	U.S.	—
Ivaugan	Voigt	W. Germany	—
Jen-Diril	Jenkins	U.S.	—
Lopressor	Geigy	U.S.	—
Loqua	Columbia	U.S.	—
Manuril	I.C.N.	Canada	—
Maschitt	Showa	Japan	—
Maxzide	Lederle	U.S.	—
Mikorten	Zensei	Japan	—
Moduretic	MSD	U.S.	—
Natrimax	Trianon	Canada	—
Nefrol	Riva	Canada	—
Neo-Codema	Neo	Canada	—
Neo-Flumen	Serono	Italy	—
Neo-Minzil	Valeas	Italy	—
Neo-Saluretic	Lafar	Italy	—
Newtolide	Towa	Japan	—
Novodiurex	Oti	Italy	—
Novohydrazide	Novopharm	Canada	—
Pantemon	Tatsumi	Japan	—
Ro-Hydrazide	Robinson	U.S.	—
Saldiuril	Bieffe	Italy	—
Ser-Ap-Es	Ciba	U.S.	—
Serpasil	Ciba	U.S.	—
Spironazide	Schein	U.S.	—
Tenzide	Metro Med	U.S.	—
Thiadril	Vanguard	U.S.	—
Thiaretic	Blue Line	U.S.	—
Timolide	MSD	U.S.	—
Unazid	Pliva	Yugoslavia	—
Unipres	Reid-Rowell	U.S.	—
Urirex	Pharmador	S. Africa	—
Urodiazin	Apogepha	E. Germany	—
Urozide	I.C.N.	Canada	—
Zide	Reid Provident	U.S.	—

Raw Materials

5-Chloro-2,4-disulfamylaniline
Paraformaldehyde

Manufacturing Process

As described in U.S. Patent 3,163,645, a mixture of 2.9 grams of 5-chloro-2,4-disulfamyl aniline in 15 ml of anhydrous diethyleneglycol dimethyl ether, 0.5 ml of an ethyl acetate solution containing 109.5 grams of hydrogen chloride per 1,000 ml and 0.33 grams (0.011 mol) of paraformaldehyde is heated to 80° to 90°C and maintained at that temperature for 1 hour. The resulting mixture is cooled to room temperature and concentrated to one-third of its volume under reduced pressure, diluted with water, then allowed to crystallize. The product is filtered off and recrystallized from water, to yield the desired 6-chloro-7-sulfamyl-3,4-dihydro-2H-[1,2,4]-benzothiadiazine-1,1-dioxide, MP 266° to 268°C, yield 1.4 grams. By replacing paraformaldehyde by 0.84 gram of 1,1-dimethoxymethane and proceeding as above, the same compound is obtained.

As described in U.S. Patent 3,025,292, the desired product may be made by hydrogenation of chlorothiazide. Three grams of 6-chloro-7-sulfamyl-1,2,4-benzothiadiazine-1,1-dioxide (chlorothiazide) is suspended in 100 ml of methanol. Then 1.0 gram of a 5% ruthenium on charcoal catalyst is added, and the mixture is reduced at room temperature and at an initial hydrogen pressure of 39 psig. The theoretical amount of hydrogen to form the 3,4-dihydro derivative is absorbed after a period of about 10 hours.

The reduction mixture then is heated to boiling and filtered hot to remove the catalyst. The catalyst is washed with a little methanol and the combined filtrate is concentrated to a volume of about 25 ml by evaporation on a steam bath. Upon cooling to room temperature, white crystals separate which are filtered, washed with water, and dried in vacuo at room temperature over phosphorus pentoxide overnight. The weight of 6-chloro-7-sulfamyl-3,4-dihydro-1,2,4-benzothiadiazine-1,1-dioxide obtained is 1.26 grams; MP 268.5° to 270°C. Dilution of the above filtrate with water to a volume of about 125 ml gives a second crop of product having the same melting point and weighing 1.22 grams, giving a combined yield of 83%. When the product is mixed with an authentic sample of 6-chloro-7-sulfamyl-3,4-dihydro-1,2,4-benzothiadiazine-1,1-dioxide, prepared by another method, the melting point is not depressed.

References

- Merck Index 4683
Kleeman & Engel p. 469
PDR pp. 546, 625, 789, 812, 896, 1014, 1137, 1184, 1201, 1211, 1449, 1606, 1674, 1713, 1999
OCDS Vol. 1 p. 358 (1977)
DOT 16 (4) 141 (1980), (8) 266 (1980), 17 (5) 213 (1981), 19 (3) 172 (1983) and 19 (9) 496 (1983)
I.N. p. 495
REM p. 939
Jones, W.H. and Novello, F.C.; U.S. Patent 3,025,292; March 13, 1962; assigned to Merck & Co., Inc.
Downing, G.V., Jr.; U.S. Patent 3,043,840; July 10, 1962; assigned to Merck & Co., Inc.
de Stevens, G. and Werner, L.H.; U.S. Patent 3,163,645; December 29, 1964; assigned to Ciba Corporation
Irons, J.S. and Cook, T.M.; U.S. Patent 3,164,588; January 5, 1965; assigned to Merck & Co., Inc.

HYDROCORTAMATE HCl

Therapeutic Function: Adrenocortical steroid

Chemical Name: Cortisol 21-ester with N,N-diethylglycine

Common Name: —

Structural Formula:

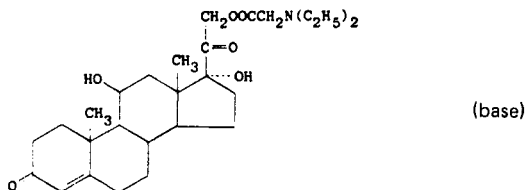

Chemical Abstracts Registry No.: 76-47-1 (Base)

Trade Name	Manufacturer	Country	Year Introduced
Magnacort	Pfizer	U.S.	1956
Etacort	Angelini	Italy	—

Raw Materials

Hydrocortisone
Chloroacetic anhydride
Diethylamine

Manufacturing Process

1 g of hydrocortisone is introduced with stirring into 5 cc of anhydrous pyridine. After heating to 45°C and then cooling again to 0°C to 5°C there is slowly added dropwise a freshly prepared solution of 0.52 g (1 mol + 10%) of chloroacetic anhydride in 4 cc of absolute ether. The reaction temperature should not exceed 10°C. During the whole time of reaction a stream of nitrogen is passed through the reaction mixture in order to achieve an exhaustive evaporation of the added ether. The batch is slowly allowed to come to room temperature, an operation requiring 4 to 5 hours, and then 0.1 cc of water is added for decomposition of the excess of anhydride. The reaction solution is introduced dropwise with stirring within 1 hour into 100 cc of water as a result of which the 21-chloroacetate of hydrocortisone is deposited. After filtration with suction, washing is carried out with water, 5% hydrochloric acid, water, 2% sodium bicarbonate solution and water again. The substance is then dried in a vacuum desiccator. The white chloroacetate thus obtained melts at 213°C to 214°C with decomposition. It is free from nitrogen and the yield amounts to 93.4% of the theoretical.

1 g of hydrocortisone-21-chloroacetate is dissolved in 15 cc of anhydrous and peroxide-free tetrahydrofuran. The solution produced is treated with a solution of 0.42 g of diethylamine in 15 cc of tetrahydrofuran. The reaction mixture is allowed to stand for 24 hours at room temperature. The separated diethylamine hydrochloride is filtered with suction and the filtrate evaporated under vacuum in a nitrogen atmosphere at 40°C. The residue is triturated with a little absolute ether and suction filtered. It is washed on the filter with a little ether and then with hexane. The 21-diethylaminoacetate of hydrocortisone melts at 150°C to 162°C. The base can be recrystallized from ethyl acetate but its melting point remains practically unchanged at 162°C to 163°C. The yield amounts to 72.5% of the theoretical. For conversion of the base into the hydrochloride it is suspended in ether and the suspension treated with ethereal hydrochloric acid. The hydrochloride is filtered with suction and recrystallized from ethanol; MP 222°C with decomposition.

With a starting quantity of 14 g, the yield amounted to 85.4% of the theoretical.

References

Merck Index 4688

I.N. p. 497

Schering A.G.; British Patent 879,208; October 4, 1961

HYDROCORTISONE

Therapeutic Function: Glucocorticoid

Chemical Name: 11 β ,17,21-trihydroxypregn-4-ene-3,20-dione

Common Name: 17-hydroxycorticosterone

Structural Formula:

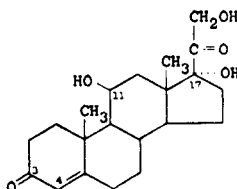

Chemical Abstracts Registry No.: 50-23-7

Trade Name	Manufacturer	Country	Year Introduced
Hydrocortone	MSD	U.S.	1952
Cortef	Upjohn	U.S.	1953
Cortril	Pfizer	U.S.	1954
Cortifan	Schering	U.S.	1954
Otosone-F	Broemmel	U.S.	1955
Cortispray	National	U.S.	1956
Domolene-HC	Dome	U.S.	1960
Texacort	Texas Pharm	U.S.	1960
Cortenema	Rowell	U.S.	1966
Lubricort	Texas Pharm	U.S.	1968
Proctocort	Rowell	U.S.	1969
Hautosone	Merrell National	U.S.	1970
Dermacort	Rowell	U.S.	1972
Rectoid	Pharmacia	U.S.	1977
Alphaderm	Norwich Eaton	U.S.	1978
H-Cort	Pharm. Assoc.	U.S.	1979
Dermolate	Schering	U.S.	1979
Clear-Aid	Squibb	U.S.	1980
Hycort	Elder	U.S.	1981
Prep-Cort	Whitehall	U.S.	1981
Corizone-5	Thompson	U.S.	1982
Flexicort	Westwood	U.S.	1982
Aeroseb	Allergan	U.S.	—
Ala-Cort	Del Ray	U.S.	—
Algicortis	Vaillant	Italy	—
Allersone	Mallard	U.S.	—
Alphacortison	Norwich-Eaton	U.S.	—
Alphaderm	Norwich	U.S.	—
Balneol-HC	Rowell	U.S.	—
Barseb -HC	Barnes-Hind	U.S.	—
Bio-Cortex	Ries	U.S.	—

Trade Name	Manufacturer	Country	Year Introduced
Carmol HC	Syntex	U.S.	—
Cleiton	Kodama	Japan	—
Cobadex	Cox	U.K.	—
Cortanal	Canada Pharmacal	Canada	—
Cort-Dome	Dome	U.S.	—
Cortes	Taisho	Japan	—
Cortasal	Pharmacia	Sweden	—
Corticaine	Glaxo	U.S.	—
Cortifair	Pharmafair	U.S.	—
Cortiment	Ferring	Sweden	—
Cortiphate	Travenol	U.S.	—
Cortisporin	Burroughs Wellcome	U.S.	—
Cortolotion	Kempthorne-Prosser	N.Z.	—
Cortril	Pfizer	U.S.	—
Cremesone	Dalín	U.S.	—
Di-Hydrotic	Legere	U.S.	—
Dioderm	Dermal	U.K.	—
Durel-Cort	Durel	U.S.	—
Ecosone	Star	U.S.	—
Efcortelan	Glaxo	U.K.	—
Egocort	Ego	Australia	—
Excerate	Foiji Zoki	Japan	—
FEP	Boots	U.S.	—
Gyno-Cortisone	Lyocentre	France	—
HC-Cream	C&M Pharmacal	U.S.	—
Heb-Cort	Barnes-Hind	U.S.	—
Hidroaltesona	Alter	Spain	—
Hycor	Sigma	Australia	—
Hycort	Douglas	U.S.	—
Hycortole	Premo	U.S.	—
Hydrocort	Ferring	W. Germany	—
Hydrocortex	Kenyon	U.S.	—
Hydrofoam	U.S.V.	U.S.	—
Hydrotisona	Roussel-Lutetia	Argentina	—
Hytone	Dermik	U.S.	—
Idracemi	Farmigea	Italy	—
Lexocort	Lexington	U.S.	—
Microcort	Alto	U.S.	—
Milliderm	A.L.	Norway	—
Octicair	Pharmafair	U.S.	—
Optef	Upjohn	—	—
Otic-HC	Hauck	U.S.	—
Otobiotic	Schering	U.S.	—
Otocort	Lemmon	U.S.	—
Pedicort	Pedinol	U.S.	—
Penecort	Herbert	U.S.	—
Pyocidin	Berlex	U.S.	—
Rectocort	Welcker-Lyster	Canada	—
Rectoid	Pharmacia	Sweden	—
Sigmacort	Sigma	Australia	—
Signef	Fellows-Testagar	U.S.	—
Sterocort	Omega	Canada	—
Synacort	Syntex	U.S.	—
Tega-Cort	Ortega	U.S.	—
Vanoxide	Dermik	U.S.	—
Vioform	Ciba	U.S.	—
Viosol	Wallace	U.S.	—
Vytone	Dermik	U.S.	—

Raw Materials

Bacterium Cunninghamella blakesleeana
11-Desoxy-17-hydroxycorticosterone

Manufacturing Process

The following example from U.S. Patent 2,602,769 illustrates the preparation of 17-hydroxycorticosterone (compound F) from 11-desoxy-17-hydroxycorticosterone (compound S). A medium was prepared from 0.5% peptone, 2% dextrose, 0.5% soybean meal, 0.5% KH_2PO_4 , 0.5% sodium chloride and 0.3% yeast extract in tap water. To 200 ml of this sterilized medium was added an inoculum of the vegetative mycella of *Cunninghamella blakesleeana*. The spores had first been transferred from a sport slant to a broth medium and the broth medium was aerobically incubated at 24°C for 24 to 72 hours in a reciprocating shaker until the development of vegetative growth. The inoculated medium containing added vegetative mycella of *Cunninghamella blakesleeana* was incubated for 48 hours at 24°C following which was added 66 mg of compound S, 11-desoxy-17-hydroxycorticosterone in solution in a minimum of ethanol, and incubation was maintained for 7 hours at 24°C. The beer containing steroid was diluted with 800 ml of acetone, shaken 1 hour on a reciprocating shaker and filtered. The cake was suspended in 500 ml of acetone, shaken another hour and again filtered. The filtrates were combined and the acetone was volatilized under reduced pressure at 50°C. Acetone was then added, if necessary, to bring the concentration to 20% acetone and this resulting aqueous acetone solution was extracted five times each with one-third volume of Skellysolve B petroleum ether to remove fatty materials. These extracts were back washed two times with one-tenth volume of 20% aqueous acetone and the washings were added to the main acetone extract.

The combined acetone extracts were extracted six times with one-fourth volume of ethylene dichloride and the ethylene dichloride extract was evaporated under vacuum to leave the steroid residue. This steroid residue was taken up in a minimum of methylene chloride and applied to the top of a column packed with 30 grams of silica which had been previously triturated with 21 ml of ethylene glycol. Then various developing mixtures, saturated with ethylene glycol, were passed over the column. Cuts were made as each steroid was eluted as determined by the lowering of the absorption of light at 240 μ on the automatic chromatographic fraction cutter.

Band	Solvent	Tube No. (60 ml)	Crude Solids (mg)
1	Cyclohexane	1-4	11
2	Cyclohexane-methylene chloride 3:1	5-13	6.4 compound S
3	Cyclohexane-methylene chloride 1:1	14-16	3.0
4	Cyclohexane-methylene chloride 2:3	17-23	6.0 compound E
5	Cyclohexane-methylene chloride 1:4	24-38	12.2 compound F
6	Methylene chloride	39-59	4.8

A 7.7 mg portion of band 5 was taken up in a minimum of acetone and refrigerated until crystals separated. This cold acetone mixture was centrifuged and the supernatant liquid removed by pipette. To the remaining crystals, a few drops of ice-cold ether-acetone, three to one mixture, were added, shaken, re-centrifuged and the supernatant wash liquid removed by pipette. The ether-acetone wash was repeated. The resulting crystals were dried under vacuum yielding 3.3 mg of pure compound F, 17-hydroxycorticosterone.

References

Merck Index 4689
Kleeman & Engel p. 470

PDR pp. 671, 684, 739, 821, 833, 908, 928, 933, 1033, 1073, 1250, 1397, 1404, 1429, 1446, 1576, 1645, 1800, 1886

OCDS Vol. 1 p. 190 (1977)

DOT 12 (9) 343 (1976)

I.N. p. 497

REM p. 967

Murray, H.C. and Peterson, D.H.; U.S. Patent 2,602,769; July 8, 1952; assigned to The Upjohn Company

Murray, H.C. and Peterson, D.H.; U.S. Patent 2,649,400; August 18, 1953; assigned to The Upjohn Company

Murray, H.C. and Peterson, D.H.; U.S. Patent 2,649,402; August 18, 1953; assigned to The Upjohn Company

Mann, K.M., Drake, H.A. and Rayman, D.E.; U.S. Patent 2,794,816; June 4, 1957; assigned to The Upjohn Company

HYDROCORTISONE SODIUM PHOSPHATE

Therapeutic Function: Glucocorticoid

Chemical Name: 11 β ,17-Dihydroxy-21-(phosphonoxy)pregn-4-ene-3,20-dione disodium salt

Common Name: —

Structural Formula:

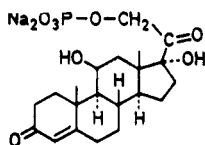

Chemical Abstracts Registry No.: 6000-74-4; 3863-59-0 (Phosphate base)

Trade Name	Manufacturer	Country	Year Introduced
Corphos	Tilden Yates	U.S.	1959
Hydrocortone Phosphate	MSD	U.S.	1960
Cortiphate	Travenol	U.S.	1962
Ocu-Cort	Dome	U.S.	1963
Actocortin	Cooper	W. Germany	—
Efcortisol	Glaxo	U.K.	—
Flebocortid	Richter	Italy	—
Gleiton	Sankyo Zoki	Japan	—

Raw Materials

21-Iodo-11 β :17 α -dihydroxypregn-4-ene-3,20-dione
Phosphoric acid
Sodium hydroxide

Manufacturing Process

21-Iodo-11 β :11 α -dihydroxypregn-4-ene-3:20-dione (5.0 g) in pure acetonitrile (125 ml) was mixed with a solution of 90% phosphoric acid (2.5 ml) and triethylamine (7.5 ml) in acetonitrile (125 ml) and boiled under reflux for 4 hours. The solvent was removed in vacuo and the residue, dissolved in ethanol (20 ml) and water (80 ml), was passed down a column of Zeo-Karb 225 (H⁺ form) (60 g) made up in 20% alcohol. Elution was continued with 20%

alcohol (50 ml), 50% alcohol (50 ml) and alcohol (150 ml). The eluate was at first cloudy, but by the end of the elution it was clear and nonacid.

The eluate was titrated to pH 7 with 0.972 N NaOH (63 ml). Removal of solvent left a gum, which was boiled with methanol (400 ml) for 20 minutes. The solid insoluble inorganic phosphate was filtered off and washed with methanol (200 ml). The slightly cloudy filtrate was filtered again, and evaporated to dryness in vacuo. The residual gum dissolved readily in water (40 ml) and on addition of acetone (600 ml) to the solution a mixture of sodium salts of hydrocortisone 21-phosphate separated as a white solid. This was collected after 2 days, washed with acetone and dried at 100°C/0.1 mm/2 hr to constant weight. Yield 4.45 g.

References

Merck Index 4691

Kleeman & Engel p. 473

I.N. p. 498

REM p. 968

Elks, J. and Phillips, G.H.; U.S. Patent 2,936,313; May 10, 1960; assigned to Glaxo Laboratories, Ltd. (U.K.)

HYDROFLUMETHIAZIDE

Therapeutic Function: Diuretic, antihypertensive

Chemical Name: 3,4-dihydro-6-(trifluoromethyl)-2H-1,2,4-benzothiadiazine-7-sulfonamide 1,1-dioxide

Common Name: —

Structural Formula:

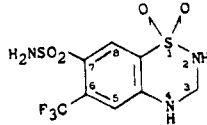

Chemical Abstracts Registry No.: 135-09-1

Trade Name	Manufacturer	Country	Year Introduced
Saluron	Bristol	U.S.	1959
Leodrine	Leo	France	1960
Diucardin	Ayerst	U.S.	1974
Di-Ademil	Squibb-Showa	Japan	—
Enjit	Meiji	Japan	—
Fluorodiuvis	Vis	Italy	—
Hydrenox	Boots	U.K.	—
Leodrine	Leo	France	—
Naclax	Glaxo	U.K.	—
Olmagran	Heyden	W. Germany	—
Plurine	Leo	France	—
Rivosil	Benvegna	Italy	—
Robezon	Mitsui	Japan	—
Rontyl	Leo-Sankyō	Japan	—
Vergonil	Ferrosan	Denmark	—

Raw Materials

α,α,α -Trifluoro-m-toluidine
Chlorosulfonic acid

Ammonia
Paraformaldehyde

Manufacturing Process

(a) *Preparation of 5-Trifluoromethylaniline-2,4-Disulfonyl Chloride:* 113 ml of chlorosulfonic acid was cooled in an ice-bath, and to the acid was added dropwise while stirring 26.6 grams of α,α,α -trifluoro-m-toluidine. 105 grams of sodium chloride was added during 1 to 2 hours, whereafter the temperature of the reaction mixture was raised slowly to 150° to 160°C, which temperature was maintained for 3 hours. After cooling the mixture, ice-cooled water was added, whereby 5-trifluoromethylaniline-2,4-disulfonyl chloride separated out from the mixture.

(b) *Preparation of 5-Trifluoromethyl-2,4-Disulfamylaniline:* The 5-trifluoromethylaniline-2,4-disulfonyl chloride obtained in step (a) was taken up in ether and the ether solution dried with magnesium sulfate. The ether was removed from the solution by distillation, the residue was cooled to 0°C and 60 ml of ice-cooled, concentrated ammonia water was added while stirring. The solution was then heated for one hour on a steam bath and evaporated in vacuo to crystallization. The crystallized product was 5-trifluoromethyl-2,4-disulfamylaniline, which was filtered off, washed with water and dried in a vacuum exsiccator over phosphorus pentoxide. After recrystallization from a mixture of 30% ethanol and 70% water the compound had a MP of 247° to 248°C.

(c) *Preparation of 6-Trifluoromethyl-7-Sulfamyl-3,4-Dihydro-1,2,4-Benzothiadiazine-1,1-Dioxide:* 3.2 grams of 5-trifluoromethyl-2,4-disulfamylaniline was added to a solution of 0.33 gram of paraformaldehyde in 25 ml of methyl Cellosolve (2-methoxy ethanol) together with a catalytic amount of p-toluenesulfonic acid, and the mixture was boiled with reflux for 5 hours. The solvent was then distilled off in vacuo, and the residue triturated with 30 ml of ethyl acetate. 6-trifluoromethyl-7-sulfamyl-3,4-dihydro-1,2,4-benzothiadiazine-1,1-dioxide crystallized out. After recrystallization from methanol/water the substance had a MP of 272° to 273°C.

References

Merck Index 4695

Kleeman & Engel p. 474

PDR pp. 617, 709, 1606, 1999

OCDS Vol. 1 p. 358 (1977)

I.N. p. 499

REM p. 939

Lund, F., Lyngby, K. and Godtfredsen, W.O.; U.S. Patent 3,254,076; May 31, 1966; assigned to Løvens Kemiske Fabrik Ved A. Kongsted, Denmark

HYDROQUINONE

Therapeutic Function: Depigmentor

Chemical Name: 1,4-Benzenediol

Common Name: Quinol

Structural Formula:

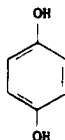

Chemical Abstracts Registry No.: 123-31-9

Trade Name	Manufacturer	Country	Year Introduced
Quinnone	Dermohr	U.S.	1980
Melanek	Neutrogena	U.S.	1981
Black & White	Plough	U.S.	—
Eldopaque	Elder	U.S.	—
Eldoquin	Elder	U.S.	—
Phiaquin	Phial	Australia	—
Phiaquin	Robins	U.S.	—
Solaquin	Elder	U.S.	—

Raw Materials

Acetylene
Methanol

Manufacturing Process

Into a pressure reactor there was charged 100 ml of methanol and 1 g of diruthenium nona-carbonyl. The reactor was closed, cooled in solid carbon dioxide/acetone, and evacuated. Acetylene, to the extent of 1 mol (26 g), was metered into the cold reactor. Carbon monoxide was then pressured into this vessel at 835–980 atmospheres, during a period of 16.5 hours; while the reactor was maintained at 100°C to 150°C. The reactor was then cooled to room temperature and opened.

The reaction mixture was removed from the vessel and distilled at a pressure of 30–60 mm, and a bath temperature of 30°C to 50°C until the methanol had all been removed. The extremely viscous tarry residue remaining in the still pot was given a very crude distillation, the distillate boiling at 82°C to 132°C/2 mm. In an attempt to purify this distillate by a more careful distillation, 5.3 g of a liquid distilling from 53°C to 150°C/5 mm was collected. At this point, much solid sublimate was noted not only in this distillate but in the condenser of the still. 7 g of the solid sublimate was scraped out of the condenser of the still. Recrystallization of the sublimate from ethyl acetate containing a small amount of petroleum ether gave beautiful crystals melting at 175°C to 177°C (5 g). Infrared analysis confirmed that this compound was hydroquinone (9% conversion).

References

Merck Index 4719
PDR pp. 865, 1268
I.N. p. 499
REM p. 788

Howk, B.W. and Sauer, J.C.; U.S. Patent 3,055,949; September 25, 1962; assigned to E.I. du Pont de Nemours & Co.

HYDROXOCOBALAMIN

Therapeutic Function: Hematopoietic vitamin

Chemical Name: Cobinamide hydroxide phosphate 3'-ester with 5,6-dimethyl-1- α -D-ribofuranosylbenzimidazole inner salt

Common Name: Vitamin B_{12a}

Structural Formula:

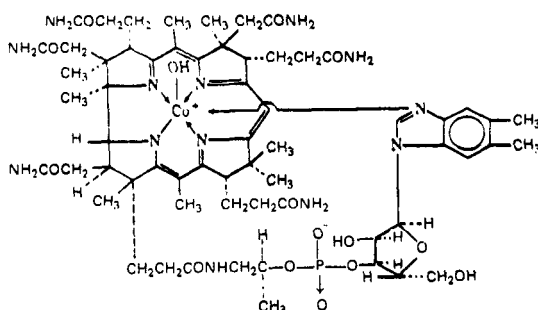

Chemical Abstracts Registry No.: 13422-51-0

Trade Name	Manufacturer	Country	Year Introduced
Alpha-Redisol	MSD	U.S.	1962
Ducobee-Hy	Breon	U.S.	1962
Rubramin-OH	Squibb	U.S.	1963
Hycobal-12	Canfield	U.S.	1964
Hydroxo B-12	Philips Roxane	U.S.	1964
Neo-Vi-Twel	SMP	U.S.	1964
Neo-Betalin 12	Lilly	U.S.	1964
Sustwelve	Ascher	U.S.	1964
Rubesol-LA	Central	U.S.	1965
Sytobex-X	Parke Davis	U.S.	1966
Acimexan	Cimex	Switz.	—
Anemisol	Tobishi	Japan	—
Aquo-B	Nippon Zoki	Japan	—
Aquo-Cytobion	Merck	W. Germany	—
Axlon	Albert-Roussel	W. Germany	—
Behepan	Kabi Vitrum	Sweden	—
Berubi	Redel	W. Germany	—
Bistin	Yamanouchi	Japan	—
Bradiruba	Ibirm	Italy	—
Cobalidrina	Italsuisse	Italy	—
Cobalamin H	Otsuka	Japan	—
Cobalvit	Tosi-Novara	Italy	—
Colsamine	Kanyo	Japan	—
Docevit	Boizot	Spain	—
Dolevern	Seiko	Japan	—
Erycytol	Sanabo	Austria	—
Fravit B-12	Francia	Italy	—
Fresmin S	Takeda	Japan	—
Funacomin-F	Funai	Japan	—
Hicobala	Mitaka	Japan	—
Hicobalan	Maruko	Japan	—
Hydocobamin	Hishiyama	Japan	—
Hydocomin	Sanwa	Japan	—
Hydroxo 5000	Heptatrol	France	—
Hydroxomin	Tokyo Hosei	Japan	—
Idoxo B12	Ferrosan	Denmark	—
Idro-Apavit	Locatelli	Italy	—
Idrobamina	Tiber	Italy	—
Idrocobalmin	Panther-Osfa	Italy	—
Idrospes B12	Ausonia	Italy	—
Idrozima	Labif	Italy	—

Trade Name	Manufacturer	Country	Year Introduced
Laseramin	Choseido	Japan	—
Longicobal	Farber-R.E.F.	Italy	—
Masblon H	Fuso	Japan	—
Natur B12	Panthox & Burck	Italy	—
Nichicoba	Nichiiko	Japan	—
Novobedouze	Bouchara	France	—
OH-BIZ	Morishita	Japan	—
Oxobemin	Vitrum	Sweden	—
Rasedon	Sawai	Japan	—
Red	Neopharmed	Italy	—
Red-B	Kowa	Japan	—
Redisol H	Merck-Banyu	Japan	—
Rosoboviv	Medici	Italy	—
Rubitard B12	Proter	Italy	—
Runova	Squibb-Sankyo	Japan	—
Solco H	Tobishi	Japan	—
Tsuerumin S	Mohan	Japan	—
Twelvmin	Mohan	Japan	—
Vigolatin	Kowa	Japan	—

Raw Materials

Vitamin B₁₂ (cyanocobalamin)
Hydrogen

Manufacturing Process

A solution containing 26.3 mg of vitamin B₁₂ in 15 ml of water was shaken with 78 mg of platinum oxide catalyst and hydrogen gas under substantially atmospheric pressure at 25°C for 20 hours. Hydrogen was absorbed. During the absorption of hydrogen the color of the solution changed from red to brown. The solution was separated from the catalyst and evaporated to dryness in vacuo. The residue was then dissolved in 1 ml of water and then diluted with about 6 ml of acetone.

After standing for several hours a small amount of precipitate (about 2 to 3 mg) was formed and was then separated from the solution. This solution was diluted with an additional 2 ml of acetone and again allowed to stand for several hours. During this time about 4 to 5 mg of noncrystalline precipitate formed. This solid was separated from the solution and an additional 2 ml of acetone was added to the solution. On standing, vitamin B_{12a} began to crystallize in the form of red needles. After standing for 24 hours, the crystalline material was separated, yield 12 mg. By further dilution of the mother liquor with acetone additional crystalline precipitate formed (from U.S. Patent 2,738,302).

References

- Merck Index 4720
Kleeman & Engel p. 475
I.N. p. 500
REM pp. 1020, 1023
Kaczka, E.A., Wolf, D.E. and Folkers, K.; U.S. Patent 2,738,301; March 13, 1956; assigned to Merck & Co., Inc.
Kaczka, E.A., Wolf, D.E. and Folkers, K.; U.S. Patent 2,738,302; March 13, 1956; assigned to Merck & Co., Inc.

HYDROXYCHLOROQUINE SULFATE

Therapeutic Function: Antimalarial

Chemical Name: 2-[[4-[(7-chloro-4-quinolinyl)amino] penty]] ethylamino] ethanol sulfate

Common Name: —

Structural Formula:

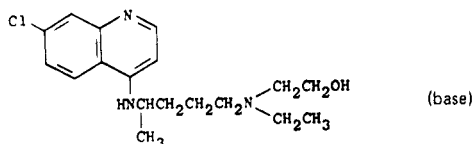

Chemical Abstracts Registry No.: 747-36-4; 118-42-3 (Base)

Trade Name	Manufacturer	Country	Year Introduced
Plaquenil	Winthrop	U.S.	1956
Plaquenil	Winthrop	France	1960
Eroquin	Erco	Denmark	—
Eroquin	Shionogi	Japan	—
Oxiklorin	Orion	Finland	—
Quensyl	Winthrop	W. Germany	—
Rhyumapirine S	Nichiiko	Japan	—
Toremonil	Iwaki	Japan	—

Raw Materials

1-Chloro-4-pentanone	Ammonia
N-Ethyl-N-2-hydroxyethylamine	Hydrogen
4,7-Dichloroquinoline	Phosphoric acid
Sulfuric acid	

Manufacturing Process

A mixture of 323 grams of 1-chloro-4-pentanone, 480 grams of N-ethyl-N-2-hydroxyethylamine and 400 grams of sodium chloride (to aid in subsequent filtration) in 1.3 liters of xylene was heated with stirring on a steam bath for two hours and then refluxed for three hours. After standing overnight, the mixture was filtered and the filter cake washed with xylene. The filtrate was fractionally distilled, yielding 207.3 grams of a fraction distilling at 89° to 90°C at 0.35 mm; $n_D^{25} = 1.4600$. This fraction, 1-(N-ethyl-N-2-hydroxyethylamino)-4-pentanone, was used in the next step of the synthesis. A sample of the fraction was further purified by distillation through a column and gave an analytically pure sample of 1-(N-ethyl-N-2-hydroxyethylamino)-4-pentanone, boiling at 85° to 87°C at 0.4 mm.

The 1-(N-ethyl-N-2-hydroxyethylamino)-4-pentanone from above (284.2 grams) was dissolved in 300 grams of 28% ammoniacal methanol and reduced catalytically with Raney nickel (at an initial pressure of 1,000 pounds) at room temperature. After 24 hours the catalyst was filtered off and the product distilled in vacuo through a column, yielding 254 grams of a fraction distilling at 88.5° to 96°C at 0.3 mm and comprising mainly 5-(N-ethyl-N-2-hydroxyethylamino)-2-pentylamine. An analytical sample of this fraction distilled at 93°C at 0.6 mm.

A mixture of 90 grams of 4,7-dichloroquinoline, 90 grams of phenol, 1 gram of potassium iodide and 132 grams of 5-(N-ethyl-N-2-hydroxyethylamino)-2-pentylamine from above was heated with stirring for 13 hours at 125° to 130°C. Methanol (1.9 liters) was added and the mixture was filtered with charcoal. The filtrate was treated with 270 cc of a solution of 100 grams of phosphoric acid in 300 cc of methanol. The walls of the flask containing the filtrate were scratched with a glass rod and the mixture was allowed to stand for two days. The solid was filtered off, washed with methanol and dried, yielding 101 grams of crude 7-chloro-4-[5-(N-ethyl-N-2-hydroxyethylamino)-2-pentyl] aminoquinoline diphosphate, MP 155° to 156°C.

Additional quinoline diphosphate was obtained as a gummy mass from the filtrate by concentrating the latter to about half its volume and adding acetone. The crude gummy diphosphate was dissolved in water, basified with ammonium hydroxide and the resulting liberated basic quinoline extracted with chloroform. After removal of the chloroform by distillation, the residue was dissolved in ether and crystallization was induced by scratching the walls of the flask with the glass rod. About 30 grams of the crude quinoline base, melting at 77° to 82°C, separated. Recrystallization of this material from ethylene dichloride or ethyl acetate yielded the purified 7-chloro-4-[5-(N-ethyl-N-2-hydroxyethylamino)-2-pentyl] aminoquinoline, MP 89° to 91°C.

The base may then be dissolved in ethanol and precipitated as the sulfate by reaction with an equimolar quantity of sulfuric acid.

References

Merck Index 4729

Kleeman & Engel p. 476

PDR p. 1926

OCDS Vol. 1 p. 342 (1977)

I.N. p. 502

REM p. 1220

Surrey, A.R.; U.S. Patent 2,546,658; March 27, 1951; assigned to Sterling Drug Inc.

HYDROXYDIONE SODIUM SUCCINATE

Therapeutic Function: General anesthetic

Chemical Name: 21-(3-Carboxy-1-oxopropoxy)-5 β -pregnane-3,20-dione sodium salt

Common Name: --

Structural Formula:

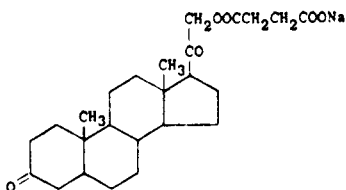

Chemical Abstracts Registry No.: 53-10-1

Trade Name	Manufacturer	Country	Year Introduced
Viadril	Pfizer	U.S.	1957
Predion	V.N.I.Kh.F.I.	USSR	—

Raw Materials

Desoxycorticosterone
Hydrogen
Succinic anhydride

Manufacturing Process

A solution of 20 g of desoxycorticosterone in 190 ml of absolute ethanol was stirred in an atmosphere of hydrogen in the presence of 1.68 g of 25% palladium on calcium carbonate

catalyst. After 20 hours, approximately 1 molar equivalent of hydrogen had been absorbed and hydrogen uptake had ceased. The catalyst was removed by filtration and the filtrate evaporated in vacuo to yield 20 g of nearly pure product, MP 135°C to 140°C. The crude product was demonstrated to be free of starting material by paper chromatography. A highly purified product was obtained by recrystallization from acetone-water with cooling in an ice bath, yield 14.5 g, MP 152°C to 154°C. The product was characterized by analysis and by absence of ultraviolet absorption.

A solution of 14 g of 21-hydroxypregnane-3,20-dione and of 14 g of recrystallized succinic anhydride in 140 ml of dry pyridine was allowed to stand at room temperature for 18 hours, then cooled in an ice bath and poured in a fine stream into 1.5 liters of ice water. Excess pyridine was neutralized with 3N hydrochloric acid and the solution further diluted with 2 liters of ice water. The precipitated product was filtered, washed with water and dried in vacuo at 50°C affording 18 g of solid MP 192°C to 195°C. Recrystallization of a small sample afforded analytically pure material, MP 200°C.

References

Merck Index 4734

I.N. p. 502

Laubach, G.D.; U.S. Patent 2,708,651; May 17, 1955; assigned to Chas. Pfizer & Co., Inc.

HYDROXYPHENAMATE

Therapeutic Function: Minor tranquilizer

Chemical Name: 2-Phenyl-1,2-butanediol-1-carbamate

Common Name: Oxyfenamate

Structural Formula:

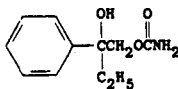

Chemical Abstracts Registry No.: 50-19-1

Trade Name	Manufacturer	Country	Year Introduced
Listica	Armour	U.S.	1961
Listica	Armour Montagu	France	1975

Raw Materials

2-Phenyl-1,2-butanediol

Ethyl chloroformate

Ammonia

Manufacturing Process

2-Phenyl-2-hydroxy-butyl carbamate was prepared by the following method:

49.81 g of 2-phenyl-1,2-butanediol and 25.01 g of pyridine were dissolved in 500 ml of benzene and cooled to 5°C. 34.01 g of ethyl chloroformate was added over a period of ¾ hour at 4°C to 8°C. The reaction mixture was warmed to room temperature and stirred for 2 hours and then extracted with 100 cc each of the following:

Water, 15% hydrochloric acid, 10% sodium bicarbonate and finally water. The solvent was stripped off. The residual oil was mixed with 300 ml of 28% aqueous ammonia for 1 hour. The ammonia and water were vacuum distilled at a temperature of 40°C or less. Then 300 cc of carbon tetrachloride was added and the solution dried with sodium sulfate. The solution was cooled at 0°C and then filtered. The crystals were washed with cold carbon tetrachloride and vacuum dried. The yield was 57 g of dried product having a melting point of 55°C to 56.5°C.

References

Merck Index 4756

OCDS Vol. 1 p. 220 (1977)

I.N. p. 718

Sifferd, R.H. and Braitberg, L.D.; U.S. Patent 3,066,164; November 27, 1962; assigned to Armour Pharmaceutical

HYDROXYPROGESTERONE CAPROATE

Therapeutic Function: Progestin

Chemical Name: 17-[(1-oxohexyl)oxy] pregn-4-ene-3,20-dione

Common Name: —

Structural Formula:

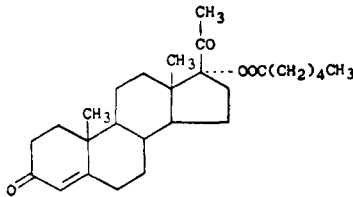

Chemical Abstracts Registry No.: 630-56-8

Trade Name	Manufacturer	Country	Year Introduced
Delalutin	Squibb	U.S.	1956
Hyproval	Tutag	U.S.	1976
Corluton Depot	I.E. Kimya Evi	Turkey	—
Caprogen Depot	Kanto	Japan	—
Depolut	Taro	Israel	—
Depot-Progen	Hokoriku	Japan	—
Hormofort	Kobanyai	Hungary	—
Idrogestene	Farmila	Italy	—
Kaprogest	Polfa	Poland	—
Lutopron	Cipla	India	—
Pergestron	Dexter	Spain	—
Primolut-Depot	Schering	U.K.	—
Prodox	Legere	U.S.	—
Proge	Mochida	Japan	—
Progesteron-Depo	Galenika	Yugoslavia	—

Raw Materials

17 α -Oxypregnene-(5)-ol-(3)-one-(20)-acetate-(3)

Caproic acid anhydride
Hydrogen chloride
Cyclohexanone

Manufacturing Process

40 grams of 17 α -oxypregnene-(5)-ol-(3)-one-(20)-acetate-(3) is brought to reaction with 22 grams of p-toluol sulfonic acid and 850 cc of caproic acid anhydride under a nitrogen atmosphere for 5 days at room temperature or 2½ days at 37°C. The excess anhydride is blown off with steam in the presence of 200 cc of pyridine and the distillation residue is extracted with ether and worked up as usual. The remaining oil is brought to crystallization with pentane and the raw 17 α -oxypregnenolone-3-acetate-17-caproate is recrystallized from methanol. The crystals are needle-like and have a MP of 104° to 105°C. This substance is partially saponified by refluxing for 1 hour in 1,800 cc of methanol in the presence of 13 cc of concentrated hydrochloric acid. After evaporation of the methanol under vacuum, the dry residue is recrystallized from isopropyl ether or methanol (dense needles). The thus obtained 17 α -oxypregnenolone-17-caproate melts at 145° to 146.5°C.

By oxidation in 100 cc of absolute toluol with 425 cc of cyclohexanone and 155 cc of a 20% aluminum isopropylate solution in absolute toluol and after repeated crystallizations from isopropyl ether or methanol, 24 grams of pure 17 α -oxyprogesterone-17-caproate is obtained, MP 119° to 121°C (dense needles).

References

Merck Index 4761

Kleeman & Engel 479

PDR p. 1033

OCDS Vol. 1 pp. 176, 190 (1977)

DOT 19 (2) 112 (1983)

I.N. p. 505

REM p. 991

Kaspar, E., Pawlowski, K.H., Junkmann, K. and Schenck, M.; U.S. Patent 2,753,360; July 3, 1956; assigned to Firma Schering AG, Germany

HYDROXYPROPYL CELLULOSE

Therapeutic Function: Topical protectant; ophthalmic vehicle

Chemical Name: Cellulose 2-hydroxypropyl ether

Common Name: Hypolose

Structural Formula:

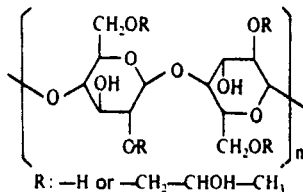

Chemical Abstracts Registry No.: 9004-64-2

Trade Name	Manufacturer	Country	Year Introduced
Lacrisert	MSD	U.S.	1981

Raw Materials

Cotton linters	Propylene oxide
Sodium hydroxide	Acetic acid

Manufacturing Process*Charge:*

	Parts
Purified cotton linters	1
Tertiary butanol	10
Water	1.4
Sodium hydroxide	0.1
Hexane	9.5
Propylene oxide	2.85

Procedure:

The tertiary butanol, water and sodium hydroxide were mixed and the mixture cooled to 20°C. The purified cotton linters were added to the mixture and aged at 20°C for one hour while stirring. Excess liquid was filtered off the resulting alkali cellulose so that the resulting alkali cellulose filter cake weighed 3.08 parts. This filter cake was broken up and slurried in the hexane, placed in a pressure vessel the pressure of which was increased to 100 psig with nitrogen, and then the pressure was vented to 5 psig. The propylene oxide was added to the pressure vessel and then the pressure was increased to 25 psig with nitrogen. The resulting charge was heated to 85°C in 30 minutes and then reacted at this temperature and 25 psig pressure for six hours. The charge was cooled to 30°C, the pressure vessel vented and 0.14 part of glacial acetic acid added. The excess hexane was filtered off from the resulting hydroxypropyl cellulose product, the product was purified by washing with hot water (85°C to 95°C) and then dried at 130°C using a two-roll drum drier.

References

- Merck Index 4763
 PDR p. 1191
 DOT 18 (7) 338 (1982)
 I.N. p. 509
 REM p. 1298
 Klug, E.D.; U.S. Patent 3,278,521; October 11, 1966; assigned to Hercules, Inc.

HYDROXYSTILBAMIDINE ISETHIONATE

Therapeutic Function: Systemic fungicide

Chemical Name: 2-hydroxy-4,4'-stilbenedicarboxamide di(β-hydroxyethanesulfonate)

Common Name: —

Structural Formula:

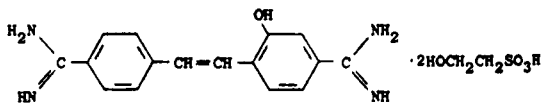

Chemical Abstracts Registry No.: 533-22-2; 495-99-8 (Base)

Trade Name	Manufacturer	Country	Year Introduced
Hydroxystilbamidin Isethionate	Merrell-National	U.S.	1954
Hydroxystilbamide	May & Baker	U.K.	—

Raw Materials

2-Nitro-p-tolunitrile	4-Cyanobenzaldehyde
Stannous chloride	Sodium nitrate
Sulfuric acid	Hydrogen chloride
Ammonia	Isethionic acid

Manufacturing Process

Preparation of 2-Nitro-4,4'-Dicyanostilbene: 10 grams of 2-nitro-p-tolunitrile and 8.1 grams of 4-cyano-benzaldehyde were heated to 170° to 180°C, 1.2 and 0.6 cc of piperidine were added at quarter-hour intervals, heating was continued for a further one and a quarter hours, the product cooled, triturated with glacial acetic acid and filtered. The residue was crystallized from glacial acetic acid as yellow needles, MP 290°C.

Preparation of 2-Amino-4,4'-Dicyanostilbene: 10.0 grams of 2-nitro-4,4'-dicyanostilbene thus prepared were suspended in 200 cc of glacial acetic acid and a hot solution of 50 grams of stannous chloride (SnCl₂·2H₂O) in 50 cc of concentrated hydrochloric acid was quickly added. Rapid reaction occurred and the boiling was continued for a further 4 minutes, the reaction mixture was cooled, filtered, and the stannous chloride residue decomposed with 25% aqueous caustic soda solution. The liberated amine crystallized from glacial acetic acid as yellow needles, MP 232°C.

Preparation of 2-Hydroxy-4,4'-Dicyanostilbene: 10 grams of 2-amino-4,4'-dicyanostilbene thus prepared were dissolved in 400 cc of boiling glacial acetic acid and 200 cc of dilute sulfuric acid added; the solution was suddenly chilled and diazotized over one and a half hours at 5° to 10°C with sodium nitrate (3.0 grams/15 cc H₂O). The diazonium salt solution was decomposed by boiling for 15 minutes with 600 cc of 55% aqueous sulfuric acid solution; the solution was diluted, cooled and filtered. The residue crystallized from ethyl alcohol as lemon yellow prismatic needles, MP 296°C.

Preparation of 2-Hydroxy-4,4'-Diamidinostilbene Dihydrochloride: 10 grams of 2-hydroxy-4,4'-dicyanostilbene were suspended in 250 cc of absolute ethyl alcohol and the mixture saturated with dry hydrogen chloride at 0°C. The whole was left for eight days at room temperature. The imino-ether hydrochloride formed was filtered off, washed with dry ether and dried in the air for a short time. It was then added to 250 cc of 10% ethyl alcoholic ammonia and the whole heated for 5 hours at 45°C. The 2-hydroxy-4,4'-diamidinostilbene dihydrochloride which separated was crystallized from 10% hydrochloric acid. It forms pale yellow needles, MP 357°C (decomposition).

Preparation of the Final Isethionate Product: The diisethionate may be produced by treating a solution of the dihydrochloride with alkali carbonate, separating and dissolving the resultant base in aqueous isethionic acid and precipitating the diisethionate with acetone. The product may be purified by dissolving in hot methyl alcohol containing a trace of water followed by precipitation by the cautious addition of acetone. The diisethionate has a MP of 286°C.

References

Merck Index 4768

Kleeman & Engel p. 480

I.N. p. 506

REM p. 1230

Ewins, A.J.; U.S. Patent 2,510,047; May 30, 1950; assigned to May & Baker Ltd., England

HYDROXYTRYPTOPHAN

Therapeutic Function: CNS stimulant

Chemical Name: 5-hydroxytryptophan

Common Name: —

Structural Formula:

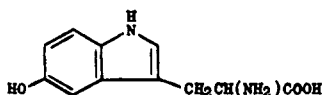

Chemical Abstracts Registry No.: 56-69-9

Trade Name	Manufacturer	Country	Year Introduced
Quietim	Nativelle	France	1973
Tript-Oh	Sigma Tau	Italy	1980
Levothym	Karlspharma	W. Germany	1980

Raw Materials

4-Benzyloxyaniline HCl	Sodium nitrite
Hydrochloric acid	Stannous chloride
Sodium hydroxide	Acrolein
Diethylacetyl amino malonate	Hydrogen

Manufacturing Process

Preparation of 4-Benzyloxyphenylhydrazine: 200 grams 4-benzyloxyaniline hydrochloride was suspended in a mixture of 264 ml concentrated hydrochloric acid, 528 ml water and 732 grams crushed ice. A solution of 62.4 grams sodium nitrite in 136 ml water was added below the surface of the stirred suspension at $-10 \pm 2^\circ\text{C}$ during 10 minutes. After stirring for 1 hour at 0°C , the suspension was treated with acid-washed charcoal and filtered.

The filtrate was cooled and maintained at -8°C while a solution of 500 grams of stannous chloride in 760 ml concentrated hydrochloric acid was added with stirring. The mixture was stirred for 2 hours at -8°C and the 4-benzyloxyphenylhydrazine hydrochloride which separated was filtered off and washed with water. The product was crystallized by adding 800 ml hot water to a 3 liter solution in ethanol and had a MP of 185° to 189°C (yield 168.5 grams, 79%).

Preparation of Ethyl α -Acetyl amino- α -Carbethoxy- β -(5-Benzyloxy-Indolyl-3)-Propionate: 4-benzyloxyphenylhydrazine hydrochloride was converted to the corresponding base 2 to 3 hours before use: 28 grams of the hydrochloride was suspended in 500 ml chloroform and shaken with 55 ml 2 N sodium hydroxide in 100 ml water. The chloroform was separated and the aqueous phase reextracted with chloroform (2 x 100 ml). After washing with 100 ml water, the chloroform solution was dried over sodium sulfate, filtered and evaporated at 30° to 35°C , leaving 4-benzyloxyphenylhydrazine as a friable buff-colored solid (23 grams, 97% from hydrochloride).

6.1 grams freshly distilled acrylic aldehyde (acrolein) in 9.7 ml chlorobenzene was added at 30°C over 30 minutes to a stirred suspension of 24.2 grams diethyl acetylaminomalonnate in 37.5 ml chlorobenzene containing a catalytic amount (0.25 ml) of 50% w/v aqueous sodium hydroxide. After a further 30 minutes the resultant solution was warmed and 23 grams 4-benzyloxyphenylhydrazine was added at 45°C . The mixture was stirred and heated at 65° to 70°C for 1 hour to complete condensation, when a red solution was formed.

The resultant chlorobenzene solution was added to 440 ml N sulfuric acid and the suspension was refluxed with stirring for 6 hours. The product was extracted with chloroform (250 + 100 ml), and the chloroform solution washed with water (3 x 100 ml), separated and dried over sodium sulfate. After filtration and concentration at 40°C to 100 ml, 300 ml light petroleum (BP 40° to 60°C) was added to the warm chloroform-chlorobenzene solution. 33.1 grams ethyl α -acetylamino- α -carboxy- β -(5-benzyloxy-indolyl-3)-propionate crystallized on cooling from the mixture. It was recrystallized by dissolving in 200 ml benzene and adding 100 ml light petroleum (BP 60° to 80°C) at the boiling point. After cooling, the buff crystals were collected, washed with cold benzene/light petroleum (1:1) mixture (50 ml), and dried at 55°C (yield 26.0 grams, 54%, MP 164° to 165°C).

Preparation of α -Acetylamino- α -Carboxy- β -(5-Benzyloxy-Indolyl-3)-Propionic Acid: 18 grams ethyl α -acetylamino- α -carboxy- β -(5-benzyloxy-indolyl-3)-propionate was suspended in 85 ml water containing 8.5 grams sodium charcoal. The suspension was refluxed for 4 hours, decolorizing charcoal added, and the solution filtered hot through Hyflo Supercel.

After cooling in ice to 10°C, the solution was acidified with 24 ml concentrated hydrochloric acid. The solid which separated was filtered off, washed with water (3 x 30 ml) and dried in vacuo over silica gel, to give α -acetylamino- α -carboxy- β -(5-benzyloxy-indolyl-3)-propionic acid, MP 144° to 146°C (15.0 grams, 95%) sufficiently pure for use in the next stage.

Preparation of α -Acetylamino- β -(5-Benzyloxy-Indolyl-3)-Propionic Acid: 15 grams α -acetylamino- α -carboxy- β -(5-benzyloxy-indolyl-3)-propionic acid was suspended in 225 ml water and the suspension refluxed and stirred in a stream of nitrogen until evolution of carbon dioxide ceased (about 2 hours). After cooling somewhat, 120 ml ethyl alcohol was added and the suspension refluxed until the product dissolved. Charcoal was added to the solution, the mixture filtered hot, and the filter-cake washed with 50 ml hot 50% aqueous ethanol. α -Acetylamino- β -(5-benzyloxy-indolyl-3)-propionic acid, MP 164° to 166°C, which crystallized from the filtrate on cooling, was collected, washed with an ice-cold mixture of 15 ml ethanol and 45 ml water, and dried in vacuo over silica gel (yield 11.1 grams, 83%).

Preparation of 5-Benzyloxytryptophan: 11 grams α -acetylamino- β -(5-benzyloxy-indolyl-3)-propionic acid was suspended in a solution of 12 grams sodium hydroxide in 90 ml water and refluxed for 24 hours. Charcoal was added to the resultant solution and the mixture filtered hot. 150 ml 2 N hydrochloric acid was added to the filtrate at 70°C and 5-benzyloxytryptophan crystallized on cooling. After washing with water and drying in vacuo over silica gel, the amino acid (6.9 grams, 71%) had MP (sealed evacuated tube) 232°C, with softening, finally melting at 237° to 238°C (decomposition). Charcoal was added to the filtrate, which was filtered hot and adjusted to pH 2. On cooling a second crop of 5-benzyloxytryptophan was obtained (2.2 grams, 23%), MP (sealed evacuated tube) 230°C, with softening, finally melting at 233° to 237°C (decomposition). The overall yield of 5-benzyloxytryptophan was 9.1 grams (94%).

Preparation of 5-Hydroxytryptophan: 0.4 gram palladium chloride and 1.7 grams acid-washed charcoal were suspended in 157 ml water and hydrogenated at room temperature and atmospheric pressure until no further hydrogen uptake occurred. A suspension of 14.2 grams 5-benzyloxytryptophan in 175 ml ethyl alcohol was added and the mixture hydrogenated under similar conditions. A hydrogen uptake slightly in excess of theory was obtained. The suspension was warmed for a few minutes on the steam bath and filtered hot. The filter-cake was washed with hot water (3 x 20 ml) and the filtrate evaporated to 20 ml under reduced pressure in a nitrogen atmosphere.

The resultant mass of colorless crystals was triturated with 250 ml ice-cold ethyl alcohol under hydrogen, filtered, and washed with cold ethyl alcohol (2 x 15 ml). The 5-hydroxytryptophan (6.9 grams, 69%) had MP (sealed evacuated tube) 288°C, with softening, finally melting at 249° to 247°C (decomposition). Concentration of the liquors under reduced pressure in a nitrogen atmosphere, and trituration as before, gave a second crop (0.9 gram, 9%). The combined crops (7.8 grams) were dissolved in 120 ml hot water, charcoal added,

and the mixture filtered hot. The filtrate was concentrated in a nitrogen atmosphere under reduced pressure and ethyl alcohol added. The 5-hydroxytryptophan then crystallized as colorless microneedles (6.5 grams, 65%), had MP (sealed evacuated tube) 290°C, with slight softening, finally melting at 295° to 297°C (decomposition).

References

Merck Index 4771

DOT 9 (6) 224 (1973), 10 (9) 323 & 10, 262 (1974)

REM p. 1083

Ash, A.S.F.; British Patent 845,034; August 17, 1960; assigned to May & Baker Ltd., U.K.

HYDROXYUREA

Therapeutic Function: Cancer chemotherapy

Chemical Name: Hydroxycarbamide

Common Name: —

Structural Formula: $\text{H}_2\text{NCONHOH}$

Chemical Abstracts Registry No.: 127-07-1

Trade Name	Manufacturer	Country	Year Introduced
Hydrea	Squibb	U.K.	1967
Hydrea	Squibb	U.S.	1968
Litalir	Heyden	W. Germany	1968
Hydrea	Squibb	France	1969
Biosuppressin	Biogal	Hungary	—
Hidroks	Yurtoglu	Turkey	—
Onco-Carbide	Simes	Italy	—

Raw Materials

Hydroxylamine hydrochloride

Sodium cyanate

Manufacturing Process

The procedure may be illustrated by the following equations relating to the preparation of hydroxyurea from hydroxylamine hydrochloride:

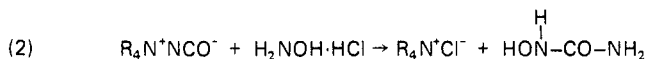

Equation (1) shows the simple conversion of a quaternary ammonium anion exchange resin from the chloride form to the cyanate form. Equation (2) shows the reaction of the resin in the cyanate form with hydroxylamine hydrochloride whereby hydroxyurea is formed and the anion Cl^- is retained by the quaternary resin.

A 90 x 6 cm column was packed with 2 kg of granular Amberlite IRA-410 resin in the chloride form (a vinylpyridine/divinylbenzene copolymer quaternized with dimethyl sulfate and converted to chloride) and washed with 3 kg of a 10% aqueous solution of sodium

cyanate. This changed the resin from the chloride to the cyanate form. Sodium chloride and excess sodium cyanate were then washed from the column with distilled water until the effluent failed to give a white precipitate with silver nitrate. The reaction of equation (2) was conducted by elutriating the column with a solution of 105 grams (1.5 moles) of hydroxylamine hydrochloride in 400 ml water at about 15°C.

A hot (50° to 70°C) reaction zone developed near the top of the column and about 30 minutes was required for this hot zone to descend the full length of the column. The reaction solution was followed in the column by 2.5 liters of distilled water. Collection of the product was begun when hydroxyurea could be detected in the effluent, as indicated by a black precipitate on warming a sample with a silver nitrate test solution. All the effluents were combined and vacuum evaporated at 35°C to give 90 grams of tan residue corresponding to 79% yield of crude product. After recrystallization from 100 ml of water heated to 75°C, the colorless product was dried in a vacuum desiccator over phosphorus pentoxide to give 60.6 grams (53% yield) of hydroxyurea, MP 133° to 136°C.

References

Merck Index 4772

Kleeman & Engel, p. 476

PDR p. 1746

I.N. p. 501

REM p. 1155

Graham, P.J.; U.S. Patent 2,705,727; April 5, 1955; assigned to E.I. du Pont de Nemours and Company

HYDROXYZINE HYDROCHLORIDE

Therapeutic Function: Tranquilizer

Chemical Name: 2-[2-[4-[(4-chlorophenyl)phenylmethyl]-1-piperazinyl]ethoxy] ethanol hydrochloride

Common Name: —

Structural Formula:

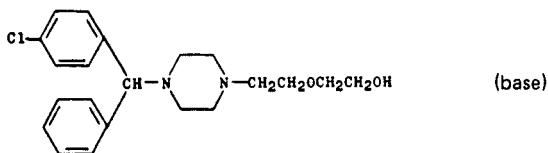

Chemical Abstracts Registry No.: 2192-20-3; 68-88-2 (Base)

Trade Name	Manufacturer	Country	Year Introduced
Atarax	UCB	France	1956
Atarax	Roerig	U.S.	1956
Vistaril	Pfizer	U.S.	1958
Quiess	O'Neal Jones	U.S.	1958
Hyzine	Hyrex	U.S.	1980
Orgatrax	Organon	U.S.	1980
Durrax	Dermik	U.S.	1983
Alamon	Grelan	Japan	—
Arcanax	Arcana	Austria	—
Atazina	Panthox & Burck	Italy	—

Trade Name	Manufacturer	Country	Year Introduced
Disron	Teikoku	Japan	—
Masmoran	Pfizer	W. Germany	—
Marax	Roerig	U.S.	—
Neucalm	Legere	U.S.	—
Neurozina	Farge	Italy	—
Theozine	Schein	U.S.	—

Raw Materials

N-Mono-1-p-chlorobenzohydrilpiperazine
 1-Chloro-2-(2-hydroxyethoxy)ethane
 Sodium hydroxide
 Hydrogen chloride

Manufacturing Process

A mixture of 0.1 mol of N-mono-1-p-chlorobenzohydrilpiperazine and 0.1 mol of 1-chloro-2-(2-hydroxy-ethoxy)-ethane is heated for 3 hours to 150°C. The mass is then taken up in 100 ml of benzene and 100 ml of a 10% aqueous solution of NaOH; decanting takes place, and the benzene solution is washed with water and the solvent is evaporated. Vacuum distilling of the residue yields 1-p-chlorobenzohydril-4-[2-(2-hydroxy-ethoxy)-ethyl]-piperazine, BP 220°C/0.5 mm Hg.

The corresponding dihydrochloride is prepared by dissolving this base in about twice its weight of alcohol, by treating it with excess of gaseous HCl and by precipitating it with ether. The solvent is decanted and the residue, dissolved in a minimum of alcohol, crystallizes on the addition of ether, MP 193°C.

References

- Merck Index 4773
 Kleeman & Engel p. 480
 PDR pp. 832, 872, 993, 1033, 1288, 1416, 1520, 1528, 1606, 1989, 1999
 OCDS Vol. 1 p. 59 (1977)
 I.N. p. 506
 REM p. 1071
 Morren, H.; U.S. Patent 2,899,436; August 11, 1959; assigned to Union Chimique Belge Societe Anonyme, Belgium

I

IBUPROFEN

Therapeutic Function: Antiinflammatory

Chemical Name: α -methyl-4-(2-methylpropyl)benzene acetic acid

Common Name: 2-(4-isobutylphenyl)propionic acid

Structural Formula:

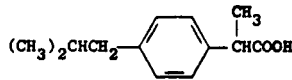

Chemical Abstracts Registry No.: 15687-27-1

Trade Name	Manufacturer	Country	Year Introduced
Brufen	Boots	U.K.	1969
Brufen	Kakenyaku Kako	Japan	1971
Brufen	Labaz	W. Germany	1971
Brufen	Formenti	Italy	1972
Brufen	Dacour	France	1972
Motrin	Upjohn	U.S.	1974
Rufen	Boots	U.S.	1981
Advil	Whitehall	U.S.	—
Algofen	Ibirn	Italy	—
Andran	Takata	Japan	—
Anflagen	Ohta	Japan	—
Artofen	Ikapharm	Israel	—
Artril	Eczacibasi	Turkey	—
Artril 300	Farmasa	Brazil	—
Bluton	Morishita	Japan	—
Brufamic	Teigo	Japan	—
Buburone	Towa Yakuhin	Japan	—
Butylenin	Sanken	Japan	—
Daiprophen	Daito	Japan	—
Donjust-B	Horita	Japan	—
Ebufac	D.D.S.A.	U.K.	—
Epinal	Mitsubishi Yuka	Japan	—
Epobron	Ono	Japan	—
Eputes	Kobayashi Kako	Japan	—
Focus	Angelini	Italy	—
IB-100	Hishiyama	Japan	—
Iborufen	Kyoritsu Yamagata	Japan	—
Ibucasen	Casen	Spain	—
Ibulav	A.L.	Norway	—
Ibumetin	Benzon	Denmark	—
Ibuprocin	Nisshin	Japan	—
Ibo-Slo	Lipha	U.K.	—

Trade Name	Manufacturer	Country	Year Introduced
Inflam	Protea	Australia	—
Lamidon	Kowa	Japan	—
Landelun	Tsuruhara	Japan	—
Liptan	Kowa	Japan	—
Manypren	Zensei	Japan	—
Mono-Attritin	Atmos	W. Germany	—
Mynosedin	Toho Yakuhin	Japan	—
Napacetin	Toyama	Japan	—
Neobrufen	Liade	Spain	—
Nobfelon	Toho	Japan	—
Nobfen	Toho	Japan	—
Nobgen	Kanebo	Japan	—
Nurofen	Crookes	U.K.	—
Opturem	Kade	W. Germany	—
Paduden	Terapia	Rumania	—
Pantrop	Nippon Zoki	Japan	—
Rebugen	Dessy	Italy	—
Roidenin	Showa	Japan	—
Saren	Bracco	Italy	—
Sednafen	Taisho	Japan	—

Raw Materials

Isobutylbenzene	Acetyl chloride
Sulfur	Ethanol
Sodium	Ethyl carbonate
Ethyl iodide	Sodium hydroxide

Manufacturing Process

Isobutylbenzene is first acetylated to give isobutylacetophenone. 4-*i*-butylacetophenone (40 g), sulfur (11 g) and morpholine (30 ml) were refluxed for 16 hours, cooled, acetic acid (170 ml) and concentrated hydrochloric acid (280 ml) were added and the mixture was refluxed for a further 7 hours. The mixture was concentrated in vacuo to remove acetic acid and the concentrate was diluted with water.

The oil which separated was isolated with ether, the ethereal solution was extracted with aqueous sodium carbonate and this extract was acidified with hydrochloric acid. The oil was isolated with ether, evaporated to dryness and the residue was esterified by refluxing with ethanol (100 ml) and concentrated sulfuric acid (3 ml) for 5 hours. The excess alcohol was distilled off, the residue was diluted with water, and the oil which separated was isolated with ether. The ethereal solution was washed with sodium carbonate solution; then with water and was dried. The ether was evaporated off and the oil was distilled to give ethyl 4-*i*-butylphenylacetate.

Sodium ethoxide from sodium (3.67 g) in absolute alcohol (64 ml) was added over 20 minutes with stirring to a mixture of ethyl 4-*i*-butylphenylacetate (28.14 g) and ethyl carbonate (102 ml) at 100°C. The reaction flask was fitted with a Fenske column through which alcohol and then ethyl carbonate distilled. After 1 hour when the still head reached 124°C heating was discontinued. Glacial acetic acid (12 ml) and water (50 ml) was added to the stirred ice-cooled mixture and the ester isolated in ether, washed with sodium carbonate solution, water and distilled to give ethyl 4-*i*-butylphenylmalonate.

Ethyl 4-*i*-butylphenylmalonate (27.53 g) in absolute alcohol (25 ml) was added with stirring to a solution of sodium ethoxide from sodium (2.17 g) in absolute alcohol (75 ml). Ethyl iodide (15 ml) was added and the mixture refluxed for 2½ hours, the alcohol distilled and the residue diluted with water, extracted with ether, washed with sodium bisulfite, water, and evaporated to dryness.

The residual oil was stirred and refluxed with sodium hydroxide (75 ml of 5 N), water (45 ml) and 95% ethanol (120 ml). Within a few minutes a sodium salt separated and after 1 hour the solid was collected, washed with ethanol, dissolved in hot water and acidified with dilute hydrochloric acid to give the methyl malonic acid which was collected and dried in vacuo MP 177° to 180°C (dec.).

The malonic acid (9 g) was heated to 210° to 220°C in an oil bath for 20 minutes until decarboxylation had ceased. The propionic acid was cooled and recrystallized from light petroleum (BP 60° to 80°C). Two further recrystallizations from the same solvent gave colorless prisms of 2-(4-isobutylphenyl)propionic acid MP 75° to 77.5°C. (The procedure was reported in U.S. Patent 3,228,831.)

References

Merck Index 4797

Kleeman & Engel p. 482

PDR pp. 687, 728, 830, 1854, 1897

OCDS Vol. 1 p. 86 (1977) & 2, 218, 356 (1980)

DOT 5 (3) 101 (1969)

I.N. p. 510

REM p. 1117

Nicholson, J.S. and Adams, S.S.; U.S. Patent 3,228,831; January 11, 1966; assigned to Boots Pure Drug Company Limited, England

Nicholson, J.S. and Adams, S.S.; U.S. Patent 3,385,886; May 28, 1968; assigned to Boots Pure Drug Company Limited, England

IBUPROXAM

Therapeutic Function: Antiinflammatory

Chemical Name: N-Hydroxy- α -methyl-4-(2-methylpropyl)benzene-acetamide

Common Name: —

Structural Formula:

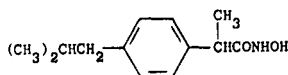

Chemical Abstracts Registry No.: 53648-05-8

Trade Name	Manufacturer	Country	Year Introduced
Ibudros	Manetti-Roberts	Italy	1978
Ibudros	Ferrer	Spain	—

Raw Materials

2-(4-Isobutylphenyl)propionic acid	Ethanol
Hydroxylamine hydrochloride	Potassium hydroxide

Manufacturing Process

In a 1,000 ml three-necked flask equipped with a stirrer, a dropping funnel and a silica gel guard pipe, 46.7 g hydroxylamine hydrochloride are dissolved cold in 480 ml methanol. Separately a solution of 56.1 g KOH in 280 ml methanol is prepared, heated to 30°C and admixed, dropwise under stirring to the hydroxylamine solution. All successive temperature increases dur-

ing this admixture are prevented by cooling in an ice bath. After the whole KOH solution has been admixed, the mixture is left standing for 5 minutes so as to attain the complete precipitation of the KCl.

Separately, 72.02 g ethyl 2-(4-isobutylphenyl)-propionate, obtained by the esterification of 2-(4-isobutylphenyl)-propionic acid with ethanol and concentrated H_2SO_4 , are solved with 100 ml methanol, this solution is introduced drop by drop into the reaction flask, and stirred and cooled for 5 hours on an ice bath. Thereafter it is suction filtered, the residue is washed with all together 50 ml methanol, the wash is added to the filtrate, thereafter the whole is evaporated in a water bath with a rotating evaporator at a reduced pressure, until 100–200 ml of a concentrated solution are obtained. This solution is poured into a 200 ml beaker into which are stirred approximately 1,000 ml 1.25N acetic acid. This mixture is left standing for 24 hours, thereafter suction filtered. The resulting filtrate is taken up with 100 ml petroleum ether at 40°C to 60°C, in order to solve any possible residue of unreacted starting ester, and refiltered. Approximately 50 g of 2-(4-isobutylphenyl)-propiohydroxamic acid are obtained, having a melting point of 119°C to 121°C on Kofler's hot stage.

References

Merck Index 4798

DFU 2 (12) 808 (1977)

I.N. p. 511

Orzalesi, G. and Selleri, R.; U.S. Patent 4,082,707; April 4, 1978; assigned to Societa Italo-Britannica L. Manetti-H. Roberts & Co. (Italy)

IDOXURIDINE

Therapeutic Function: Antiviral (ophthalmic)

Chemical Name: 2'-deoxy-5-iodouridine

Common Name: —

Structural Formula:

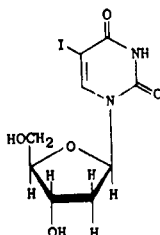

Chemical Abstracts Registry No.: 54-42-2

Trade Name	Manufacturer	Country	Year Introduced
Dendrid	Alcon	U.S.	1963
Stoxil	SKF	U.S.	1963
Herplex	Allergan	U.S.	1963
Idoxene	Spodefelli	U.K.	1963
Idoviran	Chauvin Blache	France	1963
Herpetil	Farmila	Italy	1963
Spectanefran	Pharm-Allergan	W. Germany	1964
Cheratil	Francia	Italy	—
Colircusi Virucida	Cusi	Spain	—

Trade Name	Manufacturer	Country	Year Introduced
Dendrit	Smith & Nephew	U.K.	—
Gel "V"	P.O. S.	France	—
Herpid	W.B. Pharm.	U.K.	—
Herpidu	Dispersa	Switz.	—
IDU	Pliva	Yugoslavia	—
IDU Ophthalmic	Sumitomo	Japan	—
Iducher	Farmigea	Italy	—
Iduridin	Ferring	Sweden	—
Idustatin	Isnardi	Italy	—
Kerecid	SKF	U.K.	—
Oftan-Idurín	Star	Finland	—
Ophthalmadine	S.A.S.Sci.	U.K.	—
Synmiol	Winzer	W. Germany	—
Virexin	Vinas	Spain	—
Virunguent	Hermal	W. Germany	—
Virusan	Ikapharm	Israel	—
Vistaspectran	Allergan	W. Germany	—
Zostrum	W.B. Pharm.	U.K.	—

Raw Materials

5-Iodouracil
 Acetic anhydride
 3,5-Di-p-toluyyl-desoxy-D-ribofuranosyl chloride
 Sodium hydroxide
 Acetic acid

Manufacturing Process

5 g of 5-iodo-uracil (obtained according to T.B. Johnson et al., *J. Biol. Chem.* 1905/6, 1, 310) in 15 cc of acetic anhydride are heated under reflux for 4½ hours. The acetylated derivative crystallizes on cooling. The crystallized product is chilled for ½ hour then filtered with suction, washed with acetic anhydride and then with ether and dried. 4.5 g of 1-acetyl-5-iodo-uracil, MP 167°C, are thus obtained.

1.51 g of mercuric acetate are dissolved in 50 cc of methanol under reflux and 1.35 g of 1-acetyl-5-iodo-uracil are added. A white precipitate is soon formed. The reaction mixture is kept under reflux for ½ hour and then allowed to cool to room temperature. The precipitate is then filtered with suction, washed with methanol and dried.

2.1 g of monomeric 5-iodo-uracil, MP 280°C, are thus obtained as a colorless powder, insoluble in water and the majority of the usual organic solvents, such as benzene, chloroform, alcohol, ether and acetone.

1.46 g of 5-iodo-uracil monomeric derivative are introduced into 50 cc of chloroform and 20 to 30 cc of the solvent are distilled off under normal pressure to ensure good dehydration of the reaction medium. The mixture is cooled to room temperature and 2.59 g of 3,5-di-p-toluyyl-desoxy-D-ribofuranosyl chloride added. The mixture is agitated for 6 hours with glass balls, filtered, rinsed with chloroform and the filtrate is successively washed with an aqueous sodium iodide solution, with water, with a saturated solution of sodium bicarbonate and again with water. The product is dried over sodium sulfate, filtered and evaporated to dryness.

The residue crystallizes in ether and yields about 600 mg of β -3',5'-di-p-toluyyl-2'-desoxy-5-iodo-uridine which is recrystallized from toluene. The product is obtained as colorless crystals, soluble in chloroform and pyridine, sparingly soluble in acetone, benzene ether and alcohol, insoluble in water, MP 193°C.

206 mg of 3',5'-di-p-toluyl-2'-desoxy-5-iodo-uridine are heated at 80°C with 2.5 cc of caustic soda solution (0.4 N) for ½ hour. The solution obtained is cooled, filtered and then acidified with acetic acid. The desoxy-iodo-uridine and the p-toluic acid crystallize. Ether is added to dissolve the p-toluic acid, the mixture is chilled, filtered with suction, washed with water and ether, and dried. The residue is recrystallized from water and 100 mg of 5-iodo-2'-desoxy-uridine, are obtained.

References

- Merck Index 4804
 Kleeman & Engel p. 483
 DOT 7 (5) 191 (1971) & 10 (10) 268 (1974)
 I.N. p. 512
 REM p. 1232
 Roussel-Uclaf; British Patent 1,024,156; March 30, 1966

IFENPRODIL TARTRATE

Therapeutic Function: Vasodilator

Chemical Name: α -(4-hydroxyphenyl)- β -methyl-4-(phenylmethyl)-1-piperidineethanol tartrate

Common Name: —

Structural Formula:

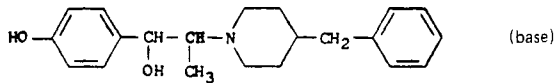

Chemical Abstracts Registry No.: 23210-58-4; 23210-56-2 (Base)

Trade Name	Manufacturer	Country	Year Introduced
Vadilex	Carriere	France	1972
Cerocral	Funai	Japan	1979
Angiotrofin	Montpellier	Argentina	—
Dilvax	Promeco	Argentina	—
Validex	Robert & Carriere	France	—

Raw Materials

Benzyl chloride	4-Hydroxypropiophenone
4-Benzylpiperidine	Bromine
Hydrogen	Tartaric acid

Manufacturing Process

The initial steps involve reacting benzyl chloride with 4-hydroxypropiophenone. The benzyl-oxypropiophene thus obtained is first brominated and then reacted with 4-benzylpiperidine to give 1-(p-benzyloxyphenyl)-2-(4-benzyl-piperidino)propan-1-one.

The neutral tartrate may be prepared directly by reduction of 1-(p-benzyloxyphenyl)-2-(4-benzyl-piperidino)propan-1-one. For the reduction, a mixture of 175 g of ketone (0.425 mol) and 32 g of tartaric acid (0.213 mol) is hydrogenated at 50°C under pressure of 50 kg/cm² in 440 ml of methanol in the presence of 12 g of palladium on charcoal.

The catalyst is filtered off at elevated temperature, and the filtrate is concentrated by evaporation under reduced pressure to a volume of 300 ml and added in a thin stream to 2.5 liters of diethyl ether with mechanical agitation. The precipitate is separated, washed with diethyl ether and dried in vacuo at 80° to 85°C for several hours. 325 g (96% yield) of the neutral tartrate of 1-(p-hydroxyphenyl)-2-(4-benzyl-piperidino)propan-1-ol are obtained.

References

Merck Index 4806

Kleeman & Engel p. 484

OCDS Vol. 2 p. 39 (1980)

I.N. p. 513

Carron, M.C.E., Carron, C.L.C. and Bucher, B.P.; U.S. Patent 3,509,164; April 28, 1970; assigned to Societe Anonyme des Laboratoires Robert et Carriere, France

I FOSFAMIDE

Therapeutic Function: Antineoplastic

Chemical Name: N,3-Bis(2-chloroethyl)tetrahydro-2H-1,3,2-oxazaphosphorin-2-amine-2-oxide

Common Name: Isoendoxan

Structural Formula:

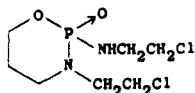

Chemical Abstracts Registry No.: 3778-73-2

Trade Name	Manufacturer	Country	Year Introduced
Holoxan	Lucien	France	1976
Holoxan	Asta	W. Germany	1977
Mitoxana	W.B. Pharm	U.K.	1979
Holoxan	Asta-Werke	Switz.	1979
Holoxan	Schering	Italy	1981
Cyfos	Mead-Johnson	—	—
Naxamide	Mead-Johnson	—	—

Raw Materials

N-(2-Chloroethyl)amine HCl

N-(2-Chloroethyl)-N,O-propylene phosphoric acid ester amide HCl

Triethylamine

Manufacturing Process

127.6 g (1.1 mols) of N-(2-chloroethyl)-amine hydrochloride are suspended in a solution of 218 g (1 mol) of N-(2-chloroethyl)-N,O-propylene phosphoric acid ester amide monochloride in 600 cc of methylene dichloride, and 212 g of triethylamine are added thereto dropwise with stirring. The reaction mixture is heated to boiling by the reaction heat. After termination of the addition, the reaction mixture is heated to boiling for another 2 hours. Thereafter, it is cooled to room temperature and the precipitated triethylamine hydrochloride is separated

by filtration with suction. The filtrate is extracted with about 60 cc of dilute hydrochloric acid (pH 3), then twice with about 60 cc of water, thereafter with about 60 cc of dilute soda lye and finally twice with about 60 cc of water. After drying over anhydrous sodium sulfate, methylene dichloride is distilled off under normal pressure. The oily residue is dried in a vacuum and thereafter extracted in a perforator with 500 cc of anhydrous ether. The oily extract crystallizes upon inoculation and standing in an ice box. After standing for several hours, the precipitate is filtered off, washed with a small amount of cold ether and dried in a vacuum at room temperature. Yield: 185 g (71% of the theoretical). This material is also identified as 3-(2-chloroethyl)-2-(2-chloroethylamino)-tetrahydro-2H-1,3,2-oxazaphosphorin-2-oxide; generic name: ifosfamide. F.P.: 39°C to 41°C.

References

Merck Index 4807

Kleeman & Engel p. 485

OCDS Vol. 3 p. 151 (1984)

DOT 12 (11) 450 (1976) & 16 (5) 171 (1980)

i.N. p. 513

REM p. 1155

Arnold, H., Brock, N., Bourseaux, F. and Bekel, H.; U.S. Patent 3,732,340; May 8, 1973; assigned to Asta-Werke A.G. Chemische Fabrik (W. Germany)

IMIPRAMINE HYDROCHLORIDE

Therapeutic Function: Antidepressant

Chemical Name: 10,11-dihydro-N,N-dimethyl-5H-dibenz[b,f]azepine-5-propanamine HCl

Common Name: Imizin

Structural Formula:

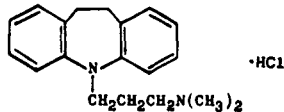

Chemical Abstracts Registry No.: 113-52-0; 50-49-7 (Base)

Trade Name	Manufacturer	Country	Year Introduced
Tofranil	Ciba-Geigy	France	1959
Tofranil	Ciba-Geigy	U.S.	1959
Presamine	USV Pharm	U.S.	1971
SK-Pramine	SKF	U.S.	1974
Janimine	Abbott	U.S.	1975
WDD Tab	Tutag	U.S.	1979
Berkomine	Berk	U.K.	—
Censtim	Ohio Medical	U.S.	—
Chemipramine	Chemo-Drug	Canada	—
Chemoreptin	Toho Iyaku	Japan	—
Chrytemin	Fujinaga	Japan	—
Depress	Toho	Japan	—
Deprinol	Dumex	Denmark	—
Dimipressin	Drugs	U.K.	—
Dynaprin	Monico	Italy	—
Eupramin	Pliva	Yugoslavia	—
Feinalmin	Sanko	Japan	—

Trade Name	Manufacturer	Country	Year Introduced
I.A.-Pram	Inter-Alia Pharm	U.K.	—
Imavate	Robins	U.S.	—
Imidol	Yoshitomi	Japan	—
Imilanyle	Takata	Japan	—
Imipramine	Lederle	U.S.	—
Imipranil	Medica	Finland	—
Imiprin	Protea	Australia	—
Impranil	Barlow Cote	Canada	—
Impril	I.C.N.	—	—
Intalpran	Inter-Alia Pharm.	U.K.	—
Iprogen	Genethic	U.K.	—
Iramil	Knoll	W. Germany	—
Melipramin	Egyt	Hungary	—
Meripramin	Kanebo	Japan	—
Norpramine	Norton	U.K.	—
Novopramine	Novopharm	Canada	—
Primonil	Ikapharm	Israel	—
Prodepress	Medac	Australia	—
Pryleugan	Arzneimittelwerk Dresden	E. Germany	—
Psychoforin	Pharmachim	Bulgaria	—
Servipramine	Servipharm	Switz.	—
Surplix	Vis	Italy	—

Raw Materials

Iminodibenzyl	Sodium amide
3-Dimethylamino n-propyl chloride	Hydrogen chloride

Manufacturing Process

20 parts of imino dibenzyl are dissolved in 100 parts by volume of absolutely dry benzene. A suspension of 4 parts NaNH_2 in 50 parts by volume of absolute benzene are then added dropwise at 50° to 60°C after which the mixture is boiled for an hour under reflux. 13 parts of 3-dimethylamino n-propyl chloride are then added dropwise at 40° to 50°C and the mixture is boiled for 10 hours under reflux. After cooling, the benzene solution is thoroughly washed with water, whereupon the basic constituents are extracted with dilute hydrochloric acid.

The hydrochloric extract is then made alkaline and the separated base is extracted with ether. After drying, the solvent is evaporated and the residue is distilled in the high vacuum, whereby the N-(3-dimethylamino propyl)-imino dibenzyl passes over at a temperature of 160°C under 0.1 mm pressure. The chlorohydrate with a melting point of 174° to 175°C is obtained therefrom with alcoholic hydrochloric acid.

References

- Merck Index 4817
 Kleeman & Engel p. 485
 PDR pp. 527, 673, 901, 993, 1569, 1606, 1723
 OCDS Vol. 1 p. 401 (1977); 2, 420 (1980) & 3, 32 (1984)
 I.N. p. 514
 REM p. 1095
 Haefliger, F. and Schindler, W.; U.S. Patent 2,554,736; May 29, 1951; assigned to J.R. Geigy AG, Switzerland

IMPROSULFAN TOSYLATE

Therapeutic Function: Antitumor

Chemical Name: Bis-(3-methanesulfonyloxypropyl)amine

Common Name: —

Structural Formula:

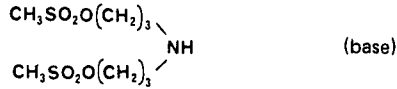

Chemical Abstracts Registry No.: 13425-98-4 (Base)

Trade Name	Manufacturer	Country	Year Introduced
Protecton	Yoshitomi	Japan	1980

Raw Materials

Bis-(3-Methylsulfonyloxypropyl)amine hydrochloride
Sodium carbonate
p-Toluenesulfonic acid

Manufacturing Process

A solution of 5 g of bis(3-methylsulfonyloxypropyl)amine hydrochloride in 20 ml of ice water is neutralized with 1 N sodium carbonate solution. The resulting amine base is extracted with five 20 ml portions of chloroform. The combined extract is dried over anhydrous sodium sulfate, the solvent is distilled off under reduced pressure, and the residue is dissolved in 20 ml of ethanol. To the ethanol solution is added slowly with stirring under ice cooling a solution of 2.6 g of p-toluenesulfonic acid in 30 ml of ethanol. The white precipitate formed is collected by filtration and recrystallized from ethanol to give 5.0 g of white crystalline bis-(3-methylsulfonyloxypropyl)amine p-toluenesulfonate melting at 115°C to 116°C.

References

Merck Index 4823

DFU 4 (2) 106 (1979)

DOT 16 (12) 422 (1980)

I.N. p. 515

Yoshitomi Pharmaceutical Industries, Ltd.; British Patent 1,272,497; April 26, 1972

INDALPINE

Therapeutic Function: Antidepressant

Chemical Name: 4-[2-(3-Indolyl)ethyl] piperidine

Common Name: —

Structural Formula:

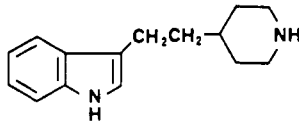

Chemical Abstracts Registry No.: —

Trade Name	Manufacturer	Country	Year Introduced
Upstene	Fournier	France	1983

Raw Materials

Bis(Methoxy-2-ethoxy)sodium aluminum hydride
(Indolyl-3)(piperidinyl-4-methyl)ketone

Manufacturing Process

0.5 g of bis(methoxy-2-ethoxy)sodium aluminum hydride in a 70% solution in toluene is added to a solution of 0.29 g of (indolyl-3)(piperidyl-4-methyl)ketone in 10 ml of toluene. The mixture is heated under refluxing conditions for 15 hours, then cooled to 0°C. 10 ml of an aqueous solution of 5 N sodium hydroxide is added dropwise thereto, followed by stirring for 1 hour. The organic phase is decanted, washed with water, dried using potassium carbonate and evaporated under partial vacuum. 0.26 g of oil is obtained, which is purified by chromatography and hydrochloride formation. The product obtained is 0.1 g of [(indolyl-3)-2-ethyl-4-piperidine] hydrochloride which has a melting point of 167°C.

References

DFU 4 (12) 873 (1979)

DOT 19 (10) 584 (1983)

Champseix, A.A., Gueremy, C.G.A. and LeFur, G.R.; U.S. Patent 4,064,255; December 20, 1977; assigned to Mar-Pha Societe D'Etudes et D'Exploitation De Marques

INDANAZOLINE

Therapeutic Function: Vasoconstrictive agent (nasal spray)

Chemical Name: 2-(4-Indanylamino)-2-imidazoline

Common Name: —

Structural Formula:

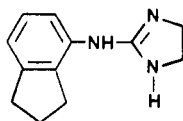

Chemical Abstracts Registry No.: 40507-78-6

Trade Name	Manufacturer	Country	Year Introduced
Farial	Nordmark-Werke	W. Germany	1980
Farial	Knoll	Switz.	1983

Raw Materials

N-4-Indanyl thiourea
Methyl iodide
Ethylene diamine

Manufacturing Process

38.5 g (0.1 mol) of N-4-indanyl thiourea are dissolved in 250 cc of methanol. 42.6 g (0.3 mol)

of methyl iodide are added thereto and the mixture is refluxed for 2½ hours. The mixture thereafter is cooled and the solvent is removed in a rotation evaporator in a vacuum. Thus, 57.5 g of N-4-indanyl-S-methylisothiuronium hydroiodide (86% of theoretical) are obtained. Melting point 144°C to 146°C.

33.4 g (0.1 mol) of N-4-indanyl-S-methylisothiuronium hydroiodide are mixed with 9.0 g (0.15 mol) of anhydrous ethylenediamine. The mixture is slowly heated to 80°C and heating is continued until the termination of the formation of methylmercaptan (about 4 hours). After cooling the residue is dissolved in 2N hydrochloric acid and the solution is extracted with chloroform. The extract is discarded and the aqueous phase is rendered alkaline by the addition of 10% soda lye. The resulting solution is extracted with chloroform and the extract is washed with water, dried over anhydrous sodium sulfate and the solvent is removed. An oily residue is obtained which upon standing soon crystallizes.

The product is recrystallized from petroleum ether having a boiling range of 100°C to 140°C in the presence of activated carbon. Thus, 11.1 g of 2-(4-indanylamino)-2-imidazoline (55% of theoretical) are obtained as the free base. Melting point 109°C to 113°C.

References

Merck Index 4826

DFU 6 (7) 417 (1981)

DOT 17 (10) 413 (1981)

I.N. p. 516

May, H.J. and Berg, A.; U.S. Patent 3,882,229; May 6, 1975; assigned to Nordmark-Werke GmbH

INDAPAMIDE

Therapeutic Function: Diuretic

Chemical Name: 3-(aminosulfonyl)-4-chloro-N-(2,3-dihydro-2-methyl-1H-indol-1-yl)-benzamide

Common Name: Metindamide

Structural Formula:

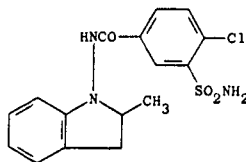

Chemical Abstracts Registry No.: 26807-65-8

Trade Name	Manufacturer	Country	Year Introduced
Natrilix	Pharmacodex	W. Germany	1976
Fludex	Eutherapie	France	1977
Natrilix	Servier	U.K.	1978
Natrilix	Servier	Australia	1983
Lozol	Revlon	U.S.	1983
Arifon	Servier	France	—
Bajaten	Volpino	Argentina	—
Idamix	Gentili	Italy	—
Lozide	Servier	France	—

Trade Name	Manufacturer	Country	Year Introduced
Nap-Sival	Promeco	Argentina	—
Norانات	Labinca	Argentina	—
Pressural	Polifarma	Italy	—
Tertensil	Servier	France	—

Raw Materials

3-Sulfamyl-4-chloro-benzoyl chloride
N-Amino-2-methyl indoline

Manufacturing Process

A total of 8.9 parts of 3-sulfamyl-4-chloro-benzoyl chloride in a solution of 50 parts of anhydrous tetrahydrofuran are added portionwise in the course of 60 minutes, while stirring, to a solution of 5.2 parts of N-amino-2-methyl indoline and 3.5 parts of triethylamine in 150 parts of anhydrous tetrahydrofuran. The reaction mixture is left to stand 3 hours at room temperature, then the precipitated chlorhydrate of triethylamine is filtered off. The filtrate is evaporated under vacuum and the residue is crystallized from a solution of 60 parts of isopropanol in 75 parts of water. There are obtained 9 parts of N-(3-sulfamyl-4-chlorobenzamido)-2-methyl indoline, MP (K) 184° to 186°C, MP (MK) 160° to 162°C (isopropanol/water). [The melting points being determined on a Kofler heater plate under the microscope (MK) or on a Kofler Bank (K)].

References

Merck Index 4828

Kleeman & Engel p. 487

PDR p. 1816

OCDS Vol. 2 p. 349 (1980)

DOT 12 (8) 313 (1976) & 13 (1) 41 (1977)

I.N. p. 516

REM p. 944

Beregl, L., Hugon, P., Laubie, M.; U.S. Patent 3,565,911; February 23, 1971; assigned to Science Union et Cie, Societe Francaise de Recherche Medicale, France

INDENOLOL

Therapeutic Function: Beta-adrenergic blocker

Chemical Name: 1-[1H-Inden-4(or 7)yl]oxy]-3-[(1-methylethyl)amino]-2-propanol

Common Name: —

Structural Formula:

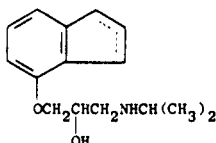

Chemical Abstracts Registry No.: 60607-68-3

Trade Name	Manufacturer	Country	Year Introduced
Pulsan	Yamanouchi	Japan	1979

Trade Name	Manufacturer	Country	Year Introduced
Iambeta	Yamanouchi	Japan	—
Iambeta	Poli	Italy	—

Raw Materials

4-Hydroxyindene	Epichlorohydrin
Isopropylamine	Hydrogen chloride

Manufacturing Process

(a) A mixture of 0.9 g of 4-hydroxyindene, 2.0 g of 1,2-epoxy-3-chloropropane (epichlorohydrin), 2.7 g of potassium carbonate and 15 ml of acetone was refluxed at about 57°C for 24 hours. Acetone was removed by vacuum distillation, the residue was washed with 10 ml of water and then extracted with 20 ml of ether three times. The ether extract was dried with magnesium sulfate, filtered and subjected to column chromatography using a column (having an inside diameter of about 3 cm and a height of about 50 cm) packed with silica gel. The 5th to 7th fractions (volume of one fraction is 50 ml) recovered from the chromatographic column using chloroform as the effluent were combined together and concentrated to provide 0.6 g of 4-(2,3-epoxypropoxy)indene.

(b) A mixture of 0.42 g of 4-(2,3-epoxypropoxy)indene, 1.20 g of isopropylamine and 20 ml of methanol was stirred in a flask at room temperature for 2 hours. Methanol and unchanged isopropylamine were removed by vacuum distillation and the residue was recrystallized from a mixture of n-hexane and ether to yield 0.41 g of 4-(3-isopropylamino-2-hydroxypropoxy)indene having a melting point of 88°C to 89°C.

(c) To a solution of 0.41 g of 4-(3-isopropylamino-2-hydroxypropoxy)indene in 80 ml of absolute ether there was added dropwise a hydrochloric acid-ether mixture at 0°C with stirring. The precipitates thus formed were recovered by filtration and recrystallized from a mixture of ethanol and ether to provide 0.44 g of the hydrochloride of 4-(3-isopropylamino-2-hydroxypropoxy)indene. Melting point 147°C to 148°C.

References

- Merck Index 4831
 DFU 2 (11) 730 (1977)
 Kleeman & Engel p. 487
 DOT 16 (1) 24 (1980)
 I.N. p. 516
 Murakami, M., Murase, K., Niigata, K., Tachikawa, S. and Takenaka, T.; U.S. Patent 4,045,482; August 30, 1977; assigned to Yamanouchi Pharmaceutical Co., Ltd. (Japan)

INDOMETHACIN

Therapeutic Function: Antiinflammatory

Chemical Name: 1-(p-chlorobenzoyl)-5-methoxy-2-methylindole-3-acetic acid

Common Name: —

Structural Formula:

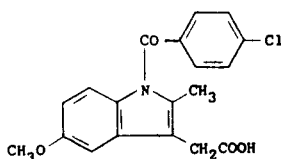

Chemical Abstracts Registry No.: 53-86-1

Trade Name	Manufacturer	Country	Year Introduced
Indocin	MSD	U.S.	1965
Amuno	MSD	W. Germany	1965
Indocid	MSD-Chibret	France	1966
Indocid	MSD	U.K.	1966
Mefacen	Chiesi	Italy	1967
Algometacin	Biagini	Italy	—
Argun	Merckle	W. Germany	—
Arthrexin	Lennon	S. Africa	—
Artracin	D.D.S.A.	U.K.	—
Artrinova	Llorens	Spain	—
Artrivia	Lifasa	Spain	—
Artrobase	Libra	Italy	—
Artrocid	Schoum	Italy	—
Bonidon	Mepha	Switz.	—
Boutycin	Bouty	Italy	—
Calmocin	Mulda	Turkey	—
Cidalgon	Ecobi	Italy	—
Confortid	Dumex	Denmark	—
Durametacin	Durachemie	W. Germany	—
Endol	Deva	Turkey	—
Endomet	Dif-Dogru	Turkey	—
Endsetin	Nobel	Turkey	—
Imbrilon	Berk	U.K.	—
Imet	Firma	Italy	—
Indacin	Merck-Banyu	Japan	—
Inderapollon	Kaigai	Japan	—
Indetrit	Medica	Finland	—
Indium	Pharma Williams	Italy	—
Indo	Arcana	Austria	—
Indodur	Medica	Finland	—
Indolag	Lagap	Switz.	—
Indolene	Italprofar	Italy	—
Indone RC	Sawai	Japan	—
Indomed	Teva	Israel	—
Indomet	Ratiopharm	W. Germany	—
Indomethine	Kowa	Japan	—
Indometin	Orion	Finland	—
Indorektal	Sanorania	W. Germany	—
Indoremmed	Remed Econerica	W. Germany	—
Indo-Tablinen	Sanorania	W. Germany	—
Indotard	Benzon	Denmark	—
Indren	Spofa	Czechoslovakia	—
Inflazon	Taisho	Japan	—
Inmecin	Nippon Chemiphar	Japan	—
Inmetocin	Tobishi	Japan	—
Inmetsin	Farmos	Finland	—
Inteban	Sumitomo	Japan	—
Lausit	Showa	Japan	—
Metacen	Chiesi	Italy	—
Metartril	Ifisa	Italy	—
Methabid	Pharmador	S. Africa	—
Methazine	Sankyo	Japan	—
Metindol	Polfa	Poland	—
Mezolin	Meiji	Japan	—
Mobilan	Galen	U.S.	—
Novomethacin	Novopharm	Canada	—

Trade Name	Manufacturer	Country	Year Introduced
Osmogit	Merck-Frosst	Canada	—
Peralgon	S.A.R.M.	Italy	—
Ralacid	Waldheim	Austria	—
Rheumacin	Protea	Australia	—
Romacid	I.E. Kimya Evi	Turkey	—
Sadoreum	Mediolanum	Italy	—
Salinac	Nippon Kayaru	Japan	—
Takosashin S	Taiho	Japan	—
Tannex	Duncan-Flockhart	U.K.	—
Zalbico	Toyo	Japan	—

Raw Materials

Dicyclohexylcarbodiimide	t-Butyl alcohol
2-Methyl-5-methoxy-3-indolyl acetic acid	Sodium hydride
p-Chlorobenzoyl chloride	

Manufacturing Process

(A) *2-Methyl-5-Methoxy-3-Indolylacetic Anhydride*: Dicyclohexylcarbodiimide (10 g, 0.049 mol) is dissolved in a solution of 2-methyl-5-methoxy-3-indolylacetic acid (22 g, 0.10 mol) in 200 ml of THF, and the solution is allowed to stand at room temperature for 2 hours. The precipitated urea is removed by filtration, and the filtrate is evaporated in vacuo to a residue and flushed with Skellysolve B. The residual oily anhydride is used without purification in the next step.

(B) *t-Butyl 2-Methyl-5-Methoxy-3-Indolylacetate*: t-Butyl alcohol (25 ml) and fused zinc chloride (0.3 g) are added to the anhydride from Part A. The solution is refluxed for 16 hours and excess alcohol is removed in vacuo. The residue is dissolved in ether, washed several times with saturated bicarbonate, water, and saturated salt solution. After drying over magnesium sulfate, the solution is treated with charcoal, evaporated, and flushed several times with Skellysolve B for complete removal of alcohol. The residual oily ester (18 g, 93%) is used without purification.

(C) *t-Butyl 1-p-Chlorobenzoyl-2-Methyl-5-Methoxy-3-Indolylacetate*: A stirred solution of ester (18 g, 0.065 mol) in dry DMF (450 ml) is cooled to 4°C in an ice bath, and sodium hydride (4.9 g, 0.098 mol, 50% susp.) is added in portions. After 15 minutes, p-chlorobenzoyl chloride (15 g, 0.085 mol) is added dropwise during 10 minutes, and the mixture is stirred for 9 hours without replenishing the ice bath. The mixture is then poured into one liter of 5% acetic acid, extracted with a mixture of ether and benzene, washed thoroughly with water, bicarbonate, saturated salt, dried over magnesium sulfate, treated with charcoal, and evaporated to a residue which partly crystallizes. This is shaken with ether, filtered and the filtrate is evaporated to a residue (17 g) which solidifies after being refrigerated overnight.

The crude product is boiled with 300 ml of Skellysolve B, cooled to room temperature, decanted from some gummy material, treated with charcoal, concentrated to 100 ml, and allowed to crystallize. The product thus obtained (10 g) is recrystallized from 50 ml of methanol and gives 4.5 g of analytically pure material, MP 103° to 104°C.

(D) *1-p-Chlorobenzoyl-2-Methyl-5-Methoxy-3-Indolylacetic Acid*: A mixture of 1 g ester and 0.1 g powdered porous plate is heated in an oil bath at 210°C with magnetic stirring under a blanket of nitrogen for about 2 hours. No intensification of color (pale yellow) occurs during this period. After cooling under nitrogen, the product is dissolved in benzene and ether, filtered, and extracted with bicarbonate. The aqueous solution is filtered with suction to remove ether, neutralized with acetic acid, and then acidified weakly with dilute hydrochloric acid. The crude product (0.4 g, 47%) is recrystallized from aqueous ethanol and dried in vacuo at 65°C; MP 151°C.

References

Merck Index 4852

Kleeman & Engel p. 488

PDR pp. 993, 1034, 1187, 1354, 1606, 1999

OCDS Vol. 1 p. 318 (1977); 2, 345 (1980) & 3, 165 (1984)

DOT 1 (4) 125 (1965); 18 (8) 373 (1982) & 19 (5) 286 (1983)

I.N. p. 517

REM p. 1118

Shen, T.-Y.; U.S. Patent 3,161,654; December 15, 1964; assigned to Merck & Co., Inc.

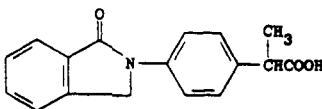
INDOPROFEN**Therapeutic Function:** Antiinflammatory**Chemical Name:** 4-(1,3-dihydro-1-oxo-2H-isoindol-2-yl)- α -methylbenzeneacetic acid**Common Name:** —**Structural Formula:****Chemical Abstracts Registry No.:** 31842-01-0

Trade Name	Manufacturer	Country	Year Introduced
Flosint	Carlo Erba	Italy	1976
Flosin	Carlo Erba	W. Germany	1982
Flosin	Carlo Erba	Switz.	1982
Flosint	Carlo Erba	U.K.	1982
Fenint	Montedison	W. Germany	—
Praxis	Lisapharma	Italy	—

Raw MaterialsEthyl α -(4-aminophenyl)propionate

Ethyl 2-chloromethyl benzoate

Potassium hydroxide

Manufacturing Process

The mixture of 7.9 g of ethyl α -(4-aminophenyl)propionate and 8.3 g of ethyl 2-chloromethylbenzoate is refluxed under nitrogen for one hour. The residue is recrystallized from hexane, to yield the ethyl α -[4-(1-oxo-isoindolino)-phenyl]-propionate of the formula

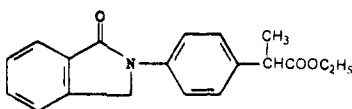

melting at 104° to 106°C. The mixture of 4.5 g thereof, 1.6 g of potassium hydroxide, 2 ml of water and 250 ml of ethanol is refluxed under nitrogen for 2 hours and evapo-

rated under reduced pressure. The residue is taken up in water, the solution washed with chloroform, acidified with hydrochloric acid and extracted with ethyl acetate. The extract is dried, evaporated and the residue recrystallized from ethyl acetate, to yield the corresponding free acid melting at 208° to 210°C. (Procedure reported in U.S. Patent 3,767,805.)

References

Merck Index 4853

DFU 1 (5) 242 (1976)

Kleeman & Engel p. 489

OCDS Vol. 3 p. 171 (1984)

DOT 13 (5) 200 (1977)

I.N. p. 517

Carney, R.W.J. and de Stevens, G.; U.S. Patent 3,767,805; October 23, 1973; assigned to Ciba-Geigy Corporation

Carlo Erba, S.p.A., Italy; British Patent 1,344,663; January 23, 1974

INDORAMIN

Therapeutic Function: Antihypertensive

Chemical Name: N-[1-[2-(1H-Indol-3-yl)ethyl]-4-piperidiny] benzamide

Common Name: —

Structural Formula:

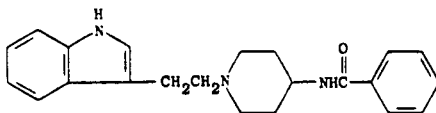

Chemical Abstracts Registry No.: 26844-12-2

Trade Name	Manufacturer	Country	Year Introduced
Baratol	Wyeth	U.K.	1981
Wydora	Wyeth	W. Germany	1983

Raw Materials

4-Benzamido-1-[2-(3-indolyl)ethyl] pyridinium bromide
Hydrogen

Manufacturing Process

4-Benzamido-1-[2-(3-indolyl)ethyl] pyridinium bromide (3.0 g) was dissolved in 91% ethanol (300 ml) containing triethylamine (0.08 g) and freshly prepared W7 Raney nickel catalyst (ca 3 g) was added. The mixture was hydrogenated in an autoclave at 400 psi hydrogen pressure and 50°C for 4 hours. After filtering off the catalyst the filtrate was evaporated in vacuo and the residue was shaken with a mixture of chloroform and 2N sodium hydroxide solution. The resulting insoluble material was filtered off and dried to give 1.61 g of product, MP 203°C to 206°C. Recrystallization from ethanol gave the title compound as colorless needles (1.34 g), MP 208°C to 210°C.

References

Merck Index 4854

DFU 1 (10) 476 (1976)

OCDS Vol. 2 p. 344 (1980)

DOT 17 (10) 420 (1981)

I.N. p. 518

Archibald, J.L. and Jackson, J.L.; U.S. Patent 3,527,761; September 8, 1970; assigned to John Wyeth & Brother, Ltd. (U.K.)

INOSINE

Therapeutic Function: Cardi tonic

Chemical Name: 9- β -D-ribofuranosylhypoxanthine

Common Name: Hypoxanthine riboside

Structural Formula:

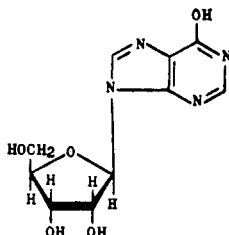

Chemical Abstracts Registry No.: 58-63-9

Trade Name	Manufacturer	Country	Year introduced
Foreart	Guarnieri	Italy	1970
Oxiamin	Made	Spain	—
Ribonosine	Toyo Jozo	Japan	—
Salinite	Shinshin	Japan	—
Tebertin	Berenguer-Beneyto	Spain	—
Trophicardyl	Innothera	France	—
Virusina	Dukron	Italy	—

Raw Materials

Adenosine
Barium nitrite
Sulfuric acid

Manufacturing Process

As described in U.S. Patent 3,049,536, inosine may be prepared starting with adenosine.

The Deamination of Adenosine: 20 g of adenosine are dissolved in one liter of water by warming, and after cooling to room temperature 120 g of barium nitrite (monohydrate) are added to the solution. Under stirring there is added in time intervals of one hour 160 cc of 2 N sulfuric acid after each time interval. After the third addition, the reaction mass is allowed to stand for 3 hours at room temperature. The solution is then tested for barium, and if some barium is still present a slight excess of sulfuric acid is added. 300 cc of methanol is then added. In order to drive off the excess of nitrous acid, CO₂ is conducted

through the solution until the solution is free of nitrous acid as determined by testing with potassium iodide-starch paper. The precipitated barium sulfate is separated by centrifugation. The residue is washed one time with about 500 cc of water. The total volume of the centrifugate is about 2.3 liters.

Isolation of Inosine by Ion Exchange Method: Half of the above clear centrifugate (1.15 liters) is treated with 250 cc of anion exchange (bicarbonate form) and stirred together therewith for 16 hours at room temperature. The pH value is increased thereby to about 4 to 5. The ion exchanger is filtered off under suction and washed 3 times, each time with 150 cc of water. The solution is brought to a pH value of 7 by means of normal sodium hydroxide (total volume of the solution about 1.55 liters), and concentrated to a volume of about 100 cc under vacuum.

The inosine is crystallized overnight in an ice box and the inosine is then filtered off by suction, washed with a small amount of ice water and dried at a temperature of 105°C. A first fraction of crude inosine consisting of 5.4 g having a purity of 99% is obtained. Further fractions of crude inosine are obtained from the mother liquid by concentration, the total amount constituting 3.2 g having a purity of 96 to 98%. The yield of crude inosine is 8.6 g which is equal to 86%.

Recrystallization of the Crude Inosine: 17.0 g of crude inosine are dissolved in 400 cc of 80% ethanol in a water bath, filtered while hot and brought to crystallization in an ice box. After standing overnight the crystalline material is filtered off under suction and washed with ice water. The pure inosine is dried in a drying chamber at a temperature of 105°C. The yield of pure inosine is 15.0 g which is equal to 75%. The yield can be further increased by working up the mother liquor of the crystallization as set forth above.

Alternatively, inosine may be made by fermentation as described in U.S. Patent 3,111,459. 3 ml portions of a culture medium consisting of glucose (5 g/dl), ammonium chloride (0.4 g/dl), urea (0.4 g/dl), KH_2PO_4 (0.1 g/dl), $\text{MgSO}_4 \cdot 7\text{H}_2\text{O}$ (0.02 g/dl), Mn^{++} (2 ppm), Fe^{++} (2 ppm), casein hydrolyzate (0.2 g/dl), yeast extract (0.2 g/dl), corn steep liquor (0.2 ml/dl), polypeptone (0.1 g/dl), meat extract (0.1 g/dl) and sodium ribonucleate (10 mg/dl) were poured into respective test tubes and each tube was sterilized at 115°C for 10 minutes. Thereafter separately sterilized calcium carbonate was added in the amount of 2 g/dl and then cells of *Bacillus subtilis* S26910 were inoculated into the above media and cultured with shaking at 30°C for 20 hours.

The resulting culture liquids were utilized for seeding. 20 ml of the medium having the composition described above were poured into a 500 ml shaking flask and sterilized at 115°C for 10 minutes and five drops of the above seed were added, and then cultured with shaking at 30°C for 65 hours. Thereafter 0.15 g/dl of inosine were accumulated.

The inosine-containing solution, which was obtained by separating the cells from the resulting fermentation liquid, was treated with both decolorizing resins and anion exchange resins by means of a conventional method and then acetone was added to crystallize the inosine. 1.47 g of the crude crystals of inosine were obtained from 3.5 liters of the culture liquid containing 1 g of inosine per liter.

References

Merck Index 4858

I.N. p. 519

Reiff, F., Huber, G. and Holle, K.; U.S. Patent 3,049,536; August 14, 1962; assigned to Zellstoff Fabrik Waldhof, Germany

Motozaki, S., Tsunoda, T., Aoki, R., Okumura, S., Kondo, Y., Muramatsu, N., Momose, H. and Tamagawa, Y.; U.S. Patent 3,111,459; November 19, 1963; assigned to Ajinomoto KK, Japan

INOSITOL

Therapeutic Function: Vitamin B complex; lipotropic

Chemical Name: Myo-Inositol

Common Name: Hexahydroxycyclohexane; cyclohexitol

Structural Formula:

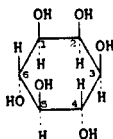

Chemical Abstracts Registry No.: 87-89-8

Trade Name	Manufacturer	Country	Year Introduced
Inositol	Comm. Solvents	U.S.	1949
Amino-Ceru	Milex	U.S.	—
Inosital	Biomedica Foscam	Italy	—
Inositine	Vis	Italy	—
Lipo-BC	Legere	U.S.	—
Mega-B	Arco	U.S.	—
Megadose	Arco	U.S.	—

Raw Materials

Starch factory steep water
Calcium hydroxide

Manufacturing Process

Inactive inositol may be prepared from starch factory steep water which is the liquid in which corn is steeped to soften the covering of the corn kernel and to thoroughly soften the entire kernel. It contains approximately 1% sulfurous acid (H_2SO_3) in solution. A typical example of such treatment consists in adding to the acid steep water, lime $\text{Ca}(\text{OH})_2$ or CaO to approximate neutrality, or to a pH of 6.0 to 8.0, at which range the insoluble "phytin" is precipitated. This precipitate of impure "phytin" or calcium phytate is removed by suitable means, as stated before, and may be mixed with (1) 1 to 10% acid solution; or (2) diluted with water; or (3) the solution may be made alkaline. This alkaline or neutral or acid mixture is placed in a suitable container in an autoclave or steam digester, and the steam turned on whereupon the reaction is allowed to proceed as long as desired. The autoclave in which the mixture has been placed may be heated by generating steam therein, by means of an electric heater, or by suitable heat from outside. A pressure of from 1 to 200 pounds steam for 1 to 18 hours may be used, the time required being correspondingly less for higher pressures. A suitable pressure is 80 pounds. The time expected for 80 pounds is three hours.

After hydrolysis or decomposition is complete, pressure is released, the autoclave cooled, the mixture removed, diluted, and made alkaline with $\text{Ca}(\text{OH})_2$, $\text{Ba}(\text{OH})_2$, etc., brought to boiling, thoroughly agitated with steam, the insoluble sludge allowed to settle, and the supernatant liquid removed by decantation, siphoning or filtration. The supernatant liquid is concentrated in an open vessel, or in vacuum, to remove the precipitating inorganic impurities as calcium carbonate (CaCO_3), magnesium carbonate (MgCO_3), etc. The liquid is concentrated until it becomes thick and syrupy. The concentrated solution is filtered, cooled, and agitated by a suitable mechanical means to precipitate i-inositol. The i-inositol is removed by filtration, the mother liquor concentrated, and the process repeated until the solution becomes too thick to filter advantageously. A filter press may be employed to remove further quantities of i-inositol,

or the thick residue may be diluted with a reagent in which i-inositol is insoluble; as, for example, acetic acid (CH_3COOH) and alcohol-acetic acid ($\text{C}_2\text{H}_5\text{OH}$, CH_3COOH , etc.). On cooling and stirring the solution, additional i-inositol, etc., results and can be removed by filtration or other mechanical means. The i-inositol may be recrystallized by dissolving the crude product in boiling water, and reprecipitated by cooling and stirring. The final crystallization from a hot water solution to which an equal volume of alcohol is added with cooling and stirring, gives a purer product.

References

Merck Index 4861

PDR pp. 581, 1033, 1263, 1734

I.N. p. 519

REM p. 1015

Bartow, E. and Walker, W.W.; U.S. Patent 2,112,553; March 29, 1938

Elkin, M. and Meadows, C.M.; U.S. Patent 2,414,365; January 14, 1947; assigned to American Cyanamid Co.

INOSITOL NIACINATE

Therapeutic Function: Vasodilator (peripheral)

Chemical Name: Myo-Inositol hexa-3-pyridine carboxylate

Common Name: Inositol hexanicotinate

Structural Formula:

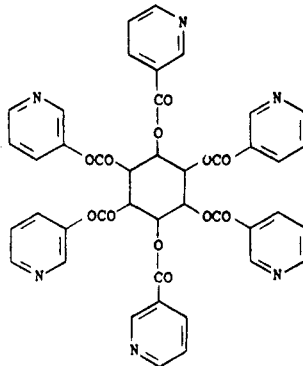

Chemical Abstracts Registry No.: 6556-11-2

Trade Name	Manufacturer	Country	Year Introduced
Hexanicotol	Philadelphia	U.S.	1962
Dilexpal	Winthrop	France	1968
Bendigon	Bayer	W. Germany	—
Clevamin	Kowa	Japan	—
Cycnate	Toyo	Japan	—
Ebelin	Samva	Japan	—
Hammovenad	Bastian Werk	W. Germany	—
Hexalmin	Maruishi	Japan	—
Hexainosineat	Hishiyama	Japan	—

Trade Name	Manufacturer	Country	Year Introduced
Hexanate	Nippon Chemiphar	Japan	—
Hexanicit	Yoshitomi	Japan	—
Hexate	Mohan	Japan	—
Hexatin	Kobayashi	Japan	—
Hexit	Toho	Japan	—
Inochinate	Nichiiko	Japan	—
Inosinit	Kanto	Japan	—
Kotanicit	—Kotani	Japan	—
Mesonex	Tokyo Tanabe	Japan	—
Mesosit	Toyo Jozo	Japan	—
Nasky	Nikken	Japan	—
Neonitin	Chugai	Japan	—
Nicosamin	Toyama	Japan	—
Nicosinate	Toyo Ono	Japan	—
Nicosinit	Hokuriku	Japan	—
Nicotol	Maruko	Japan	—
Nicoxatin	Fuso	Japan	—
Romanit	Kowa	Japan	—
Salex	Iwaki	Japan	—
Sannecit	Sanko	Japan	—
Secotinen	Seiko	Japan	—
Shikioit	Shiri	Japan	—
Xatolone	Showa	Japan	—
Yonomol	Sawai	Japan	—

Raw Materials

Nicotinic acid
Phosphorus oxychloride
meso-Inositol

Manufacturing Process

100 g of nicotinic acid were suspended in 265 ml of distilled and dried pyridine without stirring. 68 g of phosphorus oxychloride were added dropwise to this mixture under continual stirring. The temperature of the reactants, initially at 20°C, was allowed to rise to about 60°C, and this temperature was maintained for a further 60 minutes. Thereafter 24.5 g of meso-inositol were added gradually, the temperature being controlled so that it did not exceed about 80°C. The reactants were maintained at this temperature for from 2 to 3 hours, and thereafter the reaction mixture was poured into 500 ml of water. The pyridine salts formed during the reaction readily dissolved, and the meso-inositol hexanicotinate which had formed crystallized out. The ester was filtered off and washed with water and acetone or alcohol. Finally, the meso-inositol hexanicotinate was dried at 100°C.

The yield was 90%, the melting point of the product was 258°C to 260°C, and the chlorine content <0.01%.

References

Merck Index 4863
Kleeman & Engel p. 490
I.N. p. 519
A.B. Bofors; British Patent 1,053,689; January 4, 1967

INSULIN

Therapeutic Function: Antidiabetic

Chemical Name: Complex polypeptide hormone with molecular weight over 6,000; see Structural Formula

Common Name: —

Structural Formula:

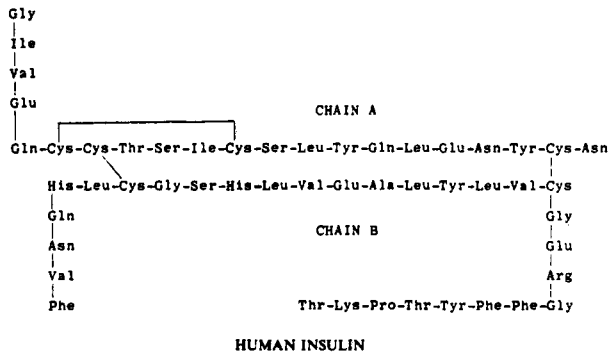

Chemical Abstracts Registry No.: 9004-10-8

Trade Name	Manufacturer	Country	Year Introduced
Humulin	Lilly	U.S.	1982
Humulin	Lilly	U.K.	1982
Humulin	Lilly	Switz.	1983
Huminsulin	Lilly	W. Germany	1983
Velosulin	Leo	Switz.	1983
Monotard	Squibb	U.S.	1983
Monotard	Nova	W. Germany	1983
Actrapid	Squibb	U.S.	1983
Actrapid	Novo	W. Germany	1983
Basal-H	Hoechst	W. Germany	1983
Iletin	Lilly	U.S.	—
Insulatard	Nordisk	U.S.	—
Mixtard	Nordisk	U.S.	—
Novolin	Squibb-Novo	U.S.	—
Velosulin	Nordisk	U.S.	—

Raw Materials

Beef pancreas glands
Ethanol

Manufacturing Process

40 pounds of frozen beef pancreas glands were hashed and extracted by stirring with 45,500 cc of 85% alcohol containing 925 cc of phosphoric acid. The acidity of the extraction mixture was pH 3.0 and the alcohol concentration approximately 65% after equilibrium was attained. The pancreatic meat solids removed were then reextracted by stirring in 45,000 cc of 65% alcohol. The pH of the combined filtrates was raised to pH 8.0 by addition of ammonium hydroxide to precipitate inert proteins and phosphoric acid salts. The solids were removed by filtration and sulfuric acid was then added to the filtrate to bring the pH to 3.5. The acidified extracts were then concentrated under reduced pressure to an alcohol concentration of 20%. Lipoidal material was removed by filtration and the filtrate concentrated under reduced pressure to the aqueous phase. Lipoidal material was then removed by filtration and the insulin-containing filtrate biologically assayed for insulin activity. The biological assay showed the insulin recovered to be equivalent to 1425 I.U. for each pound of pancreas glands processed.

References

Merck Index 4866

PDR pp. 1054, 1270, 1777

DOT 19 (2) 111 & (5) 262 (1983)

REM p. 973

Maxwell, L.C. and Hinkel, W.P.; U.S. Patent 2,695,861; November 30, 1954; assigned to Armour & Co.

INSULIN ISOPHANE

Therapeutic Function: Hypoglycemic

Chemical Name: Isophane insulin

Common Name: Isophane insulin injection

Structural Formula:

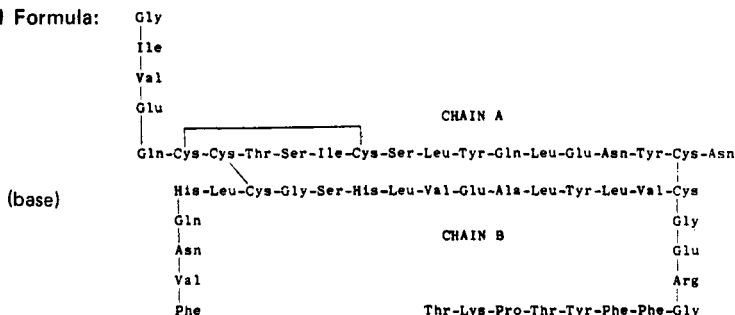

Chemical Abstracts Registry No.: —

Trade Name	Manufacturer	Country	Year Introduced
NPH-Iletin	Lilly	U.S.	1950
Protaphane	Novo	U.S.	1981
Humulin-I	Lilly	U.K.	1982
Insulatard	Leo	Switz.	1983
Novolin N	Squibb-Novoo	U.S.	—

Raw Materials

Zinc insulin

Salmiridine sulfate

Manufacturing Process

This is a crystalline product of insulin and an alkaline protein where the protein/insulin ratio is called the isophane ratio. This product gives a delayed and uniform insulin action with a reduction in the number of insulin doses necessary per day. Such a preparation may be made as follows: 1.6 g of zinc-insulin crystals containing 0.4% of zinc are dissolved in 400 ml of water, with the aid of 25 ml of 0.1 N hydrochloric acid. To this are added aqueous solutions of 3 ml of tricresol, 7.6 g of sodium chloride, and sufficient sodium phosphate buffer that the final concentration is $\frac{1}{3}$ molar and the pH is 6.9.

Then 0.14 g of salmiridine sulfate dissolved in water is added, while shaking. Salmiridine is a protamine derived from the sperm of *Salmo irideus* Gibbons, or rainbow trout. Salmiridine-insulin (a protamine-insulin) containing zinc is promptly precipitated. Enough water is now added to make a total of one liter, and the whole is shaken again. After standing for about an hour, the precipitated salmiridine-insulin is found to have become crystalline.

This crystalline salmiridine-insulin can be removed if desired, as by filtration; but it is not necessary to do that, as the suspension of crystalline salmiridine-insulin may be preserved as thus prepared, and dispensed and used (in the same manner as known preparations of protamine insulin and protamine-zinc-insulin are used) in the original suspending medium in which it is formed.

References

PDR p. 1778

REM p. 974

Krayenbuhl, C.H. and Rosenberg, T.; U.S. Patent 2,538,018; January 16, 1951; assigned to Nordisk Insulinlaboratorium, Denmark

INSULIN ZINC SUSPENSION

Therapeutic Function: Hypoglycemic

Chemical Name: Insulin zinc suspension

Common Name: —

Structural Formula:

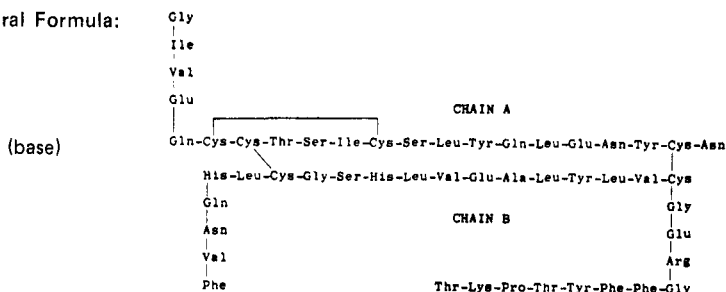

Chemical Abstracts Registry No.: 8049-62-5

Trade Name	Manufacturer	Country	Year Introduced
Lente Insulin	Squibb	U.S.	1971
Iletin I	Lilly	U.S.	—
Protamine	Lilly	U.S.	—
Semilente	Squibb-Novo	U.S.	—
Ultralente	Squibb-Novo	U.S.	—

Raw Materials

- Insulin
- Zinc chloride

Manufacturing Process

First, a series of stock solutions are made.

Stock Solution 1: 2.18 g of recrystallized insulin are dissolved in 25 ml of 0.1 N hydrochloric acid, and distilled water to a volume of 125 ml is added.

Stock Solution 2: To 20 ml of an aqueous zinc chloride solution containing 1% zinc is added distilled water to a volume of 125 ml.

Stock Solution 3: 1.36 g of sodium acetate with 3 mols crystal water are dissolved in distilled water to a volume of 100 ml.

Then, 1.3 ml of glycerine are mixed with 0.5 ml of a 25% solution of methyl p-hydroxybenzoate in ethanol, and 50 ml of distilled water are added. To the produced mixture are, after sterile filtration, added 10 ml of the stock solution 1, 2.5 ml of the stock solution 2 and 10 ml of the stock solution 3, after which 3.0 ml of sterile 0.1 N sodium hydroxide are added, and the mixture is filled up with sterile distilled water to a volume of 100 ml. The insulin will be precipitated amorphously by the admixture of the sodium hydroxide, and the produced suspension acquires the pH value of 7. It will contain approximately 1 gamma zinc per insulin unit.

References

Merck Index 4869

PDR pp. 1055, 1777

REM p. 975

Petersen, K., Schlichtkrull, J. and Hallas-Moller, K.; U.S. Patent 2,882,203; April 14, 1959 assigned to Novo Terapeutisk Laboratorium A/S, Denmark

INTERFERON

Therapeutic Function: Antineoplastic; antiviral

Chemical Name: See Structural Formula

Common Name: —

Structural Formula: Complex protein; structure not precisely defined

Chemical Abstracts Registry No.: 9008-11-1

Trade Name	Manufacturer	Country	Year Introduced
Fiblaferon	Bioferon	W. Germany	1983
Wellferon	Burroughs-Wellcome	—	—

Raw Materials

Semliki Forest arborvirus

Animal kidneys

Trypsin

Manufacturing Process

Semliki Forest arborvirus was grown in chick embryo tissue culture. The infectious tissue culture liquid was decanted and diluted with medium 199 to give a preparation containing between 10^6 and $10^{6.5}$ mouse ID₅₀ of virus/ml.

Calf kidneys, dog kidneys and rhesus monkey kidneys were treated with trypsin to give suspensions of cells. The suspensions were centrifuged and the packed cells diluted with 400 volumes (calf cells) or 200 volumes (dog cells and rhesus monkey cells) of a growth medium consisting of 5% horse serum and 0.5% lactalbumen hydrolysate in Earle's saline, with 100 units/ml each of penicillin and streptomycin. These media were used separately to produce Semliki Forest/calf interferon, Semliki Forest/dog interferon and Semliki Forest/rhesus monkey interferon. The cell-containing growth medium was dispensed into 500 ml medical flat bottles (70 ml in each). The cultures were incubated at 36°C. Confluent sheets of cells (monolayers) were formed in 5 to 6 days. The growth medium was then removed and the monolayers were washed with isotonic phosphate-buffered saline, pH 7.5.

Each bottle for interferon production received the arborvirus preparation in medium 199 (0.5 ml) and further medium 199 (50 ml); some bottles received only medium 199 (50 ml) and no virus and served as controls. The bottles were incubated for 3 to 5 days at 36°C.

The supernatants containing the interferons were decanted from monolayers, pooled, and tested for freedom from bacteria. Residual arborvirus was inactivated by acid and heat as follows. The liquid was brought to pH 2 by the addition of 0.3N hydrochloric acid in Earle's saline (minus sodium chloride and sodium bicarbonate), kept at 4°C for 24 hours, and then brought back to pH 7 by the addition of 0.3N sodium hydroxide in distilled water. The liquid was then heated at 56°C for 30 minutes.

At this stage the interferon preparations were assayed and submitted to safety tests for the absence of contaminating viruses.

Rhesus monkey kidney infected with Semliki Forest arborvirus gave interferon of titre 1.5 log interferon units/2 ml. (The interferon unit, determined in a volume of 2 ml, is the dilution of interferon which produced a half-maximal score for degree of cytopathic effect in virus-infected tissue culture tubes at the time when the control without interferon first showed the maximal score.)

Each interferon preparation was ultracentrifuged at 20,000 revolutions per minute for one hour to remove tissue debris and inactivated virus. The supernatant was dialyzed against distilled water (1:400) for 24 hours at 4°C. The material was then freeze-dried. The dried product was reconstituted in one-tenth of the original volume in distilled water and dispensed into ampoules. Reconstituted solutions were assayed for interferon activity, examined for toxicity, and tested for sterility.

References

- Merck Index 4870
 DOT 18 (8) 393 (1982)
 I.N. p. 520
 REM p. 1233
 Sellers, R.F.; British Patent 960,769; June 17, 1964; assigned to The Wellcome Foundation Ltd. (U.K.)

IODAMIDE

Therapeutic Function: Diagnostic aid (radiopaque medium)

Chemical Name: 3-(Acetylamino)-5-[(acetylamino)methyl]-2,4,6-triiodobenzoic acid

Common Name: Ametriodinic acid

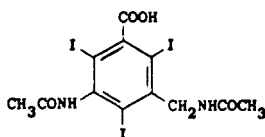
Structural Formula:**Chemical Abstracts Registry No.:** 440-58-4

Trade Name	Manufacturer	Country	Year Introduced
Uromiro	Heyden	W. Germany	1965
Uromiro	Bracco	Italy	1970
Angiomiron	Schering	W. Germany	—
Contraxin	Takeda	Japan	—
Isteropac	Bracco	Italy	—
Opacit	Bracco	Italy	—

Raw Materials

3-Acetylaminomethyl-4-chloro-5-nitrobenzoic acid
 Hydrogen
 Potassium iodide dichloride
 Acetic anhydride

Manufacturing Process

65.4 g (0.24 mol) 3-acetylaminomethyl-4-chloro-5-nitrobenzoic acid were dissolved in a mixture of 48 ml 10N sodium hydroxide and 1,800 ml water. 12 g of a 10% palladium catalyst on a carbon carrier were added, and the nitrobenzoic acid derivative was hydrogenated at slightly elevated temperature and at atmospheric pressure. The hydrogen was avidly absorbed. The nitro group was fully reduced to the corresponding amino radical within about 20 to 40 minutes, and 99 to 100% of the amount of chlorine ions to be theoretically expected was formed. Hydrogen absorption then stopped.

The catalyst was removed by filtration. The filtrate was diluted to about 18 liters, and was acidified with 15 ml concentrated hydrochloric acid. With vigorous stirring, 1,152 ml N KICl₂ solution were run into the diluted filtrate over a period of about 20 to 30 minutes. A solid precipitate was formed, and was filtered off after about six hours. The solid material was washed with water, with sodium bisulfite solution, and again with water. It was dissolved in aqueous ammonium hydroxide solution, the solution was filtered, and the filtrate was acidified with concentrated hydrochloric acid containing a small amount of sodium bisulfite. After a short time, the precipitate formed was filtered with suction, washed with water, and dried.

There were obtained 109 g 3-acetylaminomethyl-5-amino-2,4,6-triiodobenzoic acid which decomposes and melts at approximately 230°C. The equivalent weight was determined experimentally as being 591, as compared to a theoretical value of 586.

A suspension of 40 g 3-acetylaminomethyl-5-amino-2,4,6-triiodobenzoic acid in 180 ml acetic anhydride were mixed with 0.4 ml concentrated sulfuric acid. An exothermic reaction was thereby initiated. Acetylation was completed by heating to 80°C for three hours. The reaction mixture was then evaporated to dryness in a vacuum at a temperature not exceeding 50°C. The residue was treated with a mixture of 30 ml concentrated aqueous ammonium hydroxide and 40 ml water, whereby the solid material dissolved with spontaneous heating. Within a few minutes, the ammonium salt of the acetylated product started precipitating. The precipitate and residual liquid were cooled externally with ice after about 15 minutes. The salt was separated from the liquid by filtration with suction, and was washed with ice cold saturated ammonium chloride solution.

The salt was dissolved in 300 ml water, and insoluble matter was removed from the solution

by filtration. The free acid was precipitated from the filtrate at 50°C to 60°C by the addition of 40 ml 1:1 hydrochloric acid. The precipitate was filtered off after a few hours, washed with water, and dried. There were obtained 34 g 3-acetylaminomethyl-5-acetyl-amino-2,4,6-triiodobenzoic acid (79% of theoretical yield) having a melting point of 246°C to 248°C. The equivalent weight of this practically pure acid was found to be 631 as compared to the calculated value of 627.96.

When recrystallized from glacial acetic acid, the pure acid melts at 255°C to 257°C.

References

Merck Index 4878

Kleeman & Engel p. 493

I.N. p. 521

REM p. 1269

Felder, E. and Pitre, D.; U.S. Patent 3,360,436; December 26, 1967; assigned to Eprova Ltd. (Switz.)

IODIPAMIDE

Therapeutic Function: Diagnostic aid (radiopaque medium)

Chemical Name: 3,3'-[(1,6-Dioxo-1,6-hexanediy)ldiimino] bis[2,4,6-triiodobenzoic acid]

Common Name: Adipodione

Structural Formula:

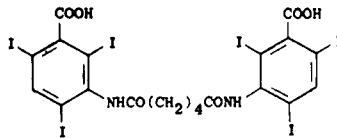

Chemical Abstracts Registry No.: 606-17-7 (2618-26-0 = No Salt; 3521-84-4 = Meglumate)

Trade Name	Manufacturer	Country	Year Introduced
Cholografin	Squibb	U.S.	1954
Intralibix	Guerbet	France	1955
Biligrafin	Schering	W. Germany	—
Endocistobil	Bracco	Italy	—
Endografin	Schering	W. Germany	—
Radio-Selectan Biliare	S.E.P.P.S.	France	—
Transbilix	Guerbet	France	—
Ultrabil	Spofa	Czechoslovakia	—

Raw Materials

2,4,6-Triiodo-3-amino benzoic acid
Adipic acid dichloride

Manufacturing Process

125 g of 2,4,6-triiodo-3-amino benzoic acid are dissolved in 250 cc of chlorobenzene and 15 g of adipic acid dichloride are added at a temperature between 110° and 130°C drop by drop to the solution. After evolution of hydrochloric acid (about 2 to 3 hours) has ceased, the precipitated crude adipic acid di-(3-carboxy-2,4,6-triiodo anilide) of the above

formula is filtered hot with suction, washed with chlorobenzene, extracted by boiling with methanol and, for purification, dissolved in an amount of methanolic caustic soda solution required for neutralization, filtered with charcoal, and precipitated with dilute hydrochloric acid. Yield: 82.3 g, MP 306° to 308°C (with decomposition).

References

Merck Index 4890

Kleeman & Engel p. 16

I.N. p. 46

REM p. 1265

Priewe, H. and Rutkowski, R.; U.S. Patent 2,776,241; January 1, 1957; assigned to Schering AG, Germany

IDOALPHIONIC ACID

Therapeutic Function: Diagnostic aid (radiopaque medium)

Chemical Name: 4-hydroxy-3,5-diiodo- α -phenylbenzenepropanoic acid

Common Name: Pheniodol

Structural Formula:

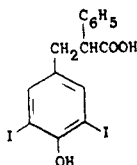

Chemical Abstracts Registry No.: 577-91-3

Trade Name	Manufacturer	Country	Year Introduced
Priodax	Schering	U.S.	1943
Perfectochol	Lafayette	U.S.	1952
Bilopsyl	Labaz	—	—
Choletrast	Burroughs-Wellcome	—	—

Raw Materials

Dextro- β -(4-hydroxyphenyl)- α -phenylpropionic acid
 Iodine
 Dimethylaminoethanol
 Acetic acid

Manufacturing Process

Dextro- β -(4-hydroxyphenyl)- α -phenylpropionic acid (24 g) was dissolved in 630 ml of water containing 8.0 g of sodium hydroxide, and, with good stirring at 25°C, 51 g of iodine and 51 g of potassium iodide dissolved in 240 ml of water was added dropwise over a period of 30 minutes. During this period another 8 g of sodium hydroxide dissolved in 60 ml of water was added in order to keep the reaction mixture alkaline to phenolphthalein. Stirring was continued for 15 minutes longer. The resulting solution was made acid to Congo red with concentrated hydrochloric acid, and about 5 g of sodium bisulfite was

added to partially decolorize the resulting slurry. The solid was collected by filtration and washed well with water.

The crude iodinated acid was then dissolved in 500 ml of 95% alcohol, 10 g of dimethylaminoethanol was added, the solution was decolorized with activated charcoal and filtered at 70°C. After keeping the filtrate for several hours at 5°C, the heavy crystalline precipitate which formed was collected by filtration and washed with acetone. The mother liquors were concentrated to 150 ml and cooled to give a second crop which was further purified by recrystallization from 50 ml of 95% alcohol. In this way a total of 36.0 g of dimethylaminoethanol salt of dextro- β -(3,5-diiodo-4-hydroxy)- α -phenylpropionic acid, MP 151° to 153°C, was obtained. The melting point of the dimethylaminoethanol salt of unresolved β -(3,5-diiodo-4-hydroxy)- α -phenylpropionic acid was 142° to 144°C.

The pure dimethylaminoethanol salt was dissolved in 400 ml of 50% acetic acid at 90°C and then cooled to 5°C. The solid which precipitated was collected by filtration, washed with water, cold 50% acetic acid and finally with low-boiling petroleum ether. After drying in vacuo there was obtained 24 g of hydrated dextro- β -(3,5-diiodo-4-hydroxy)- α -phenylpropionic acid, MP 80° to 85°C.

References

Merck Index 4893

I.N. p. 756

Tullar, B.F. and Hoppe, J.O.; U.S. Patent 2,552,696; May 15, 1951; assigned to Sterling Drug Inc.

IOGLYCAMIC ACID

Therapeutic Function: Diagnostic air (radiopaque medium)

Chemical Name: 3,3'-[Oxybis[(1-oxo-2,1-ethanediy)limino]] bis[2,3,6-triiodobenzoic acid]

Common Name: —

Structural Formula:

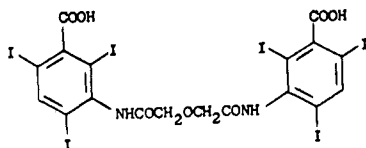

Chemical Abstracts Registry No.: 2618-25-9

Trade Name	Manufacturer	Country	Year Introduced
Meglumine Salt:			
Biligram	Schering	W. Germany	1971
Biligram	Schering	U.K.	1972
Biligram	S.E.P.P.S.	France	1974
Bilivistan	Schering	Italy	—
Rayvist	Schering	W. Germany	—

Raw Materials

2,4,6-Triiodo-aminobenzoic acid
Diglycolic acid dichloride

Manufacturing Process

910 g of dry 2,4,6-triiodo amino benzoic acid are dissolved with stirring in 4,800 cc of dry, boiling chlorobenzene. A solution of 151.7 g diglycolic acid dichloride in 100 cc of dry chlorobenzene is slowly added to this solution and the mixture is further heated for 4 to 5 hours under reflux until development of hydrogen chloride has ceased. The resulting precipitate is filtered from the warm solution with suction and washed with chlorobenzene and then with ether. The microcrystalline, almost colorless crude product, 942 g, consists of the α -modification of diglycolic acid di-(3-carboxy-2,4,6-triiodo anilide).

The crude product is suspended, while stirring, in 2.5 liters of pure methanol and a solution of 73 g of pure sodium hydroxide in the same weight of water, diluted with 675 cc methanol, is slowly added to this suspension until the acid is dissolved and the pH of this solution reaches 9.0. The solution is allowed to stand at this pH for 15 minutes. The pH is then brought to 4.0 by addition of 10% acetic acid and 17 g of charcoal are stirred in. After 15 minutes the coal is filtered off and the clear filtrate is slowly added to a stirred solution of 415 cc of pure, concentrated hydrochloric acid in 4.15 liters of 50% methanol. After ½ hour of stirring and decanting after 1 hour, the precipitate is easily filtered off with suction, washed with little methanol and thoroughly with water, until the thixotropic residue is free of hydrochloric acid. In order to obtain a product of highest purity, this treatment is repeated two times. The resulting pure product, after drying in vacuo at 50°C still containing one molecule of methanol per two molecules of the acid (plus 4 molecules of water), must be suspended in boiling water and steamed out. The hot suspension is filtered with suction, the white microcrystalline residue is dried in vacuo at 50°C to give 860 g (83.5% of the theoretical yield) of the pure dihydrate of the diglycolic acid di-(3-carboxy-2,4,6-triiodo anilide), β -modification.

References

Merck Index 4912

Kleeman & Engel p. 494

I.N. p. 28

Priewe, H. and Rutkowski, R.; U.S. Patent 2,853,424; September 23, 1958; assigned to Schering A.G. (W. Germany)

IOPAMIDOL

Therapeutic Function: Radiopaque contrast medium

Chemical Name: 5-(α -Hydroxypropionylamino)-2,4,6-triiodoisophthalic acid di-(1,3-dihydroxyisopropylamide)

Common Name: —

Structural Formula:

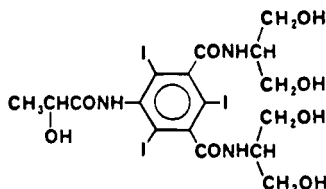

Chemical Abstracts Registry No.: 60166-93-0

Trade Name	Manufacturer	Country	Year Introduced
Iopamiro	Bracco	Italy	1981
Solutrast	Byk Gulden	W. Germany	1981

Trade Name	Manufacturer	Country	Year Introduced
Niopam	Merck	U.K.	1982
Iopamiro	Astra	Sweden	1983
Isovue	Squibb	—	—

Raw Materials

5-Amino-2,4,6-triiodo-isophthalic acid
 Thionyl chloride
 DL-2-Acetoxypropionyl chloride
 2-Amino-1,3-propanediol

Manufacturing Process

400 g (0.72 mol) 5-amino-2,4,6-triiodo-isophthalic acid was added to 200 ml thionyl chloride, the mixture was stirred at a boil for 6 hours, and the resulting solution was evaporated. The residue was dissolved in anhydrous ethyl acetate, and the solution was again evaporated to dryness. The solid material was dissolved in 4,000 ml ethyl acetate, and the solution was stirred into an ice-cold solution of 500 g sodium chloride and 200 g sodium bicarbonate in 2.5 liters water. The organic phase was separated from the aqueous solution, washed with aqueous sodium solution, dried by contact with anhydrous calcium chloride, and evaporated to dryness.

The residue of 420 g 5-amino-2,4,6-triiodo-isophthalyl chloride (97.5% yield) had a melting point above 300°C when recrystallized from toluene.

300 g (0.503 mol) 5-amino-2,4,6-triiodo-isophthalyl chloride was dissolved in 1,200 ml dimethylacetamide, and 187 g (1.26 mol) DL-2-acetoxypropionyl chloride was added dropwise to the solution with agitation. The mixture was permitted to stand overnight at ambient temperature and was then evaporated in a vacuum to approximately 400 ml. The oily residue was stirred into ice water to precipitate 353 g crystalline DL-5-(α -acetoxypropionylamino)-2,4,6-triiodo-isophthalyl chloride (98% yield) which was purified by suspension in warm chloroform free alcohol.

The purified intermediate melted at 210°C. 70.9 g (0.10 mol) of the intermediate was dissolved in 150 ml dimethylacetamide, and 15 g (0.08 mol) tributylamine was added. The mixture was heated to 50°C, and 56.6 g (0.62 mol) 1,3-dihydroxyisopropylamine (2-amino-1,3-propanediol) dissolved in 80 ml dimethylacetamide was added drop by drop. The reaction went to completion within a few hours, and the reaction mixture was evaporated to dryness in a vacuum. The oily residue was added to 350 ml methylene chloride with vigorous agitation, and the resulting precipitate was filtered off and purified by repeated suspension of warm methylene chloride.

Work-up of the reaction mixture yielded 56.5 g (73.5%) DL-5- α -hydroxypropionylamino-2,4,6-triiodo-isophthalic acid di-(1,3-dihydroxyisopropylamide) which was recrystallized from aqueous ethanol and melted with decomposition above 300°C.

References

- Merck Index 4915
 DFU 4 (12) 876 (1979)
 I.N. p. 524
 Felder, E., Vitale, R.S. and Pitre, D.E.; U.S. Patent 4,001,323; January 4, 1977; assigned to Savac AG

IOPANOIC ACID

Therapeutic Function: Diagnostic aid (radiopaque medium)

Chemical Name: 3-amino- α -ethyl-2,4,6-triodobenzenepropanoic acid

Common Name: —

Structural Formula:

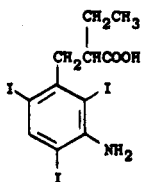

Chemical Abstracts Registry No.: 96-83-3

Trade Name	Manufacturer	Country	Year Introduced
Telepaque	Winthrop	U.S.	1952
Telepaque	Winthrop	France	1955
Ace-Line	Maruishi	Japan	—
Biliopaco	Rovi	Spain	—
Chole-Contrast	Orion	Finland	—
Cistobil	Bracco	Italy	—
Colegraf	Estedi	Spain	—
Holevid	Krka	Yugoslavia	—
Leabar	Toyo	Japan	—
Molpaque	Tokyo Tanabe	Japan	—
Neocontrast	Bama-Geve	Spain	—
Polognost	Polfa	Poland	—
Teletrast	Astra	—	—

Raw Materials

m-Nitrobenzaldehyde	Hydrogen
Butyric anhydride	Iodine monochloride

Manufacturing Process

(A) *Preparation of α -Ethyl-m-Nitrocinnamic Acid:* This acid is prepared from 100 g of m-nitrobenzaldehyde, 210 g of butyric anhydride and 73 g of sodium butyrate. The crude α -ethyl-m-nitrocinnamic acid is crystallized from ethanol giving about 105 g, MP 140° to 142°C. From the filtrates there may be isolated a small amount of a stereoisomer, which when pure melts at 105° to 106°C.

(B) *Preparation of m-Amino- α -Ethylhydrocinnamic Acid:* A mixture of 50 g of α -ethyl-m-nitrocinnamic acid, 9.1 g of sodium hydroxide, 600 cc of water and 5 teaspoons of Raney nickel catalyst is shaken at 32°C in an atmosphere of hydrogen at an initial pressure of 450 psi until the calculated amount of hydrogen is absorbed. The filtered solution is acidified with hydrochloric acid, made basic with ammonium hydroxide and again acidified with acetic acid. Upon concentration of this solution, an oil separates which crystallizes upon standing, giving about 20 g, MP 60° to 68°C. Complete evaporation of the filtrate and extraction of the residue of inorganic salts with ether gives about 20 g of additional material, MP 54° to 59°C. Recrystallization of the combined product from benzene-petroleum ether gives about 35 g of m-amino- α -ethylhydrocinnamic acid, MP 67° to 70°C.

(C) *Preparation of β -(3-Amino-2,4,6-Triiodophenyl)- α -Ethylpropionic Acid:* A solution of 5.0 g of m-amino- α -ethylhydrocinnamic acid in 100 cc of water containing 5 cc of concentrated hydrochloric acid is added over a period of ½ hour to a stirred solution of 3.2 cc of iodine monochloride in 25 cc of water and 25 cc of concentrated hydrochloric acid

heated to 60°C. After addition is complete, the heating is continued for one hour longer at 60° to 70°C. A black oil separates which gradually solidifies.

The mixture is then cooled and sodium bisulfite added to decolorize. Recrystallization of the product from methanol gives about 8 g, MP 147° to 150°C. The β -(3-amino-2,4,6-triiodophenyl)- α -ethylpropionic acid may be purified further by precipitation of the morpholine salt from ether solution and regeneration of the free amino acid by treatment of a methanol solution of the morpholine salt with sulfur dioxide. The pure amino acid has the MP 155° to 156.5°C.

References

Merck Index 4916

Kleeman & Engel p. 495

DOT 15 (7) 310 (1979)

I.N. p. 28

REM p. 1266

Archer, S.; U.S. Patent 2,705,726; April 5, 1955; assigned to Sterling Drug Inc.

IOPHENDYLATE

Therapeutic Function: Diagnostic aid (radiopaque medium)

Chemical Name: Ethyl 10-(p-iodophenyl)undecylate

Common Name: —

Structural Formula:

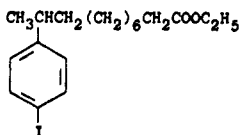

Chemical Abstracts Registry No.: 99-79-6

Trade Name	Manufacturer	Country	Year Introduced
Pantopaque	Lafayette	U.S.	1944
Ethiodan	Allen & Hanburys	U.K.	—

Raw Materials

Ethyl undecylenate
Iodobenzene

Manufacturing Process

60 volumes of ethyl undecylenate is introduced gradually at 7° to 8°C during 35 minutes to a well-cooled mixture of 52.5 parts of aluminum chloride and 150 volumes of iodobenzene. The mixture is decomposed with cracked ice and dilute hydrochloric acid. The iodobenzene layer is washed with sodium bisulfite solution and with water, and then distilled. The composition of matter having the probable formula, ethyl 4-iodophenyl-undecylate, is a colorless liquid boiling at 196° to 198°C/1 mm, and of specific gravity of 1.26/20°C.

References

Merck Index 4917

Kleeman & Engel p. 494

REM p. 1267

Strain, W.H., Plati, J.T. and Warren, S.L.; U.S. Patent 2,348,231; May 9, 1944; assigned to Noned Corporation and Eastman Kodak Company

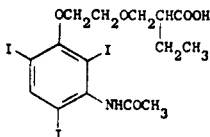
IOPRONIC ACID**Therapeutic Function:** Diagnostic aid (radiopaque medium)**Chemical Name:** 2-[[2-[3-(Acetylamino)-2,4,6-triiodophenoxy] ethoxy] methyl]-butanoic acid**Common Name:** —**Structural Formula:****Chemical Abstracts Registry No.:** 37723-78-7

Trade Name	Manufacturer	Country	Year Introduced
Bilimiro	Bracco	Italy	1974
Bilimiro	Byk Gulden	W. Germany	1980

Raw Materials

3-Acetylamino-2,4,6-triiodophenol

Sodium

3-(2-Iodoethoxy)-2-ethylpropionic acid ethyl ester

Sodium hydroxide

Hydrogen chloride

Manufacturing Process

A solution of 192 g 3-acetylamino-2,4,6-triiodophenol, sodium (0.35 mol) in 350 ml dimethylacetamide, was mixed with 107.5 g 3-(2-iodoethoxy)-2-ethylpropionic acid ethyl ester (0.35 mol) at 90°C with stirring over a period of about 20 to 30 minutes. Stirring was continued while the mixture was held at 95°C to 100°C for 16 hours. The solvent was then removed by distillation in a vacuum, and the residue was poured into 4,000 ml water. The solid precipitate formed was recovered and washed with water, dilute sodium carbonate solution, dilute sodium bisulfite solution, and again with much water. The ethyl ester was obtained in a yield of 220 g (90%). When recrystallized from 75% aqueous ethanol, it melted at 80°C to 86°C.

The ester (70 g, 0.1 mol) was saponified in a boiling mixture of 250 ml methanol and 250 ml water to which 100 ml N sodium hydroxide solution was added in small batches with stirring. The methanol was distilled from the saponification mixture, the residue was mixed with water and extracted with ethyl acetate. The aqueous phase was acidified with hydrochloric acid in the presence of sodium bisulfite.

The free acid gradually crystallized from the acidified solution in the amount of 42.4 g (63% yield). When recrystallized from 50% ethanol and from ethyl acetate, it melted at 130°C.

References

Merck Index 4919

I.N. p. 29

Felder, E. and Pitre, D.; U.S. Patent 3,842,124; October 15, 1974; assigned to Bracco Industria Chimica, Società per Azioni (Italy)

IOTHALMATE MEGLUMINE

Therapeutic Function: Diagnostic aid (radiopaque medium)

Chemical Name: 3-(Acetylamino)-2,4,6-triiodo-5-[(methylamino)carbonyl]-benzoic acid

Common Name: —

Structural Formula:

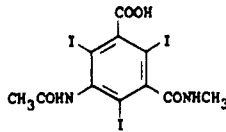

(base)

Chemical Abstracts Registry No.: 13087-53-1; 2276-90-6 (Acid)

Trade Name	Manufacturer	Country	Year Introduced
Conray	Mallinckrodt	U.S.	1962
Conray	Byk Gulden	W. Germany	1964
Contrix	Guerbet	France	1965
Angio-Conray	Daiichi	Japan	—
Cysto-Conray	Mallinckrodt	U.S.	—
Gastro-Conray	May & Baker	U.K.	—
Sombril	Rovi	Spain	—
Vascoray	Mallinckrodt	U.S.	—
Vascoray	Astra	Sweden	—

Raw Materials

5-Amino-2,4,6-triiodo-N-methylisophthamic acid
Acetic anhydride
N-methyl glucamine

Manufacturing Process

Crude 5-amino-2,4,6-triiodo-N-methylisophthamic acid (21.0 g) was dissolved in warm dimethylacetamide (40 ml) and acetic anhydride (30 ml) and concentrated sulfuric acid (2 drops) were added. This solution was heated on the steam bath for 2 hours, then heated at 110°C for 5 minutes, then cooled. Water and ammonium hydroxide were added to destroy the excess acetic anhydride, after which the mixture was evaporated to a volume of 50 ml. The cooled solution was acidified with concentrated hydrochloric acid and a tan solid was collected. The crude product was dissolved in 100 ml of water containing a slight excess of sodium hydroxide. The pH was adjusted to 4.5 with acetic acid, and the solution was treated with charcoal. The colorless solution was acidified with concentrated hydrochloric acid and

cooled, and the precipitate was filtered off and dried under reduced pressure. The resulting 5-acetamido-2,4,6-triiodo-N-methylisophthamic acid decomposes about 285°C and does not melt below 300°C.

5-acetamido-2,4,6-triiodo-N-methylisophthamic acid was slurried in water and dissolved by the addition of an equivalent quantity of N-methylglucamine. The solution was evaporated to dryness to yield the meglumate salt of 5-acetamido-2,4,6-triiodo-N-methylisophthamic acid.

References

Merck Index 4922

Kleeman & Engel p. 496

I.N. p. 29

REM p. 1269

Hoey, G.B.; U.S. Patent 3,145,197; August 18, 1964; assigned to Mallinckrodt Chemical Works

IOTHIOURACIL

Therapeutic Function: Thyroid inhibitor

Chemical Name: 2,3-Dihydro-5-iodo-2-thioxo-4(1H)-pyrimidinone

Common Name: Iodothiouracil

Structural Formula:

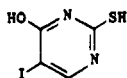

Chemical Abstracts Registry No.: 5984-97-4

Trade Name	Manufacturer	Country	Year Introduced
Itrumil	Ciba	U.S.	1951

Raw Materials

5-Iodo-2-benzyl thiouracil
Acetic anhydride

Manufacturing Process

As an illustrative example 64.4 g of 5-iodo-2-benzyl thiouracil were deposited in the reaction vessel and dissolved by adding 400 cc of glacial acetic acid containing 10 cc of acetic anhydride and the reaction vessel was connected tightly with the reflux condenser. The second vessel or generator was charged with 95 cc of acetic anhydride and the vessel connected to a vessel such as a dropping funnel or equivalent containing 75 cc of a 50% solution of hydriodic acid which was added slowly, as by dropwise addition, to the acetic anhydride in the generator. The mixture in the generator soon became hot and the hydrogen iodide which evolved passed continuously through the connecting conduit into the reaction flask just above the level of liquid therein. As the hydrogen iodide contacted the solution of the 2 benzyl derivative, a ring of the debenzylated product formed under the inlet conduct. This operation was continued until all of the hydriodic acid was added to the generator vessel. The hydrogen iodide remaining in the generator was driven over into the reaction vessel by heating the generator. It was ascertained that the reaction is complete when no more precipitate forms

in the main reaction vessel. During the reaction vapors evolved were condensed in the condenser and returned to the reaction vessel as reflux. The upper end of the reflux is preferably connected with a vent leading to a drying chamber.

The reaction vessel was cooled and the precipitate separated by pouring or decanting off the supernatant liquor. The precipitate of the 5-iodo-2-thiouracil was then thoroughly washed, as, for example, on a Buchner funnel. The precipitate was then extracted twice with hot glacial acetic acid to remove unreacted material and then washed thoroughly by alternate washes with alcohol and water. The product was then further purified by dissolving it in warm dilute sodium hydroxide and after cooling was reprecipitated by careful acidulation with acetic acid. Utilizing this procedure 37 g of purified 5-iodo-2-thiouracil were obtained.

The supernatant liquid separated from the precipitate was concentrated in vacuo and 7.4 g of the unreacted 5-iodo-2-benzyl thiouracil were recovered. This obviously may be utilized for further debenzilation.

As pointed out previously, the 5-iodo-2-thiouracil is carefully dried, preferably in a vacuum over P_2O_5 .

References

Merck Index 4924

OCDS Vol. 1 p. 265 (1977)

I.N. p. 573

Barrett, H.W.; U.S. Patent 2,585,615; February 12, 1952; assigned to The Chemical Foundation

IOTROXIC ACID

Therapeutic Function: Diagnostic aid (radiopaque medium)

Chemical Name: 3,3'-[Oxybis(ethyleneoxymethylenecarbonylimino)] bis-[2,4,6-triiodobenzoic acid]

Common Name: —

Structural Formula:

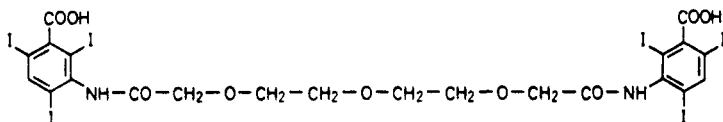

Chemical Abstracts Registry No.: 51022-74-3

Trade Name	Manufacturer	Country	Year Introduced
Biliscopin	Schering	W. Germany	1978
Biliscopin	Schering	Switz.	1981
Biliscopin	Nippon Schering	Japan	1982
Chologram	Schering	Italy	1982

Raw Materials

3-Amino-2,4,6-triiodobenzoic acid

3,6,9-Trioxaundecane diacid dichloride

Manufacturing Process

(a) *Condensation in dimethylacetamide*: To a suspension of 51.5 g of anhydrous 3-amino-2,4,6-triiodo-benzoic acid (0.1 mol) in 100 ml of dimethylacetamide were slowly added dropwise, while stirring, 15.5 g of 3,6,9-trioxaundecane diacid dichloride (0.06 mol), during which the temperature gradually rose to about 50°C and the whole passed into solution. After being stirred overnight, the solution was added dropwise to 1 liter of a 0.28 N solution of sodium hydroxide, and then 200 ml of 2 N hydrochloric acid were cautiously added. The precipitate was filtered off with suction, washed with water and dried. The yield was practically quantitative.

(b) *Condensation in dioxan*: 15.5 g of 3,6,9-trioxaundecane diacid dichloride were added dropwise at about 95°C to a solution of 51.5 g of anhydrous 3-amino-2,4,6-triiodo-benzoic acid in 52 ml of anhydrous dioxan. After further stirring and heating for 3 hours, the solution was cooled, stirred dropwise into 500 ml of a 0.4 N solution of sodium hydroxide, and further worked up as described in paragraph (a). The yield was practically quantitative.

(c) *Purification*: To the crude product obtained as described under paragraph (a) or (b) in 300 ml of methanol was slowly added a quantity (about 15 ml) of a 12 N solution of sodium hydroxide such that a test portion diluted with water had a pH-value of 8 to 9. After stirring the mixture overnight, the sodium salt of 3,6,9-trioxaundecane-1,11-diyl-bis-(3-carboxy-2,4,6-triiodo-anilide) which crystallized out was filtered off with suction, washed with methanol and dried. Yield: 92 g (90% of the theoretical yield).

A solution of the salt in 900 ml of water was treated with active carbon, and concentrated hydrochloric acid was added until the pH-value was 1. The precipitate was filtered off with suction, washed with water, and dried at 50°C.

The yield of pure 3,6,9-trioxaundecane-1,11-diyl-bis-(3-carboxy-2,4,6-triiodo-anilide) was 80 g (80% of the theoretical yield). The substance melted at 175°C with sintering.

References

Kleeman & Engel p. 497

DOT 15 (1) 48 (1979)

I.N. p. 30

Schering, A.G.; British Patent 1,501,507; February 15, 1978

IPRATROPIUM BROMIDE

Therapeutic Function: Bronchodilator

Chemical Name: 3-(3-Hydroxy-1-oxo-2-phenylpropoxy)-8-methyl-8-(1-methylethyl)-8-azoniabicyclo[3.2.1]octane bromide

Common Name: —

Structural Formula:

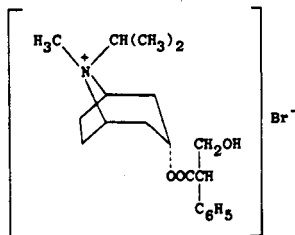

Chemical Abstracts Registry No.: 22254-24-6

Trade Name	Manufacturer	Country	Year Introduced
Atrovent	Boehr. Ingel.	W. Germany	1975
Atrovent	Boehr. Ingel.	U.K.	1977
Atrovent	De Angeli	Italy	1980
Breva	Valeas	Italy	1980
Atrovent	Teijin	Japan	1981
Atrovent	Boehr. Ingel.	Canada	1982
Atem	Chiesi	Italy	—
Itrop	Boehr. Ingel.	—	—
Vagos	Valeas	Italy	—

Raw Materials

N-Isopropyl-noratropine
Methyl bromide

Manufacturing Process

211.5 g (0.667 mol) of N-isopropyl-noratropine were dissolved at 60°C in 2.11 liters of absolute toluene in a 3-liter glass pressure tube. While the solution was still warm, 95 g (1 mol) of ice-cold methylbromide were added, and the pressure tube was sealed immediately thereafter. The reaction mixture was kept at 60°C for four days. After one hour of standing, the formation of crystals began. At the end of four days the crystals were separated by vacuum filtration at 60°C, washed with 600 cc of toluene at 60°C, and dried in vacuo in a drying cabinet at 100°C. Raw yield: 263.7 g (95.8% of theory). MP: 224°C to 225°C (decomp.). The raw product was refluxed with 2.5 liters of chloroform for 30 minutes, vacuum filtered while hot, washed with 200 cc of chloroform, and dried in a vacuum drying cabinet at 100°C. Yield: 249 g (90.6% of theory). MP: 226°C to 228°C (decomp.). The purified product was recrystallized from 1.2 liters of n-propanol, washed with 200 cc of n-propanol and dried in a vacuum drying cabinet at 100°C. Yield: 237 g (86.15% of theory). MP: 230°C to 232°C (decomp.). By evaporation of the mother liquor to 100 cc another 6.0 g of the pure product, MP 230°C to 231.5°C (decomp.), were obtained.

References

- Merck Index 4929
Kleeman & Engel p. 498
QCDS Vol. 3 p. 160 (1984)
DOT 11 (12) 461 (1975) & 17 (7) 299 (1981)
I.N. p. 525
REM p. 916
Zeile, K., Schulz, W., Banholzer, R. and Wick, H.; U.S. Patent 3,505,337; April 7, 1970; assigned to Boehringer Ingelheim G.m.b.H. (W. Germany)

IPRONIAZID

Therapeutic Function: Antidepressant; monoamine oxidase inhibitor

Chemical Name: 4-Pyridinecarboxylic acid 2-(1-methylethyl)hydrazide

Common Name: —

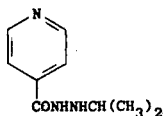
Structural Formula:**Chemical Abstracts Registry No.:** 54-92-2

Trade Name	Manufacturer	Country	Year Introduced
Marsilid	Roche	U.S.	1952
Marsilid	Roche	France	1960
Ellepibina	L.P.B.	Italy	—
Ipronid	A.F.I.	Norway	—
Rivivol	Zambeletti	Italy	—

Raw Materials

Isonicotinyl hydrazide
 Acetone
 Hydrogen

Manufacturing Process

A mixture of 40 g of isonicotinyl hydrazine and 600 cc of acetone was heated on a steam bath until solution was complete. Upon cooling the reaction mixture, 1-isonicotinyl-2-isopropylidene hydrazine precipitated in the form of white needles; MP 161°C to 161.5°C.

A solution of 20 g of 1-isonicotinyl-2-isopropylidene hydrazine in 150 cc of methanol was reduced with hydrogen at room temperature and 50 psi using 300 mg of platinum black as a catalyst.

References

Merck Index 4934
 Kleeman & Engel p. 499
 OCDS Vol. 1 p. 254 (1977)
 I.N. p. 525
 Fox, H.H.; U.S. Patent 2,685,585; August 3, 1954; assigned to Hoffmann-La Roche, Inc.

IPRONIDAZOLE

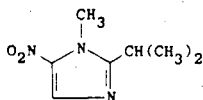
Therapeutic Function: Antiprotozoal**Chemical Name:** 1-Methyl-2-(1-methylethyl)-5-nitro-1H-imidazole**Common Name:** 2-Isopropyl-1-methyl-5-nitroimidazole**Structural Formula:****Chemical Abstracts Registry No.:** 14885-29-1

Trade Name	Manufacturer	Country	Year Introduced
Iprobran	Roche	W. Germany	1981

Raw Materials

2-Isopropyl-4-nitroimidazole
Dimethyl sulfate

Manufacturing Process

2-Isopropyl-4(or 5-nitroimidazole) (31 g = 0.2 mol), dioxane (70 g) and dimethylsulfate (28 g = 0.22 mol) were heated on a steam bath under reflux for 45 minutes. The solvent was removed in vacuo on a steam bath, the residue dissolved in 20 ml of water and the product precipitated by the gradual addition of 80 g of 25% sodium hydroxide solution at 0°C. A small additional amount was obtained by extraction of the mother liquor with methylene chloride. The product melted at 60°C.

The product was purified as follows. 60 g of product was dissolved in 3 N aqueous hydrochloric acid, the solution was treated with charcoal and filtered. The filtrate was neutralized by the gradual addition of aqueous concentrated ammonia at 0°C to 5°C under stirring whereupon the product precipitated in white plates as the neutralization proceeded. The precipitate was filtered by suction, washed on the filter with 50 ml of ice cold water and dried at room temperature, MP 60°C.

The hydrochloride salt was formed by reacting the product, dissolved in isopropanol, with 25% ethanolic hydrochloric acid, whereupon the salt precipitated and was isolated. It has a melting point of 177°C to 182°C (dec). Similarly, the bisulfate salt was formed using 96% sulfuric acid. It has a MP of 151.5°C to 152.5°C.

References

Merck Index 4934

OCDS Vol. 2 p. 244 (1980)

I.N. p. 525

Hoffer, M. and Mitrovic, M.; U.S. Patent 3,502,776; March 24, 1970; assigned to Hoffmann-La Roche Inc.

ISAXONINE PHOSPHATE

Therapeutic Function: Peripheral neuropathy treatment

Chemical Name: N-(1-Methylethyl)-2-pyrimidinamine

Common Name: —

Structural Formula:

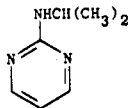

(base)

Chemical Abstracts Registry No.: 4214-72-6 (Base)

Trade Name	Manufacturer	Country	Year Introduced
Nerfactor	Ipsen	France	1981

Raw Materials

2-Isopropylamino pyrimidine
Phosphoric acid

Manufacturing Process

6 liters of ethanol and 685 g (5 mols) of 2-isopropylamino pyrimidine were added to a 10 liter reactor and stirred. To the solution were added 600 g (5.2 mols) of phosphoric acid and the mixture was boiled under reflux for one hour. There was obtained a dark green solution which was treated with 30 g of carbon black. After separation and crystallization while stirring overnight, the crystallized product was separated, washed with ethanol and dried at 50°C. There was obtained 1,027 g (87% yield) of a white powder melting at 125°C. The analysis of the compound showed a good correspondence with the formula $C_7H_{14}O_4N_3P$.

References

Merck Index 4953

DFU 1 (5) 315 (1982)

Esanu, A.; U.S. Patent 4,073,895; February 14, 1978; assigned to Societe D'Etudes de Produits Chimiques (France)

ISOAMINILE

Therapeutic Function: Antitussive

Chemical Name: α -[2-(dimethylamino)propyl] - α -(1-methylethyl)benzeneacetonitrile

Common Name: —

Structural Formula:

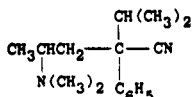

Chemical Abstracts Registry No.: 77-51-0

Trade Name	Manufacturer	Country	Year Introduced
Peracon	Toyo Jozo	Japan	1969
Dimyrl	Fisons	U.K.	—
Mucalan	Delagrange	France	—
Sedotosse	Panthox & Burck	Italy	—

Raw Materials

α -Isopropyl phenyl acetonitrile
Sodium amide
2-Dimethylamino-1-chloropropane

Manufacturing Process

140 cc of benzene and 24 g of α -isopropyl phenyl acetonitrile are added to 7.5 g of sodium amide. The mixture is stirred and refluxed for one hour. After cooling, 25 g of 2-dimethylamino-1-chloropropane, dissolved in 20 cc of benzene, are added and stirring and refluxing of the mixture is continued for 4 hours. After the reaction is completed, water is added to the reaction mixture. The benzene layer is separated from the aqueous layer and is extracted by means of 4 N hydrochloric acid. The acid solution is rendered alkaline.

The separated oil is taken up in ether. After drying the ethereal solution over sodium sulfate and distilling off the ether, the resulting crude α -isopropyl- α -(β -dimethylamino propyl) phenyl acetonitrile is purified by distillation in a vacuum. The compound boils at 138° to 146°C/3 mm, according to U.S. Patent 2,934,557.

References

Merck Index 4956

Kleeman & Engel p. 499

OCDS Vol. 1 p. 82 (1977)

I.N. p. 527

Stuhmer, W. and Funke, S.; U.S. Patent 2,934,557; April 26, 1960; assigned to Kali-Chemie AG, Germany

Dickinson, H.M.N.; U.S. Patent 3,074,996; January 22, 1963; assigned to Abbott Labs.

ISOBORNYL THIOCYANOACETATE

Therapeutic Function: Pediculicide

Chemical Name: Thiocyanatoacetic acid 1,7,7-trimethylbicyclo[2.2.1]-hept-2-yl ester

Common Name: —

Structural Formula:

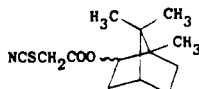

Chemical Abstracts Registry No.: 115-31-1

Trade Name	Manufacturer	Country	Year Introduced
Bornate	Wyeth	U.S.	1946

Raw Materials

Camphene

Chloroacetic acid

Potassium thiocyanate

Manufacturing Process

200 g of camphene and 150 g of chloroacetic acid were heated 16 hours at 125°C, cooled to room temperature and the resulting product washed with water. In this way, 177 g of isobornyl monochloroacetate, analyzing 12.8%, by weight, chlorine was recovered. 174 g of the isobornyl monochloroacetate was dissolved in 300 cc of ethyl alcohol, 100 g of potassium thiocyanate added to this solution and the mixture refluxed for a period of 8 hours. 276 g of a product was recovered, which analyzed as follows: chlorine, 0.2% by wt. and sulfur, 10.9% by wt. This analysis shows the product to be principally isobornyl thiocyanacetate.

References

Merck Index 4976

I.N. p. 527

Borglin, J.N.; U.S. Patent 2,217,611; October 8, 1940; assigned to Hercules Powder Co.

ISOCARBOXAZID

Therapeutic Function: Antidepressant

Chemical Name: 5-Methyl-3-isoxazolecarboxylic acid 2-benzylhydrazide

Common Name: —

Structural Formula:

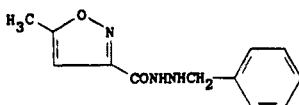

Chemical Abstracts Registry No.: 59-63-2

Trade Name	Manufacturer	Country	Year Introduced
Marplan	Roche	U.S.	1959
Marplan	Roche	France	1961
Enerzer	Takeda	Japan	—

Raw Materials

5-Methyl-3-isoxazole carboxylic acid hydrazide
Benzaldehyde
Lithium aluminum hydride

Manufacturing Process

800 g of benzaldehyde was added to a hot solution (75°C) of 7 liters of ethanol containing 720 g of 5-methyl-2-isoxazole carboxylic acid hydrazide. The solution was stirred for ten minutes at which time the product began to crystallize. On cooling at 4°C for 14 hours, the solid was filtered off under vacuum and the solid filter cake was washed twice using 250 ml of ice cold ethanol for each washing. The 1-benzylidene-2-(5-methyl-3-isoxazolylcarbonyl)-hydrazine was recrystallized from ethanol, MP 199°C to 200°C.

115 g of 1-benzylidene-2-(5-methyl-3-isoxazolylcarbonyl)hydrazine was added portionwise over the period of an hour to 5 liters of anhydrous ether containing 18.5 g of lithium aluminum hydride. The reaction mixture was stirred for four hours and permitted to stand overnight. The excess lithium aluminum hydride was decomposed with 250 ml of ethyl acetate and 150 ml of water was added to decompose the complex. The solid was separated by filtration and the ether layer was concentrated to about 500 ml. 200 ml of benzene was added to dehydrate the solution. Concentration was continued until a solid remained. The 1-benzyl-2-(5-methyl-3-isoxazolylcarbonyl)hydrazine was recrystallized from methanol, MP 105°C to 106°C.

References

Merck Index 5003
Kleeman & Engel p. 500
PDR p. 1490
OCDS Vol. 1 p. 233 (1977) & 2, 266 (1980)
I.N. p. 527
REM p. 1095
Gardner, T.S., Lee, J. and Wenis, E.; U.S. Patent 2,908,688; October 13, 1959; assigned to Hoffmann-La Roche, Inc.

ISOCONAZOLE NITRATE

Therapeutic Function: Antibacterial, antifungal

Chemical Name: 1-[2,4-Dichloro- β -(2,6-dichlorobenzyl)oxy] phenylethyl]imidazole nitrate

Common Name: —

Structural Formula:

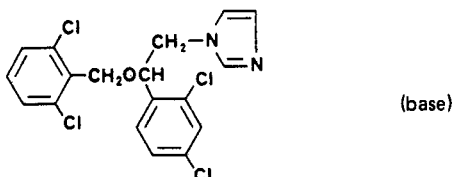

Chemical Abstracts Registry No.: 24168-96-5; 27523-40-6 (Base)

Trade Name	Manufacturer	Country	Year Introduced
Fazol	Fournier	France	1979
Travogen	Schering	W. Germany	1979
Travogen	Schering	Switz.	1980
Travogyn	Keymer	U.K.	1981
Adestan	Nihon Schering	Japan	1982
Travogen	Schering	Australia	—
Icaden	Schering	W. Germany	—
Gyno-Travogen	Schering	W. Germany	—

Raw Materials

α -(2,4-Dichlorophenyl)imidazole-1-ethanol
Sodium hydride
2,6-Dichlorobenzyl chloride

Manufacturing Process

To a stirred and refluxing solution of 40 parts of benzene and 35 parts of dimethylformamide (both solvents previously dried azeotropically) are added successively 1.6 parts of sodium hydride and 7.7 parts of α -(2,4-dichlorophenyl)imidazole-1-ethanol, (cooling on ice is necessary). After the addition is complete, stirring and refluxing is continued for 30 minutes. Then there are added 7.8 parts of 2,6-dichlorobenzyl chloride and the whole is stirred at reflux for another 3 hours. The reaction mixture is poured onto water and the product 1-[2,4-dichloro- β -(2,6-dichlorobenzyl)oxy]phenethyl]imidazole, is extracted with benzene. The extract is washed twice with water, dried, filtered and evaporated in vacuo. The base residue is dissolved in a mixture of acetone and diisopropyl ether and to this solution is added an excess of concentrated nitric acid solution. The precipitated nitrate salt is filtered off and recrystallized from a mixture of methanol and diisopropyl ether, yielding 1-[2,4-dichloro- β -(2,6-dichlorobenzyl)oxy]phenethyl]imidazole nitrate; melting point 179°C.

References

Merck Index 5007
DFU 4 (11) 814 (1979)
Kleeman & Engel p. 500
DOT 15 (12) 542 (1979) & 17 (9) 388 (1981)
I.N. p. 528
Godefroi, E.F. and Heeres, J.; U.S. Patents 3,717,655; February 20, 1973 and 3,839,574; October 1, 1974; both assigned to Janssen Pharmaceutica NV

ISOFLURANE

Therapeutic Function: Inhalation anesthetic

Chemical Name: 1-Chloro-2,2,2-trifluoroethyl difluoromethyl ether

Common Name: —

Structural Formula:

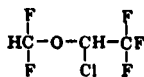

Chemical Abstracts Registry No.: 26675-46-7

Trade Name	Manufacturer	Country	Year Introduced
Forane	Ohio Medical	U.S.	1980
Aerrane	Ohio Medical	Switz.	1983
Aerrane	Ohio Medical	U.K.	1983

Raw Materials

1-Chloro-2,2,2-trifluoroethyl dichloromethyl ether
Hydrogen fluoride

Manufacturing Process

A 1-liter 3-necked stainless steel flask was fitted with a copper "Dry Ice" cold finger condenser, a stainless steel stirring shaft and gland and a copper gas inlet tube. To the flask there was then added 50 g (0.23 mol) of $\text{CF}_3\text{CHClOCHCl}_2$ and 1.5 g of $\text{SbCl}_5 \cdot \text{HF}$ gas was then slowly bubbled through the stirred mixture which was maintained at 0°C . The reaction was run until 0.35 mol of HCl was collected, as indicated by the titration of the effluent gas which was dissolved in water. Following the fluorination 26 g of material were recovered and determined to be 90% pure by vapor phase chromatography. Fractional distillation using a 30 x 0.5 cm column packed with glass helices gave the pure product, BP 48°C to 48.5°C .

References

Merck Index 5021

DOT 16 (11) 374 (1980)

I.N. p. 528

REM p. 1042

Terrell, R.C.; U.S. Patent 3,535,388; October 20, 1970; assigned to Air Reduction Co., Inc.

ISOFLUROPHATE

Therapeutic Function: Cholinergic (ophthalmic)

Chemical Name: Phosphorofluoridic acid bis(1-methylethyl)ester

Common Name: Fluostigmine

Structural Formula:

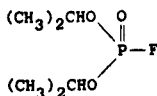

Chemical Abstracts Registry No.: 55-91-4

Trade Name	Manufacturer	Country	Year Introduced
Floropryl	MSD	U.S.	1949
D.F.P.	Sumitomo	Japan	—
D.F.P.	Boots	U.K.	—
D.F.P.	Winzer	W. Germany	—
Diflupyl	Labaz	—	—
Fluopryl	MSD	—	—

Raw Materials

Isopropanol	Phosphorus trichloride
Chlorine	Sodium fluoride

Manufacturing Process

212 lb (3.54 lb-mols) of isopropanol containing less than 0.2 wt % of water was cooled with brine to -5°C in a jacketed reactor. 160 lb (1.16 lb-mols) of phosphorus trichloride was gradually added to the isopropanol with cooling and stirring during a period of 4 hours. The temperature of the reaction was not allowed to exceed 12°C and the system was maintained under slight negative pressure (about 700 mm) to remove undesirable vapors.

After completion of the addition, the mixture was stirred for $\frac{1}{2}$ hour and then subjected to a pressure of 12 to 100 mm of mercury. Chlorine was then passed into the crude reaction product at a rate of 12 lb/hr, the temperature of the reaction being kept below 12°C by brine cooling. The end of the reaction was indicated by a temperature drop which occurred after a total of 122 lb of chlorine (1.72 lb-mols, 48% excess) was used.

To remove excess chlorine, hydrogen chloride and isopropyl chloride, the well-stirred mixture was subjected to a pressure of 12 to 100 mm of mercury for 2 hours. The temperature was gradually raised to 20°C during this time by passing steam into the jacket of the reactor. 10 gallons of benzene was then added and distilled off under reduced pressure, gradually raising the temperature of the reaction mixture to 30°C . The last traces of hydrogen chloride were removed by adding an additional 10 gallons of benzene which was distilled off under reduced pressure at reactor temperatures not exceeding 50°C . The total time required for the removal of the volatile acid components of the reaction mixture was 4 hours.

The mixture was then cooled to 20°C and 19 gallons of benzene was added. This was followed by the introduction of 123.5 lb (2.80 lb-mols) of dry powdered sodium fluoride (95% pure). The mixture was stirred and heated to the refluxing temperature in a period of 1 hour and held at this temperature (95° to 98°C) for 4 hours. The product obtained was cooled and filtered to yield a filter cake which was washed with three 5-gallon portions of benzene. The filtrate and washing were then combined and distilled under reduced pressure. There was obtained 158 lb (74% yield of theory based on PCl_3) of diisopropyl fluorophosphate, BP 62°C at 9 mm and 46°C at 5 mm.

References

Merck Index 5022

Kleeman & Engel p. 501

PDR p. 1179

I.N. p. 437

REM p. 899

Hardy, E.E. and Kosolapoff, G.M.; U.S. Patent 2,409,039; October 8, 1946; assigned to Monsanto Chemical Company

ISOMETHEPTENE

Therapeutic Function: Muscle relaxant

Chemical Name: N,1,5-trimethyl-4-hexenylamine

Common Name: Methyl isoocetenylamine

Structural Formula:

$$\begin{array}{c} \text{NHCH}_3 \\ | \\ (\text{CH}_3)_2\text{C}=\text{CHCH}_2\text{CH}_2\text{CHCH}_3 \end{array}$$

Chemical Abstracts Registry No.: 503-01-5

Trade Name	Manufacturer	Country	Year Introduced
Octinum	Knoll	U.S.	1948
Cesal	Dainippon	Japan	—
Midrin	Carrick	U.S.	—
Migralam	Bart	U.S.	—

Raw Materials

Methyl heptenone
Methylamine

Manufacturing Process

Methyl heptenone dissolved in 75% alcohol is reduced with activated aluminum in the presence of methylamine to give isometheptene.

References

Merck Index 5031

Kleeman & Engel p. 502

PDR pp. 654, 781

I.N. p. 529

REM p. 891

Klavehn, W. and Wolf, A.; U.S. Patent 2,230,753; February 4, 1941; assigned to E. Bilhuber Corporation, Germany

Klavehn, W. and Wolf, A.; U.S. Patent 2,230,754; February 4, 1941; assigned to E. Bilhuber Corporation, Germany

ISONIAZID

Therapeutic Function: Antitubercular

Chemical Name: 4-pyridinecarboxylic acid hydrazide

Common Name: Isonicotinic acid hydrazide

Structural Formula:

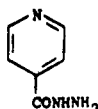

Chemical Abstracts Registry No.: 54-85-3

Trade Name	Manufacturer	Country	Year Introduced
Nyrazid	Squibb	U.S.	1952
Niconyl	Parke Davis	U.S.	1952
INH	Lilly	U.S.	1952
Tisin	USV Pharm	U.S.	1952
Pyrizidin	Warner Lambert	U.S.	1952
Cotinazin	Pfizer	U.S.	1952
Tyvid	Merrell National	U.S.	1952
Ditubin	Schering	U.S.	1952
Rimafon	Roche	U.S.	1952
Armazide	Armour	U.S.	1952
Anteben	Dainippon	Japan	—
Cedin	Lyssia	W. Germany	—
Cemidon	Gayoso Wellcome	Spain	—
Cin Vis	Vis	Italy	—
Dardex	Llorente	Spain	—
Diazid	Nippon Shinyaku	Japan	—
Dinacrin	Winthrop-Stearns	Phillipines	—
Dow-Isoniazid	Dow	U.S.	—
Eutizon	Pliva	Yugoslavia	—
Fimazid	Wassermann	Spain	—
Hidrafasa	Lifasa	Spain	—
Hidranic	Efeyn	Spain	—
Hidrazinda	Jorba	Spain	—
Hiperazida	Martin Santos	Spain	—
Hycozid	Takeda	Japan	—
Hydra	Otsura	Japan	—
Hyzyd	Mallinckrodt	U.S.	—
Idrazil	Bracco	Italy	—
INH-Burgthal	Conzen	W. Germany	—
Iscoatin	Daiichi	Japan	—
Isobicini	Maggioni	Italy	—
Iso-Dexter	Dexter	Spain	—
Isotamine	I.C.N.	Canada	—
Isozide	I.C.N.	Canada	—
Kridan	Cidan	Spain	—
Lefos	Bicsa	Spain	—
Lubacida	Alfar	Spain	—
Neoteben	Bayer	W. Germany	—
Neo-Tizide	Aesca	Austria	—
Niadrin	Enzo	U.S.	—
Niazid	Sankyo	Japan	—
Nicazide	Wassermann	Italy	—
Niconyl	Parke Davis	U.S.	—
Nicotibina	Zambeletti	Italy	—
Nicotbine	Abic	Israel	—
Nicotubin	Leiras	Finland	—
Nicozid	Piam	Italy	—
Nicozide	Premo	U.S.	—
Niplen	Tanabe	Japan	—
Panazid	Panray	U.S.	—
Pycazide	Smith & Nephew	U.K.	—
Pyrizidin	Nepera	U.S.	—
Rifamate	Merrell Dow	U.S.	—
Rimifon	Roche	France	—
Sumifon	Sumitomo	Japan	—
TB-Phlogin	Heyl	W. Germany	—

Trade Name	Manufacturer	Country	Year Introduced
Tebesium	Hefa-Frenon	W. Germany	—
Tebilon	Kwizda	Austria	—
Tibinide	Ferrosan	Denmark	—
Tibizina	Farmochimica	Italy	—
Tubanox	Morgens	Spain	—
Tuberon	Shionogi	Japan	—
Tubilysin	Orion	Finland	—
Zidafimia	Santos	Spain	—
Zideluy	Miluy	Spain	—

Raw Materials

4-Cyanopyridine
Hydrazine hydrate

Manufacturing Process

4 parts of 4-cyanopyridine in 12 parts of water were reacted with 4 parts of hydrazine hydrate in the presence of 0.08 part of sodium hydroxide at 100°C under reflux for 7 hours. The product, after filtration and evaporation to dryness, was crystallized from ethanol. The yield of isonicotinyl hydrazide amounted to 3.27 parts which is 62% of the theoretical.

References

Merck Index 5032
Kleeman & Engel p. 503
PDR pp. 798, 830, 1237
OCDS Vol. 1 p. 254 (1977) & 2, 266 (1980)
I.N. p. 529
REM p. 1214
Gasson, E.J.; U.S. Patent 2,830,994; April 15, 1958; assigned to The Distillers Company Limited, Scotland
Fox, H.H.; U.S. Patent 2,596,069; May 6, 1952; assigned to Hoffmann-La Roche Inc.

ISOPROPAMIDE IODIDE

Therapeutic Function: Antispasmodic

Chemical Name: γ -(aminocarbonyl)-N-methyl-N,N-bis(1-methylethyl)- γ -phenylbenzene-propanaminium iodide

Common Name: Diisopropylamino diphenyl butyramide methiodide

Structural Formula:

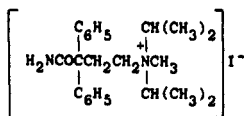

Chemical Abstracts Registry No.: 71-81-8

Trade Name	Manufacturer	Country	Year Introduced
Darbid	SKF	U.S.	1957
Priamide	Delalande	France	1959
Combid	SKF	U.S.	—

Trade Name	Manufacturer	Country	Year Introduced
Dipramid	Valeas	Italy	—
Marygin M	Sumitomo	Japan	—
Ornade	SKF	U.S.	—
Prochlor-Iso	Schein	U.S.	—
Pro-Iso	Zenith	U.S.	—
Tyrimide	SKF	U.K.	—

Raw Materials

γ -Diisopropylamino- α,α -diphenylbutyronitrile
Sulfuric acid
Methyl iodide

Manufacturing Process

γ -Diisopropylamino- α,α -diphenylbutyronitrile (60 g) was added in several portions to a mixture of sulfuric acid (150 ml) and water (15 ml) and the solution was heated 3½ hours on the steam bath and then poured on ice and made basic with NH_4OH . The γ -diisopropylamino- α,α -diphenylbutyramide precipitated as a solid, which was taken up in methylene chloride from an aqueous slurry. The methylene chloride was separated and dried by filtering through anhydrous K_2CO_3 . The solvent was removed by distillation, leaving the amide which was crystallized from Skellysolve B five times and found then to have MP 87.0° to 88.5°C .

γ -Diisopropylamino- α,α -diphenylbutyramide in propanol was refluxed 4 hours in the presence of excess methyl iodide. Upon dilution of the solution with ethyl acetate (100 ml per 50 ml isopropyl alcohol) and cooling γ -diisopropylamino- α,α -diphenylbutyramide methiodide precipitated, was collected by filtration and recrystallized (9.0 g) by dissolving in a hot mixture of 100 ml isopropyl alcohol and 10 ml methanol and then diluting with 90 ml Skellysolve B, to give 8.3 g recrystallized product, MP 182° to 184°C .

References

Merck Index 5051
Kleeman & Engel p. 504
PDR pp. 1606, 1706, 1711, 1999
I.N. p. 531
REM p. 916
Speeter, M.E.; U.S. Patent 2,823,233; February 11, 1958; assigned to Bristol Laboratories Inc.

ISOPROTERENOL SULFATE

Therapeutic Function: Bronchodilator

Chemical Name: 4-[1-hydroxy-2-[(1-methylethyl)amino]ethyl]-1,2-benzenediol sulfate

Common Name: Isoprenaline sulfate; isopropylarterenol sulfate

Structural Formula:

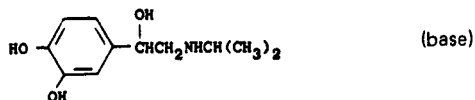

Chemical Abstracts Registry No.: 299-95-6; 7683-59-2 (Base)

Trade Name	Manufacturer	Country	Year Introduced
Isonorin	Smith Miller & Patch	U.S.	1949
Norisodrine	Abbott	U.S.	1950
Medihaler-Iso	Riker	U.S.	1956
Luf-Iso	Mallinckrodt	U.S.	1974
Aleudrin	Lewis	U.K.	—
Aludrin	Boehr. Ingel.	W. Germany	—
Asmadren	A.F.I.	Norway	—
Asthpul	Nippon Shoji	Japan	—
Bellasthman Medihaler	Kettelhack Riker	W. Germany	—
Dyspnoesan	Nourypharma	Neth.	—
Ingelan	Boehr. Ingel.	W. Germany	—
Isomenyl	Kaken	Japan	—
Meterdos-Iso	West-Silten	U.K.	—
Nebair	Warner-Chilcott	U.S.	—
Novodrin	VEB Berlin-Chemie	E. Germany	—
Prenomiser	Fisons	U.K.	—
Propynalin	Ferrosan	Denmark	—
Protrenol	Nikken	Japan	—
Sedansol "Iso"	Nippon Zoki	Japan	—
Vapo-N-Iso	Fisons	U.S.	—

Raw Materials

3,4-Dihydroxy- ω -chloroacetophenone
Hydrogen

Isopropylamine
Sulfuric acid

Manufacturing Process

As described in U.S. Patent 2,308,232, 100 g 3,4-dihydroxy- ω -chloroacetophenone, 200 cc ethyl alcohol and 200 cc of about 50% aqueous isopropylamine solution are boiled during 3 hours on the water bath with the use of a reflux condenser, whereupon neutralizing with diluted sulfuric acid is carried out and the sulfate, obtained upon cooling, from alcohol of 50% is recrystallized; its MP is 245°C.

21 g 3,4-dihydroxy- ω -isopropylaminoacetophenone sulfate are hydrogenated with 50 cc methyl alcohol and 50 cc water, 0.5 g carbon and 3 cc palladium chloride solution of 2%. After 2 hours the hydrogen absorption comes to a standstill, after the theoretical quantity of hydrogen has been absorbed. After concentrating, the isopropylaminomethyl-(3,4-dihydroxyphenyl)carbinolsulfate crystallizes out. It has a MP of 180°C after refining.

References

Merck Index 5065

Kleeman & Engel p. 503

OCDS Vol. 1 p. 63 (1977); 2, 37, 107 (1980) & 3, 20 (1984)

I.N. p. 531

REM p. 886

Scheuing, G. and Thoma, O.; U.S. Patent 2,308,232; January 12, 1943

Delmar, G.S. and Macallum, E.N.; U.S. Patent 2,715,141; August 9, 1955; assigned to Delmar Chemicals Limited, Canada

ISOSORBIDE DINITRATE

Therapeutic Function: Vasodilator (coronary)

Chemical Name: 1,4:3,6-Dianhydro-D-glucidol dinitrate

Common Name: Dinitrosorbide

Structural Formula:

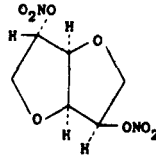

Chemical Abstracts Registry No.: 87-33-2

Trade Name	Manufacturer	Country	Year Introduced
Isordil	Ives	U.S.	1959
Sorbitrate	Stuart	U.S.	1968
Isordil	Ayerst	U.K.	1971
Sorquad	Tutag	U.S.	1972
ISDN	Cooper	U.S.	1975
Iso-Bid	Geriatric Pharm.	U.S.	1975
Isomotic	Alcon	U.S.	1980
Dilatrate	Reed Carnrick	U.S.	1981
Cardio-10	Nicholas	W. Germany	—
Cardis	Iwaki	Japan	—
Carvanil	Banyu	Japan	—
Cardopax	Erco	Denmark	—
Carvasin	Ayerst	Italy	—
Cedocard	Tillotts	U.K.	—
Cordil	Disco	Israel	—
Cornilat	Galenika	Yugoslavia	—
Corovliss	Boehr. Mann.	W. Germany	—
Difutrat	Srbolek	Yugoslavia	—
Dilatrate	Reed & Carnrick	U.S.	—
Diretan	Ono	Japan	—
Duranitrate	Durachemie	W. Germany	—
Isobid	Geriatric	U.S.	—
Isocardide	Sam-On	Israel	—
Iso-D	Dunhall	U.S.	—
Isoket	Gebro	Austria	—
Isomack	Mack	W. Germany	—
Isopuren	Klinge	W. Germany	—
Isordil	Wyeth	U.S.	—
Isotrate	Hauck	U.S.	—
Laserdil	Laser	U.S.	—
Marrolingual	Pohl-Boskamp	W. Germany	—
Maycor	Parke-Davis	W. Germany	—
Metonitron	Petazon	Switz.	—
Nitorol R	Eisai	Japan	—
Nitroret	Hishiyama	Japan	—
Nitrosit	Pharmacal	Finland	—
Nitrosorbide	Lusofarmaco	Italy	—
Nitro-Tablinen	Sanorania	W. Germany	—
Nosim	Richet	Argentina	—
Risordan	Theraplrix	France	—
Soni-Slo	Lipha	U.K.	—
Sorbangil	Kabi-Vitrum	Sweden	—
Sorbid	I.E. Kimya Evi	Turkey	—

Trade Name	Manufacturer	Country	Year Introduced
Tinidil	Pliva	Yugoslavia	—
Vascardin	Nicholas	U.K.	—

Raw Materials

1,4:3,6-Dianhydro-D-glucitol
Nitric acid

Manufacturing Process

An aqueous syrup of 1,4:3,6-dianhydro-D-glucitol is slowly added to a cooled mixture of HNO₃ and H₂SO₄. After standing a few minutes the mixture is poured into cold water and the precipitated product is collected and recrystallized from ethanol.

References

Merck Index 5074

Kleeman & Engel p. 505

PDR pp. 830, 905, 928, 993, 1442, 1606, 1784, 1951, 1999

I.N. p. 533

REM p. 853

Cordes, G., Munch, U. and Giesselmann, E.; U.S. Patent 4,156,736; May 29, 1979; assigned to Sanol Schwarz-Monheim G.m.b.H. (W. Germany)

ISOTHIPENDYL HCl

Therapeutic Function: Antihistaminic

Chemical Name: 10-(2-Dimethylamino-2-methylethyl)-10H-pyrido[3,2-b][1,4]benzothiazine

Common Name: —

Structural Formula:

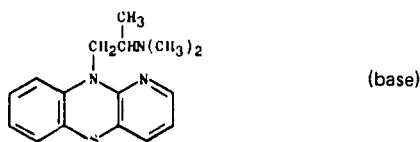

Chemical Abstracts Registry No.: 1225-60-1; 482-15-5 (Base)

Trade Name	Manufacturer	Country	Year Introduced
Theruhistin	Ayerst	U.S.	1957
Andantol	Gerda	France	1957
Aczen NS	Kanebo	Japan	—
Adantol	Imidas	Brazil	—
Andanton	Lacer	Spain	—
Nilergex	I.C.I.	U.K.	—
Thiodantol	Teva	Israel	—

Raw Materials

Phenylpyridylamine	Sulfur
Sodium amide	Hydrogen chloride
Dimethylaminoisopropyl chloride	

Manufacturing Process

85 parts of phenylpyridyl amine, 21 parts of powdered sulfur and 1.7 parts of iodine were heated to 275°C for two hours. Evolution of hydrogen sulfide began when the mixture reached a temperature of 250°C and became vigorous when it reached 275°C. Such evolution of hydrogen sulfide diminished after about one hour at 275°C. A light oil was distilled from the reaction mixture under vacuum (pressure = 2-3 mm Hg). This oil which contained phenylpyridyl amine in addition to the thiophenylpyridyl amine was then treated at boiling temperature with approximately the theoretical amount of 2-3 normal HCl until complete solution resulted with formation of the HCl salts of the amines. The solution was then treated with 1 to 2% (based upon the substance mixture) of active carbon and then filtered hot. The nitrate was then cooled to 0°C whereupon the thiophenylpyridyl amine hydrochloride crystallized out while the phenylpyridyl amine hydrochloride remained in solution. The thiophenylpyridyl amine hydrochloride was filtered off and suspended in water and the pH adjusted with half concentrated ammonia to 8. The thiophenylpyridyl amine set free was filtered off and dried. It was in the form of gold yellow needles and had a melting point of 114°C to 115°C.

40 parts of thiophenylpyridyl amine were dissolved in 200 parts of water free toluene. After the addition of 16 parts of soda amide, the mixture was refluxed for 1½ hours. Thereafter, 28 parts of dimethylaminoisopropyl chloride in 30 parts of water free toluene were dropped in and the temperature maintained at 20°C to 25°C for 30 minutes. Thereafter, the mixture was heated at 60°C for 30 minutes and subsequently refluxed for 20 minutes. Water and hydrochloride acid were then added to the reaction mixture and this mixture rendered alkaline with NaOH and then the alkalized mixture shaken out with ether. The dimethylaminoisopropyl-N9-thiophenylpyridyl amine base thus obtained was vacuum distilled. It was then converted to hydrochloride salt. The monohydrochloride salt is almost white in color and melts at 213°C to 216°C. The yield was almost 100% of the theoretical.

References

Merck Index 5077

Kleeman & Engel p. 505

OCDs Vol. 1 p. 430 (1977)

I.N. p. 534

Schuler, W.A. and Klebe, H.; U.S. Patent 2,974,139; March 7, 1961; assigned to Degussa (W. Germany)

ISOXICAM

Therapeutic Function: Antiinflammatory

Chemical Name: 4-Hydroxy-3-(5-methyl-3-isoxazolocarbamyl)-2-methyl-2H-1,2-benzothiazine 1,1-dioxide

Common Name: —

Structural Formula:

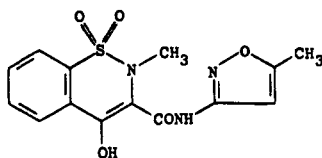

Chemical Abstracts Registry No.: 34552-84-6

Trade Name	Manufacturer	Country	Year Introduced
Pacyl	Warner-Lambert	Switz.	1983
Pacyl	Adenylchemie	W. Germany	1983
Maxicam	Parke Davis	—	—

Raw Materials

3-Carboethoxy-4-hydroxy-2-methyl-2H-1,2-benzothiazine-1,1-dioxide
3-Amino-5-methyl-isoxazole

Manufacturing Process

A mixture of 40.5 g (0.15 mol) of 3-carboethoxy-4-hydroxy-2-methyl-2H-1,2-benzothiazine 1,1-dioxide, 20.6 g (0.21 mol) of 3-amino-5-methylisoxazole, and 2,500 ml of xylene was refluxed for 24 hours in a Soxhlet apparatus, the thimble of which contained 60 g of Linde type 4A molecular sieve. The mixture was cooled to 25°C and the resulting crystalline precipitate was collected and washed with ether to give 44 g of crude product. Recrystallization from 1,600 ml of 1,4-dioxan gave 34.7 g of material, MP 265°C to 271°C dec.

References

Merck Index 5085

DFU 1 (3) 123 (1976)

OCDS Vol. 2 p. 394 (1980)

DOT 19 (2) 119 (1983) & 19 (7) 414 (1983)

I.N. p. 534

Zinnes, H., Schwartz, M.L. and Shavel, J. Jr.; U.S. Patent 3,787,324; January 22, 1974; assigned to Warner-Lambert Co.

ISOXSUPRINE HYDROCHLORIDE

Therapeutic Function: Vasodilator

Chemical Name: 4-hydroxy- α -[1-[(1-methyl-2-phenoxyethyl)amino]ethyl] benzenemethanol hydrochloride

Common Name: —

Structural Formula:

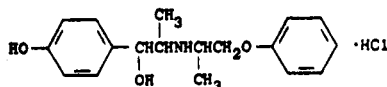

Chemical Abstracts Registry No.: 579-56-6; 395-28-8 (Base)

Trade Name	Manufacturer	Country	Year Introduced
Duvadilan	Duphar	France	1958
Vasodilan	Mead Johnson	U.S.	1959
Cardilan	Ferrosan	Denmark	—
Defencin	Bristol	U.K.	—
Isokulin	Toho Iyaku	Japan	—
Isolait	Elder	U.S.	—
Largiven	Bristol	Italy	—
Suprilent	Duphar	Belgium	—
Synzedrin	Teisan	Japan	—

Trade Name	Manufacturer	Country	Year Introduced
Trophodilan	Duphar	France	—
Vahodilan	Morita	Japan	—
Vascoprin	Guidotti	Italy	—
Vasodilene	Chiesi	Italy	—
Vasolan	Disco	Israel	—
Vasoplex	Frika	Austria	—
Vasosuprina	Lusofarmaco	Italy	—
Xuprin	Duphar	Belgium	—

Raw Materials

1-Phenoxy-2-aminopropane
 1-(4'-Benzyloxyphenyl)-2-bromopropanone-1
 Hydrogen

Manufacturing Process

To a solution of 30.7 g (0.203 mol) of 1-phenoxy-2-aminopropane in 150 ml of ethanol there was added 31.9 g (0.100 mol) of 1-(4'-benzyloxyphenyl)-2-bromopropanone-1. The mixture was heated to boiling temperature and the solution was then refluxed in a reflux condenser for 3 hours. Most of the ethanol was then distilled off in vacuo. Then to the residue there was added about 150 ml of diethyl ether. The hydrogen bromide salt of 1-phenoxy-2-aminopropane was filtered off and washed with diethyl ether.

The collected ethereal filtrates were acidified with 50 ml of 4 N hydrochloric acid and this solution was stirred vigorously. The hydrochloride of 1-(4'-benzyloxyphenyl)-2-(1'-methyl-2-phenoxy-ethylamino)propanone-1 precipitated out, was filtered off, washed with water and then with diethyl ether. Then this substance was dried in vacuo. The yield was 37.7 g, i.e., 89% of the theoretically possible yield, calculated on 1-(4'-benzyloxyphenyl)-2-bromine propanone-1. This substance had a light yellow color and melted at 197° to 198°C, while decomposing.

Then 21.89 g of the hydrochloride salt was dissolved in 600 ml of 80% aqueous ethanol. With the addition of a palladium carbon catalyst, this solution was hydrogenated at room temperature under a hydrogen pressure of about 1.1 atmospheres. After 2 mols hydrogen had been absorbed, the catalyst was filtered off and the filtrate was evaporated in vacuo until crystallization occurred. Then the crystals were dissolved by heating in the smallest possible quantity of water and after cooling, the crystallized substance was filtered off, washed with water and dried in vacuo. The yield was 6.80 g, i.e., 39% of the theoretically possible yield. The resultant product recrystallized from water melted at 203° to 204°C.

References

Merck Index 5086
 Kleeman & Engel p. 506
 PDR pp. 830, 993, 1129, 1569, 1606, 1999
 OCDS Vol. 1 p. 69 (1977)
 I.N. p. 534
 REM p. 892
 Moed, H.D.; U.S. Patent 3,056,836; October 2, 1962; assigned to North American Philips Company

K

KANAMYCIN SULFATE

Therapeutic Function: Antibacterial

Chemical Name: 0-3-amino-3-deoxy- α -D-glucopyranosyl-(1 \rightarrow 6)-0-[6-amino-6-deoxy- α -D-glucopyranosyl-(1 \rightarrow 4)-2-deoxy-D-streptamine sulfate

Common Name: —

Structural Formula:

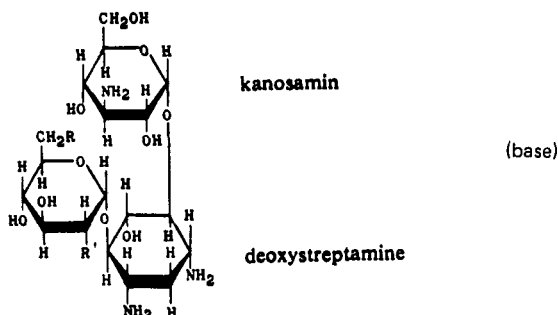

Chemical Abstracts Registry No.: 25389-94-0; 8063-07-8 (Base)

Trade Name	Manufacturer	Country	Year Introduced
Kantrex	Bristol	U.S.	1958
Kanamycine	Bristol	France	1959
Kanabristol	Bristol	W. Germany	1969
Klebcil	Beecham	U.S.	1979
Enterokanacin	Labif	Italy	—
Kamycine	Bristol	France	—
Kanabiol	Osfa	Italy	—
Kanabiot	Galepharma Iberica	Spain	—
Kanacet	Boniscontro-Gazzone	Italy	—
Kanacillin	Banyu	Japan	—
Kanacyclin	Banyu	Japan	—
Kanacyn	Continental Pharma.	Belgium	—
Kanafil	Farmila	Italy	—
Kanafuracin	Fujita	Japan	—
Kanahidro	Medical	Spain	—
Kanamicina Normon	Normon	Spain	—
Kanamycin	Ferosan	Denmark	—
Kanamytrex	Basotherm	W. Germany	—
Kanapiam	Piam	Italy	—
Kanaqua	Andromaco	Spain	—
Kanasig	Sigma	Australia	—

Trade Name	Manufacturer	Country	Year Introduced
Kanatrol	Lusofarmaco	Italy	—
Kanescin	Torlan	Spain	—
Kano	Pierrel	Italy	—
Keimicina	Robin	Italy	—
Koptin	Chinoïn	Mexico	—
Ophtalmokalixan	Bristol	France	—
Orakanamicil	Merifarma	Italy	—
Otokalixan	Bristol	France	—
Visiokan	S.I.F.I.	Italy	—

Raw Materials

Bacterium *Streptomyces kanamyceticus*
Soybean meal
Dextrin

Manufacturing Process

As described in U.S. Patent 2,931,798, *Streptomyces kanamyceticus* (K2-J) was first cultured in shake flasks in the following media: (a) 0.75% meat extract, 0.75% peptone, 0.3% NaCl, with 1.0% of starch, dextrin, maltose, glucose, lactose, sucrose or glycerol; or (b) 2.0% soybean meal, 0.05% KCl, 0.05% MgSO₄·7H₂O, 0.5% NaCl, 0.2% NaNO₃, with 1.0% of starch, dextrin, maltose, glucose, lactose, sucrose or glycerol. The initial pH of all media was adjusted to 7.0. After 24 to 48 hours shaking in some cases the pH decreased to about 6.0 to 6.8, but from 72 to 120 hours the pH rose and became 7.5 to 8.6. The production of kanamycin was apparent after 48 hours and, depending on the media; the maximum production was found after 72 to 120 hours.

The yield was highest with starch or dextrin, intermediate and about the same with sucrose, glucose, maltose and lactose and poorest with glycerol. Kanamycin was produced by media containing soybean meal, peanut meal, cottonseed meal, corn steep liquor, peptone, yeast extract or meat extract, with or without sodium nitrate. Commercially available soybean meal was recognized to be one of the best nitrogen sources. The addition of corn steep liquor, peptone, yeast extract or nitrate to the soybean meal promoted the production of kanamycin.

The brownish white kanamycin (5 g) was dissolved in 50 ml of 60% aqueous methanol, insoluble material was removed and to the filtrate 40 ml of 60% aqueous methanol containing 2,000 mg of ammonium sulfate was added, and the precipitated kanamycin sulfate was collected, washed with 50 ml of 80% aqueous methanol, and dried. Thus, 4.5 g of kanamycin sulfate was obtained as a light brownish powder.

References

Merck Index 5118

Kleeman & Engel p. 508

PDR p. 698

I.N. p. 539

REM p. 1181

Umezawa, H., Maeda, K. and Ueda, M.; U.S. Patent 2,931,798; April 5, 1960

Extraction:

Johnson, D.A., Hardcastle, G.A., Jr. and Perron, Y.G.; U.S. Patent 2,936,307; May 10, 1960; assigned to Bristol-Myers Company

Purification:

Johnson, D.A. and Harcastle, G.A., Jr.; U.S. Patent 2,967,177; January 3, 1961; assigned to Bristol-Myers Company

Separation Process:

Rothrock, J.W. and Putter, I.; U.S. Patent 3,032,547; May 1, 1962; assigned to Merck & Co., Inc.

KEBUZONE

Therapeutic Function: Antirheumatic

Chemical Name: 4-(3-Oxobutyl)-1,2-diphenyl-3,5-pyrazolidinedione

Common Name: Ketophenylbutazone

Structural Formula:

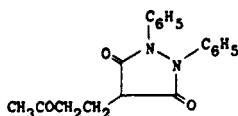

Chemical Abstracts Registry No.: 853-34-9

Trade Name	Manufacturer	Country	Year Introduced
Chebutan	Bioindustria	Italy	1961
Phloguron	Steiner	W. Germany	1976
Chetazolidine	Zeria	Japan	—
Chetopir	Sidus	Italy	—
Chetosol	Aristochimica	Italy	—
Copirene	Marxer	Italy	—
Ejor	Elea	Argentina	—
Hichillos	Kotani	Japan	—
Kebuzon	Steiner	W. Germany	—
Kentan-S	Sawai	Japan	—
Ketazon	Kyowa	Japan	—
Ketazone	Spofa	Czechoslovakia	—
Ketobutan	Santen	Japan	—
Ketobutane	Yamagata	Japan	—
Ketobutazone	Toho	Japan	—
Ketofen	Francia	Italy	—
Ketophezon	Kissei	Japan	—
Neo-Panalgyl	Italsuisse	Italy	—
Neuphenyl	Ohta	Japan	—
Pecnon	Sanken	Japan	—
Reumo Campil	Lopez-Brea	Spain	—
Vintop	Maruro	Japan	—

Raw Materials

Diethyl malonate	Methyl vinyl ketone
Ethylene glycol	Sodium ethoxide
Hydrazobenzene	Acetone

Manufacturing Process

(a) *3,3-ethylene dioxybutyl malonic acid diethyl ester*: Diethylmalonate is reacted with methyl vinyl ketone and the resulting oxobutyl diethylmalonate is reacted with ethylene glycol.

(b) *1,2-diphenyl-4-(3',3'-ethylene dioxybutyl)3,5-dioxopyrazolidine*: 274 parts of (3,3-ethylene dioxybutyl)-malonic acid diethyl ester are dissolved in 100 parts by volume of abs. benzene and 57 parts of sodium ethylate and 184 parts of hydrazobenzene are added. Heat is generated. The reaction mass is boiled for 15 hours under reflux. After cooling, it is poured into water, separated and the aqueous part is washed twice with benzene. The benzene solutions are washed three times with 2 N sodium carbonate solution and the unified aqueous so-

lutions are acidified with 2N hydrochloric acid. The 1,2-phenyl-4-(3',3'-ethylene dioxy-butyl)-3,5-dioxopyrazolidine which precipitates can be recrystallized from alcohol. Melting point 165°C to 167°C.

(c) *1,2-diphenyl-4-(3'-oxobutyl)-3,5-dioxopyrazolidine*: 36.6 parts of 1,2-diphenyl-4-(3',3'-ethylene dioxybutyl)-3,5-dioxopyrazolidine in 750 parts by volume of acetone are boiled under reflux for 18 hours with 0.35 part of p-toluene sulfonic acid. The solution is then filtered, 1,500 parts of water are added and the whole is allowed to stand for 24 hours at 5°C. The 1,2-diphenyl-4-(3'-oxobutyl)-3,5-dioxopyrazolidine which precipitates is filtered off under suction and washed with 50% acetone. Melting point from alcohol/water mixture: 115.5°C to 116.5°C. Sometimes a crystal form is obtained which melts at 127.5°C to 128.5°C.

References

Merck Index 5125

Kleeman & Engel p. 509

I.N. p. 540

Denss, R., Pfister, R. and Hafliker, F.; U.S. Patent 2,910,481; October 27, 1959; assigned to Geigy Chemical Corp.

KETAMINE HYDROCHLORIDE

Therapeutic Function: Anesthetic

Chemical Name: 2-(o-chlorophenyl)-2-(methylamino)-cyclohexanone hydrochloride

Common Name: —

Structural Formula:

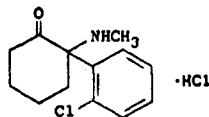

Chemical Abstracts Registry No.: 1867-66-9; 6740-88-1 (Base)

Trade Name	Manufacturer	Country	Year Introduced
Ketanest	Parke Davis	W. Germany	1969
Ketanest	Parke Davis	U.K.	1970
Ketalar	Parke Davis	U.S.	1970
Ketalar	Sankyo	Japan	1970
Ketalar	Parke Davis	France	1970
Ketaject	Bristol	U.S.	1970
Ketalar	Parke Davis	Italy	1972

Raw Materials

Cyclopentyl bromide
o-Chlorobenzonitrile
Methylamine

Magnesium
Bromine

Manufacturing Process

The 1-hydroxycyclopentyl-(o-chlorophenyl)-ketone N-methylimine used as an intermediate is prepared as follows. To the Grignard reagent prepared from 119.0 g of cyclopentyl

bromide and 19.4 g of magnesium is added 55.2 g of o-chlorobenzonitrile. The reaction mixture is stirred for 3 days and thereafter hydrolyzed in the usual manner. From the hydrolysis there is obtained o-chlorophenylcyclopentylketone, BP 96° to 97°C (0.3 mm), n_D^{25} 1.5452. To 21.0 g of the ketone is added 10.0 g of bromine in 80 ml of carbon tetrachloride.

1-Bromocyclopentyl-(o-chlorophenyl)-ketone, BP 111° to 114°C (0.1 mm) is isolated in the usual manner. Since it is unstable, it must be used immediately. The bromoketone (29.0 g) is dissolved in 50 ml of liquid methylamine. After one hour, the excess liquid methylamine is allowed to evaporate. The organic residue is dissolved in pentane, and upon evaporation of the solvent, 1-hydroxycyclopentyl-(o-chlorophenyl)-ketone N-methylimine, MP 62°C, is isolated.

1-Hydroxycyclopentyl-(o-chlorophenyl)-ketone N-methylimine (2.0 g) is dissolved in 15 ml of Decalin and refluxed for 2½ hours. After evaporation of the Decalin under reduced pressure, the residue is extracted with dilute hydrochloric acid, the solution treated with decolorizing charcoal, and the resulting acidic solution is made basic. The liberated product, 2-methylamino-2-(o-chlorophenyl)-cyclohexanone, after crystallization from pentane-ether, has MP 92° to 93°C. The hydrochloride of this compound has MP 262° to 263°C.

References

Merck Index 5133

Kleeman & Engel p. 510

PDR p. 1356

OCDS Vol. 1 p. 57 (1977) & 2, 16 (1980)

DOT 2 (4) 152 (1966); 6 (2) 42 (1970) & 2, 16 (1980)

I.N. p. 542

REM p. 1045

Stevens, C.L.; U.S. Patent 3,254,124; May 31, 1966; assigned to Parke, Davis and Company

KETAZOLAM

Therapeutic Function: Antianxiety

Chemical Name: 11-Chloro-8,12b-dihydro-2,8-dimethyl-12b-phenyl-4H-[1,3]-oxazino-[3,2-d][1,4]benzodiazepine-4,7 (6H)-dione

Common Name: —

Structural Formula:

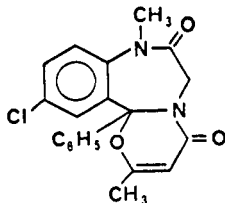

Chemical Abstracts Registry No.: 27223-35-4

Trade Name	Manufacturer	Country	Year Introduced
Anxon	Beecham	U.K.	1980
Solatran	Beecham	Switz.	1980
Solatran	Beecham	W. Germany	1980

Trade Name	Manufacturer	Country	Year Introduced
Unakalm	Upjohn	France	1981
Ansetin	Exa	Argentina	—
Contamex	Beecham-Wulfig	W. Germany	—
Loftran	Beecham	—	—

Raw Materials

2-(2-Amino-N-methylacetamido)-5-chlorobenzophenone
Diketene

Manufacturing Process

A solution of 0.7 g of 2-(2-amino-N-methylacetamido)-5-chlorobenzophenone in 10 ml of a 50% solution (by weight) of diketene in acetone is refluxed for 3 hours and then evaporated to give a brown oil. The oil is chromatographed on 200 g of silica gel using a 1:1 (by volume) mixture of ethyl acetate cyclohexane; 25 ml fractions are collected. Fractions 11-14 are combined, mixed with chloroform, evaporated and triturated with ether to give 0.337 g of 11-chloro-8,12b-dihydro-2,8-dimethyl-12b-phenyl-4H-[1,3]oxazino[3,2-d][1,4]benzodiazepine-4,7(6H)-dione as a pale yellow solid, MP 174°C to 176°C.

References

Merck Index 5134

DFU 1 (6) 293 (1976)

OCDS Vol. 1 p. 369 (1977)

DOT 16 (9) 293 (1980)

I.N. p. 542

Szmuszkoviez, J.; U.S. Patent 3,575,965; April 20, 1971; assigned to The Upjohn Co.

KETOCONAZOLE

Therapeutic Function: Antifungal

Chemical Name: 1-Acetyl-4-[4-[[2-(2,4-dichlorophenyl)-2(1H-imidazol-1-yl)methyl]-1,3-dioxolan-4-yl]methoxy]phenyl]piperazine

Common Name: —

Structural Formula:

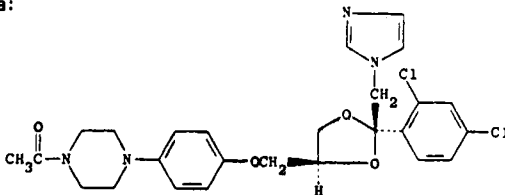

Chemical Abstracts Registry No.: 65277-42-1

Trade Name	Manufacturer	Country	Year Introduced
Nizoral	Janssen	U.S.	1981
Nizoral	Janssen	W. Germany	1981
Nizoral	Janssen	Switz.	1981

Trade Name	Manufacturer	Country	Year Introduced
Nizoral	Janssen	U.K.	1981
Nizoral	Janssen-Le Brun	France	1983
Nizoral	Janssen	Italy	1983
Ketazol	Exa	Argentina	—

Raw Materials

4-(1-Piperazinyl)phenol dihydrobromide
 Acetic anhydride
 cis-2-(2,4-Dichlorophenyl)-2-(1H-imidazol-1-ylmethyl)-1,3-dioxolan-4-yl methyl methane sulfonate

Manufacturing Process

(A) A mixture of 33.8 parts of 4-(1-piperazinyl)phenol dihydrobromide, 11.2 parts of acetic acid anhydride, 42 parts of potassium carbonate and 300 parts of 1,4-dioxane is stirred and refluxed for 3 days. The reaction mixture is filtered and the filtrate is evaporated. The solid residue is stirred in water and sodium hydrogen carbonate is added. The whole is stirred for 30 minutes. The precipitated product is filtered off and dissolved in a diluted hydrochloric acid solution. The solution is extracted with trichloromethane. The acid aqueous phase is separated and neutralized with ammonium hydroxide. The product is filtered off and crystallized from ethanol, yielding 5.7 parts of 1-acetyl-4-(4-hydroxyphenyl)piperazine; MP 181.3°C.

(B) A mixture of 2.4 parts of 1-acetyl-4-(4-hydroxyphenyl)piperazine, 0.4 part of sodium hydride dispersion 78%; 75 parts of dimethylsulfoxide and 22.5 parts of benzene is stirred for one hour at 40°C. Then there are added 4.2 parts of cis-2-(2,4-dichlorophenyl)-2-(1H-imidazol-1-ylmethyl)-1,3-dioxolan-4-ylmethyl methane sulfonate and stirring is continued overnight at 100°C. The reaction mixture is cooled and diluted with water. The product is extracted with 1,1'-oxybisethane. The extract is dried, filtered and evaporated. The residue is crystallized from 4-methyl-2-pentanone. The product is filtered off and dried, yielding 3.2 parts (59%) of cis-1-acetyl-4-[2-(2,4-dichlorophenyl)-2-(1H-imidazol-1-ylmethyl)-1,3-dioxolan-4-ylmethoxy]phenyl] piperazine; MP 146°C.

References

- Merck Index 5139
 DFU 4 (7) 496 (1979)
 PDR p. 956
 OCDS Vol. 3 p. 132 (1984)
 DOT 17 (9) 377 (1981)
 I.N. p. 542
 REM p. 1229
 Heeres, J., Backx, L.J.J. and Mostmans, J.H.; U.S. Patent 4,144,346; March 13, 1979; assigned to Janssen Pharmaceutica N.V. (Belgium)

KETOPROFEN

Therapeutic Function: Antiinflammatory

Chemical Name: m-benzoylhydratropic acid

Common Name: 2-(3-benzoylphenyl)propionic acid

Structural Formula:

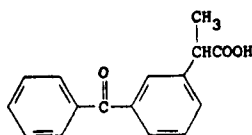

Chemical Abstracts Registry No.: 22071-15-4

Trade Name	Manufacturer	Country	Year Introduced
Profenid	Specia	France	1973
Orudis	May & Baker	U.K.	1973
Alrheumin	Bayropharm	W. Germany	1975
Orudis	Farmitalia	Italy	1975
Keto	Sigurta	Italy	1976
Orudis	Hokuriku	Japan	1978
Capisten	Kissei	Japan	1978
Inflen	Ohta	Japan	1983
Zaditen	Sandoz	Japan	1983
Orudis	Leo Rhodia	Sweden	1983
Alrheumat	Bayer	U.K.	—
Arcental	Janovich	Spain	—
Dexal	Pulitzer	Italy	—
Fastum	Manetti-Roberts	Italy	—
Flexen	Italfarmaco	Italy	—
Helenil	Roux-Ocefa	Argentina	—
Iso-K	San Carlo	Italy	—
Kefenid	S.I.T.	Italy	—
Ketalgin	I.B.P.	Italy	—
Ketofen	Nobel	Turkey	—
Keton	Ilisan	Turkey	—
Ketonal	Lek	Yugoslavia	—
Ketopron	Biosintetica	Brazil	—
Ketoprosil	Lieberman	Spain	—
Ketoval	Valles Mestre	Spain	—
Kevadon	Lemonier	Argentina	—
Knavon	Belupo	Yugoslavia	—
Lertus	Exa	Argentina	—
Meprofen	A.G.I.P.S.	Italy	—
Niflam	Alkaloid	Yugoslavia	—
Profenid	Specia	France	—
Remauric	Lifepharm	Spain	—
Romin	Fako	Turkey	—
Salient	Biomedica Foscama	Italy	—
Sinketol	Italchemie	Italy	—
Wasserprofen	Wassermann	Spain	—

Raw Materials

(3-Benzoylphenyl)acetonitrile
Ethanol
Sulfuric acid

Sodium
Methyl iodide

Manufacturing Process

In an initial step, the sodium derivative of ethyl (3-benzoylphenyl)cianoacetate is prepared as follows: (3-benzoylphenyl)acetonitrile (170 g) is dissolved in ethyl carbonate (900 g). There is added, over a period of 2 hours, a sodium ethoxide solution [prepared from sodium (17.7 g) and anhydrous ethanol (400 cc)], the reaction mixture being heated at

about 105° to 115°C and ethanol being continuously distilled. A product precipitates. Toluene (500 cc) is added, and then, after distillation of 50 cc of toluene, the product is allowed to cool. Diethyl ether (600 cc) is added and the mixture is stirred for 1 hour. The crystals which form are filtered off and washed with diethyl ether (600 cc) to give the sodium derivative of ethyl (3-benzoylphenyl)cynoacetate (131 g).

Then, ethyl methyl(3-benzoylphenyl)cynoacetate employed as an intermediate material is prepared as follows: The sodium derivative of ethyl (3-benzoylphenyl)cynoacetate (131 g) is dissolved in anhydrous ethanol (2 liters). Methyl iodide (236 g) is added and the mixture is heated under reflux for 22 hours, and then concentrated to dryness under reduced pressure (10 mm Hg). The residue is taken up in methylene chloride (900 cc) and water (500 cc) and acidified with 4 N hydrochloric acid (10 cc). The methylene chloride solution is decanted, washed with water (400 cc) and dried over anhydrous sodium sulfate. The methylene chloride solution is filtered through a column containing alumina (1,500 g). Elution is effected with methylene chloride (6 liters), and the solvent is evaporated under reduced pressure (10 mm Hg) to give ethyl methyl(3-benzoylphenyl)cynoacetate (48 g) in the form of an oil.

In the final production preparation, a mixture of ethyl methyl(3-benzoylphenyl)cynoacetate (48 g), concentrated sulfuric acid (125 cc) and water (125 cc) is heated under reflux under nitrogen for 4 hours, and water (180 cc) is then added. The reaction mixture is extracted with diethyl ether (300 cc) and the ethereal solution is extracted with N sodium hydroxide (300 cc). The alkaline solution is treated with decolorizing charcoal (2 g) and then acidified with concentrated hydrochloric acid (40 cc). An oil separates out, which is extracted with methylene chloride (450 cc), washed with water (100 cc) and dried over anhydrous sodium sulfate. The product is concentrated to dryness under reduced pressure (20 mm Hg) to give a brown oil (33.8 g).

This oil is dissolved in benzene (100 cc) and chromatographed through silica (430 g). After elution with ethyl acetate, there is collected a fraction of 21 liters, which is concentrated to dryness under reduced pressure (20 mm Hg). The crystalline residue (32.5 g) is recrystallized from acetonitrile (100 cc) and a product (16.4 g), MP 94°C, is obtained. On recrystallization from a mixture of benzene (60 cc) and petroleum ether (200 cc), there is finally obtained 2-(3-benzoylphenyl)propionic acid (13.5 g), MP 94°C.

References

Merck Index 5142

Kleeman & Engel p. 511

OCDS Vol. 2 p. 64 (1980)

DOT 9 (11) 469 (1973) & 19 (3) 160 (1983)

I.N. p. 543

Farge, D., Messer, M.N. and Moutonnier, C.; U.S. Patent 3,641,127; February 8, 1972; assigned to Rhone-Poulenc S.A., France

KETOTIFEN

Therapeutic Function: Antiasthmatic, antihistaminic

Chemical Name: 4-(1-Methyl-4-piperidylidene)-4H-benzo[4,5]cyclohepta[1,2-b]-thiophen-10(9H)-one

Common Name: —

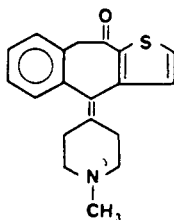
Structural Formula:

Chemical Abstracts Registry No.: 34580-13-7

Trade Name	Manufacturer	Country	Year Introduced
Zaditen	Wander	Switz.	1978
Zaditen	Sandoz	W. Germany	1979
Zaditen	Sandoz	U.K.	1979
Zaditen	Sandoz	France	1980
Zaditen	Sandoz	Italy	1982
Zaditen	Sandoz	Japan	1983
Totifen	Chiesi	Italy	1983
Zasten	Sandoz	—	—

Raw Materials

4-Chloro-1-methylpiperidine
 Magnesium
 10-Methoxy-4H-benzo[4,5]cyclohepta[1,2-b]thiophen-4-one
 Hydrogen chloride

Manufacturing Process

3.07 g of iodine-activated magnesium shavings are covered with a layer of 25 cc of tetrahydrofuran, and approximately 1/10 of a solution of 17.7 g of 4-chloro-1-methylpiperidine base in 70 cc of absolute tetrahydrofuran is added. The Grignard reaction is initiated by the addition of a few drops of 1,2-dibromoethane. The remaining 4-chloro-1-methylpiperidine solution is then added dropwise to the magnesium at such a rate that the reaction mixture boils continuously at reflux without external heating. Boiling at reflux is then continued for 1 hour. 15.3 g of 10-methoxy-4H-benzo[4,5]cyclohepta[1,2-b]thiophen-4-one are subsequently added portionwise at 20°C, within 40 minutes, with slight cooling. After stirring at 20°C for 1½ hours, the reaction solution is poured on a mixture of 180 g of ice and 20 g of ammonium chloride. The free base is extracted with chloroform.

The chloroform solution is concentrated and the residue recrystallized from 270 cc of absolute ethanol. The pure 10-methoxy-4-(1-methyl-4-piperidyl)-4H-benzo[4,5]cyclohepta[1,2-b]thiophen-4-ol base, having a melting point of 194°C to 196°C, is obtained in this manner. Microanalysis corresponds with the formula $C_{20}H_{23}NO_2S$.

A mixture of 3.4 g of 10-methoxy-4-(1-methyl-4-piperidyl)-4H-benzo[4,5]cyclohepta[1,2-b]thiophen-4-ol base and 40 cc of 3 N hydrochloric acid is kept in a boiling water bath at 95°C to 100°C for 1 hour. The mixture is subsequently made alkaline with concentrated caustic soda solution at 20°C while cooling, and the free base is extracted with chloroform. The chloroform solution is concentrated, and the residue is recrystallized from ethanol/water 1:1. The pure 4-(1-methyl-4-piperidylidene)-4H-benzo[4,5]cyclohepta[1,2-b]thiophen-10(9H)-one base, having a melting point of 152°C to 153°C, is obtained in this manner.

References

Merck Index 5144
 DFU 2 (2) 108 (1977)

Kleeman & Engel p. 512

OCDS Vol. 3 p. 239 (1984)

DOT 14 (8) 370 (1978)

I.N. p. 543

Bourquin, J.P., Schwarb, G. and Waldvogel, E.; U.S. Patents 3,682,930; Aug. 8, 1972; 3,770,728; Nov. 6, 1973 and 3,960,894; June 1, 1976; all assigned to Sandoz, Ltd.

L

LABETALOL HYDROCHLORIDE

Therapeutic Function: α and β -Adrenergic blocker

Chemical Name: 2-Hydroxy-5-[1-hydroxy-2-[(1-methyl-3-phenylpropyl)amino] ethyl] benzamide hydrochloride

Common Name: Ibadomide

Structural Formula:

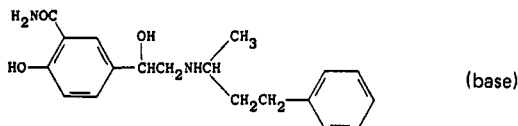

Chemical Abstracts Registry No.: 36894-69-6; 32780-64-6 (Hydrochloride)

Trade Name	Manufacturer	Country	Year Introduced
Trandate	Allen & Hanburys	U.K.	1977
Trandate	Glaxo	W. Germany	1977
Labetalol	Duncan	Italy	1978
Trandate	Glaxo	Switz.	1979
Trandate	Glaxo	France	1980
Trandate	Glaxo	Japan	1983
Abetol	C.T.	Italy	—
Labelol	Elea	Argentina	—
Lamitol	Pliva	Yugoslavia	—
Lolum	Farmochimica	Italy	—
Mitalolo	Ellem	Italy	—
Normodyne	Schering	U.S.	—
Presdate	Alfa Farm.	Italy	—

Raw Materials

5-Bromoacetylsalicylamide
 N-Benzyl-N-(1-methyl-3-phenylpropyl)amine
 Hydrogen

Manufacturing Process

(a) 5-Bromoacetylsalicylamide (2.6 g), N-benzyl-N-(1-methyl-3-phenylpropyl)amine (4.8 g) and methyl ethyl ketone (50 ml) were heated at reflux for 40 minutes. The solvent was removed and the residue was treated with benzene. The secondary amine hydrobromide was filtered off and discarded, and the filtrate was evaporated to dryness. The residue was treated with an excess of ethanolic hydrogen chloride when 5-[N-benzyl-N-(1-methyl-3-phenylpropyl)-glycyl] -salicylamide hydrochloride (1.15 g) crystallized out, MP 139°C to 141°C.

(b) 5-[N-benzyl-N-(1-methyl-3-phenylpropyl)glycyl]-salicylamide hydrochloride (0.75 g), 10% mixture of PdO and PtO on carbon catalyst (0.1 g) and ethanol (20 ml) were shaken at room temperature and pressure with hydrogen until uptake ceased. The catalyst was filtered off and the filtrate evaporated to dryness. The residue was crystallized from ethanol to give 5-[1-hydroxy-2-(1-methyl-3-phenylpropyl)aminoethyl] salicylamide hydrochloride as a white solid (0.40 g), MP 188°C.

References

Merck Index 5166

DFU 1 (3) 125 (1976)

Kleeman & Engel p. 513

PDR pp. 913, 1638

OCDS Vol. 3 p. 24 (1984) & 18 (8) 378 (1982)

DOT 13 (11) 493 (1977)

I.N. p. 547

REM p. 904

Lunts, L.H.C. and Collin, D.T.; U.S. Patent 4,012,444; March 15, 1977; assigned to Allen & Hanburys Ltd. (U.K.)

LACTULOSE

Therapeutic Function: Laxative

Chemical Name: 4-O- β -D-galactopyranosyl-D-fructose

Common Name: —

Structural Formula:

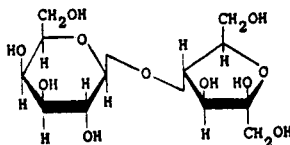

Chemical Abstracts Registry No.: 4618-18-2

Trade Name	Manufacturer	Country	Year Introduced
Duphalac	Philips-Duphar	U.K.	1969
Bifiteral	Philips-Duphar	W. Germany	1971
Duphalac	Duphar	France	1972
Duphalac	Duphar	Italy	1973
Gatinar	Duphar	U.K.	1973
Lactulose	Nikken	Japan	1973
Cephalac	Merrell Dow	U.S.	1976
Duphalac	Philips-Roxane	U.S.	1977
Chronulac	Merrell Dow	U.S.	1979
Dia-Colon	Piam	Italy	—
Epalfen	Zambon	Italy	—
Laevilac	Wander	W. Germany	—
Laevolac	Laevosan	Austria	—
Monilac	Chugai	Japan	—

Raw Materials

Lactose

Sodium aluminate

Manufacturing Process

105 g of lactose monohydrate were dissolved in 500 ml of water. 48 g of NaAlO_2 was dissolved in 100 ml of water and was then added to the lactose solution. The mixture was then diluted to one liter to provide a pH of 11.5. The reactant concentrations of 48 g of sodium aluminate and 105 g of lactose are equivalent to a mol ratio of two mols of aluminate to one mol of lactose. The mixture was then heated to 50°C and 100 ml aliquots were removed at periodic intervals to determine the level of conversion. The reaction was terminated after three hours by adding sufficient 30% HCl to lower the pH to 4.2. The pH was then raised to neutrality, i.e., 6.5 to 7.0, with ammonium hydroxide so as to completely precipitate insoluble aluminum hydroxide. The precipitate was then removed by vacuum filtration and the filtrate was analyzed for the presence of ketose sugar by chromatographic analysis. The chromatographic analysis of the filtrate confirmed that the main component of the filtrate was lactulose and not the monosaccharide ketose sugar, fructose.

References

Merck Index 5184

Kleeman & Engel p. 513

PDR p. 1224

I.N. p. 548

REM p. 814

Guth, J.H. and Tumerman, L.; U.S. Patent 3,546,206; December 8, 1970; assigned to Kraftco Corp.

LETOSTEINE

Therapeutic Function: Mycolytic

Chemical Name: 4-Carboxy thiazolidinyl-2-ethylmercapto-acetic acid ethyl ester

Common Name: —

Structural Formula:

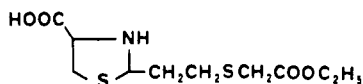

Chemical Abstracts Registry No.: 53943-88-7

Trade Name	Manufacturer	Country	Year Introduced
Viscotiol	Carlo Erba	France	1979
Viscotiol	Carlo Erba	Switz.	1980
Viscotiol	I.S.F.	Italy	1981

Raw Materials

Acrolein

Thioglycolic acid

Cysteine hydrochloride

Manufacturing Process

In an Erlenmeyer flask placed in an ice bath, and under a well-ventilated hood, a solution of 0.1 mol of acrolein in 100 ml of ether was introduced. With the aid of a bromine ampoule,

0.1 mol (≈ 11 ml) of the ethyl ester of thioglycolic acid containing 0.5 ml of triethylamine was added drop by drop.

One hour after completion of the addition, there was added 0.1 mol (15.6 g) of chlorhydrate of cysteine in alcoholic solution. The chlorhydrate of the expected derivative, which appeared in the form of a thick oil, was precipitated by addition of 0.1 mol (10 g) of potassium acetate in aqueous solution. The abundant precipitate obtained was filtered and washed in water and ether. The product was recrystallized in a minimum of absolute alcohol.

References

DFU 4 (10) 729 (1979)

Kleeman & Engel p. 516

DOT 16 (4) 109 (1980)

I.N. p. 553

Chodkiewicz, M.X.; U.S. Patent 4,032,534; June 28, 1977; assigned to Ferlus-Chimie SA

LEVAMISOLE HYDROCHLORIDE

Therapeutic Function: Antiinflammatory

Chemical Name: L-2,3,5,6-Tetrahydro-6-phenylimidazo[2,1-b]thiazole hydrochloride

Common Name: L-Tetramisole hydrochloride

Structural Formula:

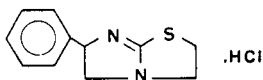

Chemical Abstracts Registry No.: 16695-80-5; 14769-73-4 (Base)

Trade Name	Manufacturer	Country	Year Introduced
Solaskil	Specia	France	1971
Ergamisol	Janssen	Italy	1978
Ascaryl	Abic	Israel	—
Meglum	Bago	Argentina	—
Niratic-Pur-On	Vet. Med. Handel	W. Germany	—
Tramisol	Lederle	U.S.	—
Vermisol	Andreu	Spain	—

Raw Materials

DL-2-Thio-1-phenyl-imidazolidine	Potassium hydroxide
1,2-Dibromoethane	Hydrogen chloride
d-10-Camphorsulfonic acid	Sodium hydroxide

Manufacturing Process

To a stirred and refluxed suspension of 17 parts of 1,2-dibromoethane, 7.8 parts of sodium hydrogen carbonate and 50 parts of 2-propanol is added a mixture of 3.4 parts of di-2-thio-1-phenyl-imidazolidine, 9 parts of a 20% potassium hydroxide solution in 40 parts of 2-propanol over a period of about 1 hour. After the addition is complete, the whole is stirred and refluxed for an additional 3 hours. The reaction mixture is evaporated. To the residue are added 18 parts of a 15% potassium hydroxide solution. The whole is extracted with toluene. The extract is dried and evaporated. The oily residue is dissolved in acetone and gaseous hy-

drogen chloride is introduced into the solution. The precipitated solid salt is filtered off and recrystallized from 2-propanol, yielding dl-2,3,5,6-tetrahydro-6-phenyl-imidazo[2,1-b]thiazole hydrochloride; melting point 264°C to 266°C.

dl-6-phenyl-2,3,5,6-tetrahydroimidazo[2,1-b]thiazole hydrochloride, 188 g (0.785 mol), is suspended in a mixture of 500 ml of water and 500 ml of methylene chloride. The suspension is stirred mechanically while 20% sodium hydroxide solution is added until the solution is basic. Ice is added from time to time to keep the temperature below the boiling point of the methylene chloride. The methylene chloride layer is separated, washed with water, dried over potassium carbonate and evaporated. The oily residue crystallizes with the evolution of the heat when poured into a beaker containing 100 ml of ether. The free base is washed with ether. The yield of dl-6-phenyl-2,3,5,6-tetrahydroimidazo[2,1-b]thiazole is 151.4 g (0.746 mol), 94%. The product has a melting point of 90°C.

A solution of 204.3 g (1 mol) of dl-6-phenyl-2,3,5,6-tetrahydroimidazo[2,1-b]thiazole and 232.3 g (1 mol) of d-10-camphorsulfonic acid in 1,750 ml of chloroform is allowed to crystallize overnight at -28°C. The solvate is recovered by filtration and washed with ice cold chloroform (400 ml). The solvate is dried (decomposed) under nitrogen 7 hours and then in air overnight. The yield of d(+)-6-phenyl-2,3,5,6-tetrahydroimidazo[2,1-b]thiazole d-10-camphorsulfonate is 202.5 g (0.464 mol) 92.8%, melting point 139°C to 140°C $[\alpha]_{D}^{25} + 82.6$ (C = 16, H₂O).

A solution of 150 g (0.344 mol) of d(+)-6-phenyl-2,3,5,6-tetrahydroimidazo[2,1-b]thiazole, d-10-camphorsulfonate in water is treated with 15.5 g (0.378 mol) of 98% sodium hydroxide and the liberated base extracted with chloroform. The chloroform solution is washed with water followed by sodium chloride solution and dried over magnesium sulfate. Evaporation of the solvent left 72.1 g of residue which crystallized shortly. The free base hereby obtained has a melting point of 60°C to 61.5°C and an optical rotation $[\alpha]_{D}^{25} + 85.1$ (C = 10, CHCl₃).

The free base d(+)-6-phenyl-2,3,5,6-tetrahydroimidazo[2,1-b]thiazole is dissolved in 112 ml of acetone and 178 ml of isopropanolic hydrogen chloride is added all at once. The hydrochloride crystallizes at once. After cooling to below 0°C, the salt is recovered by filtration and washed with acetone. The product weighs 75.2 g (0.312 mol), 91%, from the camphorsulfonate, melting point 227°C to 227.5°C $[\alpha]_{D}^{25} + 123.1$ (C = 15, H₂O).

References

- Merck Index 9055
 DFU 4 (6) 420 (1979)
 Kleeman & Engel p. 517
 DOT 8 (6) 225 (1972) & 16 (10) 327, 359 (1980)
 I.N. p. 554
 REM p. 1156
 Raeymaekers, A.H.M., Thienpont, D.C.I.C. and Demoen, P.J.A.W.; U.S. Patents 3,274,209; September 20, 1966 and 3,364,112; January 16, 1968; both assigned to Janssen Pharmaceutica NV
 Bullock, M.W.; U.S. Patent 3,463,786; August 26, 1969; assigned to American Cyanamid Co.
 Dewar, R.A., Maier, V.E. and Ingram, M.A.; U.S. Patent 3,579,530; May 18, 1971; assigned to Imperial Chemical Industries of Australia and New Zealand Ltd.
 Dewilde, F. and Frot, G.G.; U.S. Patent 3,646,051; February 29, 1972; assigned to Rhone-Poulenc SA

LEVODOPA

Therapeutic Function: Antiparkinsonism

Chemical Name: 3-hydroxy-L-tyrosine

Common Name: β -(3,4-dihydroxyphenyl)- α -alanine; 2-amino-3-(3,4-dihydroxyphenyl)propanoic acid

Structural Formula:

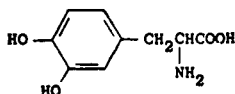

Chemical Abstracts Registry No.: 59-92-7

Trade Name	Manufacturer	Country	Year Introduced
Larodopa	Roche	U.S.	1970
Dopar	Norwich Eaton	U.S.	1970
Dopaidan	De Angeli	Italy	1970
Larodopa	Roche	W. Germany	1970
Larodopa	Roche	U.K.	1970
Larodopa	Roche	France	1970
Larodopa	Roche	Italy	1970
Brocadopa	Brocades	U.K.	1970
Levodopa	SKF	U.S.	1971
Bendopa	I.C.N.	U.S.	1971
Larodopa	Roche	Japan	1972
Biodopa	DDR Pharm	U.S.	—
Ceredopa	Merckle	W. Germany	—
Cidandopa	Cidan	Spain	—
Dehdopa	De Angeli	Brazil	—
Dopacin	I.C.N.	Brazil	—
Dopaflex	Egyt	Hungary	—
Dopaidan	De Angeli	Italy	—
Dopalfher	Fher	Spain	—
Doparkin	Farmos	Finland	—
Doparkine	Armstrong	Argentina	—
Doparl	Kyowa	Japan	—
Dopasol	Daiichi	Japan	—
Dopason	Yurtoglu	Turkey	—
Dopaston	Sankyo	Japan	—
Eldopar	Weifa	Norway	—
Eldopatec	Labatec	Switz.	—
Eurodopa	Castejon	Spain	—
Levopa	Arco	Switz.	—
Maipedopa	Maipe	Spain	—
Medidopa	Medica	Finland	—
Novedopa	Torlan	Spain	—
Parkidopa	Farmos	Finland	—
Parmedin	Kwizda	Austria	—
Prodopa	Faulding	Australia	—
Syndopa	Sankyo	Japan	—
Weldopa	Smith & Nephew	U.K.	—

Raw Materials

Velvet beans
Acetic acid

Manufacturing Process

A charge of 1,000 g of ground velvet beans was extracted with 9 liters of 1% aqueous

acetic acid at room temperature over a 20-hour period with occasional stirring during the first 4 hours. The liquor was decanted and the bean pulp slurry was vacuum filtered through a cake of acid-washed diatomaceous earth in a Buechner funnel. The decanted liquor was combined with the filtrate and concentrated under vacuum and a nitrogen atmosphere to a volume of 900 ml. After treating with acid-washed activated carbon, the concentrate was then filtered through acid-washed diatomaceous earth.

After concentrating the filtrate to approximately 400 ml, solids started crystallizing out at which time the filtrate was cooled by refrigerating at 5°C for several hours. Filtration gave 18.7 g of L-Dopa, MP 284° to 286°C (dec.); $[\alpha]_D$ 8.81° (1% solution in aqueous 4% HCl). The infrared spectrum and paper chromatography indicated very good L-Dopa according to U.S. Patent 3,253,023.

Various synthetic routes are also described by Kleeman & Engel.

References

Merck Index 5298

Kleeman & Engel p. 520

PDR pp. 1210, 1489

DOT 9 (6) 247 (1973) & 10 (9) 317, 332 (1974)

I.N. p. 555

REM p. 930

Wysong, D.V.; U.S. Patent 3,253,023; May 24, 1966; assigned to The Dow Chemical Company

Krieger, K.H., Lago, J. and Wantuck, J.A.; U.S. Patent 3,405,159; October 8, 1968; assigned to Merck & Co., Inc.

LEVOTHYROXINE SODIUM

Therapeutic Function: Thyroid hormone

Chemical Name: L-3,3',5,5'-Tetraiodothyronine sodium salt

Common Name: —

Structural Formula:

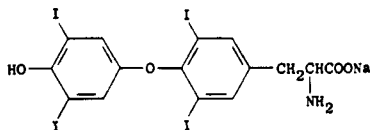

Chemical Abstracts Registry No.: 55-03-8; 51-48-9 (Base)

Trade Name	Manufacturer	Country	Year Introduced
Synthroid	Flint	U.S.	1953
Letter	Armour	U.S.	1965
Eitroxin	Glaxo	U.K.	—
Euthyrox	Merck	W. Germany	—
Eutirox	Bracco	Italy	—
Levaxin	Nyegaard	Norway	—
Levothyrox	Merck-Clevenot	France	—
Levotiron	Abdi Ibrahim	Turkey	—
Ro-Thyroxine	Robinson	U.S.	—

Trade Name	Manufacturer	Country	Year Introduced
Syntaroid	Travenol	U.S.	—
Thevier	Glaxo	W. Germany	—
Thyradin-S	Teikoku Zoki	Japan	—
Thyrplex	Erco	Denmark	—
Thyrex	Sanabo	Austria	—

Raw Materials

N-Acetyl-L-diiiodotyrosinamide	Acetic acid
Manganese sulfate	Hydrochloric acid
Sodium hydroxide	

Manufacturing Process

A 9.30 g portion of N-acetyl-L-diiiodotyrosinamide was suspended in 100 ml of 0.05M boric acid (H_3BO_3) and 100 ml of 95% ethanol, and the solid was dissolved by adjusting the pH to 10.5 with 2 N sodium hydroxide (NaOH). A 15% (by weight) portion of manganese sulfate monohydrate was added and the solution heated at 44°C under conditions of oxygenation while being agitated mechanically. After approximately 24 hours of incubation, the precipitated product was collected and separated from the catalyst, providing the amide of N-acetyl-L-thyroxine in 30.6% yield. On hydrolysis (removal of both amide functions), achieved by refluxing in glacial acetic acid-hydrochloric acid (approximately 2:1), L-thyroxine is obtained. It was isolated as the sodium salt, containing approximately 5 molecules of water of hydration.

References

Merck Index 5303

Kleeman & Engel p. 525

PDR p. 993

OCDs Vol. 1 p. 97 (1977)

I.N. p. 558

REM p. 980

Anthony, P.Z. and Ginger, L.G.; U.S. Patent 2,889,364; June 2, 1959; assigned to Baxter Laboratories, Inc.

LIDOCAINE

Therapeutic Function: Local anesthetic, antiarrhythmic

Chemical Name: 2-(diethylamino)-N-(2,6-dimethylphenyl)acetamide

Common Name: Lignocaine

Structural Formula:

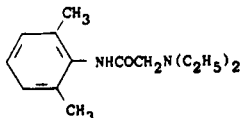

Chemical Abstracts Registry No.: 137-58-6; 73-78-9 (Hydrochloride)

Trade Name	Manufacturer	Country	Year Introduced
Xylocaine	Astra	U.S.	1949
Anestacon	Contal	U.S.	1967

Trade Name	Manufacturer	Country	Year Introduced
Octocaine	Novocol	U.S.	1980
Clinicaine	Johnson & Johnson	U.S.	1982
Anestacain	Farmos	Finland	—
Anestecidan	Cidan	Spain	—
Baylocaine	Bay	U.S.	—
Cidancaina	Cidan	Spain	—
Cito-Optadren	Fischer	Switz.	—
Dolicaine	Reid-Provident	U.S.	—
Dulicaine	Dulcis	Monte Carlo	—
Duncaine	Duncan-Flockhart	U.K.	—
Esracain	Hillel	Israel	—
Leotesin-N	Showa	Japan	—
Lida-Mantal	Dome	U.S.	—
Lidocain	Bristol	U.S.	—
Lidocard	Orion	Finland	—
Lidocaton	Pharmaton	Switz.	—
Lidocor	Gebro	Austria	—
Lido Pen	Survival Tech.	U.S.	—
Lignane	Propan-Lipworth	S. Africa	—
Neo-Novutox	Braun	W. Germany	—
Ortodermina	Tiber	Italy	—
Qualigens	Qualipharma	Switz.	—
Rapidocaine	Sintetica	Switz.	—
Sedodent	Belupo	Yugoslavia	—
Xylanaest	Gebro	Austria	—
Xylesin	Amino	Switz.	—
Xylestesin	Espe	W. Germany	—
Xylocard	Hassle	Sweden	—
Xylocitin	Jenapharm	E. Germany	—
Xyloneural	Gebro	Austria	—
Xylonor	Septodont	France	—
Xylotox	Willows-Francis	U.K.	—

Raw Materials

2,6-Xylidine
 Chloroacetyl chloride
 Diethylamine

Manufacturing Process

One mol of 2,6-xylidine is dissolved in 800 ml glacial acetic acid. The mixture is cooled to 10°C, after which 1.1 mol chloroacetyl chloride is added at one time. The mixture is stirred vigorously during a few moments after which 1,000 ml half-saturated sodium acetate solution, or other buffering or alkalizing substance, is added at one time. The reaction mixture is shaken during half an hour. The precipitate formed which consists of ω -chloro-2,6-dimethyl-acetanilide is filtered off, washed with water and dried. The product is sufficiently pure for further treatment. The yield amounts to 70 to 80% of the theoretical amount.

One mole of the chloroacetyl xylidide thus prepared and 2.5 to 3 mols diethyl amine are dissolved in 1,000 ml dry benzene. The mixture is refluxed for 4 to 5 hours. The separated diethyl amine hydrochloride is filtered off. The benzene solution is shaken out two times with 3 N hydrochloric acid, the first time with 800 ml and the second time with 400 ml acid. To the combined acid extracts is added an approximately 30% solution of sodium hydroxide until the precipitate does not increase.

The precipitate, which sometimes is an oil, is taken up in ether. The ether solution is dried with anhydrous potassium carbonate after which the ether is driven off. The remain-

ing crude substance is purified by vacuum distillation. During the distillation practically the entire quantity of the substance is carried over within a temperature interval of 1° to 2°C. The yield approaches the theoretical amount, MP 68° to 69°C. BP 180° to 182°C at 4 mm Hg; 159° to 160°C at 2 mm Hg. (Procedure is from U.S. Patent 2,441,498.)

References

Merck Index 5310

DFU 8 (12) 1021 (1983)

Kleeman & Engel p. 526

PDR pp. 607, 888, 1569

OCDS Vol. 1 p. 16 (1977); 2, 95, 449 (1980) & 3, 40 (1984)

I.N. p. 559

REM p. 1051

Löfgren, N.M. and Lundqvist, B.J.; U.S. Patent 2,441,498; May 11, 1948; assigned to AB Astra, Sweden

Brown, C.L.M. and Poole, A.; U.S. Patent 2,797,241; June 25, 1957

LIDOFLAZINE

Therapeutic Function: Vasodilator (coronary)

Chemical Name: 4-[4,4-Bis(4-fluorophenyl)butyl]-N-(2,6-dimethylphenyl)-1-piperazine-acetamide

Common Name: —

Structural Formula:

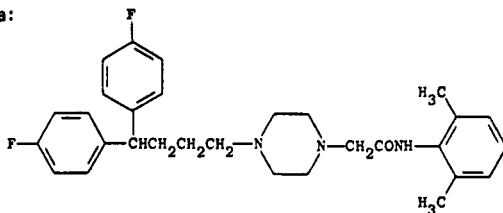

Chemical Abstracts Registry No.: 3416-26-0

Trade Name	Manufacturer	Country	Year Introduced
Clinium	Janssen	W. Germany	1969
Corflazine	Cassenne	France	1972
Clinium	Janssen	Italy	1974
Clinium	Janssen	U.K.	1980
Anginin	Yurtoglu	Turkey	—
Clavidene	Corvi	Italy	—
Clinium	McNeil	U.S.	—
Klinium	Esteve	Spain	—
KIintab	Eczacibasi	Turkey	—

Raw Materials

1-[4,4-Di-4-fluorophenyl]butyl] piperazine
N-(2-Chloroacetyl)-2,6-dimethylaniline

Manufacturing Process

A mixture of 6.6 parts 1-[4,4-di-(4-fluoro-phenyl)butyl]-piperazine, 4.33 parts N-(2-chloroacetyl)-2,6-dimethyl-aniline, 3.2 parts sodium carbonate, a few crystals of potassium iodide in 200 parts 4-methyl-2-pentanone is stirred and refluxed for 70 hours. After cooling there are added 70 parts water. The organic layer is separated, dried over potassium carbonate, filtered and evaporated. The oily residue is dissolved in 80 parts diisopropyl-ether and the solution is filtered hot. After cooling the filtrate at 0°C, the formed solid is filtered off and recrystallized from 80 parts ether, yielding 1-[4,4-di-(4-fluoro-phenyl)butyl]-4-[(2,6-dimethyl-anilino-carbonyl)-methyl]-piperazine; MP 159°C to 161°C.

References

Merck Index 5311

Kleeman & Engel p. 526

OCDS Vol. 1 p. 279 (1977)

DOT 2 (4) 118 (1966) & 6 (1) 21 (1970)

I.N. p. 560

Hermans, H.K.F. and Schaper, W.K.A.; U.S. Patent 3,267,164; August 16, 1966; assigned to Janssen Pharmaceutica N.V. (Belgium)

LINCOMYCIN

Therapeutic Function: Antibacterial

Chemical Name: Methyl 6,8-dideoxy-6-(1-methyl-4-propyl-2-pyrrolidinecarboxamido)-1-thio-D-erythro-D-galacto-octopyranoside

Common Name: Lincolnensin

Structural Formula:

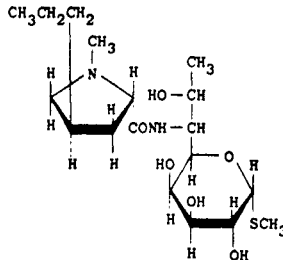

Chemical Abstracts Registry No.: 154-21-2; 859-18-7 (Hydrochloride)

Trade Name	Manufacturer	Country	Year Introduced
Lincocin	Upjohn	U.K.	1964
Lincocin	Upjohn	U.S.	1965
Lincocine	Upjohn	France	1966
Albionic	Upjohn	W. Germany	1966
Lincocin	Upjohn	Italy	1966
Cillimicina	Albert Farma	Spain	—
Cillimycin	Hoechst	W. Germany	—
Lincolcina	Atral	Portugal	—
Mycivin	Boots	U.K.	—

Raw Materials

Bacterium *Streptomyces lincolnensis*
Nutrient medium

Manufacturing Process

As described in U.S. Patent 3,086,912, the process comprises cultivating *Streptomyces lincolnensis* var. *lincolnensis* in an aqueous nutrient medium containing a source of assimilable carbohydrate and assimilable nitrogen under aerobic conditions until substantial activity is imparted to the medium by production of lincolnensin and isolating the lincolnensin so produced.

References

Merck Index 5328

Kleeman & Engel p. 527

PDR p. 1847

DOT 2 (2) 62 (1966)

I.N. p. 561

REM p. 1212

Bergy, M.E., Herr, R.R. and Mason, D.J.; U.S. Patent 3,086,912; April 23, 1963; assigned to The Upjohn Company

Bergy, M.E., Herr, R.R. and Mason, D.J.; U.S. Patent 3,155,580; November 3, 1964; assigned to The Upjohn Company

Argoudelis, A.D., Bannister, B., Hoeksema, H., Kagan, F. and Magerlein, B.J.; U.S. Patent 3,380,992; April 30, 1968; assigned to The Upjohn Company

Jariwala, S.L.; U.S. Patent 4,091,204; May 23, 1978; assigned to The Upjohn Company

LINDANE

Therapeutic Function: Pediculicide; scabicide

Chemical Name: 1 α ,2 α ,3 β ,4 α ,5 α ,6 β -hexachlorocyclohexane

Common Name: gamma-BHC

Structural Formula:

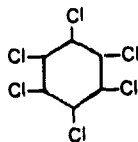

Chemical Abstracts Registry No.: 58-89-9

Trade Name	Manufacturer	Country	Year Introduced
Kwell	Reed Carnrick	U.S.	1952
Gamene	Barnes Hind	U.S.	1975
Escabiol	Stiefel	U.S.	1979
Scabene	Stiefel	U.S.	1981
Bicide	Fischer	Israel	—
Gambex	Continental Ethicals	S. Africa	—
HCH-Salbe	VEB Leipziger Arz.	E. Germany	—
Jacutin	Hermal	W. Germany	—
Malice Shampoo	Restan	S. Africa	—
Quellada	Stafford-Miller	U.K.	—

Raw Materials

Benzene
Chlorine

Manufacturing Process

Chlorine gas was gradually passed into 660 parts of benzene contained in a lead-lined reaction vessel until 890 parts of the gas had been absorbed. The mixture was stirred continuously and the temperature maintained at 15°C to 20°C.

The supply of chlorine was then interrupted and the precipitated solid filtered off and dried. In weight, it was found to be equivalent to 900 parts. The mother liquid was then mixed with 330 parts of benzene and the mixture again treated with 890 parts of chlorine in the manner described.

After filtering the reaction mixture resulting from the second chlorination, the filtrate was again mixed with a smaller quantity of benzene and again chlorinated in a similar manner. In this way, a continuous process for the preparation of benzene hexachloride resulted.

That benzene hexachloride isomer mixture is then the raw material for lindane production. The production of lindane per se is not a chemical synthesis operation but a physical separation process. It is possible to influence the gamma isomer content of benzene hexachloride to an extent during the synthesis process. Basically, however, one is faced with the problem of separating a 99%-plus purity gamma isomer from a crude product containing perhaps 12 to 15% of the gamma isomer. The separation and concentration process is done by a carefully controlled solvent extraction and crystallization process. One such process is described by R.D. Donaldson et al. Another description of hexachlorocyclohexane isomer separation is given by R.H. Kimball.

References

Merck Index 5329

PDR pp. 1444, 1606, 1779

I.N. p. 561

REM pp. 1239, 1253

Donaldson, R.D. et al; U.S. Patent 2,767,223; October 16, 1956; assigned to Allied Chemical and Dye Corp.

Kimball, R.H.; U.S. Patent 2,767,224; October 16, 1956; assigned to Hooker Electrochemical Co.

Hay, J.K. and Webster, K.C.; U.S. Patent 2,502,258; March 28, 1950; assigned to Imperial Chemical Industries, Ltd.

Hardie, T.; U.S. Patent 2,218,148; October 15, 1940; assigned to Imperial Chemical Industries, Ltd.

LIOTHYRONINE

Therapeutic Function: Thyroid replacement therapy

Chemical Name: O-(4-hydroxy-3-iodophenyl)-3,5-diiodo-L-tyrosine

Common Name: 3,5,3'-triiodothyronine; L-3-[4-(4-hydroxy-3-iodophenoxy)-3,5-diiodophenyl]alanine

Structural Formula:

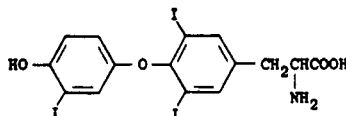

Chemical Abstracts Registry No.: 6893-02-3; 55-06-1 (Sodium Salt)

Trade Name	Manufacturer	Country	Year Introduced
Cytomel	SKF	U.S.	1956
Cynomel	Merrell	France	1961
Cytobin	Norden	U.S.	—
Cytomine	Darby	U.S.	—
Ro-Thyronine	Robinson	U.S.	—
Tertroxin	Glaxo	U.K.	—
Thybon	Hoechst	W. Germany	—
Thyronamin	Takeda	Japan	—
Thyronine	Taisho	Japan	—
Tiromel	Abdi Ibrahim	Turkey	—
Ti-Tre	Glaxo	Italy	—
Trijodthyronin	Nyegaard	Norway	—
Trithyron	Millot	France	—

Raw Materials

L-Diiodothyronine
Iodine

Manufacturing Process

The 3,5-diiodo compound used as a starting material is a known material and may be prepared by the method in British Patents 643,089 and 671,070 and in the *Journal of the Chemical Society*, London, 1949, page 3424.

Synthesis: L-diiodo thyronine (1.05 g) is dissolved in ammonia (specific gravity 0.880) (40 ml) and methanol (40 ml) and iodinated slowly with shaking with N-iodine in KI solution at room temperature. After iodination, most of the ammonia and methanol are removed by evaporation under diminished pressure, water is added to the original volume, the solution is heated to 60°C and brought to pH 4 with hydrochloric acid. A crystalline precipitate is obtained which after cooling to room temperature is collected and washed with water. At this stage, the crude triiodo thyronine is contaminated with thyroxine and a little unchanged diiodo thyronine.

Purification: The crude precipitate is dissolved in boiling 2 N HCl (300 ml) and filtered from the relatively insoluble thyroxine hydrochloride. The hot filtrate is brought to pH 4 with 5 N NaOH and triiodo thyronine again separates; after chilling at 0° to 4°C it is collected, washed with water and dried. The yield of triiodo thyronine is 70 to 75% of the theoretical. This triiodo thyronine still contains some thyroxine (about 10%).

The final purification consists of chromatographic separation of thyroxine and triiodo thyronine on a kieselguhr column using 20% chloroform in n-butanol equilibrated with 0.5 N NaOH as the developing solvent. 80 to 100 mg triiodo thyronine is purified during each run on a 50 g kieselguhr column. Pure L-triiodo thyronine has MP 236° to 237°C (dec.) and $[\alpha]_D^{29.5} = +21.5$ in a 4.75% solution in a mixture of 1 part of N HCl and 2 parts of ethanol. Liothyronine is commonly used as the sodium salt.

References

Merck Index 5337

Kleeman & Engel p. 527

PDR pp. 1606, 1709

OCDS Vol. 1 p. 97 (1977)

I.N. p. 562

REM p. 980

Pitt-Rivers, R. and Gross, J.; U.S. Patent 2,823,164; February 11, 1958; assigned to National Research Development Corporation, England

Platt, J.T. and Wenner, W.; U.S. Patent 2,784,222; March 5, 1957; assigned to Hoffmann-La Roche Inc.

Razdan, R.K. and Wetherill, L.A.; U.S. Patent 2,993,928; July 25, 1961; assigned to Glaxo Laboratories, Ltd.

LOFEXIDINE HYDROCHLORIDE

Therapeutic Function: Antihypertensive

Chemical Name: 2-[1-(2,6-Dichlorophenoxy)ethyl]-2-imidazoline

Common Name: —

Structural Formula:

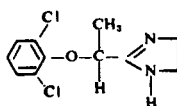

(base)

Chemical Abstracts Registry No.: —

Trade Name	Manufacturer	Country	Year Introduced
Lofetensin	Nattermann	W. Germany	1981

Raw Materials

α -2,6-Dichlorophenoxypropionitrile	Ethanol
Hydrogen chloride	Ethylenediamine

Manufacturing Process

10.4 ml of absolute ethanol are added to 57.5 g of α -2,6-dichlorophenoxypropionitrile, followed by the introduction of 100 ml of chloroform dried over phosphorus pentoxide; 10.4 g of carefully dried hydrogen chloride being slowly introduced with stirring and cooling with ice/common salt. Most of the chloroform and excess hydrogen chloride is then removed by filtration in vacuo at room temperature, and dry ether added to the residue until the imido acid ester hydrochloride is quantitatively precipitated. The α -dichlorophenoxypropionimido acid ethyl ester hydrochloride can be obtained analytically pure in the form of white, strongly hygroscopic crystals by repeated dissolution in a little absolute ethanol in the absence of heat, and precipitation with ether.

The crude α -(2,6-dichlorophenoxy)propionamido acid ethyl ester hydrochloride is added in portions to a stirred, ice-cooled solution of 29.5 g of anhydrous ethylenediamine in 200 ml of absolute ethanol in such a way that the temperature does not exceed 0°C to 5°C. The cooling bath is then removed and the reaction mixture heated for 1 hour on a water bath to approximately 70°C.

After cooling, unreacted ethylenediamine is neutralized in a cooling mixture with the absolute ethanolic hydrochloric acid, filtered off from any components that are insoluble in ethanol and approximately two-thirds of the solvent filtered off under suction in a water jet pump vacuum. Residual quantities of ethylenediamine dihydrochloride are precipitated in fractions by the careful addition of ethyl methyl ketone, after which the imidazoline hydrochloride is separated off by the addition of dry ether. Following repeated recrystallization from ethanol ether, 2-[α -(2,6-dichlorophenoxy)ethyl]- Δ^2 -imidazoline hydrochloride is obtained in the form of small white crystals melting at 221°C to 223°C.

References

Merck Index 5388

DFU 3 (8) 592 (1978)

DOT 19 (9) 496 (1983)

I.N. p. 566

Baganz, H. and May, H.J.; U.S. Patent 3,966,757; June 29, 1976; assigned to A. Natterman and Cie GmbH

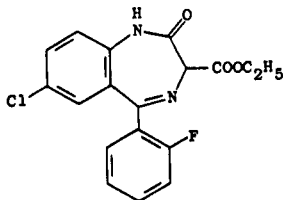
LOFLAZEPATE ETHYL**Therapeutic Function:** Minor tranquilizer**Chemical Name:** 7-Chloro-5-(2-fluorophenyl)-2,3-dihydro-2-oxo-1H-1,4-benzodiazepine-3-carboxylic acid ethyl ester**Common Name:** —**Structural Formula:****Chemical Abstracts Registry No.:** —

Trade Name	Manufacturer	Country	Year Introduced
Victan	Clin Midy	France	1982

Raw Materials

2-Methylimidazole HCl

2-Amino-5-chloro-2'-fluoro-benzophenone

Ethyl aminomalonate hydrochloride

Manufacturing Process

(A) 1-(2-Amino-5-chlorophenyl)-1-(2-fluorophenyl)-2-aza-but-1-en-4-ol: A mixture of 40 g of 2-methylimidazole hydrochloride and of 90 g of 2-amino-5-chloro-2'-fluoro-benzophenone in 240 ml of ethanolamine is heated at 135°C for 2 hours. After cooling, the reaction mixture is poured into an aqueous sodium bicarbonate solution. The mixture is extracted with ether, the organic phase is washed repeatedly with water and is dried over sodium sulfate, and the solvent is evaporated to dryness. The residual oil is chromatographed on a silica column, elution being carried out with a 50/50 mixture of cyclohexane and ethyl acetate.

88 g of the expected amine are thus isolated. Melting point: 105°C to 110°C.

(B) 1-(2-Amino-5-chlorophenyl)-1-(2-fluorophenyl)-3,3-bis-(ethoxycarbonyl)-2-aza-prop-1-ene: A mixture of 88 g of the product obtained above, 300 g of ethyl aminomalonate hydrochloride and 60 ml of acetic acid in 2.3 liters of absolute ethanol is heated to the reflux temperature for 6 hours. The alcohol and the acetic acid are evaporated in vacuo and the residue is taken up in ether. The solution is washed with a dilute sodium bicarbonate solution and

then with water and is dried over sodium sulfate. The solvent is evaporated and the residue is then chromatographed on a silica column, using a 90/10 mixture of chloroform and ethyl acetate for the elution. An oil (64 g) is thus obtained, and is used, without further treatment, for the cyclization.

A sample recrystallized from isopropyl ether has a melting point of 119°C.

(C) *Compound of Code No. CM 6912*: 25 g of the imine obtained under (B), dissolved in 400 ml of acetic acid, are heated at the reflux temperature for 1 hour. After evaporating the solvent in vacuo, the residue is taken up in methylene chloride. The solution is washed with a dilute sodium bicarbonate solution and then with water. After evaporating the solvent, the residue is chromatographed on silica, elution being carried out with an 80/20 mixture of ether and ethyl acetate. 9 g of benzodiazepine are thus obtained. Melting point: 196°C.

References

Merck Index 3766

DFU 6 (12) 772 (1981)

DOT 19 (1) 24 (1983)

I.N. p. 566

Demarne, H. and Hallot, A.; British Patent 1,538,165; January 17, 1979; assigned to C.M. Industries (France)

LONAZOLAC

Therapeutic Function: Antiinflammatory

Chemical Name: 3-(4-Chlorophenyl)-1-phenyl-1H-pyrazole-4-acetic acid

Common Name: —

Structural Formula:

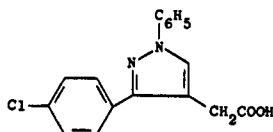

Chemical Abstracts Registry No.: 53808-88-1

Trade Name	Manufacturer	Country	Year Introduced
Irriten	Tosse	W. Germany	1981
Irritren	Byk Gulden	Switz.	1982

Raw Materials

1-Phenyl-3-(p-chlorophenyl)-pyrazol-4-acetonitrile
Hydrogen chloride

Manufacturing Process

17.6 g 1-phenyl-3-(p-chlorophenyl)-pyrazol-4-acetonitrile and 180 ml 25% aqueous hydrochloric acid were mixed and heated to the boiling temperature under reflux for 6 hours. To the mixture was then added dropwise concentrated aqueous sodium hydroxide until the pH of the mixture reached a value in the range from 3 to 5. The free pyrazol-4-acetic acid pre-

precipitated thereby was filtered off, redissolved in dilute aqueous sodium hydroxide, the solution cleared by treatment with activated carbon, and the pyrazol-4-acetic acid precipitated by acidifying the solution by the addition of dilute mineral acid, sulfuric acid. The filtered acid was crystallized from a mixture of ethanol and water. 17.1 g 1-phenyl-3-(p-chlorophenyl)-pyrazol-4-acetic acid, melting at 148°C to 150°C, were obtained, representing a yield of 91%.

References

Merck Index 5392

DFU 7 (2) 110 (1982)

DOT 18 (4) 184 (1982)

I.N. p. 567

Rainer, G.; U.S. Patent 4,146,721; March 27, 1979; assigned to Byk Gulden Lomberg Chemische Fabrik G.m.b.H. (W. Germany)

LOPERAMIDE HYDROCHLORIDE

Therapeutic Function: Antidiarrheal

Chemical Name: 4-(4-chlorophenyl)-4-hydroxy-N,N-dimethyl- α,α -diphenyl-1-piperidine-butanamide hydrochloride

Common Name: —

Structural Formula:

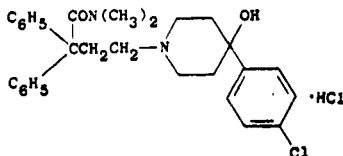

Chemical Abstracts Registry No.: 34552-83-5; 53179-11-6 (Base)

Trade Name	Manufacturer	Country	Year Introduced
Imodium	Janssen	U.K.	1975
Imodium	Janssen-Le Brun	France	1976
Imodium	Janssen	W. Germany	1976
Imodium	Ortho	U.S.	1977
Dissenten	S.P.A.	Italy	1978
Imodium	Janssen	Italy	1979
Lopemid	Gentili	Italy	1979
Imodium	Janssen	Switz.	1981
Imodium	Dainippon	Japan	—
Blox	Biomedica Foscama	Italy	—
Brek	Irbi	Italy	—
Fortasec	Esteve	Spain	—
Lopermid	Drifen	Turkey	—
Loperyl	Zambeletti	Italy	—
Regulane	Finadiet	Argentina	—
Seldiar	Krka	Yugoslavia	—
Tebloc	Dukron	Italy	—

Raw Materials

2-Oxo-3,3-diphenyl-tetrahydrofuran

Hydrogen bromide

Thionyl chloride
4-(p-Chlorophenyl)-4-piperidinol

Dimethyl amine
Hydrogen chloride

Manufacturing Process

23.6 parts of 2-oxo-3,3-diphenyl-tetrahydrofuran are melted at 100°C in an oil-bath and gaseous hydrogen bromide is introduced into it during 3 hours. The reaction mixture is cooled and triturated in benzene. The product is filtered off, washed with petroleum ether and dried in an exsiccator, yielding 4-bromo-2,2-diphenylbutyric acid; MP 127.5°C.

To a stirred suspension of 16 parts of 4-bromo-2,2-diphenylbutyric acid in 150 parts of chloroform are added dropwise 16 parts of thionyl chloride and the whole is stirred and refluxed for 2 hours. The reaction mixture is evaporated, yielding 4-bromo-2,2-diphenylbutyrylchloride as a residue.

60 parts of 4-bromo-2,2-diphenylbutyrylchloride are dissolved in 400 parts of toluene and gaseous dimethylamine is introduced slowly into the solution while cooling (temperature is kept at about 0°C). The introduction is ceased when dimethylamine escapes from the cooler, and stirring is continued for 2 hours at ordinary temperature. The precipitated product is filtered off and dissolved in a minimum quantity of water. The product is extracted with chloroform. The extract is dried and evaporated. The residue solidifies on triturating in 4-methyl-2-pentanone. The solid is filtered off and dried, yielding dimethyl (tetrahydro-3,3-diphenyl-2-furylidene)ammonium bromide; MP 169° to 171.5°C.

A mixture of 6.33 parts of 4-(p-chlorophenyl)-4-piperidinol, 8 parts of sodium carbonate, 0.2 part of potassium iodide and 240 parts of 4-methyl-2-pentanone is distilled azeotropically. Then there are added 12.12 parts of dimethyl-(tetrahydro-3,3-diphenyl-2-furylidene)ammonium bromide (from the preceding step) and the whole is stirred and refluxed for about 15 hours. The reaction mixture is filtered hot and the filtrate is evaporated.

The oily residue is dissolved in 2-propanol and to this solution is added an excess of 2-propanol previously saturated with gaseous hydrogen chloride. The whole is evaporated and the oily residue is warmed in diluted hydrochloric acid solution. Upon the addition of toluene, the salt is precipitated. It is filtered off, boiled in acetone, and filtered off again after cooling, yielding 4-(p-chlorophenyl)-4-hydroxy-N,N-dimethyl- α,α -diphenylpiperidine-1-butyramide hydrochloride; MP 222.1°C.

References

Merck Index 5396

Kleeman & Engel p. 530

PDR p. 953

OCDs Vol. 2 p. 334 (1980)

DOT 10 (6) 220 (1974)

I.N. p. 567

REM p. 814

Janssen, P.A.J., Niemegeers, C.J.E.J., Stokbroekx, R.A. and Vandenberg, J.; U.S. Patent 3,714,159; January 30, 1973; and U.S. Patent 3,884,916; May 20, 1975; both assigned to Janssen Pharmaceutica, NV, Belgium

LOPRAZOLAM

Therapeutic Function: Tranquilizer

Chemical Name: 8-Nitro-1,2-dihydro-2-(N-methyl-piperazin-1-yl)methylene-6-(o-chlorophenyl)-1H,4H-imidazo-[1,2-a] [1,4]-benzodiazepin-1-one methanesulfonate

Common Name: —

Structural Formula:

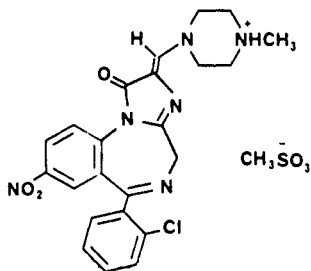

Chemical Abstracts Registry No.: 61197-93-1

Trade Name	Manufacturer	Country	Year Introduced
Avlane	J.A.S.M.	France	1981
Dormonox	Roussel	U.K.	1983

Raw Materials

8-Nitro-1,2-dihydro-2-(N-methylpiperazin-1-yl)methylene-6-(o-chlorophenyl)-1H,4H-imidazo[1,2-a][1,4]-benzodiazepin-1-one
Methane sulfonic acid

Manufacturing Process

1.1 g of methanesulfonic acid were added dropwise to a mixture of 4.6 g of 8-nitro-1,2-dihydro-2-(N-methylpiperazin-1-yl)methylene-6-(o-chlorophenyl)-1H,4H-imidazo-[1,2-a][1,4]-benzodiazepin-1-one in 100 ml of anhydrous methylene chloride and 5 ml of methanol. Dry ether was slowly added until crystals formed on scratching and the solution was allowed to crystallize with further ether being added to complete the crystallization. The pale yellow solid was filtered off, washed with ether and crystallized from methylene chloride-methanol to obtain 5.4 g of 8-nitro-1,2-dihydro-2-(N-methylpiperazin-1-yl)methylene-6-(o-chlorophenyl)-1H,4H-imidazo-[1,2-a][1,4]-benzodiazepin-1-one methanesulfonate melting at 205°C to 210°C.

References

Merck Index 5399

DFU 5 (3) 144 (1980) (As Ru-31,158) & 5 (12) 635 (1980)

Taylor, F.B. and Harrison, D.R.; U.S. Patent 4,044,142; August 23, 1977; assigned to Roussel Uclaf.

LORAZEPAM

Therapeutic Function: Tranquilizer

Chemical Name: 7-chloro-5-(o-chlorophenyl)-1,3-dihydro-3-hydroxy-2H-1,4-benzodiazepin-2-one

Common Name: —

Structural Formula:

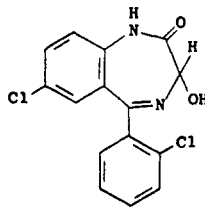

Chemical Abstracts Registry No.: 846-49-1

Trade Name	Manufacturer	Country	Year Introduced
Tavor	Wyeth	Italy	1972
Tavor	Wyeth	W. Germany	1972
Ativan	Wyeth	U.K.	1973
Temesta	Wyeth-Byla	France	1973
Ativan	Wyeth	U.S.	1977
Wypax	Wellcome	Japan	1978
Bonton	Unipharm	Israel	—
Control	Sigurta	Italy	—
Emotion	Alpes	Argentina	—
Emotival	Armstrong	Argentina	—
Idalprem	Prem	Spain	—
Lorans	Schiapparelli	Italy	—
Lorivan	Disco	Israel	—
Lorsilan	Belupo	Yugoslavia	—
Orfidal	Orfi	Spain	—
Piralone	Ferrer	Spain	—
Placidia	Fedal	Spain	—
Pro Dorm	Schurholz	W. Germany	—
Quait	Jamco	Italy	—
Securit	Marxer	Italy	—
Sedarkey	Cuatrecasas-Darkey	Spain	—
Sedatival	Raffo	Argentina	—
Sedicepan	Septa	Spain	—
Sidenar	Syncro	Argentina	—

Raw Materials

2-Amino-2',5-dichlorobenzophenone	Hydroxylamine
Chloroacetylchloride	Methyl amine
Acetic anhydride	Sodium hydroxide

Manufacturing Process

The starting material was 2-amino-2',5-dichlorobenzophenone which was reacted with hydroxylamine and then with chloroacetylchloride. The intermediate thus obtained is reacted with methylamine and then with acetic anhydride.

To a slightly warm suspension of 3-acetoxy-7-chloro-5-(o-chlorophenyl)-1,3-dihydro-2H-1,4-benzodiazepin-2-one thus obtained was added 4N sodium hydroxide solution with stirring. All the solid dissolved and soon a thick white solid precipitated out. The solid was filtered, washed well with water and recrystallized from ethanol. The product was isolated as a solvate with 1 mol of ethanol. When heated it loses the ethanol of solvation and melts at 166°C to 168°C.

References

Merck Index 5400

Kleeman & Engel p. 530

PDR p. 1938

OCDS Vol. 1 p. 368 (1977)

DOT 7 (6) 210 (1971) & 9 (6) 238 (1973)

I.N. p. 568

REM p. 1063

Bell, S.C. British Patent 1,057,492; February 1, 1967; assigned to American Home Products Corporation

Bell, S.C. U.S. Patent 3,176,009; March 30, 1965; assigned to American Home Products Corp.

Bell, S.C.; U.S. Patent 3,296,249; January 3, 1967; assigned to American Home Products Corp.

LORCAINIDE HYDROCHLORIDE

Therapeutic Function: Antiarrhythmic

Chemical Name: N-(p-Chlorophenyl)-N-(1-isopropylpiperidin-4-yl)phenylacetamide hydrochloride

Common Name: Isocainide hydrochloride; socialide hydrochloride

Structural Formula:

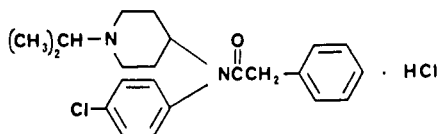

Chemical Abstracts Registry no.: 59729-31-6 (Base)

Trade Name	Manufacturer	Country	Year Introduced
Remivox	Janssen	W. Germany	1980

Raw Materials

N-(4-Chlorophenyl)-N-(piperidinyl)benzeneacetamide
2-Bromopropane
Hydrogen chloride

Manufacturing Process

To a stirred suspension of 5 parts of N-(4-chlorophenyl)-N-(4-piperidinyl)benzeneacetamide, 5 parts of sodium carbonate, a few crystals of potassium iodide in 200 parts of butanol is added dropwise 4 parts of 2-bromopropane at room temperature. After the addition is complete, the whole is stirred and refluxed for 20 hours. Then the second portion of 4 parts of 2-bromopropane is added and stirring and refluxing is continued for another 19 hours. The reaction mixture is cooled, filtered and the filtrate is evaporated. From the oily free base, the hydrochloride salt is prepared in the conventional manner in 1,1'-oxybisethane and 2-propanone. The precipitated solid salt is filtered off and crystallized from a mixture of 2-propanone and 2-propanol, yielding 2 parts of N-(4-chlorophenyl)-N-[1-(1-methylethyl)-4-piperidinyl] benzeneacetamide hydrochloride; melting point 263°C.

References

Merck Index 5401

DFU 3 (7) 518 (1978)
 OCDS Vol. 3 p. 40 (1984)
 DOT 18 (1) 17 & (10) 548 (1982)
 I.N. p. 568

Sanczuk, S. and Hermans, H.K.F.; U.S. Patent 4,196,210; April 1, 1980; assigned to Janssen Pharmaceutica NV

LORMETAZEPAM

Therapeutic Function: Hypnotic

Chemical Name: 7-Chloro-5-(o-chlorophenyl)-1,3-dihydro-3-hydroxy-1-methyl-2H-1,4-benzodiazepin-2-one

Common Name: N-Methyllorazepam

Structural Formula:

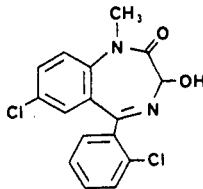

Chemical Abstracts Registry No.: 848-75-9

Trade Name	Manufacturer	Country	Year Introduced
Loramet	Wyeth	W. Germany	1980
Noctamid	Schering	W. Germany	1980
Loramet	Wyeth	Switz.	1981
Noctamid	Schering	U.K.	1981
Noctamid	Schering	France	1981
Loramet	Wyeth	U.K.	1983
Loramid	Wyeth	W. Germany	—
Minias	Farmades	Italy	—
Pronoctan	Schering	—	—

Raw Materials

3-Acetoxy-7-chloro-1,3-dihydro-5-(o-chlorophenyl)-2H-1,4-benzodiazepin-2-one
 Sodium hydroxide

Manufacturing Process

To a suspension of 3.4 g of 3-acetoxy-7-chloro-1,3-dihydro-5-(o-chlorophenyl)-2H-1,4-benzodiazepin-2-one in 80 ml of alcohol was added 6 ml of 4N sodium hydroxide. After complete solution had taken place a solid precipitated that redissolved upon the addition of 80 ml of water. The solution was acidified with acetic acid to give white crystals. After recrystallization from alcohol the compound melted at 192°C to 194°C.

References

Merck Index 5403
 DFU 5 (10) 495 (1980)

Kleeman & Engel p. 531
 OCDS Vol. 3 p. 196 (1984)
 DOT 17 (4) 137 (1981)

I.N. p. 569

American Home Products Co.; British Patent 1,022,642; March 16, 1966

LOXAPINE

Therapeutic Function: Tranquilizer

Chemical Name: 2-chloro-11-(4-methyl-1-piperaziny)-dibenz[b,f] [1,4] oxazepine

Common Name: Oxilapine

Structural Formula:

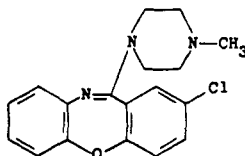

Chemical Abstracts Registry No.: 1977-10-2

Trade Name	Manufacturer	Country	Year Introduced
Loxitane	Lederle	U.S.	1976
Loxapac	Lederle	France	1980
Loxapac	Cyanamid	Italy	1981
Daxolin	Dome	U.S.	—

Raw Materials

o-(p-Chlorophenoxy)aniline	Ethyl chloroformate
1-Methylpiperazine	Phosphorus oxychloride

Manufacturing Process

One route is described in U.S. Patent 3,412,193 as follows. To a mixture of o-(p-chlorophenoxy)aniline hydrochloride (prepared from 32 g of the base) in 50 ml of pyridine is added gradually while heating under reflux, 25 ml of ethyl chloroformate. After the addition is completed, the mixture is heated under reflux for one hour longer, and then evaporated under reduced pressure to an oily residue. The residue is taken up in 300 ml of water, and extracted with ether (approximately 200 ml).

The ether extract is separated, dried over sodium sulfate, and evaporated to an oily residue (40 g) which contains ethyl o-(p-chlorophenoxy)carbanilate and is used without further purification. The crude ethyl o-(p-chlorophenoxy)carbanilate is dissolved in 20 ml of benzene, and 20 ml of 1-methylpiperazine and a small amount of sodium methylate (approximately 25 to 50 mg) are added. Benzene is then removed by slow distillation; and the mixture is heated overnight under reflux (approximately 16 hours).

Evaporation under reduced pressure then gives a solid residue which is dissolved in 400 ml of ether with heating. Concentration to half-volume under reduced pressure produces a precipitate which is collected, washed with petroleum ether and dried (36 g). A second crop

of product is isolated from the filtrate. This product is dissolved in 200 ml of chloroform and treated with an excess of anhydrous hydrogen chloride. The resulting precipitate is collected and dried at 50°C (in vacuo), and 4-methyl-2'-(p-chlorophenoxy)-1-piperazinecarboxanilide hydrochloride, MP 210° to 213°C, is thereby obtained.

A mixture of 4-methyl-2'-(p-chlorophenoxy)-1-piperazinecarboxanilide hydrochloride (6 g), 50 ml of phosphorus oxychloride and 10 g of phosphorus pentoxide is heated under reflux for about 24 hours, and then concentrated to a gummy residue by evaporation under reduced pressure. This residue is taken up in 150 ml of ether, 200 g of ice is added, and the mixture is made basic with concentrated aqueous ammonium hydroxide. The ether layer is separated, dried over potassium hydroxide pellets and evaporated to a solid residue (approximately 4 g).

This crude product is dissolved in 100 ml of dilute hydrochloric acid, the acid solution is extracted with ether, and the aqueous layer is made basic with sodium hydroxide solution (3 N) in the presence of ether (approximately 250 ml). The ether layer is separated, dried over potassium hydroxide and evaporated to a white solid. Additional purification by repeating the formation of the hydrochloric acid salt and reprecipitation of the base is carried out. When purified in this manner, followed by drying at 80°C in vacuo over phosphorus pentoxide, 2-chloro-11-(4-methyl-1-piperazinyl)dibenz[b,f] [1,4] oxazepine, MP 109° to 111°C, is obtained.

References

Merck Index 5404

Kleeman & Engel p. 532

PDR p. 1012

OCDS Vol. 2 p. 427 (1980)

DOT 14 (6) 248 (1978)

I.N. p. 569

REM p. 1089

Coppola, J.A.; U.S. Patent 3,412,193; November 19, 1968; assigned to American Cyanamid Company

Schmutz, J., Hunziker, F. and Künzle, F.M.; U.S. Patent 3,546,226; December 8, 1970

M

MAFENIDE ACETATE

Therapeutic Function: Antibacterial

Chemical Name: α -Acetylamino-p-toluenesulfonamide

Common Name: —

Structural Formula:

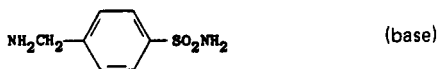

Chemical Abstracts Registry No.: 13009-99-9; 138-39-6 (Base)

Trade Name	Manufacturer	Country	Year Introduced
Sulfamylon	Winthrop	U.S.	1949
Napaltan	Winthrop	W. Germany	1969
Sulfamylon	Winthrop	U.K.	1970
Mafatate	Torii	Japan	1980
Mafylon	Winthrop	—	—

Raw Materials

Acetylbenzylamine
Chlorosulfonic acid
Ammonia

Manufacturing Process

For the preparation of mafenide 50 g of acetylbenzylamine are introduced while stirring into 150 cc of chlorosulfonic acid, whereby the temperature is kept below 40°C by external cooling. After several hours' storing at ordinary temperature the mixture is heated for 1 hour in the boiling water-bath and after cooling, poured on to ice. Thereupon the 4-acetylaminoethyl-benzenesulfonic acid chloride precipitates at first in an oily form, but solidifies after short stirring to crystals. The product sucked off and washed with cold water is introduced into a 10% aqueous ammonia solution. Thereby dissolution takes place while heating and after a short time the 4-acetylaminoethyl-benzenesulfonic acid amide precipitates in a crystalline form. After heating to 70°C for 30 minutes the solution is cooled, filtered with suction and washed out. The product is obtained when recrystallized from water or dilute alcohol in colorless crystals melting at 177°C. It is readily soluble in warm water, extremely readily soluble in dilute sodium hydroxide solution.

References

Merck Index 5466
Kleeman & Engel p. 534
PDR p. 1929
OCDS Vol. 2 p. 114 (1980)

DOT 5 (4) 132 (1969)

I.N. p. 574

REM p. 1162

Klarer, J.; U.S. Patent 2,288,531; June 30, 1942; assigned to Winthrop Chemical Co., Inc.

MAGALDRATE

Therapeutic Function: Antacid

Chemical Name: Tetrakis(hydroxymagnesium)decahydroxydialuminate dihydrate

Common Name: Magnesium aluminate hydrate; monalium hydrate

Structural Formula: $[\text{Mg}(\text{OH})]_4\{(\text{HO})_4\text{Al}(\text{OH})(\text{HO})\text{Al}(\text{OH})_4\} \cdot 2\text{H}_2\text{O}$

Chemical Abstracts Registry No.: 1317-26-6

Trade Name	Manufacturer	Country	Year Introduced
Riopan	Ayerst	U.S.	1960
Riopan	Byk Gulden	W. Germany	1981
Dynese	Galen	U.K.	1983
Bismag-Lac	Much	W. Germany	—

Raw Materials

Aluminum chloride

Sodium hydroxide

Magnesium sulfate

Manufacturing Process

1 kg aluminum chloride hydrate was dissolved in 2 kg water and reacted with a solution of 1.2 kg sodium hydroxide in 2.5 kg water, under constant stirring. The resultant sodium aluminate solution was cooled to about 20°C and, with thorough stirring, it was reacted with 3.5 kg of a magnesium sulfate solution produced by dissolving 1 kg of magnesium sulfate anhydride in 2.5 kg water. The magnesium sulfate solution was introduced in a plurality of thin jets through several shower heads to avoid localized differences of concentration as much as possible. After all the magnesium sulfate was added, stirring was continued for about ½ hour.

A colorless, colloidal precipitate was formed and stirred thoroughly for about 15 minutes, whereupon it was filtered by suction. The raw product thus obtained was washed with water until it contained only about ½% water-soluble salts. After drying for 12 hours in a vacuum apparatus at 60°C and under a pressure of 12 mm Hg, the product had the form of hard pieces. The pieces were comminuted to powder in a ball mill and the powder was passed through a sieve (3,600 meshes per cm²). The small residue on the sieve was again pulverized and passed through the same sieve. The yield was 870 g, or 99% of theoretical, calculated on the assumed formula



with a molecular weight of 425.

References

Merck Index 5467

PDR p. 650

I.N. p. 574

REM p. 795

Hallmann, G.; U.S. Patent 2,923,660; February 2, 1960; assigned to Byk-Gulden Lomberg
Chemische Fabrik GmbH, Germany

MALATHION

Therapeutic Function: Pediculicide

Chemical Name: Diethyl(dimethoxyphosphinothioyl)thiobutanedioate

Common Name: Mercaptothion (South Africa), maldison (Australia and New Zealand),
carbofos (U.S.S.R.)

Structural Formula:

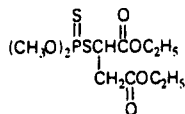

Chemical Abstracts Registry No.: 121-75-5

Trade Name	Manufacturer	Country	Year Introduced
Prioderm	Purdue Fredrick	U.S.	1982
Organoderm	Mundipharma	W. Germany	1982
Derbac	Benque	U.K.	—
Lusap	Interdelta	Switz.	—
Taskil	Tasman Vaccine	U.K.	—

Raw Materials

O,O-Dimethyl phosphorodithioic acid
Diethyl maleate

Manufacturing Process

The feed materials for malathion manufacture are O,O-dimethyl phosphorodithioic acid and diethyl maleate or fumarate which react according to the equation:

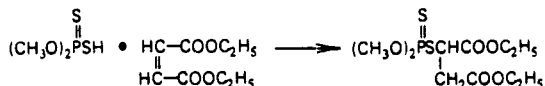

An antipolymerization agent such as hydroquinone may be added to the reaction mixture to inhibit the polymerization of the maleate or fumarate compound under the reaction conditions. This reaction is preferably carried out at a temperature within the range of 20°C to 150°C. This reaction is preferably carried out at atmospheric pressure. Reaction time of 16 to 24 hours have been specified for this reaction by J.T. Cassaday. The reaction is preferably carried out in a solvent such as the low molecular weight aliphatic monohydric alcohols, ketones, aliphatic esters, aromatic hydrocarbons or trialkyl phosphates.

The reaction may be accelerated by using an aliphatic tertiary amine catalyst, usually within the range of 0.2 to 2.0% based on the total weight of the reactants. A stirred, jacketed re-

actor of conventional design may be used. After cooling, the reaction mixture may be taken up in benzene. It is then washed with 10% Na_2CO_3 and with water. The organic layer is dried over anhydrous Na_2SO_4 , filtered and concentrated in vacuo to give the final product as residue.

References

Merck Index 5522

I.N. p. 575

REM p. 1240

Cassaday, J.T.; U.S. Patent 2,578,652; December 18, 1951; assigned to American Cyanamid Co.

Backlund, G.R., Martino, J.F. and Divine, R.D.; U.S. Patent 3,463,841; August 26, 1969; assigned to American Cyanamid Co.

Usui, M.; U.S. Patent 2,962,521; November 29, 1960; assigned to Sumitomo Chemical Co.

MALTOSE

Therapeutic Function: Sugar supplement for diabetics

Chemical Name: 4-O- α -Glucopyranosyl-D-glucose

Common Name: —

Structural Formula:

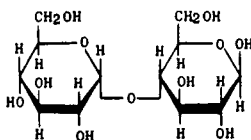

Chemical Abstracts Registry No.: 69-79-4

Trade Name	Manufacturer	Country	Year Introduced
Maltos-10	Otsuka	Japan	1974

Raw Materials

Starch
Water

Manufacturing Process

The process of manufacturing a maltose product from a suitably purified starch source includes preparing an aqueous starchy suspension, adjusting the acidity thereof to from 4.6 to 6.0 pH, liquefying the suspension by heating in the presence of a diastatic agent, diastatically saccharifying the liquefied mixture, filtering, and concentrating the liquid to a syrup.

References

Merck Index 5536

DOT 10 (11) 308 (1974)

REM p. 1029

Gore, H.C.; U.S. Patent 1,657,079; January 24, 1928; assigned to The Fleischmann Co.

MANNITOL

Therapeutic Function: Diuretic; diagnostic aid (kidney function)

Chemical Name: D-mannitol

Common Name: —

Structural Formula:

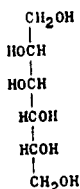

Chemical Abstracts Registry No.: 69-65-8

Trade Name	Manufacturer	Country	Year Introduced
Mannitol	MSD	U.S.	1946
Osmitrol	Travenol	U.S.	1964
Mannitol I.V.	Abbott	U.S.	1968
Eufusol	Knoll	W. Germany	—
Isotol	Baxter	Italy	—
Manit	Pliva	Yugoslavia	—
Mannidex	Pharmacia	Sweden	—
Osmofundin	Braun	W. Germany	—
Osmosol	Farmer Hill	Australia	—
Rectisol	McGaw	U.S.	—

Raw Materials

Glucose
Hydrogen

Manufacturing Process

250 g of glucose is dissolved in distilled water to give a solution of 48% concentration. This solution is heated to 65°C and barium hydroxide added in quantity sufficient to make the concentration of the barium hydroxide 0.2 mol/liter. The solution is agitated and maintained at 65°C for 6 hours after the addition of the barium hydroxide. It is then cooled and neutralized to a pH of 6.8 with sulfuric acid. The precipitated barium sulfate is filtered out. A quantity of activated supported nickel catalyst containing 5 g of nickel is added.

The slurry is introduced into a 3-liter rocking autoclave, and hydrogen admitted to a pressure of 1,500 psi. The autoclave is heated to a temperature of 150°C in one hour and held at this temperature for 2½ hours more. Pressure rises to about 1,800 psi and then declines to about 1,600 during the hydrogenation. The autoclave is then cooled, emptied, and the catalyst filtered from the product. The filtrate is then concentrated under vacuum on a hot water bath to remove a part of the water.

The concentrate is taken up in warm aqueous methanol so adjusted that the composition of the solvent is 90% methanol/10% water, and the weight of the solvent is 3 times the weight of the solids in the concentrate. This solution is cooled to 20°C and held overnight. The mannitol which crystallizes is filtered out. The filtrate is concentrated on a water bath under vacuum to remove methanol and adjusted to a water percentage of 16%. The re-

sulting syrup is viscous, noncrystallizing and nongelling, and analysis shows a PN (Pyridine Number) of 32 and essentially no reducing sugar, according to U.S. Patent 2,749,371.

References

Merck Index 5569

I.N. p. 576

REM p. 935

Kasehagen, L.; U.S. Patent 2,642,462; June 16, 1953; assigned to Atlas Powder Company
Kasehagen, L.; U.S. Patent 2,749,371; June 5, 1956; assigned to Atlas Powder Company
Kasehagen, L. and Luskin, M.M.; U.S. Patent 2,759,024; August 14, 1956; assigned to Atlas Powder Company

MAZATICOL HYDROCHLORIDE

Therapeutic Function: Antiparkinsonian

Chemical Name: 6,6,9-Trimethyl-9-azabicyclo[3.3.1]non-3 β -yl di-(2-thienyl)glycolate hydrochloride

Common Name: —

Structural Formula:

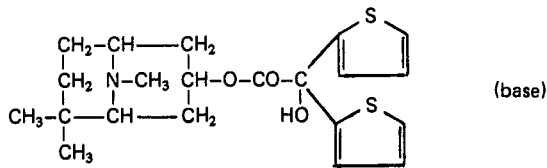

Chemical Abstracts Registry No.: 38738-59-9; 42024-98-6 (Base)

Trade Name	Manufacturer	Country	Year Introduced
Pentona	Tanabe	Japan	1978

Raw Materials

6,6,9-Trimethyl-9-azabicyclo[3.3.1]nonan-3 α -ol
Methyl α,α -di-(2-thienyl)glycolate

Manufacturing Process

A mixture of 1.0 g of 6,6,9-trimethyl-9-azabicyclo[3.3.1]nonan-3 β -ol, methyl α,α -di-(2-thienyl)-glycolate and 30 mg of metallic sodium is heated at 80°C to 90°C for about 2 hours under reduced pressure. After cooling, ether is added to the reaction mixture. The mixture is extracted with 10% hydrochloric acid. The aqueous layer is alkalified with sodium carbonate and reextracted with ethyl acetate. The extract is washed with water, dried and concentrated to dryness. The residue thus obtained is treated with hydrogen chloride by conventional manner. 2.0 g of the α,α -di-(2-thienyl)glycolate of 6,6,9-trimethyl-9-azabicyclo[3.3.1]nonan-3 β -ol hydrochloride are obtained. Yield 83%.

References

Kleeman & Engel p. 535

DOT 13 (2) 72 (1977)

I.N. p. 579

Yoneda, N., Ishihara, T., Kobayashi, T., Kondo, Y., Okumura, K., Kojima, M. and Nose, T.; U.S. Patent 3,673,195; June 27, 1972; assigned to Tanabe Swiyaku Co.

MAZINDOL

Therapeutic Function: Antiobesity

Chemical Name: 5-(4-chlorophenyl)-2,5-dihydro-3H-imidazo[2,1-a]isoindol-5-ol

Common Name: —

Structural Formula:

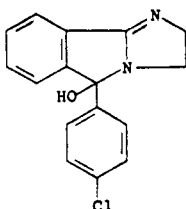

Chemical Abstracts Registry No.: 22232-71-9

Trade Name	Manufacturer	Country	Year Introduced
Sanorex	Sandoz	U.S.	1973
Teronac	Wander	U.K.	1974
Teronac	Wander	W. Germany	1976
Mazildene	Farmochimica	Italy	1979
Mazanor	Wyeth	U.S.	1980
Degonan	Spofa	Czechoslovakia	—
Magrilan	Sintyal	Argentina	—

Raw Materials

3-(p-Chlorophenyl)phthalimidine
 Epichlorohydrin
 Ethyleneimine

Manufacturing Process

Step 1: 1-(p-Chlorophenyl)-3-Ethoxy-1H-Isoindole – Crystalline triethyloxonium boron-tetrafluoride (21 g) (prepared from 23 g of borontrifluoride etherate and 11 g of epichlorohydrin) is dissolved in 100 ml of absolute methylenechloride. 3-(p-Chlorophenyl) phthalimidine (21 g) is added and the reaction mixture is stirred overnight at room temperature. The resulting solution is poured onto 50 ml of saturated sodium carbonate, extracted with 500 ml of ether and dried. Upon evaporation of the solvent there is obtained crude material which is recrystallized from methylene chloride/hexane (1:1) to yield 1-(p-chlorophenyl)-3-ethoxy-1H-isoindole; MP 102° to 103°C.

Step 2: 5-(p-Chlorophenyl)-5-Hydroxy-2,3-Dihydro-5H-Imidazo[2,1-a] Isoindole – 1-(p-Chlorophenyl)-3-ethoxy-1H-isoindole (1 g), 2 g of ethyleneimine hydrotetrafluoroborate moistened with methylene chloride (containing approximately 0.66 g of dry salt) is refluxed in 25 ml of absolute toluene for 2 hours in an atmosphere of nitrogen. The result-

ing mixture is poured into 2 N sodium carbonate solution (25 ml) and extracted with ether. The ether solution is contacted with air for 6 days at room temperature to give the desired product. The crude material is recrystallized from acetone/hexane (1:1) to give 5-(p-chlorophenyl)-5-hydroxy-2,3-dihydro-5H-imidazo[2,1-a]isoindole; MP 198° to 199°C.

References

Merck Index 5585

Kleeman & Engel p. 535

PDR pp. 1595, 1958

OCDS Vol. 2 p. 462 (1980)

DOT 10 (1) 24 (1974)

I.N. p. 579

REM p. 892

Houlihan, W.J. and Eberle, M.K.; U.S. Patent 3,597,445; August 3, 1971; assigned to Sandoz-Wander, Inc.

Sulkowski, T.S.; U.S. Patent 3,763,178; October 2, 1973; assigned to American Home Products Corp.

MEBENDAZOLE

Therapeutic Function: Anthelmintic

Chemical Name: (5-benzoyl-1H-benzimidazol-2-yl)carbamic acid methyl ester

Common Name: Methyl-5-benzoyl-2-benzimidazole carbamate

Structural Formula:

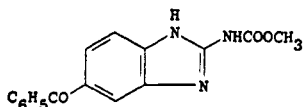

Chemical Abstracts Registry No.: 31431-39-7

Trade Name	Manufacturer	Country	Year Introduced
Vermox	Ortho	U.S.	1975
Vermox	Janssen	U.K.	1976
Vermox	Janssen	W. Germany	1976
Vermox	Janssen	Italy	1978
Vermox	Janssen	Sweden	1983
Lomper	Esteve	Spain	—
Mebutar	Andromaco	Argentina	—
Panfugan	Byk Prociencx	Brazil	—
Sirben	Andromaco	Brazil	—
Sufil	Cusi	Spain	—
Vermirax	Biosintetica	Brazil	—
Verpanil	Krka	Yugoslavia	—

Raw Materials

4-Chloro-3-nitrobenzophenone

Ammonia

S-Methylisothiurea sulfate

Hydrogen

Methyl chloroformate

Manufacturing Process

A mixture of 5.2 parts of 4-chloro-3-nitrobenzophenone, 5 parts of ammonia, 72 parts of methanol and 13 parts of sulfolane is heated overnight at 125°C in a sealed tube. The reaction mixture is evaporated in vacuo. The semisolid residue is boiled in 100 parts of a diluted hydrochloric acid solution. After cooling, the precipitated product is filtered off and dissolved in chloroform. The chloroform phase is dried and evaporated. The residue is crystallized from toluene, yielding 4-amino-3-nitrobenzophenone; MP 141°C.

A mixture of 9.6 parts of 4-amino-3-nitrobenzophenone, 160 parts of methanol, 8 parts of concentrated hydrochloric acid and 1 part of palladium-on-charcoal catalyst 10% is hydrogenated at normal pressure and at room temperature. After the calculated amount of hydrogen is taken up, hydrogenation is stopped. The catalyst is filtered off and the solvent is evaporated. The solid residue is triturated in 2-propanol. The latter is partly evaporated and the solid product is filtered off, washed with 2-propanol and dried, yielding 3,4-diaminobenzophenone hydrochloride; MP 207°C.

7.8 parts of S-methylisothiurea sulfate are stirred in 10 parts of water in an ice bath and there are added 4.5 parts of methyl chloroformate. While keeping the temperature below 20°C, there are added dropwise, in the course of 10 minutes, 17 parts of sodium hydroxide solution 25% (pH 8±), followed by the addition of 5.6 parts of acetic acid (pH 5±). To this mixture is added at 20°C a suspension of 7 parts of 3,4-diaminobenzophenone hydrochloride in 100 parts of water, followed by the addition of 2.3 parts of sodium acetate.

The whole is slowly heated to 85°C and stirred at this temperature for 45 minutes. The reaction mixture is cooled and the precipitated product is filtered off. It is washed successively with water and ethanol, dried and crystallized from a mixture of acetic acid and methanol, yielding methyl N-[5(6)-benzoyl-2-benzimidazolyl] carbamate; MP 288.5°C.

References

Merck Index 5589

Kleeman & Engel p 536

PDR p. 960

OCDS Vol. 2 p. 353 (1980)

DOT 7 (5) 195 (1971); 9 (7) 299 (1973); 16 (10) 350 (1980) & 17 (6) 262 (1981)

I.N. p. 580

REM p. 1235

Van Gelder, J.L.H., Roevens, L.F.C. and Raeymaekers, A.H.M.; U.S. Patent 3,657,267; April 18, 1972; assigned to Janssen Pharmaceutica, NV, Belgium

MEBEVERINE HYDROCHLORIDE

Therapeutic Function: Antispasmodic

Chemical Name: 3,4-dimethoxybenzoic acid 4-[ethyl-[2-(4-methoxyphenyl)-1-methylethyl]-amino]butyl ester hydrochloride

Common Name: —

Structural Formula:

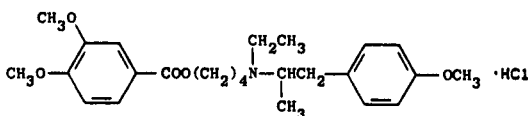

Chemical Abstracts Registry No.: 2753-45-9; 3625-06-7 (Base)

Trade Name	Manufacturer	Country	Year Introduced
Duspatalin	Duphar	France	1965
Colofac	Duphar	U.K.	1967
Duspatal	I.S.M.	Italy	1970
Duspatal	Thomae	W. Germany	1977
Duspatalin	Duphar	Switz.	1981

Raw Materials

3,4-Dimethoxybenzoic acid	Sodium
Tetramethylene dichloride	Ethanol
p-Methoxyphenyl acetone	Sodium iodide
Ethylamine	Hydrogen

Manufacturing Process

(A) *Sodium-3,4-Dimethoxybenzoate*: A solution of 91 g of 3,4-dimethoxybenzoic acid in 500 ml of boiling, absolute alcohol was added quickly to a solution of 11.5 g of sodium in 300 ml of absolute alcohol; after cooling to room temperature the resulting precipitate was filtered off and washed with 2 x 50 ml of absolute alcohol and 4 x 200 ml of ether and dried in air to constant weight; yield 92.5 g, MP about 265°C. The filtrate was bulked with the alcohol and ether washings, left to stand overnight, and a further precipitate then filtered off, washed with 3 x 100 ml of ether, and dried in air to constant weight. Yield 22.5 g, MP about 265°C. Total yield therefore 115 g (=113%).

(B) *4'-Chlorobutyl-3,4-Dimethoxybenzoate*: 92 g of the sodium salt described under (A) (it contains at the most 81.5 g of sodium 3,4-dimethoxybenzoate) was boiled in 900 ml of tetramethylene dichloride for 90 hours; after cooling the mixture was filtered and the residue washed with 3 x 50 ml of ether. The filtrate was evaporated to dryness in vacuo and the residue (102 g) was distilled in vacuo. Fraction 1: 50° to 55°C/0.5 mm; 19 g (probably tetramethylene dichloride). Fraction 2: 175° to 184°C/0.5 mm; 77.5 g (=71%); Cl=12.6% (calculated 13.0%). Remark: The second fraction partially solidified or became more viscous on standing, and even during the distillation.

(C) *4'-Iodobutyl-3,4-Dimethoxybenzoate*: 32.5 g of 4'-chlorobutyl-3,4-dimethoxybenzoate and 19.5 g of sodium iodide (10% excess) were boiled in 150 ml of methyl ethyl ketone for 2.5 hours; after cooling and filtering off the sodium chloride produced, the reaction was found not to be entirely completed; boiling was then continued for another two hours; the reaction mixture was cooled, and the solid filtered off and washed with 2 x 100 ml of ether.

The filtrate was evaporated to dryness in vacuo and the residue was dissolved in 300 ml of ether and 100 ml of water; the layers were separated and the water layer was once again extracted with 100 ml of ether; then the ether layers were boiled and washed again with a solution of 3.5 g of sodium thiosulfate in 100 ml of water. The ether layer was dried over sodium sulfate. Finally the solution was filtered and the ether was evaporated; the residue was an almost colorless oil, which partially solidified or became more viscous after being left to stand for some time. Yield: 40 g (=92%), l=34.2% (calculated 34.9%).

(D) *4'-[N-Ethyl-1''-Methyl-2''-(4'''-Methoxyphenyl)Ethylamino]Butyl-3,4-Dimethoxybenzoate Hydrochloride*: 10.3 g of 4'-iodobutyl-3,4-dimethoxybenzoate and 11.0 g of N-ethyl-p-methoxyphenylisopropylamine (obtained by catalytic reduction of an alcoholic solution of an excess quantity (60%) of p-methoxy-phenyl-acetone, to which was added a 33% (weight-for-weight) aqueous solution of ethylamine, with Pt as a catalyst), were boiled in 200 ml of methyl ethyl ketone for 20 hours, cooled and the iodine ion was determined; the reaction was found to be complete. Then the methyl ethyl ketone was evaporated in vacuo and the residue was dissolved in 300 ml of water and 30 ml of ether; the layers were separated and the water layer was extracted twice more with 20 ml portions of ether.

References

Merck Index 5590

Kleeman & Engel p. 537

OCDS Vol. 2 p. 54 (1980)

DOT 3 (4) 143 (1967)

I.N. p. 580

Phillips' Gloeilampenfabrieken; British Patent 1,009,082; November 3, 1965

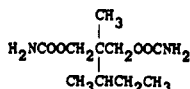
MEBUTAMATE**Therapeutic Function:** Antihypertensive**Chemical Name:** 2-Methyl-2-(1-methylpropyl)-1,3-propanediol dicarbamate**Common Name:** Dicomoylmethane**Structural Formula:****Chemical Abstracts Registry No.:** 64-55-1

Trade Name	Manufacturer	Country	Year Introduced
Capla	Wallace	U.S.	1961
Axiten	Zambon	Italy	—
Butatensin	Benvegna	Italy	—
Carbuten	Kalopharma	Italy	—
Dormate	Wallace	U.S.	—
Ipotensivo	Vita	Italy	—
Mebutina	Formenti	Italy	—
No-Press	Janus	Italy	—
Prean	Chemil	Italy	—
PremineX	Dumex	Denmark	—
Sigmafon	Lafare	Italy	—
Vallene	Simes	Italy	—

Raw Materials

Diethyl-sec-butyl methyl malonate
 Lithium aluminum hydride
 Ethyl urethane

Manufacturing Process

The following example illustrates the preparation of 2-methyl-2-sec-butyl-1,3-propanediol:

92 g of diethyl-sec-butyl methyl malonate were reduced in the usual manner using 22.8 g of lithium aluminum hydride in a suitable volume of anhydrous ethyl ether. The mixture was treated with 10% sulfuric acid and the ether soluble components extracted. The ether solution was dried, using a suitable drying agent, and the residue obtained by the removal of the ether was purified by distilling under reduced pressure. This material was further purified by redistillation. Approximately 46 g of 2-methyl-2-sec-butyl-1,3-propanediol were obtained as a clear colorless liquid, boiling point 92°C to 97°C (0.1 mm pressure).

The following example describes the preparation of 2-methyl-2-sec-butyl-1,3-propanediol di-carbamate using the urethane exchange method:

14.6 g of 2-methyl-2-sec-butyl-1,3-propanediol and 18.7 g ethyl urethane are dissolved in about 100 ml anhydrous toluene. 3 g of aluminum isopropylate are added and the mixture distilled to remove the ethyl alcohol formed in the condensation of ethyl urethane and the diol. The alcohol distills in the form of an azeotrope with toluene. Distillation is continued until the theoretical quantity of ethanol has been removed. The toluene is distilled from the mixture under reduced pressure and the residue dissolved in hot aqueous isopropanol solution. The hot solution is filtered and allowed to cool, whereupon approximately 14 g of product separates. The purified product represents a yield of about 60% of theoretical and melts at 77°C to 79°C.

References

Merck Index 5594

Kleeman & Engel p. 538

OCDS Vol. 1 p. 218 (1977)

I.N. p. 581

Berger, F.M. and Ludwig, B.J.; U.S. Patent 2,878,280; March 17, 1959; assigned to Carter Products, Inc.

MECAMYLAMINE HYDROCHLORIDE

Therapeutic Function: Antihypertensive

Chemical Name: N,2,3,3-Tetramethylbicyclo[2.2.1]heptan-2-amine hydrochloride

Common Name: Dimecamin hydrochloride

Structural Formula:

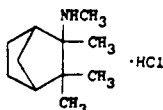

Chemical Abstracts Registry No.: 826-39-1; 60-40-2 (Base)

Trade Name	Manufacturer	Country	Year Introduced
Inversine	MSD	U.S.	1956
Mevasine	MSD	W. Germany	—
Prexion	I.T.I.	Italy	—

Raw Materials

dl-Camphene	Sodium cyanide
Lithium aluminum hydride	Sulfuric acid

Manufacturing Process

Preparation of 2-(N-Formylamino)isocamphane: Into a 5-liter 3-necked round bottom flask equipped with stirrer, dropping funnel and thermometer, was added 325 ml of glacial acetic acid. Then, portionwise, a total of 133 g of sodium cyanide (granular, 2.6 mols) was added with stirring while holding the temperature at 15°C. To the thick white slurry was added dropwise a previously prepared cold mixture of 325 ml glacial acetic acid and 360 ml concentrated sulfuric acid.

After addition of a few milliliters at 15°C, the thick slurry thins slowly and the remainder of the sulfuric-glacial acetic acid mixture was added at 0° to 2°C. A total of about 2 hours was required for the addition. After addition, stirring was continued for 15 minutes. Then dropwise, over an hour, a solution of 178 g (1.3 mols) of dl-camphene in 50 ml of glacial acetic acid was added while keeping the temperature at about 0°C ($\pm 3^\circ\text{C}$).

Stirring was continued for two hours at 0°C during which time a slight pinkish-yellow color developed in the reaction mixture. The cooling bath was removed and the temperature allowed to rise to 15° to 20°C in about 2 to 3 hours. The ice bath was then replaced and while holding the temperature at about 20°C, the mixture was gradually diluted with 3 liters of water while stirring vigorously. After an hour or two of good agitation at room temperature, the oily product was extracted with 2 x 500 ml and 1 x 200 ml of chloroform and the combined extracts washed with 2 x 500 ml of water. The chloroform extract was then rendered neutral by stirring with 500 ml water and gradually adding solid sodium bicarbonate to the mixture until the aqueous phase had a pH of about 7; required, approximately 88 g of NaHCO₃.

After separation the chloroform layer was washed with 2 x 500 ml water, dried over calcium chloride, and after filtration the solvent was removed in vacuo on the steam bath. A solid somewhat sticky residue of 231.2 g was obtained. After removal of last traces of chloroform by repeated swishing with petroleum ether, the cake was finally refluxed with about 500 ml petroleum ether (BP 30° to 60°C) until a thick crystalline slurry was obtained. After refrigeration for a day, the white crystalline mass was filtered by suction, washed with petroleum ether (2 x 125 ml), then n-heptane (2 x 125 ml) and again with petroleum ether (2 x 125 ml). After air drying at room temperature to constant weight, 180.6 g of the dl-2-(N-formylamino)isocamphane melting at 160° to 165°C was obtained.

The combined petroleum ether and n-heptane washes were concentrated under diminished pressure and the residual oil dissolved in a minimum amount of hot petroleum ether (about 75 ml). The resulting solution was placed in the refrigerator for two days. The precipitated dl-2-(N-formylamino)isocamphane was then recovered by filtration and washed with petroleum ether and n-heptane as described above. Obtained, 12.6 g of product having a MP of 158° to 164°C.

The dl-2-(N-formylamino)isocamphane (193 g) was dissolved in 1.9 liters n-heptane by heating on a steam bath. After clarifying the solution by filtration, the clear filtrate was allowed to stand at room temperature until crystallization was complete. The crystalline product is filtered by suction, washed with a little cold n-heptane and air dried. The dl-2-(N-formylamino)isocamphane melted at 169° to 174°C.

Preparation of 2-(N-Methylamino)Isocamphane: To 4.23 liters of anhydrous ether in a 12-liter 3-necked flask fitted with a stirrer, reflux condenser and dropping funnel was quickly added 78 g (2.05 mols) of lithium aluminum hydride. The mixture was gently refluxed with stirring until all hydride had dissolved which required several hours.

A solution of 168 g (0.92 mol) of dl-2-(N-formylamino)isocamphane, prepared as described above, in 1.81 liters of anhydrous ether was then added during a period of about one hour with stirring. After addition, the mixture was refluxed for about 6 hours after which it was cooled slightly and 347 ml of water added with stirring, hydrogen gas being evolved during the addition. Stirring was continued until the precipitate changed to a powder, which was filtered by suction and washed with ether (a total of about 2 liters).

The combined filtrate and washes were concentrated to 1.6 liters and the concentrate containing the dl-2-(N-methylamino)isocamphane washed once with about 350 cc water, and then dried over anhydrous sodium sulfate. The dried ether concentrate was then cooled in an ice bath and with stirring a cold saturated ethereal-hydrogen chloride solution was added slowly until acid to Congo red; required, about 440 ml anhydrous ether saturated (at 0°C) with HCl gas. After precipitation was complete, the white crystalline dl-2-(N-methylamino)isocamphane hydrochloride was filtered, and washed with anhydrous ether

(about 1 liter) until the washes were neutral. The dl-2-(N-methylamino)isocamphane hydrochloride was air dried at room temperature. Obtained, 156.5 g of product melting with decomposition at 249°C.

References

Merck Index 5595

Kleeman & Engel p. 538

I.N. p. 581

REM p. 849

Pfister, K., III and Stein, G.A.; U.S. Patent 2,831,027; April 15, 1958; assigned to Merck & Co., Inc.

MECILLINAM

Therapeutic Function: Antibacterial

Chemical Name: 6-[[[(Hexahydro-1H-azepin-1-yl)methylene]amino]-3,3-dimethyl-7-oxo-4-thia-1-azabicyclo[3.2.0]heptane-2-carboxylic acid

Common Name: Amdinocillin

Structural Formula:

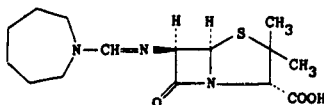

Chemical Abstracts Registry No.: 32887-01-7

Trade Name	Manufacturer	Country	Year Introduced
Selexidin	Leo	U.K.	1979
Celfuron	Roche	—	—

Raw Materials

Hexamethylene imine	Chloral
Trimethylsilyl 6-amino penicillinate	Oxalyl chloride

Manufacturing Process

The starting material N-formylhexamethyleneimine was prepared from hexamethyleneimine and chloral.

12.7 g of N-formylhexamethyleneimine were dissolved in 250 ml of dry ether. While stirring and cooling, 8.5 ml of oxalyl chloride in 50 ml of dry ether were added dropwise, whereafter the mixture was stirred overnight at room temperature. The precipitated amide chloride was filtered off and washed with dry ether, and was placed in an exsiccator.

A solution of the amide chloride (4.6 g) in dry, alcohol-free chloroform (20 ml) was added slowly to a solution of trimethylsilyl 6-amino-penicillanate (7.2 g) and triethylamine (3.5 ml) in dry, alcohol-free chloroform (50 ml) with stirring and cooling to -70°C. The temperature was raised to 0°C during 1½ hours. The solution was evaporated to dryness *in vacuo* and the residue was triturated with dry ether (200 ml). The precipitate was filtered off and washed with dry ether. The filtrate was diluted with ether (200 ml). 2-Butanol (2.8 ml) was added dropwise with stirring and cooling to 0°C. The stirring was continued for ¼ hour at 0°C, whereupon the precipitate was filtered off, washed with ether and dried. It was a white, amorphous powder, soluble in water.

References

Merck Index 390

Kleeman & Engel p. 539

OCDS Vol. 3 p. 208 (1984)

DOT 11 (11), 489 (1975) and 16 (6) 193 (1980)

I.N. p. 582

REM p. 1201

Lund, F.J.; British Patent 1,293,590; October 18, 1972; and U.S. Patent 3,957,764; May 18, 1976; both assigned to Lovens Kemiske Fabrik Produktionsakties Lab (Denmark)

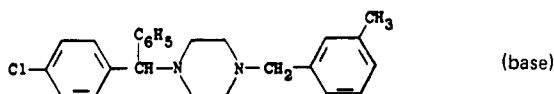
MECLIZINE HYDROCHLORIDE**Therapeutic Function:** Antinauseant**Chemical Name:** 1-[(4-Chlorophenyl)phenylmethyl]-4-[(3-methylphenyl)methyl] piperazine hydrochloride**Common Name:** Meclozin; histamethizine**Structural Formula:****Chemical Abstracts Registry No.:** 1104-22-9; 569-65-3

Trade Name	Manufacturer	Country	Year Introduced
Antivert	Roerig	U.S.	1957
Ru-Vert M	Reid Provident	U.S.	1983
Ancolan	Duncan Flockhart	U.K.	—
Bonamine	Pfizer	W. Germany	—
Calmonal	Heyden	W. Germany	—
Chiclida	Torpens	Spain	—
Diadrii	Pliva	Yugoslavia	—
Duremesan	Streuli	Switz.	—
Itinerol	Galenica	Switz.	—
Mecazine	Barlow Cote	Canada	—
Navicalur	Delagrangé	France	—
Peremesin	Heyden	W. Germany	—
Postafen	U.C.B.	W. Germany	—
Supermesin	M.P.Q.	Spain	—
Suprimal	A.C.F.	Neth.	—
Taizer	Pfizer Taito	Japan	—
V-Cline	Vanguard	U.S.	—
Veritab	Vista	U.S.	—
Vertizine	Merchant	U.S.	—

Raw Materials

1-p-Chlorobenzhydryl-4-benzyl-piperazine

Hydrogen

Sodium amide

m-Methyl benzyl chloride

Manufacturing Process

32.3 g of 1-p-chlorobenzhydryl-4-benzyl-piperazine, dissolved in 300 cm³ of alcohol are heated in an autoclave vessel, in the presence of Raney nickel, under a pressure of 100 kg H₂ at about 150°C for 6 hours. The catalyst is filtered, the solvent is evaporated and the residue is fractionated under a high vacuum. p-Chlorobenzylhydryl-piperazine (BP 180° to 185°C/1 mm Hg) is isolated with a yield of 75%. Then finely ground NaNH₂ is added. The mixture is heated under reflux for 1 hour, the mass is cooled and a molar equivalent of m-methyl benzyl chloride is added.

The solvent is evaporated and the residue is dissolved in chloroform. This solution is washed with a saturated solution of K₂CO₃ and dried on K₂CO₃. The solvent is evaporated and the residue is distilled under high vacuum. The product of the condensation distills near 230°C at 2 mm Hg pressure and the corresponding dihydrochloride melts at 217° to 224°C.

References

Merck Index 5598

Kleeman & Engel p. 540

PDR pp. 993, 1403, 1449, 1520, 1606, 1999

OCDs Vol. 1 p. 59 (1977)

I.N. p. 583

REM p. 808

Morren, H.; U.S. Patent 2,709,169; May 24, 1955; assigned to Union Chimique Belge Societe Anonyme, Belgium

MECLOFENAMIC ACID

Therapeutic Function: Antiinflammatory

Chemical Name: N-(2,6-Dichloro-3-methylphenyl)anthranilic acid

Common Name: —

Structural Formula:

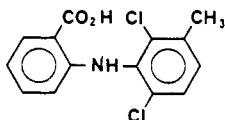

Chemical Abstracts Registry No.: 644-62-2; 6385-02-0 (Sodium Salt)

Trade Name	Manufacturer	Country	Year Introduced
Meclomen	Warner Lambert	U.S.	1980
Meclomen	Parke Davis	Switz.	1982
Arquel	Parke Davis	—	—

Raw Materials

Potassium o-bromobenzoate
2,6-Dichloro-3-methylaniline
N-ethylmorpholine

Manufacturing Process

A mixture consisting of 22.7 g potassium o-bromobenzoate, 16.6 g 2,6-dichloro-3-methylaniline, 12 ml N-ethylmorpholine, 60 ml diethylene glycol dimethyl ether, and 1.0 g anhydrous cupric bromide is heated in a nitrogen atmosphere at 145°C to 155°C for 2 hours. The reaction mixture is diluted with 60 ml diethylene glycol dimethyl ether and acidified with 25 ml concentrated hydrochloric acid. The acidic mixture is diluted with 100 ml of water and the liquid phase decanted from the insoluble oil. The insoluble oil is stirred with methanol and the crystalline N-(2,6-dichloro-3-methylphenyl)anthranilic acid which separates is collected and washed with methanol. The product, after recrystallization from acetone-water mixture, melts at 248°C to 250°C.

References

Merck Index 5600

DFU 3 (4) 307 (1978)

Kleeman & Engel p. 539

PDR p. 1366

OCDS Vol. 1 p. 110 (1977) & 2, 88 (1980)

DOT 17 (6) 250 (1981)

I.N. p. 31

REM p. 1118

Scherrer, R.A. and Short, F.W.; U.S. Patent 3,313,848; April 11, 1967; assigned to Parke-Davis & Co.

MEDAZEPAM

Therapeutic Function: Tranquilizer

Chemical Name: 7-chloro-2,3-dihydro-1-methyl-5-phenyl-1H-1,4-benzodiazepine

Common Name: —

Structural Formula:

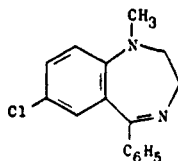

Chemical Abstracts Registry No.: 2898-12-6

Trade Name	Manufacturer	Country	Year Introduced
Nobrium	Roche	Italy	1969
Nobrium	Roche	W. Germany	1969
Nobrium	Roche	France	1970
Lesmit	Shionogi	Japan	1971
Nobrium	Roche	Japan	1971
Nobrium	Roche	U.K.	1971
Azepamid	Taiyo	Japan	—
Becamedic	Nemi	Argentina	—
Benson	Farber-R.E.F.	Italy	—
Cerase	Torii	Japan	—
Diepin	Biosintetica	Brazil	—
Enobrin	I.E. Kimya Evi	Turkey	—

Trade Name	Manufacturer	Country	Year Introduced
Esmail	Richter	Mexico	—
Glorium	Teva	Israel	—
Kobazepam	Nihon Yakuhin	Japan	—
Lerisum	Poli	Italy	—
Medaurin	Isis	Yugoslavia	—
Megasedan	Andrew	Spain	—
Metonas	Kanto	Japan	—
Mezepan	Hosbon	Brazil	—
Narsis	Sumitomo	Japan	—
Nivelton	Lemonier -	Argentina	—
Nobraskin	Fako	Turkey	—
Nobral	Nobel	Turkey	—
Pazital	Andromaco	Spain	—
Psiquium	Sintofarma	Brazil	—
Rudotel	Arzneimittelwerk Dresden	E. Germany	—
Sedepam	Sawai	Japan	—
Serenium	Richter	Brazil	—
Tranquilax	Hokuriku	Japan	—
Vegatar	Orion	Finland	—

Raw Materials

5-Chloro-N-methylantranilic acid	Oxalic acid
Bromoethylamine hydrobromide	Acetic anhydride
Calcium carbonate	Bromobenzene
Sodium hydroxide	Magnesium
Phosphorus oxychloride	

Manufacturing Process

(A) Preparation of 4-Acetyl-7-Chloro-1,2,3,4-Tetrahydro-1-Methyl-5H-1,4-Benzodiazepin-5-one: A mixture of 68.5 g (0.37 mol) of 5-chloro-N-methylantranilic acid, 51 g (0.51 mol) of calcium carbonate, 76 g (0.37 mol) of bromoethylamine hydrobromide and 2.5 liters of water was stirred and heated under reflux for 3 hours. A solution of 23.4 g (0.26 mol) of anhydrous oxalic acid in 250 ml of water was slowly added to the refluxing mixture. The precipitated calcium oxalate was filtered off, and the filtrate adjusted to pH 7 with concentrated ammonium hydroxide. The filtrate was then concentrated to dryness in vacuo and the residue heated on the steam bath with 400 ml of 6 N ethanolic hydrogen chloride until the residue was crystalline. Filtration gave 122 g of N-(aminoethyl)-5-chloro-N-methylantranilic acid hydrochloride as a solid.

A mixture of 100 g of this solid and 1 liter of acetic anhydride was stirred and heated under reflux for 1.5 hours and then allowed to stand for 18 hours at room temperature. The excess acetic anhydride was removed in vacuo, and the residue was treated with one liter of water and ice and sufficient sodium bicarbonate to make neutral. The solid was collected, sucked dry on the filter, and triturated with hot ethanol. The ethanol solution on cooling gave 30.8 g of 4-acetyl-7-chloro-1,2,3,4-tetrahydro-1-methyl-5H-1,4-benzodiazepin-5-one.

(B) Preparation of 7-Chloro-1,2,3,4-Tetrahydro-1-Methyl-5H-1,4-Benzodiazepin-5-one: A mixture of 25.25 g (0.1 mol) of 4-acetyl-7-chloro-1,2,3,4-tetrahydro-1-methyl-5H-1,4-benzodiazepin-5-one, 33.3 ml (0.1 mol) of 3 N sodium hydroxide and 350 ml of ethanol was heated under reflux for 15 minutes and then concentrated to dryness in vacuo. The residue was treated with 500 ml of water, collected and washed with ethanol to give 20.2 g of 7-chloro-1,2,3,4-tetrahydro-1-methyl-5H-1,4-benzodiazepin-5-one.

(C) Preparation of 7-Chloro-2,3-Dihydro-1-Methyl-5-Phenyl-1H-1,4-Benzodiazepine: A mixture of 4.7 g (22.6 mol) of 7-chloro-1,2,3,4-tetrahydro-1-methyl-5H-1,4-benzodiazepin-5-one and 100 ml of phosphorus oxychloride was heated in an oil bath at 100°C for 15 minutes. The solution was concentrated to dryness in vacuo. The residue was partitioned

between methylene chloride and cold saturated sodium bicarbonate solution. The methylene chloride phase was dried over sodium sulfate and sodium bicarbonate, filtered, diluted with benzene and concentrated in vacuo to produce crude 5,7-dichloro-2,3-dihydro-1-methyl-1H-1,4-benzodiazepine.

The residue was dissolved in 75 ml of tetrahydrofuran, treated with charcoal, and sodium sulfate and filtered. This solution was added to a solution in 250 ml of tetrahydrofuran of phenyl magnesium bromide prepared from 17.7 ml (0.17 mol) of bromobenzene. This mixture was stirred and heated under reflux for 1 hour. It was then cooled and diluted with 400 ml of ether and sufficient 3 N hydrochloric acid to make it acidic. The aqueous phase was separated, adjusted to pH 8 with 3 N sodium hydroxide and extracted 3 times with 200 ml of ether. The ether extracts were combined, washed with water and dried over sodium sulfate. The residue left on removal of the ether in vacuo was crystallized from petroleum ether to give 3.3 g of 7-chloro-2,3-dihydro-1-methyl-5-phenyl-1H-1,4-benzodiazepine, according to U.S. Patent 3,624,703.

A variety of alternative routes are outlined by Kleeman & Engel.

References

Merck Index 5609

Kleeman & Engel p. 542

OCDS Vol. 1 p. 368 (1977)

DOT 5 (4) 150 (1969) & 9 (6) 238 (1973)

I.N. p. 584

Reeder, E. and Sternbach, L.H.; U.S. Patent 3,109,843; November 5, 1963; assigned to Hoffmann-LaRoche Inc.

Archer, G.A. and Sternbach, L.H.; U.S. Patent 3,131,178; April 28, 1964; assigned to Hoffmann-LaRoche Inc.

Reeder, E. and Sternbach, L.H.; U.S. Patent 3,141,890; July 21, 1964; assigned to Hoffmann-LaRoche Inc.

Reeder, E. and Sternbach, L.H.; U.S. Patent 3,144,439; August 11, 1964; assigned to Hoffmann-LaRoche Inc.

Field, G.F., Sternbach, L.H. and Zally, W.J.; U.S. Patent 3,624,073; November 30, 1971; assigned to Hoffmann-LaRoche Inc.

MEDIGOXIN

Therapeutic Function: Cardiotonic

Chemical Name: 3 β ,12 β ,14 β -Trihydroxy-5 β -card-20(22)-enolide-3-(4'''-o-methyltridigitoxoside)

Common Name: β -Methylidigoxin

Structural Formula:

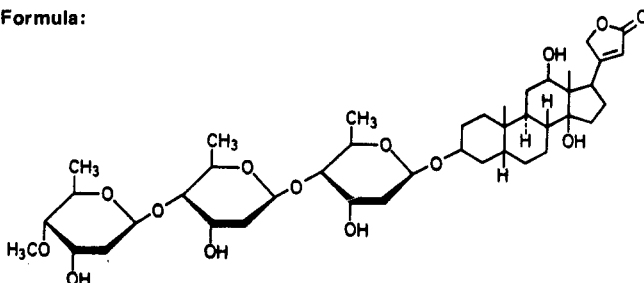

Chemical Abstracts Registry No.: 30685-43-9

Trade Name	Manufacturer	Country	Year Introduced
Lanitop	Boehr-Mann.	W. Germany	1972
Lanitop	Boehr-Mann.	Italy	1973
Lanitop	Roussel	U.K.	1976
Lanirapid	Yamanouchi	Japan	1979
Cardiolan	Tosi-Novara	Italy	—
Digicor	Lek	Yugoslavia	—
Intensain-Lanitop	Boehr-Mann.	W. Germany	—

Raw Materials

Digoxin
Methyl mesylate

Manufacturing Process

Digoxin (10 g) is dissolved in a mixture of dimethylformamide (80 ml) and dioxane (80 ml) and then strontium hydroxide (3.5 g) and aluminum oxide (10 g, activity 1-2 according to Brockmann) are added. To this suspension methyl mesylate (9.3 g), dissolved in dioxane (80 ml) is added dropwise within one hour in the presence of an inert gas and under stirring. After the addition of the methylating agent is completed, the reaction mixture is stirred for further 5 hours, then chloroform (160 ml) is added, the precipitate is filtered off, washed with chloroform (100 ml), pyridine (40 ml) is added to the filtrate, which is then concentrated in vacuo to an oily residue. The latter is diluted with chloroform (300 ml) and extracted four times with distilled water (40 ml portions). The combined chloroform extracts are dried with anhydrous sodium sulfate and then concentrated in vacuo to a dry residue. Therefrom β -methyl-digoxin is eluted on a SiO_2 column with a chloroform/ethanol mixture (93:7). After recrystallization from ethyl acetate, saturated with water, the yield of β -methyl digoxin is 6.7 g; MP 225°C to 229°C. IR spectrum is identical with the spectrum of standard methyl digoxin.

References

Merck Index 3148

Kleeman & Engel p. 544

DOT 12 (8) 319, 323 (1976)

I.N. p. 627

Pelan, B., Milohnoja, M. and Pezdirc, M.; U.S. Patent 4,145,528; March 20, 1979; assigned to L.E.K. Tovarna Farmaceutskih in Kemicnih Izdelkov (Yugoslavia)

MEDROGESTONE

Therapeutic Function: Progestin

Chemical Name: 6,17-dimethylpregna-4,6-diene-3,20-dione

Common Name: 6,17 α -dimethyl-6-dehydropregesterone

Structural Formula:

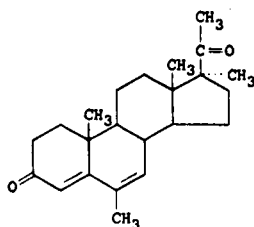

Chemical Abstracts Registry No.: 977-79-7

Trade Name	Manufacturer	Country	Year Introduced
Colpro	Ayerst	Italy	1970
Colprone	Auclair	France	1972
Prothil	Kali-Chemie	W. Germany	1975
Colpron	Arcana	Austria	—

Raw Materials

17 α -Methyl-17 β -carbomethoxyandrost-5-ene-3 β -ol

Hydrogen peroxide

N-Bromosuccinimide

Acetic anhydride

Methyl magnesium bromide

Chromic acid

Manufacturing Process

The manufacturing process as described in U.S. Patent 3,170,936 uses the readily available methyl 3 β -hydroxy-17 α -methyl- Δ^5 -etienate (I), described by Plattner in *Helv. Chim. Acta*, vol. 31, p 603 (1948), as the starting material. The etienic acid ester (I) may also be called 17 α -methyl-17 β -carbomethoxyandrost-5-ene-3 β -ol.

3 β ,5 α ,6 β -Trihydroxy-17 α -Methyl-17 β -Carbomethoxyandrostane (II): 5 g of 17 α -Methyl-17 β -carbomethoxyandrost-5-ene-3 β -ol (I) is dissolved in formic acid (50 ml) and heated on the steam bath for 10 minutes. The solution is cooled to room temperature and a crystalline solid precipitates. This is stirred, 30% hydrogen peroxide (5 ml) is added, and the reaction mixture is left at room temperature for 2 hours. The clear solution is poured into water (300 ml) and the solid which precipitates is filtered.

It is dissolved in hot methanol and heated on the steam bath with 10% methanolic potassium hydroxide solution (15.8 ml) for 10 minutes. Then more potassium hydroxide solution (2 ml) is added, the solution is cooled and on dilution with water a solid (II), MP 245° to 255°C, is obtained. A second crop is obtained from the mother liquors. Several recrystallizations from acetone yield an analytical sample, MP 262° to 265°C, $[\alpha]_D^{24}$ is -2.1°.

3 β -Acetoxy-5 α -Hydroxy-17 α -Methyl-17 β -Carbomethoxyandrostane-6-one (IIIb): 3 β ,5 α ,6 β -Trihydroxy-17 α -methyl-17 β -carbomethoxyandrostane (II, 5.2 g) is dissolved in methanol (105 ml) to which ether (105 ml) and water (84 ml) are added. Then N-bromosuccinimide (5.2 g) is added with stirring and the clear solution is left in the refrigerator for 3 hours. The ether is removed under reduced pressure at room temperature and a crystalline solid (IIIa) separates, MP 268° to 272°C.

The above substance is dissolved in pyridine (15 ml) and acetic anhydride (7.5 ml), and heated on the steam bath for ½ hour. The product (IIIb) crystallizes from aqueous ethanol in leaflets, MP 237° to 239°C. An analytical sample has MP 241° to 243°C.

3 β ,5 α ,6 β -Trihydroxy-6 α ,17 α -Dimethyl-17 β -Carbomethoxyandrostane (IV): 3 β -Acetoxy-5 α -hydroxy-17 α -methyl-17 β -carbomethoxyandrostane-6-one (III, 1.004 g) is dissolved in dry benzene (25 ml) and methyl magnesium bromide solution in ether (3M, 10 ml) is added. The reaction mixture is diluted with dry tetrahydrofuran (25 ml) and allowed to stand at room temperature for 20 hours. Excess Grignard reagent is quenched by adding a saturated solution of ammonium chloride. The organic layer is separated and the aqueous layer is extracted with ethyl acetate.

After washing the combined extracts with ammonium chloride solution and water and working up in the usual way a white solid (IV) is obtained which after one recrystallization from aqueous methanol has MP 242° to 243°C. The infrared spectrum of this compound indi-

cates the presence of a carbomethoxy group ($1,730\text{ cm}^{-1}$) and disappearance of the 6-keto group together with the presence of an ester group ($1,727\text{ cm}^{-1}$). This substance is used without further purification for the next step.

3 β ,5 α ,6 β -Trihydroxy-6 α ,17 α -Dimethylpregnan-20-one (V): Crude 3 β ,5 α ,6 β -trihydroxy-6 α ,17 α -dimethyl-17 β -carbomethoxyandrostane (IV, 773 mg) is dissolved in dry benzene (25 ml) and tetrahydrofuran (freshly distilled over lithium aluminum hydride, 25 ml). To the stirred solution under dry N₂ there is added methyl magnesium bromide solution in ether (3M, 10 ml) over a period of 10 minutes. Then the ether and tetrahydrofuran are almost all distilled and the resulting solution is refluxed for 3 hours (solid precipitates during the reaction). The reaction mixture is cooled and worked up in the same way as in the previous experiment leaving a white solid (V) with an infrared spectrum which indicates the presence of a 20-ketone group ($1,690\text{ cm}^{-1}$), a sample of which is recrystallized to MP 238° to 240°C.

Analysis confirmed the empirical formula C₂₃H₃₈O₄·H₂O: Required: C, 69.60%; H, 10.17%. Found: C, 69.90%; H, 10.15%.

Alternatively, 25.0 g of either 3 β ,5 α -dihydroxy-17 α -methyl-17 β -carbomethoxyandrostane-6-one (IIIa) or 25.0 g of its 3 β -acetate (IIIb), are dissolved in dry tetrahydrofuran (1,250 ml, freshly distilled over lithium aluminum hydride) and dry benzene (2,000 ml) is added. Methyl magnesium bromide in ether solution (3M, 750 ml) is added to the stirred solution and the resulting mixture is stirred at room temperature for 16 hours. An additional quantity of methyl magnesium bromide solution in ether (2M, 375 ml) is added, and 1,250 ml of the solvent mixture are distilled off. The resulting mixture is refluxed for 5 hours and worked up as described above, yielding compound (V) as a colorless oil.

5 α ,6 β -Dihydroxy-6 α ,17 α -Dimethylpregnane-3,20-dione (VI): Crude 3 β ,5 α ,6 β -trihydroxy-6 α ,17 α -dimethylpregnan-20-one (V, 650 mg) is dissolved in acetone (freshly distilled over potassium permanganate, 150 ml) and cooled in an ice-water bath with stirring. Then excess chromic acid solution (8N) is added and stirring is continued at room temperature for 4 minutes. The reaction mixture is poured into water and extracted with ethyl acetate. The combined extracts are washed with dilute sodium bicarbonate solution and water and then dried over magnesium sulfate. Removal of the solvent leaves a white solid (VI). This crude product is used for the next step. Its IR spectrum shows a strong band at $1,705\text{ cm}^{-1}$. A sample is recrystallized to MP 243° to 245°C (dec.).

6,17 α -Dimethyl-4,6-Pregnadiene-3,20-dione (VII): 5 α ,6 β -Dihydroxy-6 α ,17 α -dimethylpregnane-3,20-dione (VI, 553 mg) is dissolved in absolute ethanol (60 ml) and two drops of concentrated hydrochloric acid are added. This solution is heated on a steam bath for 45 minutes, cooled, diluted with water and extracted with ether. The combined extracts are washed with dilute sodium bicarbonate solution and water and subsequently dried over magnesium sulfate. After the solvent has been removed a syrup remains and the UV spectrum of this substance indicates the presence of a $\Delta^{4,6}$ -ketone. Elution of this material over alumina (Woelm, Grade III, 25 g) with 1:1 hexane-benzene gives a crystalline substance, MP 138° to 141°C which, after one recrystallization from ether, has an infrared spectrum identical to that of an authentic sample of 6,17 α -dimethyl-4,6-pregnadiene-3,20-dione (VII).

References

Merck Index 5613

Kleeman & Engel p. 545

OCDs Vol. 1 p. 182 (1977)

I.N. p. 586

Deghenghi, R.; U.S. Patent 3,133,913; May 19, 1964; assigned to American Home Products Corporation

Morand, P.F. and Deghenghi, R.; U.S. Patent 3,170,936; February 23, 1965; assigned to American Home Products Corporation

Deghenghi, R.; U.S. Patent 3,210,387; October 5, 1965; assigned to American Home Products Corporation

MEDROXYPROGESTERONE ACETATE

Therapeutic Function: Progestin

Chemical Name: 17-acetoxy-6 α -methyl-pregn-4-ene-3,20-dione

Common Name: 6 α -methyl-17 α -acetoxyprogesterone

Structural Formula:

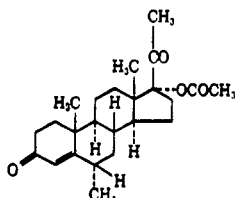

Chemical Abstracts Registry No.: 71-58-9; 520-85-4 (Base)

Trade Name	Manufacturer	Country	Year Introduced
Provera	Upjohn	U.S.	1959
Farlutal	Carlo Erba	France	1962
Provest	Upjohn	U.S.	1964
Amen	Carnrick	U.S.	1975
Unison	Reid-Provident	U.S.	1978
Mepred	Savage	U.S.	1978
Curretab	Reid-Provident	U.S.	1979
Farlutal	Carlo Erba	U.K.	1982
Depcorlutin	O'Neal, Jones & Feldman	U.S.	—
Depo-Clinovir	Upjohn	W. Germany	—
Depo-Progevera	Alter	Spain	—
Depo-Provera	Upjohn	U.S.	—
Gestapuran	Lovens	Denmark	—
Hysron	Kyowa	Japan	—
Luteocrin	Richter	Italy	—
Luteodione	Panther-Osfa	Italy	—
Luteos	Ion	Italy	—
Lutopolar	Farmos	Finland	—
Lutoral	Midy	Italy	—
Metilgestene	Farmila	Italy	—
Nadigest	Streuli	Switz.	—
Oragest	Ikapharm	Israel	—
Petogen	Petersen	S. Africa	—
P-Medrate	Tutag	U.S.	—
Progevera	Alter	Spain	—
Sodelut G	Sodex	Switz.	—

Raw Materials

17 α -Hydroxyprogesterone	Ethylene glycol
Methyl magnesium bromide	Peracetic acid
Sulfuric acid	Acetic anhydride

Manufacturing Process

Preparation of 17 α -Hydroxyprogesterone 3,20-Bis-(Ethylene Ketal): A solution was prepared containing 50.0 g of 17 α -hydroxyprogesterone in 1,000 ml of benzene, 100 ml of ethylene glycol and 2.5 g of p-toluenesulfonic acid monohydrate. This mixture was re-

fluxed for a period of 17 hours using a calcium carbide water-trap to remove the water formed in the reaction. After this period of reflux 6.5 ml of pyridine was added to the solution, and the mixture cooled to room temperature.

The lower glycol layer was separated and washed with benzene. The benzene layer and the benzene washings were combined and the combined solution was divided into two equal portions, one of which was used for the isolation of 17 α -hydroxyprogesterone 3,20-bis-(ethylene ketal) as follows. The benzene solution was washed with 5% sodium carbonate solution, water and saturated sodium chloride solution. After being dried over anhydrous magnesium sulfate the solution was concentrated to dryness at reduced pressure. The residue was recrystallized by taking up in hot methylene chloride, adding acetone and boiling to remove the methylene chloride until a final volume of about 200 ml was reached.

The solution was then refrigerated overnight and 17.8 g of crystals were removed by filtration. A second crop was obtained yielding 3.7 g of compound. The total yield of 17 α -hydroxyprogesterone 3,20-bis-(ethylene ketal) was 20.3 g (64.3% of theory). Recrystallization of the crude 17 α -hydroxyprogesterone 3,20-bis-(ethylene ketal) from methanol gave the pure bisketal of MP 209° to 211°C.

Preparation of 5 α ,6 α -Oxido-17 α -Hydroxyallopregnane-3,20-dione 3,20-Bis-(Ethylene Ketal):

A solution was prepared by heating 19.96 g (0.0477 mol) of 17 α -hydroxyprogesterone 3,20-bis-(ethylene ketal) and 500 ml of benzene. After the solution was effected the flask was cooled to 5°C and a mixture of 3.68 g (0.0449 mol) of sodium acetate and 174 ml of 40% peracetic acid was added with stirring. The reaction mixture was stirred in the ice bath for 3 hours. The lower peracid layer was separated, diluted with water and extracted twice with benzene.

The upper layer was neutralized by the addition of cold 10% sodium hydroxide solution while stirring in an ice bath. The rate of addition of the sodium hydroxide was regulated to keep the temperature below 10°C. The benzene extracts from the peracid layer were combined and washed with cold 10% sodium hydroxide solution and with saturated sodium chloride solution. All the aqueous layers were washed again with the same portion of benzene. The combined benzene layers were dried over anhydrous magnesium sulfate and concentrated to dryness at reduced pressure.

The residue was recrystallized from acetone using methylene chloride to aid in solution. The crystalline material was removed by filtration and was recrystallized from methylene chloride-acetone to yield a total of 8 g of 5 α ,6 α -oxido-17 α -hydroxyallopregnane-3,20-dione 3,20-bis-(ethylene ketal) of MP 211° to 215°C. For analytical purposes, another recrystallization from methylene chloride-acetone gave pure 5 α ,6 α -oxido-17 α -hydroxyallopregnane-3,20-dione 3,20-bis-(ethylene ketal) of MP 216° to 218.5°C.

Preparation of 5 α ,17 α -Dihydroxy-6 β -Methylallopregnane-3,20-dione 3,20-Bis-(Ethylene Ketal): To a solution of 91.6 g of 5 α ,6 α -oxido-17 α -hydroxyallopregnane-3,20-dione 3,20-bis-(ethylene ketal) in 3,500 ml of freshly distilled tetrahydrofuran was added 1,170 ml of commercial 3 molar methyl magnesium bromide in ether solution. The reaction mixture was boiled to remove 1,800 ml of solvent by distillation and thereafter 1,000 ml of freshly distilled tetrahydrofuran was added.

Boiling was continued under reflux for a period of 16 hours. The solution was then concentrated to about one-half its original volume by distillation and was poured slowly with vigorous stirring into a large volume of ice water containing 340 g of ammonium chloride. The aqueous solution was saturated with sodium chloride and extracted with benzene. The benzene extract was washed with saturated brine, and both aqueous layers were washed again with the same portions of benzene.

The combined benzene layers were dried over anhydrous sodium carbonate and the solvent was removed at reduced pressure to give 90.5 g of crude crystalline 5 α ,17 α -dihydroxy-6 β -methylallopregnane-3,20-dione 3,20-bis-(ethylene ketal). Half of the residue, 45.2 g, was

recrystallized from acetone and some methylene chloride to give 34.4 g of 5 α ,17 α -dihydroxy-6 β -methylallopregnane-3,20-dione 3,20-bis-(ethylene ketal). A sample recrystallized from acetone and methylene chloride for analysis melted at 160° to 163°C.

Preparation of 5 α ,17 α -Dihydroxy-6 β -Methylallopregnane-3,20-dione: A solution was prepared containing 38.9 g of 5 α ,17 α -dihydroxy-6 β -methylallopregnane-3,20-dione 3,20-bis-(ethylene ketal) in 389 ml of boiling acetone. Thereto was added 39 ml of 1 N sulfuric acid in portions under swirling and seeding with product. Boiling was continued for a period of 2 minutes and the mixture was allowed to stand at room temperature. Thereafter the mixture was diluted with 1,500 ml of water, chilled and filtered.

The precipitate was washed with water, dilute ammonium hydroxide and water, and dried in a vacuum oven overnight. The yield was 31.2 g which was recrystallized by dissolving in 1,200 ml of dimethylformamide, heating to 150°C, cooling slightly, and adding 12 ml of hot water. The recrystallized 5 α ,17 α -dihydroxy-6 β -methylallopregnane-3,20-dione thus obtained was 28.75 g of MP 270° to 275.5°C. After an additional recrystallization from aqueous dimethylformamide, the MP was 274° to 279°C.

Preparation of 6 α -Methyl-17 α -Hydroxyprogesterone: A suspension was made by introducing 2 g of 5 α ,17 α -dihydroxy-6 β -methylallopregnane-3,20-dione into 200 ml of chloroform. The suspension was chilled in an ice bath with stirring, and thereupon hydrogen chloride was bubbled through the reaction mixture for 80 minutes with continuous cooling and stirring. After bubbling in nitrogen for a period of 15 minutes the solution was washed with water, 1 N sodium bicarbonate solution and again with water.

The aqueous layers were rewashed with one portion of chloroform, and the washings combined with the remainder of the chloroform solution. After drying over anhydrous magnesium sulfate, the chloroform solution was concentrated to dryness, then taken up in a small volume of methylene chloride, treated with Magnesol anhydrous magnesium silicate and filtered. Acetone was added to the solution and the solution was boiled to remove the methylene chloride. After the solution was concentrated to a volume of about 15 ml it was chilled and the crystals were collected through filtration. The 1.37 g of crystals so obtained were recrystallized from acetone to give pure 6 α -methyl-17 α -hydroxyprogesterone of MP 220° to 223.5°C.

Preparation of 6 α -Methyl-17-Hydroxyprogesterone 17-Acetate: 1 g of 6 α -methyl-17 α -hydroxyprogesterone was dissolved in a mixture of 10 ml of acetic acid and 2 ml of acetic anhydride by heating. After solution was effected the mixture was cooled to 15°C, and 0.3 g of p-toluenesulfonic acid was added. After allowing the mixture to stand for a period of 2½ hours at room temperature, the pink solution was poured into ice water to give an amorphous solid which was recovered by filtration.

The precipitate was washed carefully with water and was then dissolved in 10 ml of methanol and 1.5 ml of methylene chloride. The solution was concentrated to 10 ml, diluted with 0.5 ml of 10% sodium hydroxide, boiled for one minute and cooled. The product, which crystallized on cooling, was recrystallized to give flakes of 6 α -methyl-17 α -hydroxyprogesterone 17-acetate, having a MP 205° to 209°C, according to U.S. Patent 3,147,290.

References

Merck Index 5614

Kleeman & Engel p. 546

PDR pp. 777, 1447, 1839, 1858

OCDS Vol. 1 pp. 180, 186 (1977) & 2, 165 (1980)

DOT 4 (1) 14 (1968)

I.N. p. 586

REM p. 992

Miramontes, L.E., Romero, M.A. and Farjat, F.A.; U.S. Patent 3,000,914; September 19, 1961; assigned to G.D. Searle & Co.

de Ruggieri, P. and Ferrari, C.; U.S. Patent 3,043,832; July 10, 1962; assigned to Ormonoterapia Richter S.p.A., Italy
 Camerino, B., Modelli, R., Patelli, B., Sala, G. and Baldratti, G.; U.S. Patent 3,061,616; October 30, 1962; assigned to Società Farmaceutici Italia, Italy
 Patchett, A.A. and Hoffman, F.G.; U.S. Patent 3,084,174; April 2, 1963; assigned to Merck & Co., Inc.
 Beyler, R.E.; U.S. Patent 3,105,840; October 1, 1963; assigned to Merck & Co.
 Spero, G.B.; U.S. Patent 3,147,290; September 1, 1964; assigned to The Upjohn Company

MEDRYSONE

Therapeutic Function: Glucocorticoid

Chemical Name: 11 β -hydroxy-6 α -methylpregn-4-ene-3,20-dione

Common Name: Hydroxymesterone; 6 α -methyl-11 β -hydroxyprogesterone

Structural Formula:

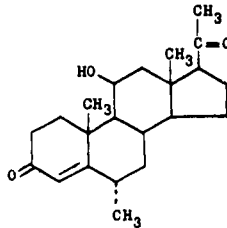

Chemical Abstracts Registry No.: 2668-66-8

Trade Name	Manufacturer	Country	Year Introduced
HMS	Allergan	U.S.	1970
Visudrisone	Italseber	Italy	1970
Spectamedryn	Pharm-Allergan	W. Germany	1975
Medryson Faure	Faure	France	1976
Ipfloglin	Tubi Lux	Italy	—
Medrifar	Farmila	Italy	—
Medritonic	Llorens	Spain	—
Medroptil	Farmigea	Italy	—
Ophthocortin	Winzer	W. Germany	—
Sedestrol	Poen	Argentina	—

Raw Materials

11-Keto-6 β -methylprogesterone
 Ethylene glycol
 Lithium aluminum hydride

Manufacturing Process

Preparation of 11-Keto-6 β -Methylprogesterone 3,20-Bis-(Ethylene Ketal): A mixture of 5 g of 11-keto-6 β -methylprogesterone [Spero et al, *J. Am. Chem. Soc.*, 78, 6213 (1956)], 503 ml of benzene, 26 ml of ethylene glycol, and 0.152 g of p-toluenesulfonic acid monohydrate was stirred and heated under reflux for 22 hours while water was removed by means of a water trap. The reaction mixture was then cooled to 30°C, 0.4 ml of pyridine was added, and stirring was continued for 10 minutes.

The reaction mixture was then shaken with 110 ml. of water and the organic and aqueous layers separated. The organic layer was dried over sodium sulfate and evaporated under diminished pressure giving a residue. The thus obtained residue was recrystallized from methanol giving 2.68 g of 11-keto-6 β -methylprogesterone 3,20-bis-(ethylene ketal) having a MP of 168° to 175°C.

Preparation of 11 β -Hydroxy-6 α -Methylprogesterone: A mixture of 2.68 g of 11-keto-6 β -methylprogesterone 3,20-bis-(ethylene ketal), 161 ml of tetrahydrofuran (previously distilled from lithium aluminum hydride), 1.34 g of lithium aluminum hydride and 14.5 ml of absolute ether was stirred and refluxed under nitrogen for 1.5 hours, then 27 ml of water was added cautiously, to decompose excess hydride. The resulting mixture was filtered and the filter cake was washed with 135 ml of ether. The combined filtrate and wash was shaken with 135 ml of water and separated. The aqueous layer was washed with four 55-ml portions of ether, then the organic layer and the washes were combined, washed once with water, and evaporated to dryness under diminished pressure leaving a tan residue.

The thus-obtained residue was dissolved in a mixture of 268 ml of methanol and 26.8 ml of 3N aqueous sulfuric acid and heated under reflux for 40 minutes, with a color change from yellow to green. The reaction mixture was then cooled, neutralized by addition of 127 ml of 5% sodium bicarbonate solution, and concentrated under reduced pressure until almost all the methanol was removed. The resulting solid was removed by filtration, washed with water, dried, and twice crystallized from ethyl acetate to give 1.1 g of 11 β -hydroxy-6 α -methylprogesterone having a MP of 155° to 158°C, according to U.S. Patent 2,864,837.

References

Merck Index 5616

Kleeman & Engel p. 548

OCDS Vol. 2 p. 200 (1980)

DOT 6 (5) 184 (1970)

I.N. p. 587

REM p. 972

Sebek, O.K., Spero, G.B. and Thompson, J.L.; U.S. Patent 2,864,837; assigned to The Upjohn Company

Spero, G.B. and Thompson, J.L.; U.S. Patent 2,968,655; January 17, 1961; assigned to The Upjohn Company

MEFENAMIC ACID

Therapeutic Function: Analgesic

Chemical Name: 2-[2,3-dimethylphenyl]amino]benzoic acid

Common Name: N-(2,3-xyllyl)anthranilic acid

Structural Formula:

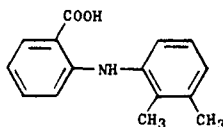

Chemical Abstracts Registry No.: 61-68-7

Trade Name	Manufacturer	Country	Year Introduced
Ponstan	Parke Davis	U.K.	1963
Ponalar	Parke Davis	W. Germany	1964

Trade Name	Manufacturer	Country	Year Introduced
Ponstyl	Parke Davis	France	1967
Ponstel	Parke Davis	U.S.	1967
Bafameritin	Hishiyama	Japan	—
Bonabol	Sawai	Japan	—
Fenamin	Yurtoglu	Turkey	—
Lysalgo	Schiapparelli	Italy	—
Mefacit	Poifa	Poland	—
Mefedolo	Ion	Italy	—
Parkemed	Parke Davis	W. Germany	—
Rolan	Nobel	Turkey	—
Spantac	UJI	Japan	—
Vialidin	Italfarmaco	Italy	—

Raw Materials

Potassium o-bromobenzoate
2,3-Dimethylaniline

Manufacturing Process

A mixture of 800 g of potassium o-bromo-benzoate, 1,500 ml of bis-(2-methoxyethyl)ether, 355 g of N-ethyl-morpholine, 375 g of 2,3-dimethylaniline, and 30 g of cupric acetate is heated gradually with stirring to 140°C over a period of 90 minutes. The hot reaction mixture is then acidified with 260 ml of concentrated hydrochloric acid and the acidified mixture divided into 2 equal portions. One liter of water is added to each portion and the mixtures allowed to cool. The N-(2,3-dimethylphenyl)anthranilic acid which separates upon cooling is collected by filtration and recrystallized from bis(2-methoxyethyl)ether; MP 229° to 230°C (corr.).

References

Merck Index 5617
Kleeman & Engel p. 548
PDR p. 1383
OCDS Vol. 1 p. 110 (1977) & 2, 280 (1980)
DOT 1 (2) 59 (1965)
I.N. p. 31
REM p. 1118
Scherrer, R.A.; U.S. Patent 3,138,636; June 23, 1964; assigned to Parke, Davis & Company

MEFENOREX HYDROCHLORIDE

Therapeutic Function: Anorexic

Chemical Name: N-(3-Chloropropyl)- α -methylphenylethylamine hydrochloride

Common Name: —

Structural Formula:

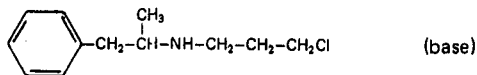

Chemical Abstracts Registry No.: 5586-87-8; 17243-57-1 (Base)

Trade Name	Manufacturer	Country	Year Introduced
Pondinil	Roche	France	1970
Rondimen	Homburg	W. Germany	1976
Anexate	Roche	U.S.	—
Doracil	Gador	Argentina	—

Raw Materials

β -Chloropropionaldehyde
1-Phenyl-2-aminopropane
Hydrogen

Manufacturing Process

9.5 parts of β -chloropropionaldehyde were added slowly, at a temperature of 0°C, to a solution of 31.5 parts of 1-phenyl-2-aminopropane in 150 parts of methanol. Thereafter, 0.2 part of platinum oxide was added to the reaction mixture following which the mixture was reacted with hydrogen, in a shaking vessel, until the theoretical quantity of hydrogen had been taken up. When the hydrogenation reaction was completed, the catalyst was removed by filtration and the filtrate neutralized with hydrochloric acid. Subsequently, the filtrate was evaporated to dryness and recrystallized from isopropyl alcohol. The thus-obtained N-(3-chloropropyl)- α -methylphenethylamine hydrochloride melted at 128°C to 130°C.

References

Merck Index 5618

Kleeman & Engel p. 549

OCDs Vol. 2 p. 47 (1980)

DOT 6 (4) 133 (1970)

I.N. p. 587

Schuler, W.A., Schlichtegroll, A.V., Beschke, H. and Klingler, K.H.; U.S. Patent 3,485,926; December 23, 1969; assigned to Hoffmann-LaRoche, Inc.

MEFRUSIDE

Therapeutic Function: Diuretic

Chemical Name: 4-chloro-N'-methyl-N'[(tetrahydro-2-methyl-2-furanyl)methyl]-1,3-benzenedisulfonamide

Common Name: —

Structural Formula:

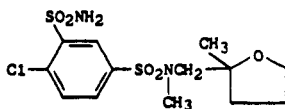

Chemical Abstracts Registry No.: 7195-27-9

Trade Name	Manufacturer	Country	Year Introduced
Baycaron	Bayer	W. Germany	1967
Mefrusal	Bayropharm	Italy	1969
Baycaron	Bayer	U.K.	1971
Baycaron	Yoshitomi	Japan	1975
Bendigon	Bayer	W. Germany	—

Trade Name	Manufacturer	Country	Year Introduced
Caprinol	Bayer	W. Germany	—
Sali-Presinol	Bayer	W. Germany	—

Raw Materials

α -methyl- α -cyanotetrahydrofuran
 Hydrogen
 Dimethyl sulfate
 4-Chloro-3-sulfamyl benzene sulfochloride

Manufacturing Process

By hydrogenation of α -methyl- α -cyanotetrahydrofuran with Raney nickel as catalyst, α -methyl- α -tetrahydrofurfuryl amine is obtained (BP 48°C/12 mm Hg) which is alkylated by dimethyl sulfate to give α -methyl- α -tetrahydrofurfurylmethylamine (BP 70°C/40 mm Hg). The amine is then reacted with 4-chloro-3-sulfamyl benzene sulfochloride in the presence of an acid acceptor. The mixture is stirred overnight, the solvent (acetone or pyridine) is driven off under vacuum and the residue is recrystallized from alcohol.

References

Merck Index 5621

Kleeman & Engel p. 550

OCDS Vol. 1 p. 134 (1977)

I.N. p. 588

Horstmann, H., Wollweber, H. and Meng, K.; British Patent 1,031,916; June 2, 1966; assigned to Farbenfabriken Bayer AG, Germany

Horstmann, H., Wollweber, H. and Meng, K.; U.S. Patent 3,356,692; December 5, 1967; assigned to Farbenfabriken Bayer AG

MEGESTROL ACETATE

Therapeutic Function: Cancer chemotherapy

Chemical Name: 17 α -hydroxy-6-methylpregna-4,6-diene-3,20-dione acetate

Common Name: —

Structural Formula:

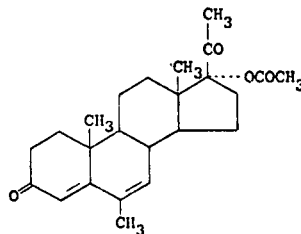

Chemical Abstracts Registry No.: 595-33-5

Trade Name	Manufacturer	Country	Year Introduced
Megestat	Bristol	W. Germany	1964
Megace	Bristol	U.K.	1967

Trade Name	Manufacturer	Country	Year Introduced
Megace	Mead Johnson	U.S.	1982
Pallace	Bristol	U.S.	1982
Megestat	Bristol	Switz.	1983
Megeron	Neofarma	Finland	—
Minigest	Novo	—	—
Niagestin	Novo	—	—
Ovarid	Glaxo	—	—
Volplan	B.D.H.	U.K.	—

Raw Materials

17 α -Acetoxy-3 β -hydroxy-6-methylpregn-5-ene-20-one
 Aluminum-t-butoxide
 p-Benzoquinone

Manufacturing Process

The following preparation is given in U.S. Patent 3,356,573. 17 α -Acetoxy-3 β -hydroxy-6-methylpregn-5-en-20-one (1 g), aluminum tert-butoxide (1 g) and p-benzoquinone (6 g) were dissolved in dry benzene (100 ml) and the mixture was heated under reflux for 30 minutes. The reaction mixture was cooled and washed with potassium hydroxide solution until the benzene layer was colorless. The benzene was washed with water, dried and evaporated to dryness under reduced pressure. The residue crystallized from aqueous methanol to give 17 α -acetoxy-6-methylpregna-4,6-diene-3,20-dione, needles, MP 214° to 216°C.

References

Merck Index 5623

Kleeman & Engel p. 550

PDR p. 721

OCDS Vol. 1 p. 180 (1977)

DOT 4 (1) 17 (1968)

I.N. p. 588

REM p. 993

Dodson, R.M. and Sollman, P.B.; U.S. Patent 2,891,079; June 16, 1959; assigned to G.D. Searle & Co.

Kirk, D.N., Petrow, V. and Williamson, D.M.; U.S. Patent 3,356,573; December 5, 1967; assigned to The British Drug Houses Limited, England

Cross, A.D.; U.S. Patent 3,400,137; September 3, 1968; assigned to Syntex Corporation, Panama

MELITRACEN

Therapeutic Function: Antidepressant

Chemical Name: 3-(10,10-Dimethyl-9(10H)-anthracenylidene)-N,N-dimethyl-1-propanamine

Common Name: —

Structural Formula:

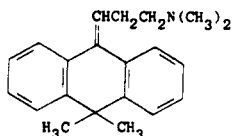

Chemical Abstracts Registry No.: 5118-29-6; 10563-70-9 (Hydrochloride)

Trade Name	Manufacturer	Country	Year Introduced
Trausabun	Lusofarma	W. Germany	1965
Meixeran	Lusofarma	Italy	1975
Dixeran	Lundbeck	—	—
Thymeol	Takeda	Japan	—

Raw Materials

2-o-Benzoylphenylpropanol-2	Magnesium
Dimethylaminopropyl chloride	Sulfuric acid
Hydrogen chloride	

Manufacturing Process

24 g of 2-o-benzoylphenylpropanol-2 (MP 116°C) were dissolved in 250 ml of anhydrous ether and the resulting solution was added dropwise while stirring to a suspension of 0.22 mol of dimethylaminopropylmagnesium chloride in 100 ml of ether. The reaction mixture was refluxed for one hour on a steam bath, and water and dilute hydrochloric acid were added until the reaction was pH 4-5. The aqueous phase was separated and 60 ml of concentrated aqueous ammonia were added. The mixture was extracted with ether, and the ether phase was separated, dried and evaporated in a steam bath. The residue was dissolved in hot petroleum ether and the solution left standing to cool for some time, whereupon 4-dimethylamino-1-phenyl-1-[2-(2-hydroxy-2-propyl)phenyl]-butanol-1 crystallized out as white crystals which were sucked off. After drying they melted at 88°C to 90°C.

10 g of this compound were cautiously dissolved in 50 ml of concentrated sulfuric acid under cooling and the mixture was kept at room temperature for 24 hours, whereupon the reaction mixture was poured into 200 g of finely crushed ice, and concentrated aqueous ammonia was added to about pH 9, whereupon the oil which separated out was extracted with ether. The ether phase was separated, dried and the ether evaporated on a steam bath. The residue was dissolved in 20 ml of acetone and the solution neutralized with a solution of dry hydrogen chloride in ether. The white crystals of 9-γ-dimethylaminopropylidene-10,10-dimethyl-9,10-dihydroanthracene hydrochloride which separated out was filtered off and dried. Yield 9 g, MP 245°C to 247°C.

References

- Merck Index 5642
 Kleeman & Engel p. 552
 OCDS Vol. 2 p. 220 (1980)
 I.N. p. 589
 Holm, T.O.; U.S. Patent 3,190,893; June 22, 1965; assigned to Kefalas A/S (Denmark)

MELPERONE

Therapeutic Function: Neuroleptic

Chemical Name: 1-(4-Fluorophenyl)-4-(4-methyl-1-piperidinyl)-1-butanone

Common Name: Flubuperone; methylperone

Structural Formula:

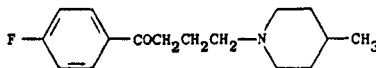

Chemical Abstracts Registry No.: 3575-80-2; 1622-79-3 (Hydrochloride)

Trade Name	Manufacturer	Country	Year Introduced
Eunerpan	Nordmark	W. Germany	1965
Buronil	Ferrosan	Sweden	—

Raw Materials

γ -Chloro-p-fluorobutyrophenone
4-Methylpiperidine

Manufacturing Process

A solution or dispersion consisting of 20.1 g (0.1 mol) of γ -chloro-p-fluorobutyrophenone, 19.8 g (0.2 mol) of 4-methylpiperidine and 0.1 g of potassium iodide in 150 ml toluene is heated in a sealed glass tube for 15 hours at 100°C to 110°C. The potassium iodide and the 4-methylpiperidine hydrochloride formed in the reaction are separated by filtration and the solvent removed from the filtrate by evaporation in vacuum on a steam bath. The residue is distilled and the fraction obtained at 120°C to 125°C and at a pressure lower than 0.1 mm Hg is collected. The base is dissolved in ether and the 4-fluoro- γ -(4-methylpiperidino)-butyrophenone precipitated as the hydrochloride. The reaction product is purified by recrystallization in ethanol/ether.

Yield 22.0 g (73% of theory). MP 209°C to 211°C.

References

Merck Index 5645

Kleeman & Engel p. 552

I.N. p. 590

Hernestam, S.E.H., Sterner, N.O.B. and Lassen, J.; U.S. Patent 3,816,433; June 11, 1974; assigned to A.B. Ferrosan (Sweden)

MELPHALAN

Therapeutic Function: Cancer chemotherapy

Chemical Name: 4-[bis(2-chloroethyl)amino]-L-phenylalanine

Common Name: Alanine nitrogen mustard; L-sarcoslysine

Structural Formula

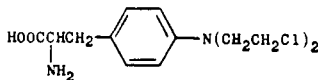

Chemical Abstracts Registry No.: 148-82-3

Trade Name	Manufacturer	Country	Year Introduced
Alkeran	Burroughs-Wellcome	U.S.	1964
Alkeran	Wellcome	U.K.	1964
Alkeran	Wellcome	W. Germany	1965
Alkeran	Wellcome	France	1966
Alkeran	Wellcome	Italy	1968
Alkeran	Wellcome	Japan	1979

Raw Materials

Diethyl sodium phthalimidomalonate
 p-Nitrobenzoyl chloride
 Cinchonidine
 Hydrogen
 Phosphorus oxychloride

Sodium carbonate
 Acetic anhydride
 Hydrogen chloride
 Ethylene oxide

Manufacturing Process

Diethyl sodium phthalimidomalonate (Barger and Weichselbaum, *Organic Syntheses*, 1943, Coll. Vol. II, 384) (6.52 g) was dissolved in boiling methyl ethyl ketone (80 ml) and a solution of p-nitrobenzyl chloride (3.44 g; 1.0 mol) in the same solvent (20 ml) was added. Sodium iodide (ca 0.5 g) dissolved in hot methyl ethyl ketone (10 ml) was introduced, and produced an immediate precipitation. The mixture was refluxed for 1.5 hours, cooled, filtered, evaporated under vacuum and the residual gum crystallized from ethanol. The diethyl-p-nitrobenzyl-phthalimidomalonate formed colorless prisms (88%), MP 103° to 105°C, sharpening to 104° to 105°C on recrystallizing from ethanol.

Diethyl-p-nitrobenzyl-phthalimidomalonate (70 g) and sodium carbonate (70 g) in water (700 ml) were refluxed overnight with mechanical stirring (to avoid bumping). The clear brown solution was acidified with hydrochloric acid and refluxing and stirring were continued for a further 40 minutes. The mixture was cooled and the colorless precipitate (31 g) collected. A second crop (18.5 g) was obtained on evaporation of the mother liquors. Crystallization from aqueous ethanol gave the compound N-carboxybenzoyl-p-nitro-DL-phenylalanine as small needles, MP 198° to 200°C.

The N-carboxybenzoyl compound (2.7 g) was refluxed for 30 minutes with acetic anhydride (10 ml), the mixture taken to dryness (vacuum) and the residue heated with water. The cooled gummy product became granular on rubbing and crystallized from methyl ethyl ketone-petrol or aqueous ethanol in almost colorless needles, MP 184° to 186°C, of p-nitro-N-phthaloyl-DL-phenylalanine.

A solution of p-nitro-N-phthaloyl-DL-phenylalanine (1.0 g) in methanol (25 ml) and a solution of cinchonidine (0.865 g) in methanol (30 ml) were mixed. Crystallization soon set in. The mixture was left overnight, and the colorless needles (0.97 g), MP 209° to 210°C, collected. After two recrystallizations from methanol the cinchonidine salt of the D-acid had MP 211°C.

Evaporation of the mother liquors from the original cinchonidine experiment gave a gum which crystallized readily from aqueous ethanol in almost colorless needles (0.73 g), MP 191° to 192.5°C. Two recrystallizations from aqueous ethanol gave the cinchonidine salt of the L-acid, MP 192.5° to 194°C. To the salt (2.9 g) in warm ethanol (50 ml) was added water (50 ml) and a slight excess (ca 10 ml) of N aqueous sodium hydroxide. The mixture was diluted with water, cooled, filtered from the precipitated base and the filtrate acidified with hydrochloric acid. Refluxing with 2 N ethanolic hydrogen chloride yielded p-nitro-N-phthaloyl-L-phenylalanine ethyl ester, according to U.S. Patent 3,032,585.

Then, as described in U.S. Patent 3,032,584, ethyl N-phthaloyl p-nitrophenylalaninate (9.0 g) was hydrogenated in a mixture of ethyl acetate (120 g) and methanol (80 g) with a palladium-calcium carbonate (1% Pd) catalyst (1.4 g). When gas uptake was complete, the filtrate from the hydrogenation mixture was evaporated under reduced pressure. The residual gum was taken up in ether, the solution filtered, and a slight excess of a dry ethereal hydrogen chloride solution added slowly with stirring. The gummy precipitate became granular on rubbing and the ether-washed product was crystallized from ethyl acetate-acetone [1st crop, 2.8 g, MP 188° to 192°C (decomp.); 2nd crop, 3.9 g, MP 189° to 192°C (decomp.)]. Part of the first batch was recrystallized from ethyl acetate and gave very slightly tinted needles, MP 188° to 190°C (decomp.) of ethyl N-phthaloyl p-amino-phenylalaninate hydrochloride.

The free base was obtained from the hydrochloride by adding a slight excess of dilute ammonium hydroxide to the aqueous solution, and crystallizing the product from aqueous methanol. A further recrystallization with charcoal treatment gave almost colorless needles, MP 110° to 112°C of ethyl N-phthaloyl p-aminophenylalaninate.

Ethyl N-phthaloyl p-aminophenylalaninate (3.15 g) (unrecrystallized) was suspended in water (50 g) and glacial acetic acid (30 g) added. To the clear solution, ethylene oxide (8.0 g) was added, the mixture allowed to stand for 17 hours, and then poured into water (350 g). The solution was neutralized with sodium hydrogen carbonate and the liberated gum extracted with ether. The ethereal solution was dried (magnesium sulfate) and evaporated. The residual gum (3.95 g) was dissolved in benzene (50 g) and the solution dried azeotropically by distilling off some of the solvent. Freshly distilled phosphorus oxychloride (8 g) was added and the mixture heated under reflux for 30 minutes.

The solvent was evaporated off under reduced pressure, and the residual gum refluxed with concentrated hydrochloric acid (50 g) for 6 hours. The solution was allowed to cool overnight. It was filtered from the phthalic acid crystals, and freeze-dried, and to the pink residue was added acetone (160 g) and ethyl acetate (50 g). The mixture was left in the cold room overnight and the clear pink supernatant liquid poured off. The pink gummy hydrochloride remaining in the flask was dissolved in water (20 g), saturated sodium acetate solution added until precipitation was complete, and the product collected and dried in a desiccator. The crude p-bis-(2-chloroethyl)-aminophenylalanine (3.6 g) was crystallized from methanol giving colorless needles, MP 172° to 174°C (decomp.) of p-bis-(2-chloroethyl)-aminophenylalanine.

References

Merck Index 5646

Kleeman & Engel p. 552

PDR p. 733

OCDs Vol. 2 p. 120 (1980)

I.N. p. 590

REM p. 1151

Bergel, F. and Stock, J.A.; U.S. Patent 3,032,584; May 1, 1962; assigned to National Research Development Corporation, England

Bergel, F. and Stock, J.A.; U.S. Patent 3,032,585; May 1, 1962; assigned to National Research Development Corporation, England

MEMANTINE

Therapeutic Function: Spasmolytic

Chemical Name: 3,5-Dimethyltricyclo[3.3.1.1^{3,7}]decanol-1-amine

Common Name: —

Structural Formula:

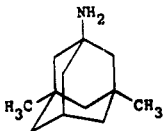

Chemical Abstracts Registry No.: —

Trade Name	Manufacturer	Country	Year Introduced
Akatinol	Merz	W. Germany	1983

Raw Materials

1,3-Dimethyladamantane	Bromine
Acetonitrile	Sulfuric acid
Sodium hydroxide	Hydrogen chloride

Manufacturing Process

A mixture of 24 g of 1,3-dimethyladamantane and 80 ml of bromine was refluxed for 6 hours. The reaction product mixture was cooled, taken up in about 200 ml of chloroform, and poured onto ice. The excess bromine was removed by adding sodium hydrosulfite. The chloroform layer was separated from the aqueous layer, dried, concentrated in vacuo, and distilled at reduced pressure to yield 30.5 g of product having a boiling point of about 118°C at 5–6 mm; $n_D^{25} = 1.5169-1.5182$. The product was identified by nuclear magnetic resonance (NMR) and elemental analyses as 1-bromo-3,5-dimethyladamantane.

A mixture of 20 g of 1-bromo-3,5-dimethyladamantane, 75 ml of acetonitrile, and 150 ml of concentrated sulfuric acid was allowed to react overnight at ambient room temperature. The red reaction product mixture was poured over crushed ice, and the white solid which precipitated was taken up in benzene and the benzene solution dried over sodium hydroxide pellets. The benzene solution was filtered from the drying agent and evaporated to dryness in vacuo to yield 18.2 g of product having a melting point of about 97°C and identified by infrared spectrum as 1-acetamido-3,5-dimethyladamantane.

A mixture of 18 g of 1-acetamido-3,5-dimethyladamantane, 38 g of sodium hydroxide, and 300 ml of diethylene glycol was refluxed for a period of 6 hours. The reaction product mixture was cooled and poured onto about 2,000 ml of crushed ice. The basic solution thus obtained was extracted five times with 250-ml portions of benzene and the aqueous layer was discarded. The combined benzene extracts were dried over sodium hydroxide and the dried benzene solution concentrated in vacuo to give a crude oil weighing 14 g and having $n_D^{25} = 1.4941$. A 4 g sample of the crude oil was dissolved in ether and the solution saturated with anhydrous hydrogen chloride. The solid which precipitated was filtered off and recrystallized from a mixture of alcohol and ether to yield product weighing 3.5 g and melting at 258°C. It was identified by analysis as 1-amino-3,5-dimethyladamantane hydrochloride.

References

- Merck Index A-7
 DFU 1 (9) 427 (1976)
 DOT 19 (6) 303 (1983)
 I.N. p. 590
 Mills, J. and Krumkalns, E.; U.S. Patent 3,391,142; July 2, 1968; assigned to Eli Lilly & Co.

MENADIOL SODIUM DIPHOSPHATE

Therapeutic Function: Prothrombogenic vitamin

Chemical Name: 2-Methyl-1,4-naphthalenediol diphosphoric acid ester tetrasodium salt

Common Name: —

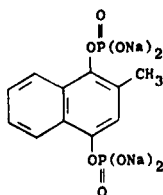
Structural Formula:**Chemical Abstracts Registry No.:** 131-13-5; 84-98-0 (Phosphate)

Trade Name	Manufacturer	Country	Year Introduced
Synkayvite	Roche	U.S.	1941
Analogue	Upjohn	U.S.	1951
Kappadione	Lilly	U.S.	1956
Carbocaina	Pierrel	Italy	—
Katij	Takeda	Japan	—
Thylokay	Squibb	—	—

Raw Materials

2-Methyl-1,4-naphthohydroquinone
Phosphorus oxychloride
Sodium hydroxide

Manufacturing Process

2,000 g 2-methyl-1,4-naphthohydroquinone diphosphoryl chloride (from the quinone and POCl_3) are dissolved in 2 liters ether and decomposed with 2 liters distilled water. The mixture is transferred to a separatory funnel and the aqueous layer separated from the ether layer, the latter being discarded. The aqueous layer is extracted with a further 2 liters of ether and again separated and discarded. The aqueous solution of the 2-methyl-1,4-naphthohydroquinone diphosphoric acid is extracted with successive portions of isobutyl carbinol in 500 cc quantities until the aqueous layer becomes almost colorless, after which this latter is discarded. The isobutyl carbinol solution is then concentrated to remove water and hydrochloric acid, and the crystalline residue neutralized with sodium hydroxide solution. The resulting solution of the sodium salt of 2-methyl-1,4-naphthohydroquinone diphosphoric ester is extracted with two successive portions of 1 liter acetone each and the latter discarded. Methanol and acetone are then added, filtered, and the product brought to crystallization by heating. Crystals of the sodium salt of 2-methyl-1,4-naphthohydroquinone diphosphoric acid ester are sucked off. The substance contains much moisture of crystallization and is dried in vacuum until it contains 21–22% moisture of crystallization as determined by drying at 145°C at 2 mm vacuum.

References

Merck Index 5649
Kleeman & Engel p. 553
PDR p. 1502
I.N. p. 591
REM p. 1010
Solmsen, U.V.; U.S. Patent 2,345,690; April 4, 1944; assigned to Hoffmann-LaRoche, Inc.

MENBUTONE**Therapeutic Function:** Choleric

Chemical Name: 4-Methoxy-6-oxo-1-naphthalene butanoic acid

Common Name: Methonaphthone

Structural Formula:

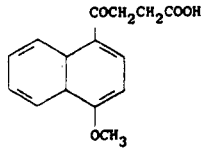

Chemical Abstracts Registry No.: 3562-99-0

Trade Name	Manufacturer	Country	Year Introduced
Hepalande	Dejalande	W. Germany	1977
Sintobilina	A.F.I.	Italy	—

Raw Materials

α -Methoxynaphthalene	Succinic anhydride
Aluminum chloride	Hydrogen chloride
Sodium carbonate	

Manufacturing Process

395 parts of α -methoxynaphthalene and 265 parts of succinic anhydride are dissolved in 8,000 parts of dry benzene at room temperature. The resulting solution is stirred and 710 parts of anhydrous aluminum chloride are added over a period of twenty minutes. During the addition the temperature of the reaction mixture rises to about 60°C to 70°C. After the addition the reaction mixture is stirred for fifteen or twenty minutes at 60°C to 70°C and then refluxed for one hour. The hot reaction mixture is then poured onto a mixture of 5,000 parts of ice and 900 parts of concentrated hydrochloric acid. The benzene is removed by steam distillation and the hot aqueous residue is filtered to remove the insoluble β -(1-methoxy-4-naphthoyl)-propionic acid. The residue of the latter is dried and then dissolved in 16,000 parts of hot water containing 300 parts of sodium carbonate. The hot solution is treated with activated charcoal, filtered while hot, chilled and acidified. The residue of purified acid is collected on a filter, washed with water, and dried at 65°C. A yield of 552 parts of purified β -(1-methoxy)-4-naphthoyl)propionic acid, melting at 172°C to 173°C is obtained.

References

Merck Index 5656

I.N. p. 592

Burtner, R.R.; U.S. Patent 2,623,065; December 23, 1952; assigned to G.D. Searle & Co.

MEPAZINE

Therapeutic Function: Tranquilizer

Chemical Name: 10-[(1-Methyl-3-piperidinyl)methyl]-10H-phenothiazine

Common Name: Mepasin, pecazine

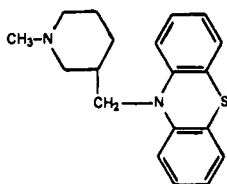
Structural Formula:

Chemical Abstracts Registry No.: 60-89-9; 2975-36-2 (Hydrochloride)

Trade Name	Manufacturer	Country	Year Introduced
Pacatal	Warner Lambert	U.S.	1957
Pacatal	Promonta	W. Germany	—
Lacumin	Lundbeck	—	—
Ravenil	Caber	Italy	—

Raw Materials

1-Methyl-3-bromomethylpiperidine	Phenothiazine
Sodium amide	Acetic acid

Manufacturing Process

A 500 cc flask equipped with a mechanical stirrer, reflux condenser and a soda-lime tube was filled with 230 cc of absolute xylene, 27.5 g of 1-methyl-3-bromomethylpiperidine, 53.3 g of phenothiazine and 14.2 g of finely powdered sodium amide, and the solution was heated under reflux for 6 hours. After cooling water was added and the batch was extracted with ether. As the hydrochloric acid salt of the obtained phenothiazine derivative is difficultly soluble in water, the further processing was carried out by way of the acetate. The etheric solution was extracted several times in a separating funnel with dilute acetic acid. The combined aqueous extracts were basified, extracted with ether, dried with potassium carbonate and, after removal of the ether, distilled in vacuo.

Yield = 64%; boiling point 230°C to 235°C at 4 mm; melting point of hydrochloride is 180°C to 181°C.

References

Merck Index 5672

Kleeman & Engel p. 689

I.N. p. 735

Schuler, W.A.; U.S. Patent 2,784,185; March 5, 1957; assigned to Chemische Fabrik Promonta GmbH

MEPENZOLATE BROMIDE

Therapeutic Function: Antispasmodic

Chemical Name: 3-[(hydroxydiphenylacetyl)oxy]-1,1-dimethylpiperidinium bromide

Common Name: N-methyl-3-piperidyl benzilate methobromide

Structural Formula:

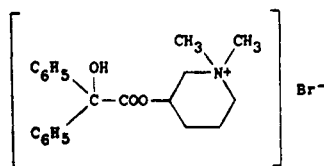

Chemical Abstracts Registry No.: 76-90-4

Trade Name	Manufacturer	Country	Year Introduced
Cantil	Merrell National	U.S.	1956
Cantilon	Draco	Sweden	—
Colibantil	Tosi-Novara	Italy	—
Colum	Jamco	Italy	—
Eftoron	Maruko	Japan	—
Gastropodil	Fabo	Italy	—
Sachicoron	Zensei	Japan	—
Tendalin	Nihon Yakuhiin	Japan	—
Tralanta	Sawai	Japan	—
Trancolon	Fujisawa	Japan	—

Raw Materials

N-Methyl-3-chloropiperidine
Benzilic acid
Methyl bromide

Manufacturing Process

A mixture containing 8 g (0.06 mol) of N-methyl-3-chloro-piperidine and 13.6 g (0.06 mol) of benzilic acid in 50 cc of anhydrous isopropyl alcohol was refluxed for 3 days; the isopropyl alcohol was removed by distillation in vacuo, the residue treated with dilute aqueous hydrochloric acid and the aqueous acid mixture extracted repeatedly with ether. The aqueous phase was separated, made strongly alkaline with 20% aqueous sodium hydroxide and extracted with ether. The ether extracts were dried with potassium carbonate and distilled; the product was collected at 175° to 176°C (0.03 mm), yield 11.5 g (59%). The ester base thus prepared was then dissolved in 75 cc of isopropyl alcohol and 3.4 g (0.037 mol) methyl bromide added. The reaction mixture was allowed to stand at 30°C for 2 days and the product isolated by filtration, yield, 13 g (87%), MP 228° to 229°C dec.

References

Merck Index 5673
Kleeman & Engel p. 555
PDR p. 1223
I.N. p. 593
REM p. 916
Biel, J.H.; U.S. Patent 2,918,408; December 22, 1959; assigned to Lakeside Laboratories, Inc.

MEPERIDINE HYDROCHLORIDE

Therapeutic Function: Narcotic analgesic

Chemical Name: 1-methyl-4-phenyl-4-piperidinecarboxylic acid ethyl ester hydrochloride

Common Name: Isonipecaine hydrochloride; pethidine hydrochloride

Structural Formula:

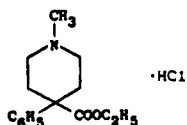

Chemical Abstracts Registry No.: 50-13-5; 57-42-1 (Base)

Trade Name	Manufacturer	Country	Year Introduced
Dolosal	Specia	France	1943
Dolantin	Hoechst	W. Germany	1943
Demerol	Winthrop	U.S.	1944
Algil	Maggioni	Italy	—
Alodan	Gerot	Austria	—
Centralgin	Amino	Switz.	—
Demer-Idine	Sabex	Canada	—
Dolanquifa	Uquifa	Spain	—
Dolcontral	Arzneimittelwerk Dresden	E. Germany	—
Dolestine	Teva	Israel	—
Doloneurin	O.P.G.	Neth.	—
Dolopethin	Gattiker	Switz.	—
Medfina	Carlo Erba	—	—
Pethidine Roche	Roche	U.K.	—
Supposal	Specia	France	—

Raw Materials

Diethanol methylamine	Thionyl chloride
Sodium amide	Benzyl cyanide
Sulfuric acid	Ethanol
Hydrogen chloride	

Manufacturing Process

80 parts of finely pulverized sodium amide are added in portions each of about $\frac{1}{5}$ of the entire quantity, while stirring and cooling in a suitable manner, to a mixture of 156 parts of methyl-di(β -chloroethyl)-amine (prepared from di-ethanol-methylamine by means of thionyl chloride), 117 parts of benzyl cyanide and 600 parts of toluene. The reaction sets in at once at room temperature. The temperature is maintained between 30° and 40°C; when self-heating no longer occurs a further portion of the sodium amide is introduced. During the reaction heat is liberated and gaseous ammonia escapes.

The mixture is then slowly heated to the boiling point of toluene and kept boiling for one hour under reflux. After the mixture has been allowed to cool the sodium chloride which precipitates is separated by extraction with water. The solution of toluene is then extracted with dilute hydrochloric acid. From the hydrochloric acid extract the basic substance is separated in the form of an oil by means of caustic soda solution and is introduced into ether. The ethereal solution is dried with the aid of potassium carbonate and then distilled.

Under a pressure of 4.5 ml the 1-methyl-4-phenyl-piperidine-4-carboxylic acid nitrile passes over at a temperature of about 148°C in the form of a colorless oil; under a pressure of 6 ml it passes over at about 158°C. After having been allowed to cool the distillate solidifies completely to form a crystalline mass. Its solidification point is at 53°C; the yield amounts to about 135 parts, that is, about $\frac{2}{3}$ of the theoretical yield. When recrystallized from isopropyl alcohol the hydrochloride of the nitrile forms colorless crystals, readily soluble in water and melting at 221° to 222°C.

The nitrile may best be saponified with methyl alcoholic potash while heating to 190° to 200°C with application of pressure. After the methyl alcohol has evaporated the salt is introduced into water and by the addition of dilute mineral acid until the alkaline reaction to phenolphthalein has just disappeared, the amphoteric 1-methyl-4-phenyl-piperidine-4-carboxylic acid is precipitated while hot in the form of a colorless, coarsely crystalline powder. When dried on the water bath the acid still contains 1 mol of crystal water which is lost only at a raised temperature. The acid melts at 299°C. Reaction with ethanol yields the ester melting at 30°C and subsequent reaction with HCl gives the hydrochloride melting at 187° to 188°C.

References

Merck Index 5674

Kleeman & Engel p. 707

PDR pp. 872, 1908, 1959, 1989

OCDS Vol. 1 p. 300 (1977); 2, 328 (1980) & 3, 116 (1984)

I.N. p. 750

REM p. 1108

Eisleb, O.; U.S. Patent 2,167,351; July 25, 1939; assigned to Winthrop Chemical Company, Inc.

MEPHENESIN

Therapeutic Function: Skeletal muscle relaxant

Chemical Name: 3-(2-Methylphenoxy)-1,2-propanediol

Common Name: o-Cresyl glycerol ether, glyceryl o-tolyl ether, cresoxypropanediol, cresoxydiol

Structural Formula:

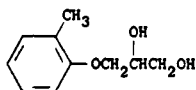

Chemical Abstracts Registry No.: 59-47-2

Trade Name	Manufacturer	Country	Year Introduced
Tolserol	Squibb	U.S.	1948
Oranixon	Organon	U.S.	1949
Avosyl	Schenley	U.S.	—
Curaresin	Kyoto	Japan	—
Decontractyl	Robert & Carriere	France	—
Glyotol	U.S. Standard	U.S.	—
Myanesin	B.D.H.	U.K.	—
Myanol	Chugai	Japan	—
Myocuran	Deutsch. Hydrierwerk	E. Germany	—
Myoserol	Sankyo	Japan	—
Myoxane	Ascher	U.S.	—
Noctynol	Moore	U.K.	—
Prolax	Cole	U.S.	—
Relaxar	Bouty	Italy	—
Rhex	Hobein	W. Germany	—
Spasmolyn	Heun	U.S.	—
Tolosate	Brewer	U.S.	—

Trade Name	Manufacturer	Country	Year Introduced
Tolulox	Miller	U.S.	—
Tolyspaz	Chicago Pharmacal	U.S.	—

Raw Materials

meta-Cresol
Glycerol

Manufacturing Process

Into an iron or copper reaction vessel having an efficient stirring device and furnished with a refluxing column and condenser, were charged 330 lb of high quality meta-cresol and 150 lb of glycerol, together with 25 lb of sodium acetate to serve as the catalyst in the reaction. The reaction mixture, of this composition, was then heated to 250°C. The water of the reaction distilled off during the heating as the ether formation proceeded, this removal of water from the reaction chamber being promoted by the presence of the excess of phenol, some of which also continued to distill over. Towards the end of the reaction, after about 12 hours, when about 60% of the glycerol had been converted, at which point the reaction slowed down and the distillate was mainly cresol, the batch was cooled and 50 gallons of water were added to it along with 150 lb of xylene. As the result of these additions and the cooling down of the material the batch stratified into an aqueous layer containing unreacted glycerol, poly-glycerols and sodium acetate, and a nonaqueous layer containing the ethers that had been formed in the reaction, together with unreacted cresol which remained in the reaction chamber, dissolved in the xylene that had been added to the batch. The aqueous layer was then separated and the water content removed therefrom by evaporation to a degree suitable for the recovery of the glycerol and sodium acetate contents of the layer, for their reuse in the process in a succeeding batch therein. The separated nonaqueous layer containing the ethers was distilled to recover the xylene and cresol contents respectively as the early fractions of the layer thus subjected to distillation. The cresol thus recovered, together with the cresol recovered from the distillate obtained during the heating of the reaction mixture, was returned to the process for reuse in a succeeding batch. Redistillation of the ether mixture recovered is usually necessary and desirable, particularly from the point of view of removing last traces of cresol therefrom. The yield of mixed ethers in this example was about 200 lb, in the relative proportions stated of about 70 parts of monoether to 30 of diether.

References

Merck Index 5675
Kleeman & Engel p. 556
OCDS Vol. 1 p. 118 (1977)
I.N. p. 593
Carroll, M.F. and A. Boake Roberts & Co., Ltd.; British Patent 589,821; July 1, 1947

MEPHENESIN CARBAMATE

Therapeutic Function: Skeletal muscle relaxant

Chemical Name: 3-(2-Methylphenoxy)-1,2-propanediol 1-carbamate

Common Name: —

Structural Formula:

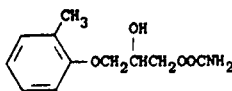

Chemical Abstracts Registry No.: 533-06-2; 59-47-2 (Base)

Trade Name	Manufacturer	Country	Year Introduced
Tolseram	Squibb	U.S.	1954
Kinavosyl	Schenley	U.S.	—

Raw Materials

3-o-Toloxyl-1,2-propanediol
Phosgene
Ammonia

Manufacturing Process

A solution of 32 g (0.30 mol) phosgene in 200 ml benzene is added dropwise at 30°C to a stirred solution of 53.5 g (0.32 mol) 3-o-toloxyl-1,2-propanediol in 400 ml benzene. The mixture is stirred for an hour after the addition is completed, and a solution of 39 g of dimethylaniline in 100 ml benzene is then added, and stirring continued for a half-hour. Ice water (about one-third volume) is then added, and the benzene layer formed is separated and stirred with 500 ml concentrated ammonia at 5°C for six hours. The precipitated solid (weighing about 55 g) is recovered and recrystallized from water. The product thus obtained in a yield of about 53 g is 3-(o-toloxyl)-2-hydroxypropyl carbamate; it is a crystalline solid melting at about 93°C, and having a lower water-solubility and higher oil-solubility than 3-o-toloxyl-1,2-propanediol.

References

Merck Index 5676

Kleeman & Engel p. 556

OCDS Vol. 1 p. 118 (1977)

I.N. p. 593

Lott, W.A. and Pribyl, E.; U.S. Patent 2,609,386; September 2, 1952; assigned to E.R. Squibb & Sons

MEPHENOXALONE

Therapeutic Function: Tranquilizer

Chemical Name: 5-[(o-Methoxyphenoxy)methyl]-2-oxazolidinone

Common Name: Methoxadone

Structural Formula:

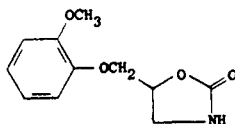

Chemical Abstracts Registry No.: 70-07-5

Trade Name	Manufacturer	Country	Year Introduced
Trepidone	Lederle	U.S.	1961
Tranpoise	Robins	U.S.	1962
Lenetran	Lakeside	U.S.	1962
Xerene	Martinet	France	1964

Trade Name	Manufacturer	Country	Year Introduced
Control-Om	O.M.	Switz.	—
Dorsiflex	Syntex-Medial	Switz.	—
Placidex	Toraude	—	—
Riself	Gibipharma	Italy	—

Raw Materials

3-o-Methoxyphenoxy-2-hydroxy-1-propyl-carbamate
Urea

Manufacturing Process

A mixture of 24.1 g (0.10 mol) of 3-o-methoxyphenoxy-2-hydroxy-1-propyl carbamate and 6.0 g (0.10 mol) of urea was heated rapidly to the temperature range of 180°C to 200°C, and maintained there for five hours. The reaction melt was poured into 50% ethyl alcohol, from which the product crystallized as a white solid. The crude yield was 18.3 g (82%); melting point 131.5°C to 137°C. Crystallization from water and 95% alcohol gave 9.0 g (40.3%) of pure 5-o-methoxyphenoxy-methyl-2-oxazolidone; melting point 141°C to 143°C. This melting point was not depressed when the material was mixed with an authentic sample. In additional runs acetone was used instead of ethyl alcohol with equivalent results.

It was found that when the heating time was reduced to three hours and a reaction temperature of 190°C to 200°C was maintained, equivalent yields (40 to 50%) were obtained, but that the yields were appreciably lowered when the heating time was further reduced to two hours. It was also found that when the temperature was lowered to the range of 170°C to 180°C the yield was significantly lowered.

When the material was isolated by extraction with chloroform and distillation, the yield of pure material was 58.5%.

References

Merck Index 5679

OCDS Vol. 1 p. 119 (1977)

I.N. p. 593

Lunsford, C.D.; U.S. Patent 2,895,960; July 21, 1959; assigned to A.H. Robins Co., Inc.

MEPHENTERMINE

Therapeutic Function: Adrenergic (vasopressor)

Chemical Name: N,α,α-Trimethylbenzene ethanamine

Common Name: —

Structural Formula:

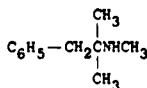

Chemical Abstracts Registry No.: 100-92-5

Trade Name	Manufacturer	Country	Year Introduced
Wyamine	Wyeth	U.S.	1947

Raw Materials

2-(N-Methylamino)-2-methyl-1-phenyl-1-propanol
 Thionyl chloride
 Hydrogen

Manufacturing Process

0.5 g of 2-(N-methylamino)-2-methyl-1-phenyl-1-propanol was treated with 1 cc of thionyl chloride at room temperature. A vigorous reaction set in. The gummy material was stirred with a small amount of petroleum ether and allowed to stand overnight. The brown crystalline solid after washing with petroleum ether was recrystallized from a small amount of absolute alcohol with addition of charcoal followed by filtration. On dilution with several volumes of ether and refrigeration white granular crystals of 1-chloro-2-(N-methylamino)-2-methyl-1-phenyl propane hydrochloride were deposited.

250 mg of 1-chloro-2-(N-methylamino)-2-methyl-1-phenyl propane hydrochloride was dissolved in 2 cc of warm methanol and hydrogenated in the presence of 250 mg of palladium barium carbonate catalyst with provision for the absorption of the carbon-dioxide formed. When the theoretical amount of hydrogen had been taken up the mixture was filtered to remove the catalyst, concentrated to small volume and extracted with ether. After separating the ether the residue was further concentrated yielding a white crystalline solid. This solid on solution in water, strongly alkalinizing, extraction with ether and removal of the ether yielded 2-(N-methylamino)-2-methyl-1-phenyl propane identified as the picrate by melting point 155°C to 156°C and mixed melting point 154.0°C to 154.5°C, with an authentic sample melting at 150°C to 153°C.

References

Merck Index 5680

OCDS Vol. 1 p. 72 (1977)

I.N. p. 593

REM p. 887

Bruce, W.F., Szabo, J.L. and Tubis, S.; U.S. Patent 2,597,445; May 28, 1952; assigned to Wyeth, Inc.

MEPICYCLINE

Therapeutic Function: Antimicrobial

Chemical Name: 4-(dimethylamino)-1,4,4a,5,5a,6,11,12a-octahydro-3,6,10,12,12a-penta-hydroxy-N-[[4-(2-hydroxyethyl)-1-piperazinyl] methyl] -6-methyl-1,11-dioxo-2-naphthacene-carboxamide

Common Name: N-[[4-(2-Hydroxyethyl)-1-piperazinyl] methyl] tetracycline; pipacycline

Structural Formula:

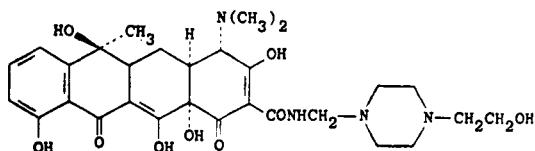

Chemical Abstracts Registry No.: 1110-80-1

Trade Name	Manufacturer	Country	Year Introduced
Sieromicin	Sierchimica	Italy	1962
Ambra-Vena	Lepetit	—	—
Boniciclina	Boniscontro-Gazzone	Italy	—
Tetrasolvina	N.C.S.N.	Italy	—
Valtomicina	Midy	—	—

Raw Materials

N-(β -Hydroxyethyl)diethylene diamine
 p-Formaldehyde
 Tetracycline

Manufacturing Process

1.55 g p-formaldehyde were added to a solution of 7 g N-(β -hydroxyethyl)-diethylene-diamine in 150 cc isopropanol and the whole was heated to 60°C for 30 minutes, to obtain complete dissolution; after cooling the solution to 40°C, 22.2 g of anhydrous tetracycline base were added as a fine powder and the reaction was allowed to proceed for 3 hours with agitation and while passing through a current of dry nitrogen; the solution was then filtered on a Büchner funnel and the filter cake was washed twice with 20 cc isopropanol; the crystalline cake was resuspended in 100 cc anhydrous ether, again filtered and washed 3 times with 50 cc anhydrous ether; finally, it was dried in vacuo and 28.6 g of product were obtained, namely a yield of 98%.

The characteristics of this product are as follows. It is a pale yellow, nonodorous, slightly bitter, crystalline powder, very soluble in water (> 1.5 g/cc), soluble in methanol and formamide, slightly soluble in ethanol and isopropanol, insoluble in ether, benzene and chloroform; MP 162° to 163°C with decomposition (uncorrected).

References

Merck Index 7325

I.N. p. 775

Gradnik, B., Pedrazzoli, A. and Cipelletti, G.; U.S. Patent 3,149,114; September 15, 1964; assigned to Societe d'Etudes de Recherches et d'Applications Scientifiques et Medicales, France

MEPINDOLOL

Therapeutic Function: β -Receptor blocker

Chemical Name: 4-(2-Hydroxy-3-isopropylaminopropoxy)-2-methylindole

Common Name: —

Structural Formula:

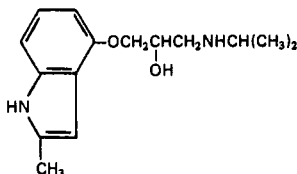

Chemical Abstracts Registry No.: 56396-94-2 (Sulfate)

Trade Name	Manufacturer	Country	Year Introduced
Corindolan	Schering	W. Germany	1980

Raw Materials

4-Benzyloxy-2-dimethylamino-methylindole	Hydrogen
Epichlorohydrin	Isopropylamine

Manufacturing Process

The 4-hydroxy-2-methylindole (MP 112°C to 115°C from benzene/ethyl acetate), used as starting material, may be obtained by hydrogenation of 4-benzyloxy-2-dimethylamino-methylindole (MP 117°C to 120°C from benzene) in the presence of a palladium catalyst (5% on aluminum oxide).

11.6 g of 4-hydroxy-2-methylindole are added to a solution of 3.1 g of sodium hydroxide in 150 cc of water, and then 12.4 cc of epichlorohydrin are added while stirring and in an atmosphere of nitrogen. The reaction mixture is further stirred at room temperature for 24 hours, is extracted 4 times with methylene chloride, and the combined organic layers which have been dried over magnesium sulfate are concentrated by evaporation at reduced pressure. The resulting residue is taken up in 150 cc of dioxane and 50 cc of isopropyl amine, and the mixture is heated to the boil for 6 hours. The reaction mixture is evaporated to dryness at reduced pressure, the residue is shaken 4 times between ethyl acetate and a 1N aqueous tartaric acid solution, and a 5N caustic soda solution is then added to the combined tartaric acid phases until an alkaline reaction is obtained. The alkaline solution is then shaken out 6 times with methylene chloride, the combined extracts are dried over magnesium sulfate, and the solvent is evaporated in a vacuum. The oily viscous residue may be crystallized from ethyl acetate. The title compound has a MP of 95°C to 97°C.

References

Merck Index 5684

DFU 3 (5) 381 (1978)

DOT 17 (10) 426 (1981) & 18 (10) 551 (1982)

I.N. p. 594

Troxler, F. and Hofmann, A.; British Patent 1,260,907; January 19, 1972; assigned to Sandoz, Ltd.

MEPITIOSTANE

Therapeutic Function: Antiestrogenic

Chemical Name: 17 β -(1-Ethoxycyclopentyl)oxy-2 α ,3 α -epithio-5 α -androstane

Common Name: —

Structural Formula:

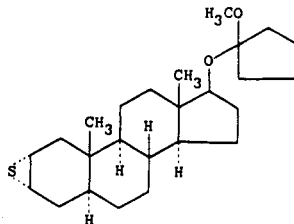

Chemical Abstracts Registry No.: 21362-69-6

Trade Name	Manufacturer	Country	Year Introduced
Thioderon	Shionogi	Japan	1979

Raw Materials

2 α ,3 α -Epithio-5 α -androstan-17 β -ol
Methoxycyclopentene

Manufacturing Process

A mixture of 1.759 g of 2 α ,3 α -epithio-5 α -androstan-17 β -ol, 2.3 ml of 1-methoxycyclopentene, 20 mg of pyridine salt of p-toluenesulfonic acid and 20 ml of t-butanol is stirred for 4 hours at room temperature. The reaction mixture is poured into an aqueous solution of sodium carbonate and the whole extracted with dichloromethane. The extract is dried over anhydrous sodium sulfate and evaporated to remove solvent. Purification of the residue by chromatography over alumina gives 1.487 g of 17 β -(1-methoxycyclopentyl)oxy-2 α ,3 α -epithio-5 α -androstanone. Yield 68.2%. MP 98°C to 101°C.

References

Merck Index 5687
DFU 3 (4) 311 (1978)
Kleeman & Engel p. 557
I.N. p. 594
Komeno, T.; U.S. Patent 3,567,713; March 2, 1971; assigned to Shionogi & Co.

MEPIVACAINE

Therapeutic Function: Local anesthetic

Chemical Name: N-(2,6-dimethylphenyl)-1-methyl-2-piperidinecarboxamide

Common Name: N-methylpipecolic acid 2,6-dimethylanilide

Structural Formula:

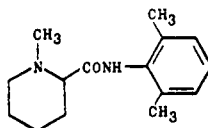

Chemical Abstracts Registry No.: 96-88-8; 16452-56-5 (Hydrochloride)

Trade Name	Manufacturer	Country	Year Introduced
Carboraine	Winthrop	U.S.	1960
Chlorocain	Pharmac. Mfg.	U.K.	—
Isocaine	Novocol	U.S.	—
Meaverin	Woelm Pharma.	W. Germany	—
Mepivastesin	Espe	W. Germany	—
Scandicain	Astra	Sweden	—
Tevacaine	Teva	Israel	—

Raw Materials

Ethyl bromide
N-Methylpipecolic acid ethyl ester

Magnesium
2,6-Dimethylaniline

Manufacturing Process

Ethyl magnesium bromide is prepared in the usual way by reacting 185 parts by weight of ethyl bromide in 800 parts of anhydrous ether with 37 parts by weight of magnesium turnings. Under vigorous stirring 121 parts of 2,6-dimethyl aniline are added at a rate depending on the vigor of the gas evaporation. When the evolution of gas has ceased, 85 parts by weight of N-methylpipercolic acid ethyl ester are added to the 2,6-dimethyl aniline magnesium bromide slurry. The mixture is refluxed for ½ hour with continued stirring, after which it is cooled down. Dilute hydrochloric acid is added carefully in order to dissolve and hydrolyze the magnesium compound formed.

The pH is adjusted to 5.5 and the water phase separated and extracted with additional ether in order to remove the surplus dimethyl aniline. After addition of an excess of ammonia to the solution, the reaction product, N-methylpipercolic acid 2,6-dimethyl anilide, is recovered by extraction with isoamyl alcohol. The isoamyl alcohol solution is evaporated to dryness, the product dissolved in dilute hydrochloric acid, treated with charcoal and reprecipitated with NaOH. N-methylpipercolic acid 2,6-dimethyl anilide is obtained in crystalline form.

References

Merck Index 5688

Kleeman & Engel p. 558

PDR pp. 824, 1906

OCDS Vol. 1 p. 17 (1977)

I.N. p. 594

REM p. 1052

af Ekenstam, B.T. and Egner, B.P.H.; U.S. Patent 2,799,679; July 16, 1957; assigned to AB Bofors, Sweden

Pettersson, B.G.; U.S. Patent 4,110,331; August 29, 1978; assigned to AB Bofors

MEPREDNISONE

Therapeutic Function: Glucocorticoid

Chemical Name: 17,21-dihydroxy-16 β -methylpregna-1,4-diene-3,11,20-trione

Common Name: 16 β -methylprednisone

Structural Formula:

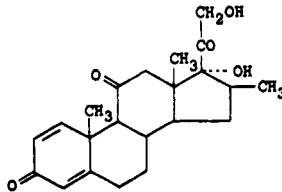

Chemical Abstracts Registry No.: 1247-42-3

Trade Name	Manufacturer	Country	Year Introduced
Betapar	Parke Davis	U.S.	1970
Betalone	Lepetit	France	—
Betapred	Schering	U.S.	—
Corti-Bi	Sidus	Italy	—

Raw Materials

16 β -Methylprednisone-21-acetate
 Potassium bicarbonate
 Bacterium *Bacillus sphaericus* var. *fusiformis*
 Nutrient broth

Manufacturing Process

16 β -Methylprednisone 21-acetate (0.5 g), when hydrolyzed by means of aqueous alcoholic potassium bicarbonate yields 16 β -methylprednisone. An alternative method of the preparation of the compound of this example is as follows. *Bacillus sphaericus* var. *fusiformis* (A.T.C.C. 7055) is incubated on a nutrient agar (composed of Bacto-beef extract, 3 g; Bacto-peptone, 5 g; sodium chloride, 8 g; agar, 15 g; and tap water, 1 liter) for 24 hours at 28°C.

To 100 ml of a sterile nutrient broth (composed of Bacto-beef extract, 3 g; Bacto-peptone, 5 g; per liter of tap water) in a 300 ml flask is added one loopful of the incubated culture and the broth mixture is further incubated for 24 hours at 28°C on a shaking machine. The broth culture so obtained is employed as an inoculum (1%). Into each of ten flasks containing 100 ml of sterile nutrient broth is added 1 ml of the inoculum. The flasks are agitated on a rotary shaker for 8 hours at 28°C at 240 strokes per minute. After this growth period, a solution of 25 mg of 16 β -methylcortisone in 0.5 ml of methanol is aseptically added to each flask which in turn is reshaken and incubated for an additional 24 hours. The final pH is 7.8.

The contents of the flasks are then combined and extracted 3 times with two liters of chloroform per extraction. The combined chloroform extracts are evaporated to dryness yielding 310 mg of crude product. The crude steroid is purified by chromatography on a chromatographic system described by G.M. Shull, *Abstracts of Papers of the 126th Meeting of the American Chemical Society*, December 12-17, 1954, page 9a, paper No. 24. Chromatographic evaluation shows a quantitative conversion of the starting material to the diene when an authentic sample of the 16 β -methylprednisone is used as a control. Alternatively, the crude product is recrystallized from acetone affording 225 mg of 16 β -methylprednisone.

References

Merck Index 5689
 Kleeman & Engel p. 558
 I.N. p. 595
 Rausser, R. and Oliveto, E.P.; U.S. Patent 3,164,618; January 5, 1965; assigned to Schering Corporation

MEPROBAMATE

Therapeutic Function: Tranquilizer

Chemical Name: 2-methyl-2-propyl-1,3-propanediol dicarbamate

Common Name: Procalmadiol; procalmidol

Structural Formula:

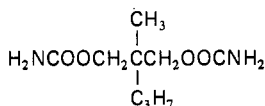

Chemical Abstracts Registry No.: 57-53-4

Trade Name	Manufacturer	Country	Year Introduced
Equanil	Wyeth	U.S.	1955
Miltown	Wallace	U.S.	1955
Mepro tabs	Wallace	U.S.	1957
Meprospan	Wallace	U.S.	1958
Viobamate	Rowell	U.S.	1963
Meprocon	Consol. Midl. Co.	U.S.	1964
Canquill	Canfield	U.S.	1964
Klort	Lemmon	U.S.	1964
Equanil	Clin Midy	France	1967
SK-Bamate	SKF	U.S.	1971
Amepromamat	Arcana	Austria	—
Amosene	Ferndale	U.S.	—
Aneuril	Wyeth	W. Germany	—
Ansietan	Italfarmaco	Italy	—
Ansiowas	Wassermann	Spain	—
Artolon	Roter	Neth.	—
Atraxin	Daiichi	Japan	—
Carb-A-Med	Chemieprodukte	Austria	—
Coprobate	Coastal	U.S.	—
Cyrpon	Tropon	W. Germany	—
Dabrobamat	Dabrowski	W. Germany	—
Dapaz	Alter	Spain	—
Deprol	Wallace	U.S.	—
Dormabrol	Kwizda	Austria	—
Dystoid	Makara	W. Germany	—
Ecuaniil	Orfi	Spain	—
Edenal	Wassermann	Italy	—
Epikur	Agepha	Austria	—
Equagesic	Wyeth	U.S.	—
Erina	Sumitomo	Japan	—
Gene-Bamate	Franca	Canada	—
Harmonin	Yoshitomi	Japan	—
Kesso-Bamate	McKesson	U.S.	—
Lan-Dol	Bio-Chimique	Canada	—
Marbate	Mardale	U.S.	—
Meditran	Medic	Canada	—
Mepavlon	I.C.I.	U.K.	—
Meptrate	DDSA	U.K.	—
mepriam	Lennon	U.S.	—
Mepro	Rekah	Israel	—
Meproban	Draco	Sweden	—
Meprocon CMC	Consol. Midl. Co.	U.S.	—
Meprodiil	Streuli	Switz.	—
Meprodiol	Pirri	Italy	—
Meprol	Lokman	Turkey	—
Meproon	Choseido	Japan	—
Meproon	Hamilton	Australia	—
Meproonel	Heather Drug	U.S.	—
Meproso	Chemipharm	W. Germany	—
Meprotil	Brunner-Tillman	U.S.	—
Meriprobate	Meriot	Canada	—
Microbamat	Werfft	Austria	—
Midixin	Reid-Provident	U.S.	—
Miltaun	Mack	W. Germany	—
Misedant	Lemmon	U.S.	—
M.P. Trantabs	Martin-Phillips	U.S.	—

Trade Name	Manufacturer	Country	Year Introduced
My-Trans	Heather Drug	U.S.	—
Neo-Tran	Neo	Canada	—
Nervonus	Orion	Finland	—
Neuramate	Halsey	U.S.	—
Novamato	Torlan	Spain	—
Novomepro	Novopharm	Canada	—
Oasil	Simes	Italy	—
Paxin	Pierrel	Italy	—
Pensive	Norbrook	U.K.	—
Perequil	Lepetit	Italy	—
PMB Ayerst	Ayerst	U.S.	—
Probasan	I.C.N.	Canada	—
Quietidon	Pharma. Farm. Spec.	Italy	—
Relaksin	Deva	Turkey	—
Restanil	Kabi	W. Germany	—
Sedanyl	Washington	Italy	—
Selene	Biomedica Foscama	Italy	—
Sopanil	Sopar	Belgium	—
Sowell	Cophar	Switz.	—
Stensolo	Salfa	Italy	—
TCM	Zenith	U.S.	—
Trankilin	Biofarma	Turkey	—
Tranlisant	Vita	Canada	—
Trelmar	Elliott-Marion	Canada	—
Urbilat	Hor-Fer-Vit	W. Germany	—
Wescomep	Saunders	Canada	—
Xalogen	Ono	Japan	—

Raw Materials

2-Methyl-2-n-propyl-1,3-propanediol
Phosgene
Ammonia

Manufacturing Process

A solution containing 52.8 parts of 2-methyl-2-n-propyl-1,3-propanediol and 128 parts of acetone is added with stirring to 112 parts of liquid phosgene at such a rate that the temperature of the reaction is maintained at -5° to 0°C . The reaction is stirred one hour at about 0°C then cooled to -15°C . A cooled 30% solution of 32 parts of sodium hydroxide is added with stirring to the reaction at such a rate that the temperature is maintained at -15° to -5°C . The mixture is stirred for an additional $\frac{1}{2}$ hour at about 0°C then cooled to -20°C . 180 parts of cooled ammonium hydroxide solution (28.6% NH_3) are added while cooling and with stirring at such a rate that the temperature rises slowly to 20°C and stirring is continued for an additional $\frac{1}{2}$ hour. The mixture is poured with agitation into 1,700 parts of ice water. The solid which separates is removed by filtration and dried. Recrystallization from water gives 55 parts (63% of theoretical yield) of 2-methyl-2-n-propyl-1,3-propanediol dicarbamate, MP 104° to 105°C .

References

Merck Index 5690
Kleeman & Engel p. 559
PDR pp. 634, 830, 1024, 1606, 1723, 1874, 1880, 1947, 1949
OCDS Vol. 1 p. 218 (1977) & 2, 21 (1980)
I.N. p. 595
REM p. 1072

Berger, F.M. and Ludwig, B.J.; U.S. Patent 2,724,720; November 22, 1955; assigned to Carter Products, Inc.

MEPTAZINOL

Therapeutic Function: Analgesic

Chemical Name: 3-Ethyl-3-(m-hydroxyphenyl)-1-methylhexahydro-1H-azepine

Common Name: —

Structural Formula:

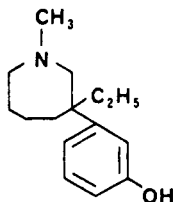

Chemical Abstracts Registry No.: —

Trade Name	Manufacturer	Country	Year Introduced
Meptid	Wyeth	U.K.	1983

Raw Materials

2-(m-Methoxyphenyl)butyronitrile	Sodium amide
Ethyl-4-iodobutyrate	Hydrogen
Lithium aluminum hydride	Hydrogen bromide
Formaldehyde	

Manufacturing Process

2-(m-Methoxyphenyl)butyronitrile in dry ether was added to a stirred suspension of sodium amide in liquid ammonia. The mixture was stirred for 30 minutes then ethyl-4-iodobutyrate (99.25 g, 0.4 mol) in dry ether (200 ml) was added dropwise. The mixture was stirred at the temperature of refluxing liquid ammonia for 5 hours. Ammonium chloride (10 g) was added and the mixture allowed to warm to room temperature. Water (300 ml) was added, the organic layer separated, washed with water, 2 N sulfuric acid and water. After drying over magnesium sulfate and removing the ether, the product was distilled yielding ethyl 5-cyano-5-(m-methoxyphenyl)heptanoate.

That material was hydrogenated in cyclohexane using a Raney nickel catalyst. The product after distillation was recrystallized from ethyl acetate affording 10.0 g of 6-ethyl-6-(m-methoxyphenyl)hexahydro-2H-azepin-2-one, MP 87°C to 88°C.

The azepinone (9.1 g) in dry tetrahydrofuran (50 ml) and ether (50 ml) was added dropwise to a stirred suspension of aluminum lithium hydride (7.5 g) in dry ether (50 ml). After heating under reflux for 3 hours the reaction mixture was worked up and distilled yielding 7.66 g of a compound which was a colorless oil, BP 108°C to 110°C/0.01 mm.

That product was then heated under reflux with 50% hydrobromic acid for 1.5 hours. The reaction mixture was evaporated to dryness and reevaporated with three portions of propan-2-ol. The oil obtained was dissolved in propan-2-ol and diluted with ether. 3-Ethyl-3-(m-hydroxyphenyl)hexahydro-1H-azepine was obtained. That material in turn was reductively methylated by hydrogenation in the presence of formaldehyde in absolute ethanol solution to give 3-ethyl-3-(m-methoxyphenyl)-1-methylhexahydro-1H-azepine.

The methoxy group was converted to a hydroxy group by refluxing with 80% HBr giving meptazinol hydrobromide.

References

Merck Index A-8

DFU 1 (2) 68 (1976)

DOT 19 (7) 415 (1983)

I.N. p. 597

Cavalla, J.F. and White, A.C.; British Patent 1,285,025; August 9, 1972; assigned to John Wyeth & Brother Ltd.

Cavalla, J.F. and White, A.C.; U.S. Patent 3,729,465; April 24, 1973; assigned to John Wyeth & Brother Ltd.

Cavalla, J.F. and White, A.C.; U.S. Patent 4,197,241; April 8, 1980; assigned to John Wyeth & Brother Ltd.

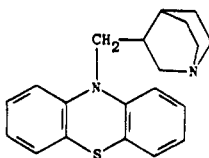
MEQUITAZINE**Therapeutic Function:** Antihistaminic**Chemical Name:** 10-(1-Azabicyclo[2.2.2]oct-3-yl-methyl)-10H-phenothiazine**Common Name:** --**Structural Formula:****Chemical Abstracts Registry No.:** 29216-28-2

Trade Name	Manufacturer	Country	Year Introduced
Primalan	Berk	U.K.	1976
Primalan	Spret Mauchant	France	1976
Metaplexan	Bad. Arzneimittel	W. Germany	1977
Nipolazine	Nippon Shoji	Japan	1983
Zesulan	Toyo Jozo	Japan	1983
Instotal	Ima	Argentina	—
Mircol	Pharmuka	Belgium	—
Vigigan	Spret-Mauchant	France	—

Raw Materials

Phenothiazine

Sodium amide

3-Chloromethyl quinuclidine HCl

Manufacturing Process

30 g of phenothiazine were added, all at once, to a suspension of 6 g of sodium amide in 240 ml of anhydrous xylene. The mixture was agitated and heated to reflux. When evolution of ammonia ceased (5 hours), 15 g of 3-chloromethyl-quinuclidine hydrochloride were added portionwise over a period of 50 minutes and reflux was then maintained for 22 hours. After cooling to room temperature, 250 ml of distilled water and 250 ml of ethyl acetate were added to the reaction mixture. The aqueous phase was decanted and extracted twice with a total of 250 ml of methyl acetate. The combined organic extracts were extracted three

times with a total of 750 ml of a 10% aqueous solution of tartaric acid. The combined acid solutions were treated with 5 g of animal charcoal, filtered and rendered alkaline on an ice bath with 96 ml of 10 N aqueous caustic soda. The oil which separated was extracted three times with a total of 1,500 ml of ethyl acetate. The combined organic extracts were washed to neutrality by washing twice with a total of 1 liter of distilled water, dried over anhydrous magnesium sulfate and evaporated under reduced pressure on a water bath at 45°C. 17 g of oil were obtained which was purified by chromatography on an inert alumina column. 13.3 g of crystallized product were obtained. 10-(3-Quinuclidinyl-methyl)-phenothiazine having a MP of 130°C to 131°C was obtained by recrystallization in boiling acetonitrile.

The 3-chloromethyl-quinuclidine hydrochloride used as starting material in this process can be obtained as described by Grob and coll., *Helv. Chim. Acta*, 37 (1954), 1689.

References

Merck Index 5694

Kleeman & Engel p. 562

DOT 15 (4) 199 (1979)

I.N. p. 597

Gueremy, C., Labey, R., Wirth, D. and Auclair, M.; U.S. Patent 3,987,042; October 19, 1976

MERALLURIDE

Therapeutic Function: Diuretic

Chemical Name: [3-[[[(3-carboxy-1-oxopropyl)amino]carbonyl]amino]-2-methoxypropyl]-hydroxymercury mixture with 3,7-dihydro-1,3-dimethyl-1H-purine-2,6-dione

Common Name: [3-[3-(3-carboxypropionyl)ureido]-2-methoxypropyl] hydroxymercury mixture with theophylline

Structural Formula:

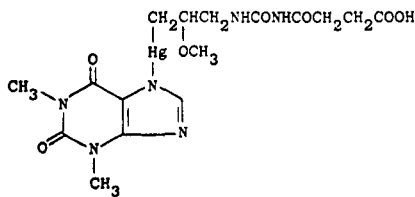

Chemical Abstracts Registry No.: 8069-64-5

Trade Name	Manufacturer	Country	Year Introduced
Mercurhydrin	Merrell National	U.S.	1943
Mercardac	Parke Davis	U.S.	—
Mercadon	Parke Davis	U.S.	—

Raw Materials

Allyl carbamide
Mercury acetate

Succinic anhydride
Theophylline

Manufacturing Process

First, to produce the mercury component, a pulverized mixture of 50 g of allylcarbamide and 50 g of succinic anhydride is heated for 30 minutes at 110°C. After cooling the fused

mass is ground with 50 cc of cold water and the crystalline mass after quick filtering from the liquid is recrystallized from hot water. The white crystalline needles having a MP of 142° to 144°C are allyl-succinyl-carbamide. In order to produce a mercury compound thereof a mixture of 20 g of the allyl-succinyl-carbamide and 30 g of mercury acetate is shaken for 3 hours with methanol. The scarcely soluble precipitate of the mercury compound after filtration is washed with methanol and with water and dried in vacuum. The white powder melts at 185° to 186°C under decomposition. Then, condensation with an equimolar proportion of theophylline yields meralluride.

References

Merck Index 5696

OCDS Vol. 1 p. 224 (1977)

I.N. p. 598

Geiger, E., Vargha, L. and Richter, L.; U.S. Patent 2,208,941; July 23, 1940; assigned to Chemical Works of Gedeon Richter Ltd., Hungary

MERCAPTOMERIN SODIUM

Therapeutic Function: Diuretic

Chemical Name: [3-[[[3-carboxy-2,2,3-trimethylcyclopentyl]carbonyl]amino]-2-methoxypropyl] (mercaptoacetato-S)mercury disodium salt

Common Name: —

Structural Formula:

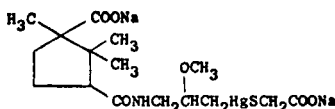

Chemical Abstracts Registry No.: 21259-76-7

Trade Name	Manufacturer	Country	Year Introduced
Thiomerin	Wyeth	U.S.	1949
Diucardyn	Ayerst	—	—
Thio-Novurit	Chinoïn	Hungary	—

Raw Materials

dl-N-Allyl-camphoramic acid
Sodium methylate

Mercuric acetate
Thioglycolic acid

Manufacturing Process

(A) *Preparation of dl-N-(γ-Chloromercuri-β-Methoxy)-Propylcamphoramic Acid:* A suspension of 31.9 g (= 0.10 M) of mercuric acetate in 25 ml of methanol is stirred for 30 minutes at room temperature in a 4-necked flask equipped with stirrer, dropping funnel, drying tube and thermometer. To this suspension is added dropwise and with stirring, a solution of 23.9 g (= 0.10 M) of dl-N-allyl-camphoramic acid

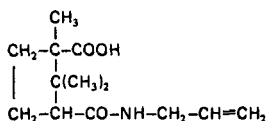

in 65 ml of methanol over a period of 30 minutes. The temperature of the reaction mixture should not rise over 30°C. The stirring is continued for one hour. The reaction mixture is allowed to stand at room temperature overnight in the dark to complete the reaction. A solution of 5.9 g (= 0.10 M) of sodium chloride in 25 ml of water is added and the stirring is continued for four hours. The small amount of gray precipitate produced is removed by centrifuging. The colorless, clear supernatant is concentrated to about half of its original volume and then dropped into 300 ml of water with stirring.

The white precipitate which forms is filtered and dried at 80°C, yielding 45 g of chloromercuri acid (= 89% of the theory), MP 106° to 109°C (decomp.). This compound is finally obtained in analytically pure form and with a constant melting point by two recrystallizations from acetone-water giving a MP of 131° to 132°C with decomposition.

(B) Preparation of the Chloromercuri Acid Sodium Salt Solution: 50.6 g (= 0.100 M) of the chloromercuri acid (dried over CaCl₂ at 0.1 mm and room temperature overnight) is dissolved in 100 ml of warm methanol. To this solution 6.0 g (= 0.111 M) of sodium methylate is added in small portions with constant stirring, so that the temperature of the solution does not rise over 30°C. The solution is centrifuged, and the glass is rinsed with 10 ml of methanol. The final pH of the combined solutions is 8.5.

(C) Preparation of the Disodium Thioglycolate Solution: The following steps are carried out under nitrogen. To 9.2 g (= 0.100 M) of freshly distilled thioglycolic acid (BP at 2 mm, 84° to 85°C) in 100 ml of methanol in a flask is added 12.0 g (= 0.222 M) of sodium methylate in small portions with stirring. The turbid solution is poured into a dropping funnel and the flask is rinsed with 20 ml of methanol. The final pH of the combined methanolic solutions is 11, according to U.S. Patent 2,834,795.

To 50 cc of a carefully purified aqueous solution of the sodium salt of N(γ-chloromercuri-β-methoxy-propyl)-d-α-camphoramic acid containing 40 mg of mercury per cc is added 10 cc of a solution containing 1.14 g (1 mol equivalent) of sodium thioglycollate and the mixture is then evaporated to dryness at room temperature and reduced pressure in the presence of a desiccant. The product is an amorphous white powder which decomposes at 156° to 158°C (uncorr.), and which was found on analysis to have a mercury content of 33.0%, according to U.S. Patent 2,576,349.

References

Merck Index 5701

OCDS Vol. 1 p. 224 (1977)

I.N. p. 599

Lehman, R.A.; U.S. Patent 2,576,349; November 27, 1951; assigned to Wyeth Incorporated
Wendt, G.R.; U.S. Patent 2,834,795; May 13, 1958; assigned to American Home Products Corporation

MERCAPTOPURINE

Therapeutic Function: Cancer chemotherapy

Chemical Name: 6-purinethiol

Common Name: —

Structural Formula:

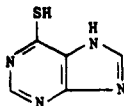

Chemical Abstracts Registry No.: 50-44-2

Trade Name	Manufacturer	Country	Year Introduced
Purinethol	Sandoz	France	1950
Purinethol	Burroughs-Wellcome	U.S.	1953
Classen	Nippon Shoji	Japan	—
Ismipur	I.S.M.	Italy	—
Leukerin	Takeda	Japan	—
Mercalleukin	Arzneimittelwerk Dresden	E. Germany	—
Mern	Tanabe	Japan	—
6—MP	Dojin	Japan	—
Oncomercaptopurina	Simes	Belgium	—
Puri-Nethol	Burroughs Wellcome	U.K.	—
Thioinosie	Morishita	Japan	—

Raw Materials

4-Amino-6-chloro-5-nitropyrimidine	Formic acid
Hydrogen sulfide	Sodium hydroxide

Manufacturing Process

7.5 g of 4-amino-6-chloro-5-nitropyrimidine was suspended in 200 ml of 1 N potassium hydrosulfide and heated on the steam bath for 2 hours while passing hydrogen sulfide through the reaction mixture. The reaction mixture was allowed to cool slowly, acidified with 10 N sulfuric acid and chilled. The precipitate consisted of 4,5-diamino-6-mercaptopurine and sulfur. It was boiled with 300 ml of water, filtered hot and then chilled. The product precipitated as pale yellow needles (4.2 g); an additional 0.95 g was obtained by concentration of the mother liquors to 100 ml.

A mixture of 2 g of 4,5-diamino-6-mercaptopurine and 10 ml of 98% formic acid was heated at 70°C for two hours and then evaporated to dryness on the steam bath to give as a residue, 7-amino-thiazolo (5,4-d) pyrimidine.

To 820 mg of 7-amino-thiazolo (5,4-d) pyrimidine was added 2.5 cc of 2 N sodium hydroxide. The water was removed under reduced pressure. The sodium salt was then heated at 240°C for one hour, during which time it melted, gave off water and resolidified. The sodium salt of 6-mercaptopurine was dissolved in 15 ml of water and acidified to pH 5 with acetic acid. Yellow crystals of 6-mercaptopurine hydrate precipitated, according to U.S. Patent 2,933,498.

References

Merck Index 5702

Kleeman & Engel p. 563

PDR p. 759

I.N. p. 599

REM p. 1151

Hitchings, G.H. and Elion, G.B.; U.S. Patent 2,721,866; October 25, 1955; assigned to Burroughs Wellcome & Co. (U.S.A.) Inc.

Hitchings G.H. and Elion, G.B.; U.S. Patent 2,724,711; November 22, 1955; assigned to Burroughs Wellcome & Co. (U.S.A.) Inc.

Hitchings, G.H. and Elion, G.B.; U.S. Patent 2,933,498; April 19, 1960; assigned to Burroughs Wellcome & Co. (U.S.A.) Inc.

MESNA

Therapeutic Function: Mucolytic

Chemical Name: 2-Mercaptoethane sulfonic acid sodium salt

Common Name: —

Structural Formula: $[\text{HSCH}_2\text{CH}_2\text{SO}_3]^- \text{Na}^+$

Chemical Abstracts Registry No.: 19767-45-4; 3375-50-6 (Base)

Trade Name	Manufacturer	Country	Year Introduced
Mistabronco	UCB	W. Germany	1973
Mistabron	Diethelm	Switz.	1978
Mucofluid	UCB Frayesse	France	1978
Mucofluid	UCB	Italy	1981
Uromitexan	W.B. Pharm	U.K.	1983
Uromitexan	Asta	W. Germany	—

Raw Materials

β -S-Thiuronium ethanesulfonate
Ammonia

Manufacturing Process

2,100 g of β -S-thiuronium ethanesulfonate were placed in a solution of 2,100 cc of concentrated aqueous ammonia and 400 cc of water. The mixture was carefully warmed on a steam bath and an exothermic reaction ensued, at which point the β -S-thiuronium ethanesulfonate passed into solution. After standing for two hours at room temperature, the solution was concentrated until all of the excess ammonia had been removed.

The resultant clear solution from the ammonolysis reaction was processed through "Amberlite IR-120" ion exchange resin and converted into β -S-mercaptoethanesulfonic acid in 93.7% yield (based on β -S-thiuronium ethanesulfonate).

It is expedient not to heat the reaction mixture rapidly since this increases the loss of ammonia and effects an incomplete reaction. Heating the mixture too rapidly may retard the ammonolysis reaction entirely. The amount of ammonia used is considered to be a satisfactory minimum and larger quantities of ammonia are not found to have any beneficial effect on the reaction. It is also expedient to remove the excess ammonia before processing the guanidinium β -mercaptoethanesulfonate solution through the ion exchange resin since the resin will also remove the ammonia with the result that the capacity of the resin for the exchange of guanidinium ions will be reduced.

Although the preparation of β -mercaptoethanesulfonic acid through the ammonolysis reaction is the preferred method, it is also possible to prepare the sulfonic acid by the sodium hydroxide hydrolysis of β -S-thiuronium ethanesulfonate followed by the ion exchange treatment. The resulting acid, however, is generally not as satisfactory as that prepared by the ammonolysis reaction.

References

Merck Index 5754

Kleeman & Engel p. 563

DOT 8 (5) 180 (1972); 19 (10) 585 & (11) 608 (1983)

J.N. p. 601

Schramm, C.H. and Karlson, R.H.; U.S. Patent 2,695,310; November 23, 1954; assigned to Lever Brothers Co.

MESORIDAZINE BESYLATE

Therapeutic Function: Tranquilizer

Chemical Name: 10-[2-(1-methyl-2-piperidinyl)ethyl]-2-methylsulfinyl-10H-phenothiazine benzene sulfonate

Common Name: —

Structural Formula:

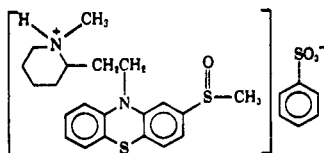

Chemical Abstracts Registry No.: 32672-69-8; 5588-33-0 (Base)

Trade Name	Manufacturer	Country	Year Introduced
Serentil	Sandoz	U.S.	1970
Calodal	Heyden	Switz.	1980
Lidanil	Salvoxy-Wander	France	—

Raw Materials

3-Methylmercaptophenothiazine	Acetic anhydride
Hydrogen peroxide	Potassium carbonate
2-(N-Methyl-piperidyl-2')-1-chloroethane	Sodium hydroxide

Manufacturing Process

10.0 g of 3-methylmercapto phenothiazine and 17.5 cc of acetic acid anhydride are refluxed for 8 hours from an oil bath maintained at a temperature of 180°C. After concentration of the solution the residue is crystallized from ethanol. The pure 3-methylmercapto-10-acetyl phenothiazine melts at 89° to 91°C. For the purpose of oxidation 5.0 g of 3-methylmercapto-10-acetyl phenothiazine are dissolved in 50 cc of ethanol, refluxed from an oil bath maintained at 120°C and 1.6 cc of a 40% hydrogen peroxide solution are then added dropwise in the course of 30 minutes.

Heating is continued for another 5 hours and the reaction mixture is concentrated after 50 cc of water have been added. The residue is taken up in 40 cc of benzene and the benzene layer washed with 10 cc of water. After having been concentrated, the residue, crude 3-methylsulfinyl-10-acetyl phenothiazine, is dissolved in 55 cc of a 90% methanol solution for splitting off the acetyl group and, after 2.9 g of potassium carbonate have been added, it is boiled for 2 hours under reflux on an oil bath kept at a temperature of 120°C. After concentration, the residue is taken up in 50 cc of chloroform, the chloroform layer is washed with a total of 25 cc of water, dried over potassium carbonate, filtered and concentrated. After twice crystallizing the residue, each time from 50 cc of ethanol, analytically pure 3-methylsulfinyl phenothiazine (MP 193° to 195°C) is obtained.

A mixture of 10.0 g of 3-methylsulfinyl phenothiazine (MP 193° to 195°C), 6.1 g of finely powdered sodium hydroxide and 125 cc of toluene is boiled for 1 hour under reflux with a water separator on an oil bath kept at a temperature of 150°C, while the mixture is stirred. Without interrupting the boil a solution of 7.0 g of 2-(N-methyl-piperidyl-2')-1-chloroethane (BP 84°C/10 mm Hg) in 10 cc of toluene is added dropwise in the course of 1 hour, after which boiling is continued for another 3 hours. When the reaction mixture has cooled it is first washed with 25 cc of water three times and then extracted with 75 cc of a 15% aqueous tartaric acid solution. The tartaric acid extract is shaken out with 25 cc

of benzene, 20 cc of concentrated caustic soda are added until the phenolphthalein reaction is alkaline, and the separated oily base is taken up in a total of 150 cc of benzene.

After having been washed with 50 cc of water the benzene layer is dried over potassium carbonate, filtered, allowed to stand over 10 g of alumina for about 1½ hours for partial decolorization, filtered again and concentrated under reduced pressure. The oily base which remains as a residue is directly converted into the tartrate. A solution cooled to 0°C, of 6.50 g of the free base in 100 cc of acetic acid ethyl ester is thoroughly shaken and poured into an ice cold solution of 2.66 g of tartaric acid in 410 cc of acetic acid ethyl ester. The precipitated, analytically pure, tartrate of 3-methylsulfinyl-10-[2'-N-methyl-piperidyl-2'']-ethyl-1']-phenothiazine melts at 115° to 120°C (foam formation) and sinters above 80°C. The base is reacted with benzene sulfonic acid in a suitable solvent to give the besylate.

References

Merck Index 5755

Kleeman & Engel p. 564

PDR p. 681

OCDS Vol. 1 p. 389 (1977)

DOT 6 (6) 211 (1970) & 9 (6) 227 (1973)

I.N. p. 601

REM p. 1089

Renz, J., Bourquin, J.-P. and Schwarb, G.; U.S. Patent 3,084,161; April 2, 1963; assigned to Sandoz Ltd., Switzerland

MESTEROLONE

Therapeutic Function: Androgen

Chemical Name: 17β-hydroxy-1α-methyl-5α-androstan-3-one

Common Name: —

Structural Formula:

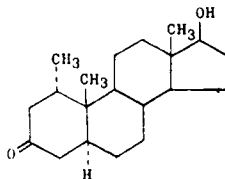

Chemical Abstracts Registry No.: 1424-00-6

Trade Name	Manufacturer	Country	Year Introduced
Proviron	Schering	W. Germany	1967
Proviron	Schering	Italy	1971
Pro-Viron	Schering	U.K.	1971
Proviron	S.E.P.P.S.	France	1975
Mestoran	Schering	W. Germany	—
Vistimon	Jenapharm	E. Germany	—

Raw Materials

1α-Methyl-androstan-17β-ol-3-one-17-acetate
Sodium hydroxide

Manufacturing Process

500 mg of 1 α -methyl-androstan-17 β -ol-3-one-17-acetate are heated under reflux for 90 minutes in a nitrogen atmosphere in 5 ml of 4% methanolic sodium hydroxide solution. The reaction mixture is then stirred into ice water, the precipitated product filtered with suction and recrystallized from isopropyl ether. 1 α -Methyl-androstan-17 β -ol-3-one melts at 203.5° to 205°C.

References

Merck Index 5760

Kleeman & Engel p. 565

OCDS Vol. 1 p. 174 (1977)

I.N. p. 602

Schering AG, Germany; British Patent 977,082; December 2, 1964

Schering AG, Germany; British Patent 977,083; December 2, 1964

Wiechert, R.; U.S. Patent 3,361,773; January 2, 1968; assigned to Schering A.G.

MESTRANOL

Therapeutic Function: Estrogen

Chemical Name: 3-methoxy-19-nor-17 α -pregna-1,3,5(10)-trien-20-yn-17-ol

Common Name: 17 α -ethynylestradiol 3-methyl ether

Structural Formula:

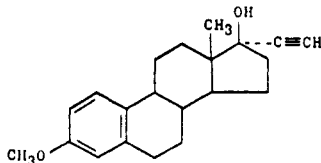

Chemical Abstracts Registry No.: 72-33-3

Trade Name	Manufacturer	Country	Year Introduced
Enovid	Searle	U.S.	1957
Ortho-Novum	Ortho	U.S.	1963
Enovid-E	Searle	U.S.	1964
Norinyl	Syntex	U.S.	1964
C-Quens	Lilly	U.S.	1965
Ovulen	Searle	U.S.	1966
Conceplan	Gruenthal	W. Germany	—
Conovid	Searle	U.K.	—
Enavid	Dainippon	Japan	—
Estalor	Lilly	U.S.	—
Gestamestrol	Hermal	W. Germany	—
Lutedione	Teikoku Zoki	Japan	—
Lyndiol	Organon-Sankyo	Japan	—
Metrulen	Searle	U.K.	—
Noracycline	Ciba Geigy	France	—
Noriday	Syntex	U.S.	—
Norinyl	Syntex	U.S.	—
Norluton	Shionogi	Japan	—

Trade Name	Manufacturer	Country	Year Introduced
Norquen	Syntex	U.S.	—
Nuriphasic	Noury Pharma	W. Germany	—
Orgaluton	Organon	U.K.	—
O.V. 28	Biosedra	France	—
Ovanon	Organon	U.K.	—
Ovastol	Rendell	U.K.	—

Raw Materials

3-Methoxy- $\Delta^{1,3,5}$ -estratrien-17-one
Acetylene

Manufacturing Process

A stirred solution of 120 parts of 3-methoxy- $\Delta^{1,3,5}$ -estratrien-17-one in 2,600 parts of anhydrous toluene and 4,300 parts of anhydrous ether is saturated with a slow stream of acetylene. In the course of 30 minutes there is added a solution of 120 parts of potassium tert-amylate in 2,800 parts of anhydrous tert-pentanol. The passage of acetylene and stirring are continued for an additional 5 hours after which the reaction mixture is washed 5 times with 3,000-part portions of saturated ammonium chloride solution and then with water. It is then dried over anhydrous sodium sulfate and concentrated to dryness under vacuum. The residue is recrystallized from methanol. The 3-methoxy-17-ethynyl- $\Delta^{1,3,5}$ -estratrien-17-ol thus obtained melts at about 143° to 146°C. A further recrystallization from acetone yields crystals melting at about 150° to 151°C.

References

Merck Index 5762

Kleeman & Engel p. 566

PDR pp. 1297, 1680, 1793

OCDS Vol. 1 p. 162 (1977)

I.N. p. 602

REM p. 989

Colton, F.B.; U.S. Patent 2,666,769; January 19, 1954; assigned to G.D. Searle & Co.

METAMPICILLIN SODIUM

Therapeutic Function: Antibacterial

Chemical Name: 3,3-Dimethyl-6[[[(methyleneamino)phenylacetyl] amino]-7-oxo-4-thia-1-azabicyclo[3.2.0]heptane-2-carboxylic acid sodium salt

Common Name: —

Structural Formula:

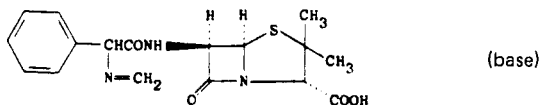

Chemical Abstracts Registry No.: 6489-61-8; 6489-97-0 (Base)

Trade Name	Manufacturer	Country	Year Introduced
Magnipen	Clin-Comar-Byla	Italy	1969
Magnipen	Clin Midy	France	1970

Trade Name	Manufacturer	Country	Year Introduced
Actuapen	Larma	Spain	—
Ampilprats	Prats	Spain	—
Apliopenil	Miluy	Spain	—
Co-Metampicil	Sanchez-Covisa	Spain	—
Daniven	Aldon	Spain	—
Doctamicina	Aristegui	Spain	—
Dompil	Spyfarma	Spain	—
Durmetan	Durban	Spain	—
Fedacilina	Fedal	Spain	—
Janopen	Janovich	Spain	—
Madecilina	Made	Spain	—
Maipen	Maipe	Spain	—
Mempil	Kairon	Spain	—
Metabacter	Rubio	Spain	—
Metacidan	Cidan	Spain	—
Meta-Ferran	Ferran	Spain	—
Metakes	Kessler	Spain	—
Metambac	Wolner	Spain	—
Metampicef	Cecef	Spain	—
Metamplimedix	Medix	Spain	—
Metiskia	Iskia	Spain	—
Ocelina	Roux-Ocefa	Argentina	—
Pluriespec	Vir	Spain	—
Ruticina	Bernabo	Argentina	—
Tisquibron	Bryan	Spain	—
Venzoquimpe	Quimpe	Spain	—
Vigocina	Europa	Spain	—

Raw Materials

6-[D(-)- α -(aminophenylacetamido)] penicillanic acid (ampicillin)
 Sodium bicarbonate
 Formaldehyde

Manufacturing Process

0.01 mol of 6-[D(-)- α -(aminophenylacetamido)]-penicillanic acid was suspended in 150 cc of water cooled to +5°C and treated with 0.01 mol of sodium bicarbonate.

The solution was treated with 0.01 mol of formaldehyde in aqueous solution, with agitation. The solution was then filtered to eliminate traces of insoluble product and the filtrate was lyophilized. Sodium 6-[D(-)- α -(methylene-amino-phenylacetamido)]-penicillanate was obtained.

References

Merck Index 5775

Kleeman & Engel p. 569

OCDS Vol. 1 p. 414 (1977)

DOT 6 (3) 85 (1970)

I.N. p. 604

Gradnick, B.; British Patent 1,081,093; August 31, 1967; assigned to Societe d'Etudes de Recherches et d'Applications Scientifiques et Medicales (E.R.A.S.M.E.) (France)

METAPRAMINE

Therapeutic Function: Antidepressant

Chemical Name: 10,11-Dihydro-5-methyl-10(methylamino)-5H-dibenzo[b,f]azepine

Common Name: —

Structural Formula:

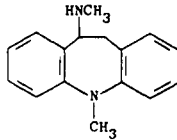

Chemical Abstracts Registry No.: 21730-16-5; 21737-55-3 (Hydrochloride)

Trade Name	Manufacturer	Country	Year Introduced
Timaxel	Specia	France	1983
Rodostene	Rhone-Poulenc	France	—

Raw Materials

5-Methyl-dibenzo[b,f]azepine
Methylamine
Sodium hypochlorite

Manufacturing Process

5-Methyl-dibenzo[b,f]azepine (4.1 g), N-diethylaminoborane (1.7 g) and freshly distilled toluene (150 cc) are introduced into a 500 cc three-neck flask equipped with a dropping funnel and a condenser, and protected against moisture by a calcium chloride guard tube. The solution is heated under reflux (110°C) for 22 hours under a nitrogen atmosphere and then cooled. A 2N aqueous sodium hydroxide solution (33 cc) is then run in followed by an 0.316N aqueous methylchloramine solution (190 cc), the addition of which takes 9 minutes. The mixture is stirred for 1 hour and then decanted. The organic layer is washed with water until it has a pH of 6 and is then extracted with 2N hydrochloric acid (5 times 50 cc), dried over sodium sulfate, filtered and evaporated. Recrystallization of the residue from petroleum ether yields some unconverted 5-methyl-dibenzo[b,f]azepine (2.17 g).

The aqueous acid solution is rendered alkaline by adding 2N sodium hydroxide solution. After extracting with diethyl ether (3 times 100 cc), drying the extracts over potassium carbonate, treating them with decolorizing charcoal, filtering and evaporating the ether, a yellowish oil (0.9 g), identified as 5-methyl-10-methylamino-10,11-dihydro-dibenzo[b,f]azepine, is obtained in a yield of 37.5%.

Methylchloramine can be prepared by adding an aqueous solution of sodium hypochlorite to an aqueous solution of methylamine in accordance with the process described by W.S. Metcalf, *J. Chem. Soc.* 1942, 148.

References

Merck Index 5781
DFU 6 (8) 479 (1981)
Kleeman & Engel p. 569
I.N. p. 605
Linares, H.; British Patent 1,323,219; July 11, 1973; assigned to Rhone-Poulenc SA
Fouche, J.C.L. and Gueremy, C.G.A.; U.S. Patent 3,622,565; November 23, 1971; assigned to Rhone-Poulenc S.A.

METAPROTERENOL SULFATE

Therapeutic Function: Bronchodilator

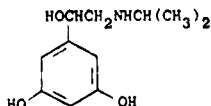
Chemical Name: 5-[1-Hydroxy-2-[(1-methylethyl)amino]ethyl]-1,3-benzenediol sulfate**Common Name:** Orciprenaline sulfate**Structural Formula:**

(base)

Chemical Abstracts Registry No.: 5874-97-5; 586-06-1 (Base)

Trade Name	Manufacturer	Country	Year Introduced
Alupent	Boehr. Ingel.	W. Germany	1961
Dosalupent	Boehr. Ingel.	Italy	1963
Alupent	Badrial	France	1966
Alupent	Boehr. Ingel.	U.S.	1973
Metaprel	Dorsey	U.S.	1973
Alotec	Tanabe	Japan	—
Astmopent	Polfa	Poland	—
Astop	Rafa	Israel	—
Lenasma	Ravasini	Italy	—
Novasmasol	Zambeletti	Italy	—

Raw Materials

3,5-Diacetoxyacetophenone	Bromine
Isopropylamine	Hydrogen

Manufacturing Process

In an initial operation, 3,5-diacetoxyacetophenone was reacted first with bromine and then with isopropylamine to give 1-(3,5-dihydroxyphenyl)-2-isopropylaminoethanone.

59 g of 1-(3,5-dihydroxy-phenyl)-2-isopropylaminoethanone (free base) were dissolved in 590 cc of methanol, and the solution was hydrogenated in the presence of about 80 g Raney nickel at room temperature and under a pressure of 5 atm. Hydrogen absorption was terminated after a few minutes. The catalyst was separated by vacuum filtration, and the filtrate, an ethanolic solution of 1-(3,5-dihydroxyphenyl)-1-hydroxy-2-isopropylaminoethane, was admixed with the calculated amount of an alcoholic 20% sulfuric acid solution. A crystalline precipitate formed which was filtered off and washed with alcohol. For purification, the product was dissolved in water and the solution was filtered through iron-free charcoal.

Thereafter, the filtrate was evaporated to dryness in vacuo and the residue was taken up in alcohol. The crystalline precipitate which separated out after some standing was separated by vacuum filtration and washed with alcohol. After recrystallization from 90% alcohol, 61 g (83.2% of theory) of 1-(3,5-dihydroxyphenyl)-1-hydroxy-2-isopropylamino-ethane sulfate, MP 202° to 203°C, was obtained.

References

Merck Index 5782

Kleeman & Engel p. 658

PDR pp. 674, 848

OCDS Vol. 1 p. 64 (1977)

I.N. p. 705

REM p. 887

Thoma, O. and Zeile, K.; U.S. Patent 3,341,594; September 12, 1967; assigned to Boehringer Ingelheim G.m.b.H., Germany

METARAMINOL

Therapeutic Function: Hypertensive

Chemical Name: α -(1-aminoethyl)-3-hydroxybenzenemethanol

Common Name: m-hydroxynorephedrine; m-hydroxypropadrine; metaradrine

Structural Formula:

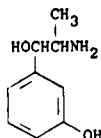

Chemical Abstracts Registry No.: 54-49-9

Trade Name	Manufacturer	Country	Year Introduced
Aramine	MSD	U.S.	1952
Pressoral	Travenol	U.S.	1963
Pressonex	Winthrop	U.S.	1963
Aramine	MSD-Chibret	France	1963
Araminium	Sharp & Dohme	W. Germany	—
Araminon	Merck-Banyu	Japan	—
Icopal B	Bayer	—	—
Levicor	Bioindustria	Italy	—
Metaraminol	Bristol	U.S.	—

Raw Materials

m-Hydroxyphenylethyl ketone
Butyl nitrite
Hydrogen

Manufacturing Process

The hydrochloride of the m-hydroxyphenylpropanolamine may be prepared by dissolving or suspending 90 parts of m-hydroxyphenylethyl ketone, $O=C(C_6H_4-OH)-C_2H_5$, in about 400 parts of ether. Hydrogen chloride is slowly bubbled through the solution or suspension while agitating it and 61.8 g of butyl nitrite is added during the course of 60 to 90 minutes. During the addition of the butyl nitrite the suspended m-hydroxyphenylethyl ketone gradually dissolves. The mixture or solution is allowed to stand for at least an hour, but preferably overnight. It is then repeatedly extracted with dilute alkali until all alkali-soluble material is removed. The alkaline extract is slowly acidified and the precipitate which forms is crude m-hydroxyphenyl- α -oximinoethyl ketone. After recrystallization from water this melts at 138°C.

10.8 parts of the meta ketone is dissolved in about 125 parts of absolute alcohol containing 5.6 parts of hydrogen chloride. The solution is agitated with a catalyst such as the palladium catalyst above described in an atmosphere of hydrogen until no more hydrogen is absorbed. This requires from 60 to 90 minutes or more. When reduction is complete the catalyst is filtered off and the filtrate evaporated to dryness by being placed in a desiccator at ordinary temperature.

The residue is the hydrochloride of m-hydroxyphenyl- α -aminoethyl ketone. This is purified by recrystallization from absolute alcohol. It is then dissolved in 200 parts of water and agitated with a further quantity of the palladium catalyst in an atmosphere of hydrogen until saturated. The product thus recovered from the solution is the hydrochloride

of m-hydroxyphenylpropanol amine. After recrystallization from absolute alcohol this melts at 177°C. The corresponding free base can be prepared from the hydrochloride by treatment with ammonia, according to U.S. Patent 1,995,709.

Metaraminol is often used in the form of the bitartrate.

References

Merck Index 5783

Kleeman & Engel p. 570

PDR pp. 695, 1140

I.N. p. 605

REM p. 888

Bockmühl, M., Ehrhart, G. and Stein, L.; U.S. Patent 1,948,162; February 20, 1934; assigned to Winthrop Chemical Company, Inc.

Bockmühl, M., Ehrhart, G. and Stein, L.; U.S. Patent 1,951,302; March 13, 1934; assigned to Winthrop Chemical Company, Inc.

Hartung, W.H.; U.S. Patent 1,995,709; March 26, 1935; assigned to Sharp & Dohme, Inc.

METAXALONE

Therapeutic Function: Skeletal muscle relaxant

Chemical Name: 5-(3,5-dimethylphenoxy)methyl-2-oxazolidinone

Common Name: —

Structural Formula:

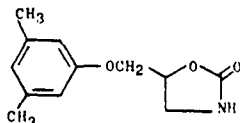

Chemical Abstracts Registry No.: 1665-48-1

Trade Name	Manufacturer	Country	Year Introduced
Skelaxin	Robins	U.S.	1962

Raw Materials

Urea

3-(3',5'-Dimethylphenoxy)-1,2-propanediol

Manufacturing Process

Urea (118 g, 1.96 mols) was added to 192 g (0.98 mol) of 3-(3',5'-dimethylphenoxy)-1,2-propane-diol which had previously been heated to 150°C. The reaction mixture was then heated rapidly to 195° to 200°C and maintained at this temperature for 5 hours with constant stirring. The resulting mixture was partitioned between water and ethyl acetate and the ethyl acetate layer was dried over sodium sulfate and concentrated. The residue was distilled in vacuo and the fraction boiling at 220° to 225°C/1.5 mm was collected. Yield, 172 g (79%). The distillate was crystallized from dry ethyl acetate; MP, 121.5° to 123°C.

References

Merck Index 5785

Kleeman & Engel. p.571

PDR p. 783

OCDS Vol. 1 p. 119 (1977)

I.N. p. 606

REM p. 927

Lunsford, C.D.; U.S. Patent 3,062,827; November 6, 1962; assigned to A.H. Robins Company, Inc.

METERGOLINE

Therapeutic Function: Analgesic

Chemical Name: [[(8 β)-1,6-dimethylergolin-8-yl] methyl] carbamic acid phenylmethyl ester

Common Name: Methyl-N-carbobenzoxy-dihydro-lysergamine

Structural Formula:

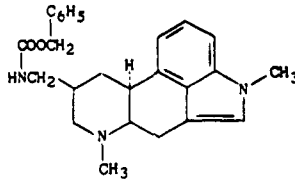

Chemical Abstracts Registry No.: 17692-51-2

Trade Name	Manufacturer	Country	Year Introduced
Liserdol	Farmitalia	Italy	1970

Raw Materials

1-Methyl-dihydro-lysergamine
Carbobenzoxy chloride

Manufacturing Process

16 g of 1-methyl-dihydro-lysergamine (the 10-position hydrogen has the α -configuration) are dissolved in 80 cc of anhydrous pyridine by mildly heating. To the solution, cooled to -10°C and stirred, 18 cc of 85% carbobenzoxy-chloride (in toluene) diluted in 36 cc of chloroform are added dropwise, rather rapidly. The mixture is kept at -10°C during the addition, and for 10 minutes afterwards. The cooling means is removed and the temperature is allowed to rise to room level in 10 minutes. The reaction mixture is diluted with 240 cc of chloroform and rapidly washed with 80 cc of 5% aqueous sodium hydroxide solution, with saturated aqueous sodium bicarbonate solution, and finally with water.

The chloroform solution is briefly dried over anhydrous sodium sulfate and evaporated to dryness in vacuo at 40°C . The oily residue is taken up in 160 cc of benzene and passed through a column containing 48 g of alumina. The column is then eluted with further 160 cc of benzene. The collected eluates are evaporated in vacuo at 40°C . The thick oily residue is mixed with a small amount of anhydrous diethyl ether. After some time a crystalline mass is obtained, which is collected and washed with a small amount of benzene and diethyl ether. 12 g of white crystals are obtained, melting at 146° to 148°C .

References

Merck Index 5790
I.N. p. 606

Camerino, B., Patelli, B. and Glaesser, A.; U.S. Patent 3,238,211; March 1, 1966; assigned to Societa Farmaceutici Italia, Italy

METHACYCLINE

Therapeutic Function: Antibiotic

Chemical Name: 4-dimethylamino-1,4,4a,5,5a,6,11,12a-octahydro-3,5,10,12,12a-pentahydroxy-6-methylene-1,11-dioxo-2-naphthacene-carboxamide

Common Name: 6-methylene-5-hydroxytetracycline

Structural Formula:

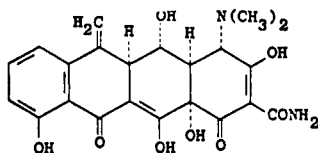

Chemical Abstracts Registry No.: 914-00-1; 3963-95-9 (Hydrochloride)

Trade Name	Manufacturer	Country	Year Introduced
Randomycin	Pfizer	U.K.	1963
Megamycine	Creat	France	1966
Randomycin	Wallace	U.S.	1966
Adramycin	Janko	Japan	—
Apriclina	Lancet	Italy	—
Benciclina	Benvegna	Italy	—
Boscillina	Molteni	Italy	—
Brevicillina	Neopharmed	Italy	—
Ciclobiotic	Beta	Italy	—
Ciclum	Italsuisse	Italy	—
Duecap	Sam	Italy	—
Duplaciclina	Locatelli	Italy	—
Duramicina	Bergamon	Italy	—
Dynamicin	Medal	Italy	—
Esarondil	Terapeutico	Italy	—
Esquilin	Saito	Italy	—
Fitociclina	Ifisa	Italy	—
Franciclina	Francia	Italy	—
Francomicina	N.C.S.N.	Italy	—
Gammaciclina	Sthol	Italy	—
Globociclina	Importex	Italy	—
Idrossimicina	San Carlo	Italy	—
Isometa	Isom	Italy	—
Largomicina	Jamco	Italy	—
Medomycin	Medosan	Italy	—
Megamycine	C.R.E.A.T.	Italy	—
Metabiotic	Panther-Osfa	Italy	—
Metabioticon BG	Boniscontro-Gazzone	Italy	—
Metac	Dima	Italy	—
Metacil	Ibirn	Italy	—
Metaclin	Medici	Italy	—
Metaclor	Esset	Italy	—
Metadomus	Medici Domus	Italy	—

Trade Name	Manufacturer	Country	Year Introduced
Metagram	Zanardi	Italy	—
Metilenbiotic	Coli	Italy	—
Microcilina	Biotrading	Italy	—
Mit-Ciclina	Von Boch	Italy	—
Molciclina	Molteni	Italy	—
Optimicine	Biochemie	Austria	—
Ossirondil	Gazzini	Italy	—
Paveciclina	I.B.P.	Italy	—
Physiomycline	Roland-Marie	France	—
Piziacina	Farmochimica	Italy	—
Plurigram	Lafare	Italy	—
Prontomicina	Tosi-Novara	Italy	—
Quickmicina	Panthox & Burck	Italy	—
Radiomicina	Radiopharma	Italy	—
Rindex	Sidus	Italy	—
Rotilen	Amelix	Italy	—
Sernamicina	Pharma Williams	Italy	—
Stafilon	A.G.I.P.S.	Italy	—
Tachiciclina	C.T.	Italy	—
Tetrabios	Ausonja	Italy	—
Tetranovo	Totalpharm	Italy	—
Tiberciclina	Tiber	Italy	—
Ticomicina	Benedetti	Italy	—
Treis-Ciclina	Ecobi	Italy	—
Valcin	Chemil	Italy	—
Vitabiotic	Pharmex	Italy	—
Wassermicina	Wassermann	Italy	—
Yatrociclina	Italfarmaco	Italy	—
Zermicina	Pulitzer	Italy	—

Raw Materials

Oxytetracycline
Sulfur trioxide
Hydrogen fluoride

Manufacturing Process

To a stirred solution of 4.6 g (0.01 mol) of anhydrous oxytetracycline in 40 ml of dry tetrahydrofuran is added 3.5 g (0.021 mol) of pyridine-sulfur trioxide complex. After 16 hours of stirring at room temperature, the resulting suspension is filtered, and the solid is slurried with 25 ml of 2% hydrochloric acid for 10 minutes, filtered and thoroughly washed with methanol followed by ether. The pale yellow crystalline 5-oxytetracycline-6, 12-hemiketal-12-sulfuric acid ester melts at 210°C.

500 mg 5-oxytetracycline-6,12-hemiketal-12-sulfuric acid ester, prepared as described, is added to 4 ml dry liquid hydrogen fluoride, and the mixture is stirred for 1.5 hours at ice bath temperature. The hydrogen fluoride is then evaporated in a stream of nitrogen and the resulting gummy solids are triturated with about 15 ml ether and filtered. The resulting solid hydrofluoride salt is further purified by suspending in water, adjusting the pH to about 4, and extracting the 6-methylene-5-oxytetracycline free base from the aqueous phase with ethyl acetate. The extract is separated and evaporated to dryness under reduced pressure. The resulting residue is triturated with ether and filtered, and the solid is recrystallized from methanol-acetone-ether-concentrated hydrochloric acid to obtain the product as a purified hydrochloride, according to U.S. Patent 3,026,354.

References

Merck Index 5798

Kleeman & Engel p. 567

PDR p. 1881

OCDS Vol. 2 p. 227 (1980)

DOT 1 (1) 10 (1965)

I.N. p. 603

REM p. 1205

Blackwood, R.K., Rennhard, H.H., Beereboom, J.J. and Stephens, C.R., Jr.; U.S. Patent 2,984,686; May 16, 1961; assigned to Chas. Pfizer & Co., Inc.

Blackwood, R.K.; U.S. Patent 3,026,354; March 20, 1962; assigned to Chas. Pfizer & Co., Inc.

METHADONE HYDROCHLORIDE

Therapeutic Function: Narcotic analgesic

Chemical Name: 6-dimethylamino-4,4-diphenyl-3-heptanone hydrochloride

Common Name: Amidone hydrochloride

Structural Formula:

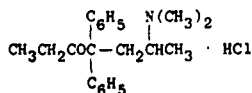

Chemical Abstracts Registry No.: 1095-90-5; 76-99-3 (Base)

Trade Name	Manufacturer	Country	Year Introduced
Dolophine	Lilly	U.S.	1947
Adanon	Winthrop	U.S.	1947
Westadone	Vitarine	U.S.	1973
Adolan	Abic	Israel	—
Eptadone	Tosi	Italy	—
Heptadon	E.B.E.W.E.	Austria	—
Heptanal	Treupha	Switz.	—
Heptanon	Pliva	Yugoslavia	—
Ketalgin	Amino	Switz.	—
Mephenon	Spemsa	Italy	—
Optalgin	Dr. Wust	Switz.	—
Physeptone	Burroughs-Wellcome	U.K.	—

Raw Materials

Diphenylacetone nitrile	Ethyl bromide
2-Chloro-1-dimethylaminopropane	Magnesium
Hydrogen chloride	

Manufacturing Process

Diphenylacetone nitrile is condensed with 2-chloro-1-dimethylaminopropane to give 4-(dimethylamino)-2,2-diphenyl valerone nitrile. It is then reacted with ethyl magnesium bromide and then hydrolyzed using HCl to give methadone hydrochloride.

References

Merck Index 5799

Kleeman & Engel p. 573

PDR pp. 1048, 1061, 1571

OCDS Vol. 1 pp. 79, 289, 298 (1971) & 2, 328 (1980)

I.N. p. 607

REM p. 1109

Resolution of Optical Isomers:

Howe, E.E. and Tishler, M.; U.S. Patent 2,644,010; June 30, 1953; assigned to Merck & Co., Inc.

Zaugg, H.E.; U.S. Patent 2,983,757; May 9, 1961; assigned to Abbott Laboratories

METHALLENESTRIL

Therapeutic Function: Estrogen

Chemical Name: β -ethyl-6-methoxy- α,α -dimethyl-2-naphthalenepropionic acid

Common Name: —

Structural Formula:

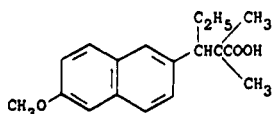

Chemical Abstracts Registry No.: 517-18-0

Trade Name	Manufacturer	Country	Year Introduced
Vallestril	Searle	U.S.	1952
Cur-Men	Novapharma	Italy	—
Ercostrol	Erco	Denmark	—
Ercostrol	Green Cross	Japan	—

Raw Materials

2-Bromo-6-methoxynaphthalene	Cuprous cyanide
Ethyl bromoisobutyrate	Ethyl bromide
Magnesium	Potassium bisulfate
Hydrogen	Sodium hydroxide

Manufacturing Process

A first step involves the preparation of 2-cyano-6-methoxynaphthalene (cyanonerolin). 90 g of 2-bromo-6-methoxynaphthalene are heated with 60 g of cuprous cyanide in a metal bath at 240° to 250°C stirring for one hour. At the instant when the cuprous cyanide begins to react and dissolves, the mass turns brown, liquefies and heats up strongly. The molten mass is poured onto a cold surface, is pulverized and sifted. This powder is treated with dilute ammonia (1 liter of water to 300 cc of commercial ammonia solution). The solution is filtered on a Büchner filter and the precipitate that remains on the filter is washed with dilute ammonia and then with water.

After drying, the residue is treated in a Kumagawa extracting apparatus with boiling benzene. The benzene is evaporated and the residue is distilled in vacuo. About 50 g of cyanonerolin (BP = 205° to 208°C/14 mm) are obtained with a yield of about 70%. By re-crystallization in 200 cc of methyl alcohol, 40 g of the product are obtained in absolutely pure state, in the shape of beautiful colorless needles (MP = 103°C with the Maquene block). By concentrating the mother liquor to half its original volume, a further 3.6 g of pure product are obtained.

The 2-cyano-6-methoxy-naphthalene is in turn converted by successive reactions into: (a) β -ketonic ester, (b) ester-alcohol, (c) β -ethylene ester by dehydration, (d) saturated ester, and (e) [3-(6-methoxy-2-naphthyl)] 2,2-dimethyl pentanoic acid which is the required product.

(A) Obtaining a β -Ketonic Ester by Reacting Ethyl Bromoisobutyrate with Cyanonerolin: 9 g of cyanonerolin are heated in a reflux apparatus for 40 minutes with 7 g of zinc and 19 g of ethyl bromoisobutyrate in the presence of 150 cc of anhydrous benzene. After cooling, the mixture is filtered to eliminate unreacted zinc and is hydrolyzed by stirring for one hour with dilute sulfuric acid (10 cc of sulfuric acid to 200 cc of water). The benzene layer is washed, dried and the solvent is eliminated. It is purified by recrystallization in methyl alcohol. 12.5 g of ketonic ester (MP = 72.5° to 73.5°C) are thus obtained in the form of large prismatic crystals.

(B) Obtaining an Ester-Alcohol by Reacting Magnesium Ethyl Bromide with the Previous Ketonic Ester: 10 g of the previous ester dissolved in 40 cc of anhydrous benzene are gradually poured while stirring into an iced solution of magnesium ethyl bromide prepared from 1.035 g of magnesium, 4.15 cc of ethyl bromide and 40 cc of anhydrous ether. After heating in a reflux apparatus for one-half hour, the mixture is poured into ice in the presence of ammonium chloride.

After washing the ether-benzene layer, the solvents are eliminated in vacuo and an ester-alcohol is thus obtained with a yield of 98%, in the form of a transparent resin. This resin, if treated with petroleum ether, yields 6.35 g of ester-alcohol in the form of fine needles (MP = 66.68°C) which are very soluble in the chief organic solvents and in petroleum ether.

(C) Conversion into Ethyl [3-(6-Methoxy-2-Naphthyl)] 2,2-Dimethyl-3-Pentanoate by Dehydrating the Previous Ester-Alcohol: The semi-oily raw product of the previous reaction is dehydrated by heating with its own weight of potassium bisulfate to 180°C until boiling stops. After cooling, the magma is removed from the anhydrous ether in small portions. The ether is then evaporated and an ethylene ester is obtained in the form of an oil which slowly solidifies, with a yield of 98%. The product, after being purified by chromatography, melts at 48° to 51°C.

(D) Obtaining Ethyl [3-(6-Methoxy-2-Naphthyl)] 2,2-Dimethyl Pentanoate by Hydrogenation of the Previous Ethylene Ester: 3.5 g of the previous ethylene ester, purified by chromatography, are hydrogenated in the presence of 3.6 g of platinum in 30 cc of ether. The quantity of hydrogen fixed corresponds to the theoretical quantity calculated. After filtering, the ether is evaporated, 3.45 g of ester are thus obtained in the form of an oil which quickly solidifies. Purification is effected by chromatography.

(E) Obtaining [3-(6-Methoxy-2-Naphthyl)] 2,2-Dimethyl Pentanoic Acid: 2.5 g of the previous ester are saponified by means of 15 cc of soda lye and 25 cc of methyl glycol. The mixture is boiled for one hour, diluted with water and, after cooling, is treated twice with ether in order to eliminate the remaining neutral fractions. The aqueous layer is precipitated by means of 15 cc of acetic acid. 2.1 g of raw acid are obtained. After effecting two crystallizations in 10 parts of acetic acid mixed with 3 parts of water, fine needles are obtained which are grouped in rosettes and melt at 131.5° to 132.5°C.

References

Merck Index 5803

Kleeman & Engel p. 574

OCDs Vol. 1 p. 87 (1977)

I.N. p. 608

Horeau, A. and Jacques, J.; U.S. Patent 2,547,123; April 3, 1951

METHANDROSTENOLONE

Therapeutic Function: Androgen; anabolic

Chemical Name: 17 β -Hydroxy-17-methylandrosta-1,4-dien-3-one

Common Name: Methandienone

Structural Formula:

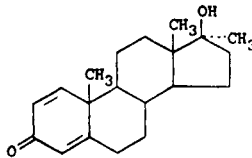

Chemical Abstracts Registry No.: 72-63-9

Trade Name	Manufacturer	Country	Year Introduced
Dianabol	Ciba	U.S.	1960
Abirol	Takeda	Japan	—
Anabolin	Medica	Finland	—
Anoredan	Kodama	Japan	—
Encephan	Sato/Shinshin	—	—
Lanabolin	Labatec	Switz.	—
Metabolina	Guidi	Italy	—
Metanabol	Polfa	Poland	—
Metastenol	Farber-R.E.F.	Italy	—
Naposim	Terapia	Rumania	—
Nerobol	Galenika	Yugoslavia	—
Perbolin	Ion	Italy	—
Vanabol	Vitrum	Sweden	—

Raw Materials

Bacterium *Didymella lycopersici*
17 β -Methyl testosterone
Selenium dioxide

Manufacturing Process

As described in U.S. Patent 2,929,763, methandrostenolone may be made by a fermentation route. 2 g of sodium nitrate, 1 g of primary potassium orthophosphate, 0.5 g of magnesium sulfate heptahydrate, 0.5 g of potassium chloride, 50 g of glucose and 1 g of Difco yeast extract are dissolved in one liter of tap water, brought to pH 5 by addition of a sodium hydroxide solution and sterilized. The resulting nutrient solution is inoculated with 50 cc of a 4-day-old shaking culture of *Didymella lycopersici* and shaken for 48 hours at 27°C, whereby the culture becomes well developed.

To two liters of a culture so prepared there is added under sterile conditions a solution of 500 mg of 17 α -methyl-testosterone in 15 cc of acetone. Shaking is carried out for 3 days at 27°C, the mycellium then filtered off with suction, washed with water and ethyl acetate and the combined filtrates extracted with ethyl acetate. The extraction residue obtained after evaporation of the solvent is dissolved in a little acetone. On addition of ether, the 1-dehydro-17 α -methyl-testosterone is obtained in compact crystals. MP 163° to 164°C.

An alternative synthetic route is described in U.S. Patent 2,900,398 as follows. A suspension of 30 g of 17 α -methyl-testosterone and 10 g of selenium dioxide in 600 cc of tertiary amyl alcohol is treated with 60 g of magnesium powder and 6 cc of glacial acetic acid.

The mixture is refluxed for 24 hours with good stirring in an atmosphere of nitrogen, another 10 g of selenium dioxide being added after 10 hours. After some cooling, the suspension is filtered through some Hyflo and washed thoroughly with ethyl acetate. The resulting brown solution is evaporated in vacuo and the residue dissolved in ethyl acetate.

The ethyl acetate solution is then washed with water, dried and evaporated. To remove any selenium still present, the residue is dissolved in 200 cc of methanol and mixed with 100 g of iron powder and 2 g of active carbon. The mixture is heated for 30 minutes with stirring under reflux, then filtered with suction, washed with methanol and the solution evaporated in vacuo. The residue is then chromatographed on 900 g of aluminum oxide. The residues of the evaporated benzene and ether fractions are treated with active carbon in methanol or acetone, evaporated again, and the residue recrystallized from a mixture of acetone and ether. There are obtained 17.5 g of pure 1-dehydro-17 α -methyltestosterone which melts at 163° to 164°C.

References

Merck Index 5810

Kleeman & Engel p. 570

OCDS Vol. 1 p. 173 (1977)

I.N. p. 605

REM p. 998

Wettstein, A., Hunger, A., Meystre, C. and Ehmann, L.; U.S. Patent 2,900,398; August 18, 1959; assigned to Ciba Pharmaceutical Products, Inc.

Wettstein, A., Vischer, E. and Meystre, C.; U.S. Patent 2,929,763; March 22, 1960; assigned to Ciba Pharmaceutical Products, Inc.

METHAPYRILENE HYDROCHLORIDE

Therapeutic Function: Antihistaminic

Chemical Name: N,N-dimethyl-N'-2-pyridinyl-N'-(2-thienylmethyl)-1,2-ethanediamine hydrochloride

Common Name: Thenylpyramine hydrochloride

Structural Formula:



Chemical Abstracts Registry No.: 135-23-9; 91-80-5 (Base)

Trade Name	Manufacturer	Country	Year Introduced
Thenylene	Abbott	U.S.	1947
Pyrathyn	Davis Sly	U.S.	1947
Histadyl	Lilly	U.S.	1948
Semikon	Beecham	U.S.	1949
Lullamin	Reed Carnrick	U.S.	1954
Dozar	Tutag	U.S.	1956
Allergin	Myers-Carter	U.S.	—
Allerest	Pharmacraft	U.S.	—
Brexin	Savage	U.S.	—
Citra	Boyle	U.S.	—

Trade Name	Manufacturer	Country	Year Introduced
Ephed-Organidin	Wallace	U.S.	--
Excedrin P.M.	Bristol-Myers	U.S.	--
Histadyl	Lilly	U.S.	--
M.P.	Dymond	Canada	--
Sedanact	Woelm-Pharma	W. Germany	--
Contac	Vonora	W. Germany	--
Co-Pyronil	Lilly	Italy	--

Raw Materials

2-Aminopyridine	Sodium amide
N,N-Dimethyl- β -chloroethylamine	Hydrogen chloride
2-Thenyl chloride	

Manufacturing Process

To a slurry of sodamide in 200 cc of toluene representing 6.7 g of sodium was added at 30° to 40°C, 32.3 g (0.31 mol) of 2-aminopyridine. The mixture was heated to reflux temperature and was refluxed for 1½ hours. To the resulting mixture was added over a period of approximately one hour a solution of 32 g of freshly distilled N,N-dimethyl- β -chloroethylamine in 40 to 50 cc of dry toluene. The reaction mixture was then heated for 2 hours at reflux temperature. Thereafter, 200 cc of water was added and the toluene layer was separated and washed with water. The toluene was stripped from the mixture by distillation and the residue was distilled under reduced pressure. The distillate was re-fractionated and the portion distilled at 93° to 103°C/1 mm was recovered. Yield of N-(2-pyridyl)-N',N'-dimethyl-ethylenediamine, 60%.

A solution of 20 g (0.121 mol) of N-(2-pyridyl)-N',N'-dimethyl-ethylenediamine in 25 cc of toluene was added to a slurry of sodamide in 100 cc of toluene representing 2.8 g of sodium. The mixture was refluxed for one hour. To this mixture was added over a period of ½ hour a solution of 16 g (0.121 mol) of 2-thenyl chloride in 25 cc of toluene. The resulting reaction mixture was refluxed for 3 hours. Thereafter, water was added and the toluene layer was separated and washed with water.

The toluene was then stripped off by distillation and the residue was distilled under reduced pressure. The main fraction was redistilled. Yield of N-(2-pyridyl)-N-(2-thenyl)-N',N'-dimethyl-ethylenediamine was 69%; BP 130° to 140°C/0.4 mm. A portion of the product was dissolved in ether and an ether solution of hydrogen chloride was added. The monohydrochloride of N-(2-pyridyl)-N-(2-thenyl)-N',N'-dimethyl-ethylenediamine which separated was washed with ether and dried.

References

- Merck Index 5819
 Kleeman & Engel p. 575
 OCDS Vol. 1 p. 54 (1977)
 I.N. p. 609
 Kyrides, L.P.; U.S. Patent 2,581,868; January 8, 1952; assigned to Monsanto Chemical Company

METHAQUALONE

Therapeutic Function: Hypnotic

Chemical Name: 2-methyl-3-o-tolyl-4(3H)-quinazolinone

Common Name: Metolquizolone; ortonal

Structural Formula:

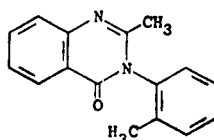

Chemical Abstracts Registry No.: 72-44-6; 340-56-7 (Hydrochloride)

Trade Name	Manufacturer	Country	Year Introduced
Quaalude	Lemmon	U.S.	1965
Sopor	Amer. Crit. Care	U.S.	1967
Somnafac	Cooper	U.S.	1968
Parest	Lemmon	U.S.	1969
Quaalude	Rorer	Italy	1969
Optimil	Wallace	U.S.	1972
Aqualon	Arcana	Austria	—
Cateudyl	Cavor	Belgium	—
Citexal	Draco	Sweden	—
Divinoctal	I.S.H.	France	—
Dormigoa	Scheurich	W. Germany	—
Dormir	Langley	Australia	—
Dormutil	Isis-Chemie	E. Germany	—
Hyptor	Bio-Chimique	Canada	—
Hyminal	Eisai	Japan	—
Mandrax	I.S.H.	France	—
Mequelon	Merck-Frosst	Canada	—
Meroctan	Sanwa	Japan	—
Methadorm	Eri	Canada	—
Metasedil	Cooper	Switz.	—
Mollinox	Asperal	Belgium	—
Motolon	Chinoïn	Hungary	—
Nene	Sankyo	Japan	—
Nobadorm	Streuli	Switz.	—
Normi-Nox	Herbrand	W. Germany	—
Normorest	Doitsu-Aoi	Japan	—
Noxybel	Probel	Belgium	—
Obliozer	Gamaprod.	Australia	—
Optinoxan	Robisch	W. Germany	—
Parmilene	Chiesi	Italy	—
Paxidorm	Wallace	U.S.	—
Pexaqualone	Therapex	Canada	—
Pro-Dorm	Schurholz	W. Germany	—
Revonol	Merck	U.K.	—
Rouqualone	Rougier	Canada	—
Sedalone	Pharbec	Canada	—
Sleepinal	Medichem	Australia	—
Somnium	Fargal	Italy	—
Sovelin	Weifa	Norway	—
Sovinal	N.D. & K.	Denmark	—
Spasmipron	Mack	W. Germany	—
Tiqualone	Barlow Cote	Canada	—
Tualone	I.C.N.	Canada	—

Raw MaterialsAnthrannilic acid
o-ToluidineAcetic anhydride
Hydrogen chloride

Manufacturing Process

Anthranilic acid (1 part) is dissolved in acetic anhydride (2 parts) and the temperature raised progressively to 190° to 200°C while distillation takes place. The last traces of acetic acid are removed under vacuum and, after cooling to about 50° to 60°C, o-toluidine (1 part) is added in portions.

The temperature is then raised to 170° to 200°C when the excess water and o-toluidine is gradually distilled off, finally maintaining the temperature at 180° to 200°C for 2 hours. After cooling to about 100°C dilute hydrochloric acid (3 parts) is added and the mixture boiled and stirred. The solution is then neutralized with NaOH with stirring and the product which separates is recrystallized twice from alcohol after decolorizing with carbon. Yield: 70% of theoretical, MP 114° to 115°C.

References

Merck Index 5820

Kleeman & Engel p. 576

OCDS Vol. 1 p. 353 (1977)

DOT 9 (6) 245 (1973)

I.N. p. 610

REM p. 1072

Laboratoires Torade, France; British Patent 843,073; August 4, 1960

METHAZOLAMIDE

Therapeutic Function: Carbonic anhydrase inhibitor

Chemical Name: N-[5-(aminosulfonyl)-3-methyl-1,3,4-thiadiazol-2(3H)-ylidene]acetamide

Common Name: —

Structural Formula:

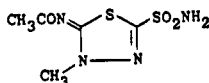

Chemical Abstracts Registry No.: 554-57-4

Trade Name	Manufacturer	Country	Year Introduced
Neptazane	Lederle	U.S.	1959
Neptazane	Theraplix	France	1961

Raw Materials

5-Acetylimino-4-methyl-2-benzylmercapto- Δ^2 -1,3,4-thiadiazoline
Chlorine
Ammonia

Manufacturing Process

A suspension of 6 parts by weight of 5-acetylimino-4-methyl-2-benzylmercapto- Δ^2 -1,3,4-thiadiazoline in 180 parts by volume of 33% aqueous acetic acid was chlorinated at 5°C for 30 minutes. The solid was filtered off, dried, and added portion-wise to 100 parts by volume of liquid ammonia. The ammonia was removed under a stream of dry nitrogen.

The residual solid was partially dissolved in 10 parts by volume of water, filtered, and acidified to give 5-acetylmino-4-methyl- Δ^2 -1,3,4-thiadiazoline-2-sulfonamide. The product was purified by two recrystallizations from hot water.

References

Merck Index 5824

Kleeman & Engel p. 576

PDR p. 1021

OCDS Vol. 1 p. 250 (1977)

I.N. p. 610

REM p. 936

Young, R.W., Wood, K.H. and Vaughan, J.R., Jr.; U.S. Patent 2,783,241; February 26, 1957; assigned to American Cyanamid Company

METHDILAZINE HYDROCHLORIDE

Therapeutic Function: Antipruritic

Chemical Name: 10-[(1-methyl-3-pyrrolidyl)methyl]phenothiazine hydrochloride

Common Name: —

Structural Formula:

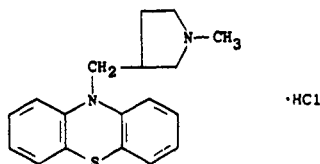

Chemical Abstracts Registry No.: 1229-35-2; 1982-37-2 (Base)

Trade Name	Manufacturer	Country	Year Introduced
Tacaryl	Westwood	U.S.	1960
Dilosyn	Duncan Flockhart	U.K.	—
Disyncran	Allard	France	—
Tacryl	Pharmacia	Sweden	—

Raw Materials

1-Methyl-3-pyrrolidylmethyl chloride

Phenothiazine

Hydrogen chloride

Manufacturing Process

10.8 parts of 10-(1-methyl-3-pyrrolidylmethyl) phenothiazine (prepared from 1-methyl-3-pyrrolidylmethyl chloride by reaction with phenothiazine) in 80 parts of 99% isopropyl alcohol were treated with a solution of 1.33 parts of hydrogen chloride in 30 parts of the same solvent. The clear light yellow solution soon deposited white crystals of the acid addition salt. After cooling overnight at 0°C, the crystalline product was collected on a filter, washed with 99% isopropyl alcohol and anhydrous ether and then dried in a vacuum oven at 95°C. Yield 10.4 parts, MP 187.5° to 189°C.

References

- Merck Index 5826
 Kleeman & Engel p. 577
 PDR p. 1895
 OCDS Vol. 1 p. 387 (1977)
 I.N. p. 611
 REM p. 1129
 Feldkamp, R.F. and Wu, Y.H.; U.S. Patent 2,945,855; July 19, 1960; assigned to Mead Johnson & Company

METHENAMINE HIPPURATE

Therapeutic Function: Antibacterial (urinary)

Chemical Name: Hexamethylenetetramine hippurate

Common Name: —

Structural Formula: $C_6H_5CONHCH_2COOH \cdot (CH_2)_6N_4$

Chemical Abstracts Registry No.: 5714-73-8

Trade Name	Manufacturer	Country	Year Introduced
Hiprex	Merrell National	U.S.	1967
Hiprex	Riker	U.K.	1971
Hiprex	Kettelhack	W. Germany	1975
Hipeksäl	Leiras	Finland	—
Hippuran	Orion	Finland	—
Lisogerm	Labofarma	Brazil	—
Urotractan	Klinge	W. Germany	—

Raw Materials

Hexamethylenetetramine
 Hippuric acid

Manufacturing Process

179 g (1 mol) hippuric acid (benzoyl glycine) and 140 g (1 mol) hexamethylenetetramine were heated under reflux in 500 ml methanol. The small amount of water necessary to give a clear, homogeneous solution was added to the resulting reaction mixture which was then evaporated to dryness. The residue soon crystallized, a procedure that could be greatly accelerated by seeding with crystals of hexamethylenetetramine hippurate from a previous preparation. The resulting solid product was broken up and pulverized. Hexamethylenetetramine hippurate is stable on exposure to air and is soluble in water and alcohol. It melts at 105° to 110°C.

References

- Merck Index 5832
 PDR pp. 1227, 1453
 DOT 4 (3) 108 (1968)
 I.N. p. 611
 REM p. 1167
 Galat, A.; U.S. Patent 3,004,026; October 10, 1961

METHENOLONE ACETATE

Therapeutic Function: Anabolic

Chemical Name: 17 β -Hydroxy-1 β -methyl-5 α -androst-1-ene-3-one acetate

Common Name: —

Structural Formula:

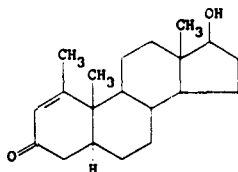

(base)

Chemical Abstracts Registry No.: 434-05-9; 153-00-4 (Base)

Trade Name	Manufacturer	Country	Year Introduced
Primobolan	Schering	W. Germany	1961
Dacomid	Schering	W. Germany	—
Fortabol	Schering	W. Germany	—
Neuro-Fortabol	Schering	W. Germany	—

Raw Materials

Methyl iodide
Magnesium
 $\Delta^{1,4,6}$ -Androstatrien-17 β -ol-3-one-17-acetate
Hydrogen

Manufacturing Process

8.42 ml of methyl iodide are slowly added dropwise at room temperature with stirring in a nitrogen atmosphere to 3.067 g of magnesium turnings and 107 ml of absolute ether. After about 30 minutes, 185 ml of absolute tetrahydrofuran are slowly introduced and then liquid is distilled off until a boiling point of 62°C is reached. After cooling to room temperature, 613 mg of cuprous chloride are added and then 10 g of $\Delta^{1,4,6}$ -androstatrien-17 β -ol-3-one-17-acetate in 110 ml of tetrahydrofuran slowly introduced. After 30 minutes reaction time, the whole is cooled to 0°C, the excess of Grignard reagent decomposed with saturated ammonium chloride solution, the product diluted with ether and the aqueous phase separated. The ethereal phase is washed consecutively with aqueous sodium thiosulfate solution, saturated ammonium chloride solution and water. It is dried over sodium sulfate and evaporated to dryness under vacuum. The residue is dissolved in 40 ml of pyridine and 20 ml of acetic anhydride and the solution kept for 16 hours at room temperature. It is then stirred into ice water and the precipitate filtered with suction, dried and recrystallized from isopropyl ether. 1 α -Methyl- $\Delta^{4,6}$ -androstadien-17 β -ol-3-one-17-acetate is obtained. MP 156°C to 157°C; $[\alpha]_D^{25} = -33.8^\circ$ (in CHCl_3 ; $c = 0.9$). Yield 65-70% of the theoretical.

4.67 g of 1 α -methyl- $\Delta^{4,6}$ -androstadien-17 β -ol-3-one-17-acetate are dissolved in 273 ml of methanol and, after the addition of 350 mg of 10% palladium on calcium carbonate catalyst, hydrogenated until 1 mol equivalent of hydrogen has been taken up. After filtering off the catalyst, the solution is treated with 150 ml of 2N hydrochloric acid and evaporated under vacuum to about 1/3 of the volume. The whole is then diluted with water and extracted with ether. The ethereal solution is washed with water until neutral, dried over sodium sulfate and evaporated. The crude product is heated on a steam bath for 90 minutes in 10 ml of pyridine and 10 ml of acetic anhydride. Extraction with ether is then carried out and the ethereal phase washed until neutral with water. The crude crystalline 1 α -methyl- Δ^4 -androst-17 β -

ol-3-one-17-acetate obtained after drying and evaporation of the solution, melts at 122°C to 129°C. Yield 98% of the theoretical.

1 α -Methyl- Δ^4 -androsen-17 β -ol-3-one-17-acetate when purified by recrystallization from isopropyl ether melts at 138°C to 139°C.

References

Merck Index 5839

Kleeman & Engel p. 571

OCDS Vol. 1 p. 175 (1977)

I.N. p. 606

Schering A.G.; British Patent 977,082; December 2, 1944

METHICILLIN SODIUM

Therapeutic Function: Antimicrobial

Chemical Name: 6-(2,6-dimethoxybenzamido)-3,3-dimethyl-7-oxo-4-thia-1-azabicyclo[3.2.0]-heptane-2-carboxylic acid sodium salt

Common Name: 2,6-dimethoxyphenylpenicillin sodium salt

Structural Formula:

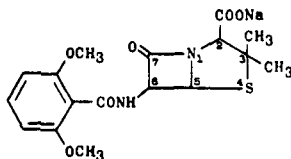

Chemical Abstracts Registry No.: 7246-14-2

Trade Name	Manufacturer	Country	Year Introduced
Celbenin	Beecham	U.K.	1960
Staphcillin	Bristol	U.S.	1960
Dimocillin	Squibb	U.S.	1961
Flabelline	Delagrangre	France	1961
Celbenin	Beecham	U.S.	1973
Azapen	Pfizer	U.S.	1975
Baclyn	Sifrochimica	Italy	—
Celpillina	Farmitalia	Italy	—
Ellecillina	Ellea	Italy	—
Esapenil B.G.	Boniscontro-Gazzone	Italy	—
Metin	C.S.L.	Australia	—
Methocillin	Meiji	Japan	—
Penysol	Saita	Italy	—
Sintespen	Coli	Italy	—
Staficyn	Firma	Italy	—

Raw Materials

6-Aminopenicillanic acid
2,6-Dimethoxybenzoyl chloride

Manufacturing Process

To a stirred suspension of 6-aminopenicillanic acid (540 g) in dry alcohol-free chloroform (3.75 liters) was added dry triethylamine (697 ml), and the mixture stirred for 10 minutes at room temperature. It was then cooled in a bath of crushed ice while a solution of 2,6-dimethoxybenzoyl chloride (500 g) in dry alcohol-free chloroform (3.75 liters) was added in a steady stream over 20 minutes. When all the acid chloride had been added the cooling bath was removed and the mixture stirred for 1 hour at room temperature. The mixture was stirred vigorously and sufficient dilute hydrochloric acid (2.3 liters of 0.87 N) was added to give an aqueous layer of pH 2.5. The mixture was filtered, the layers separated, and only the chloroform layer was retained.

This was stirred vigorously while further dilute hydrochloric acid (0.69 liter of 0.87 N) was added to give an aqueous layer of pH 1. The layers were separated and again only the chloroform layer was retained. Then the chloroform layer was stirred vigorously while sufficient sodium bicarbonate solution (3.2 liters of 0.97 N) was added to give an aqueous layer of pH 6.7 to 7.0. The layers were separated and both were retained. The chloroform layer was stirred vigorously while sufficient sodium bicarbonate solution (50 ml of 0.97 N) was added to give an aqueous layer of pH 7.7, and again the layers were separated. The two bicarbonate extracts were combined, washed with ether (1 liter), and then concentrated at low temperature and pressure until the concentrate weighed 1,415 g.

The concentrate was treated with dry acetone (22 liters), the mixture well mixed, and then filtered to remove precipitated solid impurities. Further dry acetone (4 liters) was added to the filtrate, then the product started to crystallize slowly. Crystallization was allowed to proceed at a temperature between 0° and 3°C for 16 hours and then the product (563 g) was collected by filtration. Dry ether (7.5 liters) was added to the filtrate, and after several hours a second crop (203 g) of solid was collected. The two crops were combined to give sodium 2,6-dimethoxyphenylpenicillin monohydrate (766 g, 73%) as a white crystalline solid.

References

Merck Index 5842

Kleeman & Engel p. 591

PDR p. 713

OCDs Vol. 1 p. 412 (1977)

I.N. p. 626

REM p. 1200

Doyle, F.P., Naylor, J.H.C. and Rolinson, G.N.; U.S. Patent 2,951,839; September 6, 1960

METHIONINE

Therapeutic Function: Lipotropic

Chemical Name: 2-amino-4-(methylthio)butyric acid

Common Name: —

Structural Formula: $\text{CH}_3\text{SCH}_2\text{CH}_2\text{CH}(\text{NH}_2)\text{COOH}$

Chemical Abstracts Registry No.: 63-68-3

Trade Name	Manufacturer	Country	Year Introduced
Meonine	Ives	U.S.	1944
Lobamine	Opodex	France	1948

Trade Name	Manufacturer	Country	Year Introduced
Oradash	Lambda	U.S.	1955
Ammonil	Philips Roxane	U.S.	1957
Dyprin	Lincoln	U.S.	1958
Acimetion	Continental Pharm.	Belgium	—
Amino-Serv	Milex	U.S.	—
Amino-Plex	Tyson	U.S.	—
Antamon P.E.D.	Protea	S. Africa	—
Methnine	Medical Research	Australia	—
Monile	Cortunon	Canada	—
Ninol	Horner	Canada	—
Uracid	Wesley	U.S.	—
Unanap	N. Amer. Pharm.	U.S.	—
Urimeth	N. Amer. Pharm.	U.S.	—

Raw Materials

Methyl mercaptan	Acrolein
Sodium cyanide	Ammonium chloride
Sodium hydroxide	

Manufacturing Process

A 3-necked flask fitted with a stirrer, thermometer, gas inlet, dropping funnel, and brine-cooled reflux condenser was charged with 53 g (1.1 mol) methyl mercaptan and 0.35 g mercuric methyl mercaptide. After admitting 56 g (1.0 mol) of acrolein during the course of 15 minutes with an inside temperature of about 10°C, the temperature was allowed to rise spontaneously to 75°C, at which point an ice bath was applied. There was no indication of further reaction one hour after the addition of the acrolein. Distillation of the product gave 71 g (yield 68%) of β -methylmercaptopropionaldehyde, as described in U.S. Patent 2,584,496.

Then as described in U.S. Patent 2,732,400, β -methylmercaptopropionaldehyde (0.60 M) (56.5 g) is added to a stirred solution of sodium cyanide (0.66 M) (32.4 g) and ammonium chloride (0.63 M) (33.7 g) in water (140 ml). The temperature of the mixture rises to 49°C and is maintained at this point by heat evolution for about 5 minutes when it slowly begins to fall. Methanol (50 ml) is added and the mixture is stirred for 4 hours as the temperature falls to 28°C (room temperature).

After chilling to +12°C, additional methanol (35 ml) and a concentrated aqueous ammonium hydroxide solution (1.4 M) (100 ml) are added and stirring is continued for 2 hours at a temperature maintained at from +5° to +15°C. The organic layer is separated and solvent is stripped from the aqueous layer at water aspirator pressure at a temperature below 40°C. The residue is extracted several times with chloroform and the chloroform extracts are combined with the separated oil. Chloroform is removed at water aspirator pressure at a temperature below 35°C to leave crude α -amino- γ -methylmercaptobutyronitrile (methionine nitrile) in 88% yield (68 g) as a clear, somewhat viscous oil.

The methionine nitrile (20 g) is dissolved in a solution prepared from 50 ml of aqueous 5N sodium hydroxide solution and 65 ml of ethanol. The solution is then refluxed for 24 hours; ammonia is evolved. The solution is treated with activated carbon, filtered, acidified with glacial acetic acid (17 ml), chilled to -10°C and filtered to give crude product. This crude product is then slurried with a solution made up of 20 ml of water and 20 ml of methanol, filtered at -5° to +10°C and dried to give dl-methionine as white platelets.

References

Merck Index 5849
PDR pp. 1263, 1807

I.N. p. 612

Pierson, E. and Tishler, M; U.S. Patent 2,584,496; February 5, 1952; assigned to Merck & Co., Inc.

Weiss, M.J.; U.S. Patent 2,732,400; January 24, 1956; assigned to American Cyanamid Company

METHITURAL

Therapeutic Function: Hypnotic; sedative

Chemical Name: Dihydro-5-(1-methylbutyl)-5-[2-(methylthio)ethyl]-2-thioxo-4,6(1H,5H)-pyrimidinedione monosodium salt

Common Name: Methioturiate

Structural Formula:

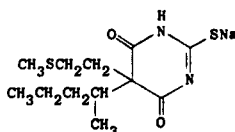

Chemical Abstracts Registry No.: 730-68-7

Trade Name	Manufacturer	Country	Year Introduced
Neraval	Schering	U.S.	1956
Diogenal	Merck	—	—
Thiogenal	Merck	—	—

Raw Materials

β -Methyl-thioethyl-(1-methyl)-n-butyl-cyanoacetic acid ethyl ester
 Thiourea
 Ethanol
 Sodium
 Sulfuric acid
 Sodium hydroxide

Manufacturing Process

A solution of 69 g of sodium in 1,380 cc of absolute alcohol is mixed with 257.4 g of β -methyl-thioethyl-(1-methyl)-n-butyl-cyano-acetic acid ethyl ester and 114 g of thiourea and the whole mass boiled under reflux with stirring for six hours. After concentration under vacuum the residue is taken up in 1.5 liters of water and shaken up thrice, each time with 300 cc of ether. The aqueous alcoholic layer is stripped, under vacuum, of the dissolved ether and mixed with 300 cc of 30% acetic acid under stirring and ice cooling. The precipitated material is sucked off, washed with water, dried and recrystallized from isopropyl alcohol. The thus obtained β -methyl-thioethyl-(1-methyl)-n-butyl-cyano-acetyl thiourea forms yellowish green crystals having a melting point of 229°C to 230°C.

100 g of this product are boiled under reflux for three hours with 1 liter of 20% sulfuric acid. After cooling the mixture is taken up in ether, the ether solution washed with water, dried, filtered, concentrated and drawn off under vacuum. The residue is caused to crystallize by treatment with a mixture of 60 volume parts of methanol and 40 volume parts of petroleum benzene. The isolated crystals are recrystallized from the mentioned solvent mixture

and yield thereby 5- β -methyl-thioethyl-5-(1-methyl)-n-butyl-2-thiobarbituric acid having a melting point of 79°C to 81°C.

20 g of the free acid are shaken up (in a machine) for one hour with 69.5 cc/l (normal) caustic soda. The filtered solution is concentrated under vacuum, the residue is taken up in absolute alcohol and again withdrawn under vacuum. After two recrystallizations of the residue from isopropyl alcohol one obtains the readily water-soluble, analytically pure, sodium salt of the 5- β -methyl-thioethyl-5-(1-methyl)-n-butyl-2-thiobarbituric acid.

References

Merck Index 5854

OCDS Vol. 1 p. 275 (1977)

I.N. p. 612

Zima, O. and Von Werder, F.; U.S. Patent 2,802,827; August 13, 1957; assigned to Emanuel Merck (Germany)

METHIXENE HYDROCHLORIDE

Therapeutic Function: Antispasmodic

Chemical Name: 1-methyl-3-(9H-thioxanthen-9-yl-methyl)piperidine hydrochloride

Common Name: —

Structural Formula:

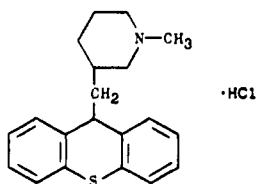

Chemical Abstracts Registry No.: 1553-34-0; 4969-02-2 (Base)

Trade Name	Manufacturer	Country	Year Introduced
Tremarit	Wander	W. Germany	1960
Tremaril	Wander	Italy	1962
Tremonil	Wander	U.K.	1963
Trest	Dorsey	U.S.	1965
Atosil	Teikoku	Japan	—
Cholinfall	Tokyo Tanabe	Japan	—
Dalpan	Grelan	Japan	—
Inoball	Sawai	Japan	—
Methixart	Fuso	Japan	—
Methyloxan	Nippon Shoji	Japan	—
Raunans	Kowa	Japan	—
Spasmenzyme	Salvoxy-Wander	France	—
Thioperkin	Hokuriku	Japan	—

Raw Materials

Thioxanthene	Chlorobenzene
N-Methyl-3-chloromethyl-piperidine	Sodium
Hydrogen chloride	

Manufacturing Process

To 4.9 g of finely pulverized sodium in 50 ml of absolute benzene add dropwise with stirring 12 g of chlorobenzene in 50 ml of absolute benzene. As soon as the exothermic reaction begins, maintain the temperature by cooling between 30° and 35°C, and continue stirring for 2 to 3 hours. To the resulting phenyl sodium add dropwise 19.8 g of thioxanthene in 120 ml of absolute benzene. The slightly exothermic reaction ceases after about 1 to 1½ hours.

To this newly formed 9-thioxanthylium sodium add dropwise, with stirring and cooling, 13.1 g of N-methyl-3-chloromethyl-piperidine in 30 to 40 ml of absolute benzene, then continue stirring at about 25°C for 1½ hours, and heat subsequently to 40°C for 1 hour. Decompose the resulting mixture by adding carefully a small amount of water, and then extract the newly formed base from the benzene solution by means of dilute hydrochloric acid. The aqueous hydrochloric solution is made alkaline by adding dilute sodium hydroxide, and the thioxanthene base is isolated by extraction with ether. This results in 22 g of a slightly yellow, viscous base of BP 171° to 175°C/0.07 mm.

The base is acidified with alcoholic hydrochloric acid. Alcohol-ether (1:2) is then added and the hydrochloride salt is crystallized as colorless flakes melting at 211° to 213°C.

References

Merck Index 5855

Kleeman & Engel p. 592

OCDS Vol. 1 p. 400 (1977) & 2, 413 (1980)

I.N. p. 628

REM p. 919

Schutz, J.; U.S. Patent 2,905,590; September 22, 1959; assigned to The Wander Company

METHOCARBAMOL

Therapeutic Function: Skeletal muscle relaxant

Chemical Name: 3-(o-methoxyphenoxy)-1,2-propanediol 1-carbamate

Common Name: Guaiacol glyceryl ether carbamate

Structural Formula:

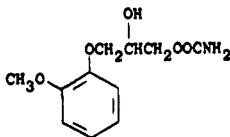

Chemical Abstracts Registry No.: 532-03-6

Trade Name	Manufacturer	Country	Year Introduced
Robaxin	Robins	U.S.	1957
Lumirelax	Serbach	France	1968
Robaxin	Brenner	W. Germany	1976
Carbametin	Uji	Japan	—
Carxin	Kanto	Japan	—
Delaxin	Ferndale	U.S.	—
Methocabal	Zeria	Japan	—

Trade Name	Manufacturer	Country	Year Introduced
Methocol	Daiko	Japan	—
Miowas	Wassermann	Italy	—
Myomethol	Abic	Israel	—
Parabaxin	Parmed	U.S.	—
Relax	Ion	Italy	—
Robamol	Cenci	Italy	—
Robaxisal	Robins	U.S.	—
Romethocarb	Robinson	U.S.	—
Traumacut	Brenner	W. Germany	—
Tresortil	Gea	Denmark	—

Raw Materials

Guaiacol glyceryl ether
Phosgene
Ammonia

Manufacturing Process

The starting material for methocarbamol is 3-o-methoxyphenoxy-1,2-propanediol (guaiacol glyceryl ether) (see entry under Guaifenesin for its preparation). To a stirred suspension of 198.2 g (1.0 mol) of 3-o-methoxyphenoxy-1,2-propanediol in 1,000 ml of dry benzene contained in a 5-liter, 3-neck, round bottom flask equipped with a thermometer, dropping funnel and blade stirrer, was added dropwise (in 30 minutes) a solution of 98.9 g (1.0 mol) of phosgene in 400 ml of cold dry benzene. The mixture was stirred at 30°C until all solid material dissolved (about 3 hours was required) and stirring was continued for 30 minutes longer. To this mixture was added dropwise 79.1 g (1.0 mol) of dry pyridine, the temperature being held below 30°C by cooling. After addition of the pyridine, stirring at 30°C was continued for 30 minutes.

The mixture was cooled to 7°C, extracted with two 500-cc portions of ice water to remove pyridine hydrochloride, and the benzene solution of 3-o-methoxyphenoxy-2-hydroxypropyl chlorocarbonate was added to 500 ml of cold concentrated ammonium hydroxide. The mixture was vigorously stirred at 5°C for 6 hours, then the crude white precipitate of 3-o-methoxyphenoxy-2-hydroxypropyl carbamate was filtered off, dissolved in 1,500 ml of hot benzene and completely dried by codistillation of last traces of water with benzene, treated with decolorizing carbon and filtered while hot. On cooling 160 g of product crystallized as white needles melting at 88° to 90°C.

References

Merck Index 5856
Kleeman & Engel p. 578
PDR pp. 830, 993, 1466, 1569, 1606, 1999
OCDS Vol. 1 p. 118 (1977)
I.N. p. 613
REM p. 927
Murphey, R.S.; U.S. Patent 2,770,649; November 13, 1956; assigned to A.H. Robins Company, Inc.

METHOHEXITAL SODIUM

Therapeutic Function: Anesthetic (intravenous)

Chemical Name: (±)-1-methyl-5-(1-methyl-2-pentynyl)-5-(2-propenyl)-2,4,6(1H,3H,5H)-pyrimidinetrione sodium salt

Common Name: Methohexitone

Structural Formula:

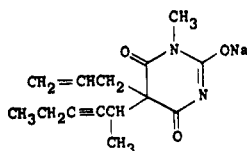

Chemical Abstracts Registry No.: 309-36-4

Trade Name	Manufacturer	Country	Year Introduced
Brevital	Lilly	U.S.	1960
Brietal	Lilly	U.K.	1961
Brevimytal	Lilly	W. Germany	1963
Brietal	Lilly	Italy	1963

Raw Materials

Ethyl acetylene (1-butyne)	Ethyl bromide
Magnesium	Acetaldehyde
Phosphorus tribromide	Diethyl malonate
Sodium	Ethanol
Allyl bromide	Methyl urea

Manufacturing Process

Preparation of 3-Hexyne-2-ol: A solution of ethyl magnesium bromide was prepared by the reaction of 229 g of ethyl bromide and 48.6 g of magnesium in 750 ml of anhydrous ether. To the ether solution was then added with stirring a solution of 108 g of ethyl acetylene in 250 ml of cold anhydrous ether. The addition required approximately 3 hours, and the mixture was stirred and refluxed for a further period of 3½ hours. Thereafter there was added to the reaction mixture a solution of 88 g of freshly distilled acetaldehyde in 170 ml of anhydrous ether, over a period of about 45 minutes and at a temperature in the range of about -10° to 0°C.

The resulting reaction mixture was poured over about 1 kg of crushed ice, and neutralized with 10% aqueous hydrochloric acid. The organic phase of the resulting mixture was separated, and the aqueous phase was extracted 3 times with 250 ml portions of ether. The combined organic phase and ether washings were washed twice with water and dried over anhydrous potassium carbonate. The dried ether solution was fractionally distilled, and the 3-hexyne-2-ol formed in the reaction was collected as a fraction boiling at about 79° to 80°C at the pressure of 60 mm of mercury.

Preparation of 2-Bromo-3-Hexyne: A solution of 138 g of 3-hexyne-2-ol and 9 g of pyridine in 138 ml of anhydrous ether was treated with 175 g of phosphorus tribromide, added dropwise over a period of about 20 minutes at a temperature of about -10°C. The reaction mixture was permitted to come to room temperature while stirring for about 3 hours, and was then heated to refluxing for about 1 hour. After cooling, the reaction mixture was poured over about 50 g of crushed ice. A two-phase system formed, and the ether layer was separated, washed with dilute sodium bicarbonate solution, dried over anhydrous potassium carbonate and fractionally distilled. The 2-bromo-3-hexyne formed in the reaction was collected at 75°C at the pressure of 50 mm of mercury.

Preparation of Diethyl (1-Methyl-2-Pentynyl) Malonate: To a solution of 28.6 g of sodium in 430 ml of absolute ethanol were added 200 g of diethyl malonate. About half of the alcohol was removed by distillation in vacuo, and thereafter a solution of 200 g of 2-bromo-3-hexyne in 100 ml of anhydrous ether was added slowly to the reaction mixture.

The heat of reaction brought about refluxing during the addition of the 2-bromo-3-hexyne, and when the addition was complete the reaction mixture was heated to refluxing for a further period of 30 minutes. A sufficient amount of water was then added to the reaction mixture to dissolve the sodium bromide which had formed, and the only organic layer was separated, washed with water and dried over anhydrous magnesium sulfate. The dried organic layer was then fractionally distilled under reduced pressure, and the diethyl (1-methyl-2-pentynyl) malonate formed in the reaction was collected at about 117° to 120°C at the pressure of 2 mm of mercury.

Preparation of Diethyl Allyl (1-Methyl-2-Pentynyl) Malonate: A solution of 12.1 g of sodium in 182 ml of absolute ethanol was prepared, and thereto were added 126.6 g of diethyl (1-methyl-2-pentynyl) malonate. Most of the ethanol was then distilled off under reduced pressure, and the residue was cooled and 63.5 g of allyl bromide were slowly added thereto. After completion of the addition, the mixture was refluxed for about 1 hour. The reaction mixture was cooled, treated with about 100 ml of water, and the oily organic layer which formed was removed, washed with water and dried over anhydrous magnesium sulfate. The dried oily organic material was fractionally distilled in vacuo, and diethyl allyl (1-methyl-2-pentynyl) malonate boiling at 105° to 107°C at the pressure of 1 mm of mercury was recovered.

Preparation of 1-Methyl-5-Allyl-5-(1-Methyl-2-Pentynyl) Barbituric Acid: A solution of 23.8 g of sodium in 360 ml of absolute alcohol was prepared and thereto were added 38.3 g of methyl urea and 96.8 g of diethyl allyl (1-methyl-2-pentynyl) malonate. The mixture was refluxed for about 20 hours, cooled, and the ethanol was removed by distillation in vacuo. The residue was dissolved in about 300 ml of water and the aqueous solution was washed with ether, and the washings were discarded. The aqueous solution was then acidified with acetic acid, and extracted with three 150 ml of portions of ether.

The combined ether extracts were washed with 5% aqueous sodium bicarbonate solution, dried over anhydrous sodium sulfate, and fractionally distilled in vacuo. The fraction boiling at about 145° to 150°C at the pressure of 0.5 mm of mercury, weighing 61 g and consisting of 1-methyl-5-allyl-5-(1-methyl-2-pentynyl) barbituric acid, was collected. The only distillate was substantially pure, and could be used as such in pharmaceutical preparation or a salt could be prepared therefrom according to the procedures disclosed herein-after. On standing, the oil crystallized. The crystalline 1-methyl-5-allyl-5-(1-methyl-2-pentynyl) barbituric acid melted at about 60° to 64°C after recrystallization from dilute ethanol.

Preparation of Sodium 1-Methyl-5-Allyl-5-(1-Methyl-2-Pentynyl) Barbiturate: A solution of 61 g of 1-methyl-5-allyl-5-(1-methyl-2-pentynyl) barbituric acid in 100 ml of ether was extracted with 465 ml of 2% aqueous sodium hydroxide solution. The aqueous extract was washed with successive 75 ml and 50 ml portions of ether. The pH of the aqueous solution was adjusted to 11.7, using 5% aqueous sodium hydroxide solution. 5 g of decolorizing carbon were added to the solution with stirring; the mixture was permitted to stand for 20 minutes at room temperature, and the carbon was removed by filtration. A solution containing 4 g of sodium carbonate in 25 ml of water was added to the aqueous solution, and the mixture was filtered sterile through a porcelain filter candle of 02 porosity into sterile bottles. The aqueous solution was then dried from the frozen state, whereupon a sterile residue of sodium 1-methyl-5-allyl-5-(1-methyl-2-pentynyl) barbiturate, weighing about 62 g was obtained.

References

- Merck Index 5857
 Kleeman & Engel p. 578
 PDR p. 1038
 OCDS Vol. 1 p. 269 (1977)
 I.N. p. 613
 REM p. 1046
 Doran, W.J.; U.S. Patent 2,872,448; February 3, 1959; assigned to Eli Lilly and Company

METHOTREXATE

Therapeutic Function: Antineoplastic

Chemical Name: N-[4-[[[(2,4-Diamino-6-pteridiny) methyl] methylamino] -benzoyl] -L-glutamic acid

Common Name: Amethopterin

Structural Formula:

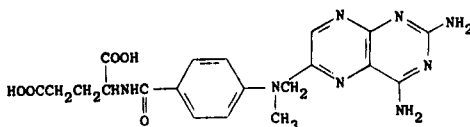

Chemical Abstracts Registry No.: 59-05-2

Trade Name	Manufacturer	Country	Year Introduced
Methotrexate	Lederle	U.S.	1955
Mexate	Bristol	U.S.	1979
Emtexate	Nordic	U.K.	1981
Folex	Adria	U.S.	1983
Abitrexate	Abic	Israel	—
Emthexate	Pharmachemie	Neth.	—
Ledertrexate	Lederle	France	—

Raw Materials

Diethyl-p-methylaminobenzoyl-L-glutamate
 Aminomalnonitrile tosylate
 β -Bromopyruvaldoxime
 Guanidine acetate

Manufacturing Process

5 g (15 mmol) of diethyl-p-methylaminobenzoyl-L-glutamate and 8.0 g of aminomalnonitrile tosylate (65% by NMR assay, 20 mmol) were dissolved in warm ethanol (65 ml, with 15% water by volume). To this solution, cooled to 0°C, was added all at once and with vigorous stirring, 3.6 g of β -bromopyruvaldoxime (89% by NMR assay, 19 mmol). After 30 minutes the stirred mixture, which was allowed to warm slowly to room temperature, was neutralized with powdered NaHCO₃ to pH 6, stirring continued for four additional hours, and the resulting mixture filtered through Celite. The filtrate was evaporated under reduced pressure to a glasslike substance, which was taken up in 500 ml of chloroform. The resulting suspension was then filtered using Celite, and the filtrate was washed with water, dried with anhydrous MgSO₄, and evaporated to give an orange glasslike substance which was used directly in the next step.

To a 20% solution of titanium trichloride in water (39 mmol), stirred under nitrogen, was added a solution of 18 g (230 mmol) of ammonium acetate in 55 ml of water. Then, to this mixture, cooled to 10°C and stirred with an air-driven stirrer, was added over a period of 5 minutes a solution of the orange glassy substance above distilled in 60 ml of tetrahydrofuran. The mixture was vigorously stirred for 15 minutes while a rapid stream of nitrogen was passed through. After this time, 15 g of powdered sodium sulfite (120 mmol) was added to the mixture, which after several minutes turned from green to yellowish white. This mixture was stirred into 1 liter of chloroform, and the heavy yellow layer separated by use of a separatory funnel. This chloroform layer was washed with water, dried using anhydrous MgSO₄, and evaporated under reduced pressure to give a light orange glass, which was then chromatographed rapidly on a column made from 80 g of Baker silica gel, using 5% ethyl acetate in chloroform as the eluent.

The product obtained by evaporation of the eluate was recrystallized from ethanol-ether (1:10) to give a light yellow powder, MP 85°C to 88°C. The yield was 4.4 g (63%).

A solution containing 4.8 g (10.2 mmol) of diethyl-N-[p[[(2-amino-3-cyano-5-pyrazinyl)-methyl] methylamino] benzoyl] glutamate and 5 g (42 mmol) of guanidine acetate in 40 ml of dimethylformamide was stirred under nitrogen at 120°C for six hours. The resulting solution was cooled to room temperature, filtered and evaporated to a glassy product using a rotary evaporator and a mechanical vacuum pump to insure a better vacuum. The residual glass was taken up in 500 ml of chloroform, the resulting suspension filtered using Celite, and the filtrate washed with water, dried using anhydrous MgSO₄, and evaporated to dryness. (The residual material was chromatographed rapidly on a column prepared from 250 g of Baker silica gel using, initially, 2% ethanol in chloroform, and then 5% ethanol in chloroform as eluents.) The material obtained by evaporation of the eluates was crystallized from ethanol-chloroform (4:1) to give small, pale yellow lustrous platelets, MP 142°C to 154°C; yield, 3.8 g (73%). Further crystallization of this material from ethanol-chloroform (4:1) raised the MP to 153°C to 155°C. The compound is completely racemic.

A sample of this product was hydrolyzed in a mixture of water and methanol in the presence of potassium hydroxide. Essentially pure methotrexate was thus obtained.

References

Merck Index 5861

Kleeman & Engel p. 579

PDR p. 1016

DOT 8 (11) 426 (1972) & 16 (5) 170 (1980)

I.N. p. 614

REM p. 1152

Wiecko, J.; U.S. Patent 4,057,548; November 8, 1977

Ellard, J.A.; U.S. Patent 4,080,325; March 21, 1978; assigned to U.S. Dept. of Health, Education and Welfare

METHOTRIMEPRAZINE

Therapeutic Function: Analgesic

Chemical Name: 2-methoxy-N,N,β-trimethyl-10H-phenothiazine-10-propanamine

Common Name: Levomepromazine

Structural Formula:

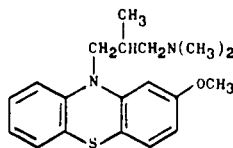

Chemical Abstracts Registry No.: 60-99-1; 1236-99-3 (Hydrochloride)

Trade Name	Manufacturer	Country	Year Introduced
Levoprome	Lederle	U.S.	1966
Hirnamin	Shionogi	Japan	—
Levaru	Mohan	Japan	—
Levomezine	Toho	Japan	—

Trade Name	Manufacturer	Country	Year Introduced
Levotomin	Shionogi	Japan	—
Nozinan	Farmalabor	Italy	—
Ronexine	Ikapharm	Israel	—
Sinogan	Rhodia Iberica	Spain	—
Sofmin	Dainippon	Japan	—
Veractil	May & Baker	U.S.	—

Raw Materials

3-Methoxyphenthiazine
Sodium amide
1-Dimethylamino-2-methyl-3-chloropropane

Manufacturing Process

95% sodamide (2.33 g) is added to a boiling solution of 3-methoxyphenthiazine (12 g) in anhydrous xylene (150 cc) and the mixture is heated with agitation under reflux for 1½ hours. A solution of 1-dimethylamino-2-methyl-3-chloropropane (8.2 g) in anhydrous xylene (90 cc) is then run in over a period of 45 minutes while the reaction temperature is maintained and heating under reflux is continued for 18 hours.

After cooling, the reaction mixture is agitated with a mixture of water (40 cc) and a normal solution of methanesulfonic acid (70 cc), the xylene layer is removed and the acid liquors are washed with ether (200 cc). The aqueous phase is then made alkaline with sodium hydroxide (d = 1.33; 10 cc) and the liberated base is extracted with ether. The ethereal solution is dried over anhydrous potassium carbonate and concentrated at normal pressure. On distillation of the residue under reduced pressure 3-(3-methoxy-10-phenthiazinyl)-2-methyl-1-dimethylaminopropane (11.3 g) is obtained, MP 103°C, BP 182° to 191°C/0.15 mm Hg. The hydrochloride prepared in isopropanol melts at about 90°C.

References

- Merck Index 5862
Kleeman & Engel p. 522
DOT 3 (2) 62 (1967) & 9 (7) 227 (1971)
I.N. p. 556
REM p. 1113
Jacob, R.M. and Robert, J.G.; U.S. Patent 2,837,518; June 3, 1958; assigned to Societe des Usines Chimiques Rhone-Poulenc, France

METHOXAMINE HYDROCHLORIDE

Therapeutic Function: Hypertensive

Chemical Name: α -(1-aminoethyl)-2,5-dimethoxybenzenemethanol hydrochloride

Common Name: —

Structural Formula:

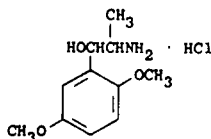

Chemical Abstracts Registry No.: 61-16-5; 390-28-3 (Base)

Trade Name	Manufacturer	Country	Year Introduced
Vasoxyl	Burroughs Wellcome	U.S.	1949
Idasal	Gayoso Wellcome	Spain	—
Mexan	Nippon Shinyaku	Japan	—
Vasylox	Burroughs Wellcome	—	—

Raw Materials

2,5-Dimethoxypropiophenone
Methyl nitrite
Hydrogen

Manufacturing Process

2,5-Dimethoxypropiophenone is treated in absolute ether with methyl nitrite and hydrogen chloride. The hydrochloride of 2,5-dimethoxy- α -isonitrosopropiophenone crystallizes out of the solution. It is removed, the base is liberated and crystallized from benzene-heptane forming yellow leaflets that melt at about 97° to 98°C. This isonitrosoketone is dissolved in absolute alcohol containing an excess of hydrogen chloride and is hydrogenated with palladized charcoal, yielding β -(2,5-dimethoxyphenyl)- β -ketoisopropylamine hydrochloride, a salt that melts at about 176°C with decomposition.

12.3 g ($\frac{1}{20}$ mol) of β -(2,5-dimethoxyphenyl)- β -ketoisopropylamine hydrochloride (MP 176°C) is dissolved in 50 cc of water and hydrogenated with platinum oxide platinum black in the customary Adams-Burgess Parr apparatus. About $\frac{1}{20}$ mol of hydrogen is absorbed, after which the solution is filtered off from the catalyst, evaporated to dryness in vacuo and re-crystallized from absolute alcohol, absolute ether being added to decrease solubility. The hydrochloride is thus obtained in substantially theoretical yield. It crystallizes in plates and melts at 215°C.

References

Merck Index 5863

Kleeman & Engel p. 580

PDR p. 768

I.N. p. 614

REM p. 888

Baltzly, R., de Beer, E.J. and Buck, J.S.; U.S. Patent 2,359,707; October 3, 1944; assigned to Burroughs Wellcome & Co. (U.S.A.) Inc.

METHOXSALEN

Therapeutic Function: Dermal pigmentation enhancer

Chemical Name: 9-methoxy-7H-furo[3,2-g] [1] benzopyran-7-one

Common Name: 8-Methoxypsoralen; ammoidin; xanthotoxin

Structural Formula:

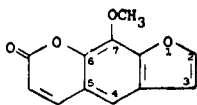

Chemical Abstracts Registry No.: 298-81-7

Trade Name	Manufacturer	Country	Year Introduced
Oxsoracen	Elder	U.S.	1955
Meloxine	Upjohn	U.S.	1958
Meladinine	Basoterm	W. Germany	—
Oxoralen	Farmochimica	Italy	—
Psoritin	Yurtoglu	Turkey	—
Puvalen	Star	Finland	—
Soloxsalen	I.C.N.	Canada	—

Raw Materials

8-Geranoxy psoralen
Sulfuric acid
Diazomethane

Manufacturing Process

It has been found that the compound 8-geranoxy psoralen is present in citrus oils, particularly lemon and lime oils. This compound can be isolated from the oil by a process which involves primarily absorption on an adsorbent material followed by elution with a suitable solvent.

(A) Cleavage of 8-Geranoxy psoralen: 275 mg of 8-geranoxy psoralen was dissolved with mechanical stirring in 4 ml glacial acetic acid. After 10 minutes, one drop of concentrated sulfuric acid was added to the solution. In 4 minutes thereafter a light tan precipitate began to form. Stirring was continued for 35 minutes and the reaction mixture was refrigerated for one hour and 20 minutes. The precipitate was then removed by suction filtration and washed on the filter with glacial acetic acid followed by ice-cold ethyl ether. The product, 8-hydroxy psoralen, weighed 115 mg, that is, 74% of theory.

(B) Methylation of 8-Hydroxy psoralen: 115 mg of 8-hydroxy psoralen was dissolved in 10 ml absolute methanol, an excess of diazomethane dissolved in ether was added and the mixture allowed to stand at room temperature with occasional stirring for 3 hours. The next day the reaction mixture was reduced in volume to 3 ml by evaporation on the steam bath and the concentrate was held in a refrigerator overnight. The next day, fine needles (80 mg) of 8-methoxy psoralen were filtered from the solution. The compound had a MP of 145° to 146°C and was obtained in a yield of 65% of theory.

There is also a wholly synthetic route to Methoxsalen as outlined by Kleeman & Engel.

References

- Merck Index 5864
Kleeman & Engel p. 580
PDR p. 867
OCDS Vol. 1 p. 333 (1977)
I.N. p. 614
REM p. 788
Stanley, W.L. and Vannier, S.H.; U.S. Patent 2,889,337; June 2, 1959; assigned to the U.S. Secretary of Agriculture
Glunz, L.J. and Dickson, D.E.; U.S. Patent 4,129,575; December 12, 1978; assigned to Thomas C. Elder, Inc.
Liebman, A.A. and Liu, Y.-Y.; U.S. Patent 4,147,703; April 3, 1979; assigned to Hoffmann-LaRoche, Inc.

METHOXYFLURANE

Therapeutic Function: Anesthetic (inhalation)

Chemical Name: 2,2-dichloro-1,1-difluoro-1-methoxyethane

Common Name: 1,1-difluoro-2,2-dichloroethyl methyl ether

Structural Formula: $\text{CH}_3\text{OCF}_2\text{CHCl}_2$

Chemical Abstracts Registry No.: 76-38-0

Trade Name	Manufacturer	Country	Year Introduced
Penthrane	Abbott	U.S.	1962
Penthrane	Abbott	W. Germany	1962
Penthrane	Abbott	U.K.	1963
Anecotan	Spofa	Czechoslovakia	—
Methofane	Pitman-Moore	U.S.	—

Raw Materials

1,1-Dichloro-2,2-difluoroethylene
Methanol

Manufacturing Process

Into a reactor equipped with agitator and temperature control jacket is charged approximately 100 lb (about 3 lb mols) of methanol, technical. This methanol is used in excess, and so it is both a reactant and a solvent in the synthesis.

Approximately 1 U.S. gallon of ion exchange resin beads wet with methanol is then added to the methanol. This is in the hydroxide form with at least 0.7 milliequivalent OH^- per milliliter of wet beads. Approximately 190 lb of 1,1-dichloro-2,2-difluoroethylene (about 1.44 lb mols) is then added to the reactor and, within it, to the 100 lb of methanol through a sparge pipe while the beads are kept in suspension by agitation. Coolant is run through the jacket of the reactor during this addition because the reaction is exothermic. The temperature in the reaction medium is kept at 10° to 20°C , to prevent side reactions and to minimize losses of the dichlorodifluoroethylene, which boils at 17°C . Reaction time is affected by the rate of heat removal and the reaction normally takes from 4 to 8 hours, using the stated quantities and conditions. After the dichlorodifluoroethylene is added, the resin is checked for residual alkalinity. If the resin is alkaline to phenolphthalein, it is assumed to have been of sufficient capacity and is removed from the $\text{CH}_3\text{OCF}_2\text{CHCl}_2$ -methanol mixture. If it is not alkaline to phenolphthalein, additional resin is added to insure complete reaction.

Essentially the same procedure can be carried out, employing as alkali any strongly alkaline substance, such as caustic soda in methanol solution. Control of the reaction rate may be accomplished by the rate of the addition of reactants and the amount of cooling applied to the reaction mixture. Agitation is employed to insure efficient contact of the reactants.

After removal of the resin catalyst, the excess methanol is extracted out of the mixture using three separate water washes, suitably of 25 gallons each. The water layer is decanted off, leaving product as an immiscible organic layer, after each wash. The 2,2-dichloro-1,1-difluoroethyl methyl ether containing intolerable unsaturated impurities may be purified and stabilized by a treatment with oxidizing agents such as air, oxygen, ozone, peroxy compounds, or other similar oxidizing agents, with subsequent removal of the decomposition or oxidation products and distilling if desired.

References

Merck Index 5869
Kleeman & Engel p. 581
PDR p. 547

I.N. p. 615

REM p. 1043

Larsen, E.R.; U.S. Patent 3,264,356; August 2, 1966; assigned to The Dow Chemical Company

METHSCOPOLAMINE BROMIDE

Therapeutic Function: Antispasmodic

Chemical Name: 7-(3-hydroxy-1-oxo-2-phenylpropoxy)-9,9-dimethyl-3-oxa-9-azoniatricyclo-[3.3.1.0^{2,4}]nonane bromide

Common Name: Hyoscine methyl bromide

Structural Formula:

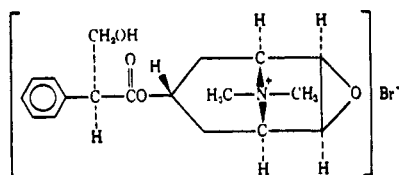

Chemical Abstracts Registry No.: 155-41-9

Trade Name	Manufacturer	Country	Year Introduced
Pamine	Upjohn	U.S.	1953
Daipin	Daiichi Seiyaku	Japan	1972
Ace	Ono	Japan	—
Blocan	Estedi	Spain	—
Lescopine	Lincoln	U.S.	—
Meporamim	Taiyo	Japan	—
Neo Avagal	Andrews	Australia	—
Parantin	Teva	Israel	—
Proscomid	Miller	U.S.	—
Scopolate	Strassenburgh	U.S.	—
Scordin	Ono	Japan	—
Skopyl	Farillon	U.K.	—

Raw Materials

Scopolamine hydrobromide trihydrate
Methyl bromide

Manufacturing Process

In a one-liter separatory funnel, 94 g (0.215 mol) of scopolamine hydrobromide trihydrate was dissolved in 250 ml of water, made alkaline by shaking with 40 g (1 mol) of sodium hydroxide in 150 ml of water, and the free base immediately extracted with ether. As scopolamine is somewhat soluble in water, the aqueous layer was saturated with potassium carbonate and again extracted with ether. The combined ether extracts were dried over anhydrous magnesium sulfate and the ether removed by distillation, leaving 65 g (0.214 mol; 100% yield) of nearly colorless oil. Then 100 g (1.05 mols) of cold methyl bromide was added to a chilled, 500-ml pressure flask containing the 65 g of scopolamine, the flask stoppered tightly with a clamp, and allowed to stand at room temperature for 96 hours.

The flask was cooled before opening, excess methyl bromide removed by filtration, and the white solid washed thoroughly with dry ether. The yield of crude scopolamine methyl bromide was 80 g (94% yield; 93.5% over-all yield).

The salt was recrystallized from 550 ml of alcohol; first crop, 70 g, MP 212° to 214°C; second crop, 6 g, MP 195° to 200°C. The combined crops were again recrystallized from 500 ml of 3-A alcohol; MP 210° to 212°C. The third recrystallization from 600 ml of alcohol yielded 64 g, MP 214° to 216°C, a 75% yield based on scopolamine hydrobromide trihydrate starting material.

References

Merck Index 5881

Kleeman & Engel p. 582

PDR p. 1857

I.N. p. 508

REM p. 917

Visscher, F.E.; U.S. Patent 2,753,288; July 3, 1956; assigned to The Upjohn Company

METHSUXIMIDE

Therapeutic Function: Anticonvulsant

Chemical Name: 1,3-Dimethyl-3-phenyl-2,5-pyrrolidinedione

Common Name: Mesuximid

Structural Formula:

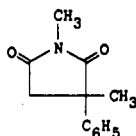

Chemical Abstracts Registry No.: 77-41-8

Trade Name	Manufacturer	Country	Year Introduced
Celontin	Parke Davis	U.S.	1957
Petinutin	Parke Davis	W. Germany	—

Raw Materials

α -Phenyl- α -methylsuccinic acid
Methylamine

Manufacturing Process

100 g of α -phenyl- α -methylsuccinic acid and 110 g of 40% aqueous methyl amine are heated together at 200° to 250°C until no more distillate is obtained. Upon vacuum distillation of the residue, the N-methyl- α -phenyl- α -methylsuccinimide, of BP 121° to 122°C at 0.1 mm is obtained. After recrystallization from aqueous ethanol, this compound melts at 52° to 53°C.

References

Merck Index 5882

Kleeman & Engel p. 567

PDR p. 1320

OCDS Vol. 1 p. 228 (1977)

I.N. p. 602

REM p. 1079

Miller, C.A. and Long, L.M.; U.S. Patent 2,643,257; June 23, 1953; assigned to Parke, Davis & Company

METHYLDOPA

Therapeutic Function: Antihypertensive

Chemical Name: 3-hydroxy- α -methyl-L-tyrosine

Common Name: L- α -methyl-3,4-dihydroxyphenylalanine

Structural Formula:

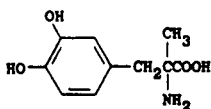

Chemical Abstracts Registry No.: 555-30-6

Trade Name	Manufacturer	Country	Year Introduced
Aldometil	MSD	W. Germany	1962
Aldomet	MSD	U.K.	1962
Aldomet	MSD	Italy	1962
Aldomet	MSD	U.S.	1963
Aldomet	MSD-Chibret	France	1964
Adopal	Pharmacial	Finland	—
Aldomin	Teva	Israel	—
Aldorii	MSD	U.S.	—
Alphamex	Protea	S. Africa	—
Becanta	Kissei	Japan	—
Caprinol	Bayer	W. Germany	—
Dansul	Nippon Yakko	Japan	—
Desens	Nissin	Japan	—
Dimal	Protea	Australia	—
Domecin	Sankyo	Japan	—
Dopamet	Berk	U.S.	—
Dopamin	Hokuriku	Japan	—
Dopatec	Labatec	Switz.	—
Dopegyt	Gideon Richter	Hungary	—
Equibar	Genekod	France	—
Grospisk	Toho Iyaku	Japan	—
Hydromet	MSD	France	—
Hyperten	Toho	Japan	—
Hypolag	Lagap	Switz.	—
Hy-Po-Tone	Lennon	S. Africa	—
Medimet	Medic	Canada	—
Medomet	D.D.S.A.	U.K.	—
Medopa	Kaigai	Japan	—
Medopal	A.L.	Norway	—

Trade Name	Manufacturer	Country	Year Introduced
Medopren	Dietopharma	Italy	—
Metholes	Taisho	Japan	—
Methoplain	Kowa	Japan	—
Nichidopa	Nichiiko	Japan	—
Novomedopa	Novopharm	Canada	—
Polinal	Boehr-Yamanouchi	Japan	—
Sembrina	Boehr. Mann.	Italy	—

Raw Materials

3-Hydroxy-4-methoxyphenylalanine
Hydrogen chloride

Manufacturing Process

The dl- α -methyl-3,4-dihydroxyphenylalanine may be made as described in U.S. Patent 2,868,818. Five-tenths of a gram of 3-hydroxy-4-methoxyphenylalanine was dissolved in 20 ml of concentrated hydrochloric acid, the solution saturated with hydrogen chloride and heated in a sealed tube at 150°C for 2 hours. The dark reaction mixture was concentrated to dryness in vacuo, excess acid removed by flushing several times with ethanol. On dissolving the dark residue in a minimum amount of water and adjusting the clarified solution to pH 6.5 with ammonium hydroxide the compound separated in fine crystals which were filtered, washed with alcohol and ether. The crystalline product had a MP of 299.5° to 300°C with decomposition.

Then, as described in U.S. Patent 3,158,648, the optical isomers may be resolved as follows. 37 g of racemic α -methyl-3,4-dihydroxyphenylalanine are slurried at 35°C in 100 cc of 1.0N hydrochloric acid. The excess solids are filtered leaving a saturated solution containing 34.6 g of racemic amino acid of which about 61% is present as the hydrochloride. The solution is then seeded at 35°C with 7 g of hydrated L- α -methyl-3,4-dihydroxyphenylalanine (6.2 g of anhydrous material). The mixture is then cooled to 20°C in 30 minutes and aged one hour at 20°C. The separated material is isolated by filtration, washed twice with 10 cc of cold water and dried in vacuo. The yield of product is 14.1 g of L- α -methyl-3,4-dihydroxyphenylalanine in the form of a sesquihydrate of 100% purity as determined by the rotation of the copper complex.

References

- Merck Index 5928
 Kleeman & Engel p. 583
 PDR pp. 993, 1133
 OCDS Vol. 1 p. 95 (1977)
 DOT 10 (9) 323 (1974) & 19 (3) 170 (1983)
 I.N. p. 618
 REM p. 846
 Pfister, K., III and Stein, G.A.; U.S. Patent 2,868,818; January 13, 1959; assigned to Merck & Co., Inc.
 Jones, R.T., Krieger, K.H. and Lago, J.; U.S. Patent 3,158,648; November 24, 1964; assigned to Merck & Co., Inc.

METHYLERGONOVINE MALEATE

Therapeutic Function: Oxytocic

Chemical Name: 9,10-didehydro-N-[1-(hydroxymethyl)propyl]-6-methylergoline-8-carboxamide

Common Name: d-Lysergic acid di-hydroxybutylamide-2; methylergometrin maleate

Structural Formula:

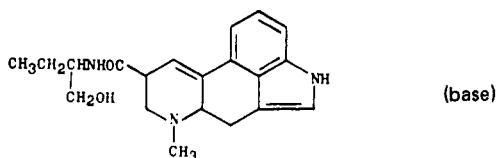

Chemical Abstracts Registry No.: 7054-07-1; 113-42-8 (Base)

Trade Name	Manufacturer	Country	Year Introduced
Methergine	Sandoz	U.S.	1948
Methergin	Sandoz	France	1953
Ergotrate	Lilly	U.S.	—
Levospan	Isei	Japan	—
Metenarin	Teikoku Zoki	Japan	—
Methylergobrevin	Arzneim. Dresden	E. Germany	—
Metiler	Adika	Turkey	—
Myomergin	Leiras	Finland	—
Ryegonovin	Morishita	Japan	—
Spametrim M	Sanzen	Japan	—
Takimetrim M	Nakataki	Japan	—
Uterin	Biofarma	Turkey	—

Raw Materials

d-Isolysergic acid azide
d-2-Aminobutanol-1

Manufacturing Process

To a freshly prepared solution of 2 parts of d-isolysergic acid azide in 300 parts of ether is added an ethereal solution of 2 parts of d-2-aminobutanol-1 and the mixture is left to stand at room temperature during 12 hours. The yellowish clear solution is then washed several times with some water, dried over sodium sulfate and the ether evaporated in vacuo. The crystallized residue is treated with a small quantity of acetone and filtered. Yield: 2.2 parts of d-isolysergic acid-d-1-hydroxybutylamide-2. On recrystallization from some hot methanol the new compound is obtained in form of beautiful polygonal crystals that melt with some decomposition at 192° to 194°C (corr.).

1 part of the iso-compound is then dissolved in 10 parts of absolute ethanol and an alcoholic potassium hydroxide solution is added thereto. The mixture is left to stand at room temperature during 45 minutes. After this time equilibrium is reached between lysergic acid and the isolysergic acid forms, which can be checked by determination of the constancy of the optical rotation of the solution. When this point is reached, potassium hydroxide is transformed into potassium carbonate by bubbling through the solution a stream of carbon dioxide; the thick crystal paste of potassium carbonate is then diluted with 50 parts of ether, filtered and washed again with 50 parts of ether.

The alcoholic ethereal filtrate is then dried over calcined potassium carbonate and the solution evaporated, whereby 0.9 to 1 part of a mixture of d-lysergic acid-d-1-hydroxybutylamide-2 and of d-isolysergic acid-d-1-hydroxybutylamide-2 is obtained. In order to separate the isomers, the residue is dissolved in 15 parts of hot chloroform and filtered from the small quantity of inorganic salt, whereby on cooling down, the difficultly soluble chloroform compound of d-lysergic acid-d-1-hydroxybutylamide-2 crystallizes out. Yield: 0.4 part. This compound can be recrystallized from hot benzene, whereby crystals melting

with some decomposition at 172°C (corr.) are obtained. It may then be reacted with maleic acid to give the maleate.

References

Merck Index 5943

Kleeman & Engel p. 584

PDR p. 1587

I.N. p. 619

REM p. 948

Stoll, A. and Hofmann, A.; U.S. Patent 2,265,207; December 9, 1941; assigned to Sandoz AG, Switzerland

METHYLHEXANEAMINE CARBONATE

Therapeutic Function: Nasal decongestant

Chemical Name: 4-methyl-2-hexylamine carbonate

Common Name: —

Structural Formula:

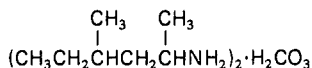

Chemical Abstracts Registry No.: 105-41-9 (Base)

Trade Name	Manufacturer	Country	Year Introduced
Forthane	Lilly	U.S.	1948

Raw Materials

4-Methylhexanone-2	Hydroxylamine
Hydrogen	Carbon dioxide

Manufacturing Process

One molecular equivalent of 4-methylhexanone-2 is reacted with slightly more than one molecular equivalent of hydroxylamine. Desirably, the hydroxylamine is prepared in the presence of the 4-methylhexanone-2 by reacting the hydrochloride or sulfate or other salt of the hydroxylamine with a suitable base, such as sodium carbonate or sodium hydroxide. Desirably, the reaction mixture is agitated for a few hours to insure the conversion of the 4-methylhexanone-2 to 4-methylhexanone-2 oxime.

The resulting 4-methylhexanone-2 oxime separates and is dried by any suitable means, such as with a dehydrating agent, for example, sodium sulfate or magnesium sulfate. After drying, 4-methylhexanone-2 oxime is reduced with hydrogen by means of a catalyst, such as Raney nickel, or by reaction of sodium and a primary alcohol, such as ethanol. The resulting 2-amino-4-methylhexane may be purified by distillation, as described in U.S. Patent 2,350,318.

115 g (1 mol) of 2-amino-4-methylhexane and 9 g (0.5 mol) of water are placed in a tared 500 cc 3-necked flask which is equipped with a mechanical stirrer, a thermometer, and a gas delivery tube. The flask is surrounded by a cooling bath of ice and water. Dry carbon dioxide gas is introduced into the solution through the gas delivery tube, with con-

stant stirring, until the increase in weight is approximately 22 g (0.5 mol). The temperature during this addition is maintained between 20° and 30°C. A viscous liquid results, and consists essentially of 2-amino-4-methylhexane carbonate. This also dissociates very slowly at room temperature to the free amine, carbon dioxide, and water; and is effective as an inhalant, according to U.S. Patent 2,386,273.

References

Merck Index 5955

I.N. p. 620

Shonle, H.A. and Rohrmann, E.; U.S. Patent 2,350,318; May 30, 1944; assigned to Eli Lilly and Company

Shonle, H.A. and Rohrmann, E.; U.S. Patent 2,386,273; October 9, 1945; assigned to Eli Lilly and Company

METHYLOL RIBOFLAVIN

Therapeutic Function: Enzyme Cofactor vitamin source

Chemical Name: See Structural Formula

Common Name: —

Structural Formula:

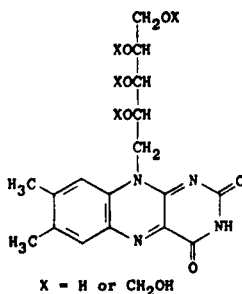

Chemical Abstracts Registry No.: —

Trade Name	Manufacturer	Country	Year Introduced
Hyflavin	Endo	U.S.	1948

Raw Materials

Riboflavin
Formaldehyde

Manufacturing Process

100 g of riboflavin and 4 g of potassium carbonate are suspended in 500 cc of the aqueous formaldehyde solution and the mixture is stirred at 30°C for 8 hours. At the end of this period, 5 cc of glacial acetic acid and 1 liter of methanol are added, with stirring. The solution is freed from undissolved material by filtration and the clear solution is poured slowly at about 20°C to 22°C with vigorous stirring into 8 liters of anhydrous acetone. The resultant precipitate is filtered off, washed repeatedly with anhydrous acetone and with ether, and then dried at room temperature and with vacuum. The resultant dried powder is dissolved

in hot water at 95°C to give an aqueous solution of 20% by weight. This solution is kept in the dark at room temperature for 3 to 4 weeks, after which time a large amount of material crystallizes out of the solution. This crystallized material is removed by filtration and recrystallized from hot water. A small amount of dark red insoluble material is filtered from the hot solution. This recrystallization step is repeated four times. The resultant end product is monomethylol riboflavin, which crystallized in small orange clusters. It has a melting point of 232°C to 234°C with decomposition, and it becomes dark when heated above 225°C.

References

Merck Index 5974

I.N. p. 621

Schoen, K. and Gordon, S.M.; U.S. Patent 2,587,533; February 26, 1952; assigned to Endo Products, Inc.

METHYLPHENIDATE HYDROCHLORIDE

Therapeutic Function: Psychostimulant

Chemical Name: α -phenyl-2-piperidineacetic acid methyl ester

Common Name: —

Structural Formula:

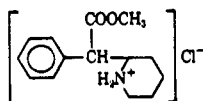

Chemical Abstracts Registry No.: 298-59-9; 113-45-1 (Base)

Trade Name	Manufacturer	Country	Year Introduced
Ritalin	Ciba	U.S.	1958
Rubifen	Rubio	Spain	—

Raw Materials

Phenyl acetonitrile	Sodium amide
2-Chloropyridine	Sulfuric acid
Methanol	Hydrogen chloride
Hydrogen	

Manufacturing Process

As described in U.S. Patent 2,507,631, 80 g of pulverized sodium amide are gradually added, while stirring and cooling, to a solution of 117 g of phenyl-acetonitrile and 113 g of 2-chloropyridine in 400 cc of absolute toluene. The mixture is then slowly heated to 110° to 120°C and maintained at this temperature for 1 hour. Water is added thereto after cooling, the toluene solution is shaken with dilute hydrochloric acid and the hydrochloric acid extracts are made alkaline with concentrated caustic soda solution. A solid mass is separated thereby which is taken up in acetic ester and distilled, α -phenyl- α -pyridyl-(2)-acetonitrile passing over at 150° to 155°C under 0.5 mm pressure. When recrystallized from ethyl acetate it melts at 88° to 89°C, the yield amounting to 135 g.

100 g of α -phenyl- α -pyridyl-(2)-acetonitrile are introduced into 400 cc of concentrated sulfuric acid, allowed to stand overnight at room temperature, poured into ice and ren-

dered alkaline with sodium carbonate. α -Phenyl- α -pyridyl-(2)-acetamide is precipitated thereby which melts at 134°C after recrystallization from ethyl acetate.

100 g of the resulting α -phenyl- α -pyridyl-(2)-acetamide, when dissolved in one liter of methyl alcohol and treated for 6 hours at water-bath temperature with hydrogen chloride, and after concentrating, diluting with water and rendering alkaline with sodium carbonate, yield 90 g of the α -phenyl- α -pyridyl-(2)-acetic acid methylester of MP 74° to 75°C (from alcohol of 50% strength).

The α -phenyl- α -piperidyl-(2)-acetic acid methylester of BP 135° to 137°C under 0.6 mm pressure is obtained in theoretical yield by hydrogenation of 50 g of α -phenyl- α -pyridyl-(2)-acetic acid methylester in glacial acetic acid in the presence of 1 g of platinum catalyst at room temperature, while taking up 6 hydrogen atoms. Reaction with HCl gives the hydrochloride. Resolution of stereoisomers is described in U.S. Patent 2,957,880.

References

Merck Index 5981

Kleeman & Engel p. 586

PDR p. 811

OCDS Vol. 1 p. 88 (1977)

I.N. p. 622

REM p. 1136

Hartmann, M. and Panizzon, L.; U.S. Patent 2,507,631; May 16, 1950; assigned to Ciba Pharmaceutical Products Inc.

Rometsch, R.; U.S. Patent 2,957,880; October 25, 1960; assigned to Ciba Pharmaceutical Products Inc.

METHYLPREDNISOLONE

Therapeutic Function: Glucocorticoid

Chemical Name: 11 β ,17 α ,21-trihydroxy-6 α -methyl-1,4-pregnadiene-3,20-dione

Common Name: 1-dehydro-6 α -methylhydrocortisone

Structural Formula:

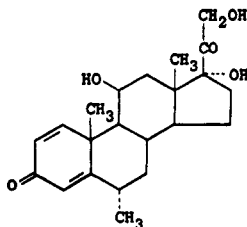

Chemical Abstracts Registry No.: 83-43-2

Trade Name	Manufacturer	Country	Year Introduced
Medrol	Upjohn	U.S.	1957
Medrol	Upjohn	France	1959
A-Methapred	Abbott	U.S.	1978
Solu-Medrol	Upjohn	Japan	1980
Caberdelta	Caber	Italy	—
Cortalfa	S.A.M.	Italy	—

Trade Name	Manufacturer	Country	Year Introduced
Depo-Medrate	Upjohn	W. Germany	—
Emmetip	Magis	Italy	—
Esametone	Lisapharma	Italy	—
Eutisone	Eufarma	Italy	—
Firmacort	Firma	Italy	—
Horusona	Horus	Spain	—
Medesone	Fargal	Italy	—
Mega-Star	Ausonia	Italy	—
Metilbetasone	Coli	Italy	—
Metilcort	Gazeini	Italy	—
Metilprednilone	Guidi	Italy	—
Metilstendiolo	Panther-Osfa	Italy	—
Moderin	Alter	Spain	—
Nirypan	Jugoremedija	Yugoslavia	—
Nixolan	S.I.T.	Italy	—
Prednilen	Lenza	Italy	—
Prednol	Mustafa Nevzat	Turkey	—
Radiosone	Radiumpharma	Italy	—
Reactenol	Lafare	Italy	—
Sieropresol	Sierochimica	Italy	—
Summicort	Benvegna	Italy	—
Suprametil	Geistlich	Switz.	—
Urbason	Hoehst	Italy	—

Raw Materials

Bacterium <i>Septomyxa affinis</i>	Glucose
Corn steep liquor	6- α -Methylhydrocortisone

Manufacturing Process

The following process description is taken from U.S. Patent 2,897,218. Six 100-ml portions of a medium in 250-ml Erlenmeyer flasks containing 1% glucose, 2% corn steep liquor (60% solids) and tap water was adjusted to a pH of 4.9. This medium was sterilized for 45 minutes at 15 psi pressure and inoculated with a one to two day growth of *Septomyxa affinis* ATCC 6737. The Erlenmeyer flasks were shaken at room temperature at about 24°C for a period of 3 days.

At the end of this period, this 600-ml volume was used as an inoculum for ten liters of the same glucose-corn steep liquor medium which in addition contained 10 ml of an anti-foam (a mixture of lard oil and octadecanol). The fermentor was placed into the water bath, adjusted to 28°C, and the contents stirred (300 rpm) and aerated (0.5 liter air/10 liters beer). After 17 hours of incubation, when a good growth developed and the acidity rose to pH 6.7, 2 g of 6 α -methylhydrocortisone plus 1 g of 3-ketobisnor-4-cholen-22-al, dissolved in 115 ml of dimethylformamide, was added and the incubation (conversion) carried out at the same temperature and aeration for 24 hours (final pH 7.9).

The mycelium (56 g dry weight) was filtered off and the steroidal material was extracted with methylene chloride, the methylene extracts evaporated to dryness, and the resulting residue chromatographed over a Florisil column. The column was packed with 200 g of Florisil and was developed with five 400-ml fractions each of methylene chloride, Skellysolve B-acetone mixtures of 9:1, 8:2, 7:3, 1:1, and methanol. The fraction eluted with Skellysolve B-acetone (7:3) weighed 1.545 g and on recrystallization from acetone gave, in three crops, 928 mg of product of MP 210° to 235°C. The sample prepared for analysis melted at 245° to 247°C.

References

Merck Index 5984

Kleeman & Engel p. 587

PDR pp. 1286, 1606, 1850

OCDS Vol. 1 p. 196 (1977)

I.N. p. 623

REM p. 968

Sebek, O.K. and Spero, G.B.; U.S. Patent 2,897,218; July 28, 1959; assigned to The Upjohn Company

Gould, D.H.; U.S. Patent 3,053,832; September 11, 1962; assigned to Schering Corporation

METHYLTESTOSTERONE

Therapeutic Function: Androgen

Chemical Name: 17 β -hydroxy-17-methyl-androst-4-ene-3-one

Common Name: —

Structural Formula:

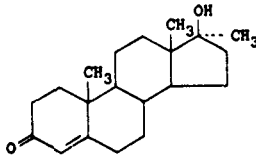

Chemical Abstracts Registry No.: 58-18-4

Trade Name	Manufacturer	Country	Year Introduced
Metandren	Ciba	U.S.	1941
Oreton-M	Schering	U.S.	1941
Neo-Hombreol	Organon	U.S.	1941
Hormale	Key	U.S.	1958
Android-S	Brown	U.S.	—
Arcosterone	Arcum	U.S.	—
Climaterine	Lucien	France	—
Climatone	Paines & Byrne	U.K.	—
Dumone	Squibb	U.S.	—
Estan	Schering	U.S.	—
Gynosterone	Sam-On	Israel	—
Hormobin	Munir Sahin	Turkey	—
Malogen	Fellows-Testagar	U.S.	—
Orchisterone	Negrioni	Italy	—
Seksfort	Uranium	Turkey	—
Steronyl	Kay	U.S.	—
Synandrets	Pfizer	U.S.	—
Testipron	Kwizda	Austria	—
Testomet	Protea	Australia	—
Testora	Alcon	U.S.	—
Testostalets	Barlow Cote	Canada	—
Testonic B	Sam-On	Israel	—
Testovis	Vister	Italy	—
Testred	I.C.N.	U.S.	—
Virilon	Star	U.S.	—

Raw Materials

17-Methyl- $\Delta^{5,6}$ -androstenediol-(3,17)
Magnesium

Acetone
Methyl chloride

Manufacturing Process

0.6 g of 17-methyl- $\Delta^{5,6}$ -androstenediol-(3,17) is heated under reflux cooling during 20 hours in 50 cm³ of benzene and 12 cm³ of acetone with 3 g of tertiary chloromagnesium butylate, which may be prepared by conversion of acetone with methyl magnesium chloride. The magnesium is then removed by shaking out with dilute H₂SO₄; the benzene layer is washed with water, dried with sodium sulfate and then evaporated to dryness. Methyltestosterone (MP 160° to 162°C) is obtained in a yield of more than 75% of the theory, according to U.S. Patent 2,384,335.

References

Merck Index 6000

Kleeman & Engel p. 588

PDR pp. 645, 729, 802, 949, 1447, 1643, 1778

OCDS Vol. 1 p. 172 (1977)

I.N. p. 625

REM p. 998

Miescher, K. and Wettstein, A.; U.S. Patent 2,374,369; April 24, 1945; assigned to Ciba Pharmaceutical Products, Incorporated

Miescher, K. and Wettstein, A.; U.S. Patent 2,374,370; April 24, 1945; assigned to Ciba Pharmaceutical Products, Incorporated

Oppenauer, R.; U.S. Patent 2,384,335; September 4, 1945

Miescher, K.; U.S. Patent 2,386,331; October 9, 1945; assigned to Ciba Pharmaceutical Products, Incorporated

Miescher, K.; U.S. Patent 2,435,013; January 27, 1948; assigned to Ciba Pharmaceutical Products, Incorporated

METHYPRYLON

Therapeutic Function: Sedative, hypnotic

Chemical Name: 3,3-diethyl-5-methyl-2,4-piperidinedione

Common Name: 2,4-dioxo-3,3-diethyl-5-methylpiperidine

Structural Formula:

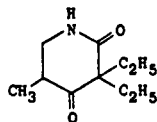

Chemical Abstracts Registry No.: 125-64-4

Trade Name	Manufacturer	Country	Year Introduced
Noludar	Roche	U.S.	1955
Noctan	Yamanouchi	Japan	—
Nolurate	Roche	—	—

Raw Materials

2,4-Dioxo-3,3-diethyl-piperidine
Hydrogen

Sodium
Methyl formate

Manufacturing Process

24 parts by weight of powdered sodium are suspended in 100 parts by volume of absolute benzene and to this suspension is added a freshly prepared solution of 150 parts by weight of methyl formate and 165 parts by weight of 2,4-dioxo-3,3-diethyl-piperidine in 900 parts by volume of absolute benzene. By cooling with cold water, the temperature is maintained at 25° to 28°C. After being stirred for 12 hours 200 parts by volume of 0.6 N sodium hydroxide are added while cooling. The aqueous layer is separated and acidified to Congo red by means of 35% hydrochloric acid. The 2,4-dioxo-3,3-diethyl-5-oxymethylene-piperidine is precipitated in good yield as a solid. After having been recrystallized in chloroform/petroleum ether it melts at 140° to 141°C.

5 parts by weight of 2,4-dioxo-3,3-diethyl-5-oxymethylene-piperidine are hydrogenated in 25 parts by volume of methanol in the presence of about 2 parts by weight of Raney nickel at 120°C and under an elevated pressure of 100 atm. Once 2 mols of hydrogen are absorbed, the hydrogenation is interrupted, the solution is separated from the catalyst and concentrated and the residue is distilled in vacuo. The distillate, boiling between 178° and 185°C under a pressure of 16 mm, consists of 2,4-dioxo-3,3-diethyl-5-methyl-piperidine, which melts at 74° to 75°C.

The same compound is obtained when proceeding according to the following alternative procedure. A mixture of 39.4 parts by weight of 2,4-dioxo-3,3-diethyl-5-oxymethylene-piperidine and 27 parts by weight of dibutylamine are heated to 150°C in a closed vessel. The 2,4-dioxo-3,3-diethyl-5-dibutylamino-methylene-piperidine formed melts at 77°C after having been recrystallized in petroleum ether.

31 parts by weight of the latter compound are hydrogenated in 150 parts by volume of alcohol, containing 6 parts by weight of acetic acid, in the presence of 10 parts by weight of Raney nickel, at 120°C and under an elevated pressure of 100 atm. The catalyst is separated and the solution is distilled in vacuo. The 2,4-dioxo-3,3-diethyl-5-methyl-piperidine boils between 178° and 185°C under a pressure of 16 mm and melts at 74° to 75°C.

References

Merck Index 6010

Kleeman & Engel p. 590

PDR p. 1495

DOT 9 (6) 245 (1973)

I.N. p. 626

REM p. 1072

Frick, H. and Lutz, A.H.; U.S. Patent 2,680,116; June 1, 1954; assigned to Hoffmann-LaRoche Inc.

METHYSERGIDE MALEATE

Therapeutic Function: Migraine therapy

Chemical Name: 9,10-didehydro-N-[1-(hydroxymethyl)propyl]-1,6-dimethylergoline-8-carboxamide maleate

Common Name: 1-methyl-d-lysergic acid butanolamide maleate

Structural Formula:

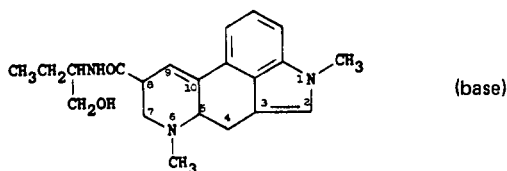

Chemical Abstracts Registry No.: 129-49-7; 361-37-5 (Base)

Trade Name	Manufacturer	Country	Year Introduced
Sansert	Sandoz	U.S.	1962
Desernil	Sandoz	France	1962
Deseril	Sandoz	U.K.	1963

Raw Materials

Lysergic acid-1'-hydroxy-butylamide-2'
 Potassium
 Ammonia
 Methyl iodide
 Maleic acid

Manufacturing Process

As described in U.S. Patent 3,218,324, 0.9 part of potassium are dissolved in 500 parts by volume of liquid ammonia, then oxidized with ferric nitrate to potassium amide, after which 4.85 parts of lysergic acid-1'-hydroxy-butylamide-2' are dissolved in the obtained mixture. After 15 minutes there are added to the obtained yellow solution 4.1 parts of methyl iodide in 5 parts by volume of ether, the mixture being allowed to stand for 30 more minutes at -60°C . The liquid ammonia is thereupon evaporated and the dry residue is shaken out between water and chloroform. The mixture of bases which remains after the evaporation of the chloroform is chromatographed on a column of 250 parts of aluminum oxide, the desired 1-methyl-lysergic acid-1'-hydroxy-butylamide-2' being washed into the filtrate with chloroform and chloroform-0.2% ethanol. The 1-methyl-lysergic acid-1'-hydroxy-butylamide-2' crystallizes from chloroform in the form of plates which melt at 194° to 196°C . Reaction with maleic acid gives the dimaleate, melting at 187° to 188°C .

References

- Merck Index 6011
 Kleeman & Engel p. 590
 PDR p. 1596
 OCDS Vol. 2 p. 477 (1980)
 I.N. p. 626
 REM pp. 949, 1113
 Hofmann, A. and Troxler, F.; U.S. Patent 3,113,133; December 3, 1963; assigned to Sandoz Ltd., Switzerland
 Hofmann, A. and Troxler, F.; U.S. Patent 3,218,324; November 16, 1965; assigned to Sandoz Ltd., Switzerland

METIAZINIC ACID

Therapeutic Function: Antiinflammatory

Chemical Name: 10-methylphenothiazine-2-acetic acid

Common Name: —

Structural Formula:

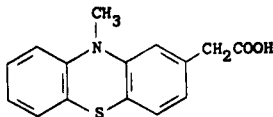

Chemical Abstracts Registry No.: 13993-65-2

Trade Name	Manufacturer	Country	Year Introduced
Soripan	Specia	France	1970
Soripal	Torii	Japan	1977
Soripal	Farmalabor	Italy	1978
Ambrunate	Rhodia	Argentina	—
Metian	Horus	Spain	—
Novartril	Andromaco	Spain	—
Roimal	Nippon Rhodia	Japan	—
Soridermal	Specia	France	—

Raw Materials

10-Methyl-3-acetylphenothiazine	Sulfur
Morpholine	Potassium hydroxide

Manufacturing Process

10-Methyl-3-acetylphenothiazine is prepared in accordance with G. Cauquil and A. Casadevall, *Bull. Soc. Chim.*, p 768 (1955). (10-Methyl-3-phenothiazinyl)acetic acid (MP 146°C; 21.4 g) is prepared by Willgerodt's reaction (action of sulfur and morpholine, followed by hydrolysis) employing 10-methyl-3-acetylphenothiazine as starting material.

References

Merck Index 6013

Kleeman & Engel p. 591

I.N. p. 32

Farge, D., Jeanmart, C. and Messer, M.N.; U.S. Patent 3,424,748; January 28, 1969; assigned to Rhone-Poulenc S.A., France

METOCLOPRAMIDE HCl**Therapeutic Function:** Antiemetic**Chemical Name:** 4-Amino-5-chloro-N-[(2-diethylamino)ethyl]-2-methoxybenzamide

Common Name: —

Structural Formula:

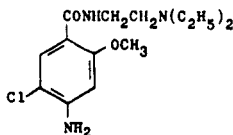

(base)

Chemical Abstracts Registry No.: 7232-21-5; 364-62-5 (Base)

Trade Name	Manufacturer	Country	Year Introduced
Primperan	Delagrance	France	1964
Paspertin	Kali-Chemie	W. Germany	1965
Maxolon	Beecham	U.K.	1967
Plasil	Richter	Italy	1967
Reglan	Robins	U.S.	1979
Metox	Steinhard	U.K.	1983
Ananda	Bonomelli-Hommel	Italy	—
Cerucal	Arzneimittelwerk Dresden	E. Germany	—
Clodil-Ion	Ion	Italy	—
Clopamon	Petersen	S. Africa	—
Clopan	Firma	Italy	—
Contromet	Script Intal	S. Africa	—
Digetres	Scalari	Italy	—
Donopon-GP	Sana	Japan	—
Elietin	Nippon Kayaku	Japan	—
Emesa	Mulda	Turkey	—
Emetisan	Phoenix	Argentina	—
Emperal	Neofarma	Finland	—
Gastronertron	Dolorgiet	W. Germany	—
Imperan	Bender	Austria	—
Kilozim	A.G.I.P.S.	Italy	—
Maxeran	Nordic	Canada	—
MCP-Ratiopharm	Ratiopharm	W. Germany	—
Meclopran	Lagap	Switz.	—
Metamide	Protea	Australia	—
Metoclof	Toyama	Japan	—
Metocobil	Beta	Italy	—
Metopram	Leiras	Finland	—
Metpamid	Sifar	Turkey	—
Moriperan	Morishita	Japan	—
Nadir	Oti	Italy	—
Netaf	Sintyal	Argentina	—
Peraprin	Taiyo	Japan	—
Placitril	Sigurta	Italy	—
Pramiel	Nagase	Japan	—
Pramin	Rafa	Israel	—
Primperil	Lacefa	Argentina	—
Prindarl	Sawai	Japan	—
Prometin	Yamanouchi	Japan	—
Putoprin	Mohan	Japan	—
Quanto	Mediolanum	Italy	—
Randum	Scharper	Italy	—
Regastrol	Sarm	Italy	—
Reliveran	Finadiet	Argentina	—
Rimetin	Farmakhim	Bulgaria	—
Terperan	Teikoru Zoki	Japan	—
Viscal	Zoja	Italy	—

Raw Materials

o-Toluidine	Nitric acid
Nitrous acid	Dimethyl sulfate
Potassium permanganate	Thionyl chloride
N,N-Diethylene diamine	Hydrogen
Acetic anhydride	Chlorine
Hydrogen chloride	

Manufacturing Process

The N-(diethylaminoethyl)-2-methoxy-4-aminobenzamide used as the starting material may be prepared from o-toluidine. The o-toluidine is initially nitrated with nitric acid to produce 4-nitro-o-toluidine. The 4-nitro-o-toluidine is then converted to 2-hydroxy-4-nitrotoluene by heating with nitrous acid. By reacting the resulting 2-hydroxy-4-nitrotoluene with dimethyl sulfate, 2-methoxy-4-nitrotoluene is formed. The 2-methoxy-4-nitrotoluene is oxidized with potassium permanganate to produce 2-methoxy-4-nitrobenzoic acid. The latter substituted benzoic acid is treated with thionyl chloride to form 2-methoxy-4-nitrobenzoyl chloride. A methyl ethyl ketone solution of the 2-methoxy-4-nitrobenzoyl chloride is added over a period of about 1½ hours to a methyl ethyl ketone solution containing an equal molecular quantity of N,N-diethylethylene diamine while stirring and maintaining the temperature between 0°C and 5°C. The N-(diethylaminoethyl)-2-methoxy-4-nitrobenzamide hydrochloride formed precipitates. It is filtered, washed twice with methyl ethyl ketone, dissolved in alcohol, and reduced catalytically in an absolute isopropyl alcohol solution to form N-(diethylaminoethyl)-2-methoxy-4-aminobenzamide. The base is obtained by precipitating with sodium hydroxide.

80 g (0.3 mol) of N-(2-diethylaminoethyl)-2-methoxy-4-aminobenzamide are dissolved in small portions in 150 cc of acetic acid. The mixture is cooled and 45 g (0.45 mol) of acetic anhydride are added, and the solution obtained is heated for two hours on a water bath. After cooling, the solution is decanted into a round-bottomed flask with a stirrer, a thermometer and a tube for introducing the chlorine. It is stirred and the current of chlorine is passed through, the temperature being maintained between 20°C and 25°C. The stirring is continued for one hour after the completion of the absorption of the chlorine.

The mixture obtained is poured into 2 liters of water and the base is precipitated with 30% soda. The precipitated base is extracted with 400 cc of methylene chloride. After evaporation of the solvent, the N-(2-diethylaminoethyl)-2-methoxy-4-acetamino-5-chlorobenzamide formed crystallizes. The melting point is 86°C to 87°C and the yield is 95%.

To obtain the corresponding amino derivative, 109 g of base are heated under agitation in a round-bottomed flask with 300 cc of 35-36% concentrated hydrochloric acid and 600 cc of water. It is heated on a water bath until dissolution is complete, then maintained at boiling point for 90 minutes, cooled, diluted with 1 liter of water, and neutralized with about 350 cc of 30% soda. The N-(2-diethylaminoethyl)-2-methoxy-4-amino-5-chlorobenzamide formed crystallizes, is centrifuged and washed in water. Its melting point is 122°C and the yield is 74%.

To obtain the corresponding dihydrochloride, the base is dissolved in absolute alcohol (3 volumes) and to that solution is added 5 N alcoholic hydrochloric acid. The dihydrochloride precipitates, is centrifuged and washed with alcohol. It is a solid white material, having a melting point of 134°C to 135°C.

References

Merck Index 6019

Kleeman & Engel p. 593

PDR p. 1463

DOT 1 (2) 66 (1965); 16 (5) 159 (1980) & 19 (8) 476 (1983)

I.N. p. 629

REM p. 809

Thominet, M.L.; U.S. Patent 3,177,252; April 6, 1966; assigned to Soc. d'Etudes Scientifiques et Industrielles de l'Île de France (France)

METOLAZONE

Therapeutic Function: Diuretic

Chemical Name: 7-chloro-1,2,3,4-tetrahydro-2-methyl-3-(2-methylphenyl)-4-oxo-6-quinolinesulfonamide

Common Name: --

Structural Formula:

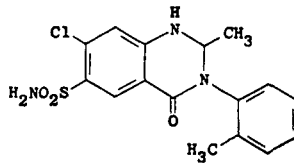

Chemical Abstracts Registry No.: 17560-51-9

Trade Name	Manufacturer	Country	Year Introduced
Zaroxolyn	Pennwalt	U.K.	1973
Zaroxolyn	Pennwalt	U.S.	1974
Diulo	Searle	U.S.	1978
Zaroxolyn	Searle	W. Germany	1978
Zaroxolyn	Sandoz	Switz.	1978
Zaroxolyn	I.S.F.	Italy	1981
Normeran	Sankyo	Japan	1982
Metenix	Hoechst	U.K.	—
Oldren	Roemmers	Argentina	—

Raw Materials

5-Chloro-2-methylaniline	Acetic anhydride
Chlorosulfonic acid	Ammonia
o-Toluidine	Phosphorus trichloride
Sodium borohydride	

Manufacturing Process

Preparation of Intermediate Compound N-Acetyl-5-Chloro-2-Methylaniline: To a well-stirred mixture of 1,270 g (9 mols) of 5-chloro-2-methylaniline in 7.5 liters of water at 34°C was added all at once 1,710 ml (18 mols) of acetic anhydride. A solution was obtained and then almost immediately the product started to crystallize. The temperature rose to 60°C. The mixture was stirred until the temperature dropped to 30°C. The product was filtered and washed well with water. Yield 97% (1,640 g), MP 134° to 138°C. Product was air dried and then in vacuum over P₂O₅.

Preparation of Intermediate Compound 5-Chloro-2-Methyl-4-Sulfamylacetanilide: Into a 3-necked 3-liter flask fitted with stirrer and thermometer 540 ml of chlorosulfonic acid were placed and cooled in an ice bath to 20°C. 300 g of the acetanilide were added portionwise while stirring and maintaining temperature at 20°C. This addition takes approximately 20 minutes. Remove the ice bath and add 88 g of sodium chloride portionwise (approximately 1 tsp every 10 minutes). This addition takes approximately 1 hour. Some foaming takes place. Using heating mantle bring temperature up slowly (approximately ½ hour) to 75°C. Considerable foaming takes place and heating is continued another ½ hour until 92°C is reached. Foaming can be controlled by shutting off heat and with good stirring. Once the temperature of 92°C has been reached and foaming has subsided reaction can be left unattended. Keep reaction at 92°C for a total of 2½ hours.

Pour the hot reaction mixture onto 4 liters of crushed ice. Pour slowly and stir the ice mixture. What remains in the flask can be worked up by adding ice to it and swirling the contents. After approximately ¾ of an hour, the solid is filtered and washed with approximately 600 ml water.

Break up cake into small pieces and add to 2.5 liters concentrated NH_4OH in 4 liter beaker. Stir. Solid goes into solution and then the sulfonamide precipitates out. Heat to 50°C and then turn off heat. After $\frac{1}{2}$ hour cool in ice bath and filter. Wash cake with 600 ml water. Add cake to 2 liters 5% NaOH (130 ml 50% NaOH to 2 liters water). Filter and discard insolubles. While cooling filtrate add concentrated HCl until mixture is acid. Filter and wash cake until filtrate is neutral. Suck cake as dry as possible then air dry. Yield approximately 200 g (45%), MP 255° to 260°C .

Preparation of Intermediate Compound 4-Chloro-5-Sulfamyl-N-Acetylanthranilic Acid: To a hot solution (80°C) of 366 g (1.482 mols) of magnesium sulfate (Epsom salts) in 2.8 liters of water was added 130 g (0.495 mol) of powdered 5-chloro-2-methyl-4-sulfamyl-acetanilide. With stirring and maintaining the temperature at 83°C , 234 g (1.482 mols) of potassium permanganate was added portionwise over a period of 2 hours. The mixture was then kept at 85°C with stirring for an additional 3 hours. By this time the pink color of the permanganate had been discharged.

The mixture was cooled to 65°C and 250 g (2.0 mols) of sodium carbonate monohydrate was added. The warm reaction mixture was filtered and the cake washed with water. The filtrate was then slowly treated with concentrated hydrochloric acid until mixture tested acid. Product was then filtered, washed with water and dried. Yield 103 g (71.0%), MP 245° to 249°C (dec.).

Preparation of Intermediate Compound 2-Methyl-3-o-Tolyl-6-Sulfamyl-7-Chloro-4(3H)-Quinazolinone: Set up a 5-liter 3-necked flask fitted with a stirrer, condenser and a drying tube. To a stirred mixture of 100 g (0.342 mol) of powdered 4-chloro-5-sulfamyl-N-acetylanthranilic acid, 40.2 g (0.376 mol) of o-toluidine and 2.0 liters of dry toluene was added dropwise, over a period of 15 minutes, 21.7 ml (34.1 g) (0.248 mol) of phosphorus trichloride. The mixture was then refluxed for 10 hours. The solid turned somewhat gummy towards the latter part of the first hour. The mixture then became more free flowing as heating was continued. Let stand overnight. The yellow solid was filtered, washed with toluene and dried. The toluene filtrate was discarded. The dried solid was triturated with 1.5 liters of 10% sodium bicarbonate, filtered and the cake washed with water. The filtrate on acidification yielded 11.5 g of the starting acid. The damp product was dissolved in 4.5 liters of 95% ethanol and the solution treated with charcoal and filtered. On cooling filtrate yielded 69.5 g (55.5%) of the title compound, MP 271.5° to 274°C .

Preparation of the Final Compound 2-Methyl-3-o-Tolyl-6-Sulfamyl-7-Chloro-1,2,3,4-Tetrahydro-4(3H)-Quinazolinone: To 4 liters of dry diglyme in a 12-liter 3-necked flask fitted with a stirrer, thermometer and drying tube was added 5.34 g (0.04 mol) of aluminum chloride, while stirring. To the resulting solution was added 43.6 g (0.12 mol) of 2-methyl-3-o-tolyl-6-sulfamyl-7-chloro-4(3H)-quinazoline. A solution of 4.56 g (0.12 mol) of sodium borohydride in 1 liter of dry diglyme was added portionwise over a period of 1 hour while stirring the mixture. The mixture was then heated at 85°C , with stirring, for 1 hour.

After cooling the reaction mixture to 25°C in an ice bath 600 ml of water was added and then enough dilute hydrochloric acid (approximately 100 ml) to make the solution acid. The solvent was then removed under reduced pressure at 60° to 70°C . The very viscid residue solidified when triturated with water. The solid was filtered and washed with water. The solid was dissolved in approximately 400 ml 95% ethanol and the solution filtered through Celite. On cooling the solution yielded 30 g of colorless solid, MP 253° to 259°C . The filtrate was concentrated to 200 ml to yield another 4.6 g, MP 253° to 259°C .

The above product was then recrystallized from 900 ml of 95% ethanol after filtering the hot solution through Celite. Crystallization was initiated and the mixture agitated occasionally while being cooled in the refrigerator. Yield of product 29 g, MP 253° to 259°C . Concentration of the filtrate to 125 ml yielded another 7.5 g of product, MP 253° to 259°C . The product was recrystallized another time in the manner described above. Total yield, first and second crops, 28.8 g (66%), MP 250° to 255°C . Product was dried at 80°C in a vacuum, according to U.S. Patent 3,360,518.

References

Merck Index 6024

Kleeman & Engel p. 594

PDR pp. 1401, 1668

OCDS Vol. 2 p. 384 (1980)

DOT 9 (12) 498 (1973)

I.N. p. 629

REM p. 940

Shetty, B.V.; U.S. Patent 3,360,518; December 26, 1967; assigned to Wallace & Tiernan Inc.

Shetty, B.V.; U.S. Patent 3,557,111; January 19, 1971

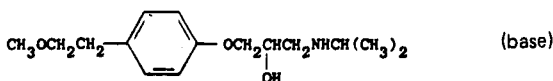
METOPROLOL TARTRATE**Therapeutic Function:** Beta-adrenergic blocker**Chemical Name:** 1-[4-(2-Methoxyethyl)phenoxy]-3-[(1-methylethyl)amino]-2-propanol**Common Name:** —**Structural Formula:****Chemical Abstracts Registry No.:** 56392-17-7; 37350-58-6 (Base)

Trade Name	Manufacturer	Country	Year Introduced
Betaloc	Astra	U.K.	1975
Lopressor	Geigy	U.K.	1975
Beloc	Astra	W. Germany	1976
Lopressor	Ciba-Geigy	W. Germany	1976
Lopressor	Ciba-Geigy	Italy	1978
Selomen	Bracco	Italy	1978
Lopressor	Ciba Geigy	U.S.	1978
Seloken	Searle	France	1980
Seloken	Fujisawa	Japan	1983
Lopresol	Takeda	Japan	1983
Lati 2	Unifa	Argentina	—
Neobloc	Unipharm	Israel	—
Prelis	Brunnengraber	W. Germany	—

Raw Materials

Isopropylamine	p-(β-Methoxyethyl)phenol
Sodium bicarbonate	Epichlorohydrin
Tartaric acid	

Manufacturing Process

The starting material 1,2-epoxy-3-[p-(β-methoxyethyl)-phenoxy]-propane was obtained from p-(β-methoxyethyl)-phenol which was reacted with epichlorohydrin whereafter the reaction product was distilled at 118°C to 128°C at a pressure of 0.35 mm Hg.

1,2-Epoxy-3-[p-(β-methoxyethyl)-phenoxy]-propane (16.7 g) was dissolved in 50 ml isopropanol and mixed with 20 ml isopropylamine. The mixture was heated in an autoclave on

boiling water-bath overnight, whereafter it was evaporated and the remainder dissolved in 2N HCl. The solution was extracted first with ether and thereafter with methylene chloride. After evaporating the methylene chloride phase, the hydrochloride of 1-isopropylamino-3-[p-(β -methoxyethyl)-phenoxy]-propanol-2 was obtained which, after recrystallization from ethyl acetate, weighed 10.4 g. Melting point 83°C. Equivalent weight: found 304.0, calculated 303.8.

The hydrochloride is then converted to the tartrate.

References

Merck Index 6027

Kleeman & Engel p. 595

PDR p. 894

OCDS Vol. 2 p. 109 (1980)

DOT 11 (9) 360 (1975) & 17 (2) 65 (1981)

I.N. p. 630

REM p. 905

Brandstrom, A.E., Carlsson, P.A.E., Carlsson, S.A.I., Corrodi, H.R., Ek, L. and Ablad, B.A.H.; U.S. Patent 3,873,600; March 25, 1975

METRIZOIC ACID

Therapeutic Function: Diagnostic aid (radiopaque medium)

Chemical Name: 3-(Acetylamino)-5-(acetylmethylamino)-2,4,6-triiodobenzoic acid

Common Name: —

Structural Formula:

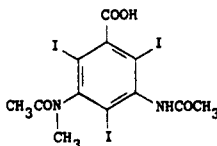

Chemical Abstracts Registry No.: 1949-45-7

Trade Name	Manufacturer	Country	Year Introduced
Isopaque	Winthrop	France	1973
Isopaque	Sterling Winthrop	U.S.	1975
Isopaque	Winthrop	Italy	1978
Ronpacon	Cilag-Chemie	W. Germany	—

Raw Materials

Diatrizoic acid (diatrizoate)

Dimethyl sulfate

Manufacturing Process

3,5-Diacetamido-2,4,6-triiodobenzoic acid (diatrizoic acid) (see Datrizoate entry for synthesis) (10 g) is suspended in water (10 ml), 5N potassium hydroxide (4.3 equivalent) is added and the mixture cooled to about 15°C. Dimethyl sulfate (0.5 equivalent) dissolved in an equal volume of acetone is added drop by drop while stirring. After the reaction mixture has

been stirred for about 1 hour hydrochloric acid (1:1) is added, with stirring to pH about 0.5. The precipitate is filtered, washed and suspended moist in 4 parts of water, concentrated ammonia is added to pH about 7 and the ammonium salt solution is isomerized at 90°C to 100°C for about one-half hour whereafter additional ammonia is added to pH about 9 followed by solid ammonium chloride (about 10% weight/volume) and the solution stirred overnight and the excess of 3,5-diacetamide-2,4,6-triiodobenzoic acid recovered as ammonium salt on the filter. The filtrate is precipitated by means of hydrochloric acid (1:1) at pH about 0.5 and the N-methyl-3,5-diacetamido-2,4,6-triiodobenzoic acid collected on a filter, washed and dried.

References

Merck Index 6032

Kleeman & Engel p. 597

I.N. p. 631

REM p. 1270

Holtermann, H., Haugen, L.G., Nordal, V. and Haavaldsen, J.L.; U.S. Patent 3,178,473; April 13, 1965; assigned to Nyegaard & Co. A/S (Norway)

METRONIDAZOLE

Therapeutic Function: Antiprotozoal

Chemical Name: 2-methyl-5-nitroimidazole-1-ethanol

Common Name: —

Structural Formula:

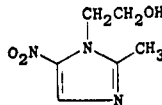

Chemical Abstracts Registry No.: 443-48-1

Trade Name	Manufacturer	Country	Year Introduced
Flagyl	Specia	France	1960
Flagyl	May & Baker	U.K.	1960
Flagyl	Rhone-Poulenc	W. Germany	1961
Flagyl	Farmitalia	Italy	1962
Flagyl	Searle	U.S.	1963
Satric	Savage	U.S.	1982
Metryl	Lemmon	U.S.	1982
Metro IV	McGaw	U.S.	1982
Protostat	Ortho	U.S.	1983
Anaerobex	Gerot	Austria	—
Arilin	Wolff	W. Germany	—
Asuzol	Fuji	Japan	—
Clont	Bayer	W. Germany	—
Deflamon	Spa	Italy	—
Efloran	Krka	Yugoslavia	—
Elyzol	Dumex	Denmark	—
Entizol	Polfa	Poland	—
Flagemona	Phoenix	Argentina	—
Fossyol	Merckle	W. Germany	—
Gineflavir	Crosara	Italy	—

Trade Name	Manufacturer	Country	Year Introduced
Kilon	Kobanyai	Hungary	—
Kreucosan	Kreussler	W. Germany	—
Medazol	Belupo	Yugoslavia	—
Meronidal	Kissei	Japan	—
Metrajil	Mulda	Turkey	—
Metrogil	Ikapharm	Israel	—
Metrolag	Lagap	Switz.	—
Monasin	Helvepharm	Switz.	—
Nalox	Omega	Argentina	—
Neo-Tric	Neo	Canada	—
Nida	Toyo Pharm.	Japan	—
Novonidazol	Novopharm	Canada	—
Orvagil	Galenika	Yugoslavia	—
Rathimed N	Pflegler	W. Germany	—
Rivazol	Rivopharm	Switz.	—
Rodogyl	Specia	France	—
Salandol	Sato	Japan	—
Sanatrichom	Godecke	W. Germany	—
Sawagyl	Sawai	Japan	—
Servizol	Servipharm	Switz.	—
Surimol	Labatec	Switz.	—
Takimetol	Nakataki	Japan	—
Tarozole	Taro	Israel	—
Tranoxa	Exa	Argentina	—
Trichazol	Will	Canada	—
Trichex	Gerot	Austria	—
Trichocide	Green Cross	Japan	—
Tricho Cordes	Ichthyol	W. Germany	—
Tricho-Gynaedron	Artesan	W. Germany	—
Trichomol	Gea	Denmark	—
Trichostop	Sigmapharm	Austria	—
Trichozole	Protea	Australia	—
Tricowas B	Wassermann	Spain	—
Trikamon	Elliott-Marion	Canada	—
Trikozol	Farmos	Finland	—
Trivazol	Vister	Italy	—
Vagilen	Farmigea	Italy	—
Vagimid	Apogepha	E. Germany	—
Vaginyl	D.D.S.A.	U.K.	—
Wagitran	Ono	Japan	—

Raw Materials

2-Methyl-5-nitroimidazole
Ethylene chlorohydrin

Manufacturing Process

2-Methyl-4(or 5)-nitroimidazole (127 g) is heated with ethylene chlorohydrin (795 g) for 18 hours at 128° to 130°C and the chlorohydrin (660 g) is then distilled under reduced pressure (30 mm Hg). The residue is treated with water (300 cc) and filtered, and the filtrate is made alkaline by the addition of sodium hydroxide solution (d = 1.33, 100 cc). It is then extracted with chloroform (1,000 cc) and, after evaporation of the chloroform in vacuo, there is obtained a pasty mass (77 g) which is recrystallized from ethyl acetate (450 cc) in the presence of animal charcoal. There is thus obtained 1-(2-hydroxyethyl)-2-methyl-5-nitroimidazole (24 g) as a creamy white crystalline powder melting at 158° to 160°C.

References

Merck Index 6033

Kleeman & Engel p. 597

PDR pp. 830, 872, 876, 993, 1034, 1305, 1605, 1670, 1723, 1999

OCDS Vol. 1 p. 240 (1977)

DOT 13 (4) 147 (1977) & 17 (1) 34 (1981)

I.N. p. 632

REM p. 1222

Jacob, R.M., Regnier, G.L. and Crisan, C.; U.S. Patent 2,944,061; July 5, 1960; assigned to Societe des Usines Chimiques Rhone-Poulenc, France

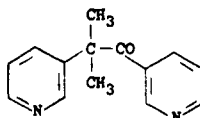
METYRAPONE**Therapeutic Function:** Diagnostic aid (pituitary function)**Chemical Name:** 2-methyl-1,2-di-3-pyridyl-1-propanone**Common Name:** —**Structural Formula:****Chemical Abstracts Registry No.:** 54-36-4

Trade Name	Manufacturer	Country	Year Introduced
Metopirone	Ciba	U.S.	1961
Metopirone	Ciba	U.K.	1961
Metyrapone	Ciba	Switz.	1964
Metopiron	Ciba	W. Germany	1966

Raw Materials

3-Acetylpyridine	Hydrogen
Sulfuric acid	Hydroxylamine sulfate

Manufacturing Process

According to U.S. Patent 2,966,493, the 2,3-bis-(3-pyridyl)-2,3-butanediol used as the starting material may be prepared as follows. A solution of 1,430 g of 3-acetyl-pyridine in 7,042 ml of a 1 N aqueous solution of potassium hydroxide is placed into a cathode chamber containing a mercury cathode with a surface of 353 cm² and is separated from an anode chamber by an Alundum membrane. As anode a platinum wire is used and the anolyte consists of a 1 N solution of aqueous potassium hydroxide which is replenished from time to time.

The electrolysis is carried out at a reference potential of -2.4 volts vs a standard calomel electrode. An initial current density of 0.0403 amp/cm² is obtained which drops to 0.0195 amp/cm² at the end of the reduction, which is carried on over a period of 1,682 minutes at 15° to 20°C. The catholyte is filtered, the solid material is washed with water and dried. 430 g of the 2,3-bis-(3-pyridyl)-butane-2,3-diol is recrystallized from water, MP 244° to 245°C.

A mixture of 3.43 g of 2,3-bis-(3-pyridyl)-2,3-butane-diol and 25 ml of concentrated sulfuric acid is heated to 76°C and kept at that temperature for 7½ hours. It is then poured on ice, neutralized with 50% aqueous solution of sodium hydroxide and the pH is adjusted to 8 with solid sodium carbonate. The aqueous solution is three times extracted with ethyl acetate, the separated organic layer dried over sodium sulfate and evaporated to dryness. The residue is distilled and 1.86 g of viscous, colorless oil is obtained which is purified by distillation. BP 140° to 160°C/0.07 mm. The infrared spectrum shows the presence of a mixture of two compounds, one containing a conjugated, the other one an unconjugated carbonyl group, without the presence of a compound containing a hydroxyl group; thus the rearrangement has taken place.

The resulting mixture does not crystallize and is converted into a mixture of oximes by treating of a solution of the mixture in 20 ml of ethanol with a solution of 1.8 g of hydroxylamine sulfate in 3 ml of water. 1.8 g of sodium acetate in 5 ml of water is added, and the mixture is refluxed for 5 hours, then extracted with ethyl acetate, and the ethyl acetate solution is washed with a saturated aqueous sodium chloride solution and dried over sodium sulfate. After evaporating the solvent, the residue is triturated with warm ether and 1.1 g of a crystalline oxime is obtained, MP 168° to 171°C.

0.1 g of the resulting oxime is dissolved in 5 ml of 2 N aqueous sulfuric acid and the mixture is refluxed for 3 hours and allowed to stand overnight. After being rendered basic by adding a concentrated aqueous solution of sodium hydroxide and adjusted to a pH of 8 with sodium carbonate, the mixture is extracted 3 times with ethyl acetate; the organic layer is washed with water, dried and evaporated. Upon distillation of the residue an oily product is obtained, BP 130° to 160°C/0.3 mm. Infrared analysis shows the presence of a uniform compound, containing a conjugated carbonyl group. The 2-methyl-1,2-bis-(3-pyridyl)-propane-1-one crystallizes upon standing at room temperature or by covering the oily distillate with pentane and cooling to -80°C and filtering the oily crystals. It melts after recrystallization from a mixture of ether, hexane and petroleum ether at 48° to 50°C.

References

Merck Index 6036

Kleeman & Engel p. 598

PDR p. 803

I.N. p. 633

REM p. 1276

Bencze, W.L. and Allen, M.J.; U.S. Patent 2,923,710; February 2, 1960; assigned to Ciba Pharmaceutical Products, Inc.

Allen, M.J. and Bencze, W.L.; U.S. Patent 2,966,493; December 27, 1960; assigned to Ciba Pharmaceutical Products, Inc.

METYROSINE

Therapeutic Function: Tyrosine hydroxylase inhibitor

Chemical Name: α-Methyl-L-tyrosine

Common Name: Metirosine

Structural Formula:

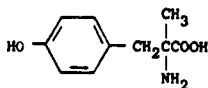

Chemical Abstract Registry No.: 672-87-7

Trade Name	Manufacturer	Country	Year Introduced
Demser	MSD	U.S.	1979

Raw Materials

α -Methyl-N-dichloroacetyl-p-nitrophenylalanine
 Hydrogen
 Sodium nitrite
 Sulfuric acid
 Hydrogen chloride

Manufacturing Process

50 g of α -methyl-N-dichloroacetyl-p-nitrophenylalanine was dissolved in 500 ml methanol, 300 mg of platinum oxide were added and the mixture reduced at 41 pounds of pressure; within an hour 14.5 pounds were used up (theory 12.4 pounds). After filtration of the catalyst, the red clear filtrate was concentrated in vacuo and the residual syrup flushed several times with ether. The crystalline residue thus obtained, after air drying, weighed 45.3 g (99.5%), MP unsharp at about 104°C to 108°C with decomposition. After two precipitations with ether from an alcoholic solution, the somewhat hygroscopic amine was dried over sulfuric acid for analysis.

10 g of the amine prepared above was dissolved in 5 ml of 50% sulfuric acid at room temperature; the viscous solution was then cooled in ice and a solution of sodium nitrite (2.4 g) in 10 ml water gradually added with agitation. A flocculent precipitate formed. After all the nitrite had been added, the mixture was aged in ice for an hour, after which it was allowed to warm up to room temperature. Nitrogen came off and the precipitate changed to a sticky oil. After heating on the steam bath until evolution of nitrogen ceased, the oil was extracted with ethyl acetate. After removal of the solvent in vacuo, 9.4 g of colored solid residue was obtained, which was refluxed with 150 ml hydrochloric acid (1:1) for 17 hours. The resulting dark solution; after Norite treatment and extraction with ethyl acetate, was concentrated in vacuo to dryness and the tan colored residue (7.4 g) sweetened with ethanol. Dissolution of the residue in minimum amount of ethanol and neutralization with diethylamine of the clarified solution, precipitated the α -methyl tyrosine, which was filtered, washed with ethanol (until free of chlorides) and ether. The crude amino acid melted at 309°C with decomposition. For further purification, it was dissolved in 250 ml of a saturated sulfur dioxide-water solution, and the solution, after Noriting, concentrated to about 80 ml, the tan colored solid filtered washed with ethanol and ether. Obtained 1.5 g of α -methyl tyrosine, MP 320°C dec.

References

Merck Index 6038
 PDR p. 1167
 DOT 16 (10) 346 (1980)
 I.N. p. 628
 REN p. 909
 Pfister, K. III and Stein, G.A.; U.S. Patent 2,868,818; January 13, 1959; assigned to Merck & Co., Inc.

MEXENONE

Therapeutic Function: Sunscreen agent

Chemical Name: (2-hydroxy-4-methoxyphenyl)(4-methylphenyl)methanone

Common Name: 2-hydroxy-4-methoxy-4'-methylbenzophenone

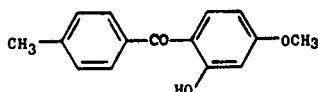
Structural Formula:**Chemical Abstracts Registry No.:** 1641-17-4

Trade Name	Manufacturer	Country	Year Introduced
Uvistat-L	Ward Blenkinsop	U.K.	1960

Raw Materials

p-Toluyl chloride	Hydrogen chloride
1,3-Dimethoxybenzene	Sodium hydroxide

Manufacturing Process

p-Toluyl chloride is the starting material. To this is added chlorobenzene and 1,3-dimethoxybenzene. The reaction mixture is cooled to 12°C in an ice bath and aluminum chloride is added gradually, keeping the reaction below 30°C. The reaction is then gradually heated to 115°C with the evolution of hydrogen chloride gas. As the temperature increases, the reaction mixture becomes thicker. At 105°C, dimethyl formamide is added slowly. The reaction is heated at 115°C for a short time and is then poured into concentrated hydrochloric acid. The reaction mixture pours very easily and very cleanly. The acid mixture is heated with steam to dissolve all the material which had not hydrolyzed and the mixture is filtered. The red chlorobenzene layer is separated and washed twice with hot water.

To the chlorobenzene solution is then added sodium hydroxide dissolved in water and the chlorobenzene is removed by a steam distillation. After all of the chlorobenzene is removed, the precipitate which forms during the distillation is removed by filtration and discarded. The solution is cooled and acidified with hydrochloric acid, precipitating a tan solid. This is removed by filtration and washed acid-free. It is then treated with sodium bicarbonate solution to remove any acid present and is then washed with water to remove all traces of bicarbonate. After drying approximately a 75% yield of mexenone is obtained.

References

Merck Index 6045

Kleeman & Engel p. 598

OCDS Vol. 2 p. 175 (1980)

I.N. p. 633

Hardy, W.B. and Forster, W.S.; U.S. Patent 2,773,903; December 11, 1956; assigned to American Cyanamid Company

MEXILETINE HCl**Therapeutic Function:** Antiarrhythmic**Chemical Name:** 1-(2,6-Dimethylphenoxy)-2-propanamine hydrochloride**Common Name:** —

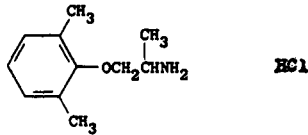
Structural Formula:

Chemical Abstracts Registry No.: 5370-01-4; 31828-71-4 (Base)

Trade Name	Manufacturer	Country	Year Introduced
Mexitil	Boehr. Ingel.	U.S.	1976
Mexitil	Boehr. Ingel.	Switz.	1978
Mexitil	Boehr. Ingel.	W. Germany	1979
Mexitil	Boehr. Ingel.	France	1981
Mexitil	Boehr. Ingel.	Italy	1982

Raw Materials

Dimethyl phenol	Sodium hydroxide
Chloroacetone	Hydroxylamine
Hydrogen	

Manufacturing Process

The sodium salt of dimethyl phenol was reacted with chloroacetone and this product with hydroxylamine to give the starting material.

245 g of this 1-(2',6'-dimethyl-phenoxy)-propanone-(2)-oxime were dissolved in 1,300 cc of methanol, and the solution was hydrogenated at 5 atmospheres gauge and 60°C in the presence of Raney nickel. After the calculated amount of hydrogen had been absorbed, the catalyst was filtered off, the methanol was distilled out of the filtrate, and the residue, raw 1-(2',6'-dimethyl-phenoxy)-2-amino-propane, was dissolved in ethanol. The resulting solution was acidified with ethereal hydrochloric acid, the acidic solution was allowed to cool, and the precipitate formed thereby was collected by vacuum filtration. The filter cake was dissolved in ethanol and recrystallized therefrom by addition of ether. 140.5 g (51.5% of theory) of a substance having a melting point of 203°C to 205°C were obtained, which was identified to be 1-(2',6'-dimethyl-phenoxy)-2-amino-propane hydrochloride.

References

- Merck Index 6047
 DFU 1 (4) 180 (1976)
 Kleeman & Engel p. 598
 DOT 12 (9) 361 (1976)
 I.N. p. 633
 REM p. 861
 Koppe, H., Zeile, K., Kummer, W., Stahle, H. and Dannenberg, P.; U.S. Patent 3,659,019; April 25, 1972; assigned to Boehringer Ingelheim G.m.b.H. (W. Germany)

MEZLOCILLIN

Therapeutic Function: Antibiotic

Chemical Name: Sodium D(-)-α-[(3-methylsulfonyl-imidazolidin-2-on-1-yl)-carbonyl-amino]benzylpenicillin

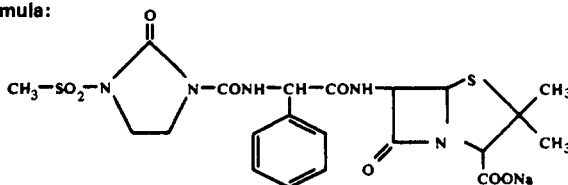
Common Name: —**Structural Formula:****Chemical Abstracts Registry No.:** 51481-65-3

Trade Name	Manufacturer	Country	Year Introduced
Baypen	Bayer	W. Germany	1977
Baypen	Bayer	U.K.	1980
Baypen	Bayer	Switz.	1980
Baypen	Bayer	Italy	1981
Mezlin	Miles	U.S.	1981
Baypen	Bayer Yakuhin	Japan	1982
Baypen	Bayer	France	1983
Baypen	Bayer	Sweden	1983
Baycipen	Bayer	—	—
Optocillin	Bayer	W. Germany	—

Raw Materials

Ampicillin	2-Imidazolidone
Methane sulfonyl chloride	Phosgene

Manufacturing Process

9.3 parts by weight of ampicillin were suspended in 80% strength aqueous tetrahydrofuran (140 parts by volume) and sufficient triethylamine (approximately 6.3 parts by volume) was added dropwise while stirring at 20°C, just to produce a clear solution and to give a pH value of between 7.5 and 8.2 (glass electrode). The mixture was cooled to 0°C and 5.1 parts by weight of 3-methyl-sulfonyl-imidazolidin-2-one-1-carbonyl chloride were added gradually in portions over the course of 30 minutes, while the mixture was stirred and kept at a pH value of between 7 and 8 by simultaneous addition of triethylamine.

The carbonyl chloride reactant was prepared by reacting 2-imidazolidone with methane sulfonyl chloride then that product with phosgene. The mixture was stirred for 10 minutes at 0°C and subsequently further stirred at room temperature until no further addition of triethylamine was necessary to maintain a pH value of 7 to 8. 150 parts by volume of water were added and the tetrahydrofuran was largely removed in a rotary evaporator at room temperature.

The residual aqueous solution was extracted once by shaking with ethyl acetate, covered with 250 parts by volume of fresh ethyl acetate and acidified to pH 1.5 to 2.0 with dilute hydrochloric acid while being cooled with ice. The organic phase was separated off, washed twice with 50 parts by volume of water at a time and dried for 1 hour over anhydrous MgSO₄ in a refrigerator. After filtration, about 45 parts by volume of a 1 molar solution of sodium 2-ethyl hexanoate in ether containing methanol were added to the solution of the penicillin. The mixture was concentrated on a rotary evaporator until it had an oily consistency and was dissolved in a sufficient amount of methanol by vigorous shaking, and the solution was rapidly added dropwise, with vigorous stirring, to 500 parts by volume of ether which contained 10% of methanol.

The precipitate was allowed to settle for 30 minutes, the solution was decanted from the pre-

cipitate, and the latter was again suspended in ether, filtered off and washed with anhydrous ether. After drying over P_2O_5 in a vacuum desiccator, the sodium salt of the mezlocillin was obtained in the form of a white solid substance.

References

- Merck Index 6049
 DFU 2 (9) 200 (1977)
 Kleeman & Engel p. 599
 PDR p. 1254
 OCDS Vol. 3 p. 206 (1984)
 DOT 11 (11) 444 (1975) & 15 (2) 54 (1979)
 I.N. p. 633
 REM p. 1196
 König, H.B., Schrock, W. and Metzger, K.G.; U.S. Patents 3,972,869; August 3, 1976; 3,972,870; August 3, 1976; 3,974,141; August 10, 1976; 3,974,142; August 10, 1976; 3,975,375; August 17, 1976; 3,978,056; August 31, 1976; 3,983,105; September 28, 1976; and 4,009,272; February 22, 1977; all assigned to Bayer AG

MIANSERIN

Therapeutic Function: Serotonin inhibitor; antihistaminic

Chemical Name: 1,2,3,4,10,14b-hexahydro-2-methylbenzo[c]pyrazino[1,2-a]azepine

Common Name: 2-methyl-1,2,3,4,10,14b-hexahydro-2H-pyrazino-[1,2-f]morphanthridine

Structural Formula:

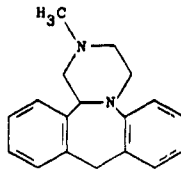

Chemical Abstracts Registry No.: 24219-97-4; 21535-47-7 (Hydrochloride)

Trade Name	Manufacturer	Country	Year Introduced
Tolvin	Organon	W. Germany	1975
Bolvidon	Organon	U.K.	1976
Norval	Bencard	U.K.	1976
Lantanon	Ravasini	Italy	1976
Athymil	Organon	France	1979
Athmyl	Organon	Switz.	1980
Tetramide	Sankyo	Japan	1983

Raw Materials

2-Benzylaniline	Chloroacetyl chloride
Polyphosphoric acid	Methylamine
Diethylxalate	Lithium aluminum hydride
Diborane	

Manufacturing Process

(A) 25 g of 2-benzylaniline dissolved in 150 ml of benzene are cooled down in an ice bath to 8°C. To this solution are added 15 ml of pyridine and after that a solution of 15 ml of

chloroacetyl chloride in 25 ml of benzene, maintaining the temperature of the reaction mixture at 10° to 15°C. After stirring for 1 hour at room temperature 25 ml of water are added and the mixture is shaken for 30 minutes. Next the mixture is sucked off and the benzene layer separated. Then the benzene layer is washed successively with 2 N HCl, a sodium carbonate solution and water. The extract dried on sodium sulfate is evaporated and the residue crystallized together with the crystals obtained already from benzene. Yield 18 g; MP 130° to 133°C.

(B) 40 g of N-chloroacetyl-2-benzylaniline are heated for 2 hours at 120°C together with 50 ml of phosphorus oxychloride and 320 g of polyphosphoric acid. Next the reaction mixture is poured on ice and extracted with benzene. The extract is washed and dried on sodium sulfate and the benzene distilled off. The product obtained (31 g) yields after recrystallization 24 g of 6-chloromethyl-morphanthridine of MP 136° to 137°C.

(C) 10 g of 6-chloromethyl-morphanthridine are passed into 150 ml of a solution of methylamine in benzene (10%). After storage of the solution for 20 hours at 0° to 5°C the methylamine hydrochloride formed is sucked off and the filtrate evaporated to dryness. There remains as residue 11 g of crude 6-methylaminomethyl-morphanthridine.

(D) 11 g of crude 6-methylaminomethyl-morphanthridine are dissolved in 50 ml of absolute ether. While cooling in ice 2.7 g of lithium aluminumhydride, dissolved in 100 ml of absolute ether, are added. After boiling for 1 hour and cooling down in ice 11 ml of water are added slowly dropwise while stirring. After stirring for another 30 minutes at room temperature the mixture is sucked off and the filtrate evaporated to obtain 11 g of crude 5,6-dihydro-6-methylaminomethyl-morphanthridine in the form of a light yellow oil.

(E) 10 g of 5,6-dihydro-6-methylaminomethyl-morphanthridine are heated slowly, in 30 minutes, from 100° to 160°C with 7 g of pure diethyloxalate and after that from 160° to 180°C in 45 minutes. After cooling down the reaction mixture is stirred with benzene. The crystals are sucked off and yield after crystallization from dimethylformamide 9 g of 1,2-diketo-3(N)-methyl-2,3,4,4a-tetrahydro-1H-pyrazino-[1,2-f]-morphanthridine of MP 245° to 247°C.

(F) 9 g of the diketo-pyrazino-morphanthridine compound obtained above are reduced with diborane to give mianserin.

References

Merck Index 6050

Kleeman & Engel p. 599

OCDS Vol. 2 p. 451 (1980)

DOT 12 (1) 31 (1976)

I.N. p. 634

van der Burg, W.J. and Delobelle, J.; U.S. Patent 3,534,041; October 13, 1970; assigned to Organon Inc.

MICONAZOLE NITRATE

Therapeutic Function: Antifungal

Chemical Name: 1-[2,4-Dichloro-β-[(2,4-dichlorobenzyl)oxy]phenethyl]imidazole mono-nitrate

Common Name: —

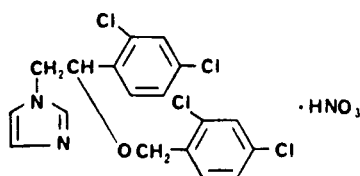
Structural Formula:

Chemical Abstracts Registry No.: 22832-87-7; 22916-47-8 (Base)

Trade Name	Manufacturer	Country	Year Introduced
Daktarin	Janssen	Italy	1974
Daktarin	Janssen	U.K.	1974
Daktar	Janssen	W. Germany	1974
Dermonistat	Ortho	U.K.	1974
Monistat	Ortho	U.S.	1974
Daktarin	Le Brun	France	1975
Micatin	Johnson & Johnson	U.S.	1976
Minostate	Janssen	U.S.	1978
Andergin	Isom	Italy	1980
Frolid P	Mochida	Japan	1981
Aflorix	Gerardo Ramon	Argentina	—
Conofite	Pitman-Moore	U.S.	—
Dektarin	Janssen	Italy	—
Deralbine	Andromaco	Argentina	—
Epi-Monistat	Cilag	W. Germany	—
Florid	Mochida	Japan	—
Fungisdin	Esteve	Spain	—
Gyno-Daktarin	Le Brun	France	—
Gyno-Monistat	Cilag	W. Germany	—
Micatin	McNeil	U.S.	—
Miconal	Ecobi	Italy	—
Micotef	Italfarmaco	Italy	—
Vodol	Andromaco	Brazil	—

Raw Materials

Imidazole	Sodium borohydride
ω -Bromo-2,4-dichloroacetophenone	Sodium hydride
2,4-Dichlorobenzyl chloride	Nitric acid

Manufacturing Process

Imidazole is reacted with ω -bromo-2,4-dichloroacetophenone and that product reduced with sodium borohydride.

A suspension of 10.3 parts of the α -(2,4-dichlorophenyl)imidazole-1-ethanol thus obtained and 2.1 parts of sodium hydride in 50 parts of dry tetrahydrofuran is stirred and refluxed for 2 hours. After this reaction time, the evolution of hydrogen is ceased. Then there are added successively 60 parts dimethylformamide and 8 parts of 2,4-dichlorobenzyl chloride and stirring and refluxing are continued for another 2 hours. The tetrahydrofuran is removed at atmospheric pressure. The dimethylformamide solution is poured onto water.

The product, 1-[2,4-dichloro- β -(2,4-dichlorobenzoyloxy)phenethyl] imidazole, is extracted with benzene. The extract is washed with water, dried, filtered and evaporated in vacuo. From the residual oily free base, the nitrate salt is prepared in the usual manner in 2-propanol by treatment with concentrated nitric acid, yielding, after recrystallization of the crude solid salt from a mixture of 2-propanol, methanol and diisopropyl ether, 1-[2,4-dichloro- β -dichlorobenzoyloxy)phenethyl] imidazole nitrate; melting point 170.5°C.

References

Merck Index 6053

Kleeman & Engel p. 601

PDR pp. 956, 1293

OCDS Vol. 2 p. 249 (1980)

DOT 7 () 192 (1971) & 8 (6) 229 (1972)

I.N. p. 634

REM p. 1229

Godefroi, E.F. and Heeres, J.; U.S. Patent 3,717,655; February 20, 1973; assigned to Janssen Pharmaceutica NV

Godefroi, E.F. and Heeres, J.; U.S. Patent 3,839,574; October 1, 1974; assigned to Janssen Pharmaceutica NV

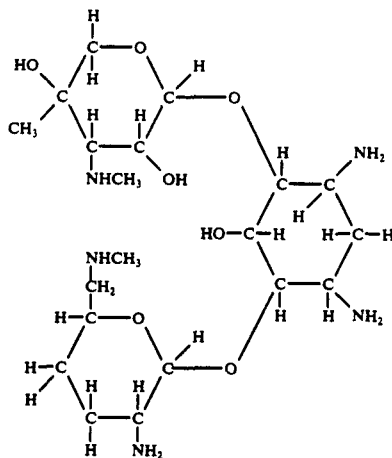
MICRONOMICIN**Therapeutic Function:** Antibiotic**Chemical Name:** O-2-amino-2,3,4,6-tetradeoxy-6-(methylamino)- α -D-erythrohexopyranosyl-(1 \rightarrow 4)-O-[3-deoxy-4-C-methyl-3-(methylamino)- β -L-arabinopyranosyl-(1 \rightarrow 6)-2-deoxy-D-streptamine**Common Name:** 6'-N-Methylgentamicin; sagamicin**Structural Formula:****Chemical Abstracts Registry No.:** —

Trade Name	Manufacturer	Country	Year Introduced
Sagamicin	Kyowa Hakko	Japan	1982

Raw MaterialsBacterium *Micromonospora sagamiensis*

Dextrin

Soybean meal

Manufacturing Process

A. Culturing of MK-65: In this example, *Micromonospora sagamiensis* MK-65 ATCC 21826 (FERM-P No. 1530) is used as the seed strain. One loopful of the seed strain is inoculated into 30 ml of a first seed medium in a 250 ml-Erlenmeyer flask. The first seed medium has the following composition:

	Percent
Dextrin	1
Glucose	1
Peptone	0.5
Yeast xtract	0.5
CaCO ₃	0.1
(pH: 7.2 before sterilization)	

Culturing is carried out with shaking at 30°C for 5 days. 30 ml of the seed culture is then inoculated into 300 ml of a second seed medium, of the same composition as the first seed medium, in a 2 liter-Erlenmeyer flask provided with baffles. The second seed culturing is carried out with shaking at 30°C for 2 days. Then 1.5 liters of the second seed culture (corresponding to the content of 5 flasks) is inoculated into 15 liters of a third seed medium of the same composition as set forth above, in a 30 liter-glass jar fermenter. Culturing in the jar fermenter is carried out with aeration (15 liters/minute) and stirring (350 rpm) at 30°C for 2 days. Then, 15 liters of the third seed culture is inoculated into 60 liters of a fourth seed medium of the same composition as set forth above, in a 300 liter-fermenter. Culturing in the fermenter is carried out with aeration (60 liters/minute) and stirring (150 rpm) at 30°C for 2 days. Finally, 60 liters of the fourth seed culture is inoculated into 600 liters of a fermentation medium having the following composition in a 1,000 liter-fermenter.

	Percent
Dextrin	5
Soybean meal	4
CaCO ₃	0.7
(pH: 7.2 before sterilization)	

Culturing in the fermenter is carried out with aeration (600 liters/minute) and stirring 150 rpm) at 35°C for 5 days.

B. Isolation of crude antibiotic: After the completion of fermentation, the culture liquor is adjusted to a pH of 2.0 with 12N sulfuric acid and stirred for 30 minutes. Then, about 10 kg of a filter aid, Radiolite No. 600 (product of Showa Kagaku Kogyo Co., Ltd., Japan) is added thereto and the microbial cells are removed by filtration. The filtrate is adjusted to a pH of 8.0 with 6N sodium hydroxide and passed through a column packed with about 50 liters of a cation exchange resin, Amberlite IRC-50 (ammonia form). The active substance is adsorbed on the resin and the eluate is discarded. After washing the resin with water, the active substance is eluted out with 1N aqueous ammonia. The eluate is obtained in fractions and the activity of each of the fractions is determined against *Bacillus subtilis* No. 10707 by a paper disk method using an agar plate.

Active fractions are combined and concentrated in vacuo to about 5 liters. The concentrate is then adjusted to a pH of 8.0 with 6N sulfuric acid and passed through a column packed with 1 liter of an anion exchange resin, Dowex 1X2 (OH⁻ form). The column is washed with about 5 liters of water and the effluent and the washings containing active substance are combined and are concentrated to 1/15 by volume. The concentrate is adjusted to a pH of 10.5 with 6N sodium hydroxide and 5 volumes of acetone is added thereto. The resultant precipitate is removed by filtration and the filtrate is concentrated to 500 ml. The concentrate is adjusted to a pH of 4.5 with 6N sulfuric acid and 2.5 liters of methanol is added thereto. After cooling, a white precipitate is obtained. The precipitate is separated by filtration and washed with methanol. After drying in vacuo, about 300 g of white powder is obtained.

The white powder is a mixture of the sulfate of gentamicin C_{1a} and the sulfate of XK-62-2, and exhibits an activity of 620 units/mg (the activity of 1 mg of pure product corresponds to 1,000 units).

C. Isolation and purification of XK-62-2: 100 g of the white powder obtained in the above step B are placed to form a thin, uniform layer on the upper part of a 5 cm ϕ X 150 cm column packed with about 3 kg of silica gel advancedly suspended in a solvent of chloroform, isopropanol and 17% aqueous ammonia (2:1:1 by volume). Thereafter, elution is carried out with the same solvent at a flow rate of about 250 ml/hour. The eluate is separated in 100 ml portions. The active fraction is subjected to paper chromatography to examine the components eluted. XK-62-2 is eluted in fraction Nos. 53-75 and gentamicin C_{1a} is eluted in fraction Nos. 85-120. The fraction Nos. 53-75 are combined and concentrated under reduced pressure to sufficiently remove the solvent. The concentrate is then dissolved in a small amount of water. After freeze-drying the solution, about 38 g of a purified prepare of XK-62-2 (free base) is obtained. The prepare has an activity of 950 units/mg. Likewise, fraction Nos. 85-120 are combined and concentrated under reduced pressure to sufficiently remove the solvent. The concentrate is then dissolved in a small amount of water. After freeze-drying the solution, about 50 g of a purified prepare of gentamicin C_{1a} (free base) is obtained. The activity of the prepare is about 980 units/mg.

References

Merck Index A-9

DFU 4 (5) 360 (1979) (as sagamicin) & 6 (5) 332 (1980)

DOT 19 (4) 211 (1983)

I.N. p. 635

Nara, T., Takasawa, S., Okachi, R., Kawamoto, I., Yamamoto, M., Sato, S., Sato, T. and Morikawa, A.; U.S. Patent 4,045,298; August 30, 1977; assigned to Abbott Laboratories

MIDAZOLAM MALEATE

Therapeutic Function: Anaesthetic

Chemical Name: 8-Chloro-6-(2-fluorophenyl)-1-methyl-4H-imidazo-[1,5-a][1,4]-benzodiazepine maleate

Common Name: —

Structural Formula:

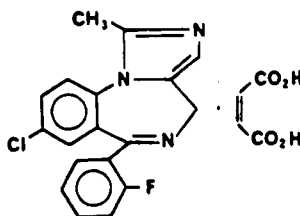

Chemical Abstracts Registry No.: 59467-70-8 (Base)

Trade Name	Manufacturer	Country	Year Introduced
Dormicum	Roche	Switz.	1982
Dormonid	Roche	—	—

Trade Name	Manufacturer	Country	Year Introduced
Hypnovel	Roche	U.K.	—
Sorenor	Roche	—	—

Raw Materials

2-Aminomethyl-7-chloro-2,3-dihydro-5-(2-fluorophenyl)-1H-1,4-benzodiazepine
 Acetic anhydride
 Polyphosphoric acid
 Manganese dioxide
 Maleic acid

Manufacturing Process

Acetic anhydride (7 ml) was added to a solution of 6.16 g of crude 2-aminomethyl-7-chloro-2,3-dihydro-5-(2-fluorophenyl)-1H-1,4-benzodiazepine in 200 ml of methylene chloride. The solution was added to 200 ml of saturated aqueous sodium bicarbonate and the mixture was stirred for 20 minutes. The organic layer was separated, washed with sodium bicarbonate, dried over sodium sulfate and evaporated to leave resinous 2-acetylaminoethyl-7-chloro-2,3-dihydro-5-(2-fluorophenyl)-1H-1,4-benzodiazepine. This material was heated with 40 g of polyphosphoric acid at 150°C for 10 minutes. The cooled reaction mixture was dissolved in water, made alkaline with ammonia and ice and extracted with methylene chloride. The extracts were dried and evaporated and the residue was chromatographed over 120 g of silica gel using 20% methanol in methylene chloride. The clean fractions were combined and evaporated to yield resinous 8-chloro-3a,4-dihydro-6-(2-fluorophenyl)-1-methyl-4H-imidazo[1,5-a][1,4]-benzodiazepine.

A mixture of this material with 500 ml of toluene and 30 g of manganese dioxide was heated to reflux for 1½ hours. The manganese dioxide was separated by filtration over Celite. The filtrate was evaporated and the residue was crystallized from ether to yield 8-chloro-6-(2-fluorophenyl)-1-methyl-4H-imidazo[1,5-a][1,4]-benzodiazepine, melting point 152°C to 154°C. The analytical sample was recrystallized from methylene chloride/hexane.

A warm solution of 6.5 g (0.02 mol) of 8-chloro-6-(2-fluorophenyl)-1-methyl-4H-imidazo[1,5-a][1,4]-benzodiazepine in 30 ml of ethanol was combined with a warm solution of 2.6 g (0.022 mol) of maleic acid in 20 ml of ethanol. The mixture was diluted with 150 ml of ether and heated on the steam bath for 3 minutes. After cooling, the crystals were collected, washed with ether and dried in vacuo to yield 8-chloro-6-(2-fluorophenyl)-1-methyl-4H-imidazo[1,5-a][1,4]-benzodiazepine maleate, melting point 148°C to 151°C.

References

Merck Index 6056
 DFU 3 (11) 822 (1978)
 OCDS Vol. 3 p. 197 (1984)
 DOT 19 (2) 113; (4) 221 & (7) 378 (1983)
 I.N. p. 635
 F. Hoffmann-La Roche & Co.; British Patent 1,527,131; October 4, 1978

MIDECAMYCIN

Therapeutic Function: Antibacterial

Chemical Name: Kleeman, p. 601

Common Name: Espinomycin

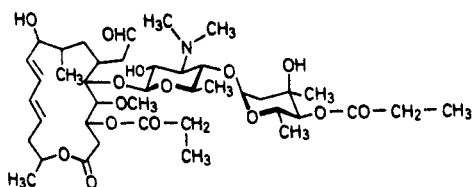
Structural Formula:

Chemical Abstracts Registry No.: 35457-80-8

Trade Name	Manufacturer	Country	Year Introduced
Medemycin	Meiji Seika	Japan	1974
Midecacin	Clin Midy	France	1978
Midecacin	Clin Midy	Switz.	1980
Midicacin	Midy	Italy	1981
Aboren	Promeco	Argentina	—
Macro-Dil	Roussel	—	—

Raw Materials

Bacterium *Streptomyces mycarofaciens*

Starch

Vegetable protein

Manufacturing Process

The SF-837 strain, namely *Streptomyces mycarofaciens* identified as ATCC No. 21454 was inoculated to 60 liters of a liquid culture medium containing 2.5% saccharified starch, 4% soluble vegetable protein, 0.3% potassium chloride and 0.3% calcium carbonate at pH 7.0, and then stir-cultured in a jar-fermenter at 28°C for 35 hours under aeration. The resulting culture was filtered directly and the filter cake comprising the mycelium cake was washed with dilute hydrochloric acid.

The culture filtrate combined with the washing liquid was obtained at a total volume of 50 liters (potency 150 mcg/ml). The filtrate (pH 8) was then extracted with 25 liters of ethyl acetate and 22 liters of the ethyl acetate phase was concentrated to approximately 3 liters under reduced pressure. The concentrate was diluted with 1.5 liters of water, adjusted to pH 2.0 by addition of 5N hydrochloric acid and then shaken thoroughly. The aqueous phase was separated from the organic phase and this aqueous solution was adjusted to pH 8 by addition of 3N sodium hydroxide and then extracted with 800 ml of ethyl acetate. The resulting ethyl acetate extract was then shaken similarly together with 500 ml of aqueous hydrochloric acid to transfer the active substances into the latter which was again extracted with 400 ml of ethyl ether at pH 8. The ether extract was dried with anhydrous sodium sulfate and concentrated under reduced pressure to give 16.5 g of light yellow colored powder.

12 g of this crude powder were dissolved in 200 ml of ethyl acetate and the solution was passed through a column of 600 ml of pulverized carbon which had been impregnated with ethyl acetate. The development was carried out using ethyl acetate as the solvent and the active fractions of eluate were collected to a total volume of 2,500 ml, which was then evaporated to dryness under reduced pressure to yield 5 g of a white colored powder. This powder was dissolved in 10 ml of benzene and the insoluble matters were filtered out. The filtered solution in benzene was then subjected to chromatographic isolation by passing through a column of 700 ml of silica gel which had been impregnated with benzene. The development of the active substances adsorbed on the silica gel was effected using a solvent system consisting of benzene-acetone (4:1), and the eluate was collected in fractions of each 20 ml. The active fractions No. 90-380 which gave a single spot in alumina thin layer chromatography and which could be recognized as containing the SF-837 substance purely in view of

the Rf-value of the single spot were combined together to a total volume of 4,000 ml, and then concentrated under reduced pressure to yield 1.5 g of white colored powder of a melting point of 122°C to 124°C which was found by analysis to be the pure SF-837 substance free base.

References

Merck Index 6057

Kleeman & Engel p. 601

DOT 10 (2) 62 (1974)

I.N. p. 635

Tsuruoka, T., Shomura, T., Ezaki, N., Akita, E., Inoue, S., Fukatsu, S., Amano, S., Watanabe, H. and Niida, T.; U.S. Patent 3,761,588; September 25, 1973; assigned to Meiji Seika Kaisha, Ltd. (Japan)

MIDODRINE

Therapeutic Function: Peripheral vasotonic; antihypotensive

Chemical Name: 2-Amino-N-[2-(2,5-dimethoxyphenyl)-2-hydroxyethyl]-acetamide

Common Name: —

Structural Formula:

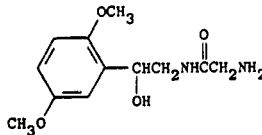

Chemical Abstracts Registry No.: 42794-76-3; 3092-17-9 (Hydrochloride)

Trade Name	Manufacturer	Country	Year Introduced
Gutron	Hormon-Chemie	W. Germany	1977
Gutron	Chemie Linz	Italy	1981
Alphamine	Centerchem	U.S.	—

Raw Materials

Carbobenzoxyglycine

Isovaleric acid chloride

1-(2',5'-Dimethoxyphenyl)-2-aminoethanol-(1)

Hydrogen

Manufacturing Process

19.5 parts of carbobenzoxyglycine, 7.1 parts of triethylamine and 162 parts of dry toluene are mixed with 11.2 parts of isovaleric acid chloride at 0°C to form the mixed anhydride and the mixture is agitated for two hours at 0°C. 32.4 parts of 1-(2',5'-dimethoxyphenyl)-2-aminoethanol-(1) are then added, the mixture is agitated for four hours at a temperature between 0°C and +10°C and then left to stand overnight at that temperature. A thick crystal paste forms. The reaction product is dissolved in 450 parts of ethyl acetate and 200 parts of water. The ethyl acetate solution is separated, washed with hydrochloric acid, sodium bicarbonate solution and water, dried over sodium sulfate and inspissated. The inspissation residue is digested with 342 parts of xylene, the required product crystallizing out. 34.9 parts of 1-(2',5'-dimethoxyphenyl)-2-(N-carbobenzoxyglycineamido)-ethanol -(1) are obtained.

66.2 parts of 1-(2',5'-dimethoxyphenyl)-2-(N-carbobenzoxyglycineamido)-ethanol-(1) are hydrogenated in the presence of 6.6 parts of palladium carbon (10%) in 2,000 parts of glacial acetic acid. When no more hydrogen is absorbed (3 mols of hydrogen are used), hydrogenation stops. The catalyst is removed by suction and the equivalent quantity of hydrochloric acid in ethanol is added to the filtrate with agitation. During further agitation at room temperature 28.6 parts of crude 1-(2',5'-dimethoxyphenyl)-2-glycineamidoethanol-(1)-hydrochloride crystallize, and are isolated and recrystallized from water-methanol for purification. 22.1 parts of pure product are obtained with a melting point of 192°C to 193°C.

An alternative synthesis route is described by Kleeman & Engel.

References

Merck Index 6058

Kleeman & Engel p. 602

DOT 18 (10 530 (1982)

I.N. p. 636

Wismayr, K., Schmid, O., Kilches, R. and Zolss, G.; U.S. Patent 3,340,298; September 5, 1967; assigned to Oesterreichische Stickstoffwerke A.G. (Austria)

MINAPRINE

Therapeutic Function: Antidepressant

Chemical Name: 3-(2-Morpholinoethylamino)-4-methyl-6-phenylpyridazine dihydrochloride

Common Name: —

Structural Formula:

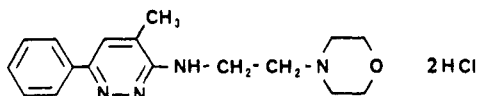

Chemical Abstracts Registry No.: 25905-77-5; 25953-17-7 (Dihydrochloride)

Trade Name	Manufacturer	Country	Year Introduced
Cantor	Clin Midy	France	1979
Kantor	Gador	Argentina	1983

Raw Materials

3-Chloro-4-methyl-6-phenylpyridazine
N-(2-Aminoethyl)morpholine
Hydrogen chloride

Manufacturing Process

(a) *Preparation of the free base:* A mixture comprising 0.1 mol (20.4 g) of 3-chloro-4-methyl-6-phenylpyridazine and 0.2 mol (26.2 g) of N-(2-aminoethyl)-morpholine in 100 ml of n-butanol, with a pinch of copper powder, was heated under reflux for 12 hours. At the end of this time, the hot solution was poured into 200 ml of cold water. The resulting mixture was filtered through a sintered glass filter and the precipitate washed with ether. The filtrate and the ether washings were placed in a separating funnel and extracted with two 150 ml portions of ether. The ethereal layer was then extracted with about 250 ml of N sulfuric acid.

The acid solution was made alkaline with a 10% aqueous solution of sodium carbonate, and left to crystallize overnight.

The solution was filtered, yielding the colorless needles which were recrystallized from isopropanol. The yield was 15 g (53%).

(b) *Preparation of the hydrochloride:* The base was dissolved in the smallest amount possible of anhydrous acetone. Double that volume of anhydrous ether was added, and a stream of hydrogen chloride gas was passed through the solution. The hydrochloride salt obtained was recrystallized from absolute alcohol. The yield after recrystallization was 17 g (90%).

References

Merck Index 6066

DFU 2 (12) 811 (1977)

Kleeman & Engel p. 602

I.N. p. 637

Laborit, H.; British Patent 1,345,880; Feb. 6, 1974; and U.S. Patent 4,169,158; Sept. 25, 1979; both assigned to Centre D'Etudes Experimentales et Cliniques de Physiobiologie de Pharmacologie et D'Eutonologie (C.E.P.B.E.P.E.)

MINOCYCLINE

Therapeutic Function: Antibiotic

Chemical Name: 4,7-bis(dimethylamino)-1,4,4a,5,5a,6,11,12a-octahydro-3,10,12,12a-tetrahydroxy-1,11-dioxo-2-naphthacene-carboxamide

Common Name: 7-dimethylamino-6-demethyl-6-deoxytetracycline

Structural Formula:

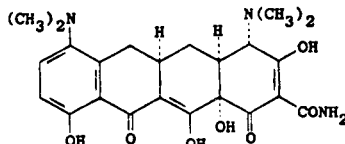

Chemical Abstracts Registry No.: 10118-90-8; 13614-98-7 (Hydrochloride)

Trade Name	Manufacturer	Country	Year Introduced
Minocin	Lederle	U.S.	1971
Minomycin	Lederle	Japan	1971
Klinomycin	Lederle	W. Germany	1972
Minocin	Lederle	Italy	1972
Minomycin	Takeda	Japan	1972
Vectrin	Parke Davis	U.S.	1973
Minocin	Lederle	U.K.	1973
Mynocine	Lederle	France	1973
Ultramycin	Parke Davis	—	—

Raw Materials

6-Demethyltetracycline
 Dibenzyl azodicarboxylate
 Hydrogen

Manufacturing Process

Preparation of 7-(N,N'-Dicarbobenzyloxyhydrazino)-6-Demethyltetracycline: A 1.0 g portion of 6-demethyltetracycline was dissolved in a mixture of 9.6 ml of tetrahydrofuran and 10.4 ml of methanesulfonic acid at -10°C . The mixture was allowed to warm to 0°C . A solution of 0.86 g of dibenzyl azodicarboxylate in 0.5 ml of tetrahydrofuran was added dropwise and the mixture was stirred for 2 hours while the temperature was maintained at 0°C . The reaction mixture was added to ether. The product was filtered off, washed with ether and then dried. The 7-(N,N'-dicarbobenzyloxyhydrazino)-6-demethyltetracycline was identified by paper chromatography.

Reductive Methylation of 7-(N,N'-Dicarbobenzyloxyhydrazino)-6-Demethyl-6-Deoxytetracycline to 7-Dimethylamino-6-Demethyl-6-Deoxytetracycline: A solution of 100 mg of 7-(N,N'-dicarbobenzyloxyhydrazino)-6-demethyl-6-deoxytetracycline in 2.6 ml of methanol, 0.4 ml of 40% aqueous formaldehyde solution and 50 mg of 5% palladium on carbon catalyst was hydrogenated at room temperature and two atmospheres pressure. Uptake of the hydrogen was complete in 3 hours. The catalyst was filtered off and the solution was taken to dryness under reduced pressure. The residue was triturated with ether and then identified as 7-dimethylamino-6-demethyl-6-deoxytetracycline by comparison with an authentic sample, according to U.S. Patent 3,483,251.

References

Merck Index 6068

Kleeman & Engel p. 603

PDR p. 1018

OCDS Vol. 1 p. 214 (1977) & 2, 288 (1980)

DOT 5 (2) 75 (1969); 7 (5) 188 (1971) & 8 (3) 93 (1972)

I.N. p. 637

REM p. 1206

Boothe, J.H. and Petisi, J.; U.S. Patent 3,148,212; September 8, 1964; assigned to American Cyanamid Company

Petisi, J. and Boothe, J.H.; U.S. Patent 3,226,436; December 28, 1965; assigned to American Cyanamid Company

Winterbottom, R., Bitha, P. and Kissman, H.M.; U.S. Patent 3,345,410; October 3, 1967; assigned to American Cyanamid Company

Zambrano, R.T.; U.S. Patent 3,403,179; September 24, 1968; assigned to American Cyanamid Company

Zambrano, R.T.; U.S. Patent 3,483,251; December 9, 1969; assigned to American Cyanamid Company

MINOXIDIL

Therapeutic Function: Antihypertensive

Chemical Name: 6-Amino-1,2-dihydro-1-hydroxy-2-imino-4-piperidinopyrimidine

Common Name: —

Structural Formula:

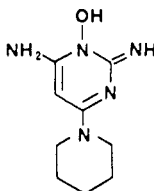

Chemical Abstracts Registry No.: 38304-91-5

Trade Name	Manufacturer	Country	Year Introduced
Loniten	Upjohn	U.S.	1979
Loniten	Upjohn	U.K.	1980
Loniten	Upjohn	Switz.	1981
Lonolox	Upjohn	W. Germany	1982
Loniten	Upjohn	Italy	1983
Prexidil	Bioindustria	Italy	1983

Raw Materials

Barbituric acid	Phosphorus oxychloride
2,4,6-Trichloropyrimidine	Ammonia
m-Chloroperbenzoic acid	Piperidine

Manufacturing Process

Barbituric acid is reacted with phosphorus oxychloride then with 2,4,6-trichloropyrimidine and that product with ammonia to give 4-chloro-2,6-diaminopyrimidine

A 30 g (0.15 mol) quantity of 4-chloro-2,6-diaminopyrimidine is dissolved in 600 ml of hot 3A alcohol, the solution cooled to 0°C to 10°C and 41.8 g (0.24 mol) of m-chloroperbenzoic acid is added. The mixture is held at 0°C to 10°C for 4 hours and filtered. The solid is shaken for 2 hours in 0.24 mol of 10% sodium hydroxide and filtered. The solid is washed with water and dried to yield 19.3 g of crude product. This product is extracted for 1 hour with 900 ml of boiling acetonitrile to yield 14.8 g (44.7% yield) of 6-amino-4-chloro-1,2-dihydro-1-hydroxy-2-iminopyrimidine, melting point 193°C.

A mixture of 3.0 g (0.019 mol) of 6-amino-4-chloro-1,2-dihydro-1-hydroxy-2-iminopyrimidine and 35 ml of piperidine is refluxed for 1.5 hours, cooled and filtered. The solid is shaken for 20 minutes in a solution of 0.8 g of sodium hydroxide in 30 ml of water and filtered. The solid is washed with water and extracted with 800 ml of boiling acetonitrile and filtered to yield 3.5 g (89%) yield of 6-amino-1,2-dihydro-1-hydroxy-2-imino-4-piperidinopyrimidine, melting point 248°C, decomposition at 259°C to 261°C.

References

- Merck Index 6069
 DFU 2 (6) 383 (1977)
 Kleeman & Engel p. 604
 PDR p. 1848
 OCDS Vol. 1 p. 262 (1977)
 DOT 8 (7) 277 (1972) & 16 (9) 298 (1980)
 I.N. p. 638
 REM p. 848
 Anthony, W.C. and Ursprung, J.J.; U.S. Patents 3,382,247; May 7, 1968 and 3,382,248; May 7, 1968; both assigned to The Upjohn Co.
 Anthony, W.C.; U.S. Patent 3,644,364; February 22, 1972; assigned to The Upjohn Co.

MITOBRONITOL

Therapeutic Function: Cancer chemotherapy

Chemical Name: 1,6-dibromo-1,6-dideoxy-D-mannitol

Common Name: —

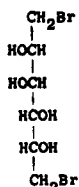
Structural Formula:**Chemical Abstracts Registry No.:** 488-41-5

Trade Name	Manufacturer	Country	Year Introduced
Myelobromol	Hormon Chemie	W. Germany	1967
Myelobromol	Berk	U.K.	1970
Myebrol	Kyorin	Japan	1978

Raw Materials

D-Mannitol
Hydrogen bromide

Manufacturing Process

750 g D-mannitol are dissolved in 4,000 ml of a 48% aqueous hydrogen bromide solution, whereupon the solution thus obtained is saturated at 0°C with gaseous hydrogen bromide until a HBr content of 69 to 70% is achieved. The reaction mixture is heated for 6 hours at 60°C in an autoclave, is then decolorized with charcoal, extracted with 1 liter chloroform twice and diluted with 7 liters of water. The pH value of the solution is adjusted by means of sodium bicarbonate to 1 to 2. The crystals precipitated after cooling for a day are filtered and washed with water until free from acid. 250 g crude 1,6-dibromo-1,6-desoxy-D-mannitol are obtained. MP 176° to 178°C. Analysis: Br % = 52 (calc.: 51.9).

250 g of the crude DBM are dissolved in 2.5 liters of hot methanol and on decolorizing and filtration 2.5 liters of dichloroethane are added. 220 g of crystalline DBM are obtained. MP 178°C. Br % = 51.9.

References

Merck Index 6076

Kleeman & Engel p. 604

I.N. p. 639

REM p. 1156

Chinoïn Gyogyszer-es Vegyeszeti Termekék Gyarart; British Patent 959,407; June 3, 1964

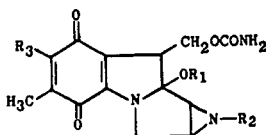
MITOMYCIN**Therapeutic Function:** Cancer chemotherapy**Chemical Name:** See structural formula**Common Name:** —**Structural Formula:**

Chemical Abstracts Registry No.: 50-07-7

Trade Name	Manufacturer	Country	Year Introduced
Mitomycin	Medac	W. Germany	1960
Mitomycin C	Kyowa	Italy	1961
Ametycine	Choay	France	1970
Mutamycin	Bristol	U.S.	1974
Mytomycin C	Kyowa	Japan	1980
Mutamycin	Bristol	Sweden	1983
Mitomycin C	Syntex	Switz.	1983

Raw Materials

Bacterium *Streptomyces caespitosus*
Nutrient broth

Manufacturing Process

The commercial production of mitomycin involves the preparation of mitomycin-containing broths by culturing a mitomycin-producing organism, e.g. *Streptomyces caespitosus*, in suitable media as described at length in the literature. At the end of the fermentation cycle the whole broth is usually centrifuged, filtered or otherwise treated to separate the solids (mycelia) from the supernatant which contains substantially all of the antibiotic activity.

In commercial processes there is usually a period of time intervening between the end of the fermentation cycle and the time at which the mycelia is actually removed from the broth; such a period may range from several minutes to several hours in length and may be due to a number of factors, e.g., the time necessary to conduct the actual centrifugation or filtration of large quantities of broth, or the time involved in waiting for equipment to become available for use. In the commercial preparation of mitomycin, the mitomycin-containing whole broths decrease rapidly in potency during the time following the completion of the fermentation cycle and prior to the removal of the mycelia. It has been observed that a whole broth will lose substantially all of its mitomycin activity within about 6 hours at room temperature and within about 24 hours at 10°C. It has, however, been discovered, as described in U.S. Patent 3,042,582, that in the process for the recovery of mitomycin C from mitomycin C-containing whole broth, the step of adding about 0.1 wt % with whole broth of sodium lauryl sulfate to the whole broth at the completion of the fermentation cycle substantially eliminates such destruction of mitomycin C by mitase.

References

Merck Index 6079

Kleeman & Engel p. 604

PDR p. 724

I.N. p. 640

REM p. 1156

Gourevitch, A., Chertow, B. and Lein, J.; U.S. Patent 3,042,582; July 3, 1962; assigned to Bristol-Myers Company

MITOPODOZIDE**Therapeutic Function:** Antineoplastic**Chemical Name:** 5,6,7,8-Tetrahydro-8-hydroxy-7-(hydroxymethyl)-5-(3,4,5-trimethoxyphenyl)naphtho[2,3-d]-1,3-dioxole-6-carboxylic acid-2-ethylhydrazide

Common Name: Podophyllinic acid 2-ethylhydrazide

Structural Formula:

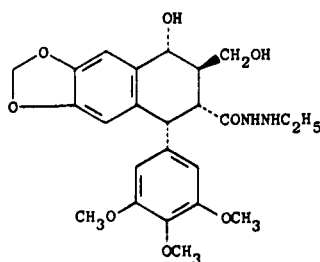

Chemical Abstracts Registry No.: 1508-45-8

Trade Name	Manufacturer	Country	Year Introduced
Proresid	Sandoz	W. Germany	1966
Proresid	Sankyo	Japan	1969

Raw Materials

Podophyllinic acid hydrazide
Acetaldehyde
Hydrogen

Manufacturing Process

500 g of podophyllinic acid hydrazide are heated together with 150 cc of acetaldehyde with 2,200 cc of methanol to 40°C. The solution obtained is filtered and then cooled. The product which crystallizes out is filtered off with suction and washed with methanol. Together with a second fraction obtained after concentration of the mother liquors there are produced 450 g of podophyllinic acid ethylidene hydrazide, having a melting point of 222°C to 224°C and a specific rotation of $[\alpha]_D = -285^\circ$ (c. = 0.5 in ethanol).

The product is hydrogenated in 4,000 cc of ethanol at room temperature and under normal atmospheric pressure with a catalyst prepared in the usual manner from 400 g of Raney nickel alloy. The calculated amount of hydrogen is taken up in approximately 75 hours. After filtration and evaporation to a small volume, the residue is distributed between 1,000 cc of chloroform and water each. The chloroform solution is then dried over sodium sulfate and evaporated to a small volume. Precipitation of the hydrogenation product with petroleum ether yields an amorphous white powder which is filtered by suction, washed with petroleum ether and dried at 50°C in a high vacuum. 1-ethyl-2-podophyllinic acid hydrazide is obtained in a practically quantitative yield.

References

Merck Index 7414

Kleeman & Engel p. 605

I.N. p. 640

Rutschmann, J.; U.S. Patent 3,054,802; September 18, 1962; assigned to Sandoz Ltd. (Switzerland)

MOLINDONE

Therapeutic Function: Antipsychotic

Chemical Name: 3-Ethyl-1,5,6,7-tetrahydro-2-methyl-5-(4-morpholinylmethyl)-4H-indol-4-one

Common Name: —

Structural Formula:

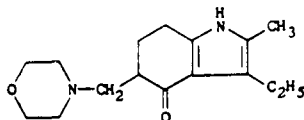

Chemical Abstracts Registry No.: 7416-34-4; 15622-65-8 (Hydrochloride)

Trade Name	Manufacturer	Country	Year Introduced
Moban	Endo	U.S.	1974
Lidone	Abbott	U.S.	1977

Raw Materials

Diethyl ketone	Methyl nitrite
Cyclohexan-1,3-dione	Morpholine hydrochloride
Paraformaldehyde	

Manufacturing Process

Diethyl ketone may be reacted with methyl nitrite and that product in turn reacted with cyclohexan-1,3-dione to give 3-ethyl-4,5,6,7-tetrahydro-2-methyl-4-oxoindole.

3-ethyl-4,5,6,7-tetrahydro-2-methyl-4-oxoindole 14.1 g (0.08 mol), 14.8 g morpholine hydrochloride (0.12 mol), and 3.6 g paraformaldehyde (0.12 mol) were refluxed in 200 ml ethanol for 40 hours. The solution was evaporated to dryness in vacuo on a steam bath and the residue digested with a mixture of 150 ml water and 10 ml 2 N HCl. An insoluble residue of unreacted starting material was filtered off. To the acid solution, ammonia water was added dropwise with stirring and the amine crystallized out. It was purified by dissolving in 1 N HCl and addition of ammonia, then by 2 crystallizations from benzene followed by 2 crystallizations from isopropanol, to yield 3-ethyl-4,5,6,7-tetrahydro-2-methyl-5-morpholino-methyl-4-oxoindole, melting point 180°C to 181°C.

References

- Merck Index 6086
- Kleeman & Engel p. 606
- PDR p. 856
- OCDS Vol. 2 p. 455 (1980)
- DOT 5 (1) 34 (1969); 9 (6) 233 (1973) & 11 (2) 60 (1975)
- I.N. p. 642
- REM p. 1092
- Pachter, I.J. and Schoen, K.; U.S. Patent 3,491,093; January 20, 1970; assigned to Endo Laboratories, Inc.

MOPIDAMOL

Therapeutic Function: Blood platelet aggregation inhibitor

Chemical Name: 2,6-Bis(diethanolamino)-8-(N-piperidino)pyrimido[5,4-d]pyrimidine

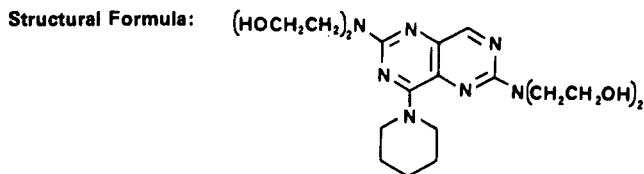
Common Name: —**Chemical Abstracts Registry No.:** 13665-88-8

Trade Name	Manufacturer	Country	Year Introduced
Rapenton	Thomae	W. Germany	1980

Raw Materials

Dipyridamole	Zinc
Iodine	Formic acid

Manufacturing Process

3.9 g (0.06 mol) of zinc powder were introduced into a solution of 5.0 g (0.01 mol) of 2,6-bis-(diethanolamino)-4,8-dipiperidino-pyrimido-[5,4-d]-pyrimidine (dipyridamole; see entry under that name for its synthesis) in 120 cc of aqueous 10% formic acid. The resulting mixture was heated on a water bath, while occasionally stirring, until the intense yellow color of the starting compound disappeared, which occurred after about 30 to 40 minutes. Thereafter, the unconsumed zinc powder was separated by vacuum filtration, the virtually colorless filtrate was essentially an aqueous solution of 2,6-bis-(diethanolamino)-8-piperidino-1,2,3,4-tetrahydropyrimido-[5,4-d] pyrimidine.

The filtrate was adjusted to a pH of 9 by adding concentrated ammonia, and then a 1 N aqueous iodine-potassium iodide solution was added dropwise, whereby the tetrahydro-pyrimido-[5,4-d] pyrimidine obtained by hydrogenation with zinc in formic acid was converted by oxidation into 2,6-bis-(diethanolamino)-8-piperidino-pyrimido-[5,4-d]-pyrimidine. The completion of the oxidation was checked by means of a starch solution. The major amount of the oxidation product already separated out as a deep yellow crystalline precipitate during the addition of the iodine solution. After the oxidation reaction was complete, the reaction mixture was allowed to stand for a short period of time, and then the precipitate was separated by vacuum filtration, washed with water and dried. It had a melting point of 157°C to 158°C. The yield was 8.0 g, which corresponds to 95% theory.

References

Merck Index 6115

DFU 5 (11) 550 (1980)

Kleeman & Engel p. 608

DOT 17 (3) 89 (1981)

I.N. p. 644

Roch, J. and Scheffler, H.; U.S. Patent 3,322,755; May 30, 1967; assigned to Boehringer Ingelheim GmbH

MORCLOFONE**Therapeutic Function:** Antitussive

Chemical Name: (4-Chlorophenyl)[3,6-dimethoxy-4-[2-(4-morpholinyl)-ethoxy]phenyl]-methanone

Common Name: Dimeclophenone

Structural Formula:

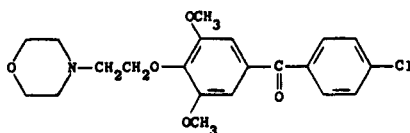

Chemical Abstracts Registry No.: 31848-01-8; 31848-02-9 (Hydrochloride)

Trade Name	Manufacturer	Country	Year Introduced
Plausitin	Carlo Erba	Italy	1975
Nitux	Inpharzam	Switz.	1981
Medicil	Medici	Italy	—
Novotussil	Inpharzam	Belgium	—

Raw Materials

3,5-Dimethoxy-4'-chloro-4-hydroxybenzophenone
Sodium methoxide
 β -Morpholinoethyl chloride

Manufacturing Process

Sodium methoxide (1.2 g) in dimethylformamide (150 ml) was stirred with 3,5-dimethoxy-4'-chloro-4-hydroxybenzophenone (6 g) in dimethylformamide (50 ml), for 2 hours at 120°C. The reaction mixture was then treated with β -morpholinoethyl chloride (3.4 g) and heated for 1 hour at 140°C, then evaporated to dryness, and treated with water to give a solid material. The mixture was filtered, washed and crystallized from cyclohexane to give 3,5-dimethoxy-4'-chloro-4-(β -morpholinoethoxy)-benzophenone (6.5 g), MP 91°C to 92°C. The product was then reacted at about 0°C with gaseous hydrogen chloride in ether to give, after crystallization from isopropanol, the corresponding hydrochloride which had a MP of 187.9°C.

References

Merck Index 6120

Kleeman & Engel p. 609

DOT 12 (7) 269 (1976)

I.N. p. 645

Lauria, F., Vecchiotti, V. and Logemann, W.; U.S. Patent 3,708,482; January 2, 1973; assigned to Carlo Erba SpA (Italy)

MOTRETINIDE

Therapeutic Function: Antipsoriasis

Chemical Name: N-Ethyl-9-(4-methoxy-2,3,6-trimethylphenyl)-3,7-dimethyl-2,4,6,8-nonatetraenamido

Common Name: —

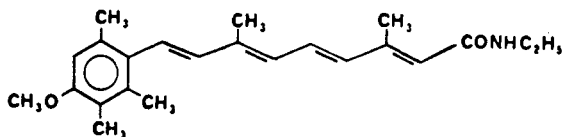
Structural Formula:**Chemical Abstracts Registry No.:** 56281-36-8

Trade Name	Manufacturer	Country	Year Introduced
Tasmaderm	Roche	Switz.	1981

Raw Materials

5-(4-Methoxy-2,3,6-trimethylphenyl)-3-methylpenta-2,4-diene-1-triphenylphosphonium bromide
 Sodium hydride
 3-Formylcrotonic acid butyl ester
 Sodium hydroxide
 Phosphorus trichloride
 Ethylamine

Manufacturing Process

228 g of 5-(4-methoxy-2,3,6-trimethyl-phenyl)-3-methyl-penta-2,4-diene-1-triphenylphosphonium bromide are introduced under nitrogen gassing into 910 ml of dimethylformamide and treated with cooling at 5°C to 10°C within 20 minutes with 17.5 g of a suspension of sodium hydride (about 50% by weight) in mineral oil. The mixture is stirred for 1 hour at about 10°C, then treated at 5°C to 8°C dropwise with 61.8 g of 3-formylcrotonic acid butyl ester, heated for 2 hours at 65°C, subsequently introduced into 8 liters of ice-water and, after the addition of 300 g of sodium chloride, thoroughly extracted with a total of 18 liters of hexane. The extract is washed 5 times with 1 liter of methanol/water (6:4 parts by volume) each time and 2 times with 1.5 liters of water each time, dried over sodium sulfate and evaporated under reduced pressure to leave 9-(4-methoxy-2,3,6-trimethylphenyl)-3,7-dimethyl-nona-2,4,6,8-tetraen-1-yl acid butyl ester, MP 80°C to 81°C as the residue.

125.8 g of 9-(4-methoxy-2,3,6-trimethyl-phenyl)-3,7-dimethyl-nona-2,4,6,8-tetraen-1-yl acid butyl ester are introduced into 2,000 ml of absolute ethanol and treated with a solution of 125.8 g of potassium hydroxide in 195 ml of water. The mixture is heated to boiling under nitrogen gassing for 30 minutes, then cooled, introduced into 10 liters of ice-water and, after the addition of about 240 ml of concentrated hydrochloric acid (pH 2-4), thoroughly extracted with a total of 9 liters of methylene chloride. The extract is washed with about 6 liters of water to neutrality, dried over calcium chloride and evaporated under reduced pressure. The residue is taken up in 700 ml of hexane. The precipitated 9-(4-methoxy-2,3,6-trimethyl-phenyl)-3,7-dimethyl-nona-2,4,6,8-tetraen-1-yl acid melts at 228°C to 230°C.

28.6 g of 9-(4-methoxy-2,3,6-trimethyl-phenyl)-3,7-dimethyl-nona-2,4,6,8-tetraen-1-yl acid are introduced into 300 ml of benzene and treated under nitrogen gassing with 12 g of phosphorus trichloride. The benzene is subsequently distilled off under reduced pressure. The remaining 9-(4-methoxy-2,3,6-trimethyl-phenyl)-3,7-dimethyl-nona-2,4,6,8-tetraen-1-yl acid chloride is dissolved in 1,200 ml of diethyl ether. The solution is added dropwise at -33°C into 500 ml of ethylamine and stirred for 3 hours. The reaction mixture is then diluted with 500 ml of diethyl ether and stirred without cooling for a further 12 hours, the ammonia evaporating. The residue is dissolved in 10 liters of methylene chloride. The solution is washed 2 times with 3 liters of water, dried over sodium sulfate and evaporated under reduced pressure. The remaining N-ethyl-9-(4-methoxy-2,3,6-trimethylphenyl)-3,7-dimethyl-nona-2,4,6,8-tetraen-1-yl acid amide melts, after recrystallization from ethanol, at 179°C to 180°C.

References

Merck Index 6142

DFU 3 (2) 126 (1978)

OCDS Vol. 3 p. 12 (1984)

DOT 18 (12) 653 (1982)

I.N. p. 647

Bollag, W., Ruegg, R. and Ryser, G.; U.S. Patents 4,105,681; August 8, 1978; and 4,215,215; July 29, 1980; both assigned to Hoffmann-LaRoche, Inc.

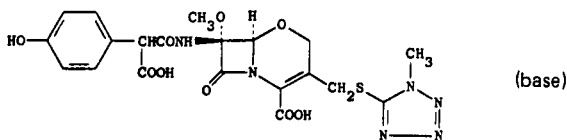
MOXALACTAM DISODIUM**Therapeutic Function:** Antiinfective**Chemical Name:** 7-[[Carboxy(4-hydroxyphenyl)acetyl] amino] 7-methoxy-3-[[(1-methyl-1H-tetrazol-5-yl)thio] -methyl] -8-oxo-5-oxa-1-azabicyclo[4.2.0] oct-2-ene-2-carboxylic acid disodium salt**Common Name:** Lamoxactam; latamoxef**Structural Formula:****Chemical Abstracts Registry No.:** 64952-97-2 (Base)

Trade Name	Manufacturer	Country	Year Introduced
Moxam	Lilly	U.S.	1981
Moxalactam	Lilly	W. Germany	1981
Festamoxin	Shionogi	W. Germany	1981
Moxalactam	Lilly	France	1981
Moxalactam	Lilly	U.K.	1982
Shiomalin	Shionogi	Japan	1982

Raw Materials

p-(p-Methoxybenzyloxy)-phenylmalonic acid

Diphenylmethyl 7 β -amino-7 α -methoxy-3-(1-methyltetrazol-5-yl)-thiomethyl-1-oxadethia-3-cephem-4-carboxylate

Aluminum chloride

Sodium-2-ethylhexanoate

Manufacturing Process

To a stirred suspension of p-(p-methoxybenzyloxy)-phenylmalonic acid (125 mg) in methylene chloride (3 ml) are added triethylamine (55 μ l) and oxalyl chloride (26 μ l) at -15°C , and the suspension is stirred for 40 minutes at 0°C . The mixture is added to a solution of diphenylmethyl 7 β -amino-7 α -methoxy-3-(1-methyltetrazol-5-yl)thiomethyl-1-oxadethia-3-cephem-4-carboxylate (100 mg) in methylene chloride (3 ml) and pyridine (63 μ l), and the mixture is stirred for 30 minutes at 0°C . The reaction mixture is diluted with ethyl acetate, washed with aqueous 2N-hydrochloric acid and water, dried over sodium sulfate, and concentrated to give crude product (212 mg), which is chromatographed on silica gel (20 g) and

eluted with a mixture of ethyl acetate and acetic acid (99:1) to give diphenylmethyl-7 β -[α -p-(p-methoxybenzyloxy)phenyl- α -carboxylacetamido]-7 α -methoxy-3-(1-methyltetrazol-5-yl)thiomethyl-1-oxadethia-3-cephem-4-carboxylate as foam (71 mg). Yield: 45%.

To a solution of diphenylmethyl 7 β -[α -p-(p-methoxybenzyl)-oxy-phenyl- α -p-methoxybenzyl-oxy-carbonyl-acetamido]-7 α -methoxy-3-(1-methyltetrazol-5-yl)thiomethyl-1-oxadethia-3-cephem-4-carboxylate (1.20 g) in methylene chloride (24 ml) are added anisole (2.4 ml) and a solution of aluminum chloride (2.58 g) in nitromethane (12 ml) at 0°C under nitrogen. After stirring for 15 minutes at 0°C, the mixture is poured into cold 5% sodium hydrogen carbonate aqueous solution (100 ml) and filtered to remove the formed precipitate. The filtrate is washed twice with methylene chloride (2 X 100 ml), acidified with 2N-hydrochloric acid to pH 2.60, and poured in a column of high porous polymer HP-20 (60 ml) sold by Mitsubishi Chemical Industries Ltd. The column is washed with water (300 ml) and eluted with methanol. The eluate is concentrated under reduced pressure at room temperature. The residue is dissolved in methanol, treated with active carbon, and concentrated under reduced pressure to give 7 β -[α -p-hydroxyphenyl- α -carboxylacetamido]-7 β -methoxy-3-(1-methyl-tetrazol-5-yl)thiomethyl-1-oxadethia-3-cephem-4-carboxylic acid as powder (595 mg) decomposing at 125°C to 132°C. Yield: 88.5%.

To a solution of 7 β -[α -p-hydroxyphenyl- α -carboxylacetamido-7 α -methoxy-3-(1-methyl-tetrazol-5-yl)thiomethyl-1-oxadethia-3-cephem-4-carboxylic acid (359 mg) in methanol (7 ml) is added a solution of sodium 2-ethylhexanoate in methanol (2 mols/liter; 1.73 ml) at room temperature. After stirring for 10 minutes, the reaction mixture is diluted with ethyl acetate, stirred for 5 minutes, and filtered to collect separated solid, which is washed with ethyl acetate, and dried to give disodium salt of 7 β -[α -p-hydroxyphenyl- α -carboxylacetamido)-7 α -methoxy-3-(1-methyl-tetrazol-5-yl)thiomethyl-1-oxadethia-3-cephem-4-carboxylic acid (342 mg). Yield: 88.8%. Colorless powder. MP decomposition from 170°C.

References

Merck Index 6143

DFU 5 (9) 467 (1980)

PDR p. 1064

OCDS Vol. 3 p. 218 (1984)

DOT 18 (3) 132 (1982)

I.N. p. 550

Narisada, M. and Nagata, W.; U.S. Patent 4,138,486; February 6, 1979; assigned to Shionogi & Co., Ltd. (Japan)

MOXESTROL

Therapeutic Function: Estrogen

Chemical Name: 11 β -methoxy-19-nor-17 α -pregna-1,3,5(10)-trien-20-yne-3,17-diol

Common Name: 11 β -methoxy-17 α -ethynylestradiol

Structural Formula:

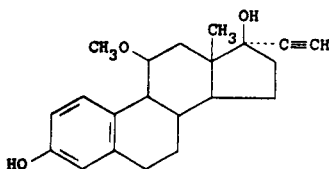

Chemical Abstracts Registry No.: 34816-55-2

Trade Name	Manufacturer	Country	Year Introduced
Surestryl	Roussel	France	1974

Raw Materials

$\Delta^{4,9}$ -Estradiene-11 β -ol-3,17-dione	Methanol
Palladium hydroxide	Potassium
Acetylene	

Manufacturing Process

(A) *Preparation of 11 β -Methoxy- $\Delta^{4,9}$ -Estradiene-3,17-Dione:* 0.5 g of $\Delta^{4,9}$ -estradiene-11 β -ol-3,17-dione were dissolved at room temperature in 25 cc of methylene chloride containing 2% of methanol and after 5 mg of p-toluene-sulfonic acid were added, the reaction mixture was agitated for several minutes. Then the reaction mixture was poured into ice water, washed with water until the wash waters were neutral, and distilled to dryness under vacuum. The resulting residue was crystallized from ethyl ether to obtain 0.46 g of 11 β -methoxy- $\Delta^{4,9}$ -estradiene-3,17-dione having a MP of 140°C.

(B) *Preparation of 11 β -Methoxy- $\Delta^{1,3,5(10)}$ -Estratriene-3-ol-17-one:* 12.3 g of 11 β -methoxy- $\Delta^{4,9}$ -estradiene-3,17-dione were dissolved in 1,230 cc of methanol and then, under an atmosphere of nitrogen, 7.38 g of palladium hydroxide were added and the mixture was held at reflux for one hour under agitation and a nitrogen atmosphere. Then the reaction mixture was cooled to 30°C, filtered, vacuum filtered and washed with methanol. The methanolic solutions were concentrated to about 50 cc, allowed to stand overnight at room temperature and filtered. The precipitate formed was triturated in methanol and dried at 80°C to obtain 10.74 g (yield = 87.5%) of 11 β -methoxy- $\Delta^{1,3,5(10)}$ -estratriene-3-ol-17-one having a MP of 264°C.

(C) *Preparation of 11 β -Methoxy-17 α -Ethylnyl- $\Delta^{1,3,5(10)}$ -Estratriene-3,17 β -Diol:* Under agitation and an atmosphere of nitrogen, 12 g of potassium were heated at 80°C in 180 cc of tertiary-amyl alcohol. The mixture was agitated for 30 minutes, cooled to 20°C and after 60 cc of dioxane were added thereto, a stream of acetylene was allowed to bubble through the mixture for one hour and fifteen minutes. Then a solution of 3 g of 11 β -methoxy- $\Delta^{1,3,5(10)}$ -estratriene-3-ol-17-one in 50 cc of dioxane was added and the mixture was agitated for 4 hours while continuing the passage of acetylene at room temperature. Thereafter, 50 cc of a 50% aqueous acetic acid solution was added and the mixture was poured into water and extracted with ether. The organic phases were washed first with an aqueous solution containing 10% of neutral sodium carbonate, then with water until the wash waters were neutral, dried over sodium sulfate and concentrated under vacuum until crystallization started. The reaction mixture was iced for one hour, vacuum filtered and the precipitate dried under vacuum to obtain 3.8 g of the raw 17 α -ethynyl derivative, which was purified by dissolution in ethyl acetate at reflux and by icing to obtain 2.33 g (yield = 77%) of 11 β -methoxy-17 α -ethynyl- $\Delta^{1,3,5(10)}$ -estratriene-3,17 β -diol, having a MP of 280°C.

References

Merck Index 6145

Kleeman & Engel p. 611

DOT 11 (4) 149 (1975)

I.N. p. 647

Bertin, D. and Pierdet, A.; U.S. Patent 3,579,545; May 18, 1971; assigned to Roussel-UCLAF, France

MOXISYLYTE**Therapeutic Function:** Peripheral vasodilator

Chemical Name: 4-[2-(Dimethylamino)ethoxy] 2-methyl-5-(1-methylethyl)-phenol acetate (ester)

Common Name: Thymoxamine

Structural Formula:

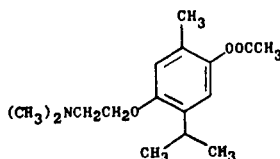

Chemical Abstracts Registry No.: 54-32-0

Trade Name	Manufacturer	Country	Year Introduced
Carlytene	Dedieu	France	1962
Vasoklin	Godecke	W. Germany	1973
Opilon	Parke Davis	Italy	1975
Apifor	Substancia	Spain	—
Arlitene	Chinoïn	Italy	—
Sympal	VEB Berlin-Chemie	E. Germany	—
Valyten	Landerlan	Spain	—

Raw Materials

Thymol	Sodium nitrite
Hydrogen sulfide	Acetic anhydride
Sodium	Ethanol
Dimethylaminoethyl chloride	Hydrogen chloride
Sulfuric acid	

Manufacturing Process

A hydrochloric acid solution of 100 g of thymol in alcohol is reacted with 72 g of sodium nitrite, the nitrosothymol (*Organic Syntheses* 6, New York, 1926, p. 92) thus obtained is introduced into ammonia, and is reduced by the introduction of hydrogen sulfide to 4-aminothymol (*Organic Syntheses Coll.* Vol. 1, New York, 1932, p. 458). 133.3 g of this 4-aminothymol are mixed with 67 g of sodium acetate, 107 g of glacial acetic acid and 80 g of acetic anhydride to form 4-acetaminothymol (Plancher, *Gazzetta Chimica Italiana* 25, II, p. 388). 156 parts by weight of this last formed substance dissolved in 600 cc of alcohol are added to a solution of 17.6 parts by weight of sodium in 600 cc of alcohol, the mixture being boiled under reflux for some time with 82 g of dimethylaminoethyl chloride. The reaction product is treated with water, and neutralized with hydrochloric acid using acid Congo reagent indicator, and the alcohol is distilled off in vacuo. The base liberated by alkali is dissolved in ether. By evaporating the ether solution the dimethylaminoethyl ether of the 4-acetaminothymol is obtained as a brownish-yellow oil. After some time this oil solidifies in a crystalline state.

100 g of this base are dissolved in a mixture of 300 cc of concentrated hydrochloric acid (density 1.19) and 400 cc of water, and the solution is boiled for one hour under a reflux condenser. Thereupon it is made alkaline, extracted with ether, and the ether is distilled off. 23.6 g of the 4-aminothymoxyethyl dimethylamine thus obtained are diazotized in the presence of sulfuric acid at a temperature not exceeding 0°C using a solution of 7.2 g of sodium nitrite in 70 cc of water, and the diazo compound is heated to boiling point after the addition of 1 g of copper sulfate, until no further gas is evolved. It is then made alkaline, and carbon dioxide is introduced. The base is precipitated first in an oily state, and soon becomes crystalline. The 4-oxythymoxyethyl dimethylamine forms a neutral hydrochloride which is readily soluble in water, and has a melting point of 174°C to 175.5°C.

36.8 g of 4-oxythymoxyethylidimethylamine are boiled for one hour on a water bath with 160 cc of acetic anhydride and 17.5 cc of pyridine. After this period, the solution is diluted with water, made alkaline, and the base is extracted with ether and the ether distilled off. With acids, the base obtained forms crystalline salts which are readily soluble in water. The hydrochloride melts between 208°C and 210°C.

References

Merck Index 6146
 Kleeman & Engel p. 612
 OCDS Vol. 1 p. 116 (1977)
 I.N. p. 647
 Veritas Drug Co., Ltd; British Patent 745,070; February 22, 1956

MUZOLIMINE

Therapeutic Function: Diuretic

Chemical Name: (3-Amino-1-(α -methyl-3,4-dichlorobenzyl)pyrazol-5-one

Common Name: —

Structural Formula:

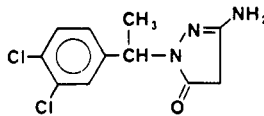

Chemical Abstracts Registry No.: 55294-15-0

Trade Name	Manufacturer	Country	Year Introduced
Edrul	Bayer	Italy	1982

Raw Materials

α -Methyl-3,4-dichlorobenzylhydrazine
 β -Amino- β -ethoxyacrylic acid ethyl ester

Manufacturing Process

41 g of α -methyl-3,4-dichlorobenzylhydrazine, dissolved in absolute ethanol, were added dropwise to a solution of 31.8 g of β -amino- β -ethoxyacrylic acid ethyl ester and 1.5 g of *p*-toluenesulfonic acid in 150 ml of ethanol at room temperature under nitrogen gas. After stirring for 2 hours and standing overnight, the reaction solution was concentrated as far as possible on a rotary evaporator. The residue which remained was dissolved in 2N sodium hydroxide solution. Any unconverted starting products or by-products were extracted with ether. The aqueous phase was then brought to pH 5 with acetic acid. The oil thereby produced was taken up in methylene chloride and the organic phase was dried over Na_2SO_4 . After evaporating off the solvent, the reaction product crystallized out. It was recrystallized from methanol; melting point 127°C to 129°C; yield 21 g (38.5% of theory).

References

Merck Index 6165
 DFU 2 (6) 387 (1977)
 OCDS Vol. 3 p. 137 (1984)

DOT 18 (10) 555 (1982) & 19 (5) 267 (1983)

I.N. p. 649

Moller, E., Meng, K., Wehinger, E. and Horstmann, H.; British Patent 1,429,141; March 24, 1976; assigned to Bayer AG

Moller, E., Meng, K., Wehinger, E. and Horstmann, H.; U.S. Patent 4,018,890; April 19, 1977; assigned to Bayer AG

N

NABILONE

Therapeutic Function: Antianxiety

Chemical Name: 1-Hydroxy-3-(1',1'-dimethylheptyl)-6,6-dimethyl-6,6a,7,8,10,10a-hexahydro-9H-dibenzo[b,d]pyran-9-one

Common Name: —

Structural Formula:

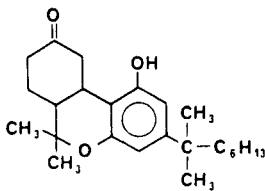

Chemical Abstracts Registry No.: 51022-71-0

Trade Name	Manufacturer	Country	Year Introduced
Cesamet	Lilly	Canada	1982
Cesametic	Lilly	W. Germany	1983
Cesamet	Lilly	U.K.	1983

Raw Materials

dl-3-(1',1'-Dimethylheptyl)-6,6a,7,8-tetrahydro-1-hydroxy-6,6-dimethyl-9H-dibenzo[b,d]pyran-9-one

Lithium
Ammonia

Manufacturing Process

A solution of 1.5 g of dl-3-(1',1'-dimethylheptyl)-6,6a,7,8-tetrahydro-1-hydroxy-6,6-dimethyl-9H-dibenzo[b,d]pyran-9-one in 50 ml of anhydrous tetrahydrofuran (THF) was added dropwise to a solution of lithium metal in liquid ammonia at -80°C . Excess lithium metal was added in chunks to the solution as the blue color, indicating free dissolved lithium, disappeared. After the addition was complete, ammonium chloride was added to react with any excess lithium metal still present.

The mixture was then allowed to warm to room temperature in a nitrogen atmosphere during which process the ammonia evaporated. The reaction mixture was then acidified with 1 N aqueous hydrochloric acid, and the organic constituents extracted with ethyl acetate. The ethyl acetate extracts were combined, washed with water and dried. Evaporation of the ethyl acetate under reduced pressure yielded 1.4 g of crude dl-trans-3-(1',1'-dimethylheptyl)-6,6a β ,7,8,10,10a β -hexahydro-1-hydroxy-6,6-dimethyl-9H-dibenzo[b,d]pyran-9-one. The

crude product was chromatographed over 50 g of silica gel from benzene solution and the desired product was eluted in 20 ml fractions with a benzene eluant containing 2% ethyl acetate. Fractions 200 to 240 contained 808 mg of a white crystalline solid comprising purified dl-trans-3-(1',1'-dimethylheptyl)-6,6a β ,7,8,10,10a β -hexahydro-1-hydroxy-6,6-dimethyl-9H-dibenzo[b,d]pyran-9-one. The purified compound melted at 159°C to 160°C after recrystallization from an ethyl acetate-hexane solvent mixture.

References

Merck Index 6193

DFU 3 (3) 207 (1978)

OCDS Vol. 3, p 189 (1984)

DOT 19 (7) 415 & (8) 436 (1983)

I.N. p. 652

Archer, R.A.; U.S. Patents 3,928,598; December 23, 1975; 3,944,673; March 16, 1976; and 3,953,603; April 27, 1976; all assigned to Eli Lilly & Co.

NADOLOL

Therapeutic Function: Antiarrhythmic

Chemical Name: 2,3-Cis-1,2,3,4-tetrahydro-5-[2-hydroxy-3-(tert-butylamino)propoxy]-2,3-naphthalenediol

Common Name: —

Structural Formula:

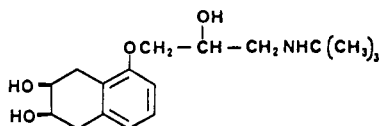

Chemical Abstracts Registry No.: 42200-33-9

Trade Name	Manufacturer	Country	Year Introduced
Solgol	Heyden	W. Germany	1978
Corgard	Squibb	Switz.	1978
Corgard	Squibb	U.K.	1979
Corgard	Squibb	U.S.	1979
Corgard	Squibb	Italy	1980
Corgard	Squibb	France	1982
Betadol	Fako	Turkey	—
Corzide	Squibb	U.S.	—

Raw Materials

5,8-Dihydro-1-naphthol	Acetic anhydride
Silver acetate	Iodine
Sodium hydroxide	Sodium methoxide
Epichlorohydrin	tert-Butylamine

Manufacturing Process

(a) *cis*-5,6,7,8-Tetrahydro-1,6,7-naphthalenetriol: A solution of 29.2 g (0.2 mol) of 5,8-dihydro-1-naphthol and 40 ml of acetic anhydride in 100 ml of pyridine is prepared. After 16

hours the solvent is removed in vacuo and the residue dissolved in ether and washed with 200 ml of 5% hydrochloric acid, water, 200 ml of 10% sodium hydroxide, saturated salt solution and dried. Solvent removal gives 34.2 g (90.5%) of crude acetate which is dissolved in 900 ml of acetic acid and 36 ml of water. 53.3 g (0.32 mol) of silver acetate is added followed by 40.6 g (0.16 g-atom) of iodine. The slurry is heated with good stirring at $85^{\circ}\pm 10^{\circ}\text{C}$ for 3 hours under nitrogen, cooled and filtered. The filtrate is evaporated in vacuo and the residue dissolved in 250 ml of methanol and cooled to 0°C .

A solution of 40 g of sodium hydroxide in 200 ml of water is added under nitrogen and the mixture stirred overnight. The bulk of the methanol is removed in vacuo whereupon a solid forms. The solid is separated by filtration, dissolved in 150 ml of water and acidified with 20 ml of concentrated hydrochloric acid. Cooling gives a solid which is filtered and dried to give 16.5 g *cis*-5,6,7,8-tetrahydro-1,6,7-naphthalenetriol, melting point 184.5°C to 187°C . Three recrystallizations from absolute ethanol give the analytical sample, melting point 188°C to 188.5°C .

(b) 2,3-cis-1,2,3,4-Tetrahydro-5-[2,3-(epoxy)propoxy]-2,3-naphthalenediol: A solution of 1.20 g (0.03 mol) of sodium methoxide and 5.4 g (0.03 mol) of *cis*-5,6,7,8-tetrahydro-1,6,7-naphthalenetriol in 200 ml of methanol is prepared under nitrogen. The residue obtained upon solvent removal is stirred overnight with 200 ml of dimethylsulfoxide and 4.65 g (0.05 mol) of epichlorohydrin under nitrogen. The bulk of the solvent is removed at 50°C at 0.1 mm and the residue dissolved in 100 ml of water. Extraction with chloroform (10 x 200 ml) gives a solid which is recrystallized from 150 ml of hexane-ethyl acetate to give epoxy diol of the above title.

(c) 2,3-cis-1,2,3,4-Tetrahydro-5-[2-hydroxy-3-(tert-butylamino)propoxy]-2,3-naphthalenediol: A mixture of 2,3-*cis*-1,2,3,4-tetrahydro-5-[2,3-(epoxy)propoxy]-2,3-naphthalenediol (melting point 104°C to 107°C , one spot on TLC-alumina, 5% methanol in chloroform, iodine visualization) and 22 ml of *tert*-butylamine is heated at 85°C to 95°C for 15 hours in a Parr bomb and the excess amine removed in vacuo. The solid obtained by trituration of the residue with ether is filtered and recrystallized from benzene to give 3.4 g, melting point 124°C to 136°C .

References

- Merck Index 6195
 DFU 1 (9) 434 (1976)
 Kleeman & Engel p. 614
 PDR pp. 1739, 1741
 OCDS Vol. 2 p. 110 (1980)
 DOT 15 (9) 411 (1979)
 I.N. p. 652
 REM p. 905
 Hauck, F.P., Cimarusti, C.M. and Narayanan, V.L.; U.S. Patent 3,935,267; January 27, 1976; assigned to E.R. Squibb & Sons, Inc.

NAFCILLIN SODIUM

Therapeutic Function: Antibacterial

Chemical Name: 6-(2-ethoxy-1-naphthamido)-3,3-dimethyl-7-oxo-4-thia-1-azabicyclo[3.2.0]-heptane-2-carboxylic acid sodium salt

Common Name: 6-(2-ethoxy-1-naphthamido)penicillin sodium salt

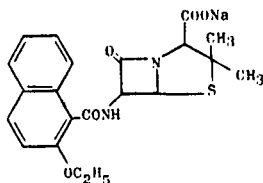
Structural Formula:

Chemical Abstracts Registry No.: 985-16-0; 147-52-4 (Base)

Trade Name	Manufacturer	Country	Year Introduced
Unipen	Wyeth	U.S.	1964
Nafcil	Bristol	U.S.	1976
Nallpen	Beecham	U.S.	1983
Naftopen	Gist-Brocades	—	—

Raw Materials

6-Aminopenicillanic acid
2-Ethoxy-1-naphthoyl chloride
Sodium bicarbonate

Manufacturing Process

A stirred suspension of 12.6 grams 6-aminopenicillanic acid in 130 ml dry alcohol-free chloroform was treated with 16 ml triethylamine and then with 13.8 grams of a solution of 2-ethoxy-1-naphthoyl chloride in 95 ml chloroform. After being washed successively with 58 ml each of 1N and then 0.1 N hydrochloric acid the chloroform solution was extracted with N aqueous sodium bicarbonate (58 ml + 6 ml). The combined bicarbonate extracts were washed with 20 ml ether and then evaporated at low temperature and pressure to give the crude sodium salt of 2-ethoxy-1-naphthylpenicillin [also called sodium 6-(2-ethoxy-1-naphthamido)penicillinate] as a yellow powder (20.3 grams). This was dissolved in 20 ml water at 30°C and diluted with 180 ml n-butanol, also at 30°C, with stirring. Slow cooling to 0°C gave colorless needles of the product.

References

Merck Index 6199
Kleeman & Engel p. 615
PDR pp. 700, 1991
OCDS Vol. 1 p. 412 (1977)
I.N. p. 653
REM p. 1196
Doyle, F.P. and Nayler, J.H.C.; U.S. Patent 3,157,639; November 17, 1964; assigned to Beecham Group Limited, England

NAFIVERINE

Therapeutic Function: Antispasmodic

Chemical Name: α -methyl-1-naphthaleneacetic acid 1,4-piperazinediyl-di-2,1-ethanediy ester

Common Name: —

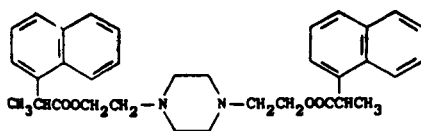
Structural Formula:**Chemical Abstracts Registry No.:** 5061-22-3

Trade Name	Manufacturer	Country	Year Introduced
Naftidan	De Angeli	Italy	1969

Raw Materials

α -Methyl-1-naphthylacetic acid
 Thionyl chloride
 N,N'-Di-(β -hydroxyethyl)piperazine

Manufacturing Process

15 grams of α -methyl-1-naphthylacetic acid were refluxed with 50 ml of thionyl chloride during 3 hours. The excess thionyl chloride was removed under reduced pressure and the product was also isolated by distillation under reduced pressure. Yield: 15.6 grams (96%). The α -methyl-1-naphthyl acetyl chloride boils at 120° to 124°C. 1.76 grams of N,N'-di-(β -hydroxyethyl)-piperazine, 1.9 grams of sodium bicarbonate and 4.45 grams of α -methyl-1-naphthyl acetyl chloride in 30 ml of anhydrous acetonitrile were refluxed with stirring during 5 hours. After cooling the mixture was filtered and the acetonitrile evaporated off under reduced pressure. 5.2 grams of crude ester were obtained. The hydrochloride, melting at 220° to 221°C, may be prepared by dissolving the ester in absolute ethanol and treating the solution with anhydrous gaseous hydrogen chloride.

References

Merck Index 6200

I.N. p. 653

Pala, G.; British Patent 1,016,968; Jan. 12, 1966; assigned to Istituto de Angeli, SpA, Italy

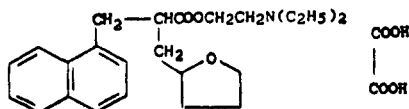
NAFRONYL OXALATE**Therapeutic Function:** Vasodilator**Chemical Name:** Tetrahydro- α -(1-naphthalenylmethyl)-2-furanpropanoic acid 2-(diethylamino)ethyl ester acid oxalate**Common Name:** Naftidofuryl**Structural Formula:****Chemical Abstracts Registry No.:** 3200-06-4; 31329-57-4 (Base)

Trade Name	Manufacturer	Country	Year Introduced
Dusodril	Roland	W. Germany	1968
Praxilene	Oberval	France	1968

Trade Name	Manufacturer	Country	Year Introduced
Prazilene	Lipha	U.K.	1972
Praxilene	Formenti	Italy	1973
Praxilene	Biochimica	Switz.	1980
Citoxid	Disprovent	Argentina	—

Raw Materials

β -(1-Naphthyl)- β '-tetrahydrofurfuryl isobutyric acid
 β -Chloroethyl-N-diethylamine
 Oxalic acid

Manufacturing Process

30 grams (0.106 mol) of β -(1-naphthyl)- β '-tetrahydrofurfuryl isobutyric acid are heated under reflux for 8½ hours in 230 cc of isopropanol with 14 grams (0.103 mol) of β -chloroethyl-N-diethylamine. After evaporation of the isopropanol in vacuo, the syrupy residue is treated with a solution of K_2CO_3 . Extraction with ether is carried out after drying over Na_2SO_4 .

Distillation of the extract yields 28.5 grams of a very viscous yellow liquid with a $BP_{0.95-1.09}$ millibar = 198° to 202°C. The yield is 70.5% (theoretical quantity = 40.5 grams). 1.3 grams (0.0103 mol) of dihydrated oxalic acid are dissolved while being made tepid in 8 cc of acetone. The cooled solution has added thereto 4 grams (0.0104 mol) of N-diethyl-aminoethyl- β -(1-naphthyl)- β '-tetrahydrofurfuryl isobutyrate, obtained according to the process described above and dissolved in 10 cc of acetone. The solution is brought to boiling point for 15 minutes. After cooling to ambient temperature, it is placed in a refrigerator. Crystallization occurs after 2 hours, the crystals which have formed are separated by centrifuging, and after washing in hexane and drying in vacuo 3.5 grams of white crystals are obtained. After being recrystallized three times, in alcohol and then in a mixture of alcohol and ethyl acetate, the product is analytically pure and has a MP = 110° to 111°C (heating stage).

References

Merck Index 6201

Kleeman & Engel p. 615

OCDS Vol. 2 p. 213 (1980)

DOT 5 (1) 19 (1969)

I.N. p. 654

Szarvasi, E. and Bayssat, M.; U.S. Patent 3,334,096; August 1, 1967; assigned to Lipha, Lyonnaise Industrielle Pharmaceutique, France

NALBUPHINE

Therapeutic Function: Analgesic

Chemical Name: N-cyclobutylmethyl-14-hydroxydihydronormorphinone

Common Name: —

Structural Formula:

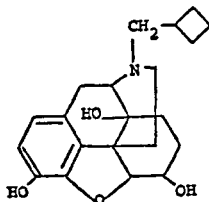

Chemical Abstracts Registry No.: 20594-83-6; 23277-43-2 (Hydrochloride)

Trade Name	Manufacturer	Country	Year Introduced
Nubain	Du Pont	U.S.	1979
Nubain	Du Pont	U.K.	1983

Raw Materials

14-Hydroxydihydronormorphinone
Cyclobutane carboxylic acid chloride
Lithium aluminum hydride

Manufacturing Process

To a slurry of 110.5 g of 14-hydroxydihydronormorphinone in 2.5 liters of methylene chloride and 280 ml of triethylamine was added a solution of 106 g of cyclobutanecarboxylic acid chloride in 500 ml of methylene chloride. The temperature of the reaction mixture was maintained at 20°C to 25°C during the addition. After 5 minutes the reaction mixture was brought to reflux and heated for 5 hours.

It was then cooled, washed with water, dried over sodium sulfate and evaporated to dryness. The residue was crystallized from benzene and pentane to give 138.5 g of the dicyclobutane-carbonyl derivative, melting point about 112°C (dec.).

The dicyclobutanecarbonyl derivative (136.7 g) was dissolved in 200 ml of tetrahydrofuran and added dropwise to a suspension of 34.2 g of lithium aluminum hydride in 1 liters of tetrahydrofuran. The temperature of the mixture rose to reflux during the addition. Reflux was maintained for 2 hours after the addition was completed. After cooling, 110 ml of ethyl acetate was added dropwise, followed by 30 ml of water, followed by a solution of 53 g of ammonium chloride in 125 ml of water. The resulting mixture was filtered and the inorganic precipitate was washed with methanol. Evaporation of the combined filtrates gave 66 g of N-cyclobutylmethyl-14-hydroxydihydronormorphinone, melting point 229°C to 231°C.

References

Merck Index 6203
DFU 2 (9) 613 (1977)
Kleeman & Engel p. 616
PDR p. 858
OCDS Vol. 2 p. 319 (1980)
DOT 16 (2) 51 (1980)
I.N. p. 654
REM p. 1109
Blumberg, H., Pachter, I.J. and Matossian, Z.; U.S. Patent 3,332,950; July 25, 1967; assigned to Endo Laboratories, Inc.

NALIDIXIC ACID

Therapeutic Function: Antibacterial

Chemical Name: 1-ethyl-1,4-dihydro-7-methyl-4-oxo-1,8-naphthyridine-3-carboxylic acid

Common Name: —

Structural Formula:

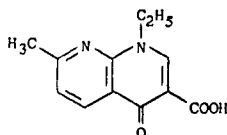

Chemical Abstracts Registry No.: 389-08-2

Trade Name	Manufacturer	Country	Year Introduced
Neggram	Winthrop	U.S.	1964
Nalidixique	Winthrop	France	1974
Jicsron	Towa Yakuhin	Japan	1981
Baktogram	Farmakos	Yugoslavia	—
Betaxina	Amelix	Italy	—
Chemiurin	Cifa	Italy	—
Cybis	Breon	U.S.	—
Dixiben	Benvegna	Italy	—
Dixuroi	I.T.I.	Italy	—
Enexina	S.I.T.	Italy	—
Entolon	Sawai	Japan	—
Eucistin	San Carlo	Italy	—
Faril	Saita	Italy	—
Innoxalon	Sanko	Japan	—
Kusnarin	Kodama	Japan	—
Nali	Iltas	Turkey	—
Nalcidin	Schoum	Italy	—
Nalidicron	San-A	Japan	—
Nalidixico	Level	Spain	—
Nalidixin	Spofa	Czechoslovakia	—
Nalidixol	Hermes	Spain	—
Naligen	Sam	Italy	—
Naligram	Isis	Yugoslavia	—
Nalissina	Armour	Italy	—
Nalitucsan	Hishiyama	Japan	—
Nalix	Sigurta	Italy	—
Nalixan	Neofarma	Finland	—
Nalurin	Von Boch	Italy	—
Narigix	Taiyo	Japan	—
Naxuril	Esterfarm	Italy	—
Negabatt	Dessy	Italy	—
Nicelate	Toyo Jozo	Japan	—
Nogermin	Madaus	Spain	—
Notricel	Hortel	Spain	—
Pielos	S.T.I.P.	Italy	—
Poleon	Sumitomo	Japan	—
Renogram	Belupo	Yugoslavia	—
Restelon	Maruishi	Japan	—
Sicmylon	Niichiko	Japan	—
Specifin	Bergamon	Italy	—
Unaserus	Isei	Japan	—
Uralgin	Ceccarelli	Italy	—
Uretrene	Mitim	Italy	—
Uriben	R.P. Drugs	U.K.	—
Uriclar	Crosara	Italy	—
Uri-Flor	A.G.I.P.S.	Italy	—
Urigram	Trima	Israel	—
Urisco	I.C.I.	Italy	—
Uristeril	Ripari-Gero	Italy	—
Urodixin	Italchimici	Italy	—
Urogram	Firma	Italy	—
Urolex	Sirt-B.B.P.	Italy	—
Urolgin N	Takata	Japan	—
Uromina	Ausonia	Italy	—
Uroneg	Ibirn	Italy	—
Valuren	Intersint	Italy	—

Trade Name	Manufacturer	Country	Year Introduced
Wintomylon	Daiichi	Japan	—
Wintron	Tobishi	Japan	—

Raw Materials

2-Amino-6-methylpyridine
 Ethoxymethylenemalonic acid diethyl ester
 Sodium hydroxide
 Ethyl iodide

Manufacturing Process

A warm solution containing 41 grams of 4-hydroxy-7-methyl-1,8-naphthyridine-3-carboxylic acid and 39 grams of potassium hydroxide in 1 liter of ethanol and 200 cc of water was treated with 50 cc of ethyl iodide and the resulting mixture was refluxed gently overnight, acidified with hydrochloric acid and cooled. The resulting precipitate was collected and recrystallized twice from acetonitrile to yield 26 grams (56% yield) of 1-ethyl-7-methyl-4-oxo-1,8-naphthyridine-3-carboxylic acid, MP 229° to 230°C.

The starting material is prepared by reacting 2-amino-6-methylpyridine with ethoxymethylene-malonic acid diethyl ester and then reacting that product with sodium hydroxide.

References

Merck Index 6205
 Kleeman & Engel p. 616
 PDR p. 1922
 OCDS Vol. 1 p. 429 (1977) & 2, 370, 469 (1980)
 DOT 1 (1) 16 (1965)
 I.N. p. 33
 REM p. 1216
 Leshner, G.Y. and Gruett, M.D.; U.S. Patent 3,149,104; September 15, 1964; assigned to Sterling Drug Inc.

NALORPHINE

Therapeutic Function: Narcotic antagonist

Chemical Name: 7,8-didehydro-4,5-epoxy-17-(2-propenyl)morphinan-3,6-diol

Common Name: N-allylnormorphine

Structural Formula:

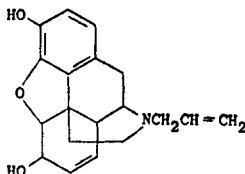

Chemical Abstracts Registry No.: 62-67-9; 57-29-4 (Hydrochloride)

Trade Name	Manufacturer	Country	Year Introduced
Nalline	MSD	U.S.	1952
Lethidrone	Wellcome	W. Germany	—
Nalorphine	Clin-Comar-Byla	France	—
Norfin	Lusofarmaco	Italy	—

Raw Materials

Normorphine
 Allyl bromide
 Sodium bicarbonate

Manufacturing Process

6 grams of normorphine, 2.7 grams of allyl bromide, 2.65 grams of sodium bicarbonate, and 75 cc of methanol were mixed together, and the resulting mixture was heated under reflux with stirring for a period of about 5½ hours. The reaction mixture was evaporated to dryness in vacuo, the residual material was extracted with 60 cc of boiling chloroform, 0.5 gram of activated charcoal was added, and the resulting mixture was filtered through a layer of diatomaceous silica. The filter cake was washed with four 10 cc portions of boiling chloroform, and the chloroform filtrate and washings were combined and evaporated to dryness in vacuo. The residual material was triturated with 25 cc of anhydrous ether until crystalline, the ethereal mixture was cooled, maintained at a temperature of 3°C overnight, filtered, and the crystalline mixture was washed with three 10 cc portions of ice-cold ether. The resulting crystalline product was dried to give 6.0 grams of N-allyl-normorphine, yield approximately 87% of theory, according to U.S. Patent 2,891,954.

References

Merck Index 6206
 Kleeman & Engel p. 617
 OCDS Vol. 1 p. 288 (1977) & 2, 318 (1980)
 I.N. p. 655
 REM p. 1106
 Weijlard, J. and Erickson, A.E.; U.S. Patent 2,364,833; December 12, 1944; assigned to Merck & Co., Inc.
 Weijlard, J.; U.S. Patent 2,891,954; June 23, 1959; assigned to Merck & Co., Inc.

NALOXONE

Therapeutic Function: Narcotic antagonist

Chemical Name: 17-allyl-4,5 α -epoxy-3,14-dihydroxy-morphinan-6-one

Common Name: N-allylnoroxymorphone; N-allyl-1,4-hydroxydihydronormorphinone

Structural Formula:

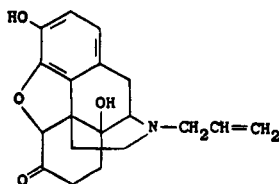

Chemical Abstracts Registry No.: 465-65-6; 357-08-4 (Hydrochloride)

Trade Name	Manufacturer	Country	Year Introduced
Narcan	Du Pont	U.S.	1971
Narcan	Du Pont	U.K.	1975
Narcanti	Winthrop	W. Germany	1978
Narcan	Winthrop	France	1980
Narcan	Crinos	Italy	1980
Nalone	End	U.S.	—
Talwin	Winthrop-Breon	U.S.	—

Raw Materials

Oxymorphone	Acetic anhydride
Cyanogen bromide	Hydrogen chloride
Allyl bromide	

Manufacturing Process

10 grams of 14-hydroxydihydromorphinone (oxymorphone) was converted into its diacetate by warming it on the steam bath with 80 cc of acetic anhydride for about 2 hours. The acetic anhydride was removed on the water bath under a vacuum of about 30 mm absolute pressure. The melting point of the residue was 220°C. The residue was taken up in 100 cc of chloroform. An equal amount by weight of cyanogen bromide was added and the mixture was refluxed at about 60°C for about 5 hours. After refluxing, the mixture was washed with 100 cc of a 5% aqueous hydrochloric acid solution, dried over sodium sulfate and the chloroform removed by evaporation under a vacuum of about 30 mm. The residue had a melting point of 240°C.

The residue was then heated at about 90°C for 16 hours on a steam bath with 300 cc of 20% aqueous hydrochloric acid solution, and treated with a small amount, e.g., 1 gram of charcoal. The hydrochloric acid was then removed under a vacuum of 15 mm, the residue dissolved in 30 cc of water and precipitated by the addition of 2.4 cc of concentrated aqueous ammonia. The precipitate was filtered off and dried. It consists of 14-hydroxydihydromorphinone. It is soluble in ethanol.

The 14-hydroxydihydromorphinone was suspended in 200 cc of pure ethyl alcohol, half its weight of sodium bicarbonate and half its weight of allyl bromide added and the resulting mixture was refluxed at about 75°C for 48 hours. The solution was cooled, e.g., to 10°C and filtered and the alcohol removed under a vacuum of 30 mm. The residue was dissolved in chloroform and filtered. The chloroform was removed under a vacuum of 30 mm and the residue was crystallized from ethylacetate. The crystallized product, N-allyl-1,4-hydroxydihydromorphinone, has a melting point of 184°C, is soluble in chloroform and insoluble in petroleum ether. The yield amounts to 20% based on the weight of the reacted 14-hydroxydihydromorphinone.

References

- Merck Index 6208
- Kleeman & Engel p. 618
- PDR pp. 858, 1932
- OCDS Vol. 1 p. 289 (1977) & 2, 318, 323 (1980)
- DOT 8 (8) 295 (1972)
- I.N. p. 655
- REM p. 1106
- Lewenstein, M.J. and Fishman, J.; U.S. Patent 3,254,088; May 31, 1966

NANDROLONE DECANOATE

Therapeutic Function: Anabolic

Chemical Name: 17 β -[(1-oxodecyl)oxy] estr-4-en-3-one

Common Name: 19-nortestosterone decanoate; norandrostenolone decanoate

Structural Formula:

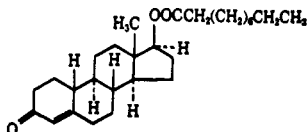

Chemical Abstracts Registry No.: 360-70-3; 434-22-0 (Base)

Trade Name	Manufacturer	Country	Year Introduced
Deca-Durabolin	Organon	U.S.	1962
Deca-Hybolin	Hyrex	U.S.	1979
Deca-Noralone	Taro	Israel	—
Fortabolin	Deva	Turkey	—
Iebolan	I.E. Kimya Evi	Turkey	—
Kabolin	Legere	U.S.	—
Methybol	Mepha	Switz.	—
Nordecon	Ibsa	Switz.	—
Sterobolin	Neofarma	Finland	—
Turinabol-Depot	Jenapharm	E. Germany	—

Raw Materials

19-Nortestosterone
Decanoic acid chloride

Manufacturing Process

1 gram of 19-nortestosterone is dissolved in 3 ml of dry pyridine, after which the resulting solution is cooled to -20°C . A solution of 1.0 gram of decanoic acid chloride in 3 ml of dry benzene is added to the cooled solution. The mixture is maintained at -15°C for 16 hours and then poured into ice water. The aqueous liquid is extracted with benzene, the benzene solution is washed with respectively 1 N sodium hydroxide solution, 2 N hydrochloric acid and with water until neutral reaction.

Then the solution is dried on sodium sulfate, filtered, and evaporated to dryness. The residue, 1.63 grams is dissolved in hexane, this solution is filtered over 30 grams of neutral aluminum oxide, and evaporated to dryness. On paper chromatographic investigation it turned out that the obtained 19-nortestosterone 17-decanoate which at room temperature is an oil consists of a single compound, according to U.S. Patent 2,998,423.

References

Merck Index 6212
Kleeman & Engel p. 620
PDR pp. 1033, 1286
OCDS Vol. 1 p. 171 (1977)
I.N. p. 655
REM p. 999

Donia, R.A. and Ott, A.C.; U.S. Patent 2,798,879; July 9, 1957; assigned to The Upjohn Company

De Wit, E.D. and Overbeek, G.A.; U.S. Patent 2,998,423; August 29, 1961; assigned to Organon Inc.

NANDROLONE PHENPROPIONATE

Therapeutic Function: Anabolic

Chemical Name: 17 β -hydroxyestr-4-en-3-one 3-phenylpropionate

Common Name: 19-nortestosterone β -phenylpropionate

Structural Formula: See Nandrolone Decanoate for the steroid structure

Chemical Abstracts Registry No.: 62-90-8; 434-22-0 (Base)

Trade Name	Manufacturer	Country	Year Introduced
Durabolin	Organon	U.S.	1959
Nandrolin	Tutag	U.S.	1979
Activin	Aristegui	Spain	—
Anticatabolin	Falorni	Italy	—
Hepa-Obaton	Nourypharma	W. Germany	—
Hybolin Improved	Hyrex	U.S.	—
Norabol	Pharmacia	Sweden	—
Noralone	Taro	Israel	—
Norandrol	Panther-Osfa	Italy	—
Norandros	Castillon	Spain	—
Norbalin	Bieffe	Italy	—
Noromon	Ibsa	Switz.	—
Norstenol	Ravizza	Italy	—
Sintabolin	A.F.I.	Italy	—
Strabolene	Isola-Ibi	Italy	—
Superanbolon	Spofa	Czechoslovakia	—
Superbolin	Labif	Italy	—
Turinabol	Jenapharm	E. Germany	—

Raw Materials

19-Nortestosterone
 β -Phenylpropionyl chloride

Manufacturing Process

An ice-cold solution of 1.5 grams of 19-nortestosterone and 1.5 ml of dry pyridine in 10 ml of dry benzene is prepared and a solution of 1.5 ml of β -phenylpropionyl chloride in 5 ml of dry benzene is added dropwise over a period of about 2 minutes with stirring. The resulting mixture is allowed to stand overnight under an atmosphere of nitrogen and then washed successively with cold 5% aqueous hydrochloric acid solution, cold 2.5% aqueous sodium hydroxide solution, and water. After drying over anhydrous sodium sulfate, the solvent is evaporated to give an almost colorless oil. Recrystallization from methanol gives white crystals of 19-nortestosterone 17- β -phenylpropionate, MP 91° to 92.5°C.

References

Merck Index 6214

Kleeman & Engel p. 621

PDR p. 1286

OCDS Vol. 1 p. 171 (1977)

I.N. p. 656

REM p. 999

Donia, R.A. and Ott, A.C.; U.S. Patent 2,868,809; January 13, 1959; assigned to The Upjohn Company

NAPHAZOLINE

Therapeutic Function: Nasal decongestant

Chemical Name: 4,5-dihydro-2-(1-naphthalenylmethyl)-1H-imidazole

Common Name: 2-(1-naphthylmethyl)imidazoline

Structural Formula:

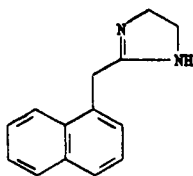

Chemical Abstracts Registry No.: 835-31-4; 550-99-2 (Hydrochloride)

Trade Name	Manufacturer	Country	Year Introduced
Privine	Ciba	U.S.	1942
Albalon	Allergan	U.S.	1970
Naphcon Forte	Alcon	U.S.	1975
Clera	Person Covey	U.S.	1978
Vasoclear	Smith Miller & Patch	U.S.	1979
Opcon	Muro	U.S.	1981
Nafazair	Pharmafair	U.S.	1983
Actinophyl	Gregoire	France	—
Bactio-Rhin	Byk Liprandi	Argentina	—
Biogan	Recip	Sweden	—
Coldan	Sigmapharm	Austria	—
Degest-2	Barnes-Hind	U.S.	—
Gotinal	Promeco	Argentina	—
Imidazyl	Tubi Lux Pharma	Italy	—
Imidin	Ysat Wernigerode	E. Germany	—
Imizol	Farmigea	Italy	—
Murine	Abbott	U.K.	—
Naftazolina	Bruschettini	Italy	—
Nafine	Ibsa	Switz.	—
Nasal Yer	Yer	Spain	—
Nomaze	Fisons	U.K.	—
Ocunasal	Sam-on	Israel	—
Pivanol	Tek	Turkey	—
Privin	Ciba	W. Germany	—
Proculin	Ankerwerk	E. Germany	—
Ran	Corvi	Italy	—

Trade Name	Manufacturer	Country	Year Introduced
Rhinex S	Ysat Wernigerode	E. Germany	—
Rhinon	Petrasch	Austria	—
Rimidol	Leo	Sweden	—
Rinofug	Chimimport Export	Rumania	—
Vasoconstrictor	Pensa	Spain	—
Vistalbalon	Pharm-Allergan	W. Germany	—

Raw Materials

Naphthyl-(1)-acetonitrile	Methanol
Ethanol	Ethylene diamine

Manufacturing Process

2.7 parts of naphthyl-(1)-acetiminoethylether hydrochloride of the formula

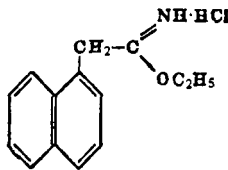

(produced from naphthyl-(1)-acetonitrile and methanol) are dissolved in 12 parts of absolute alcohol. 1 part of ethylenediamine is then added and the whole is heated to gentle boiling while passing nitrogen through it and simultaneously stirring until ammonia escapes no longer. The alcohol is then distilled and the residue mixed with 40 parts of benzene and 1.8 parts of caustic potash. Stirring is continued for some time whereby the imidazoline base is dissolved in benzene. The benzene residue is recrystallized several times from toluene. Reaction with HCl gives the hydrochloride.

References

- Merck Index 6218
- Kleeman & Engel p. 622
- PDR pp. 728, 809, 1549
- OCDS Vol. 1 p. 241 (1977)
- I.N. p. 657
- REM p. 888
- Sonn, A.; U.S. Patent 2,161,938; June 13, 1939; assigned to the Society of Chemical Industry in Basle, Switzerland

NAPROXEN

Therapeutic Function: Antiinflammatory

Chemical Name: (+)-6-methoxy- α -methyl-2-naphthaleneacetic acid

Common Name: d-2-(6-methoxy-2-naphthyl)propionic acid

Structural Formula:

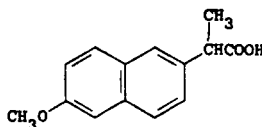

Chemical Abstracts Registry No.: 22204-53-1

Trade Name	Manufacturer	Country	Year Introduced
Naprosyn	Syntex	U.K.	1973
Naprosyne	Cassenne	France	1975
Proxen	Gruenenthal	W. Germany	1975
Naprosyn	Recordati	Italy	1975
Naprosyn	Syntex	Switz.	1975
Naprosyn	Syntex	U.S.	1976
Naixan	Tanabe	Japan	1978
Congex	Nemi	Argentina	—
Floginax	Farmochimica	Italy	—
Gibixen	Gibipharm	Italy	—
Laser	Tosi-Novara	Italy	—
Madaprox	Madariaga	Spain	—
Naprium	Radium farma	Italy	—
Naprius	Magis	Italy	—
Naprox	Andromaco	Argentina	—
Naxyn	Teva	Israel	—
Novonaprox	Novopharm	Canada	—
Numide	Hosbon	Spain	—
Prexan	Lafare	Italy	—
Veradol	Schering	W. Germany	—
Xenar	Alfar Farma Clutici	Italy	—

Raw Materials

2-Bromo-6-methoxynaphthalene	Magnesium
Ethyl-2-bromopropionate	Cadmium chloride
Sodium hydroxide	

Manufacturing Process

According to U.S. Patent 3,658,858, a solution of 24 grams of 2-bromo-6-methoxynaphthalene in 300 ml of tetrahydrofuran is slowly added to 2.5 grams of magnesium turnings and 100 ml of tetrahydrofuran at reflux temperature. After the addition is complete, 20 grams of cadmium chloride is added, and the resultant mixture is refluxed for 10 minutes to yield a solution of di-(6-methoxy-2-naphthyl)cadmium (which can be separated by conventional chromatography, although separation is unnecessary).

A solution of 18 grams of ethyl 2-bromopropionate in 20 ml of tetrahydrofuran is then added to the cooled reaction mixture. After 24 hours at 20°C, the product is hydrolyzed by adding 200 ml of 5 weight percent methanolic sodium hydroxide followed by heating to reflux for 1 hour. The reaction mixture is then diluted with excess 1 N sulfuric acid and extracted with ether. The ether phase is separated, evaporated to dryness and the residue is recrystallized from acetone-hexane to yield 2-(6-methoxy-2-naphthyl)propionic acid.

References

- Merck Index 6269
 Kleeman & Engel p. 623
 PDR p. 1801
 OCDS Vol. 1 p. 86 (1977)
 DOT 9 (9) 384 (1973) & 10 (3) 95 (1974)
 I.N. p. 658
 REM p. 1119
 Alvarez, F.S.; U.S. Patent 3,637,767; January 25, 1972; assigned to Syntex Corp., Panama
 Harrison, I.T.; U.S. Patent 3,658,858; April 25, 1972; assigned to Syntex Corp., Panama
 Alvarez, F.S.; U.S. Patent 3,663,584; May 16, 1972; assigned to Syntex Corp., Panama

Alvarez, F.S.; U.S. Patent 3,694,476; September 26, 1972; assigned to Syntex Corp., Panama Halpern, O.; U.S. Patent 3,720,708; March 13, 1973

NATAMYCIN

Therapeutic Function: Antibacterial (ophthalmic)

Chemical Name: See Structural Formula

Common Name: Pimaricin

Structural Formula:

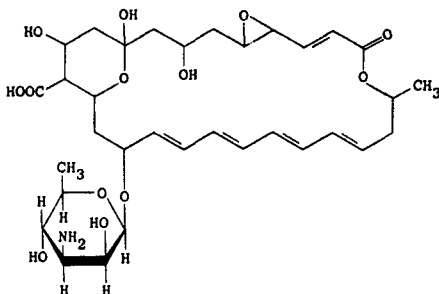

Chemical Abstracts Registry No.: 7681-93-8

Trade Name	Manufacturer	Country	Year Introduced
Pimafucine	Beytout	France	1964
Pimafucin	Brocades	U.K.	1965
Pimafucort	Brocades	Italy	1966
Pimafucin	Basotherm	W. Germany	1967
Natacyn	Alcon	U.S.	1979
Myprozine	Lederle	U.S.	—

Raw Materials

Bacterium *Streptomyces gilvosporeus*
Starch
Corn steep liquor

Manufacturing Process

The Fermentation Process: The process by which this antifungal substance is produced is an aerobic fermentation of an aqueous nutrient medium inoculated with a pimaricin-producing strain of *Streptomyces gilvosporeus*. The nutrient medium contains an assimilable source of carbon such as starch, molasses, or glycerol, an assimilable source of nitrogen such as corn steep liquor and inorganic cations such as potassium, sodium or calcium, and anions such as sulfate, phosphate or chloride. Trace elements such as boron, molybdenum or copper are supplied as needed in the form of impurities by the other constituents of the medium.

In more detail the nutrient medium used may contain sources of carbon such as starch, hydrolyzed starch, sugars such as lactose, maltose, dextrose, sucrose, or sugar sources such as molasses; alcohols, such as glycerol and mannitol; organic acids, such as citric acid and acetic acid; and various natural products which may contain other nutrient materials in addition to carbonaceous substances.

Nitrogen sources include proteins, such as casein, zein, lactalbumin; protein hydrolyzates such as proteoses, peptones, peptides, and commercially available materials, such as N-Z Amine which is understood to be a casein hydrolyzate; also corn steep liquor, soybean meal, gluten, cottonseed meal, fish meal, meat extracts, stick liquor, liver cake, yeast extracts and distillers' solubles; amino acids, urea, ammonium and nitrate salts. Such inorganic elements as sodium, potassium, calcium and magnesium; and chlorides, sulfates, phosphates and combinations of these anions and cations in the form of mineral salts may be advantageously used in the fermentation.

The so-called trace elements, such as boron, cobalt, iron, copper, zinc, manganese, chromium, molybdenum and still others may also be used to advantage. Generally, these trace elements occur in sufficient quantities in the carbonaceous and nitrogenous constituents of the medium, particularly if derived from natural sources, or in the tap water, and the addition of further quantities of these trace elements may consequently be unnecessary.

The fermentation liquor is aerated in the customary manner by forcing sterile air through the fermenting mixture usually at the rate of about 1 volume of air per volume of fermentation medium per minute. To minimize contamination with foreign microorganisms, the fermentation vessels should be closed and a pressure of 2 to 15 pounds above atmospheric pressure maintained in the vessel. In addition to the agitation provided by aeration, mechanical agitation is generally desirable. Antifoaming agents, such as 1% octadecanol in lard oil, may be added from time to time as required to prevent excessive foaming. Fermentation is conducted at a temperature preferably on the order of 26°C to 30°C but may be as low as 17°C or as high as 42°C.

The time required for maximum production of the antifungal substance will vary considerably depending upon other conditions of the fermentation. Generally, about 48 hours is required before appreciable quantities of the antifungal substance are detected in the medium. The production of the antifungal substance increases with time, and the fermentation may run as long as 120 hours. The hydrogen ion conditions normally vary from about pH 6 to pH 8.0, although deviations from these values are permissible, according to British Patent 846,933. The reader is referred to the patents cited for details of pimarinic purification.

References

Merck Index 6278

Kleeman & Engel p. 624

DOT 14 (6) 255 (1978)

I.N. p. 659

REM p. 1230

Koninklijke Nederlandsche Gist- & Spiritusfabriek N.V., Netherlands; British Patent 844,289; August 10, 1960

American Cyanamid Company; British Patent 846,933; September 7, 1960

NEFOPAM HYDROCHLORIDE

Therapeutic Function: Muscle relaxant; antidepressant

Chemical Name: 3,4,5,6-tetrahydro-5-methyl-1-phenyl-1H-2,5-benzoxazine hydrochloride

Common Name: —

Structural Formula:

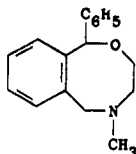

(base)

Chemical Abstracts Registry No.: 13669-70-0 (Base)

Trade Name	Manufacturer	Country	Year Introduced
Ajan	Kettelnack	W. Germany	1976
Acupan	Carnegie	U.K.	1978
Acupan	Riker	France	1981
Lenipan	Chiesi	Italy	1981
Oxadol	I.S.I.	Italy	1982
Acupan	Boehr. Mann.	Italy	1983

Raw Materials

2-Benzoylbenzoic acid	Thionyl chloride
2-Methylaminoethanol	Lithium aluminum hydride
p-Toluenesulfonic acid	Hydrogen chloride

Manufacturing Process

The starting material is prepared by reacting 2-benzoylbenzoic acid with thionyl chloride and then with 2-methylaminoethanol. 20.0 grams (0.07 mol) of N-(2-hydroxyethyl)-N-methyl-p-benzoylbenzamide is suspended in 100 ml tetrahydrofuran and then slowly added in small portions to a solution of 5.5 grams (0.14 mol) of lithium aluminum hydride in 150 ml tetrahydrofuran with cooling and stirring. The mixture is then refluxed for 18 hours, cooled and then to it is successively added 5.5 ml water, 5.5 ml of 3.75 N sodium hydroxide and 16 ml water. After removal of precipitated salts by filtration, the solution remaining is concentrated under reduced pressure and the residue dried to yield 19.5 grams of crude product. Yield after conversion to the hydrochloride salt and recrystallization is 17.0 grams (89%), MP 128° to 133°C.

5-methyl-1-phenyl-1,3,4,6-tetrahydro-5H-benz[f]-2,5-oxazocine is prepared as follows. 3.0 grams (0.011 mol) of 2-([N-(2-hydroxyethyl)-N-methyl]amino)methylbenzhydrol, prepared as described above, 3.0 grams p-toluenesulfonic acid and 15 ml benzene are heated together with stirring until all the benzene is distilled off. The residual oil is heated to 105°C and held at this temperature for 1 hour, then cooled and dissolved in 30 ml water. This aqueous solution is then basified to pH 10.0 with 12 N sodium hydroxide, extracted with ether, and the extracts washed with water, dried over anhydrous sodium sulfate and the solvent removed under reduced pressure. The 2.26 grams (81%) oil remaining is converted to the hydrochloride salt, MP 238° to 242°C.

References

- Merck Index 6287
- Kleeman & Engel p. 626
- OCDS Vol. 2 p. 447 (1980)
- DOT 12 (7) 275 (1976)
- I.N. p. 661
- Baltes, B.J.; U.S. Patent 3,487,153; December 30, 1969; assigned to Rexall Drug and Chemical Company

NEOMYCIN

Therapeutic Function: Antibacterial

Chemical Name: O-2,6-diamino-2,6-dideoxy- α -D-glucopyranosyl-(1 \rightarrow 3)-O- β -D-ribofuranosyl-(1 \rightarrow 5)-O-[2,6-diamino-2,6-dideoxy- α -D-glucopyranosyl-(1 \rightarrow 4)]-2-deoxy-D-streptomine

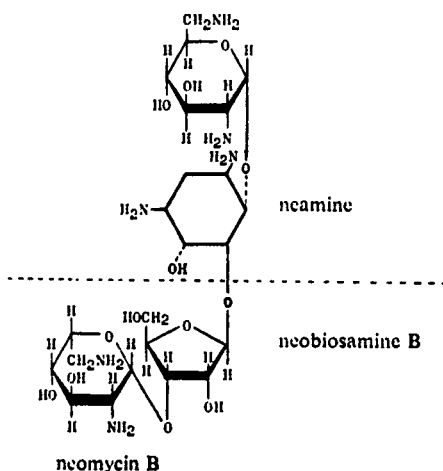
Common Name: Framycetin**Structural Formula:****Chemical Abstracts Registry No.:** 1404-04-2; 4146-30-9 (Sulfate)

Trade Name	Manufacturer	Country	Year Introduced
Myciguent	Upjohn	U.S.	1951
Otobiotic	Schering	U.S.	1954
Mycifradin	Upjohn	U.S.	1957
Neobiotic	Pfizer	U.S.	1958
Apokalin	A.L.	Norway	—
Biofradin	Uriach	Spain	—
Bykomycin	Byk-Gulden	W. Germany	—
Cortisporin	Burroughs-Wellcome	U.S.	—
Dexmy	Takeda	Japan	—
Endomixin	Lusofarmaco	Italy	—
Fradio	Nippon Kayaku	Japan	—
Fradyl	Christiaens	Belgium	—
Ivax	Boots	U.K.	—
Larmicin	Larma	Spain	—
Myacyne	Werner Schnur	W. Germany	—
Mytrex	Savage	U.S.	—
Neobretin	Norbrook	U.K.	—
Neodecadron	MSD	U.S.	—
Neointestin	Hosbon	Spain	—
Neolate	Therafarm	U.K.	—
Neomicina Roger	Roger	Spain	—
Neomin	Glaxo	U.K.	—
Neo-Polycin	Merrell Dow	U.S.	—
Neopt	Sigma	Australia	—
Neosporin	Burroughs-Wellcome	U.S.	—
Neosulf	Protea	Australia	—
Neo-Synalar	Syntex	U.S.	—
Octicair	Pharmafair	U.S.	—
Otocort	Lemmon	U.S.	—
Siquent	Sigma	Australia	—
Tampovagan	Norgine	U.K.	—
Topisporin	Pharmafair	U.S.	—
Tri-Thalmic	Schein	U.S.	—

Raw Materials

Bacterium *Streptomyces fradiae*
Nutrient medium

Manufacturing Process

Neomycin has been produced by growing the organism, *Streptomyces* No. 3535, in a suitable nutrient medium under appropriate stationary or submerged aerobic (viz shaken) conditions, and then isolating and purifying the substance, e.g., by procedure of the sort described in the figure including various steps of adsorption, recovery by elution, separation from impurities, and precipitation.

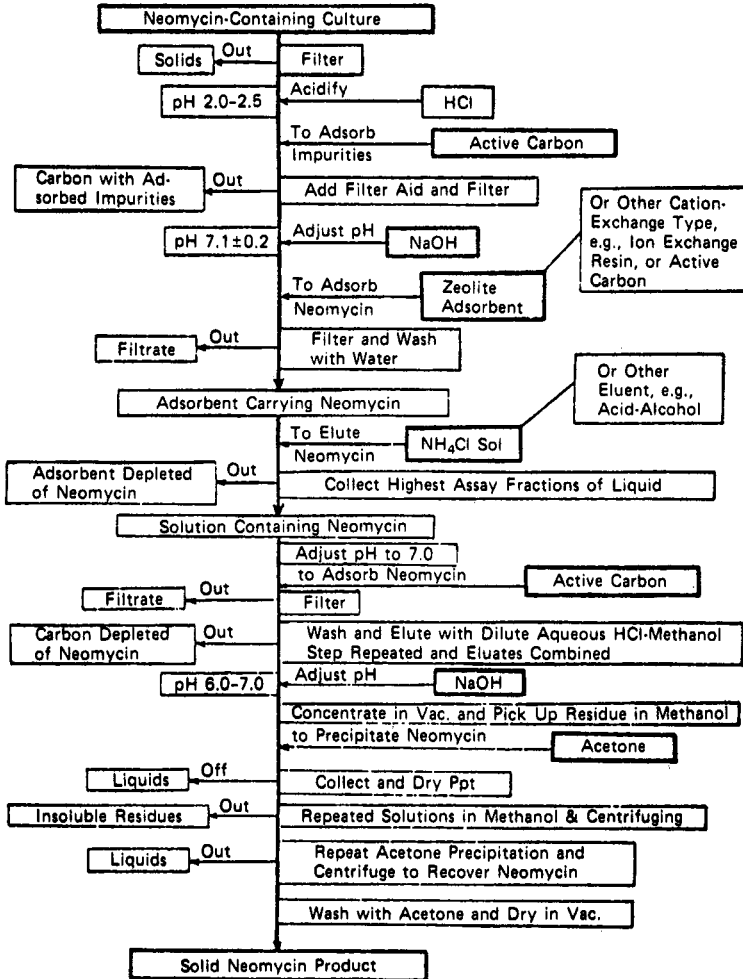

Neomycin is usually used as the sulfate.

References

Merck Index 6300

Kleeman & Engel 626

PDR pp. 673, 738, 756, 888, 993, 1034, 1206, 1232, 1429, 1569, 1604, 1800

I.N. p. 663

REM p. 1181

Waksman, S.A. and Lechevalier, H.A.; U.S. Patent 2,799,620; July 16, 1957; assigned to

Rutgers Research and Educational Foundation

Jackson, W.G.; U.S. Patent 2,848,365; August 19, 1958; assigned to The Upjohn Company

Miller, T.W.; U.S. Patent 3,005,815; October 24, 1961; assigned to Merck & Co., Inc.

Moses, W.; U.S. Patent 3,022,228; February 20, 1962; assigned to S.B. Penick & Company

Haak, W.J.; U.S. Patent 3,108,996; October 29, 1963; assigned to The Upjohn Company

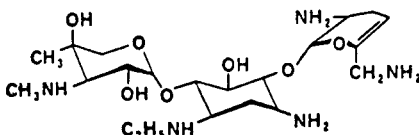
NETILMICIN**Therapeutic Function:** Antibiotic**Chemical Name:** 1-N-Ethylisomicin**Common Name:** —**Structural Formula:****Chemical Abstracts Registry No.:** 56391-56-1

Trade Name	Manufacturer	Country	Year Introduced
Netromycine	Schering	Switz.	1980
Certomycin	Byk-Essex	W. Germany	1980
Netillin	Kirby-Warrick	U.K.	1981
Netromicine	Unicet	France	1981
Nettacin	Essex	Italy	1982
Netromycin	Schering	U.S.	1983

Raw Materials

Sisomicin	Sulfuric acid
Acetaldehyde	Sodium cyanoborohydride

Manufacturing Process

To a solution of 5 g of sisomicin in 250 ml of water add 1 N sulfuric acid until the pH of the solution is adjusted to about 5. To the solution of sisomicin sulfuric acid addition salt thereby formed, add 2 ml of acetaldehyde, stir for 10 minutes, then add 0.85 g of sodium cyanoborohydride. Continue stirring at room temperature for 15 minutes, then concentrate solution in vacuo to a volume of about 100 ml, treat the solution with a basic ion exchange resin [e.g., Amberlite IRA 401S (OH⁻)], then lyophilize to a residue comprising 1-N-ethyl-sisomicin.

Purify by chromatographing on 200 g of silica gel, eluting with lower phase of a chloroform-methanol-7% aqueous ammonium hydroxide (2:1:1) system. Combine the eluates as deter-

mined by thin layer chromatography and concentrate the combined eluates of the major component in vacuo to a residue comprising 1-N-ethylisomicin (yield 1.25 g). Further purify by again chromatographing on 100 g of silica gel eluting with a chloroform-methanol-3.5% ammonium hydroxide (1:2:1) system. Pass the combined, like eluates (as determined by thin layer chromatography) through a column of basic ion exchange resin and lyophilize the eluate to obtain 1-N-ethylisomicin (yield 0.54 g).

There is also a fermentation route to netilmicin as noted by Kleeman & Engel.

References

- Merck Index 6322
 DFU 3 (7) 527 (1978)
 Kleeman & Engel p. 627
 PDR p. 1635
 DOT 17 (8) 324 (1981)
 I.N. p. 666
 REM p. 1183
 Wright, J.J., Daniels, P.J.L., Mallams, A.K. and Nagabhushan, T.L.; U.S. Patent 4,002,742; January 11, 1977; assigned to Schering Corp.

NIALAMIDE

Therapeutic Function: Antidepressant

Chemical Name: 4-Pyridinecarboxylic acid 2-[3-oxo-3-[(phenylmethyl)-amino] propyl] hydrazide

Common Name: —

Structural Formula:

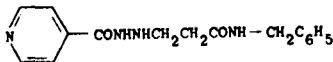

Chemical Abstracts Registry No.: 51-12-7

Trade Name	Manufacturer	Country	Year Introduced
Niamid	Pfizer	U.S.	1959
Niamide	Pfizer	France	1960
Niamid	Taito-Pfizer	Japan	—
Nuredal	Egyt	Hungary	—
SurgeX	Firma	Italy	—

Raw Materials

Isoniazid
 Methyl acrylate
 Benzylamine

Manufacturing Process

Methyl acrylate, 28.0 g (0.4 mol) was added dropwise during one hour to a solution containing 54.8 g (0.4 mol) of isonicotinic acid hydrazide (isoniazid) and 10 ml of glacial acetic acid in 400 ml of tertiary butyl alcohol. The resulting solution then was heated for 18 hours on a steam bath. Concentration of the reaction mixture to 100 ml yielded 13.0 g of unreacted isonicotinic acid hydrazide. The filtrate was concentrated to a thick syrup which was triturated

with anhydrous ether and recrystallized from isopropyl alcohol; MP 87°C to 88.5°C. Elemental analysis of the product gave 1-isonicotinyl-2-(β -carbomethoxyethyl)hydrazine.

A slurry of 7.5 g (0.034 mol) of 1-isonicotinyl-2-(carbomethoxyethyl)-hydrazine and 5 ml of benzylamine is heated with stirring at 130°C for three hours. The cooled mass is then recrystallized from ethyl acetate to yield white needles melting at 151.1°C to 152.1°C.

References

Merck Index 6330

Kleeman & Engel p. 628

OCDs Vol. 1 p. 254 (1977)

I.N. p. 667

Bloom, B.M. and Carnahan, R.E.; U.S. Patent 2,894,972; July 14, 1959; assigned to Chas. Pfizer & Co., Inc.

NIAPRAZINE

Therapeutic Function: Antihistamine

Chemical Name: 1-(4-Fluorophenyl)-4-[3-(3-pyridoyl)amino] butyl-piperazine

Common Name: —

Structural Formula:

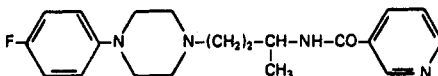

Chemical Abstracts Registry No.: 27367-90-4

Trade Name	Manufacturer	Country	Year Introduced
Nopron	Carrion	France	1976
Norpron	Riom	Italy	—

Raw Materials

1-(4-Fluorophenyl)piperazine dihydrochloride
 Trioxymethylene
 Acetone
 Hydroxylamine hydrochloride
 Lithium aluminum hydride
 Nicotinic acid chloride

Manufacturing Process

1st Stage: 10 ml of concentrated (10N) hydrochloric acid and 240 ml of acetone were added to a solution of 217.5 g (1 mol) of 1-(4-fluorophenyl)piperazine dihydrochloride in 400 ml of 96% ethanol. 50 g of powdered trioxymethylene were then added and the mixture was then slowly heated to reflux, which was maintained for 1 hour. A further 60 g of trioxymethylene were then added and heating to reflux was continued for a further 6 hours.

The mixture was then cooled, the precipitate formed was filtered off, washed with acetone and recrystallized from 96% ethanol.

The base was liberated from its salt by taking up the product in an aqueous solution of

sodium bicarbonate. The precipitate of the base thus obtained was recrystallized from petroleum ether to give 160 g of the desired product; melting point 46°C; yield 64%.

2nd Stage: 45.5 g (0.65 mol) of hydroxylamine hydrochloride were added to a solution of 128 g (0.5 mol) of the amino-ketone obtained in the preceding stage in 100 ml of ethanol and 40 ml of water. The mixture was allowed to react for 15 minutes at room temperature and was then heated to reflux for ½ hour. A part of the solvent was then distilled off and the product was then allowed to crystallize on cooling. After recrystallization from 96% ethanol, 117 g of the desired product were obtained; melting point 170°C; yield 77%.

3rd Stage: 93 g (0.35 mol) of the oxime obtained in the preceding stage, in the form of the base, were added in portions to a suspension of 17 g (0.45 mol) of lithium aluminum hydride in 400 ml of anhydrous ether. The mixture was then heated to reflux for 15 hours.

10 ml of ethyl acetate and then 50 ml of dilute caustic soda were added slowly with the usual precautions to the mixture. The organic phase was separated, dried over anhydrous Na₂SO₄, the solvent was distilled off and the residue obtained was distilled under reduced pressure to give 51 g of a thick oil; boiling point (2 mm Hg), 142°C to 143°C; yield 58%.

4th Stage: 10 ml of triethylamine were added in a solution of 25.2 g (0.1 mol) of the amine obtained in the preceding stage in 100 ml of anhydrous chloroform and the mixture was cooled to 2°C to 3°C. While maintaining this temperature, 17 g (0.12 mol) of nicotinic acid chloride were added with vigorous agitation.

After evaporation of the solvent, the residue was washed with water, the product taking the form of a mass. After recrystallization from ethyl acetate, a constant melting point of 131°C was obtained.

References

Merck Index 6331

Kleeman & Engel p. 628

DOT 13 (1) 29 (1977)

I.N. p. 667

Mauvernay, R.Y., Busch, N., Simond, J. and Moleyre, J.; U.S. Patent 3,712,893; January 23, 1973; assigned to SA Centre Europeen De Recherches Mauvernay, CERM

NICARDIPINE

Therapeutic Function: Cerebral vasodilator

Chemical Name: 2,6-Dimethyl-4-(3-nitrophenyl)-3-methoxycarbonyl-1,4-dihydropyridine-5-carboxylic acid-2-(N-benzyl-N-methylamino)ethyl ester hydrochloride

Common Name: —

Structural Formula:

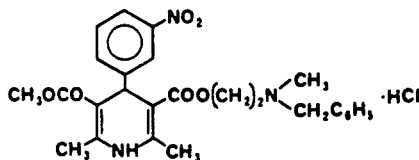

Chemical Abstracts Registry No.: 55985-32-5

Trade Name	Manufacturer	Country	Year Introduced
Nicodel	Mitsui	Japan	1981
Perdipin	Yamanouchi	Japan	1981

Raw Materials

Acetoacetic acid N-benzyl-N-methylaminoethyl ester
 β -Aminocrotonic acid methyl ester
 m-Nitrobenzaldehyde

Manufacturing Process

A mixture of 4.98 g of acetoacetic acid N-benzyl-N-methylaminoethyl ester, 2.3 g of β -aminocrotonic acid methyl ester, and 3 g of m-nitrobenzaldehyde was stirred for 6 hours at 100°C in an oil bath. The reaction mixture was subjected to a silica gel column chromatography (diameter 4 cm and height 25 cm) and then eluted with a 20:1 mixture of chloroform and acetone. The effluent containing the subject product was concentrated and checked by thin layer chromatography. The powdery product thus obtained was dissolved in acetone and after adjusting the solution with an ethanol solution saturated with hydrogen chloride to pH 1-2, the solution was concentrated to provide 2 g of 2,6-dimethyl-4-(3'-nitrophenyl)-1,4-dihydropyridine-3,5-dicarboxylic acid 3-methylester-5- β -(N-benzyl-N-methylamino)ethyl ester hydrochloride. The product thus obtained was then crystallized from an acetone mixture, melting point 136°C to 140°C (decomposed).

References

Merck Index 6334

DFU 2 (6) 409 (1977) (as Yc-93) & 4 (12) 911 (1979)

OCDS Vol. 3 p. 150 (1984)

DOT 18 (7) 325 (1982)

I.N. p. 668

Murakami, M., Takahashi, K., Iwanami, M., Fujimoto, M., Shibanuma, T., Kawai, R. and Takenaka, T.: U.S. Patent 3,985,758; October 12, 1976; assigned to Yamanouchi Pharmaceutical Co., Ltd.

NICERGOLINE

Therapeutic Function: Peripheral vasodilator

Chemical Name: 10-methoxy-1,6-dimethylergoline-8 β -methanol 5-bromonicotinate (ester)

Common Name: Nicotergoline; 1-methyllumilysergol-8-(5-bromonicotinate) 10-methyl ether

Structural Formula:

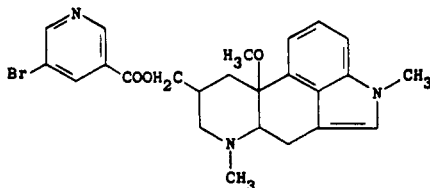

Chemical Abstracts Registry No.: 27848-84-6

Trade Name	Manufacturer	Country	Year Introduced
Sermion	Farmitalia	Italy	1974
Sermion	Specia	France	1975
Nicergolyn	Farnex	Italy	—
Nicotergoline	Carlo Erba	Italy	—
Varson	Almirall	Spain	—
Vasospan	Exa	Argentina	—

Raw Materials

1-Methyl-lumilysergic acid	Methanol
Lithium aluminum hydride	Hydrogen chloride
5-Bromonicotinyl chloride	

Manufacturing Process

Preparation of 1-Methyl Lumilysergic Acid 8-Methyl Ester-10-Methyl Ether: Into a suspension of 10 grams of 1-methyl-lumilysergic acid in 600 cc of absolute methanol a stream of anhydrous hydrogen chloride is bubbled for 1.5 hours with strong cooling. The stream of hydrogen chloride is stopped and the mixture is allowed to stand for 30 minutes at 0°C, and is evaporated in vacuo to dryness. The residue is taken up with ice-cooled water made alkaline with concentrated ammonia and extracted with chloroform. The combined chloroform extracts are washed first with a 5% aqueous solution of sodium bicarbonate, then with water, and are thereafter dried over anhydrous sodium sulfate and finally evaporated in vacuo to dryness.

Preparation of 1-Methyl Lumilysergol-10-Methyl Ether: To a boiling suspension of 2 grams of lithium aluminum hydride in 50 cc of anhydrous tetrahydrofuran, a solution of 1 gram of 1-methyl lumilysergic acid-8-methyl ester-10-methyl ether in 20 cc of anhydrous tetrahydrofuran is added dropwise and the resulting solution is refluxed for a further 2 hours. After cooling the resulting solution, aqueous tetrahydrofuran is added to destroy the excess reducing agent and the solution is filtered. Tetrahydrofuran is distilled off and the residue is recrystallized from acetone petroleum ether.

Preparation of Nicergoline: To a solution of 1-methyl lumilysergol-10-methyl ether in pyridine, 5-bromonicotinyl chloride is used as an acylating agent at room temperature. The mixture is stirred for 1 hour. Water and methanol are added and the resulting mixture is stirred for 1 hour, extracted with chloroform, and washed in sequence with 1% aqueous caustic soda, 5% aqueous sodium bicarbonate solution, and water. The resulting solution is dried over anhydrous sodium sulfate and the solvent is distilled off. By recrystallization of the residue from acetone petroleum ether, nicergoline is obtained, melting at 136° to 138°C.

References

- Merck Index 6335
- Kleeman & Engel p. 629
- OCDs Vol. 2 p. 478 (1980)
- DOT 10 (12) 342 (1974)
- I.N. p. 668
- Bernardi, L., Bosisio, G. and Goffredo, O.; U.S. Patent 3,228,943; January 11, 1966; assigned to Società Farmaceutici Italia, Italy

NICERITROL

Therapeutic Function: Cholesterol reducing agent

Chemical Name: 3-pyridinecarboxylic acid 2,2-bis[[(3-pyridinylcarbonyl)oxy] methyl]-1,3-propanediyl ester

Common Name: Pentaerythritol tetranicotinate

Structural Formula:

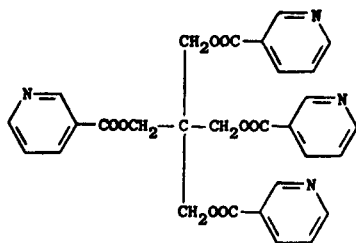

Chemical Abstracts Registry No.: 5868-05-3

Trade Name	Manufacturer	Country	Year Introduced
Cardiolipol	Gremy/Longuet	France	1972
Percyt	Sanwa	Japan	1979
Percyt	Tosi	Italy	1980
Percyt	Astra	Sweden	—

Raw Materials

Nicotinic acid chloride
Pentaerythritol
Pyridine

Manufacturing Process

160 grams of nicotinic acid chloride is charged into and made to react with 35 grams of pentaerythritol dissolved in 600 grams of dried, stabilized chloroform and 100 grams of carefully dried pyridine. Pyridinehydrochloride, pyridine and the excess of nicotinic acid chloride are removed through repeated extraction with water at a pH of approximately 3. Pentaerythritol nicotinate remains in the chloroform phase and is extracted by forming the hydrochloric acid salt of the ester using 1,000 ml of aqueous HCl at a pH of 1. The strongly acid extract is thereafter extracted several times with toluene. The acid extract is allowed to stand at room temperature for several hours in the presence of active carbon and the substance known as Versenate, i.e., the disodium salt of ethylene diamine tetraacetic acid; it is then filtered and pentaerythritol nicotinate is precipitated as a white, amorphous substance using 25% w/v aqueous ammonia, while stirring. Recrystallization of the product from ethyl alcohol gives flaky crystals, according to British Patent 1,022,880.

References

Merck Index 6336
Kleeman & Engel p. 630
I.N. p. 668
AB Bofors, Sweden; British Patent 1,022,880; March 16, 1966
AB Bofors, Sweden; British Patent 1,053,689; January 4, 1967

NICLOSAMIDE

Therapeutic Function: Anthelmintic

Chemical Name: 2',5-Dichloro-4'-nitrosalicylanilide

Common Name: —

Structural Formula:

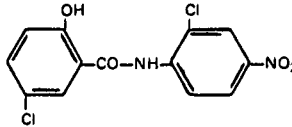

Chemical Abstracts Registry No.: 50-65-7

Trade Name	Manufacturer	Country	Year Introduced
Yomesan	Bayer	W. Germany	1960
Yomesan	Bayer	U.K.	1961
Yomesan	Bayer	Italy	1962
Tredemine	Roger Bellon	France	1964
Niclocide	Miles	U.S.	1982
Anti-Tenia	Uranium	Turkey	—
Atenase	I.C.N.-Usafarma	Brazil	—
Radeverm	Arzneimittelwerk Dresden	E. Germany	—
Teniarene	A.M.S.A.	Italy	—
Tenisid	Liba	Turkey	—

Raw Materials

5-Chlorosalicylic acid
2-Chloro-4-nitroaniline
Phosphorus trichloride

Manufacturing Process

17.2 g of 5-chlorosalicylic acid and 20.8 g of 2-chloro-4-nitroaniline are dissolved in 250 ml of xylene. While boiling, there are introduced slowly 5 g of PCl_3 . Heating is continued for 3 further hours. The mixture is then allowed to cool down and the crystals which separate are filtered off with suction. The crude product may be recrystallized from ethanol, melting at 233°C .

References

Merck Index 6356
Kleeman & Engel p. 630
PDR p. 1260
OCDS Vol. 2 p. 94 (1980)
I.N. p. 669
REM p. 1236
Schraufstatter, E. and Gonnert, R.; U.S. Patent 3,147,300; September 1, 1964; assigned to Farbenfabriken Bayer A.G.

NICOMOL

Therapeutic Function: Anticholesterol

Chemical Name: Cyclohexanol-2,2,6,6-tetrakis(hydroxymethyl)tetratricotinate

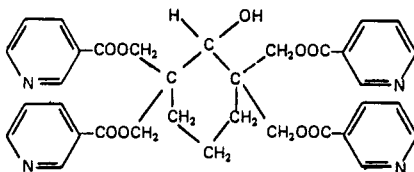
Common Name: —**Structural Formula:****Chemical Abstracts Registry No.:** 27959-26-8

Trade Name	Manufacturer	Country	Year Introduced
Cholexamine	Kyorin	Japan	1971
Acenol	Kissei	Japan	1981
Nicolanta	Sawai	Japan	—

Raw Materials

2,2,6,6-Tetramethylcyclohexanol
Nicotinic acid chloride

Manufacturing Process

To a mixture of 60 cc of benzene, 40 cc of pyridine and 17 g of hydrochloric acid salt of nicotinic acid chloride, was added 4.5 g of 2,2,6,6-tetramethylcyclohexanol, and the whole mixture was refluxed at 75°C to 80°C for 2.5 hours. After the mixture was cooled water was added. Precipitate formed was separated by filtration, washed thoroughly with water and dried. Recrystallization from dilute acetic acid gave 14 g of the final compound, melting point 177°C to 180°C.

References

Merck Index 6360

DOT 7 (5) 173 (1971)

I.N. p. 670

Irikura, T., Sato, S., Abe, Y. and Kasuga, K.; U.S. Patent 3,299,077; January 17, 1967; assigned to Kyorin Seiyaku KK

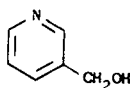
NICOTINYL ALCOHOL**Therapeutic Function:** Peripheral vasodilator**Chemical Name:** 3-pyridinemethanol**Common Name:** 3-pyridylcarbinol**Structural Formula:****Chemical Abstracts Registry No.:** 100-55-0

Trade Name	Manufacturer	Country	Year Introduced
Roniacol	Roche	U.S.	1949
Danaden	Cascan	W. Germany	—
Peritard	Ikapharm	Israel	—
Ronicol	Roche	U.K.	—
Thilocombin	Thilo	W. Germany	—

Raw Materials

3-Cyanopyridine	Hydrogen
Ethyl alcohol	Nitrosyl chloride

Manufacturing Process

The catalyst is prepared by suspending 5 kg of catalyst grade charcoal in 200 liters of water, in a pressure vessel, and adding thereto 25 liters of 4% (as Pd metal) aqueous palladous chloride. Air is displaced from the vessel and then hydrogen is passed into the aqueous mixture at a pressure of 3 to 5 psi, while stirring, until no further absorption is noted and the chloride is completely reduced to metal.

To the aqueous suspension of the palladized charcoal catalyst thus obtained are added 20.8 kg of 3-cyano-pyridine (96% purity); and then are added 70 liters of a hydrochloric acid solution prepared by diluting 30 liters of 36% HCl with 40 liters of water. This represents approximately 1.75 mols of HCl for each mol of 3-cyano-pyridine. The suspension is maintained at 10° to 15°C and stirred continuously while introducing a current of hydrogen at a pressure of 3 to 5 psi. When absorption of hydrogen ceases and the 3-cyano-pyridine is completely reduced, the reaction mixture is filtered to remove the catalyst. The filter cake is washed with 40 liters of water in two equal portions, and the wash water is added to the filtrate.

The combined liquors, which comprise an aqueous hydrochloric acid solution of 3-amino-methyl-pyridine hydrochloride, are then heated to a temperature of 60° to 65°C, and ethyl nitrite gas is passed into the heated solution. The ethyl nitrite is generated by placing 20 liters of 90% ethyl alcohol in a suitable vessel, diluting with 200 liters of water, and, while stirring, adding to the dilute alcohol 18.3 kg of nitrosyl chloride at the rate of 2.25 kg per hour. (The process using methyl nitrite is carried out by substituting a stoichiometrically equivalent quantity of methyl alcohol for the ethyl alcohol.)

When all the ethyl nitrite has been added, the reaction mixture is refluxed for approximately one hour, then concentrated to dryness under reduced pressure (25 to 30 mm Hg) and at a maximum temperature of 70°C. The crystalline residue is dissolved in 35 liters of water and adjusted to a pH of 8 to 9 by addition (with cooling and stirring) of 11 to 12 kg of caustic soda. The sodium chloride formed is filtered off, and the filter cake is washed with 20 liters of normal butyl alcohol. This wash liquid is used for the first extraction of the product from the aqueous filtrate. The filtrate is then further extracted with four successive 20-liter portions of n-butyl alcohol.

All the extracts are combined and concentrated in vacuo (100°C/20 mm) to remove the n-butyl alcohol. The residue is submitted to fractionation under reduced pressure. The forerun (up to 112°C/2 to 3 mm) consists of a small amount of n-butyl alcohol and some 3-pyridylcarbinol. The main fraction, boiling at 112° to 114°C/2 to 3 mm, consists of 3-pyridylcarbinol.

References

- Merck Index 6369
- Kleeman & Engel p. 633
- I.N. p. 672
- REM p. 852

Ruzicka, L. and Prelog, V.; U.S. Patent 2,509,171; May 23, 1950; assigned to Ciba Limited, Switzerland

Cohen, A.; U.S. Patent 2,520,037; August 22, 1950; assigned to Hoffmann-La Roche Inc.

Schlöpfer, R.; U.S. Patent 2,547,048; April 3, 1951; assigned to Hoffmann-La Roche Inc.

Chase, G.O.; U.S. Patent 2,615,896; October 28, 1952; assigned to Hoffmann-La Roche Inc.

NIFEDIPINE

Therapeutic Function: Coronary vasodilator

Chemical Name: 1,4-dihydro-2,6-dimethyl-4-(2'-nitrophenyl)-3,5-pyridinedicarboxylic acid dimethyl ester

Common Name: —

Structural Formula:

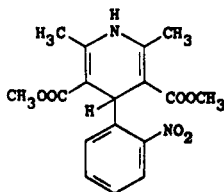

Chemical Abstracts Registry No.: 21829-25-4

Trade Name	Manufacturer	Country	Year Introduced
Adalat	Bayer	W. Germany	1975
Adalat	Bayer	Italy	1976
Adalat	Bayer	Japan	1976
Adalat	Bayer	U.K.	1977
Adalate	Bayer	France	1979
Procardia	Pfizer	U.S.	1982
Alfadat	Alfa	Italy	—
Anifed	Zoja	Italy	—
Atanal	Sawai	Japan	—
Citilat	C.T.	Italy	—
Coral	Tosi	Italy	—
Corinfar	Arzneimittelwerk Dresden	E. Germany	—
Nifedacor	Schiapparelli	Italy	—
Nifedin	Gentili	Italy	—
Nifelat	Sidus	Argentina	—
Oxcord	Biosintetica	Brazil	—

Raw Materials

2-Nitrobenzaldehyde
Acetoacetic acid methyl ester
Ammonia

Manufacturing Process

45 grams 2-nitrobenzaldehyde, 80 cc acetoacetic acid methyl ester, 75 cc methanol and 32 cc ammonia are heated under reflux for several hours, filtered off, cooled and, after

suction-filtration, 75 grams of yellow crystals of MP 172° to 174°C are obtained, according to U.S. Patent 3,485,847.

References

Merck Index 6374

DFU 6 (7) 427 (1981)

Kleeman & Engel p. 633

PDR p. 1423

OCDS Vol. 2 p. 283 (1980)

DOT 8 (11) 438 (1972); 11 (4) 154 (1975) & 19 (3) 171 (1983)

I.N. p. 673

REM p. 862

Bossert, F. and Vater, W.; U.S. Patent 3,485,847; December 23, 1969; assigned to Farbenfabriken Bayer AG, Germany

Bossert, F. and Vater, W.; U.S. Patent 3,488,359; January 6, 1970; assigned to Farbenfabriken Bayer AG, Germany

Bossert, F. and Vater, W.; U.S. Patent 3,511,837; May 12, 1970; assigned to Farbenfabriken Bayer AG, Germany

NIFLUMIC ACID

Therapeutic Function: Antiinflammatory

Chemical Name: 2-[[3-(trifluoromethyl)phenyl]amino]-3-pyridinecarboxylic acid

Common Name: 2-[3-(trifluoromethyl)anilino] nicotinic acid

Structural Formula:

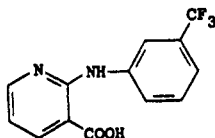

Chemical Abstracts Registry No.: 4394-00-7

Trade Name	Manufacturer	Country	Year Introduced
Nifluril	U.P.S.A.	France	1968
Actol	Von Heyden	W. Germany	1971
Fiaminon	Squibb	Italy	1979
Forenol	Roemmers	Argentina	—
Landruma	Landerlan	Spain	—
Nifluran	Eczacıbasi	Turkey	—
Niflux	Labofarma	Brazil	—

Raw Materials

Nicotinic acid
m-Trifluoromethylaniline
Potassium iodide

Manufacturing Process

Niflumic acid is prepared as follows: Nicotinic acid, m-trifluoromethylaniline, and potassium iodide are intimately mixed and heated on an oil bath at 140°C. The mixture melts

to give a dark red liquid. The temperature of the oil bath is allowed to fall to 100°C and is maintained at this temperature for an hour and a half. The mixture puffs up and forms a yellow crystalline mass. After cooling to ordinary temperature, this mass is ground up in a mortar and extracted several times with small volumes of ether to remove excess m-trifluoromethylaniline. The residue is then washed twice with 10 ml of distilled water to remove m-trifluoromethylaniline hydrochloride and potassium iodide, and finally twice with 10 ml of 95% alcohol to remove colored resinous contaminants. After drying at 100°C, 2-(m-trifluoromethylanilino)nicotinic acid is obtained as pale yellow needles (from 70% ethanol) melting at 204°C (Kofler block).

References

Merck Index 6377

Kleeman & Engel p. 634

OCDS Vol. 1 p. 256 (1977)

DOT 4 (2) 82 (1968)

I.N. p. 34

Hoffmann, C. and Faure, A.; U.S. Patent 3,415,834; December 10, 1968; assigned to Societe anonyme dite: Laboratoires UPSA, France

NIFURATEL

Therapeutic Function: Vaginal antiinfective

Chemical Name: 5-[(methylthio)methyl]-3-[[[(5-nitro-2-furanyl)methylene]amino]-2-oxazolidinone

Common Name: Methylmercadone

Structural Formula:

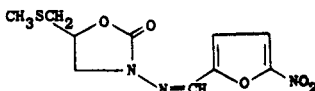

Chemical Abstracts Registry No.: 4936-47-4

Trade Name	Manufacturer	Country	Year Introduced
Macmiror	Poli	Italy	1965
Inimur	Woelm	W. Germany	1969
Omnes	Fumouze	France	1971
Magmilor	Calmic	U.K.	—
Polmiror	Poli	Italy	—
Tydantil	Poli	Italy	—

Raw Materials

Methyl mercaptan	Epichlorohydrin
Hydrazine hydrate	Diethyl carbonate
5-Nitro-2-furaldehyde	

Manufacturing Process

In an initial step of reactions, methyl mercaptan is reacted with epichlorohydrin to give 1-chloro-3-methylthio-2-propanol. That is reacted with hydrazine hydrate to give 3-methylmercapto-2-hydroxypropyl hydrazine.

11.8 grams of diethyl carbonate (0.1 mols) and a solution of sodium methoxide prepared from 0.12 gram of sodium in 4 cc of anhydrous methanol, were added to 13.2 grams of 3-methylmercapto-2-hydroxypropyl hydrazine. After the reaction vessel had been fitted with a Liebig condenser, the reaction mixture was heated by means of an oil bath which was gradually heated up to 110°C, to remove first methyl alcohol and then ethyl alcohol formed during the reaction. After about two-thirds of the theoretical amount of ethyl alcohol had been distilled off, the heating was discontinued and the reaction mixture was diluted with 50 cc of ethyl alcohol and poured into a 5-nitro-2-furfuraldehyde solution prepared by boiling for 30 minutes 0.1 mol of nitrofurfuraldehyde diacetate in 100 ml of ethyl alcohol and 50 ml of 1:10 sulfuric acid.

A yellow crystalline precipitate was immediately formed, which, after crystallization from acetic acid, melted at 182°C and consisted of N-(5-nitro-2-furfurylidene)-3-amino-5-methylmercaptomethyl-2-oxazolidinone.

References

Merck Index 6380

Kleeman & Engel p. 635

I.N. p. 674

Polichimica Sap, SpA, Italy; British Patent 969,126; September 9, 1964

NIFURFOLINE

Therapeutic Function: Antibacterial

Chemical Name: 3-(4-Morpholinylmethyl)-1-[[(5-nitro-2-furanyl)-methylene] amino]-2,4-imidazolidinedione

Common Name: —

Structural Formula:

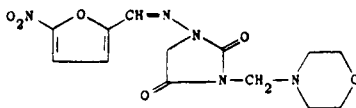

Chemical Abstracts Registry No.: 3363-58-4

Trade Name	Manufacturer	Country	Year Introduced
Furobactil	Carrion	France	1974
Urbac	Merck-Clevenot	France	—

Raw Materials

Nitrofurantoin
Formaldehyde
Morpholine

Manufacturing Process

20 g of nitrofurantoin are placed in 100 cc of dimethylformamide and the solution is heated to 75°C to 80°C. This temperature is maintained and 100 cc of 40% formaldehyde are added, followed by 10 g of freshly distilled morpholine. The heating is continued for one hour, the mixture cooled and filtered and the precipitate obtained is washed with 95% alcohol. 20 g of the desired product are obtained as yellow crystals which melt at 206°C.

References

Merck Index 6381

I.N. p. 674

Laboratorios del Dr. Esteve S.A.; British Patent 1,245,095; September 2, 1971

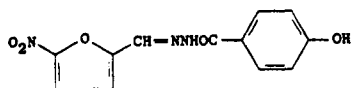
NIFUROXAZIDE**Therapeutic Function:** Antiseptic (intestinal)**Chemical Name:** 4-Hydroxybenzoic acid [(5-nitro-2-furanyl)methylene] hydrazide**Common Name:** —**Structural Formula:****Chemical Abstracts Registry No.:** 965-52-6

Trade Name	Manufacturer	Country	Year Introduced
Ercefuryl	Carriere	France	1964
Pentofuryl	Karlspharma	W. Germany	1978
Antinal	Roques	France	—
Dicoferin	Andrade	Portugal	—
Enterokod	Genekod	France	—
Mucifural	Robert et Carriere	France	—

Raw Materials

4-Hydroxybenzhydrazide

5-Nitrofurfural

Manufacturing Process

13 g (0.1 mol) of 4-hydroxybenzhydrazide were dissolved in a boiling mixture of 100 ml of water and an equal volume of dimethylformamide. 15.5 g (0.11 mol) of 5-nitrofurfural dissolved in 31 ml of dimethylformamide were added to this hot solution, and the mixture was stirred and brought to the boiling point.

The mixture was then allowed to stand for fifteen hours. The precipitate was separated, washed twice with 100 ml of water, and recrystallized by dissolving it in 250 ml of hot pyridine and pouring this solution into 250 ml of water.

The 5-nitrofurfurylidene hydrazide of 4-hydroxybenzoic acid obtained was washed with water and methanol and was dried at a moderate temperature. It weighed 23 g (83.7% yield), and melted at 298°C. The percentage nitrogen determined by the micro-Dumas method was 15.41% (theory 15.27%).

References

Merck Index 6383

Kleeman & Engel p. 636

I.N. p. 675

Carron, M.C.E.; U.S. Patent 3,290,213; December 6, 1966; assigned to S.A. des Laboratoires Robert et Carriere (France)

NIFURTOINOL

Therapeutic Function: Antibacterial

Chemical Name: 3-(Hydroxymethyl)-1-[[[(5-nitro-2-furanyl)methylene]-amino]-2,4-imidazolidinedione

Common Name: —

Structural Formula:

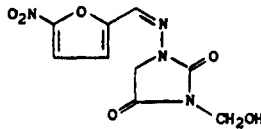

Chemical Abstracts Registry No.: 1088-92-2

Trade Name	Manufacturer	Country	Year Introduced
Urfadyne	Zambon	W. Germany	1969
Urfadyn	Arsac	France	1976
Urfadyne	Inpharzam	Switz.	1981
Levantin	Lek	Yugoslavia	—
Urfurine	Zambon	Spain	—

Raw Materials

Nitrofurantoin
Formaldehyde

Manufacturing Process

Three liters of 5% formaldehyde solution (2,625 cc water and 375 cc 40% formalin) containing 50 g of nitrofurantoin is refluxed for about 5 minutes, then filtered hot and cooled. The crystallized product is filtered and washed with 1% formaldehyde solution. It is air dried and then further dried at 65°C. There is obtained 33 g of 3-hydroxymethyl-1-(5-nitrofur-furylideneamino) hydantoin.

References

Merck Index 6388
I.N. p. 676

Michels, J.G.; U.S. Patent 3,446,802; May 27, 1969; assigned to The Norwich Pharmacal Co.

NIFURZIDE

Therapeutic Function: Antibacterial, antidiarrheal

Chemical Name: N¹-[5'-Nitro-2'-thenoyl]-N²-[5''-nitro-2''-furylacrylidene]hydrazine

Common Name: —

Structural Formula:

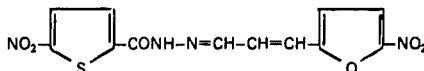

Chemical Abstracts Registry No.: 39978-42-2

Trade Name	Manufacturer	Country	Year Introduced
Ricridene	Anphar	Switz.	1981
Ricridene	Lipha	France	—

Raw Materials

5-Nitrothiophene carboxylic acid	Ethanol
Hydrazine	5-Nitro-2-furylacrolein

Manufacturing Process

(a) Ethyl-5-nitro-2-thiophene carboxylate:

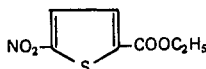

17.4 g (mol/10 = 17.31 g) of 5-nitrothiophene carboxylic acid are dissolved in 85 ml of absolute ethanol. A stream of gaseous hydrochloric acid is caused to enter the boiling solution to the point of saturation, and for 5 hours. Evaporation to dryness takes place and then the solid residue is washed with a sodium bicarbonate solution. It is suction-filtered and washed with water. After drying, there are obtained 17.7 g of a yellow product with a melting point of 63°C to 65°C and the yield is 88% (theoretical yield = 88%).

The N'-(5'-nitro-2'-thenoyl)hydrazide is prepared by reacting hydrazine with ethyl 5-nitro-2-thiophene carboxylate.

(b) 6.3 g (mol/30 = 6.5 g) of N¹-[5'-nitro-2'-thenoyl] hydrazide are dissolved in 100 ml of dry tetrahydrofuran. 5.6 g (mol/30 = 5.55 g) of 5-nitro-2-furyl acrolein in 56 ml of tetrahydrofuran are added. Heating under reflux takes place for 1 hour and, 25 minutes after starting the heating, the crystallization commences; the crystals are suction-filtered, washed with ether and dried. There are obtained 7.9 g (yield 70%—theoretical yield = 11.2 g) of a yellow solid of melting point 235°C to 236°C.

Recrystallization (tepid dimethylformamide + ether) leaves the melting point unchanged.

References

Merck Index 6389

DFU 6 (6) 358 (1981)

Kleeman & Engel p. 637

DOT 17 (7) 288 (1981)

Szarvasi, E. and Fontaine, L.; U.S. Patents 3,847,911; November 12, 1974; and 3,914,379; October 21, 1975; both assigned to Lipha, Lyonnaise Industrielle Pharmaceutique

NIMETAZEPAM

Therapeutic Function: Tranquilizer

Chemical Name: 1,3-Dihydro-1-methyl-7-nitro-5-phenyl-2H-1,4-benzodiazepin-2-one

Common Name: —

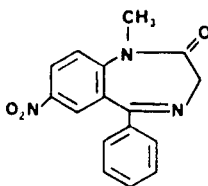
Structural Formula:

Chemical Abstracts Registry No.: 2011-67-8

Trade Name	Manufacturer	Country	Year Introduced
Erimin	Sumitomo	Japan	1977

Raw Materials

1-Methyl-5-nitro-3-phenylindole-2-carbonitrile
 Hydrogen chloride
 Boron trifluoride etherate
 Chromic anhydride

Manufacturing Process

To a suspension of 73.9 g of 1-methyl-5-nitro-3-phenylindole-2-carbonitrile in 1.5 liters of dry tetrahydrofuran is added dropwise a solution of 126 g of boron trifluoride etherate in 220 ml of dry tetrahydrofuran with stirring for 2 hours. After addition, stirring is continued for an additional 3 hours. To the reaction mixture is added dropwise 370 ml of water and then 370 ml of concentrated hydrochloric acid with stirring under ice-cooling.

The resulting precipitate is collected by filtration, washed with water followed by ethanol, and dried to give 56.3 g of crude 2-aminomethyl-1-methyl-5-nitro-3-phenylindole hydrochloride, melting point 263°C to 267°C.

To a suspension of 6.5 g of 2-aminomethyl-1-methyl-5-nitro-3-phenylindole in 65 ml of glacial acetic acid is added dropwise a solution of 6.5 g of chromic anhydride in 6.5 ml of water at 20°C with stirring. The mixture is stirred at room temperature overnight and thereto is added 195 ml of water. To the mixture is added dropwise 100 ml of 28% ammonia water with stirring under cooling. The resultant precipitate is collected by filtration, washed with water and dried to give 5.9 g of a crude product having melting point 135°C to 140°C. Fractional recrystallization from ethanol gives 3.8 g of 1-methyl-7-nitro-5-phenyl-1,3-dihydro-2H-1,4-benzodiazepine-2-one as yellow plates, melting point 153°C to 156°C. Further recrystallization from the same solvent gives pale yellow plates having melting point 156°C to 156.5°C.

References

- Merck Index 6395
 Kleeman & Engel p. 637
 DOT 8 (9) 350 (1972); 11 (5) 195 (1975) & 13 (1) 31 (1977)
 I.N. p. 676
 Yamamoto, H., Inaba, S., Okamoto, T., Hironashi, T., Ishizumi, K., Yamamoto, M., Maruyama, I., Mori, K. and Kobayashi, T.; U.S. Patents 3,770,767; November 6, 1973; and 3,652,551; March 28, 1972; both assigned to Sumitomo Chemical Co.

NIMORAZOLE

Therapeutic Function: Trichomonocidal

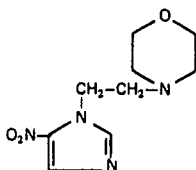
Chemical Name: N- β -Ethylmorpholino-(5)-nitroimidazole**Common Name:** Nitrimidazine**Structural Formula:****Chemical Abstracts Registry No.:** 6506-37-2

Trade Name	Manufacturer	Country	Year Introduced
Naxogin	Carlo Erba	U.K.	1970
Naxogin	Carlo Erba	Italy	1972
Esclama	Farmitalia	W. Germany	1973
Aceterol Forte	Bristol Myers	W. Germany	1973
Naxofem	Ikapharm	Israel	—
Nulogyl	Bristol	U.K.	—
Sirdedi	Causyth	Italy	—

Raw Materials

4(5)-Nitroimidazole sodium salt	Ethylene oxide
β -Chloroethyl morpholine	Morpholine
p-Toluene sulfonyl chloride	

Manufacturing Process

6 g 4(5)-nitroimidazole sodium salt and 9 g β -chloroethylmorpholine are allowed to react in 200 ml dry toluene. The mixture is refluxed for 50 hours, then cooled and filtered from the solid residue. The solvent is evaporated under reduced pressure. The half-solid product thus obtained solidifies by addition of petroleum ether and ethyl ether.

Crystallization from water results in N- β -ethylmorpholino-(5)-nitroimidazole (melting point 110°C to 111°C); from mother liquors N- β -ethylmorpholino-(4)-nitroimidazole (melting point 104°C to 106°C) is obtained.

The following procedure is given in U.S. Patent 3,458,528: 78 grams (0.675 mol) of 5-nitroimidazole is dissolved in 1,500 ml of acetic acid upon the addition of 72 ml (0.57 mol) of boron trifluoride etherate. 175 ml (3.5 mols) of ethylene oxide in 175 ml of hexane, in a dropping funnel topped with a cold finger, is added slowly over 1 hour to the above solution maintained at 32° to 35°C with a water cooling bath. The mixture is concentrated under high vacuum to 100 to 150 ml volume. The residue is diluted with 500 ml of water, neutralized to pH 7 with aqueous sodium hydroxide, and extracted with 1.5 liters of ethyl acetate. The extract is dried and evaporated to yield 1-(2'-hydroxyethyl)-5-nitroimidazole.

20 grams (0.127 mols) of 1-(2'-hydroxyethyl)-5-nitroimidazole in 50 ml of dry pyridine is reacted with 75 grams of p-toluene sulfonyl chloride at 15°C for 4 hours. The reaction mixture is poured into ice and water and the crystalline precipitate is separated by filtration, washed with water and air dried to yield 1-(2'-p-toluenesulfonyloxyethyl)-5-nitroimidazole; MP 126° to 127°C.

16 grams, (0.057 mol) of 1-(2'-p-toluenesulfonyloxyethyl)-5-nitroimidazole and 9.3 ml of morpholine are heated at 95°C for 4 hours. The reaction mixture is taken up in water and extracted with ether. Evaporation of the ether yields 1-(2'-N-morpholinylethyl)-5-nitroimidazole; MP 109° to 110°C.

References

- Merck Index 6398
 Kleeman & Engel p. 638
 OCDS Vol. 2 p. 244 (1980)
 DOT 6 (5) 185 (1970) & 7 (5) 193 (1971)
 I.N. p. 677
 Giraldi, P.N. and Mariotti, V.; U.S. Patent 3,399,193; August 27, 1968; assigned to Carlo Erba SpA, Italy
 Gal, G.; U.S. Patent 3,458,528; July 29, 1969; assigned to Merck & Co., Inc.
 Carlson, J.A., Hoff, D.R. and Rooney, C.S.; U.S. Patent 3,646,027; February 29, 1972; assigned to Merck & Co., Inc.

NIMUSTINE

Therapeutic Function: Antitumor, antileukemic

Chemical Name: 1-(2-Chloroethyl)-1-nitroso-3-[(2-methyl-4-aminopyrimidin-5-yl)-methyl]-urea

Common Name: ACNU

Structural Formula:

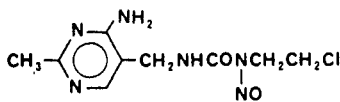

Chemical Abstracts Registry No.: 42471-28-3

Trade Name	Manufacturer	Country	Year Introduced
Nidran	Sankyo	Japan	1979

Raw Materials

1-(2-Chloroethyl)-3-[(2-methyl-4-aminopyridin-5-yl)methyl] urea
 Sodium nitrite
 Hydrogen chloride

Manufacturing Process

0.4 g of sodium nitrite was added with stirring, at 0°C to 5°C, to a solution of 450 mg of 1-(2-chloroethyl)-3-[(2-methyl-4-aminopyridin-5-yl)methyl] urea in 8 ml of 5% hydrochloric acid, and the reaction mixture was then stirred at 0°C to 10°C for an additional 1.5 hours.

After completion of the reaction, the reaction mixture was made alkaline by the addition of sodium carbonate, whereupon crystals separated out in situ. The crystals were recovered by filtration, washed with water and then recrystallized from 6 ml of ethanol, to give 0.1 g of the pale yellow pure desired product having a decomposition point of 125°C.

References

- Merck Index 6399
 DFU 3 (1) 52 (1978)
 Kleeman & Engel p. 639
 DOT 16 (12) 426 (1980)
 I.N. p. 677

Sankyo Co., Ltd.; British Patent 1,374,344; November 20, 1974

Nakao, H., Arakawa, M. and Fukushima, M.; U.S. Patent 4,003,901; January 18, 1977; assigned to Sankyo Co., Ltd.

NITRAZEPAM

Therapeutic Function: Anticonvulsant, hypnotic

Chemical Name: 1,3-Dihydro-7-nitro-5-phenyl-2H-1,4-benzodiazepin-2-one

Common Name: —

Structural Formula:

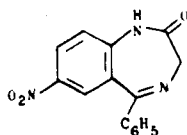

Chemical Abstracts Registry No.: 146-22-5

Trade Name	Manufacturer	Country	Year Introduced
Mogadon	Roche	W. Germany	1965
Mogadon	Roche	France	1965
Mogadon	Roche	U.K.	1965
Mogadon	Roche	Italy	1967
Apodorm	A.L.	Norway	—
Arem	Lennon	S. Africa	—
Atempol	Norgine	U.K.	—
Benzalin	Shionogi	Japan	—
Cerson	Belupo	Yugoslavia	—
Dormicum	Glebe	Australia	—
Dormo-Puren	Klinge	W. Germany	—
Dumolid	Dumex	Denmark	—
Eatan-N	Desitin	W. Germany	—
Hipsal	Salvat	Spain	—
Hypnotin	Protea	S. Africa	—
Imadorm	Scheurich	W. Germany	—
Imeson	Desitin	W. Germany	—
Insomin	Orion	Finland	—
Ipersed	Sidus	Italy	—
Ipnozem	Biofarma	Turkey	—
Lagazepam	Lagap	Switz.	—
Lyladorm	M.P.S. Labs	S. Africa	—
Mitidin	Savoma	Italy	—
Nelbon	Sankyo	Japan	—
Nelmat	Sawai	Japan	—
Neuchlonic	Taiyo	Japan	—
Nitrados	Berk	U.K.	—
Nitrempax	Lafi	Brazil	—
Noctem	Alfa Farm.	Italy	—
Noctene	Rio Ethicals	S. Africa	—
Numbon	Ikapharm	Israel	—
Ormodon	Ormed	S. Africa	—

Trade Name	Manufacturer	Country	Year Introduced
Pacisyn	Medica	Finland	—
Paxisyn	Syntetic	Denmark	—
Pelson	Infale	Spain	—
Persopir	Ion	Italy	—
Prosonno	Von Boch	Italy	—
Quill	Ellea	Italy	—
Relact	Lemonier	Argentina	—
Remnos	D.D.S.A.	U.K.	—
Rindepres	Disprovent	Argentina	—
Somitran	Farmos	Finland	—
Somnased	Duncan Flockhart	U.K.	—
Somnite	Norgine	U.K.	—
Sonnolin	Dima	Italy	—
Surem	Galen	U.K.	—
Tri	Vita	Italy	—
Unisomnia	Unigreg	U.K.	—

Raw Materials

2-Aminobenzophenone
 Glycine ethyl ester hydrochloride
 Nitric acid

Manufacturing Process

A mixture of 16.8 g of 2-aminobenzophenone, 11.9 g of glycine ethyl ester hydrochloride and 200 cc of pyridine was heated to reflux. After one hour, 20 cc of pyridine was distilled off. The solution was refluxed for 15 hours, then 11.9 g of glycine ethyl ester hydrochloride was added and the refluxing was continued for an additional 4 hours. The reaction mixture was continued for an additional 4 hours. The reaction mixture was concentrated in vacuo, then diluted with ether and water. The reaction product, 5-phenyl-3H-1,4-benzodiazepin-2(1H)-one, crystallized out, was filtered off, and then recrystallized from acetone in the form of colorless rhombic prisms, MP 182°C to 183°C.

48 g (0.2 mol) of 5-phenyl-3H-1,4-benzodiazepin-2(1H)-one was dissolved in 250 cc of concentrated sulfuric acid by stirring at 15°C for ½ hour. The solution was then cooled to 0°C and a mixture of 9.1 cc of fuming nitric acid (90%, sp. gr. = 1.50) and 11.8 cc of concentrated sulfuric acid was added dropwise with stirring, keeping the temperature of the reaction mixture between -5°C and 0°C. After completion of the addition of the nitric acid-sulfuric acid mixture, stirring was continued for 1 hour and the reaction mixture was stored in the refrigerator overnight.

The mixture was then added dropwise to 2 kg of crushed ice with stirring and cooling, keeping the temperature at 0°C. After 1 hour of stirring in the cold, 640 cc of concentrated ammonium hydroxide was added dropwise at 0°C to pH 8. Stirring was continued for ½ hour and the crude product was filtered off, washed with a small amount of ice water and sucked dry overnight. The crude product was suspended in a mixture of 100 cc of methylene chloride and 1,700 cc of alcohol. 50 g of decolorizing charcoal was added and the mixture was refluxed with stirring for 2 hours. After standing overnight at room temperature 15 g of diatomaceous earth filter aid was added and the refluxing was resumed for 1½ hours. The mixture was filtered while hot. The clear, light yellow filtrate was concentrated in vacuo on the steam bath with stirring to about 600 cc. The concentrate was stirred and cooled in ice for about 2 hours; the precipitated crystalline product was filtered off, washed with some petroleum ether and sucked dry. The product, 7-nitro-5-phenyl-3H-1,4-benzodiazepin-2(1H)-one, was recrystallized from a mixture of 1,000 cc of alcohol and 50 cc of methylene chloride to obtain white prisms melting at 224°C to 225°C.

References

Merck Index 6418

Kleeman & Engel p. 640

OCDS Vol. 1 p. 366 (1977)

DOT 1 (4) 132 (1965) & 9 (6) 237 (1973)

I.N. p. 678

REM p. 1064

Kariss, J. and Newmark, H.L.; U.S. Patent 3,116,203; December 31, 1963; assigned to Hoffmann-LaRoche, Inc.

NITROFURANTOIN

Therapeutic Function: Urinary antibacterial

Chemical Name: 1-[[[(5-nitro-2-furanyl)methylene] amino]-2,4-imidazolidinedione

Common Name: N-(5-nitro-2-furfurylidene)-1-aminohydantoin

Structural Formula:

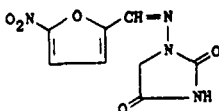

Chemical Abstracts Registry No.: 67-20-9

Trade Name	Manufacturer	Country	Year Introduced
Furadantin	Norwich Eaton	U.S.	1953
Furadoine	Oberval	France	1954
Trantoin	McKesson	U.S.	1969
Cyantoin	Lederle	U.S.	1970
Furachel	Rachelle	U.S.	1970
N-Toin	Upjohn	U.S.	1971
Parfuran	Warner Lambert	U.S.	1974
Alfuran	Alkaloid	Yugoslavia	—
Berkfurin	Berk	U.K.	—
Ceduran	Cedona	Neth.	—
Chemiofuran	Italfarmaco	Italy	—
Chemiofurin	Torlan	Spain	—
Cistofuran	Crosara	Italy	—
Cystit	Heyden	W. Germany	—
Dantafur	Norwich-Eaton	U.S.	—
Fua Med	Med	W. Germany	—
Furadoine	Oberval	France	—
Furalan	Lannett	U.S.	—
Furaloid	Edwards	U.S.	—
Furanex	Elliott-Marion	Canada	—
Furanite	Saunders	Canada	—
Furantoin	Spofo	Czechoslovakia	—
Furatin	Hemofarm	Yugoslavia	—
Furedan	Scharper	Italy	—
Furil	Off	Italy	—
Furobactina	Esteve	Spain	—
Furophen	Pharbil	Neth.	—
Gerofuran	Gerot	Austria	—
Ituran	Promonta	W. Germany	—
Macrofantin	Eaton	U.S.	—

Trade Name	Manufacturer	Country	Year Introduced
Microdoine	Gomenol	France	—
Micturol	Liade	Spain	—
Nephronex	Cortunon	Canada	—
Nierofu	Hoyer	W. Germany	—
Nifuran	Paul Maney	Canada	—
Nifurantin	Apogepha	E. Germany	—
Nitrofur C	Leiras	Finland	—
Novofuran	Novopharm	Canada	—
Phenurin	Merckle	W. Germany	—
Profura	Rachelle	U.S.	—
Trantoin	McKesson	U.S.	—
Trocurine	Labatec	Switz.	—
Urantoin	D.D.S.A.	U.K.	—
Uretoin	Tokyo Tanabe	Japan	—
Urodil	Pharma-Selz	W. Germany	—
Urodin	Streuli	Switz.	—
Urofuran	Farmos	Finland	—
Urolisa	Lisafarma	Italy	—
Urolong	Thiemann	W. Germany	—
Uro-Tablinen	Sanorania	W. Germany	—
Uvamin	Mepha	Switz.	—

Raw Materials

n-Heptaldehyde
 1-Aminohydantoin
 5-Nitro-2-furaldoxime

Manufacturing Process

To a solution of 18.9 grams (0.166 mol) n-heptaldehyde in 25 ml of isopropanol is added, with stirring, a solution of 19.1 grams (0.166 mol) of 1-aminohydantoin in 110 ml water acidified with concentrated HCl. The heavy white precipitate formed is filtered and washed, until acid free, with small amounts of water and ether. The yield of N-(n-heptylidene)-1-aminohydantoin is 14 grams of MP 150°C (with decomposition). This may be recrystallized from dimethylformamide.

A mixture of 2.5 grams (0.016 mol) of 5-nitro-2-furaldoxime, 3.9 grams (0.018 mol) of N-(n-heptylidene)-1-aminohydantoin and 5 cc of sulfuric acid (density 1.84) is placed in a 250 cc beaker. It is heated with stirring at steam bath temperature for about 1.5 hours. Upon cooling, a solid precipitates which is collected by filtration, washed with water, isopropanol and ether in turn and dried at 110°C for 4 hours. There is obtained N-(5-nitro-2-furfurylidene)-1-aminohydantoin in 96 to 98% yield, according to U.S. Patent 2,927,110.

References

- Merck Index 6445
 Kleeman & Engel p. 641
 PDR pp. 1278, 1606
 OCDS Vol. 1 p. 230 (1977)
 I.N. p. 680
 REM p. 1215
 Hayes, K.J.; U.S. Patent 2,610,181; September 9, 1952; assigned to Eaton Laboratories, Inc.
 Michels, J.G.; U.S. Patent 2,898,335; August 4, 1959; assigned to The Norwich Pharmacal Company
 Gever, G. and O'Keefe, C.; U.S. Patent 2,927,110; March 1, 1960; assigned to The Norwich Pharmacal Company

NITROFURAZONE

Therapeutic Function: Topical antiinfective

Chemical Name: 2-[(5-nitro-2-furanyl)methylene]hydrazinecarboxamide

Common Name: Nitrofuraz

Structural Formula:

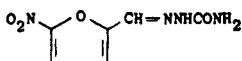

Chemical Abstracts Registry No.: 59-87-0

Trade Name	Manufacturer	Country	Year Introduced
Furacin	Norwich Eaton	U.S.	1946
Actin-N	Chesebrough-Pond	U.S.	1981
Amifur	Norwich-Eaton	U.S.	—
Escofuron	Streuli	Switz.	—
Furesol	A.F.I.	Norway	—
Germex	Lennon	S. Africa	—
Monofuracin	Dainippon	Japan	—
Muldacin	Mulda	Turkey	—
Nifucin	Jenapharm	E. Germany	—
Nifuzon	Pharmacia	Sweden	—
Nitrozone	Century	U.S.	—
Yatrocin	Italfarmaco	Italy	—

Raw Materials

Semicarbazide hydrochloride
2-Formyl-5-nitrofuraz

Manufacturing Process

A mixture of 43 grams of semicarbazide hydrochloride and 31 grams of sodium acetate is dissolved in 150 cc of water. The pH of this solution is approximately 5. Ethyl alcohol (95% by volume) in the amount of 250 cc is added and the mixture is stirred mechanically. A solution of 53.5 grams of carefully purified 2-formyl-5-nitrofuraz in 250 cc of the said alcohol is added dropwise to the semicarbazide solution at room temperature. After completing the addition of the aldehyde solution, the mixture is stirred for another hour. The precipitate is removed from the reaction mixture by filtration. It is washed well with ethyl alcohol and dried to constant weight at 70°C in an oven. The product weighs 73 grams, corresponding to a yield of 97%. It is obtained in the form of pale yellow needles, which are not subjected to further purification, according to U.S. Patent 2,416,234.

References

Merck Index 6446

Kleeman & Engel p. 641

PDR p. 1278

OCDS Vol. 1 p. 229 (1977)

I.N. p. 680

REM p. 1163

Stillman, W.B. and Scott, A.B.; U.S. Patent 2,416,234; February 18, 1947; assigned to Eaton Laboratories, Inc.

Gever, G. and O'Keefe, C.; U.S. Patent 2,927,110; March 1, 1960; assigned to The Norwich Pharmacal Company

NOMIFENSINE MALEATE

Therapeutic Function: Psychostimulant

Chemical Name: 8-amino-1,2,3,4-tetrahydro-2-methyl-4-phenyl-isoquinoline

Common Name: —

Structural Formula:

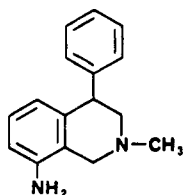

(base)

Chemical Abstracts Registry No.: 32795-47-4; 24526-64-5 (Base)

Trade Name	Manufacturer	Country	Year Introduced
Alival	Hoechst	W. Germany	1976
Merital	Hoechst	U.K.	1977
Alival	Hoechst	France	1977
Psicronizer	Albert Pharma	Italy	1977
Merital	Hoechst	Canada	1982
Neurolene	Magis	Italy	—
Nomival	Leiras	Finland	—

Raw Materials

α -Bromoacetophenone	Hydrogen
(2-Nitrobenzyl)methylamine	Sodium borohydride
Sulfuric acid	Maleic acid

Manufacturing Process

A solution of N-(2-aminobenzyl)-1-phenyl-2-methylaminoethanol-1 was prepared by the reaction of α -bromoacetophenone and (2-nitrobenzyl)methylamine, followed by hydrogenation of the nitro group by means of nickel on diatomaceous earth at room temperature and reduction of the CO group by means of sodium borohydride. The intermediate thus produced was dissolved in 100 ml of methylene chloride and introduced dropwise into 125 ml of sulfuric acid at 10° to 15°C. After a short standing, the reaction mixture was poured onto ice and rendered alkaline by means of a sodium hydroxide solution. By extraction with ether, there was obtained 1,2,3,4-tetrahydro-2-methyl-4-phenyl-8-amino-isoquinoline. The base is reacted with maleic acid to give the maleate; melting point of the maleate 199° to 201°C (from ethanol).

References

- Merck Index 6515
 DFU 1 (2) 72 (1976)
 Kleeman & Engel p. 642
 PDR p. 941
 DOT 13 (2) 77 (1977)
 I.N. p. 685
 Farbwerke Hoechst AG, Germany; British Patent 1,164,192; September 17, 1969
 Ehrhart, G., Schmitt, K., Hoffmann, I. and Ott, H.; U.S. Patent 3,577,424; May 4, 1971; assigned to Farbwerke Hoechst AG.

NONOXYNOL

Therapeutic Function: Spermicide (vaginal)

Chemical Name: α -(Nonylphenyl)- ω -hydroxypoly(oxy-1,2-ethanediyl)

Common Name: —

Structural Formula:

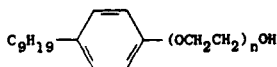

Chemical Abstracts Registry No.: 26027-38-3

Trade Name	Manufacturer	Country	Year Introduced
Ortho-Delfen	Cilag	France	1971
Semicid	Whitehall	U.S.	1978
Intercept	Ortho	U.S.	1980
Gynol	Ortho	U.S.	1982
Shur-Seal	Milex	U.S.	1983
C-Film	Hommel	Switz.	—
Emko	Emko-Schering	U.S.	—
Encare Oval	Patentex	W. Germany	—
Glovan	Teva	Israel	—
Igepal	G.A.F.	U.S.	—
Ortho-Creme	Cilag	U.S.	—

Raw Materials

Isononylphenol
Sodium hydroxide
Ethylene oxide

Manufacturing Process

220 parts of isononylphenol prepared by condensation of phenol with an olefin mixture obtained by polymerization of propylene and containing essentially isononylenes are caused to react with 0.5 part of caustic alkali powder. The whole is heated to about 130°C to 135°C and the water formed is removed under reduced pressure, while stirring. Thereupon, ethylene oxide is introduced into the melt, while well stirring, during which operation care must be taken, that the temperature of the reaction mass is maintained between 180°C and 200°C. When about 300 parts of ethylene oxide are taken up, the reaction is interrupted. A water-soluble oil is obtained.

References

Merck Index 6518
PDR pp. 1661, 1900
I.N. p. 686
REM p. 1163
Steindorff, A., Balle, G., Horst, K. and Michel, R.; U.S. Patent 2,413,477; September 3, 1940; assigned to General Aniline & Film Corp.

NORDAZEPAM

Therapeutic Function: Minor tranquilizer

Chemical Name: 7-Chloro-1,3-dihydro-5-phenyl-1(2H)-1,4-benzodiazepin-2-one

Common Name: Nordiazepam; desmethyl diazepam

Structural Formula:

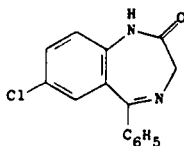

Chemical Abstracts Registry No.: 1088-11-5

Trade Name	Manufacturer	Country	Year Introduced
Madar	Ravizza	Italy	1973
Vegesan	Mack	Switz.	1981

Raw Materials

(2-Benzoyl-4-chlorophenyl-carbamoylmethyl)carbamic acid benzyl ester
 Hydrogen bromide
 Acetic acid

Manufacturing Process

A solution of 3.1 g of (2-benzoyl-4-chlorophenyl-carbamoylmethyl)carbamic acid benzyl ester in 30 cc of 20% hydrobromic acid in glacial acetic acid was stirred for 45 minutes at room temperature. On addition of 175 cc of anhydrous ether, a gummy solid precipitated. After several minutes the ether solution was decanted. The resultant 5-chloro-2-glycylaminobenzophenone was not isolated, but about 155 cc of ether was added to the residue and after chilling in an ice bath, 10% sodium hydroxide was added until the mixture was alkaline. The ether layer was then separated, washed twice with water and dried over sodium sulfate. After filtration, the ether solution was concentrated to dryness in vacuo. The residue was crystallized from benzene to yield 7-chloro-5-phenyl-3H-1,4-benzodiazepin-2(1H)-one.

References

Merck Index 6531

DOT 9 (6) 239 (1973)

I.N. p. 688

Stempel, A.; U.S. Patent 3,202,699; August 24, 1965; assigned to Hoffmann-LaRoche Inc.

NORETHANDROLONE

Therapeutic Function: Androgen

Chemical Name: 17-Hydroxy-19-norpregn-4-ene-3-one

Common Name: —

Structural Formula:

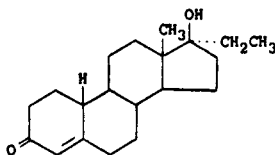

Chemical Abstracts Registry No.: 52-78-8

Trade Name	Manufacturer	Country	Year Introduced
Nilevar	Searle	U.S.	1956
Nilevar	Searle	France	1960

Raw Materials

Norethindrone
Hydrogen

Manufacturing Process

Through a mixture of 11 parts of charcoal containing 5% palladium and 2,000 parts of dioxane a stream of hydrogen is passed for 60 minutes. Then 86 parts of 17-ethynyl-19-nortestosterone (Norethindrone) in 1,500 parts of dioxane are added and the mixture is hydrogenated until 2 mols of hydrogen are absorbed. The catalyst is then removed by filtration and the solvent is evaporated under vacuum. The crystalline residue is dissolved in 2,700 parts of benzene and thus applied to a chromatography column containing 5,000 parts of silica gel. The column is washed with 2,700 parts of benzene, 4,500 parts of a 10% solution of ethyl acetate in benzene and 27,000 parts of a 20% solution of ethyl acetate in benzene and is then eluted with 30,000 parts of a 30% solution of ethyl acetate in benzene. The resulting eluate is concentrated under vacuum and the residue is recrystallized from methanol and dried to constant weight at 75°C. The 17-ethyl-19-nortestosterone thus obtained melts at about 140°C to 141°C.

References

Merck Index 6537

Kleeman & Engel p. 644

OCDs Vol. 1 p. 170 (1977)

I.N. p. 688

Colton, F.B.; U.S. Patent 2,721,871; October 25, 1955; assigned to G.D. Searle & Co.

NORETHINDRONE

Therapeutic Function: Progestin

Chemical Name: 17-hydroxy-19-nor-17 α -pregn-4-en-20-yn-3-one

Common Name: Norethisteron

Structural Formula:

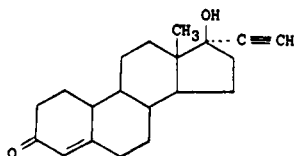
**Chemical Abstracts Registry No.:** 68-22-4

Trade Name	Manufacturer	Country	Year Introduced
Norlutin	Parke Davis	U.S.	1957
Ortho-Novum	Ortho	U.S.	1963
Norinyl	Syntex	U.S.	1964

Trade Name	Manufacturer	Country	Year Introduced
Nor-QD	Syntex	U.S.	1973
Brevicon	Syntex	U.S.	—
Conceplan	Gruenthal	W. Germany	—
Gesta-Plan	D.A.K.	Denmark	—
Micronor	Ethnor	Australia	—
Micronor	Ortho	U.S.	—
Micronovum	Cilag	W. Germany	—
Modicon	Ortho	U.S.	—
Monogest	Spofa	Czechoslovakia	—
Norfor	Gremy-Longuet	France	—
Norgestin	Janus	Italy	—
Noriday	Syntex	U.S.	—
Norlestrin	Parke Davis	U.S.	—
Ovcon	Mead Johnson	U.S.	—
Primolut N	Schering	U.K.	—
Tri-Norinyl	Syntex	U.S.	—
Utovlan	Syntex	U.K.	—

Raw Materials

3-Methoxyestrone	Lithium
Ammonia	Chromic acid
Ethyl orthoformate	Potassium
Acetylene	

Manufacturing Process

7.5 grams of 3-methoxyestrone were dissolved in 750 cc of anhydrous dioxane in a three-neck flask, placed in a box and insulated with cotton wool. 2 liters of anhydrous liquid ammonia and 15 grams of lithium metal in the form of wire were added to the mechanically stirred solution. After stirring for one hour, 150 cc of absolute ethanol were added at such speed that no bumping occurred; when the blue color had disappeared, 500 cc of water were added in the same way. The ammonia was evaporated on the steam bath and the product collected with 2 liters of water. It was extracted with ether and then with ethyl acetate and the combined extract was washed to neutral and evaporated to dryness under vacuum, leaving 7.4 grams of a slightly yellow oil.

The oil thus obtained was dissolved in 400 cc of methanol and refluxed during one hour with 150 cc of 4N hydrochloric acid. The mixture was poured into a sodium chloride solution and extracted with ethyl acetate, washed to neutral, dried and evaporated to dryness. The product was a yellow oil which showed an ultraviolet absorption maximum characteristic of a Δ^4 -3-ketone.

A solution of 2.7 grams of chromic acid in 20 cc of water and 50 cc of acetic acid was added to the stirred solution of the above oil in 100 cc of acetic acid, maintaining the temperature below 20°C. After 90 minutes standing, 50 cc of methanol were added and the mixture concentrated under vacuum (20 mm). The residue was extracted with ether, washed to neutral and evaporated to dryness. The residual semicrystalline product (7 grams) was chromatographed over alumina and the fractions eluted with ether yielded 3.2 grams of Δ^4 -19-norandrostren-3,17-dione having a MP of 163° to 167°C.

A solution of 2 grams of Δ^4 -19-norandrostren-3,17-dione and 0.4 gram of pyridine hydrochloride in 50 cc of benzene free of thiophene was made free of moisture by distilling a small portion; 4 cc of absolute alcohol and 4 cc of ethyl orthoformate were added and the mixture was refluxed during 3 hours. 5 cc of the mixture were then distilled and after adding an additional 4 cc of ethyl orthoformate the refluxing was continued for 2 hours longer. The mixture was evaporated to dryness under vacuum and the residue was taken up in ether, washed, dried and evaporated to dryness. The residue was crystallized from

hexane-acetone and then from ether to give $\Delta^{3,5}$ -19-nor-3-ethoxy-androstadien-17-one with a MP of 140° to 142°C.

One gram of potassium metal was dissolved in 25 cc of tertiary amyl alcohol by heating under an atmosphere of nitrogen. One gram of $\Delta^{3,5}$ -19-nor-3-ethoxyandrostadien-17-one in 25 cc of anhydrous toluene was added and nitrogen was passed during 15 minutes. Then acetylene (especially dried and purified) was passed during 14 hours through the mechanically stirred solution, at room temperature.

The mixture was poured in water, acidified to pH 1 with dilute hydrochloric acid, heated on the steam bath for 30 minutes and then subjected to steam distillation to remove the organic solvents. The residue was filtered, dried and recrystallized several times from ethyl acetate. The Δ^4 -19-nor-17 α -ethinylandrosten-17 β -ol-3-one thus obtained had a MP of 198° to 200°C (in sulfuric acid bath), 200° to 204°C (Kofler).

References

Merck Index 6538

Kleeman & Engel p. 644

PDR pp. 1104, 1297, 1358, 1372, 1793

OCDS Vol. 1 p. 164 (1977) & 2, 145 (1980)

DOT 4 (1) 19 (1968) & 9 (4) 144 (1973)

I.N. p. 688

REM p. 992

Djerassi, C., Miramontes, L. and Rosenkranz, G.; U.S. Patent 2,744,122; May 1, 1956; assigned to Syntex SA, Mexico

de Ruggieri, P.; U.S. Patent 2,849,462; August 26, 1958

NORETHINDRONE ACETATE

Chemical Abstracts Registry No.: 51-98-9

Trade Name	Manufacturer	Country	Year Introduced
Norlestrin	Parke Davis	U.S.	1964
Milligynon	Schering	France	1978
Aygestrin	Ayerst	U.S.	1982
Brevicon	Syntex	U.S.	—
Norlutin-A	Parke Davis	U.K.	—
Primolut-Nor	Schering	W. Germany	—

Raw Materials

Norethindrone
Acetic anhydride
Hydrogen chloride

Manufacturing Process

2.98 grams of 17-ethinyl-19-nor-testosterone (norethindrone) are suspended in 30 cc of acetic anhydride and a solution of 1.9 grams of p-toluenesulfonic acid in 19 cc of acetic anhydride is gradually added while cooling and stirring. Complete dissolution takes place after about one hour. After additional 30 to 60 minutes, a thick, pasty mass separates. The reaction is permitted to continue for a total period of 5 hours, whereupon water is added to the reaction mixture and the 3-enol-17-diacetate which separates after stirring for

1 to 2 hours is filtered off, washed until neutral and dried in vacuo over calcium chloride at room temperature.

In order to prepare the monoacetate, the crude diacetate is suspended in 150 cc of methanol and, after adding 1.5 cc, concentrated hydrochloric acid, heated to boiling for 15 minutes in a nitrogen atmosphere. The crude monoacetate which separates upon the addition of water after cooling is filtered off, washed and dried in vacuo over calcium chloride at room temperature. The pure 17-acetate, obtained after repeated recrystallizations from methylene chloride/hexane has a MP of 161° to 162°C.

References

Merck Index 6538

Kleeman & Engel p. 645

PDR pp. 615, 1378

OCDS Vol. 1 p. 165 (1977)

I.N. p. 689

REM p. 992

Engelfried, O., Kaspar, E., Schenck, M. and Popper, A.; U.S. Patent 2,964,537; Dec. 13, 1960; assigned to Schering AG, Germany

NORETHYNODREL

Therapeutic Function: Progestin

Chemical Name: 17-hydroxy-19-nor-17 α -pregn-5(10)-en-20-yn-3-one

Common Name: 13-methyl-17-ethynyl-17-hydroxy-1,2,3,4,6,7,8,9,11,12,13,14,16,17-tetradecahydro-15H-cyclopenta(α)phenanthren-3-one

Structural Formula:

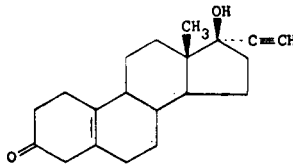

Chemical Abstracts Registry No.: 68-23-5

Trade Name	Manufacturer	Country	Year Introduced
Enovid	Searle	U.S.	1957

Raw Materials

3-Methoxy-17-oxo-2,5-estradiene
Acetylene
Acetic acid

Manufacturing Process

Convenient starting materials are the ethers of 3-hydroxy-13-methyl-1,4,6,7,8,9,11,12,13,14,16,17-dodecahydro-15H-cyclopenta(α)phenanthren-17-one described in U.S. Patent 2,655,518, according to U.S. Patent 2,691,028 where the following preparation is also described. The methyl ether is also designated as 3-methoxy-17-oxo-2,5-estradiene.

A stirred solution of 10.6 parts of 3-methoxy-13-methyl-1,4,6,7,8,9,11,12,13,14,16,17-dodecahydro-15H-cyclopenta(α)phenanthren-17-one in 700 parts of anhydrous ether and 45 parts of dry toluene is cooled to 0°C and saturated with dry acetylene. While a slow stream of acetylene is passed through the reaction mixture, a solution of 20 parts of potassium t-amylate in 135 parts of anhydrous t-pentanol is added in the course of 15 minutes with stirring. Passage of acetylene and stirring are continued for an additional 4½ hours. After standing at 0°C for 16 hours, the mixture is washed with aqueous ammonium chloride solution until the aqueous phase is neutral, then with water and saturated sodium chloride solution. The organic layer is dried over anhydrous sodium sulfate, filtered and concentrated under vacuum to a residue of about 250 parts. 500 parts of petroleum ether are added and after standing at 0°C for an hour, the mixture is filtered. The collected precipitate is recrystallized from ether. The resulting 3-methoxy-13-methyl-17-ethynyl-1,4,6,7,8,9,11,12,13,14,16,17-dodecahydro-15H-cyclopenta(α)phenanthren-17-ol melts at about 181° to 182°C.

To a refluxing solution of 10 parts of 3-methoxy-17-ethynyl-17-hydroxy-13-methyl-1,4,6,7,8,9,11,12,13,14,16,17-dodecahydro-15H-cyclopenta(α)phenanthrene in 500 parts of methanol, 20 parts of glacial acetic acid are added. Refluxing is continued for 7 minutes, water is added to the point of turbidity and the reaction mixture is permitted to come to room temperature. The precipitate is collected on a filter and recrystallized from aqueous methanol. The 13-methyl-17-ethynyl-17-hydroxy-1,2,3,4,6,7,8,9,11,12,13,14,16,17-tetradecahydro-15H-cyclopenta(α)phenanthren-3-one thus obtained melts at about 169° to 170°C.

References

Merck Index 6539

Kleeman & Engel p. 647

PDR p. 1680

OCDS Vol. 1 p. 186 (1977)

DOT 4 (1) 22 (1968)

I.N. p. 689

REM p. 993

Colton, F.B.; U.S. Patent 2,691,028; October 5, 1954; assigned to G.D. Searle & Co.

Colton, F.B.; U.S. Patent 2,725,389; November 29, 1955; assigned to G.D. Searle & Co.

NORFENEFRINE

Therapeutic Function: Adrenergic

Chemical Name: α -(Aminomethyl)-3-hydroxybenzenemethanol

Common Name: Norphenylephrine

Structural Formula:

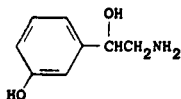

Chemical Abstracts Registry No.: 536-21-0; 4779-94-6 (Hydrochloride)

Trade Name	Manufacturer	Country	Year Introduced
Zordel	Grelan	Japan	1970
Coritat	Green Cross	Japan	—
Esbufon	Schaper & Brummer	W. Germany	—
Euro-Cir	Virgiliano	Italy	—

Trade Name	Manufacturer	Country	Year Introduced
Molycor R	Mepha	Switz.	—
Nevadral	Pharmacia	Sweden	—
Normetolo	Selvi	Italy	—
Novadral	Goedecke	W. Germany	—
Stagural	Stada	W. Germany	—
Sympatosan	Kwizda	Austria	—
Tonolift	Teisan	Japan	—

Raw Materials

m-Acetoxyacetophenone	Bromine
Sodium iodide	Hexamethylene tetramine
Hydrogen	

Manufacturing Process

100 parts of the hydrochloride of meta-hydroxy- ω -aminoacetophenone of melting point 220°C to 222°C (obtainable by brominating meta-acetoxyacetophenone, causing the bromo-ketone to react with sodium iodide, adding hexamethylenetetramine to the iodide in an indifferent solvent and scission of the addition product in acid solution) are shaken in aqueous solution with hydrogen in presence of 2 parts of palladium catalyst until 2 atomic proportions of hydrogen have been absorbed. The catalyst is now filtered and the filtrate evaporated in a vacuum; and the crystalline and completely dry residue is dissolved in absolute alcohol and a precipitate is produced by adding dry ether. The hydrochloride of meta-hydroxyphenyl-ethanolamine thus obtained forms white crystals of melting point 159°C to 160°C.

References

Merck Index 6540

Kleeman & Engel p. 647

I.N. p. 689

Legerlotz, H.; U.S. Patent 2,312,916; March 2, 1943; assigned to Ciba Pharmaceutical Products Inc.

NORFLOXACIN

Therapeutic Function: Antibacterial

Chemical Name: 1-Ethyl-6-fluoro-1,4-dihydro-4-oxo-7-(1-piperazinyl)-3-quinolinecarboxylic acid

Common Name: —

Structural Formula:

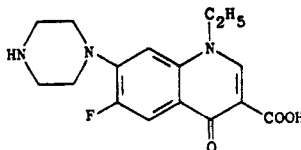

Chemical Abstracts Registry No.: 70458-96-7

Trade Name	Manufacturer	Country	Year Introduced
Noroxin	MSD	Italy	1983

Trade Name	Manufacturer	Country	Year Introduced
Sebercim	I.S.F.	Italy	1983
Primoxin	Sharp & Dohme	W. Germany	1983
Noroxin	MSD	Switz.	1983
Fulgram	A.B.C.	Italy	—

Raw Materials

7-Chloro-1-ethyl-6-fluoro-4-oxo-1,4-dihydroquinoline-3-carboxylic acid
Piperazine

Manufacturing Process

36 g (0.134 mol) of 7-chloro-1-ethyl-6-fluoro-4-oxo-1,4-dihydroquinoline-3-carboxylic acid, 46 g of piperazine and 210 cm³ of pyridine were heated under reflux for 6 hours, while stirring. After the starting material had dissolved, a precipitate appeared after heating for about 2 hours 30 minutes. The major part of the solvent was removed by concentration in vacuo (15 mm Hg; 100°C). In order to remove the pyridine as completely as possible, the residue was taken up in 200 cm³ of water and the concentration in vacuo was repeated.

The residue, resuspended in 150 cm³ of water, was stirred. 150 cm³ of 2N NaOH were added thereto. The solution, which was slightly turbid, was treated with 5 g of animal charcoal and stirred for 30 minutes. After filtration, the pH was brought to 7.2 by adding acetic acid, while stirring. The precipitate was filtered off, washed with water and dissolved in 250 cm³ of a 10% aqueous acetic acid. The acid solution (pH 4.4) was filtered and then brought to pH 7.2 by gradually added 2N NaOH.

The suspension was heated to 90°C, while stirring. The crystals were separated and recrystallized from 280 cm³ of a mixture of DMF (1 volume) and ethanol (4 volumes). After drying in vacuo over phosphorus pentoxide, 29.5 g (yield 70%) of 1-ethyl-6-fluoro-4-oxo-7-piperaziny-1,4-dihydroquinoline-3-carboxylic acid, melting point 222°C, were obtained.

In air, this product is hygroscopic and gives a hemihydrate.

References

Merck Index 6541

DFU 7 (8) 586 (1982)

DOT 19 (6) 341 (1983)

I.N. p. 689

Pesson, M.; U.S. Patent 4,292,317; September 29, 1981; assigned to Laboratoire Roger Bellon (France) and Dainippon Pharmaceutical (Japan)

NORGESTREL

Therapeutic Function: Progestin

Chemical Name: 13-ethyl-17-hydroxy-18,19-dinor-17 α -pregn-4-en-20-yn-3-one

Common Name: 17 α -ethynyl-18-homo-19-nortestosterone

Structural Formula:

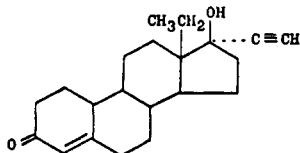

Chemical Abstracts Registry No.: 797-63-7

Trade Name	Manufacturer	Country	Year Introduced
Ovrette	Wyeth	U.S.	1968
Eugynon	Schering	Italy	1969
Neogest	Schering	U.K.	1974
Microlut	Schering	W. Germany	1974
Planovar	Wyeth	Japan	1979
Duoluton	Schering	Japan	1979
Prempak	Ayerst	U.K.	—

Raw Materials

(±)-1,4-Dihydro-17 α -ethynyl-18-homo-oestradiol 3-methyl ether
Hydrogen chloride

Manufacturing Process

To 0.7 gram of (±)-1,4-dihydro-17 α -ethynyl-18-homo-oestradiol 3-methyl ether in 36 cc methanol was added 1.6 cc water and 2.4 cc concentrated hydrochloric acid. After standing at room temperature for 2 hours ether was added, and the washed and dried ethereal solution was evaporated, yielding a gum which was dissolved in 5 cc benzene and the solution absorbed on 50 grams of an activated fuller's earth. Elution with light petroleum containing increasing proportions of benzene gave a crystalline by-product: further elution with benzene containing a small proportion of ether gave a crystalline product which was recrystallized from ethyl acetate, yielding 0.11 gram of (±)-17 α -ethynyl-18-homo-19-nortestosterone, MP 203° to 206°C.

References

- Merck Index 6543
 Kleeman & Engel p. 648
 PDR pp. 1952, 1958, 1965
 OCDS Vol. 1 p. 167 (1977); 2, 151 (1980) & 3, 84 (1984)
 DOT 4 (1) 24 (1968)
 I.N. p. 690
 REM p. 993
 Hughes, G.A. and Smith, H.; British Patent 1,041,280; September 1, 1966

NORTRIPTYLINE

Therapeutic Function: Antidepressant

Chemical Name: 3-(10,11-Dihydro-5H-dibenzo[a,d]cyclohepten-5-ylidene)-N-methyl-1-propanamine

Common Name: Desmethylamitriptyline; desitriptyline

Structural Formula:

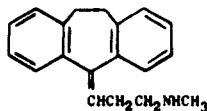

Chemical Abstracts Registry No.: 72-69-5; 894-71-3 (Hydrochloride)

Trade Name	Manufacturer	Country	Year Introduced
Aventyl	Lilly	U.K.	1963
Nortrilen	Tropon	W. Germany	1964
Aventyl	Lilly	U.S.	1965
Psychostyl	Lilly	France	1966
Vividyl	Lilly	Italy	1967
Noritren	Dainippon	Japan	1971
Altilev	Squibb	France	1976
Pamelor	Sandoz	U.S.	1977
Allegron	Dista	U.K.	—
Ateben	Sintyal	Argentina	—
Martimil	Lafarquín	Spain	—
Nortylin	Ikapharm	Israel	—
Norzepine	Bial	Portugal	—
Sensaval	Pharmacia	Sweden	—

Raw Materials

5-(3-Chloropropylidene)dibenzo[a,d]cyclohepta[1,4]diene
Methylamine

Manufacturing Process

A mixture of 114.5 g of 5-(3-chloropropylidene)dibenzo[a,d]cyclohepta[1,4]diene, 75 ml of benzene, and about 400 ml of methylamine is heated in an autoclave at 120°C for six hours. The excess methylamine is distilled from the reaction mixture under vacuum and the residue is stirred with 300 ml of water. Acidification of the mixture with hydrochloric acid causes the separation of the hydrochloride of 5-(3-methylaminopropylidene)dibenzo[a,d]cyclohepta[1,4]diene. The product is collected by filtration and is purified by recrystallization from a mixture of absolute ethanol and ethyl acetate. MP 210°C to 212°C.

References

Merck Index 6558

Kleeman & Engel p. 651

PDR p. 1588

OCDS Vol. 1 p. 151 (1977)

DOT 1 (1) 22 (1965) & 9 (6) 219 (1973)

I.N. p. 691

REM p. 1096

Peters, L.R. and Hennion, G.F.; U.S. Patent 3,281,469; October 25, 1966; assigned to Eli Lilly & Co.

NOVOBIOCIN

Therapeutic Function: Antibiotic

Chemical Name: N-[7-[[3-O-(aminocarbonyl)-5,5-di-C-methyl-4-O-methyl- α -L-lyxopyranosyl]oxy]-4-hydroxy-8-methyl-2-oxo-2H-1-benzopyran-3-yl]-4-hydroxy-3-(3-methyl-2-butenyl)benzamide

Common Name: Streptonivicin

Structural Formula:

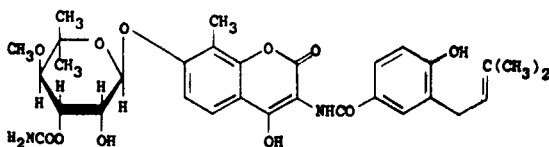

Chemical Abstracts Registry No.: 303-81-1

Trade Name	Manufacturer	Country	Year Introduced
Albamycin	Upjohn	U.S.	1956
Cathomycin	MSD	U.S.	1956
Cathomycine	Theraplix	France	1957
Albiocin	Upjohn	Japan	—
Inamycin	Hoechst	W. Germany	—
Robiocina	San Carlo	Italy	—
Stilbiocina	Donatello	Italy	—

Raw Materials

Bacterium *Streptomyces spheroides*
Soybean meal
Dextrose

Manufacturing Process

The preparation of novobiocin by fermentation is described in U.S. Patent 3,049,534 as follows: A medium containing 2% soybean meal, 1% dextrose, 0.25% sodium chloride and 0.75% distiller's solubles was made up in tap water. About 25 ml of the prepared medium was placed in a 75 ml vial and sterilized by heating at 120°C for 20 minutes. The sterilized medium was then inoculated with a vegetative culture of *Streptomyces spheroides* MA-319 (NRRL 2449), and the vial loosely stoppered with cotton. The vial was then placed on a shaking machine with an amplitude of 1½ inches at 28°C for 6 days. At the end of this fermentation time, the fermented broth was assayed using the cylinder-plate method with *Bacillus megatherium* ATCC 9885 as the assay organism and found to have an activity of 600 units/ml or 30 mcg/ml of novobiocin. The production of larger quantities of novobiocin by submerged fermentation in suitable tanks is also described in U.S. Patent 3,049,534.

The preparation of novobiocin by a synthetic route is described in U.S. Patent 2,966,484, as well as in U.S. Patent 2,925,411.

References

- Merck Index 6563
Kleeman & Engel p. 652
I.N. p. 693
REM p. 1212
Stammer, C.H.; U.S. Patent 2,925,411; February 16, 1960
Walton, E. and Spencer, C.; U.S. Patent 2,966,484; December 27, 1960; assigned to Merck & Co., Inc.
Caron, E.L., Johnson, J.L., Hinman, J.W. and Hoeksema, H.; U.S. Patent 2,983,723; May 9, 1961; assigned to The Upjohn Company
Wolf, F.J.; U.S. Patent 3,000,873; September 19, 1961; assigned to Merck & Co., Inc.
Stammer, C.H. and Miller, I.M.; U.S. Patent 3,049,475; August 14, 1962; assigned to Merck & Co., Inc.
Miller, I.M.; U.S. Patent 3,049,476; August 14, 1962; assigned to Merck & Co., Inc.
Wallick, H.; U.S. Patent 3,049,534; August 14, 1962; assigned to Merck & Co., Inc.
French, G.H.; U.S. Patent 3,068,221; December 11, 1962; assigned to The Upjohn Co.

NOXIPTILIN

Therapeutic Function: Psychostimulant

Chemical Name: 10,11-dihydro-5H-dibenzo[α , d] cyclohepten-5-one O-[2-(dimethylamino)-ethyl] oxime

Common Name: Dibenzoxin

Structural Formula:

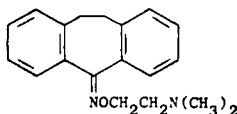

Chemical Abstracts Registry No.: 3362-45-6; 4985-15-3 (Hydrochloride)

Trade Name	Manufacturer	Country	Year Introduced
Agedal	Bayer	W. Germany	1969
Agedal	Bayer	Italy	1975
Nogedal	Theraplix	France	1978
Elronon	Deutsches Hydrierwerk	E. Germany	—
Sipcar	Bernabo	Argentina	—

Raw Materials

5-Keto-10,11-dihydrodibenzo(a,d)cycloheptene
 Hydroxylamine hydrochloride
 Sodium amide
 β -(Dimethylamino)ethyl chloride

Manufacturing Process

15 grams 5-keto-10,11-dihydrodibenzo-(a,d)cycloheptene dissolved in 225 ml of pyridine was mixed with 15 grams hydroxylamine hydrochloride, and the mixture was boiled under reflux for 22 hours. The bulk of the pyridine was then distilled off under reduced pressure, the residue was poured into water, and the aqueous mixture thus formed was extracted with ether.

The ether extract was washed with water, dried and heated to distill off the ether. The solid residue was recrystallized from a mixture of benzene and light petroleum (BP 40° to 60°C). 12.8 grams of the recrystallized oxime had a MP of 167° to 169°C.

A solution of 22 grams of the above described 5-oximino-10,11-dihydrodibenzo-(a,d)cycloheptene in 120 ml benzene was treated with 7.8 grams sodamide and the mixture was stirred and heated under reflux for 2 hours. At this stage, the 14.4 grams of hydrochloride of β -(dimethylamino)ethyl chloride was added and heating under reflux was continued for 16 hours. 50 ml water was then cautiously added to decompose unreacted sodamide and the benzene layer was separated and extracted with dilute (10%) aqueous hydrochloric acid.

The aqueous acid extracts were made alkaline with concentrated aqueous potassium hydroxide solution and then extracted with ether. The ether extracts were dried, the solvent was removed and the residual oil was distilled under reduced pressure. The product was 14.5 grams of the fraction boiling at 160° to 164°C, under a pressure of 0.05 mm of mercury.

References

Merck Index 6566
 Kleeman & Engel p. 653
 DOT 6 (2) 56 (1970)
 I.N. p. 695

Wrigley, T.I. and Leeming, P.R.; British Patent 1,045,911; October 19, 1966; assigned to Pfizer Limited, England
 Schutz, S. and Hoffmeister, F.; U.S. Patent 3,505,321; April 7, 1970; assigned to Farbenfabriken Bayer A.G.

NOXYTIOLIN

Therapeutic Function: Antifungal

Chemical Name: 1-Methyl-3-hydroxymethyl-2-thiourea

Common Name: —

Structural Formula:

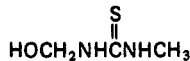

Chemical Abstracts Registry No.: 15599-39-0

Trade Name	Manufacturer	Country	Year Introduced
Noxyflex	Geistlich	U.K.	1964
Noxyflex	Innothera	France	1978
Gynaflex	Geistlich	Switz.	—

Raw Materials

Methyl thiourea
 Formaldehyde

Manufacturing Process

400 g methyl thiourea and 2.5 g NaHCO₃ are dissolved in 400 ml formaldehyde solution of 35% concentration. After having been left at ordinary temperature for 2 to 3 hours, the solution is adjusted with dilute HCl to pH 7 to 7.5. After the reaction mixture had been left overnight at 15°C some of the final product crystallized and was filtered off using a Buchner funnel. The mother liquor was concentrated by evaporation in vacuo at a bath-temperature of 30°C. The crystals obtained were again collected by filtration using a Buchner funnel and were combined with the first crystalline fraction and dried in vacuo at ordinary temperature. Yield of pure substance 400 g; melting point 84°C to 86°C.

References

Merck Index 6567
 Kleeman & Engel p. 653
 DOT 4 (3) 106 (1968)
 I.N. p. 695

Aebi, A. and Hafstetter, E.; British Patent 970,414; January 12, 1960; assigned to Ed Geistlich Sohne AG fur Chemische Industrie.

NYLIDRIN

Therapeutic Function: Peripheral vasodilator

Chemical Name: 4-hydroxy- α -[1-[(1-methyl-3-phenylpropyl)amino] ethyl] benzenemethanol

Common Name: Buphenine

Structural Formula:

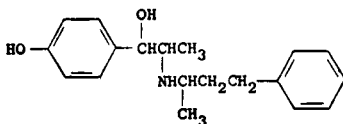

Chemical Abstracts Registry No.: 447-41-6; 849-55-8 (Hydrochloride)

Trade Name	Manufacturer	Country	Year Introduced
Arlidin	U.S.V.	U.S.	1955
Arlibide	U.S.V.	Argentina	—
Bufedon	Cosmopharma	Neth.	—
Buphedrin	Tatsumi	Japan	—
Dilatol	Tropon	W. Germany	—
Dilatropon	Draco	Sweden	—
Dilaver	Neopharma	Finland	—
Dilydrin	Medichemie	Switz.	—
Nyderal	Kobayashi	Japan	—
Nylin	Toho	Japan	—
Opino	Bayropharm	W. Germany	—
Penitardon	Woelm	W. Germany	—
Perdilal	Abdi Ibrahim	Turkey	—
Perdilatal	Smith & Nephew	U.K.	—
Pervadil	I.C.N.	Canada	—
Pharmadil	Pharmacia	Sweden	—
Rudilin	Darby	U.S.	—
Rydrin	Kodama	Japan	—
Shatorn	Seiko	Japan	—
Tacodilydrin	Swiss Pharma	W. Germany	—
Tocodrin	Medichemie	Switz.	—
Vasiten	Crinos	Italy	—
Verina	Fujisawa	Japan	—

Raw Materials

p-Benzoxy- α -bromopropiophenone
 1-Phenyl-3-aminobutane
 Hydrogen

Manufacturing Process

8 grams of the hydrobromide of 1-(p-benzoxyphenyl)-2-(α -methyl- γ -phenyl-propylamino)-propanone-(1) were obtained by heating equivalent quantities of p-benzoxy- α -bromopropiophenone and 1-phenyl-3-amino-butane for an hour on the water bath in the absence of solvents. The product was purified by twice boiling with five times the quantity of acetic acid and filtration at 80°C, then shaken in contact with hydrogen with 0.8 gram of Raney nickel in 70 cc of pure methanol containing 0.96 gram (corresponding to 1 mol) of KOH. After 4 hours 2 mols of hydrogen had been taken up and the solution was filtered from the catalyst, evaporated in vacuo, and the residue triturated first with water to remove potassium bromide and then with methanol to remove potassium bromide. 3.7 grams (72% of the theoretical yield) of the compound specified, melting at 110° to 112°C, were obtained, as described in U.S. Patent 2,661,373.

References

Merck Index 6577

Kleeman & Engel p. 123

PDR pp. 830, 993, 1606, 1809, 1999

OCDS Vol. 1 p. 69 (1977)

I.N., p. 163

REM p. 892

Schöpf, C. and Kunz, K.J.; U.S. Patent 2,661,372; December 1, 1953; assigned to Troponwerke Dinklage & Co., Germany

Külz, F. and Schöpf, C.; U.S. Patent 2,661,373; December 1, 1953

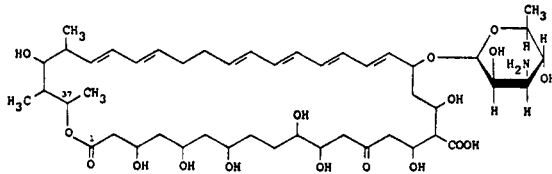
NYSTATIN**Therapeutic Function:** Antifungal**Chemical Name:** See structural formula**Common Name:** —**Structural Formula:****Chemical Abstracts Registry No.:** 1400-61-9

Trade Name	Manufacturer	Country	Year Introduced
Mycostatin	Squibb	U.S.	1954
Mycostatine	Squibb	France	1956
Nysta-Dome	Dome	U.S.	1964
Nilstat	Lederle	U.S.	1970
Nysert	Norwich-Eaton	U.S.	1979
Multilind	F.A.I.R.	U.K.	1979
Nystex	Savage	U.S.	1983
Biofanal	Pfleger	W. Germany	—
Candex	Dome	U.S.	—
Candio-Hermal	Hermal	W. Germany	—
Herniocid	Mayrhofer	Austria	—
Korostatin	Holland-Rantos	U.S.	—
Mycolog	Squibb	U.S.	—
Myc-Triacet	Lemmon	U.S.	—
Mytrex	Savage	U.S.	—
Nadostine	Nadeau	Canada	—
Nyaderm	K-Line	Canada	—
Nystacid	Farmos	Finland	—
Nyst-olone	Schein	U.S.	—
Rivostatin	Rivopharm	Switz.	—
Stereomycin	Medica	Finland	—

Raw Materials

Bacterium *Streptomyces noursei*
Nutrient medium

Manufacturing Process

A typical isolation and recovery procedure for nystatin is described in U.S. Patent 2,797,183 and is shown in the following diagram:

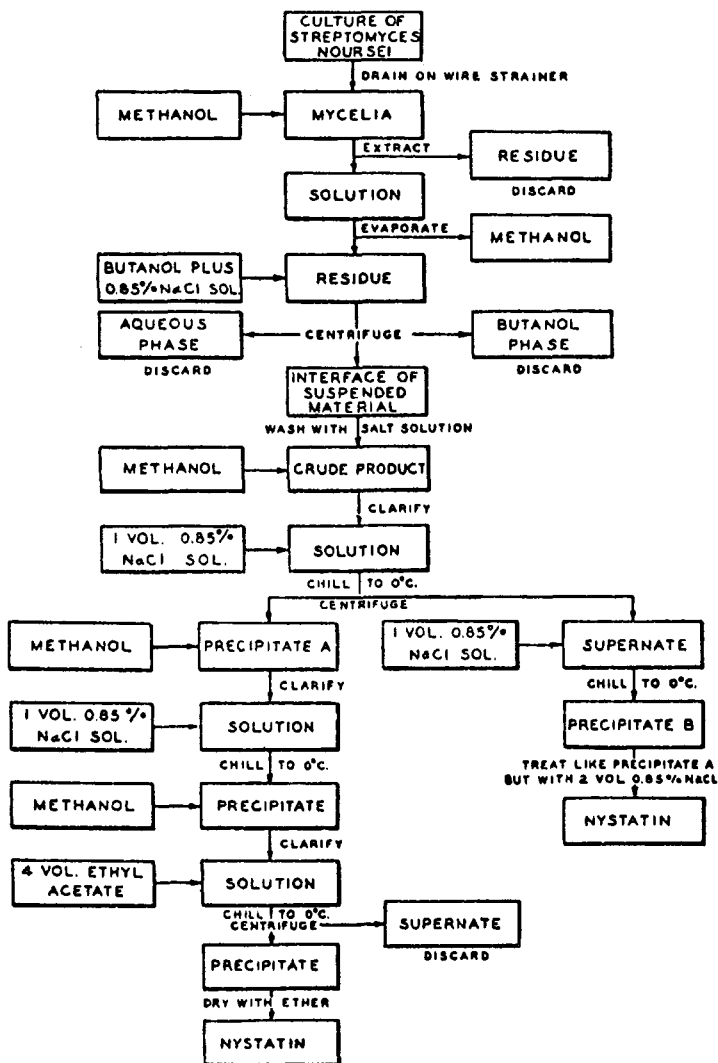

References

- Merck Index 6580
- Kleeman & Engel p. 654
- PDR pp. 888, 1022, 1034, 1429, 1604, 1751
- I.N. p. 696
- REM p. 1230

Vandeputte, J. and Gold, W.; U.S. Patent 2,786,781; March 26, 1957; assigned to Olin Mathieson Chemical Corporation
Hazen, E.L. and Brown, R.F.; U.S. Patent 2,797,183; June 15, 1957; assigned to Research Corporation
Vandeputte, J.; U.S. Patent 2,832,719; April 29, 1958; assigned to Olin Mathieson Chemical Corporation
Renella, J.G.; U.S. Patent 3,517,100; June 23, 1970; assigned to American Cyanamid Co.



OCTOPAMINE HYDROCHLORIDE

Therapeutic Function: Hypertensive

Chemical Name: α -(aminomethyl)-4-hydroxybenzene-methanol hydrochloride

Common Name: Norsympatol hydrochloride; norsynephrine hydrochloride

Structural Formula:

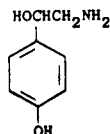

(base)

Chemical Abstracts Registry No.: 770-05-8; 104-14-3 (Base)

Trade Name	Manufacturer	Country	Year Introduced
Norfen	Morishita	Japan	1975
Depot-Norphen	Byk Gulden	W. Germany	—
Norphen	Byk Gulden	W. Germany	—

Raw Materials

Phenol	Aminoacetonitrile
Hydrogen chloride	Hydrogen

Manufacturing Process

A solution of 33 grams of anhydrous aluminum chloride in 60 grams of nitrobenzene, to which a mixture of 14 grams of phenol and 9.3 grams of hydrochloride of amino-acetonitrile was added, had dry hydrochloric acid gas introduced into it for 3 hours, while stirring and cooling to keep the temperature between 20° and 30°C. The reaction mixture was then poured, with cooling, into 70 cc of water and the deposit obtained was sucked off, washed with acetone and dissolved in 300 cc of water. The solution thus prepared was decolorized with carbon, 50 grams of 30% sodium citrate solution was added to it, and then it was made slightly alkaline with ammonia. Thereupon hydroxy-4'-phenyl-1-amino-2-ethanone crystallized out in the form of leaflets. The yield was 7.7 grams.

The hydrochloride of this base, obtained by evaporation to dryness of a solution of the base in dilute hydrochloric acid and subsequent treatment of the residue with ethyl alcohol and acetone, had a chlorine content of 18.84%, (calculated, 18.90%).

This hydrochloride, on being dissolved in water and hydrogenated with hydrogen and a nickel catalyst, gave a good yield of hydrochloride of hydroxy-4'-phenyl-1-amino-2-ethanol melting, after crystallization from a mixture of ethyl alcohol and butanone-2, at from 177° to 179°C with decomposition.

References

Merck Index 6599

Kleeman & Engel p. 655

I.N. p. 699

Asscher, M.; U.S. Patent 2,585,988; February 19, 1952

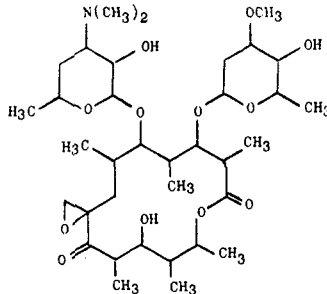
OLEANDOMYCIN**Therapeutic Function:** Antibiotic**Chemical Name:** Oleandomycin; see Structural Formula**Common Name:** Troleandomycin**Structural Formula:****Chemical Abstracts Registry No.:** 3922-90-5

Trade Name	Manufacturer	Country	Year Introduced
Matromycin	Pfizer	U.S.	1956
Oleandocyn	Pfizer	W. Germany	—
Olmicina	Morgan	Italy	—
Sigmamycin	Pfizer	Japan	—
Taacin-O	Sankyo	Japan	—
TAO	Roerig	U.S.	—
Triolmicina	Ripari-Gero	Italy	—

Raw Materials

Bacterium *Streptomyces antibioticus*
 Dextrose
 Soybean meal

Manufacturing Process

A slant of *S. antibioticus* ATCC 11891 was cultivated on agar under controlled conditions in order to develop spores for the purpose of inoculating a nutrient medium having the following composition: 20 g Cerelese (dextrose hydrate), 15 g soybean meal, 5 g distillers' solubles, 10 g cornmeal, and tap water, in a sufficient amount for a 1,000-ml solution, adjusted to pH 7.0 to 7.2 with potassium hydroxide.

After the pH was adjusted, 5 g of calcium carbonate was added. This inoculum medium was then subjected to heat sterilization. The medium was then cooled and 2 ml of a spore sus-

pension of an oleandomycin-producing strain of *S. antibioticus* was added under aseptic conditions. The cultivation of the organism was conducted in shaken flasks at 28°C for a period of 48 hours.

The mixture of broth and mycelium thus formed was then transferred under aseptic conditions to a 3-liter fermentor containing 2,000 ml of a sterile fermentation medium having the following composition: 60 g Cerelese (dextrose hydrate), 18 g soybean meal, 5 g distillers' solubles, 12 g cornmeal and tap water in a sufficient amount for a 1,000-ml total volume, adjusted to pH 7.0 to 7.2 with potassium hydroxide.

After the pH had been adjusted, 5 g of calcium carbonate, 5 ml of soybean oil antifoam and 0.020 g of Acridine Orange dye were added. The mixture was then autoclaved at 20 psi (250°F) for 15 minutes in order to sterilize the contents, before transferring the broth and mycelium thereto.

After seeding the nutrient medium with the preformed inoculum previously described, the mixture was subjected to agitation and aeration under aseptic conditions for 72 hours; at 27°C to 28°C for the first 24 hours, then at 25°C to 26°C for the next 48 hours; during this period, the pH was in the range of 6.4 to 6.8. Aeration was accomplished by cultivation under submerged conditions at an air flow rate of one volume of air per volume of medium per minute. After termination of the process, the mycelium was removed by filtration and the filtered broth found to contain 450 γ of oleandomycin per ml of solution.

References

Merck Index 6703

Kleeman & Engel p. 657

I.N. p. 701

Sobin, B.A., Routien, J.B. and Lees, T.W.; U.S. Patent 2,757,123; July 31, 1956; assigned to Chas. Pfizer & Co., Inc.

Ratajak, E.J. and Nubel, R.C.; U.S. Patent 2,842,481; July 8, 1958; assigned to Chas. Pfizer & Co., Inc.

OPIPRAMOL

Therapeutic Function: Antidepressant; antipsychotic

Chemical Name: 4-[3-(5H-Dibenz[b,f]azepin-5-yl)propyl]-1-piperazine-ethanol

Common Name: —

Structural Formula:

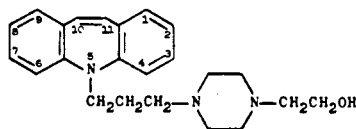

Chemical Abstracts Registry No.: 315-72-0; 909-39-7 (Dihydrochloride)

Trade Name	Manufacturer	Country	Year Introduced
Insidon	Geigy	W. Germany	1962
Insidon	Geigy	France	1962
Insidon	Geigy	Italy	1962
Deprenil	Yurtoglu	Turkey	—
Ensidon	Ciba-Geigy	U.S.	—

Trade Name	Manufacturer	Country	Year Introduced
Oprimol	Taro	Israel	—
Pramolan	Polfa	Poland	—

Raw Materials

5-(3-Toluene-p-sulfonyloxypropyl)dibenzazepine
1-(2-Hydroxyethyl)piperazine

Manufacturing Process

A solution of 5-(3-toluene-p-sulfonyloxypropyl)dibenzazepine (9.2 g) and 1-(2-hydroxyethyl)piperazine (8.6 g) in anhydrous toluene (50 cc) is heated at boiling point under reflux for 4 hours.

After cooling, distilled water (75 cc) is added. The aqueous phase is decanted. The toluene solution is washed with distilled water (25 cc) and then extracted with N-hydrochloric acid (40 cc). The hydrochloric acid solution is made alkaline to phenolphthalein with sodium hydroxide (d = 1.33). The base which separates is extracted with chloroform (50 cc). The chloroform solution is dried over anhydrous sodium sulfate and then evaporated to dryness. There are obtained 5-[3-(4-β-hydroxyethylpiperazino)propyl]-dibenzazepine (7.95 g), the dihydrochloride of which, crystallized from ethanol, melts at about 210°C.

References

Merck Index 6727

Kleeman & Engel p. 657

I.N. p. 703

Gaillot, P. and Gaudechon, J.; British Patent 881,398; November 1, 1961; assigned to Societe des Usines Chimiques Rhone-Poulenc

ORAZAMIDE

Therapeutic Function: Treatment of liver diseases

Chemical Name: 5-aminoimidazole-4-carboxamide orotate

Common Name: AICA orotate

Structural Formula:

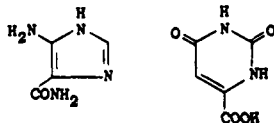

Chemical Abstracts Registry No.: 2574-78-9

Trade Name	Manufacturer	Country	Year Introduced
Aicamine	Labaz	France	1971
Aicurat	Mack	W. Germany	1962
Aicamin	Crinos	Italy	1977
Aicamin	Fujisawa	Japan	—

Raw Materials

4-Amino-5-imidazolecarboxamide
Orotic acid

Manufacturing Process

14.4 grams of 4-amino-5-imidazolecarboxamide (monohydrate) and 17.4 grams of orotic acid (monohydrate) were dissolved with heating in 600 cc of water. The solution is decolorized with Norit, cooled and then filtered off. 28.8 grams of a white crystalline salt (dihydrate) is obtained with MP 284°C (decomposition).

References

Merck Index 6739

Kleeman & Engel p. 658

I.N. p. 704

Haraoka, R. and Kamiya, T.; U.S. Patent 3,271,398; September 6, 1966; assigned to Fujisawa Pharmaceutical Co., Ltd., Japan

ORGOTEIN

Therapeutic Function: Antiinflammatory

Common Name: Ormetein

Structural Formula: Orgotein is a complex protein with a molecular weight of about 33,000. It is a divalent metal (Mg, Cu, Zn) chelated structure.

Chemical Abstracts Registry No.: 9016-01-7

Trade Name	Manufacturer	Country	Year Introduced
Ontosein	Gruenthal	W. Germany	1980
Peroxinorm	Protochemie	Switz.	1982
Peroxinorm	Gruenthal	Japan	1982
Oxinorm	Zambeletti	Italy	—

Raw Materials

Beef blood
Ethanol
Chloroform

Manufacturing Process

Fresh beef blood was centrifuged, e.g., at about 2,600 to 5,000 $\times g$ for 10 minutes at 0°C and the plasma decanted. The red blood cells were then washed at least twice and preferably repeatedly with 2 to 3 volumes of 0.9% saline solution. The washed red blood cells were lysed by mixing with 1.1 volumes of cold deionized water containing 0.02% detergent (Saponin). After a minimum of 30 minutes at 4°C with stirring, 0.25 volume (per volume of hemolysate) of ethyl alcohol at -15°C was slowly added while stirring followed by 0.31 volume (per volume of hemolysate) of chloroform, also at -15°C. Stirring was continued for about 15 minutes at -5°C or below, at which time, the mixture was a thick paste. The hemoglobin precipitation was carried out in a cold bath which was kept at below -10°C. After the paste had stood for a further 15 minutes at 4°C, 0.2 volume of cold 0.15M NaCl solution was added, giving an easily poured suspension. The precipitate and excess chloroform were removed by centrifuging at about 12,000 to 20,000 $\times g$ at about -10°C for 10 minutes. The supernatant liquid was removed and if desired, filtered and briefly dialyzed against cold-deionized water, prior to lyophilization.

The alcohol-chloroform precipitate was dislodged, chloroform was removed, the pellet broken

up and reextracted with about an equal amount of deionized water by blending the precipitate and the water in a blender and thereafter centrifuging. The reextraction solution was dialyzed and lyophilized with the main extract. If the process proceeds normally, the reextraction of the precipitated hemoglobin usually yields up to 30% of protein mixture present in the original supernatant. An additional reextraction may give an additional 5 to 15%.

The lyophilized material was redissolved in 0.025M tris-glycine buffer containing 0.001 M Mn^{2+} at pH 7.5 (usually to a concentration of 20 mg/ml). The solution was heated at or near 65°C for about 15 minutes. This step removes the carbonic anhydrase and other heat labile proteins from the solution. After heating, the solution was rapidly cooled in an ice bath to 5°C. The solution was then centrifuged at 20,000 x g at 0°C for 10 minutes to remove the precipitate. Filtration through "Versapore" works equally well. The supernatant was thoroughly dialyzed against deionized water to remove excess metal ions and buffer and then lyophilized. The resulting solid consists largely of orgotein.

References

Merck Index 6742

DOT 9 (1) 34 (1973; 11 (3) 103(1975) & 13 (3) 105 (1977)

I.N. p. 705

Huber, W.; U.S. Patent 3,579,495; May 18, 1971; assigned to Diagnostic Data, Inc.

Huber, W.; U.S. Patent 3,687,927; August 29, 1972; assigned to Diagnostic Data, Inc.

ORNIDAZOLE

Therapeutic Function: Antif Infective

Chemical Name: α -(Chloromethyl)-2-methyl-5-nitro-1H-imidazole-1-ethanol

Common Name: —

Structural Formula:

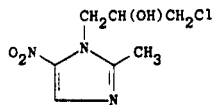

Chemical Abstracts Registry No.: 16773-42-5

Trade Name	Manufacturer	Country	Year Introduced
Tiberal	Roche	W. Germany	1977
Tiberal	Roche	Italy	1981
Tiberal	Roche	France	1981
Tiberal	Roche	Switz.	1982
Tiberal	Roche	Australia	1983
Kolpicid	Roche	Sweden	1983
Madelen	Finadiet	Argentina	—
Ornidal	Selvi	Italy	—

Raw Materials

1-(2,3-Epoxypropyl)-2-methyl-5-nitroimidazole
Hydrogen chloride

Manufacturing Process

5 g of 1-(2,3-epoxypropyl)-2-methyl-5-nitroimidazole was added to 30 ml of concentrated

aqueous hydrochloric acid. The solution was heated to the boiling point for 20 minutes, chilled, diluted with 30 ml of water and carefully neutralized with ammonia to a pH of 7 to 8. It was then saturated with ammonium sulfate. The precipitated oil crystallized after several days. Recrystallized from toluene, there was obtained the 1-(3-chloro-2-hydroxypropyl)-2-methyl-5-nitroimidazole product melting at 77°C to 78°C.

References

Merck Index 6746

OCDS Vol. 3 p. 131 (1984)

DOT 11 (9) 369 (1975)

I.N. p. 706

REM p. 1224

Hoffer, M.; U.S. Patent 3,435,049; March 25, 1969; assigned to Hoffmann-LaRoche, Inc.

ORNIPRESSIN

Therapeutic Function: Vasoconstrictor

Chemical Name: 8-L-Ornithinevasopressin

Common Name: —

Structural Formula: Cys-Tyr-Phe-Gln-Asn-Cys-Pro-Orn-GlyNH₂

Chemical Abstracts Registry No.: 3397-23-7

Trade Name	Manufacturer	Country	Year Introduced
POR-8	Sandoz	W. Germany	1977

Raw Materials

N- α -Carbobenzoxymethyl-N-(3-toluenesulfonyl)-L-ornithine

Glycine ethyl ester

N-Carbobenzoxymethyl-L-proline

N-Carbobenzoxymethyl-L-glutamyl-L-asparagyl-S-benzyl-L-cysteinyl azide

N-Carbobenzoxymethyl-S-benzyl-L-cysteinyl-L-tyrosyl-L-phenylalanine azide

Sodium

Ammonia

Manufacturing Process

(a) *N- α -carbobenzoxymethyl-N-(3-toluenesulfonyl)-L-ornithyl-glycine ethyl ester:* 104 g of N- α -carbobenzoxymethyl-N-(3-toluenesulfonyl)-L-ornithine and 27 g of glycine ethyl ester are dissolved in 450 cc of acetonitrile, the mixture is cooled at 0°C, 51 g of dicyclohexyl carbodiimide are added and the mixture is shaken at room temperature for 4 hours. Precipitated dicyclohexyl urea is filtered off and washed with acetonitrile. The whole filtrate is evaporated in a vacuum. The residue crystallizes after the addition of petroleum ether. After recrystallization from n-propanol, 93 g of N- α -carbobenzoxymethyl-N-(3-toluenesulfonyl)-L-ornithyl-glycine ethyl ester are obtained; melting point 136°C; $[\alpha]_D^{22} = -6.5^\circ$ (96% ethanol).

(b) *N-carbobenzoxymethyl-L-prolyl-N-(3-toluenesulfonyl)-L-ornithyl-glycinamide:* 90 g of N- α -carbobenzoxymethyl-N-(3-toluenesulfonyl)-L-ornithyl-glycine ethyl ester are dissolved in 800 cc of anhydrous acetic acid which has been saturated with hydrogen bromide. The mixture is left to stand for one hour at 20°C, evaporated in a vacuum at a temperature below 40°C and the residue washed carefully with diethyl ether. The residue is dissolved in 500 cc of acetonitrile, 25 cc of triethylamine and 43 g of N-carbobenzoxymethyl-L-proline are added, cooling is

effected at 0°C, 35.5 g of dicyclohexyl carbodiimide are then added and the mixture shaken overnight at 20°C. After filtering off dicyclohexyl urea, the filtrate is evaporated in a vacuum at 30°C, the residue dissolved in ethyl acetate and this solution is washed with dilute sulfuric acid and aqueous ammonia. After drying over sodium sulfate, the ethyl acetate is removed by evaporation in a vacuum and the residue dissolved in 1 liter of absolute ethanol. The solution is cooled at 0°C, saturated with ammonia and left to stand overnight at 20°C. After evaporating in a vacuum at 30°C, the residue is recrystallized from dimethylformamide/ethyl acetate. 58 g of N-carbobenzoxy-L-prolyl-N- δ -p-toluenesulfonyl-L-ornithyl-glycinamide are obtained; melting point 122°C (with decomposition).

(c) N-carbobenzoxy-L-glutamyl-L-asparagyl-S-benzyl-L-cysteinyl-L-prolyl-N- δ -p-toluenesulfonyl-L-ornithyl-glycinamide: 100 g of N-carbobenzoxy-L-prolyl-N- δ -p-toluenesulfonyl-L-ornithyl-glycinamide are dissolved in 500 cc of anhydrous acetic acid which has been saturated with hydrogen bromide, the solution is left to stand for one hour at 20°C and is evaporated in a vacuum at a temperature below 40°C. The residue is carefully washed with diethyl ether and then added to a solution of 100 g of N-carbobenzoxy-L-glutamyl-L-asparagyl-S-benzyl-L-cysteinyl-azide and 26 cc of triethylamine in 1,000 cc of dimethylformamide. The mixture is left to stand overnight at 20°C, 3,000 cc of ethyl acetate are added thereto, the precipitate is filtered off and washing is effected with ethyl acetate. 105 g of N-carbobenzoxy-L-glutamyl-L-asparagyl-S-benzyl-L-cysteinyl-L-prolyl-N- δ -p-toluenesulfonyl-L-ornithyl-glycinamide are obtained; melting point 193°C; $[\alpha]_D^{20} = -38.5^\circ$ (dimethylformamide).

(d) N-carbobenzoxy-S-benzyl-L-cysteinyl-L-tyrosyl-L-phenyl-alanyl-L-glutamyl-L-asparagyl-S-benzyl-L-cysteinyl-L-prolyl-N- δ -p-toluenesulfonyl-L-ornithyl-glycinamide: 50 g N-carbobenzoxy-L-glutamyl-L-asparagyl-S-benzyl-L-cysteinyl-L-prolyl-N- δ -p-toluenesulfonyl-L-ornithyl-glycinamide are dissolved in 250 cc of anhydrous acetic acid which has been saturated with hydrogen bromide and the solution is left to stand for one hour at 20°C. After evaporating the solvent in a vacuum at a temperature below 40°C, the residue is carefully washed with diethyl ether and a solution of 31.5 g of N-carbobenzoxy-S-benzyl-L-cysteinyl-L-tyrosyl-L-phenylalanine-azide and 7.5 cc of triethylamine in 250 cc of dimethylformamide is added thereto. The mixture is left to stand for 2 days at 20°C, 1,000 cc of ethyl acetate are subsequently added and the precipitate is washed with ethyl acetate. After drying in a vacuum at 30°C, the product is washed with warm methanol. 45 g of N-carbobenzoxy-S-benzyl-L-cysteinyl-L-tyrosyl-L-phenylalanyl-L-glutamyl-L-asparagyl-S-benzyl-L-cysteinyl-L-prolyl-N- δ -p-toluenesulfonyl-L-ornithyl-glycinamide are obtained; melting point 224°C.

(e) L-cysteinyl-L-tyrosyl-L-phenylalanyl-L-glutamyl-L-asparagyl-L-cysteinyl-L-prolyl-L-ornithyl-glycinamide: The necessary amount of sodium or potassium metal is added to a solution of 5 g of N-carbobenzoxy-S-benzyl-L-cysteinyl-L-tyrosyl-L-phenylalanyl-L-glutamyl-L-asparagyl-S-benzyl-L-cysteinyl-L-prolyl-N- δ -p-toluenesulfonyl-L-ornithyl-glycinamide in 1,200 cc of dry liquid ammonia, while stirring at the boiling temperature of the solution, to give a stable blue coloration. After the addition of 3 g of ammonium chloride, the solution is evaporated to dryness. The residue contains L-cysteinyl-L-tyrosyl-L-phenyl-alanyl-L-glutamyl-L-asparagyl-L-cysteinyl-L-prolyl-L-ornithyl-glycinamide.

References

Merck Index 6747

DOT 13 (11) 498 (1977)

I.N. p. 706

Boissonnas, R. and Huguenin, R.; U.S. Patent 3,299,036; January 17, 1967; assigned to Sandoz Ltd. (Switzerland)

ORPHENADRINE CITRATE

Therapeutic Function: Muscle relaxant

Chemical Name: N,N-dimethyl-2-[(2-methylphenyl)phenylmethoxy] ethanamine citrate

Common Name: —

Structural Formula:

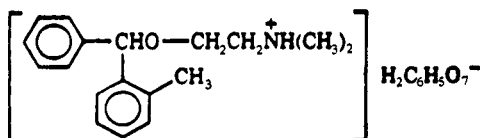

Chemical Abstracts Registry No.: 4682-36-4; 83-98-7 (Base)

Trade Name	Manufacturer	Country	Year Introduced
Norflex	Riker	U.S.	1959
Neocytan	Central	U.S.	1975
X-Otag	Tutag	U.S.	1976
Banflex	O'Neal, Jones	U.S.	1980
Bio-Flex	Foy	U.S.	—
Flexin	Taro	Israel	—
Mioflex	Formenti	Italy	—
Myotrol	Legere	U.S.	—
Norgesic	Riker	U.S.	—
Ro-Orphena	Robinson	U.S.	—
Tega-Flex	Ortega	U.S.	—

Raw Materials

o-Methylbenzhydryl bromide
 β -Dimethylaminoethanol
 Citric acid

Manufacturing Process

As described in U.S. Patent 2,567,351, o-methylbenzhydryl bromide is added slowly to β -dimethylaminoethanol at refluxing temperature. After the addition has been completed the mixture is refluxed and stirred for an additional 16 hours. The mixture is cooled and the bottom layer consisting of the crude hydrobromide salt of β -dimethylaminoethanol is drawn off. The excess amino alcohol is distilled from the upper layer in vacuo and the residue is reacted with citric acid.

References

Merck Index 6752
 Kleeman & Engel p. 661
 PDR pp. 1033, 1452
 OCDS Vol. 1 p. 42 (1977)
 DOT 9 (6) 247 (1973) & 18 (2) 90 (1982)
 I.N. p. 707
 REM p. 932
 Rieveschi, G. Jr.; U.S. Patent 2,567,351; September 11, 1951; assigned to Parke, Davis & Company
 Harms, A.F.; U.S. Patent 2,991,225; July 4, 1961; assigned to NV Koninklijke Pharmaceutische Fabrieken, Netherlands

OXACEPROL

Therapeutic Function: Antirheumatic

Chemical Name: N-Acetyl-4-hydroxy-L-proline

Common Name: Aceprolinum

Structural Formula:

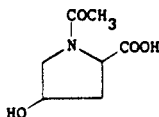

Chemical Abstracts Registry No.: 33996-33-7

Trade Name	Manufacturer	Country	Year Introduced
Jonctum	Merrell	France	1970
AHP-2000	Chephasaar	W. Germany	1975
Jonctum	Merrell	Italy	1978
Tejuntivo	Valderrama	Spain	—

Raw Materials

L-Hydroxyproline
Acetic anhydride

Manufacturing Process

16.7 g (0.127 mol) of L-hydroxyproline are dissolved in 400 ml of pure boiling acetic acid. With vigorous boiling and agitation, a mixture of 13.7 ml (0.154 mol) of rectified acetic anhydride and 250 ml of pure acetic acid is added during 25 minutes. Without discontinuing the stirring, contents of the flask are cooled by simply causing fresh air to circulate externally round the flask until the temperature of the mixture is reduced to about 35°C. The acetic acid is removed by using a rotary evaporator without exceeding 35°C under a vacuum of about 15 mm Hg. After one hour, 20 ml of anhydrous toluene are added, then 10 ml of anhydrous acetone; the mixture is homogenized and concentrated again as above during 30 minutes. Then 25 ml of acetone are added again, and subsequently 20 ml of toluene, the product being concentrated again; gradually the solution is converted into an amber-colored crystallized paste. Finally, 30 ml of acetone are added to the residue, and stirring is carried out until the oily fraction surrounding the crystals is dissolved. The product is then cooled in an ice chamber, centrifuged, washed with anhydrous acetone and eventually dried. After recrystallization from acetone, crystals are obtained, melting point 132°C.

References

Merck Index 90
Kleeman & Engel p. 662
DOT 12 (1) 9 (1976)
I.N. p. 709
Coirre, P. and Coirre, B.; British Patent 1,246,141; September 15, 1971

OXACILLIN SODIUM

Therapeutic Function: Antibacterial

Chemical Name: 3,3-dimethyl-6-(5-methyl-3-phenyl-4-isoxazolecarboxamido)-7-oxo-4-thia-1-azabicyclo[3.2.0]heptane-2-carboxylic acid, sodium salt

Common Name: 6-(5-methyl-3-phenyl-2-isoxazoline-4-carboxamido)penicillanic acid, sodium salt; 5-methyl-3-phenyl-4-isoxazolympenicillin, sodium salt

Structural Formula:

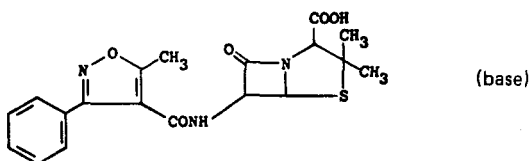

Chemical Abstracts Registry No.: 7240-38-2; 66-79-5 (Base)

Trade Name	Manufacturer	Country	Year Introduced
Resistopen	Squibb	U.S.	1962
Prostaphlin	Bristol	U.S.	1962
Cryptocillin	Hoechst	W. Germany	1962
Bristopen	Bristol	France	1963
Penstapho	Bristol	Italy	1966
Bactocill	Beecham	U.S.	1972
Oxabel	Sarva	Belgium	—
Penistafil	Antibioticos	Spain	—
Stapenor	Bayer	W. Germany	—
Staphcillin V	Banyu	Japan	—

Raw Materials

Benzaldehyde	Hydroxylamine
Chlorine	Ethyl acetoacetate
Thionyl chloride	6-Aminopenicillanic acid
Sodium bicarbonate	

Manufacturing Process

(A) Benzaldoxime: (Reference, Vogel, *Textbook of Practical Organic Chemistry*, page 883) — Materials: (Theoretical yield, 121.1 grams of free oxime), 106.1 grams (1.0 mol) of benzaldehyde (NF grade), 69.5 grams (1.0 mol) of hydroxylamine hydrochloride (practical grade), 68.0 grams (1.7 mol) of sodium hydroxide (pellet).

Procedure: The sodium hydroxide is dissolved in 200 ml water and the benzaldehyde is added. With continued stirring the hydroxylamine hydrochloride is added in portions. Some heat is developed and eventually the benzaldehyde dissolves. The solution is stirred for 15 minutes and then cooled in an ice-bath. A waxy, crystalline mass separates, and after further cooling it is collected by suction and dried in air. Yield is 86 to 149 grams. This crude material is suitable for step (B).

(B) Benzohydroxamic Chloride: [Reference, G.W. Perrold et al, *J. Am. Chem. Soc.*, 79, 462 (1957)] — Materials: 121 grams (0.77 mol) of crude benzaldoxime from step (A), 500 ml of 8.3 N hydrochloric acid, chlorine.

Procedure: The crude product from (A) is suspended in the hydrochloric acid, cooled in an ice-salt mixture, and chlorine is passed into the mixture with stirring for ½ to 1 hour. Transient blue and green colors may be noticed in the mixture during this time. The temperature will probably rise to 3° to 5°C. The solid is collected by suction filtration and dried for an hour or so on the filter before use in (C). If at all possible, it should be used on the day of preparation. Yield is 71 grams (after 1½ hours on the filter).

(C) 5-Methyl-3-Phenyl-4-Isoxazolecarboxylic Acid: [Reference, A. Quilico and R. Rusco, *Gazz. Chim. Ital.* 67, 589 (1937); *C.A.* 32, 2117⁷] — Materials: 71 grams (0.45 mol) of

crude benzohydroxamic chloride from (B), 78 grams (0.60 mol) of ethyl acetoacetate (practical grade), 34 grams (0.60 mol) of sodium methoxide (95% minimum), 400 ml of methanol (reagent grade).

Procedure: The sodium methoxide is cautiously added in portions to 200 ml of methanol with stirring. Some heat is evolved. To this warm solution is rapidly added the ethyl acetoacetate with continued stirring. The solution is stirred for 10 minutes and then cooled in an ice-salt-acetone mixture (-25°C). If desired a Dry Ice-acetone cooling bath may be used to shorten the addition time. The crude material from (B) is dissolved in 200 ml of methanol. At this point it is probably easier to filter this mixture by suction to remove a large amount of insoluble solid, which is probably sodium chloride. The solid may be rinsed with more methanol.

The filtrate is chilled in ice-water and added to the cooled methanolic solution of the sodium derivative of ethyl acetoacetate at a rate which keeps the temperature of the reaction mixture below 0°C . The addition time will be 15 to 20 minutes if ice-salt-acetone is used as a coolant. This reaction is extremely exothermic.

The reaction mixture is stirred overnight at room temperature and filtered to remove the sodium chloride. The filtrate is stripped in vacuo and the crude ester (literature reports MP 48°C) is dissolved in 150 ml of ethanol; 28 grams (0.70 mol of sodium hydroxide in 90 ml of water is added and the solution is refluxed for 2 hours. After removal of the ethanol in vacuo the residue is dissolved in water and extracted twice with ether. Dissolved ether is removed from the aqueous solution in vacuo and it is acidified to pH 2 with concentrated hydrochloric acid.

The crystalline crude acid is dried briefly and then recrystallized from acetonitrile to give 32 grams of white product; MP 193° to 194.5°C (literature reports 189° to 190°C). Concentration of the mother liquor gives an additional 5 grams of material having a MP of 192.5 to 194°C . The 37 grams of material represents an 18% overall yield from benzaldehyde.

(D) The acid is converted to the acid chloride by reaction with thionyl chloride.

(E) 5-Methyl-3-Phenyl-4-Isloxazolylpenicillin: A solution of 4.43 grams of 5-methyl-3-phenylisoxazole-4-carbonyl chloride in 120 ml acetone was added gradually to a stirred solution of 4.32 grams of 6-aminopenicillanic acid in 168 ml of 3% aqueous sodium bicarbonate and 50 ml acetone. When addition was complete the mixture was stirred at room temperature for 4 hours and then extracted with ether (2 x 200 ml), only the aqueous phase being retained. This aqueous solution was covered with 50 ml ether and adjusted to pH 2 by the addition of N hydrochloric acid. After separating the layers, the aqueous phase was extracted with two further 50 ml portions of ether. The combined ether solutions (which at this stage contained the free penicillin acid) were washed with water and then neutralized by shaking with 20 ml N sodium bicarbonate solution. The aqueous phase was separated, washed with ether, and evaporated at low temperature and pressure to leave the crude sodium salt of 5-methyl-3-phenyl-4-isloxazolylpenicillin as a white solid, which was finally dried in vacuo over phosphorus pentoxide and found to weigh 7.34 grams.

References

- Merck Index 6777
- Kleeman & Engel p. 662
- PDR pp. 673, 708, 1606
- OCDS Vol. 1 p. 413 (1977)
- DOT 1 (3) 115 (1965)
- I.N. p. 709
- REM p. 1197
- Doyle, F.P. and Naylor, J.H.C.; U.S. Patent 2,996,501; August 15, 1961

OXAFLOZANE HYDROCHLORIDE

Therapeutic Function: Antidepressant

Chemical Name: 2-(3-Trifluoromethyl)phenyl-4-isopropyl-tetrahydro-1,4-oxazine

Common Name: —

Structural Formula:

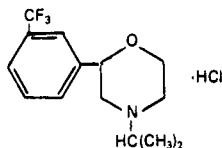

Chemical Abstracts Registry No.: 26629-86-7; 26629-87-8 (Base)

Trade Name	Manufacturer	Country	Year Introduced
Conflictan	Sarbach	France	1982
Conflictan	Riom Lab	France	—

Raw Materials

2-Chloroethylvinyl ether
 Bromine
 (3-Trifluoromethyl)phenyl magnesium bromide
 Isopropylamine
 Hydrogen chloride

Manufacturing Process

(1) *1,2-Dibromo-2-(2-chloro)ethoxyethane:* 640 g of bromine (4 mols) are added dropwise, with stirring, to 426 g (4 mols) of 2-chloroethylvinyl ether dissolved in 1,040 ml of chloroform maintained at -10°C .

When addition is ended, the solvent and then the residue are distilled in vacuum to obtain 690 g of product. Yield = 65%.

(2) *2-(3-Trifluoromethyl)-2-(2-chloro)ethoxy-1-bromoethane:* (3-Trifluoromethyl)phenyl magnesium bromide is prepared under the normal conditions for magnesium derivatives, from 48.6 g of magnesium turnings and 455.7 g of (3-trifluoromethyl)bromobenzene and 1.5 liters anhydrous ether.

To the solution of the magnesium compound so obtained the following solution is added dropwise, with stirring so as to maintain a slight reflux of ether: 1,2-dibromo-2-(2-chloro)-ethoxyethane: 550 g. Anhydrous ether: 300 ml.

After the addition, reflux heating is continued for two hours, cooling is carried out and there is hydrolysis by the mixture: Ice: 500 g. Concentrated HCl: 200 ml.

The organic phase is decanted, washed in NaCl saturated water and dried on anhydrous Na_2SO_4 ; the ether is distilled and the residue is rectified in vacuum to obtain 361 g of the product. Yield = 54%.

According to gas phase chromatography, the product so obtained is about 95% pure and it can be used in further reactions without a second rectification.

(3) *2-(3-Trifluoromethyl)phenyl-4-isopropyl tetrahydro-1,4-oxazine hydrochloride:* The

following mixture is heated in an autoclave at 100°C; 2-(3-trifluoromethyl)-2-(2-chloro)-ethoxy-1-bromoethane: 33.15 g (0.1 mol); isopropyl amine: 20 g (0.34 mol); toluene: 100 ml.

After filtration of the isopropylamine hydrochloride and bromohydrate, the solvent is stripped and the residue is admixed with ~4 N HCl and the aqueous phase is washed with ether. The aqueous phase is treated with 50% aqueous NaOH, the amine is ether-extracted and, after drying on anhydrous Na₂SO₄, the ether is distilled and the residue is rectified in vacuum to obtain 14 g of the product. Yield = 50%.

The hydrochloride is crystallized by adding ethyl acetate to the base and then adding the necessary amount of pure alcohol saturated in dry HCl. Melting point 164°C.

References

Merck Index 6780

DFU 3 (9) 667 (1978)

Kleeman & Engel p. 663

DOT 18 (10) 536 (1982)

I.N. p. 709

Mauvernay, R.Y., Busch, N., Moleyre, J. and Simond, J.; U.S. Patent 3,637,680; January 25, 1972; assigned to Societe Anonyme: Centre Europeen De Recherches Mauvernay

OXAFLUMAZINE DISUCCINATE

Therapeutic Function: Neuroleptic, antihistaminic, antispasmodic

Chemical Name: N-3-(2-Trifluoromethyl-10-phenothiazinyl)-propyl-N'-2-[2-(1,3-dioxanyl)]-ethyl-piperazine disuccinate

Common Name: —

Structural Formula:

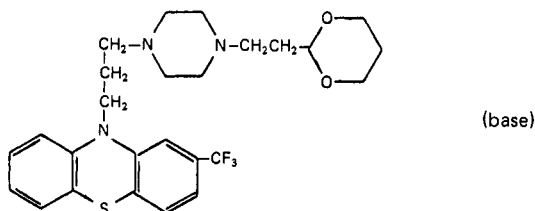

Chemical Abstracts Registry No.: 41761-40-4; 16498-21-8 (Base)

Trade Name	Manufacturer	Country	Year Introduced
Oxaflumine	Diamant	France	1970

Raw Materials

N-[2-(3,1-Dioxanyl)ethyl] piperazine
 1-Bromo-3-chloropropane
 2-Trifluoromethylphenothiazine
 Sodium
 Succinic acid

Manufacturing Process

Preparation of N-(3-chloropropyl)-N'-[2-(1,3-dioxanyl)-ethyl]-piperazine: A solution of 30 g

(0.15 mol) of N-[2-(1,3-dioxanyl)-ethyl]-piperazine and 11.8 g (0.075 mol) of 1-bromo-3-chloropropane in 150 ml of dry benzene was refluxed with stirring for 5 hours. After cooling, the N-[2-(1,3-dioxanyl)-ethyl]-piperazinium bromide which had precipitated was filtered off, the filtrate was concentrated in vacuo and the residual oil was distilled. 14.1 g (68% yield) of N-(3-chloropropyl)-N'-[2-(1,3-dioxanyl)-ethyl]-piperazine which occurred as a light yellow oil were obtained. Boiling point: 152°C to 155°C under 0.07 mm Hg ($n_D^{23} = 1.4940$). The disuccinate prepared in acetone and recrystallized from acetone melts at 104°C to 105°C on a hot stage microscope.

The sodium derivative of the 2-trifluoromethylphenothiazine was prepared from 26.7 g (0.1 mol) of 2-trifluoromethylphenothiazine and 2.3 g (0.1 g atom) of sodium in 500 ml of liquid ammonia. After the reaction was completed, the ammonia was driven off and 500 ml of dry toluene were added. A solution of 25 g (0.09 mol) of N-(3-chloropropyl)-N'-[2-(1,3-dioxanyl)-ethyl]-piperazine in 200 ml of toluene was added drop by drop to this solution which was then refluxed with stirring for 18 hours. After cooling, the precipitate which had formed was filtered and the filtrate was washed with water, dried and concentrated in vacuo. 33 g of brown oil, the N-3-(2-trifluoromethyl-10-phenothiazinyl)-propyl-N'-2-[2-(1,3-dioxanyl)]-ethyl-piperazine, were obtained.

A warm solution of 4.4 g of the base obtained in 100 ml of acetonitrile was added to a warm solution of succinic acid in 200 ml of acetonitrile. After standing for 15 hours at 0°C, the crystalline product was obtained, melting point 138°C.

References

Merck Index 6781

Kleeman & Engel p. 663

DOT 6 (3) 89 (1970)

I.N. p. 709

Societe Industrielle Pour La Fabrication Des Antibiotiques (S.I.F.A.); British Patent 1,103,311; February 14, 1968

OXAMETACINE

Therapeutic Function: Antiinflammatory

Chemical Name: 1-(4-Chlorobenzoyl)-N-hydroxy-5-methoxy-2-methyl-1H-indole-3-acetamide

Common Name: Indoxamic acid

Structural Formula:

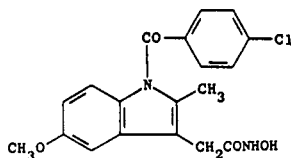

Chemical Abstracts Registry No.: 27035-30-9

Trade Name	Manufacturer	Country	Year Introduced
Flogar	A.B.C.	Italy	1976
Flogar	U.C.B.	France	1981
Dinulcid	Pharmascience	France	1983

Raw Materials

1-p-Chlorobenzoyl-2-methyl-5-methoxy-3-indoleacetic acid
 Thionyl chloride
 Hydroxylamine hydrochloride

Manufacturing Process

1 g of 1-p-chlorobenzoyl-2-methyl-5-methoxy-3-indoleacetic acid [*J. Am. Chem. Soc.* 85, 488-489 (1963)] is treated in a nitrogen stream with 10 ml thionyl chloride in which it promptly dissolves. The solution is quickly evaporated in vacuum and the residue (which typically is of a deep brown-green color) is distempered, twice or three times, with a few ml anhydrous benzene which is removed in vacuum each time. The resulting residue is thoroughly distempered with 5 ml anhydrous ether which dissolves most of the color impurities, and separated by filtering, purified by crystallizing from plenty of anhydrous ether, yielding a crystalline mass of needles of straw-yellow color, melting point 124°C to 127°C. Yield: 0.700 g. Found: Cl% 18.62 (calculated 18.84).

The product is relatively stable towards water and aqueous alkalis in which it proves to be insoluble even after dwelling therein several hours at room temperature. It reacts, better if at elevated temperature, with lower alcohols with which it forms the corresponding esters, and with ammonia under suitable conditions for forming the amide (melting point 219°C to 221°C).

A solution of 1.330 g sodium hydroxide in 20 ml water is slowly admixed with 2.330 g hydroxylamine hydrochloride while cooling, whereupon 1 g chloride of 1-p-chlorobenzoyl-2-methyl-5-methoxy-3-indoleacetic acid is distempered in this neutral or slightly alkaline solution by vigorously stirring during a few minutes.

The acid chloride reacts with the free hydroxylamine with considerable rapidity apparently without dissolving. The reaction is completed when a sample of the suspension shows to become clear on adding aqueous alkali. The crystalline pale-yellow mass of product is separated by filtering, lavishly washed with water and dried in vacuum. The crude product yield is actually quantitative. The product is purified with excellent yields by repeatedly crystallizing from hot dioxane and washing with ether; melting point 181°C to 182°C (dec.).

References

Merck Index 6788

I.N. p. 710

De Martis, F., Arrigoni-Martelli, E. and Tamietto, T.; U.S. Patent 3,624,103; November 30, 1971; assigned to Istituto Biologico Chemioterapico (A.B.C.) SpA (Italy)

OXAMNIQUINE

Therapeutic Function: Antischistosomal

Chemical Name: 1,2,3,4-Tetrahydro-2-[[[(1-methylethyl)amino] methyl]-7-nitro-6-quinolinemethanol

Common Name: —

Structural Formula:

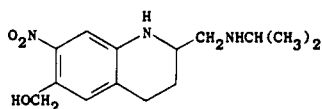

Chemical Abstracts Registry No.: 21738-42-1

Trade Name	Manufacturer	Country	Year Introduced
Vansil	Pfizer	U.S.	1980
Vansil	Pfizer	France	1981

Raw Materials

Bacterium *Aspergillus sclerotiorum* Huber
 Soybean meal
 Glucose
 2-isopropylaminomethyl-6-methyl-7-nitro-1,2,3,4-tetrahydroquinoline

Manufacturing Process

(1) Four fermenters are set up, each one of which contained 2.0 liters of the following medium, sterilized for 35 minutes at 15 psi, respectively:

Soybean meal	5 grams
Glucose	20 grams
NaCl	5 grams
K ₂ HPO ₄	5 grams
Yeast extract	5 grams
Tap water to pH adjusted with sulfuric acid to 6.5	1 liter

The fermenters are inoculated with 7.5% by volume of a 24-hour old culture of *Aspergillus sclerotiorum* Huber grown at 28°C in 50 ml aliquots of the above described soybean-glucose medium contained in 300 ml Erlenmeyer flasks, placed on a shaker rotating at approximately 230 rpm. The inoculated fermenters are agitated at 1,380 rpm and each aerated with 1 liter of air per minute and at a temperature of 28°C for 47 hours. A silicone antifoam is added when required. At the end of the 47-hour period, the pH of the fermentation broth rose to 6.8 to 6.9. Sulfuric acid is then added with sterile precautions to restore the pH to 6.5.

(2) 0.75 g of 2-isopropylaminomethyl-6-methyl-7-nitro-1,2,3,4-tetrahydroquinoline as hydrogen maleate, dissolved in 75 ml of sterile water, is added to each of the four fermenters and agitation and aeration are continued for a further 23 hours. The whole fermentation broths from each fermenter are pooled, the pH adjusted to 8.0 with sodium hydroxide and the 8.2 liters of fermentation broth thus obtained are extracted by agitating vigorously with 16.4 liters of methylene chloride for 10 minutes. The solvent extract is then dried over anhydrous sodium sulfate and subsequently evaporated to dryness at a temperature below 40°C (dry weight 5.567 g).

(3) The dark brown residue from (2) is extracted four times with methanol at room temperature, decanting the solution from the insoluble material. The combined methanol extracts, total volume about 200 ml, are then filtered and treated with 3 g of sodium borohydride, added in portions over a period of 30 minutes with stirring, to reduce any 6-formyl compound present to the 6-hydroxymethyl compound. The methanol solution is then allowed to stand overnight at room temperature and is thereafter diluted with 1 liter of ether. The solution is washed 4 times with 500 ml of water and the resulting pale yellow ethereal solution is dried over magnesium sulfate. The ether is next removed by vacuum distillation from a water bath at 40°C. The residue is dissolved in about 75 ml of isopropanol at 50°C, filtered to remove any insoluble particles and cooled overnight in the refrigerator. The product is collected and dried in vacuo to yield 0.5 g of 6-hydroxymethyl-2-isopropylaminomethyl-7-nitro-1,2,3,4-tetrahydroquinoline as pale yellow crystals of melting point 147°C to 149°C. A further 0.5 g of crude material is obtained from the mother liquors of the recrystallization. Total yield is therefore 1.0 g (0.0036 mol) from 3.0 g (0.0079 mol) of starting material, i.e., 45% of the theoretical amount.

References

Merck Index 6791
 OCDS Vol. 2 p. 372 (1980)
 DOT 17 (4) 152 (1981)
 I.N. p. 710
 REM p. 1236
 Richards, H.C.; U.S. Patent 3,821,228; June 28, 1974; assigned to Pfizer, Inc.

OXANDROLONE

Therapeutic Function: Androgen

Chemical Name: 17 β -hydroxy-17-methyl-2-oxa-5 α -androstan-3-one

Common Name: —

Structural Formula:

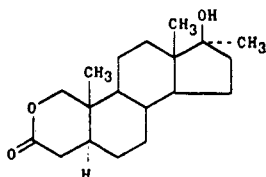

Chemical Abstracts Registry No.: 53-39-4

Trade Name	Manufacturer	Country	Year Introduced
Anavar	Searle	U.S.	1964
Anatrophill	Searle	France	1965
Vasorome	Kowa	Japan	1969
Oxandrolone Spa	SPA	Italy	1979
Lonavar	Searle	Italy	—

Raw Materials

17 β -Hydroxy-17 α -methyl-5 α -androst-1-en-3-one
 Lead tetraacetate
 Sodium borohydride

Manufacturing Process

To a solution of 6.36 parts of 17 β -hydroxy-17 α -methyl-5 α -androst-1-en-3-one in 95 parts of acetic acid and 12 parts of water is added 40 parts of lead tetracetate and 0.6 part of osmium tetroxide. This mixture is stored at room temperature for about 24 hours, then is treated with 2 parts of lead tetracetate. Evaporation to dryness at reduced pressure affords a residue, which is extracted with benzene. The benzene extract is washed with water, and extracted with aqueous potassium bicarbonate. The aqueous extract is washed with ether, acidified with dilute sulfuric acid, then extracted with ethyl acetate-benzene. This organic extract is washed with water, dried over anhydrous sodium sulfate, and concentrated to dryness in vacuo. To a solution of the residual crude product in 20 parts of pyridine is added 10 parts of 20% aqueous sodium bisulfite and the mixture is stirred for about 20 minutes at room temperature.

This mixture is then diluted with water, washed with ethyl acetate, acidified with dilute sulfuric acid, and finally extracted with benzene. The benzene extract is washed with

water, dried over anhydrous sodium sulfate, and evaporated to dryness at reduced pressure to produce crude 17 β -hydroxy-17 α -methyl-1-oxo-1,2-seco-A-nor-5 α -androstan-2-oic acid, which after recrystallization from aqueous isopropyl alcohol melts at about 166° to 173°C (decomposition).

An aqueous slurry of 6 parts of 17 β -hydroxy-17 α -methyl-1-oxo-1,2-seco-A-nor-5 α -androstan-2-oic acid in 200 parts of water is made alkaline to pH 10 by the addition of dilute aqueous sodium hydroxide, then is treated with 6 parts of sodium borohydride. This mixture is allowed to react at room temperature for about 3 hours. Benzene is added and the resulting mixture is acidified carefully with dilute hydrochloric acid. The benzene layer is separated, and the aqueous layer is further extracted with benzene. The combined benzene extracts are washed successively with aqueous potassium bicarbonate and water, dried over anhydrous sodium sulfate, then evaporated to dryness in vacuo. The resulting residue is triturated with ether to afford pure 17 β -hydroxy-17 α -methyl-2-oxa-5 α -androstan-3-one, MP about 235° to 238°C, according to U.S. Patent 3,128,283.

References

Merck Index 6794

Kleeman & Engel p. 664

PDR p. 1677

OCDS Vol. 1 p. 174 (1977)

I.N. p. 710

REM p. 999

Pappo, R.; U.S. Patent 3,128,283; April 7, 1964; assigned to G.D. Searle & Co.

Pappo, R.; U.S. Patent 3,155,684; November 3, 1964; assigned to G.D. Searle & Co.

OXATOMIDE

Therapeutic Function: Antiallergic

Chemical Name: 1-[3-[4-(Diphenylmethyl)-1-piperaziny] propyl]-2-benzimidazolone

Common Name: Oxatimide

Structural Formula:

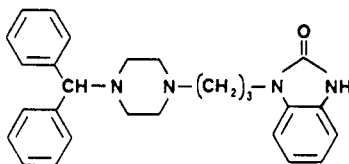

Chemical Abstracts Registry No.: 60607-34-3

Trade Name	Manufacturer	Country	Year Introduced
Tinset	Janssen	W. Germany	1981
Tinset	Janssen	U.K.	1982
Tinset	Janssen	Switz.	1983
Finsedyl	Microsules	Argentina	—

Raw Materials

1-(3-Chloropropyl)-2H-benzimidazol-2-one

1-(Diphenylmethyl)piperazine

Manufacturing Process

A mixture of 5.3 parts of 1-(3-chloropropyl)-2H-benzimidazol-2-one, 5 parts of 1-(diphenylmethyl)piperazine, 6.4 parts of sodium bicarbonate and 200 parts of 4-methyl-2-pentanone is stirred and refluxed overnight with water-separator. After cooling, water is added and the layers are separated. The 4-methyl-2-pentanone phase is dried, filtered and evaporated. The residue is purified by column-chromatography over silica gel using a mixture of trichloromethane and 5% of methanol as eluent. The pure fractions are collected and the eluent is evaporated. The oily residue is crystallized from a mixture of 2,2'-oxybispropane and a small amount of 2-propanol. The product is filtered off and dried, yielding 1-[3-[4-diphenylmethyl)-1-piperazinyl]-propyl]-2H-benzimidazole-2-one; melting point 153.6°C.

References

Merck Index 6798

DFU 3 (6) 465 (1978)

OCDS Vol. 3 p. 173 (1984)

DOT 16 (7) 219 (1980); 18 (7) 341 & (9) 440 (1982)

I.N. p. 711

Vandenberk, J., Kennis, L.E.J., Van der Aa, M.J.M.C. and Van Heertum, A.H.M.T.; U.S. Patent 4,200,641; April 29, 1980; assigned to Janssen Pharmaceutica N.V.

OXAZEPAM

Therapeutic Function: Minor tranquilizer

Chemical Name: 7-Chloro-1,3-dihydro-3-hydroxy-5-phenyl-2H-1,4-benzodiazepin-2-one

Common Name: —

Structural Formula:

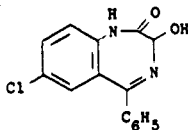

Chemical Abstracts Registry No.: 604-75-1

Trade Name	Manufacturer	Country	Year Introduced
Serax	Wyeth	U.S.	1965
Adumbran	Thomae	W. Germany	1965
Seresta	Wyeth Byla	France	1966
Praxiten	Wyeth	U.K.	1966
Serpax	Wyeth	Italy	1967
Anxiolit	Gerot	Austria	—
Aplakil	Aristegui	Spain	—
Aslapax	Asla	Spain	—
Benzotran	Protea	Australia	—
Droxazepam	Jeba	Spain	—
Durazepam	Durachemie	W. Germany	—
Enidrel	Syncro	Argentina	—
Hilong	Banyu	Japan	—
Iranil	Iltas	Turkey	—
Isochin	Tosi	Italy	—
Limbial	Chiesi	Italy	—

Trade Name	Manufacturer	Country	Year Introduced
Nesontil	Promeco	Argentina	—
Noctazepam	Brenner	W. Germany	—
Oxpam	I.C.N.	Canada	—
Propax	Cipan	Portugal	—
Psicopax	Bama-Geve	Spain	—
Psiquiwas	Wassermann	Spain	—
Purata	Lennon	S. Africa	—
Quen	Ravizza	Italy	—
Quilibrex	Isnardi	Italy	—
Sedokin	Geymonat Sud	Italy	—
Serepax	Ferrosan	Denmark	—
Sigacalm	Siegfried	Switz.	—
Sobile	Lafarquín	Spain	—
Uskan	Desitin	W. Germany	—
Vaben	Rafa	Israel	—
Wakazepam	Wakamoto	Japan	—

Raw Materials

7-Chloro-1,3-dihydro-5-phenyl-2H-1,4-benzodiazepin-2-one-4-oxide
 Acetic anhydride
 Sodium hydroxide

Manufacturing Process

(A) Suspend 10 g of 7-chloro-1,3-dihydro-5-phenyl-2H-1,4-benzodiazepin-2-one 4-oxide in 150 ml of acetic anhydride and warm on a steam bath with stirring until all the solid has dissolved. Cool and filter off crystalline, analytically pure 3-acetoxy-7-chloro-1,3-dihydro-5-phenyl-2H-1,4-benzodiazepin-2-one, melting point 242°C to 243°C.

(B) Add to a suspension of 3.4 g of 3-acetoxy-7-chloro-1,3-dihydro-5-phenyl-2H-1,4-benzodiazepin-2-one in 80 ml of alcohol, 6 ml of 4N sodium hydroxide. Allow to stand after complete solution takes place to precipitate a solid. Redissolve the solid by the addition of 80 ml of water. Acidify the solution with acetic acid to give white crystals. Recrystallize from ethanol to obtain 7-chloro-1,3-dihydro-3-hydroxy-5-phenyl-2H-1,4-benzodiazepin-2-one, melting point 203°C to 204°C.

References

Merck Index 6799
 Kleeman & Engel p. 664
 PDR p. 1980
 OCDS Vol. 1 p. 366 (1977) & 2, 402 (1980)
 DOT 1 (3) 102 (1965) & 9 (6) 238 (1973)
 I.N. p. 711
 REM p. 1063
 Bell, S.C.; U.S. Patent 3,296,249; January 3, 1967; assigned to American Home Products Corp.

OXAZOLAM

Therapeutic Function: Minor tranquilizer

Chemical Name: 7-Chloro-5-phenyl-5'-methyltetrahydrooxazol[5,4-b]-2,3,4,5-tetrahydro-1H-1,4-benzodiazepin-2-one

Common Name: Oxazolazepam

Structural Formula:

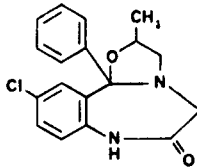

Chemical Abstracts Registry No.: 24143-17-7

Trade Name	Manufacturer	Country	Year Introduced
Serenal	Sankyo	Japan	1970
Quiadon	Merck	W. Germany	1980
Convertal	Roemmers	Argentina	—
Hializan	Pharma-Investi	Spain	—
Tranquit	Promonta	W. Germany	—

Raw Materials

5-Chloro-2-chloroacetylaminobenzophenone
Isopropanolamine

Manufacturing Process

To a solution of 12.0 g of 5-chloro-2-chloroacetylaminobenzophenone and 3.2 g of isopropanolamine in 100 ml of ethanol was added 3.3 g of sodium acetate.

The resulting mixture was heated under reflux with stirring for 12 hours. After completion of the reaction, the solvent was distilled off and the residue was extracted with dichloromethane. The extract was washed with water, dried over anhydrous sodium sulfate and the solvent was distilled off.

The residue was recrystallized from ethanol to give 10.6 g of the desired product melting at 186°C to 188.5°C.

References

Merck Index 6801
DOT 8 (1) 18 (1972) & 9 (6) 239 (1973)
I.N., p. 712
REM p. 1064

Tachikawa, R., Takagi, H., Kamioka, T., Midayera, T., Fukunaga, M. and Kawano, Y.; U.S. Patents 3,772,371; November 13, 1973; and 3,914,215; October 21, 1975; both assigned to Sankyo Co., Ltd.

OXELADIN

Therapeutic Function: Antitussive

Chemical Name: α,α -diethylbenzeneacetic acid 2-[2-(diethylamino)ethoxy]ethyl ester

Common Name: —

Structural Formula:

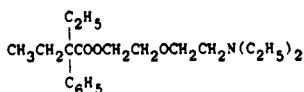

Chemical Abstracts Registry No.: 468-61-1; 16485-39-5 (Citate)

Trade Name	Manufacturer	Country	Year Introduced
Silopentol	Schulte	W. Germany	1970
Ethochlon	Hokuriku	Japan	1970
Fustopanox	Ottia Pharm.	Japan	1970
Paxeladine	Beaufour	France	1974
Dorex	Woelm	W. Germany	—
Hihustan	Maruko	Japan	—
Hustopan	Ohta	Japan	—
Marukofon	Maruko	Japan	—
Neosdrin	Toa	Japan	—
Neobex	Lampugnani	Italy	—
Neusedan	Nippon Zoki	Japan	—
Pectamol	Malesci	Italy	—
Pectussil	Kwizda	Austria	—
Tussilisil	Ibirn	Italy	—
Tussimol	B.D.H.	U.K.	—

Raw Materials

Phenylacetoneitrile	Sodium
Ethyl chloride	Potassium hydroxide
β,β' -Dichlorodiethyl ether	Diethylamine

Manufacturing Process

Preparation of Diethylphenylacetoneitrile: 25 grams of sodium was dissolved in 300 ml liquid ammonia containing 0.3 gram ferric chloride and 59 grams phenylacetoneitrile was added slowly with stirring. After about 15 minutes a cooled solution of 80 grams of ethyl chloride in 200 ml dry ether was added and the mixture stirred for 1 hour. The ammonia was then allowed to evaporate, water added and the ether layer separated, dried, concentrated and the residual oil distilled in vacuo to yield diethylphenylacetoneitrile as an oil, BP 85°C/ 1 mm.

Preparation of Diethylphenylacetic Acid: 46 grams of the foregoing nitrile was added to 140 ml ethylene glycol containing 36 grams potassium hydroxide and the mixture refluxed with stirring for about 20 hours. The mixture was diluted with water, extracted with light petroleum (BP 60° to 80°C) to remove traces of impurities and then acidified to yield diethylphenylacetic acid which was recrystallized from dilute ethanol (40% v/v ethanol in water).

Preparation of 2-(β -Chloroethoxy)Ethyl Diethylphenylacetate: 19.2 grams of the foregoing acid was added to a solution of 4 grams of sodium hydroxide in 40 ml ethylene glycol. 28.6 grams β,β' -dichlorodiethyl ether was added and the mixture refluxed for 1 hour. After removal of solvent under reduced pressure, 150 ml water was added to the residue and the product extracted with ether. The ethereal solution was dried, concentrated and the residue distilled in vacuo to yield the product as an oil, BP 140°C/0.7 mm.

Preparation of 2-(β -Diethylaminoethoxy)Ethyl Diethylphenylacetate: A mixture of 21 grams of 2-(β -chloroethoxy)ethyl diethylphenylacetate and 14 grams diethylamine was heated under pressure in a sealed tube at 140°C for 5 hours. After cooling, the mixture was dissolved in dilute hydrochloric acid and extracted with ether to remove traces of neu-

tral impurities. The acid layer was then made alkaline with 10% w/v sodium hydroxide solution with cooling, and re-extracted with two portions of ether. The ether extract was dried, the ether distilled off and the residue distilled in vacuo to yield the product as an oil, BP 140°C/0.1 mm.

References

Merck Index 6803

Kleeman & Engel p. 665

OCDS Vol. 1 p. 90 (1977)

I.N. p. 712

Petrov, V., Stephenson, O. and Wild, A.M.; U.S. Patent 2,885,404; May 5, 1959; assigned to The British Drug Houses Limited, England

OXENDOLONE

Therapeutic Function: Antiandrogen

Chemical Name: 16 β -Ethyl-17 β -hydroxyestr-4-ene-3-one

Common Name: —

Structural Formula:

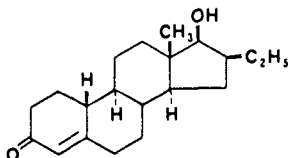

Chemical Abstracts Registry No.: 33765-68-3

Trade Name	Manufacturer	Country	Year Introduced
Prostetin	Takeda	Japan	1981

Raw Materials

16 β -Ethylestra-4-ene-3,17-dione
Sodium borohydride

Ethyl orthoformate
Hydrogen chloride

Manufacturing Process

To a solution of 3.0 g of 16 β -ethylestra-4-ene-3,17-dione dissolved in 150 ml of dioxane, are added 15 g of ethyl orthoformate and 0.1 g of p-toluenesulfonic acid, followed by stirring for 2 hours at room temperature. The reaction solution is poured into 300 ml of a 5% aqueous solution of sodium hydrogen carbonate and the resultant mixture is extracted with ether. The ether layer is washed with water and dried, followed by evaporation of the solvent to give crude crystals of 3-ethoxy-16 β -ethylestra-3,5-diene-17-one. The crystals are recrystallized from ether to give 3.0 g of the compound melting at 114°C to 115°C.

To a solution of 3.0 g of the enol-ether compound obtained above in 50 ml of methanol, is added 1.5 g of sodium borohydride. After standing for 1.5 hours at room temperature, the reaction solution is poured into 300 ml of water. The resulting precipitates are collected by filtration and recrystallized from ether to give 2.8 g of 3-ethoxy-16 β -ethylestra-3,5-dien-17 β -ol melting at 131°C to 133°C.

To make the hydrochloride salt, the bisacetamide or, by another name, 1,11-diphenyl-2,2,3,9,10,10-hexamethyl-4,8-diketo-6-(β -hydroxyethyl)-3,6,9-triazaundecane is dissolved in n-butanol. The solution is chilled and then dry hydrogen chloride gas is passed into the solution causing an oil to separate. To the heavy oil ether is added and then stirred causing crystallization to occur. MP 146°C to 147°C. Analysis for nitrogen: calc. 8.3%, found 8.2%.

To make the acetate salt, the bisacetamide (4.7 g) (0.01 mol) is dissolved in ethyl acetate to which is added glacial acetic acid (0.6 g) (0.01 mol). Ether is added to precipitate the acetate as a gum which is washed with hexane, and finally added to dry ether. Allow to stand for crystallization. MP 141°C. Analysis for nitrogen: calc. 8.0%; found 8.2%.

Other salts are: sulfate, MP 56°C; acid oxalate, MP 127°C; tartrate, MP 45°C; picrate, MP 151°C to 152°C.

References

Merck Index 6806

Kleeman & Engel p. 666

OCDS Vol. 1 p. 72 (1977)

I.N. p. 712

Seifter, J., Hanslick, R.S. and Freed, M.E.; U.S. Patent 2,780,646; February 5, 1957; assigned to American Home Products Corp.

OXETORONE FUMARATE

Therapeutic Function: Antiserotonin, antihistamine

Chemical Name: 6-(3-Dimethylamino-1-propylidene)-12H-benzofuro[2,3-e] benz[b] oxepin fumarate

Common Name: —

Structural Formula:

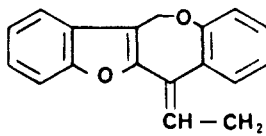

(base)

Chemical Abstracts Registry No.: 34522-46-8; 26020-55-3 (Base)

Trade Name	Manufacturer	Country	Year Introduced
Nocertone	Labaz	France	1975
Nocertone	Labaz	W. Germany	1976
Oxedix	Labaz	—	—

Raw Materials

γ -Dimethylaminopropyl chloride
Ethyl iodide
Magnesium
6-Oxo-benzo[b] benzofurano[2,3-e] oxepin
Sulfuric acid
Fumaric acid

Manufacturing Process

(A) Preparation of 6-(3-dimethylaminopropyl)-6-hydroxybenzo[b] benzofurano[2,3-e] oxepin – In a 250 ml flask equipped with a vertical condenser, a dropping-funnel, a dip thermometer and a stirrer, 1.5 g of magnesium turnings and a crystal of iodine were heated until vaporization of the iodine and then cooled, after which 20 ml of dry tetrahydrofuran were added.

The mixture was heated under reflux and a solution of 0.2 g of ethyl iodide in 5 ml of dry tetrahydrofuran was allowed to flow into the reaction medium. When the reaction started, a solution of 6.2 g of γ -dimethylaminopropyl chloride in 20 ml of dry tetrahydrofuran was added and the mixture so obtained was heated under reflux until the complete disappearance of the magnesium turnings. The reaction medium was then cooled in an ice bath, after which there was added thereto a solution in 45 ml of tetrahydrofuran of 7 g of 6-oxo-benzo[b]-benzofurano[2,3-e] oxepin. The reaction mixture was allowed to stand for 20 hours at a temperature of 20°C, and was then poured into a saturated aqueous solution of ammonium chloride maintained at a temperature of 5°C. The mixture was extracted with ether and the organic portion was washed and dried over anhydrous sodium sulfate. After evaporation of the solvent, 9.4 g of crude product were obtained, which after recrystallization from isopropanol, provided 6.7 g of pure 6-(3-dimethylaminopropyl)-6-hydroxybenzo[b] benzofurano[2,3-e] oxepin, melting point 160°C (yield, 71%).

(B) Preparation of 6-(3-dimethylaminopropylidene)-benzo[b] benzofurano[2,3-e] oxepin and its fumarate – In an Erlenmeyer flask 6.2 g of 6-(3-dimethylaminopropyl)-6-hydroxybenzo[b] benzofurano[2,3-e] oxepin prepared as described above were dissolved in 108 ml of a 10% solution of sulfuric acid. The solution obtained was heated to boiling point for 15 minutes. After cooling, 100 ml of chloroform were added and the solution was made alkaline with a 5% solution of sodium hydroxide. The solution was then extracted with chloroform, washed with water and dried over anhydrous sodium sulfate. The solvent was evaporated and the resulting oily residue composed of 6-(3-dimethylaminopropylidene)-benzo[b]-benzofurano[2,3-e] oxepin was then directly treated with a solution of fumaric acid in isopropanol to give 6.5 g of 6-(3-dimethylaminopropylidene)-benzo[b] benzofurano[2,3-e] oxepin fumarate (yield, 85%). The fumarate had a melting point of 160°C when recrystallized from isopropanol.

References

Merck Index 6807

Kleeman & Engel p. 667

OCDS Vol. 3 p. 247 (1984)

DOT 11 (1) 19 (1975)

I.N. p. 712

Binon, F. and Descamps, M.L.V.; U.S. Patent 3,651,051; March 21, 1972; assigned to Laboratoires Labaz

OXICONAZOLE NITRATE

Therapeutic Function: Antifungal

Chemical Name: 1-(2,4-Dichlorophenyl)-2-(1H-imidazol-1-yl)-O-(2,4-dichlorobenzyl)-ethanone oxime nitrate

Common Name: –

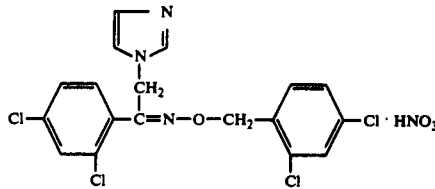
Structural Formula:**Chemical Abstracts Registry No.:** -

Trade Name	Manufacturer	Country	Year Introduced
Myfungar	Siegfried	Switz.	1983
Oceral	Roche	Switz.	1983

Raw Materials

1-(2,4-Dichlorophenyl)-2-(1H-imidazol-1-yl)ethanone oxime
 Sodium hydride
 2,4-Dichlorobenzyl chloride
 Nitric acid

Manufacturing Process

13.5 g of 1-(2,4-dichlorophenyl)-2-(1H-imidazol-1-yl)-ethanone oxime are dissolved in 100 ml dimethylformamide (DMF) and 1.2 g of sodium hydride are mixed in, whereupon an exothermic reaction is allowed to take place on its own with stirring. After cessation of evolution of hydrogen, a solution of 9.8 g of 2,4-dichlorobenzyl chloride in 10 cc DMF is added dropwise with continuous stirring and the stirring is carried on for 2 hours further. The reaction is then taken to completion at a bath temperature of 80°C, after which the reaction mixture is evaporated in a rotation evaporator under reduced pressure and the residue is dissolved in 100 ml ethanol. After filtering off of undissolved matter, the solution is stirred with 300 ml 2N nitric acid for the conversion of free base to the nitrate.

The liquid standing over the heavy deposits which have separated out is separated off by decanting, whereupon an isomer is obtained which after recrystallization from ethanol is obtained in a yield of 5.2 g and having a melting point of 137°C to 138°C.

References

DFU 6 (2) 99 (1981)

DOT 19 (12) 884 (1983)

I.N. p. 713

Mixich, G., Thiele, K. and Fischer, J.; U.S. Patent 4,124,767; November 7, 1978; assigned to Siegfried AG.

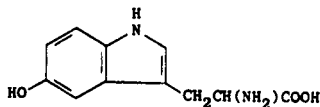
OXITRIPTAN**Therapeutic Function:** Antidepressant, antiepileptic**Chemical Name:** 5-Hydroxytryptophan**Common Name:** 5-Hydroxytryptophan**Structural Formula:**

Chemical Abstracts Registry No.: 56-69-9

Trade Name	Manufacturer	Country	Year Introduced
Levotonine	Panmedica	France	1973
Pretonine	Arkodex	France	1973
Tript-OH	Sigma Tau	Italy	1980
Levothym	Karlspharma	W. Germany	—
Quietim	Nativelle	France	—
Stimolomens	Irbi	Italy	—
Telesol	Lasa	Spain	—

Raw Materials

β -(5-Benzyloxyindolyl-3)- α -acetylamino- α -methylthiopropionic acid methane-thiol ester
 Hydrogen
 Sulfuric acid

Manufacturing Process

β -(5-Benzyloxyindolyl-3)- α -acetylamino- α -methylthiopropionic acid methanethiol ester (449 mg) was added to 10 ml of ethanol and further 1 ml of triethylamine was added to the mixture. Then, the reaction mixture was refluxed for 17 hours, after condensation under reduced pressure and subsequent separation of the residue by column chromatography (silica gel, ethyl acetate), 353 mg of methyl β -(5-benzyloxyindolyl-3)- α -acetylamino- α -methylthiopropionate was obtained as colorless glasslike substance in the yield of 81.5%. Recrystallization of the substance from methanol water afforded 287 mg of crystals.

Raney nickel (3.5 cc) was suspended in 10 ml of ethanol and 356 mg of methyl β -(5-benzyloxyindolyl-3)- α -aminoacetyl- α -methylthiopropionate was added to the mixture together with 20 ml of ethanol. Then, the reaction mixture was stirred for 1 hour at room temperature and thereafter filtered to remove insoluble substances. The residue was washed with 100 ml of ethanol and 50 ml of acetone and both the filtrate and the wash liquid were combined and concentrated under reduced pressure. By column chromatography (silica gel and acetone), 210 mg of methyl β -(5-hydroxyindolyl-3)- α -acetylamino- α -methylthiopropionate as colorless glasslike substance in the yield of 90%.

To 430 mg of methyl β -(5-hydroxyindolyl-3)- α -acetylamino- α -methylthiopropionate was added 50 ml of 10% sulfuric acid and the reaction mixture was refluxed under heating for 10 hours. After condensation under reduced pressure to 15 ml volume, the reaction solution was neutralized with ammonia to pH 4, to afford the extract. The resulting extract was filtered and washed with water to afford 265 mg of 5-hydroxytryptphan in the yield of 78%.

References

Merck Index 4771

Kleeman & Engel p. 668

I.N. p. 714

Tsuchihashi, G. and Ogura, K.; U.S. Patent 4,001,276; January 4, 1977; assigned to Sagami Chemical Research Center (Japan)

OXITROPIUM BROMIDE

Therapeutic Function: Anticholinergic bronchodilator

Chemical Name: (–)-N-Ethyl norscopolamine methobromide

Common Name: OTB

Structural Formula:

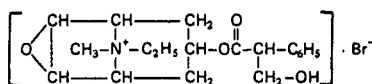

Chemical Abstracts Registry No.: -

Trade Name	Manufacturer	Country	Year Introduced
Ventilat	Boehr. Ingel.	W. Germany	1983

Raw Materials

(-)-Norscopolamine	Ethyl bromide
Methyl bromide	Sodium carbonate

Manufacturing Process

14.5 g (0.05 mol) of (-)-norscopolamine and 5.4 g (0.05 mol) of ethyl bromide were dissolved in 300 cc of acetonitrile, 5.3 g (0.05 mol) of anhydrous sodium carbonate were suspended in the solution, and the suspension was heated at the boiling point for 10 hours. After a boiling time of 2.5 and 5 hours, respectively, the supply of ethyl bromide and sodium carbonate in the reaction mixture was replenished by adding each time 5.4 g (0.05 mol) of ethyl bromide and 5.3 g (0.05 mol) of anhydrous sodium carbonate. At the end of 10 hours of boiling, the inorganic sodium salts which had separated out were separated by vacuum filtration, the filter cake was washed with acetonitrile, and the acetonitrile was distilled out of the filtrate. The distillation residue was dissolved in ether, the solution was extracted with a small amount of water and then dried, and the ether was distilled off, yielding raw (-)-N-ethylnorscopolamine.

7.0 g (0.022 mol) of (-)-N-ethylnorscopolamine were dissolved in acetonitrile, 10.4 g (0.11 mol) of methyl bromide were added to the solution, and the mixture was allowed to stand at room temperature. The crystalline precipitate formed thereby was collected and recrystallized from acetonitrile, 8.9 g (97.8% of theory) of white crystalline (-)-N-ethylnorscopolamine methobromide, melting point 203°C to 204°C (decomposition), were obtained.

References

Merck Index A-10

DFU 4 (2) 117 (1979)

DOT 19 (7) 416 & (8) 444 (1983)

Zeile, K., Banholzer, R., Walther, G., Schulz, W. and Wick, H.; U.S. Patent 3,472,861; Oct. 14, 1969; assigned to Boehringer Ingelheim GmbH.

OXOLINIC ACID

Therapeutic Function: Urinary antibacterial

Chemical Name: 1-ethyl-1,4-dihydro-4-oxo-1,3-dioxolo[4,5-g]quinoline-3-carboxylic acid

Common Name:

Structural Formula:

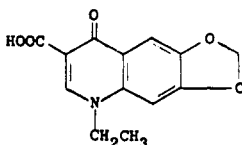

Chemical Abstracts Registry No.: 14698-29-4

Trade Name	Manufacturer	Country	Year introduced
Prodoxol	Warner	U.K.	1974
Urotrate	Substantia	France	1974
Ossian	Bioindustria	Italy	1974
Utibid	Warner Lambert	U.S.	1975
Nidantin	Sasse/Goedecke	W. Germany	1978
Decme	Poli	Italy	—
Emyrenil	Emyfar	Spain	—
Gramurin	Chinoin	Hungary	—
Oksaren	Belupo	Yugoslavia	—
Ossion	Bioindustria	Italy	—
Oxoboi	B.O.I.	Spain	—
Oxoinex	Inexfa	Spain	—
Oxol	Casen	Spain	—
Oxolin	Prodes	Spain	—
Pietil	Argentia	Argentina	—
Tilvis	Scharper	Italy	—
Tropodil	Elea	Argentina	—
Urinox	Syncro	Argentina	—
Uro-Alvar	Alvarez-Gomez	Spain	—
Uropax	Lefa	Spain	—
Uroxol	Ausonia	Italy	—

Raw Materials

3,4-Methylenedioxyaniline	Sodium hydroxide
Diethyl ethoxymethylene malonate	Ethyl iodide

Manufacturing Process

A mixture of 27 parts by weight of 3,4-methylenedioxyaniline and 43 parts by weight of diethyl ethoxymethylenemalonate is heated at 80° to 90°C for 3 hours. The mixture is then heated at 80° to 90°C for 1 hour under about 15 mm pressure to remove the by-product ethyl alcohol formed. The residue is recrystallized from ligroin (BP 60° to 90°C) to give diethyl[(3,4-methylenedioxyanilino)methylene] malonate as a yellow solid melting at 100° to 102°C. The analytical sample from ligroin melts at 101° to 102°C.

A mixture of 48 parts by weight of diethyl[(3,4-methylenedioxyanilino)methylene] malonate and 500 parts by weight of diphenyl ether is refluxed for 1 hour. The mixture is allowed to cool to about 25°C with stirring and 500 parts by weight of petroleum ether are added. Filtration gives 3-carbethoxy-6,7-methylenedioxy-4-hydroxy-quinoline as a brown solid, MP 276° to 281°C. Several recrystallizations from dimethylformamide gives almost colorless analytical material, MP 285° to 286°C, (decomposes).

A mixture of 26 parts of 3-carbethoxy-6,7-methylenedioxy-4-hydroxy-quinoline, 16 parts of sodium hydroxide and 50 parts of dimethylformamide is heated at 70° to 75°C for 2 hours, then 31 parts of ethyl iodide is added over 1 hour with continued heating and stirring. After an additional 3 to 4 hours of heating (at 70° to 75°C) and stirring, the mixture is diluted with 500 parts of water, refluxed for 3 to 4 hours, acidified with concentrated hydrochloric acid and filtered to yield 18 to 22 parts of 1-ethyl-1,4-dihydro-6,7-methylenedioxy-4-oxo-3-quinoline-carboxylic acid, MP 309° to 314°C (decomposes). The analytical sample from dimethylformamide melts at 314° to 316°C (decomposes).

References

- Merck Index 6814
 Kleeman & Engel p. 670
 OCDS Vol. 2 pp. 370, 387 (1980) & 3, 185 (1984)
 I.N. p. 34

Kaminsky, D. and Meltzer, R.I.; U.S. Patent 3,287,458; November 22, 1966; assigned to Warner-Lambert Pharmaceutical Company

OXOMEMAZINE

Therapeutic Function: Antihistaminic

Chemical Name: N,N, β -Trimethyl-10-H-phenothiazine-10-propanamine 5,5,-dioxide

Common Name: —

Structural Formula:

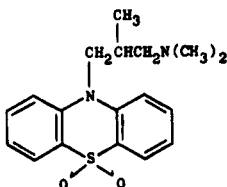

Chemical Abstracts Registry No.: 3689-50-7; 4784-40-1 (Hydrochloride)

Trade Name	Manufacturer	Country	Year Introduced
Doxergan	Specia	France	1964
Imakol	Rhone Poulenc	W. Germany	1965
Dysedon	Meiji	Japan	—
Rectoplexil	Specia	France	—
Toplexil	Specia	France	—

Raw Materials

Phenothiazine	Sodium amide
3-Dimethylamino-2-methylpropyl chloride	Hydrogen peroxide

Manufacturing Process

Phenothiazine is reacted with 3-dimethylamino-2-methylpropyl chloride in the presence of sodium amide to give 3-(10-phenothiazinyl)-2-methyl-1-dimethylaminopropane. 11.9 g of this intermediate is dissolved with agitation in glacial acetic acid (120 cc). Pure sulfuric acid (d = 1.83; 0.5 cc) is added and a mixture of glacial acetic acid (10 cc) and hydrogen peroxide (8.5 cc of a solution containing 38 g of hydrogen peroxide in 100 cc) is then run in over 20 minutes. The temperature rises from 25°C to 35°C and is then kept at 60°C for 18 hours. The mixture is cooled and water (150 cc) is added and, with cooling, aqueous sodium hydroxide (d = 1.33; 220 cc). The resulting mixture is extracted with ethyl acetate (3 X 100 cc), the solvent is evaporated on a water bath and the residue is recrystallized from heptane (150 cc). 3-(9,9-dioxy-10-phenothiazinyl)-2-methyl-1-dimethylaminopropane (7.8 g) is obtained, MP 115°C.

The corresponding hydrochloride prepared in ethyl acetate and recrystallized from a mixture of ethanol and isopropanol melts at 250°C.

References

Merck Index 6815
Kleeman & Engel p. 670

DOT 2 (4) 145 (1966)

I.N. p. 715

Jacob, R.M. and Robert, J.G.; U.S. Patent 2,972,612; February 21, 1961; assigned to Societe des Usines Chimiques Rhone-Poulenc (France)

OXPRENOLOL

Therapeutic Function: Antiarrhythmic

Chemical Name: 1-[(1-methylethyl)amino]-3-[2-(2-propenyloxy)phenoxy]-2-propanol

Common Name: —

Structural Formula:

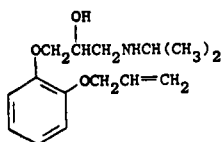

Chemical Abstracts Registry No.: 6452-71-7; 6452-73-9 (Hydrochloride)

Trade Name	Manufacturer	Country	Year Introduced
Trasicor	Ciba Geigy	Italy	1970
Trasicor	Ciba Geigy	W. Germany	1971
Trasicor	Ciba Geigy	U.K.	1972
Trasicor	Ciba Geigy	France	1975
Trasacor	Ciba-Geigy-Takeda	Japan	1976
Captol	Protea	Australia	—
Cordexol	Lagep	Switz.	—
Coretal	Polfa	Poland	—

Raw Materials

Pyrocatechol monoallyl ether
Epichlorohydrin
Isopropylamine

Manufacturing Process

75 grams of pyrocatechol monoallyl ether, 75 grams of epichlorohydrin, 75 grams of potassium carbonate and 400 ml of acetone are stirred and heated at the boil for 12 hours. The potassium carbonate is then filtered off. The solvent is distilled off in a water-jet vacuum. The residual oil is dissolved in ether and agitated with 2 N sodium hydroxide solution. The ether is separated, dried and distilled off. The residue is distilled in a water-jet vacuum. 3-(ortho-allyloxy-phenoxy)-1,2-epoxypropane passes over at 145° to 157°C under 11 mm Hg pressure. A solution of 15 grams of 3-(ortho-allyloxy-phenoxy)-1,2-epoxypropane and 15 grams of isopropylamine in 20 ml of ethanol is refluxed for 4 hours. The excess amine and the alcohol are then distilled off under vacuum, to leave 1-isopropylamino-2-hydroxy-3-(ortho-allyloxy-phenoxy)-propane which melts at 75° to 80°C after recrystallization from hexane.

References

Merck Index 6820

Kleeman & Engel p. 671
 OCDS Vol. 1 p. 117 (1977) & 2, 109 (1980)
 DOT 6 (1) 25 (1970)
 I.N. p. 716
 Ciba Limited, Switzerland; British Patent 1,077,603; August 2, 1967

OXYBUTYNIN CHLORIDE

Therapeutic Function: Antispasmodic

Chemical Name: α -cyclohexyl- α -hydroxybenzeneacetic acid 4-(diethylamino)-2-butynyl ester hydrochloride

Common Name: —

Structural Formula:

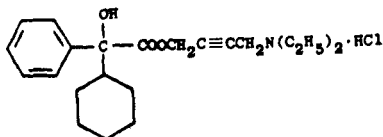

Chemical Abstracts Registry No.: 1508-65-2; 5633-20-5 (Base)

Trade Name	Manufacturer	Country	Year Introduced
Ditropan	Marion	U.S.	1975
Ditropan	Scharper	Italy	—

Raw Materials

Methyl phenylcyclohexylglycolate
 4-Diethylamino-2-butynyl acetate
 Sodium methylate

Manufacturing Process

A mixture of 394.2 grams of methyl phenylcyclohexylglycolate and 293.1 grams of 4-diethylamino-2-butynyl acetate was dissolved with warming in 2.6 liters of n-heptane. The solution was heated with stirring to a temperature of 60° to 70°C and 8.0 grams of sodium methoxide were added. The temperature of the mixture was then raised until the solvent began to distill. Distillation was continued at a gradual rate and aliquots of the distillate were successively collected and analyzed for the presence of methyl acetate by measurement of the refractive index. The reaction was completed when methyl acetate no longer distilled, and the refractive index observed was that of pure heptane ($n_D^{26} = 1.3855$). About 3½ hours were required for the reaction to be completed.

The reaction mixture was then allowed to cool to room temperature, washed with water, and extracted with four 165 ml portions of 2 N hydrochloric acid. The aqueous extracts were combined and stirred at room temperature to permit crystallization of the hydrochloride salt of the desired product. Crystallization was completed by cooling the slurry in an ice bath, and the product was collected by filtration, pressed dry, and recrystallized from 750 ml of water. Yield of pure crystalline material, 323 grams.

References

Merck Index 6823

Kleeman & Engel p. 672

PDR p. 1076

OCDS Vol. 1 p. 93 (1977)

I.N. p. 716

REM p. 919

Mead Johnson & Company; British Patent 940,540; October 30, 1963

OXYFEDRINE

Therapeutic Function: Coronary vasodilator

Chemical Name: (R)-3-[(2-hydroxy-1-methyl-2-phenylethyl)amino]-1-(3-methoxyphenyl)-1-propanone

Common Name: —

Structural Formula:

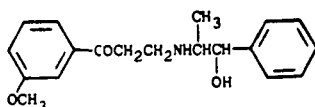

Chemical Abstracts Registry No.: 15687-41-9; 16777-42-7 (Hydrochloride)

Trade Name	Manufacturer	Country	Year Introduced
Ildamen	Homburg	W. Germany	1966
Ildamen	Chugai	Japan	1970
Ildamen	Homburg	Italy	1972
Ildamen	Farmades	Italy	1973
Modacor	I.S.H.	France	—
Myofedrin	Apogepha	E. Germany	—
Timoval	Homburg	W. Germany	—

Raw Materials

m-Methoxyacetophenone
Paraformaldehyde
L-Norephedrine

Manufacturing Process

45 grams of m-methoxy acetophenone, 8 grams of paraformaldehyde and 30.2 grams of 1 norephedrine were mixed with about 135 cc of isopropanol HCl solution to provide a pH of 4 and the mixture refluxed for 4 hours. The reaction mixture was cooled and the crystals filtered off on a suction filter. 3-[1-phenyl-1-hydroxypropyl-(2)-amino]-1-(m-methoxyphenyl)-propanone-(1)·HCl was obtained which after recrystallization from methanol had a MP of 190° to 193°C.

References

Merck Index 6830

Kleeman & Engel p. 673

OCDS Vol. 2 p. 40 (1980)

I.N. p. 718

Thiele, K.; U.S. Patent 3,225,095; December 21, 1965; assigned to Deutsche Gold- und Silber-Scheideanstalt, Germany

OXYMETAZOLINE HYDROCHLORIDE

Therapeutic Function: Nasal decongestant

Chemical Name: 3-[[4,5-dihydro-1H-imidazol-2-yl)methyl]-6-(1,1-dimethylethyl)-2,4-dimethylphenol hydrochloride

Common Name: —

Structural Formula:

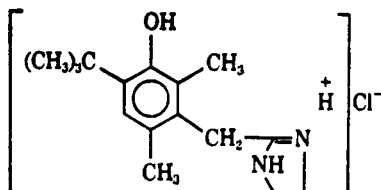

Chemical Abstracts Registry No.: 2315-02-8; 1491-59-4 (Base)

Trade Name	Manufacturer	Country	Year Introduced
Nasivin	Merck	W. Germany	1961
Iliadine	Merck Clevenot	France	1964
Afrin	Schering	U.S.	1964
Nostrilla	Boehr. Ingel.	U.S.	1982
Alrin	Teva	Israel	—
Atomol	Allen & Hanburys	U.K.	—
Dristan	Whitehall	U.S.	—
Duration	Plough	U.S.	—
Nasivin	Bracco	Italy	—
Nasafarma	Novofarma	Spain	—
Nezeril	Draco	Sweden	—
Oxymeta	Schein	U.S.	—
Pikorin	Medica	Finland	—
Rhinolitan	Kettelhack Riker	W. Germany	—
Sinerol	Draco	Sweden	—
Utabon	Uriach	Spain	—

Raw Materials

2,4-Dimethyl-6- <i>t</i> -butylphenol	Formaldehyde
Hydrogen chloride	Sodium cyanide
Ethylene diamine	Sodium hydroxide
<i>p</i> -Toluene sulfonic acid	Hydrogen chloride

Manufacturing Process

10 grams 2,6-dimethyl-3-hydroxy-4-tertiary butylbenzylcyanide (produced by chloromethylation of 2,4-dimethyl-6-tertiary butyl-phenol with formaldehyde and HCl and conversion of the substituted benzyl chloride with NaCN; crystals, from alcohol, melting at 135° to 137°C) and 10.7 grams ethylenediamine-mono-*p*-toluenesulfonate are heated in an oil bath to approximately 235°C for 1½ hours, whereby ammonia is evolved. The free base is obtained from the *p*-toluene-sulfonic acid imidazoline salt which is difficultly soluble in water, by conversion with 50 cc of a 10% NaOH solution. Said base is recrystallized from benzene, and 7.5 grams (62% of the theoretical yield) 2-(2',6'-dimethyl-3'-hydroxy-4'-tertiary butylbenzyl)-2-imidazoline, MP 180° to 182°C, are obtained.

By dissolving the free base in an ethyl alcohol solution of hydrochloric acid and adding

ether, the hydrochloride can be produced in the usual manner. Said hydrochloride melts, when recrystallized from alcoholic ether, at 300° to 303°C and is decomposed.

References

Merck Index 6834

Kleeman & Engel p. 674

PDR pp. 677, 728, 1606, 1899

OCDS Vol. 1 p. 242 (1977)

I.N. p. 719

REM p. 889

Fruhstorfer, W. and Muller-Calgan, H.; U.S. Patent 3,147,275; September 1, 1964; assigned to E. Merck AG, Germany

OXYMORPHONE

Therapeutic Function: Narcotic analgesic

Chemical Name: 4,5 α -epoxy-3,14-dihydroxy-17-methylmorphinan-6-one

Common Name: Dihydrohydroxymorphinone

Structural Formula:

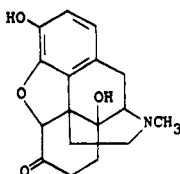

Chemical Abstracts Registry No.: 76-41-5

Trade Name	Manufacturer	Country	Year Introduced
Numorphan	Endo	U.S.	1959

Raw Materials

Thebaine	Hydrogen peroxide
Hydrogen bromide	Hydrogen

Manufacturing Process

Thebaine is dissolved in aqueous formic acid and treated with 30% H₂O₂; neutralization with aqueous ammonia gives 14-hydroxycodeinone. It is hydrogenated to give oxycodone. 90 ml of concentrated hydrobromic acid are heated to 90°C. 9 grams of 14-hydroxydi-hydrocodeinone (oxycodone) are then added under stirring and the mixture is quickly heated to 116°C and kept at this temperature under reflux condenser for 20 minutes, with continued stirring. The resulting brown solution is diluted with about 90 ml of water and chilled with ice. Aqueous 10% sodium hydroxide solution is now added to alkaline reaction and the liquid is extracted 3 times with 100 cc portions of chloroform. The layers are separated and the aqueous phase is filtered and acidified by the addition of concentrated aqueous hydrochloric acid, treated with charcoal and filtered.

The filtrate is treated with concentrated aqueous ammonia until the mixture gives a pink

color on phenolphthalein paper. The liquid is extracted seven times with 100 cc portions of chloroform, the extracts are combined, dried with anhydrous sodium sulfate and evaporated. The residue is dissolved in ethanol by refluxing and the ethanol evaporated nearly to dryness. 100 cc of benzene are then added, the mixture is refluxed for ½ hour and set aside for crystallization. After cooling, the desired compound is collected by filtration. 2.3 grams of a white crystalline powder are obtained; MP 245° to 247°C. This powder consisting of 14-hydroxydihydromorphinone can be purified by recrystallization from benzene, ethylacetate or ethanol. From benzene it generally forms diamond shaped platelets, while needles are obtained from ethylacetate.

On heating, the crystals are discolored from about 200°C on, and melt at 246° to 247°C to a black liquid, which decomposes with strong volume increase if the temperature is raised further by a few degrees.

References

Merck Index 6837

Kleeman & Engel p. 675

PDR p. 859

OCDS Vol. 1 p. 290 (1977) & 2, 319 (1980)

I.N. p. 719

REM p. 1105

Lewenstein, M.J. and Weiss, U.; U.S. Patent 2,806,033; September 10, 1957

OXYPENDYL

Therapeutic Function: Antiemetic

Chemical Name: 4-[3-(10H-Pyrido[3,2-b][1,4]benzothiazin-10-yl)propyl]-1-piperazine-ethanol

Common Name: —

Structural Formula:

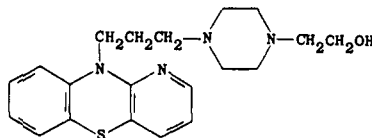

Chemical Abstracts Registry No.: 5585-93-3; 17297-82-4 (Dihydrochloride)

Trade Name	Manufacturer	Country	Year Introduced
Pervetral	Homburg	W. Germany	1962

Raw Materials

10-(γ-N-Piperazinopropyl)-4-azaphenothiazine
Ethylene chlorhydrin

Manufacturing Process

32 parts of 10-(γ-N-piperazinopropyl)-4-azaphenothiazine in 200 cc of butanol with 9 parts of ethylene chlorhydrin and 14 parts of finely powdered potash are heated for 4 hours under reflux while stirring vigorously. After cooling, extraction is carried out with dilute hydrochloric

acid, the substance is finally washed with water and the combined hydrochloric acid aqueous phase is washed twice with ether. The base is then liberated with concentrated sodium hydroxide solution and taken up in chloroform. The chloroform solution is dried with potash and concentrated by evaporation. 26.4 parts of (10- γ -N-B-hydroxyethylpiperazino-N¹-propyl)-4-azaphenthiazine are distilled over at 280°C to 300°C/6 mm. The dihydrochloride is obtained in isopropanol with isopropanolic hydrochloric acid. The product melts at 218°C to 220°C.

References

Merck Index 6838

Kleeman & Engel p. 676

OCDS Vol. 1 p. 430 (1977)

I.N. p. 719

Deutsche Gold- und Silber Scheideanstalt; British Patent 893,284; April 4, 1962

OXYPHENBUTAZONE

Therapeutic Function: Antiinflammatory

Chemical Name: 4-butyl-1-(4-hydroxyphenyl)-2-phenyl-3,5-pyrazolidinedione

Common Name: p-hydroxyphenylbutazone

Structural Formula:

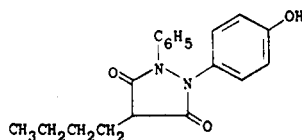

Chemical Abstracts Registry No.: 129-20-4

Trade Name	Manufacturer	Country	Year Introduced
Tanderil	Geigy	U.K.	1960
Tandearil	Geigy	U.S.	1961
Tanderil	Ciba Geigy	France	1961
Tanderil	Geigy	W. Germany	1961
Tanderil	Geigy	Italy	1962
Artroflog	Magis	Italy	—
Artzone	Cont. Ethicals	S. Africa	—
Butaflogin	Chemiepharma	Italy	—
Butapirone	Brocchieri	Italy	—
Buteril	Protea	S. Africa	—
Butilene	Francia	Italy	—
Deflogin	Valeas	Italy	—
Fibutox	Pharmador	S. Africa	—
Flanaril	Osfa	Italy	—
Floghene	Chibi	Italy	—
Flogistin	Scharper	Italy	—
Flogitolo	Isnardi	Italy	—
Flogodin	Firma	Italy	—
Iltazon	Iltas	Turkey	—
Imbun	Merckle	W. Germany	—
Inflamil	Leiras	Finland	—

Trade Name	Manufacturer	Country	Year Introduced
Ipebutona	Ipecsa	Spain	—
Iridil	Farmila	Italy	—
Isobutil	Panther-Osfa	Italy	—
Miyadril	Fako	Turkey	—
Optimal	Dojin	Japan	—
Optone	Lennon	S. Africa	—
Oxalid	U.S.V.	U.S.	—
Oxibutol	Asla	Spain	—
Oxybutazone	I.C.N.	Canada	—
Oxybuton	Streuli	Switz.	—
Phlogase	Adenylchemie	W. Germany	—
Phlogistol	Helopharm	W. Germany	—
Phlogont	Azochemie	W. Germany	—
Phloguran	Ikapharm	Israel	—
Pirabutina	Ellea	Italy	—
Piraflogin	Jamco	Italy	—
Rapostan	Mepha	Switz.	—
Rheumapax	Erco	Denmark	—
Tantal	Sawai	Japan	—
Teneral	Eczacibasi	Turkey	—
Validil	von Boch	Italy	—
Visobutina	I.S.F.	Italy	—

Raw Materials

n-Butylmalonic acid ethyl ester	Sodium
p-Benzyloxy hydrazobenzene	Hydrogen

Manufacturing Process

43.2 parts of n-butyl malonic acid ethyl ester are added to a solution of 4.6 parts of sodium in 92 parts by volume of absolute alcohol. 39 parts of p-benzyloxy hydrazobenzene (MP 88° to 90°C) are added. About two-thirds of the alcohol is distilled off and 92 parts by volume of absolute xylene are added. Without removing the sloping condenser, the mixture is stirred for 12 hours at a bath temperature of 140° to 145°C. It is then cooled to 0° to 5°C, 100 parts of ice are added, the xylene is removed, the aqueous solution is extracted twice with chloroform and made acid to Congo red at 0° to 5°C with 6 N hydrochloric acid.

The precipitate is taken up in chloroform, the solution obtained is washed twice with water, then with saturated salt solution, dried over Na₂SO₄ and evaporated under vacuum (bath temperature 20°C). The residue is recrystallized from alcohol and produces 1-(p-benzyloxyphenyl)-2-phenyl-4-n-butyl-3,5-dioxo-pyrazolidine (C) as tiny white needles which melt at 132° to 133°C.

16.6 parts of (C) are suspended in 166 parts by volume of ethyl acetate and, in the presence of 16.6 parts of Raney nickel, hydrogen is allowed to act at room temperature and atmospheric pressure.

After 6 hours the calculated amount of hydrogen has been taken up. The residue obtained after filtering and evaporating is taken up in benzene and extracted twice with diluted sodium carbonate solution. The alkali extract is then made acid to Congo red with 6 N hydrochloric acid and the precipitate is taken up in ethyl acetate. The solution obtained is washed twice with salt solution, dried with sodium sulfate and evaporated. The residue is recrystallized from ether/petroleum ether. 1-(p-hydroxyphenyl)-2-phenyl-4-n-butyl-3,5-dioxo-pyrazolidine melts at 124° to 125°C.

References

Merck Index 6840

Kleeman & Engel p. 677

PDR p. 1606

OCDS Vol. 1 p. 236 (1977)

I.N. p. 720

REM p. 1119

Häfliger, F.; U.S. Patent 2,745,783; May 15, 1956; assigned to J.R. Geigy AG, Switzerland

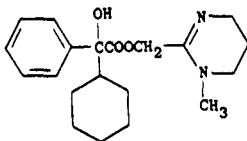
OXYPHENCYCLIMINE**Therapeutic Function:** Antispasmodic**Chemical Name:** α -cyclohexyl- α -hydroxybenzeneacetic acid (1,4,5,6-tetrahydro-1-methyl-2-pyrimidinyl)methyl ester**Common Name:** —**Structural Formula:****Chemical Abstracts Registry No.:** 125-53-1; 125-52-0 (Hydrochloride)

Trade Name	Manufacturer	Country	Year Introduced
Vio-Thene	Rowell	U.S.	1959
Daricon	Pfizer	U.S.	1959
Setrol	Flint	U.S.	1961
Gastrix	Rowell	U.S.	1973
Manir	Valpan	France	1975
Caridan	B.D.H.	U.K.	—
Cycmin	Toyo	Japan	—
Inomaru S	Sawai	Japan	—
Norma	Sankyo	Japan	—
Oximin	A.F.I.	Norway	—
Sedomucol	Asla	Spain	—
Spazamin	G.P.	Australia	—
Ulcociclina	Confas	Italy	—
Ulcomin	Remedia	Israel	—
Vagogastrin	Benvegna	Italy	—

Raw Materials

1,3-Diaminobutane	Cyclohexyl bromide
Ethyl chlorimidoacetate	Magnesium
Benzoyl formic acid	

Manufacturing Process

To a stirred solution of 8.8 grams (0.1 mol) of 1,3-diaminobutane in 150 ml of ethanol maintained at 0° to 5°C, there was added 25.8 grams (0.1 mol) of ethyl chlorimidoacetate hydrochloride during a period of 20 minutes. After the mixture had been stirred at 0° to

5°C for two hours, it was acidified at this temperature by the addition of ethanolic hydrogen chloride. The mixture was warmed to room temperature and filtered to remove 4.3 grams of solid ammonium chloride. The filtrate was concentrated to approximately 40 ml, filtered and refrigerated. The solid which separated was isolated, washed with acetone and dried. There was obtained 7.4 grams (40% of the theoretical yield) of 2-chloromethyl-4-methyl-1,4,5,6-tetrahydropyrimidine hydrochloride melting at 158° to 160°C.

In a second step, cyclohexyl bromide was reacted with magnesium, then with benzoyl formic acid to give cyclohexylphenyl glycolic acid. A solution of 1.8 grams (0.01 mol) of 2-chloromethyl-1-methyl-1,4,5,6-tetrahydropyrimidine hydrochloride in 5 ml of water was made alkaline with 5 ml of 50% NaOH and extracted with ether. The ether solution, which contained the basic chloride, was dried over calcium sulfate and added to a solution of 2.3 grams (0.01 mol) of α -cyclohexylphenylglycolic acid in 75 ml of isopropanol. The solution was distilled to remove the ether, and 0.1 gram of powdered potassium iodide added to the residual isopropanol solution which was then refluxed for 6 hours. The solid which had separated was redissolved by the addition of 20 ml of ethanol and the solution charcoaled, concentrated, and cooled. The solid which separated, 1-methyl-1,4,5,6-tetrahydro-2-pyrimidylmethyl α -cyclohexylphenyl-glycolate hydrochloride, weighed 1.4 grams and melted at 228° to 229°C with decomposition after recrystallization from ethanol.

References

Merck Index 6841

Kleeman & Engel p. 677

OCDS Vol. 2 p. 75 (1980)

I.N. p. 720

REM p. 917

Chas. Pfizer & Co., Inc.; British Patent 795,758; May 28, 1958

OXYPHENISATIN ACETATE

Therapeutic Function: Cathartic

Chemical Name: 3,3-Bis[4-(Acetyloxy)phenyl]-1,3-dihydro-2H-indol-one

Common Name: Acetphenolisatin; endophenolphthalein; diphesatin

Structural Formula:

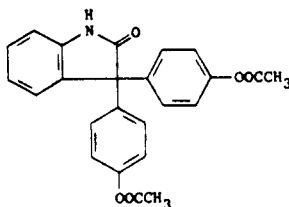

Chemical Abstracts Registry No.: 115-33-3

Trade Name	Manufacturer	Country	Year Introduced
Lavema	Winthrop	U.S.	1959
Isalax	Vale	U.S.	1963
Acetalax	Harvey	Australia	—
Bisco-Zitron	Biscova	W. Germany	—
Bydolax	Moore	U.K.	—

Trade Name	Manufacturer	Country	Year Introduced
Darmoletten	Omegin	W. Germany	—
Eulaxin	Pliva	Yugoslavia	—
Fenisan	Chemimportexport	Rumania	—
Laxatan	Divapharma	W. Germany	—
Laxanormal	Uquifa	Spain	—
Med-Laxan	Med	W. Germany	—
Nourilax	Nourypharma	Neth.	—
Obstilax	Zirkulin	W. Germany	—
Promassolax	Ysat Wernigerode	E. Germany	—
Prulet	Mission	U.S.	—
Regal	Ferrosan	Denmark	—
Sanapert	Trogalen	Austria	—
Schokolax	Dallmann	W. Germany	—
Veripaque	Winthrop	U.K.	—

Raw Materials

Diphenolisatin
Acetic anhydride

Manufacturing Process

235 gravimetric parts of acetic acid anhydride (90%) are poured over 106 gravimetric parts of diphenolisatin (*Berichte der Deutschen Chemischen Gesellschaft*, 18, 1885, p. 2641) and the mixture is heated on the water-bath while stirring. The solid starting material temporarily dissolves almost entirely and shortly afterwards the reaction product turns into a crystalline paste. In order to complete the reaction the heating on the water-bath is continued for a short time and then the whole is left to get cold. The reaction product may, for instance, be separated in the following manner: To the cold reaction mixture is gradually added about the same volumetric quantity of alcohol; in this manner the excess of acetic acid anhydride is destroyed and the paste becomes thinner. Then the fluid is drawn off and the product washed with alcohol. For complete cleansing another extraction is made with warm alcohol and the product crystallized, for instance, from 10 parts of acetic acid. The product represents a light, fine crystalline powder, which is difficultly soluble or even insoluble in the usual organic solvents. Its melting point lies at 242°C.

References

Merck Index 6842

Kleeman & Engel p. 678

OCDS Vol. 2 p. 350 (1980)

I.N. p. 720

Preiswerk, E.; U.S. Patent 1,624,675; April 12, 1927; assigned to Hoffmann-LaRoche Chemical Works

OXYTETRACYCLINE

Therapeutic Function: Antibiotic

Chemical Name: 4-(dimethylamino)-1,4,4a,5,5a,6,11,12a-octahydro-3,5,6,10,12,12a-hexahydroxy-6-methyl-1,11-dioxo-2-naphthacene-carboxamide

Common Name: —

Structural Formula:

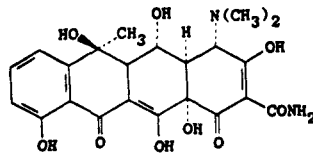

Chemical Abstracts Registry No.: 79-57-2; 2058-46-0 (Hydrochloride)

Trade Name	Manufacturer	Country	Year Introduced
Terramycin	Pfizer	U.S.	1950
Gynamousse	Pfizer	France	1966
Oxy-Kesso-Tetra	McKesson	U.S.	1970
Oxlopar	Parke Davis	U.S.	1974
E.P. Mycin	Edwards	U.S.	1983
Chrysocin	Pliva	Yugoslavia	—
Clinimycin	Glaxo	U.K.	—
Copharoxy	Cophar	Switz.	—
Crisamicin	Frumtost	Spain	—
Devacyclin	Deva	Turkey	—
Dura-Tetracyclin	Dura	W. Germany	—
Egocin	Krka	Yugoslavia	—
Elaciclina	I.F.L.	Spain	—
Galenomycin	Galen	U.K.	—
Geocycline	I.E. Kimya Evi	Turkey	—
Geomycin	Pliva	Yugoslavia	—
I.A. - Loxin	Inter-Alia Pharm.	U.K.	—
Imperacin	I.C.I.	U.K.	—
Macocyn	Mack	W. Germany	—
Oksisiklin	Uranium	Turkey	—
Ossitetra	Pierrel	Italy	—
Otesolut	Jenapharm	E. Germany	—
Oxacycline	Crookes	U.K.	—
Oxeten	Mochida	Japan	—
Oxymycin	Chelsea	U.K.	—
Proteroxyna	Proter	Italy	—
Stecsolin	Squibb	U.K.	—
Tetra-Tabliten	Sanorania	W. Germany	—
Tetrafen	Drifen	Turkey	—

Raw Materials

Bacterium *Streptomyces rimosus*
 Soybean meal
 Cerelese (glucose)

Manufacturing Process

Medium	Grams
Soybean meal	10
Cerelese	10
Distillers' solubles	0.5
Sodium chloride	5
Distilled water to 1,000 ml	

The pH was adjusted to 7.0 with sodium hydroxide and calcium carbonate was added at the rate of 1 g/l.

500 ml portions of the above medium were added to Fernbach flasks which were then sterilized at 121°C for 30 minutes. Upon cooling, the flasks were inoculated with a suspension of the growth of *S. rimosus* obtained from the surface of beef lactose agar slants, and the flasks were shaken for 4 days at 28°C on a rotary shaker having a displacement of 2" at an rpm of 200. At the end of this period the broth was found to contain 640 C.D.U./ml and 400 chloramphenicol units/ml. The mycelium was separated from the broth by filtration and the latter was adjusted to pH 9.0. The antibiotic was extracted from the broth with n-butanol, and when the ultraviolet absorption spectrum was observed on the butanol solution of the antibiotic, peaks in the absorption curve were found at 385 and 270 millimicrons.

References

- Merck Index 6846
 Kleeman & Engel p. 680
 PDR pp. 887, 1413, 1533, 1606
 OCDS Vol. 1 p. 212 (1977) & 2, 226 (1980)
 I.N. p. 721
 REM pp. 1206, 1260
 Sobin, B.A., Finlay, A.C. and Kane, J.H.; U.S. Patent 2,516,080; July 18, 1950; assigned to Chas. Pfizer & Co., Inc.

OXYTOCIN

Therapeutic Function: Oxytocic

Chemical Name: A complex peptide; see structural formula

Common Name: —

Structural Formula:

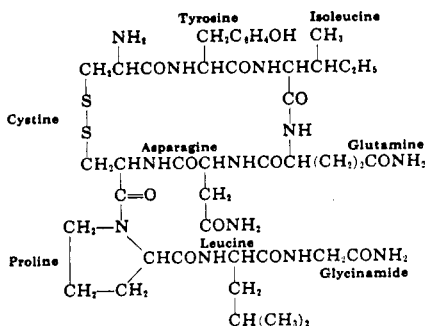

Chemical Abstracts Registry No.: 50-56-6

Trade Name	Manufacturer	Country	Year Introduced
Syntocinon	Sandoz	U.S.	1957
Syntocinon	Sandoz	France	1958
Uteracon	Hoechst	U.S.	1964
Atonin-O	Teikoku Zoki	Japan	—
Endopituitrina	I.S.M.	Italy	—
Orasthin	Hoechst	W. Germany	—
Oxitocin	Chinoin	Italy	—
Oxystin	Arzneimittelwerk Dresden	E. Germany	—

Trade Name	Manufacturer	Country	Year Introduced
Oxytal	A.L.	Norway	—
Partocon	Ferring	Sweden	—
Partolact	Medica	Finland	—
Pitocin	Sankyo	Japan	—
Pituitan	Nippon Zoki	Japan	—

Raw Materials

α -Benzyl-L-aspartic acid- β -lower alkyl ester
 N-Trityl glutamic acid- γ -lower alkyl ester
 Hydrogen
 S,N-Ditrityl-L-cysteine diethylamine salt
 L-Tyrosine lower alkyl ester
 L-Isoleucine lower alkyl ester
 Benzyl-L-proline hydrochloride
 L-Leucine lower alkyl ester
 Ammonia
 Hydrogen chloride
 Glycine lower alkyl ester

Manufacturing Process

As described in U.S. Patent 2,938,891, in the process for producing oxytocin, the steps comprise:

- (a) Adding dicyclohexyl carbodiimide to a solution of the α -benzyl-L-aspartic acid- β -lower alkyl ester in methylene chloride, cooling the mixture to about 0°C, adding thereto the N-trityl glutamic acid- γ -lower alkyl ester, allowing the mixture to stand at room temperature to complete condensation, acidifying the reaction mixture with acetic acid, filtering off precipitated dicyclohexyl urea, and separating the resulting (N-trityl- γ -lower alkyl-L-glutamyl)- α -benzyl-L-aspartic acid- β -lower alkyl ester.
- (b) Dissolving the (N-trityl- γ -lower alkyl-L-glutamyl)- α -benzyl-L-aspartic acid- β -lower alkyl ester in ethanol, adding triethylamine and palladium black to said solution, introducing hydrogen at room temperature therein to split off the benzyl group, and separating the (N-trityl- γ -lower alkyl-L-glutamyl)-L-aspartic acid- β -lower alkyl ester.
- (c) Adding dicyclohexyl carbodiimide to a solution of the diethylamine salt of S,N-ditrityl-L-cysteine and the hydrochloride of the lower alkyl ester of L-tyrosine in methylene chloride, allowing the mixture to stand at a temperature between room temperature and about 35°C to complete condensation, acidifying the reaction mixture with acetic acid, filtering off precipitated dicyclohexyl urea, and separating the resulting lower alkyl ester of S,N-ditrityl-L-cysteinyl-L-tyrosine.
- (d) Refluxing the aqueous alcoholic solution of said ester with an alcoholic alkali metal hydroxide solution to saponify the lower alkyl ester group, neutralizing the saponification mixture by the addition of hydrochloric acid, extracting the neutralized mixture with ether, and separating the resulting (S,N-ditrityl-L-cysteinyl)-L-tyrosine.
- (e) Adding triethylamine to a solution of said S,N-ditrityl compound in chloroform, and precipitating the triethylamine salt of (S,N-ditrityl-L-cysteinyl)-L-tyrosine by the addition of petroleum ether.
- (f) Adding dicyclohexyl carbodiimide to a solution of said triethylamine salt of (S,N-ditrityl-L-cysteinyl)-L-tyrosine and the hydrochloride of the lower alkyl ester of L-isoleucine in methylene chloride, allowing the mixture to stand at room temperature to complete condensation, acidifying the reaction mixture with acetic acid, filtering off precipitated dicyclohexyl urea, and separating the resulting (S,N-ditrityl-L-cysteinyl)-L-tyrosyl-L-isoleucine lower alkyl ester.

- (g) Refluxing the aqueous alcoholic solution of said ester with an alcoholic alkali metal hydroxide solution to saponify the lower alkyl ester group, neutralizing the saponification mixture by the addition of hydrochloric acid, extracting the neutralized mixture with ether, and separating the resulting (S,N-ditrityl-L-cysteinyI)-L-tyrosine-L-isoleucine.
- (h) Adding dicyclohexyl carbodiimide to a solution of the diethylamine salt of S,N-ditrityl-L-cysteine and the hydrochloride of benzyl-L-proline in methylene chloride, allowing the mixture to stand at about room temperature to complete condensation, acidifying the reaction mixture with acetic acid, filtering off precipitated dicyclohexyl urea, and separating the resulting (S,N-ditrityl-L-cysteinyI)-L-proline benzyl ester.
- (i) Refluxing said benzyl ester with an aqueous alcoholic alkali metal hydroxide solution to saponify the benzyl ester group, neutralizing the saponification mixture by the addition of hydrochloric acid, extracting the neutralized mixture with chloroform, and separating the resulting (S,N-ditrityl-L-cysteinyI)-L-proline.
- (j) Adding diethylamine to a solution of said dipeptide compound in ether to yield the diethylamine salt of (S,N-ditrityl-L-cysteinyI)-L-proline.
- (k) Adding dicyclohexyl carbodiimide to a solution of the diethylamine salt of (S,N-ditrityl-L-cysteinyI)-L-proline and the hydrochloride of the L-leucine lower alkyl ester in methylene chloride, allowing the mixture to stand at a temperature between about 25° and 30°C to complete condensation, acidifying the reaction mixture with acetic acid, filtering off precipitated dicyclohexyl urea, and separating the resulting (S,N-ditrityl-L-cysteinyI)-L-prolyl-L-leucine lower alkyl ester.
- (l) Refluxing said lower alkyl ester with an aqueous alcoholic alkali metal hydroxide solution to saponify the lower alkyl ester group, neutralizing the saponification mixture by the addition of hydrochloric acid, extracting the neutralized mixture with ether, and separating the resulting S,N-ditrityl-L-cysteinyI-L-prolyl-L-leucine.
- (m) Adding dicyclohexyl carbodiimide to a solution of the diethylamine salt of S,N-ditrityl-L-cysteinyI-L-prolyl-L-leucine and the hydrochloride of the glycine lower alkyl ester in methylene chloride, allowing the mixture to stand at a temperature between about 25° and 30°C to complete condensation, acidifying the reaction mixture with acetic acid, filtering off precipitated dicyclohexyl urea, and separating the resulting (S,N-ditrityl-L-cysteinyI)-L-prolyl-L-leucyl-glycine lower alkyl ester.
- (n) Adding aqueous hydrochloric acid to a mixture of said lower alkyl ester in a solvent selected from the group consisting of acetone and acetic acid, allowing the mixture to stand at a temperature of about 35°C to complete selective detritylation of the N-trityl group, and separating the resulting (S-trityl-L-cysteinyI)-L-prolyl-L-leucyl glycine lower alkyl ester.
- (o) Adding dicyclohexyl carbodiimide to a solution of the diethylamine salt of the (N-trityl- γ -lower alkyl-L-glutamyl)-L-aspartic acid- β -lower alkyl ester obtained according to step (b) and the hydrochloride of the (S-trityl-L-cysteinyI)-L-prolyl-L-leucyl glycine lower alkyl ester in methylene chloride, allowing the mixture to stand at about room temperature to complete condensation, filtering off precipitated dicyclohexyl urea, and separating the resulting (N-trityl- γ -lower alkyl-L-glutamyl)-(β -lower alkyl-L-aspartyl)-(β -lower alkyl-L-leucyl glycine lower alkyl ester).
- (p) Adding aqueous hydrochloric acid to a mixture of said lower alkyl ester in a solvent selected from the group consisting of acetone and acetic acid, allowing the mixture to stand at room temperature to complete selective detritylation of the N-trityl group, and separating the resulting hexapeptide compound (γ -lower alkyl-L-glutamyl)-(β -lower alkyl-L-aspartyl)-(β -lower alkyl-L-leucyl glycine lower alkyl ester).
- (q) Adding dicyclohexyl carbodiimide to a solution of the diethylamine salt of (S,N-ditrityl-

L-cysteinyll-L-tyrosyl-L-isoleucine obtained according to step (g) and the hydrochloride of (γ -lower alkyl-L-glutamyl)-(β -lower alkyl-L-aspartyl)-(S-trityl-L-cysteinyll)-L-prolyl-L-leucyl glycine lower alkyl ester in methylene chloride, allowing the mixture to stand at about room temperature to complete condensation, filtering off precipitated dicyclohexyl urea, and separating the resulting (S,N-ditryl-L-cysteinyll)-L-tyrosyl-L-isoleucyl-(γ -lower alkyl-L-glutamyl)-(β -lower alkyl-L-aspartyl)-(S-trityl-L-cysteinyll)-L-prolyl-L-leucyl glycine lower alkyl ester.

(r) Dissolving said lower alkyl ester in a lower alkanol, saturating the resulting solution at a temperature of about -15° to -20°C with ammonia gas, allowing the mixture to stand in a sealed container at room temperature to complete replacement of the lower alkyl ester group by the amide group, and separating the resulting triamide (S,N-ditryl-L-cysteinyll)-L-tyrosyl-L-isoleucyl-L-glutaminyll-L-asparaginyll-(S-trityl-L-cysteinyll)-L-prolyl-L-leucyl glycine amide.

(s) Dissolving said triamide in an anhydrous solvent selected from the group consisting of chloroform, a mixture of chloroform and acetic acid, and a mixture of methylene chloride and thioglycolic acid, saturating the solution with gaseous hydrochloric acid at room temperature to complete detritylation, and separating the resulting L-cysteinyll-L-tyrosyl-L-isoleucyl-L-glutaminyll-L-asparaginyll-L-cysteinyll-L-prolyl-L-leucyl glycine amide.

(t) Dissolving said nonapeptide triamide in water and agitating the solution in oxygen to cause conversion thereof into oxytocin.

References

Merck Index 6849

Kleeman & Engel p. 681

PDR pp. 1382, 1596, 1966, 1989

I.N. p. 722

REM pp. 949, 957

Velluz, L., Amiard, G., Bartos, J., Goffinet, B. and Heymes, R.; U.S. Patent 2,938,891; May 31, 1960; assigned to Uclaf, France

Velluz, L., Amiard, G. and Heymes, R.; U.S. Patent 3,076,797; February 5, 1963; assigned to Roussel-UCLAF SA, France

P

PANCURONIUM BROMIDE

Therapeutic Function: Muscle relaxant

Chemical Name: 1,1'-[3 α ,17 β -bis(acetyloxy)-5 α -androstane-2 β ,16 β -diyl] bis[1-methylpiperidinium] dibromide

Common Name: —

Structural Formula:

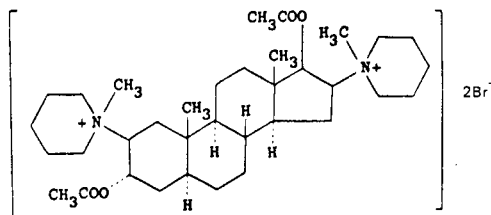

Chemical Abstracts Registry No.: 15500-66-0

Trade Name	Manufacturer	Country	Year Introduced
Pavulon	Organon-Teknika	U.K.	1968
Pancuronium	Organon	W. Germany	1969
Pavulon	Organon-Teknika	France	1971
Pavulon	Organon	U.S.	1972
Myoblock	Organon-Sankyo	Japan	1973
Pavalon	Ravasini	Italy	1973

Raw Materials

3,17-Diacetoxy-5 α -androstane-2,16-diene
 m-Chlorperbenzoic acid
 Piperidine
 Sodium borohydride
 Acetic anhydride
 Methyl bromide

Manufacturing Process

A solution of 2 α ,3 α ,16 α ,17 α -diepoxy-17 β -acetoxy-5 α -androstane (25 grams), prepared from 3,17-diacetoxy-5 α -androstane-2,16-diene (*Chem. Abs.* 1960, 54, 8908) by treatment with m-chlor-per-benzoic acid, in piperidine (120 ml) and water (40 ml) was boiled under reflux for 5 days, the solution was concentrated and the product precipitated by the addition of water. The solid was collected, dissolved in dilute hydrochloric acid, filtered to give a clear solution and precipitated by the addition of sodium hydroxide solution. Crystalliza-

tion from acetone gave 2 β ,16 β -bis-piperidino-5 α -androstan-3 α -ol-17-one (18.9 grams), MP 179°-185°C.

A solution of sodium borohydride (8 grams) in water (16 ml) was added to a stirred solution of 2 β ,16 β -bis-piperidino-5 α -androstan-3 α -ol-17-one (17 grams) in tetrahydrofuran (70 ml) and methanol (30 ml) and the solution stirred at room temperature for 16 hours. The product was precipitated by the addition of water, filtered off, dried, and crystallized from acetone to give the diol (14.9 grams).

A solution of the piperidino-diol (9 grams) in acetic anhydride (18 ml) was heated at 90°C for 1 hour, the solution cooled, excess acetic anhydride destroyed by the careful addition of water, and the resulting solution carefully made alkaline with 2 N caustic soda solution to precipitate a solid product. The solid was dried, extracted with n-hexane and the solution filtered free of insoluble material before percolation down a column (4 x 1" diameter) of alumina. Elution with n-hexane gave a fraction (4.2 grams) which was crystallized twice from ether to give the diacetate, MP 176°-180°C.

Methyl bromide (17 grams) was added to a solution of the bis-piperidinodiacetate (4 grams) in methylene chloride (10 ml) and the resulting solution allowed to stand at room temperature for 4 days. The solution was evaporated to dryness, the residue triturated with ether, and filtered to give the bis-methobromide (5.2 grams), MP 206°C. Recrystallization from acetone-methylene chloride gave material MP 214°-217°C.

References

Merck Index 6870

Kleeman & Engel p. 681

PDR p. 1288

OCDS Vol. 2 p. 163 (1980)

DOT 5 (3) 104 (1969)

I.N. p. 726

REM p. 924

Hewett, C.L. and Savage, D.S.; U.S. Patent 3,553,212; January 5, 1971; assigned to Organon Inc.

PAPAIN

Therapeutic Function: Enzyme; used to prevent wound adhesions

Chemical Name: See Structural Formula

Common Name: —

Structural Formula: Has folded polypeptide chain of 212 residues with a molecular weight of about 23,400.

Chemical Abstracts Registry No.: 9001-73-4

Trade Name	Manufacturer	Country	Year Introduced
Papain	Green Cross	Japan	1969
Panafil	Rystan	U.S.	—
Prevenzyme	Legere	U.S.	—

Raw Materials

Papaya fruit
Methanol

Manufacturing Process

Crude papain, obtained as the dried exudate of the fruit and leaves of *Carica papaya* L., Caricaceae, is usually found to have been contaminated during collection, drying, or storage by insects, rodent hair and excreta, botanical plant parts, sand, etc. and may thereby become further contaminated by harmful bacteria and enteric organisms.

Heretofore papain has been purified by dispersing the crude enzymes in water, filtering and spray-drying. In this procedure, however, the soluble contaminants are retained in the dried product. It has also been known to purify papain by dispersing it in water and adding acetone to reprecipitate the enzymes leaving many of the acetone-soluble and water-soluble impurities in the supernatant liquid. The material thus purified possesses a very disagreeable sulfide-like taste probably due to the reaction between the acetone and reactive sulfhydryl groups present in the papaya latex.

It has now been found that an enzyme mixture of high purity which contains none of the objectionable sulfidelike taste can be obtained by dispersing the crude enzymes in water, adding a quantity of a water-miscible lower-alkanol to the incipient precipitation point of the proteolytic enzymes thereby retaining the maximum proteolytic activity (i.e., the maximum amount of the proteolytic enzymes) in the solvent phase while precipitating the major portion of the lower-alkanol insoluble contaminants, removing the lower-alkanol insoluble contaminants and precipitated inert materials, for example, by filtration or centrifugation, and then adding an additional quantity of the water-miscible lower-alkanol sufficient to precipitate the proteolytic enzymes.

The following is a specific example of the conduct of the present process. 100 g of crude papain were stirred with 120 ml of 0.01 M cysteine hydrochloride for one hour during which time the papain was completely dispersed. To the dispersion was added slowly and with vigorous stirring 147 ml of methanol. The mixture, which contained 55% methanol by volume, was stirred for about thirty minutes and centrifuged and the clear supernatant liquid was removed and saved. The precipitate was washed with 50 ml of 55% aqueous methanol, and the mixture was centrifuged again. The precipitate containing the undesirable, insoluble contaminants was discarded, and the clear wash liquid was combined with the main supernatant. To the combined clear supernatant liquid was added slowly and with vigorous stirring 265 ml of methanol to give a mixture containing 75.5% methanol by volume. The enzymes were precipitated as a taffylike gum which was isolated by decantation of the supernatant liquid containing the undesirable, soluble contaminants and tray-drying. Alternatively, the precipitated enzymes can be redissolved in pure water and spray-dried.

References

Merck Index 6878

PDR pp. 1033, 1576

REM p. 1038

Lesuk, A.; U.S. Patent 3,011,952; December 5, 1961; assigned to Sterling Drug, Inc.

PAPAVERINE MONOPHOSADENINE

Therapeutic Function: Vasodilator and platelet aggregation inhibitor

Chemical Name: Papaverine adenosine 5-monophosphate

Common Name: Papaverine adenylate

Structural Formula:

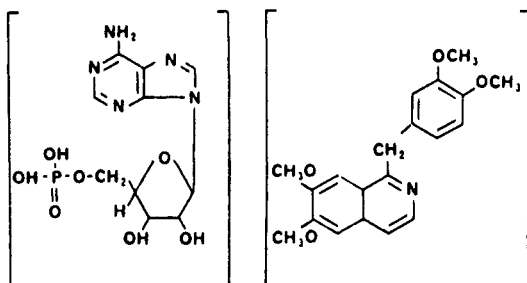

Chemical Abstracts Registry No.: 58-74-2 (Base)

Trade Name	Manufacturer	Country	Year Introduced
Lempav Ty-Med	Lemmon	U.S.	1975
Artegodan	Artesan	W. Germany	—
Cepaverin	Eurand	Italy	—
Cerespan	U.S.V.	U.S.	—
Dylate	Elder	U.S.	—
Omnopon	Roche	U.K.	—
Pamelon	Simes	Italy	—
Panergon	Mack	W. Germany	—
Papaverlumin	Pidefe	Spain	—
Papaversan	Abello	Spain	—
Pavabid	Marion	U.S.	—
Pavacron	Cenci	U.S.	—
Pavagrant	Amfre-Grant	U.S.	—
Pavakey	Key Pharm.	U.S.	—
Pavatym	Everett	U.S.	—
Paver	Mulda	Turkey	—
Spastretten	Tropon	W. Germany	—
Sustaverine	I.C.N.	U.S.	—
Udip	Marion	U.S.	—

Raw Materials

Adenosine-5'-monophosphoric acid
Papaverine base

Manufacturing Process

To 3.65 g (0.01 mol) of monohydrated adenosine-5'-monophosphoric acid, brought into suspension in a mixture of 45 ml of water and 5 ml of ethanol, are added 3.39 g (0.01 mol) of papaverine base (melting point, 147°C). The mixture is gently heated until a final temperature of 40°C is reached. The solution obtained is then filtered and the filtrate is concentrated under vacuum. The remaining product quickly crystallizes. After drying to 50°C to constant weight, there are obtained 6.68 g of desired product, in the monohydrated state, as a white crystalline powder, which melts at 140°C and is very soluble in water.

References

Merck Index 6880
Kleeman & Engel p. 683
PDR pp. 830, 875, 993, 1079, 1569, 1606, 1810
OCDS Vol. 1 p. 347 (1977)
DOT 11 (8) 315 (1975)
I.N. p. 728
REM p. 852

Mauvernay, R.Y.; U.S. Patent 3,823,234; July 9, 1974; assigned to Centre Europeen de Recherches Mauvernay C.E.R.M.

PARAMETHADIONE

Therapeutic Function: Anticonvulsant

Chemical Name: 5-ethyl-3,5-dimethyl-2,4-oxazolidinedione

Common Name: Isoethadione

Structural Formula:

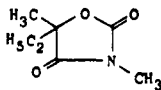

Chemical Abstracts Registry No.: 115-67-3

Trade Name	Manufacturer	Country	Year Introduced
Paradione	Abbott	U.S.	1949

Raw Materials

Methyl ethyl ketone	Sodium cyanide
Urea	Sodium
Methanol	Dimethyl sulfate

Manufacturing Process

About 143.1 grams (one mol) of 5-methyl-5-ethyloxazolidine-2,4-dione is dissolved in 300 cc of methanol containing 23 grams of sodium. To the above mixture is added 126 grams of dimethyl sulfate in 10 cc portions while the temperature is maintained at about 50°C by external cooling. The mixture is then heated briefly to boiling, cooled, diluted with about 500 cc of water and extracted with two 250 cc portions of benzene. The benzene extract is separated, washed once with sodium bicarbonate solution and once with water. The benzene is removed by evaporation on a steam bath and the residue is fractionally distilled. The material boiling at 112° to 116°C at 25 mm pressure is taken; $n_D^{25} = 1.4495$. Upon further fractionation, a very pure specimen boils at 101°-102°C at 11 mm.

The 5-methyl-5-ethyloxazolidine-2,4-dione may be prepared by reacting methyl ethyl ketone with sodium cyanide and with ammonium thiocyanate followed by desulfurization. This intermediate may also be prepared by condensing α -hydroxy- α -methylbutyramide with ethyl chlorocarbonate or by condensing ethyl α -hydroxy- α -methylbutyrate with urea. Another method described (Traube and Aschar, *Ber.*, 46, 2077-1913) consists in the condensation of ethyl α -hydroxy- α -methylbutyrate with guanidine followed by hydrolysis.

References

- Merck Index 6890
- Kleeman & Engel p. 685
- PDR p. 545
- OCDS Vol. 1 p. 232 (1977)
- I.N. p. 730
- REM p. 1080

Spielman, M.A.; U.S. Patent 2,575,693; November 20, 1951; assigned to Abbott Laboratories

PARAMETHASONE ACETATE

Therapeutic Function: Glucocorticoid

Chemical Name: 6 α -Fluoro-11 β ,17,21-trihydroxy-16 α -methylpregna-1,4-diene-3,20-dione

Common Name: —

Structural Formula:

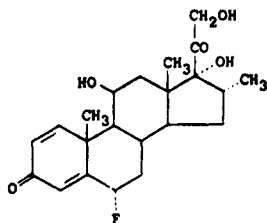

(base)

Chemical Abstracts Registry No.: 1597-82-6; 53-33-8 (Base)

Trade Name	Manufacturer	Country	Year Introduced
Haldrone	Lilly	U.S.	1961
Dilar	Cassenne	France	1962
Paramezone	Recordati	Italy	1962
Monocortin	Gruenthal	W. Germany	1963
Stemex	Syntex	U.S.	1970
Cortidene	I.F.L.	Spain	—
Metilar	Syntex	U.K.	—
Paramesone	Tanabe	Japan	—
Sintecort	Medicamenta	Portugal	—
Triniol	I.F.L.	Spain	—

Raw Materials

5 α ,11 β ,17 α ,21-Tetrahydroxy-6 β -fluoro-16 α -methylallopregna-3,20-dione-21 acetate 3-ethylene glycol ketal
Hydrogen chloride

Manufacturing Process

A solution of 0.144 g of the 3-ethylene glycol ketal of 5 α ,11 β ,17 α ,21-tetrahydroxy-6 β -fluoro-16 α -methylallopregna-3,20-dione 21-acetate in 12 ml of chloroform and 0.1 ml of absolute alcohol was cooled to -10°C in an ice-salt bath and a stream of anhydrous hydrochloric acid was gently bubbled through the solution for 2.5 hours while the temperature was maintained between -5°C and -15°C . The solution was then diluted with 25 ml of chloroform, washed with dilute sodium bicarbonate and water, dried over anhydrous sodium sulfate, and evaporated to dryness under reduced pressure at 60°C or less to give 6 α -fluoro-11 β ,17 α ,21-trihydroxy-16 α -methyl-4-pregna-3,20-dione 21-acetate.

References

Merck Index 6891

Kleeman & Engel p. 686

OCDS Vol. 1 p. 200 (1977)

I.N. p. 730

REM p. 969

Lincoln, F.H., Schneider, W.P. and Spero, G.B.; U.S. Patent 3,557,158; January 19, 1971; assigned to The Upjohn Co.

PARAPENZOLATE BROMIDE

Therapeutic Function: Antilucer

Chemical Name: N-Methyl-4-piperidylbenzilate methobromide

Common Name: —

Structural Formula:

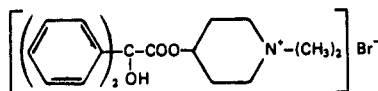

Chemical Abstracts Registry No.: —

Trade Name	Manufacturer	Country	Year Introduced
Spacine	Unilabo	France	1968
Vagopax	Essex	Italy	1976
Vagopax	Centrane	France	—

Raw Materials

N-Methyl-4-piperidinol HCl	Methyl iodide
Diphenylchloroacetyl chloride	Silver bromide

Manufacturing Process

N-methyl-4-piperidyl benzilate and the methiodide: An intimate mixture of 0.1 mol of N-methyl-4-piperidinol hydrochloride and 0.1 mol diphenylchloroacetyl chloride is heated at 160°C to 180°C until the evolution of hydrogen chloride ceases (usually about 4 to 5 hours). The melt is then dissolved in 500 ml of water and the resultant mixture heated on a steam bath for about ½ hour, after which time complete solution is effected. The acid solution is cooled and rendered alkaline with ammonium hydroxide solution whereupon the ester is precipitated. The ester is purified either by removal by filtration and recrystallization from benzene petroleum ether or by extracting the mixture with benzene and precipitating the ester by the addition of petroleum ether. After recrystallization there is obtained about 0.06 mol of N-methyl-4-piperidyl benzilate, melting point 162°C to 163°C.

To a solution of 0.05 mol of the above-obtained ester in about 100 ml of anhydrous benzene there are added 15 ml of methyl iodide. The ensuing mixture is refluxed for several hours whereupon the quaternary salt is deposited and removed by filtration. Recrystallization from ethanol or ethanol-ether yields the quaternary salt, melting point 199°C to 200°C.

N-methyl-4-piperidyl benzilate methobromide: To a suspension of 0.15 mol of freshly prepared silver bromide in 300 ml of anhydrous methanol is added a solution of 0.1 mol of quaternary iodide obtained as above. The mixture is stirred and refluxed for several hours after which time transhalogenation is complete. The mixture is cooled, the insoluble silver

salt removed by filtration and the methanolic solution of the quaternary bromide is concentrated in vacuo. The residue is recrystallized from methanol or methanol-ether yielding the quaternary bromide in quantitative amounts, melting point 237°C to 238°C.

References

OCDS Vol. 2 p. 75 (1980)

DOT 6 (3) 92 (1970)

I.N. p. 731

Papa, D.; British Patent 788,126; December 23, 1957; assigned to Schering Corp.

PARGYLINE HYDROCHLORIDE

Therapeutic Function: Antihypertensive

Chemical Name: N-methyl-N-2-propynylbenzenemethanamine hydrochloride

Common Name: N-methyl-N-propargylbenzylamine hydrochloride

Structural Formula:

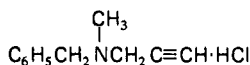

Chemical Abstracts Registry No.: 306-07-0; 555-57-7 (Base)

Trade Name	Manufacturer	Country	Year Introduced
Eutonyl	Abbott	U.S.	1963

Raw Materials

N-Methylbenzylamine
Propargyl bromide

Sodium carbonate
Hydrogen chloride

Manufacturing Process

A mixture of 23.8 grams (0.2 mol) of propargyl bromide, 24.2 grams (0.2 mol) of N-methyl benzylamine and 400 ml of anhydrous ethanol in the presence of 42.4 grams (0.4 mol) of anhydrous sodium carbonate was heated at the boiling temperature and under reflux for a period of 17 hours.

The sodium carbonate was then removed by filtration and the alcohol was removed by distillation under reduced pressure. The residue was treated with 300 ml of dry ether and the resulting solution was filtered to remove sodium bromide.

The filtrate was dried and fractionally distilled under reduced pressure to obtain the desired N-methyl-N-propargylbenzylamine which boiled at 96°-97°C at 11 mm pressure.

Analysis calculated for $\text{C}_{11}\text{H}_{13}\text{N}$: C = 82.97%; H = 8.23%; N = 8.80%. Found: C = 82.71%; H = 8.51%; N = 8.93%.

The hydrochloride salt of this amine was prepared by dissolving the amine in ether and adding ethereal hydrogen chloride to the ether solution. The solid hydrochloride salt which precipitated was recrystallized from an ethanol-ether mixture and was found to melt at 154°-155°C.

References

Merck Index 6902

Kleeman & Engel p. 688

PDR p. 523

OCDS Vol. 1 p. 54 (1977) & 2, 27 (1980)

DOT 9 (6) 217 (1973)

I.N. p. 732

REM p. 850

Martin, W.B.; U.S. Patent 3,155,584; November 3, 1964; assigned to Abbott Laboratories

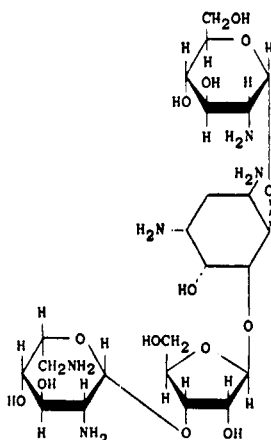
PAROMOMYCIN**Therapeutic Function:** Amebocidal**Chemical Name:** O-2,6-diamino-2,6-dideoxy- β -L-idopyranosyl-(1 \rightarrow 3)-O- β -D-ribofuranosyl-(1 \rightarrow 5)-O-[2-amino-2-deoxy- α -D-glucopyranosyl-(1 \rightarrow 4)]-2-deoxystreptamine**Common Name:** Catenulin, aminosidine, crestomycin, hydroxymycin, neomycin E, paucimycin**Structural Formula:****Chemical Abstracts Registry No.:** 7542-37-2

Trade Name	Manufacturer	Country	Year Introduced
Humatin	Parke Davis	U.S.	1960
Humatin	Parke Davis	W. Germany	1961
Humatin	Parke Davis	Italy	1961
Humagel	Parke Davis	France	1963
Aminosidine	Kyowa	Japan	—
Aminoxidin	Farmalabor	Italy	—
Gabbromycin	Montedison	Italy	—
Gabbroral	Farmalabor	Italy	—
Paramicina	Ragionieri	Italy	—

Raw MaterialsBacterium *Streptomyces rimosus* forma *paromomycinus*

Glucose
Soybean meal

Manufacturing Process

As described in U.S. Patent 2,916,485: 12 liters of a nutrient medium having the following composition is placed in a 30 liter fermentor equipped with stainless steel fittings including sparger, impeller, baffles and sampling lines and the medium is sterilized by heating at 121°C for two hours.

	Percent
Glucose monohydrate	0.5
Glycerol	0.5
Casein, acid hydrolyzed	0.3
Peptone	0.25
Brewer's yeast	0.1
Cornsteep solids	0.25
Soybean oil meal	0.25
Acetone-butanol fermentation residue	0.25
Sodium chloride	0.5
Calcium carbonate	0.1
Water sufficient to make 100%	

The medium is cooled and inoculated with 20 ml of a suspension of the spores from two Moyer's sporulation agar slant cultures of *Streptomyces rimosus* forma *paromomycinus* in sterile 0.1% sodium heptadecyl sulfate solution. The inoculated culture mixture is incubated at 26°C for sixty hours during which time the mixture is stirred at 200 rpm and sterile air is passed into the medium through the sparger at the rate of 12 liters per minute. A portion of the resulting incubated culture mixture is employed for inoculation of 16 liters of a nutrient medium having the following composition:

	Percent
Glucose monohydrate	1.0
Soybean oil meal	1.0
Sodium chloride	0.5
Calcium carbonate	0.1
Ammonium chloride	0.167
Hog stomach residue, saline extracted	0.5
Water sufficient to make 100%	

The pH of the latter nutrient medium is adjusted to 7.5 with 10 N sodium hydroxide solution and is placed in a 30 liter glass fermentor equipped with sparger, impeller, baffles and sampling line. The medium is sterilized by heating at 121°C for two hours, is allowed to cool and is then inoculated with 800 ml of the culture mixture obtained as described above.

The resulting culture mixture is incubated at 26°C for 94 hours during which time the mixture is stirred at 200 rpm and sterile air is passed into the medium through the sparger at the rate of 16 liters per minute. During the incubation, foaming is avoided by the addition, as needed, of crude lard and mineral oils containing mono- and diglycerides.

At the end of the incubation period the fermentation culture mixture is adjusted to pH 2 with concentrated hydrochloric acid, the solid material present is removed by filtration, and the filter cake is washed with water. The washings are combined with the main filtrate, adjusted to pH 7.0, and 15.5 liters of the filtered culture liquid is introduced into a columnar exchanger (1½" i.d.) packed with 380 ml of carboxylic acid resin which has been preliminarily washed in succession with two liters of an aqueous solution of 37.5 grams of sodium hydroxide and with two liters of water. The column containing paromomycin is washed with two hold-up volumes of water and is eluted with 0.5 N hydrochloric acid.

The first 19.4 liters of percolate contains little or no paromomycin and varies in pH from 6 to 7.3. When the pH of the eluate begins to fall below 6.0, two liters of the eluate are collected.

The two liter portion of the eluate, collected as indicated, is neutralized to pH 6 with 10N sodium hydroxide solution and is filtered. The filtrate is concentrated by evaporation in vacuo to a volume of approximately one liter.

An adsorption column is prepared by pouring a slurried aqueous mixture of 65 grams of acid-washed activated charcoal (Darco G-60) and 50 grams of diatomaceous earth in a 1½" column and 300 ml of the concentrated filtrate is added. The column is washed with 400 ml of water and eluted successively with 325 ml of water, 425 ml of 1% aqueous acetone and 400 ml of 10% aqueous acetone. The water and acetone eluates are concentrated and lyophilized to give paromomycin hydrochloride as a powder. The product is purified by taking up the powder in methanol, adding a large excess of acetone to the solution, recovering the precipitate which forms by filtration. The product, paromomycin hydrochloride, has an optical rotation $[\alpha]_D^{25} = +56.5^\circ$ (1% in water). By analysis it contains 35.71% carbon, 6.95% hydrogen, 8.24% nitrogen and 21.5% chlorine.

In order to obtain paromomycin in free base form, the hydrochloride is dissolved in water as a 3% solution, the solution is poured into an adsorption column containing an anion exchange resin (Amberlite IR-45 or preferably IRA-411 or IRA-400) in the hydroxyl form and the column is washed with a small amount of water.

The aqueous percolate is concentrated to dryness by lyophilization, and the solid product obtained is purified by taking up in boiling absolute ethanol, cooling and recovering the solid product paromomycin; $[\alpha]_D^{25} = +64^\circ$ (1% in water). By analysis it contains 45.17% carbon, 7.44% hydrogen and 10.35% nitrogen.

References

Merck Index 6903

Kleeman & Engel p. 688

I.N. p. 733

REM p. 1221

Davison, J.W. and Finlay, A.C.; U.S. Patent 2,895,876; July 21, 1959; assigned to Chas. Pfizer & Co., Inc.

Frohardt, R.P., Haskell, T.H., Ehrlich, J. and Knudsen, M.P.; U.S. Patent 2,916,485; Dec. 8, 1959; assigned to Parke, Davis & Company

PELARGONIC ACID

Therapeutic Function: Fungicide

Chemical Name: Nonanoic acid

Common Name: —

Structural Formula: $\text{CH}_3(\text{CH}_2)_7\text{COOH}$

Chemical Abstracts Registry No.: 112-05-0

Trade Name	Manufacturer	Country	Year Introduced
Pellar	Crookes Barnes	U.S.	1960

Raw Materials

Oleic acid
Oxygen

Manufacturing Process

A body of liquid, 18 inches high, comprising a 35% (by weight) solution of technical (95%) oleic acid in n-propanol, is maintained at a temperature of 86°C in a reactor. The solution also contains dissolved therein 0.042% by weight of cobalt, in the form of cobalt naphthenate. From the bottom of the reactor very fine bubbles of air are passed into and through the solution at the rate of about 0.3 cubic feet per minute, measured at standard conditions, per square foot for 72 hours. The gases leaving the reactor are first passed through an ice water reflux condenser and then vented to the atmosphere. At the end of the 72 hour period the reaction mixture is separated into its components. It is found that 60% of the oleic acid has been consumed in the reaction. For each pound of oleic acid consumed there are obtained 0.30 pound of azelaic acid (representing an efficiency of 46%, calculated on the basis that the technical oleic acid is 100% oleic acid), 0.13 pound of pelargonic acid (representing an efficiency of 23%) and 0.21 pound of 9,10-dihydroxystearic acid (representing an efficiency of 19%).

References

Merck Index 6923

MacKenzie, J.S. and Morgan, C.S. Jr.; U.S. Patent 2,820,046; January 14, 1958; assigned to Celanese Corp. of America

PEMOLINE

Therapeutic Function: Psychostimulant

Chemical Name: 2-imino-5-phenyl-4-oxazolidinone

Common Name: Phenoxazole; phenylisohydantoin

Structural Formula:

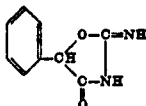

Chemical Abstracts Registry No.: 2152-34-3

Trade Name	Manufacturer	Country	Year Introduced
Deltamine	Aron	France	1960
Cylert	Abbott	U.K.	1975
Cylert	Abbott	U.S.	1975
Antimeran	Nichiiko	Japan	—
Betanamin	Sanwa	Japan	—
Dynalert	Restan	S. Africa	—
Hyton	Pharmacia	Sweden	—
Kethamed	Medo	U.K.	—
Nitan	Teva	Israel	—
Phenoxine	P.C.B.	Belgium	—
Pioxol	Horner	Canada	—

Trade Name	Manufacturer	Country	Year Introduced
Pondex	Chinoi	Hungary	—
Revibol	Pliva	Yugoslavia	—
Ronyl	Rona	U.K.	—
Sigmodyn	Spemsa	Italy	—
Sofro	Thilo	W. Germany	—
Stimul	Nadrol	W. Germany	—
Tradon	Beiersdorf	W. Germany	—
Vidil	Waldheim	Austria	—

Raw Materials

Mandelic acid ethyl ester
Guanidine

Manufacturing Process

It is preferably prepared by reacting mandelic acid ethyl ester with guanidine in boiling alcoholic solution whereby it is obtained as difficultly soluble precipitate with a yield of 90%.

This compound is a white, crystalline compound melting at 256°-257°C with decomposition. It is readily soluble in concentrated aqueous alkali hydroxide solutions and in concentrated aqueous mineral acids.

References

- Merck Index 6931
Kleeman & Engel p. 690
PDR p. 509
DOT 9 (6) 212 (1973)
I.N. p. 736
REM p. 1137
Schmidt, L. and Scheffler, H.; U.S. Patent 2,892,753; June 30, 1959; assigned to C.H. Boehringer Sohn, Germany

PENBUTOLOL

Therapeutic Function: Beta-Adrenergic blocker

Chemical Name: 1-(2-Cyclopentylphenoxy)-3-[(1,1-dimethylethyl)amino]-2-propanol

Common Name: —

Structural Formula:

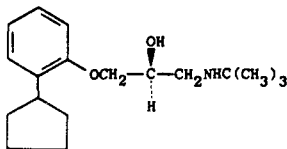

Chemical Abstracts Registry No.: 38363-40-5

Trade Name	Manufacturer	Country	Year Introduced
Betapressin	Hoechst	W. Germany	1980
Betapressin	Hoechst	Switz.	1982
Betapressin	Hoechst	Italy	1983

Raw Materials

2-Cyclopentylphenol
Epichlorohydrin
t-Butylamine

Manufacturing Process

21.8 g (0.1 mol) of 1,2-epoxy-3-(2'-cyclopentylphenoxy)propane, boiling at 113°C to 115°C/0.2 mm Hg (prepared from 2-cyclopentylphenol and epichlorohydrin in the presence of alkali) were dissolved in 250 ml of ethanol; to this solution, there were added dropwise, while stirring, 8.9 g (0.15 mol) of t-butylamine. The reaction mixture was stirred for 2 hours at 60°C and then the solvent and the excess t-butylamine were removed by distillation. The residue which had been purified via the aqueous hydrochloride, crystallized, after removal of the ether by evaporation, upon rubbing or inoculation and yielded, after recrystallization from n-heptane, the 1-t-butylamino-2-hydroxy-3-(2'-cyclopentylphenoxy)propane which was found to melt at 69°C to 70°C.

References

Merck Index 6935
DFU 1 (10) 494 (1976)
Kleeman & Engel p. 691
DOT 17 (12) 555 (1981) & 18 (10) 551 (1982)
I.N. p. 737
Ruschig, H., Schmitt, K., Lessenich, H. and Hartfelder, G.; U.S. Patent 3,551,493; Dec. 29, 1970; assigned to Farbwerke Hoechst A.G. (W. Germany)

PENFLURIDOL

Therapeutic Function: Antipsychotic

Chemical Name: 1-[4,4-Bis(4-fluorophenyl)butyl]-4-[4-chloro-3-(trifluoromethyl)phenyl]-4-piperidinol

Common Name: —

Structural Formula:

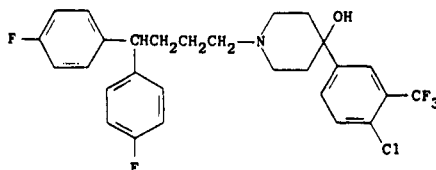

Chemical Abstracts Registry No.: 26864-56-2

Trade Name	Manufacturer	Country	Year Introduced
Semap	Janssen Le Brun	W. Germany	1975
Semap	Janssen	France	1975

Trade Name	Manufacturer	Country	Year Introduced
Flupidol	Zambeletti	Italy	1979
Longoran	Isis	Yugoslavia	—
Micefal	Spofa	Czechoslovakia	—
Semap	Abic	Israel	—

Raw Materials

4,4-Bis(p-fluorophenyl)butyl chloride
4-(4-Chloro- α,α,α -trifluoro-m-tolyl)-4-piperidinol

Manufacturing Process

A mixture of 24 parts of 4,4-bis(p-fluorophenyl)butyl chloride, 20.9 parts of 4-(4-chloro- α,α,α -trifluoro-m-tolyl)-4-piperidinol, 13.8 parts of sodium carbonate, a few crystals of potassium iodide in 600 parts of 4-methyl-2-pentanone is stirred and refluxed for 60 hours. The reaction mixture is cooled and 150 parts of water is added. The organic layer is separated, dried, filtered and evaporated. The oily residue is crystallized from diisopropylether, yielding 4-(4-chloro- α,α,α -trifluoro-m-tolyl)-1-[4,4-bis(p-fluorophenyl)butyl]-4-piperidinol; melting point 106.5°C.

References

Merck Index 6939

Kleeman & Engel p. 691

OCDS Vol. 2 p. 334 (1980)

DOT 10 (5) 167 (1974)

I.N. p. 737

Hermans, H.K.F. and Niemegeers, C.J.E.J.; U.S. Patent 3,575,990; April 20, 1971; assigned to Janssen Pharmaceutica N.V. (Belgium)

PENICILLAMINE

Therapeutic Function: Used in treatment of rheumatoid arthritis

Chemical Name: 3-Mercapto-D-valine

Common Name: Dimethylcysteine

Structural Formula:

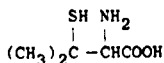

Chemical Abstracts Registry No.: 52-67-5; 2219-30-9 (Hydrochloride)

Trade Name	Manufacturer	Country	Year Introduced
Cuprimine	MSD	U.S.	1963
Trolovol	Bayer	W. Germany	1963
Pendramine	B.D.H.	U.K.	1973
Pemine	Lilly	Italy	1975
Trolovol	Bayer	France	1979
Depen	Wallace	U.S.	1979
Artamin	Biochemie	Austria	—
Cuprenil	Polfa	Poland	—
Cupripen	Rubio	Spain	—

Trade Name	Manufacturer	Country	Year Introduced
Depamine	Berk	U.K.	—
Distamine	Dista	U.K.	—
Gerodyl	Gea	Denmark	—
Metalcapase	Knoll	W. Germany	—
Reumacillin	Medica	Finland	—
Rhumantin	Gea	Denmark	—
Sufortanon	Lacer	Spain	—

Raw Materials

Potassium benzyl penicillin	Sodium hydroxide
Mercuric chloride	Phenylhydrazine
Hydrogen sulfide	

Manufacturing Process

(a) Preparation of mercuric chloride complex of penicillamine: To a solution of 372 g (1 mol) of potassium benzyl-penicillin in 940 ml of distilled water at room temperature is added a solution of 40 g (1 mol) of sodium hydroxide in 180 ml of distilled water over a period of one-half hour. The solution is then stirred for two hours at room temperature. While maintaining room temperature, 67 ml of concentrated hydrochloric acid is added at a slow rate. This solution is then added, over a period of time of one-half hour, to a solution of 271 g (1 mol) of HgCl_2 in 3.52 liters of distilled water in the presence of 50 g of Hyflo and 5 ml of octyl alcohol. After one hour of agitation, the resulting mixture is treated with 185 ml of concentrated hydrochloric acid and filtered.

(b) Removal of benzylenilloaldehyde: To the filtrate obtained in step (a), warmed to 50°C is slowly added 108 g (1 mol) of phenyl hydrazine. The mixture is cooled to room temperature and 84 ml of concentrated hydrochloric acid are added. The mixture is agitated briefly and the precipitated benzylenilloaldehyde phenyl hydrazone is filtered off.

(c) Preparation of isopropylidene penicillamine hydrochloride: To the filtrate obtained in step (b) is added at 20°C to 25°C a total of 85 g of hydrogen sulfide. The precipitated HgS is filtered off and the filtrate is concentrated under reduced pressure to a volume of 200 to 500 ml. Following a polish filtration, the product-rich concentrate is mixed with 1.5 liters of isobutyl acetate. The mixture is refluxed at about 40°C under reduced pressure in equipment fitted with a water separation device. When no further water separates, the batch is cooled to 30°C and filtered. The reactor is washed with 1 liter of acetone, which is used also to wash the cake. The cake is further washed with 200 ml of acetone. The acetone washes are added to the isobutyl acetate filtrate and the mixture is refluxed for 20 to 30 minutes. After a holding period of one hour at 5°C, the crystals of isopropylidene penicillamine hydrochloride are filtered and washed with 200 ml of acetone. On drying for twelve hours at 25°C this product, containing 1 mol of water, weighs about 178 g (73%).

(d) Preparation of penicillamine hydrochloride: The 178 g of isopropylidene penicillamine hydrochloride obtained in step (c) is dissolved in 350 ml of distilled water. The solution is heated at 90°C to 95°C for one to one and one-half hours, removing acetone by distillation through an efficient column. There is then added 2.6 liters of isobutyl acetate. The mixture is refluxed at a temperature of about 40°C under reduced pressure in equipment fitted with a water separation device. When no further water separates, the pressure is adjusted so that the mixture distills at a vapor temperature of 83°C to 88°C. A total of 650 ml of distillate is collected. The batch is allowed to cool to 50°C and then filtered. The crystals are washed with isobutyl acetate and then dried at 35°C for 24 hours. The virtually anhydrous penicillamine hydrochloride obtained weighs about 128 g (69% from potassium benzyl-penicillin).

References

Merck Index 6940
Kleeman & Engel p. 693

PDR pp. 1153, 1872

DOT 9 (7) 302 (1973)

I.N. p. 738

REM p. 1225

Restivo, A.R., Dondzila, F.A. and Murphy, H. Jr.; U.S. Patent 3,281,461; October 25, 1966; assigned to E.R. Squibb & Sons, Inc.

Sota, K., Ogawa, T. and Sawada, J.; U.S. Patent 4,150,240; April 15, 1979; assigned to Taisho Pharmaceutical Co., Ltd. (Japan)

PENICILLIN G BENZATHINE

Therapeutic Function: Antibacterial

Chemical Name: Penicillin G compound with N,N'-dibenzylethylenediamine

Common Name: Benzethacil

Structural Formula:

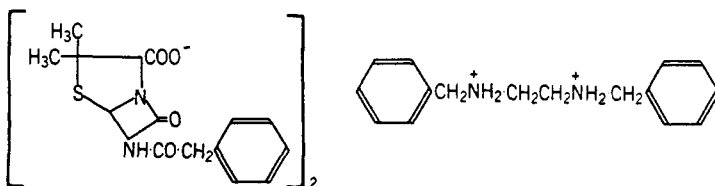

Chemical Abstracts Registry No.: 1538-09-6

Trade Name	Manufacturer	Country	Year Introduced
Bicillin	Wyeth	U.S.	1951
Permapen	Pfizer	U.S.	1953
Neolin	Lilly	U.S.	1953
Extencilline	Specia	France	1954
Benzetacil-Simple	Antibioticos	Spain	—
Brevicilina-Simple	Wassermann	Spain	—
Brunocillin	Mepha	Switz.	—
Cepacilina	Cepa	Spain	—
Depotpen	Dauelsberg	W. Germany	—
Diaminocillina	Farmalabor	Italy	—
Durabiotic	Teva	Israel	—
Longacillin	Besy	Brazil	—
LPG	C.S.L.	Australia	—
Megacillin	Merck-Frosst	Canada	—
Pen-Di-Ben	Bago	Argentina	—
Pendysin	Jenapharm	E. Germany	—
Penidural	Wyeth	U.K.	—
Peniroger Retard	Roger	Spain	—
Pipercilina	Iskia	Spain	—
Retarpen	Biochemie	Austria	—
Tardocillin	Bayer	W. Germany	—
Tardopenil	Farmabion	Spain	—

Raw Materials

Ethylenediamine
Benzaldehyde
Sodium penicillin G

Manufacturing Process

Ethylenediamine (15 g, 0.25 mol) was added dropwise to 100 ml 98–100% formic acid in a two-necked 500 ml flask, fitted with an addition tube and reflux condenser with drying tube, cooled in an ice-bath. After complete addition of the base, 53 g of benzaldehyde (0.5 mol) was added in one lot. The ice-bath was removed and the flask was heated to the refluxing temperature. The initial rate of carbon dioxide evolution was too rapid to measure. After twenty minutes, the rate was circa 100 ml per minute and decreased rapidly to 8 ml per minute in one hour. Heating at reflux was continued for 35 hours.

Following the refluxing most of the excess formic acid was removed under reduced pressure. Hydrochloric acid (200 ml 6N) was added to the viscous amber residue and heated under reflux. After 15 minutes, bumping necessitated cooling and filtering to remove crystalline dihydrochloride, which after washing with isopropanol was dried, MP circa 300°C. The mother liquors were refluxed one hour and cooled, obtaining an additional amount of product, MP circa 300°C. The filtrate was concentrated in vacuo to 100 ml, cooled and made alkaline with 40% NaOH. The supernatant oil was extracted with ether, dried, and fractionated from a stillpot packed with glass wool and heated in a sand-bath at 320°C. The first fraction at 106°C at 0.6–0.7 mm was N-benzylethylenediamine (dipicrate, MP 222°C). The N,N'-dibenzylethylenediamine was collected at 177°C to 206°C at 0.6–1.0 mm as a colorless liquid.

To a solution of 60 g of sodium penicillin G in 800 cc of distilled water cooled to 0°C to 4°C in an ice-bath, a solution of 35 g of N,N'-dibenzylethylenediamine diacetate in 200 cc of distilled water is added dropwise with stirring. The thick slurry is filtered with suction, washed twice with 100 cc of cold water, dried by suction and spread out in a thin layer for completion of drying. The product weighed 80 g.

The air-dried powder has a broad melting point, sintering at 100°C, melting above 110°C to a cloudy liquid becoming clear at 135°C.

References

Merck Index 6948
Kleeman & Engel p. 85
PDR pp. 1406, 1941, 1989
I.N. p. 126
REM p. 1197
Szabo, J.L. and Bruce, W.F.; U.S. Patent 2,627,491; February 3, 1953; assigned to Wyeth, Inc.

PENICILLIN G HYDRABAMINE

Therapeutic Function: Antibacterial

Chemical Name: N,N'-Bis(dehydroabietyl)ethylenediamine dipenicillin G

Common Name: —

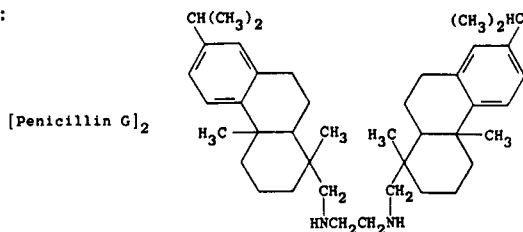
Structural Formula:

Chemical Abstracts Registry No.: 3344-16-9

Trade Name	Manufacturer	Country	Year Introduced
Compicillin	Abbott	U.S.	1954

Raw Materials

Dehydroabietylamine
Ethylene dibromide
Penicillin G

Manufacturing Process

A mixture of 142.5 g of "Rosin Amine D" containing about 70% dehydroabietylamine and 30% dihydro and tetrahydroabietylamine, 47.0 g of ethylene dibromide, and 60.6 g of triethylamine is dissolved in 350 cc of anhydrous xylene and refluxed for about 16 hours. Thereafter the triethylamine dibromide salt formed is separated from the solution by filtering the cool reaction mixture and washing with ether. The solution is then concentrated under reduced pressure to dryness to remove the ether, xylene and excess triethylamines present. The viscous oil resin is slurried twice with 250 cc portions of methanol to remove any unreacted primary amines. The oil residue after being washed with methanol is dissolved in ethyl alcohol and 75 cc of concentrated hydrochloric acid is added dropwise to the warm alcohol solution of the base. The dihydrochloride salts of the several hydroabietyl ethylenediamines precipitates immediately from solution. The salt is then separated by filtering and is washed twice with 100 cc portions of cooled ethyl alcohol. The dihydrochloride salts of the dehydroabietyl, dihydroabietyl and tetrahydroabietyl ethylenediamine mixture have a melting point of about 292°C to 295°C. On subjecting the mixture to solubility analyses it is found that the dehydroabietyl ethylenediamine is present in substantially the same proportion as is the dehydroabietylamine in the original "Rosin Amine D."

An amyl acetate-penicillin acid solution (10 liters) having a potency of 100,000 U/ml which is sufficient to supply 565 g (2 mols) of penicillin acid is added with constant agitation to 505 g of crude N,N'-bis-(dehydroabietyl)-ethylenediamine dissolved in 500 ml of amyl acetate. A slight excess of the ethylenediamine bases is added to the mixture until precipitation is completed. The reaction is preferably carried out in a cold room having a temperature of about 5°C. The precipitation salts comprise about 70% N,N'-bis-(dehydroabietyl)-ethylenediamine-dipenicillin salt and approximately 25-30% of the N,N'-bis-(dihydroabietyl)-ethylenediamine- and N,N'-bis-(tetrahydroabietyl)-ethylenediamine-dipenicillin salts are recovered by filtration and are washed with about ¹/₁₀ solution volume of amyl acetate. The crude preparation is further washed with ¹/₁₀ solution volume of diethyl ether and dried. The melting point of the product is about 153°C when taken on a microblock.

The total yield of the crude precipitation obtained in the above manner comprising about 1 kg is then dissolved in chloroform so as to form a 15% solution of a crude penicillin salt. To the filtered chloroform solution is added ethyl acetate slowly and with agitation until the solution becomes turbid as crystallization begins. Thereafter crystallization is allowed to proceed undisturbed for about 30-60 minutes in a cold room having a temperature of about 5°C. Sufficient ethyl acetate is slowly added to provide a final concentration of about 50% ethyl

acetate and the mixture is allowed to stand in the cold room for one hour to complete crystallization. The precipitate is filtered and washed with about 750 ml of ethyl acetate and thereafter washed with the same volume of ether. The crystals are dried in vacuo and a yield of about 900 g of N,N'-bis-(dehydroabietyl)-ethylenediamine-dipenicillin G is obtained. The penicillin product melts with decomposition at a temperature of 170°C to 172°C on a Kofler hot stage. Solubility analysis of the product shows the product to be 95.3% pure.

References

Merck Index 6951

I.N. p. 739

De Rose, A.F.; U.S. Patent 2,812,326; November 5, 1957; assigned to Abbott Laboratories

PENICILLIN G PROCAINE

Therapeutic Function: Antibacterial

Chemical Name: Penicillin G compound with 2-(diethylamino)ethyl p-aminobenzoate

Common Name: —

Structural Formula:

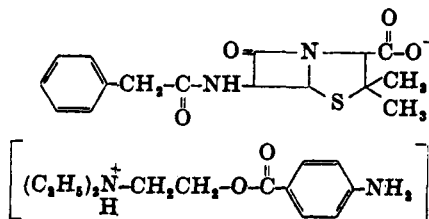

Chemical Abstracts Registry No.: 54-35-3

Trade Name	Manufacturer	Country	Year Introduced
Duracillin	Lilly	U.S.	1948
Flo-Cillin	Bristol	U.S.	1949
Ledercillin	Lederle	U.S.	1949
Wycillin	Wyeth	U.S.	1949
Diurnal Penicillin	Upjohn	U.S.	1950
Abbccillin	Abbott	U.S.	1951
Ampin-Penicillin	Badische Arzneim.	W. Germany	—
Aquacaine	C.S.L.	Australia	—
Aquasuspen	SK Kauelsberg	W. Germany	—
Aqucilina	Antibioticos	Spain	—
Cilicaine	Sigma	Australia	—
Distaquaine	Distillers	U.K.	—
Excolicin	Jenapharm	E. Germany	—
Farmaproina	Cepa	Spain	—
Francacilline	Franca	Canada	—
Hypercillin	Cutter	U.S.	—
Hypropen	Biochemie	Austria	—
Intrasept	Streuli	Switz.	—
Klaricina	Clariana	Spain	—
Novocillin	Solac	France	—
Penifasa	Lifasa	Spain	—

Trade Name	Manufacturer	Country	Year Introduced
Peniroger Procain	Roger	Spain	—
Premocillin	Premo	U.S.	—
Procapen	Orion	Finland	—
Prokapen	Weifa	Norway	—
Retardillin	Egypt	Hungary	—
Sanciline Procaina	Santos	Spain	—
Therapen I.M.	Therapex	Canada	—

Raw Materials

Penicillin G
Procaine

Manufacturing Process

There was added to 250 ml of a concentrated butyl acetate extract containing 74,000 units of the acid form of penicillin per ml, 50 ml of a butyl acetate solution containing 0.238 g per ml of procaine base. The solution was agitated for one hour. The precipitate which formed was very gummy and not in the form of discrete crystals. This precipitate was crystallized by scratching the side of the vessel and agitating further. After this treatment 18.25 g of crystalline procaine penicillin was obtained which assayed 1010 units per mg representing a yield of 99.6% of the activity contained in the concentrated extract.

References

Merck Index 6953

PDR pp. 1408, 1742, 1941, 1989

I.N. p. 739

REM p. 1198

Bardolph, M.P.; U.S. Patent 2,739,962; March 27, 1956; assigned to Commercial Solvents Corp.

PENICILLIN O

Therapeutic Function: Antibacterial

Chemical Name: 3,3-Dimethyl-7-oxo-6-[[(2-propenylthio)acetyl] amino] -4-thia-1-azabicyclo[3.2.0] -heptane-2-carboxylic acid

Common Name: Allylmercaptomethylpenicillin

Structural Formula:

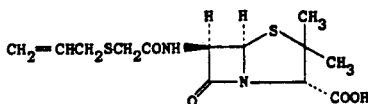

Chemical Abstracts Registry No.: 87-09-2

Trade Name	Manufacturer	Country	Year Introduced
Cero-O-Cillin	Upjohn	U.S.	1950

Raw Materials

Bacterium *Penicillium*

Lactose
 Corn steep liquor
 N-(2-Hydroxyethyl)allylmercaptoacetamide

Manufacturing Process

A culture medium is prepared in the following proportions:

Lactose	125 g
Corn steep solids	150 g
Calcium carbonate	25 g
N-(2-Hydroxyethyl)-allylmercaptoacetamide	0.140 g
Water	5,000 cc

The culture medium is distributed in 200 cc portions in 1 liter Erlenmeyer flasks, sterilized, inoculated with a spore suspension of *Penicillium* mold strain Q-176, and stoppered with cotton plugs. The flasks are maintained at a temperature of about 23°C to 26°C and shaken constantly for five days. The flask contents are then filtered to remove the mold mycelium, the filtrate cooled to about 0°C, acidified to about pH 2.2 with o-phosphoric acid and shaken with an equal volume of amyl acetate. The amyl acetate layer is separated and extracted with three 100 cc portions of cold water to which cold N/10 sodium bicarbonate solution is added during the course of each extraction until a pH of about 7.1 to 7.3 is attained in the aqueous phase. The aqueous extracts are combined, cooled to about 0°C, acidified to about pH 2.2 with o-phosphoric acid and extracted with three 100 cc portions of ether. The ether extracts are combined, and are passed through a chromatographic type silica adsorption column about 30 mm in diameter and 300 mm long, and containing a pH 6.2 phosphate buffer. The silica column is developed by percolation with six 100 cc portions of ether containing successively increasing amounts of methanol in the order of ½, 1, 1½, 2, 2½, and 3 percent.

The developed silica column is divided into about 12 equal sections and each section is eluted with three 30 cc portions of M/15 phosphate buffer of pH 7.0. The eluates are assayed bacteriologically to determine their penicillin content. Most of the antibiotic activity originates in a single band in the silica column and results from the presence of allylmercaptomethylpenicillin. The eluates obtained from this band are combined, cooled to about 0°C, acidified to about pH 2.2 and extracted with three 50 cc portions of chloroform. The combined chloroform extracts are then passed through a silica adsorption column containing a pH 6.2 phosphate buffer. This silica gel column is developed by percolation with three 100 cc portions of chloroform containing successively increasing amounts of methanol in the order of 1, 2 and 3 percent. The developed silica column is then divided into 12 equal sections and each section is eluted with three 30 cc portions of M/15 phosphate buffer of pH 7.0. Again, most of the total antibiotic activity originates in a single band in the silica column. The eluates obtained by extraction of the silica column sections which comprise this band are combined, cooled to about 0°C, acidified to about pH 2.2 and extracted with three 100 cc portions of ether. The ether extracts are combined and extracted with about 75 cc of a cool dilute aqueous solution of sodium hydroxide to which N/10 sodium hydroxide solution is added during the course of the extraction so that a final pH of about 7.0 is obtained in the aqueous phase. From this aqueous solution the sodium salt of allylmercaptomethylpenicillin is separated, for example, by freezing and evaporation in vacuo from the frozen state.

References

Merck Index 6955

I.N. p. 58

Behrens, O.K., Jones, R.G., Soper, Q.F. and Corse, J.W.; U.S. Patent 2,623,876; December 30, 1952; assigned to Eli Lilly & Co.

PENICILLIN V

Therapeutic Function: Antibacterial

Chemical Name: 3,3-dimethyl-7-oxo-6-[(phenoxyacetyl)amino]-4-thia-1-azabicyclo[3.2.0]-heptane-2-carboxylic acid

Common Name: 6-phenoxyacetamidopenicillanic acid; phenoxymethylpenicillin

Structural Formula:

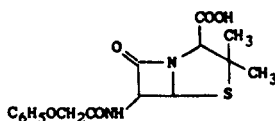

Chemical Abstracts Registry No.: 87-08-1

Trade Name	Manufacturer	Country	Year Introduced
Oracilline	Theraplix	France	1954
V-Cillin	Lilly	U.S.	1955
Pen-Vee	Wyeth	U.S.	1955
Calcipen	Farmabion	Spain	—
Fenocin	Dumex	Denmark	—
Fenospen	Farmalabor	Italy	—
Ibaden	Lek	Yugoslavia	—
Intalpen	Inter-Alia	U.K.	—
Ospen	Biochemie	Austria	—
Penorline	Allard	France	—
Rivopen V	Rivopharm	Switz.	—
V-Tablopen	Arzneimittelwerk Dresden	E. Germany	—
Weifapenin	Weifa	Norway	—

Raw Materials

Phenoxyacetyl chloride
6-Aminopenicillanic acid

Manufacturing Process

The following description is taken from U.S. Patent 2,941,995. A solution of phenoxyacetyl chloride (360 mg) in dry acetone (5 ml) was added dropwise during 10 minutes to a stirred solution of 6-aminopenicillanic acid (450 mg, approximately 75% pure) in 3% aqueous bicarbonate (18 ml) and acetone (12 ml). When addition was complete the mixture was stirred at room temperature for 30 minutes and then extracted with ether (30 ml in 3 portions), only the aqueous phase being retained. This aqueous solution was covered with butanol (5 ml) and adjusted to pH 2 by the addition of N hydrochloric acid. After separating the layers, the aqueous phase was extracted with two 2.5 ml portions of butanol, adjusting to pH 2 each time. The combined butanol solutions (which at this stage contained the free penicillanic acid) were washed with water (3 x 2 ml) and then shaken with water (10 ml) to which sufficient 3% sodium bicarbonate solution was added to bring the aqueous phase to pH 7. The butanol solution was further extracted with two 5 ml portions of water to each of which was added enough bicarbonate solution to produce an aqueous phase of pH 7. The combined aqueous solutions were washed with ether (20 ml) and then evaporated at low temperature and pressure to leave the crude sodium salt of phenoxymethyl penicillin which, after drying in a vacuum desiccator, was obtained as a slightly hygroscopic powder (591 mg).

References

Merck Index 6957
Kleeman & Engel p. 716
PDR pp. 673, 694, 1071, 1381, 1606, 1723, 1770, 1968

I.N. p. 760

REM p. 1199

Behrens, O.K., Jones, R.G., Soper, Q.F. and Corse, J.W.; U.S. Patent 2,562,410; July 31, 1951; assigned to Eli Lilly and Company

Sheehan, J.C.; U.S. Patent 3,159,617; December 1, 1964; assigned to Arthur D. Little, Inc.
 Doyle, F.P., Nayler, J.H.C. and Rolinson, G.N.; U.S. Patent 2,941,995; June 21, 1960; assigned to Beecham Research Laboratories Limited, England

PENICILLIN V HYDRABAMINE

Therapeutic Function: Antibacterial

Chemical Name: N,N'-Bis(dehydroabietyl)ethylenediamine bis(phenoxyethylpenicillin)

Common Name: —

Structural Formula:

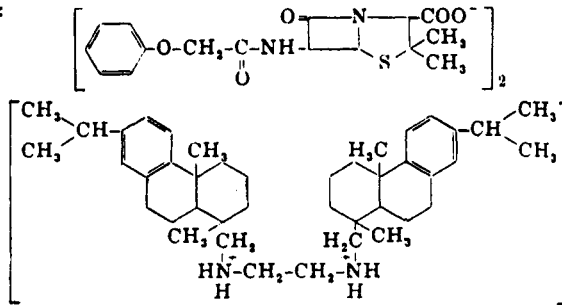

Chemical Abstracts Registry No.: 6591-72-6

Trade Name	Manufacturer	Country	Year Introduced
Compicillin-V	Abbott	U.S.	1954
Flavopen	G.P.	Australia	—

Raw Materials

Phenoxyethylpenicillin (Penicillin V)
 Dehydroabietyl ethylenediamine

Manufacturing Process

The crude dihydrochlorides of dehydroabietyl ethylenediamine bases (985 g) are extracted with a solution of about 3 liters of chloroform and 3 liters of water which is adjusted to about pH 10 and a second extraction is performed using a solution of about 2 liters of chloroform and the mixture readjusted to about pH 10 with 6N NaOH if necessary. The chloroform layer containing the mixed free bases is separated from the aqueous layer containing NaCl and is washed with about 1/10 its volume of water to remove any NaCl in the wet chloroform solution. The chloroform solution containing a mixture of the free bases having a volume of about 5 liters is dried with anhydrous Na₂SO₄ and then filtered to obtain a clear solution containing about 0.85 kg of the mixed free bases.

Approximately 1,000 g of phenoxyethylpenicillin acid (Penicillin V) is dissolved directly in about 5 liters of ethyl acetate to a concentration of 20% w/v. The resulting solution is fil-

tered to remove any insoluble salts. The penicillin V acid (1,000 g) may also be obtained by extracting an aqueous solution of 1,110 g of the potassium salt of phenoxymethylpenicillin at a temperature of about 5°C, this solution being adjusted to pH 2-3 by the addition of 6 N sulfuric acid, twice with a total of 5 liters of ethyl acetate so that the final washed combined volume will have a concentration of about 20% w/v. The abovementioned ethyl acetate solution having a volume of about 5 liters is then dried with anhydrous Na₂SO₄ and filtered to obtain a clear ethyl acetate solution of phenoxymethylpenicillin acid.

In place of the hydrochlorides of the abovedescribed bases any other acid salt thereof can be used, including both inorganic and organic salts such as phosphoric, sulfuric, and acetic acids. Also, in place of the mentioned penicillin, any of the other common salts of penicillin can be used as a source of penicillin acid.

The chloroform solution of the free bases prepared in the above manner is then slowly added to the ethyl acetate solution of the penicillin V acid prepared in the above manner. A clear solution forms which rapidly becomes turbid as the bases react with the penicillin acid and crystallization commences. The reaction mixture is allowed to stand overnight in a cool room having a temperature of about 5°C after thoroughly agitating the mixture. Thereafter, the crystalline N,N'-bis-(dehydroabietyl)-ethylenediamine-dipenicillin V is filtered to separate therefrom the cooled mother liquor which contains the unprecipitated N,N'-bis-(dihydroabietyl)-ethylenediamine-dipenicillin salt and N,N'-bis-(tetrahydroabietyl)-ethylenediamine-dipenicillin salt and other impurities. The precipitate is washed thoroughly with about 4 liters of a mixture of chloroform and ethyl acetate (1:1) which is divided into three separate portions. After the final washing, the crystals are substantially colorless. The crystalline penicillin salt is thoroughly dried under vacuum at a temperature of about 50°C. The N,N'-bis-(dehydroabietyl)-ethylenediamine-dipenicillin V salt is obtained having purity as determined by solubility analysis in excess of about 90% and melts with decomposition at 163°C to 165°C on a Kofler hot stage.

References

Merck Index 6959

I.N. p. 494

De Rose, A.F.; U.S. Patent 2,812,326; November 5, 1957; assigned to Abbott Laboratories

PENTAERYTHRITOL TETRANITRATE

Therapeutic Function: Coronary vasodilator

Chemical Name: 2,2-bis[(nitroxy)methyl]-1,3-propanediol dinitrate

Common Name: PETN, Pentanitrolum

Structural Formula:

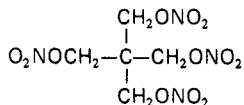

Chemical Abstracts Registry No.: 78-11-5

Trade Name	Manufacturer	Country	Year Introduced
Pentanitrine	Promedica	France	1948
Peritrate	Warner Lambert	U.S.	1952
Pentritol	Armour	U.S.	1955
Pentafin	Tutag	U.S.	1956

Trade Name	Manufacturer	Country	Year Introduced
Vasodiatol	Rowell	U.S.	1958
Metranil	Meyer	U.S.	1960
Pentryate	Fellows Testagar	U.S.	1960
Tranite D-Lay	Westerfield	U.S.	1961
Peridex	Robins	U.S.	1962
Antime	Century	U.S.	1962
SK-Petin	SKF	U.S.	1971
Perispan	USV	U.S.	1971
Pentraspan	Glenwood	U.S.	1980
Pentraspan	Vitarine	U.S.	1983
Cardiacap	Consol. Chem	U.K.	—
Dilcoran	Godecke	W. Germany	—
Duostrate	Marion	U.S.	—
Hasethrol	Shionogi	Japan	—
Hypothurol	Nissin	Japan	—
Lentrat	Medinova	Switz.	—
Neo-Corodil	Ethica	Canada	—
Neo-Corovas	Amfre-Grant	U.S.	—
Nitrodex	Dexo	France	—
Nitropent	A.C.O.	Sweden	—
Pectolex	Shionogi	Japan	—
Penritol	Langley	Australia	—
Pentalong	Isis-Chemie	E. Germany	—
Peritrine	Norgine	Belgium	—
Perynitrate	Barlow Cote	Canada	—

Raw Materials

Pentaerythritol
Nitric acid

Manufacturing Process

Cooling water was turned on and 420 parts nitric acid of 94% strength was introduced into the nitrator. The amount of acid was such that the ratio of nitric acid to pentaerythritol was 4.29. The agitator was started and the agitator speed adjusted to 120 rpm. 92 parts pentaerythritol, which had been screened previously through a 14-mesh screen was used in each charge. About 45 parts pentaerythritol was added to the nitrator at such a rate that the temperature in the nitrator gradually rose to 110°F. This required about 12 minutes. Time was allowed for the temperature rise to cease before each succeeding increment of material was added.

After reaching 110°F the charge was maintained at about said temperature from 12 to 14 minutes during which time approximately 30 parts pentaerythritol was added to the nitrator. During the following 14 minutes, approximately, the remainder of the 92 parts pentaerythritol was added in like manner to the charge and the temperature gradually reduced. The pentaerythritol was introduced into the acid in finely divided and well-dispersed particles and not in large unitary quantities. The entire 92 parts of pentaerythritol tetranitrate was introduced in 35 to 40 minutes. The pentaerythritol thus obtained was separated from the spent acid by filtering or drowning in water. To recover the spent acid the charge was passed onto a nutsch and filtered. The crude product was washed with water, then with a weak water-soluble alkali solution, such as sodium carbonate for example, and subsequently with water in order to remove the acid.

After the removal of acid, the nitrate was dried by suction on the nutsch for about 15 minutes. The dried material was refined by means of acetone treatment or other suitable refining means. About 210 parts refined pentaerythritol tetranitrate per charge was obtained.

References

Merck Index 6977

DFU 4 (5) 351 (1979)

Kleeman & Engel p. 695

PDR pp. 1382, 1606

I.N. p. 741

REM p. 854

Acken, M.F. and Vyverberg, J.C. Jr.; U.S. Patent 2,370,437; February 27, 1945; assigned to E.I. du Pont de Nemours & Co.

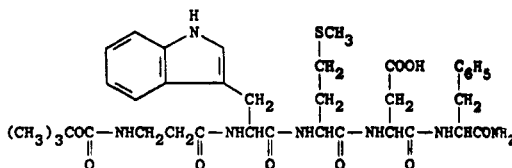
PENTAGASTRIN**Therapeutic Function:** Gastrosecretory hormone**Chemical Name:** N-carboxy- β -alanyl-L-tryptophyl-L-methionyl-L-aspartylphenyl-L-alanine-amide N-tert-butyl ester**Common Name:** —**Structural Formula:****Chemical Abstracts Registry No.:** 5534-95-2

Trade Name	Manufacturer	Country	Year Introduced
Peptavlon	I.C.I.	U.K.	1967
Gastrodiagnost	Merck	W. Germany	1970
Pentagastrin	I.C.I.	Japan	1973
Peptavlon	Ayerst	U.S.	1976
Peptavlon	I.C.I.	France	1981
Acignost	VEB Berlin-Chemie	E. Germany	—

Raw Materials

L-Tryptophanyl-L-methionyl-L-aspartyl-L-phenylalanine amide trifluoroacetate
 N-tert-Butyloxycarbonyl- β -alanine 2,4,5-trichlorophenyl ester

Manufacturing Process

A solution of 3.55 parts of L-tryptophanyl-L-methionyl-L-aspartyl-L-phenylalanine amide trifluoroacetate in 30 parts of dimethylformamide is cooled to 0°C, and 1.01 parts of triethylamine are added. The mixture is stirred while 1.84 parts of N-tert-butyloxycarbonyl- β -alanine 2,4,5-trichlorophenyl ester are added at 0°C. The reaction mixture is kept at 0°C for 48 hours and then at 20°-23°C for 24 hours. The mixture is added to a mixture of 100 parts of ice-water, 0.37 part of concentrated hydrochloric acid (SG 1.18), 1.2 parts of acetic acid and 20 parts of ethyl acetate. The mixture is stirred for 15 minutes at 0°-10°C and is then filtered. The solid residue is washed with water and then with ethyl acetate, and is dried at 40°-50°C under reduced pressure. There is thus obtained N-tert-butyloxycarbonyl- β -alanyl-L-tryptophanyl-L-methionyl-L-aspartyl-L-phenylalanine amide, MP 213°C with decomposition.

References

Merck Index 6978

PDR p. 2004

DOT 3 (4) 150 (1967)

I.N. p. 742

REM p. 1273

Hardy, P.M., Kenner, G.W., Sheppard, R.C., MacLeod, J.K. and Morley, J.S.; British Patent 1,042,487; assigned to Imperial Chemical Industries Limited, England

Hardy, P.M., Kenner, G.W., Sheppard, R.C., Morley, J.S. and MacLeod, J.K.; U.S. Patent 3,896,103; July 22, 1975; assigned to Imperial Chemical Industries Ltd.

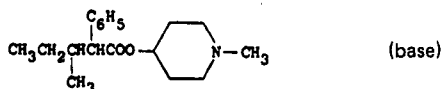
PENTAPIPERIDE METHOSULFATE**Therapeutic Function:** Antispasmodic**Chemical Name:** α -(1-methylpropyl)benzeneacetic acid 1-methyl-4-piperidiny] ester methosulfate**Common Name:** Pentapiperium methosulfate**Structural Formula:****Chemical Abstracts Registry No.:** 7681-80-3; 7009-54-3 (Base)

Trade Name	Manufacturer	Country	Year Introduced
Quilene	Warner Lambert	U.S.	1969
Crylene	Auclair	France	1971
Crilin	Ayerst	Italy	1973
Perium	Rover	U.S.	—
Togestal	Biosedra	France	—

Raw Materials

Phenylacetone nitrile	Sodium amide
Sec-Butyl bromide	Sodium hydroxide
Thionyl chloride	1-Methyl-4-piperidinol
Dimethyl sulfate	

Manufacturing Process

Phenylacetone nitrile is alkylated with secondary butyl bromide and the resultant nitrile is hydrolyzed to 3-methyl-2-phenylvaleric acid. The acid is converted to the acid chloride with thionyl chloride and the acid chloride is in turn reacted with 1-methyl-4-piperidinol. Finally dimethyl sulfate is reacted with the ester.

References

Merck Index 6988

Kleeman & Engel p. 697

OCDS Vol. 2 p. 76 (1980)

DOT 6 (2) 61 (1970)

I.N. p. 743

Martin, H. and Habicht, E.; U.S. Patent 2,987,517; June 6, 1961; assigned to Cilag Chemie Limited, Switzerland

PENTHIENATE BROMIDE

Therapeutic Function: Anticholinergic

Chemical Name: 2-[(Cyclopentylhydroxy-2-thienylacetyl)oxy]-N,N-diethyl-N-methylethanaminium bromide

Common Name: —

Structural Formula:

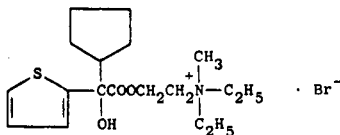

Chemical Abstracts Registry No.: 60-44-6

Trade Name	Manufacturer	Country	Year Introduced
Monodral	Winthrop	U.S.	1954
Monodral	Kanebo	Japan	1970

Raw Materials

2-Diethylaminoethyl chloride
Cyclopentyl(α -thienyl)hydroxyacetic acid
Methyl bromide

Manufacturing Process

An aqueous solution of 13.8 g of 2-diethylaminoethyl chloride hydrochloride was neutralized with sodium hydroxide, and the free 2-diethylaminoethyl chloride was extracted with ether. The ether extracts were dried over anhydrous magnesium sulfate, filtered, and the filtrate was added to a solution of 13.6 g of cyclopentyl-(α -thienyl)hydroxyacetic acid in 100 ml of isopropyl alcohol. The mixture was then distilled through a 25-cm Vigreux-type column until the temperature of the vapors reached 80°C. The residual solution was refluxed overnight and then transferred to a beaker along with 350 ml of isopropyl alcohol. The crystalline hydrochloride had meanwhile separated out, and this was filtered, washed with isopropyl alcohol, ether and then dried, giving 23 g, melting point 172°C to 173.5°C. Recrystallization from 400 ml of isopropyl alcohol gave 20.3 g of 2-diethylaminoethyl cyclopentyl-(α -thienyl)hydroxyacetate hydrochloride, melting at 174°C to 175°C; deep yellow-orange color with concentrated sulfuric acid.

The hydrochloride may then be converted to the methobromide by reaction with methyl bromide.

References

Merck Index 6996

Kleeman & Engel p. 699

I.N. p. 744

Blicke, F.F.; U.S. Patent 2,541,634; February 13, 1951; assigned to Regents of the University of Michigan

PENTOBARBITAL SODIUM

Therapeutic Function: Hypnotic, sedative

Chemical Name: 5-Ethyl-5-(1-methylbutyl)-2,4,6-(1H,3H,5H)-pyrimidinetrione mono-sodium salt

Common Name: —

Structural Formula:

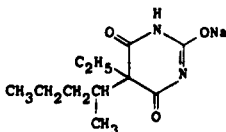

Chemical Abstracts Registry No.: 57-33-0; 76-74-4 (Base)

Trade Name	Manufacturer	Country	Year Introduced
Nembutal	Abbott	U.S.	1941
Butylone	Hartz	Canada	—
Hypnol	Stickley	Canada	—
Mintal	Tanabe	Japan	—
Nebralin	Dorsey	U.S.	—
Neodrom	Minden	W. Germany	—
Novopentobarb	Novopharm	Canada	—
Penbon	Adams	Australia	—
Pentanca	Anca	Canada	—
Pentogen	Paul Maney	Canada	—
Pentone	Faulding	Australia	—
Prodormol	Teva	Israel	—
Reposal	Desitin	W. Germany	—
Sombutol	Farmus	Finland	—
Somnotol	M.T.C.	Canada	—
Sopental	Cont. Ethicals	S. Africa	—

Raw Materials

di-n-Butyl ethyl 1-methyl-n-butylmalonate
Sodium
Butanol
Urea

Manufacturing Process

Sodium (9.6 parts) was dissolved in butanol (192 parts) and di-n-butyl ethyl 1-methyl-n-butylmalonate (62.8 parts) and urea (14.4 parts) were added to the warm solution with agitation. The mixture was then heated to reflux temperature in three quarters of an hour and maintained for 2 hours. The reaction mass was kept, water (150 parts) added, the aqueous portion separated, and the butanol layer extracted with water (3 x 50 parts). The combined aqueous extracts were then given 3 small extractions with benzene, the aqueous liquors separated, charcoaled, filtered and precipitated with concentrated hydrochloric acid (acid to congo-paper). The solid was collected, washed with water, dissolved in N-sodium hydroxide and re-precipitated with carbon dioxide. On recrystallization, from aqueous alcohol, the pentobarbitone was obtained.

References

Merck Index 6998
Kleeman & Engel p. 700

PDR pp. 531, 872, 1989

OCDS Vol. 1 p. 268 (1977)

I.N. p. 745

REM p. 1067

The Geigy Co. Ltd.; British Patent 650,354; February 21, 1951

PENTOXIFYLLINE

Therapeutic Function: Vasodilator

Chemical Name: 3,7-Dihydro-3,7-dimethyl-1-(5-oxohexyl)-1H-purine-2,6-dione

Common Name: Oxpentifylline; vazofirin

Structural Formula:

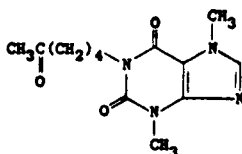

Chemical Abstracts Registry No.: 6493-05-6

Trade Name	Manufacturer	Country	Year Introduced
Trental	Albert-Roussel	W. Germany	1972
Torental	Hoechst	France	1974
Trental	Hoechst	U.K.	1975
Trental	Albert-Farma	Italy	1976
Trental	Hoechst	Japan	1977
Agapurin	Spofa	Czechoslovakia	—
Techlon	Sawai	Japan	—

Raw Materials

1-Bromo-5-hexanone
Theobromine sodium salt

Manufacturing Process

A solution of 35.4 g of 1-bromohexanone-5 in 200 ml of ethanol was gradually mixed at the reflux temperature with vigorous stirring with 39.7 g of theobromine-sodium in 100 ml of water. After 3 hours' reflux the unreacted theobromine was filtered off with suction, the filtrate was evaporated to dryness, the residue was dissolved in water and the solution was extracted with chloroform. The chloroform was distilled off and 1-(5'-oxohexyl)-3,7-dimethylxanthine was obtained as residue; after recrystallization from isopropanol, it melted at 102°C to 103°C (about 25% yield, calculated on the reacted theobromine).

References

Merck Index 7002

Kleeman & Engel p. 701

PDR p. 947

OCDS Vol. 2 p. 466 (1980)

I.N. p. 746

Mohler, W., Reiser, M. and Pependiker, K.; U.S. Patent 3,737,433; June 5, 1973; assigned to Chemische Werke Albert A.G. (W. Germany)

PEPLOMYCIN SULFATE

Therapeutic Function: Antineoplastic

Chemical Name: 3-[(S)-1'-Phenylethylamino] propylaminobleomycin sulfate

Common Name: —

Structural Formula:

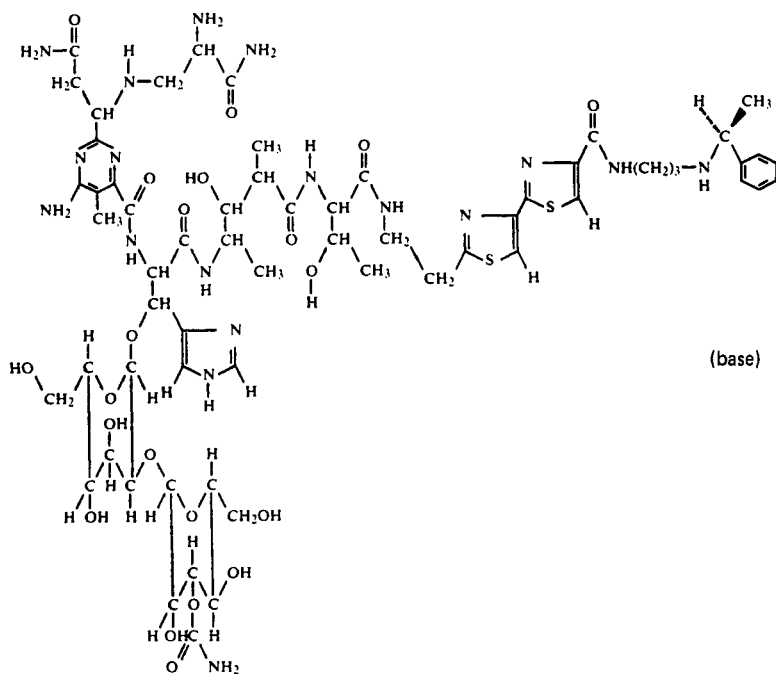

Chemical Abstracts Registry No.: 68247-85-8 (Base)

Trade Name	Manufacturer	Country	Year Introduced
Pepleo	Nippon Kayaku	Japan	1981

Raw Materials

Bleomycinic acid
 N-[(S)-1'-Phenylethyl]-1,3-diaminopropane
 Sulfuric acid

Manufacturing Process

In 400 ml of dimethylformamide was dissolved 15.0 g of bleomycinic acid (copper-containing form). To the solution kept at 0°C by cooling were added 1.1 ml of N-methylmorpholine and 10.3 g of 6-chloro-1-p-chlorobenzenesulfonyloxybenzotriazole (CCBT) as an activating compound. The mixture was stirred for 5 minutes at 0°C, then admixed with 5.3 g of N-[(S)-1'-phenylethyl]-1,3-diaminopropane and further stirred for 1 hour.

After termination of the reaction by adding 200 ml of a 25% aqueous acetic acid solution, the reaction mixture was mixed with 5 liters of cold acetone to precipitate the reaction product. The precipitate was collected by filtration, washed with acetone, and dissolved in 500 ml of distilled water. The resulting aqueous solution was immediately adjusted to pH 6.0 and poured into a column containing 2 liters of CM-Sephadex C-25 (NH_4^+ type) packed in 0.05M aqueous ammonium chloride solution to adsorb bleomycins.

Using aqueous ammonium chloride solution, elution was performed by passing through the column 20 liters of eluent in which the concentration of ammonium chloride was continually increased from 0.05 to 1.0M. The unreacted bleomycinic acid was found in the effluent at the ammonium chloride concentration of about 0.05M and NK631 at the ammonium chloride concentration of about 0.45M. Both fractions, which showed UV absorption at 292 $\text{m}\mu$, were separately collected.

The NK631-containing fraction was poured into a resin column containing 2.6 liters of Amberlite XAD-2. The column was then washed thoroughly with water and eluted with 0.01N hydrochloric acid in methanol-water (4:1 v/v). A total of 2.5 liters of the blue fraction, which showed UV absorption at 292 $\text{m}\mu$, was collected. After evaporating off the methanol from the eluent fraction, the concentrate was adjusted to pH 6.0 with Dowex 44 (OH^- type, an anion-exchange resin composed of a copolymer of epichlorohydrin and ammonia) and was freeze-dried to obtain 16.1 g (92% yield) of NK631 dihydrochloride (copper-containing form) in the form of blue amorphous powder.

By similar treatment, 280 mg of the unreacted bleomycinic acid (copper-containing form) was recovered.

In 200 ml of distilled water was dissolved 10.0 g of the NK631 dihydrochloride (copper-containing form). The solution was poured into a column containing 600 ml of Amberlite XAD-2 packed in distilled water. The column was washed successively with 2 liters of an aqueous solution containing 5% of EDTA-Na_2 , 2.5 liters of a 5% aqueous sodium sulfate solution, and 630 ml of distilled water.

The column was then eluted with 0.0025N sulfuric acid in methanol-water mixture (1:1 v/v). A total of 900 ml of fractions containing a substance which showed UV absorption at 290 $\text{m}\mu$ was collected. After removal of methanol by distillation, the residual liquid was adjusted to pH 6.0 with Dowex 44 (OH^- type) and freeze-dried to obtain 9.3 g (95% yield) of NK631 monosulfate (copper-free form) in the form of pale yellowish-white amorphous powder.

References

Merck Index 7011

DFU 6 (2) 101 (1981)

DOT 17 (8) 331 (1981)

Takita, T., Fujii, A., Fukuoka, T., Muraoka, Y., Yoshioka, O. and Umezawa, H.; U.S. Patent 4,195,018; March 25, 1980; assigned to Nippon Kayaku K.K.

Umezawa, H., Maeda, K., Takita, T., Nakayama, Y., Fujii, A. and Shimada, N.; U.S. Patent 3,846,400; November 5, 1974; assigned to Zaidan Hojin Biseibutsu Kagaku Kenkyu Kai.

PERHEXILINE MALEATE

Therapeutic Function: Coronary vasodilator

Chemical Name: 2-(2,2-dicyclohexylethyl)piperidine maleate

Common Name: —

Structural Formula:

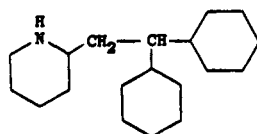

(base)

Chemical Abstracts Registry No.: 6724-53-4; 6621-47-2 (Base)

Trade Name	Manufacturer	Country	Year Introduced
Pexid	Merrell-Tourade	France	1973
Pexid	Merrell	W. Germany	1974
Pexid	Merrell	Italy	1974
Pexid	Merrell	U.K.	1975
Corzepin	Prodes	Spain	—
Daprin	Gerardo Ramon	Argentina	—

Raw Materials

Ethyl formate	Cyclohexylmagnesium bromide
α -Picoline	Hydrogen chloride
Sodium hydroxide	Hydrogen
Maleic acid	

Manufacturing Process

1,1-Dicyclohexyl-2-(2'-pyridyl)ethanol hydrochloride (5 grams) was dehydrated by heating with 25 ml of concentrated hydrochloric acid at steam bath temperature for 10 minutes. 70 ml of water were added to the reaction mixture to give the crystalline hydrochloride salt. The product, 1,1-dicyclohexyl-2-(2'-pyridyl)ethylene hydrochloride, was recrystallized from methanol-ethyl acetate to yield a white solid melting at 150°-151.5°C.

1,1-Dicyclohexyl-2-(2'-pyridyl)ethylene hydrochloride (15 grams) in 150 ml of ethanol was hydrogenated in the presence of platinum oxide at about 60 pounds per square inch of hydrogen pressure. The product, 1,1-dicyclohexyl-2-(2'-piperidyl)ethane hydrochloride, crystallized from a mixture of methanol and methyl ethyl ketone as a white solid melting at 243° to 245.5°C.

The hydrochloride salt was neutralized with 10% sodium hydroxide solution and the free base so produced was dissolved in ether. The ether solution was dried over anhydrous magnesium sulfate. Addition of an excess of maleic acid in methanol to the solution yielded the acid maleate salt which melted at 188.5°-191°C.

The starting material was obtained by reacting ethyl formate with cyclohexylmagnesium bromide to give dicyclohexylcarbinol. That is oxidized to dicyclohexylketone and then reacted with α -picoline.

References

Merck Index 7026

Kleeman & Engel p. 703

DOT 10 (8) 299 (1974)

I.N. p. 747

REM p. 854

Richardson-Merrell Inc.; British Patent 1,025,578; April 14, 1966

Horgan, S.W., Palopoli, F.P. and Schwoegler, E.J.; U.S. Patent 4,069,222; January 17, 1978; assigned to Richardson-Merrell Inc.

PERIMETHAZINE

Therapeutic Function: Tranquilizer

Chemical Name: 1-[3-(2-methoxyphenothiazin-10-yl)-2-methylpropyl]-4-piperidinol

Common Name: —

Structural Formula:

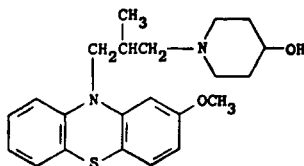

Chemical Abstracts Registry No.: 13093-88-4

Trade Name	Manufacturer	Country	Year Introduced
Leptryl	Roger Bellon	France	1970

Raw Materials

3-Methoxy-10-(3-chloro-2-methylpropyl)phenthiazine
4-Hydroxypiperidine

Manufacturing Process

A solution of 3-methoxy-10-(3-chloro-2-methylpropyl)phenthiazine (9.65 grams) and 4-hydroxypiperidine (6.1 grams) in xylene (10cc) is heated under reflux for 5 hours. After cooling the mixture is diluted with ether (60 cc) and the basic compounds are extracted by agitation with water (30 cc) and 4 N hydrochloric acid (20 cc). The aqueous acid phase is made alkaline with 4 N sodium hydroxide solution (23 cc) and the liberated base is extracted with ether. The ethereal solution is washed with water (60 cc) and dried over sodium sulfate. Finally the solvent is distilled off on a water-bath.

The solid residue obtained is recrystallized from a mixture (15:85) of benzene and cyclohexane and there is obtained 3-methoxy-10-[2-methyl-3-(4-hydroxy-1-piperidyl)-propyl]-phenthiazine (5.7 grams) as a white crystalline powder, MP 137°-138°C.

References

Merck Index 7030

Kleeman & Engel p. 704

DOT 6 (4) 190 (1970)

I.N. p. 748

Jacob, R.M. and Robert, J.G.; U.S. Patent 3,075,976; January 29, 1963; assigned to Societe des Usines Chimiques Rhone-Poulenc, France

PERISOXAL CITRATE

Therapeutic Function: Antiinflammatory, analgesic

Chemical Name: 3-(2-Piperidino-1-hydroxyethyl)-5-phenylisoxazole citrate

Common Name: —

Structural Formula:

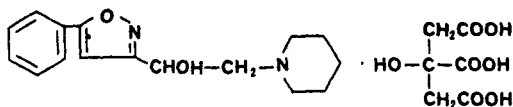

Chemical Abstracts Registry No.: 2055-44-9 (Base)

Trade Name	Manufacturer	Country	Year Introduced
Isoxal	Shionogi	Japan	1979

Raw Materials

3-(2-Methylthio-2-piperidinoacetyl)-5-phenylisoxazole
Sodium borohydride
Citric acid

Manufacturing Process

Crude crystals of 3-(2-methylthio-2-piperidinoacetyl)-5-phenylisoxazole (1.631 g) are suspended in 20 ml of methanol without being further purified and the suspension is stirred after a portionwise addition (in about 10 minutes) of 143 mg (3.78 mmol) of sodium borohydride at room temperature for about 30 minutes.

The methanol in the reaction mixture (pale yellow solution) is then removed by evaporation under reduced pressure to leave a residue which is subsequently dissolved in 30 ml of benzene. The benzene solution is shaken four times with 20 ml of 4N hydrochloric acid each time to extract the basic substance. Each of the hydrochloric acid layers is washed once with 20 ml of benzene and combined together to be neutralized with potassium carbonate while being ice-cooled until it becomes basic (pH = 10).

The liberated crystalline substance is extracted twice with 50 ml of dichloromethane each time. After being separated, the dichloromethane layers are combined and washed once with 30 ml of water and dried over sodium sulfate. The solvent of the layer is removed by evaporation under reduced pressure to leave a crystalline residue (72.56 mg, 53% crude yield).

Recrystallization of this product from dichloromethane-ether (1:4) affords needles of 3-(2-piperidino-1-hydroxyethyl)-5-phenylisoxazole (701 mg, 51.3% as an overall yield calculated based on the starting material, melting point 104°C to 106°C. The product thus obtained may be reacted with citric acid to give the citrate.

References

Merck Index 7038
DFU 4 (4) 269 (1979)
I.N. p. 748

Hirai, S. and Kawata, K.; U.S. Patent 3,939,167; February 17, 1976; assigned to Shionogi & Co., Ltd.

PERLAPINE

Therapeutic Function: Hypnotic

Chemical Name: 6-(4-methyl-1-piperazinyl)-11H-dibenz[b,e]azepine

Common Name: 6-(4-methyl-1-piperazinyl)morphanthridine

Structural Formula:

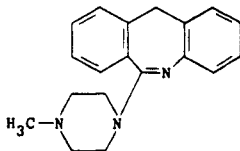

Chemical Abstracts Registry No.: 1977-11-3

Trade Name	Manufacturer	Country	Year Introduced
Hypnodin	Takeda	Japan	1974
Pipnodine	Takeda	Japan	—

Raw Materials

o-Aminodiphenylmethane	Phosgene
Aluminum chloride	Phosphorus oxychloride
N-Methylpiperazine	

Manufacturing Process

The 5,6-dihydro-6-oxo-morphanthridine used as a starting material is usefully obtained in the following way. 30.2 grams of o-aminodiphenylmethane are dissolved in 65 ml of absolute toluene and, while stirring and at a temperature of between 0° and -10°C, 140 ml of 20% phosgene solution in toluene are added drop by drop. By bubbling phosgene slowly through it the milky mixture is heated within 30 minutes to reflux temperature, which is maintained during some 20 minutes. While stirring vigorously, dry nitrogen is passed into the boiling reaction mixture for 10 minutes. After evaporation of the solvent there are obtained by vacuum distillation 29.7 grams (86% of the theory of o-isocyanatodiphenylmethane of boiling point 169°C/12 mm Hg.

21.1 grams of aluminum chloride are heated in 110 ml of o-dichlorobenzene to 80°C and, while stirring, a solution of 29.7 grams of o-isocyanatodiphenylmethane in 60 ml of o-dichlorobenzene is added drop by drop, whereupon the temperature of the mixture rises to 120°C. This temperature is maintained for one hour while stirring. After cooling the reaction mixture is poured into 200 ml of 2 N hydrochloric acid, whereupon a brown precipitate is formed. After steam distillation the residue is isolated by filtration and crystallized from acetone/water. There are obtained 28.6 grams (97% of the theory) of 5,6-dihydro-6-oxo-morphanthridine of melting point 201°-203°C.

A mixture of 4.9 grams of 5,6-dihydro-6-oxo-morphanthridine, 37 ml of phosphorus oxychloride and 1.5 ml of dimethylaniline is heated for 3 hours at reflux. The viscous oil, obtained by evaporation of the reaction mixture in vacuo at 60°C, is diluted with 20 ml of absolute dioxane and, after adding 30 ml of N-methylpiperazine, heated for 4 hours at reflux. The resulting clear solution is evaporated in vacuo at 60°C to dryness. The residue is distributed between ether and ammonia water. The ethereal solution is separated, washed with water and then extracted with 1 N acetic acid. The acetic acid extract is mixed with ammonia water and then extracted with ether. The ethereal solution is washed with water, dried over sodium sulfate, filtered through alumina and evaporated.

The residue is caused to crystallize from ether/petroleum ether, and recrystallized from acetone/petroleum ether. 6.0 grams (88% of the theory) of 6-(4-methyl-1-piperazinylo)morphanthridine of melting point 138°-138.5°C are obtained.

References

Merck Index 7040

Kleeman & Engel p. 705

OCDS Vol. 2 p. 425 (1980)

DOT 11 (2) 76 (1975)

I.N. p. 748

Schmutz, J., Hunziker, F. and Kunzle, F.M.; U.S. Patent 3,389,139; June 18, 1968; assigned to Dr. A. Wander, SA, Switzerland

PERPHENAZINE

Therapeutic Function: Tranquilizer

Chemical Name: 4-[3-(2-chlorophenothiazin-10-yl)propyl]-1-piperazineethanol

Common Name: Chlorpipazine

Structural Formula:

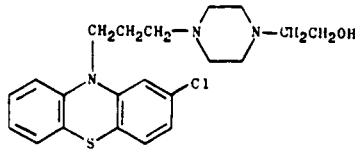

Chemical Abstracts Registry No.: 58-39-9

Trade Name	Manufacturer	Country	Year Introduced
Trilafon	Schering	U.S.	1957
Decentan	Merck	W. Germany	—
Etrafon	Schering	U.S.	—
Fentazin	Allen & Hanburys	U.K.	—
F-Mon	Nippon Shinyaku	Japan	—
Peratsin	Farmos	Finland	—
Perfenil	Scalari	Italy	—
Perphenan	Taro	Israel	—
Phenazine	I.C.N.	Canada	—
Triavil	MSD	U.S.	—
Trilifan	Cetrane	France	—
Triomin	Yamanouchi	Japan	—

Raw Materials

2-Chlorophenothiazine	1-Bromo-3-chloropropane
Piperazine	2-Bromoethanol

Manufacturing Process

A mixture of 155 parts of 2-chloro-10-(γ-chloropropyl)phenothiazine, 76 parts of sodium iodide, 216 parts of piperazine and 2,000 parts of butanone is refluxed for 8 hours, con-

centrated and extracted with dilute hydrochloric acid. The extract is rendered alkaline by addition of dilute potassium carbonate and benzene or chloroform extracted. This extract is washed with water, dried over anhydrous potassium carbonate, filtered and evaporated. Vacuum distillation at 0.1 mm pressure yields 2-chloro-10-[γ -(N-piperazino)propyl] phenothiazine at about 214°-218°C.

A stirred mixture of 5 parts of 2-chloro-10-[γ -(N-piperazino)propyl] phenothiazine, 1.92 parts of 2-bromoethanol, 2.11 parts of potassium carbonate and 35 parts of toluene is refluxed for 5 hours. The mixture is treated with water and benzene and the organic layer is separated, washed with water, dried over anhydrous potassium carbonate, filtered and evaporated. The residue is distilled at about 240°-244°C and 0.15 mm pressure to yield 2-chloro-10-[γ -(N¹- β -hydroxyethyl-N-piperazino)-propyl] phenothiazine according to U.S. Patent 2,838,507.

The 2-chloro-10-(γ -chloropropyl)phenothiazine starting material is produced from 2-chloro-phenothiazine and 1-bromo-3-chloropropane.

References

Merck Index 7044

Kleeman & Engel p. 705

PDR pp. 1217, 1617, 1655

OCDS Vol. 1 p. 383 (1977)

DOT 9 (6) 228 (1973)

I.N. p. 749

REM p. 1090

Cusie, J.W. and Hamilton, R.W.; U.S. Patent 2,838,507; June 10, 1958; assigned to G.D. Searle & Co.

Sherlock, M.H. and Sperber, N.; U.S. Patent 2,860,138; November 11, 1958; assigned to Schering Corporation

PHENACTROPINIUM CHLORIDE

Therapeutic Function: Antihypertensive

Chemical Name: α -Hydroxybenzeneacetic acid 8-methyl-8-[(2-oxo-2-phenyl)-ethyl]-8-azoniabicyclo[3.2.1]oct-3-yl ester chloride

Common Name: —

Structural Formula:

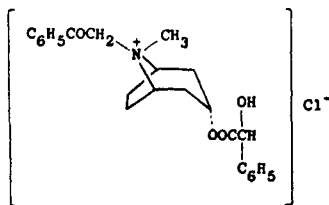

Chemical Abstracts Registry No.: —

Trade Name	Manufacturer	Country	Year Introduced
Trophenium	Amer. Cyanamid	U.S.	1961
Trophenium	Duncan Flockhart	U.K.	—

Raw Materials

Homatropine
Phenacyl chloride

Manufacturing Process

330 g (1.2M) of homatropine were dissolved in 1 liter of dry methyl ethyl ketone and gently refluxed on a water-bath during the gradual addition of a solution of 204 g (1.32M) redistilled phenacyl chloride in 200 ml of the same solvent. After 10 to 15 minutes 1 g of previously prepared homatropine phenacyl chloride was added to avoid formation of a supersaturated solution of the quaternary compound. Reflux was continued for 9 hours, then the thick suspension was allowed to cool, filtered and washed with 200 ml methyl ethyl ketone to yield 490 g (95%) slightly creamy solid, MP 188°C to 191°C.

For purification the crude quaternary salt was dissolved in hot ethyl alcohol (2 ml/g) and warm dry acetone (8 ml/g) was stirred into the clear filtrate. On cooling, 387 g (78% recovery) of a pure white powder, MP 195°C to 197°C, were obtained, in which the ionizable chlorine assayed at 99.7% of the theoretical value.

References

Merck Index 7067
I.N. p. 752

Johnston, R.G. and Spencer, K.E.V.; U.S. Patent 2,828,312; March 25, 1958; assigned to T. & H. Smith, Ltd. (U.K.)

PHENAGLYCODOL

Therapeutic Function: Tranquilizer

Chemical Name: 2-(4-Chlorophenyl)-3-methyl-2,3-butanediol

Common Name: —

Structural Formula:

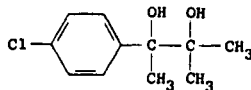

Chemical Abstracts Registry No.: 79-93-6

Trade Name	Manufacturer	Country	Year Introduced
Ultran	Lilly	U.S.	1957
Felixyn	Radiumpharma	Italy	—

Raw Materials

p-Chloroacetophenone
Hydrogen chloride
Ethanol
Magnesium

Sodium cyanide
Sodium hydroxide
Methyl iodide

Manufacturing Process

To a mixture of 460 g of p-chloroacetophenone, 350 ml of ether and 500 ml of water are added 410 g of sodium cyanide, with vigorous stirring. The reaction mixture is cooled to about 5°C to 10°C and 700 ml of concentrated hydrochloric acid are added at such a rate that no hydrogen cyanide is formed and the temperature of the mixture does not rise above 10°C. After the addition of the acid is complete, the reaction mixture is stirred for about three hours at room temperature, and allowed to separate into an aqueous and an organic phase. The organic phase is removed from the aqueous phase, and the aqueous phase and any salt which may have separated in the course of the reaction are washed with about 300 ml of ether. The combined ether washings and organic phase are dried over anhydrous magnesium sulfate, and the ether is removed by evaporation in vacuo at room temperature. The residue is poured with stirring into 800 ml of concentrated hydrochloric acid kept at about 0°C by cooling with solid carbon dioxide. The acid mixture is saturated with gaseous hydrogen chloride at 0°C, and stirred at room temperature overnight. The resulting precipitate of p-chloroatrolactamide is removed by filtration, washed by slurring with water and dried. After recrystallization from ethanol, p-chloroatrolactamide melts at about 105°C to 107°C.

A mixture of 200 g of p-chloroatrolactamide and 1 liter of 25% sodium hydroxide solution is refluxed with stirring for about sixteen hours. The reaction mixture is then poured over cracked ice and diluted with water to a volume of about 3 liters. The aqueous solution is washed with two 1 liter portions of ether, and acidified with concentrated hydrochloric acid, whereupon a precipitate of p-chloroatrolactic acid forms. The precipitated acid is removed by filtration, and is dissolved in 500 ml of ether, washed with two 250 ml portions of water and dried. The ether is removed by evaporation. p-chloroatrolactic acid thus prepared melts at about 117°C to 120°C.

A mixture of 185 g of p-chloroatrolactic acid, 600 ml of ethanol and 60 ml of concentrated sulfuric acid is refluxed for about twelve hours. About half the solvent is then removed by evaporation in vacuo at room temperature, the residue is poured over cracked ice, and diluted with water to a volume of about 2 liters. The ethyl p-chloroatrolactate formed in the reaction is extracted with two 1 liter portions of ether. The combined ether extracts are washed with successive 200 ml portions of water, 5% sodium carbonate solution, and water, and are dried over anhydrous magnesium sulfate. The dried ether solution is subjected to fractional distillation, and the fraction boiling at about 90°C to 100°C at a pressure of 0.1 mm of mercury, is collected. The distillate consists of ethyl p-chloroatrolactate.

To a solution of 2 mols of methylmagnesium iodide in 1.5 liters of ether are added with vigorous stirring 107 g (0.5 mol) of ethyl p-chloroatrolactate. The reaction mixture is stirred for about sixteen hours, and is then decomposed by the addition of about 320 ml of saturated aqueous ammonium chloride solution. After standing, the ether layer is decanted from the mixture and the aqueous phase and the precipitated salts are washed with several 500 ml portions of ether. The combined ether solution and washings are washed with successive 500 ml portions of 5% ammonium chloride solution and water, are dried over anhydrous magnesium sulfate, and are evaporated to dryness in vacuo. The crystalline residue consisting of 2-p-chlorophenyl-3-methyl-2,3-butanediol, is recrystallized from a mixture of benzene and petroleum ether.

2-p-chlorophenyl-3-methyl-2,3-butanediol thus prepared melts at about 66°C to 67°C.

References

Merck Index 7070

Kleeman & Engel p. 709

OCDS Vol. 1 p. 219 (1977)

I.N. p. 752

Mills, J.; U.S. Patent 2,812,363; November 5, 1957; assigned to Eli Lilly & Co.

PHENDIMETRAZINE TARTRATE

Therapeutic Function: Antiobesity

Chemical Name: 3,4-dimethyl-2-phenylmorpholine bitartrate

Common Name: 3,4-dimethyl-2-phenyltetrahydro-1,4-oxazine bitartrate

Structural Formula:

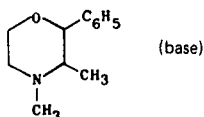

Chemical Abstracts Registry No.: 50-58-8; 634-03-7 (Base)

Trade Name	Manufacturer	Country	Year Introduced
Plegine	Ayerst	U.S.	1961
Statobex	Lemmon	U.S.	1972
Bacarate	Tutag	U.S.	1972
Prelu-2	Boehr. Ingel.	U.S.	1980
Sprx 105	Tutag	U.S.	1980
Obezine	Western Research	U.S.	1981
X-Troazine	Rexar	U.S.	1981
Hyrex-105	Hyrex	U.S.	1983
Adipost	Ascher	U.S.	1983
Slyn-LL	Edwards	U.S.	1983
Trimcaps	Mayrand	U.S.	1983
Adipo II	Sig	U.S.	—
Adphen	Ferndale	U.S.	—
Amphasub	Palmedico	U.S.	—
Anoxine T	Winston Pharm.	U.S.	—
Arcotrol	Arco	U.S.	—
Bacarate	Reid Provident	U.S.	—
Bontril	Carnrick	U.S.	—
Di-Ap-Trol	Foy	U.S.	—
Dyrexan	Trimen	U.S.	—
Ephemet	Canright	U.S.	—
Fringanor	Sobio	France	—
Melfiat	Reid-Rowell	U.S.	—
Neo-Nilorex	A.V.P.	U.S.	—
Obe-Del	Marlop	U.S.	—
Obepar	Parmed	U.S.	—
Obesan	SCS Pharnalab	S. Africa	—
Obex-LA	Rio Ethicals	S. Africa	—
Pan-Rexin	Pan American	U.S.	—
Phenazine	Jenkins	U.S.	—
Reducto	Arcum	U.S.	—
Reton	Tri-State	U.S.	—
Stodex	Jalco	U.S.	—
Symetra	Westerfield	U.S.	—
Trimstat	Laser	U.S.	—
Wehless	Hauck	U.S.	—
Weightrol	N. Amer. Pharm.	U.S.	—
X-Troazine	Rexar	U.S.	—

Raw Materials

Propiophenone
2-Methylaminomethanol

Bromine
Formic acid

Manufacturing Process

A mixture of 61 grams 1-phenyl-1-oxo-2-(N-methyl-N-ethanolamino)-propane hydrochloride and 100 cc 98-100% formic acid was refluxed at the boiling point at atmospheric pressure for 45 minutes on an oil bath. Thereafter, the oil bath temperature was increased to 180°C and as much of the excess unreacted formic acid as possible was distilled off. A vigorous evolution of carbon dioxide developed during the distillation, which ceased after approximately 45 additional minutes. The honey-yellow syrup which remained as the distillation residue was worked up by admixing it with about six volumes of water and adjusting the aqueous mixture to alkaline reaction with concentrated sodium hydroxide. An oily phase separated out which was extracted with ether. The ether extract was washed with water and dried over potassium carbonate. The solvent was distilled off and the distillation residue was fractionally distilled in vacuo. The base boils at 132°-133°C at 12 mm. The yield was 93% of theory. Reaction with tartaric acid gave the final product.

The starting material is produced by reacting propiophenone with bromine and then reacting the α -bromopropiophenone produced with 2-methylaminomethanol.

References

Merck Index 7088

Kleeman & Engel p. 711

PDR pp. 633, 679, 778, 928, 948, 992, 1448, 1450, 1807

OCDs Vol. 1 p. 260 (1977) & 2, 261 (1980)

I.N. p. 754

REM p. 892

Heel, W. and Zeile, K.; U.S. Patent 2,997,469; August 22, 1961; assigned to C.H. Boehringer Sohn, Germany

PHENELZINE SULFATE

Therapeutic Function: Psychostimulant

Chemical Name: (2-phenethyl)hydrazine sulfate

Common Name: —

Structural Formula:

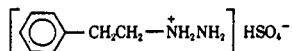

Chemical Abstracts Registry No.: 156-51-4; 51-71-8 (Base)

Trade Name	Manufacturer	Country	Year Introduced
Nardil	Parke Davis	U.S.	1959
Nardelzine	Substantia	France	—

Raw Materials

Phenethylbromide
Hydrazine hydrate

Manufacturing Process

To a refluxing solution containing 147.5 grams of 85% hydrazine hydrate in 500 cc of ethanol was added, during a period of 5 hours, 92.5 grams of phenethylbromide (0.50 mol) in 150 cc of ethanol. Stirring and refluxing were continued for two hours. The ethanol was removed by distillation and the residue extracted repeatedly with ether. The ether was dried with potassium carbonate and the product base collected by distillation, BP 74°C/0.1 mm, yield 52.3 grams (77%). The base is reacted with sulfuric acid in propanol to give the sulfate.

References

Merck Index 7089

Kleeman & Engel p. 711

PDR p. 1368

OCDS Vol. 1 p. 74 (1977)

I.N. p. 754

REM p. 1096

Biel, J.H.; U.S. Patent 3,000,903; September 19, 1961; assigned to Lakeside Laboratories, Inc.

PHENETHICILLIN POTASSIUM

Therapeutic Function: Antibacterial

Chemical Name: 3,3-Dimethyl-7-oxo-6-[(1-oxo-2-phenoxypropyl)amino]-4-thia-1-azabicyclo[3.2.0]heptane-2-carboxylic acid potassium salt

Common Name: Penicillin MY

Structural Formula:

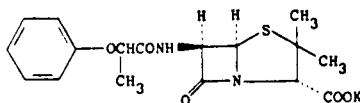

Chemical Abstracts Registry No.: 132-93-4; 147-55-7 (Base)

Trade Name	Manufacturer	Country	Year Introduced
Syncillin	Bristol	U.S.	1959
Ro-Cillin	Rowell	U.S.	1960
Chemiphen	Squibb	U.S.	1960
Semopen	Massengill	U.S.	1960
Dramcillin-S	White	U.S.	1960
Maxipen	Roerig	U.S.	1960
Darcil	Wyeth	U.S.	1960
Alpen	Schering	U.S.	1960
Altocillin	Caber	Italy	—
Bendralan	Antibioticos	Spain	—
Broxil	Beecham	U.K.	—
Metipen	Boniscontro-Gazzone	Italy	—
Optipen	C.S.L.	Australia	—
Pen-200	Pfizer	W. Germany	—

Trade Name	Manufacturer	Country	Year Introduced
Peniplus	Fumouze	France	—
Penopen	Pliva	Yugoslavia	—
Penorale	Lusofarmaco	Italy	—
Syntheticilline	Bristol	France	—
Synthepen	Meiji	Japan	—

Raw Materials

α -Phenoxypropionic acid	Isobutyl chloroformate
6-Aminopenicillanic acid	Potassium 2-ethylhexanoate

Manufacturing Process

Triethylamine (1.5 ml) was added to a cold solution (10°C) of α -phenoxypropionic acid (1.66 g, 0.01 mol) in 15 ml of pure dioxane, with stirring and cooling to 5°C to 10°C while isobutyl chloroformate (1.36 g, 0.01 mol) in 5 ml of dioxane was added dropwise. Then the mixture was stirred for ten minutes at 5°C to 8°C. A solution of 6-amino-penicillanic acid (2.16 g, 0.01 mol) in 15 ml of water and 2 ml of triethylamine was then added dropwise while the temperature was maintained below 10°C. The resulting mixture was stirred in the cold for 15 minutes then at room temperature for 30 minutes, diluted with 30 ml of cold water and extracted with ether which was discarded. The cold aqueous solution was then covered with 75 ml of ether and acidified to pH 2 with 5N H₂SO₄. After shaking, the ether layer containing the product 6-(α -phenoxypropionamido)penicillanic acid, was dried for ten minutes over anhydrous sodium sulfate and filtered. Addition of 6 ml of dry n-butanol containing 0.373 g/ml of potassium 2-ethylhexanoate precipitated the potassium salt of the product as a colorless oil which crystallized on stirring and scratching and was collected, dried in vacuo and found to weigh 2.75 g, to melt at 217°C to 219°C.

References

Merck Index 7093

Kleeman & Engel p. 712

OCDS Vol. 1 p. 410 (1977)

I.N. p. 755

Beecham Research Laboratories, Ltd.; British Patent 877,120; September 13, 1961

PHENFORMIN

Therapeutic Function: Antidiabetic

Chemical Name: N-(2-Phenylethyl)imidodicarbonimidic diamide

Common Name: Phenethyldiguanide

Structural Formula:

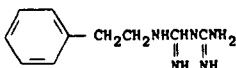

Chemical Abstracts Registry No.: 114-86-3

Trade Name	Manufacturer	Country	Year Introduced
DBI	Geigy	U.S.	1959
Meltrol	U.S.V. Pharm	U.S.	1971
Adiabetin	Arcana	Austria	—

Trade Name	Manufacturer	Country	Year Introduced
Antipond	Arcana	Austria	—
Cronoformin	Guidotti	Italy	—
De Be J	Isa	Brazil	—
Debeone	U.S.V.	U.S.	—
Diabis	Funk	Spain	—
Dibein	Pharmacia	Sweden	—
Dibophen	Polfa	Poland	—
Insoral	U.S.V.	U.S.	—
Kataglicina	Marxer	Italy	—
Prontoformin	Guidotti	Italy	—

Raw Materials

β -Phenylethylamine
Hydrogen chloride
Dicyandiamide

Manufacturing Process

15.76 g of β -phenylethylamine hydrochloride and 8.4 g of dicyandiamide were ground and intimately mixed. The mixture was heated in an oil bath in a 3-neck flask fitted with a thermometer and stirrer, and the mixture began to melt at a bath temperature of 125°C and was completely fluid at 130°C. Further heating at 145°C to 150°C initiated an exothermic reaction and the temperature of the fusion mixture (156°C) exceeded the oil bath temperature (150°C) by 6°. Heating was continued for one hour at bath temperature of 148°C to 150°C. The reaction mixture was cooled, dissolved in about 100 cc of methanol and filtered. The methanol filtrate was concentrated under reduced pressure, cooled and the product (β -phenylethylbiguanide hydrochloride) filtered off and recrystallized from 95% isopropanol.

References

Merck Index 7099

OCDS Vol. 1 p. 75 (1977)

I.N. p. 755

Shapiro, S.L. and Freedman, L.; U.S. Patent 2,961,377; November 22, 1960; assigned to U.S. Vitamin & Pharmaceutical Corp.

PHENINDAMINE TARTRATE

Therapeutic Function: Antihistaminic

Chemical Name: 2,3,4,9-tetrahydro-2-methyl-9-phenyl-1H-indeno[2,1,c]pyridine tartrate

Common Name: 2-methyl-9-phenyl-2,3,4,9-tetrahydro-1-pyridindene tartrate

Structural Formula:

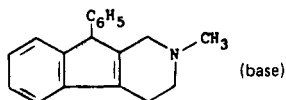

Chemical Abstracts Registry No.: 569-59-5; 82-88-2 (Base)

Trade Name	Manufacturer	Country	Year Introduced
Thephorin	Roche	U.S.	1947

Trade Name	Manufacturer	Country	Year Introduced
Nolahist	Carrick	U.S.	1982
Nolamine	Carrick	U.S.	—
Pernovin	Chinoi	Hungary	—
PV-Tussin	Reid-Rowell	U.S.	—

Raw Materials

Acetophenone	Methylamine
Formaldehyde	Sodium hydroxide
Hydrogen bromide	Hydrogen
Potassium thiocyanate	

Manufacturing Process

A mixture of 750 grams of 1-methyl-3-benzoyl-4-hydroxy-4-phenylpiperidine and 2,500 cc of 48% hydrobromic acid is refluxed for about 20 minutes. It is then poured into 8 liters of water. An oily precipitate appears which on standing crystallizes. It is filtered and crystallized from about 3.5 liters of alcohol. 2-Methyl-9-phenyl-2,3-dihydro-1-pyridindene hydrobromide, MP 201°-203°C, is obtained.

A mixture of 680 grams of 2-methyl-9-phenyl-2,3-dihydro-1-pyridindene hydrobromide, 6,000 cc of water and about 100 grams of Raney-nickel catalyst is hydrogenated at room temperature and at about 1,000 lb pressure for a period of three hours. The catalyst is filtered. The clear filtrate is treated with a solution of 240 grams potassium thiocyanate in 400 cc of water. A heavy solid precipitates from which the supernatant liquid is decanted.

The residue is dissolved in 10 liters of boiling alcohol with stirring in the presence of nitrogen. The solution is cooled to room temperature under nitrogen, and then allowed to stand overnight. 2-Methyl-9-phenyl-tetrahydro-1-pyridindene thiocyanate separates in crystals of MP 188°-189°C. From the concentrated filtrate an additional amount is obtained. The corresponding free base, prepared by treating the slightly soluble thiocyanate in aqueous suspension with sodium hydroxide and extracting with ether, has a MP of 90°-91°C. It forms a tartrate of MP 160°C.

The starting material was prepared by reacting acetophenone, methylamine and formaldehyde followed by treatment of the intermediate with sodium hydroxide.

References

Merck Index 7103

Kleeman & Engel p. 713

PDR pp. 781, 1448

I.N. p. 756

Plati, J.T. and Wenner, W.; U.S. Patent 2,470,108; May 17, 1949; assigned to Hoffmann-La Roche Inc.

PHENIPRAZINE

Therapeutic Function: Antihypertensive

Chemical Name: (1-Methyl-2-phenylethyl)hydrazine

Common Name: —

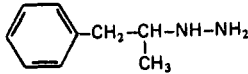
Structural Formula:**Chemical Abstracts Registry No.:** 55-52-7

Trade Name	Manufacturer	Country	Year Introduced
Catron	Lakeside	U.S.	1959
Catroniazide	Lakeside	U.S.	-

Raw Materials

1-Phenyl-2-propylidenehydrazine
Acetic acid
Hydrogen

Manufacturing Process

A solution containing 741 g (5.0 mols) of 1-phenyl-2-propylidenehydrazine, 300 g (5.0 mols) of glacial acetic acid and 900 cc of absolute ethanol was subjected to hydrogenation at 1,875 psi of hydrogen in the presence of 10 g of platinum oxide catalyst and at a temperature of 30°C to 50°C (variation due to exothermic reaction). The catalyst was removed by filtration and the solvent and acetic acid were distilled. The residue was taken up in water and made strongly alkaline by the addition of solid potassium hydroxide. The alkaline mixture was extracted with ether and the ether extracts dried with potassium carbonate. The product was collected by fractional distillation, BP 85°C (0.30 mm); yield 512 g (68%).

The hydrochloride salt was formed in a mixture of 1:10 isopropyl alcohol:diisopropyl ether and recrystallized from acetonitrile, yield 87%, MP 124°C to 125°C.

References

Merck Index 7105

OCDS Vol. 1 p. 74 (1977)

I.N. p. 757

Biel, J.H.; U.S. Patent 2,978,461; April 4, 1961; assigned to Lakeside Laboratories, Inc.

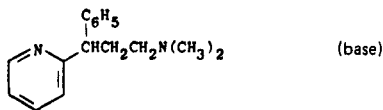
PHENIRAMINE MALEATE**Therapeutic Function:** Antihistaminic**Chemical Name:** N,N-dimethyl-γ-phenyl-2-pyridine-propanamine maleate**Common Name:** Propphenpyridine**Structural Formula:****Chemical Abstracts Registry No.:** 132-20-7; 86-21-5 (Base)

Trade Name	Manufacturer	Country	Year Introduced
Trimeton Maleate	Schering	U.S.	1948
Avil	Albert-Roussel	W. Germany	—
Citra Forte	Doyle	U.S.	—
Daneral	Hoechst	U.K.	—
Dristan	Whitehall	U.S.	—
Fenamene	Fawns & McAllan	Australia	—
Fiogesic	Sandoz	U.S.	—
Inhiston	Upjohn	U.S.	—
Poly-Histine	Bock	U.S.	—
Ru-Tuss	Boots	U.S.	—
S.T. Forte	Scot-Tussin	U.S.	—
Triaminic	Dorsey	U.S.	—
Tussirex	Scot-Tussin	U.S.	—

Raw Materials

2-Benzylpyridine	Potassium amide
β -Dimethylaminoethyl chloride	Maleic acid

Manufacturing Process

According to U.S. Patent 2,676,964: to 1.0 mol of potassium amide in 3 liters of liquid ammonia, is added 1.0 mol of 2-benzylpyridine. After 15 minutes, 1.1 mols of β -dimethylaminoethyl chloride are added. The ammonia is allowed to evaporate and the reaction product decomposed with water and ether extracted. The ether layer is dried over sodium sulfate and after evaporation the residue is distilled, giving the 3-phenyl-3-(2-pyridyl)-N,N-dimethylpropylamine, BP 139°-142°C/1-2 mm. The maleate is produced by reaction with maleic acid.

References

Merck Index 7106

Kleeman & Engel p. 713

PDR pp. 674, 688, 692, 849, 1583, 1662, 1899

OCDS Vol. 1 p. 77 (1977)

I.N. p. 757

REM p. 1131

Sperber, N., Papa, D. and Schwenk, E.; U.S. Patent 2,567,245; September 11, 1951; assigned to Schering Corporation

Sperber, N., Papa, D. and Schwenk, E.; U.S. Patent 2,676,964; April 27, 1954; assigned to Schering Corporation

PHENMETRAZINE

Therapeutic Function: Antiobesity drug

Chemical Name: 3-methyl-2-phenylmorpholine

Common Name: Oxazimedrine

Structural Formula:

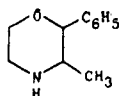

Chemical Abstracts Registry No.: 134-49-6; 1707-14-8 (Hydrochloride)

Trade Name	Manufacturer	Country	Year Introduced
Preludin	Boehr. Ingel.	U.S.	1956
Anorex	Pfizer	U.S.	—
Cafilon	Yamanouchi	Japan	—
Marsin	Ikapharm	Israel	—

Raw Materials

Bromopropiophenone	Benzyl ethanolamine
Hydrogen	Hydrogen chloride

Manufacturing Process

10 grams of β -phenyl- α -methyl- β,β' -dihydroxy-diethylamine hydrochloride (produced by hydrogenation in the presence of palladium and charcoal of β -phenyl- α -methyl- β -keto- β' -hydroxy-N-benzyl-diethylamine hydrochloride obtained from bromopropiophenone by reacting with benzyl-ethanolamine), are warmed with 10% hydrochloric acid for 6 hours on a water bath.

After working up in the usual manner, the hydrochloride of the 2-phenyl-3-methyl-morpholine crystallizes out from methanolic hydrochloric acid and acetone, MP = 182°C, according to U.S. Patent 2,835,669.

References

Merck Index 7108

Kleeman & Engel p. 714

PDR p. 678

OCDS Vol. 1 p. 260 (1977)

I.N. p. 757

REM p. 892

Thoma, O.; U.S. Patent 2,835,669; May 20, 1958; assigned to C.H. Boehringer Sohn, Germany

Siemer, H. and Hengen, O.; U.S. Patent 3,018,222; January 23, 1962; assigned to Ravensberg GmbH, Germany

PHENOPERIDINE HYDROCHLORIDE

Therapeutic Function: Analgesic

Chemical Name: 1-(3-hydroxy-3-phenylpropyl)-4-phenyl-4-piperidinecarboxylic acid ethyl ester hydrochloride

Common Name: 3-(4-carboethoxy-4-phenylpiperidino)-1-phenyl-1-propanol hydrochloride

Structural Formula:

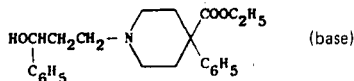

Chemical Abstracts Registry No.: 3627-49-4; 562-26-5 (Base)

Trade Name	Manufacturer	Country	Year Introduced
Operidine	Janssen	U.S.	1965
Lealgin	Leo	Sweden	—
R-1406	Le Brun	France	—

Raw Materials

Phenylacetonitrile	Benzoylethylene
Bis-Chloroethyl toluene sulfonyl amide	Hydrogen

Manufacturing Process

The starting materials for the overall process are phenylacetonitrile with bis-chloroethyl toluene sulfonyl amide. These react to give a product which hydrolyzes to normeperidine (4-carboethoxy-4-phenylpiperidine). Condensation of that material with benzoylethylene gives the ketone: β -(4-carboethoxy-4-phenylpiperidino)propiophenone.

A reaction mixture was prepared containing 4 grams of β -(4-carboethoxy-4-phenylpiperidino)-propiophenone hydrochloride, 100 ml of methanol and about 0.5 gram of platinum oxide catalyst. The mixture was placed in a low pressure hydrogenation apparatus and was hydrogenated at a temperature of about 27°C and a pressure of about 3.5 atmospheres of hydrogen to convert the keto group of the β -(4-carboethoxy-4-phenylpiperidino)-propiophenone to a hydroxy group, and to form 3-(4-carboethoxy-4-phenylpiperidino)-1-phenyl-1-propanol hydrochloride. After the hydrogenation was complete, the catalyst was separated from the reaction mixture by filtration, and the filtrate was evaporated to dryness in vacuo leaving a residue containing 3-(4-carboethoxy-4-phenylpiperidino)-1-phenyl-1-propanol hydrochloride. The residue was digested with ethyl acetate thereby causing 3-(4-carboethoxy-4-phenylpiperidino)-1-phenyl-1-propanol hydrochloride to crystallize. This compound melted at about 188°-189°C after being recrystallized three times from an ethyl acetate-methanol solvent mixture, according to U.S. Patent 2,951,080.

References

Merck Index 7125

Kleeman & Engel p. 715

OCDS Vol. 1 p. 302 (1977)

I.N. p. 759

Pohland, A.; U.S. Patent 2,951,080; August 30, 1960; assigned to Eli Lilly and Company
Cutler, F.A., Jr. and Fisher, J.F.; U.S. Patent 2,962,501; November 29, 1960; assigned to Merck & Co., Inc.

PHENOXYBENZAMINE HYDROCHLORIDE

Therapeutic Function: Adrenergic blocker

Chemical Name: N-(2-chloroethyl)-N-(1-methyl-2-phenoxyethyl)benzenemethanamine hydrochloride

Common Name: —

Structural Formula:

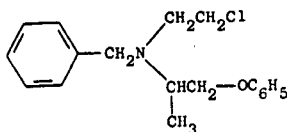

Chemical Abstracts Registry No.: 63-92-3; 59-96-1 (Base)

Trade Name	Manufacturer	Country	Year Introduced
Dibenzyline	SKF	U.S.	1953
Dibenzylan	Rohm Pharma	W. Germany	—

Raw Materials

1-Phenoxy-2-propanol	Thionyl chloride
Ethanolamine	Benzyl chloride
Hydrogen chloride	

Manufacturing Process

Step 1: In a 500 ml flask equipped with gas inlet tube, dropping funnel and reflux condenser is placed 139 grams of 1-phenoxy-2-propanol. A stream of dry air is bubbled through the alcohol while 55 grams of thionyl chloride is added dropwise with external cooling. The stream of dry air is continued for about six hours or until most of the hydrogen chloride has been expelled and then another 55 grams of thionyl chloride is added. The reaction mixture is allowed to stand twenty-four hours, a few drops of pyridine are added and the mixture heated 4 hours on the steam bath. The cooled reaction mixture is poured into water, the crude product is washed with dilute sodium bicarbonate solution and finally taken up in benzene. The benzene is distilled at ordinary pressure and the residue distilled in vacuo to yield 60-70% of 1-phenoxy-2-chloropropane, BP 93°-94°C/5 mm.

Step 2: To 494 grams of ethanolamine, heated to approximately 150°C in a 500 ml flask equipped with stirrer, condenser and dropping funnel, is added 465 grams of 1-phenoxy-2-chloropropane with mechanical stirring. The reaction mixture is then heated to reflux for 3 hours, cooled and poured into a liter of water. The organic layer is extracted into ether and the ether solution is extracted with dilute hydrochloric acid. The aqueous acid solution is then made alkaline with 40% sodium hydroxide solution and the organic base is extracted into ether. Removal of the ether leaves N-(phenoxyisopropyl)-ethanolamine which, after recrystallization from hexane, melts at 70.5°-72°C.

Step 3: To 43 grams of N-(phenoxyisopropyl)ethanolamine dissolved in 500 ml of alcohol in a 1,000 ml flask equipped with stirrer and condenser is added 28 grams of benzyl chloride and 18.5 grams of sodium bicarbonate. The mixture is stirred and refluxed for 10 hours and then approximately half the alcohol is removed by distillation. The remaining solution is poured into 500 ml of water and the organic material extracted with 3 100-ml portions of ether. The combined ether extracts are washed with water, dried over anhydrous potassium carbonate and filtered. After removal of the ether, the residue is distilled in vacuo to yield N-(phenoxyisopropyl)-N-benzylethanolamine, BP 163°-168°C/0.2 mm.

Step 4: A solution of 20 grams of the above amino alcohol is dissolved in 50 ml of dry chloroform and treated with dry hydrogen chloride until acid. Then a solution of 9 grams of thionyl chloride in 50 ml of dry chloroform is added and the reaction mixture is heated on a water bath at 50°-60°C for 2 hours. Most of the chloroform is removed by distillation under reduced pressure. Addition of ether to the residue causes the product to crystallize. After recrystallization from a mixture of alcohol and ether, the N-(phenoxyisopropyl)-N-benzyl-β-chloroethylamine hydrochloride melts at 137.5°-140°C.

References

- Merck Index 7134
- Kleeman & Engel p. 716
- PDR p. 1713
- OCDS Vol. 1 p. 55 (1977)
- I.N. p. 760
- REM p. 905

Kerwin, J.F. and Ulliyot, G.E.; U.S. Patent 2,599,000; June 3, 1952; assigned to Smith, Kline & French Laboratories

PHENPROCOUMON

Therapeutic Function: Anticoagulant

Chemical Name: 4-hydroxy-3-(1-phenylpropyl)-2H-1-benzopyran-2-one

Common Name: 3-(1-phenylpropyl)-4-hydroxycoumarin

Structural Formula:

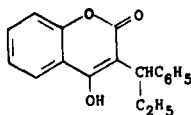

Chemical Abstracts Registry No.: 435-97-2

Trade Name	Manufacturer	Country	Year Introduced
Liquamar	Organon	U.S.	1958
Falithrom	Fahlberg-List	E. Germany	—
Fencumar	Medica	Finland	—
Marcumar	Roche	W. Germany	—

Raw Materials

Diethyl-(1'-phenylpropyl)malonate	Sodium
Acetylsalicylic acid chloride	Sodium hydroxide
Methanol	

Manufacturing Process

8.3 parts by weight of powdered sodium in 300 parts by volume of benzene, 100 parts by weight of diethyl (1'-phenylpropyl)-malonate and 72 parts by weight of acetylsalicylic acid chloride are reacted together to form diethyl 1-(o-acetoxybenzoyl)-1-(1'-phenylpropyl)-malonate, which boils at 195°-198°C/0.03 mm Hg.

10.3 parts of weight of diethyl 1-(o-acetoxybenzoyl)-1-(1'-phenylpropyl)-malonate are dissolved in 60 parts by volume of absolute ether and to this solution are added portion-wise at 10°C, while stirring, 2.6 parts by weight of sodium methylate. The reaction mixture is stirred for 4 hours, whereupon it is poured into ice water. The ether solution is washed neutral with ice water. After having distilled off the ether, a thick oil consisting of 3-carbethoxy-3-(1'-phenylpropyl)-4-oxo-dihydrocoumarin is obtained. This compound crystallized in butyl oxide and has a MP of 108°-109°C.

The 3-carbethoxy-3-(1'-phenylpropyl)-4-oxo-dihydrocoumarin may be hydrolyzed and decarboxylated as follows. The crude product is heated to 85°C for ½ hour with 100 parts by volume of 5% aqueous sodium hydroxide, while agitating or stirring. To remove traces of undissolved oil, the cooled solution is treated with 1 part by weight of charcoal, whereupon it is filtrated and acidified to Congo reaction with dilute sulfuric acid. The 3-(1'-phenylpropyl)-4-hydroxycoumarin formed is separated off and recrystallized in 80% ethanol, whereupon it melts at 178°-179°C according to U.S. Patent 2,701,804.

References

Merck Index 7139

Kleeman & Engel p. 718

I.N. p. 761

REM p. 827

Hegedüs, B. and Grüssner, A.; U.S. Patent 2,701,804; February 8, 1955; assigned to Hoffmann-La Roche Inc.

Schroeder, C.H. and Link, K.P.; U.S. Patent 2,872,457; February 3, 1959; assigned to Wisconsin Alumni Research Foundation

Preis, S., West, B.D. and Link, K.P.; U.S. Patent 3,239,529; March 8, 1966; assigned to Wisconsin Alumni Research Foundation

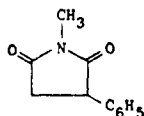
PHENSUXIMIDE**Therapeutic Function:** Anticonvulsant**Chemical Name:** 1-methyl-3-phenyl-2,5-pyrrolidinedione**Common Name:** N-methyl- α -phenylsuccinimide**Structural Formula:****Chemical Abstracts Registry No.:** 86-34-0

Trade Name	Manufacturer	Country	Year Introduced
Milontin	Parke Davis	U.S.	1953
Lifene	Debat	France	—
Petimid	Dinzel	Turkey	—
Succitimal	Katwijk	Neth.	—

Raw Materials

Phenylsuccinic anhydride
Methyl amine
Acetyl chloride

Manufacturing Process

10 grams of phenylsuccinic anhydride is dissolved in 250 ml of absolute ether and the solution is treated with dry methylamine until a precipitate ceases to form. After standing for ½ hour the ether is decanted off and the residue is washed with 40 ml of water by decantation. The mixture is filtered and the precipitate washed with 10 ml of water. By acidification of the filtrate, a white precipitate is obtained. After drying it weighs 8 grams and melts at 136°-140°C. The two precipitates are combined and recrystallized from aqueous alcohol to give β -N-methylphenylsuccinamic acid which melts at 158°-160°C.

9 grams of β -N-methylphenylsuccinamic acid and 200 ml of acetyl chloride are heated together on a steam bath for ½ hour. The excess acetyl chloride is removed by distillation and 50 ml of water are added to the thick residue. After allowing for hydrolysis of

the excess acetyl chloride the water is decanted and the yellow residue dissolved in 75 ml of ether. The resulting solution is treated with charcoal twice and dried over anhydrous magnesium sulfate. On partial evaporation of the ether a white solid precipitates. There is obtained 4 grams of N-methyl- α -phenylsuccinimide which melts at 71°-73°C.

References

Merck Index 7140

Kleeman & Engel p. 718

PDR p. 1367

OCDS Vol. 1 p. 226 (1977)

I.N. p. 762

REM p. 1080

Miller, C.A. and Long, L.M.; U.S. Patent 2,643,258; June 23, 1953; assigned to Parke, Davis & Company

PHENTERMINE HYDROCHLORIDE

Therapeutic Function: Antiobesity drug

Chemical Name: α,α -dimethylbenzeneethanamine hydrochloride

Common Name: α -benzylisopropylamine hydrochloride; phenyl-tert-butylamine hydrochloride

Structural Formula:

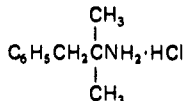

Chemical Abstracts Registry No.: 1197-21-3; 122-09-8 (Base)

Trade Name	Manufacturer	Country	Year Introduced
Wilpo	Dorsey	U.S.	1961
Linyl	Roussel	France	1962
Fastin	Beecham	U.S.	1973
Adipex-P	Lemmon	U.S.	1976
Ona Mast	Mast	U.S.	1980
Obestin	Ferndale	U.S.	1980
Oby-Trim	Rexar	U.S.	1982
Duromine	Riker	U.K.	—
Ex-Adipos	Eurand	Italy	—
Ionamin	Pennwalt	U.K.	—
Jonakraft	Kraft Pharm	U.S.	—
Lipopil	Roussel Maestretti	Italy	—
Minobese	Restan	S. Africa	—
Mirapront	Bracco	Italy	—
Netto-Longcaps	Heyden	W. Germany	—
Panbesy	Asperal	Belgium	—
Panshade	Pan American	U.S.	—
Parmine	Parmed	U.S.	—
Phentermine	Schein	U.S.	—
Phentermyl	Diethelm	W. Germany	—

Trade Name	Manufacturer	Country	Year Introduced
Regulin	Kwizda	Austria	—
Span R/D	Metro Med	U.S.	—
Teramine	Legere	U.S.	—

Raw Materials

Isobutyryl chloride	Sodium
Ammonia	Benzyl bromide
Hydrogen chloride	Benzene
Bromine	Potassium hydroxide
Calcium hydroxide	

Manufacturing Process

Preparation of Isobutyrophenone: In a 12 liter, 3-necked flask, 1,280 grams of aluminum chloride was covered with 2,000 cc of dry thiophene-free benzene and a solution of 919 grams of isobutyryl chloride, (BP 92°-94°C) in 1 liter of benzene was added slowly with stirring. After heating for 3 hours at reflux, the solution was cooled and poured over a mixture of 1 liter of concentrated hydrochloric acid and 5 kg of ice. The benzene layer was separated, the aqueous layer extracted with benzene, and the combined benzene solutions were washed, dried and concentrated in vacuo. The residue was distilled rapidly to give 1,051 grams of isobutyrophenone, boiling at 81°-89°C at 1 mm, yield 83.4%.

Preparation of 1,3-Diphenyl-2,2-Dimethylpropanone-1: Sodamide was prepared from 12.5 grams of sodium added in small portions to 600 cc of liquid ammonia with 1 gram of hydrous ferric chloride as catalyst. The ammonia was replaced by 200 cc of dry toluene and without delay a solution of 74 grams of isobutyrophenone and 76.5 grams of benzyl bromide in 200 cc of benzene was slowly added with stirring. The reaction mixture was heated on a boiling water bath for 48 hours. Water was then added, the organic layer separated and the product isolated by distillation. The 1,3-diphenyl-2,2-dimethylpropanone-1 boiled from 142°-143°C at a pressure of 3 mm, n_D^{20} 1.5652.

Preparation of α,α -Dimethyl- β -Phenylpropionamide: Sodamide was prepared from 7.6 grams of sodium in 350 cc of liquid ammonia with 0.9 gram of hydrous ferric chloride. The ammonia was replaced by 250 cc of toluene, the mixture was heated to 60°C and 71.4 grams of 1,3-diphenyl-2,2-dimethyl propanone-1 dissolved in 150 cc of toluene was added. The mixture was stirred and heated on a steam bath for 5 hours. A clear red color appeared in 15 minutes and disappeared after about an hour. After cooling, water was added, the organic layer was washed, dried, and concentrated to give 36.5 grams of α,α -dimethyl- β -phenyl propionamide which crystallized slowly after the addition of an equal volume of petroleum ether. The product melted at 62°C after crystallization from benzene-petroleum ether.

Preparation of Di-(β -Phenyl- α,α -Dimethylethyl)Urea: 3.5 grams of α,α -dimethyl- β -phenyl-propionamide in 420 cc of water was added to a solution of 87.5 grams of potassium hydroxide and 35 grams of bromine in 350 cc of water. After 2 hours at 60°C, the product was obtained on crystallization from ethanol, melting at 184°C.

*Preparation of ω -Phenyl-*tert*-Butylamine:* 24 grams of the urea derivative obtained as indicated above, were well mixed with 96 grams of calcium hydroxide in a flask immersed in an air bath and provided with a dropping funnel the stem of which reached the bottom of the flask. The mixture was heated to 240°-260°C (inside temperature) for 7 hours during which time 86 cc of water was slowly added. The vapors were collected in a receiver cooled with ice. After extraction with ether and distillation, the product was obtained as a colorless liquid boiling from 80°-84°C at 9 mm according to U.S. Patent 2,590,079.

The ether solution may be dried and saturated with hydrogen chloride and the precipitated hydrochloride recrystallized from a mixture of 50 parts alcohol and 100 parts of acetone.

The pure hydrochloride is thus obtained as a white crystalline substance having a MP of 195°-196°C, according to U.S. Patent 2,408,345.

References

Merck Index 7141

Kleeman & Engel p. 719

PDR pp. 660, 1033, 1034, 1246, 1450, 1606, 1999

OCDS Vol. 1 p. 72 (1977)

I.N. p. 762

REM p. 892

Shelton, R.S. and Van Campen, M.G., Jr.; U.S. Patent 2,408,345; September 24, 1946; assigned to The Wm. S. Merrell Company

Abell, L.L., Bruce, W.F. and Seifert, J.; U.S. Patent 2,590,079; March 25, 1952; assigned to Wyeth Incorporated

PHENTOLAMINE HYDROCHLORIDE

Therapeutic Function: Adrenergic blocker

Chemical Name: 3-[[[4,5-dihydro-1H-imidazol-2-yl)methyl] (4-methylphenyl)amino] phenol hydrochloride

Common Name: 2-(m-hydroxy-N-p-tolylanilinomethyl)-2-imidazoline hydrochloride

Structural Formula:

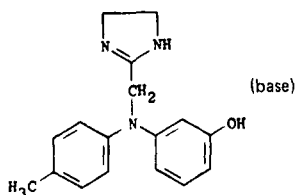

Chemical Abstracts Registry No.: 73-05-2; 50-60-2 (Base)

Trade Name	Manufacturer	Country	Year Introduced
Regitine	Ciba	U.S.	1952
Regitine	Ciba-Geigy-Takeda	Japan	—
Rogitine	Ciba	U.K.	—

Raw Materials

N-(p-Methylphenyl)-m'-hydroxyphenylamine
2-Chloromethylimidazoline HCl
Hydrogen chloride

Manufacturing Process

199.24 parts of N-(p-methylphenyl)-m'-hydroxyphenylamine and 77.52 parts of 2-chloromethylimidazoline hydrochloride are heated for sixteen hours in an oil bath having a temperature of 150°C, while stirring and introducing a current of nitrogen. The viscous contents of the flask are then cooled to about 100°C, mixed with 400 parts by volume of hot water, and stirred for a short time.

After further cooling to about 60°C, 200 parts by volume of water and 500 parts by volume of ethyl acetate at 60°C are added, and the aqueous layer is separated. The excess of starting material may be recovered from the ethyl acetate.

The aqueous portion is chilled in a cooling chamber at -10°C, whereupon the hydrochloride of 2-[N-(p-methylphenyl)-N-(m'-hydroxyphenyl)-aminomethyl]-imidazoline crystallizes. Upon being concentrated and cooled the mother liquor yields a further quantity of the hydrochloride. The combined quantities of hydrochloride are treated with a small quantity of cold water, dried with care, and washed with ethyl acetate. The product is then crystallized from a mixture of alcohol and ethyl acetate, and there is obtained a hydrochloride melting at 239°-240°C.

References

Merck Index 7143

Kleeman & Engel p. 719

PDR p. 809

OCDS Vol. 1 p. 242 (1977)

I.N. p. 762

REM p. 906

Miescher, K., Marxer, A. and Urech, E.; U.S. Patent 2,503,059; April 4, 1950; assigned to Ciba Pharmaceutical Products, Inc.

PHENYL AMINOSALICYLATE

Therapeutic Function: Antibacterial (Tuberculostatic)

Chemical Name: 4-Amino-2-hydroxybenzoic acid phenyl ester

Common Name: Fenamisal

Structural Formula:

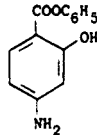

Chemical Abstracts Registry No.: 133-11-9

Trade Name	Manufacturer	Country	Year Introduced
Pheny-Pas-Teb-Amin	Purdue Frederick	U.S.	1959
Fenil-PAS	Farmabion	Spain	—

Raw Materials

p-Nitrosalicilyc acid	Phenol
Phosphorus oxychloride	Hydrogen

Manufacturing Process

183 g of p-nitrosalicilyc acid are dissolved in 564 g of phenol by heating to 140°C to 150°C on an oil bath. When all the p-nitrosalicilyc acid is dissolved, 153 g of phosphorus oxychloride are run in, drop by drop, over a period of about 2 hours, while maintaining the tempera-

ture at about 150°C. The still warm mixture is run into 2 liters of water with agitation. The precipitate formed is filtered off, washed with water until phenol is removed and then dried.

There are thus obtained 250 g of 2-hydroxy-4-nitrophenylbenzoate which melts at 154°C to 155°C.

In a hydrogenation autoclave are introduced 92 g of 2-hydroxy-4-nitrophenylbenzoate preceded by 200 cc of ethyl acetate; Raney nickel, obtained from 30 g of alloy, is added with 300 cc of ethyl acetate. Hydrogenation under pressure (100 to 120 kg) at ordinary temperature is carried out during a period of about 12 hours. The nickel is filtered off and the ethyl acetate is removed by distillation on the water bath under a vacuum of 300 mm. There is thus obtained 80 g of crude damp 2-hydroxy-4-aminophenylbenzoate which after recrystallization from isopropyl alcohol melts at 153°C.

References

Merck Index 7151

OCDS Vol. 2 p. 89 (1980)

I.N. p. 415

Freire, S.A.; U.S. Patent 2,604,488; July 22, 1952; assigned to Soc. des Usines Chimiques Rhone-Poulenc (France)

PHENYLBUTAZONE

Therapeutic Function: Antiinflammatory; antiarthritic

Chemical Name: 4-butyl-1,2-diphenyl-3,5-pyrazolidinedione

Common Name: 3,5-dioxo-1,2-diphenyl-4-n-butylpyrazolidine

Structural Formula:

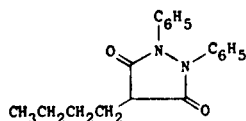

Chemical Abstracts Registry No.: 50-33-9

Trade Name	Manufacturer	Country	Year Introduced
Butazolidin	Geigy	U.S.	1952
Butazolidin	Ciba Geigy	France	1954
Azolid	U.S.V. Pharm	U.S.	1971
Acrizeal	S.S. Pharm	Japan	—
Alkabutazona	Lovens	Denmark	—
Anuspiramin	Farbios	Spain	—
Artropan	Polifarma	Italy	—
Bulentin	Sanwa	Japan	—
Butacal	Langley	Australia	—
Butacote	Geigy	U.K.	—
Butadion	Streuli	Switz.	—
Butadiona	Miquel	Spain	—
Butadyne	Bio-Chimique	Canada	—
Butalan	Lancet	Australia	—
Butalgin	Fawns & McAllan	Australia	—

Trade Name	Manufacturer	Country	Year Introduced
Butalgina	Esteve	Spain	—
Butaluy	Miluy	Spain	—
Butaphen	Mulda	Turkey	—
Butapirazol	Polfa	Poland	—
Butarex	Adams	Australia	—
Butartril	Chiesi	Italy	—
Butazina	Vis	Italy	—
Butazone	DDSA	U.K.	—
Butiwas Simple	Wassermann	Spain	—
Butoroid	Virax	Australia	—
Butrex	SCS Pharnalab	S. Africa	—
Carudol	Lab. Franc. Therap.	France	—
Chembuzone	Chemo-Drug	Canada	—
Demoplas	Adenylchemie	W. Germany	—
Digibutina	Bicsa	Spain	—
Diossidone	Eliovit	Italy	—
Ecobutazone	I.C.N.	Canada	—
Elmedal	Thiemann	W. Germany	—
Equi Bute	Fort Dodge Labs	U.S.	—
Eributazone	Eri	Canada	—
Fenibutasan	Santos	Spain	—
Fenibutol	Atral	Portugal	—
Flexazone	Berk	U.K.	—
IA-But	Inter-Alia	U.K.	—
Intalbut	Inter-Alia	U.K.	—
Kadol	Midi	Italy	—
Merizone	Meriot	Canada	—
Neo-Zoline	Neo	Canada	—
Neuplus	Toyo	Japan	—
Novobutazone	Novopharm	Canada	—
Novophenyl	Novopharm	Canada	—
Panazone	Propan-Lipworth	S. Africa	—
Phenbutazol	Smallwood	Canada	—
Phenyl Betazone	Barlow Cote	Canada	—
Phenylone	Medic	Canada	—
Pilazon	Kobayashi	Japan	—
Pirarreamol	Hermes	Spain	—
Praecirheumin	Pfleger	W. Germany	—
Rectofasa	Lifasa	Spain	—
Reumasyi	Leiras	Finland	—
Reumazin	Mohan	Japan	—
Reumuzol	Farmos	Finland	—
Reupolar	Farmos	Finland	—
Rheumaphen	Reiss	W. Germany	—
Schemergen	Azusa	Japan	—
Sedazole	Toho	Japan	—
Servizolidin	Servipharm	Switz.	—
Shigrodin	Ikapharm	Israel	—
Spondryl	Dorsch	W. Germany	—
Tetnor	Drugs, Ltd.	U.K.	—
Tevcodyne	Tevcon	U.S.	—
Therazone	Western Serum	U.S.	—
Ticinil	De Angeli	Italy	—
Todalgil	Lopez-Brea	Spain	—
Tokugen	Sawai	Japan	—
Uzone	Kempthorne Prosser	New Zealand	—
Wescozone	Saunders	Canada	—
Zolidinium	Kwizda	Austria	—

Raw MaterialsHydrazobenzene
SodiumDiethyl-n-butyl malonate
Ethanol**Manufacturing Process**

7.6 parts of sodium are dissolved in 190 parts by volume of absolute alcohol; 65 parts of diethyl-n-butyl malonate and 55 parts of hydrazobenzene are added. The alcohol is slowly distilled off and the reaction mixture heated for 12 hours at a bath temperature of 150°C and finally in vacuo, until no more alcohol comes off.

The product is dissolved in water, clarified with a little animal charcoal and 15% hydrochloric acid is slowly added until an acid reaction to Congo red paper is produced. 1,2-Diphenyl-3,5-dioxo-4-n-butyl-pyrazolidine separates as an oil, which rapidly become crystalline. It crystallizes from alcohol as colorless needles with a MP of 105°C.

References

Merck Index 7157

Kleeman & Engel p. 720

PDR pp. 830, 891, 1606, 1999

OCDS Vol. 1 p. 236 (1977) & 2, 388, 474 (1980)

I.N. p. 763

REM p. 1120

Stenzl, H.; U.S. Patent 2,562,830; July 31, 1951; assigned to J.R. Geigy AG, Switzerland

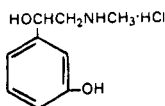
PHENYLEPHRINE HYDROCHLORIDE**Therapeutic Function:** Adrenergic**Chemical Name:** (R)-3-Hydroxy- α -[(methylamino)methyl] benzenemethanol hydrochloride**Common Name:** m-Methylaminoethanolphenol hydrochloride; metaoxedrin**Structural Formula:****Chemical Abstracts Registry No.:** 61-76-7

Trade Name	Manufacturer	Country	Year Introduced
Neosynephrine	Badrial	France	1953
Mydrin	Alcon	U.S.	1979
Nostril	Boehr. Ingel	U.S.	1982
Adrianol	Anasco	W. Germany	—
Atrohist	Adams	U.S.	—
Bromphen	Schein	U.S.	—
Codimal	Central	U.S.	—
Comhist	Norwich-Eaton	U.S.	—
Congespirin	Bristol-Myers	U.S.	—
Coryban	Pfipharmecs	U.S.	—
Dallergy	Laser	U.S.	—

Trade Name	Manufacturer	Country	Year Introduced
Deconsal	Adams	U.S.	—
Decontabs	Zenith	U.S.	—
Degest	Barnes-Hind	U.S.	—
Derizene	Hollister-Stier	U.S.	—
Donatussin	Laser	U.S.	—
Dristan	Whitehall	U.S.	—
Dura-Vent	Dura	U.S.	—
E.N.T.	Springbok	U.S.	—
Entex	Norwich Eaton	U.S.	—
Extendryl	Fleming	U.S.	—
Fenilfar	Farmila	Italy	—
Histalet	Reid-Rowell	U.S.	—
Histamic	Metro Med	U.S.	—
Histaspan	U.S.V. Pharm	U.S.	—
Histor	Hauck	U.S.	—
Hycomine	Du Pont	U.S.	—
Isonefrine	Tubi Lux Farma	Italy	—
Isophrine	Broemmel	U.S.	—
Isotropina	Tubi Lux Farma	Italy	—
Korigesic	Trimen	U.S.	—
Matafa-Lind	Anasco	W. Germany	—
Naldecon	Bristol	U.S.	—
Nasophen	Premo	U.S.	—
Neosinefrina	Reunidos	Spain	—
Newphrine	Vitarine	U.S.	—
Nostril	Boehr. Ingel	U.S.	—
Pediacof	Winthrop-Breon	U.S.	—
Phenergan	Wyeth	U.S.	—
Protid	La Salle	U.S.	—
PV-Tussin	Reid-Rowell	U.S.	—
Queidrine	Abbott	U.S.	—
Rinisol	Farmos	Finland	—
Ru-Tuss	Boots	U.S.	—
Singlet	Lakeside	U.S.	—
S-T Forte	Scot-Tussin	U.S.	—
Synasal	Texas Pharmaceutical	U.S.	—
Tear-Efrin	Tilden Yates	U.S.	—
Tussar	U.S.V. Pharm.	U.S.	—
Tussirex	Scot-Tussin	U.S.	—
Tympagesic	Adria	U.S.	—
Visopt	Sigma	Australia	—
Zeph	Scott & Turner	Australia	—

Raw Materials

m-Hydroxymethylaminoacetophenone
 Hydrogen
 Hydrogen chloride

Manufacturing Process

4.5 g of the hydrochloride of m-hydroxymethylaminoacetophenone are dissolved in a small amount of water; to the solution a solution of colloidal palladium obtained from palladium-chloride is added, and the mixture is treated with hydrogen.

After diluting the reaction liquid with acetone it is filtered, and the residue obtained after the evaporation of the filtrate in vacuo, and complete drying over pentoxide of phosphorus is then dissolved in absolute alcohol, and to this is added about the same volume of dry ether,

until turbidity just commences to occur. After a short time the hydrochloride of the m-hydroxyphenylethanol-methylamine of the formula

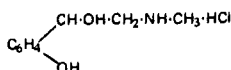

will separate out as a colorless mass of crystals at a melting point of 142°C to 143°C.

References

Merck Index 7167

PDR pp. 555, 562, 570, 677, 688, 701, 727, 784, 855, 865, 880, 928, 991, 1246, 1272, 1276, 1404, 1447, 1606, 1662, 1735, 1807, 1813, 1824, 1899, 1923, 1973, 1999

OCDs Vol. 1 p. 63 (1977); 2, 265 (1980) & 3, 20 (1984)

I.N. p. 764

REM p. 889

Legerlotz, H.; U.S. Patent 1,932,347; October 24, 1933; assigned to Frederick Stearns & Co.

PHENYLPROPANOLAMINE HYDROCHLORIDE

Therapeutic Function: Nasal decongestant; anorexic

Chemical Name: α -(1-aminoethyl)benzenemethanol hydrochloride

Common Name: dl-norephedrine hydrochloride; 2-amino-1-phenyl-1-propanol hydrochloride

Structural Formula:

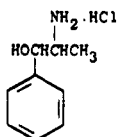

Chemical Abstracts Registry No.: 154-41-6; 492-41-1 (Base)

Trade Name	Manufacturer	Country	Year Introduced
Propadrine	MSD	U.S.	1941
Dexatrim	Thompson	U.S.	1980
Dietac	Menley James	U.S.	1980
Obestat	Lemmon	U.S.	1980
Permatrim	Lee	U.S.	1980
Nobese	O'Neal, Jones	U.S.	1981
Dexatrim Extra	Thompson	U.S.	1981
Propagest	Carnrick	U.S.	1982
Acutrim	Ciba Geigy	U.S.	1983
Help	Verex	U.S.	1983
Appedrine	Thompson	U.S.	—
Bromphen	Schein	U.S.	—
Codimal	Central	U.S.	—
Comtrex	Bristol-Myers	U.S.	—
Congespirin	Bristol-Myers	U.S.	—
Control	Thompson	U.S.	—
Corvban-D	Pfipharmecs	U.S.	—
Co-Tylenol	McNeil	U.S.	—

Trade Name	Manufacturer	Country	Year Introduced
Cremacoat	Vicks	U.S.	—
Decontabs	Zenith	U.S.	—
Dietrim	Legere	U.S.	—
Dimetane-D.C.	Robins	U.S.	—
Dura Vent	Dura	U.S.	—
E.N.T.	Springbok	U.S.	—
Entex	Norwich Eaton	U.S.	—
Fiogesic	Sandoz	U.S.	—
Head & Chest	Procter & Gamble	U.S.	—
Histaminic	Metro Med	U.S.	—
Hycamine	Du Pont	U.S.	—
Korigesic	Trimen	U.S.	—
Kronohist	Ferndale	U.S.	—
Monydrin	Draco	Sweden	—
Naldecon	Bristol	U.S.	—
Nolamine	Carrnrick	U.S.	—
Ornade	SKF	U.S.	—
Poly-Histine	Bock	U.S.	—
Prolamine	Thompson	U.S.	—
Rhindecon	McGregor	U.S.	—
Rhinolar	McGregor	U.S.	—
Ru-Tuss	Boots	U.S.	—
Sinubid	Parke Davis	U.S.	—
Sinulin	Carrnrick	U.S.	—
Tinaroc	Remeda	Finland	—
Triaminic	Dorsey	U.S.	—
Tuss-Ornade	SKF	U.S.	—

Raw Materials

Benzaldehyde	Sodium bisulfite
Nitroethane	Hydrogen
Hydrogen chloride	

Manufacturing Process

In one route as described in U.S. Patent 2,151,517, 10.7 kg of technical benzaldehyde is vigorously agitated with a solution of 11.0 kg of sodium bisulfite in 50.0 liters of water until the formation of the addition-product is complete. Simultaneously, 8.25 kg of nitroethane is dissolved in a solution of 4.5 kg of caustic soda in 20.0 liters of water and the resultant warm solution is added with vigorous stirring to the magma of benzaldehyde sodium bisulfite. The mixture is agitated for 30 minutes and then allowed to stand overnight.

The aqueous portion of the mixture is now siphoned off from the supernatant layer of oily phenylnitropropanol and replaced with a fresh solution of 11.0 kg of sodium bisulfite in 50.0 liters of water. The mixture of phenylnitropropanol and bisulfite solution is now vigorously agitated for 15 minutes in order to remove and recover small amounts of unreacted benzaldehyde, and is then again allowed to stratify. This time, the phenylnitropropanol is siphoned off and filtered to remove a small amount of resinous material. The aqueous solution of sodium bisulfite remaining behind is reacted with benzaldehyde, as described above, thus making the process continuous.

The 1-phenyl-2-nitropropanol thus obtained is a colorless oil, specific gravity 1.14 at 20°C, odorless when pure, volatile with steam and boiling at 150° to 165°C under a pressure of 5 mm of mercury. It is soluble in alcohol, ether, acetone, chloroform, carbon tetrachloride, benzene and glacial acetic acid. The yield of 1-phenyl-2-nitropropanol obtained by this procedure is 17.1 to 17.7 kg.

It is hydrogenated and converted to the hydrochloride in subsequent steps. The hydrogen chloride has a melting point of 192°-194°C.

In an alternative route described in U.S. Patent 3,028,429 propiophenone may be reacted with an alkyl nitrite to give isonitrosopropiophenone which is then hydrogenated and finally converted to the hydrochloride.

References

Merck Index 7189

Kleeman & Engel p. 721

PDR pp. 674, 688, 702, 727, 781, 784, 850, 854, 865, 875, 1033, 1084, 1246, 1277, 1388, 1404, 1431, 1454, 1583, 1606, 1719, 1730, 1735, 1805, 1807, 1869, 1999

I.N. p. 766

REM p. 889

Kamlet, J.; U.S. Patent 2,151,517 March 21, 1939

Wilbert, G. and Sosis, P.; U.S. Patent 3,028,429; April 3, 1962; assigned to Nepera Chemical Co., Inc.

PHENYLTOLOXAMINE

Therapeutic Function: Antihistaminic

Chemical Name: N,N-Dimethyl-2-[2-(phenylmethyl)phenoxy] ethanamine

Common Name: Bistrimin

Structural Formula:

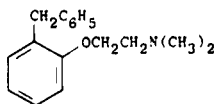

Chemical Abstracts Registry No.: 92-12-6; 6152-43-8 (Hydrochloride)

Trade Name	Manufacturer	Country	Year Introduced
Bristalin	Bristol	U.S.	1952
Bristamine	Banyu	Japan	—
Codipront	Mack	W. Germany	—
Ephepect	Bolder	W. Germany	—
Floxamine	Durst	U.S.	—
Fluidol	Metadier-Tours	France	—
Histionex	Strasenburgh	U.S.	—
Netux	Roussel	France	—
Pholtex	Riker	U.K.	—
Quadrahist	Schein	U.S.	—
Rinurel	Warner	U.K.	—
Tussionex	Pennwalt	U.S.	—

Raw Materials

o-Benzylphenol	Sodium
Methanol	Dimethylaminoethyl chloride

Manufacturing Process

Sodium methylate is made by dropping 11.7 g of sodium strips into 199 ml of absolute methanol in a 1-liter three-necked flask. 93.9 g of o-benzylphenol are dissolved in 200 ml of dry toluene and added to the sodium methylate solution. The solution is distilled until the boiling point of toluene is reached. At the end of the distillation, enough toluene is added to restore the original volume of solvent.

109.5 g of dimethylaminoethyl chloride hydrochloride and 200 ml of toluene are placed in a 1-liter Erlenmeyer flask, cooled in an ice bath, and decomposed with 167.5 g of 20% sodium hydroxide solution. The toluene and water layers are separated, and the water layer is extracted again with 50 ml of toluene. The toluene layers are combined, washed with saturated salt solution, and dried over anhydrous potassium carbonate.

The dried dimethylaminoethyl chloride solution is poured into the toluene solution of the sodium salt of o-benzylphenol, heated to reflux, and refluxed 16 hours. After refluxing, enough water is added to the mixture to dissolve the precipitated solid. The layers are separated, and the toluene layer is further washed with water until the water extract is just slightly alkaline. The toluene solution is then made acid with 6N hydrochloric acid and extracted with water until no cloudiness is produced when the extract is made alkaline. The acidic aqueous extract is washed with ether, then made alkaline with 20% sodium hydroxide solution, and extracted into ether. The ether solution is washed several times with water, then with saturated salt solution, and is dried over anhydrous potassium carbonate. The dried solution is filtered and distilled. The product distills at 143.5°C/1 mm; 69.7 g of pale yellow oil are recovered.

57.1 g of the free base are dissolved in ether and precipitated with dry HCl. 66.0 g of crude hydrochloride are recovered. The hydrochloride is dissolved in 130 ml of reagent acetone by boiling, filtered hot, and allowed to cool. The crystalline material obtained on cooling is filtered, washed with a little acetone, washed with ether, and dried in vacuo. 44.8 g, MP 119.5°C to 121°C, are recovered from the first crop of crystals. Ethyl acetate may also be used as the solvent for recrystallization.

References

Merck Index 7197

Kleeman & Engel p. 721

PDR p. 1606

OCDS Vol. 1 p. 115 (1977)

I.N. p. 766

Binkley, S.B. and Cheney, L.C.; U.S. Patent 2,703,324; March 1, 1955; assigned to Bristol Laboratories, Inc.

PHENYRAMIDOL

Therapeutic Function: Analgesic, skeletal muscle relaxant

Chemical Name: α -[(2-Pyridinylamino)methyl] benzenemethanol

Common Name: Fenyramidol

Structural Formula:

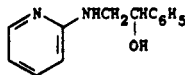

Chemical Abstracts Registry No.: 553-69-5; 326-43-2 (Hydrochloride)

Trade Name	Manufacturer	Country	Year Introduced
Analexin	Mallinckrodt	U.S.	1960
Cabral	Kali-Chemie	W. Germany	1962
Fenprin	RBS	Italy	1962
Anabloc	Irbi	Italy	—
Aramidol	A.B.C.	Italy	—
Bonapar	Minerva-Chemie	Neth.	—
Evasprine	Millot	France	—
Firmalgil	Firma	Italy	—
Miodar	I.S.M.	Italy	—
Pheniramidol	Pulitzer	Italy	—
Vilexin	Vitrum	Sweden	—

Raw Materials

2-Aminopyridine
Lithium amide
Styrene oxide

Manufacturing Process

A mixture containing 18.8 g (0.20 mol) of 2-aminopyridine, 0.55 g of lithium amide and 75 cc of anhydrous toluene was refluxed for 1.5 hours. Styrene oxide (12.0 g = 0.10 mol) was then added to the reaction mixture with stirring over a period of ten minutes. The reaction mixture was stirred and refluxed for an additional 3.5 hours. A crystalline precipitate was formed during the reaction which was removed by filtration, MP 170°C to 171°C, 1.5 g. The filtrate was concentrated to dryness and a dark residue remained which was crystallized from anhydrous ether; yield 6.0 g. Upon recrystallization of the crude solid from 30 cc of isopropyl alcohol, 2.0 g of a light yellow solid was isolated; MP 170°C to 171°C.

References

Merck Index 7203

Kleeman & Engel p. 399

OCDS Vol. 1 p. 165 (1977)

I.N. p. 422

Biel, J.H.; U.S. Patent 3,040,050; June 19, 1962; assigned to Lakeside Laboratories, Inc.

PHENYTOIN

Therapeutic Function: Antiepileptic

Chemical Name: 5,5-diphenyl-2,4-imidazolidinedione

Common Name: Diphenylhydantoin

Structural Formula:

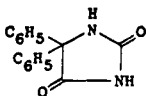

Chemical Abstracts Registry No.: 57-41-0

Trade Name	Manufacturer	Country	Year Introduced
Dilantin	Parke Davis	U.S.	1938
Ditan	Mallard	U.S.	1980
Aleviatin	Dainippon	Japan	—
Citrullamon	Sudmedica	W. Germany	—
Didan	Canfield	U.S.	—
Difhydan	Leo	Sweden	—
Dihydan	Carrion	France	—
Dihydantoin	Orion	Finland	—
Dintoina	Recordati	Italy	—
Diphentyn	I.C.N.	Canada	—
Enkefal	Leiras	Turkey	—
Epanutin	Parke Davis	W. Germany	—
Epinat	Nyegaard	Norway	—
Fenantoin	A.C.O.	Sweden	—
Hydantin	Medica	Finland	—
Hydantol	Fujinaga	Japan	—
Lehydan	Leo	Sweden	—
Novophenytion	Novopharm	Canada	—
Phenhydan	Desitin	W. Germany	—
Pyoredol	Roussel	France	—
Solantyl	Roussel	France	—
Tacosal	Helvepharm	Switz.	—
Zentropil	Nordmark	W. Germany	—

Raw Materials

Benzophenone
 Potassium cyanide
 Ammonium carbonate

Manufacturing Process

10 g of benzophenone (1 mol), 4 g of potassium cyanide (1.22 mols) and 16 g of ammonium carbonate (3.3 mols) are dissolved in 100 cc of 60% (by volume) ethyl alcohol and the mixture warmed under a reflux condenser without stirring at 58° to 62°C. After warming the mixture for 10 hours a partial vacuum is applied and the temperature is raised enough to permit concentration of the reaction mixture to two-thirds of its initial volume.

A slight excess of mineral acid, such as sulfuric or hydrochloric acid is added to acidify the mixture which is then chilled and the solid which separates is filtered off. It is then treated with an aqueous solution of dilute sodium hydroxide to dissolve the hydantoin from the solid unreacted benzophenone. After filtration, the alkaline extract is then acidified to cause the separation of solid pure diphenylhydantoin which is filtered off and dried. It melts at 293° to 296°C.

A net yield of about 95% is obtained by the procedure described above. If the time of warming the reaction mixture is increased three- or four-fold, practically 100% net yields are obtained. The same high net yields are also obtained by heating for even longer periods of time. For example, by heating for 90 hours, a 100% net yield, or 67% gross yield, is obtained.

References

Merck Index 7204
 Kleeman & Engel p. 722
 PDR pp. 1334, 1337
 DOT 9 (6) 245 (1973)
 I.N. p. 767

REM p. 1081

Henze, H.R.; U.S. Patent 2,409,754; October 22, 1946; assigned to Parke, Davis & Company

PHETHENYLATE SODIUM

Therapeutic Function: Anticonvulsant

Chemical Name: 5-Phenyl-5-(2-thienyl)-2,4-imidazolidinedione monosodium salt

Common Name: —

Structural Formula:

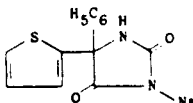

Chemical Abstracts Registry No.: 510-34-9

Trade Name	Manufacturer	Country	Year Introduced
Thiantoin	Lilly	U.S.	1950

Raw Materials

Phenyl-(2-thienyl)ketone
Potassium cyanide
Ammonium carbonate

Manufacturing Process

The 5-phenyl-5-(2-thienyl)hydantoin is prepared by heating a mixture of 5.64 g (0.03 mol) of phenyl-(2-thienyl)ketone, 3.25 g (0.03 mol) of potassium cyanide and 10.2 g (0.09 mol) of ammonium carbonate in 75 cc of 50% ethanol for 28 hours at a temperature of about 110°C. An additional 3.25 g of potassium cyanide and 3 g of ammonium carbonate are added and the mixture heated for 24 hours at about 110°C.

The reaction mixture is removed and about half of the liquid evaporated, an oil separating during the process. The mixture is acidified with concentrated hydrochloric acid and extracted with two 100 cc portions of ether. The extracts, which contain the 5-phenyl-5-(2-thienyl)hydantoin, are combined and the combined ether extracts are shaken with two 25 cc portions of 5% potassium hydroxide solution. The alkaline solution, which dissolves the 5-phenyl-5-(2-thienyl)hydantoin to form the potassium salt thereof, is acidified with hydrochloric acid and heated to expel ether.

By the process of purification, 4.3 g of 5-phenyl-5-(2-thienyl)hydantoin is obtained, and from the ether layer, 2.2 g of unreacted ketone. The yield of the 5-phenyl-5-(2-thienyl)hydantoin is about 56%. The melting point of the purified 5-phenyl-5-(2-thienyl)hydantoin is about 256°C to 257°C.

References

Merck Index 7206

Spurlock, J.J.; U.S. Patent 2,366,221; January 2, 1945

PHTHALYLSULFATHIAZOLE

Therapeutic Function: Antibacterial (intestinal)

Chemical Name: 2-[[[4-[(2-thiazolylamino)sulfonyl] phenyl] amino] carbonyl] benzoic acid

Common Name: —

Structural Formula:

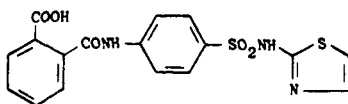

Chemical Abstracts Registry No.: 85-73-4

Trade Name	Manufacturer	Country	Year Introduced
Sulfathalidine	MSD	U.S.	1946
Talidine	Clin Midy	France	1948
AFI-Ftalyl	A.F.I.	Norway	—
Colicitina	Panthox & Burck	Italy	—
Enterosteril	Ripari-Gero	Italy	—
Ftalysept	Ferrosan	Denmark	—
Gelotamide	Choay	France	—
Lyantil	Syntex-Daltan	France	—
Novosulfina	Medosan	Italy	—
Phtalazol	Geistlich	Switz.	—
Phthalazol	Knoll	Australia	—
Sulfatallyl	Pharmacia	Sweden	—
Talisulfazol	Chemiek	E. Germany	—
Thalazole	May & Baker	U.K.	—

Raw Materials

Phthalic anhydride
Sulfathiazole

Manufacturing Process

5 g of phthalic anhydride was added to a boiling suspension of 10 g of sulfathiazole in 100 cc of alcohol. The mixture was then refluxed for 5 minutes after the addition was complete at which time all of the solids were in solution. The solution was then cooled and diluted with an equal volume of water. The white solid precipitate which formed was filtered and re-crystallized from dilute alcohol, yielding 2-N⁴-phthalylsulfanilamidothiazole, which decomposes above 260°C, according to U.S. Patent 2,324,015.

References

- Merck Index 7261
Kleeman & Engel p. 723
OCDS Vol. 1 p. 132 (1977)
I.N. p. 769
Moore, M.L.; U.S. Patent 2,324,013; July 13, 1943; assigned to Sharp & Dohme, Incorporated
Moore, M.L.; U.S. Patent 2,324,014; July 13, 1943; assigned to Sharp & Dohme, Incorporated
Moore, M.L.; U.S. Patent 2,324,015; July 13, 1943; assigned to Sharp & Dohme, Incorporated

PHYTATE SODIUM

Therapeutic Function: Hypocalcemic

Chemical Name: Myo-Inositol hexakis(dihydrogen phosphate)sodium salt

Common Name: —

Structural Formula:

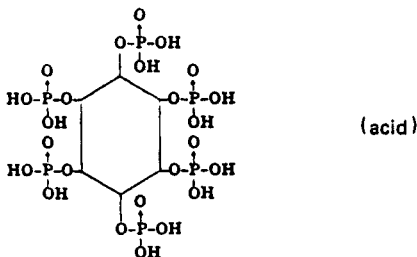

Chemical Abstracts Registry No.: 83-86-3 (Acid)

Trade Name	Manufacturer	Country	Year Introduced
Rencal	Squibb	U.S.	1962
Iliso	Made	Spain	—

Raw Materials

Corn steep water
Lime
Cation exchange resin

Manufacturing Process

Cereal grains are particularly rich in phytates; corn steep water produced in the wet milling of corn, is one of the best sources of such material. To recover the phytate from corn steep water it is customary to neutralize the same with an alkaline material, suitably lime, causing the phytate to precipitate as a crude salt which can be removed readily by filtration. This material contains substantial amounts of magnesium, even though lime may have been employed as precipitant, and traces of other metallic ions, as well as some proteinaceous materials and other contaminants from the steep water. It may be partially purified by dissolving in acid and reprecipitating but, nevertheless, such commercial phytates do not represent pure salts. They always contain some magnesium, appreciable amounts of iron and nitrogenous materials, and traces of heavy metals, such as copper.

Heretofore, no economical method for preparing pure phytic acid was known. The classical method was to dissolve calcium phytate in an acid such as hydrochloric acid, and then add a solution of a copper salt, such as copper sulfate to precipitate copper phytate. The latter was suspended in water and treated with hydrogen sulfide, which formed insoluble copper sulfide and released phytic acid to the solution. After removing the copper sulfide by filtration, the filtrate was concentrated to yield phytic acid as a syrup.

The phytic acid in the form of a calcium phytate press cake may however be contacted with a cation exchange resin to replace the calcium with sodium to yield phytate sodium.

References

Merck Index 7269
I.N. p. 25

Baldwin, A.R., Blatter, L.K. and Gallagher, D.M.; U.S. Patent 2,815,360; December 3, 1957; assigned to Corn Products Refining Co.

PHYTONADIONE

Therapeutic Function: Prothrombogenic vitamin

Chemical Name: 2-Methyl-3-(3,7,11,15-tetramethyl-2-hexadecenyl)-1,4-naphthalenedione

Common Name: Vitamin K, phytomeanadion, phylloquinone

Structural Formula:

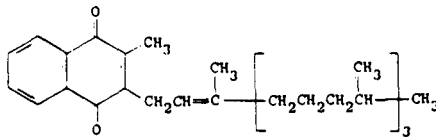

Chemical Abstracts Registry No.: 84-80-0

Trade Name	Manufacturer	Country	Year Introduced
Mephyton	MSD	U.S.	1941
Konakion	Roche	U.S.	1959
Aquamephyton	MSD	U.S.	1960
Mono-Kay	Abbott	U.S.	1961
Eleven-K	Nippon Shinyaku	Japan	—
Hymeron	Yamanouchi	Japan	—
Kanavit	Spofo	Czechoslovakia	—
Kativ-N	Takeda	Japan	—
Kayeine	Kanto	Japan	—
Kaywan	Eisai	Japan	—
K-Eine	Hokuriku	Japan	—
Keipole	Kyowa	Japan	—
Kennegin	Kowa	Japan	—
Kephton	Toyo Jozo	Japan	—
Kinadione	Chugai	Japan	—
Kisikonon	Kyorin	Japan	—
K-Top Wan	Sawai	Japan	—
Monodion	Maruko	Japan	—
Nichivita-K	Nichiiko	Japan	—
One-Kay	Mohan	Japan	—
Synthex P	Tanabe	Japan	—
Vita-K	Kobayashi	Japan	—
Vitamine K1	Delagrang	France	—

Raw Materials

2-Methyl-1,4-naphthohydroquinone
Phytol
Hydrogen

Manufacturing Process

11 parts by weight of 2-methyl-1,4-naphthohydroquinone, 30 parts by volume of water-free

dioxane and 1.5 parts by volume of boron trifluoride etherate are heated to 50°C. While agitating and introducing nitrogen, 10 parts by weight of phytol dissolved in 10 parts by volume of dioxane are added in the course of 15 minutes. Thereupon, the dark colored reaction mixture is stirred for 20 additional minutes at 50°C, cooled down and 60 parts by volume of ether are added. The reaction mixture is washed first with water, then with a mixture of 3 parts of N-sodium hydroxide and 2 parts of a 2.5% solution of sodium hydrosulfite and again with water. The aqueous extracts are washed with ether. The ether solutions are collected, dried over sodium sulfate and concentrated, toward the end under reduced pressure.

The waxlike condensation product so obtained is mixed with 60 parts by volume of petroleum ether (boiling limits 30°C to 40°C) and agitated with hydrogen in the presence of a little active palladium lead catalyst (Pd-CaCO₃ catalyst, the activity of which is reduced by the addition of lead and quinoline). During the operation, the condensation product separates in the form of a voluminous white precipitate. The latter is separated by filtration in the absence of air while adding an inert coarse-grained adsorption agent (for example, aluminum silicate salt for filter purposes), and washed with cooled petroleum ether. Thereupon, the 2-methyl-3-phytyl-1,4-naphthohydroquinone is extracted from the filter cake by means of ether, the ethereal solution is concentrated to 100 parts by volume and the reaction product is oxidized by stirring the solution with 6.6 parts by weight of silver oxide during 30 minutes. The solution is filtered through sodium sulfate, the latter is rinsed with ether and the solvent is evaporated. There are obtained 5.7 parts by weight of 2-methyl-3-phytyl-1,4-naphthoquinone (vitamin K₁) in the form of a golden yellow oil.

References

Merck Index 9834

Kleeman & Engel p. 724

PDR pp. 1140, 1488

I.N. p. 770

REM p. 1011

Isler, O. and Doebel, K.; U.S. Patent 2,683,176; July 6, 1954; assigned to Hoffmann-La Roche, Inc.

PICOPERINE

Therapeutic Function: Antitussive

Chemical Name: N-(2-Piperidinoethyl)-N-(2-pyridylmethyl)aniline

Common Name: Picoperamide

Structural Formula:

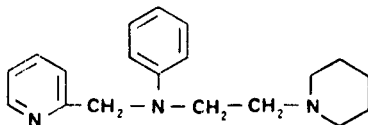

Chemical Abstracts Registry No.: 21755-66-8

Trade Name	Manufacturer	Country	Year Introduced
Coben	Takeda	Japan	1971

Raw Materials

N-(2-Pyridylmethyl)aniline
Sodium amide
2-Piperidinoethyl chloride

Manufacturing Process

To a simultaneously stirred and refluxed suspension of 5.6 parts by weight of sodamide in 60 parts by volume of anhydrous toluene, there is added dropwise a solution of 18.4 parts by weight of N-(2-pyridylmethyl)aniline in 20 parts by volume of anhydrous toluene. After the addition is complete, the mixture is refluxed for two hours under constant stirring.

To the resulting mixture there is added dropwise a solution of 14.9 parts by weight of 2-piperidinoethyl chloride in 20 parts by volume of anhydrous toluene and the whole mixture is stirred and refluxed for another two hours. After cooling, water is added carefully to decompose the unreacted sodamide, the separated toluene layer is dried over anhydrous sodium sulfate and the solvent removed under reduced pressure.

The residual oil is subjected to distillation under reduced pressure, the fraction boiling in the range of 185°C to 198°C/4 mm Hg being collected. Purification of the fraction by redistillation under reduced pressure gives 22.5 parts by weight of N-(2-piperidinoethyl)-N-(2-pyridylmethyl)-aniline which boils at 195°C to 196°C/4 mm Hg. Yield 76.3%.

References

Merck Index 7285
DOT 8 (5) 185 (1972)
I.N. p. 771

Mitano, S. and Kase, Y.; U.S. Patent 3,471,501; October 7, 1969; assigned to Takeda Chemical Industries, Ltd.

PICOSULFATE SODIUM

Therapeutic Function: Laxative

Chemical Name: 4,4'-(2-pyridinylmethylene)bisphenol bis(hydrogen sulfate) (ester) disodium salt

Common Name: Picosulfol

Structural Formula:

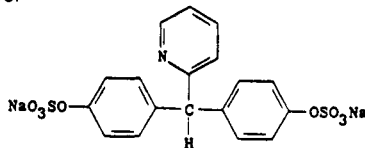

Chemical Abstracts Registry No.: 10040-45-6

Trade Name	Manufacturer	Country	Year Introduced
Guttalax	De Angelini	Italy	1967
Laxoberal	Thomae	W. Germany	1972
Laxoberal	W.B. Pharm.	U.K.	1975
Laxoberon	Teijin	Japan	1980

Trade Name	Manufacturer	Country	Year Introduced
Contumax	Casen	Spain	—
Evacuol	Almirall	Spain	—
Gocce Euchessina	Antonetto	Italy	—
Gocce Lassative Aicardi	Aicardi	Italy	—
Laxante Azoxico	Bescansa	Spain	—
Laxidogol	Dolorgiet	W. Germany	—
Picolax	Falqui	Italy	—
Skilax	Prodes	Spain	—
Trali	Sintyal	Argentina	—

Raw Materials

2-Pyridinaldehyde	Sodium hydroxide
2-Chlorophenol	Chlorosulfonic acid

Manufacturing Process

Preparation of 3,3'-Dichloro-4,4'-Dioxy-Diphenyl-(2-Pyridyl)-Methane: 75 g (0.7 mol) of 2-pyridinaldehyde are dropped during about 1 hour to a homogeneous mixture [obtained between 0° and 10°C from 107 ml of concentrated sulfuric acid and 292.9 g (2.28 mols) of 2-chlorophenol], maintaining the temperature between 0° and 5°C. The mixture is stirred for ½ hour at this temperature, which is then allowed to rise spontaneously, taking care not to exceed 30°C. After stirring for 1½ hours, the mixture is maintained overnight at room temperature, then it is dissolved, with external cooling, with a 10% sodium hydroxide solution, filtered with charcoal and neutralized with 5% hydrochloric acid. The precipitate obtained, consisting of crude product, filtered, washed with water, dried, triturated with ether and dried again, weighs 211 g.

The isomer 2,4'-dioxy-3,3'-dichloro-diphenyl-(2-pyridyl)-methane is removed by thoroughly washing with 430 ml of 95°C boiling alcohol, obtaining 167 g of isomer-free product (yield 69%). The 3,3'-dichloro-4,4'-dioxy-diphenyl-(2-pyridyl)-methane is a white solid, crystallizing from 95% alcohol; MP 212° to 215°C.

Preparation of 4,4'-Dioxy-Diphenyl-(2-Pyridyl)-Methane: 100 g of 3,3'-dichloro-4,4'-dioxy-diphenyl-(2-pyridyl)-methane, obtained as above described, are dissolved in 660 ml of 10% sodium hydroxide and 49 g of Raney-nickel alloy are added to the solution with vigorous stirring, at room temperature and during 4 hours. The mixture is stirred overnight at room temperature, then it is filtered and brought to pH 5 with 10% acetic acid. The precipitate obtained, filtered, washed and dried is then dissolved in 1,500 ml of 95°C boiling alcohol to eliminate the insoluble salts. The residue obtained after the evaporation of the alcoholic solution weighs 74 g (yield 92%). The yield in respect to 2-pyridinaldehyde is 63.5%. The compound is a white solid, crystallizing from 95% alcohol; MP 248° to 250.5°C, according to U.S. Patent 3,558,643.

Preparation of Disodium 4,4'-Disulfoxy-Diphenyl-(2-Pyridyl)-Methane: In ½ hour, 102 g chlorosulfonic acid are added to a solution of 100 g 4,4'-dihydroxydiphenyl-(2-pyridyl)-methane in 750 ml of anhydrous pyridine, the temperature being maintained at between 0° and 5°C. Towards the end of the addition of acid, a precipitate is formed which is slowly redissolved during subsequent agitation.

Upon completion of the addition, the mixture is agitated for 7 hours at ambient temperature. The solution is then poured into 3 liters of water/ice obtaining a clear solution of dark yellow color which is rendered alkaline upon phenolphthalein with 30% NaOH and extracted with ethyl ether to eliminate the majority of the pyridine. The mixture is filtered with active charcoal, the pH adjusted to 8 with hydrochloric acid 1:1 and extracted with chloroform to remove the 4,4'-dihydroxydiphenyl-(2-pyridyl)-methane which has not reacted.

The aqueous solution is then concentrated to dryness at an outside temperature of 40° to 45°C and at low pressure. The residue, obtained by drying in a vacuum at 40° to 45°C is triturated in a mortar with ethyl ether and, after filtration, is extracted with 3,400 ml boiling absolute ethanol. The ethanol extract is separated from the undissolved part by filtration, cooled and the product which crystallizes by cooling is filtered and dried at 40°C in a vacuum. In that manner the disodium (4,4'-disulfoxy-diphenyl)-(2-pyridyl)-methane bi-hydrate is obtained, which takes the form of a white solid, according to U.S. Patent 3,528,986.

References

Merck Index 7286

Kleeman & Engel p. 725

DOT 8 (8) 302 (1972)

I.N. p. 771

Pala, G.; U.S. Patent 3,528,986; September 15, 1970; assigned to Istituto de Angeli S.p.A., Italy

Pala, G.; U.S. Patent 3,558,643; January 26, 1971; assigned to Istituto de Angeli S.p.A., Italy

PIFARNINE

Therapeutic Function: Antiulcer

Chemical Name: 1-(1,3-Benzodioxol-5-ylmethyl)-4-(3,7,11-trimethyl-2,6,10-dodecatrieny)-piperazine

Common Name: —

Structural Formula:

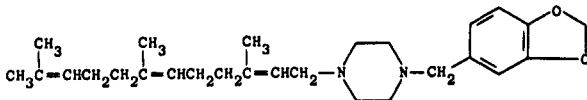

Chemical Abstracts Registry No.: 56208-01-6

Trade Name	Manufacturer	Country	Year Introduced
Pifazin	Pierrel	Italy	1983

Raw Materials

1-Bromo-3,7,11-trimethyl-2,6,10-dodecatriene
 Piperonylpiperazine
 Triethylamine

Manufacturing Process

A solution of 45 mmols of 1-bromo-3,7,11-trimethyl-2,6,10-dodecatriene (obtained from synthetic farnesol, commercially available and containing four isomers) in 10 ml of benzene was added dropwise at 0°C to a stirred solution of 45 mmols of piperonylpiperazine in 60 ml of benzene containing 5 g of triethylamine. The mixture was stirred for 2 hours and then the precipitated triethylammonium bromide was filtered off. The benzene solution was washed first with water and then with K₂CO₃ solution and finally dried (K₂CO₃). Removal of ben-

zene under reduced pressure gave a crude oily residue which was dissolved in acetone and treated at 5°C to 8°C with a slight excess of 37% HCl solution. The precipitated hydrochloride was filtered, washed with acetone and with absolute ethanol. The corresponding base was purified on a silica gel column and the purity of all fractions was checked by thin layer chromatography and gas liquid chromatography. Thin layer chromatography on silica gel gave three spots in the solvent system ethylacetate-petrol ether 1:1. Gas liquid chromatography showed three peaks indicating the presence of four possible isomers. The pure product was a colorless oil.

References

Merck Index 7299

DFU 2 (12) 829 (1977)

Kleeman & Engel p. 725

I.N. p. 772

Zumin, S.T., Riva, M. and Iafolla, G.; U.S. Patent 3,875,163; April 1, 1975; assigned to Pierrel S.p.A. (Italy)

PIMEFYLLINE NICOTINATE

Therapeutic Function: Coronary vasodilator

Chemical Name: 3,7-dihydro-1,3-dimethyl-7-[2-[(3-pyridinylmethyl)amino]ethyl]-1H-purine-2,6-dione nicotinate

Common Name: 7-(β-3'-picolylaminoethyl)theophylline nicotinate

Structural Formula:

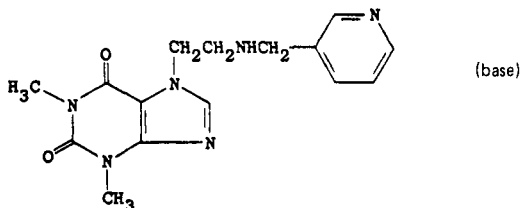

Chemical Abstracts Registry No.: 10058-07-8; 10001-43-1 (Base)

Trade Name	Manufacturer	Country	Year Introduced
Teonicon	Bracco	Italy	1975
Teonicon	Neopharmed	Japan	—

Raw Materials

7-(β-Bromoethyl)theophylline
3-Picolylamine
Nicotinic acid

Manufacturing Process

77 g 7-(β-bromoethyl)-theophylline (C.A. 50, 12071f) and 57.8 g 3-picolylamine in 750 ml toluene were refluxed 16 hours with vigorous agitation. The 3-picolylamine hydrobromide formed was filtered off, and the filtrate was evaporated in a vacuum to about one-third of its original volume. About 300 to 400 ml diisopropyl ether were added, and the solution was seeded with a few pure crystals of the desired product.

7-(β -3'-picolylaminoethyl)-theophylline crystallized over a period of a few hours. It was filtered off with suction, washed with a little diisopropyl ether, and dried. The yield of crude product was 69.3 g (82%), its MP 103° to 106°C. The MP was 111° to 112°C after recrystallization from isopropyl acetate. The compound was identified by microanalysis.

39.3 g 7-(β -3'-picolylaminoethyl)-theophylline were dissolved in 300 ml boiling isopropanol, and 15.4 g nicotinic acid were added to the solution in which the acid promptly dissolved. The nicotinate formed crystallized after a short time. It was filtered with suction and dried. The yield was 52.3 g (95.5%). The MP of 159° to 160°C was not significantly changed by recrystallization from ethanol.

References

Merck Index 7306

Kleeman & Engel p. 727

Suter, H. and Zutter, H.; U.S. Patent 3,350,400; October 31, 1967; assigned to Eprova Limited, Switzerland

PIMOZIDE

Therapeutic Function: Antipsychotic

Chemical Name: 1-[1-[4,4-Bis(4-Fluorophenyl)butyl]-4-piperidiny]-1,3-dihydro-2H-benzimidazol-2-one

Common Name: —

Structural Formula:

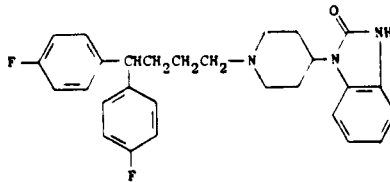

Chemical Abstracts Registry No.: 2062-78-4

Trade Name	Manufacturer	Country	Year Introduced
Orap	Janssen	W. Germany	1971
Opiran	Cassenne	France	1971
Orap	Janssen	U.K.	1971
Orap	Fujisawa	Japan	1974
Orap	Janssen	Italy	1977
Norofren	Dif-Dogu	Turkey	—
Oralep	Abic	Israel	—
Pimotid	Medica	Finland	—

Raw Materials

Cyclopropyl-di-(4-fluorophenyl)-carbinol

Thionyl chloride

Hydrogen

4-(2-Oxo-1-benzimidazoliny)-piperidine

Manufacturing Process

To a solution of 130 parts cyclopropyl-di-(4-fluorophenyl)-carbinol in 240 parts benzene are added dropwise 43 parts thionyl-chloride. The whole is refluxed until no more gas is evolved. The reaction mixture is then evaporated. The residue is distilled in vacuo, yielding 4-chloro-1,1-di-(4-fluorophenyl)-1-butene, boiling point 165°C to 167°C at 6 mm pressure; n_D^{20} : 1.5698; d_{20}^{20} : 1.2151.

A solution of 61 parts 4-chloro-1,1-di-(4-fluorophenyl)-1-butene in 400 parts 2-propanol is hydrogenated at normal pressure and at room temperature in the presence of 5.5 parts palladium-on-charcoal catalyst 10% (exothermic reaction: temperature rises to about 30°C). After the calculated amount of hydrogen is taken up, hydrogenation is stopped. The catalyst is filtered off and the filtrate is evaporated. The oily residue is distilled in vacuo, yielding 1-chloro-4,4-di-(4-fluorophenyl)-butane, boiling point 166°C to 168°C at 6 mm pressure; n_D^{20} : 1.5425; d_{20}^{20} : 1.2039.

To a mixture of 4.4 parts of 4-(2-oxo-1-benzimidazolyl)-piperidine, 3.3 parts sodium carbonate, a few crystals of potassium iodide in 200 parts 4-methyl-2-pentanone are added portionwise 6.2 parts 1-chloro-4,4-di-(4-fluorophenyl)-butane. After the addition is complete, the whole is stirred and refluxed for 65 hours. After cooling the reaction mixture, there are added 70 parts water. The organic layer is separated, dried over potassium carbonate, filtered and evaporated. The solid residue is triturated in diisopropyl-ether, filtered off again and recrystallized from a mixture of 120 parts acetone and 80 parts 4-methyl-2-pentanone, yielding the crude product. After recrystallization of this crop from 80 parts acetone, 1-[4,4-di-(4-fluorophenyl)-butyl]-4-(2-oxo-1-benzimidazolyl)-piperidine is obtained, melting point 217°C to 219°C.

References

Merck Index 7310

Kleeman & Engel p. 727

PDR p. 1091

OCDS Vol. 2 p. 390 (1980)

DOT 5 (1) 36 (1969); 7 (5) 176 (1971); and 9 (6) 235 (1973)

I.N. p. 774

REM p. 1092

Janssen, P.A.J.; U.S. Patent 3, 196,157; July 20, 1965; assigned to Research Laboratorium Dr. C. Janssen N.V. (Belgium)

PINAZEPAM

Therapeutic Function: Antidepressant

Chemical Name: 7-Chloro-1,3-dihydro-5-phenyl-1-(2-propynyl)-2H-1,4-benzodiazepin-2-one

Common Name: —

Structural Formula:

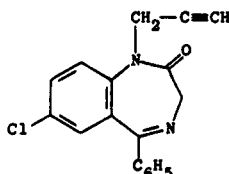

Chemical Abstracts Registry No.: 52463-83-9

Trade Name	Manufacturer	Country	Year Introduced
Domar	Zambeletti	Italy	1975
Duna	Zambeletti	Italy	—

Raw Materials

2-Amino-5-chlorobenzophenone	Propargyl bromide
Phthalimido acetyl chloride	Hydrazine hydrate

Manufacturing Process

46.3 g (0.2 mol) of 2-amino-5-chlorobenzophenone were dissolved in 100 ml (1.28 mols) of propargyl bromide and the mixture refluxed for 4 hours. Thereafter, the whole was evaporated to dryness and the residue recrystallized from methanol to give 32.4 g (60.2%) of the desired 2-propargylamino-5-chlorobenzophenone; melting point 92°C to 93°C.

2.7 g (0.01 mol) of the 2-propargylamino-5-chlorobenzophenone obtained as above and 2.23 g (0.01 mol) of phthalimido-acetyl-chloride were added to 30 ml of chloroform and the whole was refluxed overnight. Thereafter, the reaction mixture was evaporated to dryness and the residue recrystallized from methanol to give 2.66 g (58.3%) of the desired 2-(N-propargyl)-phthalimidoacetamide-5-chlorobenzophenone. Melting point: 176°C.

A suspension of 22.8 g (0.05 mol) of 2-(N-propargyl)-phthalimidoacetamido-5-chlorobenzophenone in 250 ml ethanol containing 7.5 g hydrazine hydrate (0.15 mol) was heated under reflux for 2 hours, at the end of which time the reaction mixture was set aside overnight at ambient (25°C) temperature. Thereafter, the crystalline phthalyl hydrazide which had precipitated out was removed by filtration and washed with 3 X 50 ml aliquots of chloroform. The filtrate and washings were diluted with water and exhaustively extracted with chloroform. The chloroform extract was then evaporated and the residue washed with 100 ml hexane to promote crystallization. The crude 7-chloro-1-propargyl-3H-1,4-benzodiazepine-2(1H)-one was recrystallized from a methanol-water mixture to give 10.5 g (71.4%) of the pure product. Melting point: 140°C to 142°C.

References

Merck Index 7316

Kleeman & Engel p. 728

DOT 12 (4) 147 (1976)

I.N. p. 774

Podesva, C. and Vagi, K.; U.S. Patent 3,842,094; October 15, 1974; assigned to Delmar Chemicals Ltd. (Canada)

PIPAMAZINE

Therapeutic Function: Antiemetic

Chemical Name: 1-[3-(2-Chloro-10H-phenothiazin-10-yl)propyl]-4-pyridinecarboxamide

Common Name: —

Structural Formula:

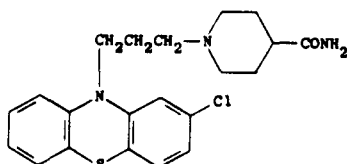

Chemical Abstracts Registry No.: 84-04-8

Trade Name	Manufacturer	Country	Year Introduced
Mornidine	Searle	U.S.	1959
Nausidol	Gremy-Longuet	France	—

Raw Materials

- 4-Piperidinecarboxamide
- 2-Chloro-10-(γ -chloropropyl)phenothiazine

Manufacturing Process

To a stirred and refluxing suspension of 4.95 parts of 4-piperidinecarboxamide, 1 part of sodium iodide and 8.4 parts of potassium carbonate in 40 parts of butanone there are added in the course of 30 minutes 9.3 parts of 2-chloro-10-(γ -chloropropyl)phenothiazine in 40 parts of butanone. Stirring and refluxing are continued for 12 hours after which the mixture is cooled and filtered. The filtrate is concentrated under vacuum to give a residue which is recrystallized from a mixture of 2-propanol and petroleum ether. The 1-[γ -(2'-chloro-10'-phenothiazine)propyl] piperidine-4-carboxamide thus obtained melts at approximately 139°C.

This base is dissolved in a small amount of 2-propanol and treated with a 25% solution of hydrogen chloride in 2-propanol. Upon treatment of this solution with anhydrous ether a hydrochloride precipitates as a white solid melting at about 196°C to 197°C with formation of bubbles.

References

Merck Index 7326

Kleeman & Engel p. 729

OCDs Vol. 1 p. 385 (1977)

I.N. p. 775

Cusic, J.W. and Sause, H.W.; U.S. Patent 2,957,870; October 25, 1960; assigned to G.D. Searle & Co.

PIPAMPERONE

Therapeutic Function: Antipsychotic

Chemical Name: 1'-[4-(4-Fluorophenyl)-4-oxobutyl]-[1,4'-bipiperidine]-4'-carboxamide

Common Name: Floropipamide

Structural Formula:

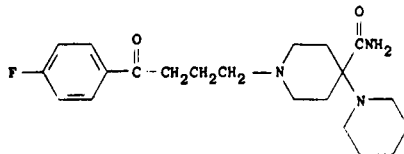
**Chemical Abstracts Registry No.:** 1893-33-0

Trade Name	Manufacturer	Country	Year Introduced
Dipiperon	Janssen	W. Germany	1961

Trade Name	Manufacturer	Country	Year Introduced
Dipiperon	Janssen-Le Brun	France	1968
Piperonil	Lusofarmaco	Italy	1970
Propitan	Eisai	Japan	—

Raw Materials

Piperidine hydrochloride	Potassium cyanide
1-Benzyl-4-piperidone	Sulfuric acid
γ -Chloro-4-fluorobutyrophenone	Hydrogen

Manufacturing Process

To a stirred solution of 130.4 parts of potassium cyanide and 243.2 parts of piperidine hydrochloride in a mixture of 800 parts of water and 320 parts of ethanol is added portionwise 378 parts of 1-benzyl-4-piperidone. After about one hour a solid starts to precipitate. Stirring is continued for 24 hours. The reaction mixture is filtered and the solid is recrystallized from 1,200 parts of diisopropyl ether. On cooling to room temperature a first crop of 1-benzyl-4-cyano-4-piperidinopiperidine melting at about 104°C to 106°C is obtained. By concentrating and further cooling of the mother liquor a second crop of the above compound is obtained.

A mixture of 14.1 parts of 1-benzyl-4-cyano-4-piperidinopiperidine and 40 parts of 90% sulfuric acid is heated on a steam bath for 10 minutes. Without further heating, the mixture is stirred until a temperature of about 20°C is obtained. The mixture is then poured into 150 parts of ice-water and the resultant solution is alkalinized with excess ammonium hydroxide solution. The aqueous solution is decanted from the precipitated oil. On treating this oil with 80 parts of acetone, crystallization sets in. After one hour the solid is filtered off and dried to yield 1-benzyl-4-piperidinopiperidine-4-carboxamide melting at about 137.5°C to 140°C.

A mixture of 215 parts of 1-benzyl-4-piperidinopiperidine-4-carboxamide, 1,200 parts of isopropyl alcohol, 1,000 parts of distilled water and 157 parts of hydrogen chloride is debenzylated under atmospheric pressure and at a temperature of about 40°C in the presence of 40 parts of a 10% palladium-on-charcoal catalyst. After the calculated amount of hydrogen is taken up, hydrogenation is stopped. The mixture is filtered and the filtrate is evaporated. The semisolid residue is treated with a mixture of 80 parts of acetone and 80 parts of benzene and evaporated again. The residue is triturated in 200 parts of methanol and filtered, yielding the dihydrochloride of 4-piperidinopiperidine-4-carboxamide melting at about 299°C to 300.8°C with decomposition. A sample of 20 parts of the dihydrochloride is dissolved in 30 parts of water. The aqueous solution is alkalinized with 15 parts of 44% sodium hydroxide and stirred for a short time. The solid obtained is filtered off yielding crude product. To separate the free base from organic and inorganic salts, it is extracted overnight in a Soxhlet apparatus with toluene. The toluene extract is evaporated and the solid residue is filtered off, yielding 4-piperidinopiperidine-4-carboxamide melting at about 118.5°C to 119.5°C.

To a mixture of 4.1 parts of 4-piperidinopiperidine-4-carboxamide, 6.4 parts of sodium carbonate, and a few crystals of potassium iodide in 100 parts of anhydrous toluene is added dropwise a solution of 5.6 parts of γ -chloro-4-fluorobutyrophenone and 40 parts of anhydrous toluene at a temperature of 30°C to 40°C. The mixture is stirred and refluxed for 48 hours. The reaction mixture is cooled and divided between 50 parts of water and 60 parts of chloroform. The combined organic layers—toluene and chloroform—are dried over potassium carbonate, filtered, and evaporated. The oily residue solidifies on treatment with 80 parts of ether. After cooling for 30 minutes at 0°C, there is obtained 1-[γ -(4-fluorobenzoyl)propyl]-4-piperidinopiperidine-4-carboxamide melting at about 124.5°C to 126°C.

References

- Merck Index 7327
 Kleeman & Engel p. 729
 OCDS Vol. 2 p. 388 (1980)

I.N. p. 775

Janssen, P.A.J.; U.S. Patent 3,041,344; June 26, 1962; assigned to Research Laboratorium Dr. C. Janssen N.V. (Belgium)

PIPAZETHATE

Therapeutic Function: Antitussive

Chemical Name: 10H-Pyrido[3,2-b][1,4]benzothiadiazine-10-carboxylic acid 2-(2-piperidinoethoxy)ethyl ester

Common Name: —

Structural Formula:



Chemical Abstracts Registry No.: 2167-85-3; 6056-11-7 (Hydrochloride)

Trade Name	Manufacturer	Country	Year Introduced
Theratuss	Squibb	U.S.	1962
Dipect	Draco	Sweden	—
Lenopect	Draco	Sweden	—
Selvigon	Homburg	W. Germany	—

Raw Materials

1-Azaphenothiazine carboxylic acid chloride
Piperidinoethoxy ethanol

Manufacturing Process

8.5 parts of 1-azaphenothiazine carboxylic acid chloride and 14 parts of piperidino-ethoxy-ethanol were introduced into 100 parts of chlorobenzene and the mixture boiled under reflux for 5 minutes. After cooling off the precipitated hydrochloride salt of piperidino-ethoxy-ethanol was filtered off on a suction filter. Water was added to the filtrate and the pH thereof adjusted to 5 to 6 with dilute HCl. The aqueous phase was then removed, a caustic soda solution added thereto and then extracted with ether. The ethyl extract was washed with water, then dried with potash and the ether distilled off. 9.4 parts of the piperidino-ethoxy-ethyl ester of 1-azaphenothiazine carboxylic acid were obtained. This product was dissolved in 20 parts of isopropanol and the solution neutralized with isopropanolic HCl. The monohydrochloride which precipitated out after recrystallization from isopropanol had a melting point of 160°C to 161°C.

References

Merck Index 7328

Kleeman & Engel p. 730

OCDs Vol. 1 p. 390 (1977)

I.N. p. 775

Schuler, W.A.; U.S. Patent 2,989,529; June 20, 1961; assigned to Degussa (Germany)

PIPEBUZONE

Therapeutic Function: Antiinflammatory

Chemical Name: 1,2-Diphenyl-3,5-dioxo-4-n-butyl-4-(N'-methylpiperazinomethyl)pyrazolidine

Common Name: —

Structural Formula:

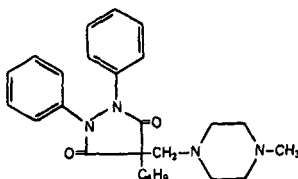

Chemical Abstracts Registry No.: 27315-91-9

Trade Name	Manufacturer	Country	Year Introduced
Elarzone	Dausse	France	1973

Raw Materials

Phenylbutazone
Formaldehyde
N-Methylpiperazine

Manufacturing Process

77 g (0.25 mol) of phenylbutazone, 30 ml of a 30% strength solution of formaldehyde and 50 ml of ethyl alcohol are introduced into a 500 ml flask, 25 g (0.25 mol) of N-methylpiperazine are slowly added to this mixture which is stirred mechanically. The mixture is then heated for one hour on a water bath, left to cool, and crystallization started by scratching.

After being left in the refrigerator overnight the mixture, which has set solid, is triturated with 50 ml of isopropyl alcohol and the solid product filtered off and dried in vacuo over phosphorus pentoxide. 63 g (60% yield) of 1,2-diphenyl-3,5-dioxo-4-n-butyl-4-(N'-methylpiperazinomethyl)pyrazolidine are obtained, melting at 129°C after recrystallization from 150 ml of isopropyl alcohol.

References

Merck Index 7329
Kleeman & Engel p. 730
DOT 9 (11) 476 (1973)
I.N. p. 775
Dausse, S.A.; British Patent 1,249,047; October 6, 1971

PIPEMIDIC ACID

Therapeutic Function: Antibacterial (urinary)

Chemical Name: 8-ethyl-5,8-dihydro-5-oxo-2-(1-piperazinyl)pyrido[2,3-d]pyrimidine-6-carboxylic acid

Common Name: Piperamic acid

Structural Formula:

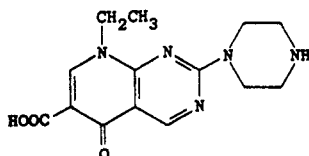

Chemical Abstracts Registry No.: 51940-44-4

Trade Name	Manufacturer	Country	Year Introduced
Pipram	Bellon	France	1975
Deblaston	Madaus	W. Germany	1975
Pipram	RBS Pharma	Italy	1978
Dolcol	Dainippon	Japan	1979
Pipram	Bellon	Italy	1979
Pipedac	Mediolanum	Italy	1980
Deblaston	Madaus	Switz.	1981
Filtrax	Biomedica Foscama	Italy	—
Gastrurol	Gibipharma	Italy	—
Memento	Volpino	Argentina	—
Nuril	Prodes	Spain	—
Pipedase	Scalari	Italy	—
Pipemid	Gentili	Italy	—
Pipurin	Brocchieri	Italy	—
Priper	Synero	Argentina	—
Septidron	Ethimed	S. Africa	—
Tractur	Baldacci	Italy	—
Uropimid	C.T.	Italy	—
Urotractin	Zambeletti	Italy	—
Uroval	Firma	Italy	—

Raw Materials

6-Amino-2-methylthiopyrimidine	Sodium hydroxide
Ethoxymethylene malonic acid diethyl ester	Diethyl sulfate
Piperazine hydrate	

Manufacturing Process

A mixture containing 1.33 g of 5,8-dihydro-8-ethyl-2-methylthio-5-oxopyridol[2,3-d]-pyrimidine-6-carboxylic acid, 1.94 g of piperazine hexahydrate and 20 ml of dimethyl sulfoxide was heated at 110°C for 1 hour with stirring. The separated solid was collected by filtration, washed with ethanol, and then dried at such a temperature that did not rise above 50°C to give 1.57 g of the trihydrate of the product as nearly colorless needles, MP 253° to 255°C.

The starting material may be produced by reacting 6-amino-2-methylthiopyrimidine with ethoxymethylene malonic acid diethyl ester. The intermediate thus produced is converted by boiling in diphenyl ether to 6-ethoxycarbonyl-2-methylthio-5-oxo-5,8-dihydropyrido-[2,3-d]pyrimidine. That is hydrolyzed by sodium hydroxide to cleave the ethoxy group and then ethylated with diethyl sulfate to give the starting material.

References

- Merck Index 7332
- Kleeman & Engel p. 731

DOT 11 (10, 408 (1975) & 12 (3) 99 (1976)

I.N. p. 36

Minami, S., Matsumoto, J.-I., Kawaguchi, K., Mishio, S., Shimizu, M., Takase, Y. and Nakamura, S.; U.S. Patent 3,887,557; June 3, 1975; assigned to Dainippon Pharmaceutical Co. Ltd., Japan

Minami, S., Matsumoto, J.-I., Kawaguchi, K., Mishio, S., Shimizu, M., Takase, Y. and Nakamura, S.; U.S. Patent 3,962,443; June 8, 1976; assigned to Dainippon Pharmaceutical Co. Ltd., Japan

PIPENZOLATE BROMIDE

Therapeutic Function: Antispasmodic

Chemical Name: 1-ethyl-3-[(hydroxydiphenylacetyl)oxy]-1-methylpiperidinium bromide

Common Name: N-ethyl-3-piperidyl benzilate methobromide

Structural Formula:

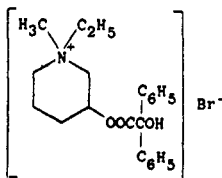

Chemical Abstracts Registry No.: 125-51-9

Trade Name	Manufacturer	Country	Year Introduced
Piptal	Merrell National	U.S.	1955
Piptal	Roger Bellon	France	1960
Piper	Panthox & Burck	Italy	—

Raw Materials

N-Ethyl-3-chloropiperidine
Benzilic acid
Methyl bromide

Manufacturing Process

N-ethyl-3-chloropiperidine was prepared according to the method of Fuson and Zirkle described in Volume 70, *J. Am. Chem. Soc.*, p 2760. 12.0 g (0.081 mol) of N-ethyl-3-chloropiperidine was mixed with 18.6 g (0.081 mol) of benzilic acid and 80 cc of anhydrous isopropyl alcohol as a solvent. The mixture was refluxed for 72 hours. The solution was then filtered and concentrated at 30 mm of mercury. The concentrate was dissolved in water, acidified with hydrochloric acid and extracted with ether to remove the unreacted benzilic acid.

The aqueous layer was neutralized with sodium bicarbonate and the product was extracted with ether. The ethereal solution of the product was dried with potassium carbonate, the ether was removed by distillation and the residue was distilled at 0.12 to 0.18 mm of mercury, the BP being 194° to 198°C. A yield of 16.5 g (60% of theoretical) of N-ethyl-3-piperidyl-benzilate was obtained.

34 g (0.1 mol) of the basic ester is dissolved in 75 cc of isopropyl alcohol and treated with 9.5 g (0.1 mol) of methyl bromide. The mixture is allowed to stand at room temperature until precipitation is complete. The product is removed by filtration and washed with isopropyl alcohol, yield 33 g, MP 175° to 177°C. On recrystallization from isopropyl alcohol, the MP was raised to 179° to 180°C dec.

References

Merck Index 7333

Kleeman & Engel p. 732

I.N. p 776

Biel, J.H.; U.S. Patent 2,918,406; December 22, 1959; assigned to Lakeside Laboratories, Inc.

PIPERACILLIN SODIUM

Therapeutic Function: Antibiotic

Chemical Name: Sodium salt of 6-[D(-)- α -(4-ethyl-2,3-dioxo-1-piperazinocarbonylamino)-phenylacetamido] penicillanic acid

Common Name: —

Structural Formula:

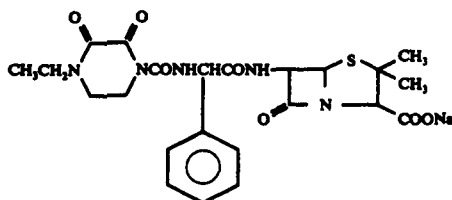

Chemical Abstracts Registry No.: 59703-84-3; 61477-96-1 (Base)

Trade Name	Manufacturer	Country	Year Introduced
Penticillin	Toyama	Japan	1980
Pipril	Lederle	W. Germany	1980
Pipril	Lederle	Switz.	1980
Piperallin	Toyama	France	1981
Pipril	Lederle	U.K.	1982
Avocin	Cyanamid	Italy	1982
Pipracil	Lederle	U.S.	1982
Pentocillin	Sankyo	Japan	—

Raw Materials

N-Ethylethylenediamine

Diethyl oxalate

Phosgene

6-[D(-)- α -aminophenylacetamido] penicillanic acid

Trimethylsilyl chloride

Sodium 2-ethyl hexanoate

Manufacturing Process

To a suspension of 0.9 g of 6-[D(-)- α -aminophenylacetamido] penicillanic acid in 30 ml of anhydrous ethyl acetate were added at 5°C to 10°C 0.55 g of triethylamine and 0.6 g of trimethylsilyl chloride. The resulting mixture was reacted at 15°C to 20°C for 3 hours to form trimethylsilylated 6-[D(-)- α -aminophenylacetamido] penicillanic acid.

To this acid was then added 1 g of 4-ethyl-2,3-dioxo-1-piperazinocarbonyl chloride (from the reaction of N-ethylethylenediamine and diethyl oxalate to give 2,3-dioxo-4-ethyl-piperazine which is then reacted with phosgene) and the resulting mixture was reacted at 15°C to 20°C for 2 hours. After the reaction, a deposited triethylamine hydrochloride was separated by filtration, and the filtrate was incorporated with 0.4 g of n-butanol to deposit crystals. The deposited crystals were collected by filtration to obtain 1.25 g of white crystals of 6-[D(-)- α -(4-ethyl-2,3-dioxo-1-piperazinocarbonylamino)phenylacetamido] penicillanic acid. Into a solution of these crystals in 30 ml of tetrahydrofuran was dropped a solution of 0.38 g of a sodium salt of 2-ethyl-hexanoic acid in 10 ml of tetrahydrofuran, upon which white crystals were deposited. The deposited crystals were collected by filtration, sufficiently washed with tetrahydrofuran and then dried to obtain 1.25 g of sodium salt of 6-[D(-)- α -(4-ethyl-2,3-dioxo-1-piperazinocarbonylamino)phenylacetamido] penicillanic acid, melting point 183°C to 185°C (decomposition), yield 90%.

References

Merck Index 7335

DFU 3 (11) 829 (1978)

Kleeman & Engel p. 732

PDR p. 1026

OCDS Vol. 3 p. 207 (1984)

DOT 17 (1) 29 (1981)

I.N. p. 776

REM p. 1199

Saikawa, I., Takano, S., Yoshida, C., Takashima, O., Momono, K., Kuroda, S., Komatsu, M., Yasuda, T. and Kodama, Y.; U.S. Patents 4,087,424; May 2, 1978; 4,110,327; Aug. 29, 1978; 4,112,090; September 5, 1978; all assigned to Toyama Chemical Co., Ltd.

PIPERIDOLATE

Therapeutic Function: Antispasmodic

Chemical Name: α -phenylbenzeneacetic acid 1-ethyl-3-piperidinyl ester

Common Name: N-ethyl-3-piperidyl diphenylacetate

Structural Formula:

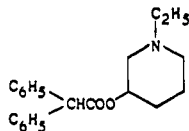

Chemical Abstracts Registry No.: 82-98-4; 129-77-1 (Hydrochloride)

Trade Name	Manufacturer	Country	Year Introduced
Dactil	Merrell National	U.S.	1954

Trade Name	Manufacturer	Country	Year Introduced
Dactil	Roger Bellon	France	1958
Cactiran	Kyorin	Japan	—
Crapinon	Sanzen	Japan	—
Dactylate	Sawai	Japan	—
Edelel	Mochida	Japan	—

Raw Materials

Furfural	Ethylamine
Hydrogen	Hydrogen bromide
Acetic acid	Diphenylacetyl chloride

Manufacturing Process

To obtain the free base, 34 g (0.256 mol) of N-ethyl-3-piperidinol and 20 g (0.22 mol) of diphenylacetyl chloride were mixed in 80 cc of isopropanol and the solution was refluxed for 2 hours. The isopropanol was evaporated in vacuo at 30 mm pressure, the residue was dissolved in 150 cc of water and the aqueous solution was extracted several times with ether. The aqueous solution was then neutralized with potassium carbonate and extracted with ether. The ethereal solution was dried over anhydrous potassium carbonate and the ether removed by distillation. The product was then distilled at its boiling point 180° to 181°C at 0.13 mm of mercury whereby 14 g of a clear yellow, viscous liquid was obtained. The nitrogen content for C₂₁H₂₅NO₂ was calculated as 4.33% and the nitrogen content found was 4.21%.

The starting material was produced by the reaction of furfural with ethylamine followed by hydrogenation to give N-ethyl-N-(2-tetrahydrofurfuryl)amine. Treatment of that material with hydrogen bromide in acetic acid gives N-ethyl-3-piperidinol.

References

Merck Index 7345

Kleeman & Engel p. 733

OCDS Vol. 1 p. 91 (1977)

I.N. p. 778

Biel, J.H.; U.S. Patent 2,918,407; December 22, 1959; assigned to Lakeside Laboratories, Inc.

PIPETHANATE ETHOBROMIDE

Therapeutic Function: Anticholinergic, antiulcer

Chemical Name: Benzilic acid, 2-piperidinoethyl ester ethobromide

Common Name: Piperilate ethyl bromide

Structural Formula:

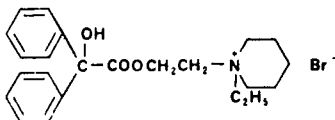

Chemical Abstracts Registry No.: 4546-39-8 (Base)

Trade Name	Manufacturer	Country	Year Introduced
Panpurol	Nippon Shinyaku	Japan	—

Raw Materials

Pipethanate hydrochloride
Sodium hydroxide
Ethyl bromide

Manufacturing Process

Pipethanate hydrochloride is dissolved in water and the solution is made alkaline by adding 10% sodium hydroxide solution. The crystals that are separated are filtered off and recrystallized from dilute ethanol. The monohydrate thereby obtained is dehydrated at 100°C under reduced pressure for 20 minutes. The products that are now in the form of a syrup due to loss of water of crystallization are further dehydrated for 2 days in a desiccator over phosphorus pentoxide whereupon the anhydrous pipethanate is obtained.

3.8 g of the anhydrous pipethanate prepared by the method described is dissolved in 15 cc of acetone, 18 g of purified ethyl bromide is added, and the mixture heated for 8 hours in a sealed tube at 100°C to 110°C. After cooling the crystals are separated and isolated by filtration. They are then washed with acetone to give 5.2 g (95.6%) of pipethanate ethylbromide with a decomposition point of 218°C to 220°C. The crystals are almost pure.

References

Merck Index 7346
DOT 7 (1) 23 (1971)
I.N. p. 779
Nippon Shinyaku Co., Ltd.; British Patent 1,148,858; April 16, 1969

PIPOBROMAN

Therapeutic Function: Antineoplastic

Chemical Name: 1,4-Bis-(3-bromo-1-oxopropyl)piperazine

Common Name: —

Structural Formula:

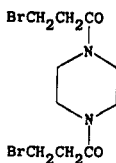

Chemical Abstracts Registry No.: 54-91-1

Trade Name	Manufacturer	Country	Year Introduced
Vercyte	Abbott	U.S.	1966
Vercyte	Abbott	France	1970
Vercite	Abbott	Italy	1972
Amedel	Dainippon	U.K.	1973

Raw Materials

3-Bromopropionyl chloride
Piperazine

Manufacturing Process

To a solution of 17.2 g (0.10 mol) of 3-bromopropionyl chloride in 100 ml of anhydrous benzene was added dropwise with stirring a solution of 8.6 g (0.10 mol) of anhydrous piperazine in 20 ml of dry chloroform over a period of 30 minutes. The temperature rose spontaneously to 45°C during the addition. After the temperature ceased to rise, stirring was continued for another hour. The reaction mixture was then filtered to remove the piperazine hydrochloride by-product. The filtrate was evaporated to dryness and the residue recrystallized from ethanol to obtain the desired N,N'-bis-(3-bromopropionyl)piperazine as a white crystalline solid melting at 103°C to 104°C. The identity of the product was further established by elemental analysis.

References

Merck Index 7355

Kleeman & Engel p. 735

OCDs Vol. 2 p. 299 (1980)

I.N. p. 779

REM p. 1156

Abbott Laboratories; British Patent 921,559; March 20, 1963

PIPOXOLAN HYDROCHLORIDE

Therapeutic Function: Antispasmodic

Chemical Name: 5,5-diphenyl-2-[2-(1-piperidinyl)ethyl]-1,3-dioxolan-4-one hydrochloride

Common Name: —

Structural Formula:

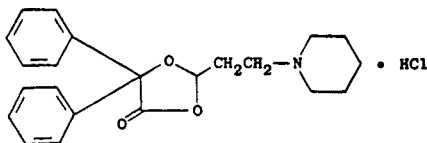

Chemical Abstracts Registry No.: 18174-58-8; 23744-24-3 (Base)

Trade Name	Manufacturer	Country	Year Introduced
Rowaprxin	Rowa/Wagner	W. Germany	1969

Raw Materials

β -Chloropropionaldehyde diethylacetal
Benzilic acid
Piperidine
Hydrogen chloride

Manufacturing Process

33 g (0.14 mol) of benzilic acid and 22 g (0.13 mol) of β -chloropropionaldehyde diethyl acetal were dissolved in 100 ml of glacial acetic acid by heating. After cooling to 40°C, a

slow stream of dry HCl gas was introduced while stirring for 2½ hours. After evaporating the glacial acetic acid in vacuo, the reforming oil was taken up in CH₂Cl₂ and treated with solid KHCO₃. After the evolution of CO₂ had ended, water was added and the organic phase was neutralized by means of KHCO₃ solution. After drying, the solvent was removed; the remaining oil distilled over under high vacuum at 0.001 mm and at 120° to 130°C to yield the compound 2-(β-chloroethyl)-4,4-diphenyl-1,3-dioxolan-5-one hydrochloride.

This compound was boiled with 12 g of dry piperidine in 120 ml of absolute benzene for 12 hours under reflux, a total of 6 g of piperidine hydrochloride being separated out. This was filtered off and the benzene solution was concentrated by evaporation. The residue was taken up in a little chloroform and the solution was applied to a dry aluminum oxide column (according to Brockmann); it was thereafter extracted with chloroform. After concentrating the solution by evaporation, an oil was obtained, which was taken up in absolute diethylether. Introduction of dry HCl gas into the cooled solution gave a precipitate which was dissolved and allowed to crystallize from isopropanol/ether. MP 193° to 199°C.

References

Merck Index 7358

Kleeman & Engel p. 736

DOT 6 (3) 95 (1970)

I.N. p. 780

Rowa-Wagner Kommanditgesellschaft Arzneimittelfabrik, Germany; British Patent 1,109,959; April 18, 1968

PIPROZOLIN

Therapeutic Function: Choloretic

Chemical Name: [3-Ethyl-4-oxo-5-(1-piperidinyl)-2-thiazolidinylidene]acetic acid ethyl ester

Common Name: —

Structural Formula:

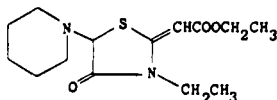

Chemical Abstracts Registry No.: 17243-64-0

Trade Name	Manufacturer	Country	Year Introduced
Probilin	Goedecke	W. Germany	1977
Probilin	Parke Davis	Italy	1979
Coleflux	Finadiet	Argentina	—
Epsyl	Exa	Argentina	—
Secrebil	Isnardi	Italy	—

Raw Materials

Ethyl thioglycolate
Sodium ethylate
Piperidine

Ethyl cyanoacetate
Diethyl sulfate

Manufacturing Process

Ethyl thioglycolate and ethyl cyanoacetate are first reacted in the presence of sodium ethylate to give 4-oxo-thiazolidin-2-ylideneacetic acid ethyl ester. That is reacted with diethyl sulfate and then with piperidine to give piprozolin.

References

Merck Index 7361

DFU 2 (10) 681 (1977)

Kleeman & Engel p. 737

OCDS Vol. 2 p. 270 (1980)

DOT 14 (1) 26 (1976)

I.N. p. 781

Satzinger, G., Herrmann, M. and Vollmer, K.O.; U.S. Patent 3,971,794; July 27, 1976; assigned to Warner-Lambert Co.

PIRACETAM

Therapeutic Function: Psychotropic

Chemical Name: 2-Oxo-1-pyrrolidineacetamide

Common Name: —

Structural Formula:

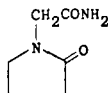

Chemical Abstracts Registry No.: 7491-74-9

Trade Name	Manufacturer	Country	Year Introduced
Nootropyl	UCB	France	1972
Nootropil	UCB-Smit	Italy	1974
Nootrop	UCB Chemie	W. Germany	1974
Normabrain	Cassella Riedel	W. Germany	1974
Gabacet	Carrion	France	1980
Cicloacetam	Callol	Spain	—
Ciclofalina	Almirall	Spain	—
Encefalux	Bama-Geve	Spain	—
Eumental	Wassermann	Spain	—
Genogris	Vita	Spain	—
Gericetam	Level	Spain	—
Huberdasen	Hubber	Spain	—
Ideaxan	Millot	France	—
Merapiran	Finadiet	Argentina	—
Nootron	Biosintetica	Brazil	—
Nootropicon	Sidus	Argentina	—
Norotrop	Drifen	Turkey	—
Norzetam	Albert Farma	Spain	—
Oikamid	Pliva	Yugoslavia	—
Pirroxil	S.I.T.	Italy	—
Pyramen	Pharmachim	Bulgaria	—
Stimubral	Lusofarmaco	Portugal	—
Stimucortex	Kalifarma	Spain	—

Raw Materials

2-Pyrrolidone
Ethyl chloroacetate

Sodium hydride
Ammonia

Manufacturing Process

2-Pyrrolidone is first reacted with sodium hydride, then with ethyl chloroacetate to give ethyl 2-oxo-1-pyrrolidine acetate.

A solution of 0.3 mol of ethyl 2-oxo-1-pyrrolidine acetate in 300 ml of methanol, saturated with ammonia at 20° to 30°C, is heated at 40° to 50°C for 5 hours, while continuously introducing ammonia. The reaction mixture is evaporated to dryness and the residue recrystallized from isopropanol. 2-Oxo-1-pyrrolidineacetamide is obtained in a yield of 86%. MP 151.5° to 152.5°C.

References

Merck Index 7363

Kleeman & Engel p. 737

DOT 9 (6) 215 (1973) & (8) 327 (1973)

I.N. p. 781

Morren, H.; U.S. Patent 3,459,738; August 5, 1969; assigned to UCB (Union Chimique-Chimische Bedrijven), Belgium

PIRBUTEROL

Therapeutic Function: Bronchodilator

Chemical Name: 2-Hydroxymethyl-3-hydroxy-(1-hydroxy-2-tert-butylaminoethyl)pyridine

Common Name: —

Structural Formula:

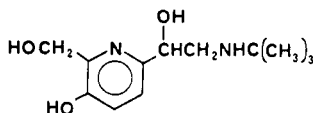

Chemical Abstracts Registry No.: 38677-81-5

Trade Name	Manufacturer	Country	Year Introduced
Exirel	Pfizer Taito	Japan	1982
Exirel	Pfizer	U.K.	1983
Exirel	Pfizer	Switz.	1983

Raw Materials

N-tert-butyl-2-(5-benzyloxy-6-hydroxymethyl-2-pyridyl)-2-hydroxyacetamide
Diborane
Hydrogen

Manufacturing Process

To 78 ml of a 1 M solution of diborane in tetrahydrofuran under nitrogen and cooled to 0°C is added dropwise over a period of 40 minutes 13.5 g of N-tert-butyl-2-(5-benzyloxy-6-hy-

droxymethyl-2-pyridyl)-2-hydroxyacetamide in 250 ml of the same solvent. The reaction mixture is allowed to stir at room temperature for 3.5 hours, and is then heated to reflux for 30 minutes and cooled to room temperature. Hydrogen chloride (70 ml, 1.34 N) in ethanol is added dropwise, followed by the addition of 300 ml of ether. The mixture is allowed to stir for 1 hour and is then filtered, yielding 11.0 g, melting point 202°C (dec.). The hydrochloride dissolved in water is treated with a sodium hydroxide solution to pH 11 and is extracted into chloroform (2 x 250 ml). The chloroform layer is dried over sodium sulfate, concentrated to dryness in vacuo, and the residue recrystallized from isopropyl ether, 3.78 g, melting point 81°C to 83.5°C.

A solution of 1.7 g of 2-hydroxymethyl-3-benzyloxy-(1-hydroxy-2-tert-butyl-aminoethyl)pyridine in 30 ml of methanol containing 1.2 ml of water is shaken with 700 mg of 5% palladium-on-charcoal in an atmosphere of hydrogen at atmospheric pressure. In 17 minutes the theoretical amount of hydrogen has been consumed and the catalyst is filtered. Concentration of the filtrate under reduced pressure provides 1.4 g of the crude product as an oil. Ethanol (5 ml) is added to the residual oil followed by 6 ml of 1.75N ethanolic hydrogen chloride solution and, finally, by 5 ml of isopropyl ether. The precipitated product is filtered and washed with isopropyl ether containing 20% ethanol, 1.35 g, melting point 182°C (dec.).

References

Merck Index 7364

DFU 2 (1) 60 (1977)

OCDS Vol. 2 p. 280 (1980)

DOT 19 (2) 113 (1983) & (7) 384 (1983)

I.N. p. 782

Barth, W.E.; U.S. Patents 3,700,681; October 24, 1972; 3,763,173; October 2, 1973; 3,772,314; November 13, 1973; all assigned to Pfizer, Inc.

PIRETANIDE

Therapeutic Function: Diuretic

Chemical Name: 3-N-Pyrrolidino-4-phenoxy-5-sulfamylbenzoic acid

Common Name: —

Structural Formula:

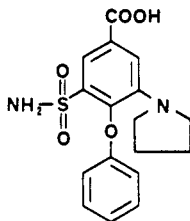

Chemical Abstracts Registry No.: 55837-27-9

Trade Name	Manufacturer	Country	Year Introduced
Arelix	Hoechst	Italy	1980
Arelix	Cassella-Riedel	W. Germany	1982
Tauliz	Hoechst	W. Germany	—

Raw Materials

3-N-Succinimido-4-phenoxy-5-sulfamylbenzoic acid methyl ester
Sodium borohydride
Sodium hydroxide

Manufacturing Process

12.3 g (0.03 mol) of 3-N-succinimido-4-phenoxy-5-sulfamylbenzoic acid methyl ester are dissolved or suspended in 100 ml of absolute diglyme. 9 g of boron trifluoride etherate are added direct to this mixture and a solution of 2.4 g (~0.063 mol) of NaBH₄ in 80 ml of diglyme is then added dropwise at room temperature with stirring. As the reaction proceeds exothermically, it is necessary to cool with ice water. The reaction is normally complete after the dropwise addition and a short period of stirring thereafter.

The excess reducing agent is then decomposed by means of a little water (foaming), the solution is filtered and about 300 ml of water are added while stirring. The 3-N-pyrrolidino-4-phenoxy-5-sulfamylbenzoic acid methyl ester which has crystallized out is recrystallized from methanol in the form of colorless crystals, melting point 191°C to 192°C.

61 g of 3-N-pyrrolidino-4-phenoxy-5-sulfamylbenzoic acid methyl ester are suspended in 350 ml of 1 N NaOH and the suspension is heated for one hour on the waterbath. 3-N-pyrrolidino-4-phenoxy-5-sulfamylbenzoic acid is precipitated from the clear solution by means of 2 N HCl while stirring well. The almost pure crude product can be recrystallized from methanol/water in the form of light yellow platelets, melting point 225°C to 227°C, with decomposition.

References

Merck Index 7366

DFU 2 (6) 393 (1977)

OCDS Vol. 3 p. 58 (1984)

DOT 18 (6) 274 (1982) & (10) 555 (1982)

I.N. p. 782

Bormann, D., Merkel, W. and Muschaweck, R.; U.S. Patents 4,010,273; March 1, 1977; 4,093,735; June 6, 1978; 4,111,953; September 5, 1978; 4,118,397; October 3, 1978; and 4,161,531; July 17, 1979; all assigned to Hoechst AG

PIRIBEDIL

Therapeutic Function: Vasodilator (peripheral)

Chemical Name: 2-[4-(1,3-Benzodioxol-5-ylmethyl)-1-piperazinyl] pyrimidine

Common Name: —

Structural Formula:

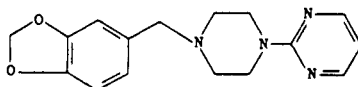

Chemical Abstracts Registry No.: 3605-01-4

Trade Name	Manufacturer	Country	Year introduced
Trivastal	Eutherapie	France	1969
Trivastan	Servier	Italy	1975
Trivastal	Pharmacodex	W. Germany	1975
Circularina	Searle	—	—

Raw Materials

2-Chloropyrimidine
1-(3':4'-Methylenedioxybenzyl)-piperazine

Manufacturing Process

To a solution of 21 g of 1-(3':4'-methylenedioxybenzyl)-piperazine in solution in 300 cc of anhydrous xylene there were added 28 g of anhydrous potassium carbonate and then 11.3 g of 2-chloropyrimidine. The suspension was then heated for 9 hours at boiling point (130°C). After this time, the mixture was cooled and extracted several times with 10% hydrochloric acid. The acid solution obtained was washed with ether and then rendered alkaline with potassium carbonate; the oily product which was separated was extracted with chloroform and this, after drying with potassium carbonate and evaporation, gave an oily residue weighing 20 g. By dissolution in boiling ethanol and crystallization, 15 g of crystals melting at 96°C were recovered.

References

Merck Index 7368

Kleeman & Engel p. 739

DOT (As ET-495) 6 (1) 29 (1970) & 10 (9) 324, 340 (1974)

I.N. p. 783

Regnier, G., Canevari, R. and Laubie, M.; U.S. Patent 3,299,067; January 17, 1967; assigned to Science Union Et Cie, Societe Francaise De Recherche Medicale (France)

PIRITRAMIDE

Therapeutic Function: Analgesic

Chemical Name: 1-(3,3-Diphenyl-3-cyanopropyl)-4-piperidino-4-piperidinecarboxamide

Common Name: Pirinitramide

Structural Formula:

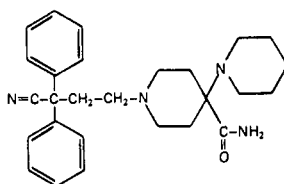

Chemical Abstracts Registry No.: 302-41-0

Trade Name	Manufacturer	Country	Year Introduced
Dipidolor	Janssen	W. Germany	1969
Dipidolor	Janssen	U.K.	1972
Piridolan	Leo	Sweden	—

Raw Materials

3,3-Diphenyl-3-cyanopropyl bromide
4-Piperidino-4-piperidinecarboxamide

Manufacturing Process

A mixture of 84 parts of 3,3-diphenyl-3-cyanopropyl bromide, 41 parts of 4-piperidino-4-piperidinecarboxamide, 64 parts of sodium carbonate, a small amount of potassium iodide and 1,200 parts of anhydrous toluene was stirred, and heated under reflux for 48 hours. At the end of this time the reaction mixture was allowed to cool to room temperature, and 500 parts of water were added. The resultant precipitate was removed by filtration, and triturated with diisopropyl ether. The crystalline material thus obtained was removed by filtration, and recrystallized from 320 parts of acetone, to give 1-(3,3-diphenyl-3-cyanopropyl)-4-piperidino-4-piperidinecarboxamide, melting at about 149°C to 150°C.

References

Merck Index 7373

Kleeman & Engel p. 739

OCDS Vol. 1 p. 308 (1977)

DOT 5 (3) 107 (1969)

I.N. p. 783

N.V. Research Laboratorium Dr. C. Janssen; British Patent 915,835; January 16, 1963

Janssen, P.A.J.; U.S. Patent 3,080,360; March 5, 1963; assigned to Research Laboratorium Dr. C. Janssen N.V.

PIROHEPTINE

Therapeutic Function: Antiparkinsonian

Chemical Name: 3-(10,11-Dihydro-5H-dibenzo[a,d]cyclohepten-5-ylidene)-1-ethyl-2-methylpyrrolidine

Common Name: —

Structural Formula:

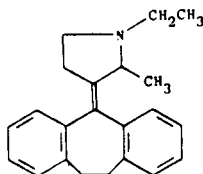

Chemical Abstracts Registry No.: 16378-21-5

Trade Name	Manufacturer	Country	Year Introduced
Trimol	Fujisawa	Japan	1974

Raw Materials

2-Methyl-3-(10,11-dihydro-5H-dibenzo[a,d]cycloheptene-5-ylidene)-1-pyrrolidine
Ethyl iodide
Sodium borohydride

Manufacturing Process

(1) To 3.8 g of 2-methyl-3-(10,11-dihydro-5H-dibenzo[a,d]cycloheptene-5-ylidene)-1-pyrrolidine, there were added 8 g of ethyl iodide. This mixture was placed into a closed vessel and heated at 80°C in a water-bath for one hour. After completing the reaction, the reaction mix-

ture was cooled and the unreacted ethyl iodide was distilled off to yield 5.5 g of 1-ethyl-2-methyl-3-(10,11-dihydro-5H-dibenzo[a,d]cycloheptene-5-ylidene)-1-pyrrolinium iodide in the form of yellow crystals. These crystals were recrystallized from a mixture of acetone and ether to yield yellow needles of the melting point 223°C.

(2) 1-Ethyl-2-methyl-3-(10,11)-dihydro-5H-dibenzo[a,d]cycloheptene-5-ylidene)-1-pyrrolinium iodide (4.7 g) was dissolved in 7 cc of methanol. To this solution there were added 1.4 g of sodium boron hydride within about 80 minutes with stirring and stirring of the solution was continued for two hours to complete the reaction. The reaction mixture was acidified with 10% aqueous hydrochloric acid solution and then the methanol was distilled off. The residual solution was alkalinized with 20% aqueous sodium hydroxide solution and extracted with ether. The ether layer was dried over magnesium sulfate and the ether was distilled off. The resulting residue was further distilled under reduced pressure to yield 2.0 g of 1-ethyl-2-methyl-3-(10,11)-dihydro-5H-dibenzo[a,d]cycloheptene-5-ylidene)pyrrolidine (boiling point 167°C/4 mm Hg.).

References

Merck Index 7375

DOT 9 (6) 247 (1973) & 10 (9) 325 (1974)

I.N. p. 784

Deguchi, Y., Nojima, H. and Kato, N.; U.S. Patent 3,454,495; July 8, 1969; assigned to Fujisawa Pharmaceutical Co., Ltd. (Japan)

PIROMIDIC ACID

Therapeutic Function: Antibacterial (urinary)

Chemical Name: 8-Ethyl-5,8-dihydro-5-oxo-2-(1-pyrrolidinyl)pyrido[2,3-d]pyrimidine-6-carboxylic acid

Common Name: —

Structural Formula:

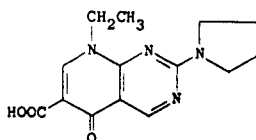

Chemical Abstracts Registry No.: 19562-30-2

Trade Name	Manufacturer	Country	Year Introduced
Panacid	Dainippon	Japan	1972
Pirodal	I.S.F.	Italy	1977
Bactramyl	Carrion	France	1978
Septural	Gruenthal	W. Germany	1978
Adelir	Teikoku	Japan	—
Coltix	Gerardo Ramon	Argentina	—
Panerco	Erco	Denmark	—
Purim	Mayoly-Spindler	France	—
Reelon	Sanken	Japan	—
Uriclor	Almirall	Spain	—
Urisept	Srbolek	Yugoslavia	—
Zaomeal	Isei	Japan	—

Raw Materials

6-Amino-2-methylthiopyrimidine
 Ethoxymethylenemalonic acid diethyl ester
 Sodium hydroxide
 Diethyl sulfate
 Pyrrolidine

Manufacturing Process

150 mg of 6-carboxy-5,8-dihydro-8-ethyl-2-methylthio-5-oxopyrido[2,3-d]pyrimidine was added to 30 ml of absolute ethanol containing 1.1 g of dissolved pyrrolidine, and the mixture was reacted for 5 hours at 95°C in a sealed tube. The solvent was removed by distillation, and the residue was recrystallized from methanol-chloroform. There were obtained 111 mg of 6-carboxy-5,8-dihydro-8-ethyl-5-oxo-2-pyrrolidino-pyrido[2,3-d]pyrimidine having a MP of 314° to 316°C.

The starting material is produced by reacting 6-amino-2-methylthiopyrimidine with ethoxymethylenemalonic acid diethyl ester. That intermediate is thermally treated in diphenyl ether to give 6-ethoxycarbonyl-2-methylthio-5-oxo-5,8-dihydro-pyrido[2,3-d]pyrimidine. The ethoxy group is hydrolyzed off with sodium hydroxide and one nitrogen is ethylated with diethyl sulfate to give the starting material. These are the same initial steps as used in the pipemicid acid syntheses earlier in this volume.

References

Merck Index 7377
 Kleeman & Engel p. 739
 OCDS Vol. 2 p. 470 (1980)
 DOT 7 (5) 188 (1971)
 I.N. p. 36
 Dainippon Pharmaceutical Co. Ltd., Japan; British Patent 1,129,358; October 2, 1968
 Minami, S., Shono, T., Shmizu, M. and Takase, Y.; U.S. Patent 3,673,184; June 27, 1972; assigned to Dainippon Pharmaceutical Co. Ltd.
 Pesson, M.E. and Geiger, S.W.; U.S. Patent 4,125,720; November 14, 1978; assigned to Laboratoire Roger Bellon

PIROZADIL

Therapeutic Function: Hypolipidemic; platelet aggregation inhibitor

Chemical Name: 2,6-Pyridinemethanol-bis(3,4,5-trimethoxybenzoate)

Common Name: —

Structural Formula:

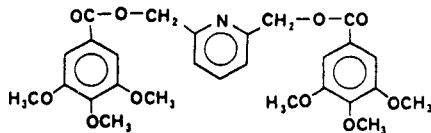

Chemical Abstracts Registry No.: 54110-25-7

Trade Name	Manufacturer	Country	Year Introduced
Pemix	Prodes	Spain	1982

Raw Materials

3,4,5-Trimethoxybenzoic acid
 Thionyl chloride
 Pyridine-2,6-dimethanol

Manufacturing Process

15 kg (70.7 mols) of 3,4,5-trimethoxybenzoic acid and 65 liters of benzene were introduced into a reactor, to which mixture was added 27.4 liters of thionyl chloride. The mass was heated to 56°C to 70°C during a period of 5 hours. The excess of benzene and thionyl chloride was distilled under vacuum. The residue was kept under vacuum at 120°C to 123°C for 1 hour, to obtain a hard crystalline solid.

A solution comprising 3.24 kg (23.3 mols) of pyridine-2,6-dimethanol in 35 liters of pure pyridine was added to the residue and the mass was heated to 80°C for 2½ hours. The reaction mass became brown in color. The chlorhydrate of pyridine so formed was cooled and crystallized. The resulting reaction mass was then poured into water. The precipitate obtained was filtered, repeatedly rinsed with water, and dissolved in 400 liters of methanol. The resulting solution was filtered with activated charcoal. From this filtration 50 liters of methanol were distilled at normal pressure and then crystallized. 8.35 kg (15.8 mols) of pyridine-2,6-dimethanol trimethoxybenzoate were obtained, which represented a yield of 68%.

The product was a white crystalline solid which melted at 119°C to 126°C. Recrystallization in methanolone gave a product which melted at 126°C to 127°C.

References

Merck Index 7379
 DFU 6 (5) 290 (1981)
 DOT 18, Suppl. 1
 Instituto International Terapeutico; British Patent 1,401,608; July 30, 1975

PIRPROFEN

Therapeutic Function: Antiinflammatory

Chemical Name: α -(3-Chloro-4-pyrrolinophenyl)-propionic acid

Common Name: —

Structural Formula:

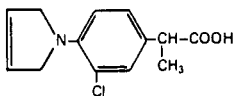

Chemical Abstracts Registry No.: 31793-07-4

Trade Name	Manufacturer	Country	Year Introduced
Rengasil	Ciba-Geigy	France	1981
Rengasil	Ciba-Geigy	Switz.	1981

Raw Materials

Ethyl α -(3-chloro-4-aminophenyl)-propionate hydrochloride
 1,4-Dibromo-2-butene

Manufacturing Process

To the mixture of 85.5 g ethyl α -(3-chloro-4-aminophenyl)-propionate hydrochloride, 142 g sodium carbonate and 600 ml dimethyl formamide, 107 g 1,4-dibromo-2-butene are added dropwise while stirring and the whole is refluxed for 5 hours and allowed to stand overnight at room temperature. The mixture is filtered, the filtrate evaporated in vacuo, the residue is triturated with hexane, the mixture filtered, the residue washed with petroleum ether and the filtrate evaporated. The residue is combined with 280 ml 25% aqueous sodium hydroxide and the mixture refluxed for 8 hours. After cooling, it is diluted with water, washed with diethyl ether, the pH adjusted to 5 to 5.2 with hydrochloric acid and extracted with diethyl ether. The extract is dried, filtered, evaporated and the residue crystallized from benzene-hexane, to yield the α -(3-chloro-4-pyrrolinophenyl)-propionic acid melting at 94°C to 96°C.

References

Merck Index 7380

DFU 1 (1) 23 (1976)

OCDS Vol. 2 p. 69 (1980)

DOT 11 (3) 103 (1975)

I.N. p. 784

Carney, R.W.J. and De Stevens, G.; U.S. Patent 3,641,040; February 8, 1972; assigned to Ciba Geigy Corp.

PIVAMPICILLIN

Therapeutic Function: Antibacterial

Chemical Name: 6-[Aminophenylacetyl]amino]-3,3-dimethyl-7-oxo-4-thia-1-azabicyclo-[3.2.0]heptane-2-carboxylic acid (2,2-dimethyl-1-oxopropoxy)methyl ester

Common Name: —

Structural Formula:

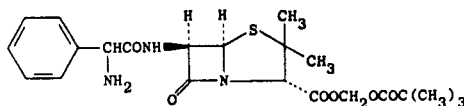

Chemical Abstracts Registry No.: 33817-20-8; 26309-95-5 (Hydrochloride)

Trade Name	Manufacturer	Country	Year Introduced
Maxifen	Sharp & Dohme	W. Germany	1972
Berocillin	Boehr. Ingel.	W. Germany	1972
Pondocillina	Sigma Tau	Italy	1972
Pivatil	MSD	Italy	1972
Pivatil	Chibret	France	1973
Pondocillin	Burgess	U.K.	1980
Acerum	Jebe	Spain	—
Bensamin	Turro	Spain	—
Brotacilina	Escaned	Spain	—
Co-Pivam	Sanchez Covisa	Spain	—
Crisbiotic	Crisol	Spain	—
Dancilin	Hemofarm	Yugoslavia	—
Devonian	Perga	Spain	—
Diancina	Septa	Spain	—

Trade Name	Manufacturer	Country	Year Introduced
Inacilin	Inibsa	Spain	—
Isvitrol	Therapia	Spain	—
Kesmicina	Kessler	Spain	—
Lancabiotic	Lanzas	Spain	—
Novopivam	Osiris	Argentina	—
Oxidina	Sanitas	Argentina	—
Penimenal	Alalan	Spain	—
Pibena	Jebena	Spain	—
Piva	Efesal	Spain	—
Pivabiot	Galepharma Iberica	Spain	—
Pivadilon	De La Cruz	Spain	—
Pivambol	B.O.I.	Spain	—
Pivamkey	Pereira	Spain	—
Pivapen	Juste	Spain	—
Pivastol	Graino	Spain	—
Piviotic	Miquel	Spain	—
Sanguicillin	Zdravljie	Yugoslavia	—
Tam-Cilin	Quimia	Spain	—
Tryco	Durban	Spain	—
Vampi-Framan	Oftalmiso	Spain	—

Raw Materials

Potassium D(-)- α -azidobenzylpenicillinate
 Chloromethyl pivalate
 Hydrogen

Manufacturing Process

(A) Pivaloyloxymethyl D(-)- α -azidobenzylpenicillinate: To a suspension of potassium D(-)- α -azidobenzylpenicillinate (4.14 g) and potassium dicarbonate (1.5 g) in acetone (100 ml) and 10% aqueous sodium iodide (2 ml), chloromethyl pivalate (2.7 ml) was added and the mixture refluxed for 2 hours. After cooling, the suspension was filtered and the filtrate evaporated to dryness in vacuo. The remaining residue was washed repeatedly by decantation with petroleum ether to remove unreacted chloromethyl pivalate. The oily residue was taken up in ethyl acetate (100 ml), and the resulting solution washed with aqueous sodium bicarbonate and water, dried and evaporated in vacuo to yield the desired compound as a yellowish gum, which crystallized from ether, melting point 114°C to 115°C.

(B) Pivaloyloxymethyl D(-)- α -aminobenzylpenicillinate, hydrochloride: To a solution of pivaloyloxymethyl D(-)- α -azidobenzylpenicillinate (prepared as described above) in ethyl acetate (75 ml) a 0.2M phosphate buffer (pH 2.2) (75 ml) and 10% palladium on carbon catalyst (4 g) were added, and the mixture was shaken in a hydrogen atmosphere for 2 hours at room temperature. The catalyst was filtered off, washed with ethyl acetate (25 ml) and phosphate buffer (25 ml), and the phases of the filtrate were separated. The aqueous phase was washed with ether, neutralized (pH 6.5 to 7.0) with aqueous sodium bicarbonate, and extracted with ethyl acetate (2 X 75 ml). To the combined extracts, water (75 ml) was added, and the pH adjusted to 2.5 with 1N hydrochloric acid. The aqueous layer was separated, the organic phase extracted with water (25 ml), and the combined extracts were washed with ether, and freeze-dried. The desired compound was obtained as a colorless, amorphous powder.

The purity of the compound was determined iodometrically to be 91%. A crystalline hydrochloride was obtained from isopropanol with a melting point of 155°C to 156°C (dec.).

References

Merck Index 7387
 Kleeman & Engel p. 741

OCDS Vol. 1 p. 414 (1977)

DOT 8 (4) 148 (1972) & 19 (6) 331 (1983)

I.N. p. 785

REM p. 1201

Frederiksen, E.K. and Godtfredsen, W.O.; U.S. Patent 3,660,575; May 2, 1972; assigned to Lovens Kemiske Fabrik Produktionsaktieselskab (Denmark)

Binderup, E.T., Petersen, H.J. and Liisberg, S.; U.S. Patent 3,956,279; May 11, 1976; assigned to Leo Pharmaceutical Products Ltd. (Denmark)

PIVMECILLINAM

Therapeutic Function: Antibacterial

Chemical Name: 6-[[(Hexahydro-1H-azepin-1-yl)methylene] amino] -3,3-dimethyl-7-oxo-4-thia-1-azabicyclo[3.2.0]heptane-2-carboxylic acid (2,2-dimethyl-1-oxopropoxy)methyl ester

Common Name: Amdinocillin pivoxil

Structural Formula:

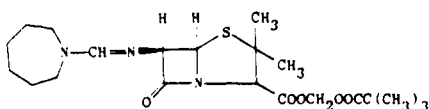

Chemical Abstracts Registry No.: 32886-97-8

Trade Name	Manufacturer	Country	Year Introduced
Selexid	Leo	U.K.	1977
Melysin	Takeda	Japan	1979
Selexid	Leo	Switz.	1980
Negaxid	Sigma Tau	Italy	1980

Raw Materials

N-Formylhexamethyleneimine
 Oxalyl chloride
 Pivaloyloxymethyl 6-aminopenicillinate tosylate
 Sodium bicarbonate

Manufacturing Process

The starting material N-formylhexamethyleneimine was prepared from hexamethyleneimine and chloral.

12.7 g of N-formylhexamethyleneimine were dissolved in 250 ml of dry ether. While stirring and cooling, 8.5 ml of oxalyl chloride in 50 ml of dry ether were added dropwise, whereafter the mixture was stirred overnight at room temperature. The precipitated amide chloride was filtered off and washed with dry ether, and was placed in an exsiccator.

27.5 g of pivaloyloxymethyl 6-aminopenicillinate tosylate was suspended in 1,500 ml of ethyl acetate with continuous stirring and cooling in an ice bath and 950 ml of ice-cold aqueous sodium bicarbonate (2%) were added. The ethyl acetate layer was separated and was shaken with 750 ml of ice-water containing 25 ml of aqueous sodium bicarbonate (2%), whereafter it was dried over magnesium sulfate at 0°C. After filtration, the solution was evaporated to dry-

ness *in vacuo*. The residue was dissolved in a solution of 15.5 ml of dry triethylamine in 75 ml of dry alcohol-free chloroform. To this solution, 10 g of the above prepared amide chloride dissolved in 75 ml of dry alcohol-free chloroform were added dropwise at a temperature of about -20°C . After standing for half an hour at -20°C , the temperature was raised to 0°C within 15 minutes and the solution was evaporated to dryness *in vacuo*. The residue was stirred with 750 ml of ether. Undissolved triethylamine hydrochloride was filtered off, and the filtrate was again evaporated to dryness *in vacuo*. The residue was reprecipitated from acetone (200 ml) – water (150 ml). After recrystallization from cyclohexane an analytically pure product was obtained with a melting point of 118.5°C to 119.5°C .

References

Merck Index 391

Kleeman & Engel p. 741

DOT 19 (6) 331 (1983)

I.N. p. 786

REM p. 1201

Lund, F.J.; U.S. Patent 3,957,764; May 18, 1976; assigned to Lovens Kemiske Fabrik Produktionsartieselskab (Denmark)

PIXIFENIDE

Therapeutic Function: Antiinflammatory

Chemical Name: 1-[4-[1-(Hydroxyimino)ethyl] phenoxy] acetyl] piperidine

Common Name: N-(p-1-Nitrosoethyl)phenoxyacetyl piperidine, pifoxime

Structural Formula:

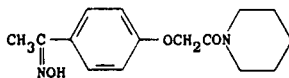

Chemical Abstracts Registry No.: 31224-92-7

Trade Name	Manufacturer	Country	Year Introduced
Flamanil	Salvoxy/Wander	France	1975

Raw Materials

p-Hydroxyacetophenone	Chloroacetic acid
Methanol	Piperidine
Hydroxylamine	

Manufacturing Process

(A) *Preparation of p-Acetylphenoxyacetic Acid:* p-Hydroxy-acetophenone is treated with chloroacetic acid in aqueous solution in the presence of sodium hydroxide. The desired acid is then isolated from its sodium salt in a total yield of 80 to 82%, excess of p-hydroxy-acetophenone having been extracted with methylene chloride.

(B) *Preparation of Methyl p-Acetylphenoxy-Acetate:* A mixture of 80 g of the acid obtained in (A) and 200 ml of methyl alcohol in 600 ml of dichloromethane is refluxed in the presence of sulfuric acid. The desired ester is isolated in accordance with a method known per se, and recrystallized. When the refluxing period is 12 hours, the ester is obtained with a yield of 70%. When the refluxing period is 18 hours, the yield for this ester is 85%.

(C) *Preparation of N-(p-Acetylphenoxy-Acetyl)-Piperidine:* The ester from (B) is refluxed for 8 hours with 2.5 mols of thoroughly dried piperidine. Then 1 volume of water is added and the product is left to crystallize in the cold. The desired amide is obtained in an 80% yield.

(D) *Preparation of N-(p-[1-Isonitrosoethyl]-Phenoxy-Acetyl)-Piperidine:* The amide from (C) is refluxed for 5 hours with technical (98%) hydroxylamine and alcohol denatured with methanol. The desired product is obtained in a 75% yield.

In semiindustrial synthesis, to achieve better yields, it is possible to omit (A), by directly preparing the ester (B) by reaction of p-hydroxy acetophenone on ethyl 2-bromoacetate in the presence of potassium carbonate in butanone. The yield of ester is 90%, and elimination of excess of p-hydroxyacetophenone is effected by washing with sodium hydroxide.

References

Merck Index 7300

Kleeman & Engel p. 725

DOT 12 (2) 50 (1976)

Mieville, A.; U.S. Patent 3,907,792; September 23, 1975

PIZOTYLINE HYDROCHLORIDE

Therapeutic Function: Migraine therapy

Chemical Name: 4-(9,10-Dihydro-4H-benzo[4,5]cyclohepta[1,2-b]thien-4-ylidene-1-methyl-piperidine hydrochloride

Common Name: Pizotifen

Structural Formula:

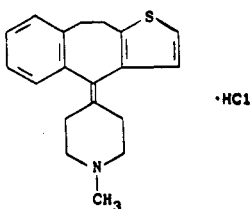

Chemical Abstracts Registry No.: 15574-96-6 (Base)

Trade Name	Manufacturer	Country	Year Introduced
Sandomigran	Sandoz	Italy	1972
Sandomigran	Sandoz	W. Germany	1974
Sanomigran	Wander	U.K.	1975
Mosegor	Wander	W. Germany	1976
Sanmigran	Salvoxy/Wander	France	1976
Polomigran	Polfa	Poland	—

Raw Materials

Thienyl-(2)-acetic acid	Phthalic anhydride
Phosphorus	Phosphorus pentoxide
1-Methyl-4-chloropiperidine	Magnesium
Hydrogen chloride	

Manufacturing Process

(A) Preparation of Thénylidene-(2)-Phthalide: 24.2 g of thényl-(2)-acetic acid, 52.0 g of phthalic acid anhydride, 4.0 g of anhydrous sodium acetate and 125 ml of 1-methylpyrrolidone-(2) are heated while stirring in an open flask for 3 hours to 205° to 208°C, while nitrogen is passed through. It is then cooled and the viscous reaction mixture poured into 1 liter of water. The precipitated substance is filtered off, washed with water and then dissolved in 200 ml of chloroform. After filtering off some undissolved substance, shaking is effected twice with 100 ml of 2 N sodium carbonate solution and then with water, drying is then carried out over sodium sulfate and the volume is reduced by evaporation. The crude phthalide is repeatedly recrystallized from ethanol, while treating with animal charcoal. It melts at 114° to 115°C.

(B) Preparation of o-[2-Thényl-(2')-Ethyl] Benzoic Acid: 24.0 g of thénylidene-(2)-phthalide, 8.8 g of red pulverized phosphorus, 240 ml of hydrochloric acid ($d = 1.7$) and 240 ml of glacial acetic acid are heated to boiling under nitrogen and while stirring vigorously. 70 ml toluen are then added and 6.0 g of red phosphorus added in small portions over a period of 1 hour. It is then poured into 3 liters of ice water, stirred with 300 ml of chloroform and the phosphorus removed by filtration.

The chloroform phase is then removed, the aqueous phase extracted twice more with 200 ml of chloroform and the united extracts shaken out 4 times, each time with 200 ml of 2 N sodium hydroxide solution. The alkaline solution is then rendered acid to Congo red reagent, using hydrochloric acid and extracted 3 times with chloroform. After drying over sodium sulfate and evaporating the solvent, the residue is chromatographed on aluminum oxide (Activity Stage V). The substance eluted with benzene and benzene/chloroform (1:1) is recrystallized from chloroform/hexane (1:1); MP 107° to 109°C.

(C) Preparation of 9,10-Dihydro-4H-Benzo[4,5]Cyclohepta[1,2-b]Thiophen-(4)-One: 200 ml of 85% phosphoric acid and 112 g of phosphorus pentoxide are heated to 135°C. 7.0 g of o-[2-thényl-(2')-ethyl] benzoic acid are then introduced while stirring thoroughly over a period of 30 min. Stirring is then continued for another hour at 135°C and the reaction mixture is then stirred into 1 liter of ice water. Extraction is then effected 3 times, using 250 ml ether portions, the ethereal extract is washed with 2 N sodium carbonate solution, dried over sodium sulfate and reduced in volume by evaporation. The residue is boiled up with 55 ml of ethanol, the solution freed of resin by decanting and then stirred at room temperature for 6 hours with animal charcoal. It is then filtered off, reduced in volume in a vacuum and the residue distilled. BP 120° to 124°C/0.005 mm, $n_D^{24.5} = 1.6559$.

(D) Preparation of 4-[1'-Methyl-Piperidyl-(4')] -9,10-Dihydro-4H-Benzo[4,5]Cyclohepta[1,2-b]Thiophen-(4)-ol: 0.94 g of magnesium filings which have been activated with iodine are covered with a layer of absolute tetrahydrofuran and etched with a few drops of ethylene bromide. A solution of 5.0 g of 1-methyl-4-chloropiperidine in 5 ml of tetrahydrofuran is then added dropwise and boiling then effected for a further hour under reflux. After cooling to room temperature, the solution of 4.5 g of 9,10-dihydro-4H-benzo[4,5]cyclohepta[1,2-b]thiophen-(4)-one in 5 ml of tetrahydrofuran is added dropwise.

Stirring is carried out first for 3 hours at room temperature and then for 2 hours at boiling temperature, it is then cooled and poured into 300 ml of ice-cold 20% ammonium chloride solution. It is then shaken out with methylene chloride, the methylene chloride solution washed with water and shaken 3 times with 30 ml portions of aqueous 2 N tartaric acid solution. The tartaric acid extract is rendered alkaline while cooling thoroughly and then extracted twice with methylene chloride. After washing with water, drying over potassium carbonate and reducing in volume by evaporation, the residue is recrystallized from ethanol. MP 197° to 199°C.

(E) Preparation of 4-[1'-Methyl-Piperidylidene-(4')] -9,10-Dihydro-4H-Benzo[4,5]Cyclohepta[1,2-b]Thiophene Hydrochloride: 2 g of 4-[1'-methyl-piperidyl-(4')] -9,10-dihydro-4H-benzo[4,5]cyclohepta[1,2-b]thiophen-(4)-ol, 60 ml of glacial acetic acid and 20 ml of

concentrated hydrochloric acid are boiled for 30 minutes under reflux. After evaporating in a vacuum, the residue is triturated with 3 ml of acetone, the precipitated hydrochloride is then filtered off and it is recrystallized from isopropanol/ether. MP 261° to 263°C (decomposition).

References

Merck Index 7389

Kleeman & Engel p. 742

DOT 9 (6) 221 (1973)

I.N. p. 786

Jucker, E., Ebnother, A., Stoll, A., Bastian, J.-M. and Rissi, E.; U.S. Patent 3,272,826; September 13, 1966; assigned to Sandoz Ltd., Switzerland

POLOXALKOL

Therapeutic Function: Pharmaceutic aid (surfactant)

Chemical Name: Poly(oxyethylene)-poly(oxypropylene)-poly(oxyethylene)

Common Name: Poloxalene

Structural Formula: $\text{HO}(\text{CH}_2\text{CH}_2\text{O})_a[\text{CH}(\text{CH}_3)\text{CH}_2\text{O}]_b(\text{CH}_2\text{CH}_2\text{O})_c\text{H}$

average values for a, b, c are:

a = 12; b = 34; c = 12

Chemical Abstracts Registry No.: 9003-11-6

Trade Name	Manufacturer	Country	Year Introduced
Polykol	Upjohn	U.S.	1958
Therabloat	Norden	U.S.	—

Raw Materials

Propylene glycol
Propylene oxide

Manufacturing Process

(A) In a 1-liter 3-necked round bottom flask equipped with a mechanical stirrer, reflux condenser, thermometer and propylene oxide feed inlet, there were placed 57 g (0.75 mol) of propylene glycol and 7.5 g of anhydrous sodium hydroxide. The flask was purged with nitrogen to remove air and heated to 120°C with stirring and until the sodium hydroxide was dissolved. Then sufficient propylene oxide was introduced into the mixture as fast as it would react until the product possessed a calculated molecular weight of 2,380. The product was cooled under nitrogen, the NaOH catalyst neutralized with sulfuric acid and the product filtered. The final product was a water-insoluble polyoxypropylene glycol having an average molecular weight of 1,620 as determined by hydroxyl number or acetylation analytical test procedures.

(B) The foregoing polyoxypropylene glycol having an average 1,620 molecular weight was placed in the same apparatus as described in procedure (A), in the amount of 500 g (0.308 mol), to which there was added 5 g of anhydrous sodium hydroxide. 105 g of ethylene oxide was added at an average temperature of 120°C, using the same technique

as employed in (A). The amount of added ethylene oxide corresponded to 17.4% of the total weight of the polyoxypropylene glycol base plus the weight of added ethylene oxide.

References

Merck Index 7431

I.N. p. 789

REM p. 1320

Lundsted, L.G.; U.S. Patent 2,674,619; April 6, 1954; assigned to Wyandotte Chemicals Corporation

POLYESTRADIOL PHOSPHATE

Therapeutic Function: Estrogen

Chemical Name: Estradiol phosphate polymer

Common Name: Polymeric ester of phosphoric acid and estradiol

Structural Formula:

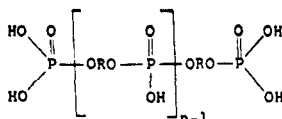

-ORO- is the estradiol radical and n is about 80

Chemical Abstracts Registry No.: 28014-46-2

Trade Name	Manufacturer	Country	Year Introduced
Estradurin	Ayerst	U.S.	1957
Estradurin	Abello	Spain	—
Estradurin	Leo	Sweden	—

Raw Materials

Estradiol
Phosphorus oxychloride

Manufacturing Process

3 g of estradiol was dissolved in 75 ml of anhydrous pyridine. The solution was cooled to -10°C , whereupon a solution of 1.1 ml of phosphorus oxychloride in 10 ml of anhydrous pyridine was added with agitation. After the addition, which required 7 minutes, the reaction mixture was kept at -10°C for a further period of 3 hours, and then it was left standing at room temperature for 15 hours. A clear solution thus resulted, to which finely crushed ice was then added. The resulting solution was evaporated in vacuum to dryness. After drying in a vacuum desiccator, 3.8 g of a white powder was obtained. This powder was suspended in 2 ml of pyridine, and 25 ml of 0.5 N sodium hydroxide was added, whereupon a solution was obtained which was then diluted with water to 100 ml.

The solution was then dialyzed through a cellophane membrane against 4 liters of water for 10 hours, with stirring. The dialysis was repeated 2 additional times, with fresh amounts of water. To the dialyzed solution there was added 2 ml of 1 N hydrochloric acid, whereupon polyestradiol phosphate was precipitated as a white bulky precipitate. This was centrifuged off and washed repeatedly with 0.1 N hydrochloric acid. Thereafter it was dried in a vacuum desiccator. The yield was 3 g of polyestradiol phosphate. The analysis shows 0.65% of water, 1.35% of pyridine and 9.3% of phosphorus (calculated on a dry sample).

References

Merck Index 7439
 PDR p. 618
 I.N. p. 790
 REM p. 987

Diczfalusy, E.R., Fernö, O.B., Fex, H.J., Högberg, K.B. and Linderot, T.O.E.; U.S. Patent 2,928,849; March 15, 1960; assigned to Leo AB, Sweden

POLYMYXIN

Therapeutic Function: Antibacterial

Chemical Name: Complex antibiotic; see structural formula

Common Name: —

Structural Formula:

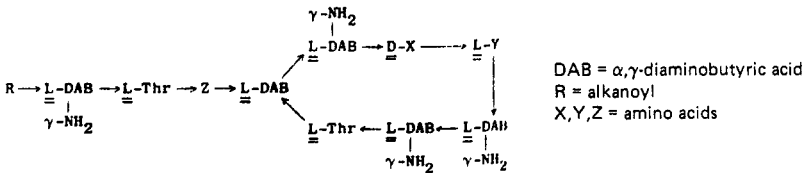

Chemical Abstracts Registry No.: 1406-11-7

Trade Name	Manufacturer	Country	Year Introduced
Aerosporin	Burroughs Wellcome	U.S.	1951
Cortisporin	Burroughs Wellcome	U.S.	—
Mastimyxin	Chassot	Switz.	—
Neo-Polycin	Merrell Dow	U.S.	—
Neosporin	Burroughs Wellcome	U.S.	—
Octicair	Pharmafair	U.S.	—
Ophthocort	Parke-Davis	U.S.	—
Otobiotic	Schering	U.S.	—
Otocort	Lemmon	U.S.	—
Polyfax	Pitman-Moore	U.S.	—
Polysporin	Burroughs Wellcome	U.S.	—
Pyocidin	Berlex	U.S.	—
Topisporin	Pharmafair	U.S.	—
Tri-Thalamic	Schein	U.S.	—

Raw Materials

Bacterium *Bacillus polymyxa*
 Nutrient medium
 Corn meal

Manufacturing Process

As described in U.S. Patent 2,595,605, in a pilot plant tank 225 liters of a medium containing the following ingredients was prepared: 2% ammonium sulfate, 0.2% potassium di-

hydrogen phosphate, 0.05% magnesium sulfate heptahydrate, 0.005% sodium chloride, 0.001% ferrous sulfate heptahydrate, 0.5% yeast extract, 1% dextrose, 1% calcium carbonate and 3% corn meal. The fermentation medium was adjusted to pH 7.3 to 7.4. It was then sterilized for 30 minutes at 110°C. After sterilization the pH was about 7. To the medium was added 225 ml of mineral oil.

The fermentation medium was inoculated with *Bacillus polymyxa* prepared as follows: A culture of *Bacillus polymyxa* in a tube with Trypticase soybean broth was incubated overnight at 25°C. 5 ml of this culture was transferred to 100 ml of the tank medium in a 500 ml Erlenmeyer flask which was incubated for 48 hours at room temperature. This 100 ml culture served as inoculum for one tank. During the course of fermentation the medium was aerated at the rate of 0.3 volume of air per volume of mash per minute. The temperature was maintained at about 27°C. Samples of mash were taken every 8 hours in order to determine pH and the presence of contaminants and spores. After 88 hours of fermentation the pH was about 6.3 and an assay using *Escherichia coli* showed the presence of 1,200 units of polymyxin per cubic centimeter. The polymyxin was extracted and purified by removing the mycelia, adsorbing the active principle on charcoal and eluting with acidic methanol.

Polymyxin is usually used as the sulfate.

References

Merck Index 7445

Kleeman & Engel p. 743

PDR pp. 671, 732, 738, 757, 888, 1034, 1232, 1380, 1415, 1429, 1606, 1645

DOT 8 (1) 21 (1972)

I.N. p. 790

REM p. 1202

Ainsworth, G.C. and Pope, C.G.; U.S. Patent 2,565,057; August 21, 1951; assigned to Burroughs Wellcome & Co. (U.S.A.) Incorporated

Petty, M.A.; U.S. Patent 2,595,605; May 6, 1952; assigned to American Cyanamid Company

Benedict, R.G. and Stodola, F.H.; U.S. Patent 2,771,397; November 20, 1956; assigned to the U.S. Secretary of Agriculture

POLYTHIAZIDE

Therapeutic Function: Diuretic

Chemical Name: 6-Chloro-3,4-dihydro-2-methyl-3-[[2,2,2-trifluoroethylthio]methyl]-2H-1,2,4-benzothiadiazine-7-sulfonamide-1,1-dioxide

Common Name: —

Structural Formula:

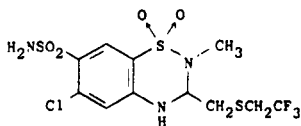

Chemical Abstracts Registry No.: 346-18-9

Trade Name	Manufacturer	Country	Year Introduced
Renese	Pfizer	U.S.	1961

Trade Name	Manufacturer	Country	Year Introduced
Drenusil	Pfizer	W. Germany	1962
Renese	Pfizer	Italy	1962
Renese	Pfizer	France	1965
Envarese	Pfizer	France	—
Minizide	Pfizer	U.S.	—
Nephril	Pfizer	U.K.	—
Polyregulon	Yamanouchi	Japan	—
Toleran	Medica	Finland	—

Raw Materials

Mercaptoacetaldehyde dimethylacetal
 Sodium
 Trifluoroethyl iodide
 4-Amino-2-chloro-5-(methylsulfamyl)benzenesulfonamide

Manufacturing Process

(A) *Preparation of Trifluoroethylthioacetaldehyde Dimethylacetal:* To 4.6 g (0.2 mol) of metallic sodium dissolved in 75 ml of absolute methanol is rapidly added 24.4 g (0.2 mol) of mercaptoacetaldehyde dimethylacetal followed by dropwise addition of 42.0 g (0.2 mol) of trifluoroethyl iodide.

The resulting reddish mixture is refluxed on a steam bath for one hour. One half of the alcohol is removed by concentration and the remainder diluted with several volumes of water and extracted with ether. The combined ether extracts are dried over sodium sulfate, the ether then removed at reduced pressure and the residue distilled to about 30 g (BP 82°C/25 mm).

(B) *Preparation of 4-Amino-2-Chloro-5-(Methylsulfamyl)Benzenesulfonamide:* The 5-substituted-2,4-disulfamyl anilines may be prepared by procedures described in the literature, for example, the general procedures in *Monatsch. Chem.* vol. 48, p 87 (1927), which involves the treatment of a m-substituted aniline with from 10 to 20 parts by weight of chlorosulfonic acid followed by the gradual addition of from about 90 to 170 parts by weight of sodium chloride. The resultant mixture is heated at approximately 150°C for about 2 hours after which the reaction mixture is poured into water and the resultant 5-substituted aniline-2,4-disulfonyl chloride is filtered and is then treated with concentrated ammonium hydroxide or suitable amine by standard procedures to obtain the corresponding disulfonamide.

(C) *Preparation of 2-Methyl-3-(2,2,2-Trifluoroethyl)Thiomethyl-6-Chloro-7-Sulfamyl-3,4-Dihydro-1,2,4-Benzothiadiazine-1,1-Dioxide:* To 4.6 g (0.015 mol) of 4-amino-2-chloro-5-(methylsulfamyl)benzenesulfonamide in 30 ml of the dimethyl ether of ethylene glycol is added 4.08 g (0.02 mol) of 2,2,2-trifluoroethylmercaptoacetaldehyde dimethylacetal followed by 1 ml of ethyl acetate saturated with hydrogen chloride gas. The resulting solution is refluxed for 1.5 hours, cooled and then slowly added to cold water dropwise with stirring. The crude product is filtered, dried and recrystallized from isopropanol (3.2 g), MP 202° to 202.5°C. A second recrystallization from isopropanol raised the MP to 202° to 203°C.

References

Merck Index 7457
 Kleeman & Engel p. 743
 PDR pp. 1409, 1421
 OCDS Vol. 1 p. 360 (1977)
 I.N. p. 791
 REM p. 940
 McManus, J.M.; U.S. Patent 3,009,911; November 21, 1961; assigned to Chas. Pfizer & Co., Inc.

POVIDONE-IODINE

Therapeutic Function: Topical antiinfective

Chemical Name: 1-Ethenyl-2-pyrrolidinone homopolymer compound with iodine

Common Name: PVP-I

Structural Formula:

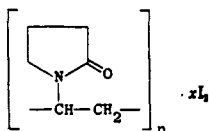

Chemical Abstracts Registry No.: 25655-41-8

Trade Name	Manufacturer	Country	Year Introduced
Betadine	Purdue Frederick	U.S.	1957
Betadine	Sarget	France	1970
Efodine	Fougera	U.S.	1978
Vagidine	Beecham	U.S.	1981
Clinidine	Clinipad	U.S.	1982
Mallisol	Mallard	U.S.	1983
ACU-Dyne	Acme	U.S.	—
Batticon	Trommsdorff	W. Germany	—
Betadine Ginecologico	Chinoi	Italy	—
Betaisodona	Mundipharma	Austria	—
Braunol	Braun	W. Germany	—
Chem-O-Dine	Remedia	S. Africa	—
Difexon	Bago	Argentina	—
Disadine	Stuart	U.K.	—
Isodine	Purdue Frederick	U.S.	—
Jodobac	Bode	W. Germany	—
Jodocur	Farm, Milanese	Italy	—
Neojodin	Iwaki	Japan	—
Nutradine	Restan	S. Africa	—
Pevidine	Berk	U.K.	—
Polydine	Fischer	Israel	—
Povadyne	Chaston	U.S.	—
Proviiodine	Rougier	Canada	—
Summer's Eve	Fleet	U.S.	—
Topionic	Rius	Spain	—

Raw Materials

Polyvinylpyrrolidone
Iodine

Manufacturing Process

12 g of dry polyvinylpyrrolidone having a K value of 90 (water content about 2 to 3%) was added to 6 g of solid iodine crystals in a glass bottle containing a few pebbles and beads. This was rolled for 3 days on a roller mill with occasional manual stirring to loosen the material caked on the sides of the bottle. Analysis showed that the thus-obtained product contained 35.4% total iodine and 31.91% available iodine. The material was heat-treated at 95°C for 64 hours in a closed glass bottle with occasional stirring. On completion of this treatment, analysis showed that the material contained 35.3% total iodine, 25.7% available iodine, according to U.S. Patent 2,706,701.

References

Merck Index 7595

PDR pp. 880, 888, 1432

DOT 7 (4) 149 (1971)

I.N. p. 793

REM p. 1164

Beller, H. and Hosmer, W.A.; U.S. Patent 2,706,701; April 19, 1955; assigned to General Aniline & Film Corporation

Hosmer, W.A.; U.S. Patent 2,826,532; March 11, 1958; assigned to General Aniline & Film Corporation

Siggia, S.; U.S. Patent 2,900,305; August 18, 1959; assigned to General Aniline & Film Corporation

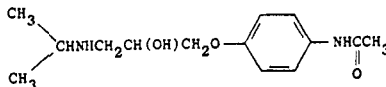
PRACTOLOL**Therapeutic Function:** Antiarrhythmic**Chemical Name:** N-[4-[2-hydroxy-3-[(1-methylethyl)amino]propoxy]phenyl]acetamide**Common Name:** 1-(4-Acetamidophenoxy)-3-isopropylamino-2-propanol**Structural Formula:****Chemical Abstracts Registry No.:** 6673-35-4

Trade Name	Manufacturer	Country	Year Introduced
Eraldin	I.C.I.	U.K.	1970
Eraldin	I.C. Pharma	Italy	1972
Dalzic	Rhein/Pharma	W. Germany	1973
Eraldine	I.C.I. Pharma	France	1973
Cardiol	Orion	Finland	—
Pralon	Farmos	Finland	—

Raw Materials

4-Acetamidophenol
 Epichlorohydrin
 Isopropylamine

Manufacturing Process

The 1-(4-acetamidophenoxy)-2,3-epoxypropane used as starting material may be obtained as follows. To a solution of 4.5 parts of 4-acetamidophenol and 1.5 parts of sodium hydroxide in 50 parts of water at 15°C, there is added 3.5 parts of epichlorohydrin. The mixture is stirred for 16 hours at ambient temperature, filtered and the solid residue is washed with water. There is thus obtained 1-(4-acetamidophenoxy)-2,3-epoxypropane, MP 110°C.

A mixture of 2 parts of 1-(4-acetamidophenoxy)-2,3-epoxypropane and 10 parts of isopropylamine is stirred at ambient temperature for 16 hours. The resulting solution is

evaporated to dryness under reduced pressure and the residue is crystallized from butyl acetate. There is thus obtained 1-(4-acetamidophenoxy)-3-isopropylamino-2-propanol, MP 134° to 136°C.

References

Merck Index 7597

OCDS Vol. 2 pp. 106, 108 (1980)

DOT 6 (5) 188 (1970)

I.N. p. 794

Howe, R. and Smith, L.H.; U.S. Patent 3,408,387; October 29, 1968; assigned to Imperial Chemical Industries Limited, England

PRAJMALINE BITARTRATE

Therapeutic Function: Antiarrhythmic

Chemical Name: 17R,21 α -Dihydroxy-4-propylajmalanum

Common Name: —

Structural Formula:

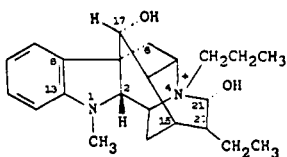

(base)

Chemical Abstracts Registry No.: 2589-47-1; 35080-11-6 (Base)

Trade Name	Manufacturer	Country	Year Introduced
Neo-Gilurtymal	Giulini	W. Germany	1973
Neo-Aritmina	Byk-Gulden	Italy	1979

Raw Materials

Ajmaline	Allyl bromide
Sodium bicarbonate	Tartaric acid

Manufacturing Process

1 g of ajmaline was dissolved in 4 cc of chloroform, and 1 cc of allyl bromide was added to the resulting solution. The reaction mixture thus obtained was allowed to stand for 24 hours at room temperature. Thereafter, the clear reaction solution was briefly cooled to a temperature below 0°C, whereby crystallization set in. The crystals were filtered off and were then recrystallized from a mixture of absolute methanol and absolute ether. The purified colorless crystalline product was identified to be N-(b)-allyl-ajmalinium-bromide having a melting point of 252°C to 254°C.

75 g of N-(b)-n-propyl-ajmalinium-bromide were suspended in 3 liters of an aqueous saturated solution of sodium bicarbonate, and the suspension was admixed with 3 liters of chloroform. The resulting mixture was vigorously stirred for six to eight hours. Thereafter, the chloroform phase was separated and evaporated to dryness. 68 g of a yellow syrup remained as a

residue. The aldehyde base was dissolved in about 150 cc of acetone and, while stirring and cooling on an ice bath, the solution was slowly admixed with a solution of 25 g of tartaric acid in 2 liters of acetone. The fine white precipitate formed thereby was separated by vacuum filtration, washed with ether and dried. The raw product, weighing 80 g, was recrystallized once from a mixture of ethanol and ether, yielding 50 g of N-(b)-n-propyl-ajmalinium hydrogen tartrate having a melting point of 149°C to 152°C (decomposition).

References

Merck Index 7598

Kleeman & Engel p. 744

I.N. p. 794

Keck, J.; U.S. Patent 3,414,577; December 3, 1968; assigned to Boehringer Ingelheim G.m.b.H. (Germany)

PRALIDOXIME CHLORIDE

Therapeutic Function: Cholinesterase reactivator (antidote for nerve gas)

Chemical Name: 2-[(Hydroxyimino)methyl]-1-methylpyridinium chloride

Common Name: 2-PAM chloride

Structural Formula:

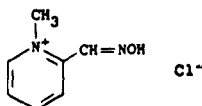

Chemical Abstracts Registry No.: 51-15-0; 495-94-3 (Base)

Trade Name	Manufacturer	Country	Year Introduced
Contrathion	Specia	France	1961
Protopam	Ayerst	U.S.	1964
Combo Pen	Rodana Res. Corp.	U.S.	-

Raw Materials

2-Pyridinealdoxime	Dimethyl sulfate
α -Picoline	Methyl chloride
Nitrosyl chloride	Sodium hydroxide

Manufacturing Process

As described in U.S. Patent 3,123,613, the preparation of the intermediate product, 2-pyridinealdoxime methomethylsulfate, is as follows. 1 kg of 2-pyridinealdoxime is dissolved in 6 liters of acetone and filtered until clear. 2 kg (2 equivalents) of freshly distilled dimethyl sulfate are added and the solution mixed. In about 30 minutes crystals start to appear, after which a cooling bath is used to keep the temperature at about 30° to 35°C until the reaction is nearly complete (about 2 hours).

The mixture is allowed to stand at room temperature overnight, the crystals filtered off and washed on a filter with acetone. The product is obtained as colorless needles, which melt at 111° to 112.5°C. The methylsulfate is not stable indefinitely. For preparation of pure chloride salt it is desirable to use methylsulfate which gives no titratable acidity with sodium hydroxide using bromophenol blue as indicator.

10 g of 2-pyridinealdoxime methomethylsulfate are then dissolved in 6 cc of concentrated hydrochloric acid, and 60 cc of isopropanol is added with stirring. Crystals appear almost instantly. After 2 hours standing at room temperature, the crystals are separated by filtration and washed with acetone. The product had a melting point of 227° to 228°C and the yield was 85%.

An alternative route is described in U.S. Patent 3,155,674.

(A) Preparation of 1-Methyl-2-Picolinium Chloride: 98 ml of α -picoline is dissolved in 200 ml of methanol, cooled and 85 ml (at -68°C) of methyl chloride is added. The solution is charged to an autoclave, sealed and the nitrogen pressure of 300 psig is established. The mixture is heated at 120° to 130°C for 2 hours, cooled and opened. The resulting solution is then evaporated to dryness in vacuo, yielding a residue of 110 g. This residue is then dissolved in 50 ml of water and extracted with two 50 ml portions of ether. The aqueous phase is then diluted to 150 ml with water and an assay for ionic chloride is performed which indicates the presence of chloride ion equivalent to 721 mg/ml of 1-methyl-2-picolinium chloride.

(B) Preparation of 2-(Hydroxyiminomethyl)-1-Methyl Pyridinium Chloride: An aqueous solution of 15 ml of 1-methyl-2-picolinium chloride having a concentration of 477 mg/ml is covered with 50 ml of benzene in an atmosphere of nitrogen and cooled to below 10°C. An aqueous solution of sodium hydroxide is added dropwise and the mixture is stirred for 5 minutes and allowed to stratify. The aqueous phase is then drawn off and the benzene solution is added slowly to a solution of 3 ml of nitrosyl chloride in 175 ml of benzene containing 0.5 ml of dimethyl formamide at about 10°C in an atmosphere of nitrogen with good agitation. The mixture is then stirred for 1.5 hours and then extracted with four 5 ml of portions of water. The aqueous extracts are then concentrated in vacuo, 30 ml of isopropanol is added and the concentration is repeated. 20 ml of isopropanol is then added to the concentrated mixture, and the mixture is cooled to room temperature and filtered, yielding 3.04 g of crude 2-(hydroxyiminomethyl)-1-methyl pyridinium chloride, melting at 202° to 214°C with decomposition. The filtrate is then further concentrated to a 7 g residue which is crystallized from absolute alcohol and yields 0.9 g of 2-(hydroxyiminomethyl)-1-methyl pyridinium chloride melting at 221° to 225°C with decomposition.

References

Merck Index 7599

Kleeman & Engel p. 744

PDR p. 648

I.N. p. 794

REM p. 901

Bloch, L.P.; U.S. Patent 3,123,613; March 3, 1964; assigned to Campbell Pharmaceuticals, Inc.

Ellin, R.I., Easterday, D.E. and Kondritzer, A.A.; U.S. Patent 3,140,289; July 7, 1964; assigned to the U.S. Secretary of the Army

McDowell, W.B.; U.S. Patent 3,155,674; November 3, 1964; assigned to Olin Mathieson Chemical Corporation

PRAMIVERIN

Therapeutic Function: Antispasmodic

Chemical Name: N-(1-Methylethyl)-4,4-diphenylcyclohexanamine

Common Name: Primaverine; propaminodiphen

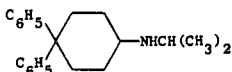
Structural Formula:

Chemical Abstracts Registry No.: 14334-40-8; 14334-41-9 (Hydrochloride)

Trade Name	Manufacturer	Country	Year Introduced
Sistalgin	Bracco	Italy	1974
Sistalgin	Cascan	W. Germany	1976

Raw Materials

4,4-Diphenyl-cyclohexen-(2)-one
 Isopropylamine
 Hydrogen

Manufacturing Process

20 g 4,4-diphenyl-cyclohexen-(2)-one, 10 g isopropylamine, and 50 ml tetrahydrofuran are agitated for 10 hours in a bomb tube at 200°C. Subsequently, the reaction mixture is cooled, and the tetrahydrofuran and the excess isopropylamine are distilled off. The remaining Schiff base is dissolved in methanol and after the addition of 2 g platinum oxide, the base is hydrogenated at normal pressure and room temperature until a quantity of hydrogen corresponding to 2 mols has been absorbed.

The mixture is filtered off from the catalyst, made acidic with dilute hydrochloric acid, and the methanol is removed under vacuum. The remaining aqueous solution is made alkaline with solution of sodium hydroxide and extracted with ether. After drying and concentrating the ether extract, there is obtained 17 g 1-isopropylamino-4,4-diphenyl-cyclohexane, boiling point 164°C to 165°C/0.05 mm. The hydrochloride melts at 230°C.

References

Merck Index 7602

Kleeman & Engel p. 745

DOT 11 (8) 320 (1975)

I.N. p. 795

Unger, R., Sommer, S., Schorscher, E. and Encakel, H.J.; U.S. Patent 3,376,312; April 2, 1968; assigned to E. Merck A.G. (Germany)

PRAMOXINE HYDROCHLORIDE

Therapeutic Function: Topical anesthetic

Chemical Name: 4-[3-(4-Butoxyphenoxy)propyl] morpholine hydrochloride

Common Name: Pramocaine hydrochloride; proxazocain hydrochloride

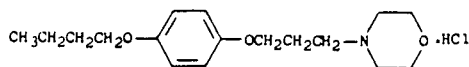
Structural Formula:

Chemical Abstracts Registry No.: 637-58-1; 140-65-8 (Base)

Trade Name	Manufacturer	Country	Year Introduced
Tronothane	Abbott	U.S.	1954
Tronothane	Abbott	France	1956
Proctofoam	Reed Carnrick	U.S.	1975
Prax	Ferndale	U.S.	1980
Analpram	Ferndale	U.S.	—
Anusol	Parke Davis	U.S.	—
F.E.P.	Boots	U.S.	—
Fleet Relief	Fleet	U.S.	—
Otic-HC	Hauck	U.S.	—
Pramosone	Ferndale	U.S.	—
Tronolane	Ross	U.S.	—
Zone-A	U.A.D. Labs	U.S.	—

Raw Materials

Hydroquinone monobutyl ether	γ -Morpholinopropyl chloride
Potassium hydroxide	Hydrogen chloride

Manufacturing Process

About 5.6 g of potassium hydroxide is dissolved in about 150 cc of refluxing ethanol, and then about 16.6 g of hydroquinone monobutyl ether is added to the alcoholic solution. When the hydroquinone is dissolved, about 16.3 g of γ -morpholinopropyl chloride (dissolved in a small amount of ethanol) is added to the refluxing solution. The solution is refluxed for about 24 hours and then cooled. The product is recovered by filtering the reaction mixture and then removing the solvent by vacuum distillation. The oily residue is acidified and shaken with ether. The acidic phase is made strongly alkaline with 40% sodium hydroxide, and the oil which separates is extracted into ether. The ethereal phase is dried, and the solvent removed by vacuum distillation. The product distills at 183° to 184°C at a pressure of 2.8 mm. The hydrochloride salt of the foregoing base is prepared by dissolving the base in ether and acidifying with hydrochloric acid and is found to have a MP of 181° to 183°C.

References

- Merck Index 7603
 Kleeman & Engel p. 745
 PDR pp. 684, 875, 880, 928, 1316, 1565, 1808
 OCDS Vol. 1 p. 18 (1977)
 I.N. p. 795
 REM p. 1057
 Wright, H.B. and Moore, M.B.; U.S. Patent 2,870,151; January 20, 1959; assigned to Abbott Laboratories

PRANOPROFEN

Therapeutic Function: Analgesic, antiinflammatory

Chemical Name: 2-(5H-[1]benzopyrano[2,3-b]-pyridin-7-yl)propionic acid

Common Name: —

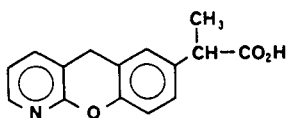
Structural Formula:

Chemical Abstracts Registry No.: 52549-17-4

Trade Name	Manufacturer	Country	Year Introduced
Niflan	Yoshitomi	Japan	1981

Raw Materials

Ethyl 2-cyano-2-(5H-[1]benzopyrano[2,3-b]-pyridin-7-yl)propionate
Hydrogen chloride

Manufacturing Process

A mixture of 100 g of ethyl 2-cyano-2-(5H-[1]benzopyrano[2,3-b]-pyridin-7-yl)propionate, 500 ml of glacial acetic acid and 200 g of concentrated hydrochloric acid is refluxed for 48 hours. The reaction mixture is concentrated, and the residue is dissolved in hot water. The solution is adjusted to pH 2 to 3 by addition of 10% sodium hydroxide. The resulting crystalline precipitate is washed thoroughly with water, and recrystallized from aqueous dioxane to give 74 g of 2-(5H-[1]benzopyrano[2,3-b]-pyridin-7-yl)propionic acid as white crystals melting at 183°C to 183.5°C.

References

Merck Index 7604

DFU 2 (3) 217 (1977) (As Y-8004) & 2 (12) 829 (1977)

Nakanishi, M., Oe, T. and Tsuruda, M.; U.S. Patent 3,931,205; January 6, 1976; assigned to Yoshitomi Pharmaceutical Industries, Ltd.

PRAZEPAM

Therapeutic Function: Tranquilizer

Chemical Name: 7-Chloro-1-(cyclopropylmethyl)-1,3-dihydro-5-phenyl-2H-1,4-benzodiazepin-2-one

Common Name: —

Structural Formula:

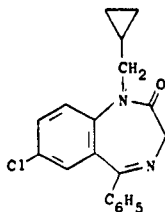

Chemical Abstracts Registry No.: 2955-38-6

Trade Name	Manufacturer	Country	Year Introduced
Demetrin	Goedecke	W. Germany	1973
Centrax	Parke Davis	U.S.	1977
Demetrin	Cosmopharm	Switz.	1978
Lysanxia	Substantia	France	1979
Prazene	Parke Davis	Italy	1980
Trepidan	Sigma Tau	Italy	1980
Centrax	Warner William	U.K.	1981
Demetrin	Parke Davis	France	1982
Reapam	Goedecke	W. Germany	—
Verstran	Warner-Chilcott	U.S.	—

Raw Materials

2-Amino-5-chlorobenzophenone	Lithium aluminum hydride
Cyclopropane carboxylic acid chloride	Manganese dioxide
Phthalimidoacetyl chloride	Hydrazine hydrate

Manufacturing Process

Preparation of 2-Cyclopropylcarbonylamido-5-Chlorobenzophenone: To 400.5 g (1.73 mols) of 2-amino-5-chlorobenzophenone dissolved in 220 g (2.18 mols) of triethylamine and 3.5 liters of tetrahydrofuran is added cautiously 181 g (1.73 mols) of cyclopropane-carboxylic acid chloride. The reaction is refluxed 2½ hours and allowed to cool to room temperature. The solvent is then removed under vacuum to obtain 2-cyclopropylcarbonylamido-5-chlorobenzophenone as a residue which is dissolved in 1 liter of methylene chloride, washed twice with 5% hydrochloric acid, and then twice with 10% potassium hydroxide. The methylene chloride solution is then dried over anhydrous magnesium sulfate, filtered and the solvent removed under vacuum. The residue is recrystallized from 1,500 ml of methanol, charcoal-treating the hot solution to give 356 g of 2-cyclopropylcarbonylamido-5-chlorobenzophenone, MP 105° to 105.5°C (69% yield).

Preparation of 2-Cyclopropylmethylamino-5-Chlorobenzhydrol: To a slurry of 94.8 g (2.47 mols) of lithium aluminum hydride in 1.2 liters of tetrahydrofuran is added with stirring a solution of 356 g (1.18 mols) of 2-cyclopropylcarbonylamido-5-chlorobenzophenone in 1.8 liters of tetrahydrofuran. The addition takes 80 minutes while maintaining gentle refluxing, and the reaction mixture is then refluxed overnight and allowed to cool to room temperature over a period of 3 days. The complex formed in the reaction mixture is then hydrolyzed with water.

During the hydrolysis, 500 ml of tetrahydrofuran is added to facilitate stirring. At a point where the flocculant white precipitate settles quickly when stirring is interrupted, the mixture is filtered, the filter cake washed with solvent, the combined filtrates dried over magnesium sulfate, filtered and the solvent removed under vacuum to obtain 2-cyclopropylmethylamino-5-chlorobenzhydrol as a residue. The residue is recrystallized from 1,300 ml of Skelly B, giving 315 g of 2-cyclopropylmethylamino-5-chlorobenzhydrol, MP 85° to 85.5°C (93% yield).

Preparation of 2-Cyclopropylmethylamino-5-Chlorobenzophenone: To a solution of 315 g (1.09 mols) of 2-cyclopropylmethylamino-5-chlorobenzhydrol in 4 liters of benzene is added 453.6 g (5.22 mols) of manganese dioxide, freshly prepared according to the method of Attenburrow et al, *J.C.S.* 1952, 1104. The mixture is then refluxed for 1¼ hours, filtered, and the filtrate evaporated under vacuum. The reddish residue is recrystallized from 510 ml of 90% acetone-10% water, giving 181 g of pure 2-cyclopropylmethylamino-5-chlorobenzophenone, MP 79° to 80°C (58% yield). Upon concentration of the mother liquor a second crop of 2-cyclopropylmethylamino-5-chlorobenzophenone weighing 34.1 g and melting at 76.5°-78°C are obtained.

Preparation of 2-(N-Phthalimidoacetyl-N-Cyclopropylmethyl)-Amino-5-Chlorobenzophenone:

To a solution of 36.0 g (0.126 mol) of 2-cyclopropylmethylamino-5-chlorobenzophenone in 500 ml of tetrahydrofuran is added 50.7 g (0.252 mol) of phthalimidoacetyl chloride. The resulting solution is refluxed for 16 to 24 hours, the solvent removed under vacuum, the residual oil crystallized from 200 ml of ethanol and recrystallized from 500 ml of 80% ethanol-20% tetrahydrofuran giving 44.7 g of 2-(N-phthalimidoacetyl-N-cyclopropylmethyl)-amino-5-chlorobenzophenone, MP 163° to 164°C (75% yield).

Preparation of 1-Cyclopropylmethyl-5-Phenyl-7-Chloro-1H-1,4-Benzodiazepine-2(3H)-one:

To a solution of 39.5 g (0.0845 mol) of 2-(N-phthalimidoacetyl-N-cyclopropylmethyl)amino-5-chlorobenzophenone in a mixture of 423 ml of chloroform and 423 ml of ethanol is added 9.52 g (0.1903 mol) of hydrazine hydrate and 9.52 ml of water. This solution is allowed to stand at room temperature. In 3 hours a precipitate begins to form in the solution. After standing 16 to 24 hours a voluminous pulpy white precipitate forms. The solvents are removed under vacuum while keeping the temperature under 40°C and the residue is partitioned between dilute ammonia water and ether.

The aqueous layer is separated and washed with ether, the ether extracted with 5% hydrochloric acid, the acidic solution is made basic with 10% sodium hydroxide and again extracted with ether. Since some spontaneous crystallization occurs in the ether, the solvent is removed without drying under vacuum and the residue is recrystallized from 35 ml of ethanol giving 18.0 g of 1-cyclopropylmethyl-5-phenyl-7-chloro-1H-1,4-benzodiazepine-2(3H)-one, MP 145° to 146°C (65% yield), according to U.S. Patent 3,192,199.

References

Merck Index 7608

Kleeman & Engel p. 747

PDR p. 1320

OCDS Vol. 2 p. 405 (1980)

DOT 2 (3) 119 (1966); 9 (6) 237 (1973); & 10 (5) 179 (1974)

I.N. p. 796

REM p. 1063

McMillan, F.H. and Pattison, I.; U.S. Patent 3,192,199; June 29, 1965

Wuest, H.M.; U.S. Patent 3,192,200; June 29, 1965

PRAZICQUANTEL

Therapeutic Function: Anthelmintic

Chemical Name: 2-(Cyclohexylcarbonyl)-1,2,3,6,7,11b-hexahydro-4H-pyrazino[2,1-a]isoquinolin-4-one

Common Name: —

Structural Formula:

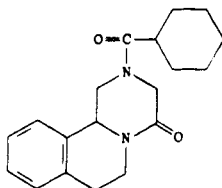

Chemical Abstracts Registry No.: 55268-74-1

Trade Name	Manufacturer	Country	Year Introduced
Cesol	Merck	W. Germany	1980
Biltricide	Bayer	W. Germany	1980
Cenaride	Merck Clevenot	France	1981
Biltricide	Bayer	France	1983
Biltricide	Miles	U.S.	1983
Droncit	Bayvet	U.S.	—

Raw Materials

2-Cyclohexylcarbonyl-4-oxo-2,3,6,7-tetrahydro-4H-pyrazino[2,1-a]isoquinoline
Hydrogen

Manufacturing Process

15 g of a nickel-aluminum alloy (1:1) is introduced in incremental portions and under agitation into 200 ml of 20% sodium hydroxide solution within 5 minutes; the mixture is maintained at 80°C for 45 minutes, then allowed to settle, decanted off, washed with water, and 1,000 ml of 1% (—)-tartaric acid solution is added thereto, adjusted to pH 5 with 1 N sodium hydroxide solution. The mixture is heated under agitation for 90 minutes to 80°C, decanted, and washed with water and methanol. The thus-obtained (—)-tartaric acid-Raney nickel catalyst is added to a solution of 2-cyclohexylcarbonyl-4-oxo-2,3,6,7-tetrahydro-4H-pyrazino[2,1-a]isoquinoline. The reaction mixture is hydrogenated under normal pressure and at room temperature. After the catalyst has been filtered off and the solvent evaporated, 2-cyclohexylcarbonyl-4-oxo-1,2,3,6,7,11b-hexahydro-4H-pyrazino[2,1-a]isoquinoline, melting point 136°C to 138°C, is produced.

References

Merck Index 7609

Kleeman & Engel p. 748

PDR p. 1249

DOT 13 (3) 121 (1977) & 17 (10) 429 (1981)

I.N. p. 796

REM p. 1237

Seubert, J., Thomas, H. and Andrews, P.; U.S. Patent 4,001,411; January 4, 1977; assigned to Merck Patent G.m.b.H. (Germany)

PRAZOSIN

Therapeutic Function: Antihypertensive

Chemical Name: 1-(4-Amino-6,7-dimethoxy-2-quinazolinyl)-4-(2-furanylcarbonyl)piperazine

Common Name: Furazosin

Structural Formula:

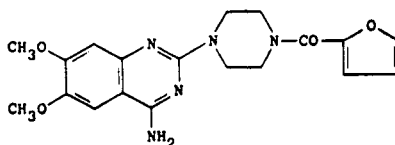

Chemical Abstracts Registry No.: 19216-56-9; 19237-84-4 (Hydrochloride)

Trade Name	Manufacturer	Country	Year Introduced
Hypovase	Pfizer	U.K.	1974
Minipress	Pfizer	U.S.	1976
Minipress	Pfizer	W. Germany	1977
Minipress	Pfizer	Italy	1978
Minipress	Pfizer	France	1979
Minipress	Pfizer Taito	Japan	1981
Adversuten	Arzneimittelwerk Dresden	E. Germany	—
Orbisan	Mack	W. Germany	—
Pratsiol	Orion	Finland	—
Prazac	Ercos	Denmark	—
Sinetens	Carlo Erba	U.K.	—
Vasoflex	Alkaloid	Yugoslavia	—

Raw Materials

2,4-Dichloro-6,7-dimethoxyquinazoline	Ammonia
Piperazine	2-Furoyl chloride

Manufacturing Process

Preparation of 2-Chloro-4-Amino-6,7-Dimethoxyquinazoline: To 800 ml of a solution of anhydrous ammonia in tetrahydrofuran at room temperature is added 30 g of 2,4-dichloro-6,7-dimethoxyquinazoline [F.H.S. Curd et al, *J. Chem. Soc.*, p 1759 (1948)]. The mixture is stirred for 44 hours. The precipitate (29 g, MP 267° to 268°C) is filtered and recrystallized from methanol to yield 19 g of 2-chloro-4-amino-6,7-dimethoxyquinazoline, MP 302°C (dec.).

Preparation of 2-(1-Piperaziny)-4-Amino-6,7-Dimethoxyquinazoline: To 5 g of 2-chloro-4-amino-6,7-dimethoxyquinazoline, is added 20 g of a 25% solution of piperazine in ethanol. The mixture is heated at 160°C for 16 hours in a pressure bottle. The solvent is then evaporated and the residue is recrystallized from methanol/water.

Preparation of 2[4-(2-Furoyl)-Piperaziny]-4-Amino-6,7-Dimethoxyquinazoline: To 0.10 mol 2-(1-piperaziny)-4-amino-6,7-dimethoxyquinazoline in 300 ml methanol is added with vigorous stirring, 0.10 mol 2-furoyl chloride. After addition is complete, the mixture is stirred for 3 hours at room temperature. The solids are filtered to give the desired product, MP 278° to 280°C.

References

- Merck Index 7610
- Kleeman & Engel p. 748
- PDR pp. 1420, 1421
- OCDS Vol. 2 p. 382 (1980) & 3, 194 (1984)
- DOT 11 (2) 67, 80 (1975)
- I.N. p. 796
- REM p. 844
- Hess, H.-J.E.; U.S. Patent 3,511,836; May 12, 1970; assigned to Chas. Pfizer & Co., Inc.

PREDNIMUSTINE

Therapeutic Function: Cancer chemotherapy

Chemical Name: Prednisolone 21-[4'-[p-bis(2-chloroethyl)amino] phenyl] butyrate

Common Name: Prednisolone chlorambucil ester

Structural Formula:

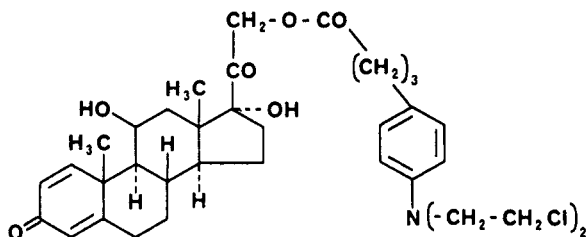

Chemical Abstracts Registry No.: 29069-24-7

Trade Name	Manufacturer	Country	Year Introduced
Stereocyt	Bellon	France	1978
Stereocyt	Leo	Switz.	1981
Mostarina	Abello	Spain	—

Raw Materials

p-[N-Bis(β-chloroethyl)amino] phenyl butyric acid
Thionyl chloride
Prednisolone

Manufacturing Process

p-[N-bis(β-chloroethyl)amino] phenyl butyric acid was dissolved in a mixture of 150 ml dry benzene and 8.04 ml dry pyridine. The solution was cooled in an ice bath, and a solution of thionyl chloride in 30 ml dry benzene was slowly added with stirring under anhydrous conditions.

The reaction mixture was then kept at room temperature for 1 hour and thereafter poured into a mixture of 5.0N HCl and crushed ice. The benzene solution was immediately washed with water, with cold 1.0N NaHCO₃ and finally with cold water. After drying over anhydrous sodium sulfate, the benzene was removed in vacuo. The residue is the p-[N-bis(β-chloroethyl)-amino] phenyl butyric anhydride which could be used without any further purification.

To a solution of 42.0 g of p-[N-bis(β-chloroethyl)amino] phenyl butyric anhydride in 500 ml dry pyridine was added 24.4 g of prednisolone. The reaction mixture was kept at room temperature for 24 hours under anhydrous condition. It was then poured into a mixture of concentrated HCl and crushed ice and extracted with ether-ethyl acetate (1:1).

The organic phase was washed several times with cold 1.0N K₂CO₃ and finally water. After drying over CaCl₂ the solvent was removed in vacuo.

The residue is prednisolone 21-[4'-[p-bis(β-chloroethyl)amino] phenyl] butyrate which after crystallization from methanol/water had a melting point of 163°C to 164°C.

References

Merck Index 7612
DFU 1 (3) 137 (1976)
Kleeman & Engel p. 749
OCDS Vol. 3 p. 93 (1984)
DOT 16 (3) 84 (1980)

I.N. p. 797

Fox, H.J., Hogberg, K.B. and Konyves, I.; U.S. Patent 3,732,260; May 8, 1973; assigned to A.B. Leo

PREDNISOLONE

Therapeutic Function: Glucocorticoid

Chemical Name: 11 β ,17,21-Trihydroxypregna-1,4-diene-3,20-dione

Common Name: Metacortandralone; Δ^1 -hydrocortisone

Structural Formula:

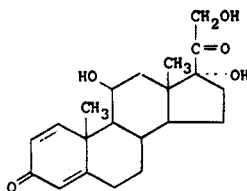

Chemical Abstracts Registry No.: 50-24-8

Trade Name	Manufacturer	Country	Year Introduced
Sterane	Pfizer	U.S.	1955
Meticortelone	Schering	U.S.	1955
Delta-Cortef	Upjohn	U.S.	1955
Hydeltra	MSD	U.S.	1955
Paracortol	Parke Davis	U.S.	1957
Sterolone	Rowell	U.S.	1957
Prednis	U.S.V. Pharm.	U.S.	1957
Ulacort	Fellows-Testagar	U.S.	1960
Cosilone	Person Covey	U.S.	1963
Adnisolone	Adams	Australia	—
Aprednisolone	Arcana	Austria	—
Caberdelta	Caber	Italy	—
Cordrol	Vita Elixir	U.S.	—
Cortalone	Halsey	U.S.	—
Cortisolone	S.I.T.	Italy	—
Cotolone	Truxton	U.S.	—
Dacortin	Igoda	Spain	—
Decaprednil	Dorsch	W. Germany	—
Decortasmyl	Larec	Ecuador	—
Delta-Hycortol	Medica	Finland	—
Delta-Larma	Larma	Spain	—
Deltalone	D.D.S.A.	U.K.	—
Deltasolone	Knoll	Australia	—
Deltidrosol	Poli	Italy	—
Deltisolone	Ferring	Sweden	—
Domucortone	Medici Domus	Italy	—
Encortolone	Polfa	Poland	—
Fernisolone	Ferndale	U.S.	—
Ibisterolone	I.B.I.	Italy	—
Keteocort-H	Desitin	W. Germany	—
Neodelta	Amelix	Italy	—

Trade Name	Manufacturer	Country	Year Introduced
Normosona	Normon	Spain	—
Novoprednisolone	Novopharm	Canada	—
Panafcortelone	Glebe	Australia	—
Predartrina	Farmochimica	Italy	—
Prednicen	Central	U.S.	—
Predni-Coelin	Pfleger	W. Germany	—
Prednicort	Cortec	Denmark	—
Predni-Helvacort	Helvepharm	Switz.	—
Predni-H-Tabliten	Sanorania	W. Germany	—
Predniretard	Boots-Dacour	France	—
Prelone	Langley	Australia	—
Ropredlone	Robinson	U.S.	—
Scherisolon	Schering	W. Germany	—
Seriflone	Serpero	Italy	—
Stermin	Schlicksup	U.S.	—
Vitacort	Vitarine	U.S.	—

Raw Materials

Bacterium *Corynebacterium simplex*
Hydrocortisone

Manufacturing Process

The following procedure is described in U.S. Patent 2,837,464: from a solution of 3 grams of yeast extract (Difco) in 3.0 liters of tap water containing 13.2 grams of potassium dihydrogen phosphate and 26.4 grams disodium hydrogen phosphate (pH of the solution, 6.9) 27 portions of 100 ml each are withdrawn, placed in 300 ml Erlenmeyer flasks and sterilized by autoclaving for 15 minutes at 15 pounds steam pressure (120°C). After autoclaving and cooling of the broth, one ml of suspension of *Corynebacterium simplex* (ATCC 6946) is placed in each flask. The flasks are then shaken on a shake table at 220 rpm and 28°C for 24 hours.

Into each of 27 Erlenmeyer flasks are placed 150 mg of Kendall's Compound F (hydrocortisone). The flasks and contents are then sterilized for 15 minutes at 15 pounds steam pressure (120°C). To each flask are then added 5.0 ml of ethanol. The 24-hour bacterial culture is then transferred aseptically and the resulting suspensions are shaken on a shake table at 220 rpm and 28°C for 48 hours. The pH at the end of the shake period is 7.0.

The contents of all the flasks are combined and extracted with a total of 9.0 liters of chloroform in 3 equal portions. The combined extracts are then concentrated to a residue which weighs 3.75 grams. The MP of the residue is 227°-232°C. From 2.75 grams of this crude material on sludging with 50 ml of acetone and cooling, there is recovered on filtration 1.35 grams of $\Delta^{1,4}$ -pregnadiene-11 β ,17 α ,21-triol-3,20-dione, MP 237°-239°C (dec.). Additional product can be recovered from the mother liquor. Recrystallization from acetone raised the MP to 239°-241°C (dec.).

References

Merck Index 7613

Kleeman & Engel p. 750

PDR pp. 830, 1569, 1606

OCDS Vol. 1 p. 192 (1977) & 2, 178 (1980)

I.N. p. 797

REM p. 969

Nobile, A.; U.S. Patent 2,837,464; June 3, 1958; assigned to Schering Corporation

Oliveto, E.P. and Gould, D.H.; U.S. Patent 2,897,216; July 28, 1959; assigned to Schering Corporation

PREDNISOLONE ACETATE

Therapeutic Function: Glucocorticoid

Chemical Name: 11 β ,17,21-Trihydroxypregna-1,4-diene-3,20-dione 21-acetate

Common Name: —

Structural Formula:

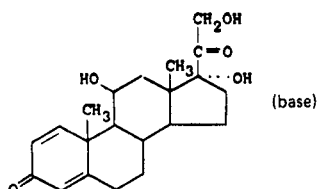

Chemical Abstracts Registry No.: 52-21-1

Trade Name	Manufacturer	Country	Year Introduced
Sterane	Phipharmex	U.S.	1955
Nisolone	Ascher	U.S.	1962
Savacort	Savage	U.S.	1969
Econapred	Alcon	U.S.	1973
Pred Mild	Allergan	U.S.	1974
Pred Cor 100	Hauck	U.S.	1977
Alto-Pred	Alto	U.S.	—
Cortipred	Italsuisse	Italy	—
Deitacortilen	S.I.F.I.	Italy	—
Dermo-Nydol	Brichard	France	—
Durapred	Federal	U.S.	—
Hexacorton	Spirig	Switz.	—
Ibisterolon-Pommada	I.B.I.	Italy	—
Inflanefran	Allergan	W. Germany	—
Key-Pred	Hyrex	U.S.	—
Metimyd	Schering	U.S.	—
Meticortelone	Essex	Italy	—
Predate	Legere	U.S.	—
Predicort	Dunhall	U.S.	—
Prednifor	Vifor	Switz.	—
Prenema	Nortech	U.S.	—
Pricortin	Premedics	U.S.	—
Sigpred	Sig	U.S.	—
Ulacort	Fellows-Testagar	U.S.	—
Ultracortenol	Dispersa	Switz.	—

Raw Materials

Prednisolone
Acetic anhydride

Manufacturing Process

To a solution of 0.85 gram of 1,4-pregnadiene-11 β ,17 α ,21-triol-3,20-dione (prednisolone) in 5 ml of pyridine are added 3 ml of acetic anhydride. The reaction mixture is allowed to stand at room temperature overnight and is then diluted with ice water. The resulting precipitate is filtered from the mixture and recrystallized from acetone-hexane. There is recovered 0.45 gram of 1,4-pregnadiene-11 β ,17 α ,21-triol-3,20-dione 21-acetate, MP 235°-239°C. On recrystallization, the MP rose to 237°-239°C.

References

Merck Index 7613

Kleeman & Engel p. 750

PDR pp. 1033, 1633

OCDS Vol. 1 p. 192 (1977)

I.N. p. 798

REM p. 969

Nobile, A.; U.S. Patent 3,134,718; May 26, 1964; assigned to Schering Corporation

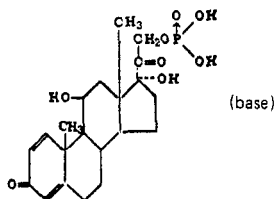
PREDNISOLONE PHOSPHATE SODIUM**Therapeutic Function:** Glucocorticoid**Chemical Name:** 11 β ,17,21-Trihydroxypregna-1,4-diene-3,20-dione 21-(dihydrogen phosphate)disodium salt**Common Name:** —**Structural Formula:****Chemical Abstracts Registry No.:** 125-02-0

Trade Name	Manufacturer	Country	Year Introduced
Hydeltrasol	MSD	U.S.	1957
Inflamase	Cooper Vision	U.S.	1969
Optival	White	U.S.	1969
PSP-IV	Tutag	U.S.	1972
Alto-Pred	Alto	U.S.	—
Caberdelta	Caber	Italy	—
Codelsol	MSD	U.K.	—
Hydrosol	Rocky Mtn.	U.S.	—
Key-Pred S.P.	Hyrex	U.S.	—
Metreton	Schering	U.S.	—
Nor-Preds	North Amer. Pharm.	U.S.	—
Parisolon	Riker	U.S.	—
Predate S	Legere	U.S.	—
Prednesol	Glaxo	U.S.	—
Savacort	Savage	U.S.	—
Sodasone	Fellows-Testagar	U.S.	—
Solucort	Chibret	France	—
Solu-Pred	Myers-Carter	U.S.	—

Raw Materials

Prednisolone	Methane sulfonyl chloride
Sodium iodide	Phosphoric acid
Sodium hydroxide	

Manufacturing Process

Preparation of Prednisolone 21-Methanesulfonate: Seventy liters of dry pyridine and 7.5 kg of prednisolone are charged to a 30-gallon jacketed glass-lined still. The mixture is agitated until complete solution is obtained. About 40 liters of pyridine are distilled at high vacuum while maintaining the batch temperature below 40°C. The solution is cooled to 0°C, and 2.2 liters of methanesulfonyl chloride are charged. The batch temperature is maintained between 0°C and +3°C during charging of the methanesulfonyl chloride. An atmosphere of flowing nitrogen is maintained in the still, and the mixture is agitated during the last stages of the addition. The mixture is then aged for one hour, and 15 gallons of ice water are added cautiously to the still while maintaining the temperature between 0° and 5°C.

The still contents are then transferred to a jacketed kettle equipped with an agitator, and 62 kg of cracked ice in 15 gallons of deionized water are added. The batch is aged one hour and a solution of 2 liters of concentrated (37%) hydrochloric acid in 4 gallons of deionized water is added. The batch is centrifuged and the centrifuge cake washed free of pyridine with deionized water. The centrifuge cake is then vacuum-dried at 50°C to a moisture content of about 1%, which requires about 3 days of drying. Yield about 7.77 kg (92%), according to U.S. Patent 2,932,657.

Preparation of Prednisolone 21-Iodide: To a 30-gallon jacketed glass-lined still 64.5 lb (31.0 liters) of dimethylformamide are charged by vacuum. The still contents are agitated as 7.74 kg of dry (less than 1% moisture) prednisolone 21-methanesulfonate are charged. Then 4.02 kg of sodium iodide are charged. The still contents are heated to 57° to 60°C by means of a steam jacket and held at this temperature for 30 minutes. The batch is cooled to 35°C and 12 gallons of deionized water are added at the rate of about 1 gallon per minute. In the event the solution becomes cloudy, addition of water is interrupted and the mixture agitated for five minutes before resumption of water addition. After all of the water is added, the batch is transferred to a 50 gallon kettle equipped with agitator and an additional 16.7 gallons of deionized water are added. The batch is cooled to 0° to 5°C and aged for one hour. The batch is filtered and the filter cake washed and vacuum dried at 30° to 35°C to a moisture content of less than 1%. Yield about 7.95 kg (96%), according to U.S. Patent 2,932,657.

Preparation of Prednisolone 21-Disodium Phosphate: Acetonitrile (50.0 ml) containing phosphoric acid (90%; 1.0 ml) was treated with triethylamine (3.0 ml) and the solution added to 11 β ,17 α -dihydroxy-21-iodopregna-1,4-diene-3,20-dione (1.0 gram; powdered). The mixture was refluxed for 2.75 hours and the solvent was then evaporated under reduced pressure to give a yellow oil. The oil was taken up in methanol (25 ml) and titrated to pH 10.9 with sodium hydroxide in methanol (N) using a pH meter. The precipitate was filtered off and the filtrate evaporated to a gum under reduced pressure. The gum was taken up in methanol (5 ml), filtered through filter paper and acetone (100 ml) was added to the filtrate. The precipitate was filtered off, washed with acetone and dried at 100°C/1 mm for 0.75 hour giving a pale yellow solid, prednisolone disodium phosphate (0.74 gram), which was completely soluble in water, according to U.S. Patent 2,936,313.

References

- Merck Index 7615
 Kleeman & Engel p. 752
 PDR pp. 1033, 1633
 I.N. p. 798
 REM p. 970
 Sarett, L.H.; U.S. Patent 2,789,117; April 16, 1957; assigned to Merck & Co., Inc.
 Christensen, B.G., Hirschmann, R.F. and Putter, I.; U.S. Patent 2,932,657; April 12, 1960; assigned to Merck & Co., Inc.
 Elks, J. and Phillipps, G.H.; U.S. Patent 2,936,313; May 10, 1960; assigned to Glaxo Laboratories Limited, England

PREDNISOLONE STEAROYLGLYCOLATE

Therapeutic Function: Glucocorticoid

Chemical Name: 11 β ,17-Dihydroxy-21-[[[(1-oxoctadecyl)oxy] acetyl] oxy] pregna-1,4-diene-3,20-dione

Common Name: Prednisolone steaglate

Structural Formula: See prednisolone for formula of base

Chemical Abstracts Registry No.: 5060-55-9

Trade Name	Manufacturer	Country	Year Introduced
Deturglyone	Dausse	France	1970
Erbacort	Erba	Italy	—
Estilsona	Erba	Italy	—
Glistelone	Erba	Italy	—
Glitisona	Vis	Italy	—
Prenisol	Cifa	Italy	—
Rollisona	Bellon	France	—
Sintisona	Erba	Italy	—
Verisona	Tiber	Italy	—

Raw Materials

Prednisolone	Stearoyl-glycolyl chloride
Prednisolone-21-chloroacetate	Potassium stearate

Manufacturing Process

This material can be prepared, e.g., by reaction of prednisolone-21-chloroacetate in solvent with the sodium or potassium salt of the corresponding aliphatic or aromatic acid, or by reaction of prednisolone with the chloride of the corresponding acyl-glycolic acid, in the presence of a hydrochloric acid acceptor.

Alternative (A): 3 grams (0.0068 mol) prednisolone chloroacetate dissolved in 200 ml tetrahydrofuran and 10 ml H₂O are added with 2.7 grams (0.0084 mol) K stearate and 0.06 g NaI and heated to boiling, under stirring, for 36 hours, then evaporated in vacuum to dryness.

The residue is washed with H₂O to disappearance of the Cl⁻ ion from the filtrate. Crystallization from diluted alcohol results in prednisolone-21-stearoyl-glycolate (MP 104°-105°C).

Alternative (B): 3.6 grams (0.01 mol) prednisolone and 4.32 grams (0.012 mol) stearoyl-glycolyl-chloride, separately dissolved in dry dioxane, are added with 0.89 ml (0.011 mol) dry pyridine. The mixture is kept at 60°C for 20 hours, then poured into water-ice and filtered. Crystallization from diluted ethanol results in prednisolone-21-stearoyl-glycolate (MP 104°-105°C).

References

Merck Index 7618

Kleeman & Engel p. 753

DOT 3 (1) 18 (1967)

I.N. p. 799

Giraldi, P.N. and Nannini, G.; U.S. Patent 3,171,846; March 2, 1965; assigned to Carlo Erba SpA, Italy

PREDNISOLONE TEBUTATE

Therapeutic Function: Glucocorticoid

Chemical Name: 21-(3,3-Dimethyl-1-oxobutoxy)-11 β ,17-dihydroxypregna-1,4-diene-3,20-dione

Common Name: Prednisolone-21-tert-butyl acetate

Structural Formula:

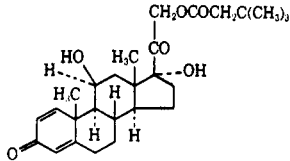

Chemical Abstracts Registry No.: 7681-14-3

Trade Name	Manufacturer	Country	Year Introduced
Hydeltra TBA	MSD	U.S.	1956
Codelcortone TBA	MSD	U.S.	—
Predate TBA	Legere	U.S.	—
Prednisol TBA	Pasadena	U.S.	—
Rodelta TBA	Rocky Mtn.	U.S.	—

Raw Materials

tert-Butyl acetyl chloride
Prednisolone

Manufacturing Process

A solution of about 10 parts of tertiary-butyl acetyl chloride in 45 parts of dry chloroform is added portionwise to a cold solution of 25 parts of $\Delta^{1,4}$ -3,20-diketo-11 β ,17 α ,21-trihydroxy-pregnadiene (prednisolone) in 125 parts of anhydrous pyridine. The resulting solution is allowed to stand for about 15 hours at 0° to 5°C, and the reaction solution is poured into 750 parts of water. The resulting aqueous mixture is extracted four times with 250 parts of chloroform each extraction. The combined chloroform layers are washed with water, dilute aqueous hydrochloric acid solution, water, 5% aqueous sodium bicarbonate solution, and finally with water. The chloroform extract is dried over magnesium sulfate, and the chloroform is evaporated in vacuo to give a residual oil. This oil is triturated with alcohol until it crystallizes, and is then recrystallized from ethanol to give substantially pure $\Delta^{1,4}$ -3,20-diketo-11 β ,17 α ,21-trihydroxy-pregnadiene 21-tertiary-butyl acetate.

References

Merck Index 7619
Kleeman & Engel p. 754
PDR pp. 1033, 1183
I.N. p. 798
REM p. 970
Sarett, L.H.; U.S. Patent 2,736,734; February 28, 1956; assigned to Merck & Co., Inc.

PREDNISONE

Therapeutic Function: Glucocorticoid

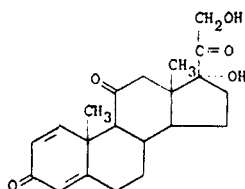
Chemical Name: 17 α ,21-Dihydroxy-pregna-1,4-diene-3,11,20-trione**Common Name:** Deltacortisone**Structural Formula:****Chemical Abstracts Registry No.:** 53-03-2

Trade Name	Manufacturer	Country	Year Introduced
Meticorten	Schering	U.S.	1955
Deltasone	Upjohn	U.S.	1955
Deltra	MSD	U.S.	1955
Paracort	Parke Davis	U.S.	1957
Lisacort	Fellows-Testagar	U.S.	1960
Servisone	Lederle	U.S.	1970
Orasone	Rowell	U.S.	1972
Wojtab	Philips Roxane	U.S.	1981
Adasone	Adams	Australia	—
Alto-Pred	Alto	U.S.	—
Colisone	Merck-Frosst	Canada	—
Cortan	Halsey	U.S.	—
Cortancyl	Roussel	France	—
Cortialper	Santos	Spain	—
Decortin	Igoda	Spain	—
Decortin	Merck	W. Germany	—
Decortisyl	Roussel	U.K.	—
Decorton	Salfa	Italy	—
Deidrocortisone	Stip	Italy	—
Deltacortene	Lepetit	Italy	—
Delta Dome	Dome	U.S.	—
Delta Prenovis	Vister	Italy	—
Deltison	Ferring	Sweden	—
Erftopred	Erfto	W. Germany	—
Fernisone	Ferndale	U.S.	—
Hostacortin	Hoechst	W. Germany	—
Inocortyl	Liposeptine	France	—
Keteocort	Desitin	W. Germany	—
Keysone	Key	U.S.	—
Liquid Pred	Muro	U.S.	—
Marnisonal	Juan Martin	Spain	—
Marvidiene	Panther-Osfa	Italy	—
Me-Korti	Farmos	Finland	—
Nisone	Llorente	Spain	—
Nizon	Bosnalijek	Yugoslavia	—
Novoprednisone	Novopharm	Canada	—
Nurison	Nourypharma	Neth.	—
Panafcort	Protea	Australia	—
Parmenison	Kwizda	Austria	—
Pred-S	Saron	U.S.	—
Predniartrit	Maipe	Spain	—
Prednicen-M	Seymour	U.S.	—

Trade Name	Manufacturer	Country	Year Introduced
Prednifor	Vifor	Switz.	—
Prednilonga	Dorsch	W. Germany	—
Predni-Tablinen	Sanorania	W. Germany	—
Predni-Wolner	Wolner	Spain	—
Prednovister	Substancia	Spain	—
Predsol	Morgan	Italy	—
Predsone	Century	U.S.	—
Presone	Langley	Australia	—
Pronison	Galenika	Yugoslavia	—
Propred	Medac	Australia	—
Rectodelt	Trommsdorff	W. Germany	—
Ropred	Robinson	U.S.	—
Sarogestic	Saron	U.S.	—
Sone	Fawns & McAllan	Australia	—
Sterapred	Mayrand	U.S.	—
Supopred	Europa	Spain	—
Urtilone	Recherche Therap.	France	—
Wescopred	Saunders	Canada	—
Winpred	I.C.N.	Canada	—

Raw Materials

Bacterium *Corynebacterium simplex*
Cortisone

Manufacturing Process

From a solution of 30 grams of yeast extract (Difco) in 3.0 liters of tap water containing 13.2 grams of potassium dihydrogen phosphate and 26.4 grams of disodium hydrogen phosphate (pH of the solution 6.9) 27 portions of 100 ml each are withdrawn, placed in 300 ml Erlenmeyer flasks and sterilized by autoclaving for 15 minutes at 15 pounds steam pressure (120°C). After autoclaving and cooling of the broth one ml of a suspension of *Corynebacterium simplex* (ATCC 6946) is placed in each flask. The flasks are then shaken on a shake table at 220 rpm and 28°C for 24 hours.

Into each of 27 Erlenmeyer flasks are placed 150 mg of Kendall's Compound E (cortisone). The flasks and contents are then sterilized for 15 minutes at 15 pounds steam pressure (120°C). To each flask are then added 5.0 ml of ethanol. The 24-hour bacterial culture is then transferred aseptically and the resulting suspensions are shaken on a shake table at 220 rpm and 28°C for 48 hours. The final pH is 7.2.

The contents of all the flasks are combined and extracted with a total of 9.0 liters of chloroform in three equal portions. The combined extracts are then concentrated to a residue which is crystallized from acetone-hexane. There results 1.1 grams of $\Delta^1,4$ -pregnadiene-17 α , 21-diol-3,11,20-trione, MP 210°-215°C (dec.). Several additional recrystallizations raised the MP to 230°-232°C (dec.).

References

Merck Index 7621
Kleeman & Engel p. 755
PDR pp. 830, 993, 1268, 1573, 1606, 1723, 1837
OCDS Vol. 1 p. 192 (1977)
I.N. p. 799
REM p. 970

Djerassi, C., Rosenkranz, G. and Berlin, J.; U.S. Patent 2,579,479; December 25, 1951; assigned to Syntex SA, Mexico
Nobile, A.; U.S. Patent 2,837,464; June 3, 1958; assigned to Schering Corporation

Oliveto, E.P. and Gould, D.H.; U.S. Patent 2,897,216; July 28, 1959; assigned to Schering Corporation

PRENALTEROL

Therapeutic Function: Adrenergic

Chemical Name: 4-[2-Hydroxy-3-[(1-methylethyl)amino]propoxy]phenol

Common Name: —

Structural Formula:

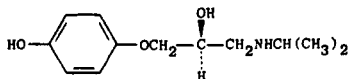

Chemical Abstracts Registry No.: 57526-81-5

Trade Name	Manufacturer	Country	Year Introduced
Coleb	Astra	W. Germany	1981
Hyprenan	Astra	U.K.	1981
Varbian	Ciba	U.K.	1981

Raw Materials

4-Hydroxyphenoxypropylene oxide
Isopropylamine

Manufacturing Process

A solution of 100 g (1.7 mols) of isopropylamine in 60 cc of water was stirred into a solution of 4-hydroxyphenoxypropylene oxide. After the exothermic reaction has subsided, the reaction mixture was heated for two hours at 60°C. Thereafter, the aqueous ethanol was distilled off, and the solid residue was dissolved in aqueous hydrochloric acid comprising more than the theoretical stoichiometric molar equivalent of hydrochloric acid. The aqueous acid solution was extracted with ether and was then made alkaline with sodium hydroxide, whereby a solid crystalline precipitate was formed which was filtered off and dried over phosphorus pentoxide. The product was 1,1-(4'-hydroxyphenoxy)-2-hydroxy-3-isopropylamino-propane. Its hydrochloride had a melting point of 166°C to 169°C.

References

Merck Index 7639

DFU 4 (1) 46 (1979)

OCDS Vol. 3 p. 30 (1984)

DOT 17 (5) 199 (1981) & 18 (4) 190 (1982)

I.N. p. 801

Koppe, H., Engelhardt, A., Ludwig, G. and Zeile, K.; U.S. Patent 3,637,852; January 25, 1972; assigned to Boehringer Ingelheim G.m.b.H. (Germany)

PRENYLAMINE

Therapeutic Function: Vasodilator (coronary)

Chemical Name: N-(1-Methyl-2-phenylethyl)-γ-phenylbenzenepropanamine

Common Name: —

Structural Formula:

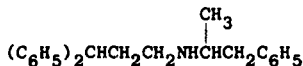

Chemical Abstracts Registry No.: 390-64-7

Trade Name	Manufacturer	Country	Year Introduced
Synadrin	Hoechst	U.K.	1961
Segontin	Hoechst	Italy	1962
Segontin	Hoechst	W. Germany	1964
Segontine	Hoechst	France	1965
Agozol	Tableta	Rumania	—
Angiovigor	Violani-Farmavigor	Italy	—
Angorsan	Isola-Ibi	Italy	—
Cardional	Unipharm	Israel	—
Corditin-Same	Savoma	Italy	—
Coredamin	Meiji	Japan	—
Crepasin	Hoei	Japan	—
Daxauten	Woelm Pharma	W. Germany	—
Epocol	Teisan-Nagase	Japan	—
Eucardion	Vita	Italy	—
Falcor	Fahlberg-List	E. Germany	—
Herzcon	Sana	Japan	—
Incoran	I.T.A.	Italy	—
Irrorin	Alfa Farm.	Italy	—
Lactamine	Daisan	Japan	—
Newsantin	Sawai	Japan	—
NP 30	Sanken	Japan	—
Nyuple	Ohta	Japan	—
Onlemin	Ono	Japan	—
Pactamin	Morishita	Japan	—
Prectolact	Showa Yakuhin	Japan	—
Rausetin	Tanabe	Japan	—
Reocorin	Farmochimica	Italy	—
Roinin	Mohan	Japan	—
Seccidin	Nippon Kayaku	Japan	—
Wasangor	Wassermann	Italy	—

Raw Materials

- 1,1-Diphenyl-propylamine-(3)
- Phenyl acetone
- Hydrogen

Manufacturing Process

10.6 g of 1,1-diphenylpropylamine-(3) are hydrogenated by means of palladium with 6.7 g of phenyl acetone in 200 cc of methanol at 50°C. The calculated amount of hydrogen is taken up. The separated oily base is dissolved by heating with alcohol. After filtration water is added until turbidity sets in. 24.5 g of 2-(1',1'-diphenylpropyl-3'-amino)-3-phenyl-propane are obtained with a boiling point at 195°C to 198°C under a pressure of 0.5 mm of mercury, which after prolonged standing crystallizes out. Melting point about 38°C to 40°C. Hydrochloride (prepared in usual manner): melting point 188°C to 190°C.

References

Merck Index 7641

Kleeman & Engel p. 759

OCDS Vol. 1 p. 76 (1977)

I.N. p. 801

Ehrhart, G., Ott, H. and Lindner, E.; U.S. Patent 3,152,173; October 6, 1964; assigned to Farbwerke Hoechst A.G. (Germany)

PRILOCAINE HYDROCHLORIDE**Therapeutic Function:** Local anesthetic**Chemical Name:** N-(2-methylphenyl)-2-(propylamino)-propanamide hydrochloride**Common Name:** Propitocaine hydrochloride**Structural Formula:****Chemical Abstracts Registry No.:** 1786-81-8; 721-50-6 (Base)

Trade Name	Manufacturer	Country	Year Introduced
Xylonest	Astra	W. Germany	1963
Citanest	Astra	U.K.	1974
Citanest	Astra	U.S.	1966
Citanest	Pierrel	Italy	1968
Citanest	Bellon	France	1973

Raw Materials

o-Toluidine

 α -Bromopropionyl bromide

n-Propylamine

Manufacturing Process

One mol of ortho-toluidine is dissolved in 800 ml of glacial acetic acid. The mixture is cooled to 10°C whereupon 1.1 mols of α -bromopropionyl bromide is added. The mixture is vigorously stirred for about a minute and a solution of sodium acetate (330 grams of $\text{CH}_3\text{COONa}\cdot 3\text{H}_2\text{O}$ in 1,380 ml of water) or another buffering or alkalinizing substance or solution is added in one portion. The reaction mixture is then shaken for half an hour. The precipitate formed is filtered off, washed with water and dried. The product is sufficiently pure for further processing. Yield: 70-80% of theory. MP 133°-134°C.

One mol of α -bromopropio-ortho-toluidide is mixed with a solution of 3 mols of n-propylamine in 500 ml of water-free benzene and the reaction mixture is heated in an autoclave to 80°C for 8 hours. After cooling the reaction mixture is treated as described above. The base is obtained as a colorless oil. BP 159°-162°C/0.1 mm. Yield 55%. The base is then converted to the hydrochloride by reaction with HCl.

References

- Merck Index 7646
 DFU 8 (12) 1021 (1983)
 Kleeman & Engel p. 760
 OCDS Vol. 1 p. 17 (1977)
 I.N. p. 802
 REM p. 1053
 Aktiebolaget Astra: Apotekarnes Kemiska Fabriker, Sweden; British Patent 839,943; June 29, 1960

PRIMIDONE

Therapeutic Function: Anticonvulsant

Chemical Name: 5-Ethylidihydro-5-phenyl-4,6(1H,5H)-pyrimidinedione

Common Name: 2-Desoxyphenobarbital; primaclone

Structural Formula:

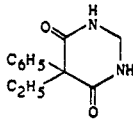

Chemical Abstracts Registry No.: 125-33-7

Trade Name	Manufacturer	Country	Year Introduced
Mysoline	I.C.I.	France	1953
Mysoline	Ayerst	U.S.	1954
Cyral	Gerot	Austria	—
Liskantin	Desitin	W. Germany	—
Majsolin	Pliva	Yugoslavia	—
Midone	Protea	Australia	—
Mylepsinum	ICI Pharma	W. Germany	—
Mysedon	Medica	Finland	—
Primidone	Schein	U.S.	—
Primoline	Darby	U.S.	—
Primron	Fujinaga	Japan	—
Prysoline	Abic	Israel	—
Resimatil	Labaz	W. Germany	—
Sertan	Chinoin	Hungary	—

Raw Materials

α,α -Phenylethylmalonic acid diamide
 Formamide

Manufacturing Process

50 parts of α,α -phenylethylmalondiamide and 150 parts of formamide are boiled together under reflux for 2 hours. The mixture is then cooled to 0°C and filtered. The solid residue is washed with 50 parts of ethanol and then crystallized from 660 parts of an 80% ethanol water mixture. There is obtained 5-phenyl-5-ethylhexahydropyrimidine-4,6-dione, MP 281°-282°C.

References

Merck Index 7649

Kleeman & Engel p. 761

PDR pp. 631, 830, 1606

OCDS Vol. 1 p. 276 (1977)

I.N. p. 803

REM p. 1081

Boon, W.R., Carrington, H.C. and Vasey, C.H.; U.S. Patent 2,578,847; December 18, 1951; assigned to Imperial Chemical Industries Limited, England

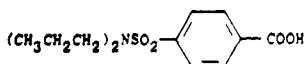
PROBENECID**Therapeutic Function:** Antiarthritic**Chemical Name:** 4-[(Dipropylamino)sulfonyl] benzoic acid**Common Name:** —**Structural Formula:****Chemical Abstracts Registry No.:** 57-66-9

Trade Name	Manufacturer	Country	Year Introduced
Benemid	MSD	U.S.	1952
Benemide	Theraplix	France	1954
<i>Benecid</i>	Kaken	Japan	—
Benuryl	I.C.N.	Canada	—
Colbenemid	MSD	U.K.	—
Panuric	Propan-Lipworth	S. Africa	—
Perdurine	Pharma-Union	Belgium	—
Probemid	Lefa	Spain	—
Probenicid	Lederle	U.S.	—
Probenemid	Merck-Banyu	Japan	—
Procid	Protea	Australia	—
Solpurin	Salfa	Italy	—
Ureacid	Frosst	Australia	—
Uroben	Mitim	Italy	—

Raw Materials

p-Carboxybenzene sulfonyl chloride

Di-n-propylamine

Manufacturing Process

24.0 grams (0.11 mol) of p-carboxybenzenesulfonyl chloride was added in small portions to a suspension of 20.0 grams (0.146 mol) of di-n-propylamine in 100 milliliters of 10% sodium hydroxide with vigorous stirring at a temperature of 15°-25°C. Stirring was continued for 15 minutes after the final addition. The clear solution was treated with decolorizing carbon and filtered. The product was precipitated by the addition of an excess of hydrochloric acid. The crude product was purified by reprecipitation from bicarbonate solution and recrystallization from dilute alcohol. The yield was 20.0 grams (64%) melting at 194°-196°C.

References

Merck Index 7656

Kleeman & Engel p. 761

PDR pp. 705, 830, 993, 1142, 1150, 1606, 1999

OCDS Vol. 1 p. 135 (1977)

I.N. p. 804

REM p. 944

Miller, C.S.; U.S. Patent 2,608,507; August 26, 1952; assigned to Sharp & Dohme, Inc.

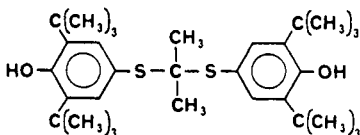
PROBUCOL**Therapeutic Function:** Hypolipidemic**Chemical Name:** Bis(3,5-di-tert-butyl-4-hydroxyphenyl) acetone mercaptole**Common Name:** —**Structural Formula:****Chemical Abstracts Registry No.:** 23288-49-5

Trade Name	Manufacturer	Country	Year Introduced
Lorelco	Merrell Dow	U.S.	1977
Lurselle	Lepetit	France	1980
Lurselle	Lepetit	U.K.	1980
Lurselle	Dow-Lepetit	Switz.	1980
Lurselle	Merrell	W. Germany	1980
Lurselle	Lepetit	Italy	1982
Biphenabid	Merrell Dow	—	—
Lesterol	Lepetit	—	—

Raw Materials

2,6-Di-tert-butyl-4-mercaptophenol
Acetone

Manufacturing Process

Bis(3,5-di-tert-butyl-4-hydroxyphenyl) acetone mercaptole, melting at 125°C to 126°C is prepared by employing 2,6-di-tert-butyl-4-mercaptophenol and acetone as starting materials. In one representative procedure, the 2,6-di-tert-butyl-4-mercaptophenol (47.5 g, 0.2 mol) is dissolved in methanol (50 ml) heated at a temperature of 50°C. A catalytic amount of concentrated hydrochloric acid (1 ml) is added, followed by acetone (5.8 g, 0.1 mol). The temperature of the mixture rises to about 60°C, and is maintained at about 60°C to 65°C for 1.5 hours. The mixture is cooled, diluted with water and about 10 ml of aqueous sodium bicarbonate and extracted with ether. The ether extract is evaporated, and the product is obtained as a residue, which is recrystallized from ethanol and then from isopropanol to obtain the bis(3,5-di-tert-butyl-4-hydroxyphenyl) acetone mercaptole as a crystalline solid melting at about 125°C to 126°C.

In another representative procedure about 2.3 mols of 2,6-di-tert-butyl-4-mercaptophenol is dissolved in about 1,700 ml of methanol under a nitrogen atmosphere; about 100 ml of concentrated hydrochloric acid and 180 ml of acetone are added, and the mixture is stirred and maintained at a temperature of about 35°C to 50°C, for 1.5 hours. The mixture is then cooled to room temperature and filtered, and the bis(3,5-di-tert-butyl-4-hydroxyphenyl) acetone mercaptole product is collected as a colorless crystalline solid filter cake. The product is washed with water and aqueous sodium bicarbonate and purified by recrystallization from ethanol.

References

Merck Index 7657

DFU 2 (2) 128 (1977)

Kleeman & Engel p. 762

PDR p. 1229

OCDS Vol. 2 p. 126 (1980)

DOT 14 (1) 33 (1978)

I.N. p. 804

REM p. 864

Barnhart, J.W. and Shea, P.J.; U.S. Patent 3,862,332; January 21, 1975; assigned to The Dow Chemical Co.

PROCARBAZINE HYDROCHLORIDE

Therapeutic Function: Cancer chemotherapy

Chemical Name: N-(1-Methylethyl)-4-[(2-methylhydrazino)methyl] benzamide HCl

Common Name: Ibenmethyzin

Structural Formula:

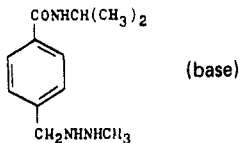

Chemical Abstracts Registry No.: 366-70-1; 671-16-9 (Base)

Trade Name	Manufacturer	Country	Year Introduced
Natulan	Roche	France	1965
Natulan	Roche	W. Germany	1966
Natulan	Roche	U.K.	1966
Natulan	Roche	Italy	1967
Matulane	Roche	U.S.	1969
Natulan	Nippon Roche	Japan	1973

Raw Materials

4-Methylbenzoic acid	Thionyl chloride
Methanol	Bromine
1-Methyl-1,2-dicarbobenzoxyhydrazine	Sodium hydride
Sodium hydroxide	Isopropyl amine
Hydrogen bromide	Hydrogen chloride

Manufacturing Process

544 grams of 4-methylbenzoic acid was boiled with 550 ml of thionyl chloride until a clear solution was obtained. After the excess thionyl chloride was distilled off, the residue was fractionated, yielding 605 g of 4-methylbenzoyl chloride; BP 91°C/9 mm Hg, $n_D^{24} = 1.5532$. This was dissolved in 550 ml of absolute benzene and the so-formed solution added to a mixture of 248 ml of absolute methanol and 550 ml of absolute benzene. After the exothermic reaction had terminated, the reaction mixture was boiled for a further 20 hours, then concentrated in vacuo and the product, 4-methylbenzoic acid methyl ester, isolated by conventional means. It could be purified by distillation, and the purified product boiled at 91°C/9 mm Hg, MP 32°C.

574 grams of this ester were dissolved in 1200 ml of carbon tetrachloride and, while boiling and exposing to a UV lamp, treated dropwise with a solution of 109 ml of bromine in 400 ml of carbon tetrachloride. After all of the bromine had been dropped in, the mixture was heated for a further hour, concentrated in vacuo and the residue crystallized from low boiling petroleum ether, yielding as colorless fine crystals, 4-(bromo-methyl)-benzoic acid methyl ester, which melted at 52°C. For the reaction of this ester with 1-methyl-1,2-dicarbobenzoxy-hydrazine, the following procedure was followed.

309 grams of a 27% suspension of sodium hydride in an inert solvent was treated with 300 ml of dimethylformamide, and a solution of 1095 grams of 1-methyl-1,2-dicarbobenzoxy-hydrazine in dimethylformamide was added thereto. When all the material had been added and the hydrogen evolution had nearly come to a standstill, the mixture was heated for an hour at about 80°C in order to carry the formation of the sodium salt to completion. A mixture of 759 grams of 4-(bromo-methyl)-benzoic acid methyl ester in 700 ml of dimethylformamide was then dropped in, and finally the reaction mixture was heated for an hour at 80°C. After cooling, the reaction mixture was poured into 10 liters of ice water and the condensation products taken up in ether. The thereby obtained crude methyl ester ($n_D^{24} = 1.1558$) was used without further purification for the next step. It was dissolved in about 2,200 ml of dioxane, treated with a solution of 133 grams of sodium hydroxide in 870 ml of water, and the resulting mixture stirred for about 24 hours at room temperature. It was then poured into 10 liters of ice water and neutral materials were extracted with ether.

The aqueous phase was rendered acid with concentrated hydrochloric acid (weak Congo red) and the separated acid taken up in ether. The isolated crude acid was recrystallized from dibutyl ether, yielding colorless crystals of 4-[(2-methyl-1,2-dicarbobenzoxy-hydrazino)-methyl]-benzoic acid, which melted at 112°C. The so-obtained product was sufficiently pure for further reaction.

15 grams of 4-[(2-methyl-1,2-dicarbobenzoxy-hydrazino)methyl]-benzoic acid were boiled with an excess of thionyl chloride for 1 hour under reflux. The unconverted thionyl chloride was distilled off in vacuo, the residue twice dissolved each time in 75 ml of absolute benzene and then concentrated in vacuo. The so-obtained 4-[(2-methyl-1,2-dicarbobenzoxy-hydrazino)-methyl]-benzoyl chloride, a viscous light yellow oil, was dissolved in 50 ml of absolute benzene and with stirring mixed with a solution of 4.45 grams of isopropylamine in 100 ml of absolute benzene. By cooling, the temperature of the reaction mixture was kept below 30°C. After the mixing had been completed, the reaction mixture was maintained first at room temperature for 3 hours and then for ½ hour at 40°C. It was then cooled down and poured into about 100 ml of ice water. After the addition of a mixture of methylene chloride and ether (40 ml + 200 ml), the organic phase was separated and then washed with water, dilute hydrochloric acid, water, dilute sodium hydroxide and again with water.

The solvents were then evaporated, yielding 4-[(2-methyl-1,2-dicarbobenzoxyhydrazino)-methyl]-benzoic acid isopropylamide as a yellow oil, which crystallized upon triturating with ether; MP 90°-92°C. This product was then covered with 70 ml of a 33% solution of hydrogen bromide in glacial acetic acid, and then permitted to stand for 2 hours with occas-

ional swirling, whereupon a thick slurry of crystals was formed. The precipitate was filtered off, washed with 20 ml of glacial acetic acid and finally with ether, yielding crystals of 4-[(2-methyl-hydrazino)-methyl]-benzoic acid isopropylamide hydrobromide, which after recrystallization from methanol/ether melted at 216°-217°C (dec.).

87.5 grams of 4-[(2-methyl-hydrazino)-methyl]-benzoic acid isopropylamide hydrobromide (obtained as described above) were dissolved in 550 ml of water. To this solution, there were added 1,000 ml of methylene chloride and, while cooling with ice and stirring under nitrogen atmosphere, 1,200 grams of potassium carbonate portionwise. The methylene chloride layer was separated and the aqueous slurry extracted three times with 500 ml of methylene chloride in a nitrogen atmosphere. The united methylene chloride extracts were concentrated in vacuo. The residue was dissolved under nitrogen in 100 ml of methanol and treated, while cooling with ice, with 40 ml of a 45% methanolic hydrochloric acid solution, which induces immediate crystallization. The crystals were filtered off and recrystallized from methanol, yielding 4-[(2-methyl-hydrazino)-methyl]-benzoic acid isopropylamide hydrochloride melting at 223°-226°C.

References

Merck Index 7662

Kleeman & Engel p. 763

PDR p. 1491

OCDs Vol. 2 p. 27 (1980)

I.N. p. 805

REM p. 1153

Bollag, W., Gutmann, H., Hegedus, B., Kaiser, A., Langemann, A., Muller, M. and Zeller, P.; U.S. Patent 3,520,926; July 21, 1970; assigned to Hoffmann-La Roche Inc.

PROCATEROL

Therapeutic Function: Bronchodilator

Chemical Name: 8-Hydroxy-5-[1-hydroxy-2-[(1-methylethyl)amino]butyl]-2(1H)-quinoline

Common Name: —

Structural Formula:

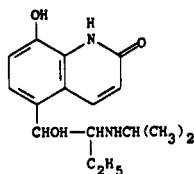

Chemical Abstracts Registry No.: 72332-33-3

Trade Name	Manufacturer	Country	Year Introduced
Meptin	Otsuka	Japan	1981

Raw Materials

α-Bromobutyric acid bromide
Isopropylamine

8-Hydroxycarbostyryl
Lithium aluminum hydride

Manufacturing Process

50 g of α -bromobutyric acid bromide, 50 g of anhydrous aluminum chloride and 400 ml of carbon disulfide were added to 20 g of 8-hydroxycarbostyryl. The resulting mixture was heated at a temperature of 50°C for 13 hours and the carbon disulfide layer was removed by decantation. Crushed ice was added to the residue, and the precipitated crystals were filtered, washed with water and recrystallized from methanol to obtain 27 g of 5-(α -bromobutyryl)-8-hydroxycarbostyryl having a melting point of 218°C to 219°C (with coloring and decomposition). To 5 g of the thus obtained 5-(α -bromobutyryl)-8-hydroxycarbostyryl was added 100 ml of isopropylamine, and the mixture was heated at a temperature of 50°C for 4 hours followed by concentration to dryness. Crystals which formed upon addition of water were filtered, washed with water and then recrystallized from methanol to obtain 4.6 g of a methanol solvate of 5-(α -isopropylaminobutyryl)-8-hydroxycarbostyryl having a melting point of 136°C to 137°C (with foaming and decomposition).

20 g of tetrahydrofuran was added to 1 g of 5-(α -isopropylaminobutyryl)-8-hydroxycarbostyryl hydrochloride, and the resulting mixture was added dropwise to a suspension of 0.12 g of lithium aluminum hydride in 10 ml of tetrahydrofuran while stirring at room temperature. After completion of the addition, a small amount of water was added to the reaction mixture to decompose any excess of lithium aluminum hydride. The reaction mixture was then poured into 50 ml of ice-water and the aqueous layer of the resulting solution was separated and concentrated to dryness. The precipitated crystals were filtered, washed with acetone and dissolved in water. The solution was adjusted to pH of 8 with aqueous sodium hydroxide to precipitate crystals which were then filtered and recrystallized from ethanol to obtain 0.8 g of 5-(1-hydroxy-2-isopropylamino)butyl-8-hydroxycarbostyryl monohydrate having a melting point of 141°C to 142°C (with cooling and decomposition).

References

Merck Index 7663

DFU 3 (2) 135 (1978)

OCDS Vol. 3 p. 184 (1984)

DOT 17 (6) 256 (1981)

Nakagawa, K., Yoshizaki, S., Tanimura, K. and Tamada, S.; U.S. Patent 4,026,897; May 3, 1977; assigned to Otsuka Pharmaceutical Co. (Japan)

PROCHLORPERAZINE

Therapeutic Function: Antiemetic; antipsychotic

Chemical Name: 2-Chloro-10-[3-(4-methyl-1-piperazinyl)propyl]-10H-phenothiazine

Common Name: Chlormeprazine

Structural Formula:

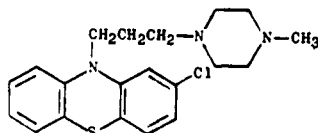

Chemical Abstracts Registry No.: 58-38-8; 84-02-6 (Maleate)

Trade Name	Manufacturer	Country	Year Introduced
Compazine	SKF	U.S.	1956
Tementil	Specia	France	1957
Anti-Naus	Protea	Australia	—
Combid	SKF	U.S.	—
Klometil	Farmos	Finland	—
Mitil	Lennon	S. Africa	—
Nibromin-A	Maruko	Japan	—
Normalmin	Sawai	Japan	—
Novamin	Shionogi	Japan	—
Pasotomin	Yoshitomi	Japan	—
Stemetil	May & Baker	U.K.	—
Vertigon	SKF	U.K.	—

Raw Materials

3-Chloro-10-[3-(di-N-2-chloroethyl)aminopropyl] phenthiazine hydrochloride
Monomethylpiperazine

Manufacturing Process

3-Chloro-10-[3-(di-N-2-chloroethyl)aminopropyl] phenthiazine hydrochloride (1.8 g) is heated in a sealed tube for 4 hours at 140°C with a 290 g/l aqueous solution (9 cc) of monomethylpiperazine. The contents of the tube are treated with chloroform (40 cc). The aqueous layer is decanted and the chloroform layer is shaken with N hydrochloric acid (15 cc followed by 2 cc). The aqueous solution is treated with sodium hydroxide (d = 1.33, 10 cc) and chloroform (20 cc). After evaporation of the solvent, the base (1.5 g) is obtained. A solution of maleic acid (1 g) in ethanol (5 cc) is added and after recrystallization from water, 3-chloro-10-[3-(4'-methyl-1'-piperaziny)propyl] phenothiazine dimaleate is obtained, melting point 228°C (inst.).

References

Merck Index 7665

Kleeman & Engel p. 764

PDR pp. 1606, 1706

OCDS Vol. 1 p. 381 (1977)

DOT 9 (6) 228 (1973)

I.N. p. 806

REM p. 809

Horclois, R.J.; U.S. Patent 2,902,484; September 1, 1959; assigned to Societe des Usines Chimiques Rhone-Poulenc, France

PROCYCLIDINE HYDROCHLORIDE

Therapeutic Function: Antiparkinsonism

Chemical Name: α -Cyclohexyl- α -phenyl-1-pyrrolidinepropanol hydrochloride

Common Name: —

Structural Formula:

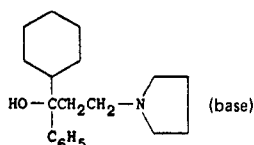

Chemical Abstracts Registry No.: 1508-76-5; 77-37-2 (Base)

Trade Name	Manufacturer	Country	Year Introduced
Kemadrin	Burroughs Wellcome	U.S.	1956
Kemadrine	Wellcome	France	1965
Arpicolin	R.P. Drugs	U.K.	—
Kemadren	Gayoso Wellcome	Spain	—
Osnervan	Wellcome	W. Germany	—
Procyclid	I.C.N.	Canada	—

Raw Materials

Acetophenone	Paraformaldehyde
Pyrrolidine	Bromobenzene
Magnesium	Hydrogen
Hydrogen chloride	

Manufacturing Process

1,1-Diphenyl-3-pyrrolidinopropan-1-ol (30 grams) was dissolved in glacial acetic acid (120 ml), Adams' platinum catalyst (6 grams) added, and the mixture shaken in an atmosphere of hydrogen until the equivalent of 3.4 molecules had been taken up per molecule of compound. Water was added, the catalyst removed by filtration, excess of ammonia added, and the liberated base extracted with ether. The ethereal extract was dried and evaporated and the residue recrystallized from light petroleum (BP 40°-60°C). The 1-cyclohexyl-1-phenyl-3-pyrrolidinopropan-1-ol (19.3 grams) so obtained had a melting point of 85.5°-86.5°C. The hydrochloride recrystallized from a mixture of ethanol and ethyl acetate, melted with decomposition at 226°-227°C according to U.S. Patent 2,891,890.

The starting material is prepared by the reaction of acetophenone, paraformaldehyde and pyrrolidine to give ω -pyrrolidinopropiophenone. That is in turn reacted with phenyl magnesium bromide to give 1,1-diphenyl-3-pyrrolidinopropan-1-ol.

References

Merck Index 7667

Kleeman & Engel p. 765

PDR p. 745

OCDS Vol. 1 p. 47 (1977)

DOT 18 (2) 88 (1982)

I.N. p. 806

REM p. 932

Bottorff, E.M.; U.S. Patent 2,826,590; March 11, 1958; assigned to Eli Lilly and Company
 Harfenist, M. and Magnien, E.G.; U.S. Patent 2,842,555; July 8, 1958; assigned to Burroughs
 Wellcome & Co. (U.S.A.) Inc.

Adamson, D.W.; U.S. Patent 2,891,890; June 23, 1959; assigned to Burroughs Wellcome
 & Co. (U.S.A.) Inc.

PROGLUMETACIN MALEATE

Therapeutic Function: Antiinflammatory

Chemical Name: N'-2-[1-(p-chlorobenzoyl)-5-methoxy-2-methyl-3-indoleacetoxy]-ethyl-N-3-(N-benzoyl-N',N'-di-n-propyl-DL-isoglutaminoyl)-oxypropyl piperazine dimaleate

Common Name: Protacine

Structural Formula:

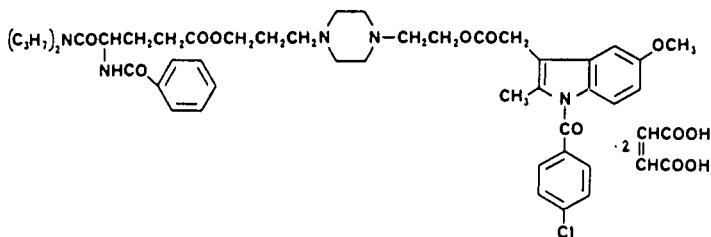

Chemical Abstracts Registry No.: 57132-53-3 (Base)

Trade Name	Manufacturer	Country	Year Introduced
Afloxan	Rotta	Italy	1981
Proxil	Rorer	Italy	1981

Raw Materials

N'-(2-Hydroxyethyl)-N-3-(N-benzoyl-N',N'-di-n-propyl-DL-isoglutaminoyl)-oxy-propyl piperazine
 1-(p-Chlorobenzoyl)-5-methoxy-2-methyl-3-indoleacetic acid
 N',N'-Dicyclohexylcarbodiimide
 Maleic acid

Manufacturing Process

To a titrated solution of 400 cc of ethyl acetate containing 0.1 mol of N'-(2-hydroxyethyl)-N-3-(N-benzoyl-N',N'-di-n-propyl-DL-isoglutaminoyl)-oxypropyl piperazine [obtained by dissolving 71.9 g (0.105 mol) of the corresponding di-oxalate in 500 cc of water, bringing this solution to a pH of between 9 and 10 with sodium bicarbonate and finally extracting the oily emulsion thus formed twice in succession with a total of 400 cc of ethyl acetate], there are added successively 35.8 g (0.1 mol) of 1-(p-chlorobenzoyl)-5-methoxy-2-methyl-3-indoleacetic acid and 20.6 g (0.1 mol) of N,N'-dicyclohexylcarbodiimide. This is left at room temperature for 24 hours, and after having filtered the N,N'-dicyclohexyl urea precipitate the organic phase is then washed with dilute HCl, a solution of sodium bicarbonate and a saturated solution of sodium chloride.

The ethyl acetate is dried with anhydrous sodium sulfate, filtered and dried off. The oily residue is dissolved in 600 cc of methanol; the di-oxalate is precipitated by the addition of a solution of oxalic acid in methanol. Yield 85%, melting point 190°C to 192°C (crystallized by methanol). Microcrystalline substance, creamy white color.

By the same method one can obtain the dimaleate. Yield, 83%; melting point, 146°C to 148°C (crystallized by ethanol). Microcrystalline pale cream colored substance.

References

Merck Index 7679

DFU 5 (3) 142 (1980)

DOT 17 (4) 157 (1981)

Makovec, F., Senin, P. and Rovati, L.; U.S. Patent 3,985,878; October 12, 1976; assigned to Rotta Research Laboratorio S.p.A.

PROMAZINE HYDROCHLORIDE

Therapeutic Function: Tranquillizer

Chemical Name: N,N-Dimethyl-10H-phenothiazine-10-propanamine hydrochloride

Common Name: —

Structural Formula:

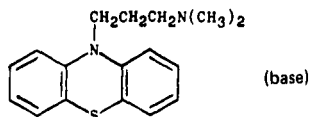

Chemical Abstracts Registry No.: 53-60-1; 58-40-2 (Base)

Trade Name	Manufacturer	Country	Year Introduced
Sparine	Wyeth	U.S.	1956
Atarzine	Saunders	Canada	—
Calmotal	S.I.T.	Italy	—
Eliranol	Wyeth	Italy	—
Frenil	Polfa	Poland	—
Neuroplegil	Gentili	Italy	—
Promanyl	Paul Maney	Canada	—
Promazettes	Barlow Cote	Canada	—
Promezerine	Barlow Cote	Canada	—
Protactyl	Wyeth	W. Germany	—
Savamine	Banyu	Japan	—
Sediston	Serono	Italy	—
Starazine	Star	Finland	—
Talofen	Pierrel	Italy	—
Tranquazine	Anthony	U.S.	—

Raw Materials

Phenothiazine	Sodium amide
3-Dimethylamino-1-chloropropane	Hydrogen chloride

Manufacturing Process

30 grams of phenothiazine, 120 grams of xylene and 7 grams of sodamide (80%) are mixed and heated under reflux. 23 grams of 3-dimethylamino-1-chloropropane, diluted with its own weight of xylene, is then added little by little during one hour, while maintaining the temperature of the reaction mixture; heating under reflux is then continued for a further hour. After cooling, the mixture is taken up in 400 cc of water and rendered slightly acid with hydrochloric acid. The xylene is decanted, the aqueous layer is rendered strongly alkaline with caustic soda and the base which separates is extracted with ether. On rectification of the ether extract, there is obtained N-(3'-dimethyl-amino-propyl)-phenothiazine which boils at 208°-210°C under 3 mm. The hydrochloride of this base melts at 181°C (Maquenne block).

References

Merck Index 7688
 Kleeman & Engel p. 768
 PDR p. 1989
 OCDS Vol. 1 p. 377 (1977)
 I.N. p. 810
 REM p. 1090

Charpentier, P.; U.S. Patent 2,519,886; August 22, 1950; assigned to Societe des Usines Chimiques Rhone-Poulenc, France

PROMEGESTONE

Therapeutic Function: Progestin

Chemical Name: 17 α ,21-Dimethyl-19-nor- $\Delta^{4,9}$ -pregnadiene-3,20-dione

Common Name: —

Structural Formula:

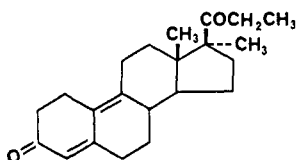

Chemical Abstracts Registry No.: —

Trade Name	Manufacturer	Country	Year Introduced
Surgestone	Cassenne	France	1983

Raw Materials

17 α -Methyl-19-nor- $\Delta^{5(10)}$ -pregnene-3,20-dione
Bromine
Pyridine

Manufacturing Process

16.3 cc of a solution of 29% of bromine in methanol were added with agitation under a nitrogen atmosphere to a solution of 8.50 g of 17 α -methyl-19-nor- $\Delta^{5(10)}$ -pregnene-3,20-dione in 85 cc of pyridine cooled to 0°C and the mixture was stirred for 30 minutes at 0°C. The temperature was allowed to return to room temperature and the mixture was stirred for 16 hours.

The mixture was added to 850 cc of water-ice mixture and 82 cc of hydrochloric acid were added thereto. The mixture was extracted with methylene chloride and the combined extracts were washed with water until the wash waters were neutral, were dried over magnesium sulfate and distilled to dryness to obtain 8.480 g of crude product which is purified by crystallization from isopropyl ether to obtain 5.810 g of 17 α -methyl-19-nor- $\Delta^{4,9}$ -pregnadiene-3,20-dione melting at 106°C.

The mother liquors from the purification of the product were combined and evaporated to dryness. The residue was fractionated by chromatography over silica gel (Kieselgel) and elution with a 7:3 mixture of benzene-ethyl acetate. The first fractions were discarded and the ensuing fraction was evaporated to obtain colorless crystals. The product was purified by mixing with five volumes of boiling isopropyl ether and the crystals formed after cooling were recovered by vacuum filtration, were washed twice with two volumes of isopropyl ether and dried in a ventilated atmosphere to obtain 17 α ,21-dimethyl-19-nor- $\Delta^{4,9}$ -pregnadiene-3,20-dione melting at 152°C.

References

DFU 3 (6) 469 (1978)

DOT 19 (7) 416 (1983)

I.N. p. 810

Warnant, J. and Farcilli, A.; U.S. Patents 3,679,714; July 25, 1972; and 3,761,591; Sept. 25, 1973; both assigned to Roussel UCLAF

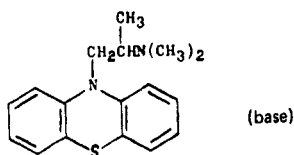
PROMETHAZINE HYDROCHLORIDE**Therapeutic Function:** Antihistaminic**Chemical Name:** N,N, α -trimethyl-10H-phenothiazine-10-ethanamine hydrochloride**Common Name:** Proazamine hydrochloride**Structural Formula:****Chemical Abstracts Registry No.:** 58-33-3; 60-87-7 (Base)

Trade Name	Manufacturer	Country	Year Introduced
Phenergan	Wyeth	U.S.	1951
Ganphen	Tutag	U.S.	1971
Remsed	Endo	U.S.	1973
Lemprometh	Lemmon	U.S.	1974
Bromethacon	Alcon	U.S.	1981
Baymethazine	Bay	U.S.	1982
Atosil	Bayer	W. Germany	—
Avomine	May & Baker	U.K.	—
Diphergan	Polfa	Poland	—
Dorme	A.V.P.	U.S.	—
Fargan	Farmitalia	Italy	—
Fellozine	Fellows-Testagar	U.S.	—
Fenazil	Sella	Italy	—
Fenergan	Rhodia Iberica	Spain	—
Hiberna	Yoshitomi	Japan	—
Lenazine	Lennon	S. Africa	—
Lergigan	Recip	Sweden	—
Mopergan	Wyeth	U.S.	—
Pelpica	P.C.B.	Belgium	—
Perduretas	Medea	Spain	—
Phencen	Central	U.S.	—
Pipolphen	Nakataki	Japan	—
Progan	Adams	Australia	—
Promet	Legere	U.S.	—
Promethapar	Parmed	U.S.	—
Promethazine	Lederle	U.S.	—
Promine	Laser	U.S.	—
Prorex	Hyrex	U.S.	—

Trade Name	Manufacturer	Country	Year Introduced
Prothazine	Knoll	Australia	—
Prothia	Kanto	Japan	—
Prothiazine	Novis	Israel	—
Provigan	Reid-Provident	U.S.	—
Pyrethia	Shionogi	Japan	—
Quadnite	Reid-Provident	U.S.	—
Rivozine	Rivopharm	Switz.	—
Sayamol	Cinfa	Spain	—
V-Gan	Hauck	U.S.	—
Zipan	Savage	U.S.	—

Raw Materials

Phenothiazine	Sodium amide
1-Dimethylamino-2-propyl chloride	Hydrogen chloride

Manufacturing Process

30 grams of phenothiazine, 120 grams of xylene, and 7 grams of sodamide (85%) are mixed and heated under reflux. A solution of 23 grams of the base obtained by the action of sodium hydroxide on the hydrochloride of 1-dimethylamino-2-chloropropane, in 25 grams of xylene, is then added little by little during one hour, while maintaining the temperature of the reaction mixture; heating under reflux is then continued for a further hour. After cooling, the mixture is taken up in 400 cc of water and rendered slightly acid with hydrochloric acid. The xylene is decanted, the aqueous layer is rendered strongly alkaline with caustic soda and the base which separates is extracted with ether. The ethereal extract is rectified, the fraction which boils at 190°-192°C under 3 mm being recovered. This is diluted with acetone or ethyl acetate and dry hydrochloric acid is added. The hydrochloride of N-(2'-dimethylamino-2'-methyl-ethyl)-phenothiazine separates, according to U.S. Patent 2,530,451.

References

- Merck Index 7691
 Kleeman & Engel p. 769
 PDR pp. 861, 993, 1033, 1959, 1968, 1989
 OCDS Vol. 1 pp. 373, 377 (1977)
 I.N. p. 811
 REM p. 1129
 Charpentier, P.; U.S. Patent 2,530,451; November 21, 1950; assigned to Societe des Usines Chimiques Rhone-Poulenc, France
 Berg, S.S. and Ashley, J.N.; U.S. Patent 2,607,773; August 19, 1952; assigned to Societe des Usines Chimiques Rhone-Poulenc, France

PROPAFENONE HYDROCHLORIDE

Therapeutic Function: Antiarrhythmic

Chemical Name: 2'-(2-Hydroxy-3-propylaminopropoxy)-3-phenylpropiofenone hydrochloride

Common Name: Fenoprain

Structural Formula:

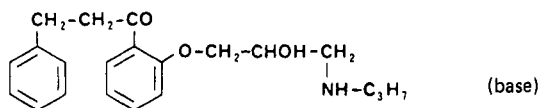

Chemical Abstracts Registry No.: 34183-22-7; 54063-53-5 (Base)

Trade Name	Manufacturer	Country	Year Introduced
Rytmonorm	Knoll	W. Germany	1978
Rytmonorm	Knoll	Italy	1983
Rytmonorm	Knoll	Switz.	1983
Baxarytmon	Helopharm	W. Germany	—
Normorytmin	Knoll	W. Germany	—

Raw Materials

2'-Hydroxy-3-phenylpropiofenone	Epichlorohydrin
n-Propylamine	Hydrogen chloride

Manufacturing Process

2'-(2,3-epoxypropoxy)-3-phenylpropiofenone — 24.8 g of the sodium salt of 2'-hydroxy-3-phenylpropiofenone were mixed with 40 cm³ of 1-chloro-2,3-epoxypropane (epichlorohydrin) and the mixture heated on a boiling water bath while stirring, using a reflux condenser. The initially pasty-to-solid mixture liquefied after about 2 hours, sodium chloride separating out. Thereafter it was heated for a further 2 hours while stirring, using a reflux condenser. The mixture was then allowed to cool and subsequently freed, by filtration, from the sodium chloride formed. The filtrate was concentrated in vacuo, and the excess 1-chloro-2,3-epoxypropane thus separated from the desired 2'-(2,3-epoxypropoxy)-3-phenylpropiofenone. The latter remained as a yellowish oil which solidified in the cold, but did not crystallize. Purification of the intermediate product, by distillation in vacuo, was not necessary, particularly as the substance only boiled at a temperature of 280°C/12 mm Hg and at the same time decomposed.

2'-(2-hydroxy-3-propylaminopropoxy)-3-phenylpropiofenone hydrochloride — The above product was treated with 20 cm³ of n-propylamine and the mixture warmed on a water bath for approximately 4 hours, while stirring, using a reflux condenser. Thereafter, the excess n-propylamine was distilled off. On cooling, the residue solidified to give a viscous yellow mass. 20 cm³ of 1 M aqueous hydrochloric acid were added to it, and the whole was boiled for 1 hour under reflux, while stirring. The mixture was then poured into a suitable vessel and allowed to crystallize at room temperature. The crude product was drained thoroughly by suction and subsequently crystallized from a mixture of acetone/methanol (80:20, v/v).

Approximately 25 g (66.2% of theory) of a white crystalline substance were obtained. The melting point of the hydrochloride was 173°C to 174°C.

References

Merck Index 7698

DFU 2 (5) 325 (1977)

Kleeman & Engel p. 770

I.N. p. 812

Sachse, R.; British Patent 1,307,455; February 21, 1973; assigned to Helopharm W. Petrick & Co. K.G.

PROPANIDID

Therapeutic Function: Anesthetic (intravenous)

Chemical Name: 4-[2-(Diethylamino)-2-oxoethoxy]-3-methoxybenzene-acetic acid propyl ester

Common Name: —

Structural Formula:

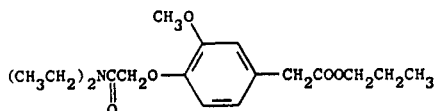

Chemical Abstracts Registry No.: 1421-14-3

Trade Name	Manufacturer	Country	Year Introduced
Epontol	Bayer	W. Germany	1965
Epontol	Bayer	Italy	1967
Epontol	Theraplix	France	1967
Epontol	Bayer	Japan	1970
Fabontal	Bayer	—	—
Sombrevin	Gedeon Richter	Hungary	—

Raw Materials

Homovanillic acid n-propyl ester
Sodium
Chloroacetic acid-N,N-diethylamide

Manufacturing Process

To a solution of 4 g of sodium in 200 ml of n-propanol is added 39 g of homovanillic acid-n-propyl ester (boiling point 160°C to 162°C/4 mm Hg) and the mixture is concentrated by evaporation under vacuum. After dissolving the residue in 200 ml of dimethylformamide and the addition of 0.5 g of sodium iodide, 26.2 g of chloroacetic acid-N,N-diethylamide are added dropwise with stirring at an internal temperature of 130°C, and the mixture is further heated at 130°C for three hours. From the cooled reaction mixture the precipitated salts are removed by filtering off with suction. After driving off the dimethylformamide under vacuum, the product is fractionated under vacuum, and 44.3 g of 3-methoxy-4-N,N-diethylcarbamido-methoxyphenylacetic acid-n-propyl ester are obtained as a yellowish oil of boiling point 210°C to 212°C/0.7 mm Hg.

References

Merck Index 7705
OCDS Vol. 2 p. 79 (1980)
DOT 2 (3) 110 (1966)
I.N. p. 813
REM p. 1047
Hiltman, R., Wollweber, H., Hoffmeister, F. and Wirth, W.; U.S. Patent 3,086,978; April 23, 1963; assigned to Farbenfabriken Bayer A.G. (Germany)

PROPANTHELIN BROMIDE

Therapeutic Function: Antispasmodic

Chemical Name: N-Methyl-N-(1-methylethyl)-N-[2-[(9H-xanthen-9-ylcarbonyl)oxy]ethyl]-2-propanaminium bromide

Common Name: Diisopropylaminoethyl xanthen-9-carboxylate methobromide

Structural Formula:

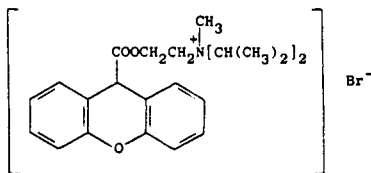

Chemical Abstracts Registry No.: 50-34-0

Trade Name	Manufacturer	Country	Year Introduced
Pro-Banthine	Searle	U.S.	1953
Probanthine	Searle	France	1981
Apopant	A.L.	Norway	—
Banlin	Paul Maney	Canada	—
Corigast	Searle	W. Germany	—
Ercoril	Erco	Denmark	—
Giquel	Danal	U.S.	—
Ketaman	Desitin	W. Germany	—
Neo-Banex	Neo	Canada	—
Neo-Dexabine	Nourypharma	Neth.	—
Neo-Gastroседan	Star	Finland	—
Neo-Metantyl	Zambon	Italy	—
Pantheline	Protea	Australia	—
Panthere	Vangard	U.S.	—
Pervagal	Zambeletti	Italy	—
Probital	Searle	U.S.	—
Prodidaxamon	A.L.	Norway	—
Propranthel	I.C.N.	Canada	—
Suprantil	Prodotti Erma	Italy	—
Tensilan	Desitin	W. Germany	—

Raw Materials

Xanthen-9-carboxylic acid
 β -Diisopropylaminoethyl chloride
 Methyl bromide

Manufacturing Process

365 parts of β -diisopropylaminoethyl chloride and 565 parts of xanthen-9-carboxylic acid dissolved in 800 parts of isopropanol is heated to reflux for 5 hours. The solution is then cooled, diluted with dry ether and the crystalline precipitate of β -diisopropylaminoethyl xanthen-9-carboxylate hydrochloride is collected on a filter and dried. This salt melts at 111°-112°C. 38 parts of the foregoing salt are dissolved in the minimum of water and treated with an aqueous solution of potassium carbonate. The suspension of β -diisopropylaminoethyl xanthen-9-carboxylate thus formed is extracted with ether and the ether extract is dried and evaporated. There is thus obtained 33 parts of the free base which are treated with 10 parts of methyl bromide in 100 parts of chloroform for 22 hours at 70°-80°C. The reaction mixture is chilled, diluted with anhydrous ether and the quaternary salt thus precipitated is collected on a filter and washed with dry ether and then with butanone. β -Diisopropylaminoethyl xanthen-9-carboxylate methobromide thus obtained melts at 152°-153°C. After recrystallization from isopropanol it melts at 157°-155°C.

References

Merck Index 7708

Kleeman & Engel p. 771

PDR pp. 830, 1569, 1606, 1694, 1723

OCDS Vol. 1 p. 394 (1977)

I.N. p. 813

REM p. 919

Cusic, J.W. and Robinson, R.A.; U.S. Patent 2,659,732; November 17, 1953; assigned to G.D. Searle & Co.

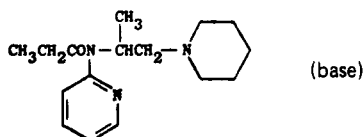
PROPIRAM FUMARATE**Therapeutic Function:** Analgesic**Chemical Name:** N-[1-Methyl-2-(1-piperidiny)ethyl]-N-2-pyridinylpropanamide fumarate**Common Name:** —**Structural Formula:****Chemical Abstracts Registry No.:** 13717-04-9; 15686-91-6 (Base)

Trade Name	Manufacturer	Country	Year Introduced
Algeril	Bayropharm	Italy	1974
Algeril	Bayer	W. Germany	1974
Dirame	Schering	—	—

Raw Materials

2-(1-Piperidino-isopropyl)aminopyridine

Propionic anhydride

Fumaric acid

Manufacturing Process

20 g of 2-(1-piperidino-isopropyl)aminopyridine and 50 ml of propionic anhydride are heated to 120°C for 8 hours. The mixture is then evaporated under vacuum and the residue taken up in water. The base is precipitated from the solution with a caustic soda solution, taken up in ether and dried with potassium carbonate. After driving off the ether and distillation under vacuum, there are obtained 18 grams of N-propionyl-2-(1-piperidino-isopropyl)aminopyridine of BP 162°-163°C/0.5 mm Hg. The base is then reacted with fumaric acid to give the final product.

References

Merck Index 7733

Kleeman & Engel p. 772

DOT 10 (11) 309 (1974)

I.N. p. 815

Hiltmann, R., Wollweber, H., Hoffmeister, F., Wirth, W. and Kroneberg, H.-G.; U.S. Patent 3,163,654; December 29, 1964; assigned to Farbenfabriken Bayer AG, Germany
 Wollweber, H., Hiltmann, R., Hoffmeister, F. and Kroneberg, H.-G.; U.S. Patent 3,594,477; July 20, 1971; assigned to Farbenfabriken Bayer AG, Germany

PROPOXYPHENE HYDROCHLORIDE

Therapeutic Function: Analgesic

Chemical Name: (S)- α -[2-(dimethylamino)-1-methylethyl]- α -phenylbenzeneethanol propionate hydrochloride

Common Name: Dextropropoxyphene hydrochloride

Structural Formula:

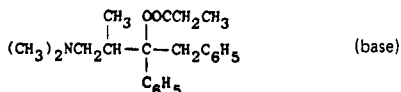

Chemical Abstracts Registry No.: 1639-60-7; 469-62-5 (Base)

Trade Name	Manufacturer	Country	Year Introduced
Darvon	Lilly	U.S.	1957
Antalvic	Houde	France	1963
SK-65	SKF	U.S.	1973
Propoxychel	Rachelle	U.S.	1973
Dolene-65	Lederle	U.S.	1973
Prophen 65	Halsey	U.S.	1981
Darvocet-N	Lilly	U.S.	—
Depronal SA	Warner	U.K.	—
Develin	Goedecke	W. Germany	—
Doloxene	Lilly	U.K.	—
Erantin	Boehr. Mann.	W. Germany	—
Liberen	Lisapharma	Italy	—
Lorcet	U.A.D. Labs	U.S.	—
Wygesic	Wyeth	U.S.	—

Raw Materials

Benzyl chloride	Magnesium
α -Methyl- β -dimethylaminopropiophenone	Hydrogen chloride
Propionic anhydride	

Manufacturing Process

A solution of benzylmagnesium chloride prepared from 63.3 grams (0.5 mol) of benzyl chloride, 30.5 grams (1.25 mol) of magnesium and 750 cc of ether was added dropwise with stirring to a solution of 61.9 grams (0.35 mol) of α -methyl- β -dimethylaminopropiophenone (prepared by the method of Burchalter et al, *JACS* 70 page 4186, 1948), in 150 cc of ether. When all of the Grignard reagent had been added, the solution was refluxed for about 1 hour. The reaction mixture was then decomposed by the addition of saturated aqueous ammonium chloride solution. The ether solution containing the 1,2-diphenyl-2-hydroxy-3-methyl-4-dimethylaminobutane formed in the reaction was decanted from the granular precipitate and dried over anhydrous magnesium sulfate.

Dry hydrogen chloride gas was passed into the ether solution until precipitation was completed. The solid was removed by filtration and was recrystallized from a mixture of methanol and ethyl acetate. The α -dl-1,2-diphenyl-2-hydroxy-3-methyl-4-dimethylaminobutane hydrochloride thus obtained melted at about 231° to 232°C.

A mixture of 50 grams of α -dl-1,2-diphenyl-2-hydroxy-3-methyl-4-dimethylaminobutane hydrochloride, 50 grams of propionic anhydride and 50 cc of pyridine was refluxed for about 5 hours. The reaction mixture was cooled to 50°C and ethyl ether was added to the point of incipient precipitation. The hydrochloride salt of α -dl-1,2-diphenyl-2-propionoxy-3-methyl-4-dimethylaminobutane formed in the reaction precipitated upon cooling and was removed by filtration and washed with anhydrous ether. On recrystallization from a mixture of methanol and ethyl acetate, α -dl-1,2-diphenyl-2-propionoxy-3-methyl-4-dimethylaminobutane hydrochloride melted at 170°-171°C.

References

Merck Index 7739

Kleeman & Engel p. 285

PDR pp. 993, 1044, 1606, 1723, 1808, 1996, 1999

OCDs Vol. 1 pp. 50, 298 (1977) & 2, 57 (1980)

I.N. p. 816

REM p. 1114

Pohland, A.; U.S. Patent 2,728,779; December 27, 1955; assigned to Eli Lilly and Company

PROPRANOLOL HYDROCHLORIDE

Therapeutic Function: β -adrenergic blocker

Chemical Name: 1-(isopropylamino)-3-(1-naphthoxy)-2-propanol hydrochloride

Common Name: —

Structural Formula:

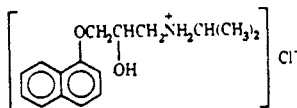

Chemical Abstracts Registry No.: 318-98-9; 525-66-6 (Base)

Trade Name	Manufacturer	Country	Year Introduced
Inderal	I.C.I.	U.K.	1965
Dociton	Rhein Pharma	W. Germany	1965
Avlocardyl	I.C.I.	France	1967
Inderal	Ayerst	U.S.	1968
Angilol	D.D.S.A.	U.K.	—
Arcablock	Arcana	Austria	—
Bedranol	Lagap	Switz.	—
Berkolol	Berk	U.K.	—
Beta-Neg	Ellem	Italy	—
Beta-Tablinen	Sanorania	W. Germany	—
Cardinol	Protea	Australia	—
Caridolol	Sankyo	Japan	—
Corotrend	Siegfried	Switz.	—

Trade Name	Manufacturer	Country	Year Introduced
Deralin	Abic	Israel	—
Detensol	Desbergers	Canada	—
Dideral	Dif-Dogu	Turkey	—
Frekven	Ferrosan	Denmark	—
Herzbase	Nichiilko	Japan	—
Herzul	Ono	Japan	—
Inderide	Ayerst	U.S.	—
Indobloc	Homburg	W. Germany	—
Kemi	Otsuka	Japan	—
Nedis	Omega	Argentina	—
Noloten	Beta	Argentina	—
Novopropranol	Novopharm	Canada	—
Obsidan	Iris-Chemie	E. Germany	—
Oposim	Richet	Argentina	—
Pranolol	A.L.	Norway	—
Pronovan	A.L.	Norway	—
Propranolol	Lederle	U.S.	—
Propranur	Henning	W. Germany	—
Pur-Bloka	Lennon	S. Africa	—
Pylapron	Kyorin	Japan	—
Reducor	Leiras	Finland	—
Sawatal	Sawai	Japan	—
Tonum	Tubi Lux Pharma	Italy	—

Raw Materials

1-Naphthol	Epichlorohydrin
Isopropyl amine	Hydrogen chloride

Manufacturing Process

In a first step, 1-naphthol was reacted with epichlorohydrin to give 1-chloro-3-(1-naphthoxy)-2-propanol.

A mixture of 4.4 parts of 1-chloro-3-(1-naphthoxy)-2-propanol and 16 parts of isopropylamine is heated in a sealed vessel at 70°-80°C for 10 hours. The vessel is cooled and to the contents there are added 50 parts of water. The mixture is acidified with 2 N hydrochloric acid, and washed with 50 parts of ether. The aqueous phase is decolorized with carbon, and then added to 50 parts of 2 N sodium hydroxide solution at 0°C. The mixture is filtered. The solid residue is washed with water, dried, and crystallized from cyclohexane. There is thus obtained 1-isopropylamino-3-(1-naphthoxy)-2-propanol, MP 96°C.

The base may be converted into the hydrochloride as follows. 4.65 parts of the base are dissolved in 60 parts of warm acetone. To the warm solution there are added 2 parts of 10 N hydrochloric acid. The mixture is allowed to cool, and is then filtered. The solid residue is washed with acetone and then dried. The solid is crystallized from propanol, and there is thus obtained 1-isopropylamino-3-(1-naphthoxy)-2-propanol hydrochloride MP 163°C.

References

- Merck Index 7740
- Kleeman & Engel p. 773
- PDR pp. 622, 993, 1999
- OCDS Vol. 1 p. 117 (1977) & 2, 105, 107, 212 (1980)
- DOT 19 (3) 172 (1983)
- I.N. p. 816
- REM p. 906

Crowther, A.F. and Smith, L.H.; U.S. Patent 3,337,628; August 22, 1967; assigned to Imperial Chemical Industries Limited, England

PROPYLHEXEDRINE

Therapeutic Function: Nasal decongestant

Chemical Name: N, α -dimethylcyclohexaneethanamine

Common Name: Hexahydrodesoxyephedrine

Structural Formula:

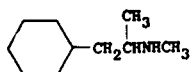

Chemical Abstracts Registry No.: 101-40-6; 6192-98-9 (Hydrochloride)

Trade Name	Manufacturer	Country	Year Introduced
Benzedrex	SKF	U.S.	1949
Dristan	Whitehall	U.S.	—
Eggobesin	Fahlberg-List	E. Germany	—
Eventin	Minden	W. Germany	—

Raw Materials

Cyclohexylacetone	N-Methylformamide
Sulfuric acid	Sodium hydroxide

Manufacturing Process

33.6 grams of cyclohexylacetone, a compound known to the art, dissolved in 13 grams of 85% formic acid is caused to interact with 72.0 grams of N-methyl formamide at 160°-180°C for 4 hours. This results in the formation of the formyl derivative of the amine, according to the following reaction:

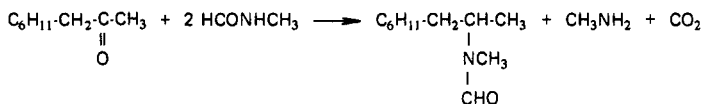

The formyl derivative is then hydrolyzed by refluxing with 50% sulfuric acid for about 4 hours, after which the hydrolysate is extracted with ether to remove the acid-insoluble material and the aqueous solution made strongly alkaline with any suitable alkalinizing agent, for example, sodium hydroxide, to liberate the amine.

The amine is then taken up in ether, dried over potassium hydroxide and purified by distillation, preferably under reduced pressure. β -cyclohexylisopropylmethylamine thus obtained boils at 90.0°-92°C at 22 mm Hg.

References

- Merck Index 7761
- Kleeman & Engel p. 774
- OCDS Vol. 1 p. 37 (1977)
- I.N. p. 817

REM p. 890

Ulliyot, G.E.; U.S. Patent 2,454,746; November 23, 1948; assigned to Smith, Kline & French Laboratories

PROQUAZONE

Therapeutic Function: Antiinflammatory

Chemical Name: 1-Isopropyl-7-methyl-4-phenyl-2(1H)-quinazolinone

Common Name: —

Structural Formula:

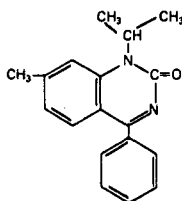

Chemical Abstracts Registry No.: 22760-18-5

Trade Name	Manufacturer	Country	Year Introduced
Biarison	Sandoz	Italy	1977
Biarison	Sandoz	Japan	1977
Biarison	Sandoz	France	1977
Biarison	Sandoz	Switz.	1977
Biarison	Wander	W. Germany	1979

Raw Materials

4-Methyl-2-isopropylaminobenzophenone
Urethane

Manufacturing Process

A mixture of 5.9 g of 4-methyl-2-isopropylaminobenzophenone, 13.9 g urethane and 500 mg of zinc chloride is heated at a temperature of 190°C for 1½ hours. There is then additionally added 7 g of urethane and 250 mg of zinc chloride, and the heating continued at a temperature of 190°C for an additional 2½ hours. The resulting mixture is cooled to about 100°C and diluted with chloroform. The resulting mixture is then filtered and the filtrate washed first with water and then with brine. The organic phase is separated, dried over anhydrous sodium sulfate and concentrated in vacuo to remove substantially all of the chloroform and obtain an oily residue which is dissolved in a small amount of about 20 ml of methylene chloride. The resulting solution is then diluted with about 40 ml of ethyl acetate and concentrated in vacuo to crystallize 1-isopropyl-7-methyl-4-phenyl-2(1H)-quinazolinone; melting point 137°C to 138°C.

References

Merck Index 7775
DFU 1 (11) 540 (1976)
Kleeman & Engel p. 777

OCDS Vol. 2 p. 386 (1980)

DOT 8 (3) 116 (1972) & 13 (12) 534 (1977)

I.N. p. 818

Linder, J., Mattner, P.G. and Salmond, W.G.; U.S. Patent 3,759,720; September 18, 1973; assigned to Sandoz-Wander Inc.

Denzer, M.; U.S. Patent 3,793,324; February 19, 1974

Ott, H.; U.S. Patent 3,925,548; December 9, 1975; assigned to Sandoz, Inc.

PROSCILLARIDIN

Therapeutic Function: Cardiotoxic

Chemical Name: 3-[[6-Deoxy- α -L-mannopyranosyl]oxy]-14-hydroxybufa-4,20,22-trienolide

Common Name: —

Structural Formula:

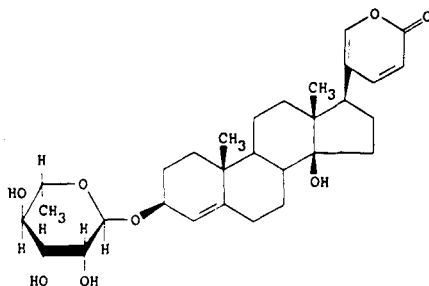

Chemical Abstracts Registry No.: 466-06-8

Trade Name	Manufacturer	Country	Year Introduced
Talusin	Knoll	W. Germany	1964
Talusin	Biosedra	France	1968
Apocerpin	Kotani	Japan	—
Bunosquin	Seiko	Japan	—
Caradrin	Kowa	Japan	—
Cardimarin	Santen	Japan	—
Cardiolidin	Nichiiko	Japan	—
Cardion	Nippon Chemiphar	Japan	—
Cardon	Kanto	Japan	—
Herzo	Toho	Japan	—
Mitredin	Nippon Shoji	Japan	—
Procardin	Mohan	Japan	—
Procillan	Hokuriku	Japan	—
Proherz	Shinshin	Japan	—
Proscillan	Streuli	Switz.	—
Proscillar	Toyo Jozo	Japan	—
Prosiladin	Sawai	Japan	—
Prostosin	Iwari	Japan	—
Proszin	Teisan	Japan	—
Protasin	Bayropharm	W. Germany	—
Purosin-TC	Tatsumi	Japan	—
Sandoscill	Sandoz	W. Germany	—

Trade Name	Manufacturer	Country	Year Introduced
Scillaridin	Moroshita	Japan	—
Silamarin A	Wakamoto	Japan	—
Stellarid	Tobishi-Mochida	Japan	—
Talusin	Dainippon	Japan	—
Urgilan	Simes	Italy	—
Wirnesin	Inpharzam	W. Germany	—

Raw Materials

Squill

Manufacturing Process

350 g of dried and cut squill were fermented at 50°C for two hours in 1.1 liters of water. The suspension was then extracted three times with 1.1 liters of ethyl acetate. The extracts were united and evaporated to dryness, the residue was dissolved in 2 ml of dioxane and chromatographed in a twenty-fold quantity (based on the amount of dried residue) of silica gel. The proscillaridin was then eluated with toluene to which increasing quantities of a methanol-dioxane mixture were added. The main fraction, containing proscillaridin, was evaporated to dryness. The residue was crystallized out of methanol. Pure proscillaridin was obtained with a melting point of 227°C to 230°C; $\alpha_{20}^D = -93.5^\circ\text{C}$ (in methanol).

The same result was obtained by fermentation on the aqueous suspension of the cut squill at room temperature for 24 hours and working up in the manner described.

References

Merck Index 7776

Kleeman & Engel p. 777

DOT 3 (3) 97 (1967)

I.N. p. 819

Steidle, W.; U.S. Patent 3,361,630; January 2, 1968; assigned to Knoll A.G. (Germany)

PROTHIPENDYL HYDROCHLORIDE

Therapeutic Function: Sedative; antihistaminic

Chemical Name: N,N-Dimethyl-10H-pyrido[3,2-b][1,4]benzothiazine-10-propanamine hydrochloride

Common Name: —

Structural Formula:

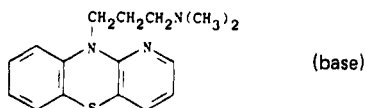

Chemical Abstracts Registry No.: 1225-65-6; 303-69-5 (Base)

Trade Name	Manufacturer	Country	Year Introduced
Timovan	Ayerst	U.S.	1960
Dominal	Homburg	W. Germany	—
Prosyl	Kanto	Japan	—
Tolnate	SKF	U.K.	—

Raw Materials

1-Azaphenothiazine	Sodium amide
3-Dimethylaminopropyl chloride	Hydrogen chloride

Manufacturing Process

A mixture of 20 g (0.1 mol) of 1-azaphenothiazine, 4.3 g (0.11 mol) of sodamide and 300 ml of dry toluene is stirred and refluxed for eight hours. A slow stream of dry nitrogen gas is used to sweep out the ammonia as formed. The mixture is cooled and 110 ml of a 1 M solution of 3-dimethylaminopropyl chloride in toluene is added dropwise, with stirring. Subsequently, the mixture is stirred and refluxed for fifteen hours, cooled, and concentrated in vacuo. The viscous residue is refluxed with 500 ml of chloroform and filtered hot. The chloroform filtrate is treated with activated charcoal and again filtered. The filtrate is concentrated and the residue distilled to give about 19.8 g (69% yield) of product, an oil distilling at about 195°C to 198°C (under 0.5 mm pressure of mercury).

To a solution of 16.4 g (0.058 mol) of the free base in 75 ml of dry acetonitrile is added dropwise while cooling (ice bath) and stirring 14.5 ml (0.053 mol) of 3.6N ethereal hydrogen chloride. An equal volume of anhydrous ether is added and the product altered, dried and recrystallized from monochlorobenzene. The product melts at about 177°C to 178°C with sintering at about 176°C. The yield is about 11.0 g (60%).

References

Merck Index 7789

Kleeman & Engel p. 779

OCDS Vol. 1 p. 430 (1977)

I.N. p. 821

Yale, H.L. and Bernstein, J.; U.S. Patent 2,943,086; June 28, 1960; assigned to Olin Mathieson Chemical Corp.

PROTIONAMIDE

Therapeutic Function: Antitubercular

Chemical Name: 2-propyl-4-pyridinecarbothioamide

Common Name: α -propyl-isonicotinic thioamide

Structural Formula:

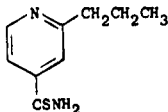

Chemical Abstracts Registry No.: 14222-60-7

Trade Name	Manufacturer	Country	Year Introduced
Ektebin	Bayer	W. Germany	1969
Protionizina	Farmitalia	Italy	1970
Entelohl	Kyowa	Japan	—
Peteha	Saarstickstoff-Fatol	W. Germany	—
Promid	Biofarma	Turkey	—

Trade Name	Manufacturer	Country	Year Introduced
Prothionamide	Toho	Japan	—
Trevintix	Theraplix	France	—
Tuberamin	Meiji	Japan	—
Tuberex	Shionogi	Japan	—
Tuberamide	Sankyo	Japan	—

Raw Materials

Ethyl oxalate	Methyl-n-propyl ketone
Sodium ethylate	Cyanacetamide
Hydrogen chloride	Phosphorus oxychloride
Hydrogen	Ammonia
Phosphoric anhydride	Hydrogen sulfide

Manufacturing Process

(A) *Ethyl Butyryl-Pyruvate*: 146 grams of ethyl oxalate are condensed with 86 grams of methyl-(n)-propyl-ketone in the presence of sodium ethylate prepared from 25 grams of sodium. 135 grams of product, having a boiling point of 113°C/6 mm, are obtained.

(B) *3-Cyano-4-Carboxy-6-(n)-Propyl-2-Pyridone*: The 135 grams of the product just obtained are condensed with 62 grams of cyanacetamide in the presence of 24 cc of piperidine in 1200 cc of 95% alcohol. 64 grams of a product, melting at 152°C, are obtained.

(C) *6-(n)-Propyl-2-Pyridone-4-Carboxylic Acid*: The 64 grams of the product just obtained are treated with 500 cc of concentrated hydrochloric acid at boiling point. 40 grams of a product, having a melting point of 285°C, are obtained.

(D) *Ethyl 2-Chloro-6-(n)-Propyl-Isonicotinate*: The 40 grams of the acid just obtained are treated with 80 grams of phosphorus oxychloride and 95 grams of phosphorus pentachloride. The phosphorus oxychloride is distilled and the reaction mixture is treated with 400 grams of absolute alcohol. 40 grams of chlorinated ester, having a BP of 115°-116°C/2 mm, are obtained.

(E) *Ethyl 2-(n)-Propyl-Isonicotinate*: The product just obtained is dechlorinated by catalytically hydrogenating it in an alcoholic medium in the presence of palladium black and potassium acetate. 30 grams of ester, having a boiling point of 121°-125°C/7 mm, are obtained.

(F) *2-(n)-Propyl-Isonicotinamide*: The 30 grams of the ester just obtained are treated with 40 cc of concentrated ammonia saturated with gaseous ammonia. 20 grams of product, having a melting point of 135°C, are obtained.

(G) *2-(n)-Propyl-Isonicotinic-Nitrile*: The 20 grams of the amide just obtained are treated with 32 grams of phosphoric anhydride. 11 grams of nitrile, having a BP of 90°-95°C/4 mm, are obtained.

(H) *2-(n)-Propyl-Isonicotinic Thioamide*: The 11 grams of nitrile just obtained, dissolved in 40 cc of ethanol containing 4 grams of triethanolamine, are treated with hydrogen sulfide. 8 grams of the desired product, having a melting point of 142°C, are obtained.

References

Merck Index 7791

Kleeman & Engel p. 780

DOT 3 (1) 24 (1967)

I.N. p. 821

Chimie et Atomistique, France; British Patent 800,250; August 20, 1958

PROTIZINIC ACID

Therapeutic Function: Antiinflammatory

Chemical Name: 7-methoxy- α ,10-dimethylphenothiazine-2-acetic acid

Common Name: —

Structural Formula:

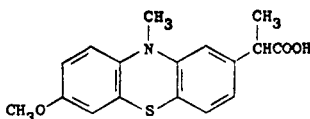

Chemical Abstracts Registry No.: 13799-03-6

Trade Name	Manufacturer	Country	Year Introduced
Pirocid	Theraplix	France	1974
Pirocid	Mochida	Japan	1979
P.R.T.	Mochida	Japan	—

Raw Materials

Methyl (7-methoxy-10-methyl-3-phenthiazinyl)acetate
 Sodium
 Ethanol
 Methyl iodide
 Diethyl carbonate
 Sodium hydroxide
 Hydrogen chloride

Manufacturing Process

Methyl ethyl (7-methoxy-10-methyl-3-phenthiazinyl)malonate is prepared by reacting a solution of sodium (4.37 grams) in anhydrous ethanol (110 cc) with a solution of methyl (7-methoxy-10-methyl-3-phenthiazinyl)acetate (59 grams) in ethyl carbonate (180 cc). The reaction mixture is heated at about 105°-110°C for 3 hours and the ethanol formed is distilled off as it is formed.

The reaction mixture is acidified with N hydrochloric acid (200 cc) and the oil formed is extracted with methylene chloride (200 cc). The methylene chloride solution is washed with water (210 cc), treated with decolorizing charcoal (5 grams), dried over anhydrous sodium sulfate and concentrated to dryness under reduced pressure (20 mm Hg) giving an oil (77 grams) which is crystallized from methanol (300 cc) to yield methyl ethyl (7-methoxy-10-methyl-3-phenthiazinyl)-malonate (62.4 grams) melting at 80°-82°C.

Methyl ethyl (7-methoxy-10-methyl-3-phenthiazinyl)malonate (62.2 grams) followed by methyl iodide (45.7 grams) is added to a solution of sodium (4.45 grams) in anhydrous ethanol (500 cc). The reaction mixture is heated under reflux for 1 hour at 45°C, then for 6 hours at 55°C, and finally concentrated to dryness under reduced pressure (20 mm Hg). The residue is taken up in methylene chloride (300 cc) and water (250 cc), filtered in the presence of a filtration adjuvant, washed with methylene chloride (150 cc) and water (150 cc), and decanted. The aqueous solution is extracted once again with methylene chloride (100 cc), and the combined organic solutions washed with water (100 cc), aqueous 0.1N sodium hyposulfite solution (200 cc) and finally with water (200 cc). After drying over anhydrous sodium sulfate and evaporation to dryness under reduced pressure (20 mm Hg), there is obtained an oil (64.8 grams) which is dissolved in methylene chloride (100 cc) and

chromatographed over alumina (650 grams). After elution with methylene chloride, a fraction of 2.5 liters is recovered and concentrated to dryness under reduced pressure (20 mm Hg) to give methyl ethyl methyl-(7-methoxy-10-methyl-3-phenthiazinyl)malonate (59.7 grams) melting at 70°-72°C.

1 N sodium hydroxide solution (296 cc) is poured over a period of 3 hours into a solution of methyl ethyl methyl-(7-methoxy-10-methyl-3-phenthiazinyl)malonate (59.7 grams) in ethanol (600 cc) heated under reflux in an atmosphere of nitrogen. The reaction mixture is concentrated to dryness under reduced pressure (20 mm Hg), the residue obtained acidified with N hydrochloric acid (300 cc) and the gum formed extracted with methylene chloride (150 cc). The organic solution is washed with water (200 cc), treated with decolorizing charcoal (10 grams), dried over anhydrous sodium sulfate and concentrated to dryness under reduced pressure (20 mm Hg). The oil obtained (48 grams) is dissolved in N sodium hydroxide solution (200 cc) and the aqueous solution washed with diethyl ether (300 cc), treated with decolorizing charcoal (5 grams) and acidified with N hydrochloric acid (200 cc). The oil formed is dissolved in methylene chloride (350 cc), the solution washed with water (100 cc), treated with decolorizing charcoal (5 grams) and dried over anhydrous sodium sulfate. The solution is concentrated to dryness under reduced pressure (20 mm Hg) to give an oil (35.6 grams) which crystallizes slowly. On recrystallization from diisopropyl ether (180 cc) a product (19.5 grams), melting at 123°-124°C, is obtained. Further recrystallization from diisopropyl ether (290 cc) yields 2-(7-methoxy-10-methyl-3-phenthiazinyl)-propionic acid (12.9 grams) melting at 124°-125°C.

References

Merck Index 7792

Kleeman & Engel p. 782

DOT 8 (12) 452 (1972)

I.N. p. 36

Farge, D., Jeanmart, C. and Messer, M.N.; U.S. Patent 3,450,698; June 17, 1969; assigned to Rhone-Poulenc SA, France

PROTOKYLOL

Therapeutic Function: Bronchodilator

Chemical Name: 4-[2-[[2-(1,3-benzodioxol-5-yl)-1-methylethyl] amino]-1-hydroxyethyl]-1,2-benzenediol

Common Name: —

Structural Formula:

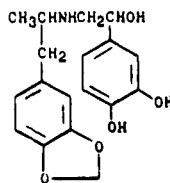

Chemical Abstracts Registry No.: 136-70-9; 136-69-6 (Hydrochloride)

Trade Name	Manufacturer	Country	Year Introduced
Caytine	Lakeside	U.S.	1959
Ventaire	Marion	U.S.	1974

Trade Name	Manufacturer	Country	Year Introduced
Asmetil	Benvegna	Italy	—
Atma-Sanol	Sanol	W. Germany	—
Beres	Simes	Italy	—
Biturix	Nemi	Argentina	—
Palison	Farmasimes	Spain	—

Raw Materials

3,4-Methylenedioxyphenylisopropanolamine
 Chloroacetylcatechol
 Hydrogen

Manufacturing Process

3,4-Methylenedioxyphenylisopropanolamine is reacted with chloroacetylcatechol in a 3:1 mol ratio in 60% ethanol at reflux temperature with continuous stirring. Stirring and refluxing were continued for another five hours after which the reaction mixture was cooled and then acidified with 20 cc of concentrated aqueous HCl. The acid solution was concentrated in vacuo to a viscous consistency and the residue dissolved in acetone. On standing, the aminoketone precipitated and was filtered. The precipitate was dissolved in isopropyl alcohol and permitted to recrystallize. An alcoholic solution of this aminoketone precipitate was reduced with PtO₂ and hydrogen, clarified by filtration, concentrated to dryness in vacuo and the residue crystallized from acetone giving the desired product.

References

Merck Index 7798

Kleeman & Engel p. 783

I.N. p. 821

Biel, J.H.; U.S. Patent 2,900,415; August 18, 1959; assigned to Lakeside Laboratories, Inc.

PROTRIPTYLINE

Therapeutic Function: Psychostimulant

Chemical Name: N-methyl-5H-dibenzo[a,d]cycloheptene-5-propylamine

Common Name: Amimetilina; 5-(3-methylaminopropyl)-5H-dibenzo[a,d]cycloheptene

Structural Formula:

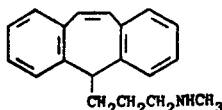

Chemical Abstracts Registry No.: 438-60-8; 1225-55-4 (Hydrochloride)

Trade Name	Manufacturer	Country	Year Introduced
Vivactil	MSD	U.S.	1967
Maximed	Sharp & Dohme	W. Germany	1968
Concordin	MSD	Italy	1972
Concordine	MSD	France	1973
Triptil	Merck-Frosst	Canada	—

Raw Materials

3-Methylaminopropanol-1
Thionyl chloride
Potassium amide

Formamide
5H-Dibenzo[a,d]-cycloheptene
Potassium hydroxide

Manufacturing Process

Preparation of 3-(N-Formyl-N-Methyl)-Aminopropanol-1: A mixture of 40 grams of 3-methylaminopropanol-1 and 20 grams of formamide is heated while stirring for 4 hours at 165°C. The crude product is fractionated in vacuo using a Widmer column yielding substantially pure 3-(N-formyl-N-methyl)-aminopropanol-1.

Preparation of 3-(N-Formyl-N-Methyl)-Aminopropyl Chloride: 50 grams of 3-(N-formyl-N-methyl)-aminopropanol-1 obtained above is dissolved in a mixture of 100 ml of chloroform and 25 grams of pyridine. 40 grams of thionyl chloride is then slowly added while maintaining the temperature below 65°C. After 6 hours of refluxing, the mixture is washed with water, then with sodium bicarbonate solution and again with water and then dried over magnesium sulfate and the solvent distilled off in vacuo. Fractional distillation at 1 mm pressure yields substantially pure 3-(N-formyl-N-methyl)-aminopropyl chloride.

Preparation of 5-[3-(N-Formyl-N-Methyl)-Aminopropyl]-5H-Dibenzo[a,d] Cycloheptene: To a suspension of 3.9 grams of potassium amide is slowly added a solution of 19.2 grams (0.1 mol) of 5H-dibenzo[a,d] cycloheptene in 600 ml of ether with stirring. The suspension is refluxed with stirring for 3 hours, then cooled to room temperature and a solution of 0.1 mol of 3-(N-formyl-N-methyl)-aminopropyl chloride in 100 ml of ether added. The mixture is then refluxed with stirring for 5 hours and then 100 ml of water added. The ether layer is then washed with dilute hydrochloric acid, then water and then dried over magnesium sulfate and evaporated to dryness yielding 5-[3-(N-formyl-N-methyl)-aminopropyl]-5H-dibenzo[a,d] cycloheptene.

Preparation of 5-(3-Methylaminopropyl)-5H-Dibenzo[a,d] Cycloheptene from 5-[3-(N-Formyl-N-Methyl)-Aminopropyl]-5H-Dibenzo[a,d] Cycloheptene: 29.5 grams of 5-[3-(N-formyl-N-methyl)-aminopropyl]-5H-dibenzo[a,d] cycloheptene is refluxed for 24 hours under nitrogen in a solution of 36.3 grams of potassium hydroxide in 378 ml of n-butanol. After cooling to room temperature, the solvent is evaporated in vacuo, the residue is stirred with 200 ml of water, 300 ml of n-hexane, the layers separated, the water layer extracted with 100 ml of n-hexane and the combined hexane layers washed with water (2 x 100 ml) and then with 0.5 N sulfuric acid (100, 80, 80 ml). The acid solution is then alkalized and extracted with ether (2 x 150 ml and 1 x 100 ml), dried over MgSO₄ and the solution evaporated to dryness yielding substantially pure 5-(3-methylaminopropyl)-5H-dibenzo[a,d] cycloheptene according to U.S. Patent 3,244,748.

References

Merck Index 7804

Kleeman & Engel p. 783

PDR p. 1220

OCDS Vol. 1 p. 152 (1977)

I.N. p. 822

REM p. 1097

Tishler, M., Chemerda, J.M. and Kollonitsch, J.; U.S. Patent 3,244,748; April 5, 1966; assigned to Merck & Co., Inc.

Tishler, M., Chemerda, J.M. and Kollonitsch, J.; U.S. Patent 3,271,451; September 6, 1966; assigned to Merck & Co., Inc.

PROXAZOLE CITRATE

Therapeutic Function: Antispasmodic

Chemical Name: N,N-diethyl-3-(1-phenylpropyl)-1,2,4-oxadiazole-5-ethanamine citrate

Common Name: Propaxoline citrate

Structural Formula:

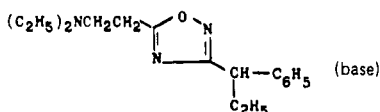

Chemical Abstracts Registry No.: 132-35-4; 5696-09-3 (Base)

Trade Name	Manufacturer	Country	Year Introduced
Recidol	Lampugnani	Italy	1967
Pirecin	Yoshitomi	Japan	1970
Mendozal	Beaufour	France	1976
Flou	Elea	Argentina	—
Solacil	Finadiet	Argentina	—
Toness	Angelini	Italy	—

Raw Materials

α -Ethylbenzamidoxime
Citric acid

β -Chloropropionyl chloride
Diethylamine

Manufacturing Process

α -Ethylbenzamidoxime and anhydrous potassium carbonate are suspended in chloroform. To this mixture, under continuous stirring and controlling of the reaction temperature to remain beyond 15°C, there is slowly added β -chloropropionyl chloride. After addition of the acid chloride, stirring is continued for a further hour. Then with cooling there is added portionwise a small amount of water. Further amounts of water are introduced into the reaction mixture and the chloroform solution containing the β -chloropropionyl α -ethylbenzamidoxime is separated.

To this solution there is added in about 20 minutes a solution of diethylamine in CHCl_3 while the temperature is kept below 35°C. The reacting mixture is heated to boiling, water formed during the reaction being distilled off thereby. After two hours the distillate contains no more water and the reaction is finished. Water is added to dissolve diethylamine hydrochloride formed during the reaction, and the chloroform layer containing the product is separated from the aqueous layer. The product may be purified by distillation; it boils at 132°C at 0.2 mm pressure. It is converted to the citrate by reaction with citric acid.

References

Merck Index 7805

Kleeman & Engel p. 784

OCDS Vol. 2 p. 271 (1980)

I.N. p. 822

Palazzo, G. and Silvestrini, B.; U.S. Patent 3,141,019; July 14, 1964; assigned to Angelini Francesco, Aziende Chimiche Riunite, Italy

PROXIBARBAL

Therapeutic Function: Sedative

Chemical Name: 5-(2-Hydroxypropyl)-5-(2-propenyl)-2,4,6(1H,3H,5H)pyrimidinetrione

Common Name: Proxibarbal

Structural Formula:

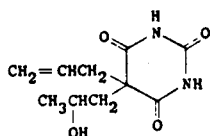

Chemical Abstracts Registry No.: 2537-29-3

Trade Name	Manufacturer	Country	Year Introduced
Axeen	Hommel	W. Germany	1962
Centralgol	Valpan	France	1965
Ipronal	Polfa	Poland	—
Vasalgin	Chinoi	Hungary	—

Raw Materials

Diallylbarbituric acid
Sulfuric acid
Water

Manufacturing Process

9 Parts of diallyl-barbituric acid are added to a precooled mixture of 15.5 parts of concentrated sulfuric acid and 0.5 part of water while stirring intensively, the mixture being cooled so that its temperature does not exceed 25°C. The honey-colored viscous solution is stirred vigorously and all at once into 45 parts of water, whereupon the mixture warms up to 35°C to 40°C and, after several seconds, solidifies into a thick pulp, which is then heated as quickly as possible to 95°C, at which temperature a clear solution is formed. This is cooled slowly until the 5-allyl-5-(β-hydroxypropyl)-barbituric acid begins to form coarse-grained crystals, after which the mass is cooled rapidly to 20°C.

The crystallized 5-allyl-5-(β-hydroxypropyl)-barbituric acid is centrifuged off, 55 to 58 parts of mother liquor and 10 to 13 parts of crude product being obtained. The latter is dispersed in 20 parts of saturated aqueous sodium chloride solution and after two hours is again centrifuged off.

The thus-washed crude product is dissolved in a mixture of 12 parts of ethanol and 20 parts of benzene, with mild warming if necessary. 1 Part of sodium chloride and 1.5 parts of saturated aqueous sodium chloride solution are added to the obtained solution in ethanol-benzene, and whole thoroughly admixed. When the brine layer has settled, it is separated and the afore-described washing repeated. The clear solution is concentrated under reduced pressure until incipient formation of crystals and is then poured into 30 parts of benzene, whereupon a thick crystalline pulp is forthwith formed which, after being cooled to room temperature, is centrifuged off. The so-obtained 5-allyl-5-(β-hydroxypropyl)-barbituric acid is dried at 70°C under reduced pressure and can be used for therapeutic purposes without further purification. Melting point 164°C to 165°C. Yield: 5 parts.

References

Merck Index 7806

I.N. p. 822

Hommel A.G.; British Patent 953,387; March 25, 1964

PYRANTEL PAMOATE

Therapeutic Function: Anthelmintic

Chemical Name: E-1,4,5,6-tetrahydro-1-methyl-2-[2-(2-thienyl)vinyl] pyrimidine pamoate

Common Name: —

Structural Formula:

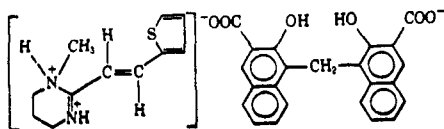

Chemical Abstracts Registry No.: 22204-24-6; 15686-83-6 (Base)

Trade Name	Manufacturer	Country	Year Introduced
Antiminth	Roerig	U.S.	1972
Helmex	Roerig	W. Germany	1972
Cobantrin	Pfizer Taito	Japan	1973
Combantrin	Pfizer	France	1973
Combantrin	Pfizer	Italy	1975
Lombriareu	Areu	Spain	—
Piranver	ICN-Usafarma	Brazil	—

Raw Materials

Thiophene-2-carboxaldehyde
 1,2-Dimethyl-1,4,5,6-tetrahydropyrimidine
 Tartaric acid
 Pamoic acid

Manufacturing Process

A solution of 0.1 mol of each of thiophene-2-carboxaldehyde and 1,2-dimethyl-1,4,5,6-tetrahydropyrimidine in dimethyl carbonate (0.2 mol) is held at 27°C for 48 hours. The reaction mixture is then stripped to give a 65% yield of product as the free base.

The base may be isolated as the tartrate as follows: A portion of reaction mixture is added to a well stirred solution of tartaric acid in ethanol at 27°C. The mixture is stirred for two hours and the product recovered by filtration. The filter cake is washed with cold ethanol followed by ether and air-dried. MP 144°-147°C.

The tartrate salt is recrystallized by dissolving in hot methanol, filtering, adding hot ethanol to the filtrate and cooling. The product is collected and air-dried. MP 148°-150°C. A second crop is obtained from the filtrate for a total yield of 59%. The tartrate is then metathesized with pamoic acid (Merck Index #6867) to give pyrantel pamoate as the product.

References

Merck Index 7856
 Kleeman & Engel p. 786
 PDR p. 1403
 OCDS Vol. 1 p. 266 (1977) & 2, 303 (1980)
 DOT 8 (11) 431 (1972); 17 (1) 41 (1981); & (6) 262 (1981)
 I.N. p. 825
 REM p. 1237

Kasubick, R.V. and McFarland, J.W.; U.S. Patent 3,502,661; March 24, 1970; assigned to Chas. Pfizer & Co., Inc.

PYRATHIAZINE

Therapeutic Function: Antihistaminic

Chemical Name: 10-[2-(1-Pyrrolidiny)ethyl] phenothiazine

Common Name: Parathiazine

Structural Formula:

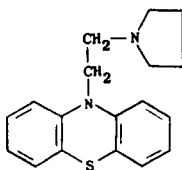

Chemical Abstracts Registry No.: 84-08-2

Trade Name	Manufacturer	Country	Year Introduced
Pyrrolazote	Upjohn	U.S.	1949

Raw Materials

Phenothiazine
Sodium amide
 β -Pyrrolidinoethyl chloride

Manufacturing Process

To a stirred suspension of 4.29 g (0.11 mol) of sodium amide in 100 ml of dry toluene was added 19.9 g (0.1 mol) of phenothiazine. The solution was heated at reflux for two hours, the sodium salt of phenothiazine precipitating from solution. The toluene suspension of the sodium salt of phenothiazine was cooled to room temperature, whereupon there was added dropwise with continued stirring 13.36 g (0.1 mol) of β -pyrrolidinoethyl chloride in 50 ml of dry toluene. After addition was complete, the solution was heated under reflux, with stirring, for an additional 15 hours. Upon cooling, the toluene was extracted with dilute hydrochloric acid and the toluene then discarded. The aqueous acid solution was made alkaline with dilute sodium hydroxide, the crude N-(β -pyrrolidinoethyl)-phenothiazine separating as a brownish oil.

The oil was extracted with ether, the ether solution dried with anhydrous magnesium sulfate, and then filtered. Dry hydrogen chloride was passed into the ether solution and a semisolid mass, which crystallized after scratching, separated therefrom. The crude N-(β -pyrrolidinoethyl)-phenothiazine was separated from the ether and, after two crystallizations from isopropanol, 17.0 g of desired product, melting at 196°C to 197°C (uncorr.), was obtained.

References

Merck Index 7857
OCDS Vol. 1 p. 373 (1977)
I.N. p. 731
Hunter, J.H. and Reid, W.B. Jr.; U.S. Patent 2,483,999; October 4, 1949; assigned to The Upjohn Co.

PYRAZINAMIDE

Therapeutic Function: Antibacterial (tuberculostatic)

Chemical Name: Pyrazinecarboxamide

Common Name: —

Structural Formula:

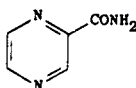

Chemical Abstracts Registry No.: 98-96-4

Trade Name	Manufacturer	Country	Year Introduced
Aldinamide	MSD	U.S.	1955
Pirilene	Lepetit	France	1981
Eprazin	Krugmann	W. Germany	—
Isopyratsin	Leiras	Finland	—
Pezatamid	Hefa-Frenon	W. Germany	—
Piraldina	Bracco	Italy	—
Pirazimida	Madaus Cerafarm	Spain	—
Pyrafat	Saarstickstoff-Fatol	W. Germany	—
Pyrazide	SCS Pharamlab	S. Africa	—
P.Z.A.	Servipharm	Switz.	—
Tebrazid	Continental Pharma	Belgium	—
Tisamid	Orion	Finland	—
Zinamide	MSD	U.K.	—

Raw Materials

Pyrazine-2,3-dicarboxamide
Sodium hydroxide

Manufacturing Process

166 Parts of pyrazine-2,3-dicarboxamide (1 mol) is slurried in 1,000 parts of 1 N aqueous sodium hydroxide. The reaction mixture is heated at 95°C to 98°C until a clear solution results. Thereupon the mixture is cooled with ice to about 5°C and acidified to approximately a pH of 1. The cold reaction mixture is allowed to stand until precipitation of the pyrazine-2-carboxamide-3-carboxylic acid is substantially complete whereupon it is recovered by filtration and dried at 50°C to 60°C.

100 Parts of pyrazine-2-carboxamide-3-carboxylic acid is heated in a reaction vessel provided with an intake for inert gas. The reaction mixture is heated in a bath held at 220°C and nitrogen is introduced. The solid material melts and effervesces and sublimed pyrazinamide vapors are carried out of the reaction vessel in the nitrogen stream. They are introduced into a suitably cooled condenser, condensing in the form of a white sublimate. After the reaction is proceeding vigorously the bath temperature is raised to 255°C and then gradually and slowly allowed to drop to 190°C over a period of time sufficient to permit the reaction to go substantially to completion. The sublimed pyrazinamide, if desired, is further purified by recrystallization from water or alcohol.

References

Merck Index 7858
Kleeman & Engel p. 787
OCDS Vol. 1 p. 277 (1977)

I.N. p. 826

REM p. 1216

Webb, J.S. and Arlt, H.G. Jr.; U.S. Patent 2,780,624; February 5, 1957; assigned to American Cyanamid Co.

PYRIDINOL CARBAMATE

Therapeutic Function: Antiarteriosclerotic

Chemical Name: Bis[Methylcarbamic acid]-2,6-pyridinediyl dimethylene diester

Common Name: Pyricarbate

Structural Formula:

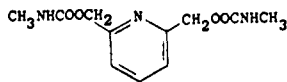

Chemical Abstracts Registry No.: 1882-26-4

Trade Name	Manufacturer	Country	Year Introduced
Movecil	Erba	Italy	1969
Angioxine	Roussel	France	1971
Anginin	Banyu	Japan	—
Angio vital	I.S.M.	Italy	—
Angioxil	Firma	Italy	—
Angiperl	Sawai	Japan	—
Arteriolangal	Lanzas	Spain	—
Aterin	Ilisan	Turkey	—
Aterofal	Nativelle	Italy	—
Atero-Flavin	Indelfar	Spain	—
Aterollano	Llano	Spain	—
Ateronova	Cheminova	Spain	—
Atover	Oti	Italy	—
Carbatona	Turro	Spain	—
Cicloven	A.G.I.P.S.	Italy	—
Colesterinex	Galenica	Switz.	—
Dual-Xol	Lifepharmia	Spain	—
Duaxol	Argentina	Argentina	—
Duvaline	Almirall	Spain	—
Gasparol	Castejon	Spain	—
Meduxal	Allard	France	—
Plavolex	Wolner	Spain	—
Proeductin	Kobanyai	Hungary	—
Ravenil	Caber	Italy	—
Sospitan	Kali-Chemie	W. Germany	—
Vasagin	Sidus	Italy	—
Vasapril	Cifa	Italy	—
Vasmol	Lifasa	Spain	—
Vasocil	Magis	Italy	—
Vasoverin	Biochimica	Switz.	—
Veranterol	Asla	Spain	—

Raw Materials

2,6-Dihydroxymethylpyridine hydrochloride
Methyl isocyanate

Manufacturing Process

(A) 15.7 g (0.1 mol) of 2,6-dihydroxymethylpyridine hydrochloride are suspended in 176 ml of acetonitrile, and 20.8 ml (0.15 mol) of triethylamine are added to the suspension. Thereafter 13 ml (0.22 mol) of methyl isocyanate are added dropwise to the reaction mixture at 20°C to 25°C. The reaction mixture is stirred at 20°C to 30°C for one hour, thereafter boiled for 3 hours, and finally the solvent is evaporated under reduced pressure. 35 to 40 g of a greyish, crystalline residue are obtained, which is a mixture of 2,6-dihydroxymethylpyridine-bis-(N-methylcarbamate) and triethylamine hydrochloride. The obtained residue is dissolved in 80 ml of hot water, decolorized with 2 g of activated carbon when hot, and filtered after 30 minutes of stirring. The filtrate is cooled, the resulting crystal suspension is stirred at 0°C to 5°C for 3 hours, the solids are filtered off, and dried at 50°C to 60°C.

23.3 g (94.4%) of 2,6-dihydroxymethylpyridine-bis(N-methylcarbamate) are obtained. The product melts at 134°C to 135°C; its purity is 99.8% (determined by UV spectrophotometry). When examined by thin layer chromatography, the product is uniform.

(B) 23.3 g of 2,6-dihydroxymethylpyridine-bis(N-methylcarbamate), prepared as described above, are dissolved in a boiling mixture of 46.6 ml of methanol and 46.6 ml of water. When the dissolution is complete, the solution is allowed to cool under slow stirring, without applying any external cooling means. The crystals start to separate at 48°C to 50°C. When the temperature of the mixture falls spontaneously below 35°C, it is cooled externally to 0°C to 5°C, and allowed to stand at this temperature for about 8 hours. The separated substance is filtered off and dried at 50°C to 100°C. 22.65 g of 2,6-dihydroxymethylpyridine-bis(N-methylcarbamate) are obtained. The quality of the product meets pharmaceutical requirements.

The yield of this crystallization procedure is 95.7%. The above process provides the γ_2 modification of 2,6-dihydroxymethylpyridine-bis(N-methylcarbamate), which can be tabletted directly. The substance melts at 134°C to 136°C, its purity is 99.9% (determined by UV spectrophotometry).

References

Merck Index 7874

Kleeman & Engel p. 787

DOT 5 (1) 16 (1969)

I.N. p. 826

Sprung, M., Toth, J., Kovatsits, M., Sztrokay, K., Szen, T., Gorgenyi, K., Boor, A., Forgacs, L., Szabo, J. and Kruzics, A.; British Patent 1,548,334; July 11, 1979; assigned to Richter Gedeon Vegyeszeti Gyar R.T. (Hungary)

PYRIDOSTIGMINE BROMIDE

Therapeutic Function: Cholinergic

Chemical Name: 3-[[Dimethylamino]carbonyl]oxy]-1-methylpyridinium bromide

Common Name: —

Structural Formula:

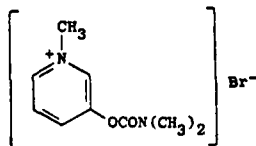

Chemical Abstracts Registry No.: 101-26-8

Trade Name	Manufacturer	Country	Year Introduced
Mestinon	Roche	U.S.	1955
Mestinon	Roche	Japan	1970
Regonol	Organon	U.S.	1973
Mestinon	Roche	France	1981
Kalymin	Arzneimittelwerk Dresden	E. Germany	—

Raw Materials

- 3-Hydroxypyridine
- Dimethyl carbamic acid chloride
- Methyl bromide

Manufacturing Process

12 parts by weight of dimethyl-carbamic acid chloride, dissolved in 20 parts by weight of xylol, are added dropwise to a boiling solution of 19 parts by weight of 3-hydroxypyridine in 120 parts by weight of xylol. Heating is continued under reflux for 3 hours. When the solution has cooled down, it is separated from the precipitated 3-hydroxypyridine hydrochloride and washed with water. After drying over sodium sulfate, the xylol is distilled off and the residue fractionated under reduced pressure. The N,N-dimethyl-carbamic acid ester of 3-hydroxypyridine distills at 148°C under a pressure of 15 mm.

A solution of 20 parts by weight of methyl bromide in 30 parts by weight of acetone is added to a solution of 35 parts by weight of N,N-dimethyl-carbamic acid ester of 3-hydroxypyridine in 70 parts by weight of acetone. After standing for a lengthy period (1 or 2 days), the N,N-dimethyl-carbamic acid ester of 3-hydroxy-1-methyl-pyridinium-bromide separates. It can be recrystallized from absolute alcohol. The colorless, strongly hygroscopic crystals melt at 151°-152°C.

References

- Merck Index 7877
- Kleeman & Engel p. 789
- PDR pp. 1289, 1491
- I.N. p. 826
- REM p. 900
- Urban, R.; U.S. Patent 2,572,579; October 23, 1951; assigned to Hoffmann-La Roche Inc.

PYRILAMINE

Therapeutic Function: Antihistamine

Chemical Name: N-[(4-Methoxyphenyl)methyl]-N',N'-dimethyl-N-2-pyridinyl-1,2-ethanediamine (often used as the maleate)

Common Name: Mepyramine, pyranisamine

Structural Formula:

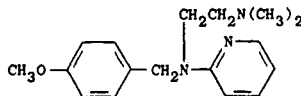

Chemical Abstracts Registry No.: 91-84-9; 6036-95-9 (Hydrochloride); 59-33-6 (Maleate)

Trade Name	Manufacturer	Country	Year Introduced
Neo-Antergan	MSD	U.S.	1948
Thylogen	Rorer	U.S.	1949
Statomin	Bowman	U.S.	1950
Pyra-Maleate	Mallinckrodt	U.S.	1950
Copsamine	Durst	U.S.	1950
Stamine	Tutag	U.S.	1951
Albatussin	Bart	U.S.	—
Allergan	Wiedenmann	Switz.	—
Amfeta	Bama-Geve	Spain	—
Anthisan	May & Baker	U.K.	—
Citra Forte	Boyce	U.S.	—
Codimal	Central	U.S.	—
Copsamine	Durst	U.S.	—
Fiogescic	Sandoz	U.S.	—
Histalet	Reid-Rowell	U.S.	—
Histavet-P	Burns-Biotec	U.S.	—
Kontristin	Eczacibasi	Turkey	—
Kriptin	Whitehall	U.S.	—
Kronohist	Ferndale	U.S.	—
Midol PMS	Glenbrook	U.S.	—
Poly-Histine	Bock	U.S.	—
Primatene	Whitehall	U.S.	—
PV-Tussin	Reid-Rowell	U.S.	—
Pyra	Mallinckrodt	U.S.	—
Pyramal	Columbus	U.S.	—
Statomin	Bowman	U.S.	—
Triaminic	Dorsey	U.S.	—

Raw Materials

4-Methoxybenzaldehyde	2-Aminopyridine
1-Dimethylamino-2-chloroethane	Sodium amide

Manufacturing Process

43 g of α -p-methoxybenzylaminopyridine (from 4-methoxybenzaldehyde reaction with 2-aminopyridine) are heated in 60 cc of toluene to 95°C to 100°C. 18 g of sodamide (85%) and 110 cc of a 40% toluene solution of 1-dimethylamino-2-chloroethane are added in small amounts alternately with shaking; the addition takes 1 hour. Toluene is distilled off, first at normal pressure, then under reduced pressure, until there remains a pasty mass. The mass is taken up with dilute hydrochloric acid and ether, neutralized to pH 7, and p-methoxybenzylaminopyridine separates. After making alkaline using excess of potash, it is extracted with benzene, dried and distilled. The product thereby obtained, N',N'-dimethylaminoethyl-N-p-methoxybenzyl- α -aminopyridine boils at 185°C to 190°C/2 mm. The monohydrochloride melts at 135°C (block Maquenne).

References

- Merck Index 7883
 Kleeman & Engel p. 561
 PDR pp. 654, 674, 692, 784, 850, 875, 925, 1447, 1583, 1900
 OCDS Vol. 1 p. 51 (1977)
 I.N. p. 597
 REM p. 1129
 Horclois, R.J.; U.S. Patent 2,502,151; March 28, 1950; assigned to Societe des Usines Chimiques Rhone-Poulenc

PYRIMETHAMINE

Therapeutic Function: Antimalarial

Chemical Name: 5-(4-chlorophenyl)-6-ethyl-2,4-pyrimidinediamine

Common Name: —

Structural Formula:

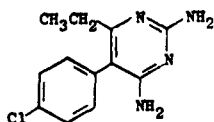

Chemical Abstracts Registry No.: 58-14-0

Trade Name	Manufacturer	Country	Year Introduced
Daraprim	Burroughs Wellcome	U.S.	1953
Daraprim	Burroughs Wellcome	W. Germany	1969
Erbaprelina	Erba	Italy	—
Fansidar	Roche	France	—
Malocide	Specia	France	—
Primecidan	Cidan	Spain	—
Pyrimethamin-Heyl	Heyl	W. Germany	—
Tindurin	Egyt	Hungary	—

Raw Materials

p-Chlorophenylacetonitrile	Ethyl propionate
Sodium ethoxide	Diazomethane
Guanidine	

Manufacturing Process

p-Chlorophenylacetonitrile (36.5 grams) and ethyl propionate (25.5 grams) were added to a solution of sodium ethoxide (from 5.75 grams sodium) in absolute ethanol (150 ml). The solution was heated on a steam bath for 6 hours. After cooling, the whole was poured into water and the oil extracted well with ether, the ether solution was discarded and the aqueous solution neutralized with 1 N sulfuric acid. A heavy oil separated which was taken into ether, washed with water, bicarbonate solution and again with water. After drying, the ether was removed to give a thick oil which solidified on standing (34.6 grams). After recrystallization from an ether-petroleum ether mixture it formed needles, MP 108°-112°C.

The above keto-nitrile (15 grams) was methylated with a solution of diazomethane in ether. (The diazomethane solution was prepared using 20 grams of N-nitrosomethylurea.) The ether and excess diazomethane were evaporated on the steam bath and the oil dissolved in ethanol (50 ml). To this was added a solution of guanidine in ethanol (100 ml) (prepared from 8.1 grams of the hydrochloride). The solution was refluxed for 5 hours, the alcohol removed and the residue treated with 5 N sodium hydroxide. The insoluble material was then filtered. After purification by precipitation from dilute acetic acid with sodium hydroxide and by recrystallization from ethanol the product formed clear colorless needles (8.0 grams), MP 218°-220°C as described in U.S. Patent 2,602,794.

References

- Merck Index 7884
- Kleeman & Engel p. 791
- PDR pp. 741, 1484
- OCDS Vol. 1 p. 262 (1977)

DOT 16 (5) 174 (1980)

I.N. p. 827

REM p. 1219

Hitchings, G.H., Russell, P.B. and Falco, E.A.; U.S. Patent 2,576,939; December 4, 1951; assigned to Burroughs Wellcome & Co. (U.S.A.) Inc.

Hitchings, G.H. and Falco, E.A.; U.S. Patent 2,579,259; December 18, 1951; assigned to Burroughs Wellcome & Co. (U.S.A.) Inc.

Hitchings, G.H., Russell, P.B. and Falco, E.A.; U.S. Patent 2,602,794; July 8, 1952; assigned to Burroughs Wellcome & Co. (U.S.A.) Inc.

Jacob, R.M.; U.S. Patent 2,680,740; June 8, 1954; assigned to Societe des Usines Chimiques Rhone-Poulenc (France)

PYRITHYLDIONE

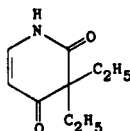
Therapeutic Function: Hypnotic; sedative**Chemical Name:** 3,3-Diethyl-2,4-(1H,3H)pyridinedione**Common Name:** —**Structural Formula:****Chemical Abstracts Registry No.:** 77-04-3

Trade Name	Manufacturer	Country	Year Introduced
Presidon	Roche	U.S.	1948
Persedon	Roche	W. Germany	—

Raw Materials

Methyl formate	Sodium methylate
Diketene	Ammonia
Ethyl bromide	

Manufacturing Process

108 g of sodium methylate were suspended in 500 ml of toluene. 120 g of methyl formate were dropped into the sodium methylate suspension thus formed at a rate so that temperature did not exceed 30°C. Thereafter a solution of 157 g of α,α -diethylacetoacetamide in 500 ml of toluene were added so that the temperature did not exceed 50°C. The mixture was stirred for one hour at 50°C and then overnight at room temperature. The reaction mixture was poured into 700 ml of ice water, permitted to stratify, the aqueous layer was separated, covered with a layer of 200 ml of toluene and then treated while stirring with 200 g of 50% sulfuric acid. Finally the reaction mixture, which was acid to congo red, was warmed at 50°C and the toluene-containing layer was separated. The aqueous layer was extracted with four 200 ml portions of toluene at 50°C and then discarded. The toluene extracts were combined and then concentrated in vacuo at 60°C. There were obtained 135 g of crystalline residue which was re-crystallized from 200 ml of toluene. The 3,3-diethyl-2,4-dioxo-1,2,3,4-tetrahydropyridine thus obtained melted at 96°C.

The α,α -diethylacetoacetamide used as starting material was obtained by converting diketene with aqueous ammonia to acetoacetamide and alkylating twice with ethyl bromide in the presence of sodium alcoholate.

References

Merck Index 7893

Kleeman & Engel p. 793

I.N. p. 828

Hinderling, R., Lutz, A.H. and Schnider, O.; U.S. Patent 3,019,230; January 30, 1962; assigned to Hoffmann-La Roche Inc.

PYRITINOL

Therapeutic Function: Neurotropic agent

Chemical Name: 3,3'-(Dithiodimethylene)bis[5-hydroxy-6-methyl-4-pyridine methanol]

Common Name: Pyrithioxin

Structural Formula:

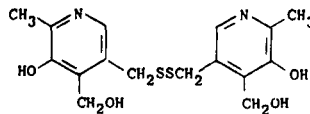

Chemical Abstracts Registry No.: 1098-97-1; 10049-83-9 (Dihydrochloride)

Trade Name	Manufacturer	Country	Year Introduced
Encephabol	Merck	W. Germany	1963
Enbol	Chugai	Japan	1971
Biocefalin	Benvegna	Italy	—
Bonol	Ikapharm	Israel	—
Cefalogen	Montefarmaco	Italy	—
Cerebropirina	Chemil	Italy	—
Cerebrotrofina	N.C.S.N.	Italy	—
Cervitalin	Savoma	Italy	—
Chioebon	Kyowa Yakuhin	Japan	—
Divalvon	Nippon Kayaku	Japan	—
Encebrovit	Sierochimica	Italy	—
Encefabol	Bracco	Italy	—
Encefart	Intersint	Italy	—
Encerebron	Pulitzer	Italy	—
Enerbol	Polfa	Poland	—
Evolubran	A.B.C.	Italy	—
Fulneurina	Fulton	Italy	—
Gladus	SKF	Italy	—
Leonar	Kalopharma	Italy	—
Life	S.I.T.	Italy	—
Maind	Also	Italy	—
Miriplex	Poli	Italy	—
Musa	Poli	Italy	—
Neurotin	Nakataki	Japan	—
Neuroxin	Yamanouchi	Japan	—

Trade Name	Manufacturer	Country	Year Introduced
Piritinol	Magis	Italy	—
Piritiomin	Hishiyama	Japan	—
Sawaxin	Sawai	Japan	—
Scintidin	I.C.I.	Italy	—
Tonobrein	C.T.	Italy	—
Tonomentis	Ion	Italy	—

Raw Materials

Potassium xanthogenate
 3,4-Bis-bromoethyl-4-hydroxy-5-methyl-pyridinium bromide
 Ammonia
 Methanol

Manufacturing Process

To a solution of 60 g of potassium xanthogenate in 240 cc of water there is added dropwise, while being cooled with ice, a solution of 42 g of 3,4-bis-bromomethyl-4-hydroxy-5-methyl-pyridinium-bromide in 1 liter of water so that the temperature remains between 2°C and 5°C. After stirring for 1 hour at the same temperature, the water is decanted off and the residue is triturated with acetone. Yield: 25 g of 4-hydroxymethyl-5-hydroxy-6-methyl-pyridyl-(3)-methylxanthogenate; melting point: 170°C to 171°C (alcohol, decomposition).

40 g of 4-hydroxymethyl-5-hydroxy-6-methyl-pyridyl-(3)-methylxanthogenate are left standing at room temperature for 5 days in a mixture of 800 cc of alcohol and 400 cc of aqueous NH₃-solution, and subsequently concentrated under vacuum to about 50 cc. The precipitated bis(4-hydroxymethyl-5-hydroxy-6-methyl-3 pyridylmethyl) disulfide is sucked off. Yield: 20 g of the disulfide; melting point: 218°C to 220°C (butanol, decomposition).

References

Merck Index 7894
 Kleeman & Engel p. 793
 DOT 9 (6) 215 (1973)
 I.N. p. 828
 Zima, O. and Schorre, G.; U.S. Patent 3,010,966; November 28, 1961; assigned to E. Merck A.G. (Germany)

PYROVALERONE HYDROCHLORIDE

Therapeutic Function: Psychostimulant

Chemical Name: 1-(4-methylphenyl)-2-(1-pyrrolidinyl)-1-pentanone hydrochloride

Common Name: —

Structural Formula:

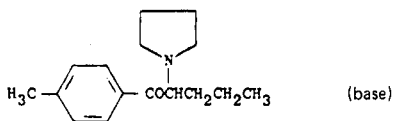

Chemical Abstracts Registry No.: 1147-62-2; 3563-49-3 (Base)

Trade Name	Manufacturer	Country	Year Introduced
Thymergix	Joullie	France	1973

Raw Materials

p-Methylvalerophenone	Bromine
Pyrrolidine	Hydrogen chloride

Manufacturing Process

23.1 grams of α -bromo-p-methyl-valerophenone, obtained by bromination of p-methyl-valerophenone, are dissolved in 50 ml of benzene and 25 ml of pyrrolidine are added at 0°C. The whole is boiled for 20 minutes, cooled, washed twice with water, dried and acidified with about 50 ml of 2 N hydrochloric acid. After evaporation, it is recrystallized from methanol-acetone-ether. 22.6 grams of α -pyrrolidino-p-methyl-valerophenone hydrochloride, melting point 178°C, equivalent to a yield of 88.5% of the theoretical are obtained according to British Patent 927,475.

References

- Merck Index 7914
- Kleeman & Engel p. 794
- OCDS Vol. 2 p. 124 (1980)
- DOT10 (5) 188 (1974)
- I.N. p. 829
- Dr. A. Wander SA, Switzerland; British Patent 927,475; May 29, 1963
- Dr. Karl Thomae, GmbH, Germany; British Patent 933,507; August 8, 1963

PYRROBUTAMINE

Therapeutic Function: Antihistaminic

Chemical Name: 1-[4-(4-Chlorophenyl)-3-phenyl-2-butenyl]-pyrrolidine

Common Name: —

Structural Formula:

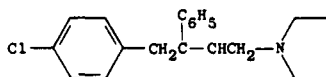

Chemical Abstracts Registry No.: 91-82-7

Trade Name	Manufacturer	Country	Year Introduced
Pyronil	Lilly	U.S.	1952
Co-Pyronil	Lilly	U.K.	—
Proladyl	Lilly	—	—

Raw Materials

Pyrrolidine	Acetophenone
Paraformaldehyde	p-Chlorobenzyl chloride
Magnesium	Hydrogen chloride

Manufacturing Process

A mixture of 1,800 ml of absolute ethanol, 427 g (6 mols) of pyrrolidine, and a trace of methyl

orange is cooled in an ice bath and gaseous hydrogen chloride is bubbled through the mixture until a red color develops, indicating that all of the amine has been converted to the hydrochloride. The addition of hydrogen chloride is stopped, the ice bath is removed and to the solution are added 720 g of acetophenone, 270 g of paraformaldehyde and 10 ml of concentrated hydrochloric acid. The mixture is stirred and refluxed vigorously for one hour. An additional 180 g of paraformaldehyde are then added, and refluxing is continued for about three hours. The hot solution is poured into 6 liters of acetone and the mixture is chilled overnight. A precipitate of ω -(N-pyrrolidino)-propiophenone hydrochloride separates. The precipitate is filtered off, washed with cold acetone, and dried in air.

ω -(N-pyrrolidino)-propiophenone hydrochloride thus prepared melted at about 163°C to 164°C after recrystallization from acetone.

To a suspension of 4 mols of ω -(N-pyrrolidino)-propiophenone hydrochloride in 1,500 ml of water and 100 g of ice in a separatory funnel are added a 50% aqueous solution containing 200 g of sodium hydroxide, and 2 liters of ether. The mixture is shaken vigorously until all of the suspended matter dissolves. The ether is then removed, washed with 1 liter of water and dried over anhydrous magnesium sulfate. The anhydrous ether solution of ω -(N-pyrrolidino)-propiophenone thus prepared is added to a Grignard reagent prepared from 6 mols of p-chlorobenzyl chloride and 6 mols of magnesium turnings in 3,000 ml of anhydrous ether. The ethereal solution of the ketone is added to the Grignard reagent at such a rate that rapid refluxing is maintained. After all of the ketone has been added, the reaction mixture is stirred for 2 hours and is decomposed by pouring it over a mixture of 500 g of ice and 6 mols of concentrated hydrochloric acid. The hydrochloric acid addition salt of 1-p-chlorophenyl-2-phenyl-4-N-(pyrrolidino)-butanol-2 formed in the reaction separates at the ether-water interface as a white crystalline material. The aqueous phase is removed and discarded, and the mixture of ether and hydrochloride salt is converted to 1-p-chlorophenyl-2-phenyl-4-(N-pyrrolidino)-butanol-2 by treatment with 10% sodium hydroxide solution. The base is removed by extraction with ether, and the ether extracts are dried over magnesium sulfate.

1-p-chlorophenyl-2-phenyl-4-(N-pyrrolidino)-butanol-2 melted at about 109°C to 110°C after recrystallization from petroleum ether.

A solution of 200 g of 1-p-chlorophenyl-2-phenyl-4-(N-pyrrolidino)-butanol-2 in 750 ml of concentrated hydrochloric acid is refluxed for 9 hours thereby causing a dehydration of the butanol compound, and the formation of the hydrochloric acid addition salt of a 1-p-chlorophenyl-2-phenyl-4-(N-pyrrolidino)-butene. The hydrochloride salt formed crystallizes in the oily lower layer of the two phase reaction mixture and is removed therefrom by filtration. The filtrate is again refluxed for 9 hours, cooled to 0°C, and a second crop of the hydrochloric acid addition salt of the dehydration product is obtained and filtered off. The filtrate containing residual amounts of 1-p-chlorophenyl-2-phenyl-4-(N-pyrrolidino)-butanol-2 is again refluxed for 9 hours to yield an additional crop of the salt of the dehydration product. The several fractions of the butene compound are combined and triturated with several small portions of hot acetone and recrystallized from alcohol-ether mixture. The hydrochloric acid addition salt of the dehydration product, 1-p-chlorophenyl-2-phenyl-4-(N-pyrrolidino)-butene hydrochloride, melts at about 227°C to 228°C.

References

- Merck Index 7916
 Kleeman & Engel p. 794
 OCDS Vol. 1 p. 78 (1977)
 I.N. p. 829
 Mills, J.; U.S. Patent 2,655,509; October 13, 1953; assigned to Eli Lilly & Co.

PYRVINIUM PAMOATE

Therapeutic Function: Anthelmintic

Chemical Name: 6-(dimethylamino)-2-[2-(2,5-dimethyl-1-phenyl-1H-pyrrol-3-yl)ethenyl]-1-methylquinolinium salt with pamoic acid (2:1)

Common Name: Pyrvinium embonate; viprynum embonate

Structural Formula:

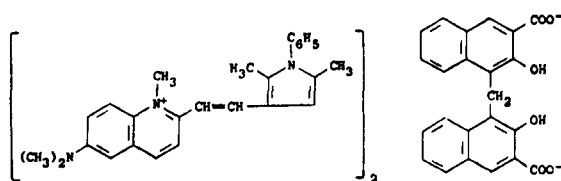

Chemical Abstracts Registry No.: 3546-41-6

Trade Name	Manufacturer	Country	Year Introduced
Povan	Parke Davis	U.S.	1959
Povanyl	Parke Davis	France	1981
Antioxur	Esteve	Spain	—
Molevac	Parke Davis	W. Germany	—
Neo-Oxypaat	Katwijk	Neth.	—
Oxialum	Wolner	Spain	—
Pamovin	Merck-Frosst	Canada	—
Pamoxan	Uriach	Spain	—
Pirok	Bilim	Turkey	—
Poquil	Parke Davis Sankyo	Japan	—
Privonium	Rivapharm	Switz.	—
Pyrcon	Jenapharm	E. Germany	—
Pyrvin	Farmos	Finland	—
Tolapin	Taro	Israel	—
Tru	Elea	Argentina	—
Vanquin	Parke Davis	Italy	—
Vermitiber	Tiber	Italy	—

Raw Materials

Pyrvinium chloride
Sodium pamoate

Manufacturing Process

A hot, filtered solution of 2.27 grams of pyrvinium chloride dihydrate in 250 ml of water is added slowly to a solution of 2.25 grams of sodium pamoate monohydrate in 50 ml of water. A red precipitate immediately forms. The mixture is heated at about 90°-100°C for 5 minutes more and then filtered. The reaction product is washed with hot water and dried at about 75°C in a vacuum. This preparation melts at about 210°-215°C with prior softening from about 190°C.

References

Merck Index 7927

Kleeman & Engel p. 796

PDR p. 1384

I.N. p. 830

REM p. 1237

Van Lare, E. and Brooker, L.G.S.; U.S. Patent 2,515,912; July 18, 1950; assigned to Eastman Kodak Company

Eislager, E.F. and Worth, D.F.; U.S. Patent 2,925,417; February 16, 1960; assigned to Parke, Davis & Company

Q

QUINESTROL

Therapeutic Function: Estrogen

Chemical Name: 3-(cyclopentyloxy)-19-nor-17 α -pregna-1,3,5(10)-trien-20-yn-17-ol

Common Name: 17 α -ethynylestradiol 3-cyclopentyl ether

Structural Formula:

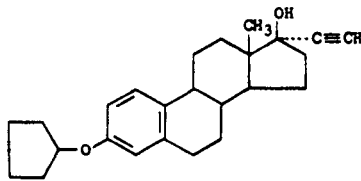

Chemical Abstracts Registry No.: 152-43-2

Trade Name	Manufacturer	Country	Year Introduced
Estrovis	Goedecke	W. Germany	1968
Estrovis	Warner	U.K.	1969
Estrovis	Warner-Lambert	U.S.	1979
Agalacto-Quilea	Elea	Argentina	—
Basaquines	Boehr. Mann.	—	—

Raw Materials

17 α -Ethynyl estradiol
Cyclopentyl bromide

Manufacturing Process

A solution of 1.5 grams of 17 α -ethynyl estradiol in 50 cc of absolute ethanol is added slowly to a mixture of 3 grams of cyclopentyl bromide and 2 grams of potassium carbonate. This mixture is heated to reflux and stirred for 3 hours, then filtered. Most of the alcohol is eliminated by distillation and the resulting solution diluted with water, and cooled in an ice-bath. The product which precipitates is collected by filtration, washed and dried. After recrystallization from methanol the 3-cyclopentyl ether of 17 α -ethynyl estradiol shows a melting point of 107° to 108°C.

References

Merck Index 7959
Kleeman & Engel p. 797
PDR p. 1347
DOT 17 (4) 163 (1981)
I.N. p. 832

REM p. 988

Ercoli, A.; U.S. Patent 3,159,543; December 1, 1964; assigned to Francesco Vismara SpA, Italy

Ercoli, A., Gardi, R. and Pedrali, C.; U.S. Patent 3,231,567; January 25, 1966; assigned to Francesco Vismara SpA, Italy

QUINETHAZONE

Therapeutic Function: Diuretic

Chemical Name: 7-chloro-2-ethyl-1,2,3,4-tetrahydro-4-oxo-6-quinazolinesulfonamide

Common Name: Chinethazonum

Structural Formula:

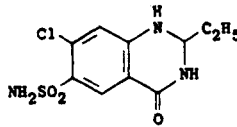

Chemical Abstracts Registry No.: 73-49-4

Trade Name	Manufacturer	Country	Year Introduced
Hydromox	Lederle	U.S.	1962
Aquamox	Lederle	U.K.	—

Raw Materials

7-Chloro-2-ethyl-6-sulfamyl-4-quinazolinone
Sodium borohydride

Manufacturing Process

For preparation of the desired tetrahydroquinazolinone, 103 parts of aluminum chloride were added to 25,000 parts by volume of diethylene glycol dimethyl ether while cooling in an ice bath. The mixture was then stirred with warming and 200 parts of 7-chloro-2-ethyl-6-sulfamyl-4-quinazolinone added. A second solution of 140 parts of sodium borohydride in 7,000 parts of dry diethylene glycol dimethyl ether was then added gradually. An orange mixture resulted which was kept at 85°C until the reaction was complete. The reaction mixture was then cooled to approximately 0°C and 4,000 parts of water slowly added. Dilute HCl was then added to form a strongly acidic clear solution which was evaporated to dryness. Following this, the solid was triturated with cold water to yield 90 parts of a solid. Fibrous crystals were obtained by recrystallization from 50% acetone.

References

Merck Index 7960

Kleeman & Engel p. 797

PDR p. 1010

OCDS Vol. 1 p. 354 (1977)

I.N. p. 833

REM p. 940

Cohen, E. and Vaughan, J.R., Jr.; U.S. Patent 2,976,289; March 21, 1961; assigned to American Cyanamid Company

QUINGESTANOL ACETATE

Therapeutic Function: Gestagen

Chemical Name: 19-Norpregna-3,5-dien-20-yn-17-ol-3-(cyclopentyloxy) acetate (17 α)

Common Name: —

Structural Formula:

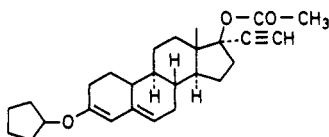

Chemical Abstracts Registry No.: 3000-39-3; 10592-65-1 (Base)

Trade Name	Manufacturer	Country	Year Introduced
Demovis	Parke Davis	Italy	1972
Demovis	Vister	Italy	—
Delovis	Substantia	France	—

Raw Materials

3-Cycloethylenedioxy-10-cyano-17 α -ethynyl-19-nor- Δ^5 -androstene-17 β -ol
 Lithium
 Ammonia
 Acetic anhydride
 Cyclopentanol

Manufacturing Process

The starting material for the purposes of this discussion is 3-cycloethylenedioxy-10-cyano-17 α -ethynyl-19-nor- Δ^5 -androstene-17 β -ol (I).

A solution of 10-cyano-3-monoketal (I) in 60 cc of dry ether and 60 cc of dry dioxane is dropped into 400 cc of liquid ammonia. Then, 1.2 g of lithium in small pieces are introduced over a period of 90 minutes and the mixture is maintained under stirring until the blue color of the solution is discharged.

10 g of ammonium chloride are added and the stirring is continued for some hours longer at room temperature. The moist ammonia is left to evaporate cautiously, maintaining the mixture on water-bath and diluting the resulting solution with water. After repeated extractions with ether, an oily residue is obtained consisting of a mixture of $\Delta^5(6)$ and $\Delta^5(10)$ isomers of 17 α -ethynyl-19-nor-androstene-17 β -ol-3-one 3-ethylene ketal (II).

To a solution of 1 g of the mixture of 3-ketal-isomers of compound (II) in 10 cc of acetic anhydride is added a solution of 700 mg of p-toluenesulfonic acid in 7 cc of acetic anhydride. The reaction mixture is kept at room temperature and under stirring for 5 hours. After some time a crystalline product begins to precipitate and the precipitation is complete by diluting with water. The precipitate is filtered and crystallized from methanol to give 17 α -ethynyl-19-nor-testosterone 3,17-diacetate (III), melting point 175°C to 178°C.

A solution of 1 g of the diacetate (III) in 100 cc of n-heptane containing 2.5 cc of cyclopentanol and 50 mg of p-toluenesulfonic acid is heated under reflux for 20 hours. After cooling, a few drops of pyridine are added and the solvent is eliminated by evaporation under vacuum. The residue is taken up with methanol to give 3-cyclopentyl enolether of 17 α -ethynyl-19-nortestosterone acetate which, after recrystallization from methanol, melts at 182°C to 184°C.

References

Kleeman & Engel p. 798

DOT 9 (5) 182 (1973)

I.N. p. 833

Ercoli, A. and Gardi, R.; U.S. Patent 3,159,620; December 1, 1964; assigned to Francesco Vismara S.p.A. (Italy)

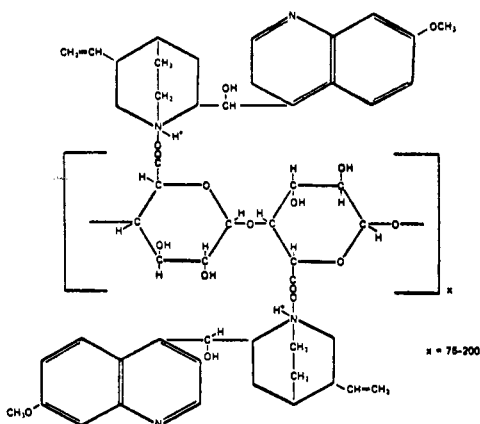
QUINIDINE POLYGALACTURONATE**Therapeutic Function:** Antiarrhythmic**Chemical Name:** See structural formula**Common Name:** —**Structural Formula:****Chemical Abstracts Registry No.:** 65484-56-2

Trade Name	Manufacturer	Country	Year Introduced
Cardioquin	Purdue Frederick	U.S.	1960
Cardioquin	N.A.P.P.	U.K.	1970
Cardioquine	Berenguer-Beneyto	Spain	—
Galactoquin	Mundipharma	W. Germany	—
Galatturil-Chinidina	Francia	Italy	—
Naticardina	Chinoïn	Italy	—
Neochinidin	Brocchieri	Italy	—
Ritmocor	Malesci	Italy	—

Raw Materials

Polygalacturonic acid
Quinidine

Manufacturing Process

100 grams of polygalacturonic acid are dissolved in 1 liter of a 60% (v/v) mixture of meth-

anol and water. The neutralization equivalent of the polygalacturonic acid is determined by titration with tenth-normal alkali on an aliquot sample. A stoichiometric equivalent of quinidino alkaloid dissolved in 2,500 cc of 80% methanol is slowly added, with continued stirring.

The pH of the reaction mixture is taken both before and after the addition of the last portion of the quinidine-methanol solution. The mixture is gently warmed (30° to 50°C), and the pH determined at 20 minute intervals. At the end of 4 hours, or when the reaction has gone to completion as evidenced by the pH of the mixture (between pH 6.5 and 7.5), the stirring is then stopped and the mixture cooled to 0°C and filtered. The solvent is evaporated to dryness under reduced pressure, utilizing as little heat as is feasible. The dried residue is powdered and suspended in 10 volumes of methanol and filtered. The insoluble powder is dried, and is quinidine polygalacturonate, melting at 180°C with decomposition.

References

Merck Index 7966

PDR p. 1433

OCDS Vol. 1 p. 339 (1977)

I.N. p. 833

REM p. 859

Halpern, A.; U.S. Patent 2,878,252; March 17, 1959; assigned to Synergistics, Inc.

QUINUPRAMINE

Therapeutic Function: Antidepressant

Chemical Name: 5-(3-Quinuclidinyl)-10,11-dihydro-dibenzo[b,f]azepine

Common Name: —

Structural Formula:

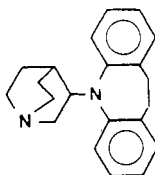

Chemical Abstracts Registry No.: 31721-17-2

Trade Name	Manufacturer	Country	Year Introduced
Kinupril	Fournier	France	1979

Raw Materials

Iminodibenzyl

Sodium amide

3-Phenylsulfonyloxyquinuclidine

Manufacturing Process

3.9 g of iminodibenzyl were added in one batch to a suspension of 0.96 g of sodium amide in 50 ml of anhydrous toluene. The mixture was heated to reflux temperature for a period of 6

hours. A solution of 5.34 g of 3-phenylsulfonyloxyquinuclidine in 15 ml of anhydrous toluene was added dropwise over a period of 75 minutes to the suspension at reflux temperature and the latter was maintained for 150 minutes after the completion of the addition. The reaction mixture was cooled to ambient temperature and treated with 75 ml of distilled water and 75 ml of ethyl acetate.

The decanted aqueous phase was extracted three times with a total of 150 ml of ethyl acetate. The combined organic solutions were filtered over Clarcel and extracted three times with a total of 150 ml of an iced normal aqueous methane-sulfonic acid solution. The combined acid extracts were rendered alkaline on an ice bath with 30 ml of 10N caustic soda solution. The separated oil was extracted four times with a total of 200 ml of ether. The combined ethereal extracts were washed twelve times with a total of 360 ml of distilled water, dried over anhydrous magnesium sulfate in the presence of 0.3 g of animal charcoal and evaporated under reduced pressure on a water bath at 40°C. The oily residue obtained (3.8 g) was dissolved in 30 ml of boiling acetonitrile. After cooling for 2 hours at 3°C, the crystals formed were separated, washed with 5 ml of acetonitrile and dried at ambient temperature at low pressure. 1.6 g of 5-(3-quinuclidinyl)-10,11-dihydro-dibenzo[b,f]azepine, melting point 150°C, were obtained.

References

Merck Index 8006

DFU 3 (7) 548 (1978)

Kleeman & Engel p. 799

DOT 16 (4) 122 (1980)

I.N. p. 835

Gueremy, C. and Wirth, P.C.; British Patent 1,252,320; November 3, 1971; assigned to Societe Generale De Recherches Et D'Applications Scientifiques Sogeras

R

RANITIDINE

Therapeutic Function: Antiulcer, antiallergic

Chemical Name: N-[2-[[[5-(Dimethylamino)methyl-2-furanyl] methyl] thio] ethyl]-N'-methyl-2-nitro-1,1-ethenediamine

Common Name: —

Structural Formula:

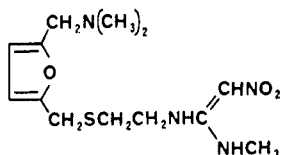

Chemical Abstracts Registry No.: 66357-35-5

Trade Name	Manufacturer	Country	Year Introduced
Zantac	Glaxo	U.K.	1981
Zantac	Glaxo	Italy	1981
Zantic	Glaxo	Switz.	1982
Zantac	Glaxo	France	1982
Sostril	Cascan	W. Germany	1982
Zantic	Glaxo	W. Germany	1982
Zantac	Glaxo	Neth.	1982
Zantac	Glaxo	Sweden	1983
Zantac	Glaxo	Canada	1983
Zantac	Glaxo	U.S.	1983
Acidex	Syncro	Argentina	—
Ranidil	Duncan	Italy	—
Taural	Roemmers	Argentina	—
Toriol	Vita	Spain	—
Ulcex	Guidotti	Italy	—
Vizerul	Montpellier	Argentina	—

Raw Materials

N-Methyl-1-(methylthio)-2-nitroetheneamine
2-[[[5-(Dimethylamino)methyl-2-furanyl] methyl] thio] ethanamine

Manufacturing Process

N-methyl-1-(methylthio)-2-nitroetheneamine (230 g) in water (400 ml) was stirred and heated at 45°C to 50°C. 2-[[[5-(Dimethylamino)methyl-2-furanyl] methyl] thio] ethanamine (321 g) was added dropwise over 4 hours and the resultant solution stirred for a further 3½ hours.

The solution was then heated at reflux for ¼ hour, cooled to 70°C and 4-methylpentan-2-one (2 liters) added. The water was removed by azeotropic distillation under reduced pressure (260 torrs) and the resultant solution treated with charcoal (10 g) at 50°C. The solution was filtered and cooled to 10°C. N-[2-[[[5-dimethylamino)methyl-2-furanyl] methyl] thio] ethyl]-N'-methyl-2-nitro-1,1-ethenediamine (380 g) was filtered off and dried, melting point 69°C to 70°C.

References

Merck Index 8019

DFU 4 (9) 663 (1979)

PDR p. 919

OCDS Vol. 3 p. 131 (1984)

DOT 18 (12) 665 (1982)

I.N. p. 839

REM p. 798

Price, B.J., Clitherow, J.W. and Bradshaw, J.; U.S. Patent 4,128,658; December 5, 1978; assigned to Allen & Hanburys Ltd.

RAZOXANE

Therapeutic Function: Antitumor

Chemical Name: dl-1,2-Bis(3,5-dioxopiperazin-1-yl)propane

Common Name: —

Structural Formula:

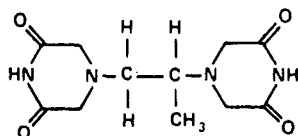

Chemical Abstracts Registry No.: 21416-87-5

Trade Name	Manufacturer	Country	Year Introduced
Razoxin	I.C.I.	U.K.	1977

Raw Materials

1,2-Diaminopropane tetraacetic acid
Formamide

Manufacturing Process

1,2-Diaminopropane tetraacetic acid (100 g) and formamide (400 ml) are heated together at reduced pressure under nitrogen at 100°C to 110°C for 1 hour, and then at 150°C to 155°C for 4 hours. The brown solution is evaporated under reduced pressure at 80°C to 90°C and the residue is taken up in methanol (120 ml) and cooled in the refrigerator overnight. Filtration, followed by washing with methanol and vacuum drying at 65°C gives dl-1,2-bis(3,5-dioxopiperazin-1-yl)propane (62 g, 70%) as a very pale cream microcrystalline solid, melting point 237°C to 239°C.

References

Merck Index 8026

DFU 2 (7) 473 (1977)
 Kleeman & Engel p. 800
 DOT 13 (12) 546 (1977)

Creighton, A.M.; U.S. Patents 3,941,790; March 2, 1976; and 4,275,063; June 23, 1981; both assigned to National Research Development Corp.

RELAXIN

Therapeutic Function: Ovarian hormone

Chemical Name: See under Structural Formula

Common Name: Relaxin

Structural Formula: Polypeptide of approximately 6,000 molecular weight

Chemical Abstracts Registry No.: 9002-69-1

Trade Name	Manufacturer	Country	Year Introduced
Relaxin	Warner Lambert	U.S.	1956
Cervilaxin	National	U.S.	1957

Raw Materials

Hog ovaries
 Acetone

Manufacturing Process

500 pounds of frozen hog ovaries (relaxin content: 20,200 G.P.U./lb) are ground with 50 pounds of solid carbon dioxide (Dry Ice) in a Fitzpatrick mill using a ¼ inch screen. The resulting finely divided tissue-carbon dioxide homogenate at a temperature of -20°C is stirred into a 1.6N HCl solution prepared by mixing 15 liters of concentrated (12N) HCl with 100 liters of water. The homogenate is added to the aqueous acid over a period of approximately 1 hour so that the temperature of the mixture does not fall below -5°C. The resulting slurry is stirred for 6 hours and then allowed to stand overnight.

The following day, a quantity of 200 gallons of acetone is added to the suspension followed by stirring for 8 hours. The mixture is again allowed to stand overnight. The following day, the clear supernatant liquid is decanted from the suspension and the tissue residue is removed by filtration. The filter cake (tissue residue) is repulped with 35 gallons of a mixture of 0.3 volume 12N HCl, 9.7 volumes water and 30.0 volumes acetone and the resulting suspension is filtered. The filtrates are combined with the supernatant liquid obtained by decantation to form the acid-acetone extract with a volume of 275 gallons. The relaxin content of the extract is 9.4 G.P.U./ml or 19,600 G.P.U./lb ovaries extracted, an activity yield of about 97 percent.

References

Merck Index 8031
 I.N. p. 841

Doczi, J.; U.S. Patent 3,096,246; July 2, 1963; assigned to Warner-Lambert Pharmaceutical Co.

REPROTEROL

Therapeutic Function: Bronchodilator

Chemical Name: 7-[3-[[2-(3,5-Dihydroxyphenyl)-2-hydroxyethyl] amino] propyl] -3,7-dihydro-1,3-dimethyl-1H-purine-2,6-dione

Common Name: —

Structural Formula:

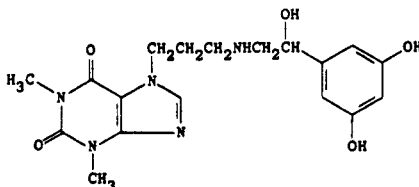

Chemical Abstracts Registry No.: 54063-54-6; 13055-82-8 (Hydrochloride)

Trade Name	Manufacturer	Country	Year Introduced
Bronchospasmin	Homburg	W. Germany	1977
Bronchospasmin	Farmades	Italy	1981
Bronchodil	Berlimed	U.K.	1981
Asmaterol	Lusofarmaco	Italy	—
Tiffen	Tosi	Italy	—

Raw Materials

Theophylline	1-Bromo-3-chloropropane
3,5-Dihydroxy- ω -bromoacetophenone	Benzylamine
Hydrogen	

Manufacturing Process

Theophylline is reacted first with 1-bromo-3-chloropropane to give chloropropyl theophylline, then with benzylamine to give benzylaminopropyltheophylline. That is reacted with 3,5-dihydroxy- ω -bromoacetophenone to give the starting material.

500 g of 7-[3-[2-(3,5-dihydroxyphenyl)-2-oxoethyl-benzylamino]-propyl]-theophylline hydrochloride obtained as above were dissolved in 5 liters of dimethyl acetamide. There were added 25 g of a 10% palladium-carbon catalyst, the mixture heated to 70°C and hydrogenated with stirring at this temperature and 2 bar pressure until the speed of hydrogenation perceptibly slowed (about 2 hours). Subsequently, the mixture was filtered and after addition of a further 25 g of the palladium catalyst hydrogenated at 6 bar to the end (2 to 3 hours). The mixture was filtered, the greatest part of the solvent distilled off at a water jet vacuum, and the residue treated with 8 liters of ethanol. The solution was cooled for 12 hours with flowing water and the precipitated material filtered off with suction. Then it was boiled for one hour with 2 liters of methanol with stirring and the passing through of nitrogen, allowed to cool to 25°C and filtered off with suction. After drying in a vacuum at 55°C there were obtained 391 g (= 94.5% of theory) of pure 7-[3-[2-(3,5-dihydroxyphenyl)-2-hydroxyethyl-amino]-propyl]-theophylline hydrochloride. Melting point 263°C to 265°C.

References

- Merck Index 8035
- Kleeman & Engel p. 800
- OCDS Vol. 3 p. 231 (1984)
- DOT 13 (2) 552 (1977)

I.N. p. 842

Klingler, K.H. and Bickel, E.; U.S. Patent 4,150,227; April 17, 1979; assigned to Degussa (Germany)

RESCIMETOL

Therapeutic Function: Antihypertensive

Chemical Name: Methylreserpate 3'-methoxy-4'-hydroxycinnamate

Common Name: —

Structural Formula:

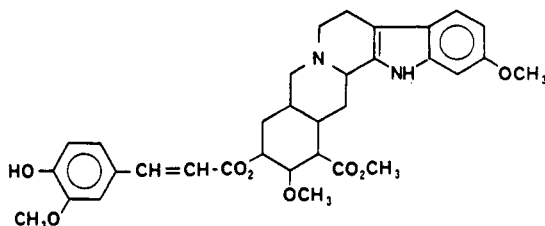

Chemical Abstracts Registry No.: 73573-42-9

Trade Name	Manufacturer	Country	Year Introduced
Toscara	Nippon Chemiphar	Japan	1982

Raw Materials

Methylreserpate 3'-methoxy-4'-ethoxycarboxycinnamate
Sodium
Methanol

Manufacturing Process

28 mg of a metal sodium were dissolved in 25 ml of anhydrous methanol, and one drop of water was added thereto. 1.5 g of methylreserpate 3'-methoxy-4'-ethoxycarboxycinnamate in 25 ml of tetrahydrofuran were added thereto.

The mixture was then stirred at room temperature for 2 hours. One drop of acetic acid was added thereto, and the solvent was evaporated. The residue was extracted with chloroform, the extract was washed with saturated sodium bicarbonate solution and then with water.

The chloroform layer was dried over sodium sulfate, and the solvent was evaporated, so that there was obtained a brown amorphous matter. This was recrystallized from chloroform-hexane, and there was then obtained 1.0 g (78% of yield) of methylreserpate 3'-methoxy-4'-hydroxycinnamate which was characterized as pale yellow needles having a melting point of 259°C to 260°C.

References

Merck Index 8038

DFU 3 (3) 183 (1978) (As CD-3400) & 5 (12) 635 (1980)

DOT 18 (10) 551 (1982)

Kametani, T.; U.S. Patent 3,898,215; August 5, 1975; assigned to Nippon Chemiphar Co., Ltd.

RESCINNAMINE

Therapeutic Function: Antihypertensive

Chemical Name: 11,17 α -dimethoxy-18 β -[[1-oxo-3-(3,4,5-trimethoxyphenyl)-2-propenyl]-oxy]-3 β ,20 α -yohimban-16 β -carboxylic acid methyl ester

Common Name: 3,4,5-trimethoxycinnamoyl methyl reserpate

Structural Formula:

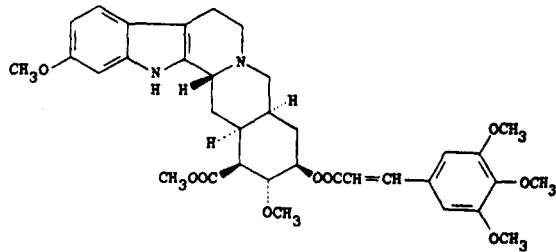

Chemical Abstracts Registry No.: 24815-24-5

Trade Name	Manufacturer	Country	Year Introduced
Moderil	Pfizer	U.S.	1956
Aldatense	Searle	France	—
Anaprel	Servier	France	—
Apolon	Toyama	Japan	—
Aporecin	Kayaku	Japan	—
Aporesin	A.L.	Norway	—
Apotension	Santen	Japan	—
Apoterin	Seiko	Japan	—
Atension	Santen	Japan	—
Caniramine	Hokuriku	Japan	—
Cartric	Sanwa	Japan	—
Cinnaloid	Taito Pfizer	Japan	—
Colstamin	Kowa	Japan	—
Daisaloid	Mohan	Japan	—
Isocalsin	Kowa	Japan	—
Paresinan	Wakamoto	Japan	—
Rescamin	Pharmacia	Sweden	—
Rescimin	Torlan	Spain	—
Rescinate	Ohta	Japan	—
Rescisan	Pharmacia	Sweden	—
Rescitens	Fargal	Italy	—
Resiloid	Nippon Shoji	Japan	—
Rosex	Teikoku	Japan	—
Rozex	Teisan	Japan	—
Sciminan	Kotani	Japan	—
Seripinin	Fuji Zoki	Japan	—
Sinselpin	Kobayashi	Japan	—

Raw Materials

3,4,5-Trimethoxycinnamic acid
Methyl reserpate

Thionyl chloride
Rauwolfia plants

Manufacturing Process

4.0 grams of 3,4,5-trimethoxycinnamic acid, MP 125.5° to 127°C was refluxed for 35 minutes under anhydrous conditions with 6.0 parts by volume of redistilled thionyl chloride.

The excess thionyl chloride was removed under vacuum and by distilling from the residue two portions of dry benzene. The crystalline residue was crystallized twice from hexane-ether to yield 3,4,5-trimethoxycinnamoyl chloride which was obtained in the form of bright yellow prisms, MP 95° to 96°C.

To a solution of 0.80 part by weight of methyl reserpate in 10 parts by volume of dry distilled pyridine at 10° to 15°C were added in portions during 20 minutes with stirring and external cooling 1.1 parts by weight of 3,4,5-trimethoxycinnamoyl chloride. The reaction was carried out under nitrogen. After standing at room temperature for 65 hours the pyridine was removed under reduced pressure and at a temperature of 50° to 60°C. A brown solid froth-like material was obtained which was chromatographed on 30 parts by weight of alumina (activity II-III). The fractions eluted with benzene-acetone mixtures, on crystallization from benzene yielded 3,4,5-trimethoxycinnamate of methyl reserpate in the form of needles, which on recrystallization from methanol melted at 232° to 234°C as described in U.S. Patent 2,854,454.

The 3,4,5-trimethoxycinnamic ester of methyl reserpate is also present in Rauwolfia plants and obtainable in purified form therefrom by extraction as described in U.S. Patents 2,974,144 and 2,876,228.

References

Merck Index 8039

Kleeman & Engel p. 801

PDR p. 1422

OCDs Vol. 1 p. 319 (1977)

I.N. p. 843

REM p. 909

Ulshafer, P.R.; U.S. Patent 2,854,454; September 30, 1958

Ordway, H.W. and Guercio, P.A.; U.S. Patent 2,876,228; March 3, 1959; assigned to Chas. Pfizer & Co., Inc.

Klohs, M.W., Draper, M.D. and Keller, F.; U.S. Patent 2,974,144; March 7, 1961; assigned to Riker Laboratories, Inc.

RESERPINE

Therapeutic Function: Antihypertensive

Chemical Name: 11,17 α -dimethoxy-18 β -[(3,4,5-trimethoxybenzoyl)oxy]-3 β ,20 α -yohimban-16 β -carboxylic acid methyl ester

Common Name: 3,4,5-trimethoxybenzoyl methyl reserpate

Structural Formula:

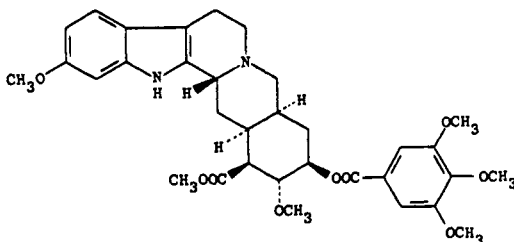

Chemical Abstracts Registry No.: 50-55-5

Trade Name	Manufacturer	Country	Year Introduced
Serpasil	Ciba	U.S.	1953
Sandril	Lilly	U.S.	1954
Rau-Sed	Squibb	U.S.	1954
Crystoserpine	Dorsey	U.S.	1954
Serpine	Pitman Moore	U.S.	1954
Serfin	Parke Davis	U.S.	1954
Reserpoid	Upjohn	U.S.	1954
Serpiloid	Riker	U.S.	1954
Serpanray	Panray	U.S.	1954
Vio-Serpine	Rowell	U.S.	1955
Serpina	Haag	U.S.	1955
Serpate	Vale	U.S.	1955
Rausaingle	Philips Roxane	U.S.	1955
Sertabs	Table Rock	U.S.	1955
Eskaserp	SKF	U.S.	1955
Serolfia	Mallard	U.S.	1955
Resercen	Central	U.S.	1956
Banasil	Ulmer	U.S.	1956
Roxinoid	MSD	U.S.	1956
Respital	Premo	U.S.	1956
Raurine D-Lay	Westerfield	U.S.	1961
Lemiserp	Lemmon	U.S.	1962
Abesta	A.N.A.	France	—
Broserpine	Brothers Pharm	U.S.	—
Cardioserpine	Star	Finland	—
Chloroserpine	Schein	U.S.	—
Demi-Regroton	U.S.V.	U.S.	—
Diupres	MSD	U.S.	—
Diutensin	Wallace	U.S.	—
HHR	Schein	U.S.	—
Hydro-Fluserpine	Schein	U.S.	—
Hydromox	Lederle	U.S.	—
Hydropres	MSD	U.S.	—
Hydroserpine	Schein	U.S.	—
Key-Serpine	Key	U.S.	—
Lemiserp	Lemmon	U.S.	—
Metatensin	Merrell Dow	U.S.	—
Naquival	Schering	U.S.	—
Neo-Serp	Neo	Canada	—
Raulen	Paul Maney	Canada	—
Rausan	Wassermann	Spain	—
Rausedan	Arzneimittelwerk Dresden	E. Germany	—
Rauvilid	Pharmacia	Sweden	—
Rauwita	Lifasa	Spain	—
Regroton	U.S.V.	U.S.	—
Renese-R	Pfipharmecs	U.S.	—
Resedril	Estedi	Spain	—
Rese-Lar	Perga	Spain	—
Reser-Ar	Luar	U.S.	—
Reserocrine	Casgrain & Charbonneau	Canada	—
Reserfia	Medic	Canada	—
Reserpur	A.F.I.	Norway	—
Resine	Kirk	U.S.	—
Resomine	Bonjean	Belgium	—
Rivasin	Giulini	W. Germany	—
Salutensin	Bristol	U.S.	—
Ser-Ap-Es	Ciba	U.S.	—
Serolfia	Ascher	U.S.	—

Trade Name	Manufacturer	Country	Year Introduced
Serpalan	Lannett	U.S.	—
Serpax	Verdun	Canada	—
Serpedin	Pharmacia	Sweden	—
Serpena	Haag	U.S.	—
Serpentil	Pliva	Yugoslavia	—
Serpipur	Kwizda	Austria	—
Serpivite	Vitarine	U.S.	—
Serpoid	Canfield	U.S.	—
Serpone	Hartz	Canada	—
Serpresan	Maipe	Spain	—
Sertina	Fellows-Testagar	U.S.	—
SK-Reserpine	SKF	U.S.	—
Unipres	Reid-Rowell	U.S.	—
Vio-Serpine	Rowell	U.S.	—
V-Serp	Vanguard	U.S.	—

Raw Materials

Rauwolfia plant bark
Methanol

Manufacturing Process

7,000 parts by weight of powdered bark from the root of *Rauwolfia serpentina* Benth, are percolated with about 35,000 parts by volume of methanol. After evaporating the methanol extract, 1,050 parts by weight are obtained of a dark colored powder which is treated several times with water for removal of soluble constituents. The insoluble residue remaining from this operation is subsequently masticated five times, in each case with 1,500 parts by volume of 10% aqueous acetic acid, the solution being best separated from the smeary residue by centrifuging. The brown acetic acid solution, which for further working up can be concentrated at low temperature to a small volume or be diluted with half the volume of water, possesses a pH of about 3.9. This solution is extracted by shaking with 3,500 to 4,000 parts by volume of chloroform divided into 3 to 4 portions. These chloroform extracts are washed once with potassium carbonate solution and twice with water, dried with sodium sulfate and evaporated to dryness under reduced pressure. The residue, amounting to 70 to 80 parts by weight, forms a green-brown colored powder. For further purification, this residue is dissolved in benzene and chromatographed over 1,000 to 1,200 parts by weight of neutral aluminum oxide (activity H-III according to Brockmann). On elution with benzene there are first obtained small quantities of a yellow oil and 0.9 part by weight of an inactive crystallizate of melting point 238°C to 239°C, after which the substance of sedative activity follows. As soon as the major quantity of the active substance has been eluted, further elution is carried out with a mixture of 2 parts by volume of benzene and 1 part by volume of acetone. In this manner the residue of the sedative substance is obtained and after that a further inactive crystallizate of melting point 141°C to 143°C. The eluate fractions containing the sedative substance are evaporated to dryness. By recrystallization of the residue from hot acetone or a mixture of chloroform and ether, 6.5 to 7 parts by weight of reserpine are obtained in the form of almost colorless crystals of melting point 262°C to 263°C (with decomposition).

References

- Merck Index 8042
 Kleeman & Engel p. 802
 PDR pp. 710, 812, 993, 1011, 1168, 1185, 1231, 1409, 1449, 1606, 1634, 1723, 1820, 1876, 1999
 I.N. p. 843
 REM p. 908
 Schwyzer, R. and Mueller, J.; U.S. Patent 2,833,771; May 6, 1958; assigned to Ciba Pharmaceutical Products, Inc.

RIBOSTAMICIN

Therapeutic Function: Antibiotic

Chemical Name: O-2,6-Diamino-2,6-dideoxy- α -D-glucopyranosyl-(1 \rightarrow 4)-O- $[\beta$ -D-ribofuranosyl-(1 \rightarrow 5)] 2-deoxy-D-streptamine

Common Name: Ribostamin

Structural Formula:

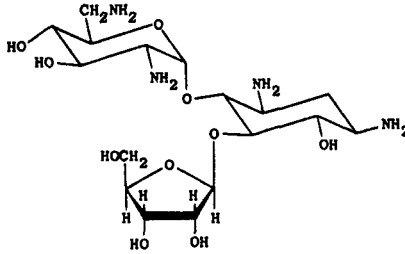

Chemical Abstracts Registry No.: 25546-65-0

Trade Name	Manufacturer	Country	Year Introduced
Vistamycin	Meiji Seika	Japan	1972
Ribomycine	Delalande	France	1977
Ribostamin	Delalande	Italy	1979
İbistacín	I.B.I.	Italy	1979
Landamycin	Delalande	W. Germany	1980

Raw Materials

Bacterium *Streptomyces thermoflavus*
 Glucose
 Soybean meal

Manufacturing Process

Streptomyces thermoflavus SF-733 strain was inoculated to 15 liters of a liquid medium (pH 7.0) containing glucose 2.5%, soybean meal 3.5%, soluble vegetable protein 1.0% and NaCl 0.25% and shake-cultured in a jar-fermenter at 28°C for 3 days. 10 liters of culture filtrate (potency, 200 meg/ml) obtained by filtering culture broth at pH 4.0 was adjusted to pH 7.0 and applied to a column filled with 1 liter of Amberlite IRC 50 (NH₄⁺ type, Rohm & Haas) to adsorb active ingredient on ion-exchange resin. After washing with water the column was eluted with 0.5 N ammonia water. Active fractions were concentrated in vacuo and freeze-dried. 5.9 g of crude powder thus obtained was dissolved in 10 ml of water, applied to a column filled with 400 ml of Dowex 1 X2 (OH⁻ type, Dow Chemicals) and developed chromatographically with water to give 250 ml of active fraction which was concentrated in vacuo, whereby 2.1 g of light yellow powder of SF-733 substance was obtained. 2.0 g of this powder was dissolved in 3 ml of water, applied to a column filled with 100 ml of Amberlite CG 50 (NH₄⁺ type) washed with water and eluted with 0.2 N ammonia water. 400 ml of active fraction was collected, concentrated in vacuo and freeze-dried to give 600 mg of white powder of free base of SF-733 substance. This powder was dissolved in about 5 ml of water and concentrated to syrup and added with about 50 ml of ethanol. The mother liquor together with white precipitate thus formed was concentrated in vacuo to dryness. 650 mg of ethanol-solvate-like white powder was dissolved in 6.5 ml of methanol. The solution became cloudy immediately after dissolution and crystals were gradually separated. After tightly sealed and left alone at 30°C overnight crystals were collected by means of glass filter and washed with

about 1 ml of methanol. The crystals were held on calcium chloride as a drying agent at room temperature in vacuo and then dried on phosphorus pentoxide as a drying agent at 60°C for 19 hours in vacuo to give 440 mg of free base crystals of SF-733 substance. Yield: 73%.

References

Merck Index 8106

Kleeman & Engel p. 807

DOT 9 (3) 112 (1973)

I.N. p. 848

Shomura, T., Ezaki, N., Tsuruoka, T., Niwa, T., Akita, E. and Niida, T.; U.S. Patent 3,661,892; May 9, 1972; assigned to Meiji Seika Kaisha, Ltd. (Japan)

RIFAMPIN

Therapeutic Function: Antitubercular

Chemical Name: 5,6,9,17,19,21-hexahydroxy-23-methoxy-2,4,12,16,18,20,22-heptamethyl-8-[N-(4-methyl-1-piperazinyl)formimidoyl]-2,7-(epoxypentadeca[1,11,13]trienimino)-naphtho[2,1-b]furan-1,11(2H)-dione 21-acetate

Common Name: 3-[(4-Methyl-1-piperazinyl)iminomethyl] rifamycin SV; rifaldazine; rifamycin AMF; rifampicin

Structural Formula:

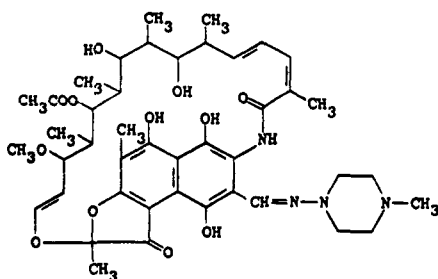

Chemical Abstracts Registry No.: 13492-46-1

Trade Name	Manufacturer	Country	Year Introduced
Rifadin	Lepetit	Italy	1968
Rifadin	Merrell	U.K.	1969
Rimactan	Ciba	W. Germany	1969
Rifadine	Lepetit	France	1969
Rimactane	Ciba Geigy	U.K.	1969
Rifadin	Daiichi	Japan	1971
Rimactan	Ciba	Japan	1971
Rimactane	Ciba	U.S.	1971
Rifadin	Dow	U.S.	1971
Archidyn	Lepetit	Italy	—
Arficin	Belupo	Yugoslavia	—
Benemicin	Polfa	Poland	—
Fenampicin	Antibioticos	Spain	—
Feronia	Lifepharm	Spain	—

Trade Name	Manufacturer	Country	Year Introduced
Riasin	Yurtoglu	Turkey	—
Rifa	Gruenthal	W. Germany	—
Rifagen	Morgens	Spain	—
Rifam	Nobel	Turkey	—
Rifapiam	Piam	Italy	—
Rifaprodin	Prodes	Spain	—
Rifarm	Pharmacal	Finland	—
Rifobac	Llade	Spain	—
Rifonilo	Aristegui	Spain	—
Riforal	Llade	Spain	—
Rimapen	Orion	Finland	—
Ripamisin	Deva	Turkey	—
Rofact	I.C.N.	Canada	—
Santadín	Santa Farma	Turkey	—
Seamicin	Galepharma Iberica	Spain	—
Tubocin	Farmakhim	Bulgaria	—

Raw Materials

3-Formylrifamycin SV
1-Amino-4-methylpiperazine

Manufacturing Process

3-Formylrifamycin SV is treated with 1-amino-4-methylpiperazine in tetrahydrofuran to give rifampin.

References

Merck Index 8113
Kleeman & Engel p. 808
PDR pp. 810, 1236
DOT 5 (1) 24 (1969)
I.N. p 848
REM p. 1233
Maggi, N. and Sensi, P.; U.S. Patent 3,342,810; September 19, 1967; assigned to Lepetit SpA, Italy

RIMITEROL

Therapeutic Function: Bronchodilator

Chemical Name: 4-(hydroxy-2-piperidinylmethyl)-1,2-benzenediol

Common Name: Erythro-3,4-dihydroxyphenyl-2-piperidinylcarbinol

Structural Formula:

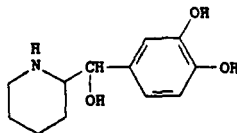

Chemical Abstracts Registry No.: 32953-89-2; 31842-61-2 (Hydrogen bromide)

Trade Name	Manufacturer	Country	Year Introduced
Pulmadil	Riker	U.K.	1974
Asmaten	Riker	—	—

Raw Materials

4-Bromoveratrole	Magnesium
2-Cyanopyridine	Hydrogen chloride
Sodium hydroxide	Hydrogen bromide
Hydrogen	

Manufacturing Process

To a stirred suspension of 5.0 grams (0.21 gram atom) of magnesium turnings in 15 ml of tetrahydrofuran under nitrogen is added 43.4 grams (0.2 mol) of 4-bromoveratrole to maintain constant reflux. An additional 40 ml of solvent is added and the Grignard reagent thus prepared is heated on a steam bath for one hour. This solution is then added dropwise to a solution of 20.8 grams (0.2 mol) of 2-cyanopyridine in 300 ml of ether. The mixture is stirred overnight at room temperature, decomposed by addition of 250 ml of 10% hydrochloric acid and the separated aqueous layer is made alkaline with 40% sodium hydroxide solution. This mixture is extracted with methylene chloride and the dried extract concentrated. The residue is distilled and the fraction at 190° to 235°C/12 mm is crystallized to give 3,4-dimethoxyphenyl-2-pyridyl ketone, MP 93° to 94°C.

A solution of 0.5 gram of the above ketone in 15 ml of 48% hydrobromic acid is refluxed for 1½ hours and then concentrated in vacuo. The residue is dissolved in ethanol, toluene is added, the solution concentrated and the residue stripped with toluene to yield 3,4-dihydroxyphenyl-2-pyridyl ketone hydrobromide, MP 246° to 247°C (decomposition).

A mixture of 0.5 gram of platinum oxide and a solution of 2.0 grams (0.0067 mol) of 3,4-dihydroxyphenyl-2-pyridyl ketone hydrobromide in 20 ml of water and 80 ml of ethanol is hydrogenated on the Parr apparatus using an initial hydrogen pressure of 50 psi at room temperature. The reaction mixture is filtered, the filtrate concentrated in vacuo and the residue triturated with acetone to give erythro-3,4-dihydroxyphenyl-2-piperidinylcarbinol hydrobromide, MP 210° to 211°C (decomposition).

Treatment of the above hydrobromide with aqueous sodium bicarbonate followed by extraction with ethyl acetate yields the free base of the carbinol MP 203° to 204°C which may be reacted with other acids to give other acid addition salts.

References

Merck Index 8117

Kleeman & Engel p. 809

OCDS Vol. 2 p. 278 (1980)

DOT 10 (11) 272 (1974)

I.N. p. 849

Kaiser, C. and Ross, S.T.; U.S. Patent 3,705,169; December 5, 1972; assigned to Smith Kline & French Laboratories

RITODRINE

Therapeutic Function: Muscle relaxant (obstetric)

Chemical Name: erythro-p-hydroxy- α -[1-[(p-hydroxyphenethyl)amino] ethyl] benzyl alcohol

Common Name: N-(p-hydroxyphenylethyl)-4-hydroxynorephedrine

Structural Formula:

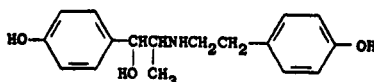

Chemical Abstracts Registry No.: 26652-09-5; 23239-51-2 (Hydrochloride)

Trade Name	Manufacturer	Country	Year Introduced
Pre-Par	Duphar	Italy	1975
Yutopar	Duphar	U.K.	1976
Pre-Par	Duphar	France	1976
Pre-Par	Duphar/Thomae	W. Germany	1976
Yutopar	Merrell Dow	U.S.	1980
Yutopar	Astra	U.S.	1980
Miolene	Lusofarmaco	Japan	—
Utopar	Ferrosan	Denmark	—

Raw Materials

2-Bromo-4'-benzyloxypropiofenone	Hydrogen chloride
2-(4-Methoxyphenyl)ethylamine	Hydrogen
Hydrogen bromide	

Manufacturing Process

A solution of 44 grams of 2-bromo-4'-benzyloxypropiofenone and 44 grams of 2-(4-methoxyphenyl)ethylamine in 270 ml of ethanol was refluxed for 3 hours. Then the ethanol was distilled off in vacuo and the concentrate mixed with ether. The resulting crystallize was sucked off after which the filtrate was mixed with an excess of 2 N hydrochloric acid. As a result of this the hydrochloride of 4'-benzyloxy-2-[2-(4-methoxyphenyl)ethylamino]-propiofenone slowly crystallized. This substance was also sucked off, washed with water and alcohol, and dried in vacuo. After recrystallization from dilute alcohol the yield was 25.5 grams of a product with a melting point of 217° to 218°C.

12 grams of the product thus obtained were dissolved in a mixture of 300 ml of ethanol and 90 ml of water. After 42 ml of 1% palladium chloride solution and 3.9 grams of Norit had been added to this solution it was hydrogenated at room temperature and at a pressure of 1.1 atmospheres until approximately 760 ml of hydrogen had been taken up. Then the catalyst was removed by filtration and the solvent of the filtered solution was evaporated entirely in vacuo.

The resulting residue, which consisted of the hydrochloride of 4'-hydroxy-2-[2-(4-methoxyphenyl)ethylamino]propiofenone, was mixed with 30 ml of a 48% hydrobromic acid solution and the mixture was boiled until no methylbromide developed any more, which was the case after approximately 45 minutes. Then the reaction mixture was stored in the refrigerator, after which the hydrobromide of 4'-hydroxy-2-[2-(4-hydroxyphenyl)ethylamino]propiofenone crystallized. It was sucked off and converted into the hydrochloride by again dissolving the resulting substance in water, discoloring the solution with a little Norit and then adding an equal volume of concentrated hydrochloric acid. As a result of this the hydrochloride crystallized. The yield was 9.6 grams of a product with a melting point of 136° to 138°C. After this product had been recrystallized once again it was reduced to the amino alcohol.

For this purpose a solution of 3.2 grams of the hydrochloride in 160 ml of distilled water was provided with 0.5 gram of Norit and 8 ml of 1% palladium chloride solution and the mixture was hydrogenated at room temperature and at a pressure of 1.1 atmospheres until no hydrogen was taken up any more. The catalyst was then removed by filtration, after

which the filtrate was concentrated in vacuo. To the concentrated solution of the reduced product was then added an excess of dilute ammonia, as a result of which the base of the 1-(4-hydroxyphenyl)-2-[2-(4-hydroxyphenyl)ethylamino]propanol precipitated as a tough mass. After the mixture had been stored in the refrigerator for some time, the product was sucked off, washed with water and dried in vacuo. This base was a resinous mass with a melting point of approximately 88° to 90°C. Yield was 2.3 grams.

References

Merck Index 8121

Kleeman & Engel p. 810

PDR p. 609

OCDS Vol. 2 p. 39 (1980)

DOT 10 (1) 23 (1974)

I.N. p. 850

Claassen, V., Van Dijk, J. and Moed, H.D.; U.S. Patent 3,410,944; November 12, 1968; assigned to North American Philips Company, Inc.

ROCIVERINE

Therapeutic Function: Antispasmodic

Chemical Name: 1-(Diethylamino)-2-propyl cis-2-hydroxy-2-cyclohexylcyclohexane-1-carboxylate

Common Name: —

Structural Formula:

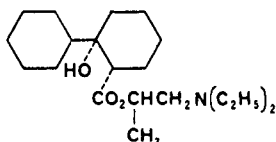

Chemical Abstracts Registry No.: 53716-44-2

Trade Name	Manufacturer	Country	Year Introduced
Rilaten	Guidotti	Italy	1979

Raw Materials

2-Phenyl-2-hydroxycyclohexane carboxylic acid

Hydrogen

1-Bromo-2-propanol

Diethylamine

Manufacturing Process

5.6 g of 2-phenyl-2-hydroxy-cyclohexane-carboxylic acid were dissolved in 75 cc of glacial acetic acid and reduced in the presence of 0.1 g of platinum oxide under hydrogen pressure of 22 kg/cm² at a temperature of 70°C to 80°C.

Hydrogen absorption being completed, the solution was filtered and evaporated to one-fifth of its volume and cooled in a refrigerator. The precipitate was filtered, washed with water, and then crystallized from ligroin, thus yielding 4 g of 2-cyclohexyl-2-hydroxy-cyclohexane-

carboxylic acid, melting point (Kofler) 122°C to 124°C. This material was esterified with 1-bromo-2-propanol by means of 85% H₂SO₄ yielding 1-bromoisopropyl-2-cyclohexyl-2-hydroxycyclohexanecarboxylate. Finally this compound was treated with diethylamine and triethylamine at 120°C to give roloverine.

References

Merck Index 8125

DFU 4 (4) 276 (1979)

I.N. p. 852

Turbanti, L; U.S. Patents 3,700,675; and 3,700,775; both dated October 24, 1972

ROLITETRACYCLINE

Therapeutic Function: Antibacterial

Chemical Name: 4-(Dimethylamino)-1,4,4a,5,5a,6,11,12a-octahydro-3,6,10,12,12a-penta-hydroxy-6-methyl-1,11-dioxo-N-(1-pyrrolidiny-methyl)-2-naphthacenecarboxamide

Common Name: —

Structural Formula:

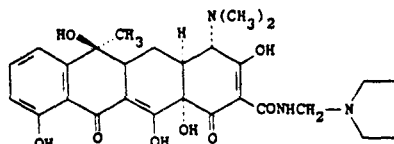

Chemical Abstracts Registry No.: 751-97-3

Trade Name	Manufacturer	Country	Year Introduced
Syntetrin	Bristol	U.S.	1959
Velacycline	Squibb	U.S.	1960
Transcycline	Hoechst	France	1961
Anergomycil	C.N.N.	Italy	—
Bristacin	Bristol Banyu	Japan	—
Farmaciclina	Selvi	Italy	—
Hostacyclin-PRM	Hoechst	Japan	—
Kinteto	Fujita	Japan	—
Quadraciclina	Squibb	Italy	—
Reverin	Hoechst	Italy	—
Solvocillin	Fabr. Antibiot.	Rumania	—
Tetrafarmed	Neopharmed	Italy	—
Tetraidina	Italsuisse	Italy	—
Tetraverin	Polfa	Poland	—

Raw Materials

Tetracycline
Paraformaldehyde
Pyrrolidine hydrochloride

Manufacturing Process

1 g (0.00225 mol) of anhydrous tetracycline base, 0.101 g (0.0038 mol) of paraformaldehyde

and 0.302 g (0.0025 mol) pyrrolidine hydrochloride are refluxed in 25 ml absolute ethanol. After two hours an additional 0.101 g paraformaldehyde is added and refluxing is continued for two more hours. The solution is then cooled and two drops of concentrated hydrochloric acid are added. The product, N'-(1-pyrrolidyl-methyl)-tetracycline hydrochloride, forms and is isolated as a crystalline, antibacterially active solid differing in specific rotation from tetracycline hydrochloride. The product is converted to the free base by solution in water followed by the addition of one equivalent of sodium hydroxide. Thus for isolation, the alcoholic solution of N'-(1-pyrrolidyl-methyl)-tetracycline hydrochloride is diluted with 5.0 ml ether to precipitate the product, which is collected by filtration and dried in vacuo over P₂O₅. The product is a crystalline solid melting at about 158°C to 165°C with decomposition.

References

Merck Index 8127

Kleeman & Engel p. 810

OCDS Vol. 1 p. 216 (1977)

I.N. p. 853

Cheney, L.C., Risser, W.C. and Gottstein, W.J.; U.S. Patent 3,104,240; September 17, 1963; assigned to Bristol-Myers Co.

ROSOXACIN

Therapeutic Function: Antibacterial; antigonorrheal

Chemical Name: 1-Ethyl-1,4-dihydro-4-oxo-7-(4-pyridyl)-3-quinolinecarboxylic acid

Common Name: Acrosoxacin

Structural Formula:

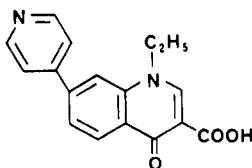

Chemical Abstracts Registry No.: 40034-42-2

Trade Name	Manufacturer	Country	Year Introduced
Eradacin	Sterling Winthrop	U.K.	1981
Eracine	Winthrop	France	1981
Winuron	Winthrop	W. Germany	1981
Eradacil	Winthrop	Canada	1983
Winoxacin	Winthrop	Switz.	1983
Roxadyl	Winthrop	—	—

Raw Materials

4-(3-Nitrophenyl)pyridine	Iron
Ethoxymethylene malonic acid diethyl ester	Acetic acid
Ethyl iodide	Sodium hydride
Sodium hydroxide	

Manufacturing Process

To a stirred suspension containing 5.1 g of 57% sodium hydride dispersed in mineral oil and

150 ml of dimethylformamide was added in portions 32.6 g of ethyl 1,4-dihydro-4-oxo-7-(4-pyridyl)-3-quinolinecarboxylate [tautomeric with ethyl 4-hydroxy-7-(4-pyridyl)-3-quinolinecarboxylate] followed by the addition of 18.7 g of ethyl iodide. The resulting reaction mixture was heated on a steam bath for three hours with stirring and then concentrated in vacuo to remove the solvent. The semisolid residue was shaken well with a mixture of chloroform and water, and a small quantity of amorphous brown solid was filtered off. The layers were separated and the chloroform layer was evaporated in vacuo to remove it.

To the oily residue containing ethyl 1-ethyl-1,4-dihydro-4-oxo-7-(4-pyridyl)-3-quinolinecarboxylate was added excess 10% aqueous sodium hydroxide solution and ethanol, and the solution was heated on a steam bath for forty-five minutes to hydrolyze the ethyl ester to the corresponding carboxylic acid. The alkaline solution was diluted to a volume of about 500 ml with water, decolorizing charcoal was added and the mixture filtered. The filtrate was neutralized with acetic acid whereupon the carboxylic acid separated as a solid. The solid was collected and dried in a rotary evaporator. The solid was boiled with ethanol, the solution chilled and the resulting solid collected. The solid was recrystallized from dimethylformamide (about 150 ml) using decolorizing charcoal. The filtrate was chilled, diluted with about one-half volume of ethanol and the separated crystalline product was collected, recrystallized again from dimethylformamide and dried in vacuo to yield 4.3 g 1-ethyl-1,4-dihydro-4-oxo-7-(4-pyridyl)-3-quinolinecarboxylic acid, melting point 272°C to 273°C raised by further recrystallization to 290°C.

4-(3-nitrophenyl)pyridine is reduced with iron in acetic acid to give 4-(3-aminophenyl)pyridine. That in turn is reacted with ethoxymethylenemalononic acid diethyl ester and then thermally rearranged to give the starting material.

References

- Merck Index 8136
DFU 5 (4) 199 (1980)
Kleeman & Engel p. 811
OCDS Vol. 3 p. 185 (1984)
DOT 18 (3) 147 (1982)
I.N. p. 855
Carabateas, P.M.; U.S. Patent 3,922,278; November 25, 1975; assigned to Sterling Drug, Inc.
Leshner, G.Y. and Carabateas, P.M.; U.S. Patents 3,753,993; August 21, 1973 and 3,907,808; September 23, 1975; both assigned to Sterling Drug, Inc.
Lorenz, R.R. and Thielking, W.H.; U.S. Patent 4,107,167; August 15, 1978; assigned to Sterling Drug, Inc.

S

SALICYLANILIDE

Therapeutic Function: Antifungal

Chemical Name: 2-hydroxy-N-phenylbenzamide

Common Name: N-phenylsalicylamide

Structural Formula:

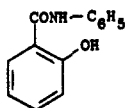

Chemical Abstracts Registry No.: 87-17-2

Trade Name	Manufacturer	Country	Year Introduced
Salinidol	Doak	U.S.	1946
Ansadol	Rorer	U.S.	1947
Hyanilid	Peau Seche	U.S.	-

Raw Materials

Salicylic acid
Aniline

Manufacturing Process

Salicylanilide is ordinarily made by reacting salicylic acid with aniline in the presence of phosphorus trichloride at an elevated temperature. The theoretical proportions of reactants are usually employed for best results, that is, one mol each of aniline and salicylic acid to a third of a mol of phosphorus trichloride. An improved process employs an inert organic solvent as a reaction diluent.

References

Merck Index 8188
I.N. p. 861

Majewski, T.E., Parsey, E.S. and Skelly, N.E.; U.S. Patent 3,221,051; November 30, 1965
Majewski, T.E., Stoesser, W.C. and Parsey, E.S.; U.S. Patent 3,231,611; January 25, 1966;
assigned to The Dow Chemical Company

SALICYLIC ACID

Therapeutic Function: Keratolytic

Chemical Name: 2-Hydroxybenzoic acid

Common Name: —

Structural Formula:

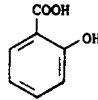

Chemical Abstracts Registry No.: 69-72-7

Trade Name	Manufacturer	Country	Year Introduced
Saligel	Stiefel	U.S.	1978
Fomac	Dermik	U.S.	1979
Aveenobar	Rydelle	U.S.	—
Barseb	Barnes-Hind	U.S.	—
Cantharone	Seres	U.S.	—
Compound W	Whitehall	U.S.	—
Duofilm	Stiefel	U.S.	—
Egocappol	Ego	Australia	—
Fostex	Westwood	U.S.	—
Fungi-Nail	Kramer	U.S.	—
Hydrisalic	Pedinol	U.S.	—
Jabon Salicilico	Imba	Spain	—
Keralyt	Westwood	U.S.	—
Komed	Barnes-Hind	U.S.	—
Night-Cast	Seres	U.S.	—
Occlusal	Gen Derm	U.S.	—
Pernox	Westwood	U.S.	—
Sal Ac	Gen Derm	U.S.	—
Salactic	Pedinol	U.S.	—
Sebucare	Westwood	U.S.	—
Sebulex	Westwood	U.S.	—
Tinver	Barnes-Hind	U.S.	—
Verrex	C & M	U.S.	—
Verrusal	C & M	U.S.	—
Viranol	Amer. Dermal	U.S.	—
Wart-Off	Pfipharmecs	U.S.	—
Whitfield's Ointment	Fougera	U.S.	—

Raw Materials

Sodium phenolate	Carbon dioxide
Bacterium <i>Pseudomonas</i>	Naphthalene
Nutrient medium	

Manufacturing Process

Made by reacting sodium phenolate and carbon dioxide. May also be made by microbiological oxidation of naphthalene by forming an aqueous nutrient medium for microorganisms capable of oxidizing naphthalene to salicylic acid of the genus *Pseudomonas* containing basal mineral salts, 0.5 to 4 wt % of finely divided naphthalene and 0.1 to 1 wt % of a boron compound, inoculating the nutrient medium with an inoculum containing a microorganism capable of oxidizing naphthalene to salicylic acid of the genus *Pseudomonas*, the inoculated nutrient medium having an initial pH value of about 4 to 9, incubating the inoculated nutrient medium at a temperature of about 25° to 50°C for a period of about 2 to 7 days and then recovering salicylic acid from the nutrient medium.

References

Merck Index 8190

PDR pp. 580, 653, 777, 905, 985, 1397, 1417, 1575, 1696, 1779, 1890, 1898

I.N. p. 37

REM p. 785

Zajic, J.E. and Dunlap, W.J.; U.S. Patent 3,274,074; September 20, 1966; assigned to Kerr-McGee Oil Industries, Inc.

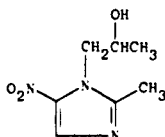
SECNIDAZOLE**Therapeutic Function:** Antiamebic; antiprotozoal**Chemical Name:** α ,2-Dimethyl-5-nitro-1H-imidazole-1-ethanol**Common Name:** —**Structural Formula:****Chemical Abstracts Registry No.:** 3366-95-8

Trade Name	Manufacturer	Country	Year Introduced
Flagentyl	Rhone Poulenc	Switz.	1980

Raw Materials

1-(2-Acetoxypropyl)-2-methylimidazole

Nitric acid

Hydrogen chloride

Manufacturing Process

1-(2-Acetoxypropyl)-2-methylimidazole (18.2 g) is gradually dissolved in fuming nitric acid (d = 1.52; 25 cc) with stirring, the temperature being kept at about 2°C. Phosphorus pentoxide (20 g) is added, with caution, to the resulting solution and while maintaining the temperature at about 2°C. Afterwards, the reaction mixture is stirred for a further 3 hours 30 minutes at 2°C and poured onto ice (180 g).

The solution obtained is treated with ammonium hydroxide (d = 0.92; 105 cc), saturated with sodium chloride, and then extracted with ethyl acetate (total 650 cc). The combined organic extracts are washed with a saturated aqueous sodium chloride solution (50 cc) and then dried over sodium sulfate. The volatile products are evaporated under reduced pressure (20 mm Hg) and a mixture of 1-(2-acetoxypropyl)-2-methyl-4-nitroimidazole and 1-(2-acetoxypropyl)-2-methyl-5-nitroimidazole (18.6 g) is obtained in the form of a red oil.

A solution of a mixture of 1-(2-acetoxypropyl)-2-methyl-4-nitroimidazole and of 1-(2-acetoxypropyl)-2-methyl-5-nitroimidazole (18.6 g) (prepared as described above) in 4N hydrochloric acid (186 cc) is heated at 90°C for 90 minutes. The cooled solution is treated with ammonium hydroxide (d = 0.9; 100 cc), saturated with sodium chloride, and then extracted with ethyl acetate (total 550 cc). The combined organic extracts are washed with a saturated aqueous

sodium chloride solution (50 cc) and then dried over sodium sulfate. The volatile products are evaporated under reduced pressure (25 mm Hg); the residual brown oil weighs 9.2 g.

This oil (5.8 g) is dissolved in methyl ethyl ketone (20 cc) and chromatographed over silica (232 g) contained in a column 4.5 cm in diameter. The column is eluted with methyl ethyl ketone; the first 600 cc of eluate are discarded and 500 cc of eluate are then collected and concentrated under reduced pressure (25 mm Hg); a partially crystalline product (2.4 g) is thus obtained. 1-(2-Hydroxypropyl)-2-methyl-5-nitroimidazole (0.96 g), melting point 72°C, is obtained on recrystallization from water (4 cc).

References

Merck Index 8267

DFU 4 (4) 280 (1979)

Kleeman & Engel p. 817

DOT 17 (2) 62 (1981)

I.N. p. 867

Jeanmart, C. and Messer, M.N.; British Patent 1,278,757; June 21, 1972; assigned to Rhone-Poulenc S.A. (France)

SECOBARBITAL SODIUM

Therapeutic Function: Hypnotic

Chemical Name: 5-(1-methylbutyl)-5-(2-propenyl)-2,4,6(1H,3H,5H)-pyrimidinetrione monosodium salt

Common Name: Meballymal sodium; quinalbarbitone sodium

Structural Formula:

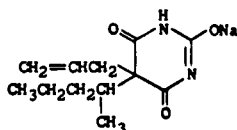

Chemical Abstracts Registry No.: 309-43-3; 76-73-3 (Base)

Trade Name	Manufacturer	Country	Year Introduced
Seconal	Lilly	U.S.	1945
Dormatylan	Herz-Jesu-Apotheke	Austria	—
Dormona	Wiedenmann	Switz.	—
Immenoctal	I.S.H.	France	—
Ional Sodium	Yoshitomi	Japan	—
Novosecobarb	Novopharm	Canada	—
Proquinal	Protea	Australia	—
Quinbar	Adams	Australia	—
Sebar	Vanguard	U.S.	—
Secaps	Saunders	Canada	—
Secocaps	M.T.C.	Canada	—
Secogen	Paul Maney	Canada	—
Seral	Medic	Canada	—
Tuinal	Lilly	U.S.	—

Raw Materials

Propyl-methyl-carbinyl barbituric acid
Allyl bromide
Sodium hydroxide

Manufacturing Process

Propyl-methyl-carbinyl allyl barbituric acid (also called allyl 1-methyl-butyl barbituric acid) may be prepared as follows: 1 mol of propyl-methyl-carbinyl barbituric acid is dissolved in a suitable vessel in a 10 to 35% aqueous solution of 1 mol of potassium hydroxide. To this are added somewhat in excess of 1 mol of allyl bromide, and alcohol equal to about 10% of the total volume of the solution. The vessel is agitated for 50 to 75 hours. At the end of this time, the solution, which may still exhibit two layers, is concentrated to about one-half its volume to remove the excess allyl bromide and the alcohol. On cooling, an oily layer, which is propyl-methyl-carbinyl allyl barbituric acid, separates out as a sticky viscous mass. It is dried, washed with petroleum ether, and dissolved in the minimum amount of benzene. Any unreacted propyl-methyl-carbinyl barbituric acid, which does not dissolve, is filtered off. The addition of petroleum ether to the clear filtrate causes the propyl-methyl-carbinyl allyl barbituric acid to precipitate as an oily mass.

This is separated, washed with petroleum ether, and dried in vacuo. After some time it hardens into a whitish solid, which if it was prepared from a 1-bromo-pentane which had some of its isomer 3-bromo-pentane copresent with it has a melting point of about 80° to 83°C. However, by using a pure 2-bromo-pentane, and/or by recrystallizing a number of times from dilute alcohol, the melting point may be raised to 98° to 100°C, corrected.

One part by weight of propyl-methyl-carbinyl allyl barbituric acid is added to enough alcohol to facilitate handling, in this case conveniently about six times its weight. To this is added a solution of sodium hydroxide, preferably carbonate-free or substantially so, containing $40/238$ parts by weight of sodium hydroxide, which is the amount of sodium hydroxide necessary to combine in equal molecular proportions with the propyl-methyl-carbinyl allyl barbituric acid. This solution is filtered clear, and is then evaporated under vacuum until the sodium propyl-methyl-carbinyl allyl barbiturate (alternatively named sodium allyl 1-methyl-butyl barbiturate) separates out in solid form. The salt as thus obtained in solid form contains a varying amount of moisture.

If it is desired to have a stable salt substantially free from contaminants, the alcohol used for dissolving the barbituric acid is absolute alcohol, and the sodium hydroxide is added as a very concentrated aqueous solution so that the reaction which occurs to form the salt is in a substantially alcoholic solution. By having a substantially alcoholic solution, decomposition of the salt during the process of drying is effectively avoided; and the drying may be carried to a point where materially less than 1% of moisture remains, so that the salt is substantially anhydrous. In this way a stable salt substantially free from decomposition products formed during preparation or drying or on standing is obtained. This salt may be used safely for making aqueous solutions for intravenous injection; for such aqueous solutions, when freshly made, are clear solutions substantially free from haziness.

Sodium propyl-methyl-carbinyl allyl barbiturate is a white hygroscopic solid, readily soluble in water and alcohol, and insoluble in ether.

References

Merck Index 8268
Kleeman & Engel p. 816
PDR pp. 1067, 1989
OCDS Vol. 1 p. 269 (1977)
I.N. p. 867
REM p. 1068
Shonle, H.A.; U.S. Patent 1,954,429; April 10, 1934; assigned to Eli Lilly and Company

SECRETIN

Therapeutic Function: Diagnostic aid (organ function)

Chemical Name: A complex polypeptide

Common Name: —

Structural Formula:

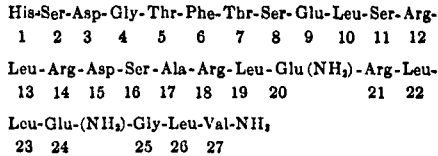

It is a peptide containing 27 amino acid residues containing the amino acids: L-histidine (His); L-aspartic acid (Asp); L-serine (Ser); glycine (Gly); L-threonine (Thr); L-phenylalanine (Phe); L-glutamic acid (Glu); L-glutamine [Glu(NH₂)] ; L-leucine (Leu); L-arginine (Arg); L-alanine (Ala); and L-valinamide (Val-NH₂).

The above mentioned peptide salts include, for instance, hydrochlorides, hydrobromides, acetates, fluoroacetates, such as trifluoroacetate, and chloroacetates such as dichloroacetate.

Chemical Abstracts Registry No.: 1393-25-5

Trade Name	Manufacturer	Country	Year Introduced
Secretin-Boots	Warren-Teed	U.S.	1970
Secretin-Kabi	Kabi	U.S.	1981
Secrepan	Eisai	Japan	—
Secretine Sinbio	Fimex	France	—
Secretolin	Hoechst	—	—

Raw Materials

Tetrapeptide: L-Thr-L-Phe-L-Thr-L-Ser
 Tetrapeptide: L-His-L-Ser-β-Benzyl-L-Asp-L-Gly

Manufacturing Process

The gastrointestinal hormone secretin is prepared by fragment condensation. The tetrapeptide L-Thr-L-Phe-L-Thr-L-Ser is coupled to the C-terminal nonadecapeptide of the hormone, and the tetrapeptide L-His-L-Ser-β-benzyl-L-Asp-Gly is coupled to the tricosapeptide resulting from the first coupling.

References

- Merck Index 8269
 Kleeman & Engel p. 817
 PDR p. 1428
 DOT 10 (6) 210 (1974) & 16 (3) 87 (1980)
 I.N. p. 868
 REM p. 1277
 Bodanszky, M., Ondetti, M.A., von Saltza, M.H., Narayanan, V.L. and Levine, S.D.; U.S. Patent 3,767,639; October 23, 1973; assigned to E.R. Squibb & Sons, Inc.

SELEGILINE

Therapeutic Function: Antidepressant

Chemical Name: N-(1-Phenylisopropyl)-N-methyl-prop-2-ynylamine

Common Name: Deprenil, deprenaline

Structural Formula:

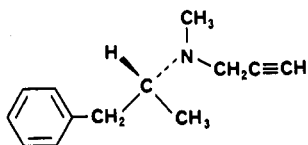

Chemical Abstracts Registry No.: —

Trade Name	Manufacturer	Country	Year Introduced
Eldepryl	Britannia	U.K.	1982
Deprenyl	Egyt	Hungary	—
Jumex	Medimpex	Hungary	—

Raw Materials

L-N-(2-phenylisopropyl)methylamine
Propargyl bromide

Manufacturing Process

50 g of L-N-(2-phenylisopropyl)methylamine are dissolved in 62.5 ml of toluene, whereupon 13 ml of propargyl bromide are added dropwise within about 20 minutes at a temperature in the range of 50°C to 60°C. The reaction mixture is stirred at 80°C for 3 hours, whereupon it is cooled and the toluene solution is extracted with 125 ml of a 5% hydrochloric acid solution. The acidic layer is separated and made alkaline. The precipitated oil is isolated, washed with benzene and evaporated. The residue is subjected to fractional distillation in vacuo. L-N-(2-phenylisopropyl)methylamine distills off at 65°C to 67°C (0.6 mm Hg, $n_D^{20} = 1.5083$). The L-N-(1-phenylisopropyl)-N-methyl-prop-2-ynylamine is obtained at 92°C to 93°C (0.8 mm Hg, $n_D^{20} = 1.5180$). The melting point of the hydrochloride is 141°C.

References

Merck Index 2876

DFU 4 (2) 128 (1979)

DOT 19 (1) 29 (1983)

I.N. p. 869

Chinoin Gyogyszer- es Vegyeszeti Termekok Gyara R.T.; British Patents 1,031,425; June 2, 1966; and 1,153,578; May 29, 1969

SELENIUM SULFIDE

Therapeutic Function: Dermatological

Chemical Name: Selenium sulfides

Common Name: —

Structural Formula: Se_4S_4 and Se_2S_6

Chemical Abstracts Registry No.: 7488-56-4

Trade Name	Manufacturer	Country	Year Introduced
Selsun	Abbott	U.S.	1951
Bioselenium	Uriach	Spain	—
Caspiselenio	Kin	Spain	—
Exsel	Herbert	U.S.	—
Iosei	Owen	U.S.	—
Sebusan	Laake	Finland	—
Selenol	N. D. & K.	Denmark	—
Sel-O-Rinse	U.S.V.	U.S.	—
Selsorin	Farmos	Finland	—
Selsun Blue	Ross	U.S.	—
Selukos	Kabi	W. Germany	—

Raw Materials

Selenious acid
Hydrogen sulfide

Manufacturing Process

Selenium disulfide, SeS_2 , may be made by the reaction of selenious acid, H_2SeO_3 , and hydrogen sulfide. Its manufacture is described by B.W. Nordlander in U.S. Patents 1,860,154 and 1,860,336. It is prepared in a detergent suspension for therapeutic use.

References

Merck Index 8283

PDR pp. 552, 930, 1563

I.N. p. 869

REM p. 1165

Baldwin, M.M. and Young, A.P. Jr.; U.S. Patent 2,694,669; November 16, 1954; assigned to Abbott Laboratories

SILYMARIN

Therapeutic Function: In liver dysfunction

Chemical Name: 2-[2,3-Dihydro-3-(4-hydroxy-3-methoxyphenyl)-2-(hydroxymethyl)-1,4-benzodioxin-6-yl]-2,3-dihydro-3,5,7-trihydroxy-4H-1-benzopyran-4-one

Common Name: Silybin, silibinin

Structural Formula:

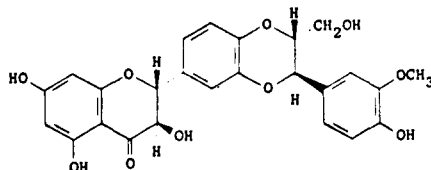

Chemical Abstracts Registry No.: 27359-03-1

Trade Name	Manufacturer	Country	Year Introduced
Legalon	Madaus	W. Germany	1969
Legalon	I.B.I.	Italy	1971
Legalon	Roger Bellon	France	1974
Silliver	Abbott	Italy	1977
Apihepar	Panchemie Homburg	Austria	—
Cardomerin	Deiters	Spain	—
Cronol	Kappa	Spain	—
Dura Silymarin	Durachemie	W. Germany	—
Emil	Horus	Spain	—
Eparfit	Europa	Spain	—
Escarmin	Dreikehl	Spain	—
Flavobion	Spofa	Czechoslovakia	—
Halodren	Escaned	Spain	—
Hepadestal	Krugmann	W. Germany	—
Hepagerina	Kairon	Spain	—
Hepalar	Larma	Spain	—
Hepalloina	Callol	Spain	—
Hepato-Framan	Oftalmiso	Spain	—
Laragon	Roemmers	Argentina	—
Sematron	Madariaga	Spain	—
Silarine	Vir	Spain	—
Silepar	Ibirn	Italy	—
Silgen	Morgens	Spain	—
Silibancol	Durban	Spain	—
Silimazu	Mazuelos	Spain	—
Silirex	Lampugnani	Italy	—

Raw Materials

Silybum marianum fruit
Ethyl acetate

Manufacturing Process

Silymarin comprising polyhydroxyphenyl chromanones is recovered from the dried fruit of *Silybum marianum* Gaertn. by separating the fatty oils therefrom, extracting the remaining solid residue with ethyl acetate, evaporating the ethyl acetate and dissolving the dry residue in a solvent mixture comprising methanol, water and petroleum ether to form a two-phase system wherein the chromanones are contained in the lower phase, recovering the polyhydroxyphenyl chromanones from the lower phase after subjecting same to multiple counter-current contact with petroleum ether.

References

Merck Index 8372
Kleeman & Engel p. 818
DOT 7 (6) 216 (1971)
I.N. p. 873
Madaus, R.; U.S. Patent 3,773,932; November 20, 1973; assigned to Dr. Madaus & Co. (Germany)

SIMETHICONE

Therapeutic Function: Antiflatulent

Chemical Name: Dimethyl polysiloxane

Common Name: —

Structural Formula:

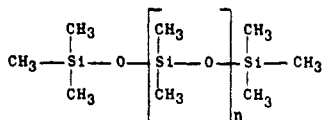

Chemical Abstracts Registry No.: 8050-81-5

Trade Name	Manufacturer	Country	Year Introduced
Mylicon	Stuart	U.S.	1960
Silain	Robins	U.S.	1961
Celluzyme	Dalin	U.S.	—
Gelusil	Parke Davis	U.S.	—
Mylanta	Stuart	U.S.	—
Phazyme	Reed & Carnrick	U.S.	—
Riopan-Plus	Ayerst	U.S.	—
Simeco	Wyeth	U.S.	—
Tri-Cone	Glaxo	U.S.	—

Raw Materials

Dimethyl diethoxy silane
Trimethyl ethoxy silane
Sodium hydroxide

Manufacturing Process

In a 5 liter three-necked flask, fitted with a reflux condenser, agitator and thermometer, were placed 1,393 grams (9.41 mols) of redistilled $(\text{CH}_3)_2\text{Si}(\text{OEt})_2$ and 1,110 grams (9.41 mols) of $(\text{CH}_3)_3\text{SiOEt}$. To this solution was added 254 grams (14.11 mols) of water containing 7.5 grams of NaOH, (approximately 1 NaOH per 100 silicon atoms). This insured the formation of only straight chain polymers. The mixture was heated to 40°C and the temperature continued to rise for nearly an hour. After adding 50 cc (20% excess) more water, the mixture was refluxed for two hours and then allowed to stand overnight.

Alcohol was then distilled off, until the temperature reached 100°C . 1,706.6 grams of distillate was collected (theory 1,430 grams). This alcohol was poured into four times its volume of water and an insoluble oil separated (457 grams). The insoluble fraction was added back to the copolymer residue from the distillation and 555 cc of 20% hydrochloric acid was added. The acid mixture was refluxed for two hours, and the silicon oils were carefully washed with distilled water until neutral. The yield was 1,420 grams (theory, 1,469 grams).

References

Merck Index 8374
PDR pp. 650, 829, 916, 1352, 1444, 1569, 1783, 1981
REM p. 814
Hyde, J.F.; U.S. Patent 2,441,098; May 4, 1948; assigned to Corning Glass Works

SIMFIBRATE

Therapeutic Function: Cholesterol-reducing agent

Chemical Name: 2-(4-chlorophenoxy)-2-methylpropanoic acid 1,3-propanediyl ester

Common Name: —

Structural Formula:

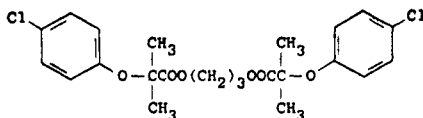

Chemical Abstracts Registry No.: 14929-11-4

Trade Name	Manufacturer	Country	Year Introduced
Cholesorbin	Takeda	Japan	1971
Cholesolvin	Cyanamid	Italy	1977
Liposolvin	Tosi-Novara	Italy	—

Raw Materials

α -(p-Chlorophenoxy)isobutyric acid
1,3-Propanediol

Manufacturing Process

A mixture of 22 grams of α -(p-chlorophenoxy)isobutyric acid, 3.8 grams of 1,3-propanediol, 0.5 gram of p-toluenesulfonic acid and 150 ml of xylene was refluxed. When the theoretically calculated amount of water had been removed, the xylene solution was washed with dilute aqueous sodium bicarbonate and then the xylene was distilled off. The residue was distilled under reduced pressure to give 11 grams (47% yield) of 1,3-propanediol bis[α -(p-chlorophenoxy)isobutyrate] boiling at 197° to 200°C/0.03 mm Hg.

References

Merck Index 8377

Kleeman & Engel p. 819

DOT 7 (6) 221 (1971)

I.N. p. 874

Nakanishi, M., Kuriyama, T., Oe, T. and Kobayakawa, T.; U.S. Patent 3,494,957; Feb. 10, 1970; assigned to Yoshitomi Pharmaceutical Industries, Ltd., Japan

SINCALIDE

Therapeutic Function: Choleric

Chemical Name: 1-De(5-oxo-L-proline)-2-de-L-glutamine-5L-methioninecaerulein

Common Name: —

Structural Formula:

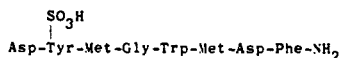

Chemical Abstracts Registry No.: 25126-32-3

Trade Name	Manufacturer	Country	Year Introduced
Kinevac	Squibb	U.S.	1976
Kinevac	Squibb	W. Germany	1977

Raw Materials

t-Butyloxycarbonyl-L-aspartyl-L-tyrosyl-L-methionylglycyl-L-tryptophyl-L-methionyl-L-aspartyl-L-phenylalanine amide
Sulfuric Acid

Manufacturing Process

The starting material in the following synthesis is: t-butyloxycarbonyl-L-aspartyl-L-tyrosyl-L-methionylglycyl-L-tryptophyl-L-methionyl-L-aspartyl-L-phenylalanine amide designated (SM).

(A) A solution of (SM) (320 mg) in trifluoroacetic acid (7 ml) was kept under nitrogen at room temperature for 15 minutes. Ether (100 ml) was added and the precipitate filtered, washed thoroughly with ether and dried. This material (280 mg) was added to concentrated sulfuric acid (20 ml), cooled at -20°C . The solution was kept in the dry ice-acetone bath at -20°C for 75 minutes. The sulfuric acid solution was poured into ice water (80 ml). The precipitate was centrifuged, resuspended in ice water (30 ml) and 4N sodium hydroxide was added until a clear solution was obtained. After reacidification to pH 4 with dilute sulfuric acid, the precipitate formed was centrifuged, washed twice with ice water and dried. Yield 155 mg. Chromatograph of DEAE Sephadex (with ammonium carbonate buffer) yielded the desired octapeptide sulfate ester: 30 mg.

(B) A solution of (SM) (330 mg) in trifluoroacetic acid (7 ml) was kept under nitrogen at room temperature for 15 minutes. Ether (100 ml) was added and the precipitate was filtered, washed thoroughly with ether and dried. This material (300 mg) was added in portions to concentrated sulfuric acid (18 ml) cooled at -20°C with vigorous stirring. After 15 minutes a solution of potassium bisulfate in concentrated sulfuric acid (408 mg in 3 ml) was added. The reaction mixture was stirred for 75 minutes at -15°C and then stored at -7°C for 285 minutes. The sulfuric acid solution was poured into cold ether (400 ml); precipitate was filtered, washed with cold ether, and suspended in cold water. Complete solution was then achieved by careful addition of 2N sodium hydroxide. Acidification with N hydrochloric acid led to the precipitation of the desired octapeptide sulfate ester. Yield 200 mg.

References

- Merck Index 8380
DOT 13 (9) 356 (1977)
I.N., p. 874
REM p. 1277
Ondetti, M.A., Pluscec, J., Sheehan, J.T., Jorpes, J.E. and Mott, V.; U.S. Patent 3,723,406; March 27, 1973; assigned to E.R. Squibb & Sons, Inc.

SISOMICIN

Therapeutic Function: Antibiotic

Chemical Name: O-2,6-diamino-2,3,4,6-tetradeoxy- α -D-glycero-hex-4-enopyranosyl-(1 \rightarrow 4)-O-[3-deoxy-4-C-methyl-3-(methylamino)- β -L-arabinopyranosyl-(1 \rightarrow 6)]-2-deoxy-D-streptamine

Common Name: Rickamicin

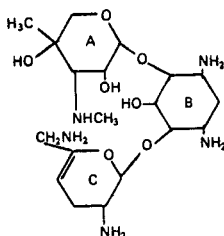
Structural Formula:

Chemical Abstracts Registry No.: 32385-11-8; 53179-09-2 (Sulfate)

Trade Name	Manufacturer	Country	Year Introduced
Pathomycin	Byk-Essex	W. Germany	1976
Extramycin	Bayer	W. Germany	1976
Extramycin	Bayer	Switz.	1978
Baymicina	Bayer	Italy	1978
Sisomin	Schering	Switz.	1978
Sisomicin	Essex	Italy	1978
Mensiso	Menarini	Italy	1979
Sissolline	Cetrane	France	1980
Siseptin	Essex	Japan	1981
Baymicine	Bayer	France	1981
Extramycin	Yoshitomi	Japan	1981

Raw Materials

Bacterium *Micromonospora inyoensis*
 Dextrin
 Soybean meal

Manufacturing Process

Tank fermentation of *Micromonospora inyoensis* — Germination stage 1: Under aseptic conditions, add a lyophilized culture (or cells obtained from a slant culture) of *M. inyoensis* to a 300 ml shake flask containing 100 ml of the following sterile medium:

Beef extract	3 g
Tryptone	5 g
Yeast extract	5 g
Dextrose	1 g
Starch	24 g
Calcium carbonate	2 g
Tap water	1,000 ml

Incubate the flask and its contents for 5 days at 35°C on a rotary shaker (280 rpm, 2" stroke).

Germination stage 2: Aseptically transfer 25 ml of the fermentation medium of Germination stage 1 to a 2-ℓ shake flask containing 500 ml of the abovedescribed sterile germination medium. Incubate the flask and its contents for 3 days at 28°C on a rotary shaker (280 rpm, 2" stroke).

Fermentation stage: Aseptically transfer 500 ml of the medium obtained from Germination stage 2 to a 14-ℓ fermentation tank containing 9.5 ℓ of the following sterile medium:

Dextrin	50 g
Dextrose	5 g
Soybean meal	35 g

Calcium carbonate	7 g
Cobalt chloride	10^{-6} M
Tap water	1,000 ml
Antifoam (GE 60)	10 ml

Prior to sterilizing the abovedescribed medium, adjust the pH to 8. Aerobically ferment for 66 to 90 hours while stirring at 250 rpm with air input at 4.5 $\ell/\ell/\text{min}$ and 25 psi. The potency of the antibiotic produced at the end of this period reaches a peak of 150 to 225 $\mu\text{g}/\text{ml}$ and remains relatively constant. The pH of the fermentation medium changes slightly during the antibiotic production, varying in the range of 6.8 to 7.3.

Isolation of Antibiotic 66-40 — The whole broth is adjusted to pH 2 with 6N sulfuric acid. (For the purpose of this example, quantities are given in terms of 170 ℓ of fermentation broth obtained by pooling acidified broth from 17 batches.) The acidified broth is stirred for about 15 minutes and then filtered. Wash the mycelium with water and combine the washings with the filtrate. Adjust the pH of the filtrate to 7 with 6N ammonium hydroxide.

To the neutralized filtrate, add sufficient oxalic acid to precipitate calcium and filter. Neutralize the filtrate with ammonium hydroxide. Charge the filtrate onto a cationic exchange adsorption column containing 1,500 to 2,000 g of IRC-50 Amberlite in its ammonium form. Discard the eluate, wash the resin with water, and elute with 2N ammonium hydroxide. Collect 400 ml fractions and monitor by disc testing with *S. aureus* ATCC-6538P. Combine active fractions and evaporate to dryness under vacuum obtaining about 28 g of crude Antibiotic 66-40 having an activity of about 500 $\mu\text{g}/\text{g}$.

Purification of Antibiotic 66-40 — Dissolve 28 g of crude Antibiotic 66-40 in 100 ml of distilled water and charge to an anion exchange adsorption column (Dowex 1X2) in the hydroxyl form. Slurry 2,000 g of the resin in water into a column 2½" in diameter and 36" high. Elute the column with distilled water at a rate of about 23 ml/min collecting 100 ml fractions and monitor with a conductivity meter and by disc testing against *Staphylococcus aureus*.

The disc testing provides a gross separation of antibiotic-containing eluate fractions from those devoid of antibiotic. To insure that the fractions are properly combined, a portion of each fraction is paper chromatographed using the lower phase of a chloroform:methanol:17% ammonium hydroxide system (2:1:1). Each paper is sprayed with ninhydrin and the eluates containing like material are combined and lyophilized yielding about 5.7 g of Antibiotic 66-40 assaying about 900 $\mu\text{g}/\text{mg}$.

References

- Merck Index 8384
 Kleeman & Engel p. 819
 DOT 8 (8) 315 (1972) & 12 (10) 407 (1976)
 I.N. p. 875
 REM p. 1183
 Weinstein, M.J., Luedemann, G.M. and Wagman, G.H.; U.S. Patent 3,832,286; August 27, 1974; assigned to Schering Corp.

SOBREROL

Therapeutic Function: Mucolytic

Chemical Name: 5-Hydroxy- $\alpha,\alpha,4$ -trimethyl-3-cyclohexene-1-methanol

Common Name: Pinol hydrate

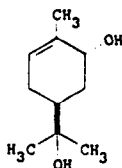
Structural Formula:

Chemical Abstracts Registry No.: 498-71-5

Trade Name	Manufacturer	Country	Year Introduced
Sobrepin	Corvi	Italy	1970
Lysmucol	Schering	Switz.	1983

Raw Materials

α -Pinene oxide

Manufacturing Process

To 19 l of well-agitated distilled water plus 18 g of ditertiary-butyl-p-cresol was added 19.84 kg (130 mols) of pure α -pinene oxide that was about half racemic, half d-form. The temperature was maintained at 30°C to 50°C, first with ice bath cooling and then with tap water cooling. The addition of the pinene oxide required 1½ hours. After the addition was complete and the exothermic reaction was about over, the mixture was stirred for 2½ hours at about 30°C, and then centrifuged to separate the crude sobrerol from the liquid phase consisting of oil and water.

The crude sobrerol was washed with naphtha and then air dried to yield 14.81 kg (87.5 mols) of pure sobrerol, $[\alpha]_D^{25} -77.0^\circ$. It was found that 1 liter of the aqueous phase from the reaction contained 22 g of sobrerol, so, therefore, the entire aqueous phase contained 0.42 kg (2.5 mols) of sobrerol.

References

Merck Index 8395

I.N. p. 877

Klein, E.A.; U.S. Patent 2,815,378; December 3, 1957; assigned to The Glidden Co.

SOMATOTROPIN

Therapeutic Function: Growth stimulant

Chemical Name: See under Structural Formula

Common Name: Somatropin

Structural Formula: Proteins of molecular weights ranging from 22,124 for human growth hormone (HGH) to 47,400 for bovine growth hormone.

Chemical Abstracts Registry No.: 9002-72-6

Trade Name	Manufacturer	Country	Year Introduced
Somatotrope	Choay	France	1951
Wachtungshormon	Kabi	W. Germany	1970

Trade Name	Manufacturer	Country	Year Introduced
Crescormon	Sumitomo	U.K.	1973
Groorm	Serono	Italy	1975
Asellacrin	Calbiochem	U.S.	1976
Crescormon	Kabi	U.S.	1978
Nanormon	Hormon-Chem.	W. Germany	1978
Corpormon	Nikken	Japan	—
Somacton	Ferring	W. Germany	—
Somatormone	Byla	France	—

Raw Materials

Human pituitary glands
Acetone

Manufacturing Process

It has been found that the growth hormone can be obtained in crystalline form from human pituitary glands by procedures comprising (1) extraction of the fresh glands with acetone, (2) extraction of the acetone residue with aqueous salt solutions, (3) precipitation from aqueous salt solutions by the addition of suitable miscible organic solvents of alkaline and acid pH, and finally crystallization from aqueous salt solutions by the addition of suitable miscible organic solvents.

References

Merck Index 8562
DOT 14 (9) 422 (1978)
I.N. p. 880
REM pp. 952, 955
Lewis, U.J. and Brink, N.G.; U.S. Patent 2,974,088; March 7, 1961; assigned to Merck & Co., Inc.

SPECTINOMYCIN

Therapeutic Function: Antibacterial

Chemical Name: Decahydro-4a,7,9-trihydroxy-2-methyl-6,8-bis(methylamino)-4H-pyrano-[2,3-b][1,4]benzodioxin-4-one

Common Name: Actinospectacin

Structural Formula:

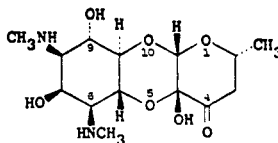

Chemical Abstracts Registry No.: 1695-77-8; 22189-32-8 (Hydrochloride)

Trade Name	Manufacturer	Country	Year Introduced
Trobicin	Upjohn	U.S.	1971
Trobicin	Upjohn	Italy	1973
Stanilo	Upjohn	W. Germany	1973

Trade Name	Manufacturer	Country	Year Introduced
Trobicin	Upjohn	U.K.	1973
Trobicine	Upjohn	France	1974
Trobicin	Upjohn	Japan	1978
Kempi	Alter	Spain	—

Raw Materials

Bacterium *Streptomyces spectabilis*
Nutrient medium

Manufacturing Process

A lyophilized culture of *Streptomyces spectabilis*, NRRL 2792, was used to seed the following sterile agar medium on tubed slants:

	Grams
Maltose	10
Tryptone	5
K ₂ HPO ₄	0.5
NaCl	0.5
FeSO ₄	0.1
Agar	20
Deionized water to make 1 liter	

The slants were incubated for 7 days at 30°C, after which time sporulation was complete. The spores from the agar slants were used, in an aqueous suspension, to inoculate 100 ml of preseed medium in a 500 ml Erlenmeyer flask. The sterile preseed medium consisted of:

	Grams
Dried whole yeast	10
Glucose	10
Pancreatic digest of casein (N-Z-Amine B)	5
Tap water to make 1 liter adjusted to pH 7.2 before sterilizing	

The seed flash was incubated for 24 hours at 32°C on a reciprocating shaker after which it was used as an inoculum for a 20 liter seed fermenter in the amount of approximately 5%. The 20 liter seed fermenter contained a sterile medium consisting of:

	Grams
Glucose	15
Cornstarch	25
Distiller's solubles	15
Brewer's yeast	10
Corn steep liquor	20
Tap water to make 1 liter adjusted to pH 7.2 before sterilizing	

The 20 liter seed fermenter was incubated for 24 hours at 32°C and aerated at the rate of 6 standard liters or about 0.2 standard cubic feet of air per minute and agitated with a sweep stirrer. The 20 liter seed fermenter was used to inoculate 250 liters of the same medium in a 100 gallon fermentation tank. 1,200 ml of lard oil were added during the fermentation to control foaming. The tank was agitated with a propeller and aerated at the rate of 75 standard liters of air per minute. After 96 hours of fermentation the beer assayed 500 mcg/ml (18.3 mcg/mg on a dry basis) of actinospectacin. Actinospectacin is assayed by its activity against *Klebsiella pneumoniae* by standard agar diffusion procedure and based on crystalline actinospectacin sulfate according to U.S. Patent 3,234,092.

References

Merck Index 8584

Kleeman & Engel p. 821

PDR p. 1864

DOT 8 (3) 107 (1972)

I.N. p. 884

REM p. 1211

Jahnke, H.K.; U.S. Patent 3,206,360; September 14, 1965; assigned to The Upjohn Co.

Bergy, M.E. and De Boer, C.; U.S. Patent 3,234,092; February 8, 1966; assigned to The Upjohn Company

Peters, V.J.; U.S. Patent 3,272,706; September 13, 1966; assigned to The Upjohn Company

Nara, T., Takasawa, S., Okachi, R., Kawamoto, I., Kumakawa, M., Yamamoto, M. and Sato, S.; U.S. Patent 3,819,485; June 25, 1974; assigned to Abbott Laboratories

SPIPERONE

Therapeutic Function: Tranquilizer

Chemical Name: 8-[4-(4-fluorophenyl)-4-oxobutyl]-1-phenyl-1,3,8-triazaspiro[4.5]decan-4-one

Common Name: —

Structural Formula:

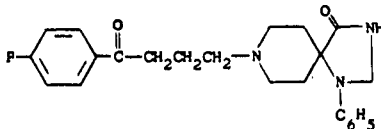

Chemical Abstracts Registry No.: 749-02-0

Trade Name	Manufacturer	Country	Year Introduced
Spiropitan	Eisai	Japan	1969
Spiroperidol	Janssen	—	—

Raw Materials

4-Carbamoyl-4-N-anilino-piperidine

Formamide

4-Chloro-p-fluoro-butyrophenone

Manufacturing Process

A mixture of 4-carbamoyl-4-N-anilino-piperidine and formamide is heated for 12 hours at 170°C. After cooling, the reaction mixture is divided between 100 parts water and 900 parts chloroform. The organic layer is separated, dried over MgSO₄, filtered and the filtrate is evaporated. The semisolid residue is stirred in ethyl acetate. The undissolved part is filtered off, washed with ethyl acetate, and dried, yielding 1-oxo-4-phenyl-2,4,8-triazaspiro-(4.5)decane.

A mixture of 3.2 parts 4-chloro-p-fluoro-butyrophenone, 3.5 parts 1-oxo-4-phenyl-2,4,8-triazaspiro(4.5)decane, 2 parts Na₂CO₃ and 0.1 part KI in 200 parts hexone is refluxed with stirring for 50 hours. The mixture is cooled to room temperature, 200 parts water are added and the layers are separated. The organic layer is dried over 10 parts MgSO₄,

filtered and the solvent removed under reduced pressure on the water bath. The residue is treated with 50 parts diisopropylether. The precipitate is filtered on a Buchner filter and recrystallized from 20 parts hexone at room temperature. The solid is filtered off and dried to yield 1-oxo-4-phenyl-8-[3-(4-fluorobenzoyl)-propyl]-2,4,8-triazaspiro(4.5)decane, melting point 190° to 193.6°C, as a light brown amorphous powder.

References

Merck Index 8596

Kleeman & Engel p. 821

I.N. p. 885

Janssen, P.A.J.; U.S. Patent 3,155,669; November 3, 1964; assigned to Research Laboratorium Dr. C. Janssen NV, Belgium

Janssen, P.A.J.; U.S. Patent 3,155,670; November 3, 1964; assigned to Research Laboratorium Dr. C. Janssen NV, Belgium

Janssen, P.A.J.; U.S. Patent 3,161,644; December 15, 1964; assigned to Research Laboratorium Dr. C. Janssen NV, Belgium

SPIRAMYCIN

Therapeutic Function: Antibacterial

Chemical Name: Spiramycin

Common Name: —

Structural Formula:

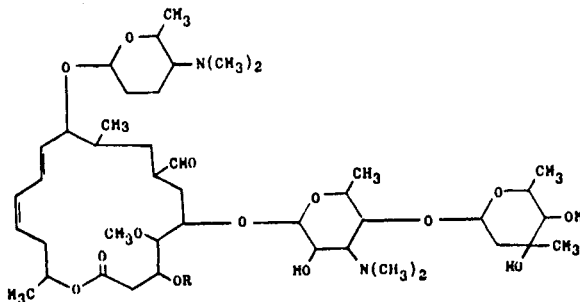

Chemical Abstracts Registry No.: 8025-81-8

Trade Name	Manufacturer	Country	Year Introduced
Rovamycine	Specia	France	1972
Rovamycina	Carlo Erba	Italy	1979
Apyrectol Spiramycine	Theranol	France	—
Bykomycetin	Byk Gulden	—	—
Selectomycin	Gruenthal	W. Germany	—
Spiramycin	Kyowa	Japan	—

Raw Materials

Bacterium *Streptomyces ambofaciens*
Nutrient medium

Manufacturing Process

The process for producing spiramycin comprises inoculating an aqueous nutrient medium with a culture of the NRRL No. 2420, allowing aerobic fermentation to take place and separating from the culture medium the spiramycin thus formed. The culture medium also contains the antibiotic substance known as Congocidin which, however, does not possess the same useful properties as spiramycin and which can be isolated in crystalline form. The separation of the two antibiotic substances is readily achieved.

References

Merck Index 8597

Kleeman & Engel p. 822

I.N. p. 885

REM p. 1224

Ninet, L. and Verrier, J.; U.S. Patent 2,943,023; June 28, 1960; assigned to Societe des Usines Chimiques Rhone-Poulenc

Ninet, L., Pinnert S. and Preud'homme, J.; U.S. Patent 3,000,785; September 19, 1961; assigned to Societe des Usines Chimiques Rhone-Poulenc

SPIRONOLACTONE

Therapeutic Function: Diuretic

Chemical Name: 7 α -(acetylthio)-17 α -hydroxy-3-oxopregn-4-ene-21-carboxylic acid

Common Name: —

Structural Formula:

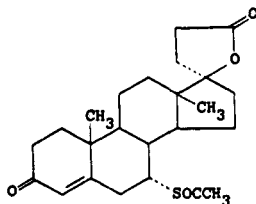

Chemical Abstracts Registry No.: 52-01-7

Trade Name	Manufacturer	Country	Year Introduced
Aldactone	Searle	U.S.	1959
Aldactone	Searle	France	1960
Altex	Cenci	U.S.	1980
Diatensec	Searle	U.K.	1981
Acelat	Endopharm	W. Germany	—
Airolactone	Horita	Japan	—
Aldactazide	Searle	U.S.	—
Aldopur	Heumann	W. Germany	—
Aldospirone	Teva	Israel	—
Alexan	Sanwa	Japan	—
Almatol	Fujisawa	Japan	—
Alpamed	Sawai	Japan	—
Alpolasnon	Nihon Yakuin	Japan	—
Aporasnon	Nichiiki	Japan	—
Dairopeal	Daito Koeki	Japan	—

Trade Name	Manufacturer	Country	Year Introduced
Deverol	Waldheim	Austria	—
Dira	Kakenyaku Kako	Japan	—
Duraspiron	Durachemie	W. Germany	—
Euteberol	Merckle	W. Germany	—
Hokulaton	Hokuriku	Japan	—
Idrolattone	Zoja	Italy	—
Lacalmin	Tatsumi	Japan	—
Lacdene	Tsuruhara	Japan	—
Nefurofan	Maruko	Japan	—
Osyrol	Hoechst	W. Germany	—
Penantin	Teikoku	Japan	—
Practon	Genekod	France	—
Sagisal	Sagitta	W. Germany	—
Sincomen	Schering	W. Germany	—
Spirexis	Farmos	Finland	—
Spiretic	D.D.S.A.	U.K.	—
Spiridon	Orion	Finland	—
Spirix	Benzon	Denmark	—
Spirolong	SKF	Italy	—
Spiroazide	Schein	U.S.	—
Spiropal	A.F.I.	Norway	—
Spiro-Tablinen	Sanorania	W. Germany	—
Spirotone	Protea	Australia	—
Suracton	Toho Iyaku	Japan	—
Uractone	Spa	Italy	—
Urosonin	Isei	Japan	—
Xenalone	Mepha	Switz.	—

Raw Materials

17 α -(2-Carboxyethyl)-17 β -hydroxyandrosta-4,6-dien-3-one lactone
Thioacetic acid

Manufacturing Process

A mixture of approximately 11 parts of 17 α -(2-carboxyethyl)-17 β -hydroxyandrosta-4,6-dien-3-one lactone and 10 parts of thioacetic acid is heated at 85° to 95°C for ½ hour. Excess thioacetic acid is removed by vacuum distillation at this point, and the residue is twice recrystallized from methanol, affording 7 α -acetylthio-17 α -(2-carboxyethyl)-17 β -hydroxyandrosta-4-en-3-one lactone, melting at approximately 134° to 135°C. Heated above this melting point, the product solidifies and melts again at approximately 201° to 202°C (with decomposition).

References

- Merck Index 8610
Kleeman & Engel p. 822
PDR pp. 830, 993, 1388, 1606, 1674, 1999
OCDS Vol. 1 p. 206 (1977); 2, 172 (1980) & 3, 91 (1984)
I.N. p. 886
REM p. 941
Cella, J.A. and Tweit, R.C.; U.S. Patent 3,013,012; December 12, 1961; assigned to G.D. Searle & Co.

STALLIMYCIN HYDROCHLORIDE

Therapeutic Function: Antibiotic

Chemical Name: N''-(2-Amidinoethyl)-4-formamido-1,1',1''-trimethyl-N,4':N',4''-ter-(pyrrole-2-carboxamide) hydrochloride

Common Name: Distamycin A

Structural Formula:

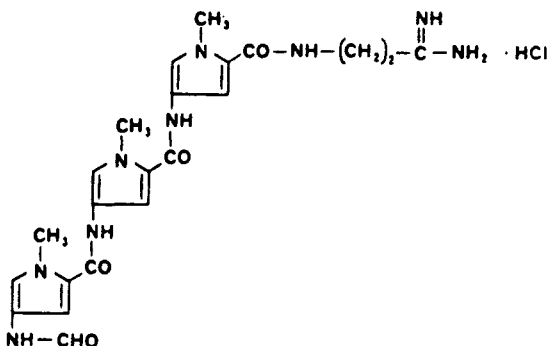

Chemical Abstracts Registry No.: 6576-51-8; 636-47-5 (Base)

Trade Name	Manufacturer	Country	Year Introduced
Herperal	Farmitalia	Italy	1978

Raw Materials

Bacterium *Streptomyces distallicus*
Dextrose
Corn steep liquor

Manufacturing Process

A spore suspension obtained upon washing a culture of *Streptomyces distallicus* is added to 3,000 ml of a sterile medium consisting of the following:

Dextrose	2 %
Corn steep liquor extract	2 %
CaCO ₃	1 %
(NH ₄) ₂ SO ₄	0.3 %
NaCl	0.3 %

Fermentation is continued at 28°C for 40 hours at a stirring rate of 150 to 250 rpm and a rate of air flow of 1 to 2 l/min/l of culture medium.

300 ml of a suspension of the vegetative mycelium of this culture are used for inoculating 6,000 ml of a similar sterile culture medium. At this production stage, the culture is kept fermenting for 85 to 100 hours (pH 7.6 at 28°C) at a stirring rate of 350 to 450 rpm and a rate of air flow of 1 to 1.5 l/min/l of culture medium.

To 17 l of a culture obtained by submerged fermentation as mentioned above, siliceous earth is added and the batch is filtered. The mixture of mycelium and the siliceous earth are agitated for 1 hour with 2.5 l of butanol. This treatment is repeated twice. The butanolic extracts are combined, washed with water, evaporated to dryness (about 10 g) and boiled with acetone (80 ml). The residue (5.41 g of yellowish powder) is distamycin.

5 g of distamycin is extracted six times with ethanol. The ethanolic extracts are combined, concentrated and filtered through a column containing 70 g of alumina. Elution is carried

out with the same solvent. The effluent (central fractions) is collected and evaporated to dryness to yield 0.43 g of pure distamycin A: decomposition point, 183°C to 185°C. The product can be further purified by crystallization from aqueous n-butanol.

References

Merck Index 8623

Kleeman & Engel p. 824

DOT 13 (8) 322 (1977)

I.N. p. 887

Arcamone, F., Canevazzi, G., Grein, A. and Bizioli, F.; U.S. Patent 3,190,801; June 22, 1965; assigned to Societa Farmaceutici Italia

STANOLONE

Therapeutic Function: Androgen

Chemical Name: 17-Hydroxyandrostan-3-one

Common Name: Androstanolone

Structural Formula:

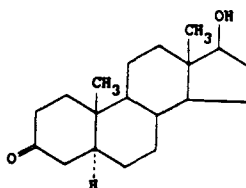

Chemical Abstracts Registry No.: 521-18-6

Trade Name	Manufacturer	Country	Year introduced
Neodrol	Pfizer	U.S.	1953
Anabolex	Lloyd	U.K.	—
Anaprotin	Cuxson	U.K.	—
Androlone	Orma	Italy	—
Ophthovitol	Winzer	W. Germany	—
Pesomax	Boniscontro	Italy	—
Protona	Gremy-Longuet	France	—
Stanaprol	Pfizer	—	—

Raw Materials

3,17-Androstandione
Selenium dioxide
Sodium borohydride

Manufacturing Process

A solution of 1.0 g of 3,17-androstandione in 50 ml of methanol and containing 1 g of selenium dioxide, was allowed to remain in an ice-chest overnight. The formed 3,3-dimethoxy-androstan-17-one was not separated. 1 g of solid potassium hydroxide and 2.5 g of sodium borohydride in 2.5 ml of water were added and the mixture allowed to react at room temperature for 24 hours. The solution was then poured into a large excess of water, extracted

with methylene chloride, the organic layer dried and evaporated to a residue. The residue was dissolved in ether, and a small amount of selenium removed by filtration. The ether was boiled off and the organic material dissolved in 100 ml of boiling acetone. 25 ml of diluted hydrochloric acid were added, the solution boiled for 5 minutes and then allowed to cool. Upon crystallization, 0.85 g of androstan-17 β -ol-3-one was obtained, melting point 175°C to 178°C.

References

Merck Index 8646

Kleeman & Engel p. 54

I.N. p. 88

Oliveto, E.P. and Hershberg, E.B.; U.S. Patent 2,927,921; March 8, 1960; assigned to Schering Corp.

STANOZOLOL

Therapeutic Function: Anabolic

Chemical Name: 17-methyl-2H-5 α -androst-2-eno[3,2-c]pyrazol-17 β -ol

Common Name: Androstanazolol

Structural Formula:

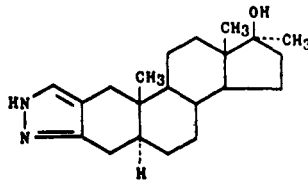

Chemical Abstracts Registry No.: 10418-03-8

Trade Name	Manufacturer	Country	Year Introduced
Winstrol	Winthrop	U.S.	1961
Strombaject	Winthrop	W. Germany	1961
Stromba	Sterling	U.K.	1961
Winstol	Zamba	Italy	1962
Stromba	Winthrop	France	1964
Amnasyth	Causyth	Italy	—

Raw Materials

17 β -Hydroxy-17 α -methyl-4-androsteno[3,2-c]pyrazole
Lithium
Ammonia

Manufacturing Process

To a stirred solution of 1.00 gram of 17 β -hydroxy-17 α -methyl-4-androsteno[3,2-c]pyrazole in 200 ml of tetrahydrofuran and 400 ml of liquid ammonia was added 2.12 grams of lithium wire during 5 minutes. The dark blue mixture was stirred for 45 minutes. A solution of 40 ml of tertiary-butyl alcohol in 160 ml of diethyl ether was added with stirring.

After 15 minutes, 25 ml of ethanol was added with stirring. The mixture turned colorless after several hours, and the liquid ammonia was allowed to evaporate and the mixture was allowed to warm to room temperature over a period of about 15 hours.

The solvent was evaporated to yield a colorless solid residue, which was taken up in ethyl acetate-ice water. The two layers were separated and the aqueous layer was extracted with ethyl acetate. The combined organic layers were washed with water, saturated sodium chloride solution and filtered through anhydrous sodium sulfate. The solvent was evaporated to yield 1.20 grams of light tan crystals, MP 151° to 155°C, ultraviolet maximum at 224 μ (E = 4,095). Two recrystallizations from ethanol afforded: 1st crop, 0.619 grams (62%) of colorless crystals (dried at 120°C in vacuo for 17 hours), MP 232.8° to 238.0°C, ultraviolet maximum at 224 μ (E = 4,840); 2nd crop, 0.142 gram (14%) of colorless crystals, MP 234° to 242°C.

References

Merck Index 8647

Kleeman & Engel p. 825

PDR p. 1935

DOT 15 (6) 278 (1979)

I.N. p. 888

REM p. 1000

Manson, A.J.; U.S. Patent 3,030,358; April 17, 1962; assigned to Sterling Drug Inc.

STREPTOKINASE

Therapeutic Function: Enzyme

Chemical Name: Streptococcal fibrinolysin

Common Name: —

Structural Formula: Complex enzyme mixture

Chemical Abstracts Registry No.: 9002-01-1

Trade Name	Manufacturer	Country	Year Introduced
Streptase	Hoechst	France	1970
Streptase	Hoechst	U.S.	1977
Kabikinase	Kabi	U.S.	1980
Awelysin	Arzneimittelwerk Dresden	E. Germany	—
Varidase	Lederle	U.K.	—

Raw Materials

Bacterium *Streptococcus haemolyticus*
Nutrient medium

Manufacturing Process

The following description is from U.S. Patent 2,701,227: To 50 liters of distilled water there was added 10.17 kg of enzyme hydrolyzed casein (N-Z-Amine). The temperature was raised to 100°C and held until the casein digest solution was clear. The container was then cooled rapidly to 15°C and the cooled solution filtered through a coarse grade of filter paper. A small amount of toluene was added as a preservative and the solution

stored at 2°C for 4 days, at the end of which time it was again filtered to remove any insoluble material.

The following ingredients were then added to the casein digest solution: 1,165.0 grams of KH_2PO_4 dissolved in 8 liters of distilled water; 35.0 grams of cysteine in approximately 800 cc of 10% HCl (the least amount of 10% HCl required to obtain a clear solution); 35 grams of glycine dissolved in 100 cc of distilled water; 300 grams dextrose in 2 liters of distilled water; 3.5 grams of uracil in 1 liter of distilled water; 3.5 grams of adenine sulfate in 1 liter of distilled water; 0.35 gram of nicotinic acid in 35 cc of distilled water; 0.59 gram of pyridoxine dissolved in 59 cc of distilled water; 7.0 grams of tryptophane in 1 liter of distilled water; 1.75 grams of calcium pantothenate in 70 cc of distilled water; 0.875 gram of thiamin hydrochloride dissolved in 87.5 cc of distilled water; 0.175 gram of riboflavin dissolved in 1,000 cc of distilled water; 55.65 cc of thioglycollic acid in 100 cc of distilled water; 700 grams of KHCO_3 in 500 cc of distilled water and 700 cc of a trace element salt solution containing 11.5 kg of MgSO_4 ; 50 g of $\text{CuSO}_4 \cdot 5\text{H}_2\text{O}$; 50 g of $\text{ZnSO}_4 \cdot 7\text{H}_2\text{O}$; 20 g $\text{MnCl}_2 \cdot 4\text{H}_2\text{O}$; 50 g of $\text{FeSO}_4 \cdot 7\text{H}_2\text{O}$; 1 liter of HCl per 100 liters of solution. The medium was then adjusted to pH 7.2 and sterilized by filtration.

The above sterilized medium was inoculated with 11 liters of seed inoculum having a bacterial count of approximately 20 billion per cc. The tank was fermented at 37°C without pH adjustment, aeration, or other modification for 14 hours at the end of which time 320 cc of 50% dextrose was added. After this the pH was adjusted to 7.0 at 15 minute intervals with 5.0N sodium hydroxide. The volume of sodium hydroxide required for neutralization was noted and 115% of this volume of 50% dextrose solution added after each pH adjustment. At the end of about 8 hours the bacterial count had ceased to increase and the fermentation was terminated. At this time the fermentation medium contained approximately 1,000 units of streptokinase per cc.

References

Merck Index 8683

Kleeman & Engel p. 826

PDR pp. 944, 963, 1428

I.N. p. 891

REM p. 1037

Ablondi, F.B. and Adam, J.N. Jr.; U.S. Patent 2,701,227; February 1, 1955; assigned to American Cyanamid Company

Mowat, J.H., Krupka, G.C. and Nalesnyk, S.; U.S. Patent 2,753,291; July 3, 1956; assigned to American Cyanamid Company

Singher, H.O. and Zuckerman, L.; U.S. Patent 3,016,337; January 9, 1962; assigned to Ortho Pharmaceutical Corporation

Siegel, M., Palombo, G. and Baumgarten, W.; U.S. Patent 3,042,586; July 3, 1962; assigned to Merck & Co., Inc.

von Pölnitz, W., Schwick, H.G. and Bickhard, J.H.; U.S. Patent 3,063,913; November 13, 1962; assigned to Behringwerke AG, Germany

von Pölnitz, W., Schwick, H.G. and Bickhard, J.H.; U.S. Patent 3,063,914; November 13, 1962; assigned to Behringwerke AG, Germany

Baumgarten, W. and Cole, R.B.; U.S. Patent 3,107,203; October 15, 1963; assigned to Merck & Co., Inc.

von Pölnitz, W., Schwick, H.G. and Bickhard, J.H.; U.S. Patent 3,138,542; June 23, 1964; assigned to Behringwerke AG, Germany

STREPTOMYCIN

Therapeutic Function: Antitubercular

Chemical Name: O-2-deoxy-2-(methylamino)- α -L-glucopyranosyl-(1 \rightarrow 2)-O-5-deoxy-3-C-formyl- α -L-lyxofuranosyl-(1 \rightarrow 4)-N,N'-bis(aminoiminomethyl)-D-streptamine

Common Name: —

Structural Formula:

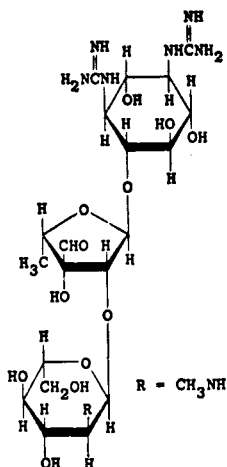

Chemical Abstracts Registry No.: 57-92-1

Trade Name	Manufacturer	Country	Year Introduced
Streptomycin	MSD	U.S.	1945
Streptomycine	Diamant	France	1961
Cidan-Est	Cidan	Spain	—
Darostrep	SCS Pharnalab	S. Africa	—
Estrepto E	Wassermann	Spain	—
Estrepto Level	Level	Spain	—
Estreptomicina	Cepa	Spain	—
Estreptomicina Normon	Normon	Spain	—
Estrepto Wolner	Wolner	Spain	—
Estreptomade	Made	Spain	—
Neodiestrostreptobap	Martin Santos	Spain	—
Orastrep	Dista	U.K.	—
Servistrep	Servipharm	Switz.	—
Solvo-Strep	Heyl	W. Germany	—
Streptaguaine	Dista	U.K.	—
Streptobretin	Norbrook	U.K.	—
Streptosol	Therapex	Canada	—
Strycin	Squibb	U.S.	—

Raw Materials

Bacterium *Streptomyces griseus*
Nutrient medium

Manufacturing Process

A medium is prepared having the following composition in tap water: 1.0% glucose; 0.5% peptone; 0.3% meat extract; and 0.5% NaCl. This medium is distributed in appropriate vessels to a depth of 1 to 2 inches, sterilized at 10 pounds steam pressure for 45 to 50 minutes, and then cooled.

The medium in each vessel is then inoculated with a heavy aqueous suspension of spores of a strain of *Actinomyces griseus*, and the inoculated media are maintained at an incubation temperature of 22° to 28°C for 10 days. The growth is then filtered off and the filtrates are combined for further treatment.

To a batch of approximately 10 liters of filtered broth is added 150 grams of activated charcoal. The mixture is stirred continuously for about 5 minutes and is then filtered. The slightly yellowish (almost colorless) filtrate is discarded and the charcoal residue is washed several times with distilled water and finally with 95% ethanol. The washed material is then suspended in 1.5 liters of 95% ethanol, made 0.15 normal with hydrochloric acid. The suspension is stirred for about an hour and allowed to stand in the cold for about 10 hours more with occasional stirring. The suspension is then filtered, the charcoal residue discarded, and the yellowish clear filtrate thus obtained is poured into 10 liters of ether, with stirring. A brown-colored aqueous layer separates and is drawn off.

The alcohol-ether solution is washed with 100 cc of water and the brown aqueous layer is drawn off and added to the first aqueous layer. The aqueous solution is neutralized to pH 6 to 7 with dilute sodium hydroxide and any precipitate that forms is filtered off and discarded. A faintly colored aqueous solution containing streptomycin is thus obtained.

References

Merck Index 8685

Kleeman & Engel p. 827

PDR p. 1410

I.N. p. 892

REM p. 1260

Waksman, S.A. and Schatz, A.; U.S. Patent 2,449,866; September 21, 1948; assigned to Rutgers Research and Endowment Foundation

Bartels, C.R., Bryan, W.L. and Berk, B.; U.S. Patent 2,868,779; January 13, 1959; assigned to Olin Mathieson Chemical Corporation

STREPTOZOCIN

Therapeutic Function: Antineoplastic

Chemical Name: 2-Deoxy-2-(3-methyl-3-nitrosoureido)-D-glucopyranose

Common Name: —

Structural Formula:

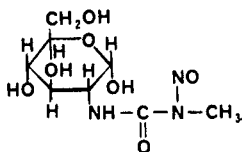

Chemical Abstracts Registry No.: 18883-66-4

Trade Name	Manufacturer	Country	Year Introduced
Zanosar	Upjohn	U.S.	1982

Raw Materials

Bacterium *Streptomyces achromogenes*

Nutrient medium

Manufacturing Process

On a sterile maltose-tryptone agar slant of the following composition: 1 g maltose; 0.5 g tryptone; 0.05 g K_2HPO_4 ; 0.01 g $FeSO_4 \cdot 7H_2O$; 1.5 g agar; and sufficient distilled water to make 100 ml, *Streptomyces achromogenes* var. *streptozoticus* was grown for 7 days at 28°C.

The culture thus produced was used as an inoculum for the following sterile medium: 1 g glucose; 1 g beef extract; 0.5 g Bacto peptone (Difco); 0.5 g NaCl; and sufficient distilled water to make 100 ml. The pH was adjusted to 7.0 before sterilization. The inoculated medium was incubated in shake flasks for 3 days at 28°C on a reciprocating shaker and 75 ml of the resulting growth was used to inoculate 12 l of sterile medium of the same formulation. The medium was incubated in a 20 l stainless steel bottle, at 28°C for 2 days, the contents being stirred continuously with sparged air at the rate of 6 l of free air per minute. The resulting growth was used to inoculate 250 l of the following sterile medium: 2 g Bacto peptone (Difco); 2.5 g blackstrap molasses; 2 g glucose; 0.25 g NaCl; and sufficient distilled water to make 100 ml. The pH was adjusted to 7.0 before sterilization.

This medium was incubated in a 100 gallon stainless steel fermentor, at 24°C with sparged air being introduced at the rate of 50 l/min and with agitation by an impeller. After 66 hours of fermentation the beer was harvested. To 100 gallons of harvested beer was added 17 pounds of diatomite, and 35 pounds of activated carbon. The mixture was stirred well and then filtered, the cake was water-washed with 10 gallons of tap water, and then washed with 25 gallons of acetone followed by 30 gallons of 1:1 aqueous acetone. The acetone solutions of streptozotocin were pooled and dried in vacuo to 3.88 pounds.

References

Merck Index 8695

DFU 4 (2) 137 (1979)

DOT 19 (5) 242 (1983)

I.N. p. 892

REM p. 1156

Bergy, M.E., De Boer, C., Dietz, A., Eble, T.E., Herr, R.R. and Johnson, L.E.; U.S. Patent 3,027,300; March 27, 1962; assigned to The Upjohn Co.

SUCCINYLSULFATHIAZOLE

Therapeutic Function: Antibacterial (intestinal)

Chemical Name: 4-Oxo-4-[4-[(2-thiazolylamino)-sulfonyl] phenyl] amino] butanoic acid

Common Name: —

Structural Formula:

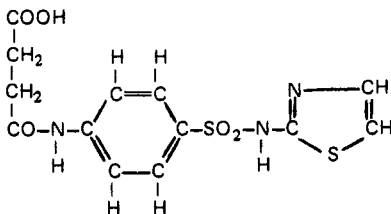

Chemical Abstracts Registry No.: 116-43-8

Trade Name	Manufacturer	Country	Year Introduced
Sulfasuxidine	MSD	U.S.	1942
Thiacyl	Theraplix	France	1946
Colistatin	Smith & Nephew	U.K.	—
Creמושuxidine	MSD	U.K.	—

Raw Materials

2-Sulfanilamidothiazole
Succinic anhydride

Manufacturing Process

3.92 g of succinic anhydride was added to a boiling suspension of 10 g of 2-sulfanilamidothiazole in 100 cc of alcohol. The mixture was then refluxed for five minutes after the addition was complete at which time all of the solids were in solution. The solution was then cooled and diluted with an equal volume of water. The white solid precipitate which formed was filtered and recrystallized from dilute alcohol, yielding 2-N⁴-succinylsulfanilamidothiazole, melting at 184°C to 186°C.

References

Merck Index 8753
Kleeman & Engel p. 831
OCDS Vol. 1 p. 132 (1977)
I.N. p. 894
Moore, M.L.; U.S. Patents 2,324,013 and 2,324,014; both dated July 13, 1943; assigned to Sharp & Dohme, Inc.

SUCRALFATE

Therapeutic Function: Antiulcerative

Chemical Name: Hexadeca- μ -hydroxy tetracosahydroxy[μ_8 -[1,3,4,6-tetra-O-sulfo- β -D-fructofuranosyl- α -D-glucopyranoside tetrakis(hydrogen sulfato){8-}]] hexadecaaluminum

Common Name: —

Structural Formula:

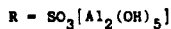
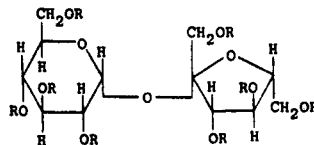

Chemical Abstracts Registry No.: 54182-58-0

Trade Name	Manufacturer	Country	Year Introduced
Antepsin	Baldacci	Italy	1975
Ulcogant	Cascan	W. Germany	1980
Carafate	Marion	U.S.	1981
Ulogant	Merck	Switz.	1982

Trade Name	Manufacturer	Country	Year Introduced
Antepsin	Ayerst	U.K.	1982
Ulsanic	DuPont	Australia	1983
Andapsin	Farmos	Sweden	1983
Sulcrate	Nordic	Canada	—
Ulcerimin	Chugai	Japan	—

Raw Materials

Sulfur trioxide	Pyridine
Sucrose	Sodium hydroxide
Aluminum dihydroxychloride	

Manufacturing Process

A disaccharide is added to a pyridine SO_3 complex solution, which is prepared by reacting 5 to 6 times the molar amount of liquid SO_3 as much as that of disaccharide with 5 to 10 times the amount of pyridine as that of the disaccharide at 0°C to 5°C , for sulfation at 50°C to 70°C for 3 to 7 hours. After the completion of sulfation, the greater part of pyridine is removed by decantation. The obtained solution exhibits an acidity that is so strong that it is improper to apply the reaction with aluminum ion and, therefore, sodium hydroxide is added for neutralization. After the remaining pyridine is removed by concentration, 100 unit volumes of water per unit volume of the residue is added thereto. To the solution is then added aluminum ion solution mainly containing aluminum dihydroxychloride, the pH of which is 1.0 to 1.2, in such an amount that the aluminum ion is present in an amount of 4 to 6 molar parts of the amount of disaccharide to provide a pH of 4 to 4.5. The mixture is reacted under stirring at room temperature and the formed disaccharide polysulfate-aluminum compound is allowed to precipitate. After filtration, the residue is washed with water and dried.

References

Merck Index 8755

PDR p. 1074

I.N. p. 894

REM p. 815

Nitta, Y., Namekata, M., Tomita, E. and Hirota, Y.; U.S. Patent 3,432,489; March 11, 1969; assigned to Chugai Seiyaku K.K. (Japan)

SUFENTANIL

Therapeutic Function: Analgesic

Chemical Name: N-[4-(Methoxymethyl)-1-[2-(2-thienyl)ethyl]-4-piperidiny]-N-phenylpropanamide

Common Name: —

Structural Formula:

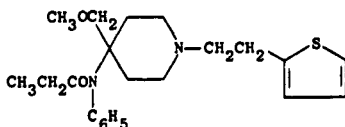

Chemical Abstracts Registry No.: —

Trade Name	Manufacturer	Country	Year Introduced
Sufenta	Janssen	Neth.	1983
Sufenta	Janssen	U.S.	—

Raw Materials

N-[4-(Methoxymethyl)-4-piperidiny] -N-phenylpropanamide
2-Thiopheneethanol

Manufacturing Process

A mixture of 4.1 parts of N-[4-(methoxymethyl)-4-piperidiny] -N-phenylpropanamide, 5.3 parts of sodium carbonate and 120 parts of 4-methyl-2-pentanone is stirred and refluxed with water-separator. Then there are added 4.1 parts of 2-thiopheneethanol methanesulfonate ester and stirring at reflux is continued for 18 hours. The reaction mixture is cooled, washed twice with water and evaporated. The oily residue is purified by column-chromatography over silica gel, using a mixture of trichloromethane and 5% of methanol as eluent. The first fraction is collected and the eluent is evaporated. The oily residue is converted into the hydrochloride salt in 2,2'-oxybispropane. The free base is liberated again in the conventional manner. After extraction with 2,2'-oxybispropane, the latter is dried, filtered and evaporated. The oily residue solidifies on triturating in petroleum-ether. The solid product is filtered off and crystallized from petroleum-ether at -20°C, yielding, after drying, N-[4-(methoxymethyl)-1-[2-(2-thienyl)ethyl] -4-piperidiny] -N-phenylpropanamide; melting point 98.6°C.

References

Merck Index A-12
DFU 2 (5) 334 (1977)
PDR p. 959
I.N. p. 895

Janssen, P.A.J. and Daele, H.P.V.; U.S. Patent 3,998,834; December 21, 1976; assigned to Janssen Pharmaceutica N.V. (Belgium)

SULBENICILLIN

Therapeutic Function: Antibacterial

Chemical Name: 3,3-Dimethyl-7-oxo-6-[(phenylsulfocetyl)amino]-4-thia-1-azabicyclo-(3.2.0) heptane-2-carboxylic acid

Common Name: Sulfocillin

Structural Formula:

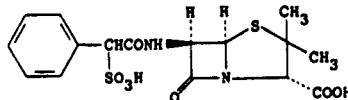

Chemical Abstracts Registry No.: 41744-40-5; 28002-18-8 (Na salt)

Trade Name	Manufacturer	Country	Year Introduced
Lillacillin	Takeda	Japan	1973
Kedacillina	Bracco	Italy	1982

Raw Materials

α -Sulfophenacetyl chloride
6-Aminopenicillanic acid

Manufacturing Process

To a suspension of 1.08 parts by weight of 6-aminopenicillanic acid in 8 parts by volume of water is added 1.48 parts by weight of sodium bicarbonate. After the mixture is dissolved, a solution of 1.18 parts by weight of α -sulfophenylacetyl chloride in 10 parts by volume of diethylether is gradually added thereto. The mixture is stirred at a temperature in the neighborhood of 0°C for 1 hour. The aqueous layer is washed twice with 10 parts by volume of portions of ether and adjusted to pH 1.2 with cation exchange resin of polystyrene sulfonic acid type under constant cooling. Then the solution is washed twice with 15 parts by volume of portions of ethyl acetate, followed by extraction twice with 15 parts by volume of portions of n-butanol. The extracts are combined and washed twice with 15 parts by volume of portions of water and, then, extracted with an aqueous solution of sodium bicarbonate. The extract is adjusted to pH 6.5, washed with ether and lyophilized to give the sodium salt of α -sulfobenzylpenicillin. Yield is 1.2 parts by weight.

References

Merck Index 8762

DOT 8 (5) 199 (1972) & 9 (4) 149 (1973)

I.N. p. 895

REM p. 1201

Morimoto, S., Nomura, H., Fugono, T., Maeda, K. and Ishiguro, T.; U.S. Patent 3,600,379; May 2, 1972; assigned to Takeda Chemical Industries, Ltd. (Japan)

SULFACETAMIDE

Therapeutic Function: Antimicrobial

Chemical Name: N-[(4-aminophenyl)sulfonyl]acetamide

Common Name: N¹-acetylsulfanilamide

Structural Formula:

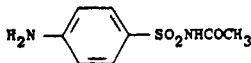

Chemical Abstracts Registry No.: 144-80-9

Trade Name	Manufacturer	Country	Year Introduced
Sulamyd	Schering	U.S.	1941
Urosulfon	Consol. Midland	U.S.	1955
Sulfacidin	Crookes	U.K.	—
Sultrin	Ortho	U.S.	—
Triple Sulfa	Fougera	U.S.	—
Trysul	Savage	U.S.	—

Raw Materials

4-Aminobenzenesulfonamide
Acetic anhydride
Sodium hydroxide

Manufacturing Process

17.2 grams of 4-aminobenzene-sulfonamide are heated to boiling with 75 cc of acetic anhydride for 1 hour and thereupon the diacetyl product caused to separate by stirring into ice water. After recrystallization from alcohol the 4-acetylaminobenzene-sulfonacetyl-amide forms colorless prisms of melting point 253°C with decomposition. The product is easily soluble in alkalies and forms neutral salts. The acetylation can also take place with acetyl chloride. Instead of the 4-aminobenzene-sulfonamide also 4-acetylaminobenzene-sulfonamide can be employed. The action of 4-acetylaminobenzene-sulfonic acid chloride on acetamide yields the same product.

By heating the diacetyl compound with sodium hydroxide solution partial saponification of the acetyl groups takes place. 25.6 grams of diacetyl compound are heated to boiling for some hours with 100 cc of 2 N sodium hydroxide solution. The precipitate produced by acidification of the solution with acetic acid is filtered off and treated with dilute sodium carbonate solution. The 4-aminobenzene-sulfonacetyl-amide passes into solution while the simultaneously formed 4-acetylaminobenzene-sulfonamide remains undissolved. It is filtered with suction and the filtrate again acidified with acetic acid. The 4-aminobenzene-sulfonacetamide separates out and is recrystallized from water. It forms colorless lustrous rhombic crystals of MP 181°C.

References

- Merck Index 100
 Kleeman & Engel p. 833
 PDR pp. 888, 1306, 1606
 OCDS Vol. 1 p. 123 (1977)
 I.N. p. 897
 REM p. 1176
 Dohrn, M. and Diedrich, P.; U.S. Patent 2,411,495; November 19, 1946; assigned to Schering Corporation

SULFACHLORPYRIDAZINE

Therapeutic Function: Antibacterial

Chemical Name: 4-amino-N-(6-chloro-3-pyridazinyl)benzenesulfonamide

Common Name: —

Structural Formula:

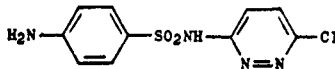

Chemical Abstracts Registry No.: 80-32-0

Trade Name	Manufacturer	Country	Year Introduced
Sonilyn	Mallinckrodt	U.S.	1962
Nefrosul	Riker	U.S.	1974
Consulid	Ciba-Geigy	U.S.	—
Cosulfa	Elliott-Marion	Canada	—
Durasulf	Dessy	Italy	—
Sulfachlorazina	Ellem	Italy	—

Raw Materials

3,6-Dichloropyridazine
Sulfanilamide

Manufacturing Process

1.9 parts of 3,6-dichloropyridazine, 3.4 parts of sulfanilamide, 2.7 parts of potassium carbonate and 1 part of sodium chloride were ground together. The solid mixture was heated with stirring and as the dichloropyridazine and sulfanilamide melted, the mixture became a slurry. When the bath temperature had reached 140°C a sudden evolution of carbon dioxide occurred which lasted about 5 minutes, after which the mixture set in fine granules. When no more carbon dioxide was evolved, heating was stopped and the reaction mixture was heated with sufficient water to dissolve it and the solution allowed to cool. Unreacted sulfanilamide was collected by filtration. Excess dichloropyridazine was removed from the filtrate by extraction with a water immiscible organic solvent such as ether.

The basic solution was chilled and poured into one-half volume of 1:3 acetic acid. Sufficient hydrochloric acid was added to bring the mixture to pH 4. The crude 3-sulfanilamido-6-chloropyridazine which precipitated was purified by solution in 6 parts of 1:100 ammonium hydroxide, charcoal treatment and precipitation by pouring of the filtrate into dilute acetic acid.

References

Merck Index 8770

Kleeman & Engel p. 833

OCDs Vol. 1 pp. 124, 131 (1977)

I.N. p. 897

Lester, M.M. and English, J.P.; U.S. Patent 2,790,798; April 30, 1957; assigned to American Cyanamid Company

SULFACYTINE

Therapeutic Function: Antibacterial

Chemical Name: 4-(amino-N-(1-ethyl-1,2-dihydro-2-oxo-4-pyrimidinyl)benzenesulfonamide

Common Name: N-Sulfanilyl-1-ethylcytosine; sulfacitine

Structural Formula:

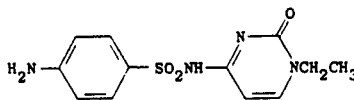

Chemical Abstracts Registry No.: 17784-12-2

Trade Name	Manufacturer	Country	Year Introduced
Renoquid	Glenwood	U.S.	1975
Renoquid	Parke Davis	U.S.	1983

Raw Materials

3-(Ethylamino)propionitrile
Sodium
Hydrogen bromide
N-Acetylsulfanilyl chloride

Potassium cyanate
Methanol
Bromine
Sodium hydroxide

Manufacturing Process

The N-(N-acetylsulfanilyl)-1-ethylcytosine used as a starting material is prepared as follows: To a solution of 333 grams of 3-(ethylamino)propionitrile in 1,697.3 ml of 2 N hydrochloric acid is added 275 grams of potassium cyanate, the resulting solution is concentrated under reduced pressure to a syrup, and the syrup is heated at 90° to 100°C for 6 hours and then evaporated to dryness at 90° to 100°C under reduced pressure. The residue is extracted with 1,600 ml of hot absolute ethanol, and the extract is concentrated to 500 ml and chilled. The crystalline 1-(2-cyanoethyl)-1-ethylurea obtained is isolated, washed with cold absolute ethanol, and dried, melting point 88° to 91°C. This intermediate (58.7 grams) is added to a solution of 11.5 grams of sodium in 500 ml of methanol and the resulting solution is heated under reflux for 30 minutes. After cooling, the mixture, containing 1-ethyl-5,6-dihydrocytosine, is treated with a slight excess of gaseous hydrogen bromide and evaporated to dryness. The residue is extracted, first with 500 ml, then with 100 ml of hot isopropyl alcohol, the extracts are combined and chilled, and the crystalline 1-ethyl-5,6-dihydrocytosine hydrobromide obtained is isolated and dried, MP 167.5 to 169.5°C. This salt (88.8 grams) is dissolved in 200 ml of nitrobenzene at 174°C, 22.6 ml of bromine is added over a period of 8 minutes, and the mixture is kept at 170° to 175°C until hydrogen bromide evolution ceases (about 15 minutes). Upon cooling, there is obtained crude 1-ethylcytosine hydrobromide, which is isolated, washed with ether, and dried, MP 170° to 187°C.

This salt is heated at 90° to 100°C with 70 ml of N,N-dimethylformamide and 60 ml of piperidine, and the resulting solution is chilled to give 1-ethylcytosine, MP 238° to 243°C. A mixture of 10.5 grams of 1-ethylcytosine, 18.6 grams of N-acetylsulfanilyl chloride, and 50 ml of pyridine is stirred at room temperature for 2 days. The precipitated solid is removed by filtration, and the filtrate is evaporated at 60°C under reduced pressure to a syrup. The syrup is triturated with 0.25 N hydrochloric acid, and the solid N-(N-acetylsulfanilyl)-1-ethylcytosine obtained is isolated and dried. This solid is suitable for use without further purification.

A solution of 65 grams of N-(N-acetylsulfanilyl)-1-ethylcytosine in 380 ml of 2 N aqueous sodium hydroxide is heated under reflux for 1 hour. Upon cooling, the solution is treated with charcoal, purified by filtration, and acidified with acetic acid. The solid N-sulfanilyl-1-ethylcytosine that precipitates is isolated, washed with water, and dried, MP 166.5° to 168°C following successive crystallizations from butyl alcohol and from methanol.

References

- Merck Index 8771
- Kleeman & Engel p. 834
- PDR p. 926
- OCDS Vol. 2 p. 113 (1980)
- DOT 12 (9) 370 (1976)
- I.N. p. 898
- REM p. 1172
- Doub, L. and Krolls, U.; U.S. Patent 3,375,247; March 26, 1968; assigned to Parke, Davis & Company

SULFADIAZINE

Therapeutic Function: Antibacterial

Chemical Name: 4-amino-N-2-pyrimidinylbenzenesulfonamide

Common Name: Sulfanilylaminopyrimidine; sulfapyrimidine

Structural Formula:

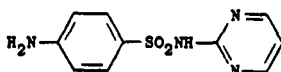

Chemical Abstracts Registry No.: 68-35-9

Trade Name	Manufacturer	Country	Year Introduced
Sulfadiazine	Lederle	U.S.	1941
Adiazin	Star	Finland	—
Adiazine	Theraplix	France	—
Coco-Diazine	Lilly	U.S.	—
Di-Azu-Mul	First Texas	U.S.	—
Flamazine	Smith & Nephew	U.K.	—
Lipo-Diazine	Donley Evans	U.S.	—
Magmaid Sulfadiazine	Pitman-Moore	U.S.	—
Sulfadets	Dymond	Canada	—
Sulfolex	Medica	Finland	—
Theradia	Daiichi	Japan	—
Theradiazine	Daiichi	Japan	—
Ultradiazin	Atabay	Turkey	—

Raw Materials

2-Aminopyrimidine	Iron
p-Nitrobenzenesulfonyl chloride	Hydrogen chloride

Manufacturing Process

5.4 parts of 2-amino-pyrimidine were covered with 15 parts of anhydrous pyridine. The reaction mixture was treated with 14 parts of p-nitrobenzenesulfonyl chloride and the whole heated briefly on the steam bath and let stand 45 minutes at room temperature. To the reaction mixture were added 80 parts of hot alcohol and the precipitate was filtered off and washed with water. The solid was dissolved in dilute caustic solution and the solution was filtered, cooled and acidified. The 2-(p-nitrobenzenesulfonamido)-pyrimidine precipitated and was collected.

The crude 2-(p-nitrobenzenesulfonamido)-pyrimidine from the preceding step was suspended in 130 parts alcohol and 1.5 parts of concentrated hydrochloric acid were added. The suspension was then heated to reflux and 30 parts of iron powder were added with mechanical stirring. The mixture was refluxed and stirred for 24 hours with occasional addition of concentrated hydrochloric acid. The reaction mixture was then made slightly basic and filtered hot and the residues were extracted with several portions of boiling alcohol. The filtrate and wash solutions were combined and evaporated. The 2-(sulfanilamido)-pyrimidine was recrystallized from boiling water with decolorizing charcoal added, according to U.S. Patent 2,410,793.

References

- Merck Index 8772
 Kleeman & Engel p. 834
 OCDS Vol. 1 p. 124 (1977)
 DOT 16 (8) 261 (1980)
 I.N. p. 898
 REM p. 1173
 Sprague, J.M.; U.S. Patent 2,407,966; September 17, 1946; assigned to Sharp & Dohme, Inc.
 Winnek, P.S. and Roblin, R.O. Jr.; U.S. Patent 2,410,793; November 5, 1946; assigned to American Cyanamid Company

SULFADIMETHOXINE

Therapeutic Function: Antibacterial

Chemical Name: 4-Amino-N-(2,6-dimethoxy-4-pyrimidinyl)benzenesulfonamide

Common Name: Sulforthomidine; sulphormethoxine

Structural Formula:

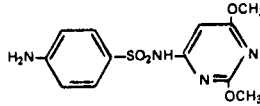

Chemical Abstracts Registry No.: 122-11-2

Trade Name	Manufacturer	Country	Year Introduced
Madribon	Roche	U.S.	1958
Madrigid	Roche	U.S.	1959
Abcid	Daichi	Japan	—
Albon	Roche	U.S.	—
Ancosul	Anchor	U.S.	—
Asthoxin	Kobayashi	Japan	—
Bensulfa	Caber	Italy	—
Chemiosalfa	Salfa	Italy	—
Crozinal	Borromeo	Italy	—
Deltin	Wassermann	Italy	—
Deposol	Pliva	Yugoslavia	—
Diasulfa	Crosara	Italy	—
Diazinol	Washington	Italy	—
Dimetossilina	Lister	Italy	—
Dimetossin	Caber	Italy	—
Dimetoxan	Nessa	Spain	—
Dimetoxin	Nissin	Japan	—
Dimexin	Fuso	Japan	—
Duramid	Deva	Turkey	—
Emerazina	Croce Bianca	Italy	—
Fultamid	Fulton	Italy	—
Hachimetoxin	Toyo	Japan	—
Ipersulfa	Ion	Italy	—
Jatsulph	Clinimed	S. Africa	—
Lensulpha	Lennon	S. Africa	—
Levisul	A.F.I.	Italy	—
Madribon	Roche	Italy	—
Madroxin	Polfa	Poland	—
Melfa	Tanabe	Japan	—
Micromega	Sidus	Italy	—
Mition D	Taisho	Japan	—
Neostreptal	Locatelli	Italy	—
Neosulfamyd	Libra	Italy	—
Omnibon	Yamanouchi	Japan	—
Oxazina	Made	Spain	—
Redifal	A.M.S.A.	Italy	—
Risulpir	Lisapharma	Italy	—
Ritarsulfa	Benvegna	Italy	—
Scandisil	Firma	Italy	—
Sulfabon	Vaillant	Italy	—
Sulfadomus	Medici Domus	Italy	—

Trade Name	Manufacturer	Country	Year Introduced
Sulfaduran	Janus	Italy	—
Sulfalon	Sumitomo	Japan	—
Sulfastop	Vis	Italy	—
Sulfathox	SCS Pharmalab	S. Africa	—
Sulfoplan	Gea	Denmark	—
Sulf-Reten	Pons	Spain	—
Sulmethon	Mohan	Japan	—
Sulmetoxyn	Nichiiku	Japan	—
Sulxin	Chugai	Japan	—
Sumetamin	Samva	Japan	—
Tempodiazina	C.I.F.	Italy	—

Raw Materials

Sodium sulfanilamide
4-Phenylsulfonyl-2,6-dimethoxypyrimidine

Manufacturing Process

1.4 g of 4-phenylsulfonyl-2,6-dimethoxypyrimidine and 4 g of sodium sulfanilamide (both dried over potassium hydroxide) were very finely ground and heated in an oil bath for 10 hours at 120°C (inside temperature). The reaction mixture was taken up in 30 ml of water and treated with 3 ml of 2 N sodium hydroxide solution. After standing for one hour at 0°C, the turbid solution was filtered and the filtrate was made alkaline with sodium carbonate. After again standing for one hour at 0°C, the precipitate was filtered off (1.9 g of regenerated sulfanilamide) and the filtrate was neutralized with acetic acid, whereupon crystallization resulted. The isolated crystals of 4-sulfanilamido-2,6-dimethoxypyrimidine weighed 1.3 g (84% of theory), melting point 190°C to 196°C.

References

Merck Index 8775

Kleeman & Engel p. 835

OCDS Vol. 1 pp. 125, 129 (1977)

I.N. p. 899

Bretschneider, H. and Klotzer, W.; U.S. Patent 2,703,800; March 8, 1955; assigned to Oesterreichische Stickstoffwerke AG

Bretschneider, H. and Klotzer, W.; U.S. Patent 3,127,398; March 31, 1964; assigned to Hoffmann-LaRoche, Inc.

SULFADOXINE

Therapeutic Function: Antibacterial

Chemical Name: 4-amino-N-(5,6-dimethoxy-4-pyrimidinyl)benzenesulfonamide

Common Name: Sulforthomidine; sulformethoxine

Structural Formula:

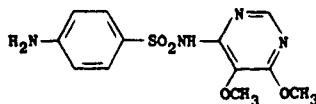

Chemical Abstracts Registry No.: 2447-57-6

Trade Name	Manufacturer	Country	Year Introduced
Fanasil	Roche	Italy	1973
Fansidar	Roche	U.S.	1982

Raw Materials

α -Methoxycyanoacetic acid methyl ester
 Thiourea
 Sodium
 Methanol
 Methyl iodide
 Phenyltrimethylammonium toluene sulfonate
 p-Acetylamino benzenesulfonyl chloride

Manufacturing Process

(a) α -methoxy-cyanoacetic acid methyl ester is condensed with thiourea, in the presence of sodium methylate, to form 2-thio-4-amino-5-methoxy-6-hydroxy-pyrimidine.

(b) The product thus obtained is methylated in a sodium methylate solution with methyl iodide to form 2-methylthio-4-amino-5-methoxy-6-hydroxy-pyrimidine of MP 203°C, from water.

(c) The latter product is methylated with phenyltrimethylammonium-toluenesulfonate to form 2-methylthio-4-amino-5,6-dimethoxy-pyrimidine of MP 112° to 115°C, from 20% methanol.

(d) 0.9 gram of 2-methylthio-4-amino-5,6-dimethoxy-pyrimidine are dissolved in 3 ml of absolute pyridine. At 0°C, 1.2 grams of p-acetylamino benzenesulfonyl chloride are added thereto and the mixture is shaken until all the material is dissolved. The solution is allowed to stand for 22 hours at 0°C and the pyridine eliminated in vacuo at 20°C. To the resulting product are added 20 ml of water and 3 ml of glacial acetic acid, whereupon the whole mixture is heated to the boil, thus causing crystallization. The crude product obtained is dissolved in 40 ml of 2.5% soda solution, and the solution obtained is filtered and supersaturated with gaseous carbon dioxide. There is thus obtained 1.5 grams (85%) of 2-methylthio-4-(N₄-acetyl-sulfanilamido)-5,6-dimethoxy-pyrimidine of MP 220° to 221°C, from 50% ethanol.

(e) 1.3 grams of 2-methylthio-4-(N₄-acetyl-sulfanilamido)-5,6-dimethoxy-pyrimidine are dissolved in 25 ml of water and 0.4 gram of anhydrous sodium carbonate, then refluxed for 3½ hours in the presence of 6 to 7 grams of Raney nickel. Then, a solution of 1 gram of sodium hydroxide in 3 ml of water is added thereto and heating continued for another hour. The catalyst is filtered off and the filtrate acidified to Congo red with hydrochloric acid. The pH is then brought to 5 by means of ammonia, thus causing crystallization. There is thus obtained 0.51 gram of 4-sulfanilamido-5,6-dimethoxy-pyrimidine of MP 190° to 194°C, from 50% ethanol.

References

Merck Index 8776

PDR p. 1484

I.N. p. 899

REM p. 1176

Bretschneider, H., Klotzer, W. and Schantl, J.; U.S. Patent 3,132,139; May 5, 1964; assigned to Hoffmann-La Roche Inc.

SULFAETHIDOLE

Therapeutic Function: Antibacterial

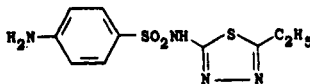
Chemical Name: 4-Amino-N-(5-ethyl-1,3,4-thiadiazol-2-yl)benzenesulfonamide**Common Name:** —**Structural Formula:****Chemical Abstracts Registry No.:** 94-19-9

Trade Name	Manufacturer	Country	Year Introduced
Sul-Spansion	SKF	U.S.	1956
Globucid	Schering	—	—
Spasmo-Urosulf	T.A.D.	W. Germany	—
Sulfa-Perlongit	Boehr. Ing.	W. Germany	—
Urosulf	T.A.D.	W. Germany	—

Raw Materials

2-Amino-5-ethyl-1,3,4-thiadiazole
 p-Acetylamino benzene sulfonyl chloride

Manufacturing Process

0.163 mol of 2-amino-5-ethyl-1,3,4-thiadiazole was covered with 43 parts of anhydrous pyridine. To the mixture was added 50 parts (0.214 mol) of p-acetylamino benzene sulfonyl chloride with vigorous shaking at 50°C to 60°C. The reaction mixture was then heated to 125°C. When the mixture had cooled somewhat it was placed in a Claisen flask and 27.6 parts (0.69 mol) of sodium hydroxide dissolved in 110 parts of water was added through a dropping funnel while distilling off a mixture of pyridine and water. The distillation was stopped when the temperature reached 100°C and the residual liquor in the flask heated at 95°C for 30 minutes.

The reaction mixture was then poured into 1,650 parts of hot water, the pH adjusted to 8 to 9, decolorizing charcoal was added and the whole was heated on the steam for 15 minutes. The charcoal was filtered off and the hot filtrate neutralized and cooled. The 2-(sulfanilamido)-5-ethyl-1,3,4-thiadiazole was purified by repeated crystallization from boiling water.

References

Merck Index 8777

Kleeman & Engel p. 836

OCDS Vol. 1 p. 125 (1977)

I.N. p. 900

Roblin, R.O. Jr. and Winner, P.S.; U.S. Patent 2,358,031; September 12, 1944; assigned to American Cyanamid Co.

SULFAGUANIDINE

Therapeutic Function: Antimicrobial**Chemical Name:** 4-Amino-N-(aminoiminomethyl)benzenesulfonamide**Common Name:** Sulfanilylguanidine

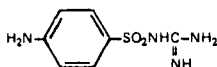
Structural Formula:**Chemical Abstracts Registry No.:** 57-67-0

Trade Name	Manufacturer	Country	Year Introduced
Sulfaguanidine	Lederle	U.S.	1941
Aseptil-Guanadina	Wassermann	Italy	—
Aterian	Takeda	Japan	—
Devaguanil	Deva	Turkey	—
Ganidan	Specia	France	—
Guabeta	O.T.W.	W. Germany	—
Guasept	Ferrosan	Denmark	—
Resulfon	Nordmark	W. Germany	—

Raw Materials

Guanidine hydrochloride	Iron
p-Nitrobenzene sulfonyl chloride	Hydrogen chloride

Manufacturing Process

10 parts of guanidine hydrochloride (0.1 mol) was dissolved in 75 parts of water and the pH adjusted to 8 to 9. The solution was warmed to 50°C to 60°C and kept at this temperature while a slurry of 25 parts (0.113 mol) of p-nitrobenzene sulfonyl chloride was added slowly with mechanical stirring. The pH was kept at 8 to 9 by the addition of 40% sodium hydroxide solution. At the end of the reaction the solution was cooled and filtered from the separated solid. The p-nitrobenzene sulfonyl guanidine was recrystallized from hot water.

5 parts (0.024 mol) of p-nitrobenzene sulfonyl guanidine was dissolved in 50 parts of boiling 95% alcohol and to the solution was added 0.5 part of concentrated hydrochloric acid. The solution was heated to reflux and 6 parts of iron dust was added. The suspension was refluxed for 3 hours, made basic with potassium carbonate, and filtered hot. The alcohol was evaporated off and the p-aminobenzene sulfonyl guanidine recrystallized from boiling water with the addition of decolorizing charcoal.

References

Merck Index 8779

Kleeman & Engel p. 837

OCDS Vol. 1 p. 123 (1977)

I.N. p. 900

Winnek, P.S.; U.S. Patent 2,218,490; October 15, 1940; assigned to American Cyanamid Co.

Winnek, P.S.; U.S. Patent 2,229,784; January 28, 1941; assigned to American Cyanamid Co.

Winnek, P.S.; U.S. Patent 2,233,569; March 4, 1941; assigned to American Cyanamid Co.

SULFAGUANOL**Therapeutic Function:** Antibacterial**Chemical Name:** N¹-[(4,5-dimethyl-2-oxazolyl)amidino]sulfanilamide**Common Name:** Sulfadimethyloxazolylguanidine

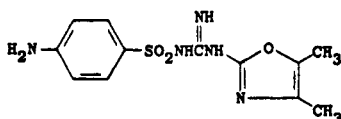
Structural Formula:**Chemical Abstracts Registry No.:** 27031-08-9

Trade Name	Manufacturer	Country	Year Introduced
Enterocura	Nordmark	W. Germany	1973
Enterocura	De Angeli	Italy	1981

Raw Materials

N^1 -[p-Aminobenzenesulfonyl]- N^3 -cyanoguanidine
 Acetoin
 Hydrogen chloride

Manufacturing Process

23.9 grams (0.1 mol) of N^1 -[p-amino benzene sulfonyl]- N^3 -cyano guanidine and 13.2 grams (0.15 mol) of acetoin are thoroughly stirred in a mixture of 120 cc of water and 120 cc of methanol. 25 cc of concentrated hydrochloric acid are added dropwise with stirring to this suspension at 40°C. A clear solution is obtained after 30 minutes which solution is kept at 40°C for another hour. Thereafter, the methanol is distilled off in a vacuum, the remaining solution is treated with charcoal and the pH of the filtered solution is quickly brought to 11 by addition of 10% soda lye with quick stirring.

The compound at first precipitated is redissolved at a pH of 11. The solution is treated another time with charcoal and is filtered. Thereafter, a mixture of anhydrous acetic acid and water in a proportion of 1:1 is added with stirring and cooling until a pH of 7 is reached. Thus, the reaction product separates with crystallization.

For purification, the product is recrystallized from 15 times the amount of a 9:1 mixture of acetone and water. The resulting N^1 -[p-amino benzene sulfonyl]- N^3 -(4,5-dimethyl-oxazolyl-(2))guanidine is obtained as colorless crystals having a MP of 233° to 236°C.

References

Merck Index 8780
 Kleeman & Engel p. 838
 DOT 9 (5) 185 (1973)
 I.N. p. 900
 Loop, W., Baganz, H., Kohlmann, F.-W. and Schultze, H.; U.S. Patent 3,562,258; Feb. 9, 1971; assigned to Nordmark-Werke GmbH, Germany

SULFALENE**Therapeutic Function:** Antibacterial**Chemical Name:** 4-amino-N-(3-methoxy-pyrazinyl)benzenesulfonamide**Common Name:** Sulfamethopyrazine

Structural Formula:

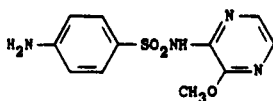

Chemical Abstracts Registry No.: 152-47-6

Trade Name	Manufacturer	Country	Year Introduced
Longum	Farmitalia	W. Germany	1962
Kelfizina	Farmitalia	Italy	1962
Kelfizine	Farmitalia	U.K.	1969
Kelfizine	Bellon	France	1969

Raw Materials

2-Aminopyrazine	Bromine
Sodium	Methanol
p-Acetylamino benzene sulfonyl chloride	Sodium hydroxide
Hydrogen	

Manufacturing Process

2-Amino-3,5-Dibromo-Pyrazine: 112.7 ml of bromine in 375 ml of acetic acid are slowly added at 0° to +2°C, while stirring, to a solution of 95.11 grams of 2-amino-pyrazine and 326.5 grams of acetic acid trihydrate (CH₃COONa·3H₂O) in 1,480 ml of acetic acid. This addition requires about 2 to 3 hours and it is carried out in the dark. The mixture is then allowed to stand at room temperature (25° to 30°C) for 15 to 16 hours. About 1.5 liters of acetic acid are distilled off under vacuum (12 to 14 mm Hg) at 35°C and the brown and viscous residue is poured into 500 grams of ice-water under stirring.

Aqueous 20% sodium hydroxide is added in order to obtain a pH = 8 and then the product is filtered and air-dried. The air-dried product is extracted 6 times with 150 ml of ether; the filtered ethereal solutions are evaporated to dryness and the residue (50 to 52 grams) is crystallized from hot water. The yield is 34.36 grams, melting at 114°C.

2-Amino-3-Methoxy-5-Bromo-Pyrazine: 7 grams of 2-amino-3,5-dibromo-pyrazine are boiled for 9 hours in a methanolic solution of sodium methylate (obtained from 0.65 gram of Na and 18.5 ml of methanol). By cooling a crystalline product is obtained, filtered and washed once with methanol and 2 to 3 times with water. The yield is 5.4 grams, melting at 138°C.

2-Amino-3-Methoxy-Pyrazine: 3 grams of 2-amino-3-methoxy-5-bromo-pyrazine are hydrogenated, in methanolic solution at room temperature and at atmospheric pressure, in the presence of 1 gram of palladium over charcoal (10%) and 0.9 gram of potassium hydroxide. When the stoichiometric amount of hydrogen is absorbed, the suspension is filtered and the filtrate is evaporated to dryness. The residue is extracted with acetone, the acetonic solution is evaporated and the residue (1.8 grams, melting at 75° to 82°C) is crystallized from cyclohexane. The yield is 1.5 grams, melting at 85°C.

2-(p-Acetylamino benzene-sulfonamido)-3-Methoxy-Pyrazine: 1.5 grams of 2-amino-3-methoxy-pyrazine dissolved in 15 ml of anhydrous pyridine are treated, under cooling and stirring, with 2.81 grams of p-acetylamino benzene-sulfonyl-chloride, at small portions in about 30 minutes. The mixture is allowed to stand for 20 hours at room temperature and then is heated to 50°C for 4 hours.

The solution is concentrated to one-third of its volume, under vacuum, and poured into ice-water under stirring. The precipitate is filtered and washed with water. 2.21 grams melting at 218° to 220°C are obtained. The MP (crystallized from alcohol) is 224°C.

2-Sulfanilamido-3-Methoxy-Pyrazine: 1.5 grams of the product from the preceding step and 7 to 8 ml of aqueous 10% sodium hydroxide are boiled for 1 hour. The cooled solution is slightly acidified to pH 6 with aqueous 2 N hydrochloric acid and the product is filtered. The yield is 1.25 grams, melting at 175°C.

References

Merck Index 8781

Kleeman & Engel p. 838

OCDS Vol. 1 p. 125 (1977)

I.N. p. 901

Camerino, B. and Palamidessi, G.; U.S. Patent 3,098,069; July 16, 1963; assigned to Societa Farmaceutici Italia, Italy

SULFAMERAZINE

Therapeutic Function: Antibacterial

Chemical Name: 4-Amino-N-(4-methyl-2-pyrimidinyl)benzenesulfonamide

Common Name: Sulfamethyldiazine; methylsulfadiazine

Structural Formula:

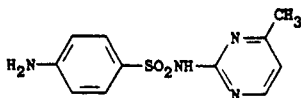

Chemical Abstracts Registry No.: 127-79-7

Trade Name	Manufacturer	Country	Year Introduced
Sulfamerazine	Lederle	U.S.	1943
Dosulfon	Geigy	W. Germany	—
Mebacid	Veb Berlin Chemie	E. Germany	—
Polagin	De Angeli	Italy	—
Percoccide	A.C.F.	Neth.	—
Romezin	Tanabe	Japan	—
Septosil	Egyt	Hungary	—
Solumedine	Specia	France	—
Spanbolet	Norden	U.S.	—

Raw Materials

2-Amino-6-methyl pyrimidine
 p-Acetylamino benzene sulfonyl chloride
 Hydrogen chloride

Manufacturing Process

To a well agitated solution of 6.95 grams of 2-amino-6-methyl pyrimidine in 40 cc of pyridine, 15 grams of p-acetylamino benzenesulfonyl chloride are added in small portions over a 30 minute period. The reaction mixture is then heated on a steam bath for 30 minutes, the free pyridine being then removed under reduced pressure and the residue mixed with cold water, and the latter mixture is vigorously stirred. The solid reaction product is removed by filtration and washed with cold water.

There is obtained a yield of 14 grams of crude 2-(p-acetylaminobenzenesulfonamido)-6-methyl pyrimidine, which on recrystallization from alcohol and water melts at 238° to 239°C. The crude product is hydrolyzed by suspending it in 400 cc of 2 N hydrochloric acid and warming until solution is complete. The solution is neutralized with sodium carbonate and the precipitated 2(sulfanilamido)-6-methyl pyrimidine is removed by filtration. The latter on recrystallization from alcohol and water shows a melting point of 225° to 226°C.

References

Merck Index 8783

Kleeman & Engel p. 839

OCDS Vol. 1 pp. 124, 128 (1977)

I.N. p. 901

REM p. 1173

Sprague, J.M.; U.S. Patent 2,407,966; September 17, 1946; assigned to Sharp & Dohme, Inc.

SULFAMETER

Therapeutic Function: Antibacterial

Chemical Name: 4-Amino-N-(5-methoxy-2-pyrimidinyl)benzenesulfonamide

Common Name: Sulfamethoxydiazine

Structural Formula:

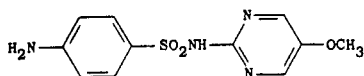

Chemical Abstracts Registry No.: 651-06-9

Trade Name	Manufacturer	Country	Year Introduced
Sulla	Robins	U.S.	1968
Bayrena	Bayer Pharma	France	—
Durenat	Bayer/Schering	W. Germany	—
Durenate	Bayer	U.K.	—
Fortesul	Pliva	Yugoslavia	—
Kirocid	Schering	W. Germany	—
Kiron	Schering	W. Germany	—
Ultras	Chemie Linz.	Austria	—

Raw Materials

Methoxymalonic acid ester	Guanidine carbonate
Phosphorus oxychloride	Zinc
Carbomethoxy-sulfanilic acid chloride	Sodium hydroxide

Manufacturing Process

2-Amino-5-methoxy pyrimidine is obtained having a melting point of about 300°C by condensation of methoxymalonic acid ester with guanidine carbonate in the presence of sodium ethylate. The resultant reaction product is then converted to 2-amino-5-methoxy-4,6-dichloropyrimidine (melting point 216°C to 217°C) by heating this reaction product with phosphorus oxychloride. The dichloro compound is then suspended in water with zinc dust and

is tested in the presence of caustic alkaline or carbonates to produce the 2-amino-5-methoxy pyrimidine compound, melting point 80°C to 82°C, (benzene).

12.6 g of 2-amino-5-methoxy pyrimidine, 26.4 g of carbethoxy-sulfanilic acid chloride and 50 cc of dry pyridine are heated for 30 minutes with frequent shaking to a temperature of 80°C. The reaction product is then mixed with 200 cc of water and with dilute hydrochloric acid (0.1 N) until the reaction is acid to Congo Red indicator. A precipitate is formed which is then filtered under suction, washed with distilled water, and dried at 150°C. A practically quantitative yield is recovered of 2-(p-carbethoxyaminobenzene-sulfonamido)-5-methoxy-pyrimidine, melting point 248°C to 250°C.

To hydrolyze the sulfa pyrimidine compound, the same is heated at 90°C with 200 cc of 2N potassium hydroxide solution for about one hour until complete solution is obtained. The resultant solution is then cooled to room temperature (25°C) and acidified with acetic acid to precipitate the hydrolyzed product, which is then recrystallized from dilute acetone admixed with animal charcoal.

References

Merck Index 8785

Kleeman & Engel p. 841

OCDS Vol. 1 pp. 125, 129 (1977)

I.N. p. 902

Diedrich, P.; U.S. Patent 3,214,335; October 26, 1965; assigned to Schering A.G. (Germany)

SULFAMETHAZINE

Therapeutic Function: Antimicrobial

Chemical Name: 4-Amino-N-(4,6-dimethyl-2-pyrimidinyl)benzenesulfonamide

Common Name: Sulfamezathine, sulfadimerazine, sulfamidine, sulfadimethylpyrimidine, sulfadimidine (U.K. Name)

Structural Formula:

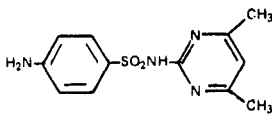

Chemical Abstracts Registry No.: 57-68-1

Trade Name	Manufacturer	Country	Year Introduced
Cremomethazine	MSD	U.S.	1947
Deladine	Delmaak	S. Africa	—
Intradine	Norbrook	U.K.	—
Rigesol	Ferrosan	Denmark	—
Rivodine	Rivopharm	Switz.	—
S-Dimidine	Protea	Australia	—
Sulphix	Protina	W. Germany	—

Raw Materials

p-Aminobenzenesulfonamidoguanidine

Sodium acetylacetonate

Manufacturing Process

A flask heated in an oil bath is filled with 600 ml water and 60 g (1 mol) glacial acetic acid (or an equivalent quantity of diluted acetic acid). While stirring 235 g (1.1 mols) anhydrous p-aminobenzenesulfonamidoguanidine (or an equivalent quantity of a nonanhydrous product) and 122 g (1 mol) sodium acetylacetonate 100% purity (or an equivalent quantity of product of a lower purity) are introduced into the flask while stirring.

The temperature of the reaction mixture is brought to 102°C to 103°C, the mixture is further stirred at this temperature during 24 hours. The pH value of the mixture, which should range between 5 and 6 is checked during the reaction.

On expiry of the reaction period heating is cut off, the mass being cooled or allowed to cool down to 60°C.

Filtering under suction is effected, the solids on the filter being washed with 100 ml water at 80°C.

After drying of the product on the filter 256 g of 2-p-aminobenzenesulfonamido-4,6-dimethylpyrimidine, melting point 196°C to 197°C, purity 99.5% are obtained. The output is 92% of the theory calculated with respect to the sodium acetylacetonate employed.

References

Merck Index 8786

I.N. p. 839

REM p. 1173

Sprague, J.M.; U.S. Patent 2,407,966; September 17, 1946; assigned to Sharp & Dohme, Inc.

Garzia, A.; U.S. Patent 3,119,818; January 28, 1964; assigned to Istituto Chemioterapico Italiano SpA

SULFAMETHIZOLE

Therapeutic Function: Antibacterial

Chemical Name: 4-amino-N-(5-methyl-1,3,4-thiadiazol-2-yl)benzenesulfonamide

Common Name: Sulfamethylthiadiazole

Structural Formula:

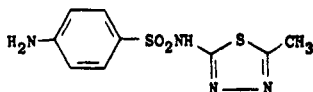

Chemical Abstracts Registry No.: 144-82-1

Trade Name	Manufacturer	Country	Year Introduced
Thiosulfil	Ayerst	U.S.	1953
Sulfurine	Table Rock	U.S.	1963
Ultrasul	Webcon	U.S.	1963
Sulfasol	Hyrex-Key	U.S.	1963
Renasul	Century	U.S.	1966
Famet	Calmic	Australia	—
Harnway	Nichiiiko	Japan	—
Rufol	Debat	France	—

Trade Name	Manufacturer	Country	Year Introduced
Salimol	Maruishi	Japan	—
S-Methizole	Protea	Australia	—
Starisil	Star	Finland	—
Sulfa Gram	Beach	U.S.	—
Sulfametin	Pharmacia	Sweden	—
Urobiotic	Roerig	U.S.	—
Urokinon	Chugai	Japan	—
Urokizol	Chugai	Japan	—
Urolex	Ohio Medical	U.S.	—
Urosol	Kanto	Japan	—
Urosul	Mohan	Japan	—
Utrasul	Chicago Pharmacal	U.S.	—

Raw Materials

Acetaldehyde thiosemicarbazone
 p-Acetaminobenzolsulfonyl chloride
 Calcium ferricyanide

Manufacturing Process

To 10 grams acetaldehyde-thiosemicarbazone in 80 grams pyridine gradually 20 grams p-acetaminobenzolsulfonylchloride is added. The reaction mixture is heated about 1 hour on a water bath and is then charged in 1 liter water, to which some acetic acid is added. The bottom sediment is sucked off and washed with water, after which it is crystallized by alcohol. 20 grams of the condensation product thus obtained is cleared in 100 cc water at about 30°C, after which 45 grams calcium ferricyanide dissolved in about 100 cc water is added. The reaction mixture is made slightly alkaline and held at a temperature of about 80°C for 2 to 3 hours. It is important that the reaction mixture during the whole period of 2 to 3 hours is steadily held alkaline.

After the said 2 to 3 hours the liquid is cooled and the bottom sediment, which has a greenish color, is filtered off. The liquid sucked off eventually is treated with active carbon, filtered and made slightly acid by means of acetic acid, at which 2-amino-benzolsulfon-amido-5-methyl-1,3,4-thiodiazol (melting point 204° to 206°C) is precipitated.

References

Merck Index 8787
 Kleeman & Engel p. 839
 PDR pp. 650, 1533
 OCDS Vol. 1 p. 125 (1977)
 I.N. p. 901
 REM p. 1174
 Hübner, O.; U.S. Patent 2,447,702; August 24, 1948; assigned to H. Lundbeck & Co., Kemisk Pharmaceutisk Laboratorium A/S, Denmark

SULFAMETHOXAZOLE

Therapeutic Function: Antibacterial

Chemical Name: 4-amino-N-(5-methyl-3-isoxazolyI)benzenesulfonamide

Common Name: Sulfisomezole

Structural Formula:

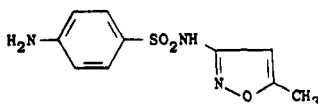

Chemical Abstracts Registry No.: 723-46-6

Trade Name	Manufacturer	Country	Year Introduced
Gantanol	Roche	U.S.	1961
Urobax	Shionogi	U.S.	1980
Azo Gantanol	Roche	U.S.	—
Bactrim	Roche	U.S.	—
Comoxol	Squibb	U.S.	—
Cotrim	Lemmon	U.S.	—
Gantaprim	Ausonía	Italy	—
Metoxal	Farmos	Finland	—
Septra	Burroughs Wellcome	U.S.	—
Sinomín	Shionogi	Japan	—
Sulfatrim	Schein	U.S.	—
Urobak	Shionogi	Japan	—

Raw Materials

Ethyl 5-methylisoxazole-3-carbamate
Sodium hydroxide
Acetylsulfanil chloride

Manufacturing Process

Preparation of 3-Amino-5-Methylisoxazole: 1.7 grams of ethyl 5-methylisoxazole-3-carbamate was heated on a boiling water-bath with 5 cc of a 10% aqueous sodium hydroxide solution for 8 hours, then the reaction mixture was extracted several times with ether or benzene and the extract was cooled followed by the removal of the solvent and drying. The residue was solidified after a while and gave prismatic crystals, melting point 61° to 62°C, of 3-amino-5-methylisoxazole by recrystallization from benzene.

Preparation of 3-Acetylsulfanilamido-5-Methylisoxazole: 0.9 gram of 3-amino-5-methylisoxazole in 5 cc of pyridine was allowed to react with 2.0 grams of acetylsulfanil chloride accompanied by the generation of heat. After about one hour, water was added to the reaction mixture and the crystal precipitated out was recrystallized from alcohol to give 2.5 grams of 3-acetylsulfanilamido-5-methylisoxazole, melting point (decomposition) 220° to 221°C.

Preparation of 3-Sulfanilamido-5-Methylisoxazole: 2 grams of 3-acetylsulfanilamido-5-methylisoxazole was heated with 10 cc of an aqueous sodium hydroxide solution on a water-bath for one hour and after cooling the reactant was acidified by addition of acetic acid. The precipitate thus formed was recrystallized from dilute alcohol to give 15 grams of colorless prisms of 3-sulfanilamido-5-methylisoxazole, melting point 167°C.

References

Merck Index 8789

Kleeman & Engel p. 840

PDR pp. 673, 763, 830, 993, 1034, 1473, 1606, 1738

DOT 7 (5) 189 (1971)

I.N. p. 901

REM p. 1174

Kano, H., Nishimura, H., Nakajima, K. and Ogata, K.; U.S. Patent 2,888,455; May 26, 1959; assigned to Shionogi & Co., Ltd., Japan

SULFAMETHOXYPYRIDAZINE

Therapeutic Function: Antibacterial

Chemical Name: 4-amino-N-(6-methoxy-3-pyridazinyl)benzenesulfonamide

Common Name: —

Structural Formula:

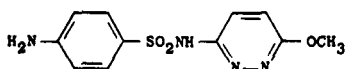

Chemical Abstracts Registry No.: 80-35-3

Trade Name	Manufacturer	Country	Year Introduced
Kynex	Lederle	U.S.	1957
Midicel	Parke Davis	U.S.	1957
Aseptilex	Wassermann	Spain	—
Asey-Sulfa	Quimia	Spain	—
B-Sulfamethoxy	Biokema	Switz.	—
Davosin	Parke Davis	W. Germany	—
Durasul	Estedi	Spain	—
Exazol	Andreu	Spain	—
Fercasulf	Arco	Switz.	—
Lederkyn	Lederle	U.K.	—
Lentosulfa	I.S.F.	Italy	—
Longamid	A.L.	Norway	—
Longisul Jarabe	Landerlan	Spain	—
Metazina	Piam	Italy	—
Microcid	Borromeo	Italy	—
Novosulfin	Galenika	Yugoslavia	—
Oroxin	Otsuka	Japan	—
Paramid Supra	Kwizda	Austria	—
Pirasulfon	Neo	Canada	—
S.D.M.	Barlow Cote	Canada	—
Sulfabon	Biokema	Switz.	—
Sulfamin	Pliva	Yugoslavia	—
Sulfadazina	Guidi	Italy	—
Sulfadepot	Almirall	Spain	—
Sulfadin	C.I.F.	Italy	—
Sulfaintensa	Robert	Spain	—
Sulfalex	De Angeli	Italy	—
Sulfamizina	Wells	Italy	—
Sulfamyd	Libra	Italy	—
Sulfapyrazin	Bosnalijek	Yugoslavia	—
Sulfatar	Arnaldi	Italy	—
Sulfocidan	Cidan	Spain	—
Sulforetent	Cifa	Italy	—
Sulfo-Rit	Aristochimica	Italy	—
Sultirene	Specia	France	—
Unisulfa	Angelini	Italy	—

Raw Materials

3-Sulfanilamido-6-chloropyridazine
Sodium
Methanol

Manufacturing Process

The following description is taken from U.S. Patent 2,712,012: 2.3 parts of clean sodium metal is dissolved in 50 parts of anhydrous methyl alcohol. 11.4 parts of 3-sulfanilamido-6-chloropyridazine is added and the mixture heated in a sealed tube 13 hours at 130° to 140°C. After the tube has cooled it is opened and the reaction mixture filtered, acidified with dilute acetic acid, then evaporated to dryness on the steam bath. The residue is dissolved in 80 parts of 5% sodium hydroxide, chilled and acidified with dilute acetic acid. The crude product is filtered and then recrystallized from water to give 3-sulfanilamido-6-methoxy-pyridazine of melting point 182° to 183°C.

References

Merck Index 8790

Kleeman & Engel p. 842

OCDS Vol. 1 pp. 124, 131 (1977)

I.N. p. 902

Clark, J.H.; U.S. Patent 2,712,012; June 28, 1956; assigned to American Cyanamid Co.

Murphy, D.M. and Shepherd, R.G.; U.S. Patent 2,833,761; May 6, 1958; assigned to American Cyanamid Co.

SULFAMOXOLE

Therapeutic Function: Antibacterial

Chemical Name: 4-Amino-N-(4,5-dimethyl-2-oxazolyl)benzenesulfonamide

Common Name: Sulfadimethyloxazole

Structural Formula:

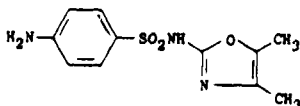

Chemical Abstracts Registry No.: 729-99-7

Trade Name	Manufacturer	Country	Year Introduced
Sulfuno	Nordmark	W. Germany	1960
Justamil	Anphar-Rolland	France	1961
Justamil	Anphar-Rolland	Italy	1964
Naprin	Upjohn	U.S.	—
Oxasulfa	Trinum	Italy	—
Tardamide	Gruenenthal	W. Germany	—

Raw Materials

2-Amino-4,5-dimethyloxazole
p-Acetaminobenzenesulfonyl chloride
Hydrogen chloride

Manufacturing Process

11.2 g of 2-amino-4,5-dimethyloxazole (0.1 mol), 46.8 g of anhydrous p-acetaminobenzenesulfonyl chloride (0.2 mol) and 60 cc of methylene chloride are mixed and then treated while stirring and with exclusion of water with 12.0 g (0.2 mol) of anhydrous trimethylamine, dis-

solved in 60 cc of benzene. After adding the trimethylamine, the mixture is heated for 30 minutes to 40°C, left to stand for 12 hours and then the solvent is distilled off. The distillation residue is heated with 300 cc of water until the residual organic solvents are driven off. The residue is filtered and thoroughly washed with water. Yield of condensation product: 46.4 g. The mass is triturated with 80 cc of cold 2.5% caustic soda solution, filtered and thoroughly washed with water. The residue which is insoluble in caustic soda solution consists of bis-(p-acetaminobenzenesulfonyl)-2-amino-4,5-dimethyloxazole. It melts indefinitely between 201°C and 206°C with decomposition (browning). Yield: 42.3 g corresponding to 83.6%.

The 42.3 g of the bis-compound are heated under reflux in 210 cc of 96% ethanol containing 10% of hydrogen chloride, to the boiling point of the alcohol. After dissolution, the substance is boiled for 20 minutes under reflux. It is cooled, filtered and washed with alcohol. By concentrating the mother liquor and the washing liquid by evaporation, further amounts of substance are obtained.

The total amount of the hydrochloride obtained is stirred with 50 cc of water and the mixture is mixed with 15 cc of 45% caustic soda solution. After complete dissolution, the mixture is treated with decolorizing carbon and the filtrate is brought to a pH value of 5.5 by means of hydrochloric acid. 17.6 g of p-aminobenzenesulfonyl-2-amino-4,5-dimethyloxazole are obtained as colorless crystals with a melting point of 193°C to 194°C (corrected), corresponding to a yield of 65.9% calculated on the basis of the 2-amino-4,5-dimethyloxazole used.

References

Merck Index 8797

Kleeman & Engel p. 843

OCDS Vol. 1 p. 124 (1977)

DOT 12 (9) 377 (1976)

I.N. p. 903

Loop, W., Luhrs, E. and Hauschildt, P.; U.S. Patent 2,809,966; October 15, 1957; assigned to Nordmark-Werke G.m.b.H. (Germany)

SULFAPHENAZOLE

Therapeutic Function: Antibacterial

Chemical Name: 4-amino-N-(1-phenyl-1H-pyrazol-5-yl)benzenesulfonamide

Common Name: —

Structural Formula:

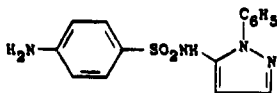

Chemical Abstracts Registry No.: 526-08-9

Trade Name	Manufacturer	Country	Year Introduced
Sulfabid	Purdue Frederick	U.S.	1962
Fenazolo	S.A.M.	Italy	—
Merian	Dainippon	Japan	—
Microsulf	Novafarnova	Italy	—
Orisul	Ciba	W. Germany	—

Trade Name	Manufacturer	Country	Year Introduced
Orisulf	Ciba	U.K.	—
Plisulfan	Pliva	Yugoslavia	—
Sulfapadil	Padil	Italy	—
Sulfazol	Barlocco	Italy	—
Sulfenal	Kanto	Japan	—
Sulforal	Farber-R.E.F.	Italy	—
Sulfostat	Bieffe	Italy	—
Sulphena	Nisshin	Japan	—

Raw Materials

3-Amino-2-phenylpyrazole
 p-Carboethoxyaminobenzenesulfonyl chloride
 Sodium hydroxide

Manufacturing Process

Into a solution of 15.9 grams of 3-amino-2-phenyl-pyrazole in 60 cc of anhydrous pyridine, 29 grams of p-carboethoxyamino-benzene sulfonyl chloride are introduced within about 25 minutes. When the reaction subsides, heating is carried out for a further hour to 90° to 95°C internal temperature. The reaction solution is then poured into 300 cc of 2 N hydrochloric acid. The precipitate is filtered with suction and recrystallized from dilute alcohol. The 3-(p-carboethoxyaminobenzene sulfonamido)-2-phenyl-pyrazole is obtained thus in white crystals of MP 175° to 176°C.

These are taken up in 250 cc of 2 N caustic soda solution and heated for 1 hour on a boiling water bath. With hydrochloric acid, the pH is then adjusted to 6 to 7 and the precipitate is filtered with suction and crystallized from 75% ethyl alcohol. The resulting 3-(p-aminobenzene sulfonamido)-2-phenyl-pyrazole crystallizes in white crystals and has a melting point of 177° to 178°C.

References

Merck Index 8810
 Kleeman & Engel p. 844
 OCDS Vol. 1 p. 124 (1977)
 I.N. p. 904
 Druey, J. and Schmidt, P.; U.S. Patent 2,858,309; October 28, 1958; assigned to Ciba Pharmaceutical Products Inc.

SULFASALAZINE

Therapeutic Function: Antibacterial

Chemical Name: 2-Hydroxy-5-[[4-[(2-pyridinylamino)sulfonyl] phenyl] azo]-benzoic acid

Common Name: Salicylazosulfapyridine, salazosulfapyridine

Structural Formula:

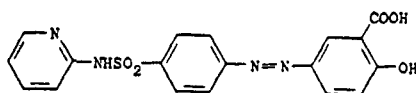

Chemical Abstracts Registry No.: 599-79-1

Trade Name	Manufacturer	Country	Year Introduced
Azulfidine	Pharmacia	U.S.	1952
Salazopyrine	Pharmacia	France	1958
Salazopyrin	Pharmacia	U.K.	1968
Salazopyrin	Green Cross	Japan	1969
S.A.S.-500	Rowell	U.S.	1972
Sulcolon	Lederle	U.S.	1974
Rorasul	Rorer	U.S.	1975
Colo-Pleon	Henning	W. Germany	—
Salisulf	Giuliani	Italy	—

Raw Materials

α -(p-Aminobenzenesulfonamido)pyridine
Sodium nitrite
Hydrogen chloride
Salicylic acid

Manufacturing Process

50 g of α -(p-aminobenzenesulfonylamido)pyridine are dissolved in a mixture of 50 cc of concentrated hydrochloric acid and 25 cc of water and diazotized with a solution of 13.8 g sodium nitrite. In the meantime 28 g of salicylic acid, 24 g of potassium hydroxide and 12 g of sodium carbonate are dissolved in water. The diazo suspension is added in portions to the alkaline solution of salicylic acid and the alkalinity maintained at a sufficiently high level during the whole reaction by means of addition of further quantities of potassium hydroxide solution. After 2 days the reaction mixture is heated for ½ hour at 50°C. After cooling the azo compound formed is precipitated by means of hydrochloric acid and filtered off.

References

Merck Index 8818
Kleeman & Engel p. 812
PDR pp. 830, 993, 1426, 1606
OCDS Vol. 2 p. 114 (1980)
I.N. p. 860
REM p. 1175
Askelof, E.E.A., Svartz, N. and Willstaedt, H.C.; U.S. Patent 2,396,145; March 5, 1946; assigned to A.B. Pharmacia (Sweden)

SULFINPYRAZONE

Therapeutic Function: Antiarthritic (uricosuric)

Chemical Name: 1,2-diphenyl-4-[2-(phenylsulfinyl)ethyl]-3,5-pyrazolidinedione

Common Name: —

Structural Formula:

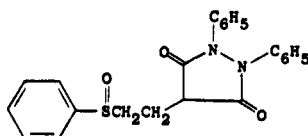

Chemical Abstracts Registry No.: 57-96-5

Trade Name	Manufacturer	Country	Year Introduced
Anturane	Geigy	U.S.	1959
Anturan	Ciga Geigy	France	1960
Antazone	I.C.N.	Canada	—
Enturen	Geigy	Italy	—
Novopyrazone	Novopharm	Canada	—
Pyrocard	Trima	Israel	—
Zynol	Horner	Canada	—

Raw Materials

Hydrazobenzene
 (β -Phenylmercaptoethyl)malonic acid diethyl ester
 Sodium
 Ethanol

Manufacturing Process

296 parts of (β -phenylmercapto-ethyl)-malonic acid diethyl ester and then 203 parts of hydrazobenzene are added while stirring to a warm sodium ethylate solution obtained from 23 parts of sodium and 400 parts by volume of absolute alcohol. About half the alcohol is then distilled off, after which 200 parts by volume of absolute xylene are gradually added without removing the inclined condenser. The temperature of the oil bath is kept at about 130°C for 12 hours while continuously stirring so that the alcohol still present and that which is liberated distills off but the xylene remains as solvent.

After cooling, 400 parts by volume of water are stirred in. The aqueous layer is separated from the xylene, shaken out twice with 40 parts by volume of chloroform and then made acid to Congo red paper with concentrated hydrochloric acid. The oil which separates is taken up in ethyl acetate and the solution obtained is washed with water. After drying over sodium sulfate the solvent is distilled off under reduced pressure and the residue is recrystallized from alcohol. 1,2-diphenyl-3,5-dioxo-4-(β -phenylmercapto-ethyl)-pyrazolidine melts at 106° to 108°C.

References

Merck Index 8828
 Kleeman & Engel p. 845
 PDR pp. 788, 830, 1606, 1999
 OCDS Vol. 1 p. 238 (1977)
 DOT 15 (2) 61 (1979)
 I.N. p. 907
 REM p. 1115
 Häfliger, F.; U.S. Patent 2,700,671; January 25, 1955; assigned to J.R. Geigy AG, Switzerland

SULFISOMIDINE

Therapeutic Function: Antibacterial

Chemical Name: 4-Amino-N-(2,6-dimethyl-4-pyrimidinyl)benzenesulfonamide

Common Name: Sulfadimetine, sulfaisodimidine, sulfasomidine

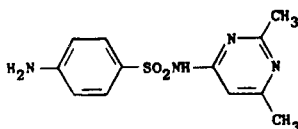
Structural Formula:**Chemical Abstracts Registry No.:** 515-64-0

Trade Name	Manufacturer	Country	Year Introduced
Elkosin	Ciba	U.S.	1951
Elosine	Ciba Geigy	France	1953
Aristamid	Nordmark	W. Germany	—
Domion	Dainippon	Japan	—
Entamidine	Nippon Shoji	Japan	—
Isosulf	A.L.	Norway	—
Sulfamethin	Chemiek. Bitterfeld	E. Germany	—

Raw Materials

6-Amino-2,4-dimethylpyrimidine	Iron
p-Nitrobenzenesulfonyl chloride	Hydrogen chloride

Manufacturing Process

This starting material can be prepared as follows. 123 parts of finely powdered 6-amino-2,4-dimethylpyrimidine are suspended in 250 parts of dry pyridine and 222 parts of p-nitrobenzenesulfonyl chloride added at 50°C to 55°C. The whole is then warmed for 2 hours to 55°C. Water is added to the crystalline aggregate obtained, the precipitated bis-N-(p-nitrobenzenesulfonyl)-6-amino-2,4-dimethylpyrimidine filtered off by suction and washed with water. It is purified by recrystallizing from methyl ethyl ketone. On slowly heating it decomposes; on rapidly heating it melts at about 210°C to 215°C with decomposition.

49.3 parts of bis-N-(p-nitrobenzenesulfonyl)-6-amino-2,4-dimethylpyrimidine are heated to boiling for one hour with 12.3 parts of 6-amino-2,4-dimethylpyrimidine in 50 parts of dry pyridine. After cooling, the 6-(p-nitrobenzenesulfonamido)-2,4-dimethylpyrimidine formed is precipitated with water and filtered off by suction. It is purified by dissolving in dilute caustic soda and precipitating with acid. On recrystallization from dilute alcohol it melts (with decomposition) at 188°C to 189°C.

On reaction, for example, with iron and hydrochloric acid, 6-(p-aminobenzenesulfonamido)-2,4-dimethylpyrimidine, melting point 236°C is obtained.

References

Merck Index 8831

Kleeman & Engel p. 846

I.N. p. 907

Hartmann, M., von Meyenburg, H. and Druey, J.; U.S. Patent 2,429,184; October 14, 1947; assigned to Ciba Pharmaceutical Products, Inc.

SULFISOXAZOLE**Therapeutic Function:** Antibacterial**Chemical Name:** 4-amino-N-(3,4-dimethyl-5-isoxazolyl)benzenesulfonamide

Common Name: Sulfafurazole

Structural Formula:

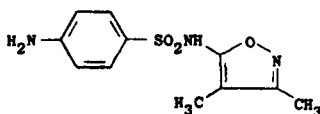

Chemical Abstracts Registry No.: 127-69-5

Trade Name	Manufacturer	Country	Year Introduced
Gantrisin	Roche	U.S.	1949
Unisulf	Lemmon	U.S.	1964
Entusul	U.S.V.	U.S.	1964
Sosol	Mc Kesson	U.S.	1970
SK-Soxazole	SKF	U.S.	1971
Soxomide	Upjohn	U.S.	1972
Sulfalar	Parke Davis	U.S.	1973
Soxo	Sutcliff/Case	U.S.	1974
Koro-Sulf	Holland Rantos	U.S.	1978
Amidoxal	Polfa	Poland	—
Azo-Gantrisin	Roche	U.S.	—
Dow-Sulfisoxazole	Dow	U.S.	—
Gansol	Abdi Ibrahim	Turkey	—
Isoxamin	Fuso	Japan	—
Novosoxazole	Novopharm	Canada	—
Pancid	Lister	Italy	—
Pediazole	Ross	U.S.	—
Sulfagan	Ohio Medical	U.S.	—
Sulfagen	Verdun	Canada	—
Sulfapolar	Farmos	Finland	—
Sulfazin	Shionogi	Japan	—
Sulfazole	Protea	Australia	—
Sulfizole	I.C.N.	Canada	—
Sulfoxol	Neopharma	Finland	—
Sulsoxin	Reid-Provident	U.S.	—
Thiasin	Yamanouchi	Japan	—
TL-Azole	Zenith	U.S.	—
Urazole	Propan-Lipworth	S. Africa	—
Urogan	Adams	Australia	—
U.S.-67	Saunders	Canada	—
V-Sul	Vanguard	U.S.	—

Raw Materials

3,4-Dimethyl-5-aminoisoxazole
 p-Acetaminobenzene sulfonic acid chloride
 Hydrogen chloride

Manufacturing Process

112 parts of 3,4-dimethyl-5-amino-isoxazole were dissolved in a mixture of 100 volume parts of pyridine and 200 volume parts of acetone. The mixture is cooled with cold water and 240 parts p-acetamino-benzene sulfonic acid chloride are added in small portions under stirring at temperatures of below 30°C. The mixture is left standing overnight at 20° to 30°C and then the 5-acetamino-benzene-sulfonylamino-3,4-dimethyl-isoxazole is precipitated by the addition of water. Recrystallized from acetic acid or alcohol it forms small prisms of the melting point 210°C.

100 parts of the 5-acetamino-benzene-sulfonyl-amino-3,4-dimethyl-isoxazole are boiled under reflux with 500 volume parts 15 to 20% aqueous hydrochloric acid for 30 to 45 minutes until all is dissolved. 500 parts crystallized sodium acetate are added and the liquid left cooling for crystallization. The sulfanilamido-3,4-dimethyl-isoxazole is sucked off, washed with water and dried. In the pure state it forms white prisms with the melting point of 193°C.

References

Merck Index 8832

Kleeman & Engel p. 837

PDR pp. 1473, 1487, 1558, 1606, 1999

OCDS Vol. 1 p. 124 (1977)

I.N. p. 900

REM p. 1175

Wuest, H.M. and Hoffer, M.; U.S. Patent 2,430,094; November 4, 1947; assigned to Hoffmann-La Roche, Inc.

SULFOXONE SODIUM

Therapeutic Function: Antibacterial (leprostatic)

Chemical Name: Disodium[sulfonylbis(p-phenylenimino)] dimethanesulfinate

Common Name: Aldesulfone sodium

Structural Formula:

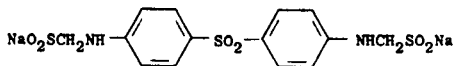

Chemical Abstracts Registry No.: 144-75-2

Trade Name	Manufacturer	Country	Year Introduced
Diasone Sodium	Abbott	U.S.	1947

Raw Materials

Diaminodiphenyl sulfone

Sodium formaldehyde sulfoxylate

Manufacturing Process

About 20 grams of diamino diphenyl sulfone is dissolved in about 500 cc of ethyl alcohol (3A made up of 5 parts methyl alcohol and 100 parts of ethyl alcohol) by placing the ingredients in a flask provided with a reflux condenser and warming over a water bath. About 24 grams of pure grade, very finely powdered (40 to 60 mesh) sodium formaldehyde sulfoxylate is then rapidly added to the alcohol solution of diamino diphenyl sulfone and the mixture refluxed in the usual manner. It was found that the mixture should be refluxed for a total of 5 hours and that a precipitate starts to form near the 3 hour period. The reaction mixture is then cooled to 15°C and kept at this temperature for about 1 hour. The precipitate formed in the filtrate is filtered off rapidly and drained as much as possible to remove mother liquor and then washed with small amounts of cold alcohol. The solid product is immediately placed in a desiccator and dried over sulfuric acid for about 20 hours.

References

Merck Index 8848

Kleeman & Engel p. 847

OCDS Vol. 1 p. 140 (1977)

I.N. p. 51

REM p. 1217

Rosenthal, S.M. and Bauer, H.; U.S. Patent 2,234,981; March 18, 1941; assigned to the U.S. Secretary of the Treasury

Raiziss, G.W., Clemence, L.R.W. and Freifelder, M.; U.S. Patent 2,256,575; September 23, 1941; assigned to Abbott Laboratories

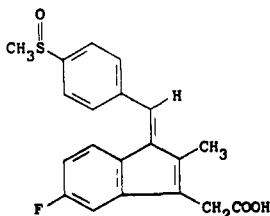
SULINDAC**Therapeutic Function:** Antiinflammatory**Chemical Name:** (Z)-5-fluoro-2-methyl-1[[4-(methylsulfinyl)phenyl]methylene]-1H-indene-3-acetic acid**Common Name:** —**Structural Formula:****Chemical Abstracts Registry No.:** 38194-50-2

Trade Name	Manufacturer	Country	Year Introduced
Imbaral	Sharp & Dohme	W. Germany	1976
Clinoril	MSD	Italy	1976
Arthrocline	Chibret	France	1977
Clinoril	MSD	U.K.	1977
Clinoril	MSD	U.S.	1978
Clinoril	Banyu	Japan	1982
Clinoril	Kyorin	Japan	1982
Aflodac	Benvegna	Italy	1982
Algocetil	Francia	Italy	—
Citireuma	C.T.	Italy	—
Lyndak	Tiber	Italy	—
Mobilin	Teva	Israel	—
Reumofil	Ausonia	Italy	—
Sudac	Errekappa	Italy	—
Sulene	Scalari	Italy	—
Sulic	Crosara	Italy	—
Sulinol	Farnex	Italy	—

Raw Materials

p-Fluorobenzaldehyde

Propionic anhydride

Hydrogen
p-Methylthiobenzaldehyde
Sodium periodate

Polyphosphoric acid
Cyanacetic acid

Manufacturing Process

The following process sequence is described in U.S. Patent 3,654,349:

p-Fluoro- α -Methylcinnamic Acid: 200 grams (1.61 mols) *p*-fluorobenzaldehyde, 3.5 grams (2.42 mols) propionic anhydride and 155 grams (1.61 mols) sodium propionate are mixed in a 1 liter three-necked flask which had been flushed with nitrogen. The flask is heated gradually in an oil-bath to 140°C. After 20 hours the flask is cooled to 100°C and the contents are poured into 8 liters of water. The precipitate is dissolved by adding 302 grams potassium hydroxide in 2 liters of water. The aqueous solution is extracted with ether, and the ether extracts washed with potassium hydroxide solution. The combined aqueous layers are filtered, acidified with concentrated HCl, filtered and the collected solid washed with water, thereby producing *p*-fluoro- α -methylcinnamic acid which is used as obtained.

p-Fluoro- α -Methylhydrocinnamic Acid: To 177.9 grams (0.987 mol) *p*-fluoro- α -methylcinnamic acid in 3.6 liters ethanol is added 11.0 grams of 5% Pd/C and the mixture reduced at room temperature under a hydrogen pressure of 40 psi. Uptake is $3\frac{1}{2}$ pounds (97% of theoretical). After filtering the catalyst, the filtrate is concentrated in vacuo to give the product *p*-fluoro- α -methylhydrocinnamic acid used without weighing in next step.

6-Fluoro-2-Methylindanone: To 932 grams polyphosphoric acid at 70°C on the steam bath is added 93.2 grams (0.5 mol) *p*-fluoro- α -methylhydrocinnamic acid slowly with stirring. This temperature is gradually raised to 95°C and the mixture kept at this temperature for 1 hour. The mixture is allowed to cool and added to 2 liters of water. The aqueous layer is extracted with ether, the ether solution washed twice with saturated sodium chloride solution, 5% Na₂CO₃ solution, water, and then dried. The ether filtrate is concentrated with 200 grams silica-gel, and added to a five pound silica-gel column packed with 5% ether-petroleum ether. The column is eluted with 5 to 10% ether-petroleum ether and followed by TLC to give 6-fluoro-2-methylindanone.

5-Fluoro-2-Methylindene-3-Acetic Acid: A mixture of 18.4 grams (0.112 mol) of 6-fluoro-2-methylindanone, 10.5 grams (0.123 mol) cyanacetic acid, 6.6 grams acetic acid and 1.7 grams ammonium acetate in 15.5 ml dry toluene is refluxed with stirring for 21 hours, as the liberated water is collected in a Dean Stark trap. The toluene is concentrated and the residue dissolved in 60 ml of hot ethanol and 14 ml of 2.2 N aqueous potassium hydroxide solution. 22 grams of 85% KOH in 150 ml of water is added and the mixture refluxed for 13 hours under N₂. The ethanol is removed under vacuum, 500 ml water added, the aqueous solution washed well with ether and then boiled with charcoal. The aqueous filtrate is acidified to pH 2 with 50% hydrochloric acid, cooled and the precipitate collected. In this way dried 5-fluoro-2-methyl-indenyl-3-acetic acid (MP 164° to 166°C) is obtained.

5-Fluoro-2-Methyl-1-(*p*-Methylthiobenzylidene)-3-Indenylacetic Acid: 15 grams (0.072 mol) 5-fluoro-2-methyl-3-indenylacetic acid, 14.0 grams (0.091 mol) *p*-methylthiobenzaldehyde and 13.0 grams (0.24 mol) sodium methoxide are heated in 200 ml methanol at 60°C under nitrogen with stirring for 6 hours. After cooling the reaction mixture is poured into 750 milliliters of ice-water, acidified with 2.5 N hydrochloric acid and the collected solid triturated with a little ether to produce 5-fluoro-2-methyl-1-(*p*-methylthiobenzylidene)-3-indenylacetic acid (MP 187° to 188.2°C).

5-Fluoro-2-Methyl-1-(*p*-Methylsulfinylbenzylidene)-3-Indenylacetic Acid: To a solution of 3.4 grams (0.01 mol) 5-fluoro-2-methyl-1-(*p*-methylthiobenzylidene)-3-indenylacetic acid in a 250 ml mixture of methanol and 100 ml acetone is added a solution of 3.8 grams (0.018 mol) of sodium periodate in 50 ml water with stirring.

450 ml water is added after 18 hours and the organic solvents removed under vacuum below

30°C. The precipitated product is filtered, dried and recrystallized from ethyl acetate to give 5-fluoro-2-methyl-1-(p-methylsulfinylbenzylidene)-3-indenylacetic acid. Upon repeated recrystallization from ethylacetate there is obtained cis-5-fluoro-2-methyl-1-(p-methylsulfinylbenzylidene)-3-indenylacetic acid (MP 184° to 186°C).

References

- Merck Index 8863
 Kleeman & Engel p. 847
 PDR p. 1147
 OCDS Vol. 2 p. 210 (1980)
 DOT 12 (2) 496 (1976)
 I.N. p. 909
 REM p. 1120
 Hinkley, D.F. and Conn, J.B.; U.S. Patent 3,647,858; March 7, 1972; assigned to Merck & Co., Inc.
 Shen, T.-Y., Greenwald, R.B., Jones, H., Linn, B.O. and Witzel, B.E.; U.S. Patent 3,654,349; April 4, 1972; assigned to Merck & Co., Inc.

SULISOBENZONE

Therapeutic Function: Ultraviolet screen

Chemical Name: 5-Benzoyl-4-hydroxy-2-methoxybenzenesulfonic acid

Common Name: —

Structural Formula:

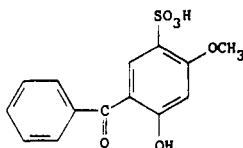

Chemical Abstracts Registry No.: 4065-45-6

Trade Name	Manufacturer	Country	Year Introduced
Uval	Dome	U.S.	1965
Cyasorb	Cyanamid	U.S.	—
Spectra-Sorb	Cyanamid	U.S.	—
Sungard	Miles	U.S.	—
Uvinul	G.A.F.	U.S.	—

Raw Materials

2-Hydroxy-4-methoxybenzophenone
 Chlorosulfonic acid

Manufacturing Process

663 g of dichloroethane and 74.6 g 2-hydroxy-4-methoxybenzophenone were charged into a 3-neck flask equipped with stirrer, thermometer, reflux condenser and dropping funnel and heating mantle. The solution was heated to the reflux temperature (85°C to 86°C) and was dehydrated by distilling off 66.5 g 1,2-dichloroethane. While maintaining at reflux, 30 g chlorosulfonic acid was added slowly over a period of about two hours. The rate of addition was

regulated by the speed of evolution of the HCl. After all the chlorosulfonic acid was added, the charge was still maintained at reflux for an additional 15 minutes to remove traces of HCl. It was then cooled to 5°C and filtered. The filter cake was washed with 500 g cold 1,2-dichloroethane and dried. 98 g of product were obtained.

References

Merck Index 8865

I.N. p. 909

Cofrancesco, A.J.; British Patent 1,136,525; December 11, 1968; assigned to General Aniline & Film Corp.

SULOCTIDIL

Therapeutic Function: Spasmolytic, vasodilator

Chemical Name: 1-(4-Isopropylthiophenyl)-2-n-octylaminopropanol

Common Name: —

Structural Formula:

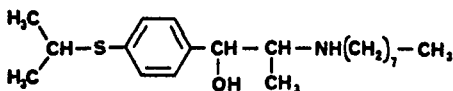

Chemical Abstracts Registry No.: 54063-56-8

Trade Name	Manufacturer	Country	Year Introduced
Suloclon	Cooper	Switz.	1978
Flavisco	Searle	France	1980
Locton	Lepetit	Italy	1980
Fluversin	Searle	W. Germany	1980
Bemperil	Sidus	Argentina	—
Cerebro	Sidus	Italy	—
Circleton	I.B.I.	Italy	—
Dulasi	Durron	Italy	—
Dulocfil	Searle	U.K.	—
Euvasal	Selvi	Italy	—
Ibisul	I.B.I.	Italy	—
Locton	Lepetit	Italy	—
Polivasal	Coli	Italy	—
Sudil	Errekappa	Italy	—
Sulc	Tosi	Italy	—
Sulodene	Alfa Farm.	Italy	—
Suloktil	Yurtoglu	Turkey	—
Sutidil	Krka	Yugoslavia	—
Tamid	Serpero	Italy	—

Raw Materials

α -Bromo-4-isopropylthiopropiophenone

n-Octylamine

Sodium borohydride

Manufacturing Process

(a) To 28.7 g of α -bromo-4-isopropylthiopropiophenone (0.1 mol) in 100 ml of isopropanol there are rapidly added 14.2 g of n-octylamine while stirring, and then the mixture is brought to 80°C for 1 hour. The solvent is evaporated under vacuum, the residue is diluted with 1 liter of ether and is left to stand overnight in the refrigerator. The precipitate obtained is filtered and dried. There are thus obtained 25 g of α -n-octylamino-4-isopropylthiopropiophenone hydrobromide. Yield: 60%; melting point: 162°C to 164°C.

(b) 41.6 g of the preceding product (0.1 mol) in 200 ml of methanol are cooled in an ice bath to 0°C. There is added drop by drop while stirring a solution of 4.1 g of NaBH₄ in 50 ml of water and 2 ml of 5% NaOH. Next, the mixture is stirred for 2 hours at room temperature. The methanol is evaporated under vacuum, diluted with 200 ml of water and extracted with methylene chloride or ether. The organic phase is dried on MgSO₄ and the solvent is evaporated under vacuum. The oily residue obtained solidifies rapidly and is recrystallized in pentane. 33.2 g are thus obtained. Yield: 90%; melting point: 62°C to 63°C.

References

Merck Index 8870

Kleeman & Engel p. 849

OCDS Vol. 3 p. 26 (1984)

DOT 13 (3) 107 (1977)

I.N. p. 910

Lambelin, G.E., Gillet, C.L. and Roba, J.L.; U.S. Patent 4,228,187; October 14, 1980; assigned to Continental Pharma

SULPIRIDE

Therapeutic Function: Tranquilizer; digestive aid

Chemical Name: 5-(aminosulfonyl)-N-[(1-ethyl-2-pyrrolidinyl)methyl]-2-methoxybenzamide

Common Name: —

Structural Formula:

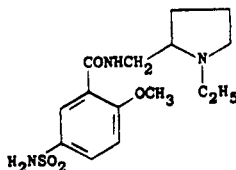

Chemical Abstracts Registry No.: 15676-16-1

Trade Name	Manufacturer	Country	Year Introduced
Dogmatil	Delagrangre	France	1969
Dogmatil	Schurholz	W. Germany	1972
Dogmatil	Delagrangre	Italy	1972
Dogmatil	Delagrangre	Switz.	1972
Dogmatil	Fujisawa	Japan	1973
Dogmatil	Squibb	U.K.	1983
Abilit	Sumitomo	Japan	—
Betamac	Sawai	Japan	—

Trade Name	Manufacturer	Country	Year Introduced
Chamionil	Vita	Italy	--
Coolspan	Hishiyama	Japan	--
Digton	Areu	Spain	--
Dobren	Ravizza	Italy	--
Eglonyl	Alkaloid	Yugoslavia	--
Equilid	Lepetit	Italy	--
Eusulpid	C.T.	Italy	--
Guastil	Uriach	Spain	--
Isnamide	Isardi	Italy	--
Kapiride	Kappa	Spain	--
Lavodina	Turro	Spain	--
Lusedan	Bryan	Spain	--
Meresa	Dolorgiet	W. Germany	--
Miradol	Mitsui	Japan	--
Misulvan	Bernabo	Argentina	--
Modal	Rafa	Israel	--
Neogama	Hormosan	W. Germany	--
Neuromyfar	Emyfar	Spain	--
Normum	Serpero	Italy	--
Omperan	Taiho	Japan	--
Paratil	Medica	Finland	--
Psicosen	Centrum	Spain	--
Pyrikappl	Isei	Japan	--
Quiridil	Zoja	Italy	--
Sato	Scharper	Italy	--
Seeglu	Teikoku	Japan	--
Sicofrenol	Basileos	Spain	--
Sulpiril	Leiras	Finland	--
Sulpisidan	Llano	Spain	--
Suprium	Orion	Finland	--
Sursumid	Sarm	Italy	--
Tepavil	Prodes	Spain	--
Tonofit	Europa	Spain	--
Trilan	Esseti	Italy	--
Ulpir	Lesvi	Spain	--
Vipral	Roemmers	Argentina	--

Raw Materials

- 1-Ethyl-2-aminomethylpyrrolidine
- 2-Methoxy-5-sulfamylbenzoic acid

Manufacturing Process

1-Ethyl-2-aminomethylpyrrolidine is reacted with 2-methoxy-5-sulfamoylbenzoic acid to give sulpiride.

References

- Merck Index 8875
- Kleeman & Engel p. 849
- OCDS Vol. 2 p. 94 (1980)
- DOT 9 (6) 244 (1973)
- I.N. p. 911
- Miller, C.S., Engelhardt, E.L. and Thominet, M.L.: U.S. Patent 3,342,826; Sept. 19, 1967; assigned to Societe d'Etudes Scientifiques et Industrielles de l'Île-de-France, France

SULPROSTONE

Therapeutic Function: Fertility control

Chemical Name: N-Methanesulfonyl-9-oxo-11 α ,15 α -dihydroxy-5-cis-13-trans-16-phenoxy- ω -tetranorprostadienamide

Common Name: —

Structural Formula:

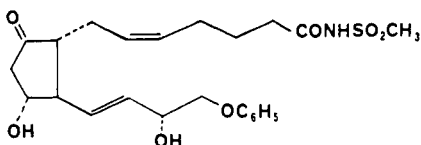

Chemical Abstracts Registry No.: 60325-46-4

Trade Name	Manufacturer	Country	Year Introduced
Nalador	Schering	W. Germany	1981
Nalador	Schering	Switz.	1983

Raw Materials

(4-Carbohydroxy-*n*-butyl)triphenylphosphonium bromide
 Sodium methylsulfinylmethide
 2-[5 α -Hydroxy-3 α -(tetrahydropyran-2-yloxy)-2 β -(3 α -tetrahydropyran-2-yloxy-4-phenoxy-trans-1-buten-1-yl)cyclopent-1 α -yl] acetaldehyde α -hemiacetal
 Chromic anhydride
 Methanesulfonyl isocyanate
 Acetic acid

Manufacturing Process

9 α -Hydroxy-11 α ,15 α -bis-(tetrahydropyran-2-yloxy)-16-phenoxy-cis-5-trans-13- ω -tetranorprostadienoic acid: To a solution of 1.6 g (3.6 mmols) (4-carbohydroxy-*n*-butyl)triphenylphosphonium bromide in a dry nitrogen atmosphere in 6.0 ml dry dimethyl sulfoxide was added 3.24 ml (6.5 mmols) of a 2.0M solution of sodium methylsulfinylmethide in dimethyl sulfoxide. To this red ylide solution was added dropwise a solution of 613 mg (1.29 mmols) 2-[5 α -hydroxy-3 α -(tetrahydropyran-2-yloxy)-2 β -(3 α -tetrahydropyran-2-yloxy-4-phenoxy-trans-1-buten-1-yl)cyclopent-1 α -yl] acetaldehyde, γ -hemiacetal in 5.0 ml dry dimethyl sulfoxide over a period of 20 minutes.

After an additional 2 hours stirring at room temperature, the reaction mixture was poured onto ice water. The basic aqueous solution was washed twice with ethyl acetate (20 ml) and acidified to pH 3 with 10% aqueous hydrochloric acid.

The acidic solution was extracted with ethyl acetate (3 x 20 ml) and the combined organic extracts washed once with water (10 ml), dried (MgSO₄) and evaporated to a solid residue. This solid residue was triturated with ethyl acetate and the filtrate concentrated. Yield: 754 mg of 9 α -hydroxy-11 α ,15 α -bis-(tetrahydropyran-2-yloxy)-16-phenoxy-cis-5-trans-13- ω -tetranorprostadienoic acid was collected.

9-Oxo-11 α ,15 α -bis-(tetrahydropyran-2-yloxy)-16-phenoxy-cis-5-trans-13- ω -tetranorprostadienoic acid: To a solution cooled to -10°C under nitrogen of 754 mg (1.3 mmols) 9 α -hydroxy-11 α ,15 α -bis-(tetrahydropyran-2-yloxy)-16-phenoxy-cis-5-trans-13- ω -tetranorprostadienoic acid in 13 ml reagent grade acetone was added dropwise to 0.56 ml (1.41 mmols) of Jones' reagent (chromic anhydride). After 20 minutes at -10°C, 0.260 ml 2-propanol was

added and the reaction mixture was allowed to stir an additional 5 minutes at which time it was combined with 75 ml ethyl acetate, washed with water (3 x 10 ml), dried ($MgSO_4$) and concentrated to give 752 mg of 9-oxo-11 α ,15 α -bis-(tetrahydropyran-2-yloxy)-16-phenoxy-cis-5-trans-13- ω -tetranorprostadienoic acid, which was chromatographed on silica gel using ethyl acetate as eluent to afford 505 mg of pure intermediate.

N-Methanesulfonyl-9-oxo-11 α ,15 α -dihydroxy-5-cis-13-trans-16-phenoxy- ω -tetranorprostadienamido: To 1.0 mmols of 9-oxo-11 α ,15 α -bis-(tetrahydropyran-2-yloxy)-16-phenoxy-cis-5-trans-13- ω -tetranorprostadienoic acid in 40 ml THF is added 2 ml triethylamine. After 15 minutes of stirring at room temperature 10.0 ml of 0.1 M methanesulfonylisocyanate in THF is added. After a further 1 hour of stirring, the reaction mixture is neutralized with acetic acid and the solvent removed by evaporation (in vacuo). The resultant residue is taken up in methylene chloride and washed successively with water and sodium bicarbonate to yield, after drying and solvent evaporation, *N*-methanesulfonyl-9-oxo-11 α ,15 α -bis-(tetrahydropyran-2-yloxy)-16-phenoxy-cis-5-trans-13- ω -tetranorprostadienamido. This intermediate is then hydrolyzed overnight with acetic acid/water and purified by column chromatography to give the desired *N*-methanesulfonyl-9-oxo-11 α ,15 α -dihydroxy-5-cis-13-trans-16-phenoxy- ω -tetranorprostadienamido.

References

Merck Index 8877

DFU 3 (1) 59 (1978)

OCDS Vol. 3 p. 9 (1984)

DOT 18 (7) 331 (1982)

I.N. p. 911

Bindra, J.S. and Johnson, M.R.; U.S. Patents 4,024,179; May 17, 1977; and 4,244,887; January 13, 1981; both assigned to Pfizer, Inc.

SULTOPRIDE HYDROCHLORIDE

Therapeutic Function: Neuroleptic

Chemical Name: N-(1-Ethyl-2-pyrrolidylmethyl)-2-methoxy-5-ethylsulfonylbenzamide hydrochloride

Common Name: —

Structural Formula:

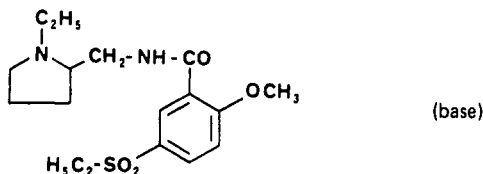

Chemical Abstracts Registry No.: 53583-79-2 (Base)

Trade Name	Manufacturer	Country	Year Introduced
Barnetil	Delagrang	France	1976
Barnotil	Vita	Italy	1983
Topral	Alkaloid	Yugoslavia	—

Raw Materials

N-Ethyl- α -aminomethylpyrrolidine
 Phosphorus trichloride
 2-Methoxy-5-ethylsulfonylbenzoic acid

Manufacturing Process

A solution of 17.22 g of N-ethyl- α -aminomethylpyrrolidine in 360 ml of pyridine is placed in a 1 l balloon flask. A solution of 3.51 g of phosphorus trichloride in 40 ml of pyridine is added at ambient temperature. After the mixture has been stirred for 1 hour, 10 g of 2-methoxy-5-ethylsulfonylbenzoic acid is introduced. The mixture is heated under reflux for 4½ hours. After cooling, the solvent is evaporated under vacuum and the residue is dissolved in 200 ml of 20% sodium hydroxide. The solution is extracted with 200 ml of chloroform.

The organic solution is dried and filtered and the solvent is evaporated under vacuum; the residue is dissolved in 150 ml of ethanol and the solution is acidified with hydrochloric acid. The hydrochloride is dried without heating and recrystallized from 100 ml of absolute ethanol. 7.2 g of N-(1-ethyl-2-pyrrolidyl-methyl)-2-methoxy-5-ethylsulfonylbenzamide hydrochloride is produced. Melting point: 190°C to 193°C.

References

Merck Index 8879
 DFU 1 (2) 83 (1976)
 Kleeman & Engel p. 851
 DOT 13 (4) 154 (1977)
 I.N. p. 911
 Societe D'Etudes Scientifiques et Industrielles de L'Ile-de-France; British Patent 1,394,559;
 May 21, 1975

SULTOSILIC ACID PIPERAZINE SALT

Therapeutic Function: Hypolipemic

Chemical Name: 2-Hydroxy-5-[[[4-methyl(phenyl)sulfonyl]oxy] benzenesulfonic acid, piperazine salt

Common Name: —

Structural Formula:

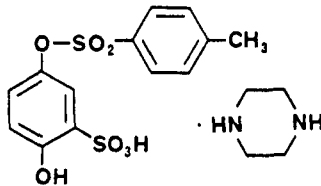

Chemical Abstracts Registry No.: 57775-27-6; 57775-26-5 (Free acid)

Trade Name	Manufacturer	Country	Year Introduced
Mimedran	Esteve	Spain	1982

Raw Materials

2,5-Dihydroxybenzenesulfonic acid	Tosyl chloride
Pyridine	Piperazine

Manufacturing Process

The monotosylation of 2,5-dihydroxybenzenesulfonic acid is carried out in a pyridine medium by treating it with tosyl chloride, thus preferably isolating the 2-hydroxy-5-tosyloxybenzenesulfonic acid, pyridine salt. This product subjected to reflux with an alcoholic solution of piperazine yields 2-hydroxy-5-tosyloxybenzenesulfonic acid, piperazine salt.

References

DFU 6 (11) 688 (1981)

Esteve-Subirana, A.; U.S. Patent 3,954,767; May 4, 1976

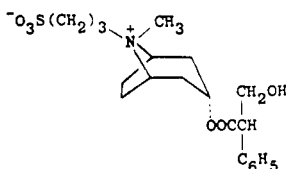
SULTROPONIUM**Therapeutic Function:** Antispasmodic**Chemical Name:** Endo(±)-3-(3-hydroxy-1-oxo-2-phenylpropoxy)-8-methyl-8-(3-sulfopropyl)-8-azoniabicyclo[3.2.1]octane hydroxide, inner salt**Common Name:** —**Structural Formula:****Chemical Abstracts Registry No.:** 15130-91-3

Trade Name	Manufacturer	Country	Year Introduced
Sultroponium-B	Biotherax	France	1970

Raw Materials

Atropine
Propane-1,3-sultone

Manufacturing Process

To a cold solution of 29 g of atropine in 250 ml of acetone a solution of 13 g of propane-1,3-sultone in 100 ml of acetone is generally added. The combined solution is left for 48 hours. The white precipitate of fine crystalline needles is separated, washed several times with acetone, and then recrystallized from ethanol. It melts at 220°C.

References

Merck Index 8880

Kleeman & Engel p. 851

DOT 6 (3) 97 (1970)

I.N. p. 912

Raudnitz, J.P.M. and Wahl, H.; British Patent 1,082,445; September 6, 1967

SYROSINGOPINE

Therapeutic Function: Antihypertensive

Chemical Name: 18-[[4-[(Ethoxycarbonyl)oxy]-3,5-dimethoxybenzoyl]oxy]-11,17-dimethoxyyohimban-16-carboxylic acid methyl ester

Common Name: —

Structural Formula:

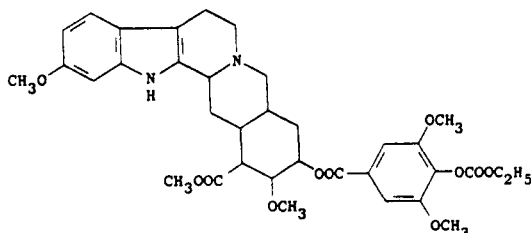

Chemical Abstracts Registry No.: 84-36-6

Trade Name	Manufacturer	Country	Year Introduced
Singoserp	Ciba	U.S.	1958
Syringia	Toyo Jozo	Japan	1975
Aurugopin	Nisshin	Japan	—
Elumonon	Tatsumi	Japan	—
Hipotensor Zambe	Zambeletti	Italy	—
Neoreserpan	Panthox & Burck	Italy	—
Nichiserpine-S	Nichiiko	Japan	—
Novoserpina	Ghimas	Italy	—
Raunova	Zambeletti	Italy	—
Rosidil	Nippon Chemiphar	Japan	—
Siroshuten	Isei	Japan	—
Tesamurin	Zensei	Japan	—

Raw Materials

Methyl reserpate
O-Carboethoxysyringoyl chloride

Manufacturing Process

1 part by weight of methyl reserpate and 1.9 parts by weight of O-carboethoxysyringoyl chloride were dissolved in 20 parts by volume of anhydrous pyridine and allowed to stand at 5°C for 3 days. An equal volume of ice was then added, and the mixture evaporated to dryness in vacuo. The residue was dissolved in 50 parts by volume of chloroform and washed in succession with three 50 parts by volume portions of 2% sodium hydroxide solution and two 50 parts by volume portions of water. The chloroform solution was dried over sodium sulfate and evaporated to dryness. The residue was dissolved in 15 parts by volume of benzene and chromatographed on a 10 part by weight column of II-III grade alumina. Eluates of benzene, 90 benzene: 10 acetone, 80 benzene: 20 acetone, 60 benzene: 40 acetone; and acetone were removed. From the 90 benzene: 10 acetone eluate there was recovered crystalline methyl O-(O'-carboethoxysyringoyl)-reserpate, melting point 175°C to 178°C, on crystallization from acetone.

References

Merck Index 8901

Kleeman & Engel p. 853

OCDS Vol. 1 p. 319 (1977)

I.N. p. 917

Lucas, R.A.; U.S. Patent 2,813,871; November 19, 1957; assigned to Ciba Pharmaceutical Products, Inc.

T

TALAMPICILLIN

Therapeutic Function: Antibacterial

Chemical Name: (2S)-6-[(aminophenylacetyl)amino]-3,3-dimethyl-7-oxo-4-thia-1-azabicyclo-[3.2.0]heptane-2-carboxylic acid 1,3-dihydro-3-oxo-1-isobenzofuranyl ester

Common Name: Phthalidyl-D- α -aminobenzylpenicillanate

Structural Formula:

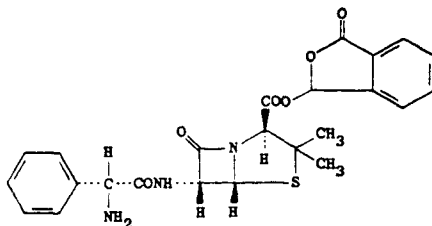

Chemical Abstracts Registry No.: 47747-56-8; 39878-70-1 (Hydrochloride)

Trade Name	Manufacturer	Country	Year Introduced
Talpen	Beecham	U.S.	1975
Yamacillin	Yamanouchi	Japan	1977
Talampicillina	Midy	Italy	1980
Talat	Polifarma	Italy	—
Talmen	Prodes	Spain	—

Raw Materials

Ampicillin
3-Bromophthalide

Manufacturing Process

A fine suspension of 25.18 grams (0.05 mol) of potassium salt of enamine protected ampicillin and 10.65 grams (0.05 mol) 3-bromophthalide were reacted in a 1:2 mixture of acetone/ethyl acetate (1,500 ml) for 24 hours. After filtration the organic layer was washed twice with 250 ml portions of 1N sodium bicarbonate and brine, dried over anhydrous magnesium sulfate and concentrated in vacuo. Addition of ether crystallized the phthalide enamine protected α -aminophenylacetamido penicillanate in 85% yield.

The enamine protecting group was removed by dissolving 10 grams in aqueous acetone (250 ml water to 250 ml acetone) and vigorously stirring this solution at pH 2.5 for 1 hour. The acetone was removed in vacuo and the ester, which was salted out of the aqueous phase as a sticky yellow gum, was dissolved in ethyl acetate (200 ml) and washed twice with 200 ml portions of 1N sodium bicarbonate and brine and dried over anhydrous magnesium sulfate. Careful addition of dry ester (about 50 ml) to the dry ethyl acetate layer

yielded the ampicillin phthalide ester as hydrochloric salt as a fine white amorphous solid in 80% yield.

References

Merck Index 8912

Kieeman & Engel p. 854

OCDS Vol. 2 p. 438 (1980)

DOT 12 (7) 283 (1976) & 15 (8) 349 (1979)

I.N. p. 919

REM p. 1201

Ferres, H.; U.S. Patent 3,860,579; January 14, 1975; assigned to Beecham Group Limited, England

Murakami, M., Isaka, I., Kashiwagi, T., Matsui, H., Nakano, K., Takahashi, K., Horiguchi, H. and Koda, A.; U.S. Patent 3,951,954; April 20, 1976; assigned to Yamanouchi Pharmaceutical Co., Ltd., Japan

TALNIFLUMATE

Therapeutic Function: Antiinflammatory, analgesic

Chemical Name: 2-[[3-(Trifluoromethyl)phenyl] amino]-3-pyridine carboxylic acid 1,3-dihydro-3-oxo-1-isobenzofuranyl ester

Common Name: —

Structural Formula:

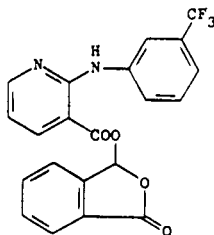

Chemical Abstracts Registry No.: 66898-62-2

Trade Name	Manufacturer	Country	Year Introduced
Somalgen	Bago	Argentina	1972

Raw Materials

2-(3'-Trifluoromethylanilino)nicotinic acid

3-Bromophthalide

Manufacturing Process

49 ml of triethylamine were added to a suspension of 2-(3'-trifluoromethylanilino)nicotinic acid (70.6 g in 250 ml of dimethylformamide). After stirring for 30 minutes 53.3 g of 3-bromophthalide were added. The reaction mixture was maintained at 25°C to 30°C during 4 hours. Ethyl acetate (750 ml) was poured into the reaction mixture. This solution was filtered and extracted with water (4 X 250 ml), discarding the water layer.

The organic layer was dried with anhydrous magnesium sulfate and then filtered. The solution was concentrated under vacuum at 30°C to 35°C until reduced to half of its original volume and then cooled to 5°C to allow the crystallization of the compound. Thus, the cake was filtered, washed with cool ethyl acetate, and dried under vacuum. Yield: 74% (76.7 g) of phthalidyl ester of 2-(3'-trifluoromethylanilino)-pyridin-3-carboxylic acid, melting point: 165°C to 167°C.

References

- Merck Index 8921
 DFU 4 (6) 448 (1979)
 OCDS Vol. 3 p. 146 (1984)
 DOT 19 (7) 99 (1983)
 I.N. p. 919
 Bago, S.; U.S. Patent 4,168,313; September 18, 1979

TAMOXIFEN

Therapeutic Function: Antiestrogen, antineoplastic

Chemical Name: 2-[4-(1,2-Diphenyl-1-butenyl)phenoxy]-N,N-dimethylethanamine

Common Name: —

Structural Formula:

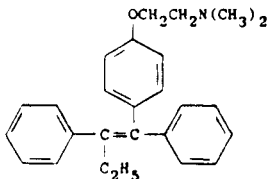

Chemical Abstracts Registry No.: 10540-29-1; 54965-24-1 (Citrate)

Trade Name	Manufacturer	Country	Year Introduced
Nolvadex	I.C.I.	U.K.	1973
Nolvadex	I.C.I.	W. Germany	1976
Nolvadex	I.C. Pharma	Italy	1976
Nolvadex	I.C.I.	France	1977
Nolvadex	I.C.I.	Switz.	1978
Nolvadex	Stuart	U.S.	1978
Nolvadex	Sumitomo	Japan	1981
Tamofen	Rhone-Poulenc	—	—
Valodex	Abic	Israel	—

Raw Materials

- Bromobenzene
 Magnesium
 4-(β-Dimethylaminoethoxy)-α-ethyldeoxybenzoin

Manufacturing Process

To the Grignard reagent prepared from 0.59 part of magnesium, 3.95 parts of bromobenzene

and 50 parts of ether there are added 7.5 parts of 4-(β -dimethylaminoethoxy)- α -ethyldeoxybenzoin in 50 parts of ether. After heating under reflux for 3 hours, the mixture is decomposed by the addition of a solution of 60 parts of ammonium chloride in 150 parts of water. The mixture is separated, and the ethereal layer is dried with anhydrous sodium sulfate, and the ether is evaporated. The residue is crystallized from methanol. There is thus obtained 1-(p - β -dimethylaminoethoxyphenyl)-1,2-diphenylbutan-1-ol, melting point 120°C to 121°C.

2.15 parts of 1-(p - β -dimethylaminoethoxyphenyl)-1,2-diphenylbutan-1-ol, 25 parts of ethanol and 0.8 part of 10N hydrochloric acid are heated together under reflux for 3 hours. The solution is evaporated to dryness under reduced pressure and the residue is extracted with methylene chloride. The methylene chloride extract is decolorized with charcoal and then evaporated to dryness. The residue is dissolved in 100 parts of water, the solution is basified by the addition of sodium hydroxide solution, and the precipitated solid is extracted three times, each time with 50 parts of ether. The combined extracts are dried with anhydrous sodium sulfate and then evaporated. The residue is crystallized from aqueous methanol, and there is thus obtained 1-(p - β -dimethylaminoethoxyphenyl)-1,2-diphenylbut-1-ene, melting point 95°C to 96°C.

References

Merck Index 8923

Kleeman & Engel p. 854

PDR p. 1783

OCDS Vol. 2 p. 127 (1980) & 3, 70 (1984)

DOT 10 (2) 71 (1974)

I.N. p. 920

REM p. 990

Harper, M.J.K., Richardson, D.N. and Walpole, A.L.; British Patent 1,013,907; December 22, 1965; assigned to Imperial Chemical Industries, Ltd. (U.K.)

TANPHETAMIN

Therapeutic Function: Antiobesity drug

Chemical Name: d-Amphetamine tannate

Common Name: Dexamphetamine tannate

Structural Formula: A complex of amphetamine, $C_6H_5CH_2CH(CH_3)NH_2$ and tannic acid

Chemical Abstracts Registry No.: 1407-85-8

Trade Name	Manufacturer	Country	Year Introduced
Synatan	Neisler	U.S.	1955
Obotan	Mallinckrodt	U.S.	—
Proptan	Irwin, Neisler	U.S.	—

Raw Materials

d-Amphetamine
Tannic acid

Manufacturing Process

Approximately 75 grams of d-amphetamine as a free base was dissolved in 300 ml of isopropanol (solution A). Approximately 200 grams of NF tannic acid was dissolved in 700

milliliters of slightly warmed isopropanol (solution B). Solution B was poured, with rapid stirring, into solution A to provide an almost immediate precipitation of the insoluble tannate complex. The solution was cooled to room temperature and the product filtered off and dried. During the filtration, most of the isopropanol was removed by washing with acetone, and the precipitate dried at 140°F to yield a light tan product. The amount of precipitate was approximately 200 grams of tannate salt but more could be obtained by concentration of the mother liquors.

References

Merck Index 8930

I.N. p. 301

Cavallito, C.J.; U.S. Patent 2,950,309; August 23, 1960; assigned to Irwin, Neisler and Company

TEGAFUR

Therapeutic Function: Antineoplastic

Chemical Name: 1-(Tetrahydro-2-furanyl)-5-fluorouracil

Common Name: Ftorafur

Structural Formula:

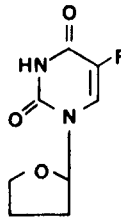

Chemical Abstracts Registry No.: 17902-23-7

Trade Name	Manufacturer	Country	Year Introduced
Futraful	Taiho	Japan	1974
Ftorafur	Gruenthal	W. Germany	1977
Citofur	Lusofarmaco	Italy	1981
Futraful	Simes	Italy	1981
Coparogin	Nippon Chemiphar	Japan	—
Daiyalose	Daito	Japan	—
Exonal	Toyama	Japan	—
Fental	Kanebo	Japan	—
F.H.	Mitsui	Japan	—
Filacul	Torii	Japan	—
Flopholin	Tsuruhara	Japan	—
Franroze	Hishiyama	Japan	—
Ftoral	Abic	Israel	—
F.T.R.	Tenyosha	Japan	—
Fulaid	Takeda	Japan	—
Fulfeel	Kyorin	Japan	—
Furofluor	Green Cross	Japan	—
Furofutran	Taiyo	Japan	—
Futraful Zupo	Taiho	Japan	—

Trade Name	Manufacturer	Country	Year Introduced
Geen	Tatumi	Japan	—
Helpa	Teikoru	Japan	—
Icalus	Isei	Japan	—
Lamar	Tokyo Tanabe	Japan	—
Lifril	Kissei	Japan	—
Lunacin	Sawai	Japan	—
Natira	Mohan	Japan	—
Neberk	Fuji	Japan	—
Nitobanil	Ohta	Japan	—
Pharmic	Toyo	Japan	—
Rescrel	Nikken	Japan	—
Richina	Taiyo	Japan	—
Riol	Toa Eiyo	Japan	—
Sinoflurol	Kaken	Japan	—
Sunfural	Toyo Jozo	Japan	—
Tefsiel	Towa	Japan	—
THF-FU	Taiho	Japan	—
Utefos	Almirall	Spain	—
Videcocan	Unifa	Argentina	—
Youfural	Showa	Japan	—

Raw Materials

2,4-Bis(trimethylsilyl)-5-fluorouracil	2,3-Dihydrofuran
Ammonia	5-Fluorouracilmercury
2-Chlorofuranidin	

Manufacturing Process

One process from U.S. Patent 4,107,162: 27.4 g of 2,4-bis(trimethylsilyl)-5-fluorouracil and 7.7 g of 2,3-dihydrofuran are dissolved in 70 ml of acetonitrile, and 30 ml of an acetonitrile solution containing 1.3 g of anhydrous stannic chloride are added thereto with cooling and stirring. 50 ml of acetonitrile containing 1.3 ml of water dissolved therein are then dropwise added over 15 minutes. After return to room temperature, the reaction is further effected with stirring at 40°C for 5 hours. The reaction mixture is neutralized by adding 1 N aqueous ammonia with cooling and stirring (conversion 83%). After the nondissolved substances are removed by filtration, the filtrate is concentrated and dried under reduced pressure. 100 ml of water and 300 ml of dichloromethane are added to the residue to completely dissolve the residue by stirring. The obtained dichloromethane layer is separated. The water layer is subjected to extraction twice with dichloromethane. The thus obtained extracts are combined with the separated dichloromethane layer and the combined extracts, after drying with anhydrous magnesium sulfate, are concentrated and dried. The obtained residue is dissolved in ethanol, and the nondissolved substances are removed by filtration. The filtrate is subjected to recrystallization to give white crystals, followed by further recrystallization of the mother liquor. There are totally obtained 15.6 g of N₁-(2'-furanidyl)-5-fluorouracil. Yield: 78% of theory, with respect to 2,4-bis(trimethylsilyl)-5-fluorouracil.

An alternative process from U.S. Patent 3,635,946: A vigorously stirred reaction mixture consisting of 32.87 g (0.1 mol) of 5-fluorouracilmercury, 100 ml of dimethylformamide and 50 ml of toluene is dried by azeotropic distillation of toluene. It is then cooled to -40°C in a stream of dry nitrogen, and a solution of 21.3 g (0.2 mol) of 2-chlorofuranidin in 20 ml of dried dimethylformamide is gradually added to the stirred mixture, the temperature being maintained between -40°C and -30°C. After completion of the reaction (which is marked by complete dissolution of the starting 5-fluorouracilmercury) i.e. after about 3 to 4 hours, 60 to 80 ml of the solvent are distilled off in vacuo at a bath temperature not exceeding 35°C; 50 to 70 ml of dry acetone are then added and also vacuum distilled. The residue is easily crystallized. It is collected, washed three times with small quantities of ethanol—10 ml each—and air-dried. 12.2 g of N₁-(2'-furanidyl)-5-fluorouracil are obtained in the form of white crystal-

fine solids; melting point 160°C to 162°C. Additional treatment of the mother liquor yields 3.0 g more of the product. Yield: 75% of theory, based on the starting 5-fluorouracilmercury.

After recrystallization from ethanol, 14.3 g of N₁-(2'-furanidyl)-5-fluorouracil are obtained, MP 164°C to 165°C.

References

Merck Index 8963

Kleeman & Engel p. 855

OCDS Vol. 3 p. 155 (1984)

I.N. p. 923

Townsend, L.B., Earl, R.A. and Manning, S.J.; U.S. Patent 3,960,864; June 1, 1976; assigned to The University of Utah

Giller, S.A., Zhuk, R.A., Lidak, M.J. and Zidermane, A.A.; U.S. Patent 3,635,946; Jan. 18, 1972

Suzuki, N., Kobayashi, Y., Hiyoshi, Y., Takagi, S., Sone, T., Wakabayashi, M. and Sowa, T.; U.S. Patent 4,107,162; August 15, 1978; assigned to Asahi Kasei Kogyo K.K. (Japan)

TEMAZEPAM

Therapeutic Function: Tranquilizer

Chemical Name: 7-chloro-1,3-dihydro-3-hydroxy-1-methyl-5-phenyl-2H-1,4-benzodiazepin-2-one

Common Name: —

Structural Formula:

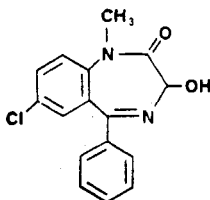

Chemical Abstracts Registry No.: 846-50-4

Trade Name	Manufacturer	Country	Year Introduced
Levanxol	Carlo Erba	Italy	1970
Euhypnos	Montedison	U.K.	1977
Normison	Wyeth	U.K.	1977
Restoril	Sandoz	U.S.	1981
Planum	Carlo Erba	W. Germany	1981
Normison	Wyeth Byla	France	1981
Euhypnos	Farmitalia	France	1981
Normison	Wyeth	Switz.	1983
Planum	Carlo Erba	Switz.	1983
Mabertin	Sidus	Argentina	—
Maeva	Ravizza	Italy	—
Signopam	Polfa	Poland	—

Raw Materials

3-Acetoxy-7-chloro-1-methyl-5-phenyl-1,3-dihydro-2H-1,4-benzodiazepin-2-one
Sodium hydroxide

Manufacturing Process

According to British Patent 1,022,645 3.4 g of 3-acetoxy-7-chloro-1-methyl-5-phenyl-1,3-dihydro-2H-1,4-benzodiazepin-2-one suspended in 80 ml alcohol was treated with 6 ml of 4 N NaOH. After complete solution had taken place, a solid precipitated; this solid was redissolved by the addition of 80 ml of water. The solution was acidified with acetic acid to give white crystals which were recrystallized from alcohol to yield 7-chloro-3-hydroxy-5-phenyl-1-methyl-1,3-dihydro-2H-1,4-benzodiazepin-2-one, MP 119° to 121°C.

References

Merck Index 8976

Kleeman & Engel p. 856

PDR p. 1591

OCDS Vol. 2 p. 402 (1980)

DOT 6 (6) 224 (1970) & 9 (6) 238 (1973)

I.N. p. 923

REM p. 1064

American Home Products Corporation; British Patent 1,022,642; March 16, 1966

American Home Products Corporation; British Patent 1,022,645; March 16, 1966

Bell, S.C.; British Patent 1,057,492; February 1, 1967; assigned to American Home Products Corporation

TENIPOSIDE

Therapeutic Function: Antineoplastic

Chemical Name: 4'-Demethylepipodophyllotoxin- β -D-thenylidene glucoside

Common Name: —

Structural Formula:

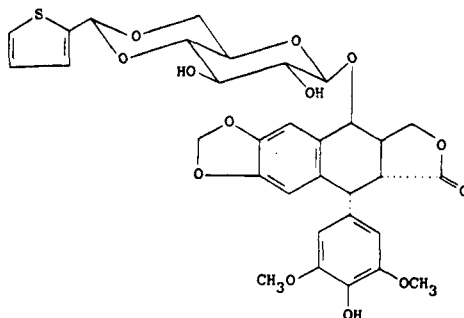

Chemical Abstracts Registry No.: 29767-20-2

Trade Name	Manufacturer	Country	Year Introduced
Vehem	Sandoz	France	1976
Vumon	Bristol	W. Germany	1980
Vumon	Bristol	Switz.	1980
Vumon	Bristol	Italy	1982

Raw Materials

4'-Demethylepipodophyllotoxin- β -D-glucoside
Thiophene-2-aldehyde

Manufacturing Process

10 ml of pure thiophene-2-aldehyde and 0.25 g of anhydrous zinc chloride are added to 0.5 g of dried 4'-demethylepipodophyllotoxin- β -D-glucoside and the mixture is shaken on a machine at 20°C in the absence of moisture, whereupon a clear solution is gradually obtained. The course of condensation is checked by thin layer chromatography. After a reaction period of 3 to 4 hours the solution is diluted with chloroform and shaken out with water. The chloroform phase is washed twice more with a small amount of water and then dried over sodium sulfate and concentrated by evaporation. Excess thiophene-2-aldehyde is removed by dissolving the resulting residue in a small amount of acetone and reprecipitation is effected by adding pentane.

Reprecipitation from acetone/pentane is repeatedly effected until the condensation product suits in flaky form. Further purification is effected in that the crude product is chromatographed on silica gel. The fractions which are uniform in accordance with thin layer chromatography are combined and yield crystals from absolute alcohol. Pure 4'-demethylepipodophyllotoxin- β -D-thenylidene glucoside has a melting point of 242°C to 246°C (last residue up to 255°C).

References

Merck Index 8978

Kleeman & Engel p. 857

DOT 12 (11) 465 (1976) & 16 (5) 170 (1980)

I.N. p. 924

REM p. 1156

Keller-Juslen, C., Kuhn, M., Renz, J. and von Wartburg, A.; U.S. Patent 3,524,844; Aug. 18, 1970; assigned to Sandoz, Ltd. (Switz.)

TERBUTALINE

Therapeutic Function: Bronchodilator

Chemical Name: 1-(3',5'-Dihydroxyphenyl)-2-(t-butylamino)-ethanol

Common Name: —

Structural Formula:

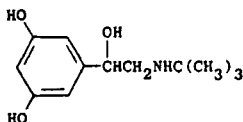

Chemical Abstracts Registry No.: 23031-25-6; 23031-32-5 (Sulfate)

Trade Name	Manufacturer	Country	Year Introduced
Bricanyl	Pharma-Stern	W. Germany	1971
Bricanyl	Astra	U.K.	1971
Bricanyl	Lematte-Boinot	France	1973
Bricanyl	Astra	U.S.	1974

Trade Name	Manufacturer	Country	Year Introduced
Bricanyl	Fujisawa	Japan	1974
Brethine	Ciba Geigy	U.S.	1975
Terbasmin	Farmitalia	Italy	1976
Arubendol	Ankerwerk	E. Germany	—
Brethaire	Ciba Geigy	U.S.	—
Bricalin	Teva	Israel	—
Brican	Draco	Sweden	—
Bristurin	Bristol	Japan	—
Filair	Riker	U.K.	—

Raw Materials

Benzyl-t-butylamine
 3,5-Dibenzoyloxy- ω -bromoacetophenone
 Hydrogen

Manufacturing Process

To a solution of 32 g of benzyl-t-butylamine in 300 ml of absolute ethanol at reflux temperature was added 32 g of 3,5-dibenzoyloxy- ω -bromoacetophenone in 10 ml of dry benzene. The mixture was refluxed for 20 hours and then evaporated. When absolute ether was added to the residue, benzyl-t-butylamine hydrobromide was precipitated. The precipitated compound was filtered off and to the filtrate was added an excess of 2N sulfuric acid. This caused precipitation of the hydrogen sulfate of 3,5-dibenzoyloxy- ω -(benzyl-t-butylamino)-acetophenone which was recrystallized from acetone/ether. If the product is crystallized from different organic solvents, the melting point will vary with the type and amount of solvent of crystallization, but the product can be used directly for hydrogenation.

15 g of 3,5-dibenzoyloxy- ω -(benzyl-t-butylamino)-acetophenone hydrogen sulfate in 200 ml of glacial acetic acid were hydrogenated in a Parr pressure reaction apparatus in the presence of 1.5 g of 10% palladium charcoal at 50°C and 5 atmospheres pressure. The reaction time was 5 hours. The catalyst was filtered off, the filtrate was evaporated to dryness and the hydrogen sulfate of 1-(3',5'-dihydroxyphenyl)-2-(t-butylamino)-ethanol was received. This compound is hygroscopic, but it can be transformed into a nonhygroscopic sulfate in the following manner.

The hydrogen sulfate was dissolved in water and the pH of the solution was adjusted to 5.6 (pH-meter) with 0.1 N sodium hydroxide solution. The water solution was evaporated to dryness and the residue dried with absolute ethanol/benzene and once more evaporated to dryness. The remaining crystal mixture was extracted in a Soxhlet extraction apparatus with absolute methanol. From the methanol phase the sulfate of 1-(3',5'-dihydroxyphenyl)-2-(t-butylamino)-ethanol crystallized. Melting point 246°C to 248°C.

References

- Merck Index 8986
 Kleeman & Engel p. 858
 PDR pp. 889, 987
 I.N. p. 925
 REM p. 890
 Wetterlin, K.Z.L. and Svensson, L.A.; U.S. Patent 3,937,838; February 10, 1976; assigned to A.B. Draco (Sweden)

TEROFENAMATE

Therapeutic Function: Antiinflammatory, analgesic

Chemical Name: 2-[(2,6-Dichloro-3-methylphenyl)amino]benzoic acid ethoxymethyl ester

Common Name: Etoclofene

Structural Formula:

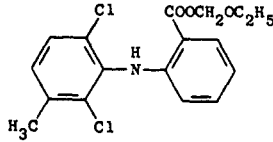

Chemical Abstracts Registry No.: 29098-15-5

Trade Name	Manufacturer	Country	Year Introduced
Etofen Ilfi	Lusofarmaco	Italy	1980

Raw Materials

N-2,6-Dichloro-m-tolylantranilic acid
Chloromethyl ethyl ether

Manufacturing Process

10 g sodium salt of N-2,6-dichloro-m-tolylantranilic acid, 3 ml chloromethyl ethyl ether and 80 ml dry acetone were refluxed for 12 hours on waterbath under stirring. The solid was filtered off, and the solution evaporated to dryness. The residue was dissolved in chloroform, washed with sodium carbonate solution, then with water until neutral. After drying on sodium sulfate, the solution was evaporated to dryness. The obtained product was recrystallized from 95% ethanol. Melting point 73°C to 74°C.

References

Merck Index 8992

DFU 1 (8) 421 (1976)

I.N. p. 927

Manghisi, E.; U.S. Patent 3,642,864; February 15, 1972; assigned to Istituto Luso Farmaco D'Italia S.R.L. (Italy)

TESTOLACTONE

Therapeutic Function: Cancer chemotherapy

Chemical Name: D-homo-17- α -oxaandrosta-1,4-diene-3,17-dione

Common Name: 1-dehydrotestolactone

Structural Formula:

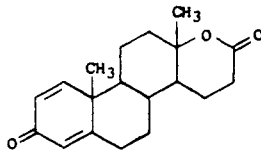

Chemical Abstracts Registry No.: 968-93-4

Trade Name	Manufacturer	Country	Year Introduced
Fludestrin	Heyden	W. Germany	1968
Teslac	Squibb	U.S.	1969

Raw Materials

Bacterium *Cylindrocarpon radicola*
 Corn steep liquor
 Brown sugar

Manufacturing Process

(a) *Fermentation*: A medium of the following composition is prepared: 3.0 grams cornsteep liquor solids; 3.0 grams $\text{NH}_4\text{H}_2\text{PO}_4$; 2.5 grams CaCO_3 ; 2.2 grams soybean oil; 0.5 gram progesterone and distilled water to make 1 liter. The medium is adjusted to pH 7.0 ± 0.1 . Then, 100 ml portions of the medium are distributed in 500 ml Erlenmeyer flasks and the flasks plugged with cotton and sterilized in the usual manner (i.e., by autoclaving for 30 minutes at 120°C). When cool, each of the flasks is inoculated with 5 to 10% of a vegetative inoculum of *Cylindrocarpon radicola* [the vegetative inoculum being grown from stock cultures (lyophilized vial or agar slant) for 48 to 72 hours in a medium of the following composition: 15 grams cornsteep liquor; 10 grams brown sugar; 6 grams NaNO_3 ; 0.001 gram ZnSO_4 ; 1.5 grams KH_2PO_4 ; 0.5 gram $\text{MgSO}_4 \cdot 7\text{H}_2\text{O}$; 5 grams CaCO_3 ; 2 grams lard oil; and distilled water to make 1 liter].

The flasks are then placed on a reciprocating shaker (120 one and one-half inch cycles per minute) and mechanically shaken at 25°C for 3 days. The contents of the flasks are then pooled and, after the pH of the culture is adjusted to about 4 ± 0.2 with sulfuric acid, filtered through Seitz filter pads to separate the mycelium from the fermented medium.

(b) *Extraction*: 40 liters of the culture filtrate obtained in (a) is extracted with 40 liters chloroform in an extractor (e.g., Podbelniak, U.S. Patent 2,530,886, or improvements thereon) and the filtered chloroform extract is evaporated to dryness in vacuo. The residue (11.1 grams) is taken up in 200 ml of 80% aqueous methanol, and the resulting solution is extracted four times with 100 ml portions of hexane. The 80% aqueous methanol solution is then concentrated in vacuo until crystals appear; and, after cooling at 0°C for several (usually about 3 to 4) hours, the crystals formed are recovered by filtration. About 2.9 grams 1-dehydrotestolactone (MP 217° to 217.5°C) are thus obtained. Concentration of the mother liquors yields additionally about 6.0 grams of the lactone. Recrystallization from acetone yields a purified 1-dehydrotestolactone having a melting point of 218° to 219°C .

References

Merck Index 8999
 Kleeman & Engel p. 860
 PDR p. 1768
 OCDS Vol. 2 p. 160 (1980)
 I.N. p. 928
 REM p. 1000
 Fried, J. and Thoma, R.W.; U.S. Patent 2,744,120; May 1, 1956; assigned to Olin Mathieson Chemical Corporation

TESTOSTERONE 17 β -CYPIONATE

Therapeutic Function: Androgen

Chemical Name: 17 β -(3-Cyclopentyl-1-oxopropoxy)androst-4-en-3-one

Common Name: Depo-testosterone

Structural Formula:

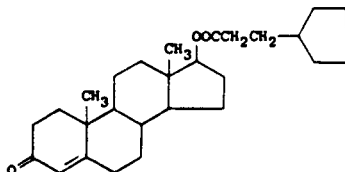

Chemical Abstracts Registry No.: 58-20-8

Trade Name	Manufacturer	Country	Year Introduced
Depo-Testosterone	Upjohn	U.S.	1951
T-Ionate P.A.	Tutag	U.S.	1970
Andro-Cyp	Keene	U.S.	—
Andronate	Pasadena	U.S.	—
Ciclosterone	Farmigea	Italy	—
Depostomead	Spencer-Mead	U.S.	—
Depotest	Blaine	U.S.	—
Dep-Test	Sig	U.S.	—
Dep-Testosterone	Rocky Mtn.	U.S.	—
Durandro	Ascher	U.S.	—
Jectatest	Reid-Provident	U.S.	—
Malogen Cyp	O'Neal, Jones & Feldman	U.S.	—
Pertestis Dep.	Orma	Italy	—
Testomed P.A.	Medics	U.S.	—
Testorit-Dep	Gallo	Italy	—

Raw Materials

β -Cyclopentylpropionic acid	Acetic anhydride
Testosterone 3-enol-ethyl ether	Hydrogen chloride

Manufacturing Process

1 g of crude 3-enol-ethyl ether of testosterone dissolved in 3 cc of pyridine is treated with 2 cc of β -cyclopentylpropionic anhydride (obtained from the β -cyclopentylpropionic acid and acetic anhydride: boiling point 180°C/2 mm Hg). After standing at room temperature overnight the mixture is diluted with water and extracted with ether, the ethereal layer, washed with water to neutrality and dried, is evaporated by vacuum. The oily residue is taken up in petroleum ether and filtered through a layer of aluminum oxide, which is afterwards washed with a further amount of petroleum ether. The solution so filtered and purified is evaporated to dryness; the crystalline residue is recrystallized from a small amount of methanol containing a trace of pyridine: about 1 g of 3-enol-ethyl-ether of the β -cyclopentyl propionate of testosterone, melting point 86°C to 88°C. is so obtained (by further recrystallization melting point 90°C to 91°C). This product (that may be employed either in the crystalline state, or in the oily one, that is, before the purification by filtration through aluminum oxide) by treatment with a small amount of hydrochloric acid in acetone solution yields the β -cyclopentyl propionate of testosterone, melting point 99°C to 101°C (recrystallized from methanol).

References

Merck Index 9002
 Kleeman & Engel p. 861
 PDR pp. 950, 1033, 1841
 OCDS Vol. 1 p. 172 (1977)

I.N. p. 929

REM p. 1001

Ercoli, A. and de Ruggieri, P.; U.S. Patent 2,742,485; April 17, 1956; assigned to Francesco Vismara Societa per Azioni & A. Ercoli (Italy)

TESTOSTERONE ENANTHATE

Therapeutic Function: Androgen

Chemical Name: 17 β -[(1-oxoheptyl)oxy] androst-4-en-3-one

Common Name: —

Structural Formula:

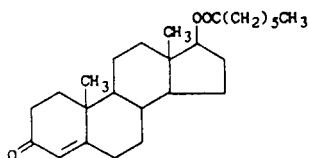

Chemical Abstracts Registry No.: 315-37-7

Trade Name	Manufacturer	Country	Year Introduced
Delatestryl	Squibb	U.S.	1954
Reposo-TMD	Canfield	U.S.	1961
Testate	Savage	U.S.	1970
Testostroval PA	Tutag	U.S.	1970
Androtardyl	S.E.P.P.S.	France	—
Andryl	Keene	U.S.	—
Arderone	Buring-Arden	U.S.	—
Atlatest	I.C.I.	U.S.	—
Deladumon	Squibb	U.S.	—
Delatest	Dunhall	U.S.	—
Dura-Testate	Ries	U.S.	—
Duratesterone	Myers-Carter	U.S.	—
Enarmon	Teikoku Zoki	Japan	—
Everone	Hyrex	U.S.	—
Malogen LA	Fellows	U.S.	—
Malogex	Stickley	Canada	—
Primoteston	Schering	W. Germany	—
Reprosteron	Spencer-Mead	U.S.	—
Repro Testro Med	Medics	U.S.	—
Retandros	Rocky Mtn.	U.S.	—
Span-Test	Scrip	U.S.	—
Tesone	Sig	U.S.	—
Testanate	Kenyon	U.S.	—
Testinon	Mochida	Japan	—
Testisan Depo	I.E. Kimya Evi	Turkey	—
Testo-Enant	Geymonat Sud	Italy	—
Testone	Ortega	U.S.	—
Testrin	Pasadena	U.S.	—
Testoviron	Schering	W. Germany	—
Testrone	N. Amer. Pharm.	U.S.	—

Raw Materials

Oenanthic acid
Testosterone

Manufacturing Process

A mixture of testosterone, pyridine and oenanthic acid anhydride is heated for 1½ hours to 125°C. The cooled reaction mixture is decomposed with water while stirring and cooling. After prolonged standing at a temperature below room temperature, the whole is extracted with ether and the ethereal solution is washed consecutively with dilute sulfuric acid, water, 5% sodium hydroxide solution, and again with water. The crude ester remaining on evaporation of the dried ether solution, after recrystallization from pentane, melts at 36° to 37.5°C.

References

Merck Index 9003

Kleeman & Engel p. 862

PDR pp. 1033, 1604

I.N. p. 929

REM p. 1001

Junkmann, K., Kathol, J. and Richter, H.; U.S. Patent 2,840,508; June 24, 1958; assigned to Schering AG, Germany

TETRABENZAZINE

Therapeutic Function: Tranquilizer

Chemical Name: 1,3,4,6,7,11b-hexahydro-9,10-dimethoxy-3-(2-methylpropyl)-2H-benzo-[a]quinolizin-2-one

Common Name: —

Structural Formula:

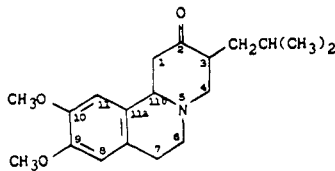

Chemical Abstracts Registry No.: 58-46-8

Trade Name	Manufacturer	Country	Year Introduced
Nitoman	Roche	U.K.	1960

Raw Materials

1-Carbethoxymethyl-6,7-dimethoxy-1,2,3,4-tetrahydroisoquinoline
Isobutyl malonic acid dimethyl ester
Paraformaldehyde
Sodium
Ethanol
Hydrogen chloride

Manufacturing Process

280 grams of 1-carbethoxymethyl-6,7-dimethoxy-1,2,3,4-tetrahydroisoquinoline, 150 grams of mono-isobutylmalonic acid dimethyl ester and 35 grams of paraformaldehyde were refluxed for 24 hours in 1,000 ml of methanol. Upon cooling, 1-carbethoxymethyl-2-(2,2-dicarbomethoxy-4-methyl-n-pentyl)-6,7-dimethoxy-1,2,3,4-tetrahydroisoquinoline crystallized; MP after recrystallization from methanol, 94° to 96°C. The latter was subjected to Dieckmann cyclization, hydrolysis and decarboxylation in the following manner.

28 grams of sodium was dissolved in 650 ml of absolute ethanol, the solution was concentrated to dryness, and the residue was mixed with 3,600 ml of toluene and 451 grams of the intermediate prepared above. The mixture was heated, and the methanol formed by condensation was distilled off until the boiling point of toluene was reached. The mixture was thereupon refluxed for 2 hours, and then it was concentrated to dryness. The residue was dissolved in 5,200 ml of 3N hydrochloric acid and heated for 14 hours at 120°C, thereby effecting hydrolysis and decarboxylation. The mixture was cooled, washed with diethyl ether, decolorized with carbon, made alkaline and taken up in diethyl ether. The process yields 2-oxo-3-isobutyl-9,10-dimethoxy-1,2,3,4,6,7-hexahydro-11b-benzo[a]-quinolizine; MP after recrystallization from diisopropyl ether, 126° to 128°C.

References

Merck Index 9009

OCDS Vol. 1 p. 350 (1977)

I.N. p. 931

Brossi, A., Schnider, O. and Walter, M.; U.S. Patent 2,830,993; April 15, 1958; assigned to Hoffmann-La Roche, Inc.

TETRACYCLINE

Therapeutic Function: Antibacterial

Chemical Name: 4-(dimethylamino)-1,4,4a,5,5a,6,11,12a-octahydro-3,6,10,12,12a-penta-hydroxy-6-methyl-1,11-dioxo-2-naphthacenecarboxamide

Common Name: Deschlorobiomycin; omegamycin

Structural Formula:

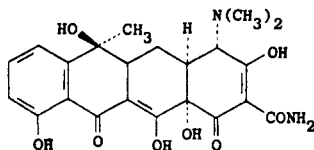

Chemical Abstracts Registry No.: 60-54-8

Trade Name	Manufacturer	Country	Year Introduced
Tetracycyn	Pfizer	U.S.	1953
Achromycin	Lederle	U.S.	1953
Polycycline	Bristol	U.S.	1954
Panmycin	Upjohn	U.S.	1955
Cancycline	Canfield	U.S.	1964
Abricycline	Farmakhim	Bulgaria	—
Biotetra	I.E. Kimya Evi	Turkey	—

Trade Name	Manufacturer	Country	Year Introduced
Copharlan	Cophar	Switz.	—
Economycin	D.D.S.A.	U.K.	—
Mervacycline	Byk	Neth.	—
Mysteclin	Squibb	U.S.	—
Pediatetracycline	Theranol	France	—
Pervasol	Poen	Argentina	—
Sanbiotetra	Santos	Spain	—
SK-Tetracycline	SKF	U.S.	—
Sumycin	Squibb	U.S.	—
Teclinazets	Miluy	Spain	—
Tetra-Co	Coastal	U.S.	—
Tetramig	Inava	France	—
Tetra-Proter	Proter	Italy	—

Raw Materials

Chlortetracycline
 Hydrogen
 Bacterium *Streptomyces aureofaciens*

Manufacturing Process

Tetracycline is usually prepared by the catalytic dechlorination of chlortetracycline as described in U.S. Patents 2,699,054 and 3,005,023, or obtained directly by fermentation of *Streptomyces aureofaciens* or *Streptomyces viridifaciens* according to U.S. Patents 2,712,517, 2,734,018, 2,886,595 and 3,019,173. The purification of tetracycline produced by either route is described in U.S. Patent 3,301,899.

The production of tetracycline by catalytic dechlorination is described in U.S. Patent 2,699,054 as follows: Pure chlortetracycline (4.8 grams) was suspended in 100 ml of methanol and sufficient anhydrous dioxane was added to completely dissolve the product. To the solution was added 0.5 gram of 5% palladium-on-charcoal catalyst. The mixture was placed in a conventional hydrogenation apparatus and subjected to a pressure of 50 psi of hydrogen while being agitated.

After the initial drop in pressure due to the absorption of gas by the catalyst and the solvent, there was a steady drop in pressure due to the hydrogenation of the antibiotic. After approximately 1 mol of hydrogen had been absorbed, no further reaction was observed. This occurred after about 2 hours. The catalyst was filtered and washed with boiling methanol and boiling dioxane. The solution gave a positive test for chloride ion when treated with silver nitrate solution. It also possessed a strongly acidic reaction demonstrating the release of the nonionic chlorine in the form of hydrogen chloride. A bioassay of the crude product in solution indicated a potency of approximately 580 $\mu\text{g}/\text{mg}$ with oxytetracycline as the standard at a potency of 1,000 $\mu\text{g}/\text{mg}$. The solution was concentrated under vacuum at room temperature and the residual liquid was dried from the frozen state under vacuum. 3.1 grams of bright yellow amorphous tetracycline hydrochloride was obtained.

This product may be converted to tetracycline per se by redissolving it in water, carefully neutralizing it to pH 4.5 with dilute sodium hydroxide, and recovering the product by drying the solution.

References

Merck Index 9021
 Kleeman & Engel p. 864
 PDR pp. 996, 1391, 1723, 1752, 1767
 OCDS Vol. 1 p. 212 (1977)
 I.N. p. 932
 REM p. 1207

Conover, L.H.; U.S. Patent 2,699,054; January 11, 1955

Gourevitch, A. and Lein, J.; U.S. Patent 2,712,517; July 5, 1955; assigned to Bristol Laboratories Inc.

Minieri, P.P., Sokol, H. and Firman, M.C.; U.S. Patent 2,734,018; February 7, 1956; assigned to American Cyanamid Company

Heinemann, B. and Hooper, I.R.; U.S. Patent 2,886,595; May 12, 1959; assigned to Bristol Laboratories Inc.

Miller, P.A.; U.S. Patent 3,005,023; October 17, 1961; assigned to American Cyanamid Company

Arishima, M. and Sekizawa, Y.; U.S. Patent 3,019,173; January 30, 1962; assigned to American Cyanamid Company

Kaplan, M.A. and Granatek, A.P.; U.S. Patent 3,301,899; January 31, 1967; assigned to Bristol-Myers Company

TETRACYCLINE PHOSPHATE COMPLEX

Therapeutic Function: Antibacterial

Chemical Name: Tetracycline phosphate complex; see tetracycline for chemical name

Common Name: —

Structural Formula: See tetracycline for formula of base

Chemical Abstracts Registry No.: —

Trade Name	Manufacturer	Country	Year Introduced
Tetrex	Bristol	U.S.	1956
Sumycin	Squibb	U.S.	1957
Panmycin Phos	Upjohn	U.S.	1957
Austrastaph	C.S.L.	Australia	—
Binicap	S.A.M.	Italy	—
Biocheclina	Wolner	Spain	—
Bristaciclina Retard	Antibioticos	Spain	—
Conciclina	Lusofarmaco	Italy	—
Devacyclin	Deva	Turkey	—
Fusfosiklin	T.E.M.S.	Turkey	—
Hexacycline	Diamant	France	—
Tetraksilin	Atabay	Turkey	—
Tetralet	Fako	Turkey	—
Tetramin	Efeyn	Spain	—
Tetrazetas Retard	Miluy	Spain	—
Upcyclin	Cophar	Switz.	—

Raw Materials

Tetracycline
Phosphorus pentoxide

Manufacturing Process

In a 500-ml round-bottomed flask equipped with stirrer, condenser and thermometer was placed 7.1 grams (0.05 mol) P_2O_5 which was immediately covered with 100 ml of chloroform. To the mixture was added with stirring 0.9 ml (0.05 mol) of distilled water. In a

few minutes, a lower oily layer appeared, which was believed to be freshly formed metaphosphoric acid resulting from the action of the P_2O_5 with an equimolar amount of water. To this mixture was added 100 ml of methanol and on continued stirring, the lower oily layer disappeared in the methanol forming a complete pale yellowish-green colored solution.

An additional 50 ml of methanol was added to the flask and then 22.2 grams (0.05 mol) of tetracycline, neutral form, was added portionwise intermittently with another 50 ml of methanol. A clear solution was maintained throughout the addition of the tetracycline. After addition of all of the tetracycline, the solution was a deep orange color and the temperature in the reaction flask was 35°C.

One hour after addition of the tetracycline, the clear reaction solution was poured into 1,500 ml of chloroform. A yellow product separated and was collected on a coarse sintered glass filter and air dried. The tetracycline-metaphosphoric acid complex weighed about 10 grams, contained 7.34% of phosphorus and had a bioassay of 634 gammas per milligram. Solubility in water is 750 mg/ml.

References

Merck Index 9021

I.N. p. 933

REM p. 1208

Sieger, G.M. Jr. and Weidenheimer, J.F.; U.S. Patent 3,053,892; September 11, 1962; assigned to American Cyanamid Company

TETRAHYDROZOLINE HYDROCHLORIDE

Therapeutic Function: Nasal decongestant, eye preparation

Chemical Name: 4,5-Dihydro-2-(1,2,3,4-tetrahydro-1-naphthalenyl)-1H-imidazole hydrochloride

Common Name: Tetryzoline HCl

Structural Formula:

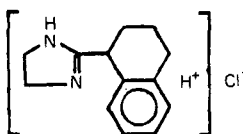

Chemical Abstracts Registry No.: 522-48-5; 84-22-0 (Base)

Trade Name	Manufacturer	Country	Year Introduced
Tyzine	Pfizer	U.S.	1954
Visine	Leeming	U.S.	1958
Constrilia	P.O.S.	France	1979
Azolin	Fischer	Israel	—
Burnil	Kurtsan	Turkey	—
Collyrium	Wyeth	U.S.	—
Ischemol	Farmila	Italy	—
Murine	Ross	U.S.	—
Narbel	Chugai	Japan	—
Nasin	Abic	Israel	—
Oftan-Starine	Star	Finland	—

Trade Name	Manufacturer	Country	Year Introduced
Rhinopront	Mack	W. Germany	—
Stilla	Abic	Israel	—
Tinarhinin	VEB Berlin Chemie	E. Germany	—
Typinal	Ikapharm	Israel	—
Yxin	Pfizer	W. Germany	—

Raw Materials

1,2,3,4-Tetrahydro- α -naphthoic acid
 Ethylenediamine
 Hydrogen chloride

Manufacturing Process

A mixture of 540 grams (9.0 mols) of ethylenediamine, 270 grams (1.53 mols) of 1,2,3,4-tetrahydro- α -naphthoic acid, and 360 ml (4.32 mols) of concentrated hydrochloric acid was introduced into a two-liter, three-necked flask fitted with a thermometer, stirrer, and distillation takeoff. The mixture was distilled under a pressure of about 20 mm of mercury absolute until the temperature rose to 210°C. Thereafter, heating was continued under atmospheric pressure and when the temperature reached about 260°C, an exothermic reaction was initiated. The heat was then adjusted to maintain a reaction temperature of 275° to 280°C for 45 minutes and the mixture thereafter cooled to room temperature.

900 ml of 4 N hydrochloric acid was added and the aqueous layer stirred with warming until a clear, brown solution resulted. This brown solution was made strongly alkaline with sodium hydroxide. The oil that separated solidified and was collected on a filter leaving filtrate A. The solid was dissolved in 370 ml of alcohol with warming, and the solution was treated with 130 ml of concentrated hydrochloric acid with stirring and cooling. This acidified mixture was diluted with 300 ml of ether and chilled. The solid salt was collected and dried and the filtrate concentrated to approximately 300 ml, diluted with 300 ml of ether and the salt which separated collected and dried.

Filtrate A was extracted with ether, dried, acidified with alcoholic hydrogen chloride, and the salt which separated was collected and dried. There was thus obtained, when all the salt had been combined, 250 grams (69.3% of the theoretical yield) of 2-(1,2,3,4-tetrahydro-1-naphthyl)imidazoline hydrochloride, melting at 256° to 257°C.

References

- Merck Index 9042
 Kleeman & Engel p. 867
 PDR pp. 974, 1555, 1945
 OCDS Vol. 1 p. 242 (1977)
 I.N. p. 936
 REM p. 890
 Synerholm, M.E., Jules, L.H. and Sahyun, M.; U.S. Patent 2,731,471; January 17, 1956; assigned to Sahyun Laboratories
 Gardocki, J.F., Hutcheon, D.E., Lanbach, G.D. and P'an, S.Y.; U.S. Patent 2,842,478; July 8, 1958; assigned to Chas. Pfizer & Co., Inc.

TETRAZEPAM

Therapeutic Function: Muscle relaxant

Chemical Name: 7-chloro-5-(1-cyclohexen-1-yl)-1,3-dihydro-1-methyl-2H-1,4-benzodiazepin-2-one

Common Name: —

Structural Formula:

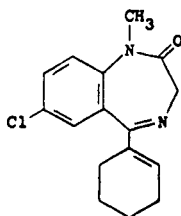

Chemical Abstracts Registry No.: 10379-14-3

Trade Name	Manufacturer	Country	Year Introduced
Myolastan	Clin-Comar	France	1969
Musaril	Mack-Midy	W. Germany	1980

Raw Materials

7-Chloro-5-cyclohexyl-2-oxo-2,3-dihydro-1H-benzo(f)diazepine-1,4
Sodium hypochlorite
Lithium carbonate
Sodium methylate
Methyl iodide

Manufacturing Process

1,7-Dichloro-5-Cyclohexyl-2-Oxo-2,3-Dihydro 1H-Benzo(f)-Diazepine-1,4: (a) Process Using Sodium Hypochlorite — 40 ml of a solution of sodium hypochlorite of 14.5 British chlorometric degrees are added to a suspension of 5.4 grams of 7-chloro-5-cyclohexyl-2-oxo-2,3-dihydro 1H-benzo(f)diazepine-1,4 in 80 ml of methylene chloride. The mixture is stirred at room temperature for 15 minutes; the solid dissolves rapidly. The organic layer is decanted, washed with water, dried over anhydrous sodium sulfate and the solvent evaporated under reduced pressure without exceeding a temperature of 30°C. The residue is taken up in a little diisopropyl ether and the crystals which form are dried. They are recrystallized as rapidly as possible from ethyl acetate. Colorless crystals are obtained (3.9 grams; yield, 85%); $MP_k = 163^\circ C$, with decomposition.

(b) Process Using Tertiary-Butyl Hypochlorite — 1.2 grams of tertiary-butyl hypochlorite are added to a suspension of 2.7 grams of 7-chloro-5-cyclohexyl-2-oxo-2,3-dihydro 1H-benzo(f)diazepine-1,4 in 20 ml of methylene chloride and the mixture is stirred and at the same time cooled in a water bath for 30 minutes. The solid dissolves in about 15 minutes. The product is evaporated to dryness under reduced pressure at a temperature below 40°C. The residue is taken up in diisopropyl ether and the crystals which separate are dried. Colorless crystals are obtained (2.8 grams; yield, 98%); $MP_k = 161^\circ$ to $162^\circ C$, with decomposition, according to U.S. Patent 3,551,412.

7-Chloro-5-(1'-Chlorocyclohexyl)-2-Oxo-2,3-Dihydro 1H-Benzo(f)Diazepine-1,4: A solution of 117 grams of the compound prepared above in 450 ml ethyl acetate is heated under reflux until a precipitate begins to form. From then onwards reflux is continued until a negative reaction is obtained when the reaction mixture is tested with a solution of sodium iodide in acetone. The reaction mixture is left to cool and the solid which separates is dried. Colorless crystals are obtained (76 grams), $MP_k = 194^\circ$ to $195^\circ C$, with decomposition. A second portion (14 grams) is isolated by concentrating the mother liquor, $MP_k = 194^\circ$ to $195^\circ C$, with decomposition. The total yield is 77%. The melting point is raised to 196° to $197^\circ C$ by recrystallization from ethyl acetate.

7-Chloro-5-(1'-Cyclohexenyl)-2-Oxo-2,3-Dihydro 1H-Benzo(f)Diazepine-1,4: 68 grams of 7-chloro-5-(1'-chlorocyclohexenyl)-2-oxo-2,3-dihydro 1H-benzo(f)diazepine-1,4, 34 grams of lithium carbonate and 17 grams of lithium bromide and 340 ml of anhydrous dimethylformamide are placed in a three-necked flask equipped with a mechanical stirrer, immersion thermometer and a reflux condenser connected with a bubble counter.

The reaction mixture is gradually heated, with stirring, until evolution of carbon dioxide commences (about 100°C) and the temperature is maintained thereat until the reaction ceases. The temperature is then raised to 110°C and held thereat for 15 minutes.

The reaction mixture is allowed to cool and the mineral salts separated and dried. The solvent is evaporated under reduced pressure and the residue dissolved in water. It is allowed to crystallize, dehydrated, dried and then recrystallized from ethyl acetate. The product is yellowish crystals (47.5 grams; yield, 80%); $MP_k = 207^\circ$ to $208^\circ C$.

7-Chloro-5-(1'-Cyclohexenyl)-1-Methyl-2-Oxo-2,3-Dihydro 1H-Benzo(f)Diazepine-1,4: 9.7 grams of sodium methylate are added to a solution of 16.5 grams of 7-chloro-5-(1'-cyclohexenyl)-2-oxo-2,3-dihydro 1H-benzo(f)diazepine-1,4 dissolved in 120 ml of dry dimethylformamide and the mixture stirred for one-half hour. The reaction mixture is cooled in a water bath and a solution of 33.8 grams of methyl iodide dissolved in 35 ml of anhydrous dimethylformamide is then slowly added with stirring. The solution becomes dark brown in color and a precipitate forms. It is stirred for 2 hours, then diluted with a large volume of water and extracted with ethyl acetate. The ethyl acetate solution is washed with water, dried over anhydrous sodium sulfate and the solvent evaporated under reduced pressure. The residue is crystallized from a small volume of ethyl acetate. Brownish yellow crystals are obtained (9 grams; yield, 52%), $MP_k = 144^\circ C$.

References

Merck Index 9065

Kleeman & Engel p. 865

DOT 6 (4) 148 (1970)

I.N. p. 936

Berger, L. and Sternbach, L.H.; U.S. Patent 3,268,586; August 23, 1966; assigned to Hoffmann-La Roche Inc.

Schmitt, J.; U.S. Patent 3,426,014; February 4, 1969; assigned to Etablissements Clin-Byla, France

Schmitt, J.; U.S. Patent 3,551,412; December 29, 1970; assigned to Etablissements Clin-Byla, France

THIABENDAZOLE

Therapeutic Function: Anthelmintic

Chemical Name: 2-(4-thiazolyl)-1H-benzimidazole

Common Name: —

Structural Formula:

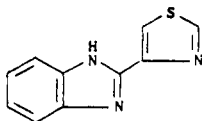

Chemical Abstracts Registry No.: 148-79-8

Trade Name	Manufacturer	Country	Year Introduced
Mintezol	MSD	U.S.	1967
Mintezol	MSD	U.K.	1968
Mintezol	MSD-Chibret	France	1969
Minzolum	Sharp & Dohme	W. Germany	1970

Raw Materials

Thiazole-4-carboxylic acid	o-Nitroaniline
Thionyl chloride	Hydrogen chloride
Zinc	

Manufacturing Process

6.5 grams of thiazole-4-carboxylic acid is stirred with 5.9 grams of thionyl chloride in 20 ml xylene for 10 hours at room temperature to form 4-thiazolyl acid chloride. 1.3 grams of 4-thiazolyl acid chloride and 1.3 grams of o-nitroaniline are then stirred together in 3.5 ml of pyridine at room temperature for about 12 hours. At the end of this time, the mixture is quenched in ice water and the solid nitroanilide recovered by filtration and washed with dilute sodium carbonate solution. The solid is suspended in 15 ml of glacial acetic acid, and 8 ml of 6 N hydrochloric acid added to the suspension. 6 grams of zinc dust is added in small portions to the acetic mixture. After the zinc addition is complete, and the reaction is essentially finished (by visual observation), the reaction mixture is filtered and the filtrate neutralized with concentrated ammonium hydroxide to precipitate 2-(4'-thiazolyl)-benzimidazole. The product is purified by recrystallization from ethyl acetate, according to U.S. Patent 3,274,207.

References

Merck Index 9126

PDR p. 1200

OCDS Vol. 1 p. 325 (1977)

DOT 7 (5) 195 (1971)

REM p. 1237

Sarett, L.H. and Brown, H.D.; U.S. Patent 3,017,415; January 16, 1962; assigned to Merck & Co., Inc.

Kaufman, A. and Wildman, G.T.; U.S. Patent 3,262,939; July 26, 1966; assigned to Merck & Co., Inc.

Kollonitsch, J.; U.S. Patent 3,274,207; September 20, 1966; assigned to Merck & Co., Inc.

Jones, R.E. and Gal, G.; U.S. Patent 3,274,208; September 20, 1966; assigned to Merck & Co., Inc.

THIAMINE DISULFIDE

Therapeutic Function: Enzyme cofactor vitamin

Chemical Name: N,N'-[dithiobis[2-(2-hydroxyethyl)-1-methylvinylene] bis[N-[(4-amino-2-methyl-5-pyrimidinyl)methyl] formamide]

Common Name: —

Structural Formula:

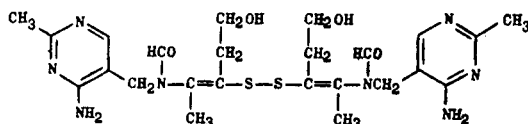

Chemical Abstracts Registry No.: 67-16-3

Trade Name	Manufacturer	Country	Year Introduced
Arcalion	Servier	France	1974

Raw Materials

Thiamine
Potassium ferricyanide

Manufacturing Process

20 parts by weight of thiamin are dissolved in 25 parts of water, a cold solution of 5 parts by weight of caustic soda in 25 parts of water added and the mixture oxidized with a solution of 2.4 parts by weight of caustic soda and 20 parts by weight of potassium ferric cyanide in 80 parts of water while stirring in the cold. The liquid is then evaporated to dryness and the resulting oxidation product extracted with warm butyl alcohol.

The butyl-alcoholic solution is evaporated in vacuo and the residue dissolved with gentle heating in 25 parts by volume of methyl alcohol. 100 parts by volume of acetone are added, the solution filtered and further quantities of acetone added, whereupon crystallization sets in. Yield: 12.2 parts by weight of the pure product, having the melting point 177° to 179°C.

References

Merck Index 9130

I.N. p. 941

Warnat, K.; U.S. Patent 2,458,453; January 4, 1949; assigned to Hoffmann-La Roche Inc.

THIAMPHENICOL

Therapeutic Function: Antibacterial

Chemical Name: D-Threo-2,2-dichloro-N-[\beta-hydroxy-\alpha-(hydroxymethyl)-p-methylsulfonylphenethyl]-acetamide

Common Name: Dextrosulphenidol, thiopenicol

Structural Formula:

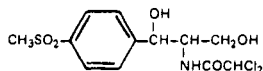

Chemical Abstracts Registry No.: 15318-45-3

Trade Name	Manufacturer	Country	Year Introduced
Thiopenicol	Clin Midy	France	1967
Chlomic J	Kowa Shinyaku	Japan	—
Descocin	Kanto	Japan	—
Efnicol	Nichizo	Japan	—
Ericol	S.S. Pharm	Japan	—
Glitisol Orale	Zambon	Italy	—
Hyrazin	Kowa	Japan	—
Igralin	Zeria	Japan	—
Macphenicol	Nakataki	Japan	—

Trade Name	Manufacturer	Country	Year Introduced
Masatirin	Maruko	Japan	—
Namicain	Nippon Kayaku	Japan	—
Neomyson	Eisai	Japan	—
Racenicol	Kissei	Japan	—
Rigelon	Dojin	Japan	—
Rincrol	Tanabe	Japan	—
Roseramin	Takata	Japan	—
Synticol	Nisshin	Japan	—
Thiamcetin	Mochida	Japan	—
Thiamcol	Morishita	Japan	—
Thiamyson	Ohta	Japan	—
Thiancol	Kakenyaku	Japan	—
Thiofact	Showa	Japan	—
Thionicol	Mohan	Japan	—
Thiotal	Sumitomo	Japan	—
Tiozon	Mitsui	Japan	—
Unaseran-D	Isei	Japan	—
Urfamycine	Zambon	Italy	—
Urophenyl	Sanwa	Japan	—

Raw Materials

2-Acetylamino-1-(4-methylmercaptophenyl)-1,3-propanediol
 Hydrogen chloride
 Ethyl dichloroacetate
 Peracetic acid

Manufacturing Process

A mixture of 50 parts by weight of racemic 2-acetylamino-1-(4-methylmercaptophenyl)-1,3-propanediol, 100 parts by weight of concentrated hydrochloric acid, and 500 parts by weight of water was warmed on a steam bath for thirty minutes. The resulting solution was cooled to about 40°C and was then made strongly alkaline by addition of 35% aqueous sodium hydroxide solution. The alkaline solution was then refrigerated. The white solid which separated from the cooled solution was collected on a filter. There was thus obtained 27 parts by weight of 2-amino-1-(4-methylmercaptophenyl)-1,3-propanediol. This product melted at 130.7°C to 131.9°C after recrystallization from methanol.

This compound was converted to the tartrate and the optical isomers were resolved.

A mixture of 1.1 g of 2-amino-1-(4-methylmercaptophenyl)-1,3-propanediol, obtained as described above and 1.6 ml of ethyl dichloroacetate was heated on a steam bath for three hours. The resulting viscous yellow oil was dissolved in 25 ml of ethylene chloride and filtered hot with charcoal, and the filtrate was allowed to cool to about 25°C. From the filtrate there separated 0.92 g of tiny white leaflets which were collected on a filter. Recrystallization of this product, which was a dextro-rotary form of 2-dichloroacetylamino-1-(4-methylmercaptophenyl)-1,3-propanediol from nitroethane yielded the pure product, which melted at 111.6°C to 112.6°C.

7 g of the 2-dichloroacetylamino-1-(4-methylmercaptophenyl)-1,3-propanediol obtained as described above was dissolved in 30 ml of acetone. To this solution there was added dropwise with stirring 10 ml of 40% peracetic acid. The temperature during the reaction was maintained at 39°C to 45°C by cooling the reaction vessel. After stirring the mixture for two hours, it was diluted with 100 ml of water and the solution allowed to stand over the weekend in the refrigerator. The solid which separated from solution was collected on a filter, washed several times with ice water, and dried overnight at 70°C.

References

Merck Index 9140

Kleeman & Engel p. 874

OCDS Vol. 2 p. 45 (1980)

I.N. p. 942

Suter, C.M.; U.S. Patent 2,759,976; August 21, 1956; assigned to Sterling Drug, Inc.

Parke, Davis & Co.; British Patent 770,277; March 20, 1957

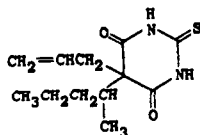
THIAMYLAL**Therapeutic Function:** Anesthetic (injectable)**Chemical Name:** Dihydro-5-(1-methylbutyl)-5-(2-propenyl)-2-thioxo-4,6(1H,5H)-pyrimidinedione**Common Name:** Thioseconal**Structural Formula:****Chemical Abstracts Registry No.:** 77-27-0

Trade Name	Manufacturer	Country	Year Introduced
Surital	Parke Davis	U.S.	1951
Citosol	Kyorin	Japan	—
Isozol	Yoshitomi	Japan	—

Raw Materials

Diethyl allyl-(1-methylbutyl)malonate

Sodium

Methanol

Thiourea

Manufacturing Process

In 450 cc of methanol is added 47 grams of sodium metal and the mixture allowed to completely react to form a methanol solution of sodium methoxide. The methanol solution of sodium methoxide is then cooled to 60°C and 68 grams of thiourea which has been thoroughly dried is added with stirring until a uniform solution is formed. Thereafter, 157 grams of diethyl allyl-(1-methylbutyl)malonate is added to the solution of the sodio derivative of thiourea at a temperature of 55°C and the condensation reaction mixture maintained at the said temperature for 24 hours. Methyl alcohol is removed under vacuum during the course of the reaction while maintaining a temperature of 55°C.

The viscous reaction mixture is then poured into 1.5 liters of ice water and agitated to form a uniform solution. The solution is treated with activated carbon and filtered. Thereafter, 80% acetic acid is added until the filtered solution remains acidic to litmus. The precipitate formed is filtered and washed thoroughly with distilled water. The product is air-dried at a temperature of 95° to 100°C for 48 hours to yield 133 grams of 5-allyl-5-(1-methylbutyl)-2-thiobarbituric acid having a melting point of 132° to 133°C and assaying at 99.5% pure, from U.S. Patent 2,876,225.

References

Merck Index 9141

Kleeman & Engel p. 875

OCDS Vol. 1 p. 274 (1977)

I.N. p. 942

REM p. 1046

Volwiler, E.H. and Tabern, D.L.; U.S. Patent 2,153,729; April 11, 1939; assigned to Abbott Laboratories

Donnison, G.H.; U.S. Patent 2,876,225; March 3, 1959; assigned to Abbott Laboratories

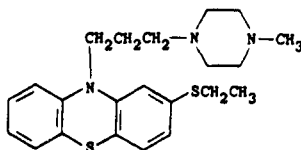
THIETHYLPERAZINE**Therapeutic Function:** Antiemetic**Chemical Name:** 2-(Ethylthio)-10-[3-(4-methyl-1-piperazinyl)propyl]phenothiazine**Common Name:** —**Structural Formula:****Chemical Abstracts Registry No.:** 1420-55-9; 52239-63-1 (Maleate)

Trade Name	Manufacturer	Country	Year Introduced
Torecan	Boehr. Ingel.	U.S.	1961
Torecan	Sandoz	Italy	1962
Torecan	Sandoz	France	1962
Torecan	Sandoz	U.K.	1962
Torecan	Sandoz	W. Germany	1964
Toresten	Sandoz-Sankyo	Japan	—

Raw Materials

3-Ethylmercapto-phenothiazine

1-Methyl-4-(3'-chloropropyl-1')-piperazine

Sodium amide

Manufacturing Process

26.1 parts of 3-ethylmercapto-phenothiazine (melting point 95°C to 97°C), 4.7 parts of finely pulverized sodium amide and 120 parts by volume of absolute xylene are heated to boiling for two hours, under reflux and while stirring the reaction mixture, at an oil-bath temperature of 180°C. Without interrupting the heating, a solution of 20.0 parts of 1-methyl-4-(3'-chloropropyl-1')-piperazine (boiling point 95°C to 97°C at a pressure of 10 mm Hg) in 20 parts by volume of xylene is added dropwise in the course of 1½ hours. After heating 3 more hours, the reaction mixture is cooled and 10.0 parts of ammonium chloride added; the mixture is then shaken out three times, using 50 parts by volume of water each time. The xylene solution is extracted with 250 parts by volume of aqueous tartaric acid of 15% strength, after which the tartaric acid extract is washed with 80 parts by volume of benzene and then ren-

dered phenolphthalein-alkaline by the addition of 60 parts by volume of concentrated aqueous caustic soda solution. The base which precipitates is taken up in a total of 150 parts by volume of benzene; the benzene layer is dried over potassium carbonate and is then evaporated under reduced pressure. The residue from the evaporation is distilled in a high vacuum. After separating a preliminary distillate which passes over up to 226°C under a pressure of 0.01 mm Hg the main fraction—3-ethylmercapto-10-[3'-(1''-methyl-piperazyl-4'')-propyl-1']-phenothiazine—which distills at 226°C to 228°C under the last-mentioned pressure is collected. The analytically pure base boils at 227°C under a pressure of 0.01 mm Hg and melts at 62°C to 64°C.

Upon the addition of ethanolic HCl to a solution, cooled to 0°C, of 26.38 parts of the free base in 130 parts by volume of absolute ethanol, until a Congo-acid reaction is achieved, the crystalline dihydrochloride of 3-ethylmercapto-10-[3'-(1''-methyl-piperazyl-4'')-propyl-1']-phenothiazine is precipitated. The analytically pure salt has a melting point of 214°C to 216°C (bubbles); it begins to sinter at 205°C. The dimaleate melts at 188°C to 190°C after sintering from 180°C (recrystallized from methanol).

References

Merck Index 9151

Kleeman & Engel p. 875

PDR p. 683

OCDS Vol. 1 p. 382 (1977)

DOT 9 (6) 228 (1973)

I.N. p. 943

REM p. 810

Renz, J., Bourquin, J.P., Gamboni, G. and Schwarb, G.; U.S. Patent 3,336,197; August 15, 1967; assigned to Sandoz, Ltd. (Switz.)

THIHEXINOL

Therapeutic Function: Anticholinergic

Chemical Name: α -[4-(Diethylamino)cyclohexyl]- α -2-thienyl-2-thiophene-methanol

Common Name: —

Structural Formula:

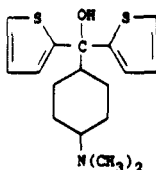

Chemical Abstracts Registry No.: 53626-54-3

Trade Name	Manufacturer	Country	Year Introduced
Sorboquel	Schering	U.S.	1960
Entoquel	White	U.S.	1961

Raw Materials

Ethyl-p-aminobenzoate	Hydrogen
Formaldehyde	2-Bromothiophene
Magnesium	

Manufacturing Process

The requisite intermediate, ethyl 4-dimethylaminocyclohexylcarboxylate is prepared as follows: 33 g of ethyl p-aminobenzoate dissolved in 300 cc of absolute ethanol containing 16.8 cc of concentrated hydrochloric acid is hydrogenated at 50 pounds hydrogen pressure in the presence of 2 g of platinum oxide. The theoretical quantity of hydrogen is absorbed in several hours, the catalyst removed by filtration and the filtrate concentrated to dryness in vacuo. The residue is dissolved in water, made alkaline with ammonium hydroxide and extracted with chloroform. After removal of the solvent, the residual oil is distilled to yield ethyl 4-aminocyclohexylcarboxylate, boiling point 114°C to 117°C/10 mm.

A mixture of 49 g of this ester compound, 76 g of 98% formic acid and 68 ml of formalin solution is heated under reflux for 8 hours. The solvents are then removed in vacuo on the steam bath, the residue dissolved in water, made alkaline with ammonium hydroxide and extracted with chloroform. Removal of the solvent and distillation in vacuo yields ethyl 4-dimethylaminocyclohexylcarboxylate, boiling point 122°C to 125°C/10 mm.

To a solution of thienyl magnesium bromide prepared from 21.4 g of magnesium and 144 g of 2-bromothiophene are added 39.8 g of ethyl 4-dimethylaminocyclohexylcarboxylate. The mixture is allowed to warm to room temperature and stirred for an additional six hours. The reaction mixture is then decomposed with dilute ammonium chloride solution and extracted with ether. The combined ether extracts are extracted thoroughly with 10% hydrochloric acid and the acid solution made alkaline with ammonium hydroxide. The aqueous solution is extracted with chloroform which is then washed with water, dried and evaporated to a residue in vacuo. Recrystallization of the residue from hexane yields α, α^1 -dithienyl-4-dimethylaminocyclohexyl carbinol, melting point 156°C to 157°C after recrystallization from benzene.

References

Merck Index 9152

I.N. p. 943

Villani, F.J.; U.S. Patent 2,764,519; September 25, 1956; assigned to Schering Corp.

THIOCARBARSONE

Therapeutic Function: Antiamebic

Chemical Name: 2,2'-[[[4-[(Aminocarbonyl)amino] phenyl] arsinidene] bis(thio)] bis[acetic acid]

Common Name: Thio-carbamisin

Structural Formula:

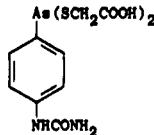

Chemical Abstracts Registry No.: 120-02-5

Trade Name	Manufacturer	Country	Year Introduced
Thiocarbarsona	Lilly	U.S.	1951

Raw Materials

Thioglycolic acid
Carbarsone oxide

Manufacturing Process

121 g of thioglycolic acid and 100 g of carbarsone oxide are reacted in a solution of 128 g of sodium bicarbonate in 2 liters of water.

The mixture is heated on a steam bath for 20 minutes. The reaction mixture is then cooled and filtered to remove a small amount of insoluble material. The filtrate is diluted with about 600 cc of water and is acidified with concentrated hydrochloric acid.

On treating the reaction mixture with acid, di-(carboxymethylthio)-p-carbamidophenylarsine precipitates, and is separated by filtration and dried.

Di-(carboxymethylthio)-p-carbamidophenylarsine thus prepared was obtained as a white amorphous solid, soluble in dilute alkali. It contained about 19.85% of arsenic as compared with the calculated amount of 19.09%.

References

Merck Index 9162

I.N. p. 944

Rohrmann, E.; U.S. Patent 2,516,831; July 25, 1950; assigned to Eli Lilly & Co.

THIOGUANINE

Therapeutic Function: Cancer chemotherapy

Chemical Name: 2-aminopurine-6-thiol

Common Name: —

Structural Formula:

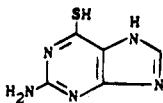

Chemical Abstracts Registry No.: 154-42-7

Trade Name	Manufacturer	Country	Year Introduced
Thioguanine Tabloid	Burroughs Wellcome	U.S.	1966
Lanvis	Wellcome	U.K.	1972
Thioguanine Wellcome	Burroughs Wellcome	Italy	1974
Thioguanin Wellcome	Burroughs Wellcome	W. Germany	1975

Raw Materials

Guanine
Phosphorus pentasulfide

Manufacturing Process

A mixture of 2.7 grams of finely divided guanine, 10 grams of pulverized phosphorus pentasulfide, 10 ml of pyridine and 100 ml of tetralin was heated at 200°C with mechani-

cal stirring for 5 hours. After cooling, the mixture was filtered and the insoluble residue treated with 150 ml of water and 50 ml of concentrated ammonium hydroxide. The ammoniacal solution was filtered, heated to boiling and acidified with acetic acid. Upon cooling, 2-amino-6-mercaptapurine precipitated as a dark yellow powder, according to U.S. Patent 2,697,709.

References

Merck Index 9177

Kleeman & Engel p. 892

PDR p. 765

OCDS Vol. 2 p. 464 (1980)

I.N. p. 954

REM p. 1153

Hitchings, G.H. and Elion, G.B.; U.S. Patent 2,697,709; December 21, 1954; assigned to Burroughs Wellcome & Co. (U.S.A.) Inc.

Hitchings, G.H. and Elion, G.B.; U.S. Patent 2,800,473; July 23, 1957; assigned to Burroughs Wellcome & Co. (U.S.A.) Inc.

Hitchings, G.H. and Elion, G.B.; U.S. Patent 2,884,667; May 5, 1959

Hitchings, G.H., Elion, G.B. and Mackay, L.E.; U.S. Patent 3,019,224; January 30, 1962; assigned to Burroughs Wellcome & Co. (U.S.A.) Inc.

Hitchings, G.H., Elion, G.B. and Goodman, I.; U.S. Patent 3,132,144; May 5, 1964; assigned to Burroughs Wellcome & Co. (U.S.A.) Inc.

THIOPROPAZATE

Therapeutic Function: Antipsychotic

Chemical Name: 4-[3-(2-Chlorophenothiazin-10-yl)propyl]-1-piperazine-ethanol acetate

Common Name: —

Structural Formula:

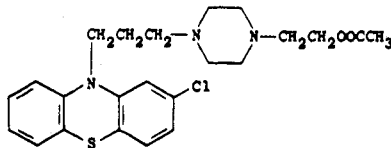

Chemical Abstracts Registry No.: 84-06-0; 146-28-1 (Hydrochloride)

Trade Name	Manufacturer	Country	Year Introduced
Dartal	Searle	U.S.	1957
Dartalan	Searle	U.K.	—
Vesitan	Boehr. Mann.	W. Germany	—

Raw Materials

2-Chloro-10-(γ -chloropropyl)phenothiazine

Piperazine

β -Bromoethyl acetate

Manufacturing Process

A mixture of 155 parts of 2-chloro-10-(γ -chloropropyl)phenothiazine, 75 parts of sodium

iodide, 216 parts of piperazine and 2,000 parts of butanone is refluxed for 8 hours, concentrated and extracted with dilute hydrochloric acid. The extract is rendered alkaline by addition of dilute potassium carbonate and extracted with ether. This ether extract is washed with water, dried over anhydrous potassium carbonate, filtered and evaporated. Vacuum distillation at 0.1 mm pressure yields 2-chloro-10-(γ -piperazinopropyl)phenothiazine at about 214°C to 218°C.

A mixture of 50 parts of the distillate, 25.6 parts of β -bromoethyl acetate, 10.7 parts of potassium carbonate and 400 parts of toluene is stirred at reflux temperature for 16 hours. The mixture is heated with water. The organic layer is separated, washed with water and extracted with dilute hydrochloric acid. The resulting extract is washed with benzene, rendered alkaline and extracted with benzene. The resulting benzene solution is dried over anhydrous potassium carbonate, filtered and concentrated. The residue is dissolved in 300 parts of ethanol and treated with 2.2 equivalents of a 25% solution of anhydrous hydrochloric acid in 2-propanol. The resulting crystals are recrystallized from 400 parts of ethanol and 10 parts of water. The dihydrochloride of N-(β -acetoxyethyl)-N'-[γ -(2'-chloro-10'-phenothiazine)propyl] piperazine melts unsharply at about 200°C to 230°C.

References

Merck Index 9198

Kleeman & Engel p. 878

OCDS Vol. 1 p. 383 (1977)

I.N. p. 946

Cusic, J.W.; U.S. Patent 2,766,235; October 9, 1956

THIOPROPERAZINE

Therapeutic Function: Neuroleptic, antiemetic

Chemical Name: N,N-Dimethyl-10-[3-(4-methyl-1-piperazinyl)propyl]-phenothiazine-2-sulfonamide

Common Name: Thioperazine

Structural Formula:

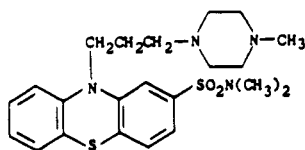

Chemical Abstracts Registry No.: 316-81-4

Trade Name	Manufacturer	Country	Year Introduced
Majeptil	Specia	France	1960
Cephalmim	Shionogi	Japan	—
Mayeptil	Rhodia Pharma	W. Germany	—
Vontil	S.K.F.	U.S.	—

Raw Materials

3-Dimethylsulfamoylphenothiazine

3-(4-Methyl-1-piperazinyl)-1-chloropropane

Sodium amide

Manufacturing Process

A solution of 3-dimethylsulfamoylphenothiazine (5 g) in anhydrous xylene (100 cc) is heated under reflux for 1 hour with sodamide (0.67 g). 3-(4-methyl-1-piperazinyl)-1-chloropropane (3.2 g) in solution in anhydrous xylene (20 cc) is added and the mixture heated under reflux for 5 hours. After treatment of the reaction products, a crude oily base (2.5 g) is obtained after treatment. By the addition of a solution of fumaric acid in ethanol to an ethanolic solution of the base, 3-dimethylsulfamoyl-10-(3-4¹-methyl-1¹-piperazinylpropyl)-phenothiazine diacid fumarate (2.6 g) is obtained, melting point 182°C. The base recrystallized from ethyl acetate melts at about 140°C.

References

Merck Index 9199

Kleeman & Engel p. 879

I.N. p. 946

Soc. des Usines Chimiques Rhone-Poulenc; British Patent 814,512; June 3, 1959

THIORIDAZINE

Therapeutic Function: Tranquilizer

Chemical Name: 10-[2-(1-methyl-2-piperidyl)ethyl]-2-(methylthio)phenothiazine

Common Name: —

Structural Formula:

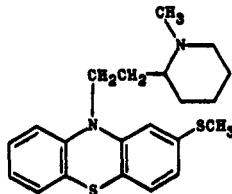

Chemical Abstracts Registry No.: 50-52-2; 130-61-0 (Hydrochloride)

Trade Name	Manufacturer	Country	Year Introduced
Mellaril	Sandoz	U.S.	1959
Mellaril	Sandoz	France	1960
Baylaril	Bay	U.S.	1983
Mellerette	Wander	Italy	—
Melleretten	Sandoz	W. Germany	—
Novoridazide	Novopharm	Canada	—
Orsanil	Orion	Finland	—
Ridazin	Taro	Israel	—
Stalleril	Pharmacial	Finland	—
Thioril	I.C.N.	Canada	—

Raw Materials

m-Methylmercaptoaniline	Potassium o-chlorobenzoate
Sulfur	Iodine
2-(N-methylpiperidyl-2'-)-1-chloroethane	Sodium amide

Manufacturing Process

N-(m-methylmercapto-phenyl)-aniline (MP 59° to 61°C) is prepared by condensing m-methylmercapto-aniline (BP 163° to 165°C/16 mm Hg) with the potassium salt of o-chloro-benzoic acid and decarboxylating the resultant N-(m-methylmercapto-phenyl)-anthranilic acid (MP 139° to 141°C) by heating, and then distilling.

9.87 parts of N-(m-methylmercapto-phenyl)-aniline are heated with 2.93 parts of sulfur and 0.15 part of powdered iodine for 15 minutes in a bath at about 160°C. Upon termination of the ensuing evolution of hydrogen sulfide, animal charcoal is added to the reaction mixture and recrystallization carried out first from 40 parts by volume of chlorobenzene, and then from 25 to 30 parts by volume of benzene at the boiling temperature. The obtained citron-yellow 3-methylmercapto-phenothiazine has a MP of 138° to 140°C.

17.82 parts of 2-methylmercapto-phenothiazine, 3.4 parts of finely pulverized sodamide and 80 parts by volume of absolute xylene are heated to boiling for two hours at a bath temperature of 180°C under a reflux condenser and while stirring the reaction mixture. Without interrupting the heating, a solution of 13.2 parts of 2-(N-methyl-piperidyl-2'-1)-chloro-ethane in 40 parts by volume of absolute xylene is then added dropwise in the course of 1½ hours. After further heating for 3 hours, the reaction mixture is cooled and, after the addition of 5 parts of ammonium chloride, is shaken three times with water, using 25 parts by volume each time. The xylene solution is extracted once with 35 parts by volume of 3 normal acetic acid and then three times, each time with 15 parts by volume of the said acid, after which the acetic acid extract is washed with 60 parts by volume of ether and is then made phenolphthalein-alkaline by means of 25 parts by volume of concentrated aqueous caustic soda solution.

The precipitated oily base is taken up in a total of 100 parts by volume of benzene. The benzene layer, dried over potassium carbonate, is filtered and then evaporated under reduced pressure. The residue from the evaporation is distilled in a high vacuum; after separating a preliminary distillate which passes over up to 228°C under a pressure of 0.92 mm Hg, the principal fraction, 2-methylmercapto-10-[2'-(N-methyl-piperidyl-2'')-ethyl-1']-phenothiazine, which distills over at 228° to 232°C under the last-mentioned pressure, is collected. The analytically pure base has a BP of 230°C/0.02 mm Hg.

References

- Merck Index 9202
- Kleeman & Engel p. 879
- PDR pp. 1586, 1606
- OCDS Vol. 1 p. 389 (1977)
- DOT 9 (6) 227 (1973)
- I.N. p. 946
- REM p. 1090
- Renz, J., Bourquin, J.P., Gamboni, G. and Schwarb, G.; U.S. Patent 3,239,514; March 8, 1966; assigned to Sandoz Ltd., Switzerland

THIOTEPA

Therapeutic Function: Antineoplastic

Chemical Name: 1,1',1''-Phosphionothioylidynetrisaziridine

Common Name: Triethylenethiophosphoramidate

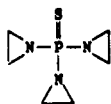
Structural Formula:

Chemical Abstracts Registry No.: 52-24-4

Trade Name	Manufacturer	Country	Year Introduced
Thio-Tepa	Lederle	U.S.	1959
Onca-Tiotepa	Simes	Italy	—
Tespamin	Somitomo	Japan	—

Raw Materials

Ethyleneimine
Thiophosphoryl chloride

Manufacturing Process

A solution of 30.3 parts of triethylamine and 12.9 parts of ethyleneimine in 180 parts of dry benzene is treated with a solution of 16.9 parts of thiophosphoryl chloride in 90 parts of dry benzene at 5°C to 10°C. Triethylamine hydrochloride is filtered off. The benzene solvent is distilled from the filtrate under reduced pressure and the resulting crude product is recrystallized from petroleum ether. The N,N',N''-triethylenethiophosphoramidate had a melting point of 51.5°C.

References

Merck Index 9484

Kleeman & Engel p. 880

PDR p. 1030

I.N. p. 946

REM p. 1156

Kun, E. and Seeger, D.R.; U.S. Patent 2,670,347; February 23, 1954; assigned to American Cyanamid Co.

THIOTHIXENE

Therapeutic Function: Tranquilizer

Chemical Name: (Z)-N,N-dimethyl-9-[3-(4-methyl-1-piperazinyl)propylidene]thioxanthene-2-sulfonamide

Common Name: Tiotixen

Structural Formula:

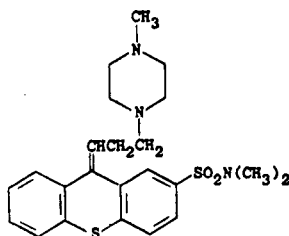

Chemical Abstracts Registry No.: 3313-26-6

Trade Name	Manufacturer	Country	Year Introduced
Navane	Roerig	U.S.	1967
Navane	Pfizer	U.K.	1967
Orbinamon	Pfizer	W. Germany	1968
Navane	Pfizer Taito	Japan	1970
Navane	Pfizer	Italy	1971

Raw Materials

Thioxanthene	Chlorosulfonic acid
Thionyl chloride	Dimethylamine
n-Butyllithium	Methyl acetate
Paraformaldehyde	1-Methylpiperazine
Sodium borohydride	Phosphorus oxychloride

Manufacturing Process

Sodium Thioxanthene-2-Sulfonate: A solution of thioxanthene (32.2 grams, 0.160 mol) in 160 ml of chloroform was cooled to 0°C and chlorosulfonic acid (12.4 ml, 0.190 mol) added as rapidly as possible while maintaining the internal temperature below 10°C. After the addition was complete, the reaction mixture was allowed to approach room temperature during 30 minutes, then refluxed for an additional 20 minutes. The deep red solution was poured onto 100 grams of crushed ice and to convert the sulfonic acid to its sodium salt there was added 20 grams of sodium chloride. After filtering the slurry through a sintered glass funnel, the filter cake was washed with 50 ml of chloroform and 50 ml of 20% sodium chloride solution.

The crude sulfonate product was digested in 1,500 ml of boiling water, and filtered at the boiling point. Crystallization was allowed to proceed overnight at 4°C and after filtration and vacuum drying at 100°C, 33.3 grams (69%) of glistening, colorless plates were obtained.

2-Dimethylsulfamylthioxanthene: To a slurry of dry sodium thioxanthene-2-sulfonate (33.3 grams, 0.111 mol) in 50 ml of N,N-dimethylformamide was added thionyl chloride (14.3 grams, 0.122 mol) in divided portions. An exothermic reaction ensued with complete dissolution being effected in minutes. Treatment of the reaction mixture with crushed ice precipitated a gum which crystallized after a short period of stirring. The sulfonyl chloride was filtered, washed with water, and stirred with 100 ml of liquid dimethylamine. After allowing the mixture to evaporate to dryness, water was added and the sulfonamide filtered, washed with water, and dried in vacuo. The crude product (32.5 grams, 96%) obtained melts at 163.5° to 165°C. One crystallization from ethanol chloroform yielded an analytical sample, MP 164.5 to 166.5°C.

9-Acetyl-2-Dimethylsulfamylthioxanthene: A suspension of 2-dimethylsulfamylthioxanthene (12.22 grams, 0.04 mol) in 60 ml of dimethoxymethane is cooled to 0°C and 17.2 ml of a 2.91 M solution of n-butyl lithium in heptane is added slowly in a nitrogen atmosphere while the temperature is maintained below 10°C. After an additional 10 minutes of stirring, the cooling bath is removed and a solution of 2.96 grams of methyl acetate in 20 ml of dimethoxyethane is added during ½ hour and then the mixture is stirred at 25°C for an additional 3 hours. The reaction mixture is then treated with 60 ml of ethyl acetate and with 60 ml of a 10% aqueous ammonium chloride solution. The layers are separated and the ethyl acetate layer is washed once with water (25 ml) and then the solvent is removed by distillation.

The product is purified by the method of Teitelbaum, *J. Org. Chem.*, 23, 646 (1958). The gummy residue is treated with 7.8 grams of Girard's "T" reagent, a commercially available (carboxymethyl) trimethylammonium chloride hydrazide which can be prepared by the method described by Girard in *Organic Syntheses*, collective volume II, page 85

(1943), 0.2 grams of a methacrylic-carboxylic cation exchange resin of 20 to 50 mesh particle size, such as Amberlite IRC-50 (Rohm & Haas Co.) and 20 ml of ethanol. The mixture is refluxed for 1 hour, then is cooled to 25°C, is diluted with 80 ml of water and is filtered. The filtrate is stirred for 16 hours with 20 ml of aqueous formaldehyde and the product precipitates as a white solid, MP 118° to 123°C, net 5.6 grams, yield, 40% of the theoretical.

9-[3-(2-Dimethylaminopropionyl)-2-Dimethylsulfamylthioxanthene: To a mixture of 9-acetyl-2-dimethylsulfamylthioxanthene (54.1 grams, 0.155 mol), 100 ml isopropanol, 10.6 grams paraformaldehyde and 16.4 grams (0.200 mol) dimethylamine hydrochloride, is added 1.0 milliliter of concentrated hydrochloric acid. The mixture is refluxed in a nitrogen atmosphere for 24 hours, then is concentrated to one-half volume by distillation of part of the solvent in vacuo. The concentrate is treated with 60 ml of ethyl acetate then the mixture is cooled to 5°C whereupon the crystalline product precipitates. This is removed by filtration and, after drying, weighs 47.8 grams, and melts at 177° to 181°C. After two crystallizations from isopropanol the product is obtained as the monohydrochloride addition salt, MP 187° to 189°C.

9-[3-(4-Methyl-1-Piperazinyl)-1-Hydroxypropyl]-2-Dimethylsulfamylthioxanthene: A mixture of 9-(3-dimethylaminopropionyl)-2-dimethylsulfamylthioxanthene hydrochloride (17 grams, 0.039 mol) and 20.0 grams (0.2 mol) 1-methylpiperazine in 40 ml of isopropanol is refluxed in a nitrogen atmosphere for 3 hours. 200 ml ethyl acetate is then added and the mixture is washed twice with 100 ml of water, the organic layer is separated and dried with anhydrous sodium sulfate, then the solvent is removed by distillation in vacuo. The 9-[3-(4-methyl-1-piperazinyl)propionyl]-2-dimethylsulfamylthioxanthene which remains as a residue is treated with a solution of 3.03 grams (0.08 mol) of sodium borohydride in 100 ml of ethanol. The mixture is refluxed under nitrogen for 3 hours, is cooled and is treated with an equal volume of water. The aminoalcohol is extracted 3 times with equal volumes of ethyl acetate. The organic layer is separated and is dried with anhydrous magnesium sulfate, then the solvent is removed by distillation leaving the product as a white, amorphous solid.

9-[3-(4-Methyl-1-Piperazinyl)-Propylidene]-2-Dimethylsulfamylthioxanthene: A solution of 12 grams of 9-[3-(4-methyl-1-piperazinyl)-1-hydroxypropyl]-2-dimethylsulfamylthioxanthene in 20 ml of pyridine is cooled to 0°C in an ice bath and 18.4 ml of phosphorus oxychloride dissolved in 60 ml of pyridine is added dropwise. The mixture is allowed to warm to 25°C during 30 minutes, then is heated, immersed in an 80°C oil bath, for an additional 30 minutes. The dark brown reaction mixture is cooled to 25°C then is poured onto 50 grams of ice. After the ice has melted, the aqueous solution is saturated with potassium carbonate and the liberated oil is extracted with three 150 ml portions of ethyl acetate. The solvents are removed from the separated organic layer by distillation. The product, a light brown amorphous solid, remains as a residue from the distillation. The free base is dissolved in 50 ml of acetone, is treated with two stoichiometric equivalents of maleic acid in 50 ml of acetone and the white crystalline dimaleate salt is removed by filtration. There is obtained 12.3 grams, 47% yield, MP 158° to 160.5°C (after recrystallization from ethanol).

References

- Kleeman & Engel p. 894
 PDR p. 1528
 OCDS Vol. 1 p. 400 (1977) & 2, 412 (1980)
 DOT 4 (4) 163 (1968) & 9 (6) 229 (1973)
 I.N. p. 955
 REM p. 1091
 Bloom, B.M. and Muren, J.F.; U.S. Patent 3,310,553; March 21, 1967; assigned to Chas. Pfizer & Co., Inc.

THIPHENAMIL HYDROCHLORIDE

Therapeutic Function: Antispasmodic

Chemical Name: α -phenylbenzeneethanethioic acid S-[2-(diethylamino)ethyl] ester hydrochloride

Common Name: 2-diethylaminoethyl diphenylthiolacetate hydrochloride

Structural Formula:

$$(C_6H_5)_2CHC(=O)SCH_2CH_2N(C_2H_5)_2 \cdot HCl$$

Chemical Abstracts Registry No.: 548-68-5; 82-99-5 (Base)

Trade Name	Manufacturer	Country	Year Introduced
Trocinate	Poythress	U.S.	1950

Raw Materials

2-Diethylaminoethanethiol
Diphenylacetyl chloride

Manufacturing Process

The following procedure is described in U.S. Patent 2,510,773: To an ice-cold solution of 13.3 grams of 2-diethylaminoethanethiol in 100 cc of dry benzene is slowly added a solution of 23.05 grams of diphenylacetyl chloride in 200 cc of dry benzene. The mixture is stirred 2 hours, then heated to dissolve the fine white solid that is formed. Upon cooling 31.3 grams of 2-diethylaminoethyl diphenylthiolacetate hydrochloride precipitates. It recrystallizes from a mixture of benzene and petroleum ether (BP 60° to 70°C) as rosettes of tiny needles and melts at 129° to 130°C. From a mixture of absolute ethanol and ethyl acetate it recrystallizes as large, almost transparent prisms.

References

Merck Index 9215

REM p. 919

Richardson, A.G.; U.S. Patent 2,390,555; December 11, 1945; assigned to William P. Poythress & Company, Inc.

Clinton, R.O.; U.S. Patent 2,510,773; June 6, 1950; assigned to Sterling Drug Inc.

THONZYLAMINE HYDROCHLORIDE

Therapeutic Function: Antihistaminic

Chemical Name: N-[(4-Methoxyphenyl)methyl]-N,N'-dimethyl-N-2-pyrimidinyl-1,2-ethanediamine monohydrochloride

Common Name: —

Structural Formula:

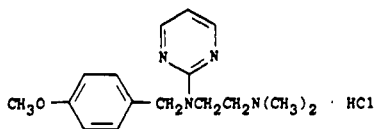

Chemical Abstracts Registry No.: 63-56-9

Trade Name	Manufacturer	Country	Year Introduced
Neohetramine	Warner Lambert	U.S.	1948
Anahist	Warner Lambert	U.S.	1949
Tonamil	Ecobi	Italy	—

Raw Materials

2-(p-Methoxybenzyl)aminopyrimidine
Sodium amide
Dimethylaminoethyl chloride

Manufacturing Process

54 g of 2-(p-methoxybenzyl)aminopyrimidine and 12.0 g of sodamide were suspended in 250 cc of toluene and were refluxed for 31 hours. To the thus prepared sodium salt of 2-(p-methoxybenzyl)aminopyrimidine, 28.1 g of dimethylaminoethyl chloride were added and refluxed under continuous stirring for 26 hours. After cooling, the reaction mixture was extracted with dilute hydrochloric acid at about pH 5.0, removing the product thus formed containing only very little of the unreacted 2-(p-methoxybenzyl)aminopyrimidine. This solution was then made alkaline to liberate the free base of the product, which was extracted with ether. The ether solution was evaporated and the residue vacuum distilled. The product, 2-(p-methoxybenzyl, dimethylaminoethyl)aminopyrimidine forms an oily liquid, boiling point 185°C to 187°C at 2.2 mm.

References

Merck Index 9219
OCDS Vol. 1 p. 52 (1977)
I.N. p. 947
Friedman, H.L. and Tolstouhov, A.V.; U.S. Patent 2,465,865; March 29, 1949; assigned to Pyridium Corp.

TIADENOL

Therapeutic Function: Cholesterol-reducing agent

Chemical Name: 2,2'-(decamethylenedithio)diethanol

Common Name: —

Structural Formula: $\text{HOCH}_2\text{CH}_2\text{S}(\text{CH}_2)_{10}\text{SCH}_2\text{CH}_2\text{OH}$

Chemical Abstracts Registry No.: 6964-20-1

Trade Name	Manufacturer	Country	Year Introduced
Fonlipol	Lafon	France	1972
Tiaden	Malesci	Italy	1979
Braxan	Bago	Argentina	—
Delipid	Coop. Farm.	Italy	—
Eulip	Robin	Italy	—
Millaterol	Therapia	Spain	—
Tiaclar	C.I.	Italy	—
Tiodenol	Leti	Spain	—

Raw Materials

Thioethylene glycol
Decamethylene bromide

Manufacturing Process

Thioethylene glycol, HSCH₂CH₂OH (prepared from ethylene oxide and hydrogen sulfide) is first reacted with sodium to give HOCH₂CH₂SNa. It is then reacted with decamethylene bromide, Br(CH₂)₁₀Br to give tiadenol.

References

Merck Index 9263

Kleeman & Engel p. 881

DOT 8 (12) 454 (1972)

J.N. p. 948

Williams, J.L.R. and Cossar, B.C.; U.S. Patent 3,021,215; February 13, 1962; assigned to Eastman Kodak Company

TIANEPTINE

Therapeutic Function: Antidepressant

Chemical Name: Sodium 7-[8-chloro-10-dioxo-11-methyldibenzo[c,f]thiazepin-(1,2)-5-yl]-aminoheptanoate

Common Name: —

Structural Formula:

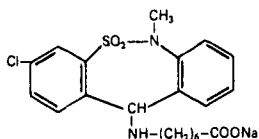

Chemical Abstracts Registry No.: 66981-73-5

Trade Name	Manufacturer	Country	Year Introduced
Stablon	Servier	France	1983

Raw Materials

Ethyl 7-aminoheptanoate
5,8-Dichloro-10-dioxo-11-methyldibenzo[c,f]thiazepine(1,2)
Sodium hydroxide

Manufacturing Process

A solution of 27.6 g (0.16 mol) of freshly distilled ethyl 7-aminoheptanoate in 40 ml of nitromethane was added all at once and with mechanical stirring to a suspension of 26.2 g (0.08 mol) of 5,8-dichloro-10-dioxo-11-methyldibenzo[c,f]thiazepine(1,2) in 120 ml of nitromethane. The whole was heated to 55°C for 30 minutes, the solvent was then evaporated in vacuo and the residue was taken up in water. The crude ester was extracted with ether. After evaporation of the ether 36 g of crude ester were obtained, and 30 g (0.065 mol) thereof were treated under reflux with a solution of 2.8 g (0.07 mol) of sodium hydroxide in 75 ml of eth-

anol and 25 ml of water. After one hour's refluxing, the alcohol was evaporated in vacuo. The residue was taken up in 150 ml of water.

The mixture was twice extracted with 75 ml of chloroform and the aqueous phase was evaporated in vacuo. The sodium salt was then dissolved in 150 ml of chloroform, the solution was dried over sodium sulfate and the product precipitated with anhydrous ether.

The salt was filtered off, washed with ether and dried at 50°C. 13 g of sodium 7-[8-chloro-10-dioxo-11-methylidibenzo[c,f]thiazepin-(1,2)-aminoheptanoate, melting with decomposition at about 180°C, were obtained.

References

Merck Index 9265

DFU 4 (7) 522 (1979) (As S-1574) & 6 (12) 797 (1981)

DOT 19 (6) 306 (1983)

Malen, C., Danree, B. and Poignant, J.C.; U.S. Patents 3,758,528; September 11, 1973; and 3,821,249; June 28, 1974; both assigned to Societe et Nom Collectif Science Union et Cie, Societe Francaise de Recherche Medicale

TIAPRIDE

Therapeutic Function: Antiemetic

Chemical Name: N-(Diethylaminoethyl)-2-methoxy-5-methylsulfonylbenzamide

Common Name: —

Structural Formula:

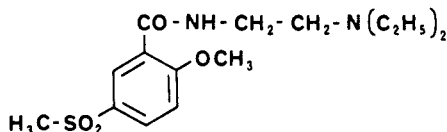

Chemical Abstracts Registry No.: 51012-32-9; 51012-33-0 (Hydrochloride)

Trade Name	Manufacturer	Country	Year Introduced
Tiapridal	Delagrangre	France	1977
Tiapridex	Schuerholz	W. Germany	1977
Sereprile	Vita	Italy	1977
Tiapridal	Pharmos	Switz.	1981
Italprid	Prophin	Italy	—
Neuropri	Italchemi	Italy	—

Raw Materials

2-Methoxy-5-methylsulfonylbenzoic acid

Isobutyl chloroformate

N,N-diethylethylenediamine

Manufacturing Process

5 g of 2-methoxy-5-methylsulfonylbenzoic acid, 50 ml of dioxan, 3.02 ml of triethylamine and 3 g of isobutyl chloroformate were introduced into a 250 ml balloon flask at ambient temperature.

After the mixture had been stirred for 30 minutes, 3 g of N,N-diethylethylenediamine were added. The reaction mixture was stirred for 6 hours and the solvents were evaporated under vacuum.

The residue was dissolved in 50 ml of water and the solution was made alkaline with sodium hydroxide. The precipitate formed was filtered, washed and dried in a drying oven at 60°C. 6 g of N-(diethylaminoethyl)-2-methoxy-5-methylsulfonylbenzamide (melting point: 124°C to 125°C) was produced.

References

DFU 1 (2) 88 (1976)

Kleeman & Engel p. 881

DOT 13 (8) 340 (1977)

I.N. p. 949

Societe d'Etudes Scientifiques et Industrielles de l'Île-de-France; British Patent 1,394,563; May 21, 1975

TIAPROFENIC ACID

Therapeutic Function: Antiinflammatory

Chemical Name: 5-Benzoyl- α -methyl-2-thiopheneacetic acid

Common Name: —

Structural Formula:

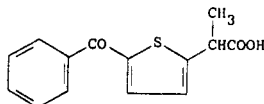

Chemical Abstracts Registry No.: 33005-95-7

Trade Name	Manufacturer	Country	Year Introduced
Surgam	Roussel	France	1975
Surgam	Roussel	W. Germany	1980
Surgam	Hoechst	Switz.	1982
Surgam	Roussel	U.K.	1982
Surgamic	Roussel-Iberica	Spain	—

Raw Materials

Thiophene-2 α -methylacetic acid
Benzoyl chloride

Manufacturing Process

A mixture of 10.3 g of thiophene-2 α -methylacetic acid [prepared by process of Bercot-Vatteroni, et al., *Bull. Soc. Chim.* (1961) pp. 1820-21], 11.10 g of benzoyl chloride and a suspension of 23.73 g of aluminum chloride in 110 cc of chloroform was allowed to stand for 15 minutes and was then poured into a mixture of ice and hydrochloric acid. The chloroform phase was extracted with a 10% aqueous potassium carbonate solution and the aqueous alkaline phase was acidified with N hydrochloric acid and was then extracted with ether. The ether was evaporated off and the residue was crystallized from carbon tetrachloride to obtain a 54% yield of 5-benzoyl-thiophene-2 α -methylacetic acid melting at 83°C to 85°C. The

product occurred in the form of colorless crystals soluble in dilute alkaline solutions, alcohol and ether and insoluble in water.

References

Merck Index 9266

Kleeman & Engel p. 882

DOT 12 (6) 238 (1976)

I.N. p. 38

Clemence, F. and Le Martret, O.; U.S. Patent 4,159,986; July 3, 1979; assigned to Roussel Uclaf (France)

TIARAMIDE

Therapeutic Function: Antiinflammatory

Chemical Name: 4-[(5-chloro-2-oxo-3(2H)-benzothiazolyl)acetyl]-1-piperazineethanol

Common Name: —

Structural Formula:

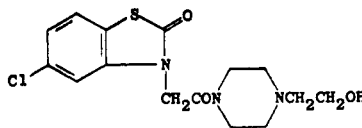

Chemical Abstracts Registry No.: 32527-55-2; 35941-71-0 (Hydrochloride)

Trade Name	Manufacturer	Country	Year Introduced
Solantai	Fujisawa	Japan	1975
Ventaval	Crinos	Italy	1981
Royzolon	Sawai	Japan	—

Raw Materials

Ethyl 5-chloro-2-oxobenzothiazoline acetate
1-(2-Hydroxyethyl)piperazine

Manufacturing Process

A solution of ethyl 5-chloro-2-oxo-3-benzo-thiazolineacetate (4.0 grams) in 1-(2-hydroxyethyl)piperazine is heated at 100°C for 24 hours. After cooling, the resulting mixture is extracted with chloroform. The chloroform extract is washed with water and shaken with 10% hydrochloric acid. The hydrochloric acid layer is washed with chloroform, made alkaline with 10% sodium hydroxide solution and extracted with chloroform. The chloroform extract is washed with water, dried over magnesium sulfate and concentrated. The residual oil (5.5 grams) is allowed to stand to form crystals, which are recrystallized from a mixture of ethyl acetate (40 ml) and ethanol (15 ml) to give 3-[4-(2-hydroxyethyl)-1-piperazinylcarbonylmethyl]-5-chloro-2(3H)-benzothiazolinone (3.2 grams) as colorless crystals, MP 159° to 161°C.

The following is an alternate method of preparation: A mixture of 3-(1-piperazinyl)carbonylmethyl-5-chloro-2(3H)-benzothiazolinone (500 mg), anhydrous potassium carbonate (400 mg), 2-hydroxyethyl bromide (300 mg) and anhydrous ethanol (20 ml) is heated while refluxing for 5 hours. The reaction mixture is concentrated under reduced pressure. The residue is extracted with chloroform. The chloroform layer is dried over magnesium

sulfate and concentrated. The residue is crystallized from a mixture of ethyl acetate and ethanol to give 3-[4-(2-hydroxyethyl)-1-piperazinylcarbonylmethyl]-5-chloro-2(3H)-benzothiazolinone (370 mg) as crystals, MP 159° to 160°C.

References

Merck Index 9268

Kleeman & Engel p. 882

DOT 9 (9) 390 (1973)

I.N. p. 949

Umio, S.; U.S. Patent 3,661,921; May 9, 1972; assigned to Fujisawa Pharmaceutical Co., Ltd., Japan

TIBEZONIUM IODIDE

Therapeutic Function: Antimicrobial

Chemical Name: 2 β -N-Diethylaminoethylthio-4-p-phenylthiophenyl-3H-1,5-benzodiazepine iodomethylate

Common Name: Thiabenzazonium iodide

Structural Formula:

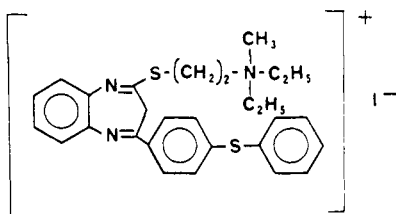

Chemical Abstracts Registry No.: 54663-47-7

Trade Name	Manufacturer	Country	Year Introduced
Antoral	Recordati	Italy	1977

Raw Materials

4-Acetyldiphenylsulfide	Carbon disulfide
o-Phenylenediamine	β -Dimethylaminoethyl chloride
Methyl iodide	

Manufacturing Process

4-Acetyldiphenylsulfide is reacted with carbon disulfide in an initial step to give 4-phenylthiobenzoyl dithioacetic acid. That, in turn, is reacted with o-phenylenediamine.

A mixture of 3.6 g of the thus obtained 4-p-phenylthiophenyl-1,3-dihydro-2H-1,5-benzodiazepine-2-thione, 0.50 g of 50% sodium hydride in oil and 200 ml of benzene is refluxed for 30 minutes, then a solution of 2.02 g of β -diethylaminoethyl chloride in 5 ml of benzene are added dropwise over 5 minutes.

The mixture is refluxed for 10 hours. The mixture is then cooled and filtered to separate the sodium chloride. The filtrate is evaporated to dryness in vacuo. The oily residue is dissolved

in petroleum ether and the solution is filtered with charcoal. The solvent is evaporated in vacuo. The oily residue is heated to 50°C in vacuo (0.01 mm Hg) to remove the excess of β -diethylaminoethyl chloride.

This treatment is continued until the β -diethylaminoethyl chloride disappears (TLC). The oil is then dissolved in isopropanol and weakly acidified with HCl in propanol. The 2 β -N-diethylaminoethylthio-4-p-phenylthiophenyl-3H-1,5-benzodiazepine-HCl product crystallizes by addition of anhydrous ethyl ether to the solution. The crystals are filtered and recrystallized from ethyl acetate. Yield 3.65 g, melting point 150°C.

2.55 g of methyl iodide are added to a solution of 5.93 g of 2 β -N-diethylaminoethylthio-4-p-phenylthiophenyl-3H-1,5-benzodiazepine in 100 ml of isopropanol. The mixture is kept at 20°C to 30°C for 60 hours. The crystals are then filtered. Yield 6.2 g, melting point 161°C.

References

Merck Index 9269

DFU 3 (2) 152 (1978)

Kleeman & Engel p. 883

DOT 14 (6) 252 (1978)

I.N. p. 950

Nardi, D., Massarani, E. and Degen, L.; U.S. Patent 3,933,793; January 20, 1976; assigned to Recordati S.A. Chemical & Pharmaceutical Co.

TICARCILLIN DISODIUM

Therapeutic Function: Antibiotic

Chemical Name: α -Carboxy- α -(3-thienyl)methyl penicillin disodium salt

Common Name: —

Structural Formula:

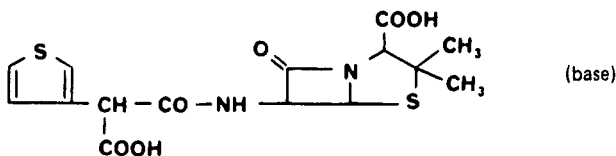

Chemical Abstracts Registry No.: 4697-14-7; 3973-04-4 (Base)

Trade Name	Manufacturer	Country	Year Introduced
Ticar	Beecham	U.S.	1976
Aerugipen	Beecham-Woelfing	W. Germany	1977
Ticar	Beecham	U.K.	1979
Monapen	Fujisawa	Japan	1979
Ticarpenin	Beecham	Japan	1980
Ticalpenin	Beecham	Italy	1980
Ticar	Beecham	France	1981
Neoanabactyl	Beecham	—	—
Ticillin	C.S.L.	Australia	—
Timentin	Beecham	U.S.	—

Raw Materials

Monobenzyl-3-thienylmalonate

Thionyl chloride

6-Aminopenicillanic acid
Hydrogen

Sodium bicarbonate

Manufacturing Process

A mixture of monobenzyl-3-thienylmalonate (1.38 g, 5 mmol) and thionyl chloride (2.5 ml) was warmed at 50°C to 55°C for 1 hour, then at 60°C to 65°C for 10 minutes. The excess of thionyl chloride was removed in vacuo at not more than 30°C, the last traces being removed by codistillation with dry benzene (1 ml) under high vacuum, leaving monobenzyl-3-thienylmalonyl chloride as a yellow oil.

The acid chloride obtained as described above was dissolved in dry acetone (10 ml) and added in a steady stream to a stirred solution of 6-aminopenicillanic acid (1.08 g, 5 mmol) in a mixture of N sodium bicarbonate (15 ml) and acetone (5 ml). After the initial reaction the reaction mixture was stirred at room temperature for 45 minutes, then washed with ether (3 x 25 ml). Acidification of the aqueous solution with N hydrochloric acid (11 ml) to pH 2 and extraction with ether (3 x 15 ml) gave an ethereal extract which was decolorized with a mixture of activated charcoal and magnesium sulfate for 5 minutes.

The resulting pale yellow ethereal solution was shaken with sufficient N sodium bicarbonate (4 ml) to give an aqueous extract of pH 7 to 7.5. This extract was concentrated to syrup at low temperature and pressure, then isopropanol was added with stirring until the mixture contained about 10% water.

Crystallization was initiated, and completed at about 0°C overnight, to give the sodium salt of α -(benzyloxycarbonyl)-3-thienylmethylpenicillin as white crystals in 50% weight yield. This product was estimated by colorimetric assay with hydroxylamine to contain 91% of the anhydrous sodium salt.

A solution of the sodium salt of α -(benzyloxycarbonyl)-3-thienylmethylpenicillin (2.13 g, 4.3 mmol) in water (30 ml) was added to a suspension of 5% palladium on calcium carbonate (10.65 g) in water (32 ml) which had been prehydrogenated for 1 hour.

The mixture was then hydrogenated at just above atmospheric pressure for 1½ hours and filtered through a Dicalite bed. The clear filtrate was evaporated at low temperature and pressure, and the residue dried in vacuo over phosphorus pentoxide, to give 1.64 g of the salt of α -(3-thienyl)methylpenicillin as a white solid.

Colorimetric assay with hydroxylamine showed this salt to contain 94% of the anhydrous penicillin. Paper chromatography showed complete reduction of the benzyl group.

References

Merck Index 9271

Kleeman & Engel p. 883

PDR pp. 663, 666

OCDS Vol. 2 p. 437 (1980)

DOT 10 (2) 55 (1974); 11 (11) 446 (1975) & 13 (9) 374 (1977)

I.N. p. 950

REM p. 1199

Beecham Group, Ltd.; British Patent 1,125,557; August 28, 1968

Brain, E.G. and Nayler, J.H.C.; U.S. Patent 3,282,926; November 1, 1966; and U.S. Patent 3,492,291; January 27, 1970; both assigned to Beecham Group, Ltd.

TICLOPIDINE HYDROCHLORIDE

Therapeutic Function: Platelet inhibitor

Chemical Name: 5-[(2-Chlorophenyl)methyl]-4,5,6,7-tetrahydrothieno[3,2-c]pyridine

Common Name: —

Structural Formula:

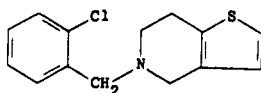

(base)

Chemical Abstracts Registry No.: 53885-35-1; 55142-85-3 (Base)

Trade Name	Manufacturer	Country	Year Introduced
Ticlid	Millot	France	1978
Tiklidan	Labaz	W. Germany	1980
Panaldin	Daiichi Seiyaku	Japan	1981
Tiklid	Midy	Italy	1981
Ticlodone	Crinos	Italy	1982
Caudaline	Exa	Argentina	—

Raw Materials

Thieno[3,2-c]pyridine	2-Chlorobenzyl chloride
Sodium borohydride	Hydrogen chloride

Manufacturing Process

A solution of thieno[3,2-c]pyridine (13.5 g; 0.1 mol) and 2-chlorobenzyl chloride (17.7 g) in acetonitrile (150 ml) is boiled during 4 hours.

After evaporation of the solvent, the solid residue consists of 5-(2-chlorobenzyl)-thieno[3,2-c]-pyridinium chloride which melts at 166°C (derivative $n^{\circ}30$). This compound is taken up into a solution comprising ethanol (300 ml) and water (100 ml). Sodium borohydride (NaBH_4) (20 g) is added portionwise to the solution maintained at room temperature. The reaction medium is maintained under constant stirring during 12 hours and is then evaporated. The residue is taken up into water and made acidic with concentrated hydrochloric acid to destroy the excess reducing agent. The mixture is then made alkaline with ammonia and extracted with ether. The ether solution is washed with water, dried and evaporated. The oily residue is dissolved in isopropanol (50 ml) and hydrochloric acid in ethanol solution is then added thereto.

After filtration and recrystallization from ethanol, there are obtained 5-(2-chlorobenzyl)-4,5,6,7-tetrahydrothieno[3,2-c]-pyridine hydrochloride crystals (yield: 60%) having a melting point (Kofler block) of 190°C.

References

Merck Index 9272

DFU 1 (4) 190 (1976)

Kleeman & Engel p. 884

OCDS Vol. 3 p. 228 (1984)

DOT 15 (8) 354 (1979)

I.N. p. 951

Castaigne, A.R.J.; U.S. Patent 4,051,141; September 27, 1977; assigned to Centre d'Etudes Pour l'Industrie Pharmaceutique (France)

TICRYNAFEN

Therapeutic Function: Diuretic, hypertensive

Chemical Name: [2,3-Dichloro-4-(2-thienylcarbonyl)phenoxy] acetic acid

Common Name: Thienylic acid

Structural Formula:

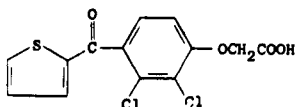

Chemical Abstracts Registry No.: 41080-04-9

Trade Name	Manufacturer	Country	Year Introduced
Diflurex	Anphar	France	1976
Diflurex	Ritter	Switz.	1978
Selacryn	SK Dauelsberg	W. Germany	1979
Selacryn	SKF	U.S.	1979

Raw Materials

2,3-Dichloroanisole	Thiophene-2-carboxylic acid chloride
Ethyl chloroacetate	Sodium hydroxide
Sulfuric acid	

Manufacturing Process

(a) To a solution of 55 g of 2,3-dichloroanisole (0.31 mol), 91 g of thiophene-2-carboxylic acid chloride (0.62 mol) and 180 ml carbon disulfide; there was added little by little 82.7 g of anhydrous aluminum chloride, keeping the temperature at about 25°C. The reaction mixture was stirred at ambient temperature for five hours, left standing overnight and then heated for one hour at 55°C. The solution was cooled and hydrolyzed by 250 g of ice and 60 ml concentrated hydrochloric acid. The precipitate formed is treated with a 30% solution of caustic soda, then washed with water. After recrystallization in 95% ethanol, 88.6 g (yield 92%) of crystals are obtained melting at 108°C.

The process can also be carried out without solvent keeping the same proportions of reactants, or in methylene chloride by adding a slight excess of aluminum chloride powder to a solution of one mol of dichloroanisole and one mol of acid chloride.

(b) 88.6 g of the ketone just obtained (0.308 mol) were dissolved in 300 ml of benzene, 123.5 g of aluminum chloride was added in small doses, and the mixture was boiled under reflux for two hours.

The reaction mixture was hydrolyzed by 500 g ice; the precipitate extracted and taken up in a 10% aqueous caustic soda solution. The benzene phase obtained after hydrolysis is concentrated. The oil obtained is treated as above and the precipitate added to the other. The crystals were recrystallized in 50% ethanol, 60 g of product were obtained, melting at 142°C.

The reaction may also be effected with excellent yields in methylene chloride.

(c) A solution of sodium ethylate was prepared by dissolving 3.45 g of sodium (0.15 mol) in 300 ml absolute ethanol. There was then added 31 g of the preceding phenol (0.15 mol) then 25.8 g ethyl chloroacetate. The mixture was refluxed for 15 hours. Hot extraction was carried out to eliminate the sodium chloride.

The ester precipitated on cooling the filtrate. The product was recrystallized once in isopropanol to give 29.4 g of crystals melting at 58°C. The pure product melts at 63°C to 64°C.

The ester was dissolved in a solution of 500 ml 95% ethanol and 9 ml of 10N caustic soda.

The mixture was boiled under reflux for 30 minutes. The precipitate of the sodium salt of the acid which forms in the cold was extracted and taken up in warm water. The free acid was then precipitated in mineral acid medium. After recrystallization in 50% ethanol, it melted at 148°C to 149°C.

References

Merck Index 9273

Kleeman & Engel p. 886

OCDS Vol. 2 p. 104 (1980)

DOT 12 (10) 413 (1976)

I.N. p. 38

Godfroid, J.J. and Thuillier, J.E.; U.S. Patent 3,758,506; September 11, 1973; assigned to Centre Europeen de Recherches Pharmacologiques (C.E.R.P.H.A.) (France)

TIEMONIUM IODIDE

Therapeutic Function: Antispasmodic, anticholinergic

Chemical Name: 4-[3-Hydroxy-3-phenyl-3-(2-thienyl)propyl]-4-methyl-morpholinium iodide

Common Name: —

Structural Formula:

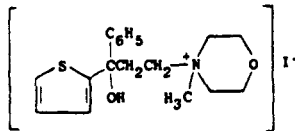

Chemical Abstracts Registry No.: 144-12-7

Trade Name	Manufacturer	Country	Year Introduced
Visceralgine	Riom	France	1963
Viseralgina	S.I.T.	Italy	1965
Ottimal	Farnex	Italy	—

Raw Materials

Bromobenzene	Magnesium
Thienyl-morpholinoethyl ketone	Methyl iodide

Manufacturing Process

(a) N-(3-hydroxy-3-phenyl-3- α -thienyl-propyl) morpholine was first prepared: The following quantities of reactants were mixed in a 2-liter balloon flask having 3 tubes fitted respectively with a mercury-sealed agitator, a reflux condenser having a calcium chloride seal, and a dropping funnel:

Magnesium turnings	27 g (1.1 g at. wt)
Bromobenzene	181 g (1.15 mol)
Anhydrous ether	500 cc

(b) To the cold Grignard solution was added a solution containing:

Thienyl-morpholinoethyl ketone
Anhydrous ether

180 g (0.8 mol)
250 cc

The ketone, preferably prepared by a Grignard reaction, was added in such a way as to maintain the ether under constant reflux. When all of the solution had been added, the mixture was refluxed for a further hour. The mixture was then allowed to stand for 12 hours at ambient temperature, after which the reaction mass was extracted with ice and ammonium chloride in known manner.

(c) The ether solution was treated with 2N hydrochloric acid solution and the amino-alcohol was obtained as the hydrochloride (yield approximately 60%); it was purified by recrystallization from methanol.

The resulting product was dissolved in water, made alkaline with dilute NH_4OH and was extracted with ether. After evaporation of the ether, the amino-alcohol was obtained as a base.

(d) To prepare the quaternary ammonium iodide, the amino-alcohol above was dissolved in a minimum amount of anhydrous ether and was treated with its own weight of methyl iodide. A well-crystallized product was obtained and was washed with anhydrous ether. (Melting point 189°C to 191°C).

References

Merck Index 9274

Kleeman & Engel p. 885

DOT 15 (9) 427 (1979)

I.N. p. 951

Laboratoires d'Analyses et de Recherches Biologiques Mauvernay C.E.R.F.A.; British Patent 953,386; March 25, 1964

TILIDINE HYDROCHLORIDE

Therapeutic Function: Analgesic

Chemical Name: 2-(dimethylamino)-1-phenyl-3-cyclohexene-1-carboxylic acid ethyl ester hydrochloride

Common Name: —

Structural Formula:

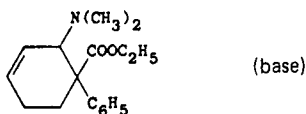

Chemical Abstracts Registry No.: 27107-79-5; 20380-58-9 (Base)

Trade Name	Manufacturer	Country	Year Introduced
Valoron	Goedecke	W. Germany	1970
Valoron	Isom	Italy	1983
Kitadol	Larma	Spain	—
Perdolat	Inca	Argentina	—
Tilitrate	Substancia	Spain	—

Raw Materials

Diethylamine
Atropic acid ethyl ester

Crotonaldehyde
Hydrogen chloride

Manufacturing Process

In a first step, dimethylamine is reacted with crotonaldehyde to give 1-(dimethylamino)-1,3-butadiene.

A solution of 194 grams (2 mols) of fresh-distilled 1-(dimethylamino)-1,3-butadiene is combined at room temperature in a 1 liter round-bottom flask with 352 grams (2 mols) atropic acid ethyl ester. After being stirred for about 10 minutes, the reaction mixture gradually becomes exothermic. By cooling with ice water, the contents of the flask are kept at a temperature of 40° to 60°C. After the reaction has ceased, the mixture is kept overnight (about 8 to 24 hours) at room temperature. The next day the viscous product is dissolved in 10 liters of ether and precipitated with ethereal hydrogen chloride forming the corresponding hydrochloride. By fractional crystallization from ethyl acetate/methyl ethyl ketone (10:1), an almost complete separation of the isomeric cis/trans isomers (I) and (II) is achieved. The separation can be carried out very easily due to the low solubility of the 1½-hydrate of (I). Therefore, during the crystallization a sufficient quantity of water for the formation of the 1½-hydrate of (I) is added to the mixture of solvents, whereby (I) readily precipitates.

Isomer (I): 4-phenyl-3-cis-dimethylamino-4-cis-carbethoxy- Δ^1 -cyclohexene hydrochloride, [ethyl-cis-3-(dimethylamino)-4-phenyl-1-cyclohexene-4-carboxylate hydrochloride], MP 84°C (the free base boils at 97.5° to 98°C at 0.01 mm pressure), 64.4% yield.

Isomer (II): 4-phenyl-3-trans-dimethylamino-4-trans-carbethoxy- Δ^1 -cyclohexene hydrochloride, [ethyl-trans-3-(dimethylamino)-4-phenyl-1-cyclohexene-4-carboxylate hydrochloride], MP 159°C (the free base boils at 95.5° to 96°C at 0.01 mm pressure), 22.2% yield.

References

Merck Index 9280

Kleeman & Engel p. 887

DOT 7 (1) 33 (1971)

I.N., p. 952

Satzinger, G.; U.S. Patent 3,557,127; January 19, 1971; assigned to Warner-Lambert Pharmaceutical Company

TIMEPIDIUM BROMIDE

Therapeutic Function: Anticholinergic

Chemical Name: 3-(Di-2-thienylmethylene)-5-methoxy-1,1-dimethylpiperidinium bromide

Common Name: —

Structural Formula:

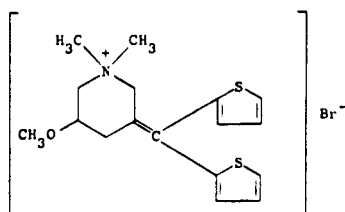

Chemical Abstracts Registry No.: 35035-05-3

Trade Name	Manufacturer	Country	Year Introduced
Sesden	Tanabe Seiyaku	Japan	1976
Mepidum	Poli	Italy	—

Raw Materials

5-Hydroxynicotinic acid	Methanol
Dimethyl sulfate	Hydrogen
2-Thienyl bromide	Hydrogen chloride
Methyl bromide	

Manufacturing Process

120 g of 5-hydroxynicotinic acid are dissolved in 1 liter of methanol. After saturating with dry-hydrogen chloride gas at 0°C, the solution is refluxed for 2 hours. Then, the solution is concentrated to dryness. The residue thus obtained is dissolved in water. The solution is neutralized with sodium bicarbonate. The precipitated crystals are collected by filtration, washed with water and then dried. 126 g of methyl 5-hydroxynicotinate are obtained. Yield: 93%. Melting point 184°C to 186°C.

460 g of methyl 5-hydroxynicotinate and 621 g of potassium carbonate are suspended in 200 ml of tetrahydrofuran-methanol (4:1). 1,134 g of dimethyl sulfate are added dropwise to the suspension in nitrogen atmosphere at room temperature. The mixture is stirred overnight at the same temperature and then filtered. The filtrate is concentrated to dryness. The residue thus obtained is mixed with 1.6 liters of methanol and 280 ml of Raney-nickel, and hydrogenated overnight in an autoclave at room temperature and at a pressure of 85 atmospheres. 200 g of Raney-nickel are added to the reaction mixture. The mixture is adjusted to pH 9.5 with triethylamine, and is further subjected to hydrogenation for 20 hours in an autoclave at 70°C and at a pressure of 100 atmospheres. Potassium carbonate and a small amount of ice are added to the reaction mixture to bring the pH to 11. The mixture is extracted with ether. After drying, the ether layer is filtered. The filtrate is evaporated to remove ether. The residue thus obtained is distilled under reduced pressure. 450 g of methyl N-methyl-5-methoxy-nipecotinate are obtained. Yield: 80%. Boiling point 80°C to 81°C/0.5 mm Hg.

A solution of 18 g of 2-thienyl bromide in 30 ml of tetrahydrofuran is gradually added to a mixture of 2.6 g of magnesium and 80 ml of tetrahydrofuran under stirring at 50°C. The mixture is stirred for 5 hours at room temperature until the magnesium is entirely dissolved in the solution. 6.2 g of methyl N-methyl-5-methoxy-nipecotinate are added to the mixture. Then, the mixture is refluxed for 4 hours. After the reaction is completed, tetrahydrofuran is distilled off under reduced pressure. An aqueous ammonium chloride solution is added to the residue, and the solution is extracted with chloroform. The extract is dried and then evaporated to remove chloroform. The viscous oil thus obtained is recrystallized from a mixture of benzene and ether. 7 g of di-(2-thienyl)-(N-methyl-5-methoxy-3-piperidyl)-carbinol are obtained as crystals. Melting point 142°C to 146°C.

7 g of the product are dissolved in 150 ml of 10% hydrochloric acid, and the solution is heated at 80°C for 30 minutes. After the reaction is completed, the solution is basified with sodium hydroxide and then extracted with ether. The extract is washed with water, dried and evaporated to remove ether. 5 g of di-(2-thienyl)-(N-methyl-5-methoxy-3-piperidylidene)-methane are obtained as pale yellow oil.

365 mg of di-(2-thienyl)-(N-methyl-5-methoxy-3-piperidylidene)-methane are dissolved in 15 ml of ether. 1 ml of methyl bromide is added to the solution. Then, the solution is stirred overnight. The precipitated crystals are collected by filtration and recrystallized from a mixture of acetone and ether. 390 mg of di-(2-thienyl)-(N-methyl-5-methoxy-3-piperidylidene)-methane methyl bromide are obtained as colorless crystals. Melting point 198°C to 200°C.

References

Merck Index 9283

Kleeman & Engel p. 888

DOT 12 (12) 490 (1976)

I.N. p. 952

Kawazu, M., Kanno, T., Saito, S. and Tamaki, H.; U.S. Patent 3,764,607; October 9, 1973; assigned to Tanabe Seiyaku Co., Ltd. (Japan)

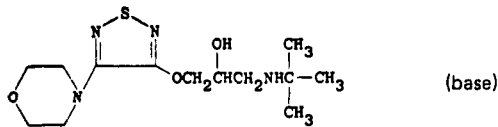
TIMOLOL MALEATE**Therapeutic Function:** Antiarrhythmic, antiglaucoma**Chemical Name:** S-(–)-1-tert-butylamino)-3-[(4-morpholino-1,2,5-thiadiazol-3-yl)oxy] -2-propanol maleate**Common Name:** –**Structural Formula:****Chemical Abstracts Registry No.:** 26921-17-5; 26839-75-8 (Base)

Trade Name	Manufacturer	Country	Year Introduced
Blocadren	MSD	U.K.	1974
Timacor	MSD	France	1976
Timserin	Sharp & Dohme	W. Germany	1976
Timoptic	MSD	U.S.	1978
Timoptic	Chibret	Switz.	1978
Timoptol	MSD	U.K.	1979
Timoptol	Sharp & Dohme	W. Germany	1979
Blocadren	MSD	Italy	1980
Timoptic	MSD	Italy	1980
Timoptol	Merck Banyu	Japan	1981
Blocadren	MSD	U.S.	1981
Betim	Leo	Denmark	–
Cardina	Orion	Finland	–
Chibro-Timoptol	Chibret	France	–
Cusimolol	Cusi	Spain	–

Raw Materials

Bromoacetol	t-Butylamine
p-Toluene sulfonyl chloride	Sodium borohydride
3-Morpholino-4-hydroxy-1,2,5-thiadiazole	Maleic acid

Manufacturing Process

Step A: Preparation of 3-tert-Butylamino-2-Oxopropanol – To an aqueous solution of tert-butylamine (1 mol) at ambient temperature, there is added slowly and with vigorous stirring 2 mols bromoacetol. The reaction mixture is allowed to stand at ambient temperature for about 5 hours whereupon it is made basic by the addition of sodium hydroxide.

The reaction mixture then is extracted with ether, the excess amine is removed from the ethereal solution under reduced pressure and the ether then removed by evaporation to give 3-tert-butylamino-2-oxopropanol.

Step B: A solution of the 3-tert-butylamino-2-oxopropanol in a mixture of pyridine hydrochloride and pyridine is treated with p-toluenesulfonylchloride. The mixture is stirred for ½ hour at 25° to 30°C and then poured into cold water. The solution is treated with potassium carbonate and the pyridine evaporated in vacuo at a temperature between 55° and 60°C. The aqueous residue is treated with potassium carbonate and the mixture extracted with methylene chloride. Evaporation of the dried extract provides 1-toluene-sulfonyloxy-2-oxo-3-tert-butylaminopropane.

Step C: Preparation of 3-Morpholino-4-(3-tert-Butylamino-2-Oxopropoxy)-1,2,5-Thiadiazole — The 1-toluene-sulfonyloxy-2-oxo-3-tert-butylaminopropane, prepared as described in Step B, (11 mols) is added to 0.80 N methanolic sodium methoxide (15 ml) at 0°C. The mixture is stirred for 15 minutes at 0° to 5°C, treated with 3-morpholino-4-hydroxy-1,2,5-thiadiazole (4.29 grams) and then refluxed for 16 hours. The solvent is evaporated in vacuo and the residue is treated with excess potassium carbonate to provide 3-morpholino-4-(3-butylamino-2-oxopropoxy)-1,2,5-thiadiazole.

Step D: Chemical Reduction Preparation of 3-Morpholino-4-(3-tert-Butylamino-2-Hydroxypropoxy)-1,2,5-Thiadiazole — The 3-morpholino-4-(3-tert-butylamino-2-oxopropoxy)-1,2,5-thiadiazole (0.01 mol) is dissolved in isopropanol (10 ml). To the solution is added sodium borohydride in portions until the initial evolution of heat and gas subsides. The excess sodium borohydride is destroyed by addition of concentrated hydrochloric acid until the mixture remains acidic. The precipitate of sodium chloride is removed, ether is added, and the solution is concentrated to crystallization. The solid material is removed by filtration and dried thus providing 3-morpholino-4-(3-tert-butylamino-2-hydroxypropoxy)-1,2,5-thiadiazole, MP 161° to 163°C (as hydrochloride).

Alternative Step D: Reduction with a Reductate — Sucrose (1 kg) is dissolved in water (9 liters) in a 20-liter bottle equipped with a gas trap. Baker's yeast (*Saccharomyces cerevisiae*, 1 kg) is made into a paste with water (1 liter) and added to the sucrose solution with stirring. After lively evolution of gas begins (within 1 to 3 hours), 3-morpholino-4-(3-tert-butylamino-2-oxopropoxy)-1,2,5-thiadiazole hydrogen maleate [1.35 mols, prepared by reaction of the 3-morpholino-4-(3-tert-butylamino-2-oxopropoxy)-1,2,5-thiadiazole with an equimolar quantity of maleic acid in tetrahydrofuran]. The mixture is allowed to stand until fermentation subsides, after which the bottle is kept in a 32°C incubator until all fermentation has ended (in approximately 1 to 3 days). The yeast is filtered off with addition of diatomaceous earth and the filtrate is evaporated to dryness to give 3-morpholino-4β-tert-butylamino-2-hydroxypropoxy)-1,2,5-thiadiazole, MP 195° to 198°C (as hydrogen maleate), according to U.S. Patent 3,619,370.

Step E: The base may be converted to the maleate by maleic acid.

References

Merck Index 9284

Kleeman & Engel p. 889

PDR pp. 1145, 1211, 1214

OCDS Vol. 2 p. 272 (1980)

DOT 10 (4) 145 (1974) & 16 (3) 92 (1980)

I.N. p. 953

REM p. 907

Weinstock, L.M., Tull, R.J. and Mulvey, M.D.; U.S. Patent 3,619,370; November 9, 1971; assigned to Charles E. Frosst & Co.

Wasson, B.K.; U.S. Patent 3,655,663; April 11, 1972

Weinstock, L.M., Tull, R.J. and Mulvey, D.M.; U.S. Patent 3,657,237; April 18, 1972; assigned to Charles E. Frosst & Co.

TIMONACIC SODIUM

Therapeutic Function: Hepatotherapeutic, choleric

Chemical Name: 4-Thiazolidinecarboxylic acid sodium salt

Common Name: ATC

Structural Formula:

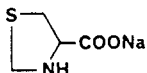

Chemical Abstracts Registry No.: 444-27-9 (acid)

Trade Name	Manufacturer	Country	Year Introduced
Hepaldine	Riker	France	1964
Leberschutz	Karner	W. Germany	1977
Dexotepa	Ayerst	Italy	1979
Tiazolidin	U.C.M.-Difme	Italy	1980
Heparegene	Syntex-Pharm.	Switz.	—
Thiobiline	Riker	France	—

Raw Materials

Cysteine
Formaldehyde
Sodium hydroxide

Manufacturing Process

Cysteine is first dissolved in distilled water which has been freed of oxygen by boiling. Formaldehyde of 30% (w/v) concentration is added while stirring and the temperature of the mixture rises, while the thiazolidine carboxylic acid begins crystallizing. The stirring is continued for 2 hours after which ethyl alcohol of 95% (w/v) concentration is added to induce further crystallization. The mixture is left to stand for 24 hours at 4°C. The mixture is then filtered with retention of a crude product, which is purified by recrystallization from boiling distilled water. The crystals are then dried at about 40°C. The free acid is then converted to the sodium salt with NaOH.

References

Merck Index 9285
DFU 5 (8) 415 (1980)
Kleeman & Engel p. 890
I.N. p. 953
Sogespar, S.A.; British Patent 1,041,787; September 7, 1966

TINIDAZOLE

Therapeutic Function: Antitrichomonal (vaginal)

Chemical Name: 1-[2-(ethylsulfonyl)ethyl]-2-methyl-5-nitroimidazole

Common Name: —

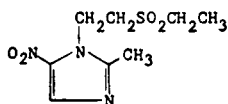
Structural Formula:**Chemical Abstracts Registry No.:** 19387-91-8

Trade Name	Manufacturer	Country	Year Introduced
Simplotan	Pfizer	W. Germany	1971
Fasigyne	Pfizer	France	1975
Fasigyn	Pfizer	Italy	1975
Fasigyn	Pfizer Taito	Japan	1981
Fasigyn	Pfizer Taito	U.K.	1982
Amplium	Farmasa	Brazil	—
Pletil	Andromaco	Brazil	—
Protocide	Unipharm	Israel	—
Sorquetan	Basotherm	W. Germany	—
Tinigyn	Leiras	Finland	—
Tricanix	Orion	Finland	—
Trichogin	Chiese	Italy	—
Trimonase	Tosi	Italy	—

Raw Materials

Ethyl sulfonyl ethanol
 p-Toluenesulfonyl chloride
 2-Methyl-5-nitroimidazole

Manufacturing Process

The preparation of ethylsulfonylethyl-p-toluenesulfonate is carried out in the following manner: 69.0 grams (0.5 mol) ethylsulfonylethanol dissolved in 150 ml pyridine is cooled to 0°C with stirring and while maintaining the temperature between 0° to 10°C, 95 grams (0.5 mol) p-toluenesulfonyl chloride is added in portions over a 10 minute period. After this time, 250 ml water is added slowly and the mixture extracted with chloroform, the organic phase washed first with 2 N HCl, then with water, separated and dried. The product which crystallizes on cooling is filtered and dried to give 77.5% yield of this intermediate.

A mixture of 12.7 grams (0.1 mol) of 2-methyl-5-nitroimidazole and 58.4 grams (0.2 mol) ethylsulfonylethyl-p-toluenesulfonate is heated with stirring, under nitrogen, at 145° to 150°C for about 4 hours. After this time, the reaction mixture is extracted with 500 ml hot water, the aqueous portion adjusted with 10% Na₂CO₃ to a pH of 9 and extracted with chloroform (3 times with 150 ml portions). The separated organic phase is washed with water, dried with Na₂SO₄ and evaporated to dryness. The crude tinidazole product is then crystallized from benzene to give 4.36 grams of product having a MP of 127° to 128°C.

References

Merck Index 9287
 Kleeman & Engel p. 890
 DOT 7 (5) 193 (1971) & 8 (2) 73 (1972)
 I.N. p. 953
 REM p. 1224
 Butler, K.; U.S. Patent 3,376,311; April 2, 1968; assigned to Chas. Pfizer & Co., Inc.

TINORIDINE

Therapeutic Function: Antiinflammatory

Chemical Name: 2-amino-6-benzyl-4,5,6,7-tetrahydrothieno[2,3-c]pyridine-3-carboxylic acid ethyl ester

Common Name: —

Structural Formula:

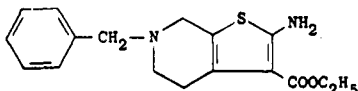

Chemical Abstracts Registry No.: 24237-54-5; 23237-55-6 (Hydrochloride)

Trade Name	Manufacturer	Country	Year Introduced
Nonflamin	Yoshitomi	Japan	1971
Dimaten	Promeco	Argentina	—

Raw Materials

1-Benzyl-4-piperidone	Ethyl cyanoacetate
Sulfur	Morpholine

Manufacturing Process

A solution of 1-benzyl-4-piperidone, ethyl cyanoacetate, powdery sulfur and morpholine in ethanol is heated moderately under reflux for about 20 minutes to dissolve the powdery sulfur. The mixture is heated under reflux for one further hour to complete the reaction. On standing at room temperature, the mixture yields a precipitate. The precipitate is collected by filtration, washed well with methanol and recrystallized from methanol to give 2-amino-6-benzyl-3-ethoxycarbonyl-4,5,6,7-tetrahydrothieno(2,3-c)-pyridine as almost colorless needles melting at 112° to 113°C.

References

Merck Index 9289

Kleeman & Engel p. 891

DOT 7 (6) 224 (1971)

I.N. p. 954

Nakanishi, M., Tahara, T., Imamura, H. and Maruyama, Y.; U.S. Patent 3,563,997; Feb. 16, 1971; assigned to Yoshitomi Pharmaceutical Industries, Ltd., Japan

TIOCARLIDE

Therapeutic Function: Antitubercular

Chemical Name: N,N'-[4-(3-Methylbutoxy)phenyl] thiourea

Common Name: Thiocarlide

Structural Formula:

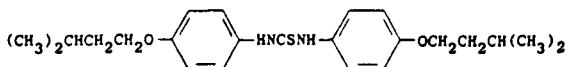

Chemical Abstracts Registry No.: 910-86-1

Trade Name	Manufacturer	Country	Year Introduced
Tiocarlide	Ciba	W. Germany	1963
Tiocarlide	Ciba	Italy	1964
Tiocarlide	Ciba	France	1965
Isoxyl	Continental Pharm	U.K.	1969
Amixyl	Inibsa	Portugal	—
Disoxyl	Ferrosan	Denmark	—

Raw Materials

Isoamyloxyaniline
Carbon disulfide

Manufacturing Process

100 parts by weight of p-isoamyloxyaniline are refluxed for 6 hours with 34 parts by volume of carbon disulfide, 300 parts by volume of ethanol and 5 parts by weight of potassium ethyl xanthate. The reaction mixture is then cooled and the formed 1,3-bis-(p-isoamyloxyphenyl)-2-thiourea is filtered off, washed with a small amount of ethanol and water, and recrystallized from ethanol. The thus-obtained product melts at 134°C to 145°C.

References

Merck Index 9292

Kleeman & Engel p. 891

I.N. p. 954

Huebner, C.F. and Scholz, C.R.; U.S. Patent 2,703,815; March 8, 1955; assigned to Ciba Pharmaceutical Products, Inc.

TIOCLOMAROL

Therapeutic Function: Anticoagulant

Chemical Name: 3-[3-(4-Chlorophenyl)-1-(5-chloro-2-thienyl)-3-hydroxypropyl]-4-hydroxy-2H-1-benzopyran-2-one

Common Name: —

Structural Formula:

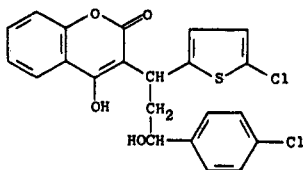

Chemical Abstracts Registry No.: 22619-35-8

Trade Name	Manufacturer	Country	Year Introduced
Apegmone	Oberval	France	1978

Raw Materials

p-Chloroacetophenone
4-Hydroxycoumarin

5-Chlorothiophene-2-aldehyde
Aluminum isopropylate

Manufacturing Process

(a) 1-parachlorophenyl-3-(5'-chloro-2'-thienyl)-2-propen-1-one — (a) This new compound was prepared in the following manner:

4.4 g of NaOH, in solution in 40 ml of water and 20 ml of ethanol, are cooled to 120°C, and then there are successively added at this temperature 13.2 g (0.086 mol) of parachloroacetophenone and 12.6 g of 5-chlorothiophene-2-aldehyde. The solution is left standing for 3 hours while stirring at ambient temperature and the precipitate which has formed is centrifuged off, whereafter it is washed with water and recrystallized from alcohol. Yield: 18.4 g, i.e., 75.7% of product, melting at 134°C.

(b) The ketone prepared according to a is condensed at the rate of 14.15 g (0.05 mol) with 8.9 g (0.055 mol) of 4-hydroxycoumarin in 80 ml of water in the presence of 42 mg of hexamethyleneimine. Heating takes place for 4 hours under reflux and, after recrystallization, first of all from a mixture of acetone and water and then from benzene, there are obtained: 12.6 g of 3-(4'-hydroxy-3'-coumarinyl)-3-(5''-chloro-2''-thienyl)-parachloropropiophenone, melting at 162°C (sealed tube).

(b) 4.45 g (0.01 mol) of 3-(4'-hydroxy-3'-coumarinyl)-3-(5''-chloro-2''-thienyl)-parachloropropiophenone, in solution in 75 ml of isopropanol, are reduced with 6.12 g (0.03 mol) of aluminum isopropylate, introduced while stirring and in small quantities at ambient temperature.

The solution is refluxed for one hour and after cooling it is poured into 250 ml of ice and 15 ml of concentrated HCl. On standing, a white precipitate is obtained, which is centrifuged, washed with water, taken up in methanol and filtered.

5 volumes of water are added to this solution, and it is allowed to crystallize at ambient temperature.

The product is analytically pure and shows a pasty fusion at 104°C (sealed tube). Yield: 89%.

References

Merck Index 9293

Kleeman & Engel p. 892

DOT 14 (8) 383 (1978)

J.N. p. 954

Boschetti, E., Molho, D. and Fontaine, L.; U.S. Patent 3,574,234; April 6, 1971; assigned to Lyonnaise Industrielle Pharmaceutique (LIPHA) (France)

TIOCONAZOLE

Therapeutic Function: Antifungal

Chemical Name: 1-[2-[(2-Chloro-3-thienyl)methoxy]-2-(2,4-dichlorophenyl)ethyl]-1H-imidazole

Common Name: —

Structural Formula:

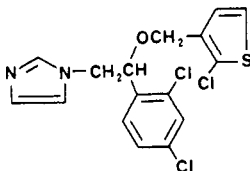

Chemical Abstracts Registry No.: 65899-73-2

Trade Name	Manufacturer	Country	Year Introduced
Fungata	Pfizer	W. Germany	1981
Trosyd	Pfizer	Switz.	1983
Trosyd	Pfizer	U.S.	1983

Raw Materials

1-(2,4-Dichlorophenyl)-2-(1-imidazolyl)ethanol
Sodium hydride
2-Chloro-3-chloromethylthiophene

Manufacturing Process

A solution of 1-(2,4-dichlorophenyl)-2-(1-imidazolyl)ethanol (1.5 g, 5.8 mmol) dissolved in dry tetrahydrofuran (10 ml) was added to a stirred suspension of sodium hydride (0.39 g, as 80% dispersion in oil, 16 mmol) in dry tetrahydrofuran (10 ml) and warmed to 70°C for 90 minutes.

The mixture was cooled in ice and a solution of 2-chloro-3-chloromethylthiophene (8.8 mmol) in dry tetrahydrofuran was added. The mixture was heated at 70°C for 3 hours and allowed to stir at room temperature overnight. The solvent was removed under vacuum and the residue stirred with dry ether (200 ml). The ether solution was filtered through Celite and saturated with hydrogen chloride gas to precipitate an oil which was solidified by trituration with ether and ethyl acetate. The solid product was collected and recrystallized from a mixture of acetone and diisopropyl ether to give the product, melting point 168°C to 170°C.

References

Merck Index 9294
DFU 5 (10) 509 (1980)
DOT 19 (8) 341 (1983)
I.N. p. 954
REM p. 1231
Gymer, G. E.; U.S. Patent 4,062,966; December 13, 1977; assigned to Pfizer, Inc.

TIOPRONIN

Therapeutic Function: Antidote in heavy metal poisoning

Chemical Name: N-(2-Mercapto-1-oxopropyl)glycine

Common Name: Mercamidum

Structural Formula:

$$\begin{array}{c} \text{CH}_3\text{CHCONHCH}_2\text{COOH} \\ | \\ \text{SH} \end{array}$$

Chemical Abstracts Registry No.: 1953-02-2

Trade Name	Manufacturer	Country	Year Introduced
Thiosol	Coop. Farm.	Italy	1969
Mercaptopropionylglycin	Fresenius	W. Germany	1976
Mucolysin	Proter	Italy	1976
Mucolysin	Interdecta	Switz.	1982

Trade Name	Manufacturer	Country	Year Introduced
Capen	Phoenix	Argentina	—
Epatiol	Medici	Italy	—
Sutilan	Cusi	Spain	—
Thiola	Santen	Japan	—
Vincol	Reig. Jofre	Spain	—

Raw Materials

α -Mercaptopropionic acid	Benzyl chloride
Thionyl chloride	Glycine
Sodium	Ammonia

Manufacturing Process

α -Benzylmercaptopropionic acid (melting point 76°C to 78°C; 100 g) prepared by condensation of α -mercaptopropionic acid with benzyl chloride is allowed to stand overnight with 80 g of thionyl chloride. After removal of excess thionyl chloride distillation in vacuo gives 70 g of α -benzylmercaptopropionic acid chloride of boiling point 138°C to 139°C/7 to 8 mm Hg.

Then, 25 g of glycine is dissolved in 165 ml of 2N sodium hydroxide solution and 70 g of α -benzylmercaptopropionic acid chloride and 100 ml of 2N sodium hydroxide solution are dropped therein simultaneously at 3°C to 5°C. The solution is then stirred at room temperature for 3 to 4 hours to complete the reaction, the reaction solution is washed with ether, the aqueous layer is acidified with hydrochloric acid, and the resulting crystals are collected by filtration. These are recrystallized from a mixture of methanol and ethyl acetate to give 60 g of α -benzylmercaptopropionylglycine of melting point 133°C to 134°C.

This α -benzylmercaptopropionylglycine (60 g) is dissolved in 400 ml of liquid ammonia, kept at about -50°C, and 12 g of sodium metal is gradually added thereto. After the reaction, excess ammonia is removed therefrom, the residue is dissolved in water, washed with ether and the residual aqueous layer is adjusted to pH 1 with hydrochloric acid and concentrated in vacuo in a stream of hydrogen sulfide. The crystalline residue is dried and recrystallized from ethyl acetate to give 25 g of α -mercaptopropionylglycine of melting point 95°C to 97°C.

References

Merck Index 9296

Kleeman & Engel p. 893

DOT 14 (1) 38 (1978)

I.N. p. 955

Mita, I., Toshioka, N. and Yamamoto, S.; U.S. Patent 3,246,025; April 12, 1966; assigned to Santen Pharmaceutical Co. (Japan)

TIRATRICOL

Therapeutic Function: Thyroid replacement therapy

Chemical Name: [4-(4-Hydroxy-3-iodophenoxy)-3,5-diiodophenyl] acetic acid

Common Name: Triiodothyroacetic acid

Structural Formula:

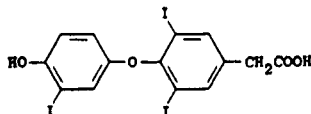

Chemical Abstracts Registry No.: 51-24-1

Trade Name	Manufacturer	Country	Year Introduced
Triacana	Ana	Italy	1972

Raw Materials

Ethyl 3,5-diiodo-4-(4'-hydroxyphenoxy)phenyl acetate
Hydriodic acid
Iodine

Manufacturing Process

Preparation of 3:5-diiodo-4-(4'-hydroxyphenoxy)phenylacetic acid (diac): A solution of ethyl 3:5-diiodo-4-(4'-methoxyphenoxy)phenyl acetate (9.5 g) in acetic acid (60 ml) was heated under reflux with hydriodic acid (SG 1.7, 50 ml) and red phosphorus (0.5 g) for 1 hour. The hot solution was filtered and the filtrate concentrated at 50°C and 15 mm of mercury to above 20 ml. The residue was treated with water (70 ml) containing a little sodium thio-sulfate to decolorize the product. The solid was collected by filtration and purified by the method of Harington and Pitt-Rivers [*Biochem. J.* (1952), Vol. 50, page 438]. Yield 8.36 g (95%). After crystallization from 70% (v/v) acetic acid it melted at 219°C.

A solution of 438 mg of diac in methanol (20 ml) and ammonia solution (SG 0.88; 20 ml) was iodinated at 0°C with 1.8 ml 1N iodine solution. The product was isolated in almost theoretical yield in a manner similar to that described for tetrac. After crystallization from 50% (v/v) methanol, triac was obtained as colorless needles which melted over the range 65°C to 90°C according to the rate of heating. The molten form resolidified at about 110°C and finally melted at 180°C to 181°C without decomposition. The compound, dried at 25°C/3 mm over silica gel, contains methanol of crystallization.

References

Merck Index 9299

I.N. p. 956

Wilkinson, J.H.; British Patent 805,761; December 10, 1958; assigned to National Research Development Corp. (U.K.)

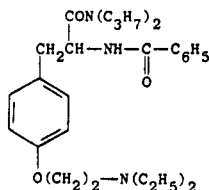
TIROPAMIDE**Therapeutic Function:** Smooth muscle relaxant**Chemical Name:** α -(Benzoylamino)-4-[2-(diethylamino)ethoxy]-N,N-dipropylbenzenepropanamide**Common Name:** —**Structural Formula:**

Chemical Abstracts Registry No.: 55837-29-1

Trade Name	Manufacturer	Country	Year Introduced
Maiorad	Rotta	Italy	1982
Alfospas	Rorer	U.S.	—

Raw Materials

N-Benzoyl-DL-tyrosil-di-n-propylamide
Sodium methylate
2-Diethylaminoethyl chloride

Manufacturing Process

36.8 g (0.1 mol) of N-benzoyl-DL-tyrosil-di-n-propylamide are suspended in 350 cc of toluene; there are then added, under agitation, 5.4 g (0.1 mol) of sodium methylate and 50 cc (0.1 mol) of a titrated toluenic solution of 2-diethylamino-ethyl-chloride. The temperature is taken up to 105°C and the solution is left at this temperature, in agitation, for 12 hours. The toluenic solution is extracted with HCl 2N; the aqueous acid phase is alkalized, cold, with sodium carbonate, and then reextracted with successive portions of ethyl acetate.

The reunited organic phases are anhydriified upon anhydrous Na₂SO₄, filtered and dried off. The oily residue which is obtained crumbles after a few hours of rest. Amount obtained 39.2 g. Yield 84%. Melting point 65°C to 67°C (crystallizes with petroleum ether).

The free base can be salified so as to render it hydrosoluble. For this purpose, for example, it is dissolved in acetone and precipitated as an oxalate by the addition of a solution of oxalic acid in ethanol. Recrystallizes with ethanol. Melting point (oxalate): 159°C to 162°C. Alternatively it can be dissolved in acetone and precipitated with an acetone solution of HCl. Recrystallizes with acetone-ethanol. Melting point (chlorhydrated): 181°C to 183°C.

References

Merck Index 9301
DFU 7 (6) 413 (1982)
DOT 19 (2) 114 & (5) 271 (1983)
I.N. p. 956
Makovec, F., Rovati, L. and Senin, P.; U.S. Patent 4,004,008; January 18, 1977; assigned to Rotta Research Laboratorium S.p.A. (Italy)

TIXOCORTOL PIVALATE

Therapeutic Function: Antiinflammatory

Chemical Name: 11,17-Dihydroxy-21-mercaptopregn-4-ene-3,20-dione

Common Name: —

Structural Formula:

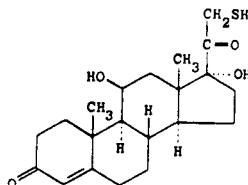

(base)

Chemical Abstracts Registry No.: 55560-96-8; 61951-99-3 (Base)

Trade Name	Manufacturer	Country	Year Introduced
Pivalone	Jouveinal	France	1978

Raw Materials

S-Thiopivalic acid
Sodium methylate
Dihydroxy-11 β ,17 α -iodo-21-dioxo-3,20-pregnene-4

Manufacturing Process

In a reactor of 50 liters, sodium S-thiopivalate is prepared from 100 g of S-thiopivalic acid (0.844 mol), 214 cc of solution of sodium methylate, 3.95M (0.844 mol) in 25 liters of anhydrous acetone.

There are then added 285 g (0.603 mol) of dihydroxy-11 β ,17 α -iodo-21-dioxo-3,20-pregnene-4 and the mixture is brought up to the acetone reflux for two hours. The solvent is eliminated by distillation under vacuum until there is obtained a syrupy residue which is poured into 10 liters of iced water. The insoluble part is filtered and dried under vacuum.

The crude product is purified by recrystallization from ethanol; weight: 250 g; yield: 89.5%.

References

Merck Index 9315

Kleeman & Engel p. 895

I.N. p. 957

Torossian, D.R., Aubard, G.G. and Legeai, J.M.G.; U.S. Patent 4,014,909; March 29, 1971; assigned to Jouveinal S.A. (France)

TOCAINIDE

Therapeutic Function: Antiarrhythmic

Chemical Name: 2-Amino-2',6'-propionoxylidide

Common Name: —

Structural Formula:

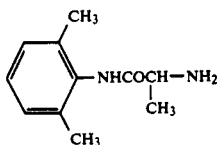

Chemical Abstracts Registry No.: 41708-72-0

Trade Name	Manufacturer	Country	Year Introduced
Tonocard	Astra	U.K.	1981
Xylotocan	Astra	W. Germany	1982
Tonocard	Hassle	Sweden	1983
Tonocard	Astra	Australia	1983

Raw Materials

2-Bromo-2',6'-propionoxylidide
Ammonia

Manufacturing Process

The compound 2-amino-2',6'-propionoxylidide was synthesized by saturating with gaseous ammonia at room temperature a suspension of 50 g (0.195 mol) of 2-bromo-2',6'-propionoxylidide in a mixture of 500 ml of 95% alcohol and 400 ml of concentrated aqueous ammonia. The saturation was carried out under mechanical stirring. After 25 hours the mixture was re-saturated with ammonia gas. The stirring at room temperature was continued for a total period of 116 hours, and a sample was taken at that time. Gas chromatographic analysis indicated that about 95% of the bromo compound had been converted to the desired product.

The solvents were evaporated in vacuo, and the residue was taken up in 80 ml of 3M hydrochloric acid. After addition of 220 ml of water, the insoluble material was filtered off, washed with 100 ml of water and then dried. The insoluble material weighed 9.5 g and was mainly unreacted bromo compound. The filtrate was reacted with 50 ml of 7M NaOH, extracted three times with methylene chloride (50 ml + 2 x 25 ml portions), dried over potassium carbonate, and then evaporated. The yield of residue was 26.8 g which corresponds to 71.4% of the theoretical yield. This residue was a colorless solidifying oil and was dissolved in 200 ml chloroform. Hydrogen chloride was bubbled in until a sample of the solution tested acidic to wet pH indicator paper. A precipitate was obtained and recovered by filtration. The precipitate was washed with chloroform and dried. The melting point was determined to be from 246°C to 247.5°C.

References

Merck Index 9319

DFU 2 (2) 141 (1977)

PDR p. 1216

OCDS Vol. 3 p. 55 (1984)

DOT 18 (3) 153 & (10) 548 (1982)

I.N. p. 958

REM p. 861

Boyes, R.N., Duce, B.R., Smith, E.R. and Byrnes, E.W.; U.S. Patents 4,218,477; August 19, 1980; and 4,237,068; December 2, 1980; both assigned to Astra Pharmaceutical Products, Inc.

TOFENACIN HYDROCHLORIDE

Therapeutic Function: Psychostimulant

Chemical Name: N-methyl-2-[(2-methylphenyl)phenylmethoxy] ethanamine hydrochloride

Common Name: N-demethylorphenadrine hydrochloride; N-methyl-2[α-(2-tolybenzyl)oxy]-ethylanamine hydrochloride

Structural Formula:

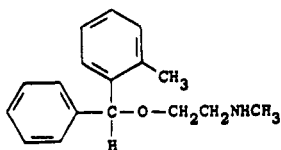

(base)

Chemical Abstracts Registry No.: 10488-36-5; 15301-93-6 (Base)

Trade Name	Manufacturer	Country	Year Introduced
Elamol	Brocades	U.K.	1971
Tofalin	Brocades	Italy	1981

Raw Materials

2-Methylbenzhydrol	β -Chloroethanol
Methylamine	Hydrogen chloride

Manufacturing Process

A mixture of 39.5 grams of 2-methylbenzhydrol, 200 ml of beta-chloroethanol and 10 ml of concentrated hydrochloric acid is boiled under reflux for 4 hours. After cooling, the reaction mixture is poured into water and extracted with petroleum ether (boiling range 40° to 60°C). The layers are separated and the ethereal solution dried with sodium sulfate. It is then filtered. The filtrate is concentrated by evaporation of the solvent. The residue is distilled under reduced pressure to give 51.0 grams (yield 98%) of beta-chloroethyl-2-methylbenzhydrol ether, boiling at 156° to 158°C/2.5 mm.

A mixture of 51 grams of beta-chloroethyl-2-methylbenzhydrol ether and 35 grams of methylamine in 140 ml of methanol is heated for 6 hours in a closed vessel at a temperature of 125° to 135°C. After cooling, the reaction mixture is poured into water and extracted with petroleum ether (boiling range 40° to 60°C). The ether layer is separated and washed with a 2N hydrochloric acid solution. The acidic layer is made alkaline and extracted with ether. The ethereal solution is separated and dried with sodium sulfate. After filtration, the solvent is evaporated and the residue distilled under reduced pressure. There is thus obtained 40 grams (yield 80%) of N-methylaminoethyl-2-methylbenzhydrol ether boiling at 139° to 143°C/0.7 mm.

The base is dissolved in anhydrous ether, and an ethereal solution of hydrochloric acid is added to form the hydrochloride of N-methylaminoethyl-2-methylbenzhydrol ether. The salt is crystallized from a mixture of ethanol and ether. Yield is 36 grams (78%); melting point 147° to 148°C.

References

Merck Index 9331

Kleeman & Engel p. 899

OCDS Vol. 2 p. 32 (1980)

DOT 8 (5) 189 (1972)

I.N. p. 960

Harms, A.F.; U.S. Patent 3,407,258; October 22, 1968; assigned to Brocades-Stheeman & Pharmacia, Netherlands

TOFISOPAM**Therapeutic Function:** Tranquilizer**Chemical Name:** 1-(3,4-Dimethoxyphenyl)-4-methyl-5-ethyl-7,8-dimethoxy-5H-2,3-benzodiazepine**Common Name:** --

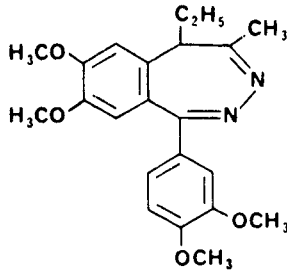
Structural Formula:

Chemical Abstracts Registry No.: 22345-47-7

Trade Name	Manufacturer	Country	Year Introduced
Grandaxine	Ozothine	France	1975
Seriel	Fabre	France	—
Tavor	Gerardo Ramon	Argentina	—

Raw Materials

3,4,3',4'-Tetramethoxy-6-(α -acetopropyl)benzophenone
Hydrazine hydrate

Manufacturing Process

A mixture of 38.6 g (0.1 mol) of 3,4,3',4'-tetramethoxy-6-(α -acetopropyl)-benzophenone, 5.5 g (0.11 mol) of 100% hydrazine hydrate or 3.52 g (0.11 mol) of hydrazine, and 500 ml of absolute ethanol is boiled for 5 hours. After adding 100 ml of benzene, 400 ml of solvent mixture is distilled off from the reaction mixture by slow boiling for 3 hours. After cooling for 8 hours, 19 g of 5H-2,3-benzodiazepine derivative are separated from the residue as small, white crystals. The melting point is 133°C to 136°C (after recrystallizing from absolute ethanol, 136°C).

References

Merck Index 9332

Kleeman & Engel p. 899

DOT 9 (6) 240 (1973); 11 (5) 198 (1975) & 12 (2) 60 (1976)

I.N. p. 960

Egyesult Gyogyszer és Tapszer Gyar; British Patent 1,202,579; August 19, 1970

Korosi, J., Lang, T., Komlos, E. and Erdelyi, L.; U.S. Patent 3,736,315; May 29, 1973; assigned to Egyesult Gyogyszer és Tapszer Gyar (Hungary)

TOLAZAMIDE

Therapeutic Function: Oral hypoglycemic

Chemical Name: N-[[[hexahydro-1H-azepin-1-yl]amino] carbonyl]-4-methylbenzenesulfonamide

Common Name: —

Structural Formula:

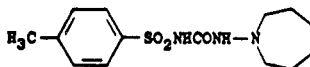

Chemical Abstracts Registry No.: 1156-19-0

Trade Name	Manufacturer	Country	Year Introduced
Tolinase	Upjohn	Italy	1964
Tolanase	Upjohn	U.K.	1965
Norglycin	Upjohn	W. Germany	1966
Tolinase	Upjohn	U.S.	1966
Diabewas	Wassermann	Italy	—
Diabutos	Medica	Finland	—
Tolazamide	Schein	U.S.	—

Raw Materials

Hexamethyleneimine	Sodium nitrite
4-Methylbenzenesulfonylurethane	Lithium aluminum hydride

Manufacturing Process

1-Nitrosohexamethyleneimine: A solution of 89.5 grams of hexamethyleneimine, 75 ml of concentrated hydrochloric acid and 36 ml of water was heated to 70°C on a steam bath. The solution was made acidic by adding 5 ml of 2 N hydrochloric acid. While maintaining the reaction mixture at 70° to 75°C, a solution of 67 grams of sodium nitrite in 95 ml of water was added with stirring over a period of 1 hour. The mixture was then stirred at 70°C for 2 hours, and then cooled. The upper oily layer was separated and the aqueous layer was then extracted with ether. The combined ether extract and oil was dried over anhydrous magnesium sulfate and concentrated to dryness. Upon distillation of the residue there was obtained 1-nitrosohexamethyleneimine as a yellow oil, boiling at 136° to 138°C/34 mm.

1-Aminohexamethyleneimine: To a mixture of 15.18 grams of lithium aluminum hydride and 400 ml of anhydrous ether was added about 10% of a solution of 51.27 grams of 1-nitrosohexamethyleneimine in 100 ml of anhydrous ether. The mixture was refluxed until the reaction started. The remainder of the solution was added at such a rate as to maintain gentle reflux. Refluxing was continued for 2 hours more, followed by the successive addition of 16 ml of water, 12 ml of 20% aqueous sodium hydroxide solution and 56 ml of water. The inorganic precipitate was removed by filtration and washed with ether. The filtrate and ether washes were dried and the ether was removed by evaporation. Upon distillation of the residue there was obtained 25.46 grams (56%) of 1-aminohexamethyleneimine as a colorless liquid boiling at 94° to 96°C/55 mm.

N-(4-Methylbenzenesulfonyl)-N'-Hexamethyleneiminourea Free Base: A mixture of 11.42 grams of 1-aminohexamethyleneimine and 24.33 grams of 4-methylbenzenesulfonylurethane was heated at 130°C (oil-bath temperature) for 2 hours. The resulting ethanol and unreacted amine were removed at 15 mm pressure for 2 hours while keeping the oil bath at 130°C. The residue was cooled and recrystallized from methanol, giving 16.73 grams (54%) of N-(4-methylbenzenesulfonyl)-N'-hexamethyleneiminourea free base melting at 163° to 166°C. After a second recrystallization from methanol, the melting point was 163.5° to 166.5°C.

References

- Merck Index 9334
 Kleeman & Engel p. 900
 PDR pp. 1606, 1862, 1999
 OCDS Vol. 1 p. 137 (1977)
 DOT 3 (2) 71 (1967)
 I.N. p. 960
 REM p. 977
 Wright, J.B.; U.S. Patent 3,063,903; November 13, 1962; assigned to The Upjohn Company

TOLAZOLINE

Therapeutic Function: Peripheral vasodilator

Chemical Name: 4,5-dihydro-2-(phenylmethyl)-1H-imidazole

Common Name: Benzazoline; 2-benzyl-4,5-imidazoline

Structural Formula:

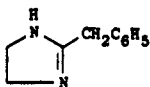

Chemical Abstracts Registry No.: 59-98-3; 59-97-2 (Hydrochloride)

Trade Name	Manufacturer	Country	Year Introduced
Priscoline	Ciba	U.S.	1948
Tolavad	Blue Line	U.S.	1962
Benzimidon	Donau-Pharm.	Austria	—
Benzolin	Nissin	Japan	—
Dilatol	A.F.Z.	Norway	—
Dilazol	Phyteia	Switz.	—
Imidalin	Yamanouchi	Japan	—
Lambral	Maggioni	Italy	—
Priscol	Ciba	U.K.	—
Vaso-Dilatan	Agepha	Austria	—
Zoline	Protea	Australia	—

Raw Materials

Benzyl cyanide
Ethanol
Ethylenediamine

Manufacturing Process

The phenyl-acetiminoether hydrochloride of the formula

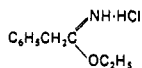

from 12 parts of benzylcyanide and ethanol and HCl is mixed with 8 parts of ethylenediamine hydrate which has been diluted with little alcohol, whereby the crystals go into solution. The whole is then heated on the water-bath until the ammonia odor has disappeared, cooled, concentrated caustic potash solution added, and the separated oil extracted with ether. The solution is dried with potassium carbonate and potassium hydroxide. After evaporation a pale oil is left which distills at 147°C under a pressure of 9 mm and which solidifies in the condenser to a white crystalline mass. The yield amounts to 90% of the theory. The hydrochloride melts at 168° to 170°C.

References

Merck Index 9335
Kleeman & Engel p. 900
PDR p. 808
OCDS Vol. 1 p.241 (1977) & 2, 106 (1980)
I.N. p. 960
REM p. 851
Sonn, A.; U.S. Patent 2,161,938; June 13, 1939; assigned to the Society of Chemical Industry in Basle, Switzerland

TOLBUTAMIDE

Therapeutic Function: Oral hypoglycemic

Chemical Name: N-[(butylamino)carbonyl]-4-methylbenzenesulfonamide

Common Name: 1-butyl-3-(p-tolylsulfonyl)urea

Structural Formula:

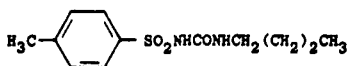

Chemical Abstracts Registry No.: 64-77-7

Trade Name	Manufacturer	Country	Year Introduced
Dolipol	Hoechst	France	1956
Orinase	Upjohn	U.S.	1957
Abeformin T	Maruko	Japan	—
Aglicem	Wassermann	Spain	—
Aglycid	Wassermann	Italy	—
Artosin	Boehr. Mann.	W. Germany	—
Chembutamide	Chemo-Drug	Canada	—
Diabetol	Polfa	Poland	—
Diabeton	Teknofarma	Italy	—
Diabex-T	Funai	Japan	—
Diatol	Protea	Australia	—
Dirastan	Spofa	Czechoslovakia	—
Fordex	Martin Santos	Spain	—
Glyconon	D. D. S. A.	U. K.	—
Guabeta N	O. T. W.	West Germany	—
Insilange D	Horita	Japan	—
Mellitox D	Ono	Japan	—
Mobinol	Horner	Canada	—
Neo-Dibetic	Neo	Canada	—
Neo-Insoral	Valeas	Italy	—
Nigloid	Nippon Universal	Japan	—
Novobutamide	Novopharm	Canada	—
Oramide	I. C. N.	Canada	—
Oribetic	Cenci	U. S.	—
Orsinon	Teva	Israel	—
Oterben	Chinoïn	Hungary	—
Pramidex	Berk	U. S.	—
Proinsul	Crosara	Italy	—
Rankmin	Maruishi	Japan	—
Rastinon	Hoechst	W. Germany	—
Takazide	Fuso	Japan	—
Tolbusal	Krka	Yugoslavia	—
Tolbutol	Smallwood	Canada	—
Tolubetin	Kwizda	Austria	—
Tolumid	A. F. I.	Norway	—
Toluvan	Zambeletti	Italy	—
Unimide	Sankyo	Japan	—
Urerubon	Seiko	Japan	—
Wescotol	Saunders	Canada	—

Raw Materials

n-Butyl isocyanate

Sodium 4-methylbenzenesulfonamide

Manufacturing Process

50 grams of n-butyl isocyanate are stirred at room temperature into a suspension of 96 grams of sodium 4-methyl-benzenesulfonamide in 120 cc of dry nitrobenzene and the whole is then heated for 7 hours at 100°C. After being cooled, the reaction mixture, which is a thick magma, is diluted with methylene chloride or ethyl acetate and the sodium salt of the sulfonylurea formed is separated by centrifuging. The centrifuged crystalline residue freed from organic solvents is dissolved in 500 to 600 cc of water heated at 50°C and decolorized with animal charcoal.

The precipitate obtained by acidification with dilute hydrochloric acid is dissolved in an equivalent quantity of dilute ammonia solution (about 1:20), again treated with animal charcoal and reprecipitated with dilute hydrochloric acid. In this manner N-4-methyl-benzenesulfonyl-N'-n-butyl-urea is obtained in analytically pure form in a yield of 70 to 80% of theory. It melts at 125° to 127°C (with decomposition).

References

Merck Index 9337

Kleeman & Engel p. 901

PDR pp. 830, 993, 1606, 1723, 1856, 1999

OCDS Vol. 1 p. 136 (1977) & 3, 62 (1984)

I.N. p. 961

REM p. 977

Ruschig, H., Aumüller, W., Korger, G., Wagner, H., Scholz, J. and Bänder, A.; U.S. Patent 2,968,158; January 17, 1961; assigned to The Upjohn Company

TOLCICLATE

Therapeutic Function: Topical antimycotic

Chemical Name: O-(1,4-Methano-1,2,3,4-tetrahydro-6-naphthyl)-N-methyl-N-(m-tolyl)-thiocarbamate

Common Name: —

Structural Formula:

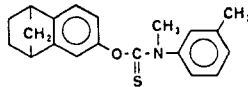

Chemical Abstracts Registry No.: 50838-36-3

Trade Name	Manufacturer	Country	Year Introduced
Tolmicen	Carlo Erba	Italy	1979
Fungifos	Basotherm	W. Germany	1981
Kilmicen	Farmitalia	W. Germany	1983

Raw Materials

Thiophosgene

1,4-Methano-1,2,3,4-tetrahydro-6-naphthoxide

N-Methyl-m-toluidine

Manufacturing Process

Thiophosgene (1.15 g, 0.01 mol) in chloroform (40 ml) was slowly treated at room tempera-

ture with sodium 1,4-methano-1,2,3,4-tetrahydro-6-naphthoxide (1.82 g, 0.01 mol). After 30 minutes, N-methyl-m-toluidine (2.42 g, 0.02 mol) in chloroform (40 ml) was added dropwise to the solution so obtained at room temperature. The reaction mixture was stirred for 48 hours at room temperature and then refluxed for 2 hours. The solvent was evaporated, and the residue redissolved in water and extracted repeatedly with diethyl ether. The organic phase was dried (Na_2SO_4) and evaporated to dryness to give, after crystallization from isopropanol, O-(1,4-methano-1,2,3,4-tetrahydro-6-naphthyl)-N-methyl-N-(m-tolyl)-thiocarbamate (1.3 g) melting point 92°C to 94°C .

References

Merck Index 9338

DFU 1 (11) 543 (1976)

OCDS Vol. 3 p. 69 (1984)

DOT 17 (3) 94 (1981)

I.N. p. 961

Melloni, P., Metalli, R., Vecchiotti, V., Logeman, W., De Carneri, I., Castellino, S. and Monti, G.; U.S. Patent 3,855,263; December 17, 1974; assigned to Carlo Erba SpA

TOLMETIN

Therapeutic Function: Antiinflammatory

Chemical Name: 5-(p-Toluoyl)-1-methylpyrrole-2-acetic acid

Common Name: —

Structural Formula:

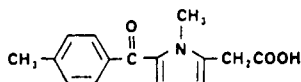

Chemical Abstracts Registry No.: 26171-23-3; 35711-34-3 (Na salt)

Trade Name	Manufacturer	Country	Year Introduced
Tolectin	McNeil	U.S.	1976
Tolectin	Cilag	Italy	1977
Tolectin	Cilag	W. Germany	1977
Tolectin	Ortho	U.K.	1979
Tolectin	Dainippon	Japan	1979
Reutol	Errekappa	Italy	—
Safitex	Montpellier	Argentina	—

Raw Materials

p-Toluoyl chloride

1-Methylpyrrole-2-acetonitrile

Sodium hydroxide

Manufacturing Process

5-(p-Toluoyl)-1-methylpyrrole-2-acetonitrile — To a cooled suspension of 26.6 g (0.2 mol) aluminum chloride in 80 ml dichloroethane is added dropwise 30.8 g (0.2 mol) p-toluoyl chloride. The resulting solution is added dropwise to a solution of 1-methylpyrrole-2-acetonitrile in 80 ml dichloroethane cooled externally with an ice bath. After the addition, the

resulting solution is stirred at room temperature for 20 minutes and then refluxed for 3 minutes. The solution is poured into ice acidified with dilute hydrochloric acid. The organic and aqueous fractions are separated. The aqueous fraction is extracted once with chloroform.

The organic fractions are combined and washed successively with *N,N*-dimethyl-1,3-propanediamine, dilute hydrochloric acid, saturated sodium bicarbonate solution and saturated sodium chloride solution. The organic fraction is dried over anhydrous magnesium sulfate. The solvent is then evaporated off. Upon trituration of the residue with methanol, a solid crystallizes, 5-(*p*-toluoyl)-1-methylpyrrole-2-acetonitrile, which is removed by filtration and purified by recrystallization from benzene.

Additional product is isolated from the mother liquors which are combined, concentrated in vacuo and the resulting oily residue column chromatographed on neutral alumina using hexane, benzene and ether as successive solvents. The product is isolated by concentrating in vacuo the first few major compound-bearing fractions (10% ether in benzene). The solids are combined and recrystallized from methanol and then from benzene-hexane, melting point 102°C to 105°C.

5-(*p*-Toluoyl)-1-methylpyrrole-2-acetic acid — A solution of 3.67 g (0.015 mol) of 5-(*p*-toluoyl)-1-methylpyrrole-2-acetonitrile, 24 ml of 1 N sodium hydroxide and 50 ml of 95% ethanol is stirred and refluxed for 24 hours.

The resulting solution is poured into ice acidified with dilute hydrochloric acid. A white solid precipitates which is extracted into ether. The ether phase is washed with a saturated solution of sodium chloride and dried over anhydrous magnesium sulfate. The solvent is evaporated and a white solid, 5-(*p*-toluoyl)-1-methylpyrrole-2-acetic acid is obtained which is recrystallized twice from isopropanol, melting point 155°C to 157°C.

References

Merck Index 9346

Kleeman & Engel p. 902

PDR p. 1094

OCDS Vol. 2 p. 234 (1980)

DOT 8 (1) 39 (1972) & 11 (3) 109 (1975)

I.N. p. 962

REM p. 1121

Carson, J.R.; U.S. Patents 3,752,826; August 14, 1973; 3,865,840; February 11, 1975; and 3,952,012; April 20, 1976; all assigned to McNeil Laboratories, Inc.

TOLNAFTATE

Therapeutic Function: Antifungal

Chemical Name: Methyl (3-methylphenyl)carbamothioic acid O-2-naphthalenyl ester

Common Name: Naphthiomate T

Structural Formula:

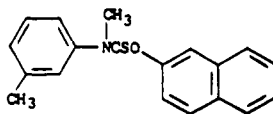

Chemical Abstracts Registry No.: 2398-96-1

Trade Name	Manufacturer	Country	Year Introduced
Tinactin	Schering	U.S.	1965
Tonofal	Essex	W. Germany	1965
Tinaderm	Kirby-Warrick	U.K.	1967
Aftate	Plough	U.S.	—
Alarzin	Yamanouchi	Japan	—
Chinofungin	Chinoin	Hungary	—
Pitrex	Ikapharm	Israel	—
Separin	Sumitomo	Japan	—
Sorgoa	Scheurich	W. Germany	—
Sporiderm	Cetrane	France	—
Sporilene	Cetrane	France	—
Tinavet	Schering	W. Germany	—

Raw Materials

N-Methyl-3-toluidine
2-Naphthol
Thiophosgene

Manufacturing Process

In a first step, 2-naphthol is reacted with thiophosgene to give 2-naphthyl chlorothionoformate.

A mixture of 4.0 grams of N-methyl-3-toluidine and 2.8 grams of sodium hydrogencarbonate in 50 cc of acetone was stirred at 0° to 10°C and 7.4 grams of 2-naphthyl chlorothionoformate was added in small portions thereto and the mixture was heated under reflux for 30 minutes. The cooled mixture was poured into about 150 cc of cold water and 2-naphthyl-N-methyl-N-(3-tolyl)thionocarbamate was obtained as white crystals. Yield is 9.1 grams (90%). Recrystallization from alcohol gave colorless needle crystals, MP 110.5° to 111.5°C.

References

- Merck Index 9347
Kleeman & Engel p. 903
PDR pp. 888, 1429
OCDS Vol. 2 p. 211 (1980) & 3, 69 (1984)
DOT 2 (1) 20 (1966)
I.N. p. 962
REM p. 1230
Miyazaki, K., Hashimoto, K., Kaji, A., Sakimoto, R., Taniguchi, K., Noguchi, T. and Igarashi, Y.; U.S. Patent 3,334,126; August 1, 1967; assigned to Nippon Soda KK, Japan

TOLONIDINE NITRATE

Therapeutic Function: Antihypertensive

Chemical Name: N-(2-Chloro-4-methylphenyl)-4,5-dihydro-1H-imidazol-2-amine

Common Name: —

Structural Formula:

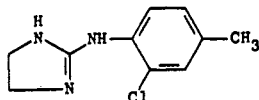

(base)

Chemical Abstracts Registry No.: 4201-23-4; 4201-22-3 (Base)

Trade Name	Manufacturer	Country	Year Introduced
Euctan	Essex	Switz.	1978
Euctan	Delalande	France	1978

Raw Materials

2-Chloro-4-methylaniline	Ammonium thiocyanate
Methyl iodide	Ethylenediamine
Nitric acid	

Manufacturing Process

43 g of the thiourea compound (melting point 124°C) of the formula

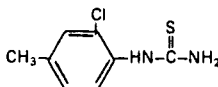

obtained in known fashion from 2-chloro-4-methylaniline and ammonium thiocyanate and 20 cc of methyl iodide were dissolved in 200 cc of methanol, and the solution was refluxed for two hours. Thereafter, the solvent was evaporated in vacuo, leaving 73.2 g of the isothiuronium hydroiodide of the formula

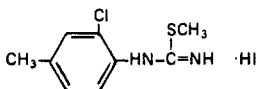

as a residue. This isothiuronium salt was admixed with 20 cc of ethylenediamine, and the mixture was heated for about 30 minutes at 150°C to 160°C, accompanied by stirring; methyl mercaptan escaped during that time. Subsequently, the reaction mixture was taken up in hot dilute acetic acid, and the resulting solution was made alkaline with 2 N sodium hydroxide. A precipitate formed, which was separated by vacuum filtration, washed with water and dried. It was identified to be 2-(2'-chloro-4'-methylphenyl)-amino-1,3-diazacyclopentene-(2) of the formula

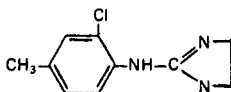

having a melting point of 142°C to 145°C. The yield was 10.2 g.

The nitrate of the base, obtained by acidifying a solution of the free base with nitric acid, had a melting point of 162°C to 164°C and was soluble in water and methanol.

References

- Merck Index 9348
 DFU 1 (5) 263 (1976)
 Kleeman & Engel p. 903
 DOT 15 (6) 303 (1979) & 18 (10) 550 (1982)
 Zelle, K., Hauptmann, K.H. and Stahle, H.; U.S. Patent 3,236,857; February 22, 1966; and U.S. Patent 3,454,701; July 8, 1969; both assigned to Boehringer Ingelheim GmbH (Germany)

TOLONIUM CHLORIDE

Therapeutic Function: Coagulant

Chemical Name: 3-amino-7-(dimethylamino)-2-methylphenothiazin-5-ium chloride

Common Name: Dimethyltoluthionine chloride; blutene chloride; toluidine blue O

Structural Formula:

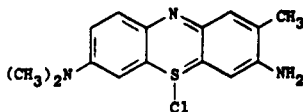

Chemical Abstracts Registry No.: 92-31-9

Trade Name	Manufacturer	Country	Year Introduced
Blutene	Abbott	U.S.	1953
Gabilin	Simons	W. Germany	—

Raw Materials

Dimethyl-p-phenylenediamine	Sodium nitrite
Zinc	o-Toluidine
Sodium thiosulfate	Zinc chloride

Manufacturing Process

As taken from U.S. Patent 416,055 (probably the oldest patent on the manufacture of a currently-used drug): In carrying out this process about 6 pbw of dimethyl-p-phenylenediamine was dissolved in about 18 pbw of hydrochloric acid of about 1.16 specific gravity and then a solution of about 3.8 pbw of nitrite of soda in about 6 pbw of water was gradually added. The hydrochlorate of nitroso-dimethylaniline thus produced in the well-known manner is then submitted to the reducing action of zinc-dust by adding, first about 30 pbw of hydrochloric acid of about 1.16 specific gravity and then (in small portions at a time) about 10 pbw of zinc-dust as is well understood by chemists. The solution of hydrochlorate of paramido-dimethylaniline thus obtained is afterwards diluted with about 250 pbw of water and then the uncombined hydrochloric acid contained in the solution is, if any, neutralized by the addition of an alkali. There are then added about 16 pbw of sulfate of alumina and about 13 pbw of thiosulfate of sodium, (hyposulfite of soda) and immediately afterwards a solution of about 5 pbw of bichromate of potash in about 60 pbw of water is quickly run in.

In this stage of the process the formation of an acid sulfureted compound of paramido-dimethylaniline takes place, possessing the formula $C_8H_{11}N_2S \cdot SO_3H$ (paramido-dimethylaniline-thiosulfonic acid). Without previous separation of this intermediate compound a solution of about 5.3 pbw of orthotoluidine, in the requisite amount of dilute hydrochloric acid (about 6 pbw of hydrochloric acid, SG about 1.16, diluted with about 6 pbw water) and shortly afterwards a solution of about 14 pbw of bichromate of potash in about 160 parts by weight of water is then added under constant agitation, when a precipitate will be formed chiefly consisting of a green indamine possessing in its dry condition the formula $C_{15}H_{17}N_3S_2O_3$. In order to transform the same into toluidine-blue, about 50 pbw of a solution of chloride of zinc of about 1.5 specific gravity are added and the mixture thus obtained is boiled during about half an hour, when, after cooling, the toluidine-blue thus formed will separate out and may then be filtered and purified, if necessary, by repeated solution in water and precipitation by means of chloride of sodium and chloride of zinc.

In the above described process the sulfate of alumina may be dispensed with and replaced

by as much hydrochloric, sulfuric, or acetic acid as will be required to liberate the thio-sulfuric acid from the thiosulfate of sodium employed.

Toluidine-blue prepared as above described presents the following characteristic properties: It consists principally of the hydrochlorate of dimethyltoluthionine, the composition of which corresponds to the formula $C_{15}H_{15}N_3 \cdot HCl$.

References

Merck Index 9349

I.N. p. 962

Dändliker, G. and Bernthsen, H.A.; U.S. Patent 416,055; November 26, 1889; assigned to Badische Anilin and Soda Fabrik, Germany

March, B. and Moore, E.E.; U.S. Patent 2,571,593; October 16, 1951; assigned to Abbott Laboratories

Hoff, D.A.; U.S. Patent 2,809,913; October 15, 1957; assigned to The Warren-Teed Products Company

TRAMADOL HYDROCHLORIDE

Therapeutic Function: Analgesic

Chemical Name: (\pm)-trans-2-[(Dimethylamino)methyl]-1-(m-methoxyphenyl)cyclohexanol hydrochloride

Common Name: —

Structural Formula:

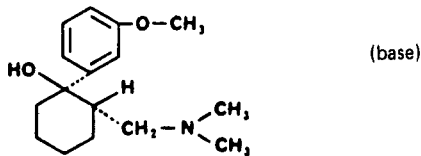

Chemical Abstracts Registry No.: 22204-88-2; 27203-92-5 (Base)

Trade Name	Manufacturer	Country	Year Introduced
Tramadol	Gruenthal	W. Germany	1977
Crispin	Kowa	Japan	1978
Tramal	Gruenthal	Switz.	1978

Raw Materials

m-Bromoanisole	Magnesium
2-Dimethylaminomethyl-cyclohexanone	Hydrogen chloride

Manufacturing Process

5 g of magnesium turnings are treated while stirring with a mixture of 37.4 g of m-bromoanisole and 160 ml of absolute tetrahydrofuran at such a rate that the reaction mixture boils gently because of the heat produced by the immediately starting reaction. Thereafter, the reaction mixture is boiled under reflux while stirring until all the magnesium dissolves. The reaction mixture is cooled to 0°C to -10°C and then a mixture of 23.25 g of 2-dimethylaminomethyl-cyclohexanone and 45 ml of absolute tetrahydrofuran is added dropwise.

The resulting mixture is stirred for 4 hours at room temperature and then poured, while stir-

ring slowly, into a mixture of 25 g of ammonium chloride, 50 ml of water and 50 g of ice. The layers are separated and the aqueous layer is extracted twice with 50 ml portions of ether. The organic layers are combined, dried with sodium sulfate and evaporated. The residue is distilled, and 1-(*m*-methoxyphenyl)-2-dimethylaminomethyl-cyclohexanol-(1), boiling point at 0.6 mm Hg 138°C to 140°C, is obtained in a yield of 78.6% of theoretical.

The hydrochloride obtained from the product, e.g., by dissolving in ether and treating with dry hydrogen chloride, melts at 168°C to 175°C. By recrystallization from moist dioxan this hydrochloride is separated into isomers melting at 162°C to 163°C and 175°C to 177°C, respectively.

References

Merck Index 9388

Kleeman & Engel p. 906

OCDS Vol. 2 p. 17 (1980)

DOT 13 (8) 345 (1977)

I.N. p. 966

Chemie Grunenthal GmbH; British Patent 997,399; July 7, 1965

Flick, K. and Frankus, E.; U.S. Patent 3,652,589; March 28, 1972; assigned to Chemie Grunenthal GmbH

TRANEXAMIC ACID

Therapeutic Function: Coagulant

Chemical Name: trans-4-(aminomethyl)cyclohexanecarboxylic acid

Common Name: —

Structural Formula:

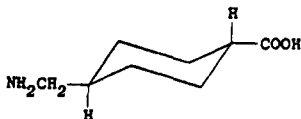

Chemical Abstracts Registry No.: 1197-18-8

Trade Name	Manufacturer	Country	Year Introduced
Anvitoff	Knoll	W. Germany	1967
Transamin	Bayer-Daiichi	Japan	1970
Ugorol	Bayer	Italy	1970
Frenolyse	Specia	France	1971
Cyklokapron	Kabi	U.K.	1978
Amcacid	Bonomelli-Hommel	Italy	—
Amchafibrin	Fides	Spain	—
Amikapron	Kabi-Vitrum	Sweden	—
Carxamin	Sankyo	Japan	—
Emorhalt	Bayropharm	W. Germany	—
Exacyl	Choay	France	—
Hexakapron	Teva	Israel	—
Hexapromin	Kowa	Japan	—
Hexatron	Nippon Shinyaku	Japan	—
Mastop	Sawai	Japan	—
Rikaverin	Toyo Jozo	Japan	—

Trade Name	Manufacturer	Country	Year Introduced
Spiramin	Mitsui	Japan	—
Tranex	Malesci	Italy	—
Tranexan	Taiyo	Japan	—
Transamin	Daiichi	Japan	—
Transamlon	Toho	Japan	—
Vasolamin	Daiichi	Japan	—

Raw Materials

p-Aminomethylbenzoic acid
Hydrogen

Manufacturing Process

In an autoclave, 2 grams of a mixture of cis- and trans-4-aminomethylcyclohexane-1-carboxylic acid, which is obtained by catalytic reduction of p-aminomethylbenzoic acid in the presence of platinum catalyst and contains 60% by weight of cis-isomer was reacted at 200°C, for 8 hours with 20 ml of ethyl alcohol in which 0.44 gram of sodium metal had been dissolved. After cooling, the reaction solution was concentrated under a reduced pressure to give a white residue. This residue was dissolved in 40 ml of water and passed through a column of a strongly acidic cation ion-exchanger resin (NH₄⁺). The eluate was concentrated under reduced pressure to form a white mass. An adequate amount of acetone was added thereto and 1.95 grams of white powder was obtained. This powder was recrystallized from water-acetone to give 1.85 grams (yield, 92.5%) of white crystalline powder having a melting point of 380° to 390°C (decomposition). This product was identified as trans-4-aminomethylcyclohexane-1-carboxylic acid by means of infrared spectrum.

References

Merck Index 9390

Kleeman & Engel p. 907

OCDS Vol. 2 p. 9 (1980)

DOT 2 (1) 26 (1966)

I.N. p. 39

REM p. 831

Naito, T., Okano, A., Aoyagi, T., Miki, T., Kadoya, S., Inaoka, M. and Shindo, M.; U.S.

Patent 3,499,925; March 10, 1970; assigned to Daiichi Seiyaku Company Limited, Japan and Mitsubishi Chemical Industries Limited, Japan

TRANILAST

Therapeutic Function: Antiallergic

Chemical Name: 2-[[3-(3,4-Dimethoxyphenyl)-1-oxo-2-propenyl] amino]-benzoic acid

Common Name: —

Structural Formula:

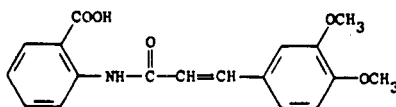

Chemical Abstracts Registry No.: 53902-12-8

Trade Name	Manufacturer	Country	Year Introduced
Rizaben	Kissei	Japan	1982

Raw Materials

3,4-Dimethoxycinnamic acid	Benzene sulfonyl chloride
Methyl anthranilate	Sodium hydroxide

Manufacturing Process

4 g of 3,4-dimethoxycinnamic acid was dissolved in 20 ml of dry pyridine. To this solution were added under cooling with ice and agitation 2 g of benzenesulfonyl chloride whereby a red orange precipitate was formed. The reaction mixture was stirred for about one hour and then 2 g of methyl anthranilate were added to the mixture under cooling with ice. The mixture was stirred for 2 hours at room temperature to complete the reaction. After completion of the reaction, the reaction mixture was concentrated and the residue was taken up in about 10 ml of chloroform. The solution was washed first with a 10% aqueous solution of caustic soda, then with a 10% aqueous solution of hydrochloric acid and finally with water and then distilled to remove chloroform whereby crystals of N-(3',4'-dimethoxycinnamoyl)-anthranilic acid methyl ester were obtained.

This product was dissolved in 10 ml of chloroform. To this solution were added 10 ml of a 10% aqueous solution of caustic soda and the mixture was warmed at 50°C to effect hydrolysis of the ester group. After completion of the reaction, the organic phase was separated, washed with water and distilled to remove the solvent whereby 2.1 g (yield: 48%) of the end product, i.e., N-(3',4'-dimethoxycinnamoyl)-anthranilic acid, were obtained. This product had a melting point of 211°C to 213°C.

References

Merck Index 9392

DFU 7 (12) 907 (1982)

DOT 19 (2) 114 & (9) 485 (1983)

I.N. p. 966

Harita, K., Ajisawa, Y., Iizuka, K., Kinoshita, Y., Kamijo, T. and Kobayashi, M.: U.S. Patent 3,940,422; February 24, 1976; assigned to Kissei Yakuin Kogyo K.K. (Japan)

TRANLYCYPROMINE SULFATE

Therapeutic Function: Psychostimulant

Chemical Name: trans(\pm)-2-phenylcyclopropanamine sulfate

Common Name: —

Structural Formula:

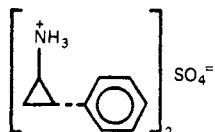

Chemical Abstracts Registry No.: 13492-01-8; 155-09-9 (Base)

Trade Name	Manufacturer	Country	Year Introduced
Parnate	SKF	U.K.	1960
Parnate	SKF	U.S.	1961

Trade Name	Manufacturer	Country	Year Introduced
Tylciprine	Theraplix	France	1963
Parnate	Rohm	W. Germany	1969
Parmodalin	Maggioni	Italy	—

Raw Materials

Styrene	Ethyl diazoacetate
Sodium hydroxide	Thionyl chloride
Sodium azide	Hydrogen chloride
Sulfuric acid	

Manufacturing Process

A solution containing 167 grams of stabilized styrene and 183 grams of ethyl diazoacetate is cooled to 0°C and dropped into 83.5 grams of styrene with stirring, in a dry nitrogen atmosphere, at 125° to 135°C. This produced the ester ethyl 2-phenylcyclopropanecarboxylate.

A solution of the above ester (207.8 grams) and 64.5 grams of sodium hydroxide in 80 cc of water and 600 cc of ethanol is refluxed for 9 hours. The carboxylic acid of 2-phenylcyclopropane is liberated with 200 cc of concentrated hydrochloric acid. The 2-phenylcyclopropanecarboxylic acid contains 3 to 4 parts of the trans isomer to 1 part of the cis isomer. The acid is recrystallized from hot water. The pure trans isomer comes out as crystalline material (solid) while the cis isomer stays in solution.

A solution of 4.62 grams of 2-phenylcyclopropanecarboxylic acid in 15 cc of dry benzene is refluxed with 4 cc of thionyl chloride for 5 hours, the volatile liquids are removed and the residue once more distilled with benzene. Fractionation of the residue yields the carbonyl chloride of 2-phenylcyclopropane.

A mixture of 15 grams of technical sodium azide and 50 cc of dry toluene is stirred and warmed and a solution of 10 grams of 2-phenylcyclopropanecarbonyl chloride in 50 cc of dry toluene is added slowly. Inorganic salts are filtered and washed well with dry benzene and the solvents are removed under reduced pressure. The RCON₃ compound produced undergoes the Curtius rearrangement to RNCO + N₂. The residual isocyanate is a clear red oil of characteristic odor. It is cooled to 10°C and treated cautiously with 100 cc of 35% hydrochloric acid whereupon RNCO + H₂O gives RNH₂ + CO₂. After most of the evolution of carbon dioxide has subsided the mixture is refluxed for 13 hours, the cooled solution is diluted with 75 cc of water and extracted with three 50 cc portions of ether. The acid solution is evaporated under reduced pressure with occasional additions of toluene to reduce foaming.

The almost dry residue is cooled to 0°C and made strongly alkaline with a 50% potassium hydroxide solution. The amine is extracted into several portions of ether, dried over potassium hydroxide, the solvent removed, and the base fractionated. Reaction of the base with a half-molar quantity of sulfuric acid gives the sulfate.

References

- Kleeman & Engel p. 907
- PDR p. 1719
- OCDS Vol. 1 p. 73 (1977) & 2, 7, 50 (1980)
- J.N. p. 967
- REM p. 1097
- Tedeschi, R.E.; U.S. Patent 2,997,422; August 22, 1961; assigned to Smith Kline & French Laboratories

TRAPIDIL

Therapeutic Function: Coronary vasodilator

Chemical Name: 5-Methyl-7-diethylamino-1-triazolo-(1,5-a)-pyrimidine

Common Name: Trapymin

Structural Formula:

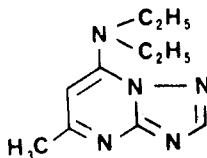

Chemical Abstracts Registry No.: 15421-84-8

Trade Name	Manufacturer	Country	Year Introduced
Rocornal	Mochida	Japan	1978
Rocornal	Deutsches Hydrierwerk	E. Germany	—

Raw Materials

5-Methyl-7-chloro-s-triazolo-(1,5-a)-pyrimidine
Diethylamine

Manufacturing Process

8.4 g of 5-methyl-7-chloro-s-triazolo-(1,5-a)-pyrimidine were suspended in 30 cc of water and 7.3 g of diethylamine added. After 2 hours stirring with stirring, the mixture was concentrated under vacuum. The residue was recrystallized from *n*-heptane. This process yielded 8.1 g of the 5-methyl-7-diethylamino-s-triazolo-(1,5-a)-pyrimidine having a melting point of 103°C to 104°C. The hydrochloride produced in the usual manner had a melting point of 212°C.

References

Merck Index 9396

DOT 8 (1) 25 (1972)

I.N. p. 967

Tenor, E., Fuller, H. and Hausschild, F.; British Patent 1,148,629; April 16, 1969; assigned to Veb. Deutsches Hydrierwerk Rodleben

TRAZODONE HYDROCHLORIDE

Therapeutic Function: Tranquilizer

Chemical Name: 2-[3-[4-(3-chlorophenyl)-1-piperazinyl]propyl]-1,2,4-triazolo[4,3-a]-pyridin-3(2H)-one hydrochloride

Structural Formula:

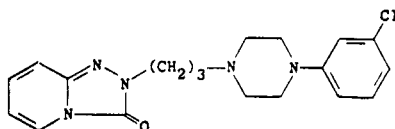

(base)

Chemical Abstracts Registry No.: 25332-39-2; 19794-93-5 (Base)

Trade Name	Manufacturer	Country	Year Introduced
Trittico	Angelini	Italy	1972
Thombran	Thomae	W. Germany	1977
Pragmazone	U.P.S.A.	France	1980
Molipaxin	Roussel	U.K.	1980
Desyrel	Bristol	Canada	1982
Desyrel	Mead Johnson	U.S.	1982
Beneficat	Nemi	Argentina	—
Bimaran	Roux-Ocefa	Argentina	—
Manegan	Argentia	Argentina	—
Tramensan	Medica	Finland	—

Raw Materials

2-Chloropyridine
 Semicarbazide
 Sodium hydride
 1-(3-Chloropropyl)-4-m-chlorophenylpiperazine

Manufacturing Process

In an initial step, 2-chloropyridine is reacted with semicarbazide to give s-triazolo-[4,3-a]-pyridine-3-one.

To a boiling solution of 6.7 grams s-triazolo-[4,3-a]-pyridine-3-one in 80 ml dioxane, there is added 2.4 grams 50% NaH. The mixture is refluxed during 1 hour under stirring, then 13.5 grams 1-(3-chloropropyl)-4-m-chlorophenylpiperazine is added. The mixture is refluxed under stirring for 20 hours, cooled, diluted with an equal volume of ether, the sodium chloride filtered out, and ethereal HCl added. The solid which precipitates is filtered out and crystallized from 95% alcohol. Yield is 13.5 grams, MP 223°C.

The following is an alternative method of preparation: 1 gram 2-(γ -chloropropyl)-s-triazolo-[4,3-a]-pyridine-3-one and 5 ml saturated ammonia alcoholic solution are heated for 5 hours in a closed tube at 100°C. The contents of the tube are cooled, the ammonium chloride filtered out and the solvent is removed. There remains a residue of 0.9 grams 2-(γ -aminopropyl)-s-triazolo-[4,3-a]-pyridine-3-one.

This residue is dissolved in isopropyl alcohol and 1 gram N-bis-chloroethyl-aniline is added to it. The mixture is refluxed for 3 hours. The solvent is removed at a reduced pressure, the residue is treated with 50% potassium carbonate, and extracted with ether. By treating with ethereal hydrochloric acid, 2-N¹-m-chlorophenylpiperazino-propyl-s-triazole-[4,3-a]-pyridine-3-one hydrochloride is precipitated; MP 223°C.

References

- Merck Index 9398
 Kleeman & Engel p. 908
 PDR p. 1123
 OCDS Vol. 2 p. 472 (1980)
 DOT 9 (3) 115 (1973)
 I.N. p. 968
 REM p. 1097
 Palazzo, G. and Silvestrini, B.; U.S. Patent 3,381,009; April 30, 1968; assigned to Aziende Chimiche Riunite Angelini Francesco a Roma, Italy

TRENBOLONE ACETATE

Therapeutic Function: Anabolic steroid

Chemical Name: 17 β -Aceto-3-oxoestra-4,9,11-triene-3-one

Common Name: Trenbolone acetate

Structural Formula:

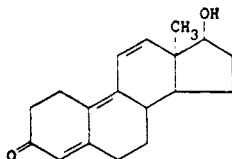

(base)

Chemical Abstracts Registry No.: 10161-34-9; 10161-33-8 (Base)

Trade Name	Manufacturer	Country	Year Introduced
Parabolan	Negma	France	1980
Finaject	Distrivet	France	—
Finaplix	Distrivet	France	—
Hexabolan	Phartec	France	—

Raw Materials

17 β -Benzyloxy-4,5-seco-estra-9,11-diene-3,5-dione

Sodium-t-amylate

Acetic acid

Methanol

Acetic anhydride

Manufacturing Process

Stage A: Preparation of 17 β -Benzoyloxy-Estra-4,9,11-Trien-3-one — 0.400 g of 17 β -benzoyloxy-4,5-seco-estra-9,11-diene-3,5-dione is dissolved in 4 cc of toluene under an inert atmosphere. The solution is cooled to 3°C, then 0.48 cc is added of the solution of sodium tert-amylate in anhydrous toluene, diluted by the addition of a further 4.8 cc of anhydrous toluene.

This reaction mixture is kept between 0°C and +5°C for six hours, with agitation and under an inert atmosphere, then 5 cc of a 0.2N solution of acetic acid in toluene are added. The mixture is extracted with toluene, and the extracts are washed with water and evaporated to dryness. The residue is taken up in ethyl acetate, and then the solution is evaporated to dryness in vacuo, yielding a resin which is dissolved in methylene chloride, and the solution passed through a column of 40 g of magnesium silicate. Elution is carried out first with methylene chloride, then with methylene chloride containing 0.5% of acetone, and 0.361 g is thus recovered of a crude product, which is dissolved in 1.5 cc of isopropyl ether; then hot methanol is added and the mixture left at 0°C for one night.

0.324 g of the desired 17 β -benzoyloxy-estra-4,9,11-trien-3-one are thus finally obtained, being a yield of 85%, melting point is 154°C.

Stage B: Preparation of 17 β -Hydroxy-Estra-4,9,11-Trien-3-one — 3 g of 17 β -benzoyloxy-estra-4,9,11-trien-3-one, obtained as described in Stage A are dissolved in 15 cc of methanol. 0.03 g of hydroquinone is added, and the mixture is taken to reflux while bubbling in nitrogen. Then 1.2 cc of 11% methanolic caustic potash is added and reflux is maintained for three hours, after which the reaction product is acidified with 0.36 cc of acetic acid.

The methyl benzoate thus formed is eliminated by steam distillation, and 2.140 g of crude product are obtained, which are dissolved in 20 cc of methylene chloride. This solution is passed through 10 parts of magnesium silicate, elution being performed with 250 cc of methylene chloride containing 5% of acetone. After evaporation of the solvent 2.050 g of product is recovered, which is recrystallized from isopropyl ether.

In this way 1.930 g of the desired 17 β -hydroxy-estra-4,9,11-trien-3-one is obtained being a yield of 89%, melting point is 186°C. It is converted to the acetate by acetic anhydride.

References

Merck Index 9402

Kleeman & Engel p. 908

DOT 12 (3) 121 (1976)

I.N. p. 968

Roussel-Uclaf; British Patent 1,035,683; July 13, 1966

TREPIBUTONE

Therapeutic Function: Choleric

Chemical Name: 3-(2',4',5'-Triethoxybenzoyl)-propionic acid

Common Name: —

Structural Formula:

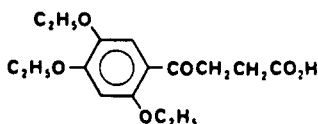

Chemical Abstracts Registry No.: 41826-92-0

Trade Name	Manufacturer	Country	Year Introduced
Supacal	Takeda	Japan	1981
Cholibil	Takeda	Japan	—

Raw Materials

1,2,4-Triethoxybenzene
Succinic anhydride

Manufacturing Process

To a mixture of 7.5 parts by weight of 1,2,4-triethoxybenzene, 40 parts by volume of tetra-chloroethane and 7.5 parts by weight of succinic anhydride are added 23 parts by weight of anhydrous aluminum chloride. The mixture is stirred for 1 hour at 25°C and for another 2 hours at 60°C. After addition of 50 parts by weight of ice and 50 parts by volume of concentrated hydrochloric acid, the reaction mixture is subjected to steam distillation.

After cooling crystals separated from the remaining liquid are collected by filtration and re-crystallized from aqueous ethanol, whereby 2.5 parts by weight of 3-(2',4',5'-triethoxybenzoyl)-propionic acid are obtained as colorless needles, melting point 150°C to 151°C.

References

Merck Index 9404

DFU 3 (11) 846 (1978)

DOT 17 (12) 566 (1981)

I.N. p. 969

Mutara, T., Nohara, A., Sugihara, H. and Sanno, Y.; U.S. Patent 3,943,169; March 9, 1976; assigned to Takeda Chemical Industries, Ltd.

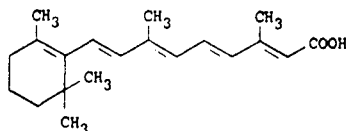
TRETINOIN**Therapeutic Function:** Keratolytic**Chemical Name:** 3,7-dimethyl-9-(2,6,6-trimethyl-1-cyclohexen-1-yl)-2,4,6,8-nonatetraenoic acid**Common Name:** Vitamin A acid; retinoic acid**Structural Formula:****Chemical Abstracts Registry No.:** 302-79-4

Trade Name	Manufacturer	Country	Year Introduced
Aberel	McNeil	U.S.	1973
Vitamin-A-Saure	Roche	W. Germany	1973
Retin-A	Ortho	U.K.	1973
Airol	Roche	Italy	1975
Effederm	Sauba	France	1975
Retin-A	Cilag	Italy	1975
Acnelyse	Abdi Ibrahim	Turkey	—
Aknoten	Krka	Yugoslavia	—
Cordes-Vas	Ichthyol-Ges.	W. Germany	—
Dermojuventus	Juventus	Spain	—
Epi-Aberel	Cilag	W. Germany	—
Eudyna	Nordmark	W. Germany	—
Stie Vaa	Stiefel	U.S.	—
Tretin-M	Ikapharm	Israel	—
Vitacid-A	Merima	Yugoslavia	—

Raw Materials

Beta-ionol

Triphenylphosphine hydrobromide

4-Methyl-1-al-hexadiene-(2,4)-acid-(6)

Manufacturing Process

100 parts of beta-ionol are dissolved in 200 parts of dimethylformamide and after the addition of 165 parts of triphenylphosphine hydrobromide, stirred for 7 hours at room temperature. Then 70 parts of 4-methyl-1-al-hexadiene-(2,4)-acid-(6) (melting point 177°C, white needles from water) are added to the now clear solution. 150 parts of isopropanol

are added and the whole cooled to -30°C . Into this solution, while stirring vigorously, 190 parts by volume of a 30% solution of sodium methylate in methanol are allowed to flow in. A vigorous exothermic reaction takes place and the temperature in the interior of the flask rises to $+5^{\circ}\text{C}$. It is stirred for another 5 minutes and neutralized with 10% of sulfuric acid (until acid to Congo).

After stirring for 2 hours at room temperature, the mass of vitamin A acid has crystallized out. It is sharply filtered off by suction and washed with a little ice-cold isopropanol. From the filtrate, a further small amount of mainly all trans vitamin A acid crystallizes out upon the addition of water. The filter cake is suspended in 600 parts of water and stirred for 4 hours at room temperature; it is filtered by suction and the product washed with water. It is dried in vacuo at 40° to 50°C and 115 parts of vitamin A acid are obtained. The melting point lies between 146° and 159°C .

The mixture of the all trans and mainly 9,10-cis vitamin A acid may be separated by fractional crystallization from ethanol. All trans vitamin A acid has a melting point of 180° to 182°C and 9,10-cis vitamin A acid, which crystallized in the form of pale yellow fine needles collected into clusters, has a melting point of 189° to 190°C .

References

Merck Index 8065

Kleeman & Engel p. 910

PDR p. 1309

DOT 8 (8) 305 (1972)

I.N. p. 970

REM p. 785

Pommer, H. and Sarnecki, W.; U.S. Patent 3,006,939; October 31, 1961; assigned to Badische Anilin- & Soda-Fabrik AG, Germany

TRIACETIN

Therapeutic Function: Topical antifungal

Chemical Name: 1,2,3-propanetriol triacetate

Common Name: Glyceryl triacetate

Structural Formula:

$$\begin{array}{c} \text{CH}_2\text{OCOCH}_3 \\ | \\ \text{CHOCOCH}_3 \\ | \\ \text{CH}_2\text{OCOCH}_3 \end{array}$$

Chemical Abstracts Registry No.: 102-76-1

Trade Name	Manufacturer	Country	Year Introduced
Enzactin	Ayerst	U.S.	1957
Fungacetin	Blair	U.S.	1957
Vanay	Ayerst	U.S.	1959

Raw Materials

Allyl acetate

Acetic acid

Oxygen

Manufacturing Process

200 grams of allyl acetate, 450 grams of glacial acetic acid and 3.71 grams of cobaltous bromide were charged to the reactor and the mixture was heated to 100°C. Pure oxygen was then introduced into the reactor below the surface of the liquid reaction mixture at the rate of 0.5 standard cubic feet per hour. Initially, all of the oxygen was consumed, but after a period of time oxygen introduced into the mixture passed through unchanged. During the course of the reaction, a small quantity of gaseous hydrogen bromide (a total of 1.9 grams) was introduced into the reaction zone, along with the oxygen. The reaction was allowed to continue for 6 hours following which the reaction mixture was distilled. Essentially complete conversion of the allyl acetate took place. A yield of 116 grams of glycerol triacetate was obtained, this being accomplished by distilling the glycerol triacetate overhead from the reaction mixture, at an absolute pressure of approximately 13 mm of mercury.

References

Merck Index 9407

PDR pp. 618, 1397

I.N. p. 970

REM p. 1231

Keith, W.C.; U.S. Patent 2,911,437; November 3, 1959; assigned to Sinclair Refining Co.

TRIAMCINOLONE

Therapeutic Function: Glucocorticoid

Chemical Name: 9-fluoro-11 β ,16 α ,17,21-tetrahydroxypregna-1,4-diene-3,20-dione

Common Name: Δ^1 -16 α -hydroxy-9 α -fluorohydrocortisone

Structural Formula:

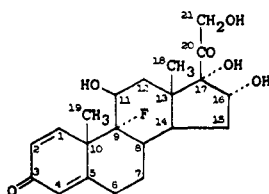

Chemical Abstracts Registry No.: 124-94-7

Trade Name	Manufacturer	Country	Year Introduced
Kenacort	Squibb	U.S.	1958
Aristocort	Lederle	U.S.	1958
Aristogel	Lederle	U.S.	1975
Albacort	Teknofarma	Italy	—
Cinolone	Pierrel	Italy	—
Cortinovus	Lampugnani	Italy	—
Delsolone	Medosan	Italy	—
Ditrizin	Ester	Spain	—
Eczil	Aesculapius	Italy	—
Flogicort	Francia	Italy	—

Trade Name	Manufacturer	Country	Year Introduced
Ipercortis	A.G.I.P.S.	Italy	—
Ledercort	Cyanamid	Italy	—
Medicort	Medici	Italy	—
Neo-Cort	Italchemi	Italy	—
Oticortrix	Oti	Italy	—
Sadocort	Guistini	Italy	—
Sedozalona	Loa	Argentina	—
Sterocort	Taro	Israel	—
Tedarol	Specia	France	—
Trialona	Alter	Spain	—
Triamcort	Helvepharm	Switz.	—
Triam-Oral	Nattermann	W. Germany	—
Tricortale	Bergamon	Italy	—
Trilon	Panther-Osfa	Italy	—
Volon	Heyden	W. Germany	—

Raw Materials

Bacterium *Corynebacterium simplex*

Δ^4 -Pregnene-9 α -fluoro-11 β ,16 α ,17 α ,21-tetrol-3,20-dione-16,21-diacetate

Soy broth

Potassium hydroxide

Manufacturing Process

Preparation of $\Delta^{1,4}$ -Pregnadiene-9 α -Fluoro-11 β ,16 α ,17 α ,21-Tetrol 16,21-Diacetate: An agar slant of *Corynebacterium simplex* was washed with 5 ml of sterile saline and the spore suspension added to 100 ml of Trypticase soy broth in a 500 ml Erlenmeyer. The mixture was incubated at 32°C for 8 hr and 1 ml was used to inoculate 10 flasks, each containing 100 ml of Trypticase soy broth. The flasks were incubated with shaking at 32°C for 16 hr. 20 mg Δ^4 -pregnene-9 α -fluoro-11 β ,16 α ,17 α ,21-tetrol-3,20-dione 16,21-diacetate dissolved in 2 ml ethanol was added and the flasks pooled. This solution was extracted several times with methylene chloride, washed with saturated saline and evaporated under reduced pressure. The residue was dissolved in methanol, treated with activated charcoal, filtered through diatomaceous earth and reevaporated to afford 277 mg of oil and acetylated overnight.

Paper strip chromatography showed approximately equal amounts of substrate and a more polar product ($\Delta^{1,4}$ -pregnadiene-9 α -fluoro-11 β ,16 α ,17 α ,21-tetrol-3,20-dione 16,21-diacetate) together with very small amounts of two less polar products. Partition chromatography of 0.25 gram of the residue (diatomaceous earth column; system: 2 parts ethyl acetate, 3 parts petroleum ether (90° to 100°C), 3 parts methanol and 2 parts water) separated the less polar products and the substrate. The desired most polar product remained on the column and was eluted with 500 ml of methanol. The residue (90 mg) from the evaporated methanol was repartitioned on diatomaceous earth [system: 3 parts ethyl acetate, 2 parts petroleum ether (90° to 100°C), 3 parts methanol, and 2 parts water] and the cut containing the desired product (determined by ultraviolet absorption spectrum) was evaporated under reduced pressure to afford 18 mg of solid.

Crystallization from acetone-petroleum ether gave 13 mg of colorless needles of $\Delta^{1,4}$ -pregnadiene-9 α -fluoro-11 β ,16 α ,17 α ,21-tetrol-3,20-dione 16,21-diacetate; melting point (Köfler block) about 150° to 240°C with apparent loss of solvent at 150°C. Recrystallization from acetone-petroleum ether did not alter the melting point.

Preparation of $\Delta^{1,4}$ -Pregnadiene-9 α -Fluoro-11 β ,16 α ,17 α ,21-Tetrol-3,20-Dione: A solution of 100 mg of $\Delta^{1,4}$ -pregnadiene-9 α -fluoro-11 β ,16 α ,17 α ,21-tetrol-3,20-dione 16,21-diacetate was dissolved in 10 ml of methanol and cooled to 0°C. After flushing with nitrogen, a solution of 35 mg of potassium hydroxide in 2 ml of methanol was added to the steroid solution. After standing at room temperature for 1 hour, the solution was neutralized

with glacial acetic acid and evaporated under a nitrogen atmosphere to a white solid. Water was added, and after cooling, the product was filtered and washed with water to afford 52 mg of $\Delta^1,4$ -pregnadiene-9 α -fluoro-11 β ,16 α ,17 α ,21-tetrol-3,20-dione, melting point 246° to 249°C. Three crystallizations from acetone-petroleum ether gave 29 mg of the tetrol, melting point 260° to 262.5°C, according to U.S. Patent 2,789,118.

References

Merck Index 9412

Kleeman & Engel p. 911

PDR pp. 830, 998, 1606

OCDs Vol. 1 p. 201 (1977) & 2, 185 (1980)

I.N. p. 971

REM p. 970

Bernstein, S., Lenhard, R.H. and Allen, W.S.; U.S. Patent 2,789,118; April 16, 1957; assigned to American Cyanamid Company

Allen, G.R., Marx, M. and Weiss, M.J.; U.S. Patent 3,021,347; February 13, 1962; assigned to American Cyanamid Company

TRIAMCINOLONE ACETONIDE

Therapeutic Function: Glucocorticoid

Chemical Name: 9-fluoro-11 β ,21-dihydroxy-16 α ,17[1-methylethylidenebis(oxy)]pregna-1,4-diene-3,20-dione

Common Name: 9 α -fluoro-16 α ,17-isopropylidenedioxy prednisolone

Structural Formula:

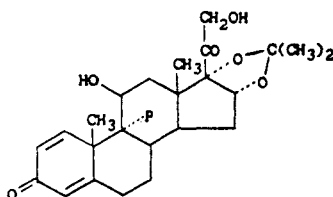

Chemical Abstracts Registry No.: 76-25-5

Trade Name	Manufacturer	Country	Year Introduced
Kenalog	Squibb	U.S.	1958
Aristocort A	Lederle	U.S.	1958
Aristoderm	Lederle	U.S.	1960
Aristogel	Lederle	U.S.	1975
Triacort	Rowel	U.S.	1981
Trymex	Savage	U.S.	1982
Kenal	N.M.C.	U.S.	1982
Triaget	Lemmon	U.S.	1983
Acetospa	Reid Provident	U.S.	—
Adcortyl	Squibb	U.K.	—
Azmacort	Rorer	U.S.	—
Azobicina Triamcin	Maggioni	Italy	—
Cinonide	Legere	U.S.	—

Trade Name	Manufacturer	Country	Year Introduced
Cremocort	Rougier	Canada	—
Cutinolone	Labaz	France	—
Extracort	Basotherm	W. Germany	—
Flogicort	Francia	Italy	—
Ftorocort	Kobanyai	Hungary	—
Kenacort	Squibb	France	—
Kenacort-A	Squibb-Sankyo	Japan	—
Kortikoid	Ratiopharm	W. Germany	—
Ledercort N	Lederle	Japan	—
Lederspan	Lederle	U.K.	—
Mycolog	Squibb	U.S.	—
Myco-Triacet	Lemmon	U.S.	—
Mytrex	Savage	U.S.	—
Neo-Cort	Italchimici	Italy	—
Nyst-Olone	Schein	U.S.	—
Paralen	Heyden	W. Germany	—
Rineton	Sanwa	Japan	—
Sterocutan	Ifisa	Italy	—
Tedarol	Specia	Italy	—
Tramycin	Johnson & Johnson	U.S.	—
Triaderm	K-Line	Canada	—
Triolona	Alter	Spain	—
Triamalone	Trans-Canada Derm.	Canada	—
Triam-Injekt	Nattermann	W. Germany	—
Tricilone	Vangard	U.S.	—
Tricinolon	Kakenyaku	Japan	—
Volon	Heyden	W. Germany	—

Raw Materials

Triamcinolone
Acetone

Manufacturing Process

A solution of 250 mg of 9 α -fluoro-11 β ,16 α ,17 α ,21-tetrahydroxy-1,4-pregnadiene-3,20-dione in 70 ml of hot acetone and 7 drops of concentrated hydrochloric acid is boiled for 3 minutes. After standing at room temperature for 17 hours, the reaction mixture is poured into dilute sodium bicarbonate and extracted with ethyl acetate. The extract is washed with saturated saline solution, dried and evaporated to a colorless glass. The residue is crystallized from acetone-petroleum ether to afford 166 mg of the acetonide, MP 270° to 274°C, decomposition, (with previous softening and browning). Three recrystallizations from acetone-petroleum ether give 113 mg of 9 α -fluoro-11 β ,21-dihydroxy-16 α ,17 α -isopropylidenedioxy-1,4-pregnadiene-3,20-dione, MP 274° to 279°C, decomposition, (with previous softening and browning).

References

- Merck Index 9413
 Kleeman & Engel p. 912
 PDR pp. 888, 999, 1003, 1033, 1429, 1535, 1604, 1746, 1750
 OCDS Vol. 1 p. 201 (1977)
 I.N. p. 971
 REM p. 971
 Bernstein, S. and Allen, G.R. Jr.; U.S. Patent 2,990,401; June 27, 1961; assigned to American Cyanamid Company
 Hydorn, A.E.; U.S. Patent 3,035,050; May 15, 1962; assigned to Olin Mathieson Chemical Corporation

TRIAMCINOLONE DIACETATE

Therapeutic Function: Glucocorticoid

Chemical Name: 9-Fluoro-11 β ,16 α ,17,21-tetrahydroxypregna-1,4-diene-3,20-dione-17,21-diacetate

Common Name: —

Structural Formula:

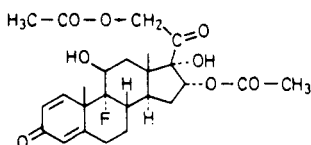

Chemical Abstracts Registry No.: 67-78-7

Trade Name	Manufacturer	Country	Year Introduced
Aristocort	Lederle	U.S.	1959
Cenocort	Central	U.S.	1975
Cino-40	Tutag	U.S.	1976
Tracilon	Savage	U.S.	1978
Cinalone	Legere	U.S.	—
Delphicort	Lederle	W. Germany	—
Kenacort	Squibb	Italy	—
Ledercort	Lederle	Italy	—
Tedarol	Specia	France	—
Triam Forte	Hyrex	U.S.	—
Triamcin	Johnson & Johnson	U.S.	—

Raw Materials

16 α ,21-Diacetoxy-11 β ,17 α -dihydroxy-9 α -fluoro-4-pregnene-3,20-dione
Selenium dioxide

Manufacturing Process

To a solution of 16 α ,21-diacetoxy-11 β ,17 α -dihydroxy-9 α -fluoro-4-pregnene-3,20-dione (1.0 g) in tertiary-butanol (160 ml) and glacial acetic acid (1.6 ml) was added 600 mg of selenium dioxide, the mixture swept with nitrogen and kept at 70°C for 24 hours, selenium dioxide (350 mg) added, and the mixture swept with nitrogen and allowed to stand for another 24 hours. The reaction mixture was filtered, and the filtrate was evaporated to dryness under reduced pressure. The material so obtained was dissolved in ethyl acetate, washed with saturated sodium bicarbonate, water, cold freshly prepared ammonium sulfide solution, cold dilute ammonia water, cold dilute hydrochloric acid, and finally with water. After treatment with anhydrous sodium sulfate and activated charcoal, filtration through diatomaceous earth and evaporation to dryness under reduced pressure, 850 mg of a tan glass was obtained. Paper strip chromatographic analysis showed predominantly product plus a small amount of starting material. The 850 mg was chromatographed on 320 g of diatomaceous earth containing 160 ml of stationary phase of a solvent system composed of 3,4,3,2-ethyl acetate-petroleum ether (boiling point 90°C to 100°C), methanol, and water, respectively. The column dimensions were 3.8 cm x 78 cm with 460 ml hold back volume. The fifth and sixth hold back volumes were combined and evaporated under reduced pressure to 250 mg of product which, after a single crystallization from acetone-petroleum ether, gave 173 mg, melting point 150°C to 190°C. Paper strip chromatography showed a single spot having the same polarity as an authentic sample of 16 α ,21-diacetoxy-11 β ,17 α -dihydroxy-9 α -fluoro-1,4-pregnadiene-3,20-dione. A further crystallization from the same solvent pair gave 134 mg, melting point 185°C to 189°C, bubbles to 230°C.

References

Kleeman & Engel p. 913
 PDR pp. 998, 1000, 1033
 I.N., p. 971
 REM p. 971
 American Cyanamid Co.; British Patent 835,836; May 25, 1960

TRIAMTERENE

Therapeutic Function: Diuretic

Chemical Name: 6-phenyl-2,4,7-pteridinetriamine

Common Name: Ademine; pterophene

Structural Formula:

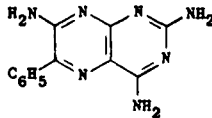

Chemical Abstracts Registry No.: 396-01-0

Trade Name	Manufacturer	Country	Year Introduced
Jatropur	Rohm	W. Germany	1962
Dytac	SKF	U.K.	1962
Teriam	Roussel	France	1963
Triamteril	Farmitalia	Italy	1963
Dyrenium	SKF	U.S.	1964
Diurene	Medix	Spain	—
Dyazide	SKF	U.S.	—
Kalistat	Disco	Israel	—
Maxzide	Lederle	U.S.	—
Triamthiazid	Henning	W. Germany	—
Urocaudal	Jorba	Spain	—

Raw Materials

5-Nitroso-2,4,6-triaminopyrimidine
 Phenylacetoneitrile

Manufacturing Process

To a solution of 9 grams of 5-nitroso-2,4,6-triaminopyrimidine in 500 ml of refluxing dimethylformamide is added 9 grams of phenylacetoneitrile and the refluxing is stopped. The 3 grams of anhydrous sodium methoxide is added and the mixture is refluxed for 15 minutes. The mixture is chilled and the solid is filtered and washed several times with warm water until the washings are neutral. Drying gives yellow crystals which are recrystallized with a Darco treatment from formamide-water heating the solution no hotter than 125°C. This product is then suspended in filtered deionized water and warmed for 15 minutes. This yields the 2,4,7-triamino-6-phenylpteridine as yellow crystals with a MP of 314° to 317°C.

References

Merck Index 9415

Kleeman & Engel p. 915

PDR pp. 1014, 1713

OCDS Vol. 1 p. 427 (1977)

I.N. p. 972

REM p. 942

Weinstock, J. and Wiebelhaus, V.D.; U.S. Patent 3,081,230; March 12, 1963; assigned to Smith Kline & French Laboratories

TRIAZOLAM

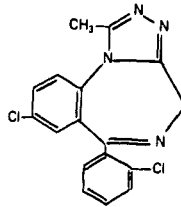
Therapeutic Function: Hypnotic**Chemical Name:** 8-Chloro-1-methyl-6-(o-chlorophenyl)-4H-s-triazolo[4,3-a][1,4]-benzodiazepine**Common Name:** Clorazolam**Structural Formula:****Chemical Abstracts Registry No.:** 28911-01-5

Trade Name	Manufacturer	Country	Year Introduced
Halcion	Upjohn	Switz.	1978
Halcion	Upjohn	Italy	1978
Halcion	Upjohn	U.K.	1979
Halcion	Upjohn	W. Germany	1980
Halcion	Upjohn	U.S.	1982
Halcion	Sumitomo	Japan	1983
Halcion	Upjohn	Japan	1983
Songar	Valeas	Italy	1983
Novidorm	Sintyal	Argentina	—

Raw Materials

7-Chloro-1,3-dihydro-5-(o-chlorophenyl)-2H-1,4-benzodiazepine-2-thione
Acetic acid hydrazide

Manufacturing Process

A mixture of 1.0 g (0.0031 mol) of 7-chloro-1,3-dihydro-5-(o-chlorophenyl)-2H-1,4-benzodiazepine-2-thione, 0.8 g (0.0108 mol) of acetic acid hydrazide and 40 ml of 1-butanol was heated at reflux temperature under nitrogen for 24 hours. During the first 5 hours the nitrogen was slowly bubbled through the solution. After cooling and removing the solvent in vacuo, the product was well mixed with water and collected on a filter, giving 0.9 g of orange solid, melting point 210°C to 212°C. This was heated under nitrogen in an oil bath at 250°C and then cooled. The solid was crystallized from ethyl acetate, giving 0.5 g of tan solid of melting point 215°C to 216°C (decomposition). This was dissolved in 25 ml of 2-propanol,

filtered, concentrated to 10 ml and cooled, yielding 0.46 g (43%) of tan, crystalline 8-chloro-1-methyl-6-(*o*-chlorophenyl)-4H-s-triazolo[4,3-*a*] [1,4]-benzodiazepine of melting point 223°C to 225°C.

References

Merck Index 9418

DFU 1 (8) 393 (1976)

Kleeman & Engel p. 916

PDR p. 1843

OCDS Vol. 1 p. 368 (1977)

DOT 11 (5) 20 (1975) & 15 (1) 30 (1979)

I.N. p. 972

REM p. 1064

Hester, J.B. Jr.; U.S. Patents 3,741,957; June 26, 1973; 3,980,790; September 14, 1976; and 3,987,052; October 19, 1976; all assigned to The Upjohn Company

TRIBENOSIDE

Therapeutic Function: Treatment of venous disorders

Chemical Name: Ethyl-3,5,6-tris-O-(phenylmethyl)-D-glucufuranoside

Common Name: —

Structural Formula:

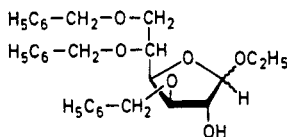

Chemical Abstracts Registry No.: 10310-32-4

Trade Name	Manufacturer	Country	Year Introduced
Glyvenol	Ciba	W. Germany	1967
Glyvenol	Ciba Geigy	France	1968
Glyvenol	Ciba	Italy	1968
Hemocuron	Takeda	Japan	1978
Alven	Firma	Italy	—
Flebosan	Dukron	Italy	—
Venalisin	A.G.I.P.S.	Italy	—
Venex	Oti	Italy	—
Venodin	Tosi-Novara	Italy	—

Raw Materials

1,2-Isopropylidene glucufuranose
Benzyl chloride

Manufacturing Process

4.9 g of 3,5,6-tribenzyl-1,2-isopropylidene glucufuranose are kept overnight at room temperature with 100 cc of N-ethanolic hydrochloric acid. Evaporation under vacuum at below 50°C is then carried out and the residue taken up in 150 cc of chloroform. The chloroform solu-

tion is thoroughly washed with sodium bicarbonate solution, dried with calcined sodium sulfate and evaporated under vacuum. The oily residue is then distilled under vacuum with a free flame. In this manner there is obtained the ethyl-3,5,6-tribenzyl-D-glucofuranoside of boiling point 270°C to 275°C under 1 mm pressure.

The glucofuranose used as starting material is obtained as follows: 8.8 g of 1,2-isopropylidene-D-glucofuranose and 50.6 g of benzyl chloride are treated with a total of 28 g of potassium hydroxide in portions with cooling and stirring. The mixture is then stirred for 3 hours at 80°C to 90°C. Working up from chloroform solution and distillation at 250°C to 260°C under 0.1 mm pressure give 8.9 g of 1,2-isopropylidene-3,5,6-tribenzyl-D-glucofuranose.

References

Merck Index 9420

Kleeman & Engel p. 917

I.N. p. 973

Druey, J. and Huber, G.L.; U.S. Patent 3,157,634; November 17, 1964; assigned to Ciba Corp.

TRICHLORMETHIAZIDE

Therapeutic Function: Diuretic

Chemical Name: 6-chloro-3-(dichloromethyl)-3,4-dihydro-2H-1,2,4-benzothiadiazine-7-sulfonamide-1,1-dioxide

Common Name: Hydrotrichlorothiazide

Structural Formula:

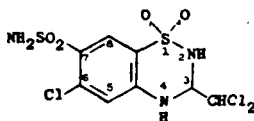

Chemical Abstracts Registry No.: 133-67-5

Trade Name	Manufacturer	Country	Year Introduced
Naqua	Schering	U.S.	1960
Metahydrin	Merrell National	U.S.	1960
Esmarin	Merck	W. Germany	1960
Fluitran	Essex	Italy	1962
Trichlorex	Lannett	U.S.	1980
Achletin	Toyama	Japan	—
Aitruran	Horita	Japan	—
Anatran	Tobishi	Japan	—
Anistadin	Maruko	Japan	—
Aponorin	Kodama	Japan	—
Carvacron	Taiyo	Japan	—
Chlopolidine	Tsuruhara	Japan	—
Cretonin	Hokuriku	Japan	—
Diu-Hydrin	Darby	U.S.	—
Diurese	Amer. Urologicals	U.S.	—
Flutoria	Towa	Japan	—
Hidroalogen	Bicsa	Spain	—
Intromene	Teikoku	Japan	—

Trade Name	Manufacturer	Country	Year Introduced
Naquival	Schering	U.S.	—
Nydor	Taro	Israel	—
Pluvex	Firma	Italy	—
Polynease	Sawai	Japan	—
Sanamiron	Zensei	Japan	—
Schebitran	Nichiiko	Japan	—
Tachionin	San-A	Japan	—
Tolcasone	Toho	Japan	—
Trametol	Green Cross	Japan	—
Triazide	Legere	U.S.	—
Trichloridiuride	Formenti	Italy	—
Tricloretec	Irifi	Italy	—
Triflumen	Serono	Italy	—

Raw Materials

5-Chloro-2,4-disulfamylaniline
Dichloroacetaldehyde

Manufacturing Process

A mixture of 5.7 grams (0.02 mol) of 5-chloro-2,4-disulfamylaniline and 4.9 grams (0.04 mol) of dichloroacetaldehyde in 25 ml of dimethyl formamide was heated at the boiling temperature and under reflux for 30 minutes. The reaction mixture was thereafter poured into a mixture of ice and water to precipitate the desired 6-chloro-7-sulfamyl-3-dichloro-methyl-3,4-dihydro-1,2,4-benzothiadiazine-1,1-dioxide as a crystalline solid melting at 250° to 270°C with decomposition.

References

Merck Index 9437
Kleeman & Engel p. 917
PDR pp. 1033, 1230, 1605, 1634
OCDS Vol. 1 p. 359 (1977)
I.N. p. 974
REM p. 941
Close, W.J.; U.S. Patent 3,264,292; August 2, 1966; assigned to Abbott Laboratories

TRICLOBISONIUM CHLORIDE

Therapeutic Function: Topical antiseptic (vaginal)

Chemical Name: N,N,N',N'-tetramethyl-N,N'-bis[1-methyl-3-(2,2,6-trimethylcyclohexyl)propyl]-1,6-hexanediaminium dichloride

Common Name: —

Structural Formula:

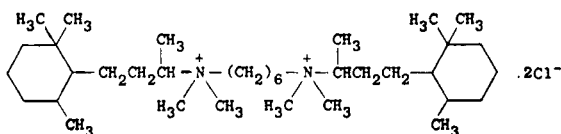

Chemical Abstracts Registry No.: 79-90-3

Trade Name	Manufacturer	Country	Year Introduced
Triburon	Roche	U.S.	1959

Raw Materials

cis-Tetrahydroionone	1,6-Hexanediamine
Hydrogen	Formic acid
Formaldehyde	Methyl chloride

Manufacturing Process

To a solution of 49 grams (0.25 mol) of cis-tetrahydroionone and 14.1 grams (0.12 mol) of 1,6-hexanediamine in 150 ml of ethanol was added 1 teaspoon of Raney nickel. The volume was adjusted to 300 ml with ethanol and the mixture was hydrogenated at 50°C and a pressure of 200 psi. The catalyst was filtered off, the filtrate was concentrated and the residual oil fractionated in vacuo to obtain N,N'-bis[1-methyl-3-(2,2,6-trimethylcyclohexyl)propyl]-1,6-hexanediamine; BP 192° to 202°C at 0.02 mm.

To 217 grams (0.456 mol) of N,N'-bis[1-methyl-3-(2,2,6-trimethylcyclohexyl)propyl]-1,6-hexanediamine were added 182 ml (3.04 mols) of formic acid (90%). The resulting colorless solution was cooled, then 91.3 ml (1.043 mols) of formaldehyde (37%) were added. The solution was heated at steam temperature with occasional shaking for 2 hours and then refluxed for 8 hours. The volatiles were distilled off at steam temperature under water vacuum and the residual oil was made strongly alkaline with 50% potassium hydroxide. The reaction product was extracted with ether. The ether extract was washed with water, dried and concentrated in vacuo. The residual oil was fractionated in vacuo to obtain N,N'-bis[1-methyl-3-(2,2,6-trimethylcyclohexyl)propyl]-N,N'-dimethyl-1,6-hexanediamine, BP_{0.4} 230° to 240°C, n_D²⁶ = 1.4833. An aliquot, when treated with an ethanolic hydrogen chloride, gave the crystalline dihydrochloride, MP 183° to 185°C (recrystallized from ethanollacetonitrile).

To 5 grams of N,N'-bis[1-methyl-3-(2,2,6-trimethylcyclohexyl)propyl]-N,N'-dimethyl-1,6-hexanediamine dissolved in 100 ml of methanol, at 4°C, were added 100 ml methanol containing 10 grams of methyl chloride. The solution was heated in a closed vessel at 60°C for 15 hours. The colorless solution was concentrated and the resulting white solid crystallized from ethanollacetonitrile-ether to obtain N,N'-bis[1-methyl-3-(2,2,6-trimethylcyclohexyl)propyl]-N,N'-dimethyl-1,6-hexanediamine bis(methochloride) hemihydrate.

References

Merck Index 9465

I.N. p. 975

Goldberg, M.W. and Teitel, S.; U.S. Patent 3,064,052; November 13, 1962; assigned to Hoffmann-La Roche Inc.

TRICLOCARBAN

Therapeutic Function: Disinfectant

Chemical Name: N-(4-Chlorophenyl)-N'-(3,4-dichlorophenyl)urea

Common Name: Trichlorocarbanilid

Structural Formula:

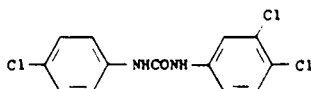

Chemical Abstracts Registry No.: 101-20-2

Trade Name	Manufacturer	Country	Year Introduced
Cutisan	Innothera	France	1960
Procutene	Bouty	Italy	1968
Nobacter	Innothera	France	—
Septivon-Lavril	Clin Midy	France	—
Solubacter	Innothera	France	—
Trilocarban	Armour-Montagu	France	—

Raw Materials

3,4-Dichloroaniline
4-Chlorophenyl isocyanate

Manufacturing Process

To a suitable reaction vessel equipped with a thermometer, agitator and reflux condenser and containing 8.1 parts by weight (substantially 0.05 mol) of 3,4-dichloroaniline in approximately 57 parts by weight of diethyl ether is added dropwise a solution of 7.7 parts by weight (substantially 0.05 mol) of 4-chlorophenyl isocyanate in approximately 15 parts by weight of diethyl ether at such a rate so as to maintain gentle reflux. Upon completion of the isocyanate addition the reaction mass is agitated for about one hour. The mass is filtered and the residue washed with diethyl ether. The dried product is a white fluffy solid which on recrystallization from ethanol gives fine white plates of 4,3',4'-trichlorocarbanilide, melting point 255.2°C to 256.0°C (88.0% yield).

References

Merck Index 9466

Kleeman & Engel p. 918

I.N. p. 975

Beaver, D.J. and Stoffel, P.J.; U.S. Patent 2,818,390; December 31, 1957; assigned to Monsanto Chemical Co.

TRICLOFOS SODIUM

Therapeutic Function: Sedative, hypnotic

Chemical Name: 2,2,2-trichloroethanol dihydrogen phosphate monosodium salt

Common Name: Trichloroethyl phosphate monosodium salt

Structural Formula:

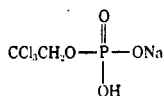

Chemical Abstracts Registry No.: 7246-20-6; 306-52-5 (Base)

Trade Name	Manufacturer	Country	Year Introduced
Triclos	Merrell National	U.S.	1972
Tricloran	C.T.S.	Israel	—
Tricloryl	Glaxo	U.K.	—

Raw Materials

Trichloroethanol
Phosphorus oxychloride
Sodium carbonate

Manufacturing Process

Trichloroethanol (500 grams) and phosphorus oxychloride (510 grams) were added to dry diethyl ether (3.5 liters) and stirred at 10°C with ice/water cooling. Dry pyridine (270 ml) was added dropwise over 1 hour, maintaining the temperature below 25°C. The resulting suspension was stirred for a further 1 hour and then stood at 0°C overnight. The pyridine hydrochloride was removed by filtration and washed with diethyl ether (2 x 300 ml) and dried in vacuo over P₂O₅ to give 380 grams.

The ether filtrate and washings were evaporated at room temperature under reduced pressure to give a clear liquid residue (801 grams). This residue was distilled under high vacuum to give trichloroethyl phosphorodichloridate (556 grams, 62.4% of theory), boiling point 75°C/0.8 mm.

The phosphorodichloridate was hydrolyzed by adding to a stirred solution of sodium carbonate (253 grams) in water (2.9 liters). After 1 hour the solution was cooled and acidified with a solution of concentrated sulfuric acid (30 ml) in water (150 ml) and then extracted with a mixture of tetrahydrofuran and chloroform (2.3/1; 3 x 1 liter). The tetrahydrofuran/chloroform liquors were bulked and evaporated to dryness to give a light brown oil. This was dissolved in water (1 liter) and titrated with 2 N sodium hydroxide solution to a pH of 4.05 (volume required 930 ml). The aqueous solution was clarified by filtration through kieselguhr and then evaporated under reduced pressure to a syrup (737 grams).

Hot acetone (4.5 liters) was added to this syrup and the clear solution stood at room temperature for 2 hours and then at 0°C overnight. The white crystalline solid was filtered off, washed with acetone (2 x 400 ml) and dried at 60°C in vacuo to give sodium trichloroethyl hydrogen phosphate (414 grams, 49.3% of theory from trichloroethanol).

References

Merck Index 9469

Kleeman & Engel p. 918

I.N. p. 975

Hems, B.A., Arkley, V., Gregory, G.I., Webb, G.B., Elks, J. and Tomich, E.G.; U.S. Patent 3,236,920; February 22, 1966; assigned to Glaxo Laboratories Limited, England

TRIDIHETHYL IODIDE

Therapeutic Function: Anticholinergic

Chemical Name: γ -Cyclohexyl-N,N,N-triethyl- γ -hydroxybenzene-propanaminium iodide

Common Name: Propethonium iodide; tridihexethide

Structural Formula:

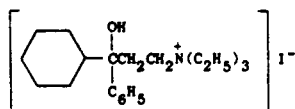

Chemical Abstracts Registry No.: 125-99-5

Trade Name	Manufacturer	Country	Year Introduced
Pathilon	Burroughs Wellcome	U.S.	1955
Duosetil	Dessy	Italy	—

Raw Materials

Acetophenone	Paraformaldehyde
Diethylamine	Magnesium
Cyclohexyl bromide	Ethyl iodide

Manufacturing Process

Acetophenone, paraformaldehyde and diethylamine are first reacted to give ω -diethylamino-propiofenone. That is reacted with cyclohexylmagnesium bromide to give 3-diethylamino-1-cyclohexyl-1-phenylpropanol-1.

To 1,320 parts of methyl isobutyl ketone is added 570 parts of 3-diethylamino-1-cyclohexyl-1-phenylpropanol-1 (2 mols) and the mixture is stirred until solution is complete. Then 500 parts (3.2 mols or 60% excess) of ethyl iodide are added. After filtration, the filtrate is diluted with an additional 300 parts of methyl isobutyl ketone and the solution is then heated at the reflux temperature (108°C to 110°C) for 9 hours. After cooling to 0°C, the precipitated solid material is removed by filtration, washed with isopropyl acetate and dried. Approximately 777 parts of product is obtained or a yield of 88.6% based on as-is starting material or 92.5% based on real starting material.

References

Merck Index 9474

Kleeman & Engel p. 918

I.N. p. 976

REM p. 919

Lobby, J.; U.S. Patent 2,913,494; November 17, 1959; assigned to American Cyanamid Co.

TRIETHYLENEMELAMINE

Therapeutic Function: Antineoplastic

Chemical Name: 2,4,6-Tris(1-aziridinyl)-s-triazine

Common Name: Tretamine

Structural Formula:

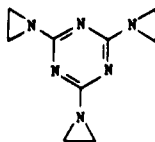

Chemical Abstracts Registry No.: 51-18-3

Trade Name	Manufacturer	Country	Year Introduced
Triethylene	Lederle	U.S.	1954
Triameline	I.C.I.	—	—

Raw Materials

Cyanuric chloride
Ethylene imine

Manufacturing Process

Cyanuric chloride (which may or may not contain the usual commercial impurities) is dispersed into ice water by stirring in a ratio of 18.8 g of cyanuric chloride to a mixture of 100 g of ice and 100 g of water. The slurry may conveniently be prepared directly in a 3-necked flask equipped with an agitator, dropping funnel, and thermometer. The temperature of the flask and contents is maintained within the range of 2°C to 5°C, with an ice-salt mixture. A solution of ethylenimine in an aqueous solution of potassium carbonate prepared in the proportions of 14 g ethylenimine, 44.5 g potassium carbonate, and 150 g of water, is added dropwise to the cyanuric chloride slurry. The reaction solution is then clarified with a little activated charcoal, filtered, and extracted with chloroform. Despite the fact that triethylenemelamine is more soluble in water than in chloroform, in a two-phase system (water-chloroform) nearly 75% of the triethylenemelamine is distributed in the chloroform, and hence a few extractions with that solvent suffice to separate the material from the original reaction medium. Five extractions with 50 ml portions of chloroform gave 19 g of product, and an additional 3 extractions with 25 ml portions gave 0.5 g, a total yield of 95.7%. The product obtained by evaporating such an extract is a white microcrystalline powder.

References

Merck Index 9481

I.N. p. 970

Wystrach, V.P. and Kaiser, D.W.; U.S. Patent 2,520,619; August 29, 1950; assigned to American Cyanamid Co.

TRIFLUOPERAZINE

Therapeutic Function: Tranquilizer

Chemical Name: 10-[3-(4-methylpiperazin-1-yl)propyl]-2-trifluoromethylphenothiazine

Common Name: Triftazin; triphthasine

Structural Formula:

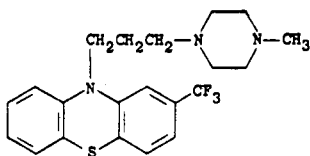

Chemical Abstracts Registry No.: 117-89-5; 440-17-5 (Dihydrochloride)

Trade Name	Manufacturer	Country	Year Introduced
Stelazine	SKF	U.S.	1958
Terfluzine	Theraplix	France	1962
Triazine	Cord	U.S.	1981
Calmazine	Protea	Australia	—
Chemflurazine	Chemo-Drug	Canada	—
Dymoperazine	Dymond	Canada	—
Flurazine	Taro	Israel	—

Trade Name	Manufacturer	Country	Year Introduced
Jatroneural	Rohm	W. Germany	—
Modalina	Maggioni	Italy	—
Normaln P	Sawai	Japan	—
Novoflurazine	Novopharm	Canada	—
Pentazine	Pentagone	Canada	—
Sedizine	Trima	Israel	—
Solazine	Horner	Canada	—
Telazin	Dinzel	Turkey	—
Terflurazine	Lennon	S. Africa	—
Tranquis	Sumitomo	Japan	—
Trifluoper-Ez-Ets	Barlow Cote	Canada	—
Triflurin	Paul Maney	Canada	—

Raw Materials

2-Trifluoromethylphenothiazine
Sodium amide
1-(3'-Chloropropyl)-4-methylpiperazine

Manufacturing Process

A mixture of 17.2 grams of 2-trifluoromethylphenothiazine, 3.1 grams of sodamide and 14 grams of 1-(3'-chloropropyl)-4-methylpiperazine in 200 ml of xylene is heated at reflux for 2 hours. The salts are extracted into 150 ml of water. The xylene layer is then extracted with several portions of dilute hydrochloric acid. The acid extracts are combined and neutralized with ammonium hydroxide solution. The product, 10-[3'-(4"-methyl-1"-piperazinyloxy)propyl]-2-trifluoromethylphenothiazine, is taken into benzene and purified by vacuum distillation, BP 202° to 210°C at 0.6 mm.

References

Merck Index 9489
Kleeman & Engel p. 919
PDR pp. 1606, 1723, 1999
DOT 9 (6) 228 (1973)
I.N. p. 976
REM p. 1091
Ulliyot, G.E.; U.S. Patent 2,921,069; January 12, 1960; assigned to Smith Kline & French Laboratories

α,α,α -TRIFLUOROTHYMIDINE

Therapeutic Function: Antiviral (ophthalmic)

Chemical Name: 2'-Deoxy-5-(trifluoromethyl)uridine

Common Name: Trifluridine

Structural Formula:

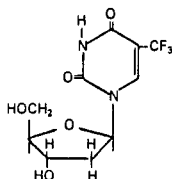

Chemical Abstracts Registry No.: 70-00-8

Trade Name	Manufacturer	Country	Year Introduced
Trifluorothymidine	Mann	W. Germany	1975
Bephen	Thilo	W. Germany	—
Triherpine	Dispersa	Switz.	—
Viroptic	Burroughs-Wellcome	U.S.	—

Raw Materials

3',5'-Bis-O-(p-nitrobenzoyl)-2'-deoxy-5-(trifluoromethyl)uridine
Diisopropylamine

Manufacturing Process

A suspension of 4.00 g (6.75 mmol) of 3',5'-bis-O-(p-nitrobenzoyl)-2'-deoxy-5-(trifluoromethyl)uridine in 250 ml of methanol was treated with 10 ml of diisopropylamine and refluxed until it had dissolved (about 18 minutes), and the solution was concentrated. The dry residue was partitioned between 50 ml of chloroform and 50 ml of water. The chloroform layer was washed with 20 ml of water, and the combined aqueous layers were concentrated. A low ultraviolet extinction (ϵ 7200 and 262 m μ ; pH 1) and the presence of isopropyl signals in the NMR spectrum (two singlets at γ 8.73 and 8.85) indicated the dry residue contained diisopropylamine, probably as a salt with the relatively acidic heterocyclic N—H in 14.

A solution in 75 ml of water was treated with 8 ml (volume of resin) of Dowex 50 (H), pre-washed with water and methanol. The resin was removed on a filter and washed with 25 ml of methanol and 50 ml of water. The combined filtrate was evaporated in vacuo to form 1.99 g of 2'-deoxy-4-(trifluoromethyl)uridine (100%), melting point 171°C to 175°C.

References

DFU 5 (11) 561 (1980)

Kleeman & Engel p. 921

PDR p. 768

DOT 16 (12) 430 (1980)

I.N. p. 977

REM p. 1232

Heidelberger, C.; U.S. Patent 3,201,387; August 17, 1965; assigned to the U.S. Secretary of Health, Education and Welfare

Ryan, K.J., Acton, E.M. and Goodman, L.; U.S. Patent 3,531,464; September 29, 1970; assigned to the U.S. Secretary of Health, Education and Welfare

TRIFLUPROMAZINE

Therapeutic Function: Tranquillizer

Chemical Name: N,N-Dimethyl-2-(trifluoromethyl)-10H-phenothiazine-10-propanamine

Common Name: Fluopromazine

Structural Formula:



Chemical Abstracts Registry No.: 146-54-3; 1098-60-8 (Hydrochloride)

Trade Name	Manufacturer	Country	Year Introduced
Vesprin	Squibb	U.S.	1957
Psyquil	Squibb	France	1970
Fluomazina	Firma	Italy	—
Fluorofen	Savio	Italy	—
Nivoman	Heyden	W. Germany	—
Siquil	Iquinosa	Spain	—

Raw Materials

2-Trifluoromethylphenothiazine
Sodium amide
3-Chloro-1-dimethylaminopropane

Manufacturing Process

Approximately 3.8 grams of sodamide is freshly prepared from 2.25 grams of sodium, 90 grams of liquid ammonia and a catalytic trace of ferric nitrate. The ammonia is allowed to evaporate. A solution of 19.1 grams of 2-trifluoromethylphenothiazine (prepared by the Bernthsen thionation of 3-trifluoromethyldiphenylamine) in 160 ml of dry benzene is added to the reaction flask followed by 18 grams of 3-chloro-1-dimethylaminopropane. The reaction mixture is heated at reflux for 20 hours. After washing the cooled mixture with 130 ml of water, the organic layer is extracted with several portions of dilute hydrochloric acid. The acid extracts are combined and neutralized with ammonium hydroxide solution. The oily free base is extracted into benzene and purified by distillation to give 19.6 grams of 10-(3'-dimethylaminopropyl)-2-trifluoromethylphenothiazine, boiling point 177° to 181°C at 1 mm. The free base (7 grams) is converted to the hydrochloride salt by reacting an alcoholic solution of the base with hydrogen chloride gas. Evaporation of the volatiles in vacuo leaves an amorphous solid which is recrystallized from ethanol/ether to pink crystals, MP 173° to 174°C, the hydrochloride salt of the free base prepared above.

References

Merck Index 9492

Kleeman & Engel p. 920

OCDS Vol. 1 p. 380 (1977)

I.N. p. 977

REM p. 1092

Ulliot, G.E.; U.S. Patent 2,921,069; January 12, 1960; assigned to Smith Kline & French Laboratories

TRIHXYPHENIDYL HYDROCHLORIDE

Therapeutic Function: Antiparkinsonian

Chemical Name: α -cyclohexyl- α -phenyl-1-piperidinepropanol hydrochloride

Common Name: Benzhexol chloride

Structural Formula:

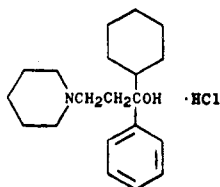

Chemical Abstracts Registry No.: 52-49-3; 144-11-6 (Base)

Trade Name	Manufacturer	Country	Year Introduced
Artane	Lederle	U.S.	1949
Pipanol	Winthrop	U.S.	1952
Tremin	Schering	U.S.	1964
Antitrem	Roerig	U.S.	1974
Anti-Spas	Protea	Australia	—
Aparkan	Chinoin	Hungary	—
Aparkane	I.C.N.	Canada	—
Broflex	Bio-Medical	U.K.	—
Novohexidyl	Novopharm	Canada	—
Paralest	Pharmachemie	Neth.	—
Pargitan	Kabi Vitrum	Sweden	—
Parkinane	Lederle	France	—
Parkopan	Fahlberg-List	E. Germany	—
Partane	Taro	Israel	—
Peragit	Gea	Denmark	—
Pyramistin	Yamanouchi	Japan	—
Rodenal	Abic	Israel	—
Sedrena	Daiichi	Japan	—
Trihexane	Darby	U.S.	—
Trihexy	Barlow Cote	Canada	—
Triphedinon	Toho	Japan	—

Raw Materials

Acetophenone	Paraformaldehyde
Piperidine	Cyclohexyl bromide
Magnesium	Hydrogen chloride

Manufacturing Process

Acetophenone, paraformaldehyde and piperidine are first reacted to give ω -(1-piperidyl)propiophenone.

To an absolute ethyl ether solution of cyclohexylmagnesium bromide (prepared from 261 parts of cyclohexyl bromide, 38.8 parts magnesium turnings and 700 parts by volume absolute ethyl ether) a dry solution of 174 parts omega-(1-piperidyl)propiophenone in 600 parts by volume of ether is added, with stirring, at such a rate that gentle reflux is maintained with no external cooling or heating. The reaction mixture is stirred for about 5 hours and then allowed to stand at room temperature until reaction appears complete. While being cooled the reaction mixture is then decomposed by the dropwise addition of 500 parts by volume of 2.5 N hydrochloric acid, and finally is made strongly acidic to Congo red by the addition of concentrated hydrochloric acid.

The resulting white solid is collected on a filter, air dried, redissolved in 2,500 parts water at 95°C and the resulting solution treated with decolorizing charcoal and clarified by filtration. The cooled filtrate is made alkaline with ammonia and the product, crude 3-(1-piperidyl)-1-cyclohexyl-1-phenyl-1-propanol is collected. The hydrochloride melts with decomposition in ten seconds in a bath held at 258.5°C. The alcohol melts at 114.3° to 115.0°C, according to U.S. Patent 2,716,121.

References

- Merck Index 9501
- Kleeman & Engel p. 921
- PDR p. 830
- OCDS Vol. 1 p. 47 (1977)
- DOT 9 (6) 247 (1973)

I.N. p. 978

REM p. 931

Adamson, D.W. and Wilkinson, S.; U.S. Patent 2,682,543; June 29, 1954; assigned to Burroughs Wellcome & Co. (U.S.A.) Inc.

Denton, J.J.; U.S. Patent 2,716,121; August 23, 1955; assigned to American Cyanamid Co.

TRILOSTANE

Therapeutic Function: Corticosteroid antagonist

Chemical Name: 2 α -Cyano-4 α ,5 α -epoxyandrostan-17 β -ol-3-one

Common Name: —

Structural Formula:

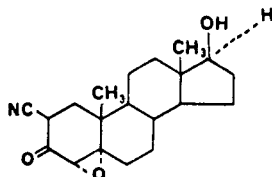

Chemical Abstracts Registry No.: 13647-35-3

Trade Name	Manufacturer	Country	Year Introduced
Modrenal	Sterling Winthrop	U.K.	1980
Winstan	Winthrop	W. Germany	1982

Raw Materials

17 β -Acetoxy-4-androsteno[2,3-d]isoxazole
 Maleic anhydride
 Hydrogen peroxide
 Sodium methoxide

Manufacturing Process

(A) 17 β -acetoxy-4 α ,5 α -epoxyandrostan-2,3-d]isoxazole, melting point 228.6°C to 229.8°C (corrected) recrystallized from a benzene-methanol mixture, [α]_D²⁵ = +76.5°C (1% in chloroform), was prepared by treating 17 β -acetoxy-4-androsteno[2,3-d]isoxazole with maleic anhydride and hydrogen peroxide in methylene dichloride solution.

(B) 2 α -cyano-4 α ,5 α -epoxyandrostan-17 β -ol-3-one was prepared by treating 17 β -acetoxy-4 α ,5 α -epoxyandrostan-2,3-d]isoxazole with sodium methoxide, and was obtained in the form of tan crystals, melting point 257.8°C to 270.0°C (decomposition) (corrected) when recrystallized from a pyridine-dioxane mixture.

References

Merck Index 9505

DFU 6 (8) 494 (1981)

OCDS Vol. 2 p. 158 (1980)

DOT 17 (5) 203 (1981)

I.N. p. 979

Clinton, R.O. and Manson, A.J.; U.S. Patent 3,296,255; January 3, 1967; assigned to Sterling Drug, Inc.

TRIMEPRAZINE

Therapeutic Function: Antipruritic

Chemical Name: N,N, β -Trimethyl-10H-phenothiazine-10-propanamine

Common Name: Alimemazine

Structural Formula:



Chemical Abstracts Registry No.: 84-96-8

Trade Name	Manufacturer	Country	Year Introduced
Temaril	SKF	U.S.	1958
Theralene	Theraplix	France	1958
Alimezine	Daiichi	Japan	—
Nedeltran	Bournonville	Belgium	—
Panectyl	Rhone-Poulenc	Canada	—
Repeltil	Bayer	W. Germany	—
Vallergan	May & Baker	U.K.	—
Variargil	Rhodia Iberica	Spain	—

Raw Materials

Phenothiazine
Sodium amide
1-Chloro-2-methyl-3-dimethylaminopropane

Manufacturing Process

95% sodamide (2.77 grams) is added to a solution of phenthiazine (9.6 grams) in xylene (140 cc) at a temperature of 130°C and the mixture is heated with reflux for 2 hours.

A 0.61 N solution (90 cc) of 1-chloro-2-methyl-3-dimethylaminopropane in xylene is then added over 50 minutes and heating with reflux is continued for 20 hours. After cooling, the mixture is treated with water (40 cc) and N methanesulfonic acid (70 cc). The aqueous layer is washed with ether, treated with aqueous sodium hydroxide (density = 1.33; 10 cc) and extracted with ether.

The extract is dried over potassium carbonate and evaporated and the residue is distilled in vacuo. 3-(10-phenthiazinyl)-2-methyl-1-dimethylaminopropane (12.6 grams) is collected, distilling between 150° and 175°C under a pressure of about 0.3 mm Hg. By dissolving this base in acetone and adding ethereal hydrogen chloride, a hydrochloride is obtained, MP 216° to 217°C.

References

Merck Index 9510
Kleeman & Engel p. 25
PDR p. 1727
OCDS Vol. 1 p. 378 (1977)
I.N. p. 55
REM p. 1130
Jacob, R.M. and Robert, J.G.; U.S. Patent 2,837,518; June 3, 1958; assigned to Societe des Usines Chimiques Rhone-Poulenc, France

TRIMETAZIDINE

Therapeutic Function: Coronary vasodilator

Chemical Name: 1-[(2,3,4-Trimethoxyphenyl)methyl] piperazine

Common Name: —

Structural Formula:

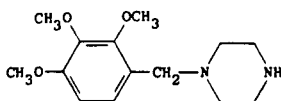

Chemical Abstracts Registry No.: 5011-34-7; 13171-25-0 (Dihydrochloride)

Trade Name	Manufacturer	Country	Year Introduced
Vastarel	Biopharma	France	1963
Cartoma	Ohta	Japan	—
Coronanyl	Toho	Japan	—
Hiwell	Toa Eiyo	Japan	—
Lubomanil	Maruko	Japan	—
Sainosine	Nippon Chemiphar	Japan	—
Trimeperad	Kotobuki	Japan	—
Vassarin-F	Taiyo	Japan	—
Vastazin	Takeda	Japan	—
Yosimilon	Kowa Yakuhin	Japan	—

Raw Materials

2,3,4-Trimethoxybenzyl chloride
1-Formylpiperazine
Sodium carbonate

Manufacturing Process

Monoformylpiperazine is reacted molecule for molecule with 2,3,4-trimethoxybenzyl chloride in the presence of 1½ molecules of sodium carbonate and in suspension in ethyl alcohol, during 2 to 3 hours.

The reaction product is filtered and the filtrate is evaporated in vacuo to remove the alcohol. There remains an oily product from which the excess formyl-ethylenediamine is removed by distillation under 1 mm Hg pressure up to 125°C. The dark yellow, residual product is treated with 10% hydrochloric acid at 100°C for 12 hours to eliminate the formyl group; it is evaporated to a syrupy consistency and taken up with ethyl alcohol at the boiling point until complete miscibility is attained; it is then discolored over carbon, filtered and stored at low temperature.

The (2,3,4-trimethoxyphenyl)methylpiperazine hydrochloride precipitates as white needles; the precipitate is drained and washed with anhydrous sulfuric ether. Melting point: 222°C to 226°C.

References

Merck Index 9511
Kleeman & Engel p. 922
I.N. p. 980
Servier, J.; U.S. Patent 3,262,852; July 26, 1966; assigned to Biofarma S.A. (France)

TRIMETHADIONE

Therapeutic Function: Anticonvulsant

Chemical Name: 3,5,5-trimethyl-2,4-oxazolinedione

Common Name: Troxidone

Structural Formula:

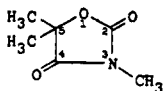

Chemical Abstracts Registry No.: 127-48-0

Trade Name	Manufacturer	Country	Year Introduced
Tridione	Abbott	U.S.	1946
Trimethadione	Abbott	France	1960
Absentol	Nourypharma	Neth.	—
Epidione	Roger Bellon	France	—
Mino-Aleviatin	Dainippon	Japan	—
Trioxanona	Bama-Geve	Spain	—

Raw Materials

Ethyl α -hydroxyisobutyrate	Urea
Sodium	Methyl iodide
Ethanol	

Manufacturing Process

To a cooled solution of 23 parts of sodium in 400 parts of dry ethanol are added 60 parts of dry urea and 132 parts of ethyl α -hydroxy-isobutyrate. The mixture is heated on a steam bath under reflux for about 16 hours and the liberated ammonia is removed from the solution by drawing a current of dry air through it at the boiling point. The solution of the sodium salt of 5,5-dimethyl-oxazolidine-2,4-dione so obtained is cooled and treated with 284 parts of methyl iodide. The mixture is allowed to stand at room temperature for 3 days, excess methyl iodide and ethanol are then removed by distillation under reduced pressure.

The residue is dissolved in ether and the solution is washed with sodium chloride solution and then with a little sodium thiosulfate solution. The ethereal solution is dried over sodium sulfate and ether removed by distillation. A yield of 108 parts of 3,5,5-trimethyl-oxazolidine-2,4-dione is obtained having a melting point of 45° to 46°C with slight softening at 43°C. This represents a 75% theory yield on the ethyl α -hydroxy-iso-butyrate taken. The product may be further purified by dissolving the minimum quantity of dry ether and cooling to -10°C. The product so obtained melts sharply at 45.5° to 46.5°C, according to U.S. Patent 2,559,011.

References

- Merck Index 9512
- Kleeman & Engel p. 922
- PDR p. 554
- OCDS Vol. 1 p. 232 (1977)
- I.N. p. 980
- REM p. 1082

Davies, J.S.H. and Hook, W.H.; U.S. Patent 2,559,011; July 3, 1951; assigned to British Schering Research Laboratories Limited, England
 Spielman, M.A.; U.S. Patent 2,575,692; November 20, 1951; assigned to Abbott Laboratories

TRIMETHOBENZAMIDE HYDROCHLORIDE

Therapeutic Function: Antinauseant

Chemical Name: N-[(2-dimethylaminoethoxy)benzyl]-3,4,5-trimethoxybenzamide hydrochloride

Common Name: —

Structural Formula:

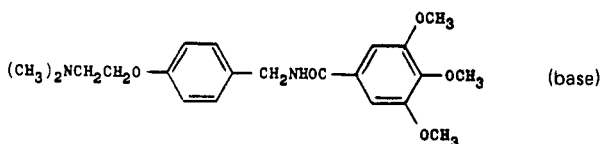

Chemical Abstracts Registry No.: 554-92-7; 138-56-7 (Base)

Trade Name	Manufacturer	Country	Year Introduced
Tigan	Beecham	U.S.	1973
Hymetic	Hyrex	U.S.	1983
Ticon	Hauck	U.S.	1983
Ametik	Lafar	Italy	—
Anaus	Molteni	Italy	—
Anti-Vomit	Deva	Turkey	—
Contrauto	Aterni	Italy	—
Emedur	Dif-Dogu	Turkey	—
Ibikin	I.B.P.	Italy	—
Kantern	Kansuk	Turkey	—
Poligerim	Biotifar	Portugal	—
Stemetic	Legere	U.S.	—
Xametina	Zambeletti	Italy	—

Raw Materials

p-Hydroxybenzaldehyde	Sodium methoxide
2-Dimethylaminoethyl chloride	Hydrogen
3,4,5-Trimethoxybenzoyl chloride	

Manufacturing Process

To 122 grams (1 mol) of p-hydroxybenzaldehyde in 1 liter of chlorobenzene were added 66 grams (1.04 mols) of sodium methoxide (85%) and 108 grams (1 mol) of 2-dimethylaminoethyl chloride. The mixture was stirred and refluxed for 15 hours, then cooled and the precipitated sodium chloride filtered off. The filtrate was concentrated at steam temperature under water vacuum and the residual oil was fractionated in high vacuum, to give 4-(2-dimethylaminoethoxy)benzaldehyde, BP_{2,2} 145°C.

Two teaspoons of Raney nickel catalyst were added to a solution of 65.6 grams (0.34 mol) of 4-(2-dimethylaminoethoxy)benzaldehyde in 300 ml of 10% ammoniacal ethanol. The

mixture was hydrogenated at 80°C and a pressure of 1,000 psi. The catalyst was filtered off, the volatiles were distilled off and the residual oil was fractionated in high vacuum, to obtain 4-(2-dimethylaminoethoxy)benzylamine, BP_{0,3} 120° to 123°C.

To 9.7 grams (0.05 mol) of 4-(2-dimethylaminoethoxy)benzylamine, dissolved in 100 ml of acetonitrile, was added all at once 12 grams (0.051 mol) of 3,4,5-trimethoxybenzoyl chloride, dissolved in 75 ml of acetonitrile. The mixture was stirred and refluxed for 8 hours, and then cooled. The crystalline solid, which had formed, was filtered off, washed with acetonitrile and recrystallized from acetonitrile, to give 4-(2-dimethylaminoethoxy)-N-(3,4,5-trimethoxybenzoyl)benzylamine hydrochloride, MP 185° to 186°C.

References

Merck Index 9515

Kleeman & Engel p. 923

PDR pp. 665, 1033, 1606

OCDS Vol. 1 p. 110 (1977)

I.N. p. 980

REM p. 810

Goldberg, M.W. and Teitel, S.; U.S. Patent 2,879,293; March 24, 1959; assigned to Hoffmann-La Roche Inc.

TRIMETHOPRIM

Therapeutic Function: Antibacterial (urinary)

Chemical Name: 5-[(3,4,5-trimethoxyphenyl)methyl]-2,4-pyrimidinediamine

Common Name: —

Structural Formula:

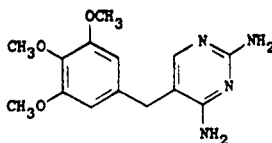

Chemical Abstracts Registry No.: 738-70-5

Trade Name	Manufacturer	Country	Year Introduced
Eusaprim	Wellcome	Italy	1970
Bactrim	Roche	Italy	1970
Baktar	Shionogi	Japan	1976
Ipral	Squibb	U.K.	1979
Trimopam	Berk	U.K.	1979
Trimanyl	Tosse	W. Germany	1980
Syraprim	Wellcome	U.K.	1980
Proloprim	Burroughs Wellcome	U.S.	1980
Trimplex	Roche	U.S.	1980
Wellcoprim	Wellcome	France	1981
Trimopan	Farmitalia	Italy	1982
Monotrim	Gea	Switz.	1983
Cistal	Gamir	Spain	—
Comoxol	Squibb	U.S.	—
Cotrim	Lemmon	U.S.	—

Trade Name	Manufacturer	Country	Year Introduced
Idotrim	Ferrosan	Denmark	—
Oratrim	Medica	Finland	—
Proloprim	Calmic	Canada	—
Septra	Burroughs Wellcome	U.S.	—
Tiempe	D.D.S.A.	U.K.	—
Trimanyl	Gea	Denmark	—
Trimecur	Leiras	Finland	—
Trimfect	Neofarma	Finland	—
Trimplex	Roche	U.S.	—
Tripriam	Berk	U.K.	—

Raw Materials

β -Methoxypropionitrile	Sodium
3,4,5-Trimethoxybenzaldehyde	Guanidine

Manufacturing Process

6 grams (0.26 mol) sodium was dissolved in 300 ml methanol under stirring and refluxing. 47.5 grams (0.55 mol) β -methoxypropionitrile and 98 grams (0.5 mol) 3,4,5-trimethoxybenzaldehyde were added and the mixture refluxed gently for 4 hours. The mixture was then chilled and 150 ml of water was added. The product crystallized rapidly. Crystallization was allowed to proceed at 5° to 10°C under stirring for 1 hour. The product was filtered by suction and washed on the filter with 200 ml of 60% ice cold methanol. The crude material was air-dried and used for further steps without purification. It melted at 78° to 80°C. A pure sample, recrystallized from methanol, melted at 82°C. The yield of 3,4,5-trimethoxy-2'-methoxymethylcinnamionitrile was 92 grams, corresponding to 70% of the theory.

19 grams (0.83 mol) sodium was dissolved in 300 ml methanol, 106 grams of 3,4,5-trimethoxy-2'-methoxymethylcinnamionitrile was added and the mixture gently refluxed for 24 hours. The solution, which had turned brown, was poured into 1 liter of water and the precipitated oil extracted repeatedly with benzene. The combined benzene layers (500 to 700 ml) were washed 3 times with 500 ml of water, the benzene removed by evaporation in a vacuum from a water bath, and the brown residual oil distilled in vacuo, boiling point 215° to 225°C/11 mm. The clear, viscous oil, 3,4,5-trimethoxy-2'-cyano-dihydrocinnamaldehyde dimethyl acetal, weighed 83 grams (71% of the theory), and showed a $n_D^{23} = 1.5230$. It solidified upon standing. A sample recrystallized from methanol melted at 69° to 70°C and showed a strong melting point depression with the starting material; $n_D^{25} = 1.5190$.

31.5 grams (0.107 mol) 3,4,5-trimethoxy-2'-cyano-dihydrocinnamaldehyde dimethyl acetal was refluxed with methanolic guanidine solution (200 ml containing 0.25 mol of guanidine) for 2 hours. The methanol completely distilled off under stirring, finally from a bath of 110° to 120°C until the residue solidified completely to a yellowish crystalline mass. After allowing to cool, it was slurried with 100 ml of water and collected by vacuum filtration and dried. The yield of 2,4-diamino-5-(3,4,5-trimethoxybenzyl)pyrimidine amounted to 28 grams (91% of the theory). The material showed the correct melting point of 199° to 200°C and was, however, yellowish discolored.

20 grams of the above product was added to 30 ml of 3 N aqueous sulfuric acid at 60°C under stirring. The solution was chilled under stirring to 5° to 10°C. The crystalline sulfate was collected by vacuum filtration and washed on the filter twice with 10 ml of cold 3 N aqueous sulfuric acid each time. From the filtrate there was recovered 1.3 grams (6.5%) of discolored material melting at 195° to 196°C and which can be added to subsequent purification batches.

The sulfate on the filter was dissolved in 200 ml of hot water, the solution charcoaled hot, and the product precipitated from the clear colorless filtrate by the gradual addition of a

solution of 20 grams of sodium hydroxide in 40 ml of water under chilling. The precipitate was filtered by suction and washed thoroughly with water on the filter. The white material, 17.5 grams (88%) showed the correct melting point of 200° to 201°C, according to U.S. Patent 3,341,541.

References

Merck Index 9516

Kleeman & Engel p. 923

PDR pp. 673, 759, 830, 993, 1034, 1474, 1505, 1606, 1738

OCDS Vol. 1 p. 262 (1977) & 2, 302 (1980)

DOT 5 (3) 113 (1969); 12 (9) 377 (1976) & 16 (4) 128 (1980)

I.N. p. 980

REM p. 1215

Stanbuck, P. and Hood, H.M.; U.S. Patent 3,049,544; August 14, 1962; assigned to Burroughs Wellcome & Co. (U.S.A.) Inc.

Hoffer, M.; U.S. Patent 3,341,541; September 12, 1967; assigned to Hoffmann-La Roche Inc.

TRIMETOZINE

Therapeutic Function: Sedative

Chemical Name: 4-(3,4,5-Trimethoxybenzoyl)morpholine

Common Name: —

Structural Formula:

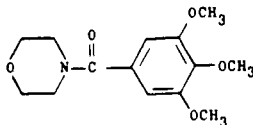

Chemical Abstracts Registry No.: 635-41-6

Trade Name	Manufacturer	Country	Year Introduced
Opalene	Theraplix	France	1966
Trioxazine	Labatec	Italy	1971

Raw Materials

3,4,5-Trimethoxybenzoyl chloride

Morpholine

Manufacturing Process

46 g 3,4,5-trimethoxybenzoyl chloride are dissolved in 300 ml anhydrous benzene and 25 g triethylamine and thereafter 19 g anhydrous morpholine are added in small portions with ice-cooling. The solution is boiled for 2 hours under reflux. The precipitate is filtered off, and the solution is washed with dilute sulfuric acid, then with sodium hydrogen carbonate solution and finally with water, and then evaporated. The residual yellow oil soon crystallizes; the crystalline mass of the desired material is taken up with ether, filtered and then recrystallized from 90% ethanol, from which it separates in prisms. It is slightly soluble in water. Yield: 80%, melting point 120°C to 122°C.

References

- Merck Index 9527
 Kleeman & Engel p. 927
 OCDS Vol. 2 p. 94 (1980)
 DOT 3 (3) 106 (1967)
 I.N. p. 981
 Egyesult Gyogyszer és Tapszer Gyar; British Patent 872,350; July 5, 1961

TRIOXSALEN

Therapeutic Function: Pigmentation enhancer

Chemical Name: 2,5,9-trimethyl-7H-furo[3,2-g] benzopyran-7-one

Common Name: 2',4,8-trimethylpsoralen

Structural Formula:

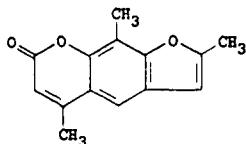

Chemical Abstracts Registry No.: 3902-71-4

Trade Name	Manufacturer	Country	Year Introduced
Trisoralen	Elder	U.S.	1965
Trisoralen	Santen	Japan	1969
Trisoralen	Farmochimica	Italy	1970
Trisoralen	Panpharma	Switz.	1981
Levrison	Rovi	Spain	—

Raw Materials

Ethyl acetoacetate	2-Methyl resorcinol
Allyl bromide	Acetic anhydride
Bromine	Sodium
Hydrogen chloride	

Manufacturing Process

(A) Preparation of 7-Hydroxy-4,8-Dimethylcoumarin: Chilled ethyl acetoacetate (157 ml, 1.20 mols) followed by 2-methyl-resorcinol (130 g, 1.04 mols) was dissolved in well-stirred concentrated sulfuric acid (600 ml) at such a rate as to keep the temperature below 10°C (ice bath). The stirred solution was allowed to warm gradually and after 3 hours was added to water (ca 8 liters) with mechanical stirring. The product was collected, washed twice with water, and dried at 70° to 80°C until the first sign of darkening. Yield 191.3 g (95.4%). Recrystallization from aqueous ethanol gave 7-hydroxy-4,8-dimethylcoumarin as colorless needles, MP 260.5° to 261°C. In dilute sodium hydroxide, the compound gives a yellow solution which exhibits blue fluorescence.

(B) Preparation of 7-Allyloxy-4,8-Dimethylcoumarin: 7-Hydroxy-4,8-dimethylcoumarin (191.3 g, 1.01 mols), anhydrous potassium carbonate (604 g, 4.37 mols), and allyl bromide (578 ml, 6.22 mols) were refluxed overnight in acetone (ca 3 liters) with mechanical stirring. The reaction mixture was concentrated nearly to dryness on a steam bath under re-

duced pressure, water (ca 8 liters) was added, and the product was collected by filtration. It was washed with 5% NaOH and water (ca 1.5-liter portions) and was dried in a vacuum desiccator. The dry solid was washed with petroleum ether (30° to 60°C) to remove excess allyl bromide. Removal of the petroleum ether under reduced pressure left 210.0 g (90.7% yield) of product. The 7-allyloxy-4,8-dimethylcoumarin was crystallized from aqueous ethanol as colorless needles, MP 108° to 109°C.

(C) Preparation of 6-Allyl-7-Hydroxy-4,8-Dimethylcoumarin: 7-Allyloxy-4,8-dimethylcoumarin (195.0 g, 0.84 mol) was heated (oil bath) to 215±4°C (reaction mixture temperature) for 3 hours and was then poured into absolute alcohol (ca 1.5 liters). Activated carbon (Norite) (19.5 g) was added, and the solution was heated to boiling, filtered, and diluted with excess water (ca 12 liters). The product was collected by filtration and partially dried at 70°C for 6 hours. 6-Allyl-7-hydroxy-4,8-dimethylcoumarin was obtained as pale yellow microcrystalline prisms, MP 166° to 168°C, by two recrystallizations from aqueous ethanol of a portion of the partially dried solid. The remaining partially dried solid was used in the next step.

(D) Preparation of 7-Acetoxy-6-Allyl-4,8-Dimethylcoumarin: A solution of the partially dried 6-allyl-7-hydroxy-4,8-dimethylcoumarin obtained in the previous step, acetic anhydride (915 ml, 9.7 mols) and fused sodium acetate (2 g) was refluxed for 4 hours and added to water (ca 8 liters) with mechanical stirring. After excess acetic anhydride had decomposed, the 7-acetoxy-6-allyl-4,8-dimethylcoumarin was collected by filtration, dried, and recrystallized from absolute alcohol, MP 144.5° to 145.5°C. Yield 145.4 g (63.8%, based on 7-allyloxy-4,8-dimethylcoumarin).

(E) Preparation of 7-Acetoxy-6-(2',3'-Dibromopropyl)-4,8-Dimethylcoumarin: 7-Acetoxy-6-allyl-4,8-dimethylcoumarin (145.4 g, 0.534 mol) was dissolved in chloroform (ca 800 ml). The stirred solution was cooled in an ice bath and bromine (85.2 g, 0.534 mol) in chloroform (200 ml) was added at such a rate as to keep the temperature below 25°C. Evaporation of chloroform on the steam bath left an off-white residue of the crude dibromide. Yield 230.6 g (quantitative). 7-Acetoxy-6-(2',3'-dibromopropyl)-4,8-dimethylcoumarin was crystallized from ethanol as colorless prisms, MP 141.5° to 142.5°C.

(F) Preparation of 2',4,8-Trimethylpsoralen: Crude 7-acetoxy-6-(2',3'-dibromopropyl)-4,8-dimethylcoumarin (245.7 g, 0.57 mol) was refluxed for 1½ hours with a stirred solution of sodium (65.4 g, 2.85 mols) in a magnesium-dried ethanol (2.1 liters). After standing at room temperature for 15 minutes, the reaction mixture was poured into a stirred mixture of ice (8,000 g) and a 3.5% HCl (8 liters). Twelve hours later, the precipitate had coagulated and was collected by filtration; it was thoroughly washed with successive 3-liter portions of 5% NaOH, water, 0.5% HCl, and water.

After partial drying at 60°C for 5 hours, the crude trimethylpsoralen material was thoroughly dried in a vacuum desiccator. Yield 110.1 g (85%). Fractional crystallization, using activated carbon (Norite) (30.8 g), from mixtures of chloroform and petroleum ether (30° to 60°C) and finally from chloroform alone gave colorless prisms of 2',4,8-trimethylpsoralen, MP 234.5° to 235°C. Yield 61.8 g (48%).

References

- Merck Index 9538
- PDR p. 871
- OCDS Vol. 1 p. 334 (1977)
- I.N. p. 982
- REM p. 790
- Kaufman, K.D.; U.S. Patent 3,201,421; August 17, 1965

TRIPARANOL

Therapeutic Function: Antilipemic

Chemical Name: 4-Chloro- α -[4-[2-(diethylamino)ethoxy]phenyl]- α -(4-methylphenyl)benzene ethanol

Common Name: —

Structural Formula:

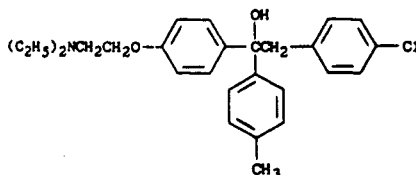

Chemical Abstracts Registry No.: 78-41-1

Trade Name	Manufacturer	Country	Year Introduced
Mer-29	Merrell National	U.S.	1960

Raw Materials

4-Hydroxy-4-methylbenzophenone	Sodium methoxide
β -Diethylaminoethyl chloride	p-Chlorobenzyl chloride
Magnesium	

Manufacturing Process

4-(β -diethylaminoethoxy)-4-methylbenzophenone was prepared as follows: a mixture of 200 g of 4-hydroxy-4-methylbenzophenone, 55 g of powdered sodium methoxide and 400 ml of ethanol was stirred for 30 minutes. A solution of 150 g of β -diethylaminoethyl chloride in 300 ml of toluene was added and the mixture was refluxed four hours. The solvent was removed, the residue was taken up in ether, extracted with 5% NaOH solution, twice with water, the ether was removed and the residue was distilled. The product was obtained as an oil boiling at 232°C at 0.6 mm.

1 liter of a 0.45N ethereal solution of p-chlorobenzyl magnesium chloride was added in 30 minutes to a stirred solution of 104 g (0.35 mol) of 4-(β -diethylaminoethoxy)-4-methylbenzophenone in 400 ml of dry ether. After stirring an additional hour, the mixture was decomposed by pouring onto 1 liter of cold 10% ammonium chloride solution, the ether solution was washed with water, and the ether was replaced with hot isopropanol containing a trace of ammonia. 1-[p-(β -diethylaminoethoxy)phenyl]-1-phenyl-2-p-tolyl-2-p-chloroethanol separated as white crystals, melting at 104°C to 106°C.

References

Merck Index 9541

I.N. p. 982

Allen, R.E., Palopoli, F.P., Schumann, E.L. and Van Campen, M.G. Jr.; U.S. Patent 2,914,562; November 24, 1959; assigned to Wm. S. Merrell Co.

TRIPLENNAMINE

Therapeutic Function: Antihistaminic

Chemical Name: N,N-dimethyl-N'-(phenylmethyl)-N'-2-pyridinyl-1,2-ethanediamine

Common Name: —

Structural Formula:

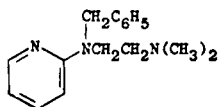

Chemical Abstracts Registry No.: 91-81-6; 154-69-8 (Hydrochloride)

Trade Name	Manufacturer	Country	Year Introduced
Pyribenzamine	Ciba	U.S.	1946
PBZ-SR	Ciba Geigy	U.S.	1977
Anhistamin	Pharmachim	Bulgaria	—
Antamine	Teva	Israel	—
Antiallergicum Medivet	Medivet	Switz.	—
Sedilene	Montefarmaco	Italy	—

Raw Materials

α -Aminopyridine	Benzaldehyde
Dimethylaminochloroethane	Sodium amide

Manufacturing Process

46 g of α -benzylaminopyridine in 50 cc of dry toluene are heated to 80°C [the α -benzylaminopyridine may be obtained either according to the method of Tchitchibabine and Knunjanz, *Berichte*, 64, 2839 (1931), which consists in warming α -aminopyridine with benzaldehyde in formic acid, or alternatively by the action of benzyl chloride on sodio- α -aminopyridine]. To the toluene solution there are added gradually 9.5 g of 85% sodamide. After evolution of ammonia, the major part of the toluene is distilled off; into the pasty mass which remains there are poured 120 cc of an ethereal solution of 27 g of dimethylaminochloroethane.

The mixture is heated until the temperature reaches 140°C, the ether distilling out, then finally heated under reduced pressure (150 mm Hg) for ½ hour. The mass is taken up with dilute hydrochloric acid and ether, neutralized at pH 7, and α -benzylaminopyridine separates. After making alkaline, using excess of potash, it is extracted with benzene, dried and distilled. The product thereby obtained, dimethylamino-ethyl-N-benzyl-N- α -aminopyridine, boils at 135° to 190°C/1.7 mm, according to U.S. Patent 2,502,151.

References

- Merck Index 9542
 Kleeman & Engel p. 928
 PDR pp. 830, 898
 OCDS Vol. 1 p. 51 (1977)
 I.N. p. 983
 REM p. 1130
 Djerassi, C., Huttner, C.P. and Scholz, C.R.; U.S. Patent 2,406,594; August 27, 1946; assigned to Ciba Pharmaceutical Products Incorporated
 Horclois, R.J.; U.S. Patent 2,502,151; March 28, 1950; assigned to Societe des Usines Chimiques Rhone-Poulenc, France

TRIPROLIDINE

Therapeutic Function: Antihistaminic

Chemical Name: (E)-2-[1-(4-methylphenyl)-3-(1-pyrrolidinyl)-1-propenyl]pyridine

Common Name: —

Structural Formula:

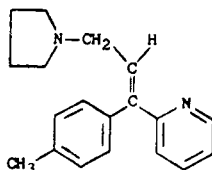

Chemical Abstracts Registry No.: 486-12-4; 550-70-9 (Hydrochloride)

Trade Name	Manufacturer	Country	Year Introduced
Actidil	Burroughs Wellcome	U.S.	1958
Actidilon	Wellcome	France	1965
Bayidyl	Bay	U.S.	1983
Actifed	Burroughs Wellcome	U.S.	—
Actiphyll	Gayoso Wellcome	Spain	—
Entra	Wellcome-Tanabe	Japan	—
Histradil	Trima	Israel	—
Pro-Actidil	Burroughs Wellcome	U.K.	—
Pro-Entra	Wellcome-Tanabe	Japan	—
Triafed	Schein	U.S.	—
Tripodrine	Danbury	U.S.	—
Venen	Tanabe	Japan	—

Raw Materials

4-Methylacetophenone	Paraformaldehyde
Pyrrolidine	Lithium
2-Bromopyridine	

Manufacturing Process

4-Methylacetophenone is first reacted with paraformaldehyde and then with pyrrolidine to give p-methyl- ω -pyrrolidinopropiophenone.

Atomized lithium (26 g, 3.75 mols) and sodium-dried ether (200 cc) are placed in a 3-liter, 3-necked flask fitted with a Herschberg stirrer, thermometer pocket and a water condenser closed by a calcium chloride tube. A slow stream of dry nitrogen is blown through the flask, which is cooled to -10°C and n-butyl chloride (138 g, 156 cc, 1.5 mols) is run in with rapid stirring; the mixture is stirred for a further 30 minutes, and then cooled to -60°C .

2-Bromopyridine (193 g, 1.22 mols) is then added dropwise over 20 minutes, the temperature of the reaction mixture being maintained at $-50\pm 2^{\circ}\text{C}$. The mixture is stirred for 10 minutes at -50°C and p-methyl- ω -pyrrolidinopropiophenone (112.5 g, 0.5 mol) in dry benzene is then added dropwise over ca 30 minutes, at a temperature of $-50\pm 2^{\circ}\text{C}$. The mixture is stirred for a further 2 hours, the temperature being allowed to rise to -30°C but no higher.

The mixture is poured onto excess ice, acidified with concentrated hydrochloric acid, the ether layer separated and extracted with water (1 x 200 cc). The combined aqueous extracts are washed with ether (1 x 200 cc) basified with 0.880 ammonia and extracted with chloroform (3 x 350 cc); the extract is washed with water (2 x 100 cc), dried over sodium sulfate, evaporated, and the residue extracted with boiling light petroleum (BP 60° to 80°C ; 10 volumes), filtered hot and evaporated to dryness. The residue is recrystallized from alcohol to give a cream solid (119 g, 80%), MP 117° to 118°C . Recrystallization gives 1-(4-methylphenyl)-1-(2-pyridyl)-3-pyrrolidinopropan-1-ol, MP 119° to 120°C .

1-(4-Methylphenyl)-1-(2-pyridyl)-3-pyrrolidinopropan-1-ol (10.0 g) is heated in a steam bath for 30 minutes with 85% aqueous sulfuric acid (30 cc). The solution is then poured onto crushed ice, excess of ammonia solution added and the liberated oil extracted with light petroleum (BP 60° to 80°C). The extract is dried over anhydrous sodium sulfate and the solvent evaporated to leave an amber syrup (8.8 g) consisting of the cis and trans isomers of 1-(4-methylphenyl)-1-(2-pyridyl)-3-pyrrolidinoprop-1-ene as described in U.S. Patent 2,712,023. The isomers may be separated by base exchange chromatography. The 4-methyl- ω -pyrrolidinopropiophenone required as the starting product for the preparation of the carbinol is prepared by the Mannich reaction (Blicke, *Organic Reactions*, 1942, vol 1, p 303; Adamson & Billinghamurst, *Journal of the Chemical Society*, 1950, 1039) from 4-methylacetophenone and pyrrolidine. The hydrochloride has a MP of 170°C with decomposition.

References

Merck Index 9552

Kleeman & Engel p. 929

PDR pp. 731, 830, 993, 1569, 1606, 1999

OCDS Vol. 1 p. 78 (1977)

I.N. p. 983

REM p. 1130

Adamson, D.W.; U.S. Patent 2,712,020; June 28, 1955; assigned to Burroughs Wellcome & Co. (U.S.A.) Inc.

Adamson, D.W.; U.S. Patent 2,712,023; June 28, 1955; assigned to Burroughs Wellcome & Co. (U.S.A.) Inc.

TROFOSFAMIDE

Therapeutic Function: Cancer chemotherapy

Chemical Name: N,N,3-tris(2-chloroethyl)-tetrahydro-2H-1,3,2-oxaphosphorin-2-amine-2-oxide

Common Name: Trophosphamide

Structural Formula:

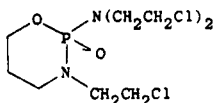

Chemical Abstracts Registry No.: 22089-22-1

Trade Name	Manufacturer	Country	Year Introduced
Ixoten	Asta	W. Germany	1973
Ixoten	Schering	Italy	1975

Raw Materials

N,N-bis-(2-chloroethyl)-phosphoric acid amide dichloride

N-(2-Chloroethyl)-N-(3-hydroxypropyl)-amine hydrochloride

Triethylamine

Manufacturing Process

259 g (1 mol) of N,N-bis-(2-chloroethyl)-phosphoric acid amide dichloride, 209 g (1.2 mols) of N-(2-chloroethyl)-N-(3-hydroxypropyl)-amine hydrochloride (crude), 1,000 cc of ethylene

dichloride and 344 g (3.4 mols) of triethylamine are the reactants. N,N-bis-(2-chloroethyl)-phosphoric acid amide dichloride is dissolved in the methylene dichloride. N-(2-chloroethyl)-N-(3-hydroxypropyl)-amine hydrochloride is suspended in this solution and triethylamine is added thereto dropwise with stirring. The temperature of the solution rises to boiling. After the termination of the addition, the mixture is heated to boiling for another 6 hours. Thereafter, the reaction mixture is cooled down and allowed to stand overnight at about 0°C. The precipitated triethylamine hydrochloride is filtered off with suction. The resulting solution is evaporated, the residue (about 370 g) is triturated with about 3.2 liters of ether and is heated to boiling for a short period of time.

The ethereal solution is decanted from the insolubles (about 90 g). The solution is rendered to pH 6.5 to 7 by the addition of ethereal hydrochloric acid and then is filtered over charcoal and thereafter is evaporated. During evaporation, the temperature should not rise above 40°C. The residue is dissolved in ether and in an amount corresponding to half of its weight (240 g of residue, dissolved in 120 cc of ether), the ethereal solution is cooled to -5°C and is inoculated. After standing for 25 hours, 140 g have been separated by crystallization. After separation by filtration with suction, the mother liquor is diluted with ether to 5 times its volume, the solution is filtered over charcoal, is again evaporated and the residue is again dissolved in a volume corresponding to half of the weight of the residue. Another cooling to -5°C and inoculation produces further 18 g of the desired compound. MP: 50° to 51°C. Total yield: 161 g (50% of the theoretical).

References

Merck Index 9571

Kleeman & Engel p. 930

OCDs Vol. 3 p. 161 (1984)

DOT 9 (12) 502 (1973) & 13 (3) 118 (1977)

I.N. p. 985

Asta-Werke AG Chemische Fabrik, Germany; British Patent 1,188,159; April 15, 1970

Arnold, H., Brock, N., Bourseaux, F. and Bekel, H.; U.S. Patent 3,732,340; May 8, 1973; assigned to Asta-Werke AG Chemische Fabrik

TROMANTIDINE HYDROCHLORIDE

Therapeutic Function: Antiviral

Chemical Name: N-(2-Dimethylamino-ethoxy)-acetyl-aminoadamantane(1) hydrochloride

Common Name: —

Structural Formula:

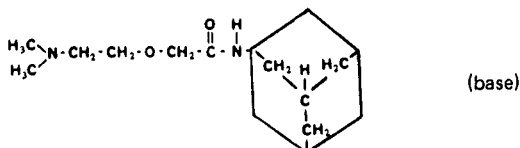

Chemical Abstracts Registry No.: 41544-24-5; 53783-83-8 (Base)

Trade Name	Manufacturer	Country	Year Introduced
Viru-Merz	Merz	W. Germany	1973
Viruserol	Zyma	Italy	1972

Raw Materials

Chloroacetyl chloride Sodium
 Adamantane
 Dimethylaminoethanol

Manufacturing Process

Adamantane is first reacted with chloroacetyl chloride to give chloroacetylaminoadamantane.

2.3 g Na (0.1 g-atom) were dissolved in 75 ml dimethylamino-ethanol. Then the excess alcohol was distilled off completely and the sodium salt developed was dried in a vacuum. After drying, the salt was dissolved in about 200 ml xylene. To this solution, 22.8 g (0.1 mol) chloroacetylaminoadamantane were added, heated for 10 hours under reflux in a 250-ml round-bottomed flask with a reflux cooler, and the sodium chloride developed subsequently filtered off.

Next the xylene was distilled away, the liquid residue dissolved in about 80 ml carbon tetrachloride and the hydrochloride precipitated through introduction of hydrochloric acid gas. The hydrochloride was dissolved in about 100 ml acetone and the solvent subsequently distilled away, whereby excess hydrochloric acid passed over with it. This operation was repeated until no excess acid was present.

A large excess of petroleum ether was added in a 500-ml three-necked flask provided with a stirrer and reflux cooler, to a concentrated acetic solution of the hydrochloride and stirred for at least 1 hour, whereby the desired substance was deposited in a crystalline form. Finally, the substance was filtered away and dried in a desiccator. 14 g of the substance (15% of theory) were obtained.

References

Merck Index 9574

Kleeman & Engel p. 930

DOT 10 (3) 105 (1974)

I.N. p. 985

Scherm, A. and Peteri, D.; U.S. Patent 3,705,194; December 5, 1972; assigned to Merz and Co., Chemische Fabrik

TROMETHAMINE

Therapeutic Function: Antacid

Chemical Name: 2-Amino-2-hydroxymethyl-1,3-propanediol

Common Name: Trometamol

Structural Formula:

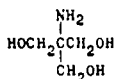

Chemical Abstracts Registry No.: 77-86-1

Trade Name	Manufacturer	Country	Year Introduced
Trisaminol	Bellon	France	1964
In Tham-E	Abbott	U.S.	1965

Trade Name	Manufacturer	Country	Year Introduced
Tham	Otsuka	Japan	1969
Thamesol	Baxter	Italy	1970
Addex-Tham	Pharmacia	Sweden	—
Alcaphor	Bellon	France	—
Apiroserum	Ibys	Spain	—
Basionic	Smith Kline-R.I.T.	Belgium	—
Buffer	Pages Maruny	Spain	—
Thamacetat	Bellon	France	—
Trizma	Sigma	U.S.	—

Raw Materials

Nitromethane
Formaldehyde
Hydrogen

Manufacturing Process

Nitromethane is reacted with formaldehyde to give tris(hydroxymethyl)nitromethane in an initial step. This intermediate may be reduced by catalytic hydrogenation (U.S. Patent 2,174,242) or by electrolytic reduction (U.S. Patent 2,485,982).

References

Merck Index 9575
DOT 1 (4) 139 (1965)
I.N. p. 986
REM p. 836
Hass, H.B. and Vanderbilt, B.M.; U.S. Patent 2,174,242; September 26, 1939; assigned to Purdue Research Foundation
McMillan, G.W.; U.S. Patent 2,485,982; October 25, 1949; assigned to Commercial Solvents Corporation

TROPICAMIDE

Therapeutic Function: Anticholinergic (ophthalmic)

Chemical Name: N-ethyl- α -(hydroxymethyl)-N-(4-pyridinylmethyl)benzeneacetamide

Common Name: N-ethyl-N-(γ -picolyl)tropamide

Structural Formula:

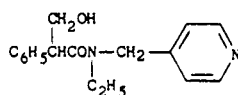

Chemical Abstracts Registry No.: 1508-75-4

Trade Name	Manufacturer	Country	Year Introduced
Mydriacyl	Alcon	U.S.	1959
Mydriaticum	MSD-Chibret	France	1960
Mydrin	Santen	Japan	—
Mydrum	Ankerwerk	E. Germany	—
Tropimil	Farmigea	Italy	—
Tryptar	Armour	U.S.	—
Visumidriatic	I.S.F.	Italy	—

Raw Materials

Ethyl amine
 γ -Chloromethyl pyridine hydrochloride

Acetyltropic acid chloride
 Hydrogen chloride

Manufacturing Process

A solution of 82 parts by weight of γ -chloromethyl-pyridine-hydrochloride in 60 parts of water is added dropwise, at 0° to 5°C, to 250 parts by weight of a 50% aqueous ethyl amine solution. The mixture is stirred for 1 hour at 60°C, whereupon it is cooled down and separated in the cold with solid potassium hydroxide. The oil formed is separated off, dried over potassium hydroxide and distilled. The ethyl-(γ -picolyl)-amine formed boils over at 103° to 104°C under a pressure of 13 mm Hg. Its dihydrochloride melts at 198° to 200°C.

To a mixture of 48.7 parts by weight of ethyl-(γ -picolyl)-amine and 36 parts by weight of dry pyridine in 220 parts by weight of dry chloroform is slowly added, while stirring and cooling with ice water, crude acetyltropic acid chloride prepared from 60 parts by weight of tropic acid. To complete the reaction, the mixture is stirred for one additional hour at 23°C. Thereupon the chloroform solution is diluted with 200 parts by weight of ether and agitated with 3 N hydrochloric acid. The weakly Congo acid solution is heated for 1 hour in a steam bath, the acetyl group of the reaction product being thereby split off, and the mixture is filtered over charcoal.

Upon adding concentrated ammonia in excess, the condensation product separates and is taken up in chloroform. The chloroform solution is dried and distilled, the tropic acid N-ethyl-N-(γ -picolyl)-amide being thereby obtained in the form of a thick oil, which crystallizes after prolonged time and which then melts at 96° to 97°C.

References

Merck Index 9585

Kleeman & Engel p. 932

DOT 16 (3) 89 (1980)

I.N. p. 986

REM p. 918

Rey-Bellet, G. and Spiegelberg, H.; U.S. Patent 2,726,245; December 6, 1955; assigned to Hoffmann-LaRoche Inc.

TUBOCURARINE CHLORIDE

Therapeutic Function: Skeletal muscle relaxant

Chemical Name: 7',12'-Dihydroxy-6,6'-dimethoxy-2,2',2'-trimethyl-tubocuraranium chloride

Common Name: —

Structural Formula:

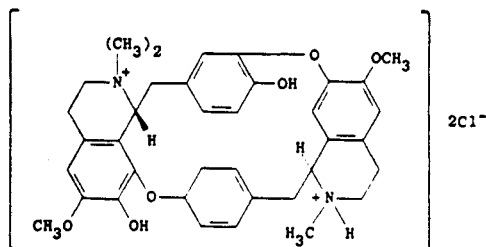

Chemical Abstracts Registry No.: 6533-76-2

Trade Name	Manufacturer	Country	Year Introduced
Mecostrin	Squibb	U.S.	1946
Amelizol	Yoshitomi	Japan	—
Curarin	Asta	W. Germany	—
Introcortin T	Squibb	Italy	—
Jexin	Duncan Flockhart	U.K.	—
Metubine	Lilly	U.S.	—
Relvene	Pharmascience	U.S.	—
Tubadil	Endo	U.S.	—
Tubocuran	N.D. & K.	Denmark	—

Raw Materials

Chondrodendron tomentosum plant
Picric acid
Hydrogen chloride

Manufacturing Process

The initial step involves extraction of the stems and bark of the plant *Chondrodendron tomentosum* with water as the solvent.

Producing substantially pure d-tubocurarine chloride essentially comprises treating with picric acid the quaternary-base fraction of a crude curare of the curarine type, hydrolyzing the resulting picrate in an emulsion of hydrochloric acid and a water-immiscible organic solvent for picric acid, recovering crystalline d-tubocurarine chloride from the aqueous phase, dissolving the d-tubocurarine chloride in a minimum of hot water, allowing the solution to stand at room temperature until the bulk of the d-tubocurarine chloride precipitates, adding sufficient concentrated hydrochloric acid to bring the HCl content up to about 6%, and refrigerating the solution.

References

Merck Index 9608
Kleeman & Engel p. 934
I.N. 988
REM p. 924
Bashour, J.T.; U.S. Patent 2,409,241; October 15, 1946; assigned to E.R. Squibb & Sons

TYBAMATE

Therapeutic Function: Tranquilizer

Chemical Name: Butylcarbamic acid 2-[(aminocarbonyl)oxy] methyl]-2-methylpentyl ester

Common Name: —

Structural Formula:

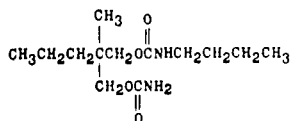

Chemical Abstracts Registry No.: 4268-36-4

Trade Name	Manufacturer	Country	Year Introduced
Solacen	Wallace	U.S.	1965
Tybatran	Robins	U.S.	1967
Effisax	Maggioni	Italy	—
Nospan	Johnsons	Sweden	—

Raw Materials

Diethylmethyl propylmalonate	Lithium aluminum hydride
Sulfuric acid	Phosgene
Butylamine	Urethane

Manufacturing Process

Diethylmethyl propylmalonate is reacted with LiAlH_4 , then H_2SO_4 to give 2-methyl-2-propyl-1,3-propanediol. That is reacted with phosgene in toluene to give the chlorocarbonate which is in turn reacted with butylamine to give N-butyl-2-methyl-2-propyl-3-hydroxy-propyl carbamate.

22.1 parts of N-butyl-2-methyl-2-propyl-3-hydroxy-propyl carbamate and 9.8 parts of urethane are dissolved in 300 parts of anhydrous xylene in a suitable vessel equipped with an efficient distillation column. Xylene is distilled to remove traces of water from the mixture. 2.3 parts of aluminum isopropylate are added and distillation is continued until substantially the theoretical quantity of ethanol has been distilled at about 78°C . The reaction mixture is then freed from xylene by distillation under reduced pressure. Approximately 100 parts of water are added and the mixture again freed of solvent by distillation under reduced pressure. 100 parts of trichloroethylene are added, the solution filtered to remove insoluble matter and the solution freed of solvent by evaporation. The residual oil is purified by molecular distillation at a pressure of about 0.01 mm. 8.7 parts (35% of theoretical yield) of purified N-butyl-2-methyl-2-propyl-1,3-propanediol dicarbamate are obtained.

References

Merck Index 9628

Kleeman & Engel p. 935

OCDS Vol. 2 p. 22 (1980)

DOT 3 (3) 101 (1967)

I.N. p. 989

REM p. 1074

Berger, F.M. and Ludwig, B.J.; U.S. Patent 2,937,119; May 17, 1960; assigned to Carter Products, Inc.

TYLOXAPOL

Therapeutic Function: Bronchodilator

Chemical Name: 4-(1,1,3,3-tetramethylbutyl)phenol polymer with formaldehyde and ethylene oxide

Common Name: —

Structural Formula: See chemical name

Chemical Abstracts Registry No.: 25301-02-4

Trade Name	Manufacturer	Country	Year Introduced
Superinone	Winthrop	U.S.	1953
Alevaire	Breon	U.S.	1953
Lacermucin	Lacer	Spain	—
Tacholiquin	Benechemie	W. Germany	—
Triton WR	Rohm & Haas	U.S.	—

Raw Materials

$\alpha,\alpha,\gamma,\gamma$ -Tetramethylbutylphenol
Formaldehyde
Ethylene oxide

Manufacturing Process

Step 1: Into a 3-necked flask equipped with thermometer, mechanical agitator, and reflux condenser was charged the following: 412 g of $\alpha,\alpha,\gamma,\gamma$ -tetramethylbutylphenol, 162 g of a 37% aqueous solution of formaldehyde, and 27.6 g of water. The mixture was agitated and heated to a temperature of 90°C. At this point, 246 g of oxalic acid and 0.92 g of Twitchell's reagent dissolved in 10 g of water were added. While being agitated, the reaction mixture was refluxed for 6 hours. 200 g of water and 384 g of toluene were added, and refluxing was continued for an hour.

Agitation was stopped and the contents of the flask were removed to a separatory funnel. The aqueous and resinous layers were separated and the solvent was removed from the resinous layer by vacuum distillation. After the removal of the solvent, heating at a reduced pressure of 1.5 to 2.5 mm and at a temperature of 245° to 250°C was continued for 4½ hours. The condensate then had a viscosity of 4.0 poises when measured as a 60% solution in toluene and, on cooling, solidified to a brittle mass.

Step 2: A mixture of 118 parts of the product of Step 1, having hydroxyl number of 260, 2 parts of solid NaH, and 100 parts of toluene was heated to 125° to 150°C in an autoclave. Ethylene oxide was added slowly over a period of 2½ hours until 261 parts of ethylene oxide were absorbed. This corresponds to 11 mols of ethylene oxide per mol of phenol in the product of Step 1. The toluene was then removed by steam distillation and the water by vacuum distillation at 10°C. The product was obtained as a viscous paste having a corrected hydroxyl number of 97. It was readily soluble in water and had marked detergent properties.

References

Merck Index 9632

I.N. p. 990

REM p. 869

Bock, L.H. and Rainey, J.L.; U.S. Patent 2,454,541; assigned to Rohm & Haas Company

TYROPANOATE SODIUM

Therapeutic Function: Diagnostic aid (radiopaque medium)

Chemical Name: α -ethyl-2,4,6-triiodo-3-[(1-oxobutyl)amino] benzenepropanoic acid monosodium salt

Common Name: —

Structural Formula:

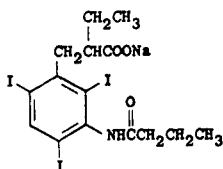

Chemical Abstracts Registry No.: 7246-21-1

Trade Name	Manufacturer	Country	Year Introduced
Bilopaque	Winthrop	U.S.	1972
Bilopaque	Winthrop	W. Germany	1977
Tyropaque	Torii	Japan	1979

Raw Materials

α -Ethyl- β -(aminophenyl)propionic acid	Butyric anhydride
Iodine monochloride	Sodium hydroxide

Manufacturing Process

A solution of 5.0 g of α -ethyl- β -(aminophenyl)propionic acid in 100 ml of water containing 5 ml of concentrated hydrochloric acid was added over a period of ½ hour to a stirred solution of 3.2 ml of iodine monochloride in 25 ml of water and 25 ml of concentrated hydrochloric acid heated to 60°C. After addition was complete, the heating was continued for ½ hour longer at 60° to 70°C. A black oil separated which gradually solidified. The mixture was then cooled and sodium bisulfite was added to decolorize. Recrystallization of the product from methanol gave about 8 g of α -ethyl- β -(2,4,6-triiodo-3-aminophenyl)propionic acid, MP 147° to 150°C. The product could be further purified by precipitation of its morpholine salt from ether solution and regeneration of the free amino acid by treatment of a methanol solution of the morpholine salt with sulfur dioxide. The pure amino acid had the MP 155° to 156.5°C (corr).

A mixture of 57.1 g (0.1 mol) of α -ethyl- β -(3-amino-2,4,6-triiodophenyl)propionic acid, 250 ml of butyric anhydride and 1 ml of 70% perchloric acid was heated at 105°C for 5 hours. After cooling, the reaction mixture in 25 ml of water and 25 ml of concentrated hydrochloric acid heated to 60°C. After addition was complete, the heating was continued for ½ hour longer at 60° to 70°C. A black oil separated which gradually solidified. The mixture was then cooled and sodium bisulfite was added to decolorize. Recrystallization of the product from methanol gave about 8 g of α -ethyl- β -(2,4,6-triiodo-3-aminophenyl)propionic acid, MP 147° to 150°C. The product could be further purified by precipitation of its morpholine salt from ether solution and regeneration of the free amino acid by treatment of a methanol solution of the morpholine salt with sulfur dioxide. The pure amino acid had the MP 155° to 156.5°C (corr).

A mixture of 57.1 g (0.1 mol) of α -ethyl- β -(3-amino-2,4,6-triiodophenyl)propionic acid, 250 ml of butyric anhydride and 1 ml of 70% perchloric acid was heated at 105°C for 5 hours. After cooling, the reaction mixture in 25 ml of water and 25 ml of concentrated hydrochloric acid heated to 60°C. After addition was complete, the heating was continued for ½ hour longer at 60° to 70°C. A black oil separated which gradually solidified. The mixture was then cooled and sodium bisulfite was added to decolorize. Recrystallization of the product from methanol gave about 8 g of α -ethyl- β -(2,4,6-triiodo-3-aminophenyl)propionic acid, MP 147° to 150°C. The product could be further purified by precipitation of its morpholine salt from ether solution and regeneration of the free amino acid by treatment of a methanol solution of the morpholine salt with sulfur dioxide. The pure amino acid had the MP 155° to 156.5°C (corr).

A mixture of 57.1 g (0.1 mol) of α -ethyl- β -(3-amino-2,4,6-triiodophenyl)propionic acid, 250 ml of butyric anhydride and 1 ml of 70% perchloric acid was heated at 105°C for 5 hours. After cooling, the reaction mixture in 25 ml of water and 25 ml of concentrated hydrochloric acid heated to 60°C. After addition was complete, the heating was continued for ½ hour longer at 60° to 70°C. A black oil separated which gradually solidified. The mixture was then cooled and sodium bisulfite was added to decolorize. Recrystallization of the product from methanol gave about 8 g of α -ethyl- β -(2,4,6-triiodo-3-aminophenyl)propionic acid, MP 147° to 150°C. The product could be further purified by precipitation of its morpholine salt from ether solution and regeneration of the free amino acid by treatment of a methanol solution of the morpholine salt with sulfur dioxide. The pure amino acid had the MP 155° to 156.5°C (corr).

References

Merck Index 9636

I.N. p. 991

REM p. 1270

Archer, S. and Hoppe, J.O.; U.S. Patent 2,895,988; assigned to Sterling Drug, Inc.

U

UBIDECARENONE

Therapeutic Function: Cardiovascular Agent

Chemical Name: 2-(3,7,11,15,19,23,27,31,35,39-decamethyl-2,6,10,14,18,22,26,30,34,38-tetracontadecaenyl)-5,6-dimethoxy-3-methyl-p-benzoquinone

Common Name: Ubiquinone

Structural Formula:

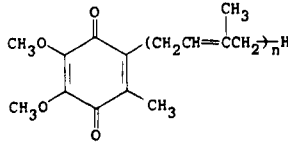

Chemical Abstracts Registry No.: 303-98-0

Trade Name	Manufacturer	Country	Year Introduced
Neuquinon	Eisai	Japan	1974
Adelir	Teikoku Kagaku	Japan	—
Emitolon	Tatsumi	Japan	—
Heartcin	Ohta	Japan	—
Hiruton	Taisho	Japan	—
Inokiten	Nippon Chemiphar	Japan	—
Justquinon	Horita	Japan	—
Kaitron	Sawai	Japan	—
Parbinon	Santen	Japan	—
Terekol	Daigo	Japan	—
Ube-Q	Tsuruhara	Japan	—
Udekinon	Tobishi	Japan	—
Yubekinson	Hishiyama	Japan	—

Raw Materials

Bacterium *Sporidiobolus ruinenii*
Nutrient medium

Manufacturing Process

A small fermentation tank (5,000 parts by volume capacity) was charged with 3,000 parts by volume of a culture medium (pH 6.0) comprising 3% glucose, 1% polypepton, 0.5% yeast extract and 0.5% malt extract. The medium was sterilized by heating in a conventional manner and cooled. This medium was inoculated with 150 parts by volume of a pre-culture of *Sporidiobolus ruinenii* CBS-5001, which had been prepared by growing the same strain on a medium of the same composition as above at 28°C for one day. The inoculated medium was in-

cupated at 28°C and under agitation at 800 rpm with sparging at a rate of 3,000 parts by volume per minute for 24 hours. During this fermentation period, the medium was maintained at pH 6.0 with ammonia and sulfuric acid.

The resultant fermentation broth was centrifuged to harvest the microbial cells, and they were washed with water and centrifuged a second time, whereupon a living cell paste was obtained. (There was obtained an amount of cells equivalent to 54 parts on a dry basis, which contained 920 μg of ubiquinone-10 per gram of dry cells.)

The moist cells were suspended in 750 parts of volume of ethanol and extracted by warming at 60°C for 1 hour. A total of 3 extractions were carried out in a similar manner and the extracts were pooled, diluted with water and further extracted three times with 1,000 parts of volume portions of n-hexane. The n-hexane layer was concentrated to dryness under reduced pressure to recover 4.12 parts of a yellow oil. This oily residue was dissolved in 6 parts by volume of benzene and passed through a column (500 parts by volume capacity) packed with Floridil (100 to 200 meshes). Elution was carried out using benzene and the eluate was collected in 10 parts by volume fractions. Each fraction was analyzed by thin-layer chromatography and color reaction and the fractions rich in ubiquinone-10 were pooled and concentrated under reduced pressure. By this procedure was obtained 0.562 part of a yellow oil. This product was dissolved in 5 parts by volume of chloroform, coated onto a thin layer plate of silica gel GF254 (silica gel with calcium sulfate) and developed with benzene. The fractions corresponding to ubiquinone-10 were extracted, whereby 0.054 part of a yellow oil was obtained. This oil was dissolved in 10 parts by volume of ethanol and allowed to cool, whereupon 0.029 part of yellow crystals of ubiquinone-10 were obtained, its melting point 48° to 50°C.

There are also synthetic routes to the ubiquinones as described in U.S. Patents 3,068,295; 3,896,153 and 4,062,879.

References

Merck Index 9641

Kleeman & Engel p. 936

DOT 13 (4) 159 (1977)

I.N. p. 992

Folkers, K.A., Hoffman, C.H. and Wolf, D.E.; U.S. Patent 3,068,295; Dec. 11, 1962; assigned to Merck & Co., Inc.

Sato, K., Inoue, S., Kijima, S. and Hamamura, K.; U.S. Patent 3,896,153; July 22, 1975; assigned to Eisai Co., Ltd. (Japan).

Kijima, S., Yamatsu, I., Minami, N. and Inai, Y.; U.S. Patent 4,062,879; Dec. 13, 1977; assigned to Eisai Co., Ltd. (Japan).

Nakao, Y., Kitano, K., Imada, I. and Morimoto, H.; U.S. Patent 4,070,244; Jan. 24, 1978; assigned to Takeda Chemical Industries Ltd. (Japan).

URACIL MUSTARD

Therapeutic Function: Cancer chemotherapy

Chemical Name: 5-[bis(2-chloroethyl)amino]-2,4(1H,3H)-pyrimidinedione

Common Name: Uramustine; demethylodopan; chloroethaminacil

Structural Formula:

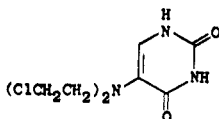

Chemical Abstracts Registry No.: 66-75-1

Trade Name	Manufacturer	Country	Year Introduced
Uracil Mustard	Upjohn	U.S.	1962

Raw Materials

5-Aminouracil	Thionyl chloride
Ethylene oxide	

Manufacturing Process:

Preparation of 5-[bis(2-Hydroxyethyl)Amino]Uracil: 20 grams (0.157 mol) of 5-amino-uracil was mixed with 350 ml of water, 23 ml of glacial acetic acid, and 160 ml of ethylene oxide in a one-liter flask immersed in an ice bath. The reaction mixture was stirred and allowed to come to room temperature slowly (as the ice melted), and stirring was continued for two days. A clear solution resulted to which was added 250 ml of water and 60 grams of Dowex-50 in the acid form. The mixture was stirred for 15 minutes, and the resin was collected on a filter. It was washed with water and the crude 5-[bis(2-hydroxyethyl)amino]uracil was eluted with a 10% aqueous solution of ammonium hydroxide. This eluate was evaporated to dryness, and the solid that remained was heated with 350 milliliters of isopropyl alcohol.

Undissolved substances were removed by filtration and the filtrate was concentrated on a steam bath to a volume of about 125 ml and cooled to effect crystallization. After 20 hours at room temperature the crystals that had formed were recovered, washed with isopropyl alcohol, and dried, yielding 15.61 grams (46.2%) of crystalline 5-[bis(2-hydroxyethyl)amino]uracil having a MP of 157° to 163°C. An analytical sample, obtained by several recrystallizations from isopropyl alcohol, melted at 166° to 168°C.

Preparation of 5-[bis(2-Chloroethyl)Amino]Uracil: 13 ml of thionyl chloride was added to 52 ml of diethylene glycol dimethyl ether accompanied by stirring. Heat was generated, and sulfur dioxide and hydrogen chloride were liberated. The mixture was cooled and 5.58 grams of 5-[bis(2-hydroxyethyl)amino]uracil was added, followed by 8 ml of thionyl chloride. No evidence of reaction was noted, and the reaction mixture was heated to about 40°C, gas then being evolved. After one hour at 40°C, 5 ml of thionyl chloride was added, and after 30 minutes, another 3 ml was added. The mixture was then heated to 55°C, whereupon it darkened and all of the solid dissolved. After cooling and storage at room temperature for 20 hours, three volumes of benzene was added and a dark solid precipitated. After one hour, the dark solid was collected on a filter, washed with benzene, and dissolved in a minimum of boiling methanol. Crystals formed upon cooling; and after 18 hours in the refrigerator, they were recovered on a filter, washed with cold methanol, and dried under reduced pressure, yielding 2.96 grams of 5-[bis(2-chloroethyl)amino]uracil. The product was recrystallized by dissolving in a minimum of hot methanol and adding water until the solution became cloudy; 2.25 grams of 5-[bis(2-chloroethyl)amino]uracil was recovered after cooling the mixture to 4°C for 16 hours (MP 200° to 205°C). A small sample was recrystallized again, and it melted at 198° to 204°C.

References:

Merck Index 9652

Kleeman & Engel p. 936

I.N. p. 995

REM p. 1157

Lyttle, D.A.; U.S. Patent 2,969,364; January 24, 1961; assigned to Upjohn Company.

URAPIDIL**Therapeutic Function:** Hypotensive

Chemical Name: 1,3-Dimethyl-4- $[\gamma$ -[4-(*o*-methoxyphenyl)piperazinyl-(1)]-propyl-amino]-uracil

Common Name: —

Structural Formula:

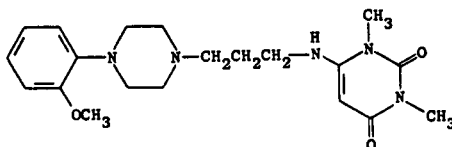

Chemical Abstracts Registry No.: 34661-75-1

Trade Names	Manufacturer	Country	Year Introduced
Ebrantil	Byk Gulden	W. Germany	1978
Ebrantil	Byk Gulden	Switzerland	1983

Raw Materials:

N-(*o*-methoxyphenyl)-N'-(3-aminopropyl)piperazine
1,3-Dimethyl-4-chlorouracil

Manufacturing Process:

20.6 g (0.083 mol) of N-(*o*-methoxyphenyl)-N'-(3-aminopropyl)-piperazine and 15.7 g (0.09 mol) of 1,3-dimethyl-4-chlorouracil were boiled for 15 hours in 100 ml triethylamine. The excess triethylamine was then distilled off in vacuo and the residue was dissolved in 300 ml 1 N hydrochloric acid with subsequent filtration. The filtrate thus obtained was cooled with ice and 2 N aqueous ammoniac solution was slowly added with stirring. As soon as the first precipitation appeared, a few crystals of the desired product were added to the solution. The ammoniacal suspension was stirred for one more hour, the precipitate filtered off by suction and washed with 200 ml water.

The material was purified by recrystallization from ethanol with the addition of activated carbon. In this manner 24.2 g 1,3-dimethyl-4- $[\gamma$ -[4-(*o*-methoxyphenyl)-piperazinyl-(1)]-propylamino]-uracil having a melting point of 156°C were obtained corresponding to a yield of 75%. The purification may also be effected by boiling the material in acetone to result in similar yields.

References

Merck Index 9669

DFU 3 (5) 397 (1978)

Kleeman & Engel p. 937

DOT 10 (2) 72 & (10) 551 (1982)

I.N. p. 995

Klemm, K., Schoetensack, W. and Prusse, W.; U.S. Patent 3,957,786; May 18, 1976; assigned to Byk Gulden

UROKINASE

Therapeutic Function: Anticoagulant

Chemical Name: A complex enzyme

Common Name: —

Chemical Abstracts Registry No.: 9039-53-6

Trade Names	Manufacturer	Country	Year Introduced
Abbofinase	Abbott	U.K.	1962
Uronase	Mochida	Japan	1970
Urokinase	Choay	France	1973
Urokinase	Choay	Italy	1975
Urokinase	Serono	W. Germany	1978
Abbokinase	Abbott	U.S.	1978
Breokinase	Breon	U.S.	1979
Abbokinase	Abbott	W. Germany	1980
Abbokinase	Abbott	France	1980
Ukidan	Serono	Sweden	1983
Abbokinase	Abbott	Sweden	1983
Actosolv	Behring Werke	W. Germany	—

Raw Materials

Human urine	Hydrogen chloride
Sodium benzoate	

Manufacturing Process

In 20 liters of human urine is dissolved 1,200 grams of sodium benzoate (6% weight by volume). The solution is acidified with aqueous hydrochloric acid (assay about 7.5% HCl) to a pH of 4.5 resulting in a heavy precipitation. This requires 10% of the original urine volume, or about 2 liters of aqueous hydrochloric acid. The suspension is stirred 20 minutes and is then allowed to stand for about 30 minutes. The mixture so obtained is filtered on a Buchner funnel that has been prepared with a precoat of benzoic acid crystals over filter paper. The filter cake is washed with a saturated benzoic acid solution, then sucked dry. The benzoic acid cake with the adsorbed urokinase weighs 2,060 grams.

The filter cake is stirred with 3.1 liters of acetone. The volume of acetone used is about 1.5 times the weight of the cake resulting in about a 65% acetone concentration. The benzoic acid dissolves in the acetone and the urokinase flocculates out. Sodium benzoate, about 1% of the weight of the cake, or 21 grams, is added to speed up the formation of the precipitate. The suspension of crude urokinase in acetone is filtered on a Buchner funnel using filter paper precoated with a diatomaceous silica product (Celite 505). The precipitate is washed with acetone until the filtrate is water clear. The precipitate is then washed with ether and air dried. The yield of powder so obtained is 2.3 grams.

Four batches of urokinase, obtained in this manner from 202 liters of urine, is pooled, amounting to 23.5 grams. The combined urokinase is suspended in 750 ml of 0.1 M phosphate-saline buffer at pH 6.2, stirred to dissolve the urokinase and centrifuged to remove the Celite. The residue is extracted two more times with 500 ml portions of 0.1 M phosphate-saline buffer. The combined extracts are filtered and labelled Extract 1. The residue is extracted three more times with 600 ml portions of buffer, the combined extracts are filtered and labelled Extract 2.

The clarified solution of the first phosphate-saline buffer extract, 1,320 ml, is passed through 110 cm of Amberlite XE-64 ion exchange resin contained in a column 10 cm in diameter. The resin exchange column has a hold-up volume of about 2.8 liters. The second extract (Extract 2) of the Celite residue, 1,720 ml, is then passed through the same exchange column. The column is washed with 11.4 liters of the phosphate-saline buffer. Then the adsorbate is eluted with 9 liters of 0.5 M sodium chloride. The eluate is dialyzed through a viscose regenerated cellulose membrane against distilled water. The active fractions within the dialysis sacs, totaling 4,940 ml, are pooled and lyophilized. The yield is 2.5 grams having an activity of 415,000 units or 166 units per milligram.

References

Merck Index 9693

Kleeman & Engel p. 937

PDR p. 502

I.N. p. 997

REM p. 1038

Singher, H.O. and Zuckerman, L.; U.S. Patent 2,961,382; November 22, 1960; assigned to Ortho Pharmaceutical Corporation

Kjeldgaard, N.O. and Herlev, J.P.; U.S. Patent 2,983,647; May 9, 1961; assigned to Løvens kemiske Fabrik ved A. Kongsted, Denmark

Singher, H.O. and Zuckerman, L.; U.S. Patent 2,989,440; June 20, 1961; assigned to Ortho Pharmaceutical Corporation

Doczi, J.; U.S. Patent 3,081,236; March 12, 1963; assigned to Warner-Lambert Pharmaceutical Company

V

VALETHAMATE BROMIDE

Therapeutic Function: Anticholinergic

Chemical Name: N,N-Diethyl-N-methyl-2-[(3-methyl-1-oxo-2-phenylpentyl)oxy] ethanaminium bromide

Common Name: —

Structural Formula:

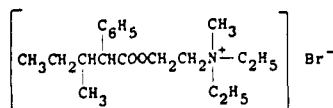

Chemical Abstracts Registry No.: 90-22-2

Trade Names	Manufacturer	Country	Year Introduced
Murel	Ayerst	U.S.	1958
Barespan	Hishiyama	Japan	—
Baretaval	Shin Fuso	Japan	—
Beruhgen	Nissin	Japan	—
Elist	Sana-Torii	Japan	—
Epidosin	Kali-Chemie	W. Germany	—
Funapan	Funai	Japan	—
Kaichyl	Samoa	Japan	—
Letamate	Mohan	Japan	—
Narest	Isei	Japan	—
Pastan	Maruro	Japan	—
Release V	Mochida	Japan	—
Resitan	Grelan	Japan	—
Shikitan	Shiki	Japan	—
Shinmetane	Towa	Japan	—
Study	Toyo	Japan	—
Ulban-Q	Toho	Japan	—
Valate	Morishita	Japan	—
Valemate	Taiho	Japan	—
Valemeton	Sanko	Japan	—
Valethalin	Hokuriku	Japan	—
Valethamin	Sawai	Japan	—

Raw Materials

Benzyl cyanide	2-Butyl bromide
Sodium amide	Sulfuric acid
2-Diethylaminoethanol	Methyl bromide

Manufacturing Process

Benzyl cyanide is first reacted with 2-butylbromide in the presence of sodium amide to give 2-phenyl-3-methylvaleronitrile which is hydrolyzed by sulfuric acid to give 3-methyl-2-phenyl-pentanoic acid. 24 g of 2-phenyl-3-methyl-pentanoic acid are heated for one hour at 175° to 185°C with 30 g of 2-diethylaminoethanol and 0.5 g of sodium methylate. The excess diethyl-aminoethanol is removed in vacuo, the residue is dissolved in 300 cc of 2 N-acetic acid, the acid solution is shaken with ether and made alkaline with concentrated potassium carbonate solution and ice. The ether solution is washed with water, dried with sodium sulfate and evaporated. The residue is distilled under high vacuum, yielding 20 to 21 g of the basic ester (60% of the theoretical) is obtained, the ester boiling at 98° to 100°C at a pressure of 0.03 mm. The hydrochloride of the ester melts at 112° to 113°C and the methbromide at 100° to 101°C.

References

Merck Index 9711

Kleeman & Engel p. 939

I.N. p. 999

Martin, H. and Habicht, E.; U.S. Patent 2,987,517; June 6, 1961; assigned to Cilag Chemie Ltd., Switzerland.

VANCOMYCIN

Therapeutic Function: Antibacterial

Chemical Name: See structural formula

Common Name: —

Structural Formula: Not definitely known; has a molecular weight of about 3,300, a nitrogen content of about 7% and a carbohydrate content of 16 to 17%.

Chemical Abstracts Registry No.: 1404-90-6

Trade Name	Manufacturer	Country	Year Introduced
Vancocin	Lilly	U.S.	1958
Vancomycin	Shionogi	Japan	1981
Vancomycin	Lilly	W. Germany	1981

Raw Materials

Bacterium *Streptomyces orientalis*
Nutrient medium

Manufacturing Process

An agar slant is prepared containing the following ingredients: 20 grams starch, 1 gram asparagine, 3 grams beef extract, 20 grams agar, and 1 liter water. The slant is inoculated with spores of *S. orientalis*, Strain M43-05865, and is incubated for about 10 days at 30°C. The medium is then covered with sterile distilled water and scraped to loosen the spores. The resulting suspension of spores is preserved for further use in the process.

A liquid nutrient culture medium is prepared containing the following ingredients: 15 grams glucose, 15 grams soybean meal, 5 grams corn steep solids, 2 grams sodium chloride, 2 grams calcium carbonate, and 1 liter water. The medium is sterilized at 120°C for about 30 min-

utes in a suitable flask and cooled. 10 ml of a spore suspension prepared as set forth above are used to inoculate the medium. The inoculated medium is shaken for 48 hours at 26°C on a reciprocating shaker having a 2-inch stroke, at 110 rpm.

The fermented culture medium which comprises a vegetative inoculum is used to inoculate a nutrient culture medium containing the following ingredients: 20 grams blackstrap molasses, 5 grams soybean peptone, 10 grams glucose, 20 grams sucrose, 2.5 grams calcium carbonate, and 1 liter water.

The medium is placed in a container having a suitable excess capacity in order to insure the presence of sufficient oxygen and is sterilized by heating at 120°C for about 30 minutes. When cool, the medium is inoculated with about 25 ml of a vegetative inoculum as described above, and the culture is then shaken for about 80 hours at 26°C. The pH of the medium at the beginning of fermentation ranges from about 6.5 to about 7.0 and the final pH is about 7.0 to about 8.0. A fermentation broth thus obtained contained about 180 µg of vancomycin per ml.

References

Merck Index 9731

PDR p. 1070

I.N. p. 1000

REM p. 1211

McCormick, M.H. and McGuire, J.M.; U.S. Patent 3,067,099; December 4, 1962; assigned to Eli Lilly and Company

VERALIPRIDE

Therapeutic Function: Menopause treatment

Chemical Name: N-(1'-Allyl-2'-pyrrolidylmethyl)-2,3-dimethoxy-5-sulfamoylbenzamide

Common Name:

Structural Formula:

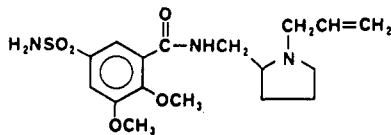

Chemical Abstracts Registry No.: 66644-81-3

Trade Name	Manufacturer	Country	Year Introduced
Agreal	Delagrangre	France	1980
Agradil	Vita	Italy	1982
Veralipral	Finadiet	Argentina	-

Raw Materials

2,3-Dimethoxy-5-sulfamoylbenzoic acid

Carbondiimidazole

1-Allyl-2-aminomethylpyrrolidine

Manufacturing Process

7.8 g (0.03 mol) of 2,3-dimethoxy-5-sulfamoylbenzoic acid, 200 ml of tetrahydrofuran and

7.3 g (0.045 mol) of carbonyldimidazole are placed in a 500 ml flask fitted with an agitator, a thermometer and a condenser.

The mixture is agitated for 30 minutes at normal temperature, then 6.7 g (0.948 mol) of 1-allyl-2-aminomethylpyrrolidine is added. The mixture is left under agitation for 5 hours at 20°C, then the solvent is evaporated under vacuum and the residue treated with 150 ml of water. The crystals are washed and dried.

6.9 g of N-(1'-allyl-2'-pyrrolidyl-methyl)-2,3-dimethoxy-5-sulfamoyl-benzamide is obtained. Yield is 60%; melting point 113°C to 114°C.

References

Merck Index 9745

DFU 6 (1) 46 (1981)

DOT 17 (3) 96 (1981)

I.N. p. 1003

Thominet, M.L. and Perrot, J.; British Patent 1,539,319; January 31, 1979; assigned to Societe d'Etudes Scientifiques et Industrielles de l'Ile-de-France

VERAPAMIL

Therapeutic Function: Coronary vasodilator; antiarrhythmic

Chemical Name: α -[3-[[2-(3,4-Dimethoxyphenyl)ethyl] methylamino] propyl]-3,4-dimethoxy- α -(1-methylethyl)benzeneacetonitrile

Common Name: Iproveratril

Structural Formula:

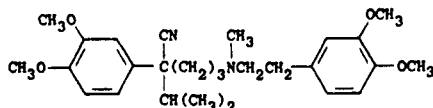

Chemical Abstracts Registry No.: 52-53-9; 152-11-4 (Hydrochloride)

Trade Name	Manufacturer	Country	Year Introduced
Isoptin	Knoll	W. Germany	1963
Isoptin	Knoll	Italy	1965
Isoptin	Knoll	Switz.	1965
Cordilox	Abbott	U.K.	1967
Isopine	Biosedra	France	1969
Calan	Searle	U.S.	1981
Isoptin	Knoll	U.S.	1981
Cardibeltin	Pharma-Schwarz	W. Germany	—
Dilacorán	Knoll	W. Germany	—
Ikacor	Ikapharm	Israel	—
Manidon	Medinsa	Spain	—
Vasolan	Eisai	Japan	—
Veramil	Yurtoglu	Turkey	—
Verpamil	Erco	Denmark	—

Raw Materials

Veratryl cyanide

Sodium amide
(N-Methyl-N-homoveratryl)- γ -aminochloropropane
Isopropyl bromide

Manufacturing Process

177.2 g (1 mol) of veratryl cyanide are dissolved in 1 liter of toluene in a three-neck flask. 42.9 g (1.1 mols) of pulverized sodium amide are added. The mixture is heated to boiling under reflux for one hour while stirring and excluding moisture. A solution of the base (N-methyl-N-homoveratryl)- γ -aminochloropropane, freshly prepared from 339.2 g (1.1 mols) of the hydrochloride, in 1.2 liters of toluene is added drop by drop into this boiling mixture within two hours while stirring vigorously. Heating and stirring are continued for four more hours. After cooling, the reaction mixture is poured into 3 liters of ice water while stirring. The mixture is acidified with 20% hydrochloric acid. The acidified aqueous layer is separated, neutralized by the addition of sodium hydroxide solution, and rendered alkaline by the addition of concentrated potassium carbonate solution. The precipitated oily base is taken up in benzene. On evaporating the solvent, 402 g of the crude base are obtained in the form of a reddish-brown, viscous oil.

The crude base is dissolved in a mixture of 550 ml of isopropanol and 650 ml of ethyl acetate; Gaseous hydrogen chloride is introduced into the solution until it is of weakly acidic reaction. On allowing the mixture to stand at 0°C, 365 g of α -[(N-methyl-N-homoveratryl)- γ -aminopropyl]-3,4-dimethoxyphenylacetonitrile hydrochloride precipitate as a slightly yellowish crystal powder of the melting point 136°C to 139°C (corr.). Yield: 81% of the theoretical yield. The pure, white hydrochloride melting at 140°C to 142°C (corr.) is obtained on recrystallizing the crude salt twice from isopropanol with the addition of decolorizing carbon. The salt is very soluble in water. The base prepared from the hydrochloride in the form of an almost colorless, very viscous oil boils at 233°C to 235°C/0.01 mm Hg; $n_D^{25} = 1.5532$. Dioxalate, melting point: 123°C to 125°C (corr.), on recrystallization from acetone and isopropanol.

61.9 g (0.15 mol) of α -[(N-methyl-N-homoveratryl)- γ -aminopropyl]-3,4-dimethoxyphenyl acetonitrile are dissolved in 300 ml of toluene. The solution is heated to boiling under reflux with 8.5 g (1.45 x 0.15 mols) of pulverized sodium amide for one hour while stirring. Thereafter, a solution of 31.4 g (1.7 x 0.15 mols) of isopropyl bromide in 50 ml of toluene is added drop by drop thereto within 90 minutes and the mixture is kept boiling for four more hours while stirring. The cooled reaction mixture is allowed to run into 1.5 liters of ice water and the mixture is acidified with 20% hydrochloric acid. The aqueous layer is separated and is rendered alkaline by the addition of a solution of potassium carbonate. The base is taken up in warm benzene. The solvent is evaporated and the residue is distilled in a vacuum. 62.6 g of α -isopropyl- α -[(N-methyl-N-homoveratryl)- γ -aminopropyl]-3,4-dimethoxyphenyl acetonitrile are obtained in the form of a light yellow, very viscous oil. Boiling point: 232°C to 235°C/0.01 mm Hg; $n_D^{25} = 1.5460$. Yield: 91.8% of the theoretical yield. Hydrochloride: melting point: 139.5°C to 140.5°C (corr.), on recrystallization from a mixture of isopropanol and ethyl acetate.

References

- Merck Index 9747
Kleeman & Engel p. 940
PDR pp. 979, 1664, 1678
I.N. p. 1003
REM p. 862
Dengel, F.; U.S. Patent 3,261,859; July 19, 1966; assigned to Knoll A.G. Chemische Fabriken (Germany)

VIDARABINE

Therapeutic Function: Antiviral

Chemical Name: 9-β-D-arabinofuranosyl-9H-purine-6-amine monohydrate

Common Name: Adenine arabinoside; spongoadenosine

Structural Formula:

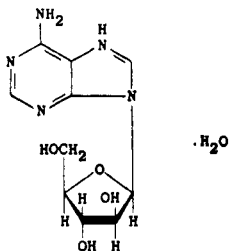

Chemical Abstracts Registry No.: 5536-17-4

Trade Name	Manufacturer	Country	Year Introduced
Vidarabin	Thilo	W. Germany	1975
Vira-A	Parke Davis	U.K.	1977
Vira-A	Parke Davis	U.S.	1977
Vira-A	Substantia	France	1981

Raw Materials

Bacterium *Streptomyces antibioticus*
Nutrient medium

Manufacturing Process

Sterile agar slants are prepared using the *Streptomyces* sporulation medium of Hickey and Tresner, *J. Bact.*, vol. 64, pages 891-892 (1952). Four of these slants are inoculated with lyophilized spores of *Streptomyces antibioticus* NRRL 3238, incubated at 28°C for 7 days or until aerial spore growth is well-advanced, and then stored at 5°C. The spores from the four slants are suspended in 40 ml of 0.1% sterile sodium heptadecyl sulfate solution. A nutrient medium having the following composition is then prepared: 2.0% glucose monohydrate; 1.0% soybean meal, solvent extracted, 44% protein; 0.5% animal peptone (Wilson's protopeptone 159); 0.2% ammonium chloride; 0.5% sodium chloride; 0.25% calcium carbonate; and water to make 100%.

The pH of the medium is adjusted with 10-normal sodium hydroxide solution to pH 7.5. 12 liters of this medium is placed in a 30-liter stainless steel fermentor. The medium is sterilized by heating it at 121°C for 90 minutes, allowed to cool, inoculated with the 40 ml spore suspension described above, and incubated at 25° to 27°C for 32 hours while being agitated at 200 rpm with air being supplied at the rate of 12 liters per minute. About 38 grams of a mixture of lard and mineral oils containing mono- and diglycerides is added in portions during this time to prevent excessive foaming.

16 liters of a nutrient medium having the composition described above is placed in each of four 30-liter stainless steel fermentors. The pH of the medium in each fermentor is adjusted with 10-normal sodium hydroxide solution to pH 7.5, and each is sterilized by heating at 121°C for 90 minutes. Upon cooling, the medium in each fermentor is inoculated with 800 ml of the fermentation mixture described above, and each is incubated at 25° to 27°C for 96 hours while being agitated at 200 rpm with air being supplied at the rate of 16 liters per minute. About 170 grams of the antifoam mixture described above is added in portions during this time to the medium in each fermentor.

The fermentation mixtures from the four fermentors are combined and filtered with the

aid of diatomaceous earth. A material such as Celite 545 can be used. The filtrate is concentrated under reduced pressure to a volume of 10 liters, and the concentrate is treated with 200 grams of activated charcoal (for example, Darco G-60), stirred at room temperature for one hour, and filtered. The charcoal cake is washed with 7.5 liters of water, and then extracted with three 10-liter portions of 50% aqueous acetone. The three aqueous acetone extracts are combined, concentrated under reduced pressure to approximately one liter, and chilled at 5°C for 48 hours. The solid 9-(β -D-arabinofuranosyl)adenine that precipitates is isolated and purified by successive crystallizations from boiling methanol and from boiling water; MP 262° to 263°C.

In the foregoing procedure, when the temperature of incubation in the two fermentation stages is raised from 25° to 27°C to 36° to 38°C, the same 9-(β -D-arabinofuranosyl)adenine product is obtained in higher yields.

References

- Merck Index 9779
 DFU 7 (8) 588 (1982)
 PDR p. 1395
 DOT 13 (9) 387 (1977)
 I.N. p. 1006
 REM p. 1232
 Parke, Davis & Company; British Patent 1,159,290; July 23, 1969

VILOXAZINE HYDROCHLORIDE

Therapeutic Function: Psychotropic

Chemical Name: 2-[(2-ethoxyphenoxy)methyl]morpholine hydrochloride

Common Name: —

Structural Formula:

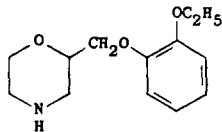

(base)

Chemical Abstracts Registry No.: 35604-67-2; 46817-91-8 (Base)

Trade Name	Manufacturer	Country	Year Introduced
Vivalan	I.C.I.	U.K.	1974
Vivalan	I.C.I.	France	1977
Vivalan	I.C. Pharma	Italy	1977
Vivalan	I.C.I.	W. Germany	1978
Emovit	Farmakhim	Bulgaria	—
Vicilan	I.C.I.	Japan	—
Viloksan	Dif-Dogu	Turkey	—

Raw Materials

- 2-Ethoxyphenol
 Epichlorohydrin
 2-Aminoethyl hydrogen sulfate

Manufacturing Process

2-Ethoxyphenol is first reacted with epichlorohydrin to give 1,2-epoxy-3-(o-ethoxyphenoxy)propane.

A mixture of crude (83%) 1,2-epoxy 3-(o-ethoxyphenoxy)propane (19.4 grams), 70.5 grams 2-aminoethyl hydrogen sulfate, 40.0 grams sodium hydroxide, 400 ml ethanol and 200 ml water is stirred at 60°C for 18 hours and is then evaporated to dryness. The residue is dissolved in 200 ml water and the mixture is extracted three times with 150 ml of diethyl ether each time. The combined extracts are dried over magnesium sulfate and evaporated to dryness. The crude product (21.5 grams) is dissolved in isopropanol (20 ml), 10.5 ml concentrated aqueous hydrochloric acid and 75 ml ethyl acetate are added and the mixture is cooled. The mixture is filtered and there is thus obtained as solid product 2-(o-ethoxyphoxymethyl)morpholine hydrochloride, MP 179° to 182°C (8.6 grams; 38% yield based on total epoxide used), according to U.S. Patent 3,712,890.

References

Merck Index 9781

Kleeman & Engel p. 941

OCDS Vol. 2 p. 306 (1980) & 3, 32 (1984)

DOT 11 (2) 72 (1975)

I.N. p. 1007

Lee, S.A.; U.S. Patent 3,712,890; January 23, 1973; assigned to Imperial Chemical Industries Limited, England

Mallion, K.B., Turner, R.W. and Todd, A.H.; U.S. Patent 3,714,161; January 30, 1973; assigned to Imperial Chemical Industries Limited, England

VIMINOL

Therapeutic Function: Analgesic

Chemical Name: α -[[Bis(1-methylpropyl)amino]methyl]-1-[(2-chlorophenyl)methyl]-1H-pyrrole-2-methanol

Common Name: Diviminol

Structural Formula:

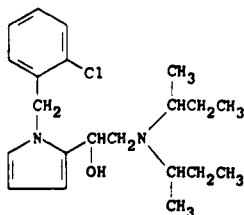

Chemical Abstracts Registry No.: 21363-18-8

Trade Name	Manufacturer	Country	Year Introduced
Dividol	Zambon	Italy	1974
Lenigesial	Inpharzam	W. Germany	1978

Raw Materials

1-(o-Chloro)-benzyl-2-di-sec-butylaminoacetyl-pyrrole
Lithium aluminum hydride

Manufacturing Process

10 g (0.0278 mol) of 1-(o-chloro)-benzyl-2-di-sec-butylaminoacetyl-pyrrole and 300 ml of anhydrous diethyl ether are placed in a 500 ml four-necked flask with a mercury-sealed stirrer, a thermometer, a dropping funnel and a reflux condenser topped with a tube containing anhydrous calcium chloride. The solution is stirred and a mixture of 1 g (0.0264 mol) of lithium aluminum hydride in 20 ml of diethyl ether is added slowly through the dropping funnel at such a rate that the solvent refluxes gently without external heating. When the addition is complete and the initial reaction subsides, the mixture is stirred and heated at gentle reflux for two hours.

The mixture is cooled and the excess of lithium aluminum hydride is decomposed with cracked ice. The water layer is separated and washed with diethyl ether. The combined ether extracts are dried over anhydrous magnesium sulfate and the solvent is removed by distillation under reduced pressure. Yield, 8.8 g; boiling point, 160°C to 165°C/0.1 mm Hg.

References

Merck Index 9782

Kleeman & Engel p. 942

DOT 10 (3) 101 (1974)

I.N. p. 1007

Teotino, U.M. and Della Bella, D.; U.S. Patent 3,539,589; November 10, 1970; assigned to Whitefin Holding S.A. (Switz.)

VINBARBITAL SODIUM

Therapeutic Function: Sedative

Chemical Name: 5-Ethyl-5-(1-methyl-1-butenyl)-2,4,6-(1H,3H,5H)-pyrimidinetrione sodium salt

Common Name: --

Structural Formula:

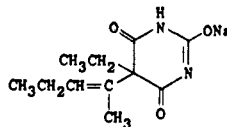

Chemical Abstracts Registry No.: 125-44-0

Trade Name	Manufacturer	Country	Year Introduced
Delvinal	MSD	U.S.	1943

Raw Materials

Ethyl (1-methyl- Δ_1 -butenyl)cianoacetic acid ethyl ester
Sodium
Ethanol
Urea

Manufacturing Process

6.9 parts of sodium are dissolved in 100 parts of absolute ethyl alcohol in a vessel provided with a reflux condenser. After the sodium is dissolved, 9.6 parts of urea and 20.9 parts of

the ethyl ester of ethyl (1-methyl- Δ_1 -butenyl)cianoacetic acid are added. The mixture is refluxed for twelve hours, after which the alcohol is removed by vacuum distillation and the residue is dissolved in 100 parts of water. The resulting solution is extracted with ether in three successive 25 part portions. The nitrile which is formed as a by-product from the cyanoacetate used is recovered from the ether extract by washing with water, evaporating the ether and distilling. The combined water solutions containing 5-ethyl-5-(1-methyl- Δ_1 -butenyl)-4-imino barbituric acid, are acidified until acid to Congo red with concentrated hydrochloric acid, after which the mixture is transferred, if necessary, to another vessel, and an equal volume of concentrated hydrochloric acid is added. The solution is then refluxed for one hour to hydrolyze the imino compound. The 5-ethyl-5-(1-methyl- Δ_1 -butenyl) barbituric acid crystallizes out on cooling. It is filtered and washed with two 25 part portions of ice water. By this process, 8 parts of the crude product (35% yield) have been obtained. After two crystallizations from 50% alcohol, the yield of the purified product is 6.5 parts (29%). The product melts at 160°C to 162°C.

The sodium salt of 5-ethyl-5-(1-methyl- Δ_1 -butenyl)barbituric acid is prepared by dissolving 23 parts of sodium in 350 parts of absolute alcohol in a vessel provided with a reflux condenser containing a drying tube, and adding the resulting solution to a solution of 224 parts of 5-ethyl-5-(1-methyl- Δ_1 -butenyl)barbituric acid dissolved in 300 to 400 parts of absolute alcohol. The resulting solution is concentrated in vacuo, with heating on a warm water bath. About 200 parts of dry benzene are then added and the mixture is again concentrated. If this evaporation is carried out to an extent such that all of the solvent is removed, no further washing is required. If all of the solvent is not removed by evaporation, the residue is washed with dry ether. The resulting sodium salt is then dried in an oven at 90°C and then is dried in vacuo (2 mm) at 78°C. The yield is 97% to 99%.

References

Merck Index 9783

OCDS Vol. 1 p. 269 (1977)

I.N. p. 1007

Cope, A.C.; U.S. Patent 2,187,703; January 16, 1940; assigned to Sharp & Dohme, Inc.

VINBLASTINE SULFATE

Therapeutic Function: Cancer chemotherapy

Chemical Name: Vincalcoloblastine sulfate

Common Name: —

Structural Formula:

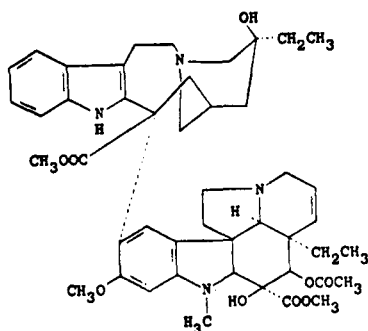

Chemical Abstracts Registry No.: 143-67-9; 865-21-4 (Base)

Trade Name	Manufacturer	Country	Year Introduced
Velban	Lilly	U.S.	1961
Velbe	Lilly	U.K.	1961
Velbe	Lilly	France	1963
Velbe	Lilly	Italy	1965
Blastovin	Teva	Israel	—
Exal	Shionogi	Japan	—
Periblastine	Petersen	S. Africa	—

Raw Materials

Vinca rosea plants
Benzene
Sulfuric acid

Manufacturing Process

According to U.S. Patent 3,225,030, 1,500 grams of dried ground plant of *Vinca rosea* were intimately mixed with 1,000 ml of a 2% tartaric acid solution, and the mixture was extracted with three 9-liter portions of benzene. The benzene extracts were combined and were concentrated in vacuo to about 1,500 ml. The concentrate was mixed with 1 liter of 2% tartaric acid and the mixture was steam-distilled under reduced pressure until all of the benzene had distilled over. The insoluble residue was dissolved in hot methanol, a second 1-liter portion of 2% tartaric acid solution was added, and the mixture was steam-distilled under reduced pressure until all of the methanol had distilled.

The undistilled aqueous tartaric acid solution was extracted with three 1-liter portions of ethylene dichloride, and was then brought to a pH of about 8.5 to 9.5 by the addition of 28% aqueous ammonium hydroxide. The ammoniacal solution was extracted with three 1-liter portions of ethylene dichloride; the ethylene dichloride extracts were combined, were dried, and were evaporated in vacuo, yielding a residue of 3.35 grams of a light-brown powder.

1½ grams of the residue were dissolved in 10 ml of benzene, and the solution was passed over a chromatographic adsorption column containing 50 grams of alumina (Alcoa activated alumina, Grade F-20) which had previously been shaken for about 20 minutes with a mixture of 100 ml of benzene containing 1.5 ml of 10% acetic acid.

The column was developed by washing it with 2,100 ml of benzene. The column was then washed sequentially with 300 ml of benzene-chloroform solvent (95:5 by volume) and 800 milliliters of benzene-chloroform solvent (75:25) to remove indeterminate impurities. The leurosine was eluted from the alumina by passing over the column 900 ml of benzene-chloroform solvent (50:50).

The eluate was evaporated to dryness in vacuo, leaving an amorphous residue of 113 mg of leurosine. The residue was treated with a few ml of methanol in which it quickly dissolved, but from which leurosine quickly precipitated in crystalline form. Because of the affinity of leurosine for water, and the presence of traces of water in the solvents, the leurosine was obtained in the form of its octahydrate. Although the material as obtained was substantially pure, it was further purified by recrystallizing it from hot methanol solution. The hydrated leurosine obtained decomposed at about 200° to 205°C.

Further elution of the above chromatographic column with a 50:50 benzene-chloroform solvent mixture or with a 25:75 benzene-chloroform solvent mixture serves to elute vincal leukoblastine. Vincal leukoblastine also occurs in the latter fractions containing leurosine. Vincal leukoblastine is obtained from vincal leukoblastine-containing fractions by evaporation

to dryness, either of a filtrate from which leurosine has previously been isolated, or from a chromatographic eluate fraction. The resulting residue is dissolved in ethanol and 2% ethanolic sulfuric acid is added until the pH is lowered to about 4. The solution is seeded with crystals of vincalokoblastine sulfate and is chilled for about 24 hours. Vincalokoblastine sulfate, if present, precipitates during this period and can be separated by filtration. Vincalokoblastine sulfate melts at about 284° to 285°C.

References

Merck Index 9784

Kleeman & Engel p. 943

PDR p. 1072

DOT 16 (5) 169 (1980)

I.N. p. 1007

REM p. 1154

Beer, C.T., Cutts, J.H. and Noble, R.L.; U.S. Patent 3,097,137; July 9, 1963; assigned to Canadian Patents and Development, Ltd., Canada

Svoboda, G.H.; U.S. Patent 3,225,030; December 21, 1965; assigned to Eli Lilly and Co.

VINCAMINE

Therapeutic Function: Vasodilator

Chemical Name: 14,15-Dihydro-14-hydroxyeburnamenine-14-carboxylic acid methyl ester

Common Name: —

Structural Formula:

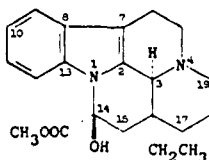

Chemical Abstracts Registry No.: 1617-90-9

Trade Name	Manufacturer	Country	Year Introduced
Pervincamine	Dausse	France	1969
Vincadar	Roussel-Maestretti	Italy	1974
Vincadil	Richter	Italy	1974
Vincapront	Mack	W. Germany	1976
Vincamin	A.G.M.	W. Germany	1976
Aethroma	Mepha	Switz.	—
Alfavinca	Alfar	Spain	—
Anasclerol	Fardeco	Italy	—
Artensen	Cusi	Spain	—
Arteriovinca	Farma-Lepori	Spain	—
Asnai	Durban	Spain	—
Ausomina	Ausonia	Italy	—
Branex	Galepharma Iberica	Spain	—
Centractiva	Larma	Spain	—
Cetal	Parke Davis	W. Germany	—
Cincuental	Nemi	Argentina	—
Equipur	Fresenius	W. Germany	—

Trade Name	Manufacturer	Country	Year Introduced
Esberidin	Schaper & Brunner	W. Germany	—
Horusvin	Horus	Spain	—
Novicet	Schwarzhaupt	W. Germany	—
Oxygeron	Syntex-Pharm	Switz.	—
Perphal	Laphal	France	—
Pervone	Millot	France	—
Tripervan	Roger Bellon	France	—
Vasculogene	Negma	France	—
Vascumine	Pharma	France	—
Vinca	Millot	France	—
Vincabiomar	Biologia Marina	Spain	—
Vincabraïn	Bouchara	France	—
Vincachron	Eurand	Italy	—
Vinca-Ecobi	Ecobi	Italy	—
Vincafarm	Radiumfarma	Italy	—
Vincafolina	Lampugnani	Italy	—
Vincafor	Clin-Comar-Byla	France	—
Vincagalup	Galup	Spain	—
Vincagil	Sarsa	Brazil	—
Vincahexal	Durachemie	W. Germany	—
Vincalen	Firma	Italy	—
Vincamidol	Magis	Italy	—
Vincanor	Theranol	France	—
Vinca-Tablinen	Sanorania	W. Germany	—

Raw Materials

Vincadiformine	Sodium hydride
Trimethylphosphite	Oxygen

Manufacturing Process

The following route is described in U.S. Patent 4,145,552: At ambient temperature, over a period of thirty minutes, a solution of 33.8 g (0.1 mol) of (–)-vincadiformine in a mixture of 140 ml of anhydrous dimethylformamide and 140 ml of anhydrous toluene is added to a suspension of 2.64 g (0.11 mol) of sodium hydride in a mixture of 200 ml of anhydrous tetrahydrofuran, 20 ml of anhydrous hexamethylphosphotriamide (EMPT) and 18.7 ml (0.14 mol) of trimethyl phosphite. When the release of hydrogen has finished (about two hours later), the solution is cooled to –10°C and then stirred under an oxygen atmosphere until absorption ceases (duration: 3 hours). Still at –10°C, 136 ml of glacial acetic acid are added, and the mixture is then left at ambient temperature for two hours. After the addition of 500 ml of 1 N sulfuric acid, the aqueous phase is isolated, reextracted with 150 ml of isopropyl ether, made alkaline with 350 ml of 11 N ammonia, then extracted 3 times with 300 ml aliquots of methylene chloride. After drying over calcium chloride and evaporating the solvent, 30.2 g of crude product are obtained which, when chromatographed on a column of silica gel (1.5 kg) yield, 9.9 g of vincamine (yield: 28%) melting point (decomp.): 250°C.

References

- Merck Index 9785
 Kleeman & Engel p. 944
 I.N. p. 1008
 Kuehne, M.E.; U.S. Patent 3,454,583; July 8, 1969; assigned to U.S. Secretary of Health, Education and Welfare
 Heymes, A.; U.S. Patent 4,145,552; March 20, 1979; assigned to Parcor (France)

VINCRIStINE SULFATE

Therapeutic Function: Cancer chemotherapy

Chemical Name: Leurocristine sulfate

Common Name: —

Structural Formula: The N-methyl group in vinblastine (which see) is replaced by N-CHO.

Chemical Abstracts Registry No.: 2068-78-2; 57-22-7 (Base)

Trade Name	Manufacturer	Country	Year Introduced
Oncovin	Lilly	U.S.	1963
Oncovin	Lilly	France	1964
Vincristin	Lilly	W. Germany	1965
Vincristina	Lilly	Italy	1966
Oncovin	Lilly	U.K.	1966
Cristovin	Teva	Israel	—
Kyocristine	Kyorin	Japan	—
Leucid	Leo	Sweden	—
Pericristine	Petersen	S. Africa	—
Vincosid	Leo	Sweden	—

Raw Materials

Vinca rosea plants
Benzene
Sulfuric acid

Manufacturing Process

The alkaloid mixture from the extraction of *Vinca rosea* plants (as in vinblastine extraction) was chromatographed to give vincristine which was then converted to the sulfate, according to U.S. Patent 3,205,220.

Vincristine may also be prepared in a semisynthetic process starting from vinblastine. Vinblastine or a salt thereof, preferably the sulfate, is oxidized with chromic acid or with one of its salts at a low temperature, the reaction mixture is neutralized or rendered alkaline and the product is separated therefrom by extraction, the extract is evaporated to dryness, the dry residue is optionally formylated, vincristine, and optionally N-demethylvinblastine also, are isolated from the product, and the product(s) are optionally converted into their salts; preferably into the sulfates, according to U.S. Patent 3,899,493.

References

Merck Index 9788

Kleeman & Engel p. 948

PDR p. 1066

DOT 16 (5) 173 (1980)

I.N. p. 1009

REM p. 1154

Svoboda, G.H., Barnes, A.J. Jr. and Armstrong, R.J.; U.S. Patent 3,205,220; September 7, 1965; assigned to Eli Lilly & Co.

Jovanovics, K., Szasz, K., Fekete, G., Bittner, E., Dezseri, E. and Eles, J.; U.S. Patent 3,899,493; August 12, 1975; assigned to Richter Gedeon Vegyeszeti Gyar R.T.

VINDESINE

Therapeutic Function: Antineoplastic

Chemical Name: 4-Desacetyl-vinblastine-C-3-carboxamide

Common Name: —

Structural Formula:

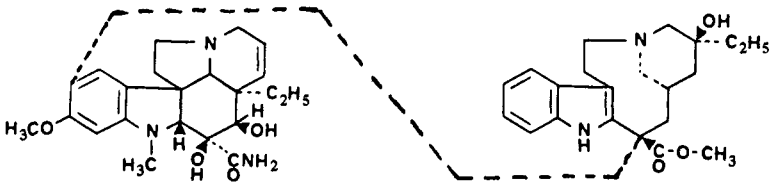

Chemical Abstracts Registry No.: 53643-48-4

Trade Name	Manufacturer	Country	Year Introduced
Eldisine	Lilly	France	1980
Eldisine	Lilly	U.K.	1980
Eldisine	Lilly	W. Germany	1980
Eldisin	Serum Impfst.	Switz.	1982

Raw Materials

Vinblastine
Ammonia

Manufacturing Process

About 10 g of VLB (vincalucoblastine or simply vinblastine) sulfate were converted by standard procedures to VLB free base. The free base, obtained as a residue after evaporation of the dried ethereal solvent, was dissolved in about 200 ml of anhydrous methanol. Anhydrous liquid ammonia (300 ml) was added, and the reaction mixture sealed and maintained at about 100°C for 60 hours. The reaction vessel was opened, and the contents removed and evaporated to dryness in vacuo. The resulting residue, containing 4-desacetyl VLB C-3 carboxamide, as shown by thin layer chromatography, were combined and the solvent evaporated therefrom in vacuo, yielding as a residue purified 4-desacetyl VLB C-3 carboxamide free base. The NMR and IR spectra of the solid free base confirmed the structure indicated. The free base showed a band in the infrared at $1,687\text{ cm}^{-1}$, characteristic of the amide function. The molecular weight of the free base determined by mass spectroscopy was 753 which is in agreement with theoretical value calculated for $\text{C}_{43}\text{H}_{55}\text{N}_5\text{O}_7$.

References

- Merck Index 9789
 DFU 3 (5) 401 (1978)
 Kleeman & Engel p. 948
 DOT 16 (5) 173 & (6) 198 (1980)
 I.N. p. 1009
 REM p. 1157
 Cullinan, G.J. and Gerzon, K.; U.S. Patent 4,203,898; May 20, 1980; assigned to Eli Lilly and Company

VIOMYCIN

Therapeutic Function: Antitubercular

Chemical Name: See structural formula

Common Name: —

Structural Formula:

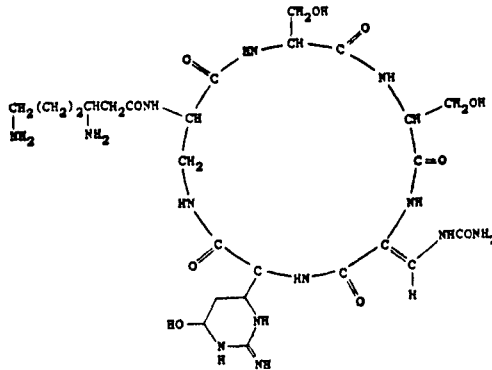

Chemical Abstracts Registry No.: 32988-50-4; 37883-00-4 (Sulfate)

Trade Name	Manufacturer	Country	Year Introduced
Vinactane	Ciba	U.S.	1953
Viocin	Pfizer	U.S.	1953
Panto-Viocine	Pfizer	France	—
Viomicin	Parke Davis Sankyo	Japan	—
Viomycin	Parke Davis	U.S.	—
Viomycin Pfizer	Taito Pfizer	Japan	—

Raw Materials

Bacterium *Actinomyces vinaceus*
Nutrient medium

Manufacturing Process

Viomycin is produced by inoculating a nutrient medium with a viable strain of the organism *Actinomyces vinaceus*. A method for the production of viomycin is set forth in U.S. Patent 2,663,445 comprising inoculating a medium containing soy peptone, beef extract, dextrose, sodium chloride and a silicone antifoaming agent with a spore suspension of *Actinomyces vinaceus* and incubating the inoculated medium for 120 hours at a temperature of 26°C while passing sterile air through the medium at a rate of 500 ml per liter of medium per minute.

References

Merck Index 9805

Kleeman & Engel p. 949

I.N. p. 1010

REM p. 1212

Marsh, W.S., Mayer, R.L., Mull, R.P., Scholz, C.R. and Townley, R.W.; U.S. Patent 2,633,445; March 31, 1953; assigned to Ciba Pharmaceutical Products, Inc.

Freaney, T. E.; U.S. Patent 2,828,245; March 25, 1958; assigned to Commercial Solvents Corporation

VIQUIDIL

Therapeutic Function: Vasodilator; antiarrhythmic

Chemical Name: 3-(3-Ethenyl-4-piperidiny)-1-(6-methoxy-4-quinoliny)-1-propanone

Common Name: Quinotoxine; mequiverine; chinicine; quinotoxol

Structural Formula:

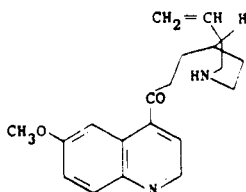

Chemical Abstracts Registry No.: 84-55-9

Trade Name	Manufacturer	Country	Year Introduced
Desclidium	Spret	France	1972
Desclidium	Rorer	Italy	1973
Desclidium	Badische	W. Germany	1979
Chinotoxin	Badische	W. Germany	—
Permiran	Lab. Franc. Therap.	France	—

Raw Materials

N-Benzoylhomomeroquinene ethyl ester	Ethyl quininate
Sodium ethoxide	Hydrogen chloride

Manufacturing Process

2.70 g of N-benzoylhomomeroquinene ethyl ester (0.0086 mol) are mixed with 4.0 g of ethyl quininate (0.0173 mol = 100% excess). 1.4 g of absolutely dry pulverulent sodium ethoxide (0.0207 mol - 140% excess, based on N-benzoylhomomeroquinene ethyl ester) is added, and the reaction mixture is heated to about 80°C with continuous stirring. As the ethyl quininate melts, and the materials become thoroughly mixed, the initial yellow color changes to brown and then gradually to deep red. The reaction mixture is maintained at about 82°C for fourteen hours with continuous stirring. It is then cooled, and the resulting very hard, dark red mass is decomposed with ice water and benzene. The (not entirely clear) combined aqueous layers are extracted with a small amount of ether. The clear, deep red, aqueous layer is then made just acid to litmus. The precipitated oil is taken up in ether. Evaporation of solvent, finally in vacuo, gives 2.56 g of a red glass. The combined benzene and ether extracts from above, containing largely neutral material, are extracted with 10% aqueous sodium hydroxide. The alkaline extract is made just acid to litmus, and extraction with ether followed by removal of solvent gives a further small quantity of β -ketoester, 0.16 g.

Total weight of N-benzoylquinotoxine carboxylic acid ethyl ester thus obtained was 2.72 g, equivalent to 63.4% of the theoretical.

2.72 g of N-benzoylquinotoxine carboxylic acid ethyl ester are dissolved in 30 cc of 1:1 aqueous hydrochloric acid (from 15 cc concentrated hydrochloric acid and 15 cc water). The clear, reddish-orange solution is then boiled under reflux for four hours. The very dark reddish-brown solution is extracted with ether (from this extract 0.50 g of benzoic acid is obtained on evaporation). The aqueous solution is then made strongly alkaline and extracted with ether. 0.23 g of ether-insoluble interface material is dissolved in benzene and set aside. Removal of solvent from the above ether extract gives 1.39 g of crude quinotoxine as a dark red viscous oil.

References

Merck Index 9808

DOT 8 (4) 156 (1972)

I.N. p. 1010

Woodward, R.B. and Doering, W.V.; U.S. Patent 2,500,444; March 14, 1950; assigned to Polaroid Corp.

VISNADINE

Therapeutic Function: Coronary vasodilator

Chemical Name: 2-Methylbutyric acid 9-ester with 9,10-dihydro-9,10-dihydroxy-8,8-dimethyl-2H,8H-benzo[1,2-b:3,4-b']dipyran-2-one acetate

Common Name: —

Structural Formula:

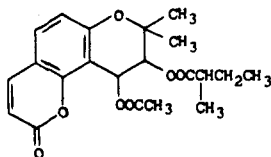

Chemical Abstracts Registry No.: 477-32-7

Trade Name	Manufacturer	Country	Year Introduced
Vibeline	Bellon	France	1960
Carduben	Madaus	W. Germany	1968
Provismine	Bellon	France	—
Visnamine	Chinoïn	Japan	—

Raw Materials

Ammi visnaga plants

Manufacturing Process

Ammi visnaga is a plant of the Umbelliferae family, which has been known and used for its therapeutic properties by the peoples of the Mediterranean basin since time immemorial.

Visnadine may be extracted from the umbels of *Ammi visnaga* by an organic solvent having a boiling point less than 110°C. The resulting solution is concentrated first by heating in a water bath and then is allowed to stand some time at a temperature of about 20°C and if necessary is treated for separation of gummy constituents therefrom, after which the solution is concentrated under reduced pressure. Finally, the crude product is crystallized and separated by retaining it on a filter.

This crude product may then, according to the process, be purified by mixing it with petroleum ether and allowing it to stand at ordinary temperature, then filtering it to obtain the pure visnadine.

References

Merck Index 9815

Kleeman & Engel p. 950

I.N. p. 1011

Le Men, J.G.; U.S. Patent 2,995,574; August 8, 1961; assigned to Laboratoire Roger Bellon S.A. (France)

W

WARFARIN SODIUM

Therapeutic Function: Anticoagulant

Chemical Name: 3-(α -acetylbenzyl)-4-hydroxycoumarin sodium salt

Common Name: —

Structural Formula:

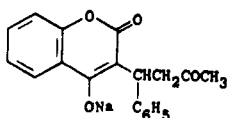

Chemical Abstracts Registry No.: 129-06-6; 81-81-2 (Base)

Trade Name	Manufacturer	Country	Year Introduced
Coumadin	Endo	U.S.	1954
Prothromadin	Harvey	U.S.	1956
Athrombin	Purdue Frederick	U.S.	1959
Coumadine	Merrell	France	1959
Panwarfin	Abbott	U.S.	1960
Adoisine	Delalande	France	—
Aldocumar	Aldo Union	Spain	—
Dicusat	Ferrosan	Denmark	—
Marevan	Orion	Finland	—
Tintorane	A.C.F.	Neth.	—
Waran	Nyegaard	Norway	—
Warcoumin	Harvey	Australia	—
Warfilone	Merck-Frosst	Canada	—

Raw Materials

4-Hydroxycoumarin
Benzalacetone
Sodium hydroxide

Manufacturing Process

About 0.1 mol each of 4-hydroxycoumarin and benzalacetone are dissolved, in any desired order, in about three times their combined weight of pyridine. The solution is refluxed for about 24 hours, and then allowed to cool; after which it is poured into about 15 volumes of water, and acidified to about pH 2 by the addition of hydrochloric acid. An oil separates, and on cooling and standing overnight solidifies. The solid product is recovered, as by filtration, and recrystallized from ethanol, according to U.S. Patent 2,427,578.

The base melts at about 161°C. It is a white crystalline solid, soluble in hot ethyl alcohol

and substantially insoluble in cold water; it dissolves in alkali solutions with formation of the salt. The yield is about 40%.

Then, as described in U.S. Patent 2,777,859, warfarin may be reacted with NaOH to give a sodium salt solution. Crystalline warfarin sodium may be prepared as described in U.S. Patent 2,765,321.

References

Merck Index 9852

Kleeman & Engel p. 950

PDR pp. 545, 852, 1606

OCDS Vol. 1 p. 331 (1977)

I.N. p. 1015

REM p. 827

Stahmann, M.A., Ikawa, M. and Link, K.P.; U.S. Patent 2,427,578; September 16, 1947; assigned to Wisconsin Alumni Research Foundation

Schroeder, C.H. and Link, K.P.; U.S. Patent 2,765,321; October 2, 1956; assigned to Wisconsin Alumni Research Foundation

Link, K.P.; U.S. Patent 2,777,859; January 15, 1957; assigned to Wisconsin Alumni Research Foundation

X

XANTHINOL NIACINATE

Therapeutic Function: Peripheral vasodilator

Chemical Name: 3-Pyridine carboxylic acid compounded with 3,7-dihydro-7-[2-hydroxy-3-[(2-hydroxymethyl)methylamino] propyl]-1,3-dimethyl-1H-purine-2,6-dione(1:1)

Common Name: —

Structural Formula:

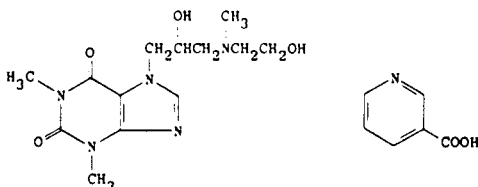

Chemical Abstracts Registry No.: 437-74-1

Trade Name	Manufacturer	Country	Year Introduced
Complamex	Calder	U.K.	1971
Adrogeron	Adroka	Switz.	—
Angioamin	Dompe	Italy	—
Circular	Unipharm	Israel	—
Complamin	Riker	U.S.	—
Digi-Complamin	Beecham-Wulfing	W. Germany	—
Emodinamin	Sigurta	Italy	—
Jupal	Arzneimittelwerk Dresden	E. Germany	—
Landrina	Landerlan	Spain	—
Niconicol	Farmos	Finland	—
Retilian	Kwizda	Austria	—
Sadamin	Polfa	Poland	—
Teonicol	Farmos	Finland	—
Vasoprin	Alfa	Italy	—
Vedrin	Polifarma	Italy	—
Xanidil	Spofa	Czechoslovakia	—
Xavin	Chinoin	Hungary	—

Raw Materials

Epichlorohydrin
Methylaminoethanol

Theophylline
Nicotinic acid

Manufacturing Process

To a well-stirred solution of 740 parts by weight of epichlorohydrin in 200 parts by volume of isopropyl alcohol are added 600 parts by weight of methylaminoethanol during about 3

hours at 15°C to 20°C. The heat generated by the condensation is removed by means of a cooling bath. After the addition of the total quantity of methylaminoethanol, stirring is continued for 1 hour at 25°C. The condensation reaction is completed when development of heat reaction can no longer be observed. The solution thus produced of the raw 1-chloro-3-(methylhydroxyethylamino)-propanol-2 in isopropyl alcohol is a colorless viscous liquid which is used without further purification for the subsequent condensation with theophylline.

320 parts by weight of caustic soda are dissolved in 200 parts by weight of water and diluted with 6,000 parts by weight of isopropyl alcohol. 1,584 parts by weight of theophylline-hydrate are added to the well-stirred alcoholic caustic soda solution having a temperature between 50°C to 60°C. As a result, most of the theophylline sodium salt is precipitated and a doughy or pasty white reaction product is formed. While being stirred and heated to the boiling point of alcohol, the solution of the afore-described 1-chloro-3-(methylhydroxyethylamino)-propanol-2 is added dropwise into the reaction vessel during about 3 hours. After further cooking for 2 hours, the alcoholic solution of deposited sodium chloride is filtered off. By vaporizing the alcohol, the 3-(methylhydroxyethylamino)-2-hydroxypropyltheophylline can be obtained as a very viscous oil which contains impurities in the form of by-products.

For purpose of purification, the hot alcoholic solution is mixed with 975 parts by weight of nicotinic acid while being stirred and heated until the nicotinic acid is completely dissolved.

The 3-(methylhydroxyethylamino)-2-hydroxypropyltheophylline-nicotinate separates, while still being warm, in the form of shiny, thin, small sheets. After cooling, the crystallization product is sucked off from the mother liquor and recrystallized from 85% isopropyl alcohol.

The melting point of the pure nicotinic acid salt is 180°C and the yield is 75% to 80% related to the used theophylline. The substance has a nearly neutral reaction and is very readily soluble in water.

References

Merck Index 9871

Kleeman & Engel p. 951

I.N. p. 1018

Bestian, A.H.W.; U.S. Patent 2,924,598; February 9, 1960; assigned to Firma Johann A. Wulffing (Germany)

XIBORNOL

Therapeutic Function: Antibacterial

Chemical Name: 6-Isobornyl-3,4-xylenol

Common Name: —

Structural Formula:

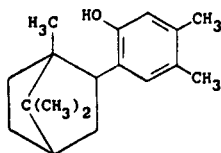

Chemical Abstracts Registry No.: 13741-18-9

Trade Name	Manufacturer	Country	Year Introduced
Nanbacine	Fournier	France	1976
Xibol	Reig Jofre	Spain	—

Raw Materials

3,4-Xylenol
Camphene

Manufacturing Process

100 g of 3,4-xylenol and 150 g of camphene are melted in a two-necked flask equipped with a reflux condenser and a thermometer. 10 g of stannic chloride are added in small quantities; the temperature is kept between 70°C and 80°C for 4 hours. The mass is then allowed to cool and 300 ml of benzene and 300 ml of water are added. The aqueous layer is decanted off, and the supernatant organic layer is washed, first with 1,200 ml of 10% potassium hydroxide and then with water until neutral. The benzene is driven off and the mass is distilled. The fraction which passes between 203°C and 223°C/200 mm Hg is collected and recrystallized in petroleum ether.

100 mg of the recrystallized product is dissolved in 10 ml of hexane.

This solution is then slowly passed through a chromatographic alumina column, 20 cm in length and 16 mm in diameter, containing 20 g of alumina (Prolabo®).

The column is then eluted with benzene and 2 ml fractions of the eluent are collected as soon as the product appears in the eluent. The presence of the product is detected by means of the color change in the collected eluent after adding 1 drop of 2% ferric chloride and 2 drops of 5% potassium ferricyanide solution.

18 ml of a first fraction are collected, the next 2 ml of eluent are discarded and then a second fraction of 20 ml is collected. Removal of the solvent from the first fraction by distillation leaves a product having a melting point of between 94°C and 96°C and removal of the solvent from the second fraction leaves a product having a melting point between 86°C and 88°C.

The product remaining from the first fraction is 6-isobornyl-3,4-xylenol while that from the second fraction is its isomer 6-exo-isocamphenyl-3,4-xylenol.

References

Merck Index 9887

Kleeman & Engel p. 952

DOT 8 (6) 235 (1972)

I.N. p. 1019

Mar-Pha, Societe d'Etude et d'Exploitation de Marques; British Patent 1,206,774; Sept. 30, 1970

XIPAMID

Therapeutic Function: Diuretic; antihypertensive

Chemical Name: 4-chloro-5-sulfamoyl-2',6'-salicyloxyllidide

Common Name: —

Structural Formula:

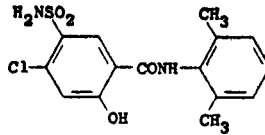

Chemical Abstracts Registry No.: 14293-44-8.

Trade Name	Manufacturer	Country	Year Introduced
Aquaphor	Beiersdorf	W. Germany	1971
Diurexan	Merck	U.K.	1979
Aquaphor	Farmades	Italy	1980
Aquaphoril	Homburg	W. Germany	—
Diurex	Lacer	Spain	—

Raw Materials

4-Chlorosalicylic acid	Chlorosulfonic acid
Ammonia	2,6-Dimethylaniline
Phosphorus trichloride	

Manufacturing Process

The 4-chloro-5-sulfamyl salicylic acid used as starting point was prepared in the following way:

(a) *4-Chloro-5-Chlorosulfonyl Salicylic Acid*: 100 grams 4-chloro salicylic acid was added portionwise with stirring at about -5°C to 275 ml chlorosulfonic acid. The temperature was not allowed to rise above $+3^{\circ}\text{C}$. At the end of the addition, the solution formed was stirred for 1 hour in an ice bath, then for 1 hour at 20°C and finally for $2\frac{1}{2}$ hours at 80°C oil bath temperature. Then the dark brown solution, after ensuing slow cooling with vigorous stirring, was poured onto ice; the precipitate was vacuum filtered, washed with water and dried. After recrystallization from toluene the compound formed had a melting point of 181° to 183°C .

(b) *4-Chloro-5-Sulfamyl Salicylic Acid*: 40 grams 4-chloro-5-chlorosulfonyl salicylic acid obtained from (a) was added portionwise with stirring to 250 ml liquid ammonia. This was allowed to stand for 2 hours, then the precipitate was vacuum filtered and dissolved in 500 ml water. The solution was filtered and the filtrate was treated with 2 N hydrochloric acid until no more precipitation occurred. The 4-chloro-5-sulfamyl salicylic acid obtained as the precipitate was filtered off and finally recrystallized from water, MP 258° to 260°C .

5.0 grams 4-chloro-5-sulfamyl salicylic acid was suspended in 100 ml water-free chlorobenzene and then 2.44 grams of 2,6-dimethylaniline and 0.9 ml phosphorus trichloride were added to the suspension in turn. The reaction mixture was heated under reflux for 5 hours. After cooling, the chlorobenzene was separated from the precipitate by decantation. The latter was finally collected on a filter and washed, first with chlorobenzene and, after drying, with 2 N hydrochloric acid and water. The compound obtained by recrystallization from methanol had a melting point of 256°C .

References

- Merck Index 9888
 Kleeman & Engel p. 952
 OCDS Vol. 2 p. 93 (1980)
 DOT 7 (6) 227 (1971)
 I.N. p. 1019
 Liebenow, W.; U.S. Patent 3,567,777; March 2, 1971; assigned to P. Beiersdorf & Co., AG, Germany

XYLOMETAZOLINE HYDROCHLORIDE

Therapeutic Function: Adrenergic (vasoconstrictor)

Chemical Name: 2-[[4-(1,1-Dimethylethyl)-2,6-dimethylphenyl] methyl]-4,5-dihydro-1H-imidazole hydrochloride

Common Name: —

Structural Formula:

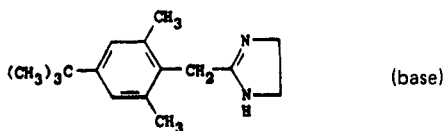

Chemical Abstracts Registry No.: 1218-35-5; 526-36-3 (Base)

Trade Name	Manufacturer	Country	Year Introduced
Otrivin	Geigy	U.S.	1959
Coryzin	Star	Finland	—
Hidropid	Pliva	Yugoslavia	—
Ilvanol	Siegfried	W. Germany	—
Novorin	Polfa	Poland	—
Olynth	Goedecke	W. Germany	—
Servilaryn	Servipharm	Switz.	—
Sinutab	Parke Davis	U.S.	—

Raw Materials

p-tert-Butyl-o,o'-dimethylphenylacetonitrile
 Ethylenediamine
 Hydrogen chloride

Manufacturing Process

62 grams of para-tertiary-butyl-ortho,ortho'-dimethyl-phenyl-acetonitrile [obtainable, for example, by the method of Buu-Hoi and P. Cagniant, *Bulletin de la Societe Chimique de France*, volume 9, page 891 (1942)], 20.6 grams of ethylenediamine of 96% purity and 1.55 cc of carbon disulfide are heated together in a distillation flask with the exclusion of moisture for 48 hours on a boiling water bath. Ammonia is evolved. Upon cooling the reaction product solidifies and is then dissolved in benzene, the solution is filtered while hot with the addition of animal charcoal and petroleum ether is added. The mixture is filtered to remove the impurities that are first precipitated and by the further addition of petroleum ether 2-(para-tertiary-butyl-ortho,ortho'-dimethyl-phenyl-methyl)-imidazoline is caused to crystallize out.

The product melts at 131° to 133°C after being recrystallized from a mixture of benzene and petroleum ether. It can be converted into its hydrochloride as follows:

189 grams of 2-(para-tertiary-butyl-ortho,ortho'-dimethyl-phenyl-methyl)-imidazoline are dissolved in 400 cc of absolute ethanol, the solution is rendered acid by the addition of 104 cc of an ethanolic solution of hydrochloric acid of 30% strength, the mixture is filtered with the addition of animal charcoal, and dry ethyl acetate and absolute ether are added until crystallization sets in. After cooling the mixture, the salt is filtered off with suction and crystallized several times from absolute ethanol with the use of animal charcoal and the addition of dry mixture of ethyl acetate and ether. The hydrochloride so obtained melts at 327° to 329°C (with decomposition).

References

Merck Index 9895

Kleeman & Engel p. 953

PDR p. 898

OCDS Vol. 1 p. 242 (1977)

I.N. p. 1020

REM p. 891

Hueni, A.; U.S. Patent 2,868,802; January 13, 1959; assigned to Ciba Pharmaceutical Products Inc.

Z

ZERANOL

Therapeutic Function: Estrogen

Chemical Name: 3,4,5,6,7,8,9,10,11,12-Decahydro-7,14,16-trihydroxy-3-methyl-1H-2-benzoxacyclotetradecin-1-one

Common Name: Zearalanol, tetrahydro F.E.S. (fermentation estrogenic substance)

Structural Formula:

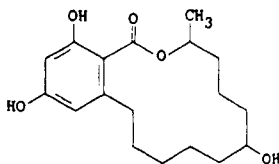

Chemical Abstracts Registry No.: 26538-44-3

Trade Name	Manufacturer	Country	Year Introduced
Ralone	I.C.I.	Italy	1975
Frideron	Sandoz	Italy	—
Ralgro	Comm. Solvents	Italy	—

Raw Materials

Bacterium *Gibberella zeae*
Nutrient medium
Hydrogen

Manufacturing Process

A spore sand culture containing *Gibberella zeae* (Gordon) NRRL-2830 was aseptically placed in a sterile tube containing 15 ml of Czapek's-Dox solution and a small amount of agar. This medium was then incubated for about 168 hours at approximately 25°C. At the end of the incubation period, the medium was washed with 5 ml of sterile deionized water and transferred to a sterile tube containing 45 ml of Czapek's-Dox solution. The contents of the tube were then incubated for about 96 hours at about 25°C after which the material was available for use in inoculation of a fermentation medium.

To a 2-liter flask were added 300 g of finely divided corn. The flask and its contents were then sterilized and after sterilization 150 ml of sterile deionized water were added. To the mixture in the flask were then added 45 ml of the inoculum prepared by the process and the material was thoroughly mixed. The mixed material was then incubated for about 20 days at 25°C in a dark room in a water-saturated atmosphere. The following illustrates the recovery of the anabolic substance from the fermentation medium.

A 300-g portion of fermented material was placed in 500 ml of deionized water and slurried.

The slurry was then heated for about 15 minutes at 75°C, 300 g of filter aid were then added and the material was filtered. The solid filtered material containing the anabolic substance was then air dried, and 333 g of the dried cake were then extracted with 500 ml of ethanol. This procedure was repeated three more times. The ethanol extract was then dried under vacuum to give 6.84 g of solid material. This solid material was then dissolved in 20 ml of chloroform and extracted with 30 ml of an aqueous solution containing 5% by weight of sodium carbonate having an adjusted pH of about 11.2. The extraction process was repeated seven more times. The pH of the sodium carbonate extract was then adjusted to 6.2 with hydrochloric acid, to yield an anabolic substance-containing precipitate. The precipitate and the aqueous sodium carbonate extract were then each in turn extracted with 75 ml of ethyl ether. This procedure was repeated three more times to yield a light yellow ethereal solution, which was then dried to yield 116 mg of solid anabolic substance. This material was then subjected to multiple transfer countercurrent distribution using 100 tubes and a solvent system consisting of two parts chloroform and two parts methanol and one part water as the upper phase, all parts by volume. The solid material obtained from the multiple transfer countercurrent distribution was then tested for physiological activity according to the well-known mouse-uterine test. The fermentation estrogenic substance produced has the formula:

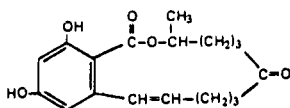

Tetrahydro F.E.S. was produced by dissolving 0.5 g F.E.S. in 200 ml of ethanol. The F.E.S. was reduced by contacting the solution with hydrogen for 3 hours at 30°C and 1,000 psi using 2 g of Raney nickel as a catalyst. After filtering and concentrating the reaction mixture, the product was washed with 2 to 3 ml of 2-nitropropane and crystallized. It was found to have a melting point from 143°C to 160°C.

References

Merck Index 9923

Kleeman & Engel p. 953

DOT 12 (6) 243 (1976)

I.N. p. 1023

Hodge, E.B., Hidy, P.H. and Wehrmeiser, H.L.; U.S. Patent 3,239,345; March 8, 1966; assigned to Commercial Solvents Corp.

Andrews, F.N. and Stob, M.; U.S. Patent 3,196,019; July 20, 1965; assigned to Purdue Research Foundation

ZIMELIDINE

Therapeutic Function: Antidepressant

Chemical Name: 3-(4-Bromophenyl)-N,N-dimethyl-3-(3-pyridinyl)-2-propen-1-amine

Common Name: —

Structural Formula:

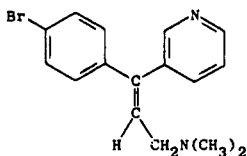

Chemical Abstracts Registry No.: 56775-88-3

Trade Name	Manufacturer	Country	Year Introduced
Normud	Astra	W. Germany	1981
Zelmid	Astra	U.K.	1982
Normud	Astra	Switz.	1982
Zelmid	Astra	Sweden	1983

Raw Materials

ω -Dimethylamino-4'-bromopropiophenone
 3-Bromopyridine
 n-Butyllithium
 Sulfuric acid

Manufacturing Process

To 9 g of n-butyllithium in 200 ml of dry ether 20 g of 3-bromopyridine is added as quickly as possible at -40°C without raising the temperature. When the addition is finished the mixture is stirred for another 30 minutes. Thereafter 32.5 g of ω -dimethylamino-4'-bromopropiophenone is added in such a way that the temperature does not exceed -40°C . The cooling is discontinued and the mixture is stirred during the night whereupon the reaction mixture is poured onto ice and diluted HCl, which is washed with ether and is extracted with 20 ml of methylene dichloride. The methylene dichloride is dried and evaporated. The crystals are dissolved in water, which then is made alkaline with a solution of Na_2CO_3 , is extracted with ether, dried, and evaporated and recrystallized from isopropyl ether, petroleum ether 1:1. Yield 4 g of 1-(4'-bromophenyl)-3-(N,N-dimethylamino)-1-(3''-pyridyl)-propanol. Melting point 67°C .

3.6 g of 1-(4'-bromophenyl)-3-(N,N-dimethylamino)-1-(3''-pyridyl)-propanol are dissolved in 15 ml of 85% H_2SO_4 and heated at 170°C for 10 minutes. The reaction mixture is poured into 60 ml of water, which is then made alkaline with 10N NaOH, and is extracted with 2 X 25 ml of ether. The ether is dried with Na_2SO_4 , treated with active carbon and evaporated. The residue is dissolved in 25 ml of acetone and an equivalent amount of oxalic acid dissolved in 25 ml of acetone is added. The precipitate obtained is filtered off, is dissolved in 50 ml of water, which is made alkaline with 10N NaOH and is extracted with 2 X 25 ml of ether. The ether solution is dried with Na_2SO_4 and is filtered, whereupon dry HCl is introduced. The precipitate obtained is filtered off. Yield 1.2 g of 3-(4'-bromophenyl)-3-(3''-pyridyl)-dimethylallylamine dihydrochloride (H 102/09). Melting point 193°C .

References

Merck Index 9924
 DFU 3 (1) 71 (1978)
 OCDS Vol. 3 p. 49 (1984)
 DOT 18 (9) 449 (1982)
 I.N. p. 1023
 Berntsson, P.B., Carlsson, P.A.E. and Corrodi, H.R.; U.S. Patent 3,928,369; December 23, 1975; assigned to A.B. Hassle (Sweden)

ZIPEPROL

Therapeutic Function: Bronchodilator

Chemical Name: 4-(2-methoxy-2-phenylethyl)- α -(methoxyphenylmethyl)-1-piperazine-ethanol

Common Name: —

Structural Formula:

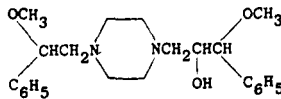

Chemical Abstracts Registry No.: 34758-83-3; 34758-84-4 (Dihydrochloride).

Trade Name	Manufacturer	Country	Year Introduced
Respilene	Winthrop	France	1973
Respilene	Sigma Tau	Italy	1979
Antituxil	Ghimas	Italy	—
Bronx	Lisapharma	Italy	—
Citizeta	C.T.	Italy	—
Mirsol	Mepha	Switz.	—
Respirase	Gibipharma	Italy	—
Respirex	Inibsa	Spain	—
Sanotus	Krka	Yugoslavia	—
Talasa	Andromaco	Argentina	—
Zitoxil	Farmochimica	Italy	—

Raw Materials

- 1-(2-Phenyl-2-methoxy)ethyl piperazine
- 3-Phenyl-3-methoxy propylene oxide

Manufacturing Process

In a reactor provided with a mechanical stirrer, a reflux refrigerant and a thermometer, there is introduced: 393 grams 1-[2-phenyl, 2-methoxy] ethyl piperazine and 22 grams 3-phenyl-3-methoxy propylene oxide in 750 ml of absolute ethanol.

When the slightly exothermic reaction (rise in temperature of about 20°C) has ceased, heating is effected for 1.5 hours at 60°C. The product is then cooled to 4°C and left to crystallize for about 12 hours. The precipitate is centrifugated then recrystallized in 500 ml of absolute ethanol.

420 grams of the desired compound is thus obtained in the form of a white, crystalline powder, melting point 83°C.

References

Merck Index 9976

Kleeman & Engel p. 953

DOT 10 (3) 104 (1974)

I.N. p. 1024

Mauvernay, R.Y., Busch, N., Moleyre, J. and Simond, J.; U.S. Patent 3,718,650; February 27, 1973; assigned to Societe Anonyme Centre Europeen de Recherches Mauvernay, France

ZOLIMIDINE

Therapeutic Function: Antiulcerative

Chemical Name: 2-[4-(Methylsulfonyl)phenyl] imidazo[1,2-a] pyridine

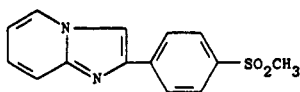
Common Name: Zoliridine**Structural Formula:****Chemical Abstracts Registry No.:** 1222-57-7

Trade Name	Manufacturer	Country	Year Introduced
Solimidin	Selvi	Italy	1974
Gastronilo	Aristegui	Spain	—
Mutil	Lakeside	U.S.	—

Raw Materials

2-Aminopyridine
p-Methylsulfonyl- ω -bromoacetophenone

Manufacturing Process

190 g of 2-aminopyridine were dissolved in 350 ml of dioxane and the solution was reacted with 277 g of p-methylsulfonyl- ω -bromoacetophenone. After two hours at room temperature the 2-(4'-methylsulfonylphenyl)[1,2-*a*]imidazopyridine was filtered, washed and recrystallized by alcohol.

References

Merck Index 9992

Kleeman & Engel p. 954

DOT 10 (6) 210 (1974)

I.N. p. 1024

Almirante, L., Murmann, W. and Friz, L.P.; U.S. Patent 3,318,880; May 9, 1967; assigned to Laboratorio Bioterapico Milanese Selvi & Co. S.a.S. (Italy)

ZOMEPIRAC

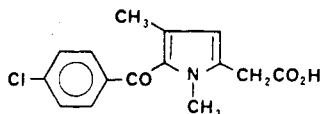
Therapeutic Function: Analgesic, antiinflammatory**Chemical Name:** 5-(p-Chlorobenzoyl)-1,4-dimethylpyrrole-2-acetic acid**Common Name:** —**Structural Formula:****Chemical Abstracts Registry No.:** 33369-31-2

Trade Name	Manufacturer	Country	Year Introduced
Zomex	Cilag	Switz.	1979
Zomax	McNeil	U.S.	1980

Trade Name	Manufacturer	Country	Year Introduced
Zomax	Cilag	France	1981
Zomax	Cilag	W. Germany	1981
Zomax	Ortho	U.K.	1981
Zomaxin	Cilag	Italy	1982
Calmador	Finadiet	Argentina	—
Dolgenal	Exa	Argentina	—
Dolwas	Wassermann	Spain	—
Zopirac	Sintyal	Argentina	—

Raw Materials

Ethyl 5-(p-chlorobenzoyl)-1,4-dimethyl-3-ethoxypyrrole-2-acetate
Sodium hydroxide
Hydrogen chloride

Manufacturing Process

5-(p-Chlorobenzoyl)-3-carboxy-1,4-dimethylpyrrole-2-acetic acid: A suspension of 17.3 g (0.0435 mol) of ethyl 5-(p-chlorobenzoyl)-1,4-dimethyl-3-ethoxypyrrole-2-acetate in 170 g of 25% hydroxide is heated under reflux for 3 hours. The suspension is poured into ice and the resulting yellow solution is added to ice-hydrochloric acid with stirring. The precipitated solid is collected by filtration, air dried and recrystallized from acetone containing 10% water to give 5-(p-chlorobenzoyl)-3-carboxy-1,4-dimethylpyrrole-2-acetic acid as a white solid; melting point 253°C to 254°C.

Ethyl 5-(p-chlorobenzoyl)-3-carboxy-1,4-dimethylpyrrole-2-acetate: A suspension of 2.0 g of 5-(p-chlorobenzoyl)-3-carboxy-1,4-dimethylpyrrole-2-acetic acid in 20 ml of 0.5% ethanolic hydrogen chloride is heated under reflux. The solid gradually dissolves. After 40 minutes a white crystalline solid precipitates. The solution is cooled and the solid product, ethyl 5-(p-chlorobenzoyl)-3-carboxy-1,4-dimethylpyrrole-2-acetate, is filtered and dried, melting point 197°C to 198°C.

Ethyl 5-(p-chlorobenzoyl)-1,4-dimethylpyrrole-2-acetate: A 9.0 g (0.0255 mol) sample of ethyl 5-(p-chlorobenzoyl)-3-carboxy-1,4-dimethylpyrrole-2-acetate is heated under nitrogen at 210°C to 230°C for 2 hours. Gas is evolved. The residue is molecularly distilled in a sublimator at 195°C, 0.05 mm/Hg. The sublimate is recrystallized from cyclohexane to give ethyl 5-(p-chlorobenzoyl)-1,4-dimethylpyrrole-2-acetate as a white solid, melting point 107°C to 109°C.

5-(p-Chlorobenzoyl)-1,4-dimethylpyrrole-2-acetic acid: A suspension of 4.0 g (0.0125 mol) of ethyl 5-(p-chlorobenzoyl)-1,4-dimethylpyrrole-2-acetate in 26 ml of 0.5N sodium hydroxide (0.013 mol) is heated under reflux for 30 minutes. The resulting solution is acidified with dilute hydrochloric acid, and the precipitated solid is collected by filtration, air dried and recrystallized from 2-propanol to give 5-(p-chlorobenzoyl)-1,4-dimethylpyrrole-2-acetic acid as a white crystalline solid, melting point 178°C to 179°C.

References

- Merck Index 9993
DFU 2 (10) 698 (1977)
Kleeman & Engel p. 955
OCDS Vol. 3 p. 128 (1984)
DOT 16 (12) 434 (1980)
I.N. p. 1025
Carson, J.R.; U.S. Patents 3,752,826; August 14, 1973 and 3,865,840; February 11, 1975; both assigned to McNeil Laboratories, Inc.

ZOTEPINE

Therapeutic Function: Tranquilizer (major)

Chemical Name: 2-[(8-Chlorodibenzo[b,f]thiepin-10-yl)oxy]-N,N-dimethylethanamine

Common Name: —

Structural Formula:

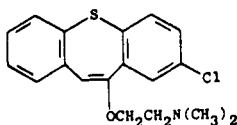

Chemical Abstracts Registry No.: 26615-21-4

Trade Name	Manufacturer	Country	Year Introduced
Lodopin	Fujisawa	Japan	1982

Raw Materials

8-Chlorodibenzo[b,f]thiepin-10(11H)-one
2-Dimethylaminoethyl chloride

Manufacturing Process

A suspension of 30 g of sodium hydride in benzene (30 ml) was added dropwise to 52 g of 8-chlorodibenzo[b,f]thiepin-10(11H)-one dissolved in dimethylformamide (800 ml), and the mixture was heated at 100°C for 2 hours. To this, there were added 68 g of 2-dimethylaminoethyl chloride, and the mixture was heated at 60°C for 39 hours. The reaction mixture, after cooled, was poured into ice-water, and the solution was extracted with ethyl acetate. The ethyl acetate layer, after washed with water, was extracted with 10% hydrochloric acid, when oil was precipitated. The aqueous layer, in which oil was precipitated, was washed with ether, made neutral with concentrated sodium hydroxide solution and then extracted with ethyl acetate. The ethyl acetate layer was washed with water, dried over magnesium sulfate, and concentrated to give oil, which was allowed to stand to provide solid. The solid was washed with petroleum ether and recrystallized from cyclohexane to yield 42.5 g of 8-chloro-10-(2-dimethylaminoethyl)-oxydibenzo[b,f]thiepin as crystals, melting point 90°C to 91°C. Maleate as colorless needle, melting point 204°C to 204.5°C.

References

Merck Index 9997

DOT 19 (3) 155 (1983)

I.N. p. 1025

Umio, S., Uedo, I., Sato, Y. and Maeno, S.: U.S. Patent 3,704,245; November 28, 1972

ZOXAZOLAMINE

Therapeutic Function: Skeletal muscle relaxant; uricosuric

Chemical Name: 5-Chloro-2-benzoxazolamine

Common Name: —

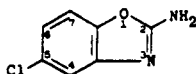
Structural Formula:**Chemical Abstracts Registry No.:** —

Trade Name	Manufacturer	Country	Year Introduced
Flexin	McNeil	U.S.	1956
Contrazole	Millot	France	—
Deflexol	Millot	France	—
Zoxine	Millot	France	—

Raw Materials

2-Amino-4-chlorophenol	Ammonium thiocyanate
Hydrogen chloride	Ferric chloride
Ammonium hydroxide	

Manufacturing Process

To a solution of 106 g (0.74 mol) of 2-amino-4-chlorophenol in 500 ml of water containing 69 ml of concentrated hydrochloric acid (29.2 g, 0.8 mol) are added 60.8 g (0.8 mol) of ammonium thiocyanate. The solution is placed in an evaporating dish and heated on a steam bath for 5 hours. The solid which results is then removed from the concentrated solution by filtration, washed with a small amount of water and dried. The filtrate is placed in an evaporating dish and heated on a water bath for 2 hours. At the end of this time, the mixture is cooled, and the solid which precipitates out is removed by filtration. Both solid products are 5-chloro-2-hydroxyphenylthiourea melting at 157°C, and may be combined. The calculated N content for C₇H₇ClN₂OS is 13.8; that found is 13.6.

To a solution of 10 g (0.05 mol) of 2-hydroxy-5-chlorophenylthiourea in 50 ml of methanol is added a solution of 11 g (0.04 mol) of ferric chloride hexahydrate in 50 ml of methanol. The initial purple-red color changes in a few minutes to amber. After stirring for one-half hour, the solution is treated with 16.5 ml of 57% ammonium hydroxide solution (0.24 mol). A brown, flocculent precipitate of ferric sulfide appears. The mixture is then refluxed with stirring for one hour, cooled and centrifuged. The centrifugate is evaporated to dryness, and the residue is shaken with ether and water to separate the organic material from the ammonium chloride. The ether layer is extracted three times with 25 ml portions of 1 N hydrochloric acid. The acid solution is then poured into excess ammonium hydroxide, and the resulting solid collected, washed with water and dried. This gives a light tan solid melting at 183°C to 185°C. The material is then dissolved in 25 ml of acetone and 50 ml of benzene are added. After treatment of the solution with activated charcoal, the light yellow solution is evaporated to 25 ml and cooled. The white crystals of 2-amino-5-chlorobenzoxazole which separate melt at 185°C to 186°C.

References

Merck Index 9998

I.N. p. 1025

Sam, J.; U.S. Patent 2,780,633; February 5, 1957; assigned to McNeil Laboratories, Inc.

Raw Materials Index

These volumes have been cross indexed by raw material. The only exceptions are those few materials which are extracted from plant or animal sources or which are produced by fermentation. These are listed separately. Each raw material is followed by the name(s) of the pharmaceutical(s) produced from it.

The question arises of course of how far back to go in the raw material chain. It has been the attempt, where information was available, to go back to reasonably simple raw materials such as benzene.

FERMENTATION OR EXTRACTION

Aceituno meal, by extraction	Daunorubicin
Glaucarubin	Demeclocycline HCl
Ammi visnaga plants, by extraction	Desoximetasone
Visnadine	Dextran 40
Amphomycin, by fermentation	Doxorubicin
Amphomycin calcium	Enviomycin
Beef blood, by extraction	Erythromycin
Orgotein	Floxuridine
Beef intestine, by extraction	Flunisolide
Heparin	Fructose
Beef pancreas glands, by extraction	Fumagillin
Insulin	Fusafungine
Carbohydrates, by fermentation or extraction	Gentamicin sulfate
Aclarubicin	Gramicidin
Acetyl digitoxin	Griseofulvin
Amphomycin calcium	Inositol
Amphotericin B	Kanamycin sulfate
Asparaginase	Lincomycin
Bacitracin	Mannitol
Beknamycin sulfate	Methandrostenolone
Candicidin	Methylprednisolone
Capreomycin sulfate	Micronomicin
Carbomycin	Midecamycin
Chlortetracycline	Mitomycin
Citicoline	Natamycin
Clavulanic acid	Neomycin
Cycloserine	Novobiocin
Cyclosporin	Nystatin
Dactinomycin	Oleandomycin

- Oxamniquine
 Oxytetracycline
 Paromomycin
 Penicillin O
 Phytate sodium
 Polymyxin
 Ribostamicin
 Salicylic acid
 Sisomicin
 Spectinomycin
 Spiramycin
 Stallimycin HCl
 Streptokinase
 Streptomycin
 Streptozocin
 Testolactone
 Tetracycline
 Triamcinolone
 Tubocurarine chloride
 Viomycin
 Ubidecarenone
 Vancomycin
 Vidarabine
 Viomycin
 Zeranol
 Chondrodendron tomentosum
 plant, by extraction
 Tubocurarine chloride
 Cytidine-5'-monophosphate, by
 fermentation
 Citicoline
 Digitalis ferrugineae leaves, by extraction
 Acetyldigoxin
 Hog ovaries, by extraction
 Relaxin
 Human pituitary glands, by extraction
 Somatotropin
 Kidneys, animal, by fermentation
 Interferon
 Microorganisms, by fermentation
 Actinomyces antibioticus
 Dactinomycin
 Actinomyces vinaceus
 Viomycin
 Aspergillus fumigatus
 Fumagillin
 Aspergillus sclerotiorum Huber
 Oxamniquine
 Bacillus lentus
 Desoximetasone
 Diflucortolone valerate
 Bacillus polymyxa
 Polymyxin
 Bacillus sphaericus var *fusiformis*
 Meprednisone
 Bacillus subtilis
 Bacitracin
 Brevibacterium ammoniagens
 Citicoline
 Corynebacterium simplex
 Fluocortolone
 Prednisolone
 Prednisone
 Triamcinolone
 Curvularia lunata
 Desoximetasone
 Fluocortolone
 Cunninghamella blakesleeana
 Hydrocortisone
 Cylindrocarpon lucidum fungus,
 (NRRL 5760)
 Cyclosporin
 Cylindrocarpon radicola
 Testolactone
 Didymella lycopersici
 Methandrostenolone
 Erwinia bacteria
 Asparaginase
 Fusarium lateritium
 Fusafungine
 Gibberella zeae
 Zeranol
 Leuconostoc mesenteroides
 Dextran 40
 Fructose
 Micromonospora inyoensis
 Sisomicin
 Micromonospora purpurea
 Gentamicin sulfate
 Micromonospora sagamiensis
 Micronomicin
 Penicillium bacterium
 Penicillin O
 Penicillium patulum
 Griseofulvin
 Pseudomonas bacterium
 Salicylic acid
 Semliki Forest arborvirus
 Interferon
 Septomyxa affinis
 Fluprednisolone
 Methylprednisolone
 Sporidiobolus ruinenii
 Ubidecarenone
 Streptococcus fecalis
 Floxadine
 Streptococcus haemolyticus
 Streptokinase
 Streptomyces achromogenes
 Streptozocin
 Streptomyces ambofaciens
 Spiramycin
 Streptomyces antibioticus
 Oleandomycin
 Vidarabine
 Streptomyces aureofaciens
 Chlortetracycline
 Demeclocycline HCl
 Tetracycline

Microorganisms, by fermentation (cont'd)

Streptomyces caespitosus
Mitomycin

Streptomyces capreolus
Capreomycin sulfate

Streptomyces clavuligerus
Clavulanic acid

Streptomyces distallicus
Stallimycin HCl

Streptomyces erythreus
Erythromycin

Streptomyces fradiae
Neomycin

Streptomyces gilvosporeus
Natamycin

Streptomyces griseoverticillatus
var. *tuberciticus*
Enviomycin

Streptomyces griseus No. 3570
Candicidin

Streptomyces griseus
Streptomycin

Streptomyces halstedii
Carbomycin

Streptomyces kanamycetius
Bekanamycin sulfate
Kanamycin sulfate

Streptomyces lavendulae
Cycloserine

Streptomyces lincolnensis
Lincomycin

Streptomyces mycarofaciens
Midecamycin

Streptomyces nodosus
Amphotericin B

Streptomyces noursei
Nystatin

Streptomyces orientalis
Vancomycin

Streptomyces peucetius
Daunorubicin

Streptomyces peucetius var.
caesius
Doxorubicin

Streptomyces rimosus
Oxytetracycline

Streptomyces rimosus forma
paromomycinus
Paromomycin

Streptomyces roseochromogenus
Flunisolide

Streptomyces spectabilis
Spectinomycin

Streptomyces spheroides
Novobiocin

Streptomyces thermoflavus
Ribostamicin

Milorganite, by extraction
Cyanocobalamin

Pancreatic gland material, by
extraction
Glucagon

Papaya fruit, by extraction
Papain

Pineapple juice, by extraction
Bromelain

Rauwolfia plants, by extraction
Deserpidine
Rescinnamine
Reserpine

Silybum marianum fruit, by extrac-
tion
Silymarin

Soybean meal, by fermentation
Bacitracin
Clavulanic acid
Cycloserine
Erythromycin
Gentamicin sulfate
Kanamycin sulfate
Micronomicin
Novobiocin
Oleandomycin
Oxamniquine
Oxytetracycline
Paromomycin
Ribostamicin
Sisomicin

Soy broth, by fermentation
Triamcinolone

Squill, by extraction
Proscillaridin

Thyroid gland carcinoma, by ex-
traction
Calcitonin

Tyrothricin fermentation liquor, by
fermentation
Gramicidin

Urine, mammalian, by isolation
Urokinase

Vegetable protein, by fermentation
Midecamycin

Velvet beans, by extraction
Levodopa

Venom of Bothrops Atrox
Batroxobin

Veratrum viride, by extraction
Cryptenamine tannates

Vinca rosea plants, by extrac-
tion
Vinblastine sulfate
Vincristine sulfate

CHEMICALS

Acetaldehyde	Amcinonide
Fosfomycin	Ancitabine HCl
Methohexital sodium	Aspirin
Mitopodozide	Azapetine phosphate
Netilmicin	Betamethasone acetate
Acetaldehyde dimethylacetal	Bisacodyl
Ambuside	Bromazepam
Acetaldehyde thiosemicarbazone	Bromopride
Sulfamethizole	Chloramphenicol
Acetamidobenzene sodium sulfonate	Cortivazol
Dapsone	Cyclofenil
4-Acetamidophenol	Cyproheptadine
Practolol	Desoximetasone
Acetanilide	Diatrizoate sodium
Chlorambucil	Diazoxide
Acetic acid	Dienestrol
Ancitabine HCl	Difluprednate
Betamethazone dipropionate	Diltiazem HCl
Carbidopa	Diosmin
Clotiazepam	Ethynodiol diacetate
Cortisone acetate	Etidronate disodium
Cyproterone acetate	Flucloronide
Danazol	Fluocinolone acetonide
Demegestone	Fluocinonide
Desmopressin	Fluocortolone
Difenoxine	Fluprednidene acetate
Dimethisterone	Fluprednisolone
Diosmin	Idoxuridine
Dobutamine	Iodamide
Felypressin	Iothelmate meglumine
Fentiazac	Iothioracil
Fluprednisolone	Ketoconazole
Gemeprost	Lorazepam
Glutethimide	Medazepam
Hydroxypropyl cellulose	Medrogestone
Idoxuridine	Medroxyprogesterone acetate
Iodoalphonic acid	Melphalan
Levodopa	Mesoridazine besylate
Levothyroxine sodium	Methoqualone
Mepazine	Metoclopramide HCl
Nordazepam	Metolazone
Norethynodrel	Midazolam maleate
Pheniprazine	Moxisylyte
Rosoxacin	Nadolol
Sulprostone	Naloxone
Trenbolone acetate	Norethindrone acetate
Triacetin	Oxaceprol
Acetic acid hydrazide	Oxazepam
Triazolam	Oxyphenisatin acetate
Acetic anhydride	Pancuronium bromide
Acetaminophen	Prednisolone acetate
Acetazolamide	Quingestanol acetate
Acetrizoate sodium	Sulfacetamide
Acetyl cysteine	Testosterone 17 β -cypionate
Acetyl sulfisoxazole	Trenbolone acetate
Afloqualone	Trioxsalen

- Acetoacetic acid N-benzyl-N-methyl-
 amino ethyl ester
 Nicardipine
 Acetoacetic acid methyl ester
 Nifedipine
 Acetoacetic ester
 Dipyrindamole
 Acetoin
 Sulfaguanol
 Acetone
 Alprenolol HCl
 Bromelain
 Ciprofibrate
 Clortermine HCl
 Desonide
 Fenofibrate
 Flucloronide
 Flunisolid
 Fluocinonide
 Flurandrenolide
 Glucagon
 Gramacidin
 Hetacillin potassium
 Iproniazid
 Kebuzone
 Methyltestosterone
 Niaprazine
 Probucol
 Relaxin
 Somatotropin
 Triamcinolone acetonide
 Acetonitrile
 Chlophedianol
 Clindamycin HCl
 Memantine
 Acetophenone
 Algestone acetophenide
 Biperiden
 Eprozinol
 Fendiline HCl
 Phenindamine tartrate
 Procyclidine HCl
 Pyrrobutamine
 Tridihexethyl iodide
 Trihexyphenidyl HCl
 m-Acetoxyacetophenone
 Norfenefrine
 17 β -Acetoxy-4-androsteno [2,3-d]
 isoxazole
 Trilostane
 3-Acetoxy-7-chloro-1,3-dihydro-5-
 (o-chlorophenyl)-2H-1,4-
 benzodiazepin-2-one
 Lormetazepam
 3-Acetoxy-7-chloro-1-methyl-5-
 phenyl-1,3-dihydro-2H-1,4-
 benzodiazepin-2-one
 Temazepam
 17 α -Acetoxy-3 β -hydroxy-6-methyl-
 pregn-5-ene-20-one
 Megestrol acetate
 3-Acetoxy-methyl-7-[2-(2-amino-4-
 thiazolyl)-2-methoxyimino-
 acetamido]-ceph-3-em-4-
 carboxylic acid (cefotaxime)
 Cefotaxime sodium
 DL-2-Acetoxypropionyl chloride
 Iopamidol
 1-(2-Acetoxy propyl)-2-methylimidazole
 Secnidazole
 p-Acetylamino-benzenesulfonyl chloride
 Sulfadoxine
 Sulfaethiodole
 Sulfalene
 Sulfamerazine
 Sulfamethizole
 Sulfamoxole
 Sulfisoxazole
 p-Acetylamino-benzoic acid
 Deanol acetamidobenzoate
 3-Acetylamino-methyl-4-chloro-5-
 nitrobenzoic acid
 Iodamide
 2-Acetylamino-1-(4-methylmercapto-
 phenyl)-1,3-propanediol
 Thiamphenicol
 N-Acetyl-p-aminophenol
 Benorylate
 3-Acetylamino-2,4,6-triiodophenol
 Iopronic acid
 Acetylbenzylamine
 Mafenide acetate
 Acetyl chloride
 Acebutolol
 Benfurodil hemisuccinate
 Chlorprothixene
 Dienestrol
 Ibuprofen
 Phensuximide
 N-Acetyl-L-diiodo tyrosinamide
 Levothyroxine
 4-Acetyl diphenylsulfide
 Tibenzonium iodide
 Acetylene
 Ethchlorvynol
 Ethinylestradiol
 Fluoxetine
 Hydroquinone
 Mestranol
 Moxestrol
 Norethindrone
 Norethynodrel
 3-Acetyl-2-fluorobiphenyl
 Flurbiprofen
 N-Acetyl-L-glutamine
 Aceglutamide aluminum

- 3-Acetyl-18 β -glycyrhethinic acid
 Acetoxolone aluminum salt
 2-(2-Acetylhydrazino)pyridine
 Fazidinium bromide
 3-Acetyl-4-hydroxyaniline
 Celiprolol
 2-Acetyl-7-hydroxy benzofuran
 Befunolol
 5-Acetylimino-4-methyl-2-benzyl-
 mercapto- Δ^2 -1,3,4-thiadi-
 azolone
 Methazolamide
 7-Acetyl-12-ketochenodeoxycholic
 acid
 Chenodiol
 Acetyl methionine
 Citilone
 2-Acetyl phenothiazine
 Acetophenazine dimaleate
 3-Acetyl pyridine
 Metyrapone
 Acetylsalicylic acid
 Caraspirin calcium
 Acetylsalicylic acid chloride
 Benorylate
 Phenprocoumon
 N-Acetylsulfanilyl chloride
 Sulfacytine
 Sulfamethoxazole
 3-Acetylthiomethyl propanoic acid
 Captopril
 Acetyltropic acid chloride
 Tropicamide
 Acrolein
 Benzocetamine HCl
 Chlorthenoxazine
 Hydroxytryptophan
 Letosteine
 Methionine
 Acrylonitrile
 Fenproporex
 Acryloyl chloride
 Atracurium besylate
 Adamantane
 Amantidine HCl
 Tromantidine HCl
 Adenosine
 Inosine
 Adenosine-5'-monophosphoric acid
 Papaverine monophosadenine
 Adipic acid dichloride
 Iodipamide
 Adrenalin
 Carbazochrome
 Ajmaline
 Prajmaline bitartrate
 Allyl acetate
 Triacetin
 1-Allyl-2-aminomethyl pyrrolidine
 Alizapride
 Veralipride
 Allyl bromide
 Azapetine phosphate
 Methohexital sodium
 Nalorphine
 Naloxone
 Prajmaline bitartrate
 Secobarbital sodium
 Trioxsalen
 Allyl carbamide
 Meralluride
 di-N-Allylcamphoramic acid
 Mercaptomerin sodium
 o-Allylepoxypropoxybenzene
 Alprenolol HCl
 2-Allylsulfamyl-5-chloro-4-sulfamylan-
 iline
 Ambuside
 Allyl-2-(7'-trifluoromethyl-4'-
 quinolinyl-amino)benzoate
 Antrafenine
 Allyl urea
 Chlormerodrin
 Aluminum alcoholate
 Acetoxolone aluminum salt
 Aluminum amalgam
 Dinoprostone
 Aluminum tert-butoxide
 Megestrol acetate
 Aluminum chloride
 Acebutolol
 Benfurodil hemisuccinate
 Diclofenac sodium
 Ethacrynic acid
 Fenbufen
 Flavoxate HCl
 Flubendazole
 Magaldrate
 Mebutone
 Moxalactam disodium
 Perlapine
 Aluminum dihydroxy chloride
 Sucralfate
 Aluminum hydroxide
 Aluminum nicotinate
 Aluminum isopropoxide
 Aceglutamide aluminum
 Tiocloamarol
 Aminoacetonitrile
 Octopamine HCl
 p-Aminoacetophenone
 Acetohexamide
 N-Amino-3-azabicyclo(3.3.0)octane
 Gliclazide
 p-Aminobenzene sulfinic acid
 Alkafanone

- 4-Aminobenzene sulfonamide
Sulfacetamide
- p-Aminobenzene sulfonamidoguanidine
Sulfamethazine
- α -(p-Aminobenzene sulfonamido)-
pyridine
Sulfasalazine
- N^1 -(p-Aminobenzene sulfonyl)- N^3 -
cyanoguanidine
Sulfaguanoil
- p-Aminobenzoic acid
Bentiromide
- 2-Aminobenzophenone
Nitrazepam
- p-Aminobenzoyl glutamic acid
Folic acid
- 2-(2-Aminobenzoyl) pyridine
Bromazepam
- 3-Amino-4-benzyloxyacetophenone
Carbuterol
- α -Aminobenzyl penicillin
Hetacillin potassium
- 2-Amino-1-butanol
Etambutol HCl
- d-2-Aminobutanol-1
Methylergonovine maleate
- 2-Amino-5-tert-butyl-1,3,4-
thiadiazole
Glybuzole
- (6R,7R)-7-Amino-3-carbamoyloxy-
methyl-ceph-3-em-4-carboxylic
acid
Cefuroxime
- 3-Amino-2-carbomethoxy-4-methyl-
thiophene
Carticaine
- 7-Aminocephalosporanic acid
Cefazolin sodium
Ceftizoxime
Cephacetrile sodium
Cephaloglycin
Cephaloridine
Cephalothin sodium
Cephapirin sodium
- 2-Amino-5-chlorobenzonitrile
Clorazepate dipotassium
- 2-Amino-5-chlorobenzophenone
Chlordiazepoxide HCl
Pinazepam
Prazepam
- 2-Amino-5-chlorobenzophenone-
 β -oxime
Diazepam
- 2-Amino-5-chlorobenzoxazole
Chlorzoxazone
- 2-Amino-4-chlorodiphenylamine-2'-
carboxylic (4''-methyl)piperazine
Clozapine
- 2-Amino-5-chloro-2'-fluorobenzo-
phenone
Loflazepate ethyl
- 4-Amino-2-chloro-5-(methylsulfamyl)-
benzenesulfonamide
Polythiazide
- 4-Amino-6-chloro-5-nitropyrimidine
Mercaptopurine
- 2-Amino-4-chlorophenol
Zoxazolamine
- β -Aminocrotonic acid methyl ester
Nicardipine
- D- α -Amino- α -(1,4-cyclohexadienyl)
acetic acid
Cefroxadine
- 1-Amino-1-cyclohexane carboxylic
acid chloride
Cyclacillin
- 2-Amino-2',5-dichlorobenzophenone
Lorazepam
- 2-Amino-4,5-dimethylxazole
Sulfamoxole
- 6-Amino-2,4-dimethylpyrimidine
Sulfisomidine
- o-Aminodiphenylmethane
Perlapine
- β -Amino- β -ethoxyacrylic acid ethyl
ester
Muzolimine
- p-(β -Aminoethyl)benzene sulfonamide
Glipizide
- 4-(β -Aminoethyl)benzenesulfonamide HCl
Glioxepid
- 2-Aminoethyl hydrogen sulfate
Viloxazine HCl
- N-(2-Aminoethyl)morpholine
Minaprine
- 2-Amino-5-ethyl-1,3,4-thiazole
Sulfaethiodole
- N-Aminohexamethylene imine
Glioxepid
- Aminoguanidine bicarbonate
Guanabenz
- 1-Aminohydantoin
Nitrofurantoin
- 1-Aminohydantoin HCl
Dantrolene sodium
- L-(-)- γ -Amino- α -hydroxybutyric acid
Amikacin
- 7-[D-(-)- α -Amino-p-hydroxyphenyl
acetamido]-3-[5-(1-methyl-1,2,3,4-
tetrazolyl)-thiomethyl]- Δ^3 -cephem-
4-carboxylic acid
Cefoperazone
- 4-Amino-5-imidazolecarboxamide
Orazamide
- Aminomalnonitrile tosylate
Methotrexate

- 7 β -Amino-3-methoxy-3-cephem-4-carboxylic acid hydrochloride dioxanate
Cefroxadine
- 2-(2-Amino-N-methylacetamido)-5-chlorobenzophenone
Ketazolam
- p-Aminomethylbenzoic acid
Tranexamic acid
- 7-Amino-3-methyl-3-cephem-4-carboxylic acid
Cefadroxil
- 2-Aminomethyl-7-chloro-2,3-dihydro-5-(2-fluorophenyl)-1H-1,4-benzodiazepine
Midazolam maleate
- N-Amino-2-methyl indoline
Indapamide
- 3-Amino-5-methylisoxazole
Isoxicam
- 2-Aminomethyl-1-methyl-5-chloro-3-(o-fluorophenyl) indole HCl
Fludiazepam HCl
- 1-Amino-4-methylpiperazine
Rifampin
- 2-Aminomethylpiperidine
Flecainide
- 2-Amino-2-methyl-1-propanol
Ambuphylline
- 2-Amino-6-methylpyridine
Nalidixic acid
- 2-Amino-4-methylpyrimidine
Azanidazole
- 2-Amino-6-methylpyrimidine
Sulfamerazine
- 7-Amino-3-(1-methyl-7H-tetrazol-5-yl-thiomethyl)-3-cephem-4-carboxylic acid
Cefamandole nafate sodium salt
- 6-Amino-2-methylthiopyrimidine
Pipemidic acid
Piromidic acid
- 2-Amino-2'-nitrobenzophenone
Clonazepam
- N-(2-Amino-5-nitrobenzyl)-o-toluidine
A floqualone
- 2-Aminoxyethylamine dihydrochloride
Fluvoxamine maleate
- 6-Aminopenicillanic acid
Amoxicillin
Ampicillin
Azidocillin
Azlocillin
Carbenicillin disodium
Carbenicillin indanyl sodium
Cloxacillin
Cyclacillin
Dicloxacillin sodium
- Epicillin
Floxacillin
Methicillin sodium
Nafcillin sodium
Oxacillin sodium
Penicillin V
Phenethicillin potassium
Sulbenicillin
Ticarillin disodium
- m-Aminophenol
Amino salicylic acid
- p-Aminophenol HCl
Amodiaquin
- 6-[D(-) α -(Aminophenylacetamido)] penicillanic acid (Ampicillin)
Metampicillin sodium
Piperacillin sodium
- α -Aminophenyl acetic acid
Ampicillin
- 1-(4'-Aminophenyl)-2-tert-butylamino-ethanol-(1) HCl
Clenbuterol
- β -(p-Aminophenyl) ethyl chloride
Anileridine dihydrochloride
- 3-Amino-2-phenylpyrazole
Sulfaphenazole
- 2-Amino-5-phenylthiomethoxyacetanilide
Febantel
- 2-Amino-1,3-propanediol
Iopamidol
- 2-Aminopyrazine
Sulfalene
- 2-Aminopyridine
Diphenpyramide
Methapyrilene HCl
Phenylamidol
Pyrilamine
Sulfadiazine
Tripeleminamine
Zolimidine
- 4-Aminosalicilic acid
Bromopride
- 4-Aminosulfonyl-phenyl-(2)-ethylamine
Gliquidone
- 2-Aminothiophenol
Diltiazem HCl
- 3-Amino-2,4,6-triiodo benzoic acid
Acetretzoate sodium
Iotroxic acid
- 5-Amino-2,4,6-triiodo isophthalic acid
Iopamidol
- 5-Amino-2,4,6-triiodo-N-methylisophthalamic acid
Iothalmate meglumine
- 5-Aminouracil
Uracil mustard
- β -Aminoxalanine ethyl ester
Cycloserine

Ammonia

- Acetazolamide
- Acetohexamide
- Acyclovir
- Alprazolam
- Alprenolol HCl
- Amiloride HCl
- Ancitabine HCl
- Azapetine phosphate
- Bendroflumethiazide
- Bethanechol chloride
- Bromazepam
- Buthiazide
- Captopril
- Carbamazepine
- Carbuterol
- Caroxazone
- Cephadrine
- Chlorothiazide
- Chlorphenesin carbamate
- Chlorthalidone
- Cimetide
- Cititolone
- Clonazepam
- Clorexolone
- Cytarabine HCl
- Demegestone
- Desmopressin
- Diazoxide
- Dibekacin
- Dichlorphenamide
- Dioxyline phosphate
- Epicillin
- Ethinamate
- Ethinylestradiol
- Ethionamide
- Ethosuximide
- Ethoxzolamide
- Felypressin
- Flubendazole
- Flucytosine
- Fludiazepam HCl
- Flumethiazide
- Flunitrazepam
- Haloperidol
- Hydroflumethiazide
- Hydroxychloroquine sulfate
- Hydroxy phenamate
- Hydroxystilbamidine isethionate
- Mafenide acetate
- Mebendazole
- Mephesisin carbamate
- Meprobamate
- Mesna
- Methazolamide
- Methocarbamol
- Methysergide maleate
- Metolazone
- Minoxidil
- Nabilone
- Nifedipine
- Norethindrone
- Ornipressin
- Oxytocin
- Phentermine HCl
- Piracetam
- Prazosin
- Protionamide
- Pyrithyldione
- Pyritinol
- Quingestanol acetate
- Stanzolol
- Tegafur
- Tiopronin
- Tocainide
- Vindesine
- Xipamid
- Zoxazolamine
- Ammonium acetate
- Cyclopentamine HCl
- Ammonium carbonate
- Aminosalicylic acid
- Phenytoin
- Phethenylate sodium
- Ammonium chloride
- Cyclofenil
- Methionine
- Ammonium sulfate
- Aminobenzoic acid
- Fibrinolysin
- Ammonium sulfamate
- Cyclamate calcium
- Ammonium thiocyanate
- Acetazolamide
- Clonidine HCl
- Tolonidine nitrate
- Zoxazolamine
- d-Amphetamine
- Tanphetamin
- Ampicillin
- Mezlocillin
- Talampicillin
- Ampicillin beta naphthalene sulfonate
- Ampicillin trihydrate
- 3,17-Androstandione
- Stanolone
- $\Delta^{1,4,6}$ -Androstatrien-17 β -ol-3-one-17-acetate
- Methenolone acetate
- Androtardyl-oestradiol
- Estradiol valerate
- Aniline
- Fentanyl
- Salicylanilide
- Anisoyl chloride
- Benzobromarone

- Anthracene
 Benzoctamine HCl
 Anthranilic acid
 Methaqualone
 L-Arginine
 Arginine glutamate
 L-Asparaginy-L-arginyl-L-valyl-L-tyrosyl-
 L-valyl-L-histidyl-L-protyl-L-
 phenylalanine methyl ester
 trihydrochloride
 Angiotensin amide
 Atropic acid ethyl ester
 Tilidine HCl
 Atropine
 Sultroponium
 1-Azabicyclo[2.2.2]-3-octanol
 Clidinium bromide
 4-Aza-10,11-dihydro-5H-dibenzo[a,d]-
 cycloheptene-5-one
 Azatadine maleate
 1-Azaphenothiazine
 Prothipendyl HCl
 1-Azaphenothiazine carboxylic acid
 chloride
 Pipazethate
 α -Azidophenylacetic acid
 Azidocillin
 Aziridine
 Carboquone

 Barbituric acid
 Minoxidil
 Barium hydroxide
 Cyclobutylol
 Barium nitrite
 Inosine
 Benzazac chloride
 Bendacort
 Benzalacetone
 Warfarin sodium
 Benzal acetophenone
 Alkofanone
 Benzaldehyde
 Butalamine HCl
 Chloramphenicol
 Fenipentol
 Isocarboxazid
 Oxacillin sodium
 Penicillin G benzathine
 Phenylpropanolamine HCl
 Tripelennamine
 Benzaldehyde cyanohydrin
 Ethotoin
 4-Benzamido-1-[2-(3-indolyl)ethyl]
 pyridinium bromide
 Indoramin
 Benzene
 Cryptenamine tannates

 Gramicidin
 Lindane
 Phentermine HCl
 Vinblastine sulfate
 Vincristine sulfate
 Benzene sulfonyl chloride
 Glybuzole
 Glymidine
 Tranilast
 Benzhydryl bromide
 Diphenyl pyraline
 Benzhydryl-3-carbamoyloxymethyl-7 α -
 hydroxy-7 β -(2-thienylacetamido)-
 decephalosporanate
 Cefoxitin sodium
 Benzhydryl piperazine
 Cinnarizine
 Cyclizine
 Benzilic acid
 Mepenzolate bromide
 Pipenzolate bromide
 Pipoxolan HCl
 Benzoic anhydride
 Flavoxate HCl
 Benzonitrile
 Fentiazac
 Benzophenone
 Diphenidol
 Phenytoin
 1,4-Benzoquinone
 Dobesilate calcium
 Ethamsylate
 Megestrol acetate
 Benzotetronic acid
 Ethyl biscoumacetate
 p-Benzoxy- α -bromopropiophenone
 Nylidrin
 2-Benzoylbenzoic acid
 Nefopan HCl
 Benzoyl chloride
 Benfluorex hydrochloride
 Bentiromide
 Dienestrol
 Endralazine
 Hexylcaine HCl
 Tiaprofenic acid
 (2-Benzoyl-4-chlorophenylcarbamoyl-
 methyl)carbamic acid benzyl ester
 Nordazepam
 Benzoylethylene
 Phenoperidine HCl
 Benzoylformic acid
 Oxyphencyclimine
 N-Benzoylhomomeroquinene ethyl
 ester
 Viquidil
 4-Benzoyl-N-methylpiperidine
 Diphepanil methyl sulfate

- (3-Benzoylphenyl)acetonitrile
Ketoprofen
N-Benzoyl-D-L-tyrosyl-di-n-propylamine
Tiropramide
Benzyl alcohol
Carbenicillin disodium
N-Benzylamine
Antazoline HCl
Beclamide
Nialamide
Reproterol
2-Benzylaniline
Mianserin
N-Benzylaniline
Bepidil
 α -Benzyl-L-aspartic acid- β -lower alkyl ester
Oxytocin
Benzyl bromide
Benzpyrinium bromide
Phentermine HCl
N-Benzyl-N-tert-butylamine
Carbuterol
Terbutaline
5-(N-Benzyl-N-tert-butylglycyl) salicylic acid methyl ester HCl
Albuterol
Benzyl chloride
Benzethonium chloride
Benzphetamine HCl
Bephenium hydroxynaphthoate
Bufeniode
Diazoxide
Ifenprodil tartrate
Phenoxybenzamine HCl
Propoxyphene HCl
Tiopronin
Tribenoside
Benzyl chlorocarbonate
Ampicillin
Benzyl cyanide
Meperidine HCl
Tolazoline
Valethamate bromide
di-1-Benzyl-4-(1,3-dicyano-1-phenyl-propyl)piperidine HCl
Dexetimide
Benzylethanolamine
Phenmetrazine
N-(Benzylidene)-3-amino-2-oxazol-
idone
Furazolidone
Benzyl levulinoyloxyacetate
Acemetacin
Benzyl magnesium chloride
Clomiphene dihydrogen citrate
Benzylmercaptan
Benzthiazide
- β -Benzylmercaptopropionyl-L-tyrosyl-L-phenylalanyl-L-glutaminy-L-asparaginy-L-S-benzyl-L-cysteiny-L-L-prolyl-N-tosyl-D-arginyl glycnamide
Desmopressin
N-Benzyl-N-(1-methyl-3-phenyl propyl) amine
Labetalol HCl
4-Benzylxyaniline HCl
Hydroxytryptophan
N-Benzylxycarbonyl-L-aspartic acid- α -nitrophenyl, β -benzyl diester
Aspartame
Benzylxycarbonyl chloride
Captopril
4-Benzylxy-2-dimethylamino methyl indole
Mepindolol
2-Benzylxyethanol
Flupentixol
p-Benzylxy hydrazobenzene
Oxyphenbutazone
1-Benzyl-3-oxindazole
Bendazac
 β -(5-Benzylxyindolyl-3)- α -acetyl-amino- α -methylthiopropionic acid methanethiol ester
Oxitriptan
p-Benzylxyphenylacetic acid
Glaziovine
1-(4'-Benzylxyphenyl)-2-bromopropane-1
Isoxsuprine HCl
17 β -Benzylxy-4,5-seco-estra-9,11-diene-3,5-dione
Trenbolone acetate
o-Benzylphenol
Phenyl tolaxamine
o-Benzylphenoxy- β -chloropropane
Benproperine
4-Benzylpiperidine
Ifenprodil tartrate
1-Benzyl-4-piperidone
Fentanyl
Pipamperone
Tinoridine
Benzyl-L-proline hydrochloride
Oxytocin
2-Benzylpyridine
Pheniramine maleate
Betaine hydrate
Chloral betaine
Beta-ionol
Tretinoin
Betamethasone
Betamethasone benzoate
Betamethasone valerate
Betamethasone acetate
Betamethasone

- Betamethasone-21-methanesulfonate
 Clobetasol
 Biphenyl
 Fenbufen
 3,4-Bis-bromoethyl-4-hydroxy-5-methylpyridinium bromide
 Pyritinol
 Bis(β -chloroethyl)amine
 Estramustine phosphate
 p-[N-bis(β -chloroethyl)amino]phenylbutyric acid
 Prednimustine
 N,N'-Bis(β -chloroethyl)phosphoric acid amide dichloride
 Cyclophosphamide
 Defosfamide
 Trofosfamide
 Bis-chloroethyl toluene sulfonyl amide
 Phenoperidine HCl
 Bis(choline)-naphthalene-1,5-disulfonate
 Aclatonium napadisylate
 4,4-Bis(p-fluorophenyl)butyl chloride
 Penfluridol
 Bis(3-hydroxypropyl)ethylene diamine
 Dilazep HCl
 N,N'-Bis-methoxycarbonyl isothiourea-S-methyl ether
 Febantel
 Bis(methoxy-2-ethoxy) sodium aluminum hydride
 Indalpine
 Bis(3-methylsulfonyloxypropyl)amine HCl
 Improsulfan tosylate
 Bismuth oxide
 Bismuth sodium triglycollamate
 3',5'-Bis-O-(p-nitrobenzoyl)-2'-deoxy-S-(trifluoromethyl)uridine
 α,α,α -Trifluorothymidine
 Bis(phenyleneoxy) cyclohexane
 Clinofibrate
 Bis-triethylammonium pyrophosphate
 Adenosine triphosphate
 Bis(trimethylsilyl) acetamide
 Cefaclor
 Cefroxadine
 Ceftizoxime
 2,4-Bis(trimethylsilyl)-5-fluorouracil
 Tegafur
 Bleomycinic acid
 Peplomycin sulfate
 Boric acid
 Epinephryl borate
 Boron trifluoride etherate
 Nimetazepam
 Bromine
 Acetazolamide
 Ambroxol
 Ancitapine HCl
 Baclofen
 Benzbromarone
 Bromazepam
 Bromhexine
 Bromopride
 Bronopol
 Bufeniode
 Carbuterol
 Clorprenaline
 Demegestone
 Diosmin
 Diphenhydramine HCl
 Endralazine
 Etozolin
 Fazidinium bromide
 Fenoterol hydrobromide
 Folic acid
 Halothane
 Ifenprodil tartrate
 Ketamine HCl
 Memantine
 Metaproterenol
 Norfenefrine
 Oxaflozane HCl
 Phendimetrazine tartrate
 Phentermine HCl
 Procarbazine HCl
 Promegestone
 Pyrovalerone HCl
 Sulfacytine
 Sulfalene
 Trioxsalen
 N-Bromoacetamide
 Fluazacort
 Fluocinolone acetonide
 Fluocortolone
 Fluoxymesterone
 Bromoacetic acid ethyl ester
 Chromonar HCl
 Bromoacetyl
 Timolol maleate
 α -Bromoacetophenone
 Nomifensine maleate
 Bromoacetyl bromide
 Bromazepam
 Cephapirin sodium
 Clonazepam
 Flunitrazepam
 5-Bromoacetyl salicylamide
 Labetalol HCl
 m-Bromoanisole
 Tramadol HCl
 p-Bromoanisole
 Cyclofenil
 Bromobenzene
 Alphaprodine HCl
 Cicloxilic acid

- Bromobenzene (cont'd)
 Clorazepate dipotassium
 Cycrimine HCl
 Diphemanil methyl sulfate
 Fenoprofen
 Medazepam
 Procyclidine HCl
 Tamoxifen
 Tiemonium iodide
 4-Bromobenzyl cyanide
 Brompheniramine maleate
N-o-Bromobenzyl-*N,N*-dimethylamine
 Breylium tosylate
 2-Bromo-4'-benzyloxypropiofenone
 Ritodrine
 2-Bromobutyric acid
 Etidocaine HCl
 α -Bromobutyric acid bromide
 Procaterol
p-Bromochlorobenzene
 Carbinoxamine maleate
 1-Bromo-2-chloroethane
 Alfentanil HCl
 7-Bromo-5-(*o*-chlorophenyl)-3H-[2,3e]-
 thieno-1,4-diazepin-2-one
 Bronopol
 1-Bromo-3-chloropropane
 Acetophenazine dimaleate
 Oxaflumazine disuccinate
 Perphenazine
 Reproterol
 ω -Bromo-2,4-dichloroacetophenone
 Miconazole nitrate
 2-Bromo-2'-(3'-dimethylaminopropyl)-
 amino-4'-chlorodiphenyl sulfide
 Chlorproethazine HCl
 2-Bromoethanol
 Perphenazine
 β -Bromoethyl acetate
 Thiopropazate
 Bromoethylamine hydrobromide
 Medazepam
 2-Bromo-2-ethylbutyryl urea (Carbromal)
 Ectylurea
 7-(β -Bromoethyl)theophylline
 Pimefylline nicotinate
 2-Bromo-6 β -fluoro-17 α ,21-dihydroxy-
 9 β ,11 β -oxido-pregna-1,4-diene-
 3,20-dione-17,21-acetate
 Halopredone acetate
 1-Bromo-5-hexanone
 Pentoxifylline
 α -Bromo-4-isopropylthiopropio-
 phenone
 Suloctidil
 2-Bromo-6-methoxynaphthalene
 Methallenestril
 Naproxen
 5-Bromonicotiny chloride
 Nicergoline
 3-Bromophthalide
 Talampicillin
 Talniflumate
 2-Bromopropane
 Lorcaïnide HCl
 1-Bromo-2-propanol
 Rociverine
 3-Bromopropanol
 Flupentixol
 2-Bromo-2',6'-propionoxylidide
 Tocainide
 α -Bromopropionyl bromide
 Prilocaine HCl
 3-Bromopropionyl chloride
 Pipobroman
 α -Bromopropiophenone
 Diethylpropion HCl
 Phenmetrazine
 2-Bromopropiophenone
 Fazidinium bromide
 3-Bromopropyl-homopiperazine
 Homofenazine
 2-Bromopyridine
 Disopyramide phosphate
 Triprolidine
 3-Bromopyridine
 Zimelidine
 β -Bromopyruvaldoxime
 Methotrexate
N-Bromosuccinimide
 Betamethasone acetate
 Bromocriptine
 Medrogestone
 2-Bromothiophene
 Thihexinol
 1-Bromo-3,7,11-trimethyl-2,6,10-
 dodecatriene
 Pifarnine
 4-Bromoveratrole
 Rimiterol
 1,4-Butanediol
 Busulfan
 Butanol
 Benoxinate hydrochloride
 Bumetanide
 Fluocortin butyl
 Pentobarbital sodium
p-*n*-Butoxy acetophenone
 Dyclonine HCl
 Butoxybenzyl bromide
 Butropium bromide
 7-[D- α -*tert*-Butoxycarbonylamino- α -
 (*p*-hydroxyphenyl)acetamido]-3-
 (1,2,3-triazol-5-ylthiomethyl)-3-
 cephem-4-carboxylic acid
 Cefatrizine

- (Z)-2-(2-tert-Butoxycarbonylprop-2-oxymino)-2-(2-tritylaminothiazol-4-yl)acetic acid
 Ceftazidime
 4-Butoxyphenoxyacetyl chloride
 Fenoxedil
 tert-Butyl(6R,7R)-3-acetoxymethyl-7-aminoceph-3-em-4-carboxylate
 Ceftazidime
 tert-Butylacetyl chloride
 Prednisolone tebutate
 tert-Butyl alcohol
 Indomethacin
 Butylamine
 Carbidopa
 Tybamate
 tert-Butylamine
 Bucumolol HCl
 Bufetrol
 Bunitrolol
 Bupranolol
 Carteolol
 Celiprolol
 Nadolol
 Penbutolol
 Timolol maleate
 n-Butylamine HCl
 Bufornin HCl
 p-Butylaminobutyric acid ethyl ester
 Benzonatate
 N-tert-Butyl-2-(5-benzyloxy-6-hydroxymethyl-2-pyridyl)-2-hydroxyacetamide
 Pirbuterol
 Butyl bromide
 Bufexamac
 Bupivacaine
 Fenipentol
 sec-Butyl bromide
 Pentapiperide methosulfate
 Valethamate bromide
 3-Butyl-1-chloroisoquinoline
 Dimethisoquin
 2-n-Butyl-3-(3,5-diiodo-4-hydroxybenzoyl) benzofuran
 Amiodarone HCl
 p-tert-Butyl-o,o'-dimethylphenylacetone nitrile
 Xylometazoline HCl
 n-Butylglycidyl ether
 Febuprol
 tert-Butyl hydroperoxide
 Fluprednidene acetate
 tert-Butyl hypobromite
 Amixtrine HCl
 Eprozinol
 tert-Butyl hypochlorite
 Fosfomycin
 Butyl lithium
 Doxepin HCl
 Gemfibrozil
 Thiothixene
 Zimelidine
 n-Butyl malonic acid ethyl ester
 Bumadizon
 Oxyphen butazone
 p-Butylmercaptobenzhydryl chloride
 Captodiamine
 Butyl nitrite
 Metaraminol
 tert-Butyloxycarbonyl-L-aspartyl-L-tyrosyl-L-methionylglycyl-L-tryptophyl-L-methionyl-L-aspartyl-L-phenylalanine amide
 Sincalide
 N-tert-Butyloxycarbonyl- β -alanine-2,4,5-trichlorophenyl ester
 Pentagastrin
 3-Butyl-1-phenylamine
 Bufeniode
 1-Butyne
 Methohexital sodium
 Butyramidophenol
 Acebutolol
 Butyric anhydride
 Iopanoic acid
 Tyropanoate sodium
 n-Butyryl chloride
 Ethacrynic acid
 Cadmium chloride
 Naproxen
 Calcium bisulfite
 Dobesilate calcium
 Calcium carbonate
 Caraspirin calcium
 Medazepam
 Calcium chloride
 Docusate calcium
 Fibrinolysin
 Calcium ferricyanide
 Sulfamethizole
 Calcium hydroxide
 Cyclamate calcium
 Inositol
 Phentermine HCl
 Camphene
 Isobornyl thiocynoacetate
 Mecamylamine HCl
 Xibornol
 d-10-Camphorsulfonic acid
 Levamisole HCl
 Caproic acid anhydride
 Hydroxyprogesterone caproate
 n-Butyl isocyanate
 Tolbutamide

- Caprolactam
 Aminocaproic acid
 4-Carbamoyl-4-N-anilinopiperidine
 Spiperone
 4-Carbamoyl-4-piperidonopiperidine
 Clocapramine
 Carbarsonic oxide
 Thiocarbarsonic
 p-Carboxyaminobenzenesulfonyl
 chloride
 Sulfaphenazole
 3-Carboxy-4-hydroxy-2-methyl-2H-
 1,2-benzothiazine-1,1-dioxide
 Isoxicam
 1-Carboxymethyl-6,7-dimethoxy-
 1,2,3,4-tetrahydroisoquinoline
 Tetrabenazine
 2-Carboxymethylene-3-methyl-4-
 thiazolidinone
 Etazolol
 N-Carboxypiperazine
 Amoxapine
 Carboxysulfanilic acid chloride
 Sulfamer
 O-Carboxysyringoyl chloride
 Syrosingopine
 N-Carbobenzyloxy-S-benzyl-L-cysteinyl-
 L-phenylalanil azide
 Felypressin
 N-Carbobenzyloxy-S-benzyl-L-cysteinyl-
 L-tyrosyl-L-phenylalanine azide
 Ornipressin
 Carbobenzyloxy chloride
 Amikacin
 Cephaloglycin
 Mergolone
 N-Carbobenzyloxy-L-glutamyl-L-aspara-
 gyl-L-S-benzyl-L-cysteinyl azide
 Felypressin
 Ornipressin
 Carbobenzyloxylglycine
 Midodrine
 N-Carbobenzyloxy-L-proline
 Ornipressin
 N-Carbobenzyloxy-L-propyl-ε-N-p-toluene-
 sulfonyl-L-lysyl-glycinamide
 Felypressin
 N-α-Carbobenzyloxy-N-δ-p-toluene-
 sulfonyl-L-ornithine
 Ornipressin
 (4-Carboxyphenyl)triphenyl-
 phosphonium bromide
 Sulprostone
 Carbondiimidazole
 Veralipride
 Carbon dioxide
 Diflunisal
 Methylhexanamine carbonate
- Salicylic acid
 Carbon disulfide
 Cimetide
 Disulfiran
 Tibezoneum iodide
 Tiocarlide
 p-Carboxybenzenesulfonyl chloride
 Probenecid
 17α-(2-Carboxyethyl)-17β-hydroxy-
 androsta-4,6-dien-3-one lactone
 Spironolactone
 17α-Carboxyethyl-17β-hydroxyandrost-
 4-ene-3-one lactone
 Canrenoate potassium
 Cerelose (glucose)
 Oxytetracycline
 Chloral
 Mecillinam
 Chloral hydrate
 Chloral betaine
 Chloramphenicol
 Chloramphenicol palmitate
 Chloranil
 Canrenoate potassium
 Carprofen
 Cloprednol
 Dydrogesterone
 Chloride ion exchange resin
 Alcuronium chloride
 Chlorine
 Acetazolamide
 Bucloxic acid
 Butalamine HCl
 Chlorotrianisene
 Chlorquinaldol
 Clenbuterol
 Diazoxide
 Enflurane
 Floxacillin
 Flucloronide
 Isoflurophate
 Lindane
 Methazolamide
 Metoclopramide HCl
 Oxacillin sodium
 Chloroacetaldehyde
 Benzthiazide
 (6R,7R)-7-[2-[2-(2-Chloroacetamido)-
 4-thiazolyl]-2-(methoxyimino)
 acetamido]-8-oxo-3-[[1,4,5,6-
 tetrahydro-4-methyl-5,6-dioxo-
 as-triazin-3-yl]thio]methyl]-5-
 thia-1-azabicyclo[4.2.0]oct-2-
 ene-2-carboxylic acid
 Ceftriaxone sodium
 Chloroacetic acid
 Carbocysteine
 Isobornyl thiocynoacetate

- Chloroacetic acid (cont'd)
 Pixifenide
 Chloroacetic acid-N,N-diethylamide
 Propanidid
 2-Chloroacetic acid ethyl ester
 Cimetide
 Chloroacetic anhydride
 Hydrocortamate HCl
 Chloroacetone
 Benfurodil hemisuccinate
 Benzbromarone
 Mexiletine HCl
 Chloroacetonitrile
 Bendazac
 o-Chloroacetophenone
 Clorprenaline
 p-Chloroacetophenone
 Phenaglycodol
 Tioclomarol
 Chloroaceto pyrocatechol
 Hexoprenaline
 Chloroacetyl catechol
 Protokylol
 Chloroacetyl chloride
 Chlordiazepoxide HCl
 Clemizole
 Diazepam
 Lidocaine
 Lorazepam
 Mianserin
 Tromantidine HCl
 N-(2-Chloroacetyl)-2,6-dimethylaniline
 Lidoflazine
 Chloroacetyl guanide
 Guanethidine sulfate
 N-Chloroacetyl-N-phenyl-2,6-dichloro-
 aniline
 Diclofenac sodium
 3-Chloro-4-allyloxyphenyl acetonitrile
 Alcofenac
 6-Chloro-4-aminobenzene-1,3-disulfon-
 amide
 Cyclothiazide
 2-Chloro-4-aminobenzoic acid
 Chloroprocaine HCl
 4-Chloro-3-aminobenzophenone-2'-
 carboxylic acid
 Chlorthalidone
 5-Chloro-2-amino- α -methyl- α -phenylbenzyl
 alcohol
 Etifoxine
 m-Chloroaniline
 Buthiazide
 Chlorothiazide
 p-Chloroaniline
 Flunitrazepam
 p-Chloroaniline HCl
 Chlorhexidine
 4-Chlorobenzaldehyde
 Chlormezanone
 Chlorobenzene
 Methixene HCl
 p-Chlorobenzene sulfonamide
 Chlorpropamide
 1-p-Chlorobenzhydryl-4-benzyl-piper-
 azine
 Meclizine HCl
 p-Chlorobenzhydryl bromide
 Cloperastine
 4-Chlorobenzhydryl chloride
 Chlorcyclizine
 Etodroxizine
 o-Chlorobenzohydroxamic chloride
 Cloxacillin
 N-p-Chlorobenzohydryl piperazine
 Hydroxyzine HCl
 o-Chlorobenzonitrile
 Ketamine HCl
 o-Chlorobenzophenone
 Chlophedianol
 4-Chlorobenzophenone
 Chlorphenoamine HCl
 p-Chlorobenzoyl chloride
 Benoxapofen
 1-(p-Chlorobenzoyl)-5-methoxy-2-
 methyl-3-indoleacetic acid
 Progumetacin maleate
 1-(p-Chlorobenzoyl)-2-methyl-5-methoxy-
 3-indoleacetic acid
 Oxametacine
 p-Chlorobenzylamine
 Clemizole
 2-Chlorobenzyl chloride
 Ambenonium chloride
 Ticlopidine HCl
 p-Chlorobenzyl chloride
 Clobutinol
 Echonazole nitrate
 Indomethacin
 Pyrrobutamine
 Triparanol
 4-Chlorobenzyl cyanide
 Chlorpheniramine maleate
 1-(o-Chloro)-benzyl-2-di-sec-butyl-
 aminoacetyl-pyrrole
 Viminol
 5-Chloro-2-bromoacetyl-amino-o-
 chlorobenzophenone
 Cloxazolam
 1,3-Chlorobromopropane
 Dilazep HCl
 4-Chlorobutyronitrile
 Buflomedil
 8-Chlorocaffeine
 Cafaminol

- 5-Chloro-2-chloroacetylaminobenzo-phenone
Oxazolam
- 2-Chloro-3-chloromethylthiophene
Tioconazole
- 3-Chloro-5-(3-chloropropyl)-10,11-dihydro-5H-dibenz(b,f)azepine
Clocapramine
- 2-Chloro-10-(γ -chloropropyl)phenothiazine
Pipamazine
Thiopropazate
- 7-Chloro-5-cyclohexyl-2-oxo-2,3-dihydro-1H-benzo(f) diazepine-1,4
Tetrazepam
- 8-Chlorodibenzo [b,f] thiepin-10(11H)-one
Zotepine
- 6-Chloro-2-dibenzoylaminobenzyl bromide
Fominoben HCl
- 3-Chloro-10-[3-(di-N-2-chloroethyl)aminopropyl] phenthiazine hydrochloride
Prochlorperazine
- 2-Chloro-1-diethylaminopropane
Ethopropazine HCl
- α -Chlorodiethyl carbonate
Bacampicillin
- 7-Chloro-1,3-dihydro-5-(o-chlorophenyl)-2H-1,4-benzodiazepine-2-thione
Triazolam
- 5-Chloro-10,11-dihydro-5H-dibenzo-(a,d)cycloheptene
Amineptine HCl
- 7-Chloro-1,3-dihydro-5-phenyl-2H-1,4-benzodiazepine-2-one
Halazepam
- 7-Chloro-1,3-dihydro-5-phenyl-2H-1,4-benzodiazepine-2-one-4-oxide
Oxazepam
- 7-Chloro-1,3-dihydro-5-phenyl-2H-1,4-benzodiazepine-2-thione
Estazolam
- 5-Chloro-1,3-dihydro-1-(4-piperidinyl)-2H-benzimidazol-2-one
Domperidone
- α -Chloro-3',4'-dihydroxyacetophenone
Dipivefrin
- 1-Chloro-2,3-dihydroxypropane
Dyphylline
- 2-Chloro-1-dimethylamino propane
Methadone HCl
- 1-Chloro-3-dimethylamino propane
Dimetacrine tartrate
Triflupromazine
- 2-Chloro-9-(3'-dimethylaminopropylidene)thioxanthene
Clopenthixol
- 2-Chloro-4,5-diphenyl oxazole
Ditazol
- 5-Chloro-2,4-disulfamylaniline
Ethiazide
Hydrochlorothiazide
Trichlormethiazide
- 2-Chloroethanol
Homofenazine
Tofenacin HCl
- 2-(2-Chloroethoxy) ethanol
Etofenamate
- N-(2-Chloroethyl)amine HCl
Ifosfamide
- β -Chloroethyl-di-n-butylcarbamate
Dibutoline sulfate
- β -Chloroethyl-N-diethylamine
Nafronyl oxalate
- β -Chloroethyl dimethylamine
Cyclopentolate HCl
Ethoheptazine
- 7-Chloro-1-ethyl-6-fluoro-4-oxo-1,4-dihydroquinoline-3-carboxylic acid
Norfloxacin
- N-(2-Chloroethyl)-N-(3-hydroxypropyl)amine hydrochloride
Trofosfamide
- 1-(2-Chloroethyl)-3-[(2-methyl-4-aminopyridin-5-yl)methyl] urea
Nimustine
- β -Chloroethylmorpholine
Nimorazole
- N-(2-Chloroethyl)-N,O-propylene phosphoric acid ester amide HCl
Ifosfamide
- 7-Chloro-2-ethyl-6-sulfamyl-4-quinazolinone
Quinethazone
- 7-(β -Chloroethyl)theophylline
Fenethylamine HCl
- 1-(2-Chloroethyl)hexahydro-1H-azepine
Cetiedil
- 2-Chloroethylvinyl ether
Oxaflozane HCl
- 2-Chloro-6-fluorobenzaldoxime
Floxacillin
- γ -Chloro-p-fluorobutyrophenone
Benperidol
Droperidol
Melitracen
Pipamperone
Spiperone
- 4-Chloro-2-fluoro-5-sulfamoyl benzonitrile
Azosemide
- Chloroform
Ciprofibrate
Fenofibrate
Heparin
Orgotein

- Chloroformic acid methyl ester
 Fenbendazole
 Glisoxepid
 2-Chlorofuranidin
 Tegafur
 6 α -Chlorohydrocortisone-21 acetate
 Cloprednol
 1-Chloro-2-hydroxy-3-tert-butylamino-
 propane
 Butofilolol
 2-Chloro-9-(2-hydroxy ethoxy methyl)
 adenine
 Acyclovir
 1-Chloro-2-(2-hydroxyethyl)ethane
 Hydroxyzine HCl
 3-Chloroiminodibenzyl
 Clomipramine
 2-Chloro-4-methylaniline
 Tolondine nitrate
 5-Chloro-2-methylaniline
 Metolazone
 5-Chloro-N-methylantranilic acid
 Medazepam
 1-Chloro-2-methyl-3-bromopropane
 Dixyrazine
 1-Chloro-2-methyl-3-dimethylamino-
 propane
 Trimeprazine
 Chloromethyl ethyl ether
 Terofenamate
 2-Chloromethylimidazole HCl
 Antazoline HCl
 Phentolamine HCl
 2-Chloro-5-methylphenol
 Bupranolol
 Chloro-N-methyl-N- ω -phenyl-tert-
 butylacetamide
 Oxethazine
 γ -(4-Chloromethylphenyl)propyl chloride
 Fomocaine
 3-Chloro-4-methyl-6-phenylpyridazine
 Minaprine
 4-Chloro-1-methylpiperidine
 Cyproheptadine
 Ketotifen
 Chloromethyl pivalate
 Pivampicillin
 γ -Chloromethylpyridine hydrochloride
 Tropicamide
 3-Chloromethyl quinuclidine HCl
 Mequitazine
 6-Chloro- α -methyl-1,2,3,4-Tetrahydro
 carbazole-2-acetic acid ethyl ester
 Carprofen
 1-Chloro-2-morpholinoethane HCl
 Floredil HCl
 3-Chloro-6-nitroacetanilide
 Albendazole
 2-Chloro-4-nitroaniline
 Niclosamide
 p-Chloronitrobenzene
 Dapsone
 4-Chloro-3-nitrobenzophenone
 Mebendazole
 4-Chloro-3-nitrobenzoyl chloride
 Flubendazole
 4-Chloro-3-nitro-5-sulfamyl benzoic
 acid
 Bumetanide
 5-Chloro-2-norbornene
 Biperiden
 1-Chloro-4-pentanone
 Hydroxychloroquine sulfate
 m-Chloroperbenzoic acid
 Alfacalcidol
 Minoxidil
 Pancuronium bromide
 Chlorophenazine
 Chlorpromazine HCl
 o-Chlorophenol
 Dichlorphenamide
 Picosulfate sodium
 p-Chlorophenol
 Chlorphenesin carbamate
 2-Chlorophenothiazine
 Perphenazine
 3-Chlorophenothiazine
 Cyamemazine
 p-Chlorophenoxy acetic acid diethyl-
 amino ethylamide
 Clofezone
 o-(p-Chlorophenoxy)aniline
 Loxipine
 o-(p-Chlorophenoxy) aniline HCl
 Amoxapine
 Chloro-2-phenoxyethane
 Bephenium hydroxy naphthoate
 α -(p-Chlorophenoxy)isobutyric acid
 Clofibrate
 Etofylline clofibrate
 Simfibrate
 2-(p-Chlorophenoxy)-2-methyl
 propionic acid
 Etofibrate
 p-Chlorophenyl acetone
 Pyrimethamine
 o-Chlorophenyl diphenyl methyl chloride
 Clotrimazole
 β -(p-Chlorophenyl)glutaric acid imide
 Baclofen
 4-Chlorophenyl isocyanate
 Triclocarban
 7-Chloro-5-phenyl-1-methyl-3-hydroxy-
 1,3-dihydro-2H-1,4-benzodiazepine-
 2-one
 Camazepam

- 3-(p-Chlorophenyl)phthalimide
Mazindol
- 4-(p-Chlorophenyl)-4-piperidinol
Loperamide HCl
- 4-(4-Chlorophenyl)piperidin-4-ol HCl
Haloperidol
- N-(4-Chlorophenyl)-N-(piperidinyl)-benzeneacetamide
Lorcainide HCl
- 4-Chlorophthalimide
Clorexolone
- β -Chloropropionaldehyde
Mefenorex HCl
- β -Chloropropionaldehyde diethyl acetal
Pipoxolan HCl
- α -Chloropropionyl chloride
Carticaine
- β -Chloropropionyl chloride
Beclamide
Proxazole citrate
- 1-(3-Chloropropyl)-2H-benzimidazol-2-one
Oxatamide
- 1-(3-Chloropropyl)-4-m-chlorophenyl-piperazine
Trazodone HCl
- α -Chloropropyl-diethylamine
Aprindine HCl
- 1-(3-Chloropropyl)-1,3-dihydro-2H-benzimidazol-2-one
Domperidone
- 5-(3-Chloropropylidene)dibenzo[a,d]cyclohepta[1,4]diene
Nortriptyline
- N-(3-Chloropropyl)-N-methylbenzamine
Desipramine HCl
- 1-(3'-Chloropropyl)-4-methylpiperazine
Trifluoperazine
- N-[1-Chloropropyl-(3)]piperidine
Diphenidol
- 2-Chloropyridine
Brompheniramine maleate
Chlorpheniramine maleate
Methyl phenidate HCl
Tranzodone HCl
- 2-Chloropyrimidine
Piribedil
- 4-Chlorosalicylic acid
Xipamid
- 5-Chlorosalicylic acid
Niclosamide
- N-Chlorosuccinimide
Beclomethasone dipropionate
Clidanac
Clomiphene dihydrogen citrate
Dichlorisone acetate
- 4-Chloro-3-sulfamylbenzene sulfonchloride
Mefruside
- Chlorosulfonic acid
Bendroflumethiazide
Buthiazide
Chlorothiazide
Dichlorphenamide
Flumethiazide
Hydroflumethiazide
Mafenide acetate
Metolazone
Picosulfate sodium
Sulisobenzone
Thiothixene
Xipamid
- 8-Chlorotheophylline
Dimenhydrinate
- 2-Chlorothioxanthone
Chlorprothixene
- 5-Chlorothiophene-2-aldehyde
Tiocloamarol
- 1-Chloro-2,2,2-trifluoroethyl dichloromethyl ether
Isoflurane
- 4-(4-Chloro- α,α,α -trifluoro-m-tolyl)-4-piperidinol
Penfluridol
- Chlortetracycline
Tetracycline
- Cholesta-5,7-diene-3 β ,25-diol
Calcifediol
- Cholesta-1,5,7-trien-3 β -ol
Alfacalcidol
- Choline
Citicoline
- Choline bicarbonate
Choline theophyllinate
- Choline chloride
Carbachol
Choline salicylate
- Choline dihydrogen citrate
Ferrocholine
- Chromic acid
Cortisone acetate
Demegestone
Fluocortolone
Medrogestone
Norethindrone
- Chromic anhydride
Fludiazepam HCl
Nimetazepam
Sulprostone
- Cinchonidine
Melphalan
- Cinnamoyl chloride
Cinnarizine

- 1-Cinnamylpiperazine
 Flunarizine HCl
 Citric acid
 Butamirate citrate
 Choline dihydrogen citrate
 Clomiphone dihydrogen citrate
 Orphenadrine citrate
 Perisoxal citrate
 Proxazole citrate
 Copper (powder)
 Chlorproethazine HCl
 Fenoprofen
 Cortisone
 Prednisone
 Cotton linters
 Hydroxypropyl cellulose
 Creatinol phosphate
 Creatinolfosfate
 m-Cresol
 Mephesisin
 Crotonaldehyde
 Tilidine HCl
 Crotonyl chloride
 Crotamiton
 Cupric acetate
 Fluocortin butyl
 Cupric cyanide
 Cyamemazine
 Cuprous chloride
 Haloproglin
 Cuprous cyanide
 Methallenestril
 Curare
 Dimethyl tubocurarine iodide
 Cyanacetamid
 Ethionamide
 Protionamide
 Cyanamide
 Albendazole
 Butalamine HCl
 Cimetide
 Cyanoacetamide
 Allopurinol
 Cyanoacetic acid
 Aminometradine
 Amisometradine
 Cyclopentamine HCl
 Sulindac
 Cyanoacetic acid methyl ester
 Heptabarbitol
 Cyanoacetyl chloride
 Cephacetrile sodium
 4-Cyano benzaldehyde
 Hydroxystilbamidine isethionate
 Cyanocobalamin
 Hydroxocobalamin
 Cyanogen bromide
 Naloxone
 2-Cyanophenol
 Bunitrolol
 2-Cyanopyridine
 Rimiterol
 3-Cyanopyridine
 Nicotinyl alcohol
 4-Cyanopyridine
 Isoniazid
 Cyanuric chloride
 Triethylene melamine
 Cyclic polypeptide
 Cargutocin
 Cyclobutane carboxylic acid chloride
 Nalbuphine
 N-Cyclobutylmethyl-14-hydroxy-3-methoxymorphinan
 Butorphanol
 3-Cycloethylenedioxy-10-cyano-17 α -ethynyl-19-nor- Δ^5 -androstene-17 β -ol
 Quingestanol acetate
 Cycloheptanone
 Heptabarbitol
 Cyclohexan-1,3-dione
 Molindone
 Cyclohexanone
 Cyclobutylol
 Hydroxyprogesterone caproate
 Cyclohexylacetone
 Droprnilamine HCl
 Propylhexedrine
 Cyclohexylamine
 Clorexolone
 Cyclamate calcium
 1-Cyclohexylamino-2-propanol
 Hexylcaine HCl
 Cyclohexyl bromide
 Cetiedil
 Cyclomethycaine
 Oxyphencyclimine
 Tridihexethyl iodide
 Trihexyphenidyl HCl
 2-Cyclohexylcarbonyl-4-oxo-2,3,6,7-tetrahydro-4H-pyrazino[2,1-a]isoquinoline
 Praziquantel
 5-Cyclohexyl-1-indanecarboxylic acid
 Clidanac
 Cyclohexyl isocyanate
 Acetohexamide
 Glipizide
 Gliquidone
 Cyclohexylmagnesium bromide
 Perhexiline sulfate
 Cyclohexylmethylamine
 Bromhexine
 1-Cyclohexyl-2-methylaminopropane HCl
 Barbexaclone

- Cyclopentanepropionyl chloride
Estradiol cypionate
- Cyclopentanol
Quingestanol acetate
- Cyclopentanone
Cyclopentamine HCl
Cyclopentolate HCl
- Cyclopentyl bromide
Ketamine HCl
Quinestrol
- 16 α ,17 α -Cyclopentylidenedioxy-9 α -fluoro-11 β ,21-dihydroxy-1,4-pregnadiene-3,20-dione
Amcinonide
- 2-Cyclopentylphenol
Penbutolol
- Cyclopentyl- β -(N-piperidyl)ethyl ketone
Cycrimine HCl
- β -Cyclopentyl propionic acid
Testosterone 17 β -cypionate
- Cyclopentyl (α -thienyl) hydroxyacetic acid
Penthienate bromide
- Cyclopropanecarboxylic acid chloride
Prazepam
- Cyclopropyl-di-(4-fluorophenyl)carbinol
Fluspirilene
Pimozide
- 4-[2-(Cyclopropylmethoxy)ethyl] phenol
Betaxolol HCl
- Cysteamine
Cimetide
- Cysteine
Carbocysteine
Timonacic sodium
- Cysteine HCl
Acetylcysteine
Letosteine
- 3-Deacetoxy-7-aminocephalosporanic acid
Cephadrine
- Decamethylene bromide
Tiadenol
- Decanoic acid chloride
Nandrolone decanoate
- Dehydroabietylamine
Penicillin G hydrabamine
- Dehydroabietyl ethylene diamine
Penicillin V hydrabamine
- 1-Dehydro-6 α -methyl-9 α -fluorohydrocortisone
Fluorometholone
- 6-Dehydro-17-methyltestosterone
Calusterone
- 4'-Demethyl epipodophyllotoxin- β -D-glucoside
Teniposide
- 6-Demethyl tetracycline
Minocycline
- Desoxycorticosterone
Hydroxydione sodium succinate
- d-Desoxyephedrine HCl
Benzphetamine HCl
- 11-Desoxy-17-hydroxycorticosterone
Hydrocortisone
- 3,5-Diacetoxyacetophenone
Fenoterol hydrobromide
Metaproterenol sulfate
- 3,17-Diacetoxy-5 α -androstane-2,16-diene
Pancuronium bromide
- 16 α ,21-Diacetoxy-11 β ,17 α -dihydroxy-9 α -fluoro-4-pregnene-3,20-dione
Triamcinolone diacetate
- 1 α ,25-Diacetoxy- α -pregnolone
Calcitriol
- Diallylbarbituric acid
Proxibarbal
- 3,3'-Diallyl-4,4'-biphenol
Bialamicol
- Diallylnortoxiferine diiodide
Alcuronium chloride
- 1,3-Diaminobutane
Oxyphencyclimine
- Diaminodiphenylsulfone
Sulfoxone sodium
- 3,4-Diaminodiphenylthio ether
Fenbendazole
- 1,2-Diaminopropanetetraacetic acid
Razoxane
- 1,4:3,6-Dianhydro-D-glucitol
Isosorbide dinitrate
- Diatrizoic acid
Metrizoic acid
- Diazomethane
Diazepam
Epirizole
Methoxsalen
Pyrimethamine
- Dibenzo [a,e] cycloheptadiene
Butriptyline
- Dibenzo [a,d] cyclohepta-1,4-diene-5-one
Amitriptylin oxide
- Dibenzo [a,e] cycloheptatrien-5-one
Cyproheptadine
- 5H-Dibenzo [a,d] cycloheptene
Protriptyline
- Dibenzo [a,d] cycloheptene-5-one
Cyclobenzaprine
- Dibenzylazodicarboxylate
Minocycline
- N,N'-Dibenzylhexamethylenediamine
Hexoprenaline
- 3,5-Dibenzoyloxy- ω -bromoacetophenone
Terbutaline

- O,N-Dibenzoyloxycarbonyl-p-oxy-di- α -aminophenylacetic acid
 Amoxicillin
 Diborane
 Mianserin
 Pirbuterol
 1,4-Dibromo-2-butene
 Pirprofen
 1,2-Dibromoethane
 Levamisole HCl
 1,3-Dibromopropane
 Doxepin HCl
 Dibutylaminoethyl chloride
 Butalamine HCl
 Di-n-butylethyl-1-methyl-n-butyl-malonate
 Pentobarbital sodium
 2,6-Di-tert-butyl-4-mercaptophenol
 Probucof
 Dichloroacetaldehyde
 Trichlormethiazide
 2,6-Dichloroaniline
 Clonidine HCl
 3,4-Dichloroaniline
 Triclocarban
 2,3-Dichloroanisole
 Ticrynafen
 2,6-Dichlorobenzaldehyde
 Guanabenz
 Guanoxabenz HCl
 2,4-Dichlorobenzoyl chloride
 Miconazole nitrate
 2,4-Dichlorobenzyl chloride
 Clofoctol
 Oxiconazole nitrate
 2,6-Dichlorobenzyl chloride
 Isoconazole nitrate
 p-(2,2-Dichlorocyclopropyl)phenol
 Ciprofibrate
 Dichlorodiethyl ether
 Benzethonium chloride
 Oxeladin
 1,1-Dichloro-2,2-difluoroethylene
 Methoxyflurane
 2,4-Dichloro-6,7-dimethoxyquinazoline
 Prazosin
 5,8-Dichloro-10-dioxo-11-methyl-di-benzo[c,f]thiazepine (1,2)
 Tianeptine
 2,6-Dichloro-3-methylaniline
 Meclufenamic acid
 2,4-Dichloronitrobenzene
 Diazoxide
 2,3-Dichlorophenoxyacetic acid
 Ethacrynic acid
 α -2,6-Dichlorophenoxypropionitrile
 Lofexidine HCl
 2,6-Dichlorophenylacetic acid chloride
 Guanfacine
 α -(2,4-Dichlorophenyl)-imidazole-1-ethanol
 Econazole nitrate
 Isoconazole nitrate
 Tioconazole
 1-(2,4-Dichlorophenyl)-2-(1H-imidazol-1-yl)ethanone oxime
 Oxiconazole nitrate
 cis-2-(2,4-Dichlorophenyl)-2-(1H-imidazol-1-ylmethyl)-1,3-dioxolan-4-ylmethyl methanesulfonate
 Ketoconazole
 3-(2',6'-Dichlorophenyl)-5-methylisoxazole-4-carbonyl chloride
 Dicloxacillin sodium
 2,6-Dichloro-4-phenylquinoline
 Alprazolam
 3,6-Dichloropyridazine
 Sulfachlorpyridazine
 4,7-Dichloroquinoline
 Amodiaquin
 Chloroquine phosphate
 Glafenine
 Hydroxychloroquine sulfate
 o, α -Dichlorotoluene
 Clortermine HCl
 N-2,6-Dichloro-m-tolylanthranilic acid
 Terofenamate
 Dicyandiamide
 Buformin HCl
 Phenformin
 Dicyclohexylcarbodiimide
 Bumadizon
 Indomethacin
 Progylmetacin maleate
 1,3-Dicyclohexylguanidium adenosine 5'-phosphoramidate
 Adenosine triphosphate
 Diethanolamine
 Dipyridamole
 Ditazol
 Diethanolmethylamine
 Meperidine HCl
 2,5-Diethoxyaniline
 Fenoxedil
 3,5-Diethoxyphenol
 Floreidil HCl
 Diethylacetylaminomalonate
 Hydroxytryptophan
 Diethylallyl-(1-methylbutyl)malonate
 Thiamylal
 Diethylamine
 Amodiaquin
 Benzquinamide
 Bialamicol
 Diethylpropion HCl
 Disulfiram
 Ethamivan

- Diethylamine (cont'd)
 Hydrocortamate HCl
 Lidocaine
 Oxeladin
 Proxazole citrate
 Rociverine
 Tilidine HCl
 Trapidil
 Tridihexethyl iodide
 Diethylamine bisulfite
 Ethamsylate
 1-Diethylamino-4-aminopentane
 Chloroquine phosphate
 4-Diethylamino-2-butyryl acetate
 Oxybutynin chloride
 2-Diethylamino-1-chloroethane
 Bietaserpine
 Fenoxedil
 Gallamine triethiodide
 2-Diethylaminoethanethiol
 Thiphenamil HCl
 β -Diethylaminoethanol
 Benactyzine hydrochloride
 Benoxinate hydrochloride
 Caramiphen edisylate
 Chloroprocaine HCl
 Dicyclomine HCl
 Valethamate bromide
 4-(β -Diethylaminoethoxy) benzophenone
 Clomiphene dihydrogen citrate
 2-(2-Diethylaminoethyl) acetic acid
 ethyl ester
 Chromonar HCl
 2-Diethylaminoethylamine
 Ambenonium chloride
 Chlorisondamine chloride
 Diethylaminoethyl chloride
 Captodiamine
 Diltiazem HCl
 Flurazepam
 Penthienate bromide
 Tiropramide
 Triparanol
 Diethyl-n-butyl malonate
 Phenylbutazone
 Diethyl-sec-butyl methyl malonate
 Mebutamate
 Diethylcarbamyl chloride
 Diethylcarbamazine citrate
 Diethyl carbonate
 Fenspiride
 Flurbiprofen
 Furaltadone
 Nifuratel
 Protizinic acid
 Diethylchlorophosphate
 Echthiopate iodide
 α,α' -Diethyl-4,4'-dihydroxystilbene
 Diethylstilbestrol diphosphate
- N,N-Diethylenediamine
 Metoclopramide HCl
 Diethylene glycol
 Etodroxizine
 Diethylethoxymethylene malonate
 Flomequine
 Oxolinic acid
 N,N-Diethylethylenediamine
 Tiaprude
 Diethyl ketone
 Molindone
 Diethyl maleate
 Malathion
 Diethyl malonate
 Bupivacaine
 Kebuzone
 Methohexital sodium
 Diethyl-p-methylaminobenzoyl-L-
 glutamate
 Methotrexate
 Diethyl-3-methyl-2-butenyl malonate
 Feprazone
 Diethylmethylpropyl malonate
 Tybamate
 Diethyl oxalate
 Cromolyn sodium
 Mianserin
 Piperacillin sodium
 Diethyl-(1'-phenylpropyl)malonate
 Phenprocoumon
 Diethylpropyl malonate
 Apazone
 Diethyl sodium phthalidomalonate
 Melphalan
 Diethyl sulfate
 Aminometradine
 Etidocaine HCl
 Fluorouracil
 Pipemidic acid
 Piprozolin
 Pirimidic acid
 1-[4,4-Di-(4-fluorophenyl)butyl] piper-
 azine
 Lidoflazine
 Di-(p-fluorophenyl)chloromethane
 Flunarizine HCl
 4-(2',4'-Difluorophenyl)phenol
 Diflunisal
 6 α ,9 α -Difluoroprednisolone
 Difluprednate
 Diglycolic acid dichloride
 loglycamic acid
 Digoxin
 Medigoxin
 6,11-Dihydrodibenz(b,e)oxepin-11-one
 Doxepin HCl
 (\pm)-1,4-Dihydro-17 α -ethynyl-18-homo-
 oestradiol 3-methyl ether
 Norgestrel

- 2,3-Dihydrofuran
Tegafur
- 5,8-Dihydro-1-naphthol
Nadolol
- Dihydrotestosterone
Dromostanolone propionate
- 2,6-Dihydroxy acetophenone
Cromolyn sodium
- 2,5-Dihydroxy benzene sulfonic acid
Sultosilic acid piperazine salt
- 3,4-Dihydroxy- ω -bromoacetophenone
Reproterol
- 3,4-Dihydroxy- ω -chloroacetophenone
Isoproterenol sulfate
- N,N'-Di-(β -hydroxyethyl)piperazine
Nafiverine
- 2,3-Dihydroxyimino-17 α -methyl-5 α -androstane-17 β -ol
Furazabol
- Dihydroxy-11 β ,17 α -iodo-21-dioxo-3,20-pregnene-4
Tixocortol pivalate
- 2,6-Dihydroxymethylpyridine hydrochloride
Pyridinol carbamate
- 16 α ,17 α -Dihydroxyprogesterone
Algestone acetophenide
- L-Diiodo thyronine
Liothyronine
- p-Diisobutylphenol
Benzethonium chloride
- Diisopropylamine
 α,α,α -Trifluorothymidine
- γ -Diisopropylamino- α,α -diphenylbutyronitrile
Isopropamide iodide
- Diisopropylaminoethyl chloride
Diopyramide phosphate
Propantheline bromide
- Diketene
Ketazolam
Pyrithyldione
- 1,3-Dimethoxybenzene
Mexenone
- 2,6-Dimethoxybenzoic acid
Methicillin sodium
- 3,4-Dimethoxybenzoic acid
Mebeverine HCl
- 3,5-Dimethoxy-4'-chloro-4-hydroxybenzophenone
Morclofone
- 3,4-Dimethoxycinnamic acid
Tranilast
- 1,1-Dimethoxy-1-(4-fluorophenyl)-4-chlorobutane
Haloperidol
- 1-(2',5'-Dimethoxyphenyl)-2-aminoethanol-(1)
Midodrine
- 1-(3',4'-Dimethoxyphenyl)-2-propanone
Dioxyline phosphate
- 2,5-Dimethoxypropiophenone
Methoxamine HCl
- 2,3-Dimethoxy-5-sulfamoyl benzoic acid
Verapride
- 5,5-Dimethylacridan
Dimetacrine tartrate
- 1,3-Dimethyladamantane
Memantine
- Dimethylamine
Benzethonium chloride
Bephenium hydroxynaphthoate
Camazepam
Dibutoline sulfate
Doxepin HCl
Furtrethonium iodide
Loperamide HCl
Thiothixene
- Dimethylamine hydrochloride
Ethacrynic acid
- 3-Dimethylamino-1,2,4-benzotriazine oxide
Apazone
- ω -Dimethylamino-4'-bromopropiophenone
Zimelidine
- 1-Dimethylamino-2-chloroethane
Pyrilamine
Tripeleonnamine
- 1-Dimethylamino-2-chloropropane
Fonazine mesylate
Promethazine HCl
- 2-Dimethylamino-1-chloropropane
Isoaminile
- 3-Dimethylamino-1-chloro propane
Chlorpromazine HCl
Promazine HCl
- 3-Dimethylamino-(1,2-dihydro-1,2,4-benzotriazine)
Apazone
- 2-Dimethylaminoethanol
Deanol acetamido benzoate
Dimethisoquin
Diphenhydramine HCl
Iodoaliphonic acid
Orphenadrine citrate
Tromantidine HCl
- Dimethylaminoethoxy ethanol
Butamirate citrate
Dimethoxanate
- 4-(β -Dimethylaminoethoxy)- α -ethyl-desoxy benzoin
Tamoxifen
- β -Dimethylamino ethyl benzhydryl ether
Dimenhydrinate
- Dimethyl amino ethyl chloride
Amiodarone HCl
Brompheniramine maleate
Carbinoxamine maleate
Chlorpheniramine maleate

- Dimethylamino ethyl chloride (cont'd)
 Chlorphenoxamine HCl
 Dibenzepin HCl
 Moxisylyte
 Noxiptilin
 Pheniramine maleate
 Phenyltoloxamine
 Thonzylamine HCl
 Tibeonium iodide
 Trimethobenzamide HCl
 Zotepine
 2-(2-Dimethylaminoethyl)-indan-1-one
 Dimethindene maleate
 β -Dimethylaminoethyl mercaptan HCl
 Echothiopate iodide
 Dimethylaminoisopropyl chloride
 Isothipendyl HCl
 3,4-Dimethyl-5-amino isoxazole
 Sulfisoxazole
 1-Dimethylamino-2-methyl-3-chloropropane
 Cyamemazine
 Methotrimeprazine
 2-Dimethylaminomethyl-cyclohexanone
 Tramadol HCl
 2-[[[5-(Dimethylamino)methyl-2-furyl] methyl] thio] ethanamine
 Ranitidine
 3-Dimethylamino-2-methylpropyl chloride
 Oxomemazine
 m-Dimethylaminophenol
 Demecarium bromide
 Edrophonium chloride
 3-Dimethylaminopropanol magnesium chloride
 Amitriptylin oxide
 3-(Dimethylamino) propyl chloride
 Amitriptyline HCl
 Chlorprothixene
 Clomipramine
 Cyclobenzaprine
 Imipramine HCl
 Oxetorone fumarate
 Prothipendyl HCl
 2,3-Dimethylaniline
 Mefenamic acid
 2,6-Dimethylaniline
 Bupivacaine
 Mepivacaine
 Xipamid
 2,4-Dimethyl-6-tert-butylphenol
 Oxymetazoline HCl
 Dimethylcarbamyl chloride
 Benzpyrinium bromide
 Celiprolol
 Pyridostigmine bromide
 N,N-Dimethyl- β -chloroethylamine
 Methapyrilene HCl
 1,3-Dimethyl-4-chlorouracil
 Urapidil
 3,8-Dimethyl-3,5,7-decatriene-1,9-diyne
 β -Carotene
 Dimethyl-diethoxy silane
 Dimethicone
 Simethicone
 N,N'-Dimethylethylenediamine
 Hexobendine
 Dimethylformamide
 Glymidine
 dl-3-(1',1'-Dimethylheptyl)-6,6a,7,8-tetrahydro-1-hydroxy-6,6-dimethyl-9H-dibenzo[b,d]pyran-9-one
 Nabilone
 2,2-Dimethyl-4-hydroxymethyl-1,3-dioxolane
 Floctafenine
 Glafenine
 1,1-Dimethylol cyclopentane
 Cycloarbamate
 N,N'-Dimethylxaldiamide
 Azathioprine
 Dimethylphenol
 Mexiletine HCl
 3-(3',5'-Dimethylphenoxy)-1,2-propanediol
 Metaxalone
 Dimethyl-p-phenylene diamine
 Tolonium chloride
 O,O-Dimethylphosphorodithioic acid
 Malathion
 Dimethyl phthalate
 Diphenadione
 1,3-Dimethyl-4-piperidone
 Alphaprodine HCl
 Dimethylsulfamoylphentiazine
 Fonazine mesylate
 Thioproperazine
 Dimethyl sulfate
 Amezinium methyl sulfate
 Bromopride
 Cefoxitin sodium
 Cimetide
 Diphehmanil methyl sulfate
 Flurbiprofen
 Hexamethonium bromide
 Hexocyclium methyl sulfate
 Iprnidazole
 Mefruside
 Metoclopramide HCl
 Metrizoic acid
 Paramethadione
 Pentapiperide methosulfate

- Pralidoxime chloride
 Timepidium bromide
 Dimethyl sulfide
 Dimethyl sulfoxide
 1,2-Dimethyl-1,4,5,6-tetrahydro-
 pyrimidine
 Pyrantel pamoate
 3,5-Dinitrobenzoic acid
 Diatrizoate sodium
 Dioctyl sodium sulfosuccinate
 Docusate calcium
 N-[2-(3,1-Dioxanyl)ethyl] piperazine
 Oxaflumazine disuccinate
 1,4-Dioxaspiro[4.5]decane-2-methyl-
 amine
 Guanadrel sulfate
 2,4-Dioxo-3,3-diethylpiperidine
 Methypyrion
 Diphenic acid
 Azapetine phosphate
 Diphenolisatin
 Oxyphenisatin acetate
 Diphenylacetic acid chloride
 Diphenylpyramide
 Thiphenamil HCl
 Diphenyl acetone
 Diphenadione
 Diphenylacetonitrile
 Doxapram HCl
 Methadone HCl
 Diphenylacetyl chloride
 Piperidolate
 2,2-Diphenyl-4-bromo butyronitrile
 Diphenoxylate HCl
 Diphenyl chloroacetyl chloride
 Clidinium bromide
 Parapenzolate bromide
 3,3-Diphenyl-3-cyanopropyl bromide
 Piritramide
 4,4-Diphenylcyclohexen-2-one
 Pramiverin
 Diphenyl diazomethane
 Benztropine mesylate
 α,α -Diphenyl- γ -dimethylamino
 valeronitrile
 Aminopentamide
 Diphenylmethane
 Diphenhydramine HCl
 Diphenylmethyl-7 β -amino-7 α -methoxy-
 3-(1-methyltetrazol-5-yl)-thio-
 methyl-1-oxadethia-3-cephem-
 4-carboxylate
 Moxalactam disodium
 1-(Diphenylmethyl)piperazine
 Oxatomide
 3,3-Diphenylpropylamine
 Drophenilamine HCl
 Fendiline HCl
- Prenylamine
 Di-n-propylacetyl chloride
 Anistropine methyl bromide
 Di-n-propylamine
 Probenecid
 Dipyridamole
 Mopidamol
 2,4-Disulfamyl-5-chloroaniline
 Benzthiazide
 3,5-Di-p-toluyil-desoxy-D-ribofuranosyl
 chloride
 Idoxuridine
 S,N-Ditrityl-L-cysteine diethylamine salt
 Oxytocin
 Dodecyl bromide
 Domiphen bromide
- 3-Endoamineborneol HCl
 Glibornuride
 2,5-Endomethylene- Δ^3 -tetrahydro
 benzaldehyde
 Cyclothiazide
 Epibromohydrin
 Carteolol
 Epichlorohydrin
 Acebutolol
 Atenolol
 Befunolol
 Betaxolol HCl
 Bufetrol
 Bunitrolol
 Bupranolol
 Carazolol
 Carnitine
 Celiprolol
 Colestipol
 Cromolyn sodium
 Indenolol
 Mazindol
 Mepindolol
 Metoprolol tartrate
 Nadolol
 Nifuratel
 Oxprenolol
 Penbutolol
 Practolol
 Propafenone HCl
 Propranolol HCl
 Viloxazine HCl
 Xanthinol niacinate
 Epinephrine
 Epinephryl borate
 2 α ,3 α -Epithio-5 α -androstan-17 β -ol
 Mepitiostane
 9 β ,11 β -Epoxy-17 α -hydroxy-21-acetoxy-
 16 α -methyl- $\Delta^{1,4}$ -pregnadiene-3,20-
 dione
 Dexamethasone acetate

- 1-(2,3-Epoxypropyl)-2-methyl-5-nitroimidazole
 Ornidazole
 Ergocryptine
 Bromocriptine
 Erythromycin
 Erythromycin gluceptate
 Erythromycin lactobionate
 Erythromycin stearate
 $\Delta^{4,9}$ -Estradiene-11 β -ol-3,17-dione
 Moxestrol
 Estradiol
 Estradiol valerate
 Estramustine phosphate
 Estriol succinate
 Polyestradiol phosphate
 Estradiol-17 β
 Estradiol cypionate
 Estrone
 Ethinylestradiol
 Ethanedithionylsulfonic acid
 Caramiphen edisylate
 Ethanol
 Alibenol
 Benoxinate HCl
 Bufenamac
 Clobazam
 Clofibrate
 Dicyclomine HCl
 Ethionamide
 Ethoheptazine
 Etiloxate
 Exalamide
 Feprazone
 Floredil HCl
 Flurbiprofen
 Gramacidin
 Heptabarbital
 Ibuprofen
 Ibuproxam
 Insulin
 Ketoprofen
 Lofexidine HCl
 Mebeverine HCl
 Meperidine HCl
 Methital
 Methohexital sodium
 Moxislyte
 Naphazoline
 Nicotiny alcohol
 Nifurzide
 Orgotein
 Phenaglycodol
 Phenylbutazone
 Protizinic acid
 Sulfinpyrazone
 Tetrabenazine
 Tolazoline
 Trimethadione
 Vinbarbital sodium
 Ethanolamine
 Alibenol
 Ciclopiroxolamine
 Cloxazolam
 Oxethazine
 Phenoxy benzamine HCl
 1-Ethinyl-1-cyclohexanol
 Ethinamate
 6-Ethoxybenzothiazole-2-thiol
 Ethoxzolamide
 N-Ethoxycarbonylpiperazine
 Flupentixol
 Ethoxymethyleneethyl malonate
 Floctafenine
 Nalidixic acid
 Pipemidic acid
 Piromidic acid
 Rosoxacin
 2-Ethoxy-1-naphthoyl chloride
 Nafcillin sodium
 2-Ethoxyphenol
 Viloxazine HCl
 ω -Ethoxystyrene
 Bendroflumethiazide
 Ethyl acetate
 Silymarin
 Ethyl acetoacetate
 Cloxacillin
 Epirizole
 Oxacillin sodium
 Trioxsalen
 Ethyl acetylene (1-butyne)
 Methohexital sodium
 Ethylamine
 Ethylestrenol
 Mebeverine HCl
 Motretinide
 Piperidolate
 Tropicamide
 Ethyl p-aminobenzoate
 Thihexinol
 Ethyl 7-aminoheptanoate
 Amineptine HCl
 Tianeptine
 Ethylamino malonate HCl
 Loflazepate ethyl
 1-Ethyl-2-aminomethyl pyrrolidine
 Sulpiride
 Sultopride HCl
 Ethyl α -(4-aminophenyl)propionate
 Indoprofen
 α -Ethyl- β -(aminophenyl)propionic acid
 Tyropanoate sodium
 3-(Ethylamino)propionitrile
 Sulfacytine

- Ethyl benzamidoxime
 Proxazole citrate
 Ethyl benzilate
 Benactyzine hydrochloride
 Ethyl bromide
 Azatadine maleate
 Chlorprothixene
 Cyproheptadine
 Diphenidol
 Flupentixol
 Heptabarbitol
 Mepivacaine
 Methadone HCl
 Methallenestril
 Methohexital sodium
 Oxitropium bromide
 Pipethanate ethobromide
 Pyrithyldione
 Ethyl bromoacetate
 Aceclidine
 Ethyl α -bromobutyrate
 Cyclobutylol
 Ethyl bromoisobutyrate
 Methallenestril
 Ethyl-2-bromopropionate
 Naproxen
 Ethyl carbonate
 Ibuprofen
 Ethyl chloride
 Oxeladin
 Ethyl chlorimidoacetate
 Oxyphencyclimine
 Ethyl chloroacetate
 Diltiazem HCl
 Etomidate HCl
 Piracetam
 Ticrynafen
 Ethyl α -(3-chloro-4-aminophenyl)
 propionate hydrochloride
 Pirprofen
 Ethyl 5-(p-chlorobenzoyl)-1,4-dimethyl-
 3-ethoxypyrrrole-2-acetate
 Zomepirac
 Ethyl chlorocarbonate
 Amoxapine
 Amoxicillin
 Ampicillin
 Cefadroxil
 Ethyl chloroformate
 Azidocillin
 Fominoben HCl
 Hydroxyphenamate
 Loxapine
 Ethyl 2-chloromethyl benzoate
 Indoprofen
 Ethyl 5-chloro-2-oxobenzothiazoline
 acetate
 Tiaramide
 Ethyl 4'-chlorophenoxy isobutyrate
 Clofibride
 N-Ethyl-3-chloropiperidine
 Pipenzolate bromide
 1-Ethyl-3-chloropyrrolidine
 Doxapram HCl
 Ethyl β -chlorovinyl ketone
 Ethchlorvynol
 Ethyl cyanoacetate
 Ethosuximide
 Piprozolin
 Tinoridine
 Ethyl 2-cyano-2-(5H-[1] benzopyrano
 [2,3b]-pyridin-7-yl) propionate
 Pranoprofen
 Ethyl-1-(3-cyano-3,3-diphenylpropyl)-4-
 phenylisonipecotate HCl
 Difenoxime
 Ethyl diazoacetate
 Tranylcypromine sulfate
 Ethyl dichloroacetate
 Thiamphenicol
 1-Ethyl-1,4-dihydro-5H-tetrazol-5-one
 Alfentanil HCl
 4-Ethyl-2,3-dioxo-1-piperazino
 carbonyl chloride
 Cefoperazone
 Ethylene chlorohydrin (2-chloroethanol)
 Cloperastine
 Defosfamide
 Metronidazole
 Oxypendyl
 Ethylenediamine
 Clonidine HCl
 Edetate disodium
 Indanazoline
 Lofexidine HCl
 Naphazoline
 Oxymetazoline HCl
 Penicillin G Benzathine
 Tetrahydrozoline HCl
 Tolazoline
 Tolonidine nitrate
 Xylometazoline HCl
 Ethylene dibromide
 Penicillin G Hydrabamine
 Ethylene dichloride
 Ethambutol HCl
 Ethyl 3,5-diiodo-4-(4'-hydroxyphenoxy)-
 phenyl acetate
 Tiratricol
 3,3-Ethylene dioxy-6 α -methylandro-
 4-ene-3,17-dione
 Dimethisterone
 Ethylene glycol
 Formocortel acetate
 Furazabol
 Kebuzone
 Medroxyprogesterone acetate

- Ethyleneimine
 Mazindol
 Thiotepa
 Triethylenemelamine
 Ethylene oxide
 Chlorambucil
 Choline dihydrogen citrate
 Etofibrate
 Melphalan
 Nimorazole
 Nonoxynol
 Tyloxapol
 Uracil mustard
 16 β -Ethylestra-4-ene-3,17-dione
 Oxendolone
 N-Ethylethylene diamine
 Piperacillin sodium
 Ethyl formate
 Cortivazol
 Dromostanolone propionate
 Fluorouracil
 Perhexiline sulfate
 2-Ethyl hexylamine
 Hexetidine
 Ethyl glycinate HCl
 Caroxazone
 Ethyl-2-(3-hydroxy-4-aminophenyl)
 propionate
 Benoxaprofen
 Ethyl p-hydroxybenzoate
 Cyclomethycaine
 Ethyl 9 α -hydroxy-11 α ,15 α -bis(2-tetra-
 hydropranyloxy)-16,16-dimethyl-
 prosta-trans-2, trans-13-dienoate
 Gemeprost
 2-Ethyl-3-hydroxy-3,3-diphenyl
 propionitrile
 Etifelmine
 N-Ethyl-N-2-hydroxyethylamine
 Hydroxychloroquine sulfate
 Ethyl α -hydroxyisobutyrate
 Trimethadione
 Ethyl iodide
 Dibutoline sulfate
 Edrophonium chloride
 Ethotoin
 Etomidolone
 Etretrate
 Gallamine triethiodide
 Ibuprofen
 Nalidixic acid
 Oxetorone fumarate
 Oxolinic acid
 Piroheptine
 Rosoxacin
 Tridihexethyl iodide
 Ethyl 4-iodobutyrate
 Meptazinol
 Ethyl isothiocyanate
 Etifoxine
 3-Ethylmercapto-phenothiazine
 Thiethylperazine
 Ethyl (1-methyl- Δ_1 -butenyl)cyno-
 acetic acid ethyl ester
 Vinbarbital sodium
 1-Ethyl-6,7-methylenedioxy-4-(1H)-
 oxocinnoline-3-carbonitrile
 Cinoxacin
 Ethyl 5-methyl isoxazole-3-carbamate
 Sulfamethoxazole
 N-Ethylmorpholine
 Meclofenamic acid
 3-(2'-Ethyl-2'-nitrovinyl) indole
 Eryptamine
 17 α -Ethylloestradiol-3-ethyl ether
 Ethylestrenol
 Ethyl orthoacetate
 Diazoxide
 Ethyl orthoformate
 Formocortal acetate
 Norethindrone
 Oxendolone
 Ethyl oxalate
 Amibenonium chloride
 Ethionamide
 Protionamide
 5-(1-Ethylpentyl)hydantoin sodium salt
 Chlordantoin
 1-Ethylpiperidine
 Erythromycin stearate
 Ethyl propionate
 Pyrimethamine
 4-Ethylpropioiphenone
 Eperisone HCl
 2-Ethylpropylaminomethanol
 Benapryzine hydrochloride
 2-Ethylpyridine
 Dimethindene maleate
 Ethyl quininate
 Viquidil
 Ethylsulfonylethanol
 Tinidazole
 β -Ethylthioacrolein diethylacetal
 Dithiazanine iodide
 Ethyl thioglycolate
 Piprozolin
 Ethyl p-toluenesulfonate
 Bretylum tosylate
 N-ethyl o-toluidine
 Crotamiton
 Ethyl undecylenate
 Iophendylate
 Ethyl urethane
 Mebutamate
 17 α -Ethynyl estradiol
 Quinestrol

- 17 α -Ethyanyl-2-hydroxymethylene-4-androst-17 β -ol-3-one
Danazol
- 17 α -Ethyanyl-19-norandrost-4-ene-3 β ,17 β -diol (ethynodiol)
Ethynodiol diacetate
- Ferric chloride
Zoxazolamine
- Ferric citrate
Ferrocholine
- Ferric hydroxide
Ferrocholine
- Ferrous sulfate
Ferroglycine sulfate
Ferrous fumarate
- Fluoranthene
Florantyrone
- Fluoroacetyl chloride
Afloqualone
- p-Fluorobenzaldehyde
Sulindac
- Fluorobenzene
Flubendazole
- o-Fluorobenzoyl chloride
Flunitrazepam
- 6 α -Fluoro-9 α -bromo-11 β ,17 α ,21-trihydroxy-16 α -methyl-1,4-pregnadiene-3,20-dione-21-acetate
Diflorasone diacetate
- 6 α -Fluoro-9 β ,11 β -epoxy-16 α -methyl-17 α ,21-dihydroxy-1,4-pregnadiene-3,20-dione-21-acetate
Flumethasone
- 6 α -Fluoro-11 β ,21-dihydroxy-16 α -methyl-1,4-pregnadiene-3,20-dione
Flucortin butyl
- 6 α -Fluoro-16 α -hydroxycortisol
Flurandrenolide
- 6 α -Fluoro-16 α -hydroxy cortisone-21-acetate
Flucloronide
- 6 α -Fluoro-16 α -hydroxy hydrocortisone
Fluocinolone acetonide
- 9 α -Fluoro-11 β -hydroxy-16 β -methyl-17 α ,21-(1'-ethyl-1'-ethoxymethylenedioxy) pregna-1,4-diene-3,20-dione
Betamethasone dipropionate
- 6-Fluoro-2-methyl tetrahydroquinoline
Flumequine
- 5-(2-Fluorophenyl)-7-chloro-2,3-dihydro-1H-benzodiazepinone (2)
Flurazepam
- 1-[(4-Fluorophenyl)methyl]-N-(4-piperidinyl)-1H-benzimidazol-2-amino dihydrobromide
Astemizole
- 1-(4-Fluorophenyl)piperazine dihydrochloride
Niaprazine
- 6 α -Fluoroprednisolone
Flunisolide
- 9 α -Fluoro-4-pregnene-11 β ,16 α ,17 α ,21-tetrol-3,20-dione-21-acetate-16 α ,17 α -acetonide
Formocortol acetate
- 5-Fluorosalicylaldehyde
Butofilolol
- 6 α -Fluoro-triamcinolone
Fluocinonide
- 9 α -Fluoro-11 β ,17,21-trihydroxy-16 α -methylpregna-1,4-diene-3,20-dione
Dexamethasone-21-linoleate
Fluprednidene acetate
- 9 α -Fluoro-11 β ,17 α ,21-trihydroxy-16 α -methyl-1,4-pregnadiene-3,20-dione-21-methane sulfonate
Dexamethasone phosphate
- 5-Fluorouracil
Carmofur
Flouxuridine
Flucytosine
- 5-Fluoro uracil mercury
Tegafur
- Formaldehyde
Biperiden
Bronopol
Cortivazol
Edetate disodium
Glaziovine
Hexetidine
Meptazinol
Metampicillin sodium
Methylol riboflavin
Nifurfoline
Nifurtinol
Noxytiolin
Oxymetazoline HCl
Phenindamine tartrate
Pipebuzone
Thiexinol
Timonac sodium
Triclobisonium chloride
Tromethamine
Tyloxapal
- Formamide
Cimetide
Primidone
Protriptyline
Razo xane
Spiperone
Formic acid
Bupivacaine

Formic acid (cont'd)

Cefamandole nafate sodium salt
 Cefatrizine
 Ceftriaxone sodium
 Chlorothiazide
 Cortivazol
 Etomidate HCl
 Flumethiazide
 Furtrethonium iodide
 Mercaptopurine
 Mopidamol
 Phendimetrazine tartrate
 Triclobisonium chloride
 Formic acid hydrazide
 Estazolam
 3-Formylcrotonic acid butyl ester
 Etreinate
 Motretinide
 N-Formylhexamethylene imine
 Pivmecillinam
 2-Formyl-1-methyl-5-nitroimidazole
 Azanidazole
 2-Formyl-5-nitrofurane
 Nitrofurazone
 1-Formylpiperazine
 Trimetazidine
 3-Formylrifamycin SV
 Rifampin
 Fumaric acid
 Clemastine fumarate
 Ferrous fumarate
 Oxetorone fumarate
 Propiram fumarate
 Furfural
 Furtrethonium iodide
 Piperidolate
 Furfurylamine
 Furosemide
 2-Furoyl chloride
 Drazosin
 2-(Fur-2-yl)-2-methoxyimino acetic acid
 Cefuroxime
 8-Geranoxy psoralen
 Methoxsalen
 d-Glucoheptonic acid lactone
 Erythromycin Gluceptate
 L-Glutamic acid
 Arginine glutamate
 Glycerol
 Mephnesin
 Glycerol 1,2-dibromohydrin
 Dimercaprol
 Glyceryl monochlorohydrin
 Chlorphenesin carbamate
 Glycidol
 Guaifenesin

Glycine

Ferroglycine sulfate
 Tiopronin
 Glycine ethyl ester
 Ornipressin
 Glycine ethyl ester hydrochloride
 Nitrazepam
 Glycine lower alkyl ester
 Oxytocin
 Glycyrrhetic acid
 Carbenoxolone
 Glyoxylic acid ethyl ester ethyl alcoholate
 Ethyl biscoumacetate
 Gold acid chloride trihydrate
 Auranofin
 Guaiacol
 Guaifenesin
 Guaiacol glyceryl ether
 Methocarbamol
 Guanidine
 Amiloride HCl
 Guanfacine
 Pemoline
 Primethamine
 Trimethoprim
 Guanidine acetate
 Methotrexate
 Guanidine carbonate
 Sulfameter
 Guanidine hydrochloride
 Sulfaguanidine
 Guanidine nitrate
 Glymidine
 Guanine
 Thioguanine
 n-Heptaldehyde
 Nitrofurantoin
 Heptamethyleneimine
 Guanethidine sulfate
 Tolazamide
 Hesperidin
 Diosmin
 Hexamethyl disilizane
 Dinoprostone
 Hexamethylene bis-dicyandiamide
 Chlorhexidine
 Hexamethylene-bis-(N-methylcarbamic acid chloride)
 Distigmine bromide
 Hexamethylene diamine
 Hexamethonium bromide
 Hexamethyleneimine
 Mecillinam
 Hexamethylene tetramine
 Methenamine hippurate
 Norfenefrine

- Hexamethylmelamine hexamethyl ether
 Altretamine
 1,6-Hexane diamine
 Triclobisonium chloride
 3-Hexoxy-2-hydroxy-1-chloropropane
 Exiproben
 n-Hexyl bromide
 Exalamide
 2-Hexyl-2-(hydroxymethyl)-1,3-propanediol
 Hepronicate
 n-Hexyl isocyanate
 Carmofur
 Hippuric acid
 Methenamine hippurate
 Homatropine
 Phenactropinium chloride
 Homovanillic acid n-propyl ester
 Propanidid
 Homoveratrylamine
 Dobutamine
 Human blood plasma
 Fibrinolysin
 Hydrazine
 Bromhexine
 Endralazine
 Nifurzide
 Hydrazine hydrate
 Acetazolamide
 Allopurinol
 Alprazolam
 Benzbromarone
 Betazole
 Bronoprol
 Carbidopa
 Chenodiol
 Furaltadone
 Hydralazine HCl
 Isoniazid
 Nifuratel
 Phenelzine sulfate
 Pinazepam
 Prazepam
 Tofisopam
 1-Hydrazinophthalazine HCl
 Budralazine
 Hydrazobenzene
 Bumadizon
 Feprazone
 Kebuzone
 Phenyl butazone
 Sulfin pyrazone
 Hydriodic acid
 Tiratricol
 Hydrochloric acid
 Amitriptyline HCl
 Carbidopa
 Chymopapain
 Cyanocobalamin
 Hydroxytryptophan
 Levo thyroxine sodium
 Hydrocortisone
 Bendacort
 Hydrocortamate HCl
 Prednisolone
 Hydrocortisone acetate
 Fludrocortisone acetate
 Hydrocyanic acid
 Amantidine HCl
 Hydrofluoric acid
 Dexamethasone acetate
 Hydrogen
 Aceclidine
 Acemetacin
 Afloqualone
 Albendazole
 Albuterol
 Alfaxalone
 Altretamine
 Amikacin
 Aminoglutethimide
 Amitriptyline HCl
 Amoxicillin
 Ampicillin
 Amrinone
 Apazone
 Aspartame
 Azacyclonol
 Bacampicillin
 Benoxinate HCl
 Benserazide
 Benzocetamine HCl
 Benzquinamide
 Betazole
 Bufeniode
 Bumetanide
 Captopril
 Carbenicillin disodium
 Carbuterol
 Cargutocin
 β -Carotene
 Caroxazone
 Cefaclor
 Cephaloglycin
 Chlophedianol
 Chlorambucil
 Chloramphenicol
 Clemizole
 Clonazepam
 Cyclopentamine HCl
 Desipramine HCl
 Diatrizoate sodium
 Dibekacin
 Dicyclomine HCl
 Dihydrostreptomycin sulfate

Hydrogen (cont'd)

Dihydrotachysterol	Nicotinyl alcohol
Dimercaprol	Nomifensine maleate
Dipivefrin	Norethandrolone
Dipyridamole	Norfenefrine
Dobutamine	Nylidrin
Doxycycline	Octopamine HCl
Droprenilamine HCl	Oxitriptan
Ethionamide	Oxymorphone
Etifelmine	Oxyphenbutazone
Etilefrine pivalate HCl	Oxytocin
Etryptamine	Perhexiline sulfate
Fendiline HCl	Phenindamine tartrate
Fenoterol hydrobromide	Pheniprazine
Fentanyl	Phenmetrazine
Flubendazole	Phenoperidine HCl
Flunitrazepam	Phenyl aminosalicylate
Fluspirilene	Phenylephrine HCl
Glafenine	Phenylpropanolamine HCl
Glaziovine	Phytonadione
Hexetidine	Pimozide
Hexoprenaline	Pipamperone
Hydrochloroquine sulfate	Piperidolate
Hydroxocobalamin	Pirbuterol
Hydroxydione sodium succinate	Pivampicillin
Hydroxy tryptophan	Pramiverin
Ifenprodil tartrate	Praziquantel
Indoramin	Prenylamine
Iodamide	Procyclidine HCl
Iopanoic acid	Protionamide
Iproniazid	Protokylol
Isoproterenol sulfate	Reproterol
Isoxsuprine HCl	Rimiterol
Labetalol HCl	Ritodrine
Mannitol	Rociverine
Mebendazole	Sulfalene
Mebeverine HCl	Sulindac
Mefenorex HCl	Terbutaline
Mefruside	Tetracycline
Melphalan	Thihexinol
Mephentermine	Ticarcillin disodium
Mepindolol	Timepidium bromide
Meptazinol	Tranexamic acid
Metaproterenol sulfate	Triclobisonium chloride
Metaraminol	Trimethobenzamide HCl
Methallenestril	Tromethamine
Methenolone acetate	Zeranol
Methoxamine HCl	Hydrogen bromide
Methyl hexaneamine carbonate	Benztropine mesylate
Methyl phenidate HCl	Butorphanol
Methyprylon	Dextromethorphan hydrobromide
Metoclopramide HCl	Dobutamine
Metyrapone	Doxepin HCl
Metyrosine	Fazidinium bromide
Mexiletine HCl	Felypressin
Midodrine	Fenoterol hydrobromide
Minocycline	Fluprednidene acetate
Mitopodozide	Hexamethonium bromide
	Loperamide HCl

Meptazinol
 Mitobronitol
 Nordazepam
 Oxymorphone
 Phenindamine tartrate
 Piperidolate
 Procarbazine HCl
 Rimiterol
 Ritodrine
 Sulfacytine
 Hydrogen chloride
 Acetohexamide
 Alphaprodine HCl
 Alprenolol HCl
 Amantidine HCl
 Amiloride HCl
 Amixtrine HCl
 Ancitabine HCl
 Anileridine dihydrochloride
 Antazoline HCl
 Aprindine HCl
 Benactyzine HCl
 Benapryzine HCl
 Bendazac
 Benfurodil hemisuccinate
 Beno xinate hydrochloride
 Benzphetamine HCl
 Benzquinamide
 Betamethasone
 Betaxolol HCl
 Biperiden
 Bromazepam
 Butethamine
 Butofilolol
 Carbidopa
 Carnitine
 Carprofen
 Cefuroxime
 Cephalexin
 Chlordiazepoxide HCl
 Chloroprocaine HCl
 Chlorphenoxamine HCl
 Chlorproethazine HCl
 Chlorpromazine HCl
 Chlorthalidone
 Chlorthenoxazine
 Chlorzoxazone
 Cinoxacin
 Citalone
 Clenbuterol
 Clindamycin HCl
 Clobutinol
 Clomiphene dihydrogen citrate
 Clonazepam
 Clonidine HCl
 Clorexolone
 Clortermine HCl
 Cortivazol
 Cryptenamine tannates
 Cyclopentamine HCl
 Cycrimine HCl
 Cyproheptadine
 Dapsone
 Demexiptiline HCl
 Dexetimide
 Dibenzepin HCl
 Diethylpropion HCl
 Diethylstilbestrol
 Difenoxine
 Diltiazem HCl
 Dimethoxanate
 Diphenylpyraline HCl
 Dobutamine
 Doxapram HCl
 Dyclonine HCl
 Edrophonium chloride
 Endralazine
 Eperisone HCl
 Eprazinone HCl
 Ethambutol HCl
 Ethionamide
 Ethopropazine HCl
 Ethotoin
 Etidocaine HCl
 Etifelmine
 Exiproben
 Fendiline HCl
 Fenethyliline HCl
 Fenoterol hydrobromide
 Fenproporex
 Flecainide
 Floctafenine
 Flucytosine
 Fludiazepam HCl
 Fluorouracil
 Flupentixol
 Fluphenazine HCl
 Fluprednisolone
 Fominoben HCl
 Fonazine mesylate
 Furaltadone
 Gepefrin
 Glycopyrrolate
 Guanfacine
 Haloperidol
 Heptabarbital
 Hexestrol
 Hexylcaine HCl
 Hydralazine HCl
 Hydroxyprogesterone caproate
 Hydroxystilbamidine isethionate
 Hydroxyzine HCl
 Imipramine HCl
 Indenolol
 Iopronic acid
 Isothipendyl HCl

Hydrogen chloride (cont'd)

Ketotifen
 Levamisole HCl
 Lofexidine HCl
 Lonazolac
 Loperamide HCl
 Lorcaïnide HCl
 Melphalan
 Memantine
 Menbutone
 Meperidine HCl
 Methadone HCl
 Methapyrilene HCl
 Methaqualone
 Methdilazine HCl
 Methixene HCl
 Methyldopa
 Methylphenidate HCl
 Metoclopramide HCl
 Metyrosine
 Mexenone
 Minaprine
 Moxisylyte
 Naloxone
 Nefopan HCl
 Nicergoline
 Nimetazepam
 Nimustine
 Norethindrone acetate
 Norgestrel
 Octopamine HCl
 Ornidazole
 Oxaflozane HCl
 Oxendolone
 Oxymetazoline HCl
 Oxytocin
 Paramethasone acetate
 Pargyline HCl
 Perhexiline sulfate
 Phenaglycodol
 Phenformin
 Phenmetrazine
 Phenoxybenzamine HCl
 Phentermine HCl
 Phentolamine HCl
 Phenylephrine HCl
 Phenylpropanolamine HCl
 Pipoxolan HCl
 Pizotyline HCl
 Pramoxine HCl
 Pranoprofen
 Procarbazine HCl
 Procyclidine HCl
 Promazine HCl
 Promethazine HCl
 Propafenone HCl
 Propoxyphene HCl
 Propranolol HCl

Prothipendyl HCl
 Protionamide
 Protizinic acid
 Pyrovalerone HCl
 Pyrrobutamine
 Rimiterol
 Ritodrine
 Secnidazole
 Sulfadiazine
 Sulfaguanidine
 Sulfaguanol
 Sulfamerazine
 Sulfamoxole
 Sulfasalazine
 Sulfisomidine
 Sulfisoxazole
 Testosterone 17 β -cypionate
 Tetrabenazine
 Tetrahydrozoline HCl
 Thiabendazole
 Thiamphenicol
 Ticlopidine HCl
 Tilidine HCl
 Timepidium bromide
 Tofenacin HCl
 Tramadol HCl
 Tranlycypromine sulfate
 Trihexyphenidyl HCl
 Trioxsalen
 Tropicamide
 Tubocurarine chloride
 Urokinase
 Viquidil
 Xylometazoline HCl
 Zomepirac
 Zoaxazolamine
 Hydrogen fluoride
 Betamethasone acetate
 Desoximetasone
 Diflorasone diacetate
 Enflurane
 Fluazacort
 Fludrocortisone acetate
 Flumethasone
 Fluocinolone acetonide
 Fluocortolone
 Fluoxymesterone
 Halopredone acetate
 Isoflurane
 Methacycline
 Hydrogen iodide
 Hexestrol
 Hydrogen peroxide
 Amitriptylin oxide
 Dinoprostone
 Disulfiram
 Medrogestone

- Mesoridazine besylate
 Oxomemazine
 Oxymorphone
 Trilostane
 Hydrogen sulfide
 Ancitabine HCl
 Ethionamide
 Mercaptopurine
 Moxisylyte
 Penicillamine
 Protionamide
 Selenium sulfide
 Hydroquinone monobutyl ether
 Pramoxine HCl
 m-Hydroxyacetophenone
 Fenoprofen
 p-Hydroxyacetophenone
 Bufexamac
 Pixifenide
 3(α)-Hydroxy-21-acetoxy-11,20-diketo pregnane
 Cortisone acetate
 p-Hydroxybenzaldehyde
 Trimethobenzamide HCl
 4-Hydroxybenzhydrazide
 Nifuroxazide
 p-Hydroxybenzoic acid methyl ester
 Exiproben
 Hydroxycarbazole
 Carazolol
 8-Hydroxy carbostyryl
 Procaterol
 4-Hydroxy-4'-chlorobenzophenone
 Fenofibrate
 8-(2-Hydroxy-3-chloropropoxy)-5-methylcoumarin
 Bucumolol HCl
 4-Hydroxycoumarin
 Acenocoumarol (Acenocoumarin)
 Tiocloamarol
 Warfarin sodium
 N-(trans-p-Hydroxy cyclohexyl)-(2-aminobenzyl)amine
 Ambroxol
 5-Hydroxy-3,4-dihydrocarbostyryl
 Carteolol
 14-Hydroxydihydronormorphinone
 Nalbuphine
 4-Hydroxy-N,N-dimethylbutyramide
 Clofibrade
 d(-)- α -Hydroxy- β - β -dimethyl- γ -butyric acid lactone
 Dexpanthenol
 1-[2-(2-Hydroxyethoxy)ethyl]piperazine
 Dixyrazine
 N-(2-Hydroxyethyl)allylmercaptoacetamide
 Penicillin O
 N'-(2-Hydroxyethyl)-N-3-(N-benzoyl-N',N'-di-n-propyl-DL-isoglutaminyloxypropyl)piperazine
 Proglumetacin maleate
 N-(β -Hydroxyethyl) diethylenediamine
 Mepicycline
 N-(2-Hydroxyethyl)piperazine
 Acetophenazine dimaleate
 Carphenazine maleate
 Clopenthixol
 Etodroxizine
 Opipramol
 Tiaramide
 7-Hydroxyethyl theophylline
 Etofylline clofibrate
 16 α -Hydroxy-9 α -fluorohydrocortisone acetamide
 Halcinonide
 4-Hydroxyindene
 Indenolol
 Hydroxylamine HCl
 Aminopentamide
 Bufexamac
 Butalamine HCl
 Chlordiazepoxide HCl
 Ciclopiroxolamine
 Danazol
 Dioxyline phosphate
 Guanoxabenz HCl
 Hydroxy urea
 Ibuproxam
 Lorazepam
 Methylhexaneamine carbonate
 Metyrapone
 Mexiletine HCl
 Niaprazine
 Noxiptilin
 Oxacillin sodium
 Oxametacine
 Pixifenide
 2-Hydroxy-3-methoxy-5-allyl benzoic acid
 Alibenol
 2-Hydroxy-4-methoxybenzophenone
 Sulisobenzene
 3-Hydroxy-4-methoxyphenylalanine
 Methyl dopa
 m-Hydroxymethyl amino acetophenone
 Phenylephrine HCl
 17 β -Hydroxy-17 α -methyl-5 α -androst-1-en-3-one
 Oxandrolone
 17 β -Hydroxy-17 α -methyl-4-androsteno-[3,2c] pyrazole
 Stanazolol
 4-Hydroxy-4-methylbenzophenone
 Triparanol
 2-Hydroxymethyl cyclohexanone
 Cicloxilic acid

- Hydroxymethylphosphonic acid
Fosfomycin
- D,L-3-Hydroxy-N-Methylmorphinan
Dextromethorphan hydrobromide
- 11 α -Hydroxy-17-methyltestosterone
Fluoxymesterone
- 2-Hydroxy-3-naphthoic acid
Bephenium hydroxynaphthoate
- 4-Hydroxy-1,5-naphthyridine-3-carboxylic acid N-succinimide ester
Apalcillin sodium
- 5-Hydroxynicotinic acid
Timepidium bromide
- 4-Hydroxyphenoxypropylene oxide
Prenalterol
- p-Hydroxy phenyl acetamide
Atenolol
- 1-(3'-Hydroxyphenyl)-2-(N-benzylaminomethyl)ethan-1-one
Etilefrine pivalate HCl
- p-Hydroxyphenyl cyclohexyl ketone
Cyclofenil
- m-Hydroxyphenyl ethyl ketone
Metaraminol
- Dextro- β -(4-Hydroxyphenyl)- α -phenylpropionic acid
Iodoalphonic acid
- 2'-Hydroxy-3-phenylpropiofenone
Propafenone HCl
- 3-Hydroxyxypiridine
Pyridostigmine bromide
- 4-Hydroxypiperidine
Perimethazine
- 3 α -Hydroxy-5 α -pregn-16-ene-11,20-dione
Alfaxalone
- 17 α -Hydroxyprogesterone
Medroxyprogesterone acetate
- L-Hydroxyproline
Oxaceprol
- 4-Hydroxypropiofenone
Bufeniode
Dienestrol
Diethylstilbestrol
Hexestrol
Ifenprodil tartrate
- 3-Hydroxypropylamine
Dexpanthenol
- 1-(3'-Hydroxypropyl)piperazine
Fluphenazine HCl
- 8-Hydroxyquinaldine
Chlorquinaldol
- N-Hydroxy succinimide
Amikacin
- 2-[5 α -Hydroxy-3 α -(tetrahydropyran-2-yloxy)-2 β -tetrahydropyran-2-yloxy-4-phenoxy-trans-1-butene-1-yl]-cyclopent-1 α -yl] acetaldehyde- α -hemiacetal
Sulprostone
- Hyoscyamine
Butropium bromide
Fentonium bromide
- Hypobromous acid
Fludrocortisone acetate
- Imidazole
Ancitabine HCl
Bifonazole
Clotrimazole
Miconazole nitrate
- D-(-)- α -[Imidazolidin-2-on-1-yl]carbonyl-amino] phenylacetic acid
Azlocillin
- 2-Imidazolidone
Mezlocillin
- Imino dibenzyl
Impipramine HCl
Quinupramine
- Iminostilbene
Carbamazepine
- 5-Indanyl alcohol
Carbenicillin indanyl sodium
- N-4-Indanyl thiourea
Indanazoline
- Indolyl piperidyl-4-methyl ketone
Indalpine
- meso-Inositol
Inositol niacinate
- Insulin
Insulin zinc suspension
- Iodine
Buteniode
Haloprogin
Iodoalphonic acid
Liothyronine
Mopidamol
Nadolol
Povidone-iodine
Thioridazine
Tiratricol
- Iodine monochloride
Diatrizoate sodium
Iopanoic acid
Tyropanoate sodium
Iodobenzene
Iophendylate
- 5-Iodo-2-benzylthiouracil
Iothioracil
- 21-Iodo-11 β :17 α -dihydroxypregn-4-ene-3,20-dione
Hydrocortisone sodium phosphate
- 3-(2-Iodoethoxy)-2-ethylpropionic acid ethyl ester
Iopronic acid
- 5-Iodouracil
Iaoxuridine
- β -Ionol
Tretinoiin

- Iron
 Carbidopa
 Diazoxide
 Rosoxacin
 Sulfadiazine
 Sulfaguandidine
 Sulfisomidine
 Isethionic acid
 Hydroxystilbamidine isethionate
 Isoamyl alcohol
 Amixtrine HCl
 Isoamyloxyaniline
 Tiocarlide
 1-(3-Isobutoxy-2-hydroxy)propyl
 pyrrolidine
 Bepiridil
 Isobutryl chloride
 Flutamide
 Phentermine HCl
 Isobutylaminoethanol
 Butethamine
 Isobutylbenzene
 Ibuprofen
 Isobutyl chloroformate
 Cephaloglycin
 Phenethicillin potassium
 Tiapride
 Isobutylene
 Captopril
 Isobutyl malonic acid ethyl ester
 Tetrabenazine
 2-(4-Isobutylphenyl)propionic acid
 Ibuproxam
 Isobutyric acid
 Gemfibrozil
 L-Isoleucine lower alkyl ester
 Oxytocin
 d-Isolysergic acid azide
 Methylergonovine maleate
 Isoniazid
 Nialamide
 Isonicotinamide
 Cefsulodin
 Isonicotinyl hydrazine
 Iproniazid
 Isononyl phenol
 Nonoxynol
 Isopropanol
 Fenofibrate
 Isoflurophate
 Isopropanolamine
 Oxazolam
 Isopropylamine
 Acebutolol
 Atenolol
 Befunolol
 Betaxolol HCl
 Carazolol
 Carisoprodol
 Clorprenaline
 Indenolol
 Isoproterenol sulfate
 Mepindolol
 Metaproterenol sulfate
 Metoprolol tartrate
 Oxaflozane HCl
 Oxprenolol
 Practolol
 Pramiverin
 Prenalterol
 Procabazine HCl
 Procaterol
 Propranolol HCl
 2-Isopropylaminomethyl-6-methyl-7-
 nitro-1,2,3,4-tetrahydroquinoline
 Oxamniquine
 2-Isopropylamino pyrimidine
 Isaxonine phosphate
 Isopropyl bromide
 Cyclopentolate HCl
 Verapamil
 1,2-Isopropylidene glucofuranose
 Tribenoside
 2-Isopropyl-4-nitro imidazole
 Iprnidazole
 N-Isopropyl noratropine
 Ipratropium bromide
 α -Isopropylphenyl acetonitrile
 Isoaminile
 Isovaleraldehyde
 Buthiazide
 Isovaleric acid chloride
 Midodrine

 Ketene
 Aspirin
 5-Keto-10,11-dihydrodibenzo(a,d)cyclo-
 heptene
 Noxiptilin
 16-Keto-17(α)-hydroxyestratrienol-3-
 methyl
 Epimestrol
 11-Keto-6 β -methylprogesterone
 Medrysone
 Lactic acid anhydride diacetate
 Aclatonium napadisylate
 Lactobiono- δ -lactone
 Erythromycin lactobionate
 Lactose
 Lactulose
 Penicillin O
 Lead tetraacetate
 Oxandrolone
 L-Leucine lower alkyl ester
 Oxytocin

- Lincomycin hydrochloride
 Clindamycin HCl
 Lithium
 Alphaprodine HCl
 Cephradine
 Demegestone
 Epicillin
 Ethchlorvynol
 Ethylestrenol
 Nabilone
 Norethindrone
 Quingestanol acetate
 Stanzolol
 Triprolidine
 Lithium aluminum hydride
 Albuterol
 Alfacalcidol
 Azapetine phosphate
 Chlorisondamine chloride
 Cinnarizine
 Fenspiride
 Fentanyl
 Guanethidine sulfate
 Hexobendine
 Isocarboxazid
 Mebutamate
 Mecamylamine HCl
 Medrysone
 Meptazinol
 Mianserin
 Nalbuphine
 Nefopam HCl
 Niaprazine
 Nicergoline
 Prazepam
 Procaterol
 Tolazamide
 Tybamate
 Viminol
 Lithium amide
 Phenylramidol
 Lithium carbonate
 Tetrazepam
 Lithium chloride
 Clobetasol
 Halcinonide
 Lysergic acid-1'-hydroxybutylamide-2'
 Methysergide maleate
 Magnesium
 Azatadine maleate
 Biperiden
 Carbinoxamine maleate
 Chlorphenoxamine HCl
 Chlorprothixene
 Cicloxicilic acid
 Clobutinol
 Clorazepate dipotassium
 Clortermine HCl
 Cyclobenzaprine
 Cyclofenil
 Cyclopentamine HCl
 Cyclopentolate HCl
 Cycrimine HCl
 Cyproheptadine
 Diphepanil methyl sulfate
 Diphenidol
 Ethiopropazine HCl
 Fenipentol
 Flupentixol
 Ketamine HCl
 Ketotifen
 Medazepam
 Mepivacaine
 Methadone HCl
 Methallenestril
 Methenolone acetate
 Methohexital sodium
 Methyltestosterone
 Naproxen
 Oxetorone fumarate
 Oxyphenicyclimine
 Phenaglycodol
 Pizotyline HCl
 Procyclidine HCl
 Propoxyphene HCl
 Pyrrobutamine
 Rimiterol
 Tamoxifen
 Thihexinol
 Tiemonium iodide
 Tramadol HCl
 Tridihexethyl iodide
 Trihexyphenidyl HCl
 Triparanol
 Magnesium sulfate
 Magladrate
 Maleic acid
 Acetophenazine dimaleate
 Azatadine maleate
 Brompheniramine maleate
 Chlorambucil
 Cinepazet maleate
 Dexbrompheniramine maleate
 Dexchlorpheniramine maleate
 Endralazine
 Methylsergide maleate
 Midazolam maleate
 Nomifensine maleate
 Perhexiline sulfate
 Pheniramine maleate
 Progumetacin maleate
 Timolol maleate
 Maleic anhydride
 Fluvoxamide maleate
 Trilostane

- D(-)-Mandelic acid
 Cefamandole nafate sodium salt
 dl-Mandelic acid
 Cyclandelate
 Mandelic acid ethyl ester
 Pemoline
 Manganese dioxide
 Fluocortin butyl
 Midazolam maleate
 Prazepam
 Manganese sulfate
 Gemeprost
 Levothyroxine sodium
 D-Mannitol
 Mitobronitol
 Mercaptoacetaldehyde dimethylacetal
 Polythiazide
 α -Mercaptopropionic acid
 Tiopronin
 β -Mercaptopropionic acid
 Chlormezanone
 6-Mercaptopurine
 Azathioprine
 2-Mercaptopyrimidine
 Cephapirin sodium
 Mercuric acetate
 Chlormerodrin
 Meralluride
 Mercaptomerin sodium
 Mercuric chloride
 Penicillamine
 Mercury oxide
 Etifoxine
 Mesityl oxide
 Budralazine
 Methacycline
 Doxycycline
 Methanesulfonic acid
 Benztropine mesylate
 Fonazine mesylate
 Loprazolam
 Methanesulfonyl chloride
 Beclomethasone dipropionate
 Busulfan
 Dexamethasone-21-linoleate
 Flucloronide
 Fluocinolone acetonide
 Fluorometholone
 Halcinonide
 Mezlocillin
 Prednisolone phosphate sodium
 Methanesulfonyl isocyanate
 Sulprostone
 Methanol
 Bromopride
 Diphenadione
 Distigmine bromide
 Eprozinol
 Fluocortin butyl
 Halazepam
 Hydroquinone
 Methoxyflurane
 Methylphenidate HCl
 Moxestrol
 Naphazoline
 Nicergoline
 Papain
 Paramethadione
 Phenprocoumon
 Phenyltoloxamine
 Pixifenide
 Procarbazine HCl
 Pyritinol
 Rescimetol
 Reserpine
 Sulfacetyline
 Sulfadoxine
 Sulfalene
 Sulfamethoxypyridazine
 Thiamylal
 Timepidium bromide
 Trenbolone acetate
 1,4-Methano-1,2,3,4-tetrahydro-6-naphth-
 oxide
 Tolciclate
 m-Methoxyacetophenone
 Oxyfedrine
 2-Methoxy-4,5-azimido benzoic acid
 Alizapride
 p-Methoxybenzaldehyde
 Anisindione
 Diltiazem HCl
 Pyrilamine
 10-Methoxy-4H-benzo-[4,5]-cyclohepta-
 [1,2-b]-thiophen-4-one
 Ketotifen
 2-(p-Methoxybenzyl)aminopyrimidine
 Thonzylamine HCl
 N-(p-Methoxybenzyl)-p-chlorobenz-
 hydrazide HCl
 Acemetacin
 p-(p-Methoxybenzyloxy)-phenylmalonic
 acid
 Moxalactam disodium
 3-Methoxy-10-(3-chloro-2-methyl propyl)-
 phenthiazine
 Perimethazine
 α -Methoxycyanoacetic acid methyl ester
 Sulfadoxine
 Methoxycyclopentene
 Mepitiostane
 2-Methoxy-2,2-difluoro-1-chloro-1-
 fluoroethane
 Enflurane
 3-Methoxy- $\Delta^1,3,5$ -estratrien-17-one
 Mestranol

- 3-Methoxyestrone
Norethindrone
- Methoxyethoxyacetaldehyde di-
methoxyethylacetal
Glymidine
- 3-Methoxy-4-ethoxyphenyl acetic acid
Dioxyline phosphate
- p-(β -Methoxyethyl)phenol
Metoprolol tartrate
- 2-Methoxy-5-ethylsulfonyl benzoic acid
Sultopride HCl
- 3-Methoxy-4-hydroxyphenethylamine
Glaziovine
- 7 β -(α -Methoxyimino- α -(2-aminothiazol-
4-yl)acetamido] cephalosporanic
acid trifluoroacetic acid salt
Cefmenoxime
- 2-Methoxyimino-2-(2-amino-1,3-triazol-
4-yl)acetic acid
Ceftizoxime
- Methoxymalonic acid ester
Sulfameter
- N-(4-Methoxymethyl)-4-piperidinyl-N-
phenylpropamide
Alfentanil HCl
Sulfentanil
- 2-Methoxy-5-methylsulfonylbenzoic acid
Tiapride
- α -Methoxy naphthalene
Menbutone
- 3-Methoxy-19-nor- $\Delta^{1,3,5(10)16}$ pregna-
tetraene-20-one
Demegestone
- 3-Methoxy-17-oxo-2,5-estradiene
Norethynodrel
- o-Methoxyphenol
Guaifenesin
- 3-o-Methoxyphenoxy-2-hydroxy-1-
propylcarbamate
Mephexalone
- 3-Methoxyphenthiazine
Methotrimeprazine
- p-Methoxyphenyl acetone
Mebeverine HCl
- D-(+)-1-(3-Methoxyphenyl)-2-amino-
propane
Gepefrin
- N-(o-Methoxyphenyl)-N'-(3-amino-
propyl)piperazine
Urapidil
- 1-p-Methoxyphenyl-2-benzylamino-
propane
Fenoterol hydrobromide
- 4-(p-Methoxyphenyl)-3-buten-2-one
Dobutamine
- 2-(m-Methoxyphenyl)butyronitrile
Meptazinol
- 2-(4-Methoxyphenyl)ethylamine
Ritodrine
- 2-(4-Methoxyphenyl)ethyl methane
sulfonate
Astemizole
- 4-(4-Methoxyphenyl)-2-oxo-2,5-di-
hydrofuran
Benfurodil hemisuccinate
- β -Methoxypropionitrile
Trimethoprim
- 2-Methoxy-5-sulfamylbenzoic acid
Sulpiride
- 5-Methoxy-4'-trifluoromethylvalero-
phenone
Fluvoxamine maleate
- 5-(4-Methoxy-2,3,6-trimethylphenyl)-
3-methylpenta-2,4-diene-1-tri-
phenylphosphonium bromide
Etrinate
Motretinide
- Methyl acetate
Thiothixene
- Methyl acetoacetate
Cephalexin
Cephradine
Epicillin
Floxacillin
- 4-Methylacetophenone
Triprolidine
- 10-Methyl-3-acetylphenthiazine
Metiazinic acid
- Methyl acrylate
Glutethimide
Hexobendine
Nialamide
- 4-Methyl-1- α -hexadiene-2,4-acid-6
Tretinoin
- Methylallyl amine
Amisometradine
- Methylamine
Benzoctamine HCl
Chlordiazepoxide HCl
Chlormezanone
Cimetide
Cyclopentamine HCl
Dipivefrin
Isometheptene
Ketamine HCl
Lorazepam
Metapramine
Methsuximide
Mianserin
Nortriptyline
Phenindamine tartrate
Phensuximide
Tofenacin HCl
- 2-N-Methylamino acetamido-3-o-chloro-
benzyl-5-ethyl thiophene
Clotiazepam
- 2-Methylaminoethanol
Cafaminol

- Nefopan HCl
 Xanthinol niacinate
 Methylaminoethyl chloride
 Demexiptiline HCl
 Methyl aminomalonate
 Clorazepate dipotassium
 2-Methylaminomethanol
 Phendimetrazine tartrate
 2-(N-Methylamino)-2-methyl-1-phenyl-1-propanol
 Mephentermine
 3-Methylaminopropanol-1
 Protriptyline
 Methyl 3-amino pyrazinoate
 Amiloride HCl
 1 α -Methylandrostan-17 β -ol-3-one-17-acetate
 Mesterolone
 17-Methyl- $\Delta^5,6$ -androstenediol-(3,17)
 Methyltestosterone
 Methyl anthranilate
 Floctafenine
 Tranilast
 Methylbenzene sulfonate
 Atracurium besylate
 4-Methylbenzene sulfonyl urethane
 Gliclazide
 Tolazamide
 2-Methylbenzhydrol
 Tofenacin HCl
 o-Methylbenzhydrol bromide
 Orphenadrine citrate
 Methyl o-benzoate
 Betamethasone benzoate
 4-Methylbenzoic acid
 Procarbazine HCl
 1-Methylbenzthiazole ethiodide
 Dithiazanine iodide
 N-Methyl benzylamine
 Pargyline HCl
 m-Methylbenzyl chloride
 Meclizine HCl
 Methyl bromide
 Anistropine methyl bromide
 Clidinium bromide
 Demecarium bromide
 Distigmine bromide
 Glycopyrrolate
 Ipratropium bromide
 Mepenzolate bromide
 Methscopolamine bromide
 Oxitropium bromide
 Pancuronium bromide
 Penthienate bromide
 Pipenzolate bromide
 Propantheline bromide
 Pyridostigmine bromide
 T imepidium bromide
 Valetamate bromide
 1-Methyl-3-bromomethylpiperidine
 Mepazine
 17 α -Methyl-17 β -carbomethoxyandrost-5-ene-3 β -ol
 Medrogestone
 Methyl-3 α -carboxybenzylaminocrotonate sodium salt
 Cefaclor
 Methyl chloride
 Chlorpheno xamine HCl
 Methyltestosterone
 Pralidoxime chloride
 Triclobisonium chloride
 α -Methyl p-chlorobenzhydrol
 Clemastine fumarate
 Methyl-3-(p-chlorobenzoyl)-3-bromo-propionate
 Fentiazac
 Methyl chloroformate
 Cefaclor
 Flubendazole
 Mebendazole
 N-Methyl-3-chloromethylpiperidine
 Methixene HCl
 N-Methyl-3-chloropiperidine
 Mepenzolate bromide
 N-Methyl-4-chloropiperidine
 Azatadine maleate
 Pizotyline HCl
 1-Methyl-4-(3'-chloropropyl-1')-piperazine
 Thiethylperazone
 5-Methyl-7-chloro-s-triazolo-(1,5a)-pyrimidine
 Trapidil
 β -Methylcholine chloride
 Bethanechol chloride
 α -Methyl- α -cyanotetrahydrofuran
 Mefruside
 4-Methyl-6-cyclohexyl-2-pyrone
 Ciclopiroxolamine
 Methyl- α -cyclopentyl mandelate
 Glycopyrrolate
 16 α -Methyldeoxycorticosterone
 Desoximetasone
 5-Methylidibenzo [b,f]azepine
 Metapramine
 1-Methyl-1,2-dicarbobenzoxyhydrazine
 Procarbazine HCl
 Methyl dichloroacetate
 Chloramphenicol
 α -Methyl-N-dichloroacetyl-p-nitrophenyl-alanine
 Metyrosine
 α -Methyl-3,4-dichlorobenzylhydrazine
 Muzolimine
 16 α -Methyl-6 α ,9 α -difluoro- Δ^4 -pregnene
 11 β ,21-diol-3,20-dione-21-acetate
 Diflucortolone valerate

- 2-Methyl-3-(10,11-dihydro-5H-dibenzo-[a,d]-cycloheptene-5-ylidene)-1-pyrroline
Piroheptine
- 1-Methyl dihydro lysergamine
Metergoline
- 3-Methyl-4-dimethylamino-butanone-2
Clobutinol
- α -Methyl- β -dimethylaminopropiophenone
Propoxyphene HCl
- 2-Methyl-3-dimethylaminopropyl chloride
Butriptyline
- Methyl- α,α -diphenylglycollate
Benapryzine hydrochloride
- Methyl- α,α -di-(2-thienyl)glycollate
Mazaticol HCl
- 3,4-Methylenedioxyaniline
Oxolinic acid
- 1-(3':4'-Methylenedioxybenzyl)piperazine
Piribedil
- 3,4-Methylenedioxyphenylisopropanol-amine
Protokylol
- 11,11-Methylene-18-methyl- Δ^4 -estren-17-one
Desogestrel
- 1,2 α -Methylene- $\Delta^{4,6}$ -pregnadiene-17 α -ol-3,20-dione acetate
Cyproterone acetate
- Methyl ethyl ketone
Clnofibrate
Ethionamide
Ethosuximide
Paramethadione
- N-Methylformamide
Propylhexedrine
- Methyl formate
Fluphenazine HCl
Methypylon
Pyrithyldione
- N-Methyl glucamine
Iothalmate meglumine
- Methyl heptenone
Isometheptene
- 4-Methylhexanone-2
Methylhexaneamine carbonate
(N-Methyl-N-homoveratryl)- γ -amino-chloropropane
Verapamil
- 6 α -Methylhydrocortisone
Methyl prednisolone
- 3-Methyl-11-hydroxy-5H-dibenzo [b,a] -[1,4]-diazepine
Dibenzepin HCl
- 2-Methylimidazole HCl
Loflazepate ethyl
- Methyl iodide
Chlorisondamine chloride
Clobazam
Clonidine HCl
Cyclopentamine HCl
Demegestone
Dimethyl tubocurarine iodide
Echothiopate iodide
Ethopropazine HCl
Flunitrazepam
Furtrethonium iodide
Indanazoline
Isopropamide iodide
Ketoprofen
Methenolone acetate
Methysergide maleate
Parapenzolate bromide
Phenaglycodol
Protizinic acid
Sulfadoxine
Tetrazepam
Tibezonium iodide
Tiemonium iodide
Tolonidine nitrate
Trimethadione
- Methyl isocyanate
Amisometradine
Pyridinol carbamate
- Methyl isonicotinate
Aceclidine
- 4-Methyl-2-isopropylaminobenzo-phenone
Proquazone
- 5-Methylisothiosemicarbazide hydro-iodide
Guano xabenz HCl
- 2-Methyl-2-isothiourea sulfate
Debrisoquin
- 5-Methylisothiourea sulfate
Mebendazole
- S-Methyl-lumilyouronium sulfate
Fluorouracil
- 5-Methyl-isoxazole-(3)-carboxylic acid chloride
Glisoxepid
- 5-Methyl-3-isoxazole carboxylic acid hydrazide
Isocarboxazid
- 1-Methyl-lumilysergic acid
Nicergoline
- Methyl magnesium bromide
Calusterone
Medrogestone
Medroxyprogesterone acetate
- Methyl mercaptan
Methionine
Nifuratel
- m-Methyl mercaptoaniline
Thioridazine

- 3-Methylmercaptophenothiazine
 Mesoridazine besylate
 1-Methyl-5-mercapto-1H-tetrazole
 Cefmenoxime
 Methyl mesylate
 Medigo xin
 2-Methyl-5-(1-methoxy-2-carbamoyl-
 oxyethyl)-1,4-benzoquinone
 Carboquone
 2-Methyl-5-methoxy-3-indolyl acetic
 acid
 Indomethacin
 Methyl (7-methoxy-10-methyl-3-
 phenthiazinyl) acetate
 Protizinic acid
 4-Methyl-6-methoxy-2-pyrimidinyl-
 hydrazine
 Epirizole
 N-Methyl-1-(methylthio)-2-nitro-
 etheneamine
 Ranitidine
 N-Methylmorpholine
 Bentiromide
 2-Methyl-1,4-naphthohydroquinone
 Menadiol sodium phosphate
 Phytonadione
 α -Methyl-1-naphthylacetic acid
 Nafiverine
 Methyl nitrite
 Methoxamine HCl
 Molindone
 2-Methyl-5-nitroimidazole
 Metronidazole
 Tinidazole
 1-Methyl-5-nitro-5-phenylindole-2-
 carbonitrile
 Nimetazepam
 17 α -Methyl-19-nor- $\Delta^5(10)$ -pregnene-
 3,20-dione
 Promegestone
 Methyl orthobutylate
 Difluprednate
 3-Methyl-3-pentanol
 Emylcamate
 dl- α -Methylphenethylamine
 Dextroamphetamine sulfate
 Methylphenylcyclohexyl glycolate
 Oxybutynin chloride
 α -Methyl- β -phenylethylamine
 Fenethylamine HCl
 Fenproporex
 N-(p-Methylphenyl)-m'-hydroxy-
 phenylamine
 Phentolamine HCl
 N-Methylpipercolic acid ethyl ester
 Mepivacaine
 Methyl piperazine
 Chlorcyclizine
 Cyclizine
 Diethylcarbamazine citrate
 Loxapine
 Perlapine
 Pipebuzone
 Prochlorperazine
 Thiothixene
 3-(4-Methyl-1-piperazinyl)-1-chloro-
 propane
 Thioproperazine
 4-Methylpiperidine
 Melitracen
 1-Methyl-4-piperidinol
 Diphenylpyraline HCl
 Pentapiperide methosulfate
 N-Methyl-4-piperidinol HCl
 Parapenzolate bromide
 3-(2'-Methylpiperidino)propyl chloride
 Cyclomethycaine
 2-(N-Methylpiperidyl-2')-1-chloroethane
 Mesoridazine besylate
 Thioridazine
 16 β -Methyl-1,4-pregnadiene-11 β ,17 α ,21-
 triol-3,2-dione-21-acetate
 Beclomethasone dipropionate
 16 α -Methyl- Δ^5 -pregnene-3 β ,21-diol-one-
 21-acetate
 Fluocortolone
 16 β -Methyl prednisone-21-acetate
 Meprednisone
 Methyl-n-propyl ketone
 Protionamide
 2-Methyl-2-propyl-1,3-propanediol
 Carisoprodol
 Meprobamate
 5-Methylpyrazine-2-carboxylic acid
 Glipizide
 1-Methylpyrrole-2-acetonitrile
 Tolmetin
 1-Methyl-3-pyrrolidinol
 Glycopyrrolate
 1-Methyl-3-pyrrolidylmethyl chloride
 Methdilazine HCl
 N-Methylpyrrolidyl-2-ethyl chloride
 Clemastine fumarate
 Methyl reserpate
 Rescinnamine
 Syrosingopine
 Methylreserpate-3'-methoxy-4'-ethoxy-
 carboxy cinnamate
 Rescimetal
 2-Methylresorcinol
 Trioxsalen
 Methyl sulfate
 Chlophedianol
 p-Methylsulfonyl- ω -bromoacetophenone
 Zolimidine
 17 β -Methyltestosterone
 Methandrostenolone

- 5-Methyl-1,3,4-thiadiazole-2-thiol
Cefazolin sodium
- p-Methylthiobenzaldehyde
Sulindac
- β -Methylthioethyl-(1-methyl)-n-butyl-
cyanoacetic acid ethyl ester
Methitural
- 3-(2-Methylthio-2-piperidinoacetyl)-
5-phenyl isoxazole
Perisoxal citrate
- 2-Methyl-2-thiopseudourea sulfate
Guanadrel sulfate
- Methylthiourea
Noxytiolin
- S-Methylthiourea
Fenbendazole
Flubendazole
- α -Methylthiyoaxine
Etiroxate
- o-Methyl-N-p-toluenesulfonyl urea
Glibornuride
- N-Methyl-m-toluidine
Tolciclate
Tolnaftate
- Methyl urea
Methohexital sodium
- Methyl o-valerate
Betamethasone Valerate
- p-Methylvalerophenone
Pyrovalerone HCl
- Methyl vinyl ketone
Kebuzone
- Monoallylurea
Aminometradine
- 6'-Monobenzyloxy carbonyl
kanamycin A
Amikacin
- Monobenzyl-3-thienyl malonate
Ticarcillin disodium
- N-Mono-1-p-chlorobenzohydril
piperazine
Hydroxyzine HCl
- Monopropionylerythromycin
Erythromycin estolate
- Morpholine
Allopurinol
Bufexamac
Doxapram HCl
Flurbiprofen
Fominoben HCl
Fomocaine
Metiazinic acid
Nifurfoline
Nimorazole
Tinoridine
Trimetozine
- Morpholine hydrochloride
Molindone
- β -Morpholinoethyl chloride
Morclofone
- 3-Morpholino-4-hydroxy-1,2,5-
thiadiazole
Timolol maleate
- γ -Morpholino propyl chloride
Praxoxine HCl
- 3-(N-Morpholinyl)-1,2-epoxy propane
Furaltadone
- Naphthalene
Bietaserpine
Salicylic acid
- 1-Naphthol
Propranolol HCl
- 2-Naphthol
Tolnaftate
- Naphthyl-1-acetonitrile
Naphazoline
- β -(1-Naphthyl) β' -tetrahydrofurfuryl
isobutyric acid
Nafronyl oxalate
- Niacin chloride HCl
Ciclonicate
- Nicotinic acid
Aluminum nicotinate
Etofibrate
Hepronicate
Inositol niacinate
Niflumic acid
Pimefylline nicotinate
Xanthinol niacinate
- Nicotinic acid chloride
Niaprazine
Niceritrol
Nicomol
- Nitric acid
Aminogluthethimide
Azathioprine
Chloramphenicol
Dipyridamole
Echonazole nitrate
Etomidate HCl
Glaziovine
Isosorbide dinitrate
Metoclopramide HCl
Miconazole nitrate
Nitrazepam
Oxiconazole nitrate
Pentaerythritol tetranitrate
Secnidazole
Tolonidine nitrate
- o-Nitroaniline
Thiabendazole
- Nitrobenzalacetone
Acenocoumarol (Acenocoumarin)
- 2-Nitrobenzaldehyde
Nifedipine

- m-Nitrobenzaldehyde
 Iopanoic acid
 Nicardipine
 Nitrobenzene
 Acetaminophen
 p-Nitrobenzenesulfonyl chloride
 Sulfadiazine
 Sulfaguanidine
 Sulfisomidine
 o-Nitrobenzoyl chloride
 Glafenine
 p-Nitrobenzoyl chloride
 Butethamine
 Melphalan
 p-Nitrobenzyl-7-amino-3-chloro-3-cephem-4-carboxylate HCl
 Cefaclor
 p-Nitrobenzyl-7-aminodesacetoxy-cephalosporanate
 Cephalexin
 2-Nitrobenzyl bromide
 Bromhexine
 (2-Nitrobenzyl)methylamine
 Nomifensine maleate
 o-Nitrochlorobenzene
 Clemizole
 8-Nitro-1,2-dihydro-2-(N-methylpiperazin-1-yl)methylene-6-(o-chlorophenyl)-1H,4H-imidazo[1,2-a]-[1,4]benzodiazepin-1-one
 Loprazolam
 Nitroethane
 Carbidopa
 Hexetidine
 Phenylpropanolamine HCl
 β -Nitroethanol
 Chloramphenicol
 5-Nitro-2-furaldehyde (5-Nitrofurfural)
 Furaladone
 Nifuratel
 Nifuroxazide
 5-Nitro-2-furaldehyde diacetate
 Furazolidone
 5-Nitro-2-furaldoxime
 Nitrofurantoin
 Nitrofurantoin
 Nifurfoline
 Nifurtinol
 5-Nitro-2-furyl acrolein
 Nifurzide
 Nitrogen dioxide
 Dimethyl sulfoxide
 4(5)-Nitroimidazole sodium salt
 Nimorazole
 Nitromethane
 Bronopol
 Tromethamine
 5-(p-Nitrophenyl)-2-furaldehyde
 Dantrolene sodium
 4-(3-Nitrophenyl)pyridine
 Rosoxacin
 3-Nitro-5-(4-pyridinyl)-2-(1H)-pyridinone
 Amrinone
 p-Nitrosalicylic acid
 Phenyl aminosaliclylate
 5-Nitroso-2,4,6-triaminopyrimidine
 Triamterene
 Nitrosyl chloride
 Bupivacaine
 Nicotinyl alcohol
 Pralidoxime chloride
 5-Nitrothiophene carboxylic acid
 Nifurzide
 o-Nitrotoluene
 Desipramine HCl
 2-Nitro-p-tolunitrile
 Hydroxystilbamidine isethionate
 4-Nitro-3-trifluoromethylaniline
 Flutamide
 Nitrous acid
 Metoclopramide HCl
 Nonaethyleneglycol monomethyl ether
 Benzonatate
 L-Norephedrine
 Oxyfedrine
 Norethindrone
 Norethandrolone
 Norethindrone acetate
 Normorphine
 Nalorphine
 (-)-Norscopolamine
 Oxitropium bromide
 19-Nortestosterone
 Nandrolone decanoate
 Nandrolone phenpropionate
 2,3,4,4a,5,6,7,8-Octahydro-3-oxo-6-pyrido[4,3-c]pyridazine carboxylic acid ethyl ester
 Endralazine
 n-Octylamine
 Suloctidil
 Oenanthic acid
 Testosterone enanthate
 Oleic acid
 Pelargonic acid
 Orotic acid
 Orazamide
 Orthoacetic acid trimethyl ester
 Diflorasone diacetate
 Orthoanilamide
 Diazoxide
 Osmium tetroxide
 Cortisone acetate
 Oxalic acid
 Difluprednate
 Fibrinolysin

- Oxalic acid (cont'd)
 Medazepam
 Nafrolyl oxalate
 Oxaly chloride
 Mecillinam
 Pivmecillinam
 5-Oximino-5H-dibenzo [a,d] cycloheptene
 Demexiptiline HCl
 1-Oxo-3-(aminophenyl-p-ethoxypiperidino) isoindoline
 Etomidoline
 4-(2-Oxo-1-benzimidazolyl)-piperidine
 Pimozide
 6-Oxobenzobenzofurano [2,3e] oxepin
 Oxetorone fumarate
 2-Oxo-3-carboxy-9,10-dimethoxy-1,2,3,4,6,7-hexahydro-11b-benzopyridocoline
 Benzquinamide
 2-Oxo-3,3-diphenyl tetrahydrofuran
 Loperamide HCl
 Oxygen
 Dimethyl sulfoxide
 Felypressin
 Pelargonic acid
 Triacetin
 Vincamine
 Oxymorphone
 Naloxone
 3-Oxy-4-nitrobenzoic acid
 Benoxinate hydrochloride
 17 α -Oxypregnene-(5)-ol-(3)-one-(20)-acetate-(3)
 Hydroxyprogesterone caproate
 3-Oxypyridine
 Distigmine bromide
 Oxytetracycline
 Methacycline
 Palladium hydroxide
 Moxestrol
 Palmitoyl chloride
 Chloramphenicol palmitate
 Pamoic acid
 Pyrantel pamoate
 Papaverine base
 Papaverine monophosadenine
 Papaya latex
 Chymopapain
 Paraformaldehyde
 Alprazolam
 Amodiaquin
 Bialamicol
 Dyclonine HCl
 Eperisone HCl
 Ethacrynic acid
 Hexachlorophene
 Hydrochlorothiazide
 Hydroflumethiazide
 Mepicycline
 Molindone
 Oxyfedrine
 Procyclidine HCl
 Pyrrobutamine
 Rolitetracycline
 Tetrabenazine
 Thiothixene
 Tridihexethyl iodide
 Trihexyphenidyl HCl
 Triprolidine
 Penicillin G
 Penicillin G hydrabamine
 Penicillin G procaine
 Penta-N-benzyloxycarbonyl-2''-O-benzyl-sulfonyl-3',4'-dideoxy-3'-enokanamycin B
 Dibekacin
 Pentaerythritol
 Niceritrol
 Pentaerythritol tetranitrate
 Pentene
 Gramicidin
 Pentane-1,5-diol
 Atracurium besylate
 Peracetic acid
 Medroxyprogesterone acetate
 Thiamphenicol
 Perbenzoic acid
 Cyproterone acetate
 Perchloric acid
 Beclomethasone dipropionate
 Betamethasone acetate
 Flunisolide
 Fluocinonide
 Flurandrenolide
 Perchloromethyl mercaptan
 Chlordantoin
 Phenacyl-6-amino penicillate HCl
 Apalcillin sodium
 Phenacyl chloride
 Phenactropinium chloride
 N-Phenacyl-N'-methylpiperazine
 Hexocyclium methyl sulfate
 β -Phenethylamine
 Phenformin
 Phenethyl bromide
 Phenelzine sulfate
 Phenol
 Batroxobin
 Bisacodyl
 Bumetanide
 Febuprol
 Octopamine HCl
 Phenyl aminosaliclylate

- Phenothiazine
 Dixyrazine
 Ethopropazine HCl
 Mepazine
 Mequitazine
 Methdilazine HCl
 Oxomemazine
 Promazine HCl
 Pyrathiazine
 Trimeprazine
 Phenothiazine-10-carboxylic acid chloride
 Dimethoxanate
 Phenoxyacetyl chloride
 Penicillin V
 β -Phenoxyethyl dimethylamine
 Domiphen bromide
 1-Phenoxy-2-aminopropane
 Isoxsuprine HCl
 Phenoxyethylpenicillin (Penicillin V)
 Penicillin V hydrabamine
 1-Phenoxy-2-propanol
 Phenoxybenzamine HCl
 α -Phenoxypropionic acid
 Phenethicillin potassium
 Phenylacetaldehyde
 Bendroflumethiazide
 Phenylacetic acid
 Amitriptyline HCl
 Phenylacetone
 Prenylamine
 Phenylacetone nitrile
 Disopyramide phosphate
 Ethoheptazine
 Methylphenidate HCl
 Oxeladin
 Pentapiperide methosulfate
 Phenoperidine HCl
 Triamterene
 L-Phenylalanine methyl ester HCl
 Aspartame
 1-Phenyl-3-aminobutane
 Nylidrin
 N-Phenyl-N-(2-amino-5-chlorophenyl)-malonic acid ethyl ester amide
 Clobazam
 N-Phenyl-2-aminoindane
 Aprindine HCl
 1-Phenyl-4-aminopyridazone
 Amezinium methyl sulfate
 1-Phenyl-2-aminopropane
 Mefenorex HCl
 4-Phenylbenzophenone
 Bifonazole
 2-Phenyl-1,2-butane diol
 Hydroxyphenamate
 Phenylbutazone
 Clofezone
 Pipebuzone
 α -Phenylbutyric acid chloride
 Butamirate citrate
 α -Phenylbutyric acid nitrile
 Glutethimide
 4-Phenyl-4-carbethoxy piperidine carbonate
 Anileridine dihydrochloride
 Phenylchloro carbonate
 Camazepam
 1-Phenyl-3-(p-chlorophenyl)-pyrazol-4-acetonitrile
 Lonazolac
 Phenylcyclohexane
 Bucloxic acid
 1-Phenylcyclohexane cyanide
 Dicyclomine HCl
 1-Phenylcyclopentyl-1-carboxylic acid chloride
 Caramiphen edisylate
 1-(2-Phenyl-2-ethoxy)piperazine dihydrochloride
 Eprazinone HCl
 o-Phenylene diamine
 Tibezonium iodide
 di-1-Phenylethylamine
 Etomidate HCl
 Phenylethylbarbituric acid
 Barbexaclone
 β -Phenylethyl chloride
 Fentanyl
 N-[(S)-1'-Phenylethyl]-1,3-diaminopropane
 Peplomycin sulfate
 α -Phenyl- α -ethyl glutarimide
 Aminoglutethimide
 α,α -Phenylethylmalonic acid diamide
 Primidone
 1-(2-Phenylethyl)-4-piperidone
 Fenspiride
 D-Phenylglycine
 Cephaloglycin
 Cephradine
 Epicillin
 D-Phenylglycyl chloride HCl
 Apalcillin sodium
 Phenylhydrazine
 Cortivazol
 Penicillamine
 2-Phenyl-2-hydroxycyclohexane carboxylic acid
 Rociverine
 Phenyl isocyanate
 Cyclarbamate
 4-Phenylisonipecotic acid ethyl ester
 Diphenoxylate HCl
 L-N-(2-Phenylisopropyl)methylamine
 Selegiline

- Phenyllithium
 β -Carotene
 Dimethindene maleate
 Phenylmalonic acid
 Carbenicillin disodium
 Carbenicillin indanyl sodium
 1-(2-Phenyl-2-methoxy)ethyl piperazine
 Zipeprol
 3-Phenyl-3-methoxy propylene oxide
 Zipeprol
 α -Phenyl- α -methylsuccinic acid
 Methsuximide
 Phenylnitropropylene
 Amphetamine phosphate
 1-Phenyl-4-oxo-1,3,8-triazaspiro(4,5)-
 decane
 Fluspirilene
 p-Phenylphenacyl bromide
 Fentonium bromide
 β -Phenylpropionyl chloride
 Nandrolone phenpropionate
 1-Phenyl-2-propylidenylhydrazine
 Pheniprazine
 Phenylpyridylamine
 Isothipendyl HCl
 d-Phenylsuccinic acid
 Dexbrompheniramine maleate
 Dexchlorpheniramine maleate
 Phenylsuccinic anhydride
 Phensuximide
 4-Phenylsulfonyl-2,6-dimethoxypyrim-
 idine
 Sulfadimethoxine
 3-Phenylsulfonyloxyquinuclidine
 Quinupramine
 Phenyl 2-thienyl ketone
 Phethenylate sodium
 4-Phenyl-1,2,4-triazoline-3,5-dione
 Alfacalcidol
 Phenyltrimethylammonium chloride
 Dextromethorphan hydrobromide
 Phenyl trimethylammonium toluene
 sulfonate
 Sulfadoxine
 Phosgene
 Bethanechol chloride
 Carbachol
 Carbamazepine
 Carbuterol
 Carisoprodol
 Caroxazone
 Chlorphenesin carbamate
 Demecarium bromide
 Estramustine phosphate
 Ethinamate
 Mephenesin carbamate
 Meprobamate
 Methocarbamol
 Mezlocillin
 Perlapine
 Piperacillin sodium
 Tybamate
 Phosphoric acid
 Amphetamine phosphate
 Azapetine phosphate
 Chloroquine phosphate
 Dexamethasone phosphate
 Disopyramide phosphate
 Hydrocortisone sodium phosphate
 Hydroxychloroquine sulfate
 Isaxonine phosphate
 Prednisolone phosphate sodium
 Phosphoric anhydride
 Alizapride
 Protionamide
 Phosphorous acid
 Etidronate disodium
 Phosphorus
 Pizotyline HCl
 Phosphorus (red)
 Hexestrol
 Phosphorus oxychloride
 Ceftizoxime
 Chlorambucil
 Clozapine
 Cortisone acetate
 Diethylstilbestrol diphosphate
 Dioxyline phosphate
 Dipyridamole
 Endralazine
 Estramustine phosphate
 Ethionamide
 Floctafenine
 Flucytosine
 Fludrocortisone acetate
 Formocortol acetate
 Glaziovine
 Hydralazine HCl
 Inositol niacinate
 Loxapine
 Medazepam
 Melphalan
 Menadiol sodium phosphate
 Minoxidil
 Perlapine
 Phenyl aminosaliclylate
 Polyestradiol phosphate
 Protionamide
 Sulfameter
 Thiothixene
 Triclofos sodium
 Phosphorus pentachloride
 Azathioprine
 Carbenicillin indanyl sodium
 Cefroxadine
 Cefuroxime

- Dichlorphenamide
 Glymidine
 Phosphorus pentasulfide
 Ancitabine HCl
 Bronopol
 Cytarabine HCl
 Thioguanine
 Phosphorus pentoxide
 Amoxapine
 Ethamivan
 Ethionamide
 Pizotyline HCl
 Tetracycline phosphate complex
 Phosphorus tribromide
 Alprazolam
 Fenoprofen
 Methohexital sodium
 Phosphorus trichloride
 Diazepam
 Isoflurophate
 Metolazone
 Motretinide
 Niclosamide
 Sultopride HCl
 Xipamid
 Phthalazone
 Hydralazine HCl
 Phthalic anhydride
 Amitiptyline HCl
 Phthalyl sulfathiazole
 Pizotyline HCl
 Phthalide
 Anisindione
 Phthalimidoacetyl chloride
 Pinazepam
 Prazepam
 Phytol
 Phytionadione
 α -Picoline
 Perhexiline sulfate
 Pralidoxime chloride
 3-Picolylamine
 Pimefylline nicotinate
 Picric acid
 Tubocurarine chloride
 α -Pinene oxide
 Sobrero
 Piperazine
 Eproxinol
 Norfloxacin
 Perphenazine
 Pipobroman
 Prazosin
 Sultosilic acid piperazine salt
 Thiopropazate
 Piperazine hydrate
 Pipemidic acid
 1-Piperazinoethyl acetate
 Cinepazet maleate
 10-(γ -N-Piperazinopropyl)-4-azaphen-
 thiazine
 Oxypendyl
 4-(1-Piperazinyl)phenol dihydrobromide
 Ketoconazole
 Piperidine
 Benpropine
 Cloperastine
 Dipyridamole
 Etozolin
 Minoxidil
 Pancuronium bromide
 Pipoxolan HCl
 Piprozolin
 Pixifenide
 Trihexyphenidyl HCl
 Piperidinecarboxamide
 Pipamazine
 Piperidine hydrochloride
 Biperiden
 Dyclonine HCl
 Eperisone HCl
 Pipamperone
 Piperidinoethanol
 Flavoxate
 Piperidinoethoxy ethanol
 Pipazethate
 2-Piperidinoethyl chloride
 Picoperine
 2-(1-Piperidino-isopropyl)aminopyridine
 Propiram fumarate
 4-Piperidino-4-piperidinecarboxamide
 Pirtramide
 1-(4-Piperidyl)-2-benzimidazoline HCl
 Benperidol
 Piperonylpiperazine
 Pifarnine
 Pipethanate hydrochloride
 Pipethanate ethobromide
 Pivalic anhydride
 Etilefrine pivalate HCl
 Pivaloyl chloride
 Dipivefrin
 Pivaloyloxymethyl-6-aminopenicillinat
 tosylate
 Pivmecillinam
 Podophyllinic acid hydrazide
 Mitopodozide
 Polygalacturonic acid
 Quinidine polygalacturonate
 Polyphosphoric acid
 Azatadine maleate
 Creatinolfosfate
 Flumequine
 Mianserin
 Midazolam nitrate
 Sulindac
 Polyvinylpyrrolidone
 Povidone-iodine

- Potassium (metal)
 Aceclidine
 Ethinylestradiol
 Fluroxene
 Methysergide maleate
 Moxestrol
 Norethindrone
 Potassium acetate
 Diflorasone diacetate
 Potassium acetylide
 Desogestrel
 Potassium amide
 Pheniramine maleate
 Protriptyline
 Potassium D(-)- α -azidobenzyl-
 penicillinate
 Pivampicillin
 Potassium benzylpenicillin
 Penicillamine
 Potassium bicarbonate
 Meprednisone
 Potassium bisulfate
 Methallenestril
 Potassium bromoaurate
 Aurothioglycanide
 Potassium o-bromobenzoate
 Meclofenamic acid
 Mefenamic acid
 Potassium tert-butylate
 Difenoxine
 Gliquidone
 Potassium carbonate
 Auranofin
 Chlorproethazine HCl
 Dexbrompheniramine maleate
 Dexchlorpheniramine maleate
 Estradiol cypionate
 Estradiol valerate
 Etodroxizine
 Etretnate
 Fenoprofen
 Mesoridazine besylate
 Potassium o-chlorobenzoate
 Thioridazine
 Potassium cyanate
 Dipyridamole
 Emylcamate
 Sulfacytine
 Potassium cyanide
 Carbidopa
 Cortisone acetate
 Cyanocobalamin
 Fenspiride
 Phenytoin
 Phethenylate sodium
 Pipamperone
 Potassium 2-ethylhexanoate
 Phenethicillin potassium
- Potassium ethylate
 Fluorouracil
 Potassium ferricyanide
 Thiamine disulfide
 Potassium hydroxide
 Alcofenac
 Benoxinate hydrochloride
 Calcitriol
 Chenodiol
 Cimetide
 Clorazepate dipotassium
 Cyclofenil
 Cycloserine
 Dienestrol
 Epitiostanol
 Etretnate
 Febuprol
 Fentiazac
 Flucloronide
 Fluocinolone acetonide
 Flupentixol
 Gemeprost
 Ibuproxam
 Indoprofen
 Levamisole HCl
 Metiazinic acid
 Oxeladin
 Phentermine HCl
 Pramoxine HCl
 Protriptyline
 Triamcinolone
 Potassium iodide
 Etidocaine HCl
 Niflumic acid
 Potassium iodide dichloride
 Iodamide
 Potassium nitrate
 Clonazepam
 Clorexolone
 Flunitrazepam
 Potassium octadeca-cis-9,cis-13-dienoate
 Dexamethasone-21-linoleate
 Potassium permanganate
 Chlormezanone
 Cicloxilic acid
 Ethoxzolamide
 Metoclopramide HCl
 Potassium stearate
 Prednisolone stearyl glycolate
 Potassium thioacetate
 Fentiazac
 Potassium thiocyanate
 Cefsulodin
 Etomidate HCl
 Isobornyl thiocyanacetate
 Phenindamine tartrate
 Potassium xanthogenate
 Pyritinol

- Prednisolone
 Prednimustine
 Prednisolone acetate
 Prednisolone phosphate sodium
 Prednisolone stearoyl glycolate
 Prednisolone tebutate
 Prednisolone-21-chloroacetate
 Prednisolone stearoyl glycolate
 1,4,9(11)-Pregnatriene-17 α ,21-diol-
 3,20-dione-21-acetate
 Dichlorisone acetate
 Pregna-1,4,9(11)-triene-21-ol-3,20-
 dione-[17 α ,16 α -d]-2'-methyl-
 oxazoline-21-acetate
 Fluazacort
 Δ^4 -Pregnene-9 α -fluoro-11 β ,16 α ,17 α ,21-
 tetrol-3,20-dione-16,21-diacetate
 Triamcinolone
 Procaine
 Penicillin G procaine
 L-Proline
 Captopril
 1,3-Propanediol
 Simfibrate
 Propane-1,3-sultone
 Sultroponium
 1,3-Propanolamine
 Cyclophosphamide
 Defosfamide
 Propargyl bromide
 Pargyline HCl
 Pinazepam
 Selegiline
 Propionaldehyde
 Ethiazide
 Propionic anhydride
 Alphaprodine HCl
 Clobetasol
 Dromostanolone propionate
 Fentanyl
 Propiram fumarate
 Propoxyphene HCl
 Sulindac
 Propionyl chloride
 Betamethasone dipropionate
 Flavoxate HCl
 Propionylerythromycin (mono)
 Erythromycin estolate
 2-Propionylphenothiazine
 Carphenazine maleate
 Propiophenone
 Eprazinone HCl
 Phendimetrazine tartrate
 n-Propylamine
 Carticaine
 Etidocaine HCl
 Prilocaine HCl
 Propafenone HCl
 Propylene glycol
 Poloxalkol
 Propylene oxide
 Cefroxadine
 Hydroxypropyl cellulose
 Poloxalkol
 Propyl isocyanate
 Chlorpropamide
 Propylmagnesium bromide
 Butofilolol
 Dimethisterone
 Propylmalonyl chloride
 Apazone
 Propyl mercaptan
 Albendazole
 Propylmethylcarbonylbarbituric acid
 Secobarbital sodium
 Prostaglandin A₂
 Dinoprostone
 Prostaglandin F_{2 α}
 Dinoprost tromethamine
 Pyrazine-2,3-dicarboxamide
 Pyrazinamide
 Pyridine
 Ceftazidime
 Cephaloridine
 Clonazepam
 Niceritrol
 Promegestone
 Sucralfate
 Sultosilic acid piperazine salt
 2-Pyridine aldehyde
 Bisacodyl
 Carbinoxamine maleate
 Picosulfate sodium
 2-Pyridinealdoxime
 Pralidoxime chloride
 Pyridine-2,6-dimethanol
 Pirozadil
 Pyridine sulfuric anhydride
 Ceruletide
 3-Pyridol
 Benzpyriminone bromide
 α -(4-Pyridyl)benzhydrol
 Azacyclonol
 3-(2-Pyridyl)-3-p-bromophenyl-N,N-
 dimethylpropylamine (racemic)
 Dexbrompheniramine maleate
 3-(2-Pyridyl)-3-p-chlorophenyl-N,N-
 dimethylpropylamine
 Dexchlorpheniramine maleate
 N-(2-Pyridylmethyl)aniline
 Picoperine
 Pyrocatechol monoallyl ether
 Oxprenolol
 Pyrogallol
 Gallamine triethiodide
 Pyrogallol aldehyde
 Benserazide

- L-Pyroglutamyl-L-glutaminy-L-aspartyl-L-tyrosine azide
 Ceruletide
 Pyrone
 Betazole
 Pyrrolidine
 Amixtrine HCl
 Buflomedil
 Clemizole
 Piromidic acid
 Procyclidine HCl
 Pyrovalerone HCl
 Pyrrobutamine
 Triprolidine
 Pyrrolidine hydrochloride
 Rolitetracycline
 β -Pyrrolidinoethyl chloride
 Pyrathiazine
 2-Pyrrolidone
 Piracetam
 Pyrvinium chloride
 Pyrvinium pamoate

 Quinidine
 Quinidine polygalacturonate

 Reserpine
 Bietaserpine
 Resorcinol
 Chromonar HCl
 Retroprogesterone
 Dydrogesterone
 Riboflavin
 Methylol riboflavin

 Salicylamide
 Exalamide
 Salicyclic acid
 Aspirin
 Flavoxate HCl
 Salicylanilide
 Sulfasalazine
 Salicyclic aldehyde
 Benzbromarone
 Caroxazone
 Salicyl amide
 Chlorthenoxazine
 Salmiridine sulfate
 Insulin isophane
 Sarcosine methyl ester
 Fominoben HCl
 Scopolamine hydrobromide trihydrate
 Methscopolamine bromide
 Selenious acid
 Selenium sulfide
 Selenium dioxide
 Betamethasone acetate
 Flucloronide

 Fluocinolone acetonide
 Methandrostenolone
 Stanolone
 Triamcinolone diacetate
 Semicarbazide HCl
 Carbazochrome
 Fluprednidene acetate
 Nitrofurazone
 Trazodone HCl
 DL-Serylhydrazide HCl
 Benserazide
 Silver acetate
 Nadolol
 Silver bromide
 Parapenzolate bromide
 Silver chloride
 Chlorisondamine chloride
 Silver nitrate
 Edrophonium chloride
 Silver oxide
 Carbazochrome
 Ectylurea
 Silver sulfate
 Dibutoline sulfate
 Sisomicin
 Netilmicin
 Sodium
 Amiloride HCl
 Antrafenine
 Apazone
 Benactyzine HCl
 Captodiamine
 Carbinoxamine maleate
 Carbocysteine
 Cetiedil
 Chloramphenicol
 Cimetide
 Citiolone
 Clidinium bromide
 Clobazam
 Cyclomethycaine
 Demecarium bromide
 Demexiptiline HCl
 Desmopressin
 Dibekacin
 Dicyclomine HCl
 Dienestrol
 Diethylstilbestrol
 Dimethisoquin
 Diphenadione
 Distigmine bromide
 Echthiopate iodide
 Etomidate HCl
 Exalamide
 Feprazone
 Floredil HCl
 Flurothyl
 Furaltadone

- Glycopyrrolate
 Halazepam
 Heptabarbital
 Ibuprofen
 Iopronic acid
 Ketoprofen
 Mebeverine HCl
 Methitural
 Methixene HCl
 Methohexital sodium
 Methypylon
 Moxisylyte
 Ornipressin
 Oxafiumazine disuccinate
 Oxeladin
 Oxyphen butazone
 Paramethadione
 Phenprocoumon
 Phentermine HCl
 Phenylbutazone
 Phenyltoloxamine
 Polythiazide
 Propanidid
 Protizinic acid
 Rescimetol
 Sulfacytine
 Sulfadoxine
 Sulfalene
 Sulfamethoxyipyridazine
 Sulfinpyrazone
 Tetrabenazine
 Thiamylal
 Tiopronin
 Trimethadione
 Trimethoprim
 Trioxsalen
 Tromantidine HCl
 Vinbarbital sodium
 Sodium (amalgam)
 Epimestrol
 Hexestrol
 Sodium acetate
 Danazol
 Sodium acetylacetonate
 Sulfamethazine
 Sodium aluminate
 Lactulose
 Sodium amide
 Acetophenazine dimaleate
 Aprindine HCl
 Bepidil
 Brompheniramine maleate
 Butalamine HCl
 Chlophedianol
 Chlorpheniramine maleate
 Chlorphenoxamine HCl
 Chlorpromazine HCl
 Clemastine fumarate
 Clomipramine
 Cyamemazine
 Dibenzepin HCl
 Dimetacrine tartrate
 Disopyramide phosphate
 Dixyrazine
 Doxapram HCl
 Ethoheptazine
 Fenoxedil
 Fonazine mesylate
 Gallamine triethiodide
 Homofenazine
 Imipramine HCl
 Isoaminile
 Isothipendyl HCl
 Meclizine HCl
 Mepazine
 Meperidine HCl
 Meptazinol
 Mequitazine
 Methapyrilene HCl
 Methotrimeprazine
 Methyl phenidate HCl
 Noxiptilin
 Oxomemazine
 Pentapiperide methosulfate
 Picoperine
 Promazine HCl
 Promethazine HCl
 Prothipendyl HCl
 Pyrathiazine
 Pyrilamine
 Quinupramine
 Thiethylperazine
 Thiopropazine
 Thioridazine
 Thonzylamine HCl
 Trifluoperazine
 Triflupromazine
 Trimeprazine
 Tripelennamine
 Valethamate bromide
 Verapamil
 Sodium p-aminosalicylate
 Aminosalicylic acid
 Sodium tert-amylate
 Trenbolone acetate
 Sodium azide
 Azosemide
 Tranlycypromine sulfate
 Sodium 6-(D- α -azidophenylacetamido)-
 penicillinate
 Bacampicillin
 Sodium benzoate
 Urokinase
 Sodium bicarbonate
 Amoxicillin
 Apalcillin sodium

Sodium bicarbonate (cont'd)	Improsulfan tosylate
Bacampicillin	Melphalan
Bumetanide	Menbutone
Carbenicillin disodium	Oxitropium bromide
Cephapirin sodium	Pargyline HCl
Cinepazet maleate	Triclofos sodium
Cefazolin sodium	Trimetazidine
Cefotaxime sodium	Sodium chloride
Dicloxacillin sodium	Chlormerodrin
Diethylstilbestrol diphosphate	Sodium cyanate
Diltiazem HCl	Carisoprodol
Fluprednisolone	Hydroxyurea
Metampicillin sodium	Sodium cyanide
Metoprolol tartrate	Carnitine
Nafcillin sodium	Clortermine HCl
Nalorphine	Edetate disodium
Oxacillin sodium	Fenoprofen
Pivmecillinam	Mecamylamine HCl
Ticarcillin disodium	Methionine
Sodium bisulfite	Oxymetazoline HCl
Folic acid	Paramethadione
Phenylpropanolamine HCl	Phenaglycodol
Sodium borohydride	Sodium cyanoborohydride
Alprenolol HCl	Netilmicin
Benfurodil hemisuccinate	Sodium ethoxide
Bifonazole	Acebutolol
Clorprenaline	Anisindione
Eprozolol	Diltiazem HCl
Fenoprofen	Kebuzone
Glaziovine	Piprozolin
Metolazone	Protionamide
Miconazole nitrate	Viquidil
Nomifensine maleate	Sodium 2-ethylhexanoate
Oxandrolone	Cefamandole nafate sodium salt
Oxendolone	Moxalactam disodium
Pancuronium bromide	Piperacillin sodium
Perisoxal citrate	Sodium 3-ethylhexanoate
Piretanide	Cephapirin sodium
Piroheptine	Sodium fluoride
Quinethazone	Isofluorophate
Stanolone	Sodium fluoroacetate
Suloctidil	Fluorouracil
Thiothixene	Sodium formaldehyde sulfoxylate
Ticlopidine HCl	Sulfoxone sodium
Timolol maleate	Sodium hydride
Sodium carbonate	Butofilolol
Anileridine dihydrochloride	Butriptyline
Astemizole	Carphenazine maleate
Bismuth sodium triglycollamate	Cefoxitin sodium
Ceruletide	Dromostanolone propionate
Dextromethorphan hydrobromide	Echonazole nitrate
Diethylcarbamazine citrate	Etomidolone
Diphenhydramine HCl	Etretinate
Emylcamate	Floctafenine
Etomidate HCl	Flunitrazepam
Ferrous fumarate	Indomethacin
Flunarizine HCl	Isoconazole nitrate
	Miconazole nitrate

Motretinide
 Oxiconazole nitrate
 Piracetam
 Procarbazine HCl
 Rosoxacin
 Tioconazole
 Trazodone HCl
 Vincamine
 Sodium hydroxide
 Acetrizoate sodium
 Amantidine HCl
 Amikacin
 Aminometradine
 Amisometradine
 Angiotensin amide
 Aprindine HCl
 Baclofen
 Beclamide
 Benzphetamine HCl
 Betztopine mesylate
 Betaxolol HCl
 Bufexamac
 Captodiamine
 Carprofen
 Cefazolin sodium
 Cefroxadine
 Cephacetrile sodium
 Cephalothin sodium
 Chlorzoxazone
 Ciclonicate
 Ciprofibrate
 Cromolyn sodium
 Cyclomethycaine
 Cyproheptadine
 Dantrolene sodium
 Dextroamphetamine sulfate
 Diatrizoate sodium
 Diazepam
 Diclofenac sodium
 Diethylcarbamazine citrate
 Diethyl stilbestrol
 Dimethicone
 Diosmin
 Dioxyline phosphate
 Disopyramide phosphate
 Disulfiram
 Dyphylline
 Edetate disodium
 Edrophonium chloride
 Ethambutol HCl
 Ethosuximide
 Etidronate disodium
 Exiproben
 Fenofibrate
 Fenoprofen
 Floxacillin
 Fluazacort
 Flumequine
 Fluoxymesterone
 Fluphenazine HCl
 Fursultiamine
 Glutethimide
 Glymidine
 Hexamethonium bromide
 Hydrocortisone sodium phosphate
 Hydroxypropyl cellulose
 Hydroxy tryptophan
 Hydroxyzine HCl
 Ibuprofen
 Idoxuridine
 Iopronic acid
 Levamisole HCl
 Levothyroxine sodium
 Lorazepam
 Lormetazepam
 Medazepam
 Memantine
 Menadiol sodium phosphate
 Mercaptopurine
 Mesoridazine besylate
 Mesterolone
 Methallenestril
 Methionine
 Methitural
 Mexenone
 Mexiletine HCl
 Motretinide
 Nadolol
 Nalidixic acid
 Naproxen
 Nonoxynol
 Oxazepam
 Oxolinic acid
 Oxymetazoline HCl
 Penicillamine
 Pentapiperide methosulfate
 Perhexiline sulfate
 Phenaglycodol
 Phenindamine tartrate
 Phenprocoumon
 Picosulfate sodium
 Pipemidic acid
 Pipethanate ethobromide
 Piretanide
 Piromidic acid
 Pralidoxime chloride
 Prednisolone phosphate sodium
 Procarbazine HCl
 Propylhexedrine
 Protizinic acid
 Pyrazinamide
 Rimiterol
 Rosoxacin
 Secobarbital sodium
 Simethicone
 Sucralfate

Sodium hydroxide (cont'd)

- Sulfacetamide
- Sulfacytine
- Sulfalene
- Sulfameter
- Sulfamethoxazole
- Sulfaphenazole
- Temazepam
- Tianeptine
- Ticrynafen
- Timonacic sodium
- Tolmetin
- Tranilast
- Tranlycypromine sulfate
- Tyropanoate sodium
- Warfarin sodium
- Zomepirac
- Sodium hypochlorite
- Aminobenzoic acid
- Ethoxzolamide
- Metapramine
- Tetrazepam
- Sodium iodide
- Fluorometholone
- Mebeverine HCl
- Norfenefrine
- Prednisolone phosphate sodium
- Sodium lauryl sulfate
- Erythromycin estolate
- Sodium methoxide
- Amiodarone HCl
- Beclomethasone dipropionate
- Benapryzine HCl
- Betamethasone acetate
- Dexamethasone phosphate
- Floxacinil
- Fluorouracil
- Flurazepam
- Mercaptomerin sodium
- Morclofene
- Nadolol
- Oxybutynin chloride
- Pyrimethamine
- Pyrithyldione
- Tetrazepam
- Tiropamide
- Tixocortol pivalate
- Trilostane
- Trimethobenzamide HCl
- Triparanol
- Sodium N-(1-methoxycarbonyl-1-propen-2-yl)-D-(-)- α -amino-(4-hydroxy-phenyl) acetate
- Cefadroxil
- Sodium 4-methylbenzensulfonamide
- Tolbutamide
- Sodium methylsulfinylmethide
- Sulprostone
- Sodium nitrate
- Chlorthalidone
- Hydroxystilbamidine isethionate
- Sodium nitrite
- Acetohexamide
- Acyclovir
- Clonazepam
- Clorexolone
- Cyanocobalamin
- Glaziovine
- Hydroxytryptophan
- Metyrosine
- Moxisylyte
- Nimustine
- Sulfasalazine
- Tolazamide
- Tolonium chloride
- Sodium pamoate
- Pyrvinium pamoate
- Sodium penicillin G
- Penicillin G benzathine
- Sodium periodate
- Alprazolam
- Sulindac
- Sodium phenolate
- Fomocaine
- Salicylic acid
- Sodium phenyl acetate
- Cyclopentolate HCl
- Sodium D- α -phenylglycine
- Cephalexin
- Sodium salicylate
- Choline salicylate
- Sodium sulfanilamide
- Sulfadimethoxine
- Sodium sulfide
- Dimercaprol
- Sodium tetrahydrofurfuryl thiosulfate
- Fursultiamine
- Sodium thiophenoxide
- Apalcillin sodium
- Sodium thiosulfate
- Fluorometholone
- Tolonium chloride
- Stannous chloride
- Clorexolane
- Dapsone
- Hydroxystilbamidine isethionate
- Hydroxytryptophan
- Stearoyl chloride
- Erythromycin stearate
- Stearoylglycolyl chloride
- Prednisolone stearoyl glycolate
- Streptomycin sulfate
- Dihydrostreptomycin sulfate
- Styrene
- Amixtrine HCl
- Eprozinol
- Tranlycypromine sulfate

- Styrene oxide
 Phenylramidol
 Succinic acid
 Oxaflumazine disuccinate
 Succinic anhydride
 Benfurodil hemisuccinate
 Bucloxic acid
 Carbenoxolone
 Estriol succinate
 Fenbufen
 Florantyrone
 Hydroxydione sodium succinate
 Menbutone
 Meralluride
 Succinylsulfathiazole
 Trepibutone
 3-N-Succinimido-4-phenoxy-5-sulfamyl-
 benzoic acid methyl ester
 Piretanide
 Sucrose
 Fructose
 Sucralfate
 3-Sulfamyl-4-chlorobenzoyl chloride
 Indapamide
 3-Sulfamyl-4,6-dichlorobenzoic acid
 Furosemide
 Sulfanilamide
 Sulfachlorpyridazine
 3-Sulfanilamido-6-chloropyridazine
 Sulfamethoxyypyridazine
 2-Sulfanilamidothiazole
 Succinyl sulfathiazole
 Sulfathiazole
 Phthalyl sulfathiazole
 Sulfisoxazole
 Acetyl sulfisoxazole
 Sulfonyl chloride
 Etidocaine HCl
 α -Sulfophenacetyl chloride
 Sulbenicillin
 7-(α -Sulfophenyl acetamido)cephalo-
 sporic acid
 Cefsulodin
 Sulfur
 Bufexamac
 Flurbiprofen
 Ibuprofen
 Isothipendyl HCl
 Metiazinic acid
 Thioridazine
 Tinoridine
 Sulfur dioxide
 Acetohexamide
 Aurothioglycanide
 Chlorthalidone
 Clorexolone
 Sulfuric acid
 Amikacin
 Azanidazole
 Brompheniramine maleate
 Chlorpheniramine maleate
 Clonazepam
 Clorexolone
 Clortermine HCl
 Cyclobutylol
 Desogestrel
 Dextimide
 Dextroamphetamine sulfate
 Dicyclomine HCl
 Diphenanil methyl sulfate
 Disopyramide phosphate
 Doxapram HCl
 Ethoheptazine
 Flunitrazepam
 Fluprednisolone
 Glaziovine
 Glutethimide
 Guanethidine sulfate
 Hydroxy chloroquine sulfate
 Hydroxystibamidine isethionate
 Inosine
 Isopropamide iodide
 Isoproterenol sulfate
 Ketoprofen
 Mecamylamine HCl
 Medroxyprogesterone acetate
 Memantine
 Meperidine HCl
 Methitural
 Methoxsalen
 Methylphenidate HCl
 Metyrapone
 Metyrosine
 Moxisylyte
 Netilmicin
 Nomifensine maleate
 Oxetorone fumarate
 Oxitriptan
 Peplomycin sulfate
 Pipamperone
 Propylhexedrine
 Proxibarbal
 Sincalide
 Ticrynafen
 Tranlycypromine sulfate
 Tybamate
 Valethamate bromide
 Vinblastine sulfate
 Vincristine sulfate
 Zimelidine
 Sulfur trioxide
 Methacycline
 Sucralfate
 Sulfuryl chloride
 Amiloride HCl
 4-Chloro-3,5-xyleneol

- Tachysterol
Dihydrotachysterol
- Tannic acid
Cryptenamine tannates
Tanphetamin
- Tartaric acid
Dextroamphetamine sulfate
Dextromethorphan hydrobromide
Dimetacrine tartrate
Ifenprodil tartrate
Metoprolol tartrate
Prajmaline bitartrate
Pyrantel Pamoate
- Testosterone
Testosterone enanthate
- Testosterone-3-enol ethyl ether
Testosterone 17 β -cypionate
- S-(2,3,4,6-Tetra-O-acetylglucopyranosyl)-
thiopseudourea hydrobromide
Auranofin
- 3,4,5,6-Tetrachlorophthalic anhydride
Chlorisondamine chloride
- Tetracycline
Mepicycline
Rolitetracycline
Tetracycline phosphate complex
- Tetraethylenepentamine
Colestipol
- 1,2,3,4-Tetrahydro-4,4-dimethyl-7-
methoxy-isochromane-1,3-dione
Gliquidone
- 2-(2-Tetrahydrofurfuryloxy) phenol
Bufetrol
- cis-Tetrahydroionone
Triclobisonium chloride
- 1,2,3,4-Tetrahydroisoquinoline
Debrisoquin
- 1,2,3,4-Tetrahydro- α -naphthoic acid
Tetrahydrozoline HCl
- Tetrahydropapaverine
Atracurium besylate
- 1-(1,2,3,6-Tetrahydro-4-pyridyl)-2-
benzimidazolinone
Droperidol
- 5 α ,11 β ,17 α ,21-Tetrahydroxy-6 β -fluoro-
16 α -methylallopregnane-3,20-
dione-21-acetate-3-ethylene
glycol ketal
Paramethasone acetate
- 11 β ,16 α ,17 α ,21-Tetrahydroxy-1,4-
pregnadiene-3,20-dione
Desonide
- 3,4,3',4'-Tetramethoxy-6-(α -aceto-
propyl)benzophenone
Tofisopam
- p-(1,1,3,3-Tetramethyl butyl) phenol
Clofocetol
Tyloxapol
- N,N,N,N-Tetramethyl decamethylene
diamine
Demecarium bromide
- Tetramethylene dichloride
Mebeverine HCl
- 2,2,6,6-Tetramethylcyclohexanol
Nicomol
- Tetrapeptide (L-His-L-Ser- β -benzyl-L-
Asp-L-Gly)
Secretin
- Tetrapeptide (L-Thr-L-Phe-L-Thr-L-
Ser)
Secretin
- 1-H-Tetrazole-1-acetyl chloride
Cefazolin sodium
- Thebaine
Oxymorphone
- Thenylamine
Azosemide
- 2-Thenyl chloride
Methapyrilene HCl
- Theobromine sodium salt
Pentoxifylline
Theophylline
Ambuphylline
Choline theophyllinate
Dyphylline
Meralluride
Reproterol
Xanthinol Niacinate
- Thiamine
Fursultiamine
Thiamine disulfide
- Thiazole-4-carboxylic acid
Thiabendazole
- Thieno-[3,2-c]-pyridine
Ticlopidine HCl
- 2-Thienylacetic acid
Cephalothin sodium
Pizotiline HCl
- (3-Thienyl)acetonitrile
Cetiedil
- 2-Thienylacetyl chloride
Cephaloridine
- 2-Thienyl bromide
Timepidium bromide
- Thienyl morpholinoethyl ketone
Tiemonium iodide
- Thioacetic acid
Spironolactone
- 2 β -Thiocyanato-3 α -methanesulfonyloxy-
5 α -androstan-17 β -ol-17-acetate
Epiotostanol
- Thiodiglycol
Auranofin
- Thioethylene glycol
Tiadamol

- Thioglycolic acid
 Letosteine
 Mercaptomerin sodium
 Thiocarbarsone
 Thioglycolic acid anilide
 Aurothioglucanide
 Thionyl chloride
 Azidocillin
 Benoxinate HCl
 Bepiridil
 Bifonazole
 Carbenicillin disodium
 Cefamandole nafate sodium salt
 Cephalothin sodium
 Chloroprocaine HCl
 Chlorthalidone
 Etodroxizine
 Fenofibrate
 Flavoxate HCl
 Floxacillin
 Flupentixol
 Fluphenazine HCl
 Fluspirilene
 Glipizide
 Iopamidol
 Loperamide HCl
 Meperidine HCl
 Mephentermine
 Metoclopramide HCl
 Nafiverine
 Nefopan HCl
 Oxacillin sodium
 Oxametacine
 Pentapiperide methosulfate
 Phenoxybenzamine HCl
 Pimozide
 Pirozadil
 Prednimustine
 Procarbazine HCl
 Protriptyline
 Rescinamine
 Thiabendazole
 Thiothixene
 Ticarcillin disodium
 Tiopronin
 Tranlycypromine sulfate
 Uracil mustard
 Thiophene-2-carboxaldehyde
 Pyrantel pamoate
 Teniposide
 Thiophene-2-carboxylic acid chloride
 Ticrynafen
 2-Thiopheneethanol
 Sufentanil
 Thiophene-2 α -methylacetic acid
 Tiaprofenic acid
 DL-2-thio-1-phenylimidazolidine
 Levamisole HCl
 Thiophosgene
 Ancitabine HCl
 Tolciclate
 Tolnaftate
 Thiophosphoryl chloride
 Thiotepa
 S-Thiopivalic acid
 Tixocortol pivalate
 Thiourea
 Captodiamine
 Diazoxide
 Methitural
 Sulfadoxine
 Thiamylal
 Thioxanthene
 Methixene HCl
 Thiothixene
 β -S-Thiuronium ethanesulfonate
 Mesna
 L-Threonyl-glycyl-L-tryptophanyl-
 L-methionyl-L-aspartyl-L-phenyl-
 alaninamide
 Ceruletide
 Thymidine
 Floxuridine
 Thymol
 Moxisylyte
 Tin (metal)
 Butethamine
 Clorexolone
 3-o-Toloxo-1,2-propanediol
 Mephesisin carbamate
 Toluene
 Heparin
 p-Toluene sulfonic acid
 Improsulfan tosylate
 Nefopan HCl
 Oxymetazoline HCl
 p-Toluenesulfonyl chloride
 Fluoxymesterone
 Flupentixol
 Flurothyl
 Hepronicate
 Nimorazole
 Timolol maleate
 Tinidazole
 5-(3-Toluene-p-sulfonyloxypropyl)di-
 benzazepine
 Opipramol
 o-Toluidine
 Methaqualone
 Metoclopramide HCl
 Metolazone
 Prilocaine HCl
 Tolonium chloride
 p-Toluyil chloride
 Mexenone
 Tolmetin

- Tosyl chloride
 Sultosilic acid piperazine salt
 1-(2,3,5-Tri-O-acetyl- β -arabino-
 furanosyl)uracil
 Cytarabine HCl
 Triamcinolone
 Triamcinolone acetonide
 2,4,5-Triamino-6-hydroxypyrimidine
 HCl
 Folic acid
 Trichloroacetic acid
 Emylcamate
 1,3,3-Trichloroacetone
 Folic acid
 Trichloroethanol
 Triclofos sodium
 Trichloroethylene
 Formocortical acetate
 2,4,5-Trichlorophenol
 Hexachlorophenol
 2,4,5-Trichlorophenyl propargyl ether
 Haloprogin
 2,4,6-Trichloropyrimidine
 Minoxidil
 Tricholine citrate
 Ferrocholinatate
 1,2,4-Triethoxybenzene
 Trepibutone
 Triethylamine
 Apalcillin sodium
 Apazone
 Azidocillin
 Carbenicillin indanyl sodium
 Chlorpropamide
 Cryptenamine tannates
 Cyclophosphamide
 Dexamethasone phosphate
 Dilazep HCl
 Fenoxedil
 Ifosfamide
 Pifarnine
 Trofosfanide
 Triethylorthoacetate
 Alprazolam
 Triethylorthoformate
 Allopurinol
 Triethylphosphine
 Auranoftin
 Trifluoroacetic acid
 Captopril
 Cefoxitin sodium
 1,1,1-Trifluoro-2-chloroethane
 Halothane
 2,2,2-Trifluoroethanol
 Flurothyl
 Fluorexene
 2,2,2-Trifluoroethyl-2,5-bis(2,2,2-tri-
 fluoroethoxy)benzoate
 Flecaïnide
 Trifluoroethyl iodide
 Halazepam
 Polythiazide
 o-Trifluoromethylaniline
 Floctafenine
 m-Trifluoromethylaniline
 Flumethiazide
 Niflumic acid
 2-(3'-Trifluoromethylanilino)nicotinic
 acid
 Talniflumate
 2-Trifluoromethylphenothiazine
 Fluphenazine HCl
 Oxaflumazine disuccinate
 Trifluoperazine
 Triflupromazine
 3-Trifluoromethyl-phenothiazine
 Homofenazine
 N-3-Trifluoromethylphenyl-
 anthranilic acid
 Etofenamate
 1-(m-Trifluoromethylphenyl)-2-(β -hy-
 droxyethyl)amino propane
 Benfluorex hydrochloride
 (3-Trifluoromethyl)phenylmagnesium
 bromide
 Oxaflozane HCl
 2-(4'-m-Trifluoromethylphenyl-piper-
 azino) ethanol
 Antrafenine
 α,α,α -Trifluoro-m-toluidine
 Bendroflumethiazide
 Hydroflumethiazide
 2-Trifluoromethyl-9-xanthenone
 Flupentixol
 Triglycollamic acid
 Bismuth sodium triglycollamate
 11 β ,17 α ,21-Trihydroxy-6,16 α -dimethyl-
 4,6-pregnadiene-3,20-dione
 Cortivazol
 5 α ,11 β ,17 α -Trihydroxy-6 β -fluoro-21-
 acetoxyallopregnane-3,20-dione-3-
 ethylene ketal
 Fluprednisolone
 2,4,6-Triido-3-aminobenzoic acid
 lodipamide
 loglycamic acid
 3,4,5-Trimethoxy benzaldehyde
 Trimethoprim
 1,3,5-Trimethoxybenzene
 Buflomedil
 3,4,5-Trimethoxybenzoic acid
 Pirozadil
 3,4,5-Trimethoxybenzoic acid chloride
 Dilazep HCl
 Hexobendine
 3,4,5-Trimethoxybenzoyl chloride
 Trimethobenzamide HCl
 Trimetozine

- 2,3,4-Trimethoxybenzyl chloride
 Trimetazidine
 3,4,5-Trimethoxycinnamic acid
 Rescinamine
 3,4,5-Trimethoxycinnamoyl chloride
 Cinepazet maleate
 Trimethylamine
 Carnitine
 Choline dihydrogen citrate
 6,6,9-Trimethyl-9-azabicyclo[3.3.1]-
 nonan-3 α -ol
 Mazaticol HCl
 Trimethylchlorosilane
 Dinoprostone
 3,3,5-Trimethylcyclohexanol
 Cyclandelate
 trans-3,3,5-Trimethylcyclohexanol
 Ciclonicate
 4-(2,6,6-Trimethyl-1-cyclohex-1-yl)-
 2-methyl-2-buten-1-ol
 β -Carotene
 Trimethylene bromide
 Ethoheptazine
 Trimethylene chlorobromide
 Carphenazine maleate
 Trimethylethoxysilane
 Dimethicone
 Simethicone
 Trimethylphosphite
 Vincamine
 Trimethylsilylacetamide (mono)
 Cefamandole nafate sodium salt
 Trimethylsilyl-6-aminopenicillinate
 Mecillinam
 Trimethylsilyl chloride
 Piperacillin sodium
 3,6,9-Trioxaundecane diacid dichloride
 Iotroxic acid
 Trioxymethylene
 Eprazinone HCl
 Eprozinol
 Niaprazine
 Triphenylphosphine
 Clindamycin HCl
 Doxepin HCl
 Triphenylphosphine hydrobromide
 Tretinoin
 Tris(hydroxymethyl)aminomethane
 Dinoprost tromethamine
 Tris-p-methoxyphenyl ethylene
 Chlorotrianisene
 Trityl chloride
 Ancitabine HCl
 N-Tritylglutamic acid alkyl ester
 Oxytocin
 Tropine
 Anistropine methylbromide
 Benztropine mesylate
 L-Tyrosine
 Bentiromide
 L-Tyrosine alkyl ester
 Oxytocin
 Trypsin
 Interferon
 L-Tryptophanyl-L-methionyl-L-aspartyl-
 L-phenyaline amide trifluoro-
 acetate
 Pentagastrin
 Urea
 Dipyridamole
 Ethotoin
 Heptabarbitol
 Mephenoaxalone
 Metaxalone
 Paramethadione
 Pentobarbitol sodium
 Trimethadione
 Vinbarbitol sodium
 Urethane
 Proquazone
 Tybamate
 Uridine
 Ancitabine HCl
 Valeric acid chloride
 Diflucortolone valerate
 n-Valeric anhydride
 Estradiol valerate
 Vanillin
 Carbidopa
 Vanillinic acid
 Ethamivan
 Veratryl cyanide
 Verapamil
 Vinblastine
 Vindesine
 Vincadiformine
 Vincamine
 Vitamin B₁₂
 Hydroxocobalamin
 Xanthene-9-carboxylic acid
 Propantheline bromide
 Xylene
 Aminobenzoic acid
 3,4-Xylenol
 Xibornol
 m-5-Xylenol
 4-Chloro-3,5-xylenol
 2,6-Xylidine
 Etidocaine HCl
 Lidocaine
 3-(2,5-Xylyloxy)propyl bromide
 Gemfibrozil

Zinc

Bupivacaine
Cephalexin
Cyclobutylol
Mopidamol
Sulfameter
Thiabendazole
Tolonium chloride

Zinc chloride

Clofoctol
Insulin zinc suspension
Tolonium chloride
Zinc-copper couple
Fosfomycin
Zinc insulin
Insulin isophane

Trade Name Index

Each trade name listed below is followed by the generic name of the pharmaceutical to which it pertains.

Acidexam - Dexamethasone phosphate
Aarane - Cromolyn sodium
AAS - Aspirin
Abacil - Chlorhexidine
Abapresin - Guanethidine sulfate
Abbotcillin - Penicillin G procaine
Abbofinase - Urokinase
Abbokinase - Urokinase
Abboticine - Erythromycin stearate
Abbutol - Ethambutol HCl
Abcid - Sulfadimethoxine
Abedine - Carnitine
Abeformin T - Tolbutamide
Abehol - Chlophedianol
Abemide - Chlorpropamide
Aberel - Tretinoin
Abesta - Reserpine
Abetol - Labetalol HCl
Abilit - Sulfpiride
Abiocrine - Dihydrostreptomycin sulfate
Abirol - Methandrostenolone
Abitrexate - Methotrexate
Abminthic - Dithiazanine iodide
Abomacetin - Erythromycin
Aboren - Midecamycin
Abovis - Aclatium napsidylate
AB-PC - Ampicillin trihydrate
Abricycline - Tetracycline
Abrol - Acetaminophen
Abrolet - Acetaminophen
Abronquil - Fenspiride
Absentol - Trimethadione
Abstenil - Disulfiram
Abstynil - Disulfiram
Acamol - Acetaminophen
Acantex - Ceftriaxone sodium
Acaporina - Cephaloridine
Acaxina - Cephalixin
Accenon - Ethotoin
Accent - Furosemide
Accu-Tap - Acetaminophen
Ace - Methscopolamine bromide
Acecor - Acebutolol
Acef - Cefazolin sodium
Acelat - Spirinolactone
Ace-Line - Iopanoic acid
Acemin - Chlorpromazine HCl
Acenol - Nicomol
Acephen - Acetaminophen
Acerum - Pivampicillin
Acesal - Aspirin
Acetalax - Oxyphenisatin acetate
Acetalgin - Acetaminophen
Acetamide - Acetazolamide
Acetamax - Acetazolamide
Acetanol - Acebutolol
Acetard - Aspirin
Acetazolam - Acetazolamide
Acetazolamide chibret - Acetazolamide
Acetein - Acetyl cysteine
Aceterol forte - Nimorazole
Acetical - Aspirin
Acetisal - Aspirin
Acetisone - Cortisone acetate
Acetophen - Aspirin
Acetospa - Triamcinolone acetonide
Acetylin - Aspirin
Acetylo - Aspirin
Acetylsal - Aspirin
Acetyl-Sal - Aspirin
Acetysal - Aspirin
Acfol - Folic acid
Achletin - Trichlormethiazide
Achromycin - Tetracycline
Acibilin - Cimetide
Acidex - Ranitidine
Acignost - Pentagastrin
Acikaprin - Aminocaproic acid
Acillin - Ampicillin trihydrate
Aciloc - Cimetide
Acimention - Methionine
Acimetten - Aspirin
Acimexan - Hydroxocobalamin
Acinipan - Cephalixin
Acisal - Aspirin
Aclacinomycline - Aclarubicin
Aclacinon - Aclarubicin
Acelyse - Tretinoin
Acnestrol - Diethylstilbestrol
Acodeen - Butamirate citrate
Acodfen - Butamirate citrate
Acrizal - Phenyl butazone
Actaciclina - Demeclocycline HCl
Actamin - Acetaminophen
Actamin - Cyanocobalamin
Actasal - Choline salicylate
Actase - Fibrinolysin
Actiderm - Desoximetasone
Actidil - Triprolidine
Actidilon - Triprolidine

Actifed - Triprolidine
 Actiphyll - Triprolidine
 Actin-N - Nitrofurazone
 Actinophyl - Naphazoline
 Actithiol - Carbocysteine
 Activin - Nandrolone phenpropionate
 Actocortin - Hydrocortisone sodium phosphate
 Actol - Niflumic acid
 Actosolv - Urokinase
 Actrapid - Insulin
 Actuapen - Metampicillin sodium
 Acucillin - Ampicillin
 Acucillin - Cloxacillin
 ACU-Dyne - Povidone-iodine
 Acupan - Nefopam HCl
 Acutrim - Phenylpropanolamine HCl
 Acylanid - Acetyldigitoxin
 Acylanide - Acetyldigitoxin
 Acylanil - Acetyldigitoxin
 Acyclin - Cyclandelate
 Acygoxine - Acetyldigitoxin
 Aczen NS - Isothipendyl HCl
 Adalat - Nifedipine
 Adalate - Nifedipine
 Adalpur - Glafenine
 Adamycin - Erythromycin
 Adanon - Methadone HCl
 Adapin - Doxepin HCl
 Adasone - Prednisone
 Adcortin - Halcinonide
 Adcortyl - Triamcinolone acetonide
 Addex-Tham - Tromethamine
 Adebit - Bufornin HCl
 Adefuronic - Diclofenac sodium
 Adelir - Piroimidic acid
 Adelir - Ubidecarenone
 Ademol - Flumethiazide
 Adenock - Allopurinol
 Adepress - Amitriptyline HCl
 Adeprel - Amitriptyline HCl
 Adestan - Isoconazole nitrate
 Adiaben - Chlorpropamide
 Adiabetin - Phenformin
 Adiazin - Sulfadiazine
 Adiazine - Sulfadiazine
 Adiparthrol - Dextroamphetamine sulfate
 Adipex-P - Phentermine HCl
 Adipo II - Phendimetrazine tartrate
 Adiposan - Diethylpropion HCl
 Adipost - Phendimetrazine tartrate
 Adiro - Aspirin
 Adiuretin - Desmopressin
 Adisolone - Prednisolone
 Adobacillin - Ampicillin
 Adobiol - Bufetrol
 Adoisine - Warfarin sodium
 Adolan - Methadone HCl
 Adomal - Diflunisal
 Adopal - Methyl dopa
 Adphen - Phendimetrazine tartrate
 Adramycin - Methacycline
 Adrenoxyl - Carbazochrome
 Adrenosem - Carbazochrome
 Adrestat - Carbazochrome
 Adrevil - Butalamine HCl
 Adriacin - Doxorubicin
 Adriamycin - Doxorubicin
 Adrianol - Phenylephrine HCl
 Adriblastina - Doxorubicin
 Adriblastine - Doxorubicin
 Adrucil - Fluorouracil
 Adumbran - Oxazepam
 Adventan - Fursultiamine
 Adversuten - Prazosin
 Advil - Ibuprofen
 Aero Bid - Flunisolide
 Aeropax - Dimethicone
 Aeroseb - Hydrocortisone
 Aerosporin - Polymyxin
 Aerrane - Enflurane
 Aerrane - Isoflurane
 Aerugipen - Ticarcillin disodium
 Aethroma - Vincamine
 AFI-FtalyI - Phthalylsulfathiazole
 Afimocil - Ethambutol HCl
 AFI-Phyllin - Dyphylline
 Afiodac - Sulindac
 Aflorix - Miconazole nitrate
 Afloxan - Proglumetacin maleate
 Afluteston - Fluoxymesterone
 Afrin - Oxymetazoline HCl
 Aftate - Tolnaftate
 Afungyl - Chlorquinaldol
 Agalacto-Quilea - Quinestrol
 Agaldog - Dienestrol
 Agapurin - Pentoxifylline
 Agasten - Clemastine fumarate
 Agedal - Noxiptilin
 Ageroplas - Ditzazol
 Agerpen - Amoxicillin
 Agilase - Dipyridamole
 Aglicem - Tolbutamide
 Aglumin - Ethamsylate
 Aglycid - Tolbutamide
 Agostlben - Diethylstilbestrol
 Agozol - Prenylamine
 Agradil - Verapride
 A-Gram - Amoxicillin
 Agreeal - Verapride
 Agrippol - Dextromethorphan hydrobromide
 Ahiston - Chlorpheniramine maleate
 Ahoit - Chenodiol
 AHP - 2000 - Oxaceprol
 Aicamin - Orazamide
 Aicamine - Orazamide
 Aicurat - Orazamide
 Airbron - Acetylcysteine
 Airol - Tretinoin
 Airolactone - Spironolactone
 Airum - Fenoterol hydrobromide
 Aiselazine - Hydralazine HCl
 Aisemide - Furosemide
 Aitruran - Trichlormethiazide
 Ajan - Nefopam HCl
 Akatinol - Memantine
 Akineton HCl - Biperiden
 Akinophyl - Biperiden
 Akiten - Benztropine mesylate
 Aknemycin - Erythromycin
 Aknoten - Tretinoin
 Ala-Cort - Hydrocortisone
 Alagyl - Clemastine fumarate
 Alamon - Hydroxyzine HCl
 Alarzin - Tolnaftate
 Alaspan - Chlorpheniramine maleate
 Alaspine - Aspirin
 Alaton - Citicoline
 Alaxa - Biscodyl
 Albacort - Triamcinolone
 Albalon - Naphazoline

Albamycin - Novobiocin
 Albatussin - Dextromethorphan hydrobromide
 Albatussin - Pyrilamine
 Albego - Camazepam
 Albiocin - Novobiocin
 Albiotic - Lincomycin
 Albipen - Ampicillin
 Albon - Sulfadimethoxine
 Albox - Acetazolamide
 Albyl - Aspirin
 Alcaphor - Tromethamine
 Alcopar - Bephenium hydroxynaphthoate
 Alcopara - Bephenium hydroxynaphthoate
 Aldactazide - Hydrochlorothiazide
 Aldactazide - Spironolactone
 Aldactone - Canrenoate potassium
 Aldactone - Spironolactone
 Aldatense - Canrenoate potassium
 Aldatense - Rescinnamine
 Aldesin - Beclomethasone dipropionate
 Aldinamide - Pyrazinamide
 Aldoclor - Chlorothiazide
 Aldocumar - Warfarin sodium
 Aldolor - Acetaminophen
 Aldomet - Methylodopa
 Aldometil - Methylodopa
 Aldomin - Methylodopa
 Aldopur - Spironolactone
 Aldoril - Hydrochlorothiazide
 Aldoril - Methylodopa
 Aldospirone - Spironolactone
 Alene - Epimestrol
 Alercrom - Cromolyn sodium
 Alermine - Chlorpheniramine maleate
 Aleryl - Diphenhydramine HCl
 Aletor - Bromhexine
 Aleudrin - Isoproterenol sulfate
 Alevaire - Tyloxapal
 Aleviatin - Phenytoin
 Alexan - Cytarabine HCl
 Alexan - Spironolactone
 Alfabios - Fluocinolone acetonide
 Alfadat - Nifedipine
 Alfadion - Alfaxalone
 Alfa-Fluorone - Fludrocortisone acetate
 Alfames E - Ethynodiol diacetate
 Alfamox - Amoxicillin
 Alfananidrone - Fludrocortisone acetate
 Alfaryl - Alfalcidol
 Alfasilin - Ampicillin
 Alfathesin - Alfaxalone
 Alfatil - Cefaclor
 Alfavinca - Vincamine
 Alfida - Amoxicillin
 Alfimid - Glutethimide
 Alfiorone acetate - Fludrocortisone acetate
 Alfone - Alkofanone
 Alfospas - Tiropramide
 Alfoxil - Amoxicillin
 Alfuran - Nitrofurantoin
 Algeril - Propiram fumarate
 Algicortis - Hydrocortisone
 Algil - Meperidine HCl
 Algo - Aspirin
 Algocetil - Sulindac
 Algofen - Ibuprofen
 Algometacin - Indomethacin
 Alimezine - Trimeprazine
 Alinam - Chlormezanone
 Alinamin F - Fursultiamine
 Aliporina - Cephaloridine
 Aliseum - Diazepam
 Alius - Fonazine mesylate
 Alival - Nomifensine maleate
 Alkabutazona - Phenyl butazone
 Alka-Seltzer - Aspirin
 Alkeran - Melphalan
 Alledryl - Diphenhydramine HCl
 Allerbid - Chlorpheniramine maleate
 Allercur - Clemizole
 Alledryl - Diphenhydramine HCl
 Allerest - Methapyrilene HCl
 Allergan - Diphenhydramine HCl
 Allergan - Pyrilamine
 Allergefon - Carbinoxamine maleate
 Allergex - Chlorpheniramine maleate
 Allergin - Chlorpheniramine maleate
 Allergin - Diphenhydramine HCl
 Allergin - Methapyrilene HCl
 Allergina - Diphenhydramine HCl
 Allergisan - Chlorpheniramine maleate
 Allergon - Nortriptyline
 Allerpant - Clemizole
 Allersan - Chlorpheniramine maleate
 Allersone - Hydrocortisone
 Allertab - Chlorpheniramine maleate
 Allerton - Chlorpheniramine maleate
 Allerzin - Diphenylpyralline HCl
 Alloferin - Alcuronium chloride
 Alloferine - Alcuronium chloride
 Allomaron - Allopurinol
 Allomaron - Benzbromarone
 Allopin - Allopurinol
 Alloprim - Allopurinol
 Alloprin - Allopurinol
 Allopur - Allopurinol
 Allopur - Allopurinol
 Allopopydin - Alcofenac
 Allorin - Allopurinol
 Allozym - Allopurinol
 Allural - Allopurinol
 Allurit - Allopurinol
 Almatol - Spironolactone
 Almopen - Ampicillin
 Aloc - Allopurinol
 Alodan - Meperidine HCl
 Aloginan - Clemastine fumarate
 Alositol - Allopurinol
 Alotec - Metaproterenol sulfate
 Alpamed - Spironolactone
 Alpen - Ampicillin
 Alpen - Ampicillin trihydrate
 Alpen - Phenethicillin potassium
 Alphacortison - Hydrocortisone
 Alphaderm - Hydrocortisone
 Alphadrol - Fluprednisolone
 Alphamex - Methylodopa
 Alphamin - Clemastine fumarate
 Alphamine - Midodrine
 Alpha-Redisol - Hydroxocobalamin
 Alplatrex - Betamethasone dipropionate
 Alphpress - Hydralazine HCl
 Alpiny - Acetaminophen
 Alpolasnon - Spironolactone
 Airheumat - Ketoprofen
 Airheumin - Ketoprofen
 Alirin - Oxymetazoline HCl
 Altabactina - Furaltadone
 Altacel - Cefuroxime

Altafur - Furaltadone
 Altex - Spiroinolactone
 Althesin - Alfaxalone
 Altilev - Nortriptyline
 Altim - Cortivazol
 Altocillin - Phenethicillin potassium
 Altodor - Ethamsylate
 Alto-Pred - Prednisolone acetate
 Alto-Pred - Prednisolone phosphate sodium
 Alto-Pred - Prednisone
 Altramet - Cimetide
 Aludrin - Isoproterenol sulfate
 Alunitine - Aluminum nicotinate
 Alupent - Metaproterenol sulfate
 Alvadermo - Fluocinolone acetonide
 Alvedon - Acetaminophen
 Alven - Tribenoside
 Alyrane - Enflurane
 Am-73 - Amoxicillin
 Amalmare - Dimenhydrinate
 Amantadin - Amantidine HCl
 Amantan - Amantidine HCl
 Amavil - Amitriptyline HCl
 Amazolon - Amantidine HCl
 Ambacamp - Bacampicillin
 Ambal - Cephalixin
 Ambaxin - Bacampicillin
 Ambenyl - Guaifenesin
 Ambenyl-D - Dextromethorphan hydrobromide
 Ambin - Aminobenzoic acid
 Ambivalon - Amitriptylin oxide
 Ambloclorin - Chlorambucil
 Amblosen - Ampicillin
 Amblosin - Ampicillin trihydrate
 Amboken - Chloramphenicol
 Ambra-Vena - Mepicycline
 Ambrunate - Metiazinic acid
 Amccacid - Tranexamic acid
 Amcap - Ampicillin trihydrate
 Amchafibrin - Tranexamic acid
 Amcill - Ampicillin
 Amcill - Ampicillin trihydrate
 Amcinonid - Amcinonide
 Amdil - Acetaminophen
 Amedel - Pipobroman
 Amelizol - Tubocurarine chloride
 Amen - Medroxyprogesterone acetate
 Amepromamat - Meprobamate
 A-Methapred - Methylprednisolone
 Ametik - Trimethobenzamide HCl
 Ametil - Dicyclomine HCl
 Ametycine - Mitomycin
 Amfe-Dyn - Dextroamphetamine sulfate
 Amfeta - Pyrilamine
 d-Amfetasul - Dextroamphetamine sulfate
 Amfipen - Ampicillin
 Ami-Anelun - Amitriptyline HCl
 Amicar - Aminocaproic acid
 Amidate - Etomidate HCl
 Amidoline - Etomidoline
 Amidonal - Aprindine HCl
 Amidoxal - Sulfisoxazole
 Amifur - Nitrofurazone
 Amiglyde-V - Amikacin
 Amikapron - Tranexamic acid
 Amikin - Amikacin
 Amilent - Amitriptyline HCl
 Aminacyl - Aminosalicilic acid
 Amino-Ceru - Inositol
 Aminofen - Acetaminophen
 Amino-Plex - Methionine
 Amino-Serv - Methionine
 Aminosidine - Paromomycin
 Aminoxidin - Paromomycin
 Amiodacore - Amiodarone HCl
 Amipenix - Ampicillin
 Amiprin - Amitriptyline HCl
 Amiprol - Diazepam
 Amiptanol - Amitriptyline HCl
 Amisin - Amikacin
 Amitid - Amitriptyline HCl
 Amitril - Amitriptyline HCl
 Amitrip - Amitriptyline HCl
 Amitriptol - Amitriptyline HCl
 Amixyl - Tiocarbide
 Ammonil - Methionine
 Amocilline - Amoxicillin
 Amoclen - Amoxicillin
 Amodex - Amoxicillin
 Amo-Flamisan - Amoxicillin
 Amoglandin - Dinoprost tromethamine
 Amoksilin - Amoxicillin
 Amoksina - Amoxicillin
 Amolin - Amoxicillin
 Amorion - Amoxicillin
 Amosene - Meprobamate
 Amosin - Amoxicillin
 Amosyt - Dimenhydrinate
 Amotril - Clofibrate
 Amox - Amoxicillin
 Amoxamil - Amoxicillin
 Amoxan - Amoxapine
 Amoxaren - Amoxicillin
 Amoxi-Basileos - Amoxicillin
 Amoxibiotic - Amoxicillin
 Amoxicil - Amoxicillin
 Amoxidal - Amoxicillin
 Amoxidin - Amoxicillin
 Amoxi-Gobens - Amoxicillin
 Amoxil - Amoxicillin
 Amoxillin - Amoxicillin
 Amoximedical - Amoxicillin
 Amoxipen - Amoxicillin
 Amoxipenil - Amoxicillin
 Amoxiroger - Amoxicillin
 Amoxi-Tabs - Amoxicillin
 Amoxyphen - Amoxicillin
 Ampen - Ampicillin
 Ampensaar - Ampicillin
 Amperil - Ampicillin trihydrate
 Ampexin - Ampicillin trihydrate
 Amphasub - Phendimetrazine tartrate
 Amphate - Amphetamine phosphate
 Amphibeta - Ampicillin
 Amphicol - Chloramphenicol
 Amphocortin CR - Amphomycin calcium
 Amphocycline - Amphotericin B
 Amphodyn - Etilefrine pivalate HCl
 Ampho-Moronal - Amphotericin B
 Amphozone - Amphotericin B
 Ampibiotic - Ampicillin
 Ampical - Ampicillin trihydrate
 Ampichelle - Ampicillin trihydrate
 Ampicil - Ampicillin
 Ampicil - Ampicillin trihydrate
 Ampicillina pharma - Ampicillin
 Ampicillina pierrel - Ampicillin
 Ampiciman - Ampicillin trihydrate
 Ampicina - Ampicillin
 Ampiclox - Cloxacillin

Ampico - Ampicillin trihydrate
 Ampicyn - Ampicillin
 Ampifar - Ampicillin trihydrate
 Ampifen - Ampicillin
 Ampikel - Ampicillin
 Ampikel - Ampicillin trihydrate
 Ampilag - Ampicillin trihydrate
 Ampilan - Ampicillin
 Ampiland - Ampicillin
 Ampileta - Ampicillin trihydrate
 Ampilisa - Ampicillin
 Ampilux - Ampicillin
 Ampimed - Ampicillin
 Ampinebiot - Ampicillin
 Ampinova - Ampicillin
 Ampino xi - Ampicillin
 Ampin-Penicillin - Penicillin G procaine
 Ampiofen - Ampicillin
 Ampio-Oral - Ampicillin trihydrate
 Ampiorus - Ampicillin trihydrate
 Ampio-Plena Simple - Ampicillin
 Ampiscel - Ampicillin trihydrate
 Ampisil - Ampicillin
 Ampisina - Ampicillin
 Ampisint - Ampicillin
 Ampio-Tabliten - Ampicillin
 Ampitex - Ampicillin
 Ampivax - Ampicillin
 Ampixyl - Ampicillin
 Ampixyl - Ampicillin trihydrate
 Ampio-Zoja - Ampicillin trihydrate
 Ampilenil - Ampicillin
 Ampilibios - Ampicillin
 Amplicefal - Cephalixin
 Amplicerina - Cephaloridine
 Amplicid - Ampicillin
 Ampigram - Cephalixin
 Ampigram - Cephaloridine
 Ampimox - Amoxicillin
 Ampilin - Ampicillin trihydrate
 Ampipen - Ampicillin
 Ampipenyl - Ampicillin
 Ampiprats - Metampicillin sodium
 Ampiscocil - Ampicillin
 Ampisom - Ampicillin
 Ampilata - Ampicillin
 Ampium - Tinidazole
 Ampizer - Ampicillin
 Ampio-Penyl - Amoxicillin
 Amsusatain - Dextroamphetamine sulfate
 Amuno - Indomethacin
 Amynoral - Cinnarizine
 Anabactyl - Carbenicillin disodium
 Anabloc - Phenyramidol
 Anabolex - Stanolone
 Anabolin - Methandrostenolone
 Anacobin - Cyanocobalamin
 Anaerobex - Metronidazole
 Anafion - Acetaminophen
 Anafranil - Clomipramine
 Anahist - Thonzylamine HCl
 Analexin - Phenyramidol
 Analock - Epirizole
 Analogue - Menadiol sodium phosphate
 Analpram - Pramoxine HCl
 Analud - Feprazone
 Anan - Bisacodyl
 Ananase - Bromelain
 Ananda - Metoclopramide HCl
 Anaphyl - Chlorpheniramine maleate
 Anaprel - Rescinnamine
 Anaprotin - Stanolone
 Anarel - Guanadrel sulfate
 Anarexol - Cyproheptadine
 Anaroxyl - Carbazochrome
 Anasclero - Vincamine
 Anaspasmin - Hydralazine HCl
 Anaspat - Cyclandelate
 Anasten - Antazoline HCl
 Anasynth - Stanozolol
 Anatensol - Fluphenazine HCl
 Anatron - Trichlormethiazide
 Anatrophyll - Oxandrolone
 Anaus - Trimethobenzamide HCl
 Anavar - Oxandrolone
 Anayok - Chlophedianol
 Ancasal - Aspirin
 Ancef - Cefazolin sodium
 Anceron - Beclomethasone dipropionate
 Ancobon - Flucytosine
 Ancolan - Meclizine HCl
 Ancosul - Sulfadimethoxine
 Ancotil - Flucytosine
 Andantol - Isothipendyl HCl
 Andanton - Isothipendyl HCl
 Andapsin - Sucralfate
 Andere - Bufornin HCl
 Andergin - Miconazole nitrate
 Anderm - Bufexamac
 Andes - Citalopram
 Andiamine - Hexobendine
 Andran - Ibuprofen
 Androcur - Cyproterone acetate
 Andro-Cyp - Testosterone 17 β -Cypionate
 Androgeron - Xanthinol niacinate
 Android-F - Fluoxymesterone
 Android-S - Methyltestosterone
 Androlone - Stanolone
 Andronate - Testosterone 17 β -Cypionate
 Androsterolo - Fluoxymesterone
 Androtardyl - Testosterone enanthate
 Andrumin - Dimenhydrinate
 Andryl - Testosterone enanthate
 Anecotan - Methoxyflurane
 Anemisol - Hydroxocobalamin
 Anemixin - Benoxinate hydrochloride
 Anergomycil - Rolitetracycline
 Anestacain - Lidocaine
 Anestacon - Lidocaine
 Anestecidan - Lidocaine
 Aneural - Meprobamate
 Anexate - Mefenorex HCl
 Anfamon - Diethylpropion
 Anflagen - Ibuprofen
 Angilol - Propranolol HCl
 Anginal - Dipyridamol
 Anginin - Lidoflazine
 Anginin - Pyridinol carbamate
 Angioamin - Xanthinol niacinate
 Angio-Conray - Iothalate meglumine
 Angiomiron - Iodamide
 Angiotrofin - Ifenprodil tartrate
 Angiovigor - Prenylamine
 Angio vital - Pyridinol carbamate
 Angioxil - Pyridinol carbamate
 Angioxine - Pyridinol carbamate
 Angiperl - Pyridinol carbamate
 Angopril - Bepridil
 Angorsan - Prenylamine
 Anhiba - Acetaminophen

Anhistamin - Tripeleennamine
 Anhistan - Clemastine fumarate
 Anhydron - Cyclothiazide
 Anhyphen - Ampicillin
 Anidropen - Ampicillin
 Anifed - Nifedipine
 Animing - Chlorpheniramine maleate
 Anisene - Chlorotrianisene
 Anistadin - Trichlormethiazide
 Anistine - Antazoline HCl
 Ankebin - Fenofibrate
 Anksiyolin - Diazepam
 Annarizine - Cinnarizine
 Annolytin - Amitriptyline HCl
 Anoprocin - Allopurinol
 Anoredan - Methandrostenolone
 Anorex - Phenmetrazine
 Anoxine T - Phendimetrazine tartrate
 Anquil - Benperidol
 Anсадol - Salicylanilide
 Ansaid - Flurbiprofen
 Ansietan - Meprobamate
 Ansietin - Ketazolam
 Ansiolin - Diazepam
 Ansiolisina - Diazepam
 Ansiopax - Dibenzeplin HCl
 Ansiowas - Meprobamate
 Anspor - Cephradine
 Ansumin - Diphenidol
 Antabus - Disulfiram
 Antabase - Disulfiram
 Antabase D - Disulfiram
 Antacin - Chloramphenicol
 Antadine - Amantidine HCl
 Antagonate - Chlorpheniramine maleate
 Antalvic - Propoxyphene HCl
 Antamine - Tripeleennamine
 Antamon P.E.D. - Methionine
 Antazone - Sulfinyprazone
 Anteben - Isoniazid
 Antegan - Cyproheptadine
 Antelepsin - Clonazepam
 Antemin - Dimenhydrinate
 Antepsin - Sucralfate
 Anthisan - Pyrilamine
 Anthistamin-Sigletten - Chlorpheniramine maleate
 Antiagor - Chromonar HCl
 Antial - Brompheniramine maleate
 Antiallergicum Medivet - Tripeleennamine
 Anticatabolin - Nandrolone phenpropionate
 Anticen - Cyclandelate
 Anticyl - Ampicillin
 Antidol - Aspirin
 Antidrazi - Dichlorphenamide
 Anti-Em - Dimenhydrinate
 Antietil - Disulfiram
 Antigeron - Cinnarizine
 Antigot - Allopurinol
 Anti-H 10 - Diphenylpyraline HCl
 Antime - Pentaerythritol tetranitrate
 Antimeran - Pemoline
 Antiminth - Pyrantel pamoate
 Antinal - Diphenylpyraline HCl
 Antinal - Nifuroxazide
 Anti-Naus - Prochlorperazine
 Antioxur - Pyrvinium pamoate
 Antipernicin - Cyanocobalamin
 Antipond - Phenformin
 Antipres - Guanethidine sulfate
 Antirex - Edrophonium chloride
 Anti-Sept - 4-Chloro-3,5-xyleneol
 Anti-Spas - Trihexyphenidyl HCl
 Antistine HCl - Antazoline HCl
 Anti-Tenia - Niclosamide
 Antitrem - Trihexyphenidyl HCl
 Antituxil - Zipeprol
 Antiul - Diphenidol
 Antivert - Meclizine HCl
 Antivitium - Disulfiram
 Anti-Vomit - Trimethobenzamide HCl
 Antivomit - Dimenhydrinate
 Antoral - Tibezonium iodide
 Antoxol - Dimercaprol
 Antriptin - Clemastine fumarate
 Anturan - Sulfinyprazone
 Anturane - Sulfinyprazone
 Anuphen - Acetaminophen
 Anusol - Pramoxine HCl
 Anuspiramin - Phenylbutazone
 Anvital - Ethambutol HCl
 Anvitoff - Tranexamic acid
 Anxidin - Clorazepate dipotassium
 Anxiolit - Oxazepam
 Anxium-6 - Diazepam
 Anxon - Ketazolam
 Anzepam - Diazepam
 Anzief - Allopurinol
 APA/Aparacet - Acetaminophen
 Apamide - Acetaminophen
 Aparkan - Trihexyphenidyl HCl
 Aparkane - Trihexyphenidyl HCl
 Apaurin - Diazepam
 Apavit B 12 - Cyanocobalamin
 Apegmone - Tiocloamarol
 A-Pen - Ampicillin
 Apernyl - Aspirin
 Apifor - Moxisylyte
 Apihepar - Silymarin
 Apiretal - Acetaminophen
 Apirogen - Chlorthenoxazine
 Apiroserum - Tromethamine
 Apitart - Amoxicillin
 Aplactan - Cinnarizine
 Aplakil - Oxazepam
 Apalex - Cinnarizine
 Apliopenil - Metampicillin sodium
 Apllobal - Alprenolol HCl
 Aplodan - Creatinolfosfate
 Apocercin - Proscillaridin
 Apodol tabs - Anileridine dihydrochloride
 Apodorm - Nitrazepam
 Apogen - Gentamicin sulfate
 Apokalin - Neomycin
 Apolar - Desonide
 Apolon - Rescinnamine
 Apomiterl - Cinnarizine
 Aponal - Doxepin HCl
 Aponorin - Trichlormethiazide
 Apopant - Propantheline bromide
 Aporasnon - Spironolactone
 Aporecin - Rescinnamine
 Aporesin - Rescinnamine
 Aposelebin - Cyclandelate
 Apotension - Rescinnamine
 Apoterin - Rescinnamine
 Apoterin A - Clofibrate
 Apotomin - Cinnarizine
 A-Po xide - Chlordiazepoxide HCl
 Apozepam - Diazepam
 Appedrine - Phenylpropanolamine HCl

Aprednislon - Prednisolone
 Aprelazine - Hydralazine HCl
 Apresazide - Hydralazine HCl
 Apresazide - Hydrochlorothiazide
 Apresoline - Hydrochlorothiazide
 Apresoline HCl - Hydralazine HCl
 Apriclina - Methacycline
 Aprinol - Allopurinol
 Aprinox - Bendroflumethiazide
 Aprobal - Alprenolol HCl
 Apsatan - Cinnarizine
 Aptin - Alprenolol HCl
 Aptina - Alprenolol HCl
 Aptine - Alprenolol HCl
 Aptol - Alprenolol HCl
 Aptol-Duriles - Alprenolol HCl
 Apurin - Allopurinol
 Apuro - Allopurinol
 Apurone - Flumequine
 Apyrectol Spiramycine - Spiramycin
 Apyron - Aspirin
 Aquacaine - Penicillin G Procaine
 Aquadon - Chlorhalidone
 Aqualon - Methaqualone
 Aquamephyton - Phytanadione
 Aquamox - Quinethazone
 Aquamycin - Chloramphenicol
 Aquaphor - Xipamid
 Aquaphoril - Xipamid
 Aquastat - Benzthiazide
 Aquasuspen - Penicillin G Procaine
 Aquatag - Benzthiazide
 Aquazone - Bumetanide
 Aquicilina - Penicillin G Procaine
 Aquo-B - Hydroxocobalamin
 Aquo-Cytobion - Hydroxocobalamin
 Arabitin - Cytarabine HCl
 Aracytin - Cytarabine HCl
 Aracytine - Cytarabine HCl
 Aralen - Chloroquine phosphate
 Aramidol - Phenylramidol
 Aramine - Metaraminol
 Araminium - Metaraminol
 Araminon - Metaraminol
 Arasemide - Furosemide
 Arasol - Acetaminophen
 A.R.B. - Acetylcysteine
 Arcablock - Propranolol HCl
 Arcalion - Thiamine disulfide
 Arcanax - Hydroxyzine HCl
 Arcavit B 12 - Cyanocobalamin
 Arcental - Ketoprofen
 Archidyn - Rifampin
 Arcocillin - Ampicillin trihydrate
 Arcored - Cyanocobalamin
 Arcosterone - Methyltestosterone
 Arcotrol - Phendimetrazine tartrate
 Ardefem - Estradiol valerate
 Arderone - Testosterone enanthate
 Ardine - Amoxicillin
 Arelix - Piretanide
 Arem - Nitrazepam
 Aremans - Clorprenaline
 Areuzolin - Cefazolin sodium
 Arficin - Rifampin
 Argocillina - Ampicillin
 Argun - Indomethacin
 Arifon - Indapamide
 Arilin - Metronidazole
 Aristamid - Sulfisomidine
 Aristocort - Triamcinolone
 Aristocort - Triamcinolone diacetate
 Aristocort A - Triamcinolone acetonide
 Aristoderm - Triamcinolone acetonide
 Aristogel - Triamcinolone
 Aristogel - Triamcinolone acetonide
 Aristophyllin - Dyphylline
 Aristoserina - Cycloserine
 Arithmin - Antazoline HCl
 Arlibide - Nyldrin
 Arlidin - Nyldrin
 Arlitene - Moxisylyte
 Armazide - Isoniazid
 Armonil - Diazepam
 Arodoc-C - Chlorpropamide
 Arofuto - A floqualone
 Arphos - Cyanocobalamin
 Arpicolin - Procyclidine HCl
 Arquel - Meclofenamic acid
 Arrest - Clemastine fumarate
 Artacin - Indomethacin
 Artamin - Penicillamine
 Artane - Trihexyphenidyl HCl
 Artate - Cinnarizine
 Artogodan - Papaverine monophosadenine
 Artensen - Vincamine
 Arterioflexin - Clofibrate
 Arteriolangal - Pyridinol carbamate
 Arteriovinca - Vincamine
 Artes - Clofibrate
 Artevil - Clofibrate
 Arthrexin - Indomethacin
 Arthrochin - Chloroquine phosphate
 Arthrocin - Sulindac
 Arthropan - Choline salicylate
 Artinova - Indomethacin
 Artivia - Indomethacin
 Artofen - Ibuprofen
 Artolon - Meprobamate
 Artomey - Bromopride
 Artosin - Tolbutamide
 Artri - Chloroquine phosphate
 Artril - Ibuprofen
 Artril 300 - Ibuprofen
 Artrobace - Indomethacin
 Artrocid - Indomethacin
 Artroflog - Oxyphenbutazone
 Artropan - Phenylbutazone
 Artzone - Oxyphenbutazone
 Arubendol - Terbutaline
 Arumel - Fluorouracil
 Arumil - Amiloride HCl
 Arvynol - Ethchlorvynol
 Asahydrin - Chlormerodrin
 Asamid - Ethosuximide
 Asart - Aspirin
 Asatard - Aspirin
 Asbron G - Guaifenesin
 Ascaryl - Levamisole HCl
 Ascumar - Acenocoumarol (Acenocoumarin)
 Asdol - Aspirin
 Asecryl - Glycopyrrolate
 Asellacrin - Somatotropin
 Asendin - Amoxapine
 Aseptigel - Chlorhexidine
 Aseptilex - Sulfamethoxyppyridazine
 Aseptil-Guanadina - Sulfaguanidine
 Asey-Sulfa - Sulfamethoxyppyridazine
 Askacef - Cephhradine
 Aslapax - Oxazepam

Asmadren - Isoproterenol sulfate
 Asmaten - Rimiterol
 Asmaterol - Reprerotol
 Asmetil - Protokylol
 Asnai - Vincamine
 Asnormal - Clorprenaline
 Aspalgin - Aspirin
 A-Spas - Dicyclomine HCl
 Aspec - Aspirin
 Aspegic - Aspirin
 Aspenil - Amoxicillin
 Aspercine - Aspirin
 Aspermin - Aspirin
 Aspiquinol - Chloroquine phosphate
 Aspirtab - Aspirin
 Aspirvess - Aspirin
 Aspisol - Aspirin
 Aspro - Aspirin
 Asrivo - Aspirin
 Assival - Diazepam
 Astamasit - Dyphylline
 Asthmolysin - Dyphylline
 Asthone - Clorprenaline
 Asthoxin - Sulfadimethoxine
 Asthul - Isoproterenol sulfate
 Astmopent - Metaproterenol sulfate
 Astonin - Fludrocortisone acetate
 Astop - Metaproterenol sulfate
 Astracilina - Azidocillin
 Astrin - Aspirin
 Astroderm - Dichlorisone acetate
 Astrophyllin - Dyphylline
 Asuzol - Metronidazole
 A.T. 10 - Dihydrotestosterone
 Atalis-D - Chlorpheniramine maleate
 Atanal - Nifedipine
 Atarax - Hydroxyzine HCl
 Atarin - Amantidine HCl
 Atarzine - Promazine HCl
 Ataspin - Aspirin
 Atazina - Hydroxyzine HCl
 Ateben - Nortriptyline
 Atecen - Dihydrotestosterone
 Ateculon - Clofibrate
 Ateles - Clofibrate
 Atem - Ipratropium bromide
 Atemarol - Clofibrate
 Atempol - Nitrazepam
 Atenase - Niclosamide
 Atenezol - Acetazolamide
 Atenol - Atenolol
 Atensine - Diazepam
 Atensine - Rescinamine
 Atepodin - Adenosine triphosphate
 Aterian - Sulfaguanidine
 Aterin - Pyridinol carbamate
 Ateriosan - Clofibrate
 Aterofel - Pyridinol carbamate
 Atero-Flavin - Pyridinol carbamate
 Aterollano - Pyridinol carbamate
 Ateronova - Pyridinol carbamate
 Aterosol - Clofibrate
 Athebrate - Clofibrate
 Atherolate - Clofibrate
 Atherolip - Clofibrate
 Atheromide - Clofibrate
 Atheropront - Clofibrate
 Athrombin - Warfarin sodium
 Athymil - Mianserin
 Atilen - Choline salicylate
 Atirin - Cefazolin sodium
 Ativan - Lorazepam
 Atladiol - Estradiol valerate
 Atlansil - Amiodarone HCl
 Atlantin - Dipyrindamole
 Atlatest - Testosterone Enanthate
 Atma-Sanol - Protokylol
 Atmol - Clofibrate
 Atomol - Oxymetazoline HCl
 Atonin-O - Oxytocin
 Atonyl - Carbachol
 Atosil - Methixene HCl
 Atosil - Promethazine HCl
 Atosterine - Clofibrate
 Atover - Pyridinol carbamate
 Atraxin - Meprobamate
 Atriphos - Adenosine triphosphate
 Atrobis - Clofibrate
 Atrofort - Clofibrate
 Atrohist - Phenylephrine HCl
 Atrolen - Clofibrate
 Atromidin - Clofibrate
 Atromid-S - Clofibrate
 Atronist - Brompheniramine maleate
 Atrovent - Ipratropium bromide
 A/T/S - Erythromycin
 Atumin - Dicyclomine HCl
 Atuss - Dimethoxanate
 Audax - Choline salicylate
 Aufofac - Chlortetracycline
 Augmentan - Clavulanic acid
 Augmentin - Amoxicillin
 Augmentin - Clavulanic acid
 Auparton - Clofibrate
 Aurantex - Alfaxalone
 Aureomycin - Chlortetracycline
 Aureum - Chlortetracycline
 Aurugopin - Syrosingopine
 Ausocel - Cephalixin
 Ausomina - Vincamine
 Austrapen - Ampicillin
 Austrastaph - Cloxacillin
 Austrastaph - Tetracycline phosphate complex
 Auxit - Bromhexine
 Avenobar - Salicylic acid
 Avenon - Cephalothin sodium
 Avenon-I - Cephalothin sodium
 Aventyl - Nortriptyline
 Aversan - Disulfiram
 Avex - Diazepam
 Avil - Pheniramine maleate
 Aviomarine - Dimenhydrinate
 Avlane - Loprazolam
 Avlocardyl - Propranolol HCl
 Avloclor - Chloroquine phosphate
 Avlosulfon - Dapsone
 Avocin - Piperacillin sodium
 Avomine - Promethazine HCl
 Avomol - Diphenidol
 Avosyl - Mepheneisn
 Awelysin - Streptokinase
 Ax-1000 - Amoxicillin
 Axbiot - Amoxicillin
 Axeen - Proxibarbal
 Axion - Hydroxocobalamin
 Axiten - Mebutamate
 Aygestrin - Norethindrone acetate
 Azacordit - Fluzacord
 Azalone - Antazoline HCl
 Azamun - Azathioprine

Azanin - Azathioprine
 Azapen - Methicillin sodium
 Azapress - Azathioprine
 Azene - Chlorazepate dipotassium
 Azepamid - Medazepam
 Azide - Chlorothiazide
 Azlin - Azlocillin
 Azmacort - Triamcinolone acetonide
 Azobicina Triamcin - Triamcinolone acetonide
 Azo Gantanol - Sulfamethoxazole
 Azo-Gantrisin - Sulfisoxazole
 Azolid - Phenylbutazone
 Azolin - Tetrahydrozoline HCl
 Azubromaron - Benzbromarone
 Azulfidine - Sulfasalazine

 B 12 Mille - Cyanocobalamin
 B 12 Vicotrat - Cyanocobalamin
 Babypyrin - Aspirin
 Babyspasmil - Dicyclomine HCl
 Bacacil - Bacampicillin
 Bacampicin - Bacampicillin
 Bacarate - Phendimetrazine tartrate
 Baciguent - Bacitracin
 Bacillotox - 4-Chloro-3,5-xyleneol
 Bacitracine - Bacitracin
 Baclon - Baclofen
 Baclyn - Methicillin sodium
 Bactidol - Hexetidine
 Bactigras - Chlorhexidine
 Bactio-Rhin - Naphazoline
 Bactocill - Oxacillin sodium
 Bactopen - Cloxacillin
 Bactramyl - Piromidic acid
 Bactrim - Sulfamethoxazole
 Bactrim - Trimethoprim
 Bafameriten - Mefenamic acid
 Bajaten - Indapamide
 Baktar - Trimethoprim
 Baktogram - Nalidixic acid
 Baktol - 4-Chloro-3,5-xyleneol
 Bal - Dimercaprol
 Balance - Chlordiazepoxide HCl
 Balminil - Guaifenesin
 Balminil-DM - Dextromethorphan hydrobromide
 Balneol-HC - Hydrocortisone
 Baltix - Chlophedianol
 Bamaxin - Bacampicillin
 Banasil - Reserpine
 Banflex - Orphenadrine citrate
 Banistyl - Fonazine mesylate
 Banlin - Propantheline bromide
 Banocide - Diethylcarbamazine citrate
 Bapresan - Clonidine HCl
 Barastonin - Dichlorphenamide
 Baratol - Indoramin
 Barespan - Valetamate bromide
 Baretaval - Valetamate bromide
 Barnetil - Sultopride HCl
 Baronorm - Cyclothiazide
 Barseb - Salicylic acid
 Barseb-HC - Hydrocortisone
 Basal-H - Insulin
 Basaquines - Quinestrol
 Bas-Bil - Cyclobutylol
 Basedock D - Hydralazine HCl
 Basionic - Tromethamine
 Baspordina - Cephaloridine
 Baspurin - Cephalexin
 Batomu - Clemastine fumarate

 Batrafen - Ciclopiroxolamine
 Batrax - Bacitracin
 Batticon - Povidone-iodine
 B-Aureo - Chlortetracycline
 Bax - Diphenhydramine HCl
 Baxan - Cefadroxil
 Baxarytmon - Propafenone HCl
 Baycaron - Mefruside
 Bayciper - Mezlocillin
 Baycuten - Clotrimazole
 Baydyl - Triprolidine
 Baylaril - Thioridazine
 Baylocaine - Lidocaine
 Baymethazine - Promethazine HCl
 Baymicina - Sisomicin
 Baymicine - Sisomicin
 Baypen - Mezlocillin
 Bayrena - Sulfameter
 Bayrogel - Etofenamate
 BB-K8 - Amikacin
 B-CP - Chloramphenicol palmitate
 Beatryl - Fentanyl
 Bebaspin - Aspirin
 Bebate - Betamethasone benzoate
 Beben - Betamethasone benzoate
 Becabil - Amoxicillin
 Becamedic - Medazepam
 Becanta - Methyldopa
 Beclacin - Beclomethasone dipropionate
 Beclamet - Beclomethasone dipropionate
 Beclamid - Beclamide
 Beclor-Asma - Beclomethasone dipropionate
 Becloforte - Beclomethasone dipropionate
 Beclosona - Beclomethasone dipropionate
 Beclotide Nasal - Beclomethasone dipropionate
 Beclotent - Beclomethasone dipropionate
 Beconase - Beclomethasone dipropionate
 Becort - Betamethasone
 Becotide - Beclomethasone dipropionate
 Bedoce - Cyanocobalamin
 Bedocefarm - Cyanocobalamin
 Be-Dodec - Cyanocobalamin
 Bedodeka - Cyanocobalamin
 Bedranol - Propranolol HCl
 Beducene - Dexpanthenol
 Beduzin - Cyanocobalamin
 Behepan - Cyanocobalamin
 Behepan - Hydroxocobalamin
 Belfene - Diphenylpyraline HCl
 Bellasthman Medihaler - Isoproterenol sulfate
 Beloc - Metoprolol tartrate
 Beloderm - Betamethasone dipropionate
 Belomet - Cimetide
 Belseren - Clorazepate dipotassium
 Bemacol - Chloramphenicol
 Bemperil - Sulocitidil
 Benaciclín - Demeclocycline HCl
 Benacol - Dicyclomine HCl
 Benadol - Diphenhydramine HCl
 Benadazol - Diphenhydramine HCl
 Benadryl - Diphenhydramine HCl
 Benamizol - Fluocinolone acetonide
 Benanzyl - Clemastine fumarate
 Benapon - Diphenhydramine HCl
 Benasin - Diphenhydramine HCl
 Benciclina - Methacycline
 Bendigon - Inositol niacinate
 Bendigon - Mefruside
 Bendogen - Bromhexine
 Bendopa - Levodopa

Bendralan - Phenethicillin potassium
 Benecid - Probenecid
 Beneficat - Trazodone HCl
 Benemycin - Rifampin
 Benemid - Probenecid
 Benemide - Probenecid
 Benezrial - Guanoxabenz HCl
 Benhydramil - Diphenhydramine HCl
 Benicil - Cloxacillin
 Benisone - Betamethasone benzoate
 Benlipoid - Fursultiamine
 Benmyo - Acetaminophen
 Benocten - Diphenhydramine HCl
 Benodil - Flurazepam
 Benoral - Benorylate
 Benorile - Benorylate
 Benortan - Benorylate
 Benoxil - Benoxinate Hydrochloride
 Benozil - Flurazepam
 Bensamin - Pivampicillin
 Bensedin - Diazepam
 Benson - Medazepam
 Bensulfa - Sulfadimethoxine
 Bensylate - Benztropine mesylate
 Bent - Chlordiazepoxide HCl
 Bentelan - Betamethasone dipropionate
 Bentomine - Dicyclomine HCl
 Benton - Fluorouracil
 Bentos - Befunolol
 Bentum - Benorylate
 Bentyll - Dicyclomine HCl
 Bentyllol - Dicyclomine HCl
 Ben-U-Ron - Acetaminophen
 Benuron - Bendroflumethiazide
 Benuryl - Probenecid
 Benusel - Ampicillin
 Benusel - Ampicillin trihydrate
 Benylin - Dextromethorphan hydrobromide
 Benylin - Diphenhydramine HCl
 Benzalcan - Benzethionium chloride
 Benzalin - Nitrazepam
 Benzamycin - Erythromycin
 Benzantine - Diphenhydramine HCl
 Benzedrex - Propylhexedrine
 Benzehist - Diphenhydramine HCl
 Benzetacil-Simple - Pencillin G benzathine
 Benzide - Bendroflumethiazide
 Benzimidon - Tolazoline
 Benzodiapin - Chlordiazepoxide HCl
 Benzoflex - Chlorzoxazone
 Benzolin - Tolazoline
 Benzoral - Amoxicillin
 Benzotran - Oxazepam
 Bepantheme - Dexpanthenol
 Bephen - α,α,α -Trifluorothymidine
 Beres - Protokylol
 Berkfurin - Nitrofurantoin
 Berkolol - Propranolol HCl
 Berkomine - Imipramine HCl
 Berkozide - Bendroflumethiazide
 Berlicetin - Chloramphenicol
 Berlicetin - Chloramphenicol palmitate
 Berocillin - Pivampicillin
 Beronald - Furosemide
 Berotec - Fenoterol hydrobromide
 Berubi - Cyanocobalamin
 Berubi - Hydroxocobalamin
 Berubigen - Cyanocobalamin
 Beruhgen - Valetamate bromide
 Besacolin - Bethanechol chloride
 Bestason - Fluocinonide
 Bestcall - Cefmenoxime
 Betacard - Alprenolol HCl
 Beta-chlor - Chloral betaine
 Betacort - Betamethasone valerate
 Betacorten - Betamethasone valerate
 Betacortil - Betamethasone
 Beta Corton - Halcinonide
 Betaderm - Betamethasone valerate
 Betadine - Povidone-iodine
 Betadine ginecologico - Povidone-iodine
 Beta Dival - Betamethasone valerate
 Betadol - Nadolol
 Betadorm A - Dimenhydrinate
 Betadran - Bupranolol
 Betadrenol - Bupranolol
 Betafluorene - Betamethasone acetate
 Beta-Intensain - Chromonar HCl
 Betaisodone - Povidone-iodine
 Betalin - Cyanocobalamin
 Betaloc - Metoprolol tartrate
 Betalone - Betamethasone
 Betalone - Meprednisone
 Betamac - Sulpiride
 Betamamallet - Betamethasone
 Betanamin - Pemoline
 Beta-Neg - Propranolol HCl
 Betapam - Diazepam
 Betapar - Meprednisone
 Betapin - Alprenolol HCl
 Betapred - Betamethasone
 Betapred - Meprednisone
 Betapressin - Penbutolol
 Betasolon - Betamethasone
 Beta-Tabliten - Propranolol HCl
 Betatrex - Betamethasone valerate
 Beta Val - Betamethasone valerate
 Betavel - Cloxazolam
 Betaxina - Nalidixic acid
 Betazol - Betazole
 Bethachorol - Bethanechol chloride
 Betim - Timolol maleate
 Betix - Chlorthenoaxazine
 Betnelan - Betamethasone
 Betnesail - Betamethasone
 Betnesol - Betamethasone
 Betnesol - Betamethasone dipropionate
 Betnesol - Betamethasone valerate
 Betnevale - Betamethasone valerate
 Betnovate - Betamethasone dipropionate
 Betolvex - Cyanocobalamin
 Betozone - Beclomethasone dipropionate
 Betrilo - Bunitrolol
 Betrilo - Bunitrolol
 Bevatine - Cyanocobalamin
 Bevidox - Cyanocobalamin
 Bevitrol Lipophil - Fursultiamine
 Bexibee - Cyanocobalamin
 Bexil - Cyanocobalamin
 Bexopron - Benoxaprofen
 Biadibe - Chlorpropamide
 Biarison - Proquazone
 Biazolina - Cefazolin sodium
 Bibocit - Cyanocobalamin
 Bicarnesine - Carnitine
 Bicide - Lindane
 Bicillin - Penicillin G benzathine
 Bicol - Bisacodyl
 Bicolun - Dimethicone
 Bidocef - Cefadroxil

- Bidramine - Diphenhydramine HCl
 Bifiteral - Lactulose
 Biforon - Bufornin HCl
 Bigunal - Bufornin HCl
 Biklin - Amikacin
 Bilatox - Cephalexin
 Biligradin - Iodipamide
 Biligram-Meglumine salt - toglycamic acid
 Bilimiro - Iopronic acid
 Bilimiru - Iopronic acid
 Biliopaco - Iopanoic acid
 Biliscopin - Iotroxic acid
 Bilivistan-Meglumine Salt - Ioglycamic acid
 Billicol - Fenipentol
 Bilo - Chenodiol
 Bilopaque - Tyropanoate sodium
 Bilopsyl - Iodoalphonic acid
 Biltricide - Praziquantel
 Bilyn - Florantyrone
 Bimanol - Deanol acetamidobenzoate
 Bimaran - Trazodone HCl
 Binicap - Tetracycline phosphate complex
 Binograc - Clofibrate
 Binomil - Chlordiazepoxide HCl
 Binotal - Ampicillin
 Binotal - Ampicillin trihydrate
 Bio-Ampi - Ampicillin
 Biocefalin - Pyritinol
 Bioceclina - Ampicillin
 Biocetin - Chloramphenicol
 Biocheclina - Tetracycline phosphate complex
 Biociclin - Cefuroxime
 Biocin - Fosfomicin
 Bio-Cortex - Hydrocortisone
 Biodopa - Levodopa
 Biofanal - Nystatin
 Bio-Flex - Orphenadrine citrate
 Biofradin - Neomycin
 Biogan - Naphazoline
 Biogastron - Carbenoxolone
 Biogastrone - Carbenoxolone
 Biogen - Gentamicin sulfate
 Bioglumin - Chlorpropamide
 Biomag - Cimetide
 Biomargen - Gentamicin sulfate
 Biomicon - Erythromycin estolate
 Biomioran - Chlorzoxazone
 Biomit - Bisacodyl
 Bionacillin - Ampicillin
 Bionacillin-C - Cyclacillin
 Bioperidolo - Haloperidol
 Biophenicol - Chloramphenicol
 Bioporina - Cephalexin
 Bioral - Carbenoxolone
 Bioscleran - Clofibrate
 Bioselenium - Selenium sulfide
 Biosuppressin - Hydroxy urea
 Biotensid - Chlorhexidine
 Bioterciclin - Demeclocycline HCl
 Biotertussin - Clbutinol
 Biotetra - Tetracycline
 Bioxidona - Amoxicillin
 Bioxima - Cefuroxime
 Biphenabid - Probucol
 Bi-Prin - Aspirin
 Bisacolax - Bisacodyl
 Biscolax - Bisacodyl
 Biscosal - Fluocinolone acetoneide
 Biscouron - Ethyl biscoumacetate
 Bisco-Zitron - Oxyphenisatin acetate
 Bismag-Lac - Magaldrate
 Bismilla - Chlorpheniramine maleate
 Bisolvanat - Erythromycin
 Bisolvon - Bromhexine
 Bi-Star - Dienestrol
 Bistermin - Fonazine mesylate
 Bistin - Hydroxocobalamin
 Biston - Carbamazepine
 Bistrimate - Bismuth sodium triglycollamate
 Bistrium - Hexamethonium bromide
 Biturix - Protokylol
 Black & White - Hydroquinone
 Bladderon - Flavoxate HCl
 Blascorid - Benproperine
 Blastovin - Vinblastine sulfate
 Bled - Ciconitate
 Bleminol - Allopurinol
 Blephaseptyl - Fludrocortisone acetate
 Blesin - Diclofenac sodium
 Blocadren - Timolol maleate
 Blocan - Methscopolamine bromide
 Blokium - Atenolol
 Blox - Loperamide HCl
 Blutene - Tolonol chloride
 Bluton - Ibuprofen
 Bolvidon - Mianserin
 Bonabol - Mefenamic acid
 Bonafer - Ferroglycine sulfate
 Bonamine - Meclizine HCl
 Bonapar - Phenyramidol
 Bonapicillin - Ampicillin
 Boncefin - Cefoxitin sodium
 Boniciclina - Mepicycline
 Boniderma - Fluocinolone acetoneide
 Bonidon - Indomethacin
 Bonipress - Debrisoquin
 Bonjela - Choline salicylate
 Bonol - Pyritinol
 Bonton - Lorazepam
 Bontourist - Dimenhydrinate
 Bontril - Phendimetrazine tartrate
 Bonumin - Diethyl propion HCl
 Bon Voyage - Cyclizine
 Bonzol - Danazol
 Bor-Cefazol - Cefazolin sodium
 Bornate - Isobornyl thiocyanacetate
 Boscillina - Methacycline
 Botrophase - Batroxobin
 Boutycin - Indomethacin
 B-Pas - Aminosalicilic acid
 Bradex-Vioform - Domiphen bromide
 Bradiruba - Hydroxocobalamin
 Brado - Domiphen bromide
 Bradoral - Domiphen bromide
 Bradosol - Domiphen bromide
 Branex - Vincamine
 Brassel - Citicoline
 Braunol - Povidone-iodine
 Braxan - Tiadenol
 Brek - Loperamide HCl
 Brendalit - Diethylpropion HCl
 Brekinase - Urokinase
 Breonesin - Guaifenesin
 Breoprin - Aspirin
 Bresit - Clofibrate
 Brethaire - Terbutaline
 Brethine - Terbutaline
 Bretylate - Breylium tosylate
 Bretylol - Breylium tosylate
 Brevia - Ipratropium bromide

Brevicillina - Methacycline
 Brevicillina-Simple - Penicillin G Benzathine
 Brevicon - Norethindrone
 Brevicon - Norethindrone acetate
 Brevimytal - Methohexital sodium
 Brevital - Methohexital sodium
 Brexin - Methapyrilene HCl
 Bricalin - Terbutaline
 Brican - Terbutaline
 Bricanyl - Terbutaline
 Bricec - Cefatrizine
 Briclin - Amikacin
 Brietal - Methohexital sodium
 Brisalin - Phenyltoloxamine
 Brisfirina - Cephapirin sodium
 Brisoral - Cephalixin
 Bristacilina Retard - Tetracycline phosphate complex
 Bristacin - Rolitetracycline
 Bristagen - Gentamicin sulfate
 Bristamine - Phenyltoloxamine
 Bristamox - Amoxicillin
 Bristocef - Cephapirin sodium
 Bristophen - Oxacillin sodium
 Bristuric - Bendroflumethiazide
 Bristurin - Terbutaline
 Bristuron - Bendroflumethiazide
 Britai - Clidanac
 Britapen Oral - Ampicillin
 Britcin - Ampicillin
 Brizin - Benapryzine hydrochloride
 Brizolina - Cefazolin sodium
 Brocadopa - Levodopa
 Brocolax - Bisacodyl
 Broflex - Trihexyphenidyl HCl
 Bromanil - Diphenhydramine HCl
 Brombay - Brompheniramine maleate
 Bromeksin - Bromhexine
 Bromergon - Bromocriptine
 Bromethacon - Promethazine HCl
 Bromfed - Brompheniramine maleate
 Bromphen - Brompheniramine maleate
 Bromphen - Guaifenesin
 Bromphen - Phenylephrine HCl
 Bromphen - Phenylpropanolamine HCl
 Bromrun - Brompheniramine maleate
 Bronalide - Flunisolide
 Bronalin - Hexoprenaline
 Bronchette - Carbocysteine
 Bronchipect - Carbocysteine
 Bronchodil - Reproterol
 Broncho-Grippol - Dextromethorphan hydrobromide
 Bronchol - Guaifenesin
 Broncholylin - Acetylcysteine
 Broncho-Rivo - Diphenhydramine HCl
 Bronchospasmin - Reproterol
 Broncodeterge - Carbocysteine
 Broncokin - Bromhexine
 Broncokod - Carbocysteine
 Broncollenas - Albuterol
 Bronco-Turbinal - Beclomethasone dipropionate
 Broncovani - Guaifenesin
 Brondaxin - Choline theophyllinate
 Brondecon - Guaifenesin
 Bronkese - Bromhexine
 Bronkolixir - Guaifenesin
 Bronkotuss - Guaifenesin
 Bronocon - Clorprenaline
 Bronosol - Bronoprol
 Bronsecur - Carbuterol
 Bronx - Zipeprol
 Bropicilina - Ampicillin
 Broserpine - Reserpine
 Brotacilina - Pivampicillin
 Brotazona - Feprazone
 Brotopon - Haloperidol
 Brovel - Eprozinol
 Broxil - Phenethicillin potassium
 Brufamic - Ibuprofen
 Brufen - Ibuprofen
 Brumetidina - Cimetide
 Brunac - Acetyl cysteine
 Brunocillin - Penicillin G benzathine
 B-Sulfamethoxy - Sulfamethoxypyridazine
 B-Twelvora - Cyanocobalamin
 Buburone - Ibuprofen
 Bucohydral - Chlormerodrin
 Bucosept - Hexetidine
 Bucumarol - Bucumolol HCl
 Bufacyl - Aspirin
 Bufedil - Buflomedil
 Bufedon - Nylidrin
 Bufemid - Fenbufen
 Bufeniod - Bufeniode
 Buffaprin - Aspirin
 Buffasal - Aspirin
 Buffer - Tromethamine
 Bufonamin - Bufornin HCl
 Bulbonin - Bufornin HCl
 Bulentin - Phenylbutazone
 Bumex - Bumetanide
 Bunosquin - Proscillaridin
 Buphedrin - Nylidrin
 Burinex - Bumetanide
 Burnil - Tetrahydrozoline HCl
 Buronil - Melitracen
 Butacal - Phenylbutazone
 Butacote - Phenylbutazone
 Butadion - Phenylbutazone
 Butadiona - Phenylbutazone
 Butadyne - Phenylbutazone
 Butaflogin - Oxyphenbutazone
 Butalan - Phenylbutazone
 Butalgin - Phenylbutazone
 Butalgina - Phenylbutazone
 Butaluy - Phenylbutazone
 Butaphen - Phenylbutazone
 Butaphyllamine - Ambuphylline
 Butapirazol - Phenylbutazone
 Butapirone - Oxyphenbutazone
 Butarex - Phenylbutazone
 Butartril - Phenylbutazone
 Butatensin - Mebutamate
 Butazina - Phenylbutazone
 Butazolil - Phenylbutazone
 Butazone - Phenylbutazone
 Buterazine - Budralazine
 Buteril - Oxyphenbutazone
 Buthoid - Ambuphylline
 Butilene - Oxyphenbutazone
 Butinat - Bumetanide
 Butiwas Simple - Phenylbutazone
 Buto-Asma - Albuterol
 Butoroid - Phenylbutazone
 Butrex - Phenylbutazone
 Butylenin - Ibuprofen
 Butylone - Pentobarbital sodium
 Bydolax - Oxyphenisatin acetate
 Bykomycetin - Spiramycin

Bykomycin - Neomycin

- Cabadon M - Cyanocobalamin
 Caberdelta - Methylprednisolone
 Caberdelta - Prednisolone
 Caberdelta - Prednisolone phosphate sodium
 Cabermox - Amoxicillin
 Cabral - Phenyramidol
 Cacholitin - Carbachol
 Cactiran - Piperidolate
 Cafenolo - Chloramphenicol
 Cafide - Butofilolol
 Cafilon - Phenmetrazine
 Calan - Verapamil
 Calcamine - Dihydrotachysterol
 Calcimar - Calcitonin
 Calcipen - Penicillin V
 Calcitar - Calcitonin
 Calcitonin-Sandoz - Calcitonin
 Calcolise - Chenodiol
 Calderol - Calcifediol
 Calmador - Zomepirac
 Calmansial - Fluphenazine HCl
 Calmasan - Dextromethorphan hydrobromide
 Calmazine - Trifluoperazine
 Calmerphan-L - Dextromethorphan hydrobromide
 Calmocin - Indomethacin
 Calmonal - Meclizine HCl
 Calmotal - Promazine HCl
 Calmo Yer - Aspirin
 Calmpose - Diazepam
 Calm-X - Dimenhydrinate
 Calodal - Mesoridazine besylate
 Calpol - Acetaminophen
 Calsekin - Fonazine mesylate
 Calsyn - Calcitonin
 Calsynar - Calcitonin
 Calthor - Cyclacillin
 Calurin - Carbaspirin calcium
 Camaldin - Clobutinol
 Cambiex - Bumetanide
 Camoform HCl - Bialamicol
 Camoquin - Amodiaquin
 Camoquin HCl - Amodiaquin
 Campaign - Acetaminophen
 Canazepam - Diazepam
 Cancycline - Tetracycline
 Candeptin - Candicidin
 Canderel - Aspartame
 Candex - Nystatin
 Candimon - Candicidin
 Candio-Hermal - Fluprednidene acetate
 Candio-Hermal - Nystatin
 Canesten - Clotrimazole
 Caniramine - Rescinnamine
 Canquil - Meprobamate
 Cantharone - Salicylic acid
 Cantil - Mepenzolate bromide
 Cantilon - Mepenzolate bromide
 Cantor - Minaprine
 Capastat - Capreomycin sulfate
 Capen - Tiopronin
 Capilan - Cyclandelate
 Capistar - Cyclandelate
 Capisten - Ketoprofen
 Capla - Mebutamate
 Caplenal - Allopurinol
 Capoten - Captopril
 Capracid - Aminocaproic acid
 Capralense - Aminocaproic acid
 Capramol - Aminocaproic acid
 Caprin - Aspirin
 Caprinol - Mefruside
 Caprinol - Methyldopa
 Caprodat - Carisoprodol
 Caprogen Depot - Hydroxyprogesterone caproate
 Caproliisin - Aminocaproic acid
 Caprysin - Clonidine HCl
 Captagon - Fenethylamine HCl
 Captol - Oxprenolol
 Captopril - Captopril
 Capurate - Allopurinol
 Capusumine - Aminocaproic acid
 Caradrin - Proscillaridin
 Carafate - Sucralfate
 Carbacel - Carbachol
 Carb-A-Med - Meprobamate
 Carbametin - Methocarbamol
 Carbamiotin - Carbachol
 Carbapen - Carbenicillin disodium
 Carbatona - Pyridinol carbamate
 Carbecin - Carbenicillin disodium
 Carbicolina - Chenodiol
 Carbocaina - Menadiol sodium phosphate
 Carbocit - Carbocysteine
 Carboraine - Mepivacaine
 Carbostesin - Bupivacaine
 Carbuten - Mebutamate
 Carbyl - Carbachol
 Carcholin - Carbachol
 Cardec - Carbinoxamine maleate
 Cardec - Dextromethorphan hydrobromide
 Cardiacap - Pentaerythritol tetranitrate
 Cardibeltin - Verapamil
 Cardilan - Isoxsuprine HCl
 Cardimarin - Proscillaridin
 Cardina - Timolol maleate
 Cardinol - Propranolol HCl
 Cardio-10 - Isosorbide dinitrate
 Cardiocap - Chromonar HCl
 Cardiol - Practolol
 Cardiolan - Medigoxin
 Cardiolidin - Proscillaridin
 Cardiolipol - Niceritrol
 Cardion - Proscillaridin
 Cardional - Prenylamine
 Cardioquin - Quinidine polygalacturonate
 Cardioquine - Quinidine polygalacturonate
 Cardioserpine - Reserpine
 Cardis - Isosorbide dinitrate
 Cardizem - Diltiazem HCl
 Cardomerin - Silymarin
 Cardon - Proscillaridin
 Cardopax - Isosorbide dinitrate
 Cardoxin - Dipyridamole
 Cardrase - Ethoxzolamide
 Carduben - Visnadine
 Carecin - Cinnarizine
 Carfonal - Floredil HCl
 Caricel - Cefazolin sodium
 Caridan - Oxyphencyclimine
 Caridolol - Propranolol HCl
 Carindapen - Carbenicillin disodium
 Carindapen - Carbenicillin indanyl sodium
 Carisol - Carisoprodol
 Carisoma - Carisoprodol
 Carloxan - Cyclophosphamide
 Carlytene - Moxisylyte
 Carmol - Hydrocortisone
 Carn - Carnitine

- Carnetina - Carnitine
 Carnitan - Carnitine
 Carnitene - Carnitine
 Carnitolo - Carnitine
 Carotaben - β -Carotene
 Carphenamine - Diphenhydramine HCl
 Cartagyl - Clofibrate
 Cartoma - Trimetazidine
 Cartric - Rescinnamine
 Carudol - Phenylbutazone
 Carvacron - Trichlormethiazide
 Carvanil - Isosorbide dinitrate
 Carvasin - Isosorbide dinitrate
 Carxamin - Tranexamic acid
 Carxin - Methocarbamol
 Carzonal - Fluorouracil
 Casmalon - Cycloarbamate
 Caspapride - Bromopride
 Caspiselenio - Selenium sulfide
 Casprium - Aspirin
 Castilium - Clobazam
 Catalgine - Aspirin
 Catanil - Chlorpropamide
 Catapres - Clonidine HCl
 Catapresan - Clonidine HCl
 Cateudyl - Methaqualone
 Cathalin - Bisacodyl
 Cathajell - Diphenhydramine HCl
 Cathomyacin - Novobiocin
 Cathomycline - Novobiocin
 Catiazide - Hydrochlorothiazide
 Catilan - Chloramphenicol
 Catron - Pheniprazine
 Catroniazide - Pheniprazine
 Caudaline - Ticlopidine HCl
 Caytine - Protok yiol
 CDP-Choline - Citicoline
 Ceaclan - Cycloandelate
 Cebedex - Dexamethasone phosphate
 Cebefrasone - Dexamethasone phosphate
 Cebenicol - Chloramphenicol
 Cebera - Alibendol
 Cebesine - Benoxinate hydrochloride
 Cebrium - Chlordiazepoxide HCl
 Cebutid - Flurbiprofen
 Ceclor - Cefaclor
 Cedad - Benactyzine hydrochloride
 Cedin - Isoniazid
 Cedocard - Isosorbide dinitrate
 Cedol - Cefamandole nafate sodium salt
 Cedrox - Aspirin
 Ceduran - Nitrofurantoin
 Ceetamol - Acetaminophen
 Cefabena - Cephaloridine
 Cefabiot - Cephaloridine
 Cefabiot oral - Cephalixin
 Cefacene - Cefazolin sodium
 Cefacidal - Cefazolin sodium
 Cefaclox - Cephaloridine
 Cefadina - Cephalixin
 Cefadros - Cephalixin
 Cefadyl - Cephapirin sodium
 Cefa-Iskia - Cephalixin
 Cefa-Lak - Cephapirin sodium
 Cefaleh Ina - Cephalixin
 Cefalekey - Cephalixin
 Cefalescord - Cephaloridine
 Cefalex-Gobens - Cephalixin
 Cefalisan - Cephaloridine
 Cefalival - Cephalixin
 Cefalobiotic - Cephaloridine
 Cefalogen - Pyritinol
 Cefalogobens - Cephaloridine
 Cefalomicina - Cefazolin sodium
 Cefalomiso - Cephaloridine
 Cefaloto - Cephalixin
 Cefam - Cefamandole nafate sodium salt
 Cefamar - Cefuroxime
 Cefamedin - Cefazolin sodium
 Cefamezin - Cefazolin sodium
 Cefamid - Cephadrine
 Cefamusel - Cephaloridine
 Cefa-Reder - Cephalixin
 Cefaresan - Cephaloridine
 Cefatrex - Cephapirin sodium
 Cefatrexil - Cephapirin sodium
 Cefatrexyl - Cephapirin sodium
 Cefatrix - Cefatrizine
 Cefaxicina - Cefoxitin sodium
 Cefaxin - Cephalixin
 Cefazina - Cefazolin sodium
 Cefibacter - Cephalixin
 Cefizox - Ceftizoxime
 Ceflon - Cephalixin
 Ceflor - Cephalixin
 Ceflorin - Cephaloridine
 Cefman - Cefamandole nafate sodium salt
 Cefobid - Cefoperazone
 Cefobine - Cefoperazone
 Cefobis - Cefoperazone
 Cefoctin - Cefoxitin sodium
 Cefol - Folic acid
 Cefoperazin - Cefoperazone
 Cefoprim - Cefuroxime
 Ceforal - Cephalixin
 Cefos - Cefadroxil
 Cefosan - Cephadrine
 Cefotax - Cefotaxime sodium
 Cefradex - Cephadrine
 Cefrag - Cephadrine
 Cefro - Cephadrine
 Cefrum - Cephadrine
 Cefrix - Ceftizoxime
 Cefumax - Cefuroxime
 Cefur - Cefuroxime
 Cefurex - Cefuroxime
 Cefurin - Cefuroxime
 Cefurox - Cefuroxime
 Celbenin - Methicillin sodium
 Celestamine - Dexchlorpheniramine maleate
 Celestan - Betamethasone
 Celestan - Betamethasone valerate
 Celestene - Betamethasone
 Celestoderm - Betamethasone valerate
 Celestone - Betamethasone
 Celestone Cronodose - Betamethasone acetate
 Celestone Soluspan - Betamethasone acetate
 Celax - Cephadrine
 Celfuron - Mecillinam
 Cellidrin - Allopurinol
 Celluzyme - Simethicone
 Celmetin - Cefazolin sodium
 Celontin - Methsuximide
 Celospor - Cephacetrile sodium
 Cellipilina - Methicillin sodium
 Celtoi - Cephacetrile sodium
 Cemado - Cefamandole nafate sodium salt
 Cemandil - Cefamandole nafate sodium salt
 Cemerit - Aspirin
 Cemidon - Isoniazid

Cen-Apap - Acetaminophen
 Cenaride - Praziquantel
 Cendex - Dextroamphetamine sulfate
 Cenocort - Triamcinolone diacetate
 Cenomicin - Cefoxitin sodium
 Censtim - Imipramine HCl
 Centractiva - Vincamine
 Centralgin - Meperidine HCl
 Centralgol - Proxibarbal
 Centrax - Prazepam
 Centrine - Aminopentamide
 Centrolyse - Butriptyline
 Centyl - Bendroflumethiazide
 Ceolat - Dimethicone
 Ceosunin - Ceruletide
 Cepacilina - Penicillin G benzathine
 Cepaloridin - Cephaloridine
 Cepalorin - Cephaloridine
 Cepaverin - Papaverine monophosadenine
 Cepexin - Cephalixin
 Cephadol - Diphenidol
 Cephalmin - Thioproperazine
 Cephaloject - Cephalirin sodium
 Cephalomax - Cephalixin
 Cephalotin - Cephalothin sodium
 Cephamox - Cefadroxil
 Cephation - Cephalothin sodium
 Cephalax - Cephalixin
 Cephulac - Lactulose
 Cepidan - Cyclandelate
 Cepol - Cephalixin
 Ceporacin - Cephalothin sodium
 Ceporan - Cephaloridine
 Ceporex - Cephalixin
 Ceporin - Cephaloridine
 Cepoven - Cephalixin
 Cepovenin - Cephalothin sodium
 Ceproduc - Cephaloridine
 Ceprorexine - Cephalixin
 Cepticol - Cefatrizine
 CER - Cephaloridine
 Cerachidol - Diphenidol
 Cerase - Medazepam
 Cercine - Diazepam
 Cereb - Citicoline
 Cerebolan - Cinnarizine
 Cerebro - Suloctidil
 Cerebropirina - Pyritinol
 Cerebrotrofina - Pyritinol
 Ceredopa - Levodopa
 Ceregulart - Diazepam
 Ceregut - Citicoline
 Cerepar - Cinnarizine
 Cerespan - Papaverine monophosadenine
 Cero-Aterin - Cinnarizine
 Ceroacral - Ifenprodil tartrate
 Cero-O-Cillin - Penicillin O
 Ceroxime - Cefuroxime
 Cerosa - Diphenidol
 Cerson - Flumethasone
 Cerson - Nitrazepam
 Certomycin - Netilmicin
 Cerubidin - Daunorubicin
 Cerubidine - Daunorubicin
 Cerucal - Metoclopramide HCl
 Cerulex - Ceruletide
 Cervilaxin - Relaxin
 Cervitalin - Pyritinol
 Cervoxan - Deanol acetamidobenzoate
 Cesal - Isometheptene
 Cesamet - Nabilone
 Cesametic - Nabilone
 Cesol - Praziquantel
 Cesporan - Cephradine
 CET - Cephalothin sodium
 Cetadol - Acetaminophen
 Cetal - Chlorhexidine
 Cetal - Vincamine
 Cetampin - Ampicillin trihydrate
 Cevanol - Benactyzine hydrochloride
 Cevi-Fer - Folic acid
 CEX - Cephalixin
 C-Film - Nonoxynol
 Chamionil - Sulpiride
 Chebutan - Kebuzone
 Cheladrate - Edetate disodium
 Chel-Iron - Ferrocholate
 Chelobil - Chenodiol
 Chembutamide - Tolbutamide
 Chembuzone - Phenylbutazone
 Chemcetaphen - Acetaminophen
 Chemdipoxide - Chlordiazepoxide HCl
 Chemflurazine - Trifluoperazine
 Chemhydraside - Hydrochlorothiazide
 Chemicetina - Chloramphenicol
 Chemicoline - Chenodiol
 Chemiofuran - Nitrofurantoin
 Chemiofuran - Nitrofurantoin
 Chemiosalfa - Sulfadimethoxine
 Chemiphen - Phenethicillin potassium
 Chemipramine - Imipramine HCl
 Chemiurin - Nalidixic acid
 Chemochin - Chloroquine phosphate
 Chem-O-Dine - Povidone-iodine
 Chemolase - Chymopapain
 Chemoreptin - Imipramine HCl
 Chemosporal - Cephalixin
 Chemthromycin - Erythromycin estolate
 Chemyparin - Heparin
 Chemyzin - Chloramphenicol
 Chenar - Chenodiol
 Chendal - Chenodiol
 Chendix - Chenodiol
 Chendol - Chenodiol
 Chenix - Chenodiol
 Chenoacid - Chenodiol
 Chenocol - Chenodiol
 Chenodecil - Chenodiol
 Chenodex - Chenodiol
 Chenofalk - Chenodiol
 Chenomas - Chenodiol
 Chenossil - Chenodiol
 Chenotar - Chenodiol
 Cheratil - Idoxuridine
 Chetazolidine - Kebuzone
 Chetopir - Kebuzone
 Chetosol - Kebuzone
 Chevita C-10 - Chlortetracycline
 Chibro-Cardon - Dexamethasone phosphate
 Chibro-Timoptol - Timolol maleate
 Chiclida - Meclizine HCl
 Chinofungin - Tolnaftate
 Chinosicc - Chlorquinaldol
 Chinotiol - Chlorquinaldol
 Chinotoxin - Viquidil
 Chioeban - Pyritinol
 Chionaryl - Clemastine fumarate
 Chitacillin - Amoxicillin
 Chlo-Amine - Chlorpheniramine maleate
 Chlodamine - Chlorpheniramine maleate

Chlomedinon - Chlormezanone
 Chlomic J - Thiamphenicol
 Chlomin - Chloramphenicol
 Chlorolidine - Trichlormethiazide
 Chloractil - Chlorpromazine HCl
 Chloramate - Chlorpheniramine maleate
 Chlorambon - Chloramphenicol palmitate
 Chloramex - Chloramphenicol
 Chloramidane - Chloramphenicol
 Chloramin - Chlorpheniramine maleate
 Chloraminophene - Chlorambucil
 Chloramol - Chloramphenicol
 Chloramphenicol-POS - Chloramphenicol
 Chlorasol - Chloramphenicol
 Chlora-Tabs - Chloramphenicol
 Chlorazin - Chlorpromazine HCl
 Chlordiazachel - Chlordiazepoxide HCl
 Chlor-Hab - Chlorpheniramine maleate
 Chlorhexamed - Chlorhexidine
 Chloricol - Chloramphenicol
 Chlor-Mal - Chlorpheniramine maleate
 Chlormene - Chlorpheniramine maleate
 Chloronitromycin - Chloramphenicol
 Chlorocain - Mepivacaine
 Chlorocid - Chloramphenicol
 Chlorohex - Chlorhexidine
 Chloromisol - Chloramphenicol palmitate
 Chloromycetin - Chloramphenicol
 Chloromycetin - Chloramphenicol palmitate
 Chloronase - Chlorpropamide
 Chloronitrin - Chloramphenicol
 Chloroptic - Chloramphenicol
 Chlorosal - Chlorothiazide
 Chloroserpine - Chlorothiazide
 Chloroserpine - Reserpine
 Chloroton - Chlorpheniramine maleate
 Chlorphen - Chlorpheniramine maleate
 Chlorpromados - Chlorpromazine HCl
 Chlor-Promanyl - Chlorpromazine HCl
 Chlorprom-Ez-Ets - Chlorpromazine HCl
 Chlor-PZ - Chlorpromazine HCl
 Chlorsig - Chloramphenicol
 Chlor-Tel - Chlorpheniramine maleate
 Chlortet - Chlorotetracycline
 Chlor-Trimeton - Chlorpheniramine maleate
 Chlortrone - Chlorpheniramine maleate
 Chlorzide - Hydrochlorothiazide
 Chlotride - Chlorothiazide
 Chlozoxine - Chlorzoxazine
 Cholasa - Chenodiol
 Chole-Contrast - Iopanoic acid
 Cholecyl - Choline theophyllinate
 Cholelyl - Choline theophyllinate
 Cholegyl - Choline theophyllinate
 Cholenal - Clofibrate
 Cholesolvin - Simfibrate
 Cholesorbin - Simfibrate
 Cholesrun - Clofibrate
 Cholestex - Chenodiol
 Cholestol - Clofibrate
 Choletrast - Iodoalphanic acid
 Cholexamine - Nicomol
 Cholibil - Trepibutone
 Cholinfall - Methixene HCl
 Cholipin - Fenipentol
 Cholografin - Iodipamide
 Chologram - Iotroxic acid
 Cholonorm - Chenodiol
 Chophyllin - Choline theophyllinate
 Chothyn - Choline dihydrogen citrate
 Chronogyn - Danazol
 Chronulac - Lactulose
 Chroxin - Chlorzoxazine
 Chrysocin - Oxytetracycline
 Chrysozincin - Chlortetracycline
 Chrytemin - Imipramine HCl
 Chymex - Bentiromide
 Chymodiactin - Chymopapain
 Ciaryl - Clopenthixol
 Cibacalcin - Calcitonin
 Cibelon - Carbinoxamine maleate
 Cicatrex - Bacitracin
 Ciclobiotic - Methacycline
 Cicloblastina - Cyclophosphamide
 Ciclocetam - Piracetam
 Cicloestradiolo - Estradiol cypionate
 Ciclofalina - Piracetam
 Ciclolux - Cyclopentolate HCl
 Cicloplegic - Cyclopentolate HCl
 Ciclosterone - Testosterone 17 β -cypionate
 Ciclovalidin - Cycloserine
 Cicloven - Pyridinol carbamate
 Ciclum - Methacycline
 Cidalgon - Indomethacin
 Cidanamox - Amoxicillin
 Cidanbutol - Ethambutol HCl
 Cidancaina - Lidocaine
 Cidan-Cef - Cephaloridine
 Cidanchin - Chloroquine phosphate
 Cidandopa - Levodopa
 Cidan-Est - Streptomycin
 Cidifos - Citicoline
 Cidomycin - Gentamicin sulfate
 Cilicaine - Penicillin G procaine
 Cilicef - Cephaloridine
 Cilicef Oral - Cephalixin
 Cilleral - Ampicillin
 Cillimicina - Lincomycin
 Cillimycin - Lincomycin
 Cimetag - Cimetide
 Cimetrin - Erythromycin estolate
 Cimetrin - Erythromycin stearate
 Cimetum - Cimetide
 Cimexillin - Ampicillin trihydrate
 Cinalone - Triamcinolone diacetate
 Cinamet - Cimetide
 Cinaperazine - Cinnarizine
 Cinazin - Cinnarizine
 Cinazyn - Cinnarizine
 Cinco-Fu - Fluorouracil
 Cincomil Bedoce - Cyanocobalamin
 Cincuental - Vincamine
 Cinnabene - Cinnarizine
 Cinnacet - Cinnarizine
 Cinnageron - Cinnarizine
 Cinnaloid - Rescinamine
 Cinnamin - Apazone
 Cinnipirine - Cinnarizine
 Cino-40 - Triamcinolone diacetate
 Cinobac - Cinoxacin
 Cinobact - Cinoxacin
 Cinobactin - Cinoxacin
 Cinolone - Triamcinolone
 Cinonide - Triamcinolone acetoneide
 Cinopal - Fenbufen
 Cinulus - Cimetide
 Cin Vis - Isoniazid
 Ciponium - Cephalixin
 Cipractin - Cyproheptadine
 Cipro - Cyproheptadine

- Circle-One - Cycandelate
 Circleton - Suloctidil
 Circulan - Xanthinol niacinate
 Circularina - Piribedil
 Circulat - Cycandelate
 Circupon - Etilefrine pivalate HCl
 Cisordinol - Clopenthixol
 Cistal - Trimethoprim
 Cistobii - Iopanoic acid
 Cistofuran - Nitrofurantoin
 Cistoplex - Florantyrone
 Citanest - Prilocaine HCl
 Citatrin - Bacitracin
 Citexal - Methaqualone
 Citicel - Cephadrine
 Citicil - Ampicillin
 Citicil - Ampicillin trihydrate
 Citidol - Diflunisal
 Citiflus - Clofibrate
 Citilat - Nifedipine
 Citiolase - Citiolone
 Citireuma - Sulindac
 Citius - Cimetide
 Citizeta - Zipeprol
 Citocilina - Cycloacillin
 Citofer - Tegafur
 Citoliver - Cyclobutylol
 Cito-Optadren - Lidocaine
 Citosarin - Cycloacillin
 Citosol - Thiamylal
 Citoxid - Nafrolyl oxalate
 Citra - Methapyrilene HCl
 Citra Forte - Pheniramine maleate
 Citra Forte - Pyrilamine
 Citrocholine - Choline dihydrogen citrate
 Citrullamon - Phenytoin
 Civent - Cimetide
 Clafanone - Airofanone
 Clafanone - Erythromycin
 Claforan - Cefotaxime sodium
 Clamox - Amoxicillin
 Clamoxyl - Amoxicillin
 Claradin - Aspirin
 Claragine - Aspirin
 Claesan - Clofibrate
 Clarex - Cyanocobalamin
 Claripex - Clofibrate
 Clariprin - Aspirin
 Clarmyl - Clobazam
 Clarol - Clofibrate
 Classen - Mercaptopurine
 Clavidene - Lidoflazine
 Cleamine - Cyclizine
 Clear-Aid - Hydrocortisone
 Clearane - Heparin
 Cleiton - Hydrocortisone
 Clemanil - Clemastine fumarate
 Cleniderm - Beclomethasone dipropionate
 Clenil - Beclomethasone dipropionate
 Cleocin - Clindamycin HCl
 Clera - Naphazoline
 Cleridium - Dipyrindamole
 Clevamin - Inositol niacinate
 Climaterine - Methyltestosterone
 Climatone - Methyltestosterone
 Clinimon - Clofibrate
 Clinicaine - Lidocaine
 Clinidine - Povidone-iodine
 Clinimycin - Oxytetracycline
 Clinium - Lidoflazine
 Clinodilat - Benfurodil hemisuccinate
 Clinoril - Sulindac
 Clistin - Carbinoxamine maleate
 Cloberat - Clafibrate
 Clobesol - Clobetasol
 Clobrat - Clofibrate
 Clobrate - Clofibrate
 Clobren - Clofibrate
 Clocil - Dicloxacillin sodium
 Clodil-Ion - Metoclopramide HCl
 Clof - Clofibrate
 Clofbate - Clofibrate
 Clofekton - Clocapramine
 Clofibril - Clofibrate
 Clofinit - Clofibrate
 Clofipront - Clofibrate
 Clofirem - Clofibrate
 Clomid - Clomiphene dihydrogen citrate
 Clomim - Dicyclomine HCl
 Clomivid - Clomiphene dihydrogen citrate
 Clonex - Clonazepam
 Clonilou - Clonidine HCl
 Clonisin - Clonidine HCl
 Clonnirit - Clonidine HCl
 Clonopin - Clonazepam
 Clont - Metronidazole
 Clopamon - Metoclopramide HCl
 Clopan - Metoclopramide HCl
 Clopane - Cyclopentamine HCl
 Clopax - Clobazam
 Clopinerin - Clorprenaline
 Clopixol - Clopenthixol
 Clorbiotina - Chloramphenicol
 Clordiabet - Chlorpropamide
 Clordiasan - Chlorpropamide
 Clorevan - Chlorphenoxamine HCl
 Clorochina - Chloroquine phosphate
 Clorofenicina - Chloramphenicol
 Cloro-Hipoglucine - Chlorpropamide
 Clorosintex - Chloramphenicol
 Clorotrisin - Chlorotrianisene
 Clorten - Chlorpheniramine maleate
 Clorteta - Chlorotetracycline
 Clortetrin - Demeclocycline HCl
 Clospor - Cephacetrile sodium
 Clostilbegyt - Clomiphene dihydrogen citrate
 Clothia - Hydrochlorothiazide
 Clothixen - Chlorprothixene
 Clotride - Chlorothiazide
 Cloxan - Chlorprothixene
 Cloxyphen - Cloxacillin
 Clozaril - Clozapine
 Clupen - Floxacillin
 C-Meton - Chlorpheniramine maleate
 Coaxin - Cephalothin sodium
 Cobadex - Hydrocortisone
 Cobalamin H - Hydroxocobalamin
 Cobalcalina - Cephaloridine
 Cobalidrina - Hydroxocobalamin
 Cobalomin - Cyanocobalamin
 Cobalparen - Cyanocobalamin
 Cobalvit - Hydroxocobalamin
 Cobantrin - Pyrantel pamoate
 Cobavite - Cyanocobalamin
 Coben - Picoperine
 Cobione - Cyanocobalamin
 Cocavitan - Cyanocobalamin
 Coco-Diazine - Sulfadiazine
 Codalgina - Aspirin
 Codelcortone TBA - Prednisolone tebutate

Codelsol - Prednisolone phosphate sodium
 Coderma - Fluocinolone acetonide
 Codesin-F - Butamirate citrate
 Codiliax - Bisacodyl
 Codimal - Dextromethorphan hydrobromide
 Codimal - Phenylephrine HCl
 Codimal - Phenylpropranolamine HCl
 Codimal - Pyrilamine
 Codipront - Phenyltoloxamine
 Coeurophylline - Dyphylline
 Co-Fluosin - Fluocinolone acetonide
 Cogentin - Benztropine mesylate
 Cogentine - Benztropine mesylate
 Cogentinol - Benztropine mesylate
 Colbenemid - Probenecid
 Coldan - Naphazoline
 Coldrin - Cinnarizine
 Coleb - Prenalterol
 Colectril - Amiloride HCl
 Coleflux - Piprozolin
 Colegraf - Iopanoic acid
 Colesterinex - Pyridinol carbamate
 Colestid - Colestipol
 Colfarit - Aspirin
 Colbantil - Mepenzolate bromide
 Colcicitina - Phtalylsulfathiazole
 Colifossim - Cefuroxime
 Colimone - Cromolyn sodium
 Colimycin - Chloramphenicol palmitate
 Coliopan - Butropium bromide
 Colircusi Aureomicina - Chlortetracycline
 Colircusi Ciclopejico - Cyclopentolate HCl
 Colircusi Virucida - Idoxuridine
 Colirio Anestésico - Benoxinate hydrochloride
 Colisone - Prednisone
 Colistatin - Succinylsulfathiazole
 Colite - Citicoline
 Colivan - Furazolidone
 Collu-Blache - Benoxinate hydrochloride
 Collu-Hextril - Hexetidine
 Collyrium - Tetrahydrozoline HCl
 Colofac - Mebeverine HCl
 Colo-Pleon - Sulfasalazine
 Colorin - Chlophedianol
 Colpro - Medrogestone
 Colpron - Medrogestone
 Colprone - Medrogestone
 Colsamine - Hydroxocobalamin
 Colstamin - Rescinamine
 Coltericin - Bekanamycin sulfate
 Coltix - Piromidic acid
 Colum - Mepenzolate bromide
 Colupressine - Felypressin
 Colvasone - Dexamethasone phosphate
 Combantrin - Pyrantel pamoate
 Combid - Isopropamide iodide
 Combid - Prochlorperazine
 Combipenix - Ampicillin
 Combipenix - Dicloxacillin sodium
 Combo Pen - Pralidoxime chloride
 Comelian - Dilazep HCl
 Co-Metampicol - Metampicillin sodium
 Comhist - Phenylephrine HCl
 Comoxol - Sulfamethoxazole
 Comoxol - Trimethoprim
 Compazine - Prochlorperazine
 Compedium - Bromazepam
 Complamex - Xanthinol niacinate
 Complamin - Xanthinol niacinate
 Compleciclín - Demeclocycline HCl
 Compicillin - Penicillin G hydrabamine
 Compicillin-V - Penicillin V hydrabamine
 Compound W - Salicylic acid
 Comtrex - Dextromethorphan hydrobromide
 Comtrex - Phenylpropranolamine HCl
 Conceplan - Mestranol
 Conceplan - Norethindrone
 Conciclina - Tetracycline phosphate complex
 Concordin - Protriptyline
 Concordine - Protriptyline
 Condition - Diazepam
 Conduction - Carazolol
 Conflictan - Oxaflozane HCl
 Confortid - Indomethacin
 Congespirin - Dextromethorphan hydrobromide
 Congespirin - Phenylephrine HCl
 Congespirin - Phenylpropranolamine HCl
 Congess - Guaifenesin
 Congex - Naproxen
 Conjuncaín - Benoxinate hydrochloride
 Conofite - Miconazole nitrate
 Conova - Ethynodiol diacetate
 Conovid - Mestranol
 Conray - Iothalmate meglumine
 Conselt - Clorprenaline
 Constaphyl - Dicloxacillin sodium
 Constrilia - Tetrahydrozoline HCl
 Consulid - Sulfachlorpyridazine
 Contac - Methapyrilene HCl
 Contalax - Bisacodyl
 Contamex - Ketazolam
 Contenton - Amantidine HCl
 Contomin - Chlorpromazine
 Contrathion - Pralidoxime chloride
 Contratuss - Dextromethorphan hydrobromide
 Contrauto - Trimethobenzamide HCl
 Contraxin - Iodamide
 Contrazole - Zoaxazolamine
 Contrheuma-Retard - Aspirin
 Contristamine - Chlorphenoxamine HCl
 Contrix - Iothalmate meglumine
 Control - Chlordiazepoxide HCl
 Control - Lorazepam
 Control - Phenylpropranolamine HCl
 Control-Om - Mephexalone
 Contromet - Metoclopramide HCl
 Contumax - Picosulfate sodium
 Converal - Oxazolam
 Convuline - Carbamazepine
 Coolsan - Sulpiride
 Coopaphene - Hexachlorophene
 Coparogin - Tegafur
 Copharcilin - Ampicillin
 Copharian - Tetracycline
 Copharoxy - Oxytetracycline
 Copharvit - Cyanocobalamin
 Copirene - Kebuzone
 Co-Pivam - Pivampicillin
 Copormin - Chlorpromazine HCl
 Coprobate - Meprobamate
 Copsamine - Pyrilamine
 Co-Pyronil - Methapyrilene HCl
 Co-Pyronil - Pyrrobutamine
 Coral - Nifedipine
 Corathiem - Cinnarizine
 Corbutyl - Amodiaquin
 Cordarexne - Amiodarone HCl
 Cordarone - Amiodarone HCl
 Cordarone X - Amiodarone HCl
 Cordel - Betamethasone valerate

Cordes F - Fluocinolone acetonide
 Cordes-Vas - Tretinoin
 Cordexol - Oxypropenol
 Cordil - Isosorbide dinitrate
 Cordilox - Verapamil
 Corditin-Same - Prenylamine
 Cordium - Bepidil
 Cordol - Prednisolone
 Cordran - Flurandrenolide
 Coredamin - Prenylamine
 Corenaln - Citicoline
 Coretal - Oxprenolol
 Corflazine - Lidoflazine
 Corgard - Nadolol
 Coribon - Dipyrnidamole
 Corigast - Propantheline bromide
 Corindolan - Mepindolol
 Corinfar - Nifedipine
 Coritat - Norfenefrine
 Corivanil - Ethamivan
 Corizone-5 - Hydrocortisone
 Corlutan Depot - Hydroxyprogesterone caproate
 Cormelian - Dilazep HCl
 Cornilat - Isosorbide dinitrate
 Coronamole - Dipyrnidamole
 Coronanyl - Trimetazidine
 Coronarine - Dipyrnidamole
 Corosan - Dipyrnidamole
 Corotrend - Propranolol HCl
 Corovliss - Isosorbide dinitrate
 Coroxin - Dipyrnidamole
 Corphos - Hydrocortisone sodium phosphate
 Corphyllin - Dyphylline
 Corpormon - Somatotropin
 Corsodyl - Chlorhexidine
 Cortalar - Fluocinolone acetonide
 Cortalfa - Methylprednisolone
 Cortalone - Prednisolone
 Cortan - Prednisone
 Cortanal - Hydrocortisone
 Cortancyl - Prednisone
 Cortcetine - Dexamethasone phosphate
 Cort-Dome - Hydrocortisone
 Cortef - Hydrocortisone
 Cortenema - Hydrocortisone
 Cortes - Hydrocortisone
 Cortesal - Hydrocortisone
 Cortialper - Prednisone
 Corti-Bi - Meprednisone
 Corticaïne - Hydrocortisone
 Corticoderm - Fluprednidene acetate
 Cortidene - Paramethasone acetate
 Cortiderma - Fluocinolone acetonide
 Cortide Tape - Flurandrenolide
 Cortiespec - Fluocinolone acetonide
 Cortifair - Hydrocortisone
 Cortifan - Hydrocortisone
 Cortilet - Fluorometholone
 Cortiment - Hydrocortisone
 Cortineff - Fludrocortisone acetate
 Cortinovus - Triamcinolone
 Cortiphate - Fluocinolone acetonide
 Cortiphate - Hydrocortisone
 Cortiphate - Hydrocortisone sodium phosphate
 Cortipred - Prednisolone acetate
 Cortisidin - Fluorometholone
 Cortisolone - Prednisolone
 Cortisporin - Hydrocortisone
 Cortisporin - Neomycin
 Cortisporin - Polymyxin
 Cortispray - Hydrocortisone
 Cortoderm - Fluocinolone acetonide
 Cortofludan - Ciclonicate
 Cortolotion - Hydrocortisone
 Cortone acetate - Cortisone acetate
 Cortril - Hydrocortisone
 Cortussin - Guaifenesin
 Corutrol - Guaifenesin
 Coryban-D - Phenylpropanolamine HCl
 Coryban - Guaifenesin
 Coryban - Phenylephrine HCl
 Coryban D - Dextromethorphan hydrobromide
 Coryphen - Aspirin
 Coryzin - Xylometazoline HCl
 Corzepin - Perhexiline sulfate
 Corzide - Bendroflumethiazide
 Corzide - Nadolol
 Cosilone - Prednisolone
 Cosmegen - Dactinomycin
 Cosmoline - Clorprenaline
 Cosulfa - Sulfachlorpyridazine
 Cosuric - Allopurinol
 Cothera - Dimethoxanate
 Cotinazin - Isoniazid
 Cotolone - Prednisolone
 Cotrane - Dimethoxanate
 Cotrim - Sulfamethoxazole
 Cotrim - Trimethoprim
 Cotuxinf - Chlorpheniramine maleate
 Co-Tylenol - Dextromethorphan hydrobromide
 Co-Tylenol - Phenylpropanolamine HCl
 Coughcon - Dextromethorphan hydrobromide
 Coumadin - Warfarin sodium
 Coumadine - Warfarin sodium
 Covantine - Captodiamine
 Covatix - Captodiamine
 Coxigon - Benoxaprofen
 Cozyme - Dexpanthenol
 Crapinon - Piperidolate
 Crastninit - Asparaginase
 Cremacoat - Dextromethorphan hydrobromide
 Cremacoat - Guaifenesin
 Cremacoat - Phenylpropanolamine HCl
 Cremesone - Hydrocortisone
 Cremocort - Triamcinolone acetonide
 Cremomethazine - Sulfamethazine
 Cremosuxidine - Succinyl sulfathiazole
 Creosidin - Bromazepam
 Crepasin - Prenylamine
 Crescormon - Somatotropin
 Cretonin - Trichlormethiazide
 Criilin - Pentapiperide methosulfate
 Crino-Hermal - Fluprednidene acetate
 Crinuryl - Ethacrynic acid
 Crisamicin - Oxytetracycline
 Crisbiotic - Pivampicillin
 Crispin - Tramadol HCl
 Cristovin - Vincristine sulfate
 Critichol - Fenipentol
 Critifib - Bretylium tosylate
 Cromedazine - Chlorpromazine HCl
 Cromene - Chromomol HCl
 Cromezin - Cefazolin sodium
 Cromo-Asma - Cromolyn sodium
 Cromosil - Carbazochrome
 Cromoxin - Carbazochrome
 Cronil - Ectylurea
 Cronoformin - Phenformin
 Cronol - Silymarin
 Crotamitex - Crotamiton

Crotan - Crotamiton
 Crozinal - Sulfadimethoxine
 Cruex - 4-Chloro-3,5-xyleneol
 Crylene - Pentapiperide methosulfate
 Cryptocillin - Oxacillin sodium
 Crystamin - Cyanocobalamin
 Crystoserpine - Reserpine
 C-Quens - Mestranol
 CTC Solube - Chlorotetracycline
 Cuantin - Betamethasone
 Cuprenil - Penicillamine
 Cuprimine - Penicillamine
 Cupripen - Penicillamine
 Curantyl - Dipyrindamole
 Curaresin - Mephenesin
 Curarin - Tubocurarine chloride
 Curban - Dextroamphetamine sulfate
 Cur-Men - Methallenestriol
 Curocef - Cefuroxime
 Curoxime - Cefuroxime
 Curretab - Medroxyprogesterone acetate
 Cusicrom - Cromolyn sodium
 Cusigel - Flucanionide
 Cusimolol - Timolol maleate
 Cusisporina - Cephaloridine
 Cutinolone - Triamcinolone acetonide
 Cutisan - Triclocarban
 Cyanabin - Cyanocobalamin
 Cyano-Gel - Cyanocobalamin
 Cyanovit - Cyanocobalamin
 Cyantin - Nitrofurantoin
 Cysorb - Sulisobenzone
 Cybis - Nalidixic acid
 Cycladiene - Dienestrol
 Cyclaine - Hexylcaine HCl
 Cyclan - Cyclandelate
 Cyclan-Cap - Cyclandelate
 Cyclansato - Cyclandelate
 Cyclapen - Cycloacillin
 Cycleat Cap - Cyclandelate
 Cyclidox - Doxycycline
 Cyclobec - Dicyclomine HCl
 Cyclobral - Cyclandelate
 Cyclo-C - Amcitable HCl
 Cyclocide - Cytarabine HCl
 Cyclocort - Amcinonide
 Cycloestrol - Hexestrol
 Cyclogyl - Cyclopentolate HCl
 Cyclolyt - Cyclandelate
 Cyclomen - Danazol
 Cyclomydrin - Cyclopentolate HCl
 Cyclonaranol - Cyclopentamine HCl
 Cyclopen - Cyclopentolate
 Cyclopentol - Cyclopentolate HCl
 Cyclospasmol - Cyclandelate
 Cyclostin - Cyclophosphamide
 Cycloteriam - Cyclothiazide
 Cycomin - Oxyphenacyclimine
 Cyncate - Inositol nicinate
 Cyfos - Ifosfamide
 Cyklokapron - Tranexamic acid
 Cykobemin - Cyanocobalamin
 Cylert - Pemoline
 Cylphenicol - Chloramphenicol
 Cymbi - Ampicillin trihydrate
 Cyplegin - Cyclopentolate HCl
 Cypromin - Cyproheptadine
 Cyprostat - Cyproterone acetate
 Cyral - Primidone
 Cyredin - Cyanocobalamin
 Cyren A - Diethylstilbestrol
 Cyrpon - Meprobamate
 Cyscholin - Citicoline
 Cysten - Cinnarizine
 Cystit - Nitrofurantoin
 Cysto-Conray - Iothalate meglumine
 Cystokon - Acetrisoate sodium
 Cytadren - Aminoglutethimide
 Cytakon - Cyanocobalamin
 Cytamen - Cyanocobalamin
 Cytinium - Cyclobutylol
 Cytobin - Liothyronine
 Cytobion - Cyanocobalamin
 Cytofol - Folic acid
 Cytomel - Liothyronine
 Cytomine - Liothyronine
 Cytonal - Diethylstilbestrol diphosphate
 Cytophosphan - Cyclophosphamide
 Cytosar - Cytarabine HCl
 Cytoxan - Cyclophosphamide
 Dabrobamat - Meprobamate
 Dabrosol - Allopurinol
 Dabylen - Diphenhydramine HCl
 Dacala - Amoxicillin
 Dacomid - Methenolone acetate
 Dacortin - Prednisolone
 Dacortin - Prednisone
 Dacrine - Chlorhexidine
 Dactil - Piperidolate
 Dactylate - Piperidolate
 Daicoline - Citicoline
 Daicon - Epirizole
 Daipin - Methscopolamine bromide
 Daiprophen - Ibuprofen
 Dairopeal - Spironolactone
 Daisaloid - Rescinamine
 Daiyalose - Tegafur
 Dakryo - Bromhexine
 Doktor - Miconazole nitrate
 Daktarin - Miconazole nitrate
 Dalacin - Clindamycin HCl
 Dalacin-C - Clindamycin HCl
 Dalalone - Dexamethasone acetate
 Dalaron - Dexamethasone phosphate
 Dalfon - Diosmin
 Dalidyne - Benzethonium chloride
 Dallery - Chlorpheniramine maleate
 Dallery - Phenylephrine HCl
 Dalmadorm - Flurazepam
 Dalmane - Flurazepam
 Dalmate - Flurazepam
 Dalpan - Methixene HCl
 Dalzic - Practolol
 Damoxicil - Amoxicillin
 D-Amp - Ampicillin trihydrate
 Damul - Dimethyl sulfoxide
 Danaden - Nicotiny alcohol
 Danatrol - Danazol
 Dancilin - Pivampicillin
 Daneral - Pheniramine maleate
 Danfenona - Feprazone
 Daniven - Metampicillin sodium
 Danocrine - Danazol
 Danol - Danazol
 Dansul - Methyldopa
 Dantafur - Nitrofurantoin
 Dantamacrin - Dantrolene sodium
 Dantrium - Dantrolene sodium
 Dantrix - Dantrolene sodium

Dapa - Acetaminophen
 Dapaz - Meprobamate
 Dapotum - Fluphenazine HCl
 Daprin - Perhexiline sulfate
 Daranide - Dichlorphenamide
 Daraprim - Pyrimethamine
 Darbid - Isopropamide iodide
 Darcil - Phenethicillin potassium
 Dardex - Isoniazid
 Darenthin - Breylium tosylate
 Daricon - Oxyphenyclimine
 Darifur - Furaltidone
 Darkeyfenac - Alcofenac
 Darmoletten - Bisacodyl
 Darmoletten - Oxyphenisatin acetate
 Darostrep - Streptomycin
 Dartal - Thiopropazate
 Dartalan - Thiopropazate
 Darvocet-N - Propoxyphene HCl
 Darvon - Propoxyphene HCl
 D-Ate - Dextroamphetamine sulfate
 Datriil - Acetaminophen
 Daunoblastin - Daunorubicin
 Daunomycin - Daunorubicin
 DAV - Desmopressin
 Davosin - Sulfamethoxyipyridazine
 Daxauten - Prenylamine
 Daxipen - Amoxicillin
 Daxolin - Loxapine
 Dayto Anase - Bromelain
 DBI - Phenformin
 D-Cillin - Ampicillin trihydrate
 D-Cycloserin - Cycloserine
 DDAVP - Desmopressin
 Deaner - Deanol acetamidobenzoate
 Deanol - Deanol acetamidobenzoate
 Deanosari - Diphenidol
 De Be J - Phenformin
 Debekacyl - Dibekacin
 Debeone - Phenformin
 Deblaston - Pipemidic acid
 Decabacin - Dibekacin
 Decaderm - Dexamethasone phosphate
 Decadron - Dexamethasone phosphate
 Decadron-La - Dexamethasone acetate
 Decadron phosphate - Dexamethasone phosphate
 Decadroxate - Algestone acetophenide
 Decadroxone - Algestone acetophenide
 Deca-Durabolin - Nandrolone decanoate
 Deca-Hybolin - Nandrolone decanoate
 Decalibour - Dexamethasone phosphate
 Deca-Noralone - Nandrolone decanoate
 Decantan - Perphenazine
 Decaprednil - Prednisolone
 Decaseryl - Benzthiazide
 Decaspir - Fenspiride
 Decasterolone - Dexamethasone acetate
 Declinax - Debrisoquin
 Declomycin - Demeclocycline HCl
 Decme - Oxolinic acid
 Decoderm - Dexamethasone acetate
 Decoderm - Fluprednidene acetate
 Decoderme - Fluprednidene acetate
 Decoderme - Fluprednisolone
 Decolan - Desoximetasone
 Decongestant Elixir - Chlorpheniramine maleate
 Deconsal - Guaifenesin
 Deconsal - Phenylephrine HCl
 Decontabs - Phenylephrine HCl
 Decontabs - Phenylpropanolamine HCl
 Decontra
 Decontractyl - Mephenesin
 Decortasmyl - Prednisolone
 Decortin - Prednisone
 Decortisyl - Prednisone
 Decorton - Prednisone
 Dedrogyl - Calcifediol
 Defencin - Isoxsuprine HCl
 Defibrase - Batroxobin
 Deficol - Bisacodyl
 Defiltran - Acetazolamide
 Defirin - Desmopressin
 Deflamene - Formocortical acetate
 Deflamon - Metronidazole
 Deflexol - Zoxazolamine
 Deflogin - Oxyphenbutazone
 Degest - Phenylephrine HCl
 Degest-2 - Naphazoline
 Degidole - Diphenidol
 Degonan - Mazindol
 Dehdopa - Levodopa
 Dehydrobenzperidol - Droperidol
 Deidral - Formocortical acetate
 Deidran - Hydrochlorothiazide
 Deidro cortisone - Prednisone
 Dekinet - Biperiden
 Dekort - Dexamethasone phosphate
 Dektarin - Miconazole nitrate
 Delacillin - Amoxicillin
 Deladine - Sulfamethazine
 Deladumon - Testosterone enanthate
 Delagil - Chloroquine phosphate
 Delakmin - Alfalcidol
 Delakmin - Calcifediol
 Delalutin - Hydroxyprogesterone caproate
 Delatest - Testosterone enanthate
 Delatestryl - Testosterone enanthate
 Delaxin - Methocarbamol
 Delcillin - Ampicillin trihydrate
 Delco-Lax - Bisacodyl
 Delco-Retic - Hydrochlorothiazide
 Delestrogen - Estradiol valerate
 Delgamer - Diethylpropion HCl
 Delipid - Tiadenol
 Deliproct - Clemizole
 Deliva - Clofibrate
 Delladec - Dexamethasone acetate
 Delladec - Dexamethasone phosphate
 Delmeson - Fluorometholone
 Delmofulvina - Griseofulvin
 Delovis - Quingestanol acetate
 Delphicort - Triamcinolone diacetate
 Delsolone - Triamcinolone
 Delsym - Dextromethorphan hydrobromide
 Delta-Cortef - Prednisolone
 Deltacortene - Prednisone
 Deltacortilen - Prednisolone acetate
 Delta Dome - Prednisone
 Delta-Hycortol - Prednisolone
 Delta-Larma - Prednisolone
 Deltalone - Prednisolone
 Deltamine - Pemoline
 Deltan - Dimethyl sulfoxide
 Delta Prenovis - Prednisone
 Deltapyrin - Chlorzoxazone
 Deltasolone - Prednisolone
 Deltasone - Prednisone
 Deltidrosol - Prednisolone
 Deltin - Sulfadimethoxine
 Deltisolon - Prednisolone
 Deltison - Prednisone

- Deltra - Prednisone
 Delvex - Dithiazanine iodide
 Delvinal - Vinbarbital sodium
 Demasorb - Dimethyl sulfoxide
 Demax - Chlophedianol
 Demazin - Chlorpheniramine maleate
 Demebronc - Demeclocycline HCl
 Demeplus - Demeclocycline HCl
 Deme-Proter - Demeclocycline HCl
 Demer-Idine - Meperidine HCl
 Demerol - Meperidine HCl
 Demesco - Dimethyl sulfoxide
 Demetetra - Demeclocycline HCl
 Demetetracilin - Demeclocycline HCl
 Demethotiazine - Fonazine mesylate
 Demetracilina - Demeclocycline HCl
 Demetraclin - Demeclocycline HCl
 Demetrin - Prazepam
 Demi-Regroton - Reserpine
 Demo-Cined - Dextromethorphan hydrobromide
 Demoksil - Amoxicillin
 Demolox - Amoxapine
 Demoplas - Phenylbutazone
 Demotil - Diphenamil methyl sulfate
 Demovis - Quingestanol acetate
 Demser - Metyrosine
 Demsodrox - Dimethyl sulfoxide
 Demulen - Ethinylestradiol
 Demulen - Ethynodiol diacetate
 Denapol - Cinnarizine
 Dencyl - Chlophedianol
 Dendrid - Idoxuride
 Dendrit - Idoxuridine
 Dentocaine - Butethamine
 Dentosmin - Chlorhexidine
 Depamine - Penicillamine
 Deparon - Demexiptiline HCl
 Depcorlutin - Medroxyprogesterone acetate
 Depen - Penicillamine
 D-Epifrin - Dipivefrin
 Depixol - Flupentixol
 Depo-Clinovir - Medroxyprogesterone acetate
 Depoestra - Estradiol cypionate
 Depo-Estradiol - Estradiol cypionate
 Depogen - Estradiol cypionate
 Depogen - Estradiol valerate
 Depolut - Hydroxyprogesterone caproate
 Depo-Medrate - Methylprednisolone
 Depo-Progevera - Medroxyprogesterone acetate
 Depo-Provera - Medroxyprogesterone acetate
 Deposol - Sulfadimethoxine
 Depostomead - Testosterone 17 β -cypionate
 Depotest - Testosterone 17 β -cypionate
 Depo-Testosterone - Testosterone 17 β -cypionate
 Depot-Norphen - Octopamine HCl
 Depotpen - Penicillin G benzathine
 Depot-Progen - Hydroxyprogesterone caproate
 Deprenil - Opipramol
 Deprenyl - Selegiline
 Depress - Imipramine HCl
 Deprestat - Amitriptyline HCl
 Deprex - Dibenzepin HCl
 Deprexan - Desipramine HCl
 Deprinol - Imipramine HCl
 Deprol - Benactyzine hydrochloride
 Deprol - Meprobamate
 Depronal SA - Propoxyphene HCl
 Dep-Test - Testosterone 17 β -cypionate
 Dep-Testosterone - Testosterone 17 β -cypionate
 Deralbine - Miconazole nitrate
 Deralin - Propranolol HCl
 Derantel - Cephalixin
 Derbac - Malathion
 Derfon - Diethylpropion HCl
 Deripen - Ampicillin
 Derizene - Phenylephrine HCl
 Dermabeta - Fluocinolone acetonide
 Dermacort - Fluocinolone acetonide
 Dermacort - Hydrocortisone
 Dermadex - Clobetasol
 Dermadex - Hexachlorophene
 Dermaisom - Fluocinolone acetonide
 Dermalar - Fluocinolone acetonide
 Dermaplus - Fluocinolone acetonide
 Dermaren - Dichlorisone acetate
 Dermialgida - Dimethyl sulfoxide
 Dermil - Fluocinolone acetonide
 Dermisone beclo - Beclomethasone dipropionate
 Dermistina - Diphenhydramine HCl
 Dermizol - Betamethasone benzoate
 Dermobiomar - Fluocinolone acetonide
 Dermodrin - Diphenhydramine HCl
 Dermofil - Fluocinolone acetonide
 Dermo Framan - Fluocinolone acetonide
 Dermohex - Hexachlorophene
 Dermo-Hidrol - Desoximetasone
 Dermojuventus - Tretinoin
 Dermolate - Hydrocortisone
 Dermolin - Fluocinolone acetonide
 Dermomagis - Fluocinolone acetonide
 Dermonistat - Miconazole nitrate
 Dermo-Nydol - Prednisolone acetate
 Dermophyl - Fluocinolone acetonide
 Dermosol - Betamethasone valerate
 Dermotergol - Fluocinolone acetonide
 Dermoval - Clobetasol
 Dermovaleas - Betamethasone
 Dermovaleas - Betamethasone valerate
 Dermovate - Clobetasol
 Dermoxin - Clobetasol
 Deronil - Dexamethasone acetate
 Deronyl - Fominoben HCl
 DES - Diethylstilbestrol
 Desacort-Beta - Betamethasone
 Desal - Furosemide
 Desalark - Dexamethasone phosphate
 Desamon - Benzethonium chloride
 Desclidium - Viquidil
 Descocin - Thiamphenicol
 Desdemin - Furosemide
 Deselazine D - Hydralazine HCl
 Desens - MethylDopa
 Desentol - Diphenhydramine HCl
 Deseril - Methysergide maleate
 Desernil - Methysergide maleate
 Desinflam - Alcofenac
 Desma - Diethylstilbestrol
 Desmanol - Chlorhexidine
 Desobesi - Fenproporex
 Desocort - Chlorhexidine
 Desphen - Chloramphenicol
 Des-Plex - Diethylstilbestrol
 Destral - Dexchlorpheniramine maleate
 Desuric - Benzbromarone
 Desurin - Desmopressin
 Desyrel - Trazodone HCl
 Detensol - Propranolol HCl
 Detigon - Chlophedianol
 Detracin - Demeclocycline HCl
 Detraviss - Demeclocycline HCl

Detreomine - Chloramphenicol
 Detreopal - Chloramphenicol palmitate
 Dettol - 4-Chloro-3,5-xyleneol
 Deturgylone - Prednisolone stearoylglycolate
 Detussin - Guaifenesin
 Devacyclin - Oxytetracycline
 Devacyclin - Tetracycline phosphate complex
 Devaguanil - Sulfaguanidine
 Devaleksin - Cephalixin
 Devamycetin - Chloramphenicol
 Develin - Propoxyphene HCl
 Deverol - Spirinolactone
 Devonian - Pivampicillin
 Dexacen - Dexamethasone acetate
 Dexacen 4 - Dexamethasone phosphate
 Dexacillin - Epicillin
 Dexacilline - Epicillin
 Dexacort - Dexamethasone phosphate
 Dexacortisyl - Dexamethasone acetate
 Dexaderme - Dexamethasone phosphate
 Dexa-Helvacort - Dexamethasone phosphate
 Dexal - Ketoprofen
 Dexalme - Dextroamphetamine sulfate
 Dexambutol - Ethambutol HCl
 Dexamed - Dexamethasone phosphate
 Dexamine - Dextroamphetamine sulfate
 Dexamplex - Dextroamphetamine sulfate
 Dexa Sequels - Dextroamphetamine sulfate
 Dexasone - Dexamethasone phosphate
 Dexaspan - Dextroamphetamine sulfate
 Dexatrim - Phenylpropanolamine HCl
 Dexatrim Extra - Phenylpropanolamine HCl
 Dexbrom - Dexbrompheniramine maleate
 Dexchlor - Dexchlorpheniramine maleate
 Dexedrine sulfate - Dextroamphetamine sulfate
 Dexium - Dobesilate calcium
 Dexmy - Neomycin
 Dexol - Dexpanthenol
 Dextotepa - Timonacic sodium
 Dextphan - Dextromethorphan hydrobromide
 Dextromycin - Chloramphenicol
 D.F.P. - Isoflurophate
 D.H.T. - Dihydrotestosterone
 Diabemide - Chlorpropamide
 Diabet - Chlorpropamide
 Diabetabs - Chlorpropamide
 Diabetasi - Chlorpropamide
 Diabetol - Tolbutamide
 Diabeton - Cephalixin
 Diabeton - Tolbutamide
 Diabetoral - Chlorpropamide
 Diabewas - Tolazamide
 Diabexan - Chlorpropamide
 Diabex-T - Tolbutamide
 Diabinese - Chlorpropamide
 Diabis - Phenformin
 Diabitex - Chlorpropamide
 Diabutos - Tolazamide
 Diaceplex - Diazepam
 Dia-Colon - Lactulose
 Di-Ademil - Hydroflumethiazide
 Diadril - Meclizine HCl
 Diafen - Diphenylpyraline HCl
 Diaforil - Aspirin
 Diafuron - Furazolidone
 Diaginol - Acetrisoate sodium
 Dialag - Diazepam
 Dial-Agesic - Acetaminophen
 Dialens - Chlorhexidine
 Dialferin - Alcuronium chloride
 Dialidene - Furazolidone
 Diamel-Ex - Chlorpropamide
 Diamicron - Gliclazide
 Diamide - Chlorpropamide
 Diaminocillina - Penicillin G benzathine
 Diamox - Acetazolamide
 Dianabol - Methandrostenolone
 Diancina - Pivampicillin
 Diane - Cyproterone acetate
 Diapam - Diazepam
 Diapax - Chlordiazepoxide HCl
 Diapressin - Diazoxide
 Di-Ap-Trol - Phendimetrazine tartrate
 Diarsed - Diphenoxylate HCl
 Diasectral - Acebutolol
 Diasone sodium - Sulfoxone sodium
 Diastal - Bufeniode
 Diaster - Cortivazol
 Diasthmol - Dyphylline
 Diasulfa - Sulfadimethoxine
 Diatensec - Spirinolactone
 Diatol - Tolbutamide
 Diatron - Diazepam
 Diaz - Diazepam
 Diazachel - Chlordiazepoxide HCl
 Diazem - Diazepam
 Diazemuls - Diazepam
 Diazid - Isoniazid
 Diazinol - Sulfadimethoxine
 Diazomid - Acetazolamide
 Di-Azu-Mul - Sulfadiazine
 Dibein - Phenformin
 Dibenzyliline - Phenoxybenzamine HCl
 Dibenzylan - Phenoxybenzamine HCl
 Dibetos - Buformin HCl
 Dibilan - Bumadizon
 Dibilene - Cyclobutylol
 Dibondrin - Diphenhydramine HCl
 Dibophen - Phenformin
 Dibutil - Ethopropazine HCl
 Dicasten - Fentonium bromide
 Dicefalin - Cephadrine
 Dicen - Dicyclomine HCl
 Dichinalex - Chloroquine phosphate
 Dichlor-Stapenor - Dicloxacillin sodium
 Dichlotride - Hydrochlorothiazide
 Dichronic - Diclofenac sodium
 Diclasone - Dichlorisone acetate
 Diclex - Dicloxacillin sodium
 Diclo - Dicloxacillin sodium
 Diclocef - Cephaloridine
 Diclocil - Dicloxacillin sodium
 Diclofenamid - Dichlorphenamide
 Diclomax - Dicloxacillin sodium
 Dicloxapen - Dicloxacillin sodium
 Dicoferin - Nifuroxazide
 Dicopac - Cyanocobalamin
 Dicorvin - Diethylstilbestrol
 Dicromil - Desogestrel
 Dicusat - Warfarin sodium
 Dicycol - Dicyclomine HCl
 Dicynene - Ethamsylate
 Dicynone - Ethamsylate
 Didan - Phenytoin
 Didandin - Diphenadione
 Dideral - Propranolol HCl
 Didoc - Acetazolamide
 Didral - Hydrochlorothiazide
 Didrex - Benzphetamine HCl
 Didrogyll - Calcifediol

- Didromycin - Dihydrostreptomycin sulfate
 Didronel - Etidronate disodium
 Diprothemat - Dihydrostreptomycin sulfate
 Diempax - Diazepam
 Diepin - Medazepam
 Diestreptopab - Dihydrostreptomycin sulfate
 Dietac - Diethylpropanolamine HCl
 Dietec - Diethylpropion HCl
 Dietil-Retard - Diethylpropion HCl
 Dietrim - Phenylpropanolamine HCl
 Difenax - Diphenpyramide
 Difenidolin - Diphenidol
 Difexon - Povidone-iodine
 Difyhdan - Phenytoin
 Difil - Diethylcarbamazine citrate
 Difilina - Dyphylline
 Diflonid - Diflunisal
 Diflunil - Diflunisal
 Diflupyl - Isoflurophate
 Diflurex - Ticrynafen
 Difmecor - Fendiline HCl
 Diforene - Deanol acetamidobenzoate
 Difosfen - Etidronate disodium
 Difosfocin - Citicoline
 Difutrat - Isosorbide dinitrate
 Digetres - Metoclopramide HCl
 Digibutina - Phenylbutazone
 Digi-Complamin - Xanthinol niacinate
 Digicor - Medigoxin
 Digton - Sulpiride
 Dihalog - Halcinonide
 Dihydan - Phenytoin
 Dihydantoin - Phenytoin
 Dihydral - Dihydrotchysterol
 Dihydral - Diphenhydramine HCl
 Dihydran - Hydrochlorothiazide
 Dihydrax - Benzthiazide
 Dihydro-Cidan Sulfato - Dihydrostreptomycin sulfate
 Dihydromycine - Dihydrostreptomycin sulfate
 Dihydrophylline - Dyphylline
 Dihydrostrepto - Dihydrostreptomycin sulfate
 Dihydrostreptofor - Dihydrostreptomycin sulfate
 Dihydrostreptomycin-Rafa - Dihydrostreptomycin sulfate
 Di-Hydrotic - Hydrocortisone
 Diidrotiazide - Hydrochlorothiazide
 Dilabar - Captopril
 Dilabron - Carbuterol
 Dilacoran - Verapamil
 Dilantin - Phenytoin
 Dilar - Paramethasone acetate
 Dilaster - Cortivazol
 Dilatol - Nylidrin
 Dilatol - Tolazoline
 Dilatrate - Isosorbide dinitrate
 Dilatropon - Nylidrin
 Dilaudid - Guaifenesin
 Dilaver - Nylidrin
 Dilazol - Tolazoline
 Diicoran - Pentaerythritol tetranitrate
 Dilexpal - Inositol niacinate
 Diloder - Dichlorisone acetate
 Dilombrin - Dithiazanine iodide
 Dilor - Dyphylline
 Dilosyn - Methdilazine HCl
 Diluran - Acetazolamide
 Dilur G - Guaifenesin
 Dilvax - Ifenprodil tartrate
 Dilydrin - Nylidrin
 Dilzem - Diltiazem HCl
 D.I.M. - Dithiazanine iodide
 Dimacef - Cephadrine
 Dimal - Methylodpa
 Dimapres - Cyclothiazide
 Dimate - Dimenhydrinate
 Dimaten - Tinoridine
 Dimegan - Brompheniramine maleate
 Dimelin - Acetohexamide
 Dimelor - Acetohexamide
 Dimenest - Dimenhydrinate
 Dimeral - Demeclocycline HCl
 Dimetane - Brompheniramine maleate
 Dimetane-D.C. - Phenylpropanolamine HCl
 Dimetapp - Brompheniramine maleate
 Dimetossilina - Sulfadimethoxine
 Dimetossin - Sulfadimethoxine
 Dimetoxan - Sulfadimethoxine
 Dimetoxin - Sulfadimethoxine
 Dimexin - Sulfadimethoxine
 Dimidril - Diphenhydramine HCl
 Dimipressin - Imipramine HCl
 Dimocillin - Methicillin sodium
 Dimotane - Brompheniramine maleate
 Dimyrl - Isoaminile
 Dinacrin - Isonazid
 Dinaplex - Flunarizine HCl
 Dinasint - Cephaloridine
 Dinestrol - Dienestrol
 Dintoina - Phenytoin
 Dioctocal - Docusate calcium
 Dinulcid - Oxametacine
 Dioderm - Hydrocortisone
 Diogenal - Methitalur
 Diogyn-E - Ethinyloestradiol
 Diol-20 - Estradiol valerate
 Diolene - Carisoprodol
 Diopine - Dipivefrin
 Diosmil - Diosmin
 Diosminil - Diosmin
 Diossidone - Phenylbutazone
 Dioval - Estradiol valerate
 Diovenor - Diosmin
 D.I.P. - Diethylpropion HCl
 Dipam - Diazepam
 Di-Paralene - Chlorcyclizine
 Dipaxin - Diphenadine
 Dipect - Pipazethate
 Dipendrate - Dimenhydrinate
 Diphentyn - Phenytoin
 Diphergan - Promethazine HCl
 Diphos - Etidronate disodium
 Diphosponat - Etidronate disodium
 Dipidolor - Piritramide
 Dipiperon - Pipamperone
 Dipirartril - Dimethyl sulfoxide
 Dipramat Infantil - Acetaminophen
 Dipramid - Isopropamide iodide
 Diproderm - Betamethasone dipropionate
 Diprogenta - Betamethasone dipropionate
 Diprolene - Betamethasone dipropionate
 Diprophylline - Dyphylline
 Diprosalic - Betamethasone dipropionate
 Diprosone - Betamethasone
 Diprosone - Betamethasone dipropionate
 Diprostene - Betamethasone
 Diprostene - Betamethasone dipropionate
 Dipyrida - Dipyridamole
 Dira - Spironolactone

Diram - Propiram fumarate
 Dirastan - Tolbutamide
 Direma - Hydrochlorothiazide
 Diretan - Isosorbide dinitrate
 Dirox - Acetaminophen
 Dirureticom-Holzinger - Acetazolamine
 Diryrtmin - Disopyramide phosphate
 Disadine - Povidone-iodine
 Disal - Furosemide
 Disaloc - Disopyramide phosphate
 Discase - Chymopapain
 Disebrin - Heparin
 Dismaren - Cinnarizine
 Disoderm - Dichlorisone acetate
 Disomer - Dexbrompheniramine maleate
 Disophrol - Dexbrompheniramine maleate
 Diso-Tate - Edetate disodium
 Disoxyl - Tiocarlide
 Disron - Hydroxyzine HCl
 Dissenten - Loperamide HCl
 Distaclor - Cefaclor
 Distamine - Penicillamine
 Distaquaine - Penicillin G procaine
 Distasol - Ectylurea
 Distilbene - Diethylstilbestrol
 Disulone - Dapsone
 Disyncran - Methdilazine HCl
 Ditan - Phenytoin
 Ditate - Estradiol valerate
 Diteriam - Benzthiazide
 Dithiazid - Hydrochlorothiazide
 Ditrizin - Triamcinolone
 Ditropan - Oxybutynin chloride
 Ditubin - Isoniazid
 Diubram - Chlorothiazide
 Diucardin - Hydroflumethiazide
 Diucardyn - Mercaptopmerin sodium
 Diuchlor H - Hydrochlorothiazide
 Diucholin - Hydralazine HCl
 Diu-Hydrin - Trichlormethiazide
 Diulo - Metolazone
 Diumide - Furosemide
 Diupres - Chlorothiazide
 Diupres - Reserpine
 Diural - Furosemide
 Diuramid - Acetazolamide
 Diurapid - Azosemide
 Diurene - Triamterene
 Diuresal - Furosemide
 Diurese - Trichloromethiazide
 Diuret - Chlorothiazide
 Diurex - Xipamid
 Diurexan - Xipamid
 Diuril - Chlorothiazide
 Diurilix - Chlorothiazide
 Diuriwas - Acetazolamide
 Diurix - Furosemide
 Diurnal penicillin - Penicillin G procaine
 Diurogen - Hydrochlorothiazide
 Diurolasa - Furosemide
 Diurone - Chlorothiazide
 Diurophylline - Dyphylline
 Diursana H - Hydrochlorothiazide
 Diusemide - Furosemide
 Diutensin - Reserpine
 Diuzol - Furosemide
 Divalvon - Pyritinol
 Divercillin - Ampicillin trihydrate
 Dividol - Viminol
 Divinoctal - Methaqualone
 Dixarit - Clonidine HCl
 Dixiben - Nalidixic acid
 Dixidrasi - Hydrochlorothiazide
 Dixurol - Nalidixic acid
 Dizam - Diazepam
 Dobacen - Diphenhydramine HCl
 Dobesin - Diethylpropion HCl
 Dobesiphar - Dobesilate calcium
 Dobetin - Cyanocobalamin
 Dobevitina - Cyanocobalamin
 Dobren - Sulpiride
 Dobuject - Dobutamine
 Doburil - Cyclothiazide
 Dobutrex - Dobutamine
 Docell - Diclufenac sodium
 Docetasan - Cyanocobalamin
 Docevita - Hydroxocobalamin
 Docibin - Cyanocobalamin
 Dociton - Propranolol HCl
 Docivit - Cyanocobalamin
 Doctamicina - Chloramphenicol
 Doctamicina - Metampicillin sodium
 Dodecabee - Cyanocobalamin
 Dodecavite - Cyanocobalamin
 Dodex - Cyanocobalamin
 Dogmatil - Sulpiride
 Doimazin - Chlorpromazine HCl
 Dokasapan - Doxepin HCl
 Doksilin - Amoxicillin
 Doktacillin - Ampicillin
 Dolamin - Acetaminophen
 Doianex - Acetaminophen
 Dolanquifa - Meperidine HCl
 Dolantin - Meperidine HCl
 Dolat - Doxepin HCl
 Dolcol - Pipermidic acid
 Dolcontral - Meperidine HCl
 Dolene-65 - Propoxyphene HCl
 Dolestan - Diphenhydramine HCl
 Dolestine - Meperidine HCl
 Dolevern - Hydroxocobalamin
 Dolgenal - Zomepirac
 Dolibrax - Chlordiazepoxide HCl
 Dolibrax - Clidinium bromide
 Dolicaïne - Lidocaine
 Dolipol - Tolbutamide
 Doliprane - Acetaminophen
 Dolobid - Diflunisal
 Dolobis - Diflunisal
 Doloneurin - Meperidine HCl
 Dolopethin - Meperidine HCl
 Dolophine - Methadone HCl
 Dolosal - Meperidine HCl
 Doloxene - Propoxyphene HCl
 Dolprone - Acetaminophen
 Dolwas - Zomepirac
 Domalium - Diazepam
 Domar - Pinazepam
 Domecin - Methyldopa
 Domical - Amitriptyline HCl
 Domicillin - Ampicillin
 Dominal - Prothipendyl HCl
 Domion - Sulfisomidine
 Domnamid - Estazolam
 Domofate - Dextroamphetamine sulfate
 Domolene-HCl - Hydrocortisone
 Dompil - Metampicillin sodium
 Domucortone - Prednisolone
 Domupirina - Aspirin
 Domureuma - Fentiazac

Donatussin - Chlorpheniramine maleate
 Donatussin - Guaifenesin
 Donatussin - Phenylephrine HCl
 Donjust-B - Ibuprofen
 Donmox - Acetazolamide
 Donopon-GP - Metoclopramide HCl
 Donorest - Fentiazac
 Dopacin - Levodopa
 Dopaflex - Levodopa
 Dopaidan - Levodopa
 Dopalfher - Levodopa
 Dopamet - Methylidopa
 Dopamin - Methylidopa
 Dopar - Levodopa
 Doparkin - Levodopa
 Doparkine - Levodopa
 Doparl - Levodopa
 Dopasol - Levodopa
 Dopason - Levodopa
 Dopaston - Levodopa
 Dopatec - Methylidopa
 Dopegyt - Methylidopa
 Dopom - Guanethidine sulfate
 Dopram - Doxapram HCl
 Doracil - Mefenorex HCl
 Dorcol - Guaifenesin
 Dorex - Oxeladin
 Doricum - Fluciclonolone acetamide
 Doriden - Glutethimide
 Doridene - Glutethimide
 Dormabrol - Meprobamate
 Dormate - Mebutamate
 Dormatylan - Secobarbital sodium
 Dorme - Promethazine HCl
 Dormethan - Dextromethorphan hydrobromide
 Dormicum - Midazolam maleate
 Dormicum - Nitrazepam
 Dormigoa - Methaqualone
 Dormir - Methaqualone
 Dormona - Secobarbital sodium
 Dormonid - Midazolam maleate
 Dormonoct - Loprazolam
 Dormo-Puren - Nitrazepam
 Dormutil - Methaqualone
 Dorsacaine HCl - Benoxinate hydrochloride
 Dorsiflex - Mephenoqualone
 Doryl - Carbachol
 Dosalupent - Metaproterenol sulfate
 Dosberotec - Fenoterol hydrobromide
 Dosulfim - Sulfamerazine
 Doval - Diazepam
 Dow-Chlorpheniramine - Chlorpheniramine maleate
 Dow-Isoniazid - Isoniazid
 Downmycin - Erythromycin
 Dow-Sulfisoxazole - Sulfisoxazole
 Doxal - Doxepin HCl
 Doxapril - Doxapram HCl
 Doxedyn - Doxepin HCl
 Doxergan - Oxomemazine
 Doxidan - Docusate calcium
 Doxi-OM - Dobesilate calcium
 Doxitar - Doxycycline
 Doxium - Dobesilate calcium
 Doxy - Doxycycline
 Doxy 200 - Doxycycline
 Doxylin - Doxycycline
 Doxy-Puren - Doxycycline
 Doxyremed - Doxycycline
 Doxytrex - Dobesilate calcium
 Dozar - Methapyrilene HCl
 Dragosil - Creatinolfosfat
 Drazine - Hydralazine HCl
 Dramaban - Dimenhydrinate
 Drama Ject - Diphenhydramine HCl
 Dramamine - Dimenhydrinate
 Dramarr - Dimenhydrinate
 Dramavir - Dimenhydrinate
 Dramavol - Dimenhydrinate
 Dramcillin-S - Phenethicillin potassium
 Draminol - Diphenhydramine HCl
 Dramion - Glucalazide
 Dramocen - Dimenhydrinate
 Drauxin - Brompheniramine maleate
 Draximox - Amoxicillin
 Dreimicina - Erythromycin estolate
 Drenian - Diazepam
 Drenison - Flurandrenolide
 Drenusil - Polythiazide
 Dridol - Droperidol
 Drimyl - Etodroxizine
 Drisentin - Dipyrindamole
 Drislin - Ampicillin
 Dristan - Oxymetazoline HCl
 Dristan - Pheniramine maleate
 Dristan - Phenylephrine HCl
 Dristan - Propylhexedrine
 Drixoral - Dexbrompheniramine maleate
 Drize - Chlorpheniramine maleate
 Drocort - Flurandrenolide
 Droctil - Exiproben
 Drogeuil - Flutamide
 Droiban - Dromostanolone propionate
 Droleptan - Droperidol
 Dromisol - Dimethyl sulfoxide
 Dromyl - Dimenhydrinate
 Droncit - Praziquantel
 Drossadin - Hexetidine
 Droxacepam - Oxazepam
 Droxan - Bufexamac
 Droxarol - Bufexamac
 Droxicef - Cefadroxil
 Droxine La - Dyphylline
 Droxone - Algestone acetophenide
 Dryllystan - Diphenhydramine HCl
 Dryptal - Furosemide
 D-Siklin - Demeclocycline HCl
 Dual-Xol - Pyridinol carbamate
 Duanox - Chenodiol
 Duaxol - Pyridinol carbamate
 Ducene - Diazepam
 Ducobee - Cyanocobalamin
 Ducobee-Hy - Hydroxocobalamin
 Duecap - Methacycline
 Dufaston - Dydrogesterone
 Dugodol - Diflunisal
 Duksen - Diazepam
 Dulasi - Suloctidil
 Dulcolax - Bisacodyl
 Dulicaine - Lidocaine
 Duloctil - Suloctidil
 Dumolid - Nitrazepam
 Dumone - Methyltestosterone
 Dumopen - Ampicillin trihydrate
 Dumoxin - Doxycycline
 Duna - Pinazepam
 Duncaine - Lidocaine
 Duofilm - Salicylic acid
 Duogastone - Carbenoxolone
 Duolip - Etofylline clofibrate

- Duoluton - Norgestrel
 Duosetil - Tridihexethyl iodide
 Duotrate - Pentaerythritol tetranitrate
 Duphalac - Lactulose
 Duphaston - Hydrogesterone
 Duplaciolina - Methacycline
 Durabiotic - Penicillin G benzathine
 Durabolin - Ethylestrenol
 Durabolin - Nandrolone phenpropionate
 Duracef - Cefadroxil
 Duracillin - Penicillin G procaine
 Dura Doxal - Doxycycline
 Dura Erythromycin - Erythromycin stearate
 Dura-Estate - Estradiol valerate
 Dura-Estradiol - Estradiol valerate
 Duramen - Ethinylestradiol
 Durametacin - Indomethacin
 Duramicina - Methacycline
 Duramid - Sulfadimethoxine
 Dur Ampicillin - Ampicillin trihydrate
 Duramycin - Demeclocycline HCl
 Duramycin - Dibekacin
 Duramycin - Gentamicin sulfate
 Durandro - Testosterone 17 β -cypionate
 Duranest - Etidocaine HCl
 Duranitate - Isosorbide dinitrate
 Durapred - Prednisolone acetate
 Dura Silymarin - Silymarin
 Duraspiron - Spironolactone
 Durasul - Sulfamethoxy pyridazine
 Durasulf - Sulfachlorpyridazine
 Dura-Tap - Brompheniramine maleate
 Dura-Testate - Testosterone enanthate
 Duratesterone - Testosterone enanthate
 Dura-Tetracyclin - Oxytetracycline
 Duration - Oxymetazoline HCl
 Duratrad - Estradiol valerate
 Dura-Vent - Guaifenesin
 Dura-Vent - Phenylephrine HCl
 Dura Vent - Phenylpropanolamine HCl
 Durazepam - Oxazepam
 Durel-Cort - Hydrocortisone
 Duremesan - Meclizine HCl
 Durenat - Sulfameter
 Durenate - Sulfameter
 Duricef - Cefadroxil
 Durmetan - Metampicillin sodium
 Durolax - Bisacodyl
 Duromine - Phentermine HCl
 Durrax - Hydroxyzine HCl
 Dusodril - Nafronyl oxalate
 Duspatal - Mebeverine HCl
 Duspatalin - Mebeverine HCl
 Duvadilan - Isosuprine HCl
 Duvaline - Pyridinol carbamate
 Duvold - Bethanechol chloride
 Duxima - Cefuroxime
 DV - Dienestrol
 Dyazide - Hydrochlorothiazide
 Dyazide - Triamterene
 Dycill - Dicloxacillin sodium
 Dyclone - Dyclonine HCl
 Dyflex - Dyphylline
 Dygraty - Dihydrotachysterol
 Dylate - Papaverine monophosphadenine
 Dymadon - Acetaminophen
 Dymelor - Acetohexamide
 Dymenol - Dimenhydrinate
 Dymoperazine - Trifluoperazine
 Dynalase - Chlorpropamide
 Dynalert - Pemoline
 Dynamicin - Methacycline
 Dynapen - Dicloxacillin sodium
 Dynaprin - Imipramine HCl
 Dyneric - Clomiphene dihydrogen citrate
 Dynese - Magaldrate
 Dyprin - Methionine
 Dyrenium - Triamterene
 Dyrexan - Phendimetrazine tartrate
 Dysedon - Oxomemazine
 Dyspas - Dicyclomine HCl
 Dyspnoesan - Isoproterenol sulfate
 Dystoid - Meprobamate
 Dytac - Triamterene
 Dytide - Benzthiazide
 EACA - Aminocaproic acid
 Easpin - Aspirin
 Eatan-N - Nitrazepam
 Ebalin - Brompheniramine maleate
 Ebalin - Dexbrompheniramine maleate
 Ebelin - Inositol niacinat
 Ebrantil - Urapidil
 Ebufac - Ibuprofen
 Ebutol - Ethambutol HCl
 Ecasil - Aspirin
 Ecatril - Dibenzepin HCl
 EC-Doparyl - Benserazide
 Echnatol - Cyclizine
 Echoiodide - Echothiopate iodide
 Ecobutazone - Phenylbutazone
 Ecolid chloride - Chlorisondamine chloride
 Econapred - Prednisone acetate
 Econochlor sol - Chloramphenicol
 Economyclin - Tetracycline
 Ecoprin - Aspirin
 Ecosone - Hydrocortisone
 Ecosporina - Cephradine
 Ecostat - Econazole nitrate
 Ecotrin - Aspirin
 Ecoval - Betamethasone valerate
 Ecuaniil - Meprobamate
 E-Cypionate - Estradiol cypionate
 Eczil - Triamcinolone
 Edecril - Ethacrynic acid
 Edecrin - Ethacrynic acid
 Edecrine - Ethacrynic acid
 Edelel - Diperidolate
 Edemax - Benzthiazide
 Edemox - Acetazolamide
 Edenal - Meprobamate
 Ederal - Cinnarizine
 Edoxana - Cyclophosphamide
 Edrol - Ethinylestradiol
 Edrul - Muzolimine
 Efcortelan - Hydrocortisone
 Efcortisol - Hydrocortisone sodium phosphate
 Effederm - Tretinoin
 Effergal - Acetaminophen
 Effisax - Tybamate
 Efflumidex - Fluorometholone
 Effortil - Etilefrine pivalate HCl
 Eforan - Metronidazole
 Efnicol - Thiamphenicol
 Efodine - Povidone-iodine
 Efenix - Amoxicillin
 Efrane - Enflurane
 Eftapan - Eprazinone HCl
 Eftoron - Mepenzolate bromide
 Efuldex - Fluorouracil

Efudix - Fluorouracil
 Eggobesin - Propylhexedrine
 Eglen - Cinnarizine
 Eglyonil - Sulpiride
 Egocappol - Salicylic acid
 Egocin - Oxytetracycline
 Egocort - Hydrocortisone
 Ehrtolan - Fluorometholone
 Einalon S - Haloperidol
 Eins-Alpha - Alfalcaldol
 E-Ionate - Estradiol cypionate
 Ejor - Kebuzone
 Ekaprol - Aminocaproic acid
 Ekaton - Fluocinolone acetonide
 Ektebin - Protionamide
 Ektyl - Ectylurea
 Ekvacilline - Cloxacillin
 Elaciclina - Oxytetracycline
 Elamol - Tofenacin HCl
 Elarzone - Pipebuzone
 Elase - Fibrinolysin
 Elasten 200 - Ciclonicate
 Elasterin - Fenofibrate
 Elatrol - Amitriptyline HCl
 Elatrolet - Amitriptyline HCl
 Elavil - Amitriptyline HCl
 Elavil HCl - Amitriptyline HCl
 Elcitonin - Calcitonin
 Eldec - Ferrous fumarate
 Eldec - Folic acid
 Eldepryl - Selegiline
 Eldercaps - Folic acid
 Eldia - Cephaloridine
 Eldisin - Vindesine
 Eldisine - Vindesine
 Eldopaque - Hydroquinone
 Eldopar - Levodopa
 Eldopatec - Levodopa
 Eidoquin - Hydroquinone
 Elenium - Chlordiazepoxide HCl
 Elestol - Chloroquine phosphate
 Eletuss - Cllophedianol
 Eleven-K - Phytionadione
 Elietin - Metoclopramide HCl
 Eliranol - Promazine HCl
 Elist - Valethamate bromide
 Elkamicina - Demeclocycline HCl
 Elkapin - Etazolol
 Elkosin - Sulfisomidine
 Ellecid - Cloxacillin
 Ellecillina - Methicillin sodium
 Ellepibina - Iproniazid
 Ellipten - Aminoglutethimide
 Elmarine - Chlorpromazine HCl
 Elmedal - Phenylbutazone
 Elmizin - Dithiazanine iodide
 Elosine - Sulfisomidine
 Elperl - Alprenolol HCl
 Elrodorm - Glutethimide
 Eironon - Noxiptilin
 Elsper - Asparaginase
 Eltroxin - Levothyroxine sodium
 Eludril - Chlorhexidine
 Elumonon - Syrosingopine
 Elyzol - Metronidazole
 Elzogram - Cefazolin sodium
 Embarin - Allopurinol
 EMB-Fatol - Ethambutol HCl
 Embolex - Heparin
 Embutol - Ethambutol HCl
 Emcortina - Fluprednidene acetate
 Emcyt - Estramustine phosphate
 Emedur - Trimethobenzamide HCl
 Emedyl - Dimenhydrinate
 Emepride - Bromopride
 Emerazina - Sulfadimethoxine
 Emergil - Flupentixol
 Emesa - Metoclopramide HCl
 Emeside - Ethosuximide
 Emete-Con - Benzquinamide
 Emetisan - Metoclopramide HCl
 Emichloline - Citicoline
 Emil - Silymarin
 Emilian - Citicoline
 Emisin - Erythromycin stearate
 Emitolon - Ubidecarenone
 Emivan - Ethamivan
 Emko - Nonoxynol
 Emmetip - Methylprednisolone
 Emodinamin - Xanthinol niacinat
 Emoren - Oxethazine
 Emorhalt - Tranexamic acid
 Emoril - Bromopride
 Emotion - Lorazepam
 Emotival - Lorazepam
 Emovit - Viloxazine HCl
 Empecid - Clotrimazole
 Emperal - Metoclopramide HCl
 Empirin - Aspirin
 Emtexate - Methotrexate
 Emthexate - Methotrexate
 E-Mycin - Erythromycin
 E-Mycin - Erythromycin stearate
 Emyrenil - Oxolinic acid
 Enadel - Cloxazolam
 Enadine - Clorazepate dipotassium
 Enarmon - Testosterone enanthate
 Enavid - Mestranol
 Enbol - Pyritinol
 Encare Oval - Nonoxynol
 Encebrovit - Pyritinol
 Encefabol - Pyritinol
 Encefalux - Piracetam
 Encefort - Pyritinol
 Encephan - Methandrostenolone
 Encerebron - Pyritinol
 Encortolone - Prednisolone
 Endak - Carteolol
 Endep - Amitriptyline HCl
 Endequil - Chlordiazepoxide HCl
 Endocistobil - Iodipamide
 Endoeritrin - Erythromycin
 Endoeritrin - Erythromycin estolate
 Endografin - Iodipamide
 Endokolat - Bisacodyl
 Endol - Indomethacin
 Endomet - Indomethacin
 Endomixin - Neomycin
 Endo-Paractol - Dimethicone
 Endopituitrina - Oxytocin
 Endoprin - Heparin
 Endospirin - Aspirin
 Endosporol - Cephaloridine
 Endoxan - Cyclophosphamide
 Endrate disodium - Edetate disodium
 Endsetin - Indomethacin
 Enduronyl - Deserpidine
 Endyol - Aspirin
 Enebiotico - Cephaloridine
 Enelfa - Acetaminophen

- Enerbol - Pyritinol
 Enerzer - Isocarboxazid
 Enexina - Nalidixic acid
 Enidrel - Oxazepam
 Enjit - Hydroflumethiazide
 Enkefal - Phenytoin
 Enobrin - Medazepam
 Enovid - Mestranol
 Enovid - Norethynodrel
 Enovid-E - Mestranol
 Enovil - Amitriptyline HCl
 Enseals - Aminosalicyclic acid
 Ensidon - Opipramol
 Ensign - Citicoline
 E.N.T. - Phenylephrine HCl
 E.N.T. - Phenylpropanolamine HCl
 Entab - Aspirin
 Entamidine - Sulfisomidine
 Entelohl - Protionamide
 Entera-Strept - Dihydrostreptomycin sulfate
 Entericin - Aspirin
 Enterocura - Sulfaguanoil
 Enterokanacin - Kanamycin sulfate
 Enterokod - Nifuroxazide
 Enterosarine - Aspirin
 Enterosteril - Phthalylsulfathiazole
 Enterostop - Bacitracin
 Enteroxon - Furazolidone
 Entex - Guaifenesin
 Entex - Phenylephrine HCl
 Entex - Phenylpropanolamine HCl
 Entizol - Metronidazole
 Entolon - Nalidixic acid
 Entomin - Carnitine
 Entoquel - Thihexinol
 Entra - Triprolidine
 Entrophen - Aspirin
 E.N.T. Syrup - Brompheniramine maleate
 Enturen - Sulfinpyrazone
 Entuss - Guaifenesin
 Entusul - Sulfisoxazole
 Entyderma - Beclomethasone dipropionate
 Envarese - Polythiazide
 Enviro-Stress - Folic acid
 Enzactin - Triacetin
 Enzaprost - Dinoprost tromethamine
 Eocill B12 - Cyanocobalamin
 Epalfen - Lactulose
 E-Pam - Diazepam
 Epanutin - Phenytoin
 Eparfit - Silymarin
 Eparina - Heparin
 Eparinoral - Heparin
 Eparinovis - Heparin
 Epatiol - Tiopronin
 Epatolark - Fenipentol
 Epha - Dimenhydrinate
 Ephed-Organidin - Methapyrilene HCl
 Ephemet - Phendimetrazine tartrate
 Epepect - Phenyltoloxamine
 Epi-Aberel - Tretinoin
 Epicain Ace - Dyclonine HCl
 Epidione - Trimethadione
 Epidosin - Valethamate bromide
 Epidropal - Allopurinol
 Epikur - Meprobamate
 Epileo-Petitmal - Ethosuximide
 Epi-Monistat - Miconazole nitrate
 Epinal - Alcofenac
 Epinal - Epinephryl borate
 Epinal - Ibuprofen
 Epinat - Phenytoin
 Epi-Pevaryl - Echonazole nitrate
 Epirocain - Dyclonine HCl
 Epitopic - Difluprednate
 E.P. Mycin - Oxytetracycline
 Epo-Bon - Cyclobutyril
 Epobron - Ibuprofen
 Epocol - Prenylamine
 Epokuhl - Chlorpromazine HCl
 Epontol - Propanidid
 Eposelin - Ceftizoxime
 Eppy - Epinephryl borate
 Eprazin - Pyrazinamide
 Eprox - Fenipentol
 Epsikapron - Aminocaproic acid
 Epsilon - Aminocaproic acid
 Epsilon-Aminoca - Aminocaproic acid
 Epsyl - Piprozolin
 Eptadone - Methadone HCl
 Eputes - Ibuprofen
 Equagesic - Ethoheptazine
 Equagesic - Meprobamate
 Equal - Aspartame
 Equanil - Meprobamate
 Equibar - Methyldopa
 Equibral - Chlordiazepoxide HCl
 Equ Bute - Phenylbutazone
 Equilibrin - Amitriptylin oxide
 Equilid - Sulpiride
 Equipur - Vincamine
 Eracine - Rosoxacin
 Eradacil - Rosoxacin
 Eradacin - Rosoxacin
 Eraldin - Practolol
 Eraldine - Practolol
 Erantin - Propoxyphene HCl
 Eratrex - Erythromycin stearate
 Erbacort - Prednisolone stearoylglycolate
 Erbaprelina - Pyrimethamine
 Erbasoma - Carisoprodol
 Erbocain - Fomocaine
 Ercefuryl - Nifuroxazide
 Ercofer - Ferrous fumarate
 Ercolax - Bisacodyl
 Ercouquin - Hydroxychloroquine sulfate
 Ercoril - Propantheline bromide
 Ercostrol - Methallenestril
 Ertamin - Cyanocobalamin
 Ertopred - Prednisone
 Ergamisol - Levamisole HCl
 Ergotrate - Methyletergonovine maleate
 Erholen - Citicoline
 Eributazone - Phenylbutazone
 Ericol - Thiamphenicol
 Eridan - Diazepam
 Erifalecin - Cephalixin
 Erimec - Erythromycin estolate
 Erimin - Nimetazepam
 Erina - Meprobamate
 Eriscel - Erythromycin estolate
 Erispan - Fludiazepam HCl
 Erisul - Erythromycin stearate
 Erital - Diazepam
 Eritonormo - Erythromycin
 Erito-Wolf - Erythromycin Estolate
 Eritral - Erythromycin stearate
 Eritrazon - Erythromycin estolate
 Eritro - Erythromycin stearate
 Eritrobios - Erythromycin

Eritrobitic - Erythromycin estolate
 Eritrocin - Erythromycin estolate
 Eritrodes - Erythromycin estolate
 Eritrolag - Erythromycin stearate
 Eritron - Cyanocobalamin
 Eritroveinte - Erythromycin estolate
 Eritrovit B12 - Cyanocobalamin
 Ermysin - Erythromycin estolate
 Ermysin S - Erythromycin stearate
 Eroctin - Cephalixin
 Erostin - Erythromycin stearate
 Erpalfa - Cytarabine HCl
 Errolon - Furosemide
 Ertonyl - Ethinylestradiol
 Eryc - Erythromycin
 Erycinum - Erythromycin
 Erycinum - Erythromycin gluceptate
 Erycylot - Cyanocobalamin
 Erycylot - Hydroxocobalamin
 Eryderm - Erythromycin
 Erymax - Erythromycin
 Ery-Max - Erythromycin
 Erymycin - Erythromycin stearate
 Eryprim - Erythromycin stearate
 Ery-Tab - Erythromycin
 Erythran - Erythromycin stearate
 Erythrocin - Erythromycin
 Erythrocin - Erythromycin stearate
 Erythrocin Piggyback - Erythromycin lactobionate
 Erythromyctine - Erythromycin estolate
 Erythro-S - Erythromycin stearate
 Erythro ST - Erythromycin
 Erythro-Teva - Erythromycin stearate
 Ery-Toxinal - Erythromycin estolate
 Erytrarco - Erythromycin estolate
 Erytro-Prot - Erythromycin estolate
 Esacinone - Fluocinolone acetonide
 Esametone - Methylprednisolone
 Esanbutol - Ethambutol HCl
 Esapenil B.G. - Methicillin sodium
 Esarondil - Methacycline
 Esberidin - Vincamine
 Esbufon - Norfenefrine
 Escabiol - Lindane
 Escarmine - Silymarin
 Esclama - Nimorazole
 Escoflex - Chlorzoxazone
 Escofuron - Nitrofurazone
 Eselin - Ethamsylate
 Esentil - Dicyclomine HCl
 Esfar - Bucloxic acid
 Esidrex - Hydrochlorothiazide
 Esidrix - Hydrochlorothiazide
 Esilgan - Estazolam
 Esilon - Fluocinolone acetonide
 Esimil - Hydrochlorothiazide
 Eskacef - Cephradine
 Eskaserp - Reserpine
 Eskotrin - Aspirin
 Esmail - Medazepam
 Esmarin - Trichlormethiazide
 Esmezin - Cephalixin
 Esmind - Chlorpromazine HCl
 Esocalm - Dixyrazine
 Esoidrina - Hydrochlorothiazide
 Espectrosina - Gentamicin sulfate
 Espectrosira - Ampicillin
 Esperal - Disulfiram
 Esperson - Desoximetasone
 Espimin-Cilin - Ampicillin trihydrate
 Espiran - Fenspiride
 Esquilin - Methacycline
 Esquinon - Carboquone
 Esracain - Lidocaine
 Estalor - Mestranol
 Estan - Dienestrol
 Estan - Methyltestosterone
 Estate - Estradiol valerate
 Estigyn - Ethinyl estradiol
 Estilbin - Diethylstilbestrol
 Estilsona - Prednisolone stearoylglycolate
 Estinyl - Ethinylestradiol
 Estracyt - Estramustine phosphate
 Estradurin - Polyestradiol phosphate
 Estraguard - Dienestrol
 Estral-L - Estradiol valerate
 Estra Plex - Hexestrol
 Estraval PA - Estradiol valerate
 Estrene - Hexestrol
 Estrepto E - Streptomycin
 Estrepto Level - Streptomycin
 Estreptoluy - Dihydrostreptomycin sulfate
 Estreptomade - Streptomycin
 Estreptomycin - Streptomycin
 Estreptomycin Norman - Streptomycin
 Estrepto Wolner - Streptomycin
 Estriadin - Adenosine triphosphate
 Estro-Cyp - Estradiol cypionate
 Estrofem - Estradiol cypionate
 Estromed-PA - Estradiol cypionate
 Estromycin - Erythromycin
 Estrosyn - Diethylstilbestrol
 Estrovis - Quinestrol
 Estulic - Guanfacine
 Esucos - Dixyrazine
 Etacort - Hydrocortamate HCl
 Eta-Cortilen - Dexamethasone phosphate
 Etacortin - Fluprednidene acetate
 Etadrol - Fluprednisolone
 Etalpha - Alfalcidol
 Etambrin - Ethambutol HCl
 Etambutol Beta - Ethambutol HCl
 Etambutul - Ethambutol HCl
 Etapiam - Ethambutol HCl
 Etbutol - Ethambutol HCl
 Ethamide - Ethoxzolamide
 Ethanis - Bisacodyl
 Ethimide - Ethionamide
 Ethinamin - Ethionamide
 Ethinyl Oestradiol - Ethinylestradiol
 Ethiocidan - Ethionamide
 Ethiodan - Iophendylate
 Ethochlon - Oxeladin
 Ethrane - Enflurane
 Ethryn - Erythromycin stearate
 Ethyfron - Etilefrine pivalate HCl
 Ethymal - Ethosuximide
 Etibi - Ethambutol HCl
 Eticyclol - Ethinylestradiol
 Etidron - Etidronate disodium
 Etifollin - Ethinylestradiol
 Eti-Puren - Etilefrine pivalate HCl
 Etivex - Ethinylestradiol
 Etofen Ifi - Terofenamate
 Etomal - Ethosuximide
 Etopalin - Exiptoben
 Etopinil - Etozolin
 Etoscol - Hexoprenaline
 Etrafon - Perphenazine
 Eucardion - Prenylamine

- Eucilat - Benfurodil hemisuccinate
 Eucistin - Nalidixic acid
 Euciton - Domperidone
 Eucol - Arginine glutamate
 Euctan - Tolonidine nitrate
 Eudemine - Diazoxide
 Eudyna - Tretinoin
 Eufusol - Mannitol
 Eugynon - Norgestrel
 Euhypnos - Temazepam
 Eukystol - Haloperidol
 Eulaxan - Bisacodyl
 Eulaxin - Oxyphenisatin acetate
 Eulip - Tiadenol
 Eumental - Piracetam
 Eumotol - Bumadizon
 Eunephran - Buthiazide
 Eunerpan - Melitracen
 Eupen - Amoxicillin
 Euphorin - Diazepam
 Eupneron - Eprozinol
 Eupramin - Imipramine HCl
 Euralan - Fenipentol
 Eurax - Crotamiton
 Euraxil - Crotamiton
 Euroceptor - Cimetide
 Eurocillin - Ampicillin
 Euro-Cir - Norfenefrine
 Eurodin - Estazolam
 Eurodopa - Levodopa
 Eurosas - Diazepam
 Eusaprim - Trimethoprim
 Euspirax - Choline theophyllinate
 Eusulpid - Sulpiride
 Euteberol - Spironolactone
 Eutensin - Furosemide
 Euthyrox - Levothyroxine sodium
 Eutimox - Fluphenazine HCl
 Eutirox - Levothyroxine sodium
 Eutisone - Methylprednisolone
 Eutizon - Isoniazid
 Eutonyl - Pargyline HCl
 Eutus - Chlophedianol
 Evaderm - Betamethasone benzoate
 Evasal - Suloctidil
 Evacalm - Diazepam
 Evac-Q-Kwik - Bisacodyl
 Evacuol - Picosulfate sodium
 Evadene - Butriptyline
 Evadyne - Butriptyline
 Evaprine - Phenyramidol
 Evasidol - Butriptyline
 Eventin - Propylhexedrine
 Everone - Testosterone enanthate
 Evimot - Clofibrade
 Evolubran - Pyritinol
 Evrodex - Dextroamphetamine sulfate
 Exacyl - Tranexamic acid
 Ex-Adipos - Phentermine HCl
 Exal - Vinblastine sulfate
 Exazol - Sulfamethoxypridazine
 Excedrin P.M. - Methapyrilene HCl
 Excerate - Hydrocortisone
 Excolicin - Penicillin G Procaine
 Exdol - Acetaminophen
 Exirel - Pirbuterol
 Exna - Benzthiazide
 Exonal - Tegafur
 Exosalt - Benzthiazide
 Expectoryn - Diphenhydramine HCl
 Exsel - Selenium sulfide
 Extencilline - Penicillin G benzathine
 Extendryl - Phenylephrine HCl
 Extracort - Triamcinolone acetonide
 Extramycin - Sisomicin
 Extranase - Bromelain
 Extren - Aspirin
 Extusone - Dextromethorphan hydrobromide
 Exurate - Benzbromarone
 Fabii-Valeas - Fenipentol
 Fabontal - Propanidid
 Fabrol - Acetyl cysteine
 Fado - Cefamandole nafate sodium salt
 Falecina - Cephalixin
 Falicor - Prenylamine
 Falithrom - Phenprocoumon
 Famet - Sulfamethizole
 Fanasil - Sulfadoxine
 Fansidar - Pyrimethamine
 Fansidar - Sulfadoxine
 Faredina - Cephaloridine
 Faremicin - Fosfomycin
 Farexin - Cephalixin
 Fargan - Promethazine HCl
 Farial - Indanazoline
 Faril - Nalidixic acid
 Farluta - Medroxyprogesterone acetate
 Farmabutol - Ethambutol HCl
 Farmaciclina - Rolitetracycline
 Farmacyrol - Dienestrol
 Farmacyrol - Ethinylestradiol
 Farmadiuril - Bumetanide
 Farmampil - Ampicillin
 Farmaproina - Penicillin G procaine
 Farmatox - Chlophedianol
 Farmicetina - Chloramphenicol
 Farmiserina - Cycloserine
 Farmo x in - Cefoxitin sodium
 Fasigyn - Tinidazole
 Fasigyne - Tinidazole
 Fastin - Phentermine HCl
 Fastum - Ketoprofen
 Faustan - Diazepam
 Fazadon - Faziidinium bromide
 Fazol - Isoconazole nitrate
 F-Cortef Acetate - Fludrocortisone acetate
 Febrica - Brompheniramine maleate
 Febrilix - Acetaminophen
 Febrogescic - Acetaminophen
 Febrolin - Acetaminophen
 Fe-Cap - Ferroglycine sulfate
 Fedacilina - Metampicillin sodium
 Fedahist - Guaifenesin
 Fefol - Folic acid
 Feinalmin - Imipramine
 Felison - Flurazepam
 Felixyn - Phenaglycodol
 Fellin - Fluocinolone acetonide
 Fellozine - Promethazine HCl
 Feminone - Ethinylestradiol
 Femirogen - Hexestrol
 Fem-Iron - Ferrous Fumarate
 Femogen - Estradiol valerate
 Femogex - Estradiol valerate
 Femovirin - Estradiol cypionate
 Femulen - Ethynodiol diacetate
 Fenactil - Chlorpromazine HCl
 Fenamide - Dichlorphenamide
 Fenamin - Mefenamic acid

Fenamine - Pheniramine maleate
 Fenampicin - Rifampin
 Fenantoin - Phenytoin
 Fenazil - Promethazine HCl
 Fenazolo - Sulfaphenazole
 Fencumar - Phenprocoumon
 Fendel - Fenspiride
 Fendilar - Fendiline HCl
 Fendon - Acetaminophen
 Energan - Promethazine HCl
 Fenibutasan - Phenylbutazone
 Fenibutol - Phenylbutazone
 Fenilfar - Phenylephrine HCl
 Fenil-PAS - Phenyl aminosalicylate
 Fenint - Indoprofen
 Fenisan - Oxyphenisatin acetate
 Fenistil - Dimethindene maleate
 Fenobrate - Fenofibrate
 Fenocin - Penicillin V
 Fenolib - Fenofibrate
 Fenoprex - Fenoprofen
 Fenopron - Fenoprofen
 Fenorex - Fenproporex
 Fenospin - Penicillin V
 Fenostil - Dimethindene maleate
 Fenprin - Phenyramidol
 Fental - Tegafur
 Fentanest - Fentanyl
 Fentanyl LeBrun - Fentanyl
 Fentazin - Perphenazine
 Fenuril - Chlorothiazide
 Fenylhist - Diphenhydramine HCl
 Feosol - Ferrous Fumarate
 Feosol - Folic acid
 Feostat - Ferrous fumarate
 Feostim - Ferrous fumarate
 FEP - Hydrocortisone
 F.E.P. - Pramoxine HCl
 Fepron - Fenoprofen
 Feprona - Fenoprofen
 Fercasulf - Sulfamethoxyypyridazine
 Fergon - Cephalixin
 Ferlon - Ferrous fumarate
 Fernisolone - Prednisolone
 Fernisone - Prednisone
 Fero-Folic - Ferrous fumarate
 Fero-Folic - Folic acid
 Fero-Grad - Ferrous fumarate
 Feronia - Rifampin
 Feroton - Ferrous fumarate
 Ferrocap - Folic acid
 Ferrochel - Ferroglycine sulfate
 Ferrocontin - Ferroglycine sulfate
 Ferro-Delalande - Ferrous fumarate
 Ferrofume - Ferrous fumarate
 Ferrograd - Folic acid
 Ferrolina - Ferrous fumarate
 Ferrolip - Ferrocholine
 Ferrromyn - Folic acid
 Ferronat - Ferrous fumarate
 Ferrone - Ferrous fumarate
 Ferronord - Ferroglycine sulfate
 Ferrosanol - Ferroglycine sulfate
 Ferrum Hausmann - Ferrous fumarate
 Fersaday - Ferrous fumarate
 Fersamal - Ferrous fumarate
 Fertodur - Cyclofenil
 Ferumat - Ferrous fumarate
 Feryl - Cyanocobalamin
 Festamoxin - Moxalactam disodium
 Feximac cream - Bufexamac
 F.H. - Tegafur
 Fiblaferon - Interferon
 Fibocil - Aprindine HCl
 Fiboran - Aprindine HCl
 Fibutox - Oxyphenbutazone
 Ficoid - Fluocortolone
 Fidesbiotic - Ampicillin
 Fidesporin - Cefazolin sodium
 Fidocin - Demeclocycline HCl
 Filacul - Tegafur
 Filair - Terbutaline
 Filarcidin - Diethylcarbamazine citrate
 Filaribits - Diethylcarbamazine citrate
 Filibon - Folic acid
 Filoklin - Cephaloridine
 Filtrax - Pipemidic acid
 Fimazid - Isoniazid
 Fimbutol - Ethambutol HCl
 Finacillin - Azidocillin
 Finaject - Trenbolone acetate
 Finaplix - Trenbolone acetate
 Finaten - Fominoben HCl
 Finimal - Acetaminophen
 Finlepsin - Carbamazepine
 Finsedyl - Oxatamide
 Fiobrol - Chlorthexoxazine
 Fiogestic - Carbaspirin calcium
 Fiogestic - Pheniramine maleate
 Fiogestic - Phenylpropanolamine HCl
 Fiogestic - Pyrilamine
 Fioricet - Heparin
 Firmacel - Cefazolin sodium
 Firmacort - Methylprednisolone
 Firmalgil - Phenyramidol
 Firon - Ferrous fumarate
 Fitociclina - Methacycline
 Fitton - Fenethylamine HCl
 Fiviton B12 - Cyanocobalamin
 Flabelline - Methicillin sodium
 Flacule - Fluorouracil
 Flagemona - Metronidazole
 Flagentyl - Secnidazole
 Flagyl - Metronidazole
 Flamanil - Pixifenide
 Flamazine - Sulfadiazine
 Flaminon - Niflumic acid
 Flanaril - Oxyphenbutazone
 Flatistine - Carnitine
 Flaveric - Benproperine
 Flavisco - Suloctidil
 Flavobion - Silymarin
 Flavopen - Penicillin V hydrabamine
 Flavoquine - Amodiaquin
 Flaxedil - Gallamine triethiodide
 Flebocortid - Hydrocortisone sodium phosphate
 Flebosan - Tribenoside
 Flebotropin - Diosmin
 Flectadol - Aspirin
 Fleet Relief - Pramoxine HCl
 Flemex - Carbocysteine
 Flemoxin - Amoxicillin
 Flexartal - Carisoprodol
 Flexazone - Phenylbutazone
 Flexen - Ketoprofen
 Flexeril - Cyclobenzaprine
 Flexicort - Hydrocortisone
 Flexin - Orphenadrine citrate
 Flexin - Zoxazolamine
 Flo-Cillin - Penicillin G procaine

Flogar - Oxametacine
 Flogene - Fentiazac
 Floghene - Oxyphenbutazone
 Flogicort - Triamcinolone
 Flogicort - Triamcinolone acetonide
 Floginax - Naproxen
 Flogistin - Oxyphenbutazone
 Flogitolo - Oxyphenbutazone
 Flogocid - Bufexamac
 Flogodin - Oxyphenbutazone
 Flogorex - Allopurinol
 Flogprofen - Etofenamate
 Floktin - Floctafenine
 Flonatril - Clorexolone
 Flopen - Floxacillin
 Flopholin - Togafur
 Florid - Miconazole nitrate
 Floridin - Cephaloridine
 Florinef Acetate - Fludrocortisone acetate
 Florispec - Epicillin
 Florobil - Fenipentol
 Florone - Diflorasone diacetate
 Floropryl - Isoflurophate
 Florotic - Fludrocortisone acetate
 Flosin - Indoprofen
 Flosint - Indoprofen
 Flou - Proxazole citrate
 Flovacil - Diflunisal
 Floxamine - Phenyl tolaxamine
 Floxapen - Floxacillin
 Floxyfral - Fluvoxamine maleate
 Flu 21 - Fluocinonide
 Fluaxol - Flupentixol
 Fluaton - Fluorometholone
 Flu-Base - Fluorometholone
 Flubason - Desoximetasone
 Flubenol - Flubendazole
 Flucinar - Fluocinolone acetonide
 Fluclox - Floxacillin
 Flucon - Fluorometholone
 Fluocort - Fluocinolone acetonide
 Fluderma - Formocortical acetate
 Fludestrin - Testolactone
 Fludex - Fluocinonide
 Fludex - Indapamide
 Fludrocortone - Fludrocortisone acetate
 Flugalín - Flurbiprofen
 Flugeral - Flunarizine HCl
 FlugereI - Flutamide
 Fluibil - Chenodiol
 Fluibron - Ambroxol
 Fluiden - Fenspiride
 Fluidil - Cyclothiazide
 Fluidol - Phenyltoloxamine
 Fluifort - Carbocysteine
 Fluimucetin - Acetylcysteine
 Fluimucil - Acetyl cysteine
 Fluitrán - Trichlormethiazide
 Fluixol - Ambroxol
 Flumerol - Fluorometholone
 Flumetol - Fluorometholone
 Flumetholon - Fluorometholone
 Flumezine - Fluphenazine HCl
 Flumoxane - Flubendazole
 Flumural - Flumequine
 Flunagen - Flunarizine HCl
 Flunicef - Cephacetrile sodium
 Fluniget - Diflunisal
 Flunox - Flurazepam
 Fluocinil - Fluocinolone acetonide
 Fluocinone - Fluocinolone acetonide
 Fluocit - Fluocinolone acetonide
 Fluoderm - Fluocinolone acetonide
 Fluoderm - Fluorometholone
 Fluodermol - Fluocinolone acetonide
 Fluogisol - Fluocinolone acetonide
 Fluolar - Fluocinolone acetonide
 Fluolon - Fluorometholone
 Fluomazina - Triflupromazine
 Fluomix - Fluocinolone acetonide
 Fluonid - Fluocinolone acetonide
 Fluonide Dermica - Fluocinolone acetonide
 Fluopan - Halothane
 Fluopryl - Isoflurophate
 Fluordima - Fluocinolone acetonide
 Fluoroblastin - Fluorouracil
 Fluorodiuvis - Hydroflumethiazide
 Fluorofen - Triflupromazine
 Fluoromar - Fluorexene
 Fluoroplex - Fluorouracil
 Fluorotop - Fluorouracil
 Fluoskin - Fluocinolone acetonide
 Fluothane - Halothane
 Fluotrex - Fluocinolone acetonide
 Fluovitef - Fluocinolone acetonide
 Flupen - Floxacillin
 Flupidol - Penfluridol
 Flupollon - Fluocinolone acetonide
 Flurazine - Trifluoperazine
 Fluorobate Gel - Betamethasone benzoate
 Flussicor - Hexobendine
 Flustar - Diflunisal
 Flutone - Diflorasone diacetate
 Flutoria - Trichlormethiazide
 Fluvean - Fluocinolone acetonide
 Fluvermal - Flubendazole
 Fluversin - Suloctidil
 Fluxarten - Flunarizine HCl
 Fluzepam - Flurazepam
 Fluon - Fluocinonide
 Fluon - Fluocinolone acetonide
 FML Liquifilm - Fluorometholone
 F-Mon - Perphenazine
 Focus - Ibuprofen
 Folicid - Folic acid
 Folacin - Folic acid
 Folaemin - Folic acid
 Folamin - Folic acid
 Folan - Folic acid
 Folasic - Folic acid
 Folbiol - Folic acid
 Folcodal - Cinnarizine
 Foldine - Folic acid
 Folettes - Folic acid
 Folex - Folic acid
 Folex - Methotrexate
 Foliamin - Folic acid
 Folical - Folic acid
 Folicet - Folic acid
 Folico - Folic acid
 Folina - Folic acid
 Folirivo - Folic acid
 Follicet - Folic acid
 Follidene - Dienestrol
 Follikoral - Ethinylestrediol
 Folliplex - Hexestrol
 Folvite - Folic acid
 Fomac - Salicylic acid
 Fonlipol - Tiadenol
 Fonofos - Fosfomycin

Fontego - Bumetanide
 Fonzylane - Buflomedil
 Forane - Isoflurane
 Fordex - Tolbutamide
 Fordiuran - Bumetanide
 Foreart - Inosine
 Forenol - Niflumic acid
 Forhista - Dimethindene maleate
 Forista - Dimethindene maleate
 Formafitil - Formocortol acetate
 Formulex - Dicyclomine HCl
 Fortabol - Methenolone acetate
 Fortabolin - Nandrolone decanoate
 Fortapen - Ampicillin
 Fortasec - Loperamide HCl
 Fortecortin - Dexamethasone acetate
 Fortesul - Sulfameter
 Forthane - Methyl hexaneamine carbonate
 Forticef - Cephadrine
 Fortombrin - Acetrizoate sodium
 Fortracin - Bacitracin
 Fortravel - Cyclizine
 Fortum - Ceftazidime
 Fortunan - Haloperidol
 Fosfocin - Fosfomycin
 Fosfocine - Fosfomycin
 Fosfogram - Fosfomycin
 Fosfotricina - Fosfomycin
 Fossyol - Metronidazole
 Fostex - Salicylic Acid
 Fovane - Benzthiazide
 Fradio - Neomycin
 Fradyl - Neomycin
 Framenco - Chlorzoxazone
 Francacilline - Penicillin G procaine
 Franciclina - Methacycline
 Francital - Fosfomycin
 Francomicina - Methacycline
 Franocide - Diethylcarbamazine citrate
 Franroze - Tegafur
 Franyl - Furosemide
 Fravit B-12 - Hydroxocobalamin
 Frekentine - Diethylpropion HCl
 Frekven - Propranolol HCl
 Fremet - Cimetide
 Franactil - Benperidol
 Frenal - Cromolyn sodium
 Frenasma - Cromolyn sodium
 Frenil - Promazine HCl
 Frenolyse - Tranexamic acid
 Frenoton - Azacyclonol
 Frenquel - Azacyclonol
 Fresmin S - Hydroxocobalamin
 Frideron - Zeranol
 Fringanor - Phendimetrazine tartrate
 Frisium - Clobazam
 Froben - Flurbiprofen
 Frolid P - Miconazole nitrate
 Fructosteril - Fructose
 Fruindex - Dextran 40
 Frusemin - Furosemide
 Frusetic - Furosemide
 Frusid - Furosemide
 Ftalysept - Phthalylsulfathiazole
 Ftorafur - Tegafur
 Ftoral - Tegafur
 Ftorocort - Triamcinolone acetonide
 F.T.R. - Tegafur
 Fua Med - Nitrofurantoin
 FUDR - Floxuridine
 Fuerpen - Ampicillin trihydrate
 Fugacillin - Carbenicillin disodium
 Fugatox - Chlophedianol
 Fugillin - Fumagillin
 Fulaid - Tegafur
 Fulcin - Griseofulvin
 Fulcine Forte - Griseofulvin
 Fulfeel - Tegafur
 Fulgram - Norfloxacin
 Fuligan - Allopurinol
 Fulcilina - Amoxicillin
 Fuineurina - Pyritinol
 Fulpen - Bromhexine
 Fulsix - Furosemide
 Fultamid - Sulfadimethoxine
 Fuluminol - Clemastine fumarate
 Fuluvamide - Furosemide
 Fulvicin - Griseofulvin
 Fumafer - Ferrous fumarate
 Fumalestine - Clemastine fumarate
 Fumaresutin - Clemastine fumarate
 Fumasorb - Ferrous fumarate
 Fumidil - Fumagillin
 Fumiron - Ferrous fumarate
 Funacomin-F - Hydroxocobalamin
 Funapan - Valethamate bromide
 Functiocardon - Dipyridamole
 Fungacetin - Triacetin
 Fungata - Tiocanazole
 Fungifos - Tolciclate
 Fungilin - Amphotericin B
 Fungi-Nail - Salicylic acid
 Fungisidin - Miconazole nitrate
 Fungivin - Griseofulvin
 Fungizone - Amphotericin B
 Fungoid - 4-Chloro-3,5-xyleneol
 Furachel - Nitrofurantoin
 Furacin - Nitrofurazone
 Furacin-E - Diethylstilbestrol
 Furadantin - Nitrofurantoin
 Furadoine - Nitrofurantoin
 Furalan - Nitrofurantoin
 Furall - Furazolidone
 Furaloid - Nitrofurantoin
 Furanex - Nitrofurantoin
 Furanite - Nitrofurantoin
 Furantral - Furosemide
 Furantril - Furosemide
 Furasol - Furaltadone
 Furatin - Nitrofurantoin
 Furazon - Furazolidone
 Furedan - Nitrofurantoin
 Furesis - Furosemide
 Furesol - Nitrofurazone
 Furetic - Furosemide
 Furex - Cefuroxime
 Furex - Furosemide
 Furfan - Furosemide
 Furlil - Nitrofurantoin
 Furix - Furosemide
 Furmethide - Furtrethonium iodide
 Furobactil - Nifurfoline
 Furobactina - Nitrofurantoin
 Furofluor - Tegafur
 Furofutran - Tegafur
 Furomex - Furosemide
 Furophen - Nitrofurantoin
 Furopuren - Furosemide
 Furosedon - Furosemide
 Furoside - Furosemide

Furoxane - Furazolidone
 Furoxone - Furazolidone
 Fusaloyos - Fusafungine
 Fusarine - Fusafungine
 Fusca - Clorprenaline
 Fusfosiklin - Tetracycline phosphate complex
 Fusid - Furosemide
 Fusten - Cetiedil
 Fustopanox - Oxeladin
 Futraful - Tegafur
 Futraful Zupo - Tegafur

G-11 - Hexachlorophene
 Gabacet - Piracetam
 Gabalon - Baclofen
 Gabbromycin - Paromomycin
 Gabbroral - Paromomycin
 Gabilin - Tolonium chloride
 Gaipect - Guaifenesin
 Galactocin - Quinidine polygalacturonate
 Galatturil-Chinidina - Quinidine polygalacturonate
 Galenomycin - Oxytetracycline
 Gamadiabet - Acetohexamide
 Gambex - Lindane
 Gamene - Lindane
 Gamiquenol - Chenodiol
 Gammaciolina - Methacycline
 Gammistin - Brompheniramine maleate
 Gamophen - Hexachlorophene
 Ganatone - Dimethicone
 Ganda - Guanethidine sulfate
 Ganidan - Sulfaguanidine
 Ganphen - Promethazine HCl
 Gansol - Sulfisoxazole
 Gantanol - Sulfamethoxazole
 Gantaprim - Sulfamethoxazole
 Gantrisin - Sulfisoxazole
 Gantrisin Acetyl - Acetyl sulfisoxazole
 Garamycin - Gentamicin sulfate
 Garasin - Cephalixin
 Gasace - Dimethicone
 Gascon - Dimethicone
 Gasless - Dimethicone
 Gaspanon - Dimethicone
 Gasparol - Pyridinol carbamate
 Gasteel - Dimethicone
 Gastrausil - Carbenoxolone
 Gastrix - Oxyphencyclimine
 Gastro-Conray - Iothalmate meglumine
 Gastrodiagnost - Pentagastrin
 Gastrodyn - Glycopyrrolate
 Gastrofrenal - Cromolyn sodium
 Gastromet - Cimetide
 Gastronerton - Metoclopramine HCl
 Gastronilo - Zolimidine
 Gastropodil - Mepenzolate bromide
 Gastrurol - Pipemidic acid
 Gaszeron - Dimethicone
 Gatinar - Lactulose
 Geapur - Allopurinol
 Geen - Tegafur
 Gelargin - Fluocinolone acetoneide
 Gelidina - Fluocinolone acetoneide
 Gelocatal - Acetaminophen
 Gelosedine - Fenethylline HCl
 Gelotamide - Phthalylsulfathiazole
 Gelstaph - Cloxacillin
 Gelusil - Simethicone
 Gel "V" - Idoxuridine

Genasprin - Aspirin
 Gecefal - Cephaloridine
 Gene-Bamate - Meprobamate
 Gene-Poxide - Chlordiazepoxide HCl
 Genogris - Piracetam
 Genoptic - Gentamicin sulfate
 Genoxal - Cyclophosphamide
 Gensumycin - Gentamicin sulfate
 Genta - Gentamicin sulfate
 Gentabac - Gentamicin sulfate
 Gentacin - Gentamicin sulfate
 Gentadavur - Gentamicin sulfate
 Gentafair - Gentamicin sulfate
 Genta-Gobens - Gentamicin sulfate
 Gentalline - Gentamicin sulfate
 Gentalyn - Gentamicin sulfate
 Gentamedical - Gentamicin sulfate
 Gentamin - Gentamicin sulfate
 Gentamina - Gentamicin sulfate
 Gentamival - Gentamicin sulfate
 Gentamorgens - Gentamicin sulfate
 Gentamycin-Pos - Gentamicin sulfate
 Gentamytrex - Gentamicin sulfate
 Gentaroger - Gentamicin sulfate
 Gentasillin - Gentamicin sulfate
 Gentibioptal - Gentamicin sulfate
 Genticina - Gentamicin sulfate
 Genticol - Gentamicin sulfate
 Gento - Gentamicin sulfate
 Gentona - Gentamicin sulfate
 Gent-Ophthal - Gentamicin sulfate
 Gen-Tos - Chlophedianol
 Gentran 40 - Dextran 40
 Genurin - Flavoxate HCl
 Geobiotic - Doxycycline
 Geocillin - Carbenicillin indanyl sodium
 Geocycline - Oxytetracycline
 Geomycin - Oxytetracycline
 Geopen - Carbenicillin disodium
 Geopen - Carbenicillin indanyl sodium
 Geopen-U - Carbenicillin indanyl sodium
 Gerex - Diethylstilbestrol
 Gericetam - Piracetam
 Germa-Medica - Hexachlorophene
 Germex - Nitrofurazone
 Germibon - Hexachlorophene
 Gerodyl - Penicillamine
 Gerofuran - Nitrofurantoin
 Geromid - Clofibrate
 Gersmin - Dimethicone
 Gestamestrol - Mestranol
 Gesta-Plan - Norethindrone
 Gestapuran - Medroxyprogesterone acetate
 Getamisin - Gentamicin sulfate
 Gevramycin - Gentamicin sulfate
 Geycillina - Ampicillin
 G G Cen - Guaifenesin
 Giarlam - Furazolidone
 Gibicef - Cefuroxime
 Gibixen - Naproxen
 Gichtex - Allopurinol
 Giganten - Cinnarizine
 Gilex - Doxepin HCl
 Gilutensin - Etifelmine
 Gineflavir - Metronidazole
 Ginvel - Furazolidone
 Gipsydol - Diphenidol
 Giquel - Propantheline bromide
 Githitan - Diazepam
 Glacostat - Aceclidine

- Gladius - Pyritinol
 Glajust - Dichlorophenamide
 Glanil - Cinnarizine
 Glarubin - Glaucaurubin
 Glauconox - Acetazolamide
 Glaucol - Dichlorophenamide
 Glauconide - Dichlorophenamide
 Glaucotensil - Ethoxzolamide
 Glaucothil - Dipivefrin
 Glaudin - Aceclidine
 Glaumid - Dichlorophenamide
 Glaunorm - Aceclidine
 Glapax - Acetazolamide
 Glaxoridin - Cephaloridine
 Gleiton - Hydrocortisone sodium phosphate
 Glevomicina - Gentamicin sulfate
 Glianimon - Benperidol
 Glibenese - Glipizide
 Gliconorm - Chlorpropamide
 Glifan - Glafenine
 Glifanan - Glafenine
 Glimid - Glutethimide
 Gliporai - Buformin HCl
 Glistelone - Prednisolone stearoylglycolate
 Glitisol Orale - Thiamphenicol
 Glitisono - Prednisolone stearoylglycolate
 Glitrim - Glibornuride
 Globenicol - Chloramphenicol
 Globociclina - Methacycline
 Globoid - Aspirin
 Globucid - Sulfaethidole
 Glomax - Choline theophyllinate
 Glorium - Medazepam
 Glorous - Chloramphenicol
 Glovan - Nonoxynol
 Gluborid - Glibornuride
 Glucagon Novo - Glucagon
 Glucamide - Chlorpropamide
 Glucetyl - Aspirin
 Glucoben - Glisoxepid
 Glucosulfina - Chlorpropamide
 Glucotrol - Glipizide
 Gludease - Glybuzole
 Glumal - Aceglutamide aluminum
 Glurenor - Gliquidone
 Glurenorm - Gliquidone
 Glutril - Glibornuride
 Glycanol - Glymidine
 Glycifer - Ferroglycine sulfate
 Glyconon - Tolbutamide
 Glyconormal - Glymidine
 Glytotol - Mephesisin
 Glypesin - Hexetidine
 Glysepin - Glisoxepid
 Glytril - Glibornuride
 Glyvenol - Tribenoside
 G-Mycin - Gentamicin sulfate
 Gnadion - Beclomethasone dipropionate
 Goce Euchessina - Picosulfate sodium
 Goce Lassative Aicardi - Picosulfate sodium
 Godalax - Bisacodyl
 Godamed - Aspirin
 Gondafon - Glymidine
 Gotinal - Naphazoline
 Gradient Polifarma - Flunarizine HCl
 Grafalex - Cephalexin
 Gramaderm - Gramicidin
 Gramicillina - Ampicillin
 Grammaxin - Cefazolin sodium
 Grampenil - Ampicillin
 Gramurin - Oxolinic acid
 Grandaxine - Tofisopam
 Graval - Dimenhydrinate
 Gravosan - Clomiphene dihydrogen citrate
 Grewcalm - Diazepam
 Gricin - Griseofulvin
 Grifulvin - Griseofulvin
 Grinsil - Amoxicillin
 Grisactin - Griseofulvin
 Grisefuline - Griseofulvin
 Grisetin - Griseofulvin
 Grisona - Feprazone
 Grisovin - Griseofulvin
 Gris-Peg - Griseofulvin
 Grorm - Somatotropin
 Gropisk - Methylodopa
 Guabeta - Sulfaguanidine
 Guabeta N - Tolbutamide
 Guajacuran - Guaifenesin
 Guajasyll - Guaifenesin
 Guanimycin - Dihydrostreptomycin sulfate
 Guasept - Sulfaguanidine
 Guastil - Sulpiride
 Gubernal - Alprenolol HCl
 Guiatuss - Guaifenesin
 Guicitrina - Ampicillin
 Gulliostin - Dipyrindamole
 Guservin - Griseofulvin
 Gutabex - Chlorphedianol
 Gutanit - Flucloronide
 Gutron - Midodrine
 Guttalax - Picosulfate sodium
 Gvaja - Guaifenesin
 Gynaflex - Noxytiolin
 Gynamousse - Oxytetracycline
 Gynelan - Chlordantoin
 Gyne-Lotrimin - Clotrimazole
 Gynetone - Ethinylestradiol
 Gynipal - Hexoprenaline
 Gyno-Cortisone - Hydrocortisone
 Gyno-Dakterin - Miconazole nitrate
 Gynol - Nonoxynol
 Gynolett - Ethinylestradiol
 Gyno-Monistat - Miconazole nitrate
 Gyno-Pevaryl - Echonazole nitrate
 Gynoral - Ethinylestradiol
 Gynorest - Dydrogesterone
 Gynosterone - Methyltestosterone
 Gyno-Sterosan - Chlorquinaldol
 Gynotherax - Chlorquinaldol
 Gyno-Travogen - Isoconazole nitrate
 Hachemina - Aminobenzoic acid
 Hachimetoxin - Sulfadimethoxine
 Hacosan - Cyclandelate
 Haelan - Flurandrenolide
 Haemiton - Clonidine HCl
 Hagedabletten - Aspirin
 Haibrain - Citicoline
 Halan - Halothane
 Halciderm - Halcinonide
 Halcimat - Halcinonide
 Halcion - Triazolam
 Halcort - Halcinonide
 Haldid - Fentanyl
 Haldol - Haloperidol
 Haldrone - Paramethasone acetate
 Halenol - Acetaminophen
 Halestyn - Chloroprocaine HCl
 Halgon - Aspirin

- Halidol - Haloperidol
 Halkan - Droperidol
 Halodren - Silymarin
 Halog - Halcinonide
 Halo Just - Haloperidol
 Halomycerin - Chloramphenicol
 Halosten - Haloperidol
 Halotestin - Fluoxymesterone
 Halotex - Haloprogin
 Halothan Hoechst - Halothane
 Halovis - Halothane
 Hammovenad - Inositol niacinate
 Hamocura - Heparin
 Haocolin - Citicoline
 Happy Trip - Cyclizine
 Harmonin - Meprobarbate
 Harmonyl - Deserpidine
 Harnway - Sulfamethizole
 Harop - Dimethicone
 Hasethrol - Pentaerythritol tetranitrate
 Hautosone - Hydrocortisone
 HC-Cream - Hydrocortisone
 HCH-Salbe - Lindane
 H-Cort - Hydrocortisone
 Head & Chest - Guaifenesin
 Head & Chest - Phenylpropanolamine HCl
 Healthstyle - Clofibrate
 Heartcin - Ubidecarenone
 Heb-Cort - Hydrocortisone
 Hebutcol - Cyclobutylol
 Hedex - Acetaminophen
 Hekbilin - Chenodiol
 Heksaden - Hexachlorophene
 Helenil - Ketoprofen
 Heliopar - Chloroquine phosphate
 Helmex - Pyrantel pamoate
 Help - Phenylpropanolamine HCl
 Helpa - Tegafur
 Helvecillin - Ampicillin trihydrate
 Helvemycin - Erythromycin stearate
 Hematon - Ferrous fumarate
 Hemocaprol - Aminocaproic acid
 Hemocuron - Tribenoside
 Hemocyte - Folic acid
 Hemomin - Cyanocobalamin
 Hemosalus - Cyanocobalamin
 Hemostyl - Folic acid
 Hemostyptanon - Estriol succinate
 Hemotin - Aminocaproic acid
 Henohol - Chenodiol
 Hepacon B12 - Cyanocobalamin
 Hepacort Plus - Heparin
 Hepadestal - Silymarin
 Hepa Gel - Heparin
 Hepagerina - Silymarin
 Hepalande - Menbutone
 Hepalar - Silymarin
 Hepaldine - Timonacnic sodium
 Hepalolina - Silymarin
 Hepa-Obaton - Nandrolone phenpropionate
 Heparegene - Timonacnic sodium
 Heparinin - Heparin
 Heparin-Pos - Heparin
 Heparin sodium - Heparin
 Hepathromb - Heparin
 Hepato-Framan - Silymarin
 Hepcovite - Cyanocobalamin
 Hep-Lock - Heparin
 Heprinar - Heparin
 Hepsal - Heparin
 Heptadon - Methadone HCl
 Heptanon - Methadone HCl
 Heptanon - Methadone HCl
 Heptuna - Ferrous fumarate
 Heracillin - Floxacillin
 Herbesser - Diltiazem HCl
 Hermolepsin - Carbamazepine
 Hernicioid - Nystatin
 Herperal - Stallimycin HCl
 Herpetil - Idoxuridine
 Herpid - Idoxuridine
 Herpidu - Idoxuridine
 Herplex - Idoxuridine
 Herzbase - Propranolol HCl
 Herzcon - Prenylamine
 Herzo - Proscillaridin
 Herzul - Propranolol HCl
 Hetabiotic - Hetacillin potassium
 Hetacin-K - Hetacillin potassium
 Hetrazan - Diethylcarbamazine citrate
 Hexabolan - Trenbolone acetate
 Hexacorton - Prednisolone acetate
 Hexacycline - Tetracycline phosphate complex
 Hexadol - Chlorhexidine
 Hexadrol Phosphate - Dexamethasone phosphate
 Hexakapron - Tranexamic acid
 Hexainosineat - Inositol niacinate
 Hexal - Hexachlorophene
 Hexalmin - Inositol niacinate
 Hexanate - Inositol niacinate
 Hexanicit - Inositol niacinate
 Hexanicotol - Inositol niacinate
 Hexanium - Hexamethonium bromide
 Hexapneumine - Chlorpheniramine maleate
 Hexapromin - Tranexamic acid
 Hexascrub - Hexachlorophene
 Hexastat - Altretamine
 Hexate - Inositol niacinate
 Hexatin - Inositol niacinate
 Hexatron - Tranexamic acid
 Hexit - Inositol niacinate
 Hexoral - Hexetidine
 Hexron - Hexestrol
 Hextril - Hexetidine
 HHR - Hydrochlorothiazide
 HHR - Reserpine
 Hializan - Oxazolam
 Hibanil - Chlorpromazine HCl
 Hiberna - Promethazine HCl
 Hibernall - Chlorpromazine HCl
 Hibiclens - Chlorhexidine
 Hibiscrub - Chlorhexidine
 Hibistat - Chlorhexidine
 Hibisterin - Beclomethasone dipropionate
 Hibitane - Chlorhexidine
 Hichillos - Kebuzone
 Hicobala - Hydroxocobalamin
 Hicobalan - Hydroxocobalamin
 Hiconcil - Amoxicillin
 Hi-Cyclane Cap - Cyclandelate
 Hidrafasa - Isoniazid
 Hidranic - Isoniazid
 Hidrazinda - Isoniazid
 Hidroalogen - Trichloromethiazide
 Hidroaltesona - Hydrocortisone
 Hidroferol - Calcifediol
 Hidroks - Hydroxyurea
 Hidropid - Xylometazoline HCl
 Hidrosaluretil - Hydrochlorothiazide
 Hihustan - Oxeladin

Hilactan - Cinnarizine
 Hillcolax - Bisacodyl
 Hilong - Oxazepam
 Himinomax - Amoxicillin
 Hipeksal - Methenamine hippurate
 Hiperazida - Isoniazid
 Hipertensal - Guanfacine
 Hipnosedon - Flunitrazepam
 Hipotensor Oftalmico - Dichlorphenamide
 Hipotensor Zambe - Syrosingopine
 Hippuran - Methenamine hippurate
 Hiprex - Methenamine hippurate
 Hipsal - Nitrazepam
 Hipuric - Benzbromarone
 Hiramycin - Doxycycline
 Hirdsyn - Cinnarizine
 Hirnamin - Methotrimeprazine
 Hiruton - Ubidecarenone
 Hishiherin-S - Etilerfrine pivalate HCl
 Hislosine - Carbinoxamine maleate
 Hismanal - Astemizol
 Hispril - Diphenylpyraline HCl
 Histachlor - Chlorpheniramine maleate
 Histadur - Chlorpheniramine maleate
 Histadyl - Methapyrilene HCl
 Histaidis - Chlorpheniramine maleate
 Histalen - Chlorpheniramine maleate
 Histalet - Guaifenesin
 Histalet - Phenylephrine HCl
 Histalet - Pyrilamine
 Histalet DM - Dextromethorphan hydrobromide
 Histalog - Betazole
 Histamic - Chlorpheniramine maleate
 Histamic - Phenylephrine HCl
 Histaminic - Phenylpropanolamine HCl
 Histanin - Chlorcyclizine
 Histapen - Chlorpheniramine maleate
 Histaspan - Chlorpheniramine maleate
 Histaspan - Phenylephrine HCl
 Histavet-P - Pyrilamine
 Histaxin - Diphenhydramine HCl
 Histex - Carbinoxamine maleate
 Histimin - Betazole
 Histionex - Phenyltoloxamine
 Histofax - Chlorcyclizine
 Histol - Chlorpheniramine maleate
 Histor - Phenylephrine HCl
 Histotab - Antazoline HCl
 Histradil - Triprolidine
 Hityl - Hexobendine
 Hiwell - Trimetazidine
 HMS - Medrysone
 Hoelcesium - Fentonium bromide
 Hokulaton - Spiroolactone
 Holevid - Iopanoic acid
 Holoxan - Ifosfamide
 Homoolan - Acetaminophen
 Homoton - Hydralazine HCl
 Horvan - Diethylstilbestrol diphosphate
 Horizon - Diazepam
 Hormale - Methyltestosterone
 Hormazone - Betamethasone
 Hormobin - Methyltestosterone
 Hormoestrol - Hexestrol
 Hormofemin - Dienestrol
 Hormofort - Hydroxyprogesterone caproate
 Hornbest - Citicoline
 Hortfenicol - Chloramphenicol
 Hortfenicol - Chloramphenicol palmitate
 Horusona - Methylprednisolone
 Horusvin - Vincamine
 Hosboral - Amoxicillin
 Hostacortin - Prednisone
 Hostacyclin-PRM - Rolitetracycline
 Hostes Pediatrico - Ampicillin
 Huberdasen - Piracetam
 Huberdilat - Cetiedil
 Huberlexina - Cephalixin
 Huberlexina - Cephaloridine
 Huberplex - Chlordiazepoxide HCl
 Hubersil - Bendazac
 Humagel - Paromomycin
 Humatin - Paromomycin
 Humibid - Guaifenesin
 Huminsulin - Insulin
 Humorsol - Demecarium bromide
 Humulin - Insulin
 Humulin-I - Insulin isophane
 Husmedin - Dextromethorphan hydrobromide
 Hustazol - Cloperastine
 Hustenstiller - Dextromethorphan hydrobromide
 Hustep - Dextromethorphan hydrobromide
 Hustopan - Oxeladin
 Hustosil - Guaifenesin
 Hyadur - Dimethyl sulfoxide
 Hyanilid - Salicylanilide
 Hyarom - Benzethonium chloride
 Hybasedock - Chlorthalidone
 Hybolin Improved - Nandrolone phenpropionate
 Hyclorate - Clofibrate
 Hyclosid - Hydrochlorothiazide
 Hycobal-12 - Hydroxocobalamin
 Hycomine - Phenylephrine HCl
 Hycomine - Phenylpropanolamine HCl
 Hycor - Hydrocortisone
 Hycoral - Guanadrel sulfate
 Hycort - Hydrocortisone
 Hycortole - Hydrocortisone
 Hycotuss - Guaifenesin
 Hycozid - Isoniazid
 Hydantin - Phenytoin
 Hydantol - Phenytoin
 Hydetra - Prednisolone
 Hydetrasol - Prednisolone phosphate sodium
 Hydetra TBA - Prednisolone tebutate
 Hydiphen - Clomipramine
 Hydoban - Chlorthalidone
 Hydocomin - Hydroxocobalamin
 Hydoril - Hydrochlorothiazide
 Hydra - Isoniazid
 Hydrapres - Hydralazine HCl
 Hydrapres - Hydralazine HCl
 Hydrate - Dimenhydrinate
 Hydrazide - Hydrochlorothiazide
 Hydrazole - Acetazolamide
 Hydrea - Hydroxyurea
 Hydrenox - Hydroflumethiazide
 Hydrex - Benzthiazide
 Hydrex - Hydrochlorothiazide
 Hy-Drine - Benzthiazide
 Hydrion - Ambuside
 Hydrisalic - Salicylic acid
 Hydrite - Hydrochlorothiazide
 Hydrocobamin - Hydroxocobalamin
 Hydrocort - Hydrocortisone
 Hydrocortex - Hydrocortisone
 Hydrocortone - Hydrocortisone
 Hydrocortone phosphate - Hydrocortisone sodium phosphate
 Hydro-D - Hydrochlorothiazide

- Hydroderm - Bacitracin
 Hydrodiuretex - Hydrochlorothiazide
 Hydrodiuril - Hydrochlorothiazide
 Hydro-Fluserpine - Reserpine
 Hydrofoam - Hydrocortisone
 Hydro-Long - Chlorthalidone
 Hydromedin - Ethacrynic acid
 Hydromet - Methyldopa
 Hydromox - Quinethazone
 Hydromox - Reserpine
 Hydropres - Hydrochlorothiazide
 Hydropres - Reserpine
 Hydro-Rapid - Furosemide
 Hydroserpine - Hydralazine HCl
 Hydroserpine - Hydrochlorothiazide
 Hydroserpine - Reserpine
 Hydrosol - Prednisolone phosphate sodium
 Hydrotisona - Hydrocortisone
 Hydro B-12 - Hydroxocobalamin
 Hydroxo 5000 - Hydroxocobalamin
 Hydroxomin - Hydroxocobalamin
 Hydroxystilbamide - Hydroxystilbamidine isethionate
 Hydroxystilbamidin Isethionate - Hydroxystilbamidine isethionate
 Hydrozide - Hydrochlorothiazide
 Hyflavin - Methylol riboflavin
 Hygroton - Chlorthalidone
 Hylorol - Guanadrel sulfate
 Hymeron - Phytanadione
 Hymetic - Trimethobenzamide HCl
 Hyminal - Methaqualone
 Hypaque sodium - Diatrizoate sodium
 Hypatol - Hydralazine HCl
 Hyperan - Exalamide
 Hyperazine - Hydralazine HCl
 Hypercillin - Penicillin G procaine
 Hyperstat - Diazoxide
 Hypertane - Ethiazide
 Hyperten - Methyldopa
 Hypertension - Angiotensin amide
 Hypertol - Chlorthalidone
 Hypertonalum - Diazoxide
 Hypnodin - Perlapine
 Hypnodorm - Flunitrazepam
 Hypnol - Pentobarbital sodium
 Hypnomidate - Etomidate HCl
 Hypnotin - Nitrazepam
 Hypnovel - Midazolam maleate
 Hypocerol - Clofibrate
 Hypolag - Methyldopa
 Hypos - Hydralazine HCl
 Hypothuro! - Pentaerythritol tetranitrate
 Hy-Po-Tone - Methyldopa
 Hypovase - Prazosin
 Hyprenan - Prenalterol
 Hypropen - Penicillin G procaine
 Hyproval - Hydroxyprogesterone caproate
 Hyptor - Methaqualone
 Hyrazin - Thiamphenicol
 Hyrexin - Diphenhydramine HCl
 Hyrex-105 - Phendimetrazine tartrate
 Hysron - Medroxy progesterone acetate
 Hytakerol - Dihydrotyachsterol
 Hyton - Pemoline
 Hytone - Hydrocortisone
 Hytrid - Hydrochlorothiazide
 Hytuss - Guaifenesin
 Hyurina - Etilerfrine divalate HCl
 Hyzine - Hydroxyzine HCl
 Hyzyd - Isoniazid
 IA-But - Phenylbutazone
 I.A.-Loxin - Oxytetracycline
 Iambeta - Indenolol
 I.A.-Pram - Imipramine HCl
 IB-100 - Ibuprofen
 Ibaden - Penicillin V
 Ibaril - Desoximetazone
 Iberet - Ferrous fumarate
 Iberet - Folic acid
 Ibiomox - Amoxicillin
 Ibilex - Cephalexin
 Ibinolo - Atenolol
 Ibiastacin - Ribostamicin
 Ibisterolon - Prednisolone
 Ibisterolon-Pommada - Prednisolone acetate
 Ibisul - Suloctidil
 Iborufen - Ibuprofen
 Ibo-Slo - Ibuprofen
 Ibucasen - Ibuprofen
 Ibudros - Ibuprofen
 Ibulav - Ibuprofen
 Ibumetin - Ibuprofen
 Ibuprocin - Ibuprofen
 Icaden - Isoconazole nitrate
 Icalus - Tegafur
 Ice-O-Derm - 4-Chloro-3,5-xyleneol
 Icopal B - Metaraminol
 Icramin - Dicyclomine HCl
 Idalon - Floctafenine
 Idalprem - Lorazepam
 Idaltim - Cortivazol
 Idamix - Indapamide
 Idarac - Floctafenine
 Idasal - Methoxamine HCl
 Ideaxan - Piracetam
 Idotrim - Trimethoprim
 Idotyl - Aspirin
 Idoviran - Idoxuridine
 Idoxene - Idoxuridine
 Idoxo B12 - Hydroxocobalamin
 Idracemi - Hydrocortisone
 Idranal - Edetate disodium
 Idrazil - Isoniazid
 Idro-Apavit - Hydroxocobalamin
 Idrobamina - Hydroxocobalamin
 Idrocbalmin - Hydroxocobalamin
 Idrodiuviv - Hydrochlorothiazide
 Idroepar - Florantyrone
 Idrogestene - Hydroxyprogesterone caproate
 Idrolattone - Spironolactone
 Idrospe B12 - Hydroxocobalamin
 Idrossimicina - Methacycline
 Idrozima - Hydroxocobalamin
 IDU - Idoxuridine
 Iducher - Idoxuridine
 Idulian - Azatadine maleate
 IDU Ophthalmic - Idoxuridine
 Iduridin - Idoxuridine
 Idustatin - Idoxuridine
 Iebolan - Nandrolone decanoate
 Ifenac - Echonazole nitrate
 Ifrasarl - Cyproheptadine
 Igepal - Nonoxynol
 Igralin - Thiamphenicol
 Igrolina - Chlorthalidone
 Igroton - Chlorthalidone
 Ikaclomine - Clomiphene dihydrogen citrate
 Ikaacor - Verapamil

Ikapen - Ampicillin
 Iktorivil - Clonazepam
 Ildamen - Oxyfedrine
 Ildamol - Acetaminophen
 Iletin - Insulin
 Iletin I - Insulin zinc suspension
 Iliadine - Oxymetazoline HCl
 I-Liberty - Chlordiazepoxide HCl
 Iliidar - Azapetine phosphate
 Iliiso - Phytate sodium
 Ilopan - Dexpanthenol
 Ilosone - Erythromycin
 Ilosone - Erythromycin estolate
 Ilotycin - Erythromycin
 Ilotycin gluceptate - Erythromycin gluceptate
 Ilotycin Otic - Erythromycin gluceptate
 Iltazon - Oxyphenbutazone
 Ilvanol - Xylometazoline HCl
 Ilvico - Brompheniramine maleate
 Ilvin - Brompheniramine maleate
 Imacillin - Amoxicillin
 Imadorm - Nitrazepam
 Imadyl - Carprofen
 Imafen - Carprofen
 Imagon - Chloroquine phosphate
 Imakol - Oxomemazine
 Imap - Fluspirilene
 Imavate - Imipramine HCl
 Imbaral - Sulindac
 Imbrilon - Indomethacin
 Imbun - Oxyphenbutazone
 Imeson - Nitrazepam
 Imet - Indomethacin
 Imidalin - Tolazoline
 Imidazyl - Naphazoline
 Imidin - Naphazoline
 Imidol - Imipramine HCl
 Imilanyle - Imipramine
 Imipranil - Imipramine HCl
 Imizol - Naphazoline
 Immenoctal - Secobarbital sodium
 Imodium - Loperamide HCl
 Imperacin - Oxytetracycline
 Imperan - Metoclopramide HCl
 Impril - Imipramine HCl
 Impugan - Furosemide
 Imuran - Azathioprine
 Inacilin - Pivampicillin
 Imurek - Azathioprine
 Inagen - Ethambutol HCl
 Inalone - Beclomethasone dipropionate
 Inamycin - Novobiocin
 Inapetyl - Benzphetamine HCl
 Inapsine - Droperidol
 Inbestan - Clemastine fumarate
 Incoran - Prenylamine
 Incron - Dicyclomine HCl
 Indacin - Indomethacin
 Indanal - Clidanac
 Inderal - Propranolol HCl
 Inderapollon - Indomethacin
 Inderide - Hydrochlorothiazide
 Inderide - Propranolol HCl
 Indetrit - Indomethacin
 Indium - Indomethacin
 Indo - Indomethacin
 Indobloc - Propranolol HCl
 Indocid - Indomethacin
 Indocin - Indomethacin
 Indodur - Indomethacin
 Indoklon - Flurothyl
 Indolag - Indomethacin
 Indolene - Indomethacin
 Indomed - Indomethacin
 Indomet - Indomethacin
 Indomethine - Indometacin
 Indometin - Indomethacin
 Indone RC - Indomethacin
 Indorektal - Indomethacin
 Indoremed - Indomethacin
 Indo-Tabliten - Indomethacin
 Indotard - Indomethacin
 Indren - Indomethacin
 Indunox - Etodroxizine
 Infectomycin - Amoxicillin
 Infiltrina - Dimethyl sulfoxide
 Inflam - Ibuprofen
 Inflamase - Prednisolone phosphate sodium
 Inflammefran - Prednisolone acetate
 Inflamen - Bromelain
 Inflamid - Benoxaprofen
 Inflammil - Oxyphenbutazone
 Inflazon - Indomethacin
 Inflen - Ketoprofen
 Influenol - Amantidine HCl
 Ingelan - Isoproterenol sulfate
 INH - Isoniazid
 INH-Burgthal - Isoniazid
 Inheltran - Enflurane
 Inhiston - Pheniramine maleate
 Inidrase - Acetazolamide
 Inimur - Nifuratel
 Injactapap - Acetaminophen
 Inmecin - Indomethacin
 Inmetocin - Indomethacin
 Inmetsin - Indomethacin
 Innovar - Fentanyl
 Innoxalon - Nalidixic acid
 Inoball - Methixene HCl
 Inochinate - Inositol niacinate
 Inocor - Amrinone
 Inocortyl - Prednisone
 Inokiten - Ubidecarenone
 Inomaru S - Oxyphenyclimmine
 Inosinit - Inositol niacinate
 Inositine - Inositol
 Intotrex - Dobutamine
 Insidon - Opipramol
 Insilange D - Tolbutamide
 Insomin - Nitrazepam
 Insomnal - Diphenhydramine HCl
 Insoral - Phenformin
 Inspir - Acetylcysteine
 Instenon - Hexobendine
 Instotal - Mequitazine
 Insulamin - Buformin HCl
 Insulase - Chlorpropamide
 Insulatard - Insulin
 Insulatard - Insulin isophane
 Insumin - Flurazepam
 Insuven - Diosmin
 Intal - Cromolyn sodium
 Intalbut - Phenylbutazone
 Intalpen - Penicillin V
 Intalpran - Imipramine HCl
 Inteban - Indomethacin
 Intefuran - Furazolidone
 Intelon - Citicoline
 Intenkordin - Chromonar HCl

Intensacrom - Chromonar HCl
 Intensain - Butthiazide
 Intensain - Chromonar HCl
 Intensain-Lanitop - Medigoxin
 Intensol - Chlorquinaldol
 Intercept - Nonoxynol
 In Tham-E - Tromethamine
 Intradermo - Fluocinolone acetonide
 Intradine - Sulfamethazine
 Intralibix - Iodipamide
 Intran - Dimethyl sulfoxide
 Intranpan - Dexpanthenol
 Intrasept - Penicillin G procaine
 Intrasporin - Cephaloridine
 Introcortin T - Tubocurarine chloride
 Intromene - Trichloromethiazide
 Intussin - Butamirate citrate
 Inulon - Fructose
 Inversine - Mecamylamine HCl
 Ioacine - Dibekacin
 Iodopaque - Acetrizoate sodium
 Ional sodium - Secobarbital sodium
 Ionamin - Phentermine HCl
 Iopamiro - Iopamidol
 Iosel - Selenium sulfide
 Ipebutona - Oxyphenbutazone
 Ipercortis - Triamcinolone
 Ipersed - Nitrazepam
 Ipersulfa - Sulfadimethoxine
 Ipnomez - Nitrazepam
 Ipflogin - Medrysone
 Ipolina - Hydralazine HCl
 Ipolipid - Clofibrate
 Iporal - Guanethidine sulfate
 Ipotensium - Clonidine HCl
 Ipotensivo - Mebutamate
 Ipotidina - Guanethidine sulfate
 Ipradol - Hexoprenaline
 Ipral - Trimethoprim
 Iprogen - Imipramine HCl
 Ipronal - Proxibarbal
 Ipronid - Iproniazid
 Ipropran - Iprnidazole
 Ipsatol - Biperiden
 Ipsilon - Aminocaproic acid
 Iramil - Imipramine HCl
 Iranil - Oxazepam
 Ircon - Ferrous fumarate
 Ircon - Folic acid
 Iretin - Cytarabine HCl
 Iricoline - Carbachol
 Iridil - Oxyphenbutazone
 Iridocin - Ethionamide
 Irinatolon - Diclofenac sodium
 Irofol - Folic acid
 Iromin - Carbaspurin calcium
 Iromin - Folic acid
 Irospan - Ferrous fumarate
 Irriten - Lonazolac
 Irritren - Lonazolac
 Irrorin - Prenylamine
 Isalax - Oxyphenisatin acetate
 Ischemol - Tetrahydrozoline HCl
 Iscotin - Isoniazid
 ISDN - Isosorbide dinitrate
 Isephanine - Dipyrindamole
 Ishitomin - Chlorpromazine HCl
 Isimoxin - Amoxicillin
 Ismelin - Guanethidine sulfate
 Ismeline - Guanethidine sulfate
 Ismicetina - Chloramphenicol
 Ismipur - Mercaptopurine
 Isnaderm - Fluocinolone acetonide
 Isnamide - Sulpiride
 Isobicini - Isoniazid
 Isobid - Isosorbide dinitrate
 Iso-Bid - Isosorbide dinitrate
 Isobutil - Oxyphenbutazone
 Isocaine - Mepivacaine
 Isocalsin - Rescinnamine
 Isocardide - Isosorbide dinitrate
 Isochin - Oxazepam
 Isochinol - Dimethisoquin
 Isocillin - Ampicillin
 Isoclor - Chlorpheniramine maleate
 Iso-D - Isosorbide dinitrate
 Isodemetil - Demeclocycline HCl
 Isoderma - Fluocinolone acetonide
 Iso-Dexter - Isoniazid
 Isodine - Povidone-Iodine
 Isoglaucan - Clonidine HCl
 Iso-K - Ketoprofen
 Isoket - Isosorbide dinitrate
 Isokulin - Isoxsuprine HCl
 Isolait - Isoxsuprine HCl
 Isomack - Isosorbide dinitrate
 Isomenyl - Isoproterenol sulfate
 Isometa - Methacryline
 Isomotic - Isosorbide dinitrate
 Isonefrine - Phenylephrine HCl
 Isonorin - Isoproterenol sulfate
 Isopeque - Metrizoic acid
 Isoperin - Choline theophyllinate
 Isophenicol - Chloramphenicol
 Isophrine - Phenylephrine HCl
 Isopine - Verapamil
 Isopredon - Fluprednisolone
 Isopresol - Captopril
 Isoptin - Verapamil
 Isopto-Carbachol - Carbachol
 Isopuren - Isosorbide dinitrate
 Isopyratsin - Pyrazinamide
 Isordil - Isosorbide dinitrate
 Isosulf - Sulfisomidine
 Isotamine - Isoniazid
 Isotol - Mannitol
 Isotonil - Dimetacrine tartrate
 Isotrate - Isosorbide dinitrate
 Isotropina - Phenylephrine HCl
 Isovue - Iopamidol
 Isuxal - Perisoxal citrate
 Isoxamin - Sulfisoxazole
 Isoxyl - Tiocarlide
 Isozide - Isoniazid
 Isozol - Thiamylal
 Issium - Flunarizine HCl
 Isteropac - Iodamide
 Isvitrol - Pivampicillin
 Itacem - Cimetide
 Italprid - Tiapride
 Itinerol - Meclizine HCl
 Itiocide - Ethionamide
 Itorex - Cefuroxime
 Itrop - Ipratropium bromide
 Itrumil - Iothiouracil
 I/T/S Ilotycin - Erythromycin
 Ituran - Nitrofurantoin
 Ivaugan - Hydrochlorothiazide
 Ivax - Neomycin
 Ivilax - Bisacodyl

Iwacillin - Ampicillin
 Iwalexin - Cephalixin
 Ixoten - Trofosamide
 Izaberizin - Cinnarizine
 Izobarin - Guanethidine sulfate

 Jabon salicilico - Salicylic acid
 Jacutin - Lindane
 Janimine - Imipramine HCl
 Janocilin - Cephalixin
 Janopen - Metampicillin sodium
 Janosina - Cephaloridine
 Jatroneural - Trifluoperazine
 Jatropur - Triamterene
 Jatsulph - Sulfadimethoxide
 Jectatest - Testosterone 17 β -cypionate
 Jellin - Fluocinolone acetonide
 Jenamicin - Gentamicin sulfate
 Jen-Diril - Hydrochlorothiazide
 Jestryl - Carbachol
 Jexin - Tubocurarine chloride
 Jicsron - Nalidixic acid
 Jodobac - Povidone-Iodine
 Jodocur - Povidone-Iodine
 Jonakraft - Phentermine HCl
 Jonctum - Oxaceprol
 Judolor - Fursultiamine
 Jumex - Selegiline
 Jupal - Xanthinol niacinate
 Justamil - Sulfamoxole
 Justpertin - Dipyrnidamole
 Justquinon - Ubidecarenone
 Juvabe - Cyanocobalamin
 Juvallax - Cyclobutylrol
 Juveprine - Aspirin

 Kabikinase - Streptokinase
 Kabolin - Nandrolone decanoate
 Kadol - Phenylbutazone
 Kafocin - Cephaloglycin
 Kaichyl - Valetamate bromide
 Kaitron - Ubidecarenone
 Kalistat - Triamterene
 Kalutein - Clorprenaline
 Kalymim - Pyridostigmine bromide
 Kamaver - Chloramphenicol
 Kaminax - Amikacin
 Kamycine - Kanamycin sulfate
 Kanabiol - Kanamycin sulfate
 Kanabiot - Kanamycin sulfate
 Kanabristol - Kanamycin sulfate
 Kanacet - Kanamycin sulfate
 Kanacillin - Kanamycin sulfate
 Kanacyclin - Kanamycin sulfate
 Kanacyn - Kanamycin sulfate
 Kanafil - Kanamycin sulfate
 Kanafuracin - Kanamycin sulfate
 Kanahidro - Kanamycin sulfate
 Kanamicina Normon - Kanamycin sulfate
 Kanamycin - Kanamycin sulfate
 Kanamycine - Kanamycin sulfate
 Kanamytrex - Kanamycin sulfate
 Kanapiam - Kanamycin sulfate
 Kanaqua - Kanamycin sulfate
 Kanasig - Kanamycin sulfate
 Kanetrol - Kanamycin sulfate
 Kanavit - Phytonadione
 Kanendomicina - Bekanamycin sulfate
 Kanendomycin - Bekanamycin sulfate
 Kanendos - Bekanamycin sulfate

 Kanescin - Kanamycin sulfate
 Kano - Kanamycin sulfate
 Kantor - Minaprine
 Kantrex - Kanamycin sulfate
 Kapiride - Sulpiride
 Kapoxi - Amoxicillin
 Kappabi - Dibekacin
 Kappadione - Menadiol sodium phosphate
 Kaprogest - Hydroxyprogesterone caproate
 Karbenol - Carbenoxolone
 Karidium - Clobazam
 Kataglicina - Phenformin
 Katij - Menadiol sodium phosphate
 Kativ-N - Phytonadione
 Katlex - Furosemide
 Katoseran - Cinnarizine
 Kayeine - Phytonadione
 Kaywan - Phytonadione
 Kebibil - Chenodiol
 Kebuzon - Kebuzone
 Kecimeton - Fluorouracil
 Kedacillina - Sulbenicillin
 Kefadol - Cefamandole nafate sodium salt
 Kefandol - Cefamandole nafate sodium salt
 Kefenid - Ketoprofen
 Kefglycin - Cephaloglycin
 Keflex - Cephalixin
 Keflin - Cephalothin sodium
 Keflodin - Cephaloridine
 Kefolor - Cefaclor
 Keforal - Cephalixin
 Kefox - Cefuroxime
 Kefral - Cefaclor
 Kefspor - Cephaloridine
 Kefzol - Cefazolin sodium
 Keimicina - Kanamycin sulfate
 K-Eine - Phytonadione
 Keipole - Phytonadione
 Kelfison - Cephalixin
 Kelfison - Cephaloridine
 Kelfizina - Sulfalene
 Kelfizine - Sulfalene
 Kemadren - Procyclidine HCl
 Kemadrin - Procyclidine HCl
 Kemadrine - Procyclidine HCl
 Kemi - Propranolol HCl
 Kemicetin - Chloramphenicol
 Kemicetine - Chloramphenicol
 Kemicotine - Chloramphenicol
 Kempfi - Spectinamycin
 Kemsol - Dimethyl sulfoxide
 Kenacort - Triamcinolone
 Kenacort - Triamcinolone acetonide
 Kenacort - Triamcinolone diacetate
 Kenacort-A - Triamcinolone acetonide
 Kenal - Triamcinolone acetonide
 Kenalog - Triamcinolone acetonide
 Kendiphen - Diphenhydramine HCl
 Kennegin - Phytonadione
 Kenolite - Chenodiol
 Kentan-S - Kebuzone
 Kephton - Phytonadione
 Keralyt - Salicylic acid
 Kerecid - Idoxuridine
 Kerlon - Betaxolol HCl
 Kerlone - Betaxolol HCl
 Keselan - Haloperidol
 Kesint - Cefuroxime
 Kesmicina - Pivampicillin
 Kesso-Bamate - Meprobamate

- Kesso-Mycin - Erythromycin
 Kestomatine - Dimethicone
 Ketaject - Ketamine HCl
 Ketalar - Ketamine HCl
 Ketalgin - Ketoprofen
 Ketalgin - Methadone HCl
 Ketaman - Propantheline bromide
 Ketanest - Ketamine HCl
 Ketawrilt - Allopurinol
 Ketazol - Ketoconazole
 Ketazon - Kebuzone
 Ketazone - Kebuzone
 Keteocort - Prednisolone
 Keteocort-H - Prednisolone
 Kethamed - Pemoline
 Keto - Ketoprofen
 Ketobun A - Allopurinol
 Ketobutan - Kebuzone
 Ketobutane - Kebuzone
 Ketobutazone - Kebuzone
 Ketocef - Cefuroxime
 Ketofen - Kebuzone
 Ketofen - Ketoprofen
 Keton - Ketoprofen
 Ketonal - Ketoprofen
 Ketophezon - Kebuzone
 Ketopron - Ketoprofen
 Ketoprosil - Ketoprofen
 Ketoscillium - Fentonium bromide
 Ketoval - Ketoprofen
 Kevadon - Ketoprofen
 Key-Pred - Prednisolone acetate
 Key-Pred S.P. - Prednisolone phosphate sodium
 Key-Serpine - Reserpine
 Keysone - Prednisone
 Kibon S - Dextromethorphan hydrobromide
 Kidrolase - Asparaginase
 Kilios - Aspirin
 Kilmicen - Tolciclate
 Kiloclyde - Cytarabine HCl
 Kilozim - Metoclopramide HCl
 Kinadione - Phytonadione
 Kinavosyl - Mepheneis carbamate
 Kinder-Finiweh - Acetaminophen
 Kinevac - Sincalide
 Kinotomin - Clemastine fumarate
 Kinteto - Rolitetracycline
 Kinupril - Quinupramine
 Kiricoron - Chlorzoxazone
 Kirocid - Sulfameter
 Kiron - Sulfameter
 Kisikonon - Phytonadione
 Kitadol - Tilidine HCl
 Klaricina - Penicillin G procaine
 Klebcil - Kanamycin sulfate
 Klinium - Lidoflazine
 Klinomycin - Minocycline
 Klintab - Lidoflazine
 Klion - Metronidazole
 Klobamicina - Dibekacin
 Klofenil - Cyclofenil
 Klofiran - Clofibrate
 Klometil - Prochlorperazine
 Klorazin - Chlorpromazine HCl
 Kloromin - Chlorpheniramine maleate
 Kloromisin - Chloramphenicol
 Klorproman - Chlorpromazine HCl
 Klorpromex - Chlorpromazine HCl
 Klort - Meprobamate
 Kloxerate - Cloxacillin
 Knavon - Ketoprofen
 Kobazepam - Medazepam
 Koffex - Dextromethorphan hydrobromide
 Kol - Fenipentol
 Kolantyl - Dicyclomine HCl
 Kolpicid - Ornidazole
 Kolpicortin - Chlorphenesin carbamate
 Kolpi Gynaedron - Ethinyloestradiol
 Kolton Gelee - Diphenylpyraline HCl
 Komed - Salicylic acid
 Komplexon III - Edetate disodium
 Konaktion - Phytonadione
 Kontristin - Pyrilamine
 Koptin - Kanamycin sulfate
 Korbutone - Beclomethasone dipropionate
 Korigestic - Phenylephrine HCl
 Korigestic - Phenylpropanolamine HCl
 Korostatin - Nystatin
 Koro-Sulf - Sulfisoxazole
 Kortikoid - Triamcinolone acetonide
 Korum - Acetaminophen
 Kotanicit - Inositol niacinat
 Kratofin - Acetaminophen
 Kreucosan - Metronidazole
 Kridan - Isoniazid
 Kriplex - Diclofenac sodium
 Kriptin - Pyrilamine
 Kromolin - Cromolyn sodium
 Kronohist - Phenylpropanolamine HCl
 Kronohist - Pyrilamine
 K-Top Wan - Phytonadione
 Kurgan - Cefazolin sodium
 Kusnarin - Nalidixic acid
 Kutrix - Furosemide
 Kwell - Lindane
 Kynex - Sulfamethoxypyridazine
 Kyocristine - Vincristine sulfate
 Labamicol - Chloramphenicol
 Labamol - Acetaminophen
 Labelol - Labetalol HCl
 Labican - Chlordiazepoxide HCl
 Lacalmin - Spironolactone
 Lacedene - Spironolactone
 Lacermucin - Tyloxapal
 Laco - Bisacodyl
 Lactetin - Clemastine fumarate
 Lacrimin - Benoxinate hydrochloride
 Lacrisert - Hydroxypropyl cellulose
 Lactamine - Prenylamine
 Lacurmin - Mepazine
 Ladogal - Danazol
 Ladogar - Danazol
 Laevilac - Lactulose
 Laevolac - Lactulose
 Laeavoral - Fructose
 Laevuflex - Fructose
 Legaquin - Chloroquine phosphate
 Lagazepam - Nitrazepam
 Laksodil - Bisacodyl
 Lamar - Tegafur
 Lambral - Tolazoline
 Lamidon - Ibuprofen
 Lamitol - Labetalol HCl
 Lamoryl - Griseofulvin
 Lampocillina Orale - Ampicillin
 Lampomanol - Cefamandole nafate sodium salt
 Lamosporin - Cefuroxime
 Lamra - Diazepam

Lanabolin - Methandrostenolone
 Lancabiocin - Pivampicillin
 Lancetina - Fosfomicin
 Landamycin - Ribostamicin
 Landelun - Ibuprofen
 Lan-Dol - Meprobamate
 Landrina - Xanthinol niacinate
 Landruma - Niflumic acid
 Landsen - Clonazepam
 Langesic - Acetaminophen
 Lanirapid - Medigoxin
 Lanitop - Medigoxin
 Lantanon - Mianserin
 Lantron - Amitriptyline HCl
 Lanvis - Thioguanine
 Laragon - Silymarin
 Largactil - Chlorpromazine HCl
 Largiven - Isoxsuprine HCl
 Largomicina - Methacycline
 Largopen - Amoxicillin
 Larixin - Cephalixin
 Larmicin - Neomycin
 Larodopa - Levodopa
 Larotid - Amoxicillin
 Laroxyl - Amitriptyline HCl
 Larylin - Chlorhexidine
 Laser - Naproxen
 Laseramin - Hydroxocobalamin
 Laserdil - Isoorbide dinitrate
 Lasilix - Furosemide
 Lasix - Furosemide
 Lastrogen - Estradiol valerate
 Lati 2 - Metoprolol tartrate
 Latocef - Cefatrizine
 Latomicina - Demeclocycline HCl
 Latoral - Cephalixin
 Latorex - Cephaloridine
 Lauridin - Cephaloridine
 Laurilin - Erythromycin estolate
 Lauromicina - Erythromycin estolate
 Lauron - Aurothioglycanide
 Laurylin - Erythromycin lactobionate
 Lausit - Indomethacin
 Lavema - Oxyphenisatin acetate
 Lavodina - Sulpiride
 Lax - Bisacodyl
 Laxadin - Bisacodyl
 Laxagetten - Bisacodyl
 Laxanin N - Bisacodyl
 Laxanormal - Oxyphenisatin acetate
 Laxante Azoxico - Picosulfate sodium
 Laxatan - Oxyphenisatin acetate
 Laxbene - Bisacodyl
 Laxematic - Bisacodyl
 Laxidogol - Picosulfate sodium
 Laxoberal - Picosulfate sodium
 Laxoberon - Picosulfate sodium
 L-Customed - Bromhexine
 Leabar - Iopanoic acid
 Lealgin - Phenoperidine HCl
 Leanol - Hexoprenaline
 Lebelon - Bromhexine
 Leberschutz - Timonacic sodium
 Lecasol - Clemastine fumarate
 Lectopam - Bromazepam
 Ledercillin - Penicillin G procaine
 Ledercort - Triamcinolone
 Ledercort - Triamcinolone diacetate
 Ledercort N - Triamcinolone acetonide
 Lederfen - Fenbufen
 Lederkyn - Sulfamethoxypridazine
 Ledermicina - Demeclocycline HCl
 Ledermycine - Demeclocycline HCl
 Lederspan - Triamcinolone acetonide
 Ledertrexate - Methotrexate
 Lefax - Dimethicone
 Lefos - Isoniazid
 Lefosporina - Cephalixin
 Legalon - Silymarin
 Legemzolina - Cefazolin sodium
 Lehydan - Phenytoin
 Lekrica - Chlorpheniramine maleate
 Lemazide - Benzthiazide
 Lembrol - Diazepam
 Lemiserp - Reserpine
 Lempav Ty-Med - Papaverine monophosadenine
 Lemprometh - Promethazine HCl
 Lenasma - Metaproterenol sulfate
 Lenazine - Promethazine HCl
 Lendorm - Brotizolam
 Lendormin - Brotizolam
 Lenetran - Mephenoaxalone
 Lenigesial - Viminol
 Lenipan - Nefopam HCl
 Lenitin - Bromazepam
 Lenopect - Pipazethate
 Lensen - Diphenhydramine HCl
 Lensualpha - Sulfadimethoxine
 Lente Insulin - Insulin zinc suspension
 Lentin - Carbachol
 Lentivasan - Carbachol
 Lentizol - Amitriptyline HCl
 Lentosulfa - Sulfamethoxypridazine
 Lentotran - Chlordiazepoxide HCl
 Lentrat - Pentaerythritol tetranitrate
 Leodrine - Hydroflumethiazide
 Leonar - Pyritinol
 Leotesin-N - Lidocaine
 Leponex - Clozapine
 Leptamine - Amphetamine phosphate
 Leptanal - Fentanyl
 Leptofen - Droperidol
 Leptryl - Perimethazine
 Lergefin - Carbinoxamine maleate
 Lergigan - Promethazine HCl
 Lergoban - Diphenylpyraline HCl
 Lerisum - Medazepam
 Leritine - Anileridine dihydrochloride
 Leritine HCl - Anileridine dihydrochloride
 Lertus - Ketoprofen
 Lescopine - Methscopolamine bromide
 Lesmit - Medazepam
 Lesterol - Probucool
 Lestid - Colestipol
 Letamate - Valetamate bromide
 Letamol - Acetaminophen
 Letaquine - Chloroquine phosphate
 Lethidrone - Nalorphine
 Letter - Levothyroxine sodium
 Leucid - Vincristine sulfate
 Leucogen - Asparaginase
 Leukeran - Chlorambucil
 Leukerin - Mercaptopurine
 Leukomycin - Chloramphenicol
 Leunase - Asparaginase
 Levanil - Ectylurea
 Levantin - Nifurtoinol
 Levanxol - Temazepam
 Levaru - Methotrimeprazine
 Levate - Amitriptyline HCl

Levatrom - Clofibrate
 Levaxin - Levothyroxine sodium
 Levicor - Metaraminol
 Levisul - Sulfadimethoxine
 Levium - Diazepam
 Levius - Aspirin
 Levomezine - Methotrimeprazine
 Levomicetina - Chloramphenicol palmitate
 Levomyccetin - Chloramphenicol
 Levopa - Levodopa
 Levoprome - Methotrimeprazine
 Levospan - Methylergonovine maleate
 Levothym - Hydroxytryptophan
 Levothym - Oxitriptan
 Levothyrox - Levothyroxine sodium
 Levotiron - Levothyroxine sodium
 Levotomin - Methotrimeprazine
 Levotonine - Oxitriptan
 Levrison - Trioxsalen
 Levugen - Fructose
 Levulose - Fructose
 Levupan - Fructose
 Lexaurin - Bromazepam
 Lexibiotico - Cephalexin
 Lexibiotico - Cephaloridine
 Lexilium - Bromazepam
 Lexin - Carbamazepine
 Lexocort - Hydrocortisone
 Lexomil - Bromazepam
 Lexotan - Bromazepam
 Lexotanil - Bromazepam
 Lexxor - Hydrochlorothiazide
 Liberan - Propoxyphene HCl
 Liberetas - Diazepam
 Libesporal - Cephalexin
 Libesporina - Cephaloridine
 Librax - Clidinium bromide
 Librium - Chlordiazepoxide HCl
 Licyl - Aspirin
 Lida-Mantal - Lidocaine
 Lidanil - Mesoridazine besylate
 Lidex - Fluocinonide
 Lidocain - Lidocaine
 Lidocar - Lidocaine
 Lidocard - Lidocaine
 Lidocaton - Lidocaine
 Lidone - Molindone
 Lido Pen - Lidocaine
 Liexina - Cephaloridine
 Lifaton B12 - Cyanocobalamin
 Life - Pyritinol
 Lifeampil - Ampicillin
 Lifeampil - Ampicillin trihydrate
 Lifene - Phensuximide
 Lifezolina - Cefazolin sodium
 Lifril - Fluorouracil
 Lifril - Tegafur
 Lignane - Lidocaine
 Likacin - Amikacin
 Likuden - Griseofulvin
 Lillacillin - Sulfenicillin
 Limbial - Oxazepam
 Limbitrol - Amitriptyline HCl
 Limpidon - Camazepam
 Lincocin - Lincomycin
 Lincocine - Lincomycin
 Lincolcina - Lincomycin
 Lineal - Fenproporex
 Lineal-Rivo - Diethylpropion HCl
 Linea Valeas - Diethylpropion HCl
 Linfolysin - Chlorambucil
 Linosal - Betamethasone
 Linostil - Dimetacrine tartrate
 Linton - Haloperidol
 Linyl - Phentermine HCl
 Lioresal - Baclofen
 Lipanor - Ciprofibrate
 Lipanthyl - Fenofibrate
 Lipantyl - Fenofibrate
 Lipavil - Clofibrate
 Lipavlon - Clofibrate
 Lipenan - Clofibrate
 Lipidax - Fenofibrate
 Lipidicon - Clofibrate
 Lipidil - Fenofibrate
 Lipo - Folic acid
 Lipo-BC - Inositol
 Lipocholn - Choline dihydrogen citrate
 Lipoclar - Fenofibrate
 Lipocrin - Clonofibrate
 Lipocyclin - Clonofibrate
 Lipo-Diazine - Sulfadiazine
 Lipofene - Fenofibrate
 Lipo-Gantrisin acetyl - Acetyl sulfisoxazole
 Lipolin - Fenproporex
 Lipo-Merz - Etofibrate
 Lipomin - Diethylpropion HCl
 Lipopil - Phentermine HCl
 Liposid - Clofibrate
 Lipoosit - Fenofibrate
 Liposlim - Diethylpropion HCl
 Liposolvln - Simfibrate
 Lipotrin - Cyclobutylol
 Liprinal - Clofibrate
 Liptan - Ibuprofen
 Liqaemin - Heparin
 Liquamar - Phenprocoumon
 Liquid Pred - Prednisone
 Lisacef - Cephadrine
 Lisacort - Prednisone
 Liserdol - Metergoline
 Lisium - Chlorhexidine
 Liskantin - Primidone
 Lisogerm - Methenamine hippurate
 Lisomucil - Carbocysteine
 Lisospasm - Cyclandelate
 Listica - Hydroxyphenamate
 Litalir - Hydroxyurea
 Liverpen - Fenipentol
 Liviatin - Doxycycline
 Livicliana - Cefazolin sodium
 Lixil - Bumetanide
 Lixin - Chlordiazepoxide HCl
 Lizan - Diazepam
 Lizik - Furosemide
 Llenas Biotic - Cephalexin
 Llenas Biotic - Cephaloridine
 Loncefal - Cephaloridine
 LMD 10% - Dextran 40
 Lobamine - Methionine
 Lobilan Nasal - Flunisolide
 Locabiosol - Fusafungine
 Locabiotal - Fusafungine
 Locacorten - Flumethasone
 Localyn - Fluocinolone acetonide
 Locapred - Desonide
 Loccalline - Cephalothin sodium
 Locorten - Flumethasone
 Locton - Suloctidil
 Lodopin - Zotepine

- Lodosyn - Carbidopa
 Lofetensin - Lofexidine HCl
 Lofoxin - Fosfomycin
 Loftran - Ketazolam
 Loftyl - Buflomedil
 Logiston - Glibornuride
 Lokilan Nasal - Flunisolide
 Lolum - Labetalol HCl
 Lomarin - Dimenhydrinate
 Lombriareu - Pyrantel pamoate
 Lomecitina - Chloramphenicol
 Lomine - Dicyclomine HCl
 Lomisat - Clobutinol
 Lomodex 40 - Dextran 40
 Lomotil - Diphenoxylate HCl
 Lompar - Mebendazole
 Lomudal - Cromolyn sodium
 Lomupren - Cromolyn sodium
 Lonavar - Oxandrolone
 Longacillin - Penicillin G benzathine
 Longamid - Sulfamethoxy pyridazine
 Longasa - Aspirin
 Longasteril - Dextran 40
 Longatren - Azidocillin
 Longicobal - Hydroxocobalamin
 Longisul Jarabe - Sulfamethoxy pyridazine
 Longoran - Penfluridol
 Longum - Sulfalene
 Loniten - Minoxidil
 Lonjee - Chlorquinaldol
 Lonolox - Minoxidil
 Looser (Lucer) - Bupranolol
 Lopemid - Loperamide HCl
 Loperamid - Loperamide HCl
 Loperyl - Loperamide HCl
 Lophakomb B12 - Cyanocobalamin
 Lopid - Gemfibrozil
 Lopirin - Captopril
 Lopres - Hydralazine HCl
 Lopresol - Metoprolol tartrate
 Lopress - Hydralazine HCl
 Lopressor - Hydrochlorothiazide
 Lopressor - Metoprolol tartrate
 Loprox - Ciclopiroxolamine
 Lopurin - Allopurinol
 Loqua - Hydrochlorothiazide
 Loramet - Lormetazepam
 Loramid - Lormetazepam
 Lorans - Lorazepam
 Lorcet - Propoxyphene HCl
 Lorelco - Probucof
 Lorexina - Cephalexin
 Loriden - Flumethasone
 Loridine - Cephaloridine
 Lorivan - Lorazepam
 Loromisin - Chloramphenicol
 Lorphen - Chlorpheniramine maleate
 Lorsiilan - Lorazepam
 Lortisone - Betamethasone dipropionate
 Lospoven - Cephalothin sodium
 Loticort - Fluorometholone
 Lotrimin - Clotrimazole
 Loviscol - Carbocysteine
 Lowpston - Furosemide
 Loxapac - Loxapine
 Loxitane - Loxapine
 Loxuran - Diethylcarbamazine citrate
 Lozide - Indapamide
 Lozol - Indapamide
 LPG - Penicillin G benzathine
 Lubacida - Isoniazid
 Lubalix - Cloxazolam
 Lubomaniil - Trimetazidine
 Lubomycine - Erythromycin estolate
 Lubomycine L - Erythromycin lactobionate
 Lubricort - Hydrocortisone
 Lucer - Bupranolol
 Lucidil - Benactyzine hydrochloride
 Lucidon - Dienestrol
 Luf-Iso - Isoproterenol sulfate
 Lufyllin - Dyphylline
 Lufyllin - Guaifenesin
 Lullamin - Methapyrilene HCl
 Lumbaxol - Chlormezanone
 Lumirelax - Methocarbamol
 Lumota - Apacillin sodium
 Lunacin - Tegafur
 Lunetoron - Bumetanide
 Lunipax - Flurazepam
 Lunis - Flunisolide
 Lurselle - Probucof
 Lusap - Malathion
 Lusedan - Sulpiride
 Lutalyse - Dinoprost tromethamine
 Lutedione - Mestranol
 Luteocrin - Medroxyprogesterone acetate
 Luteodione - Medroxyprogesterone acetate
 Luteonorm - Ethynodiol diacetate
 Luteos - Medroxyprogesterone acetate
 Lutionex - Demegestone
 Lutometrodiol - Ethynodiol diacetate
 Lutopolar - Medroxyprogesterone acetate
 Lutopron - Hydroxyprogesterone caproate
 Lutoral - Medroxyprogesterone acetate
 Lyantil - Phthalysulfathiazole
 Lycanol - Glymidine
 Lyesipoll - Diphenylpyraline HCl
 Lyladorm - Nitrazepam
 Lyndak - Sulindac
 Lyndiol - Mestranol
 Lynoral - Ethinylestradiol
 Lyogen - Fluphenazine HCl
 Lyorodin - Fluphenazine HCl
 Lyovac - Chlorothiazide
 Lyovac - Dactinomycin
 Lyovac - Fibrinolysin
 Lysalgo - Mefenamic acid
 Lysanxia - Prazepam
 Lysivane - Ethopropazine HCl
 Lysmucol - Sobrerol
 Lyspafen - Difenoquine
 Lyspafena - Difenoquine
 Lysuron - Allopurinol
 Lyteca - Acetaminophen
 Mabertin - Temazepam
 Mablín - Busulfan
 Macasirool - Furosemide
 Macmiror - Nifuratel
 Macocyn - Oxytetracycline
 Macphenicol - Thiamphenicol
 Macroclantín - Nitrofurantoin
 Macro-Dil - Midecamycin
 Madaprox - Naproxen
 Madar - Nordazepam
 Madecilina - Metampicillin sodium
 Madelen - Ornidazole
 Madlexin - Cephalexin
 Madopar - Benserazide
 Madopark - Benserazide

Madribon - Sulfadimethoxine
 Madrigid - Sulfadimethoxine
 Madroxin - Sulfadimethoxine
 Maeva - Temazepam
 Mafatate - Mafenide acetate
 Mafylon - Mafenide acetate
 Magis-Ciclina - Demeclocycline HCl
 Magmilor - Nifuratel
 Magmoid sulfadiazine - Sulfadiazine
 Magnacort - Hydrocortamate HCl
 Magnamycin - Carbomycin
 Magnecyl - Aspirin
 Magnipen - Metampicillin sodium
 Magnyl - Aspirin
 Magrene - Diethylpropion HCl
 Magrilan - Mazindol
 Maikohis - Clemastine fumarate
 Maind - Pyritinol
 Maiorad - Tiropamide
 Maipedopa - Levodopa
 Maipen - Metampicillin sodium
 Majeptil - Thioproperazine
 Majoral infantil - Aspirin
 Majorpen - Amoxicillin
 Majsolin - Primidone
 Makarol - Diethylstilbestrol
 Makrosilin - Ampicillin
 Maksipor - Cefazolin sodium
 Maksipor - Cephalexin
 Malarex - Chloroquine phosphate
 Maliasin - Barbexacalone
 Malice Shampoo - Lindane
 Malipuran - Bufenamac
 Mallermin-F - Clemastine fumarate
 Mallisol - Povidone-iodine
 Maloclide - Pyrimethamine
 Malogen - Methyltestosterone
 Malogen Cyp - Testosterone 17 β -cypionate
 Malogen LA - Testosterone enanthate
 Malogex - Testosterone enanthate
 Maloprim - Dapsone
 Maltos-10 - Maltose
 Mamalexin - Cephalexin
 Mamiesan - Dicyclomine HCl
 Mandelic - Cycloandelate
 Mandokef - Cefamandole nafate sodium salt
 Mandol - Cefamandole nafate sodium salt
 Mandolsan - Cefamandole nafate sodium salt
 Mandrax - Diphenhydramine HCl
 Mandrax - Methaqualone
 Manegan - Trazodone HCl
 Maneon - Amineptine HCl
 Manidon - Verapamil
 Manilina - Erythromycin estolate
 Maniol - Diphenidol
 Manir - Oxyphenacyclimine
 Manit - Mannitol
 Mannidex - Mannitol
 Mannitol I.V. - Mannitol
 Mansal - Cimetide
 Mantadan - Amantidine HCl
 Mantadil - Chlorcyclizine
 Mantadix - Amantidine HCl
 Manuril - Hydrochlorothiazide
 Manypren - Ibuprofen
 Maolate - Chlorphenesin carbamate
 Marax - Hydroxyzine HCl
 Marbate - Meprobamate
 Marcain - Bupivacaine
 Marcaina - Bupivacaine
 Marcaine - Bupivacaine
 Marcumar - Phenprocoumon
 Mareline - Amitriptyline HCl
 Maremal - Cyclizine
 Mareosan - Dimenhydrinate
 Marevan - Warfarin sodium
 Marezine - Cyclizine
 Margarte - Dimethicone
 Marisilan - Ampicillin
 Marnisonal - Prednisone
 Marocid - Erythromycin
 Marolin - Dimenhydrinate
 Marplan - Isocarboxazid
 Marrolingual - Isosorbide dinitrate
 Mersiilid - Iproniazid
 Marsin - Phenmetrazine
 Marsthine - Clemastine fumarate
 Martigene - Brompheniramine maleate
 Martimil - Nortriptyline
 Marucyclan - Cycloandelate
 Marukofon - Oxeladin
 Marunil - Clomipramine
 Marvelon - Desogestrel
 Marvidiene - Prednisone
 Marygin M - Isopropamide iodide
 Marzine - Cyclizine
 Masatirin - Thiamphenicol
 Masaton - Allopurinol
 Masblon H - Hydroxocobalamin
 Maschitt - Hydrochlorothiazide
 Mase-Bestrol - Diethylstilbestrol
 Maskin - Chlorhexidine
 Masletine - Clemastine fumarate
 Masmoran - Hydroxyzine HCl
 Masterid - Dromostanolone propionate
 Masteril - Dromostanolone propionate
 Masterone - Dromostanolone propionate
 Mastimyxin - Polymyxin
 Mastisol - Dromostanolone propionate
 Mastop - Tranexamic acid
 Matafa-Lind - Phenylephrine HCl
 Matromycin - Oleandomycin
 Matulane - Procarbazine HCl
 Maxeran - Metoclopramide HCl
 Maxibolin - Ethylestrenol
 Maxicam - Isoxicam
 Maxicilina - Ampicillin
 Maxidex - Dexamethasone phosphate
 Maxifen - Pivampicillin
 Maxiflor - Diflorasone diacetate
 Maximed - Protriptyline
 Maxipen - Phenethicillin potassium
 Maxolon - Metoclopramide HCl
 Max-Uric - Benzbromarone
 Maxzide - Hydrochlorothiazide
 Maxzide - Triamterene
 Maycor - Isosorbide dinitrate
 Mayeptil - Thioproperazine
 May-Vita - Dexpantenol
 May-Vita - Folic acid
 Mazanor - Mazindol
 Mazinge - Carbamazepine
 Mazildene - Mazindol
 MCP-Ratiopharm - Metoclopramide HCl
 MD-50 - Diatrizoate sodium
 Measurin - Aspirin
 Meaverin - Bupivacaine
 Meaverin - Mepivacaine
 Mebacid - Sulfamerazine
 Mebron - Epirizole

Mebutar - Mebendazole
 Mebutina - Mebutamate
 Mecazine - Meclizine HCl
 Mechothane - Bethanechol chloride
 Meciclin - Demeclocycline HCl
 Mecloderm - Fluocinolone acetate
 Meclomen - Meclofenamic acid
 Meclopran - Metoclopramide HCl
 Mecostrin - Dimethyl tubocurarine iodide
 Mecostrin - Tubocurarine chloride
 Medaron - Furazolidone
 Medaurin - Medazepam
 Medazol - Metronidazole
 Medemycin - Midecamycin
 Medesone - Methylprednisolone
 Medfina - Meperidine HCl
 Mediator - Benfluorex hydrochloride
 Mediaxal - Benfluorex hydrochloride
 Medicef - Cephadrine
 Medichol - Chloramphenicol
 Medicil - Morclofene
 Medicort - Triamcinolone
 Medicrucin - Bacitracin
 Medidopa - Levodopa
 Medidryl - Diphenhydramine HCl
 Medifenac - Alcofenac
 Medifuran - Furaltadone
 Medihaler-Iso - Isoproterenol sulfate
 Medilium - Chlordiazepoxide HCl
 Medimet - Methylidopa
 Medisyl - Aspirin
 Meditran - Meprobamate
 Med-Laxan - Bisacodyl
 Med-Laxan - Oxypheisatin acetate
 Medomet - Methylidopa
 Medomin - Heptabarbitol
 Medomine - Heptabarbitol
 Medomycin - Doxycycline
 Medomycin - Methacycline
 Medopa - Methylidopa
 Medopal - Methylidopa
 Medopren - Methylidopa
 Medoxin - Cefuroxime
 Medrifar - Medrysone
 Medritonic - Medrysone
 Medrol - Methylprednisolone
 Medroptil - Medrysone
 Medrysone Faure - Medrysone
 Meduxal - Pyridinol carbamate
 Mefacen - Indomethacin
 Mefacit - Mefenamic acid
 Mefedolo - Mefenamic acid
 Mefoxin - Cefoxitin sodium
 Mefoxitin - Cefoxitin sodium
 Mefrusal - Mefruside
 Mega-B - Folic acid
 Mega-B - Inositol
 Megace - Megestrol acetate
 Megacef - Cephadrine
 Megacillin - Amoxicillin
 Megacillin - Penicillin G benzathine
 Megacort - Dexamethasone phosphate
 Megadose - Folic acid
 Megadose - Inositol
 Megamycine - Methacycline
 Megaphen - Chlorpromazine HCl
 Megasedan - Medazepam
 Mega-Star - Methylprednisolone
 Megeron - Megestrol acetate
 Megestat - Megestrol acetate
 Meglum - Levamisole HCl
 Megrin - Hepronicate
 Meibis - Citicoline
 Me-Korti - Prednisone
 Meladinine - Methoxsalen
 Melanek - Hydroquinone
 Meldian - Chlorpropamide
 Melfa - Sulfadimethoxine
 Melfiat - Phendimetrazine tartrate
 Melianin - Allopurinol
 Melipramin - Imipramine HCl
 Melisar - Chlorpropamide
 Melitase - Chlorpropamide
 Melizid - Glipizide
 Mellaril - Thioridazine
 Mellerette - Thioridazine
 Melleretten - Thioridazine
 Mellitas - Chlorpropamide
 Mellitos D - Tolbutamide
 Melormin - Chlorpropamide
 Meloxine - Methoxsalen
 Meltrol - Phenformin
 Melysin - Pivmecillinam
 Memento - Pipemidic acid
 Mempil - Metampicillin sodium
 Menaval - Estradiol valerate
 Mendalgesia - Acetaminophen
 Mendon - Clorazepate dipotassium
 Mendozaal - Proxazole citrate
 Menesit - Carbidoopa
 Menopax - Diethylstilbestrol
 Mensiso - Sisomicin
 Menusan - Chlorhexidine
 Menutil - Diethylpropion HCl
 Meonine - Methionine
 Mepavlon - Meprobamate
 Mephanol - Allopurinol
 Mephenon - Methadone HCl
 Mephyton - Phytonadione
 Mepidium - Timepidium bromide
 Mepilacin - Cephalixin
 Mepiral - Epirizole
 Mepivastesin - Mepivacaine
 Meporamin - Methscopolamine bromide
 Meprate - Meprobamate
 Mepred - Medroxyprogesterone acetate
 Mepriam - Meprobamate
 Mepro - Ethoheptazine
 Mepro - Meprobamate
 Meproban - Meprobamate
 Meprocon - Meprobamate
 Meprocon CMC - Meprobamate
 Meprodat - Carisoprodol
 Meprodiil - Meprobamate
 Meprodiol - Meprobamate
 Meprofen - Ketoprofen
 Meprol - Meprobamate
 Mepron - Meprobamate
 Meproneil - Meprobamate
 Meprosa - Meprobamate
 Meprosplan - Meprobamate
 Meprotabs - Meprobamate
 Meprotil - Meprobamate
 Meptid - Meptazinol
 Meptin - Procatenol
 Mequelon - Methaqualone
 Mer-29 - Triparanol
 Meranom - Diphenidol
 Merapiran - Piracetam
 Meravil - Amitriptyline HCl

Merbantal - Dicyclomine HCl
 Merbentul - Chlorotrianiene
 Merbenyl - Dicyclomine HCl
 Mercadac - Meralluride
 Mercadon - Meralluride
 Mercaleukin - Mercaptopurine
 Mercaptopropionylglycine - Tiopronin
 Mercloran - Chlormerodrin
 Mercuhydrin - Meralluride
 Meresa - Sulpiride
 Merian - Sulfaphenazole
 Merilid - Chlormerodrin
 Meripramin - Imipramine HCl
 Meriprobate - Meproamate
 Merital - Normifensine maleate
 Merizone - Phenylbutazone
 Merkicin - Cefoxitin sodium
 Mern - Mercaptopurine
 Meroctan - Methaqualone
 Meronidal - Metronidazole
 Meronyl - Carbazochrome
 Mervacycline - Tetracycline
 Mervan, Mirvan - Alcofenac
 Mesin - Chlorzoxazone
 Mesonex - Inositol niacinate
 Mespatin - Doxycycline
 Mestinon - Pyridostigmine bromide
 Mestoran - Mesterolone
 Metabacter - Metampicillin sodium
 Metabiotic - Methacycline
 Metabioticon BG - Methacycline
 Metabolina - Methandrostenolone
 Metac - Methacycline
 Metacen - Indomethacin
 Metacidan - Metampicillin sodium
 Metacil - Methacycline
 Metaclin - Methacycline
 Metaclor - Methacycline
 Metaderm - Betamethasone valerate
 Metadomus - Methacycline
 Meta-Ferran - Metampicillin sodium
 Metaglucina - Acetohexamide
 Metagram - Methacycline
 Metahydrin - Trichloromethiazide
 Metakes - Metampicillin sodium
 Metalax - Bisacodyl
 Metalcapase - Penicillamine
 Metalid - Acetaminophen
 Metambac - Metampicillin sodium
 Metamide - Metoclopramide HCl
 Metamin - Flupentixol
 Metampicef - Metampicillin sodium
 Metamplimex - Metampicillin sodium
 Metanabol - Methandrostenolone
 Metandren - Methyltestosterone
 Metaplexan - Mequitazine
 Metaprel - Metaproterenol sulfate
 Metartril - Indomethacin
 Metasedil - Methaqualone
 Metasep - 4-Chloro-3,5-xyleneol
 Metastenol - Methandrostenolone
 Metatensin - Reserpine
 Metazina - Sulfamethoxypridazine
 Metenarin - Methylergonovine maleate
 Metenix - Metolazone
 Meterdos-Iso - Isoproterenol sulfate
 Methabid - Indomethacin
 Methadorm - Methaqualone
 Methazine - Indomethacin
 Methergin - Methylergonovine maleate
 Methergine - Methylergonovine maleate
 Methiofoline - Folic acid
 Methixart - Methixene HCl
 Methnine - Methionine
 Methobromin - Hexamethonium bromide
 Methocabal - Methocarbamol
 Methocal - Methocarbamol
 Methocillin - Methicillin sodium
 Methocillin-S - Cloxacillin
 Methofane - Methoxyflurane
 Metholes - Methyl dopa
 Methoplain - Methyl dopa
 Methorate - Dextromethorphan hydrobromide
 Methorcon - Dextromethorphan hydrobromide
 Methosarb - Calusterone
 Methrazone - Feprazone
 Methylbol - Nandrolone decanoate
 Methyl Curarin - Dimethyl tubocurarine iodine
 Methylergobrevin - Methylergonovine maleate
 Methylloxan - Methixene HCl
 Metian - Metiazinic acid
 Meticortelone - Prednisolone
 Meticortelone - Prednisolone acetate
 Meticorten - Prednisone
 Metifarma - Amoxicillin
 Metigestene - Medroxyprogesterone acetate
 Metiler - Paramethasone acetate
 Metilbetasone - Methylprednisolone
 Metilcort - Methylprednisolone
 Metilenbiotic - Methacycline
 Metiler - Methylergonovine maleate
 Metilpen - Phenethicillin potassium
 Metilprednisione - Methylprednisolone
 Metilstendiolo - Methylprednisolone
 Metimyd - Prednisolone acetate
 Metin - Methicillin sodium
 Metina - Carnitine
 Metindol - Indomethacin
 Metiskia - Metampicillin sodium
 Metocclol - Metoclopramide HCl
 Metocobil - Metoclopramide HCl
 Metonas - Medazepam
 Metonitron - Isosorbide dinitrate
 Metopiron - Metyrapone
 Metopirone - Metyrapone
 Metopram - Metoclopramide HCl
 Metormon - Dromostanolone propionate
 Metosyn - Fluccinonide
 Metox - Metoclopramide HCl
 Metoxal - Sulfamethoxazole
 Metpamid - Metoclopramide HCl
 Metrajil - Metronidazole
 Metranil - Pentaerythritol tetranitrate
 Metrazone - Feprazone
 Metretion - Prednisolone phosphate sodium
 Metrodiol - Ethynodiol diacetate
 Metro IV - Metronidazole
 Metrolag - Metronidazole
 Metrongil - Metronidazole
 Metroval - Ethinyl estradiol
 Metrulen - Ethynodiol diacetate
 Metrulen - Mestranol
 Metyl - Metronidazole
 Metsapal - Chlormezanone
 Metubine - Tubocurarine chloride
 Metubine Iodide - Dimethyl tubocurarine iodide
 Meval - Diazepam
 Mevanin - Folic acid
 Mevanlin - Ferrous fumarate
 Mevasine - Mecamylamine HCl

Mexan - Methoxamine HCl
 Mexase - Bromelain
 Mexate - Methotrexate
 Mexitil - Mexiletine HCl
 Mexocine - Demeclocycline HCl
 Mezepan - Medazepam
 Mezlin - Mezlocillin
 Mezolin - Indomethacin
 Miacalcic - Calcitonin
 Micatin - Miconazole nitrate
 Micefal - Penfluridol
 Michtone - Bethanechol chloride
 Micochlorine - Chloramphenicol
 Micoespec - Echonazole nitrate
 Micofugal - Echonazole nitrate
 Micogyn - Echonazole nitrate
 Miconal - Miconazole nitrate
 Micoserina - Cycloserine
 Micotef - Miconazole nitrate
 Micoter - Clotrimazole
 Micrest - Diethylstilbestrol
 Micristin - Aspirin
 Microbamat - Meprobamate
 Microcid - Sulfamethoxyipyridazine
 Microcilina - Methacycline
 Microcillin - Carbenicillin disodium
 Microcort - Hydrocortisone
 Microdoine - Nitrofurantoin
 Microest - Diethylstilbestrol
 Micro-Guard - 4-Chloro-3,5-xyleneol
 Microlut - Norgestrel
 Micromega - Sulfadimethoxine
 Micronor - Norethindrone
 Micronovum - Norethindrone
 Microsulf - Sulfaphenazole
 Mictine - Aminometradine
 Mictrol - Bethanechol chloride
 Mictural - Nitrofurantoin
 Midamor - Amiloride HCl
 Midantan - Amantidine HCl
 Midecaccine - Midecamycin
 Midicacin - Midecamycin
 Midicel - Sulfamethoxyipyridazine
 Micixin - Meprobamate
 Midnighton - Diphenidol
 Midol PMS - Pyrilamine
 Midone - Primidone
 Midrin - Isometheptene
 Midronal - Cinnarizine
 Mielucin - Busulfan
 Mifuroil - Carmofur
 Migralam - Isometheptene
 Migristen - Fonazine mesylate
 Migristene - Fonazine mesylate
 Migwell - Cyclizine
 Mikelan - Carteolol
 Miketorin - Amitriptyline HCl
 Mikorten - Hydrochlorothiazide
 Milactan - Cinnarizine
 Milbedoc - Cyanocobalamin
 Millaterol - Tiadenol
 Millevit - Cyanocobalamin
 Milliderm - Hydrocortisone
 Milligynon - Norethindrone acetate
 Milontin - Phensuximide
 Miltaun - Meprobamate
 Miltown - Meprobamate
 Milurit - Allopurinol
 Mimedran - Sultosilic acid piperazine salt
 Mincard - Aminometradine
 Mindiab - Glipizide
 Minias - Lormetazepam
 Minibetic - Glipizide
 Minigest - Megestrol acetate
 Minihep - Heparin
 Minima Benoxinate - Benoxinate hydrochloride
 Minipress - Prazosin
 Minirin - Desmopressin
 Minirin DDA VP - Desmopressin
 Minisone - Betamethasone
 Minithixen - Chlorprothixene
 Minizide - Polythiazide
 Mino-Aleviatin - Trimethadione
 Minobase - Phentermine HCl
 Minocin - Minocycline
 Minodiab - Glipizide
 Minolip - Benfluorex hydrochloride
 Minomycin - Minocycline
 Minostate - Miconazole nitrate
 Mintal - Acetaminophen
 Minprosting - Dinoprostone
 Minprosting F2A - Dinoprost tromethamine
 Mintal - Pentobarbital sodium
 Mintezol - Thiabendazole
 Minuric - Benzbromarone
 Minzolum - Thiabendazole
 Miodar - Phenyramidol
 Miodarone - Amiodarone HCl
 Mioflex - Orphenadrine citrate
 Miolene - Ritodrine
 Mioril - Carisoprodol
 Miostat - Carbachol
 Miotolon - Furazabol
 Miovas - Methocarbamol
 Mioxom - Carisoprodol
 Miradol - Sulpiride
 Miradon - Anisidine
 Miramycin - Gentamicin sulfate
 Mirapront - Phentermine HCl
 Miriciclina - Demeclocycline HCl
 Mircol - Mequitazine
 Miretilan - Endralazine
 Mirfat - Furosemide
 Miriplex - Pyritinol
 Miroseryn - Cycloserine
 Mirsol - Zipeprol
 Miscleron - Clofibrate
 Misedant - Meprobamate
 Missetin - Chloramphenicol
 Mistabron - Mesna
 Mistabronco - Mesna
 Mistral - Erythromycin
 Mistura - Carbachol
 Misulban - Busulfan
 Misulvan - Sulpiride
 Mitalolo - Labetalol HCl
 Mitalon - Cyclandelate
 Mitaptyline - Amitriptyline HCl
 Mitarson - Defocamide
 Mit-Ciclina - Methacycline
 Mitidin - Nitrazepam
 Mitil - Prochlorperazine
 Mition D - Sulfadimethoxine
 Mitomycin C - Mitomycin
 Mitoxana - Ifosfamide
 Mitredin - Proscillaridin
 Mixtard - Insulin
 Miyadril - Oxyphenbutazone
 Moban - Molindone
 Mobilan - Indomethacin

Mobilin - Sulindac
 Mobinol - Tolbutamide
 Modacor - Oxycodone
 Modal - Sulpiride
 Modalina - Trifluoperazine
 Modamate - Arginine glutamate
 Modamide - Amiloride HCl
 Modecate - Fluphenazine HCl
 Modenol - Buthiazide
 Moderatan - Diethylpropion HCl
 Moderil - Rescinnamine
 Moderin - Methylprednisolone
 Modicon - Norethindrone
 Moditen - Fluphenazine HCl
 Modopar - Benserazide
 Modrenal - Trilostane
 Moducren - Amiloride HCl
 Moduretic - Amiloride HCl
 Moduretic - Hydrochlorothiazide
 Mogadan - Nitrazepam
 Mogadon - Nitrazepam
 Moilarin - Furosemide
 Molciclina - Methacycline
 Molevac - Pyruvium pamoate
 Molipaxin - Trazodone HCl
 Molinox - Methaqualone
 Molpaque - Iopanoic acid
 Molycor R - Norfenefrine
 Momentum - Acetaminophen
 Monapen - Ticarcillin disodium
 Monarch - Allopurinol
 Monase - Etryptamine
 Monasin - Metronidazole
 Monaspor - Cefsulodin
 Mondus - Flunarizine HCl
 Monilac - Lactulose
 Monile - Methionine
 Monistat - Miconazole nitrate
 Mono-Attritin - Ibuprofen
 Monocaine - Butethamine
 Monocamin - Carnitine
 Monocortin - Paramethasone acetate
 Monoderm - Fluocinolone acetonide
 Monodion - Phytonadione
 Monodral - Penthienate bromide
 Monofillina - Choline theophyllinate
 Monofuracin - Nitrofurazone
 Monogest - Norethindrone
 Mono-Kay - Phytonadione
 Monophos - Amphetamine phosphate
 Monores - Clenbuterol
 Monotard - Insulin
 Monotrim - Trimethoprim
 Monydrin - Phenylpropanolamine HCl
 Mopergan - Promethazine HCl
 Moperidone - Domperidone
 Moredol - Butorphanol
 Morcain - Benactyzine hydrochloride
 Morepen - Ampicillin trihydrate
 Morgenxil - Amoxicillin
 Moriperan - Metoclopramide HCl
 Mormalene - Bisacodyl
 Mornidine - Pipamazine
 Moryl - Carbachol
 Mosegor - Pizotyline HCl
 Mostarina - Prednimustine
 Motillum - Domperidone
 Motilyn - Dexpanthenol
 Motion Aid - Dimenhydrinate
 Motipress - Fluphenazine HCl
 Motolon - Methaqualone
 Motozina - Cyclizine
 Motrin - Ibuprofen
 Movecil - Pyridinol carbamate
 Moxacin - Amoxicillin
 Moxadil - Amoxapine
 Moxal - Amoxicillin
 Moxalin - Amoxicillin
 Moxam - Moxalactam disodium
 Moxilean - Amoxicillin
 Moxipin - Amoxicillin
 Moxypen - Amoxicillin
 M.P. - Methapyrilene HCl
 6-MP - Mercaptopurine
 M.P. Trantabs - Meprobamate
 Mucaine - Oxethazine
 Mucalan - Isoaminile
 Muciclar - Ambroxol
 Muciclar - Carbocysteine
 Mucifural - Nifuroxazide
 Mucisol - Acetylcysteine
 Mucitux - Eprazinone HCl
 Mucocaps - Carbocysteine
 Mucocis - Carbocysteine
 Mucodyne - Carbocysteine
 Mucofilin - Acetyl cysteine
 Mucofluid - Mesna
 Mucolax - Carbocysteine
 Mucoliz - Carbocysteine
 Mucolysin - Tiopronin
 Mucolyticum - Acetylcysteine
 Mucomist - Acetylcysteine
 Mucomyst - Acetylcysteine
 Mucopront - Carbocysteine
 Mucorex - Citalone
 Mucosiro - Carbocysteine
 Mucosolvan - Ambroxol
 Mucosolvin - Acetylcysteine
 Mucosolvon - Ambroxol
 Mucospect - Carbocysteine
 Mucostop - Guaifenesin
 Mucovin - Bromhexine
 Mudrane - Guaifenesin
 Muhibeta - Betamethasone valerate
 Mukolen - Eprazinone HCl
 Muldacin - Nitrofurazone
 Multilind - Nystatin
 Mundisal - Choline salicylate
 Murcil - Chlordiazepoxide HCl
 Murel - Valetthamate bromide
 Murine - Naphazoline
 Murine - Tetrahydrozoline HCl
 Musa - Pyritinol
 Musaril - Trazepam
 Muscotal - Chlormezanone
 Muskel - Chlormezanone
 Mutamycin - Mitomycin
 Mutanxion - Amitriptyline HCl
 Mutaspiine - Amitriptyline HCl
 Mutesa - Oxethazine
 Mutil - Zolimidine
 Myacyne - Neomycin
 Myalgin - Acetaminophen
 Myambutol - Ethambutol HCl
 Myanesin - Mephenesin
 Myanol - Mephenesin
 Mycanden - Haloprogyn
 Mycelex - Clotrimazole
 Mycetin - Chloramphenicol
 Mychel - Chloramphenicol

- Mycholine - Bethanechol chloride
 Mycifradin - Neomycin
 Myciguent - Neomycin
 Mycilan - Haloprogin
 Mycinol - Chloramphenicol
 Mycivin - Lincomycin
 Myclo - Clotrimazole
 Mycobutol - Ethambutol
 Mycoderm - Amcinonide
 Mycolog - Nystatin
 Mycolog - Triamcinolone acetonide
 Myconef - Fludrocortisone acetate
 Mycopearyl - Echonazole nitrate
 Mycospor - Bifonazole
 Mycosporin - Clotrimazole
 Mycostatin - Nystatin
 Mycostatine - Nystatin
 Myco-Triacet - Nystatin
 Myco-Triacet - Triamcinolone acetonide
 Myco-Ultralan - Fluocortolone
 Mydfrin - Phenylephrine HCl
 Mydoacim - Dicyclomine HCl
 Mydplegic - Cyclopentolate HCl
 Mydriacyl - Tropicamide
 Mydriaticum - Tropicamide
 Mydrilate - Cyclopentolate HCl
 Mydrin - Tropicamide
 Mydrum - Tropicamide
 Myebrol - Mitobronitol
 Myeulekon - Busulfan
 Myelobromol - Mitobronitol
 Myfungar - Oxiconazole nitrate
 Mylanta - Simethicone
 Mylepsinum - Primidone
 Myleran - Busulfan
 Mylicon - Dimethicone
 Mylicon - Simethicone
 Mynocine - Minocycline
 Mynosedin - Ibuprofen
 Myoblock - Pancuronium bromide
 Myobutazolidin - Carisoprodol
 Myocard - Atenolol
 Myocuran - Mephesisin
 Myodel - Cinnarizine
 Myofedrin - Oxyfedrine
 Myoflex - Chlorzoxazone
 Myoflexin - Chlorzoxazone
 Myo Hermes - Bethanechol chloride
 Myolastan - Tetraxepam
 Myolespan - Chlormezanone
 Myomergin - Methylergonovine maleate
 Myomethol - Methocarbamol
 Myonal - Eperisone HCl
 Myoserol - Mephesisin
 Myotonachol - Bethanechol chloride
 Myotonine - Bethanechol chloride
 Myotrol - Orphenadrine citrate
 Myoxane - Mephesisin
 Myprozine - Natamycin
 Mysedon - Primidone
 Mysoline - Primidone
 Mysteclin - Amphoteracin B
 Mysteclin - Tetracycline
 Mysuran - Amibenonium chloride
 Mytelase - Amibenonium chloride
 Mytelase CL - Amibenonium chloride
 Mytomycin C - Mitomycin
 My-Trans - Meprobramate
 Mytrex - Gramicidin
 Mytrex - Neomycin
 Mytrex - Nystatin
 Mytrex - Triamcinolone acetonide
 NAC - Acetylcysteine
 Naclex - Hydroflumethiazide
 Nacom - Carbidopa
 Nadigest - Medroxyprogesterone acetate
 Nadir - Metoclopramide HCl
 Nadostine - Nystatin
 Nafazair - Naphazoline
 Nafcil - Nafcillin sodium
 Naftazolina - Naphazoline
 Naftidan - Nafiverine
 Naftopen - Nafcillin sodium
 Nagemid chronule - Brompheniramine maleate
 Naixan - Naproxen
 Nalador - Sulprostone
 Nalcidin - Nalidixic acid
 Nalcrom - Cromolyn sodium
 Naldecon - Guaifenesin
 Naldecon - Phenylephrine HCl
 Naldecon - Phenylpropanolamine HCl
 Nalfon - Fenoprofen
 Nalgesic - Fenoprofen
 Nali - Nalidixic acid
 Nalidicron - Nalidixic acid
 Nalidixico - Nalidixic acid
 Nalidixin - Nalidixic acid
 Nalidixique - Nalidixic acid
 Nalidixol - Nalidixic acid
 Naligen - Nalidixic acid
 Naligram - Nalidixic acid
 Naline - Naphazoline
 Nalissina - Nalidixic acid
 Naliticsan - Nalidixic acid
 Nalix - Nalidixic acid
 Nalixan - Nalidixic acid
 Nalline - Nalorphine
 Nallpen - Nafcillin sodium
 Naloven - Feprazone
 Nalox - Metronidazole
 Nalpen - Azidocillin
 Nalurin - Nalidixic acid
 Namicain - Thiamphenicol
 Nanbacine - Xibornol
 Nandrolin - Nandrolone phenpropionate
 Nanormon - Somatotropin
 Nansius - Clorazepate dipotassium
 Napacetin - Ibuprofen
 Napacil - Ampicillin
 Napalton - Mefenide acetate
 Napanol - Fenbufen
 Naphcon Forte - Naphazoline
 Napional - Acetaminophen
 Naposim - Methandrostenolone
 Napoton - Chlordiazepoxide HCl
 Naprin - Sulfamoxole
 Napris - Naproxen
 Naprium - Naproxen
 Naprosyn - Naproxen
 Naprosyne - Naproxen
 Naprux - Naproxen
 Nap-Sival - Indapamide
 Naqua - Trichlormethiazide
 Naquival - Reserpine
 Naquival - Trichlormethiazide
 Narbel - Tetrahydrozoline HCl
 Narcan - Naloxone
 Narcanti - Naloxone
 Narcaricin - Benzbromarone

Narcotan - Halothane
 Narcozep - Flunitrazepam
 Nardelzine - Phenelzine sulfate
 Nardil - Phenelzine sulfate
 Narest - Valetamate bromide
 Narigix - Nalidixic acid
 Narsis - Medazepam
 Nasafarma - Oxymetazoline HCl
 Nazalide - Flunisolide
 Nasal Yer - Naphazoline
 Nasin - Tetrahydrozoline HCl
 Nasivin - Oxymetazoline HCl
 Nasky - Inositol niacinate
 Nasmil - Cromolyn sodium
 Nasophen - Phenylephrine HCl
 Natacillin - Hetacillin potassium
 Natacyn - Natamycin
 Natam - Flurazepam
 Naticardina - Quinidine polygalacturonate
 Natira - Tegafur
 Natrilix - Indapamide
 Natrimax - Hydrochlorothiazide
 Natulan - Procarbazine HCl
 Natur B12 - Hydroxocobalamin
 Naturetin - Bendroflumethiazide
 Naturine Leo - Bendroflumethiazide
 Natyl - Dipyridamole
 Nauseal - Dimenhydrinate
 Nauseatol - Dimenhydrinate
 Nauselin - Domperidone
 Nausidol - Pipemazine
 Nautamine - Diphenhydramine HCl
 Navane - Thiothixene
 Navicalur - Meclizine HCl
 Naxamide - Ifosfamide
 Naxofem - Nimorazole
 Naxogin - Nimorazole
 Naxuril - Nalidixic acid
 Naxyn - Naproxen
 Nazett - Cyclopentamine HCl
 Nazona - Feprazone
 NC-Cillin - Ampicillin
 Nealgy - Acetaminophen
 Nebacetin - Bacitracin
 Nebair - Isoproterenol sulfate
 Neberk - Tegafur
 Nebolan - Camazepam
 Nebralin - Pentobarbital sodium
 Nebril - Desipramine HCl
 Nebs - Acetaminophen
 Nebulasma - Cromolyn sodium
 Nectocyd - Dithiazanine iodide
 Nedeltran - Trimeprazine
 Nedis - Propranolol HCl
 Nefrocarnit - Carnitine
 Nefrol - Hydrochlorothiazide
 Nefrolan - Clorexolone
 Nefrosul - Sulfachlorpyridazine
 Nefurofan - Spirolactone
 Negabatt - Nalidixic acid
 Negaxid - Pivmecillinam
 Negram - Nalidixic acid
 Negopen - Ampicillin
 Nektrofan - Allopurinol
 Nelbon - Nitrazepam
 Nelmat - Nitrazepam
 Nemasol - Aminosalicilic acid
 Nembutal - Pentobarbital sodium
 Nene - Methaqualone
 Neoallerman - Chlorpheniramine maleate
 Neobanactyl - Ticarcillin disodium
 Neo-Antergan - Pyrilamine
 Neo-Aritmina - Prajmaline bitartrate
 Neoadrin - Oxeladin
 Neo Avagal - Methscopolamine bromide
 Neobacrin - Bacitracin
 Neo-Banex - Propantheline bromide
 Neo-Betalin 12 - Hydroxocobalamin
 Neobex - Oxeladin
 Neobiotic - Neomycin
 Neobloc - Metoprolol tartrate
 Neo-Bradoral - Domiphen bromide
 Neobretin - Neomycin
 Neobrufen - Ibuprofen
 Neo-Caf - Bacitracin
 Neo-Calme - Diazepam
 Neocefal - Cefamandole nafate sodium salt
 Neocetin - Chloramphenicol
 Neochinidin - Quinidine polygalacturonate
 Neoclym - Cyclofenil
 Neo-Codema - Hydrochlorothiazide
 Neocontrast - Iopanoic acid
 Neo-Corodil - Pentaerythritol tetranitrate
 Neo-Corovas - Pentaerythritol tetranitrate
 Neo-Cort - Triamcinolone
 Neo-Cort - Triamcinolone acetonide
 Neo-Cromacilin - Demeclocycline HCl
 Neo-Cytamen - Cyanocobalamin
 Neocytan - Orphenadrine citrate
 Neodecadron - Neomycin
 Neodelta - Prednisolone
 Neo-Dexabine - Propantheline bromide
 Neo-Dibetic - Tolbutamide
 Neodiestrostreptobap - Streptomycin
 Neodit - Dibenzepin HCl
 Neo-DM - Dextromethorphan hydrobromide
 Neodopasol - Benserazide
 Neo-Dopaston - Carbidopa
 Neodrast - Bisacodyl
 Neodrol - Stanolone
 Neodrom - Pentobarbital sodium
 Neo-Erycinum - Erythromycin estolate
 Neofazol - Cefazolin sodium
 Neo-Fer - Ferrous fumarate
 Neo-Flumen - Hydrochlorothiazide
 Neogama - Sulpiride
 Neo-Gastrocedan - Propantheline bromide
 Neogest - Norgestrel
 Neo-Gilurtymal - Prajmaline bitartrate
 Neoginon Depositum - Estradiol cypionate
 Neohetramine - Thonzylamine HCl
 Neo-Hombreol - Methyltestosterone
 Neohydrin - Chlormerodrin
 Neo-Ilotylin - Erythromycin estolate
 Neo-Insoral - Tolbutamide
 Neointestin - Neomycin
 Neojodin - Providone-Iodine
 Neolate - Neomycin
 Neolexina - Cephalixin
 Neolin - Penicillin G benzathine
 Neolutin Depo - Algestone acetophenide
 Neolutin Depositum - Algestone acetophenide
 Neo-Metantyl - Propantheline bromide
 Neomicina Roger - Neomycin
 Neomin - Neomycin
 Neo-Minzil - Hydrochlorothiazide
 Neomyson - Thiamphenicol
 Neo-Naclex - Bendroflumethiazide
 Neo-Nilorex - Phendimetrazine tartrate
 Neonitin - Inositol niacinate

Neo-Novutox - Lidocaine
 Neo-Oxypaat - Pyrvinium pamoate
 Neo-Panalgy - Kebuzone
 Neopap - Acetaminophen
 Neopasalate - Aminosalicilic acid
 Neophyllin-M - Dyphylline
 Neo-Polycin - Bacitracin
 Neo-Polycin - Neomycin
 Neo-Polycin - Polymyxin
 Neopt - Neomycin
 Neoquess - Dicyclomine HCl
 Neoreserpan - Syrosingopine
 Neorestamin - Chlorpheniramine maleate
 Neo-Rontyl - Bendroflumethiazide
 Neo-Saluretic - Hydrochlorothiazide
 Neo-Salvilax - Bisacodyl
 Neosar - Cyclophosphamide
 Neo-Serp - Reserpine
 Neosinefrina - Phenylephrine HCl
 Neo-Sintrom - Acenocoumarol (Acenocoumarin)
 Neo-Spec - Guaifenesin
 Neospect - Dyphylline
 Neospirine - Aspirin
 Neosporin - Bacitracin
 Neosporin - Gramicidin
 Neosporin - Neomycin
 Neosporin - Polymyxin
 Neoston - Alcofenac
 Neostreptal - Sulfadimethoxine
 Neosulf - Neomycin
 Neosulfamyd - Sulfadimethoxide
 Neo-Synalar - Neomycin
 Neosynephrine - Phenylephrine HCl
 Neoteben - Isoniazid
 Neothylline - Dyphylline
 Neo-Tizide - Isoniazid
 Neo-Tran - Meprobamate
 Neotrend - Acetaminophen
 Neo-Tric - Metronidazole
 Neo-Vasophylline - Dyphylline
 Neo-Vi-Twel - Hydroxocobalamin
 Neo-Zoline - Phenylbutazone
 Nephramid - Acetazolamide
 Nephril - Polythiazide
 Nephron - Furosemide
 Nephronex - Nitrofurantoin
 Neptal - Acebutolol
 Neptall - Acebutolol
 Neptazane - Methazolamide
 Neptusan - Dimenhydrinate
 Neraval - Methitalur
 Nerfactor - Isaxonine phosphate
 Nergize - Creatinolfosfate
 Neriodin - Diclofenac sodium
 Nerisona - Diflucortolone valerate
 Nerisone - Diflucortolone valerate
 Nerobol - Methandrustenolone
 Nervium - Diazepam
 Nervonus - Meprobamate
 Nesacaine - Chloroprocaine HCl
 Nesontil - Oxazepam
 Netaf - Metoclopramide HCl
 Netex - Dichlorphenamide
 Netillin - Netilmicin
 Netromicine - Netilmicin
 Netromycin - Netilmicin
 Netromycine - Netilmicin
 Nettacin - Netilmicin
 Netto-Longcaps - Phentermine HCl
 Netux - Phenyltoloxamine
 Neuacetyl - Aspirin
 Neucalm - Hydroxyzine HCl
 Neuchlonic - Nitrazepam
 Neucolis - Citicoline
 Neufan - Allopurinol
 Neugel - Carbenoxolone
 Neuphenyl - Kebuzone
 Neuplus - Phenylbutazone
 Neuquinon - Ubidecarenone
 Neuracen - Beclamide
 Neuramate - Meprobamate
 Neurazine - Chlorpromazine HCl
 Neuriplege - Chlorproethazine HCl
 Neuritol Carbamazepine
 Neurobaltina - Cyanocobalamin
 Neuro-Fortabol - Methenolone acetate
 Neurolene - Nomifensine maleate
 Neurolidol - Droperidol
 Neuro Liser B 12 - Cyanocobalamin
 Neurolytril - Diazepam
 Neuromyfar - Sulpiride
 Neuroplegil - Promazine HCl
 Neuropri - Tiapride
 Neuroprocin - Ectylurea
 Neurotin - Pyritinol
 Neurotol - Carbamazepine
 Neuroxin - Pyritinol
 Neurozina - Hydroxyzine HCl
 Neusedan - Oxeladin
 Neutrephylline - Dyphylline
 Neutrogastrol Ulcus - Carbenoxolone
 Nevadral - Norfenefrine
 Nevral - Acetaminophen
 Newcellan - Cyclandelate
 Newphrine - Phenylephrine HCl
 Newsantin - Prenylamine
 Newtownide - Hydrochlorothiazide
 Nezeril - Oxymetazoline HCl
 Niadrin - Isoniazid
 Niagar - Chlorothiazide
 Niagestin - Megestrol acetate
 Niamid - Nialamide
 Niamide - Nialamide
 Niaziid - Isoniazid
 Nibol - Aspirin
 Nibromin-A - Prochlorperazine
 Nicalex - Aluminum nicotinate
 Nicazide - Isoniazid
 Nicelate - Nalidixic acid
 Nicergolyn - Nicergoline
 Nichicoba - Hydroxocobalamin
 Nichidopa - Methyl dopa
 Nichiserpine-S - Syrosingopine
 Nichivita-K - Phytanadione
 Nicholin - Citicoline
 Nicloside Niclosamide
 Nicodel - Nicardipine
 Nicolanta - Nicomol
 Niconicol - Xanthinol niacinate
 Niconyl - Isoniazid
 Nicorol - Furosemide
 Nicosamin - Inositol niacinate
 Nicosinate - Inositol niacinate
 Nicosinit - Inositol niacinate
 Nicotbine - Isoniazid
 Nicotergoline - Nicergoline
 Nicotibina - Isoniazid
 Nicotion - Ethionamide
 Nicotol - Inositol niacinate
 Nicotubin - Isoniazid

Nicoxatin - Inositol niacinate
 Nicozid - Isoniazid
 Nicozide - Isoniazid
 Nida - Metronidazole
 Nidantin - Oxolinic acid
 Nidran - Nimustine
 Nierofu - Nitrofurantoin
 Nifedico - Nifedipine
 Nifedin - Nifedipine
 Nifelat - Nifedipine
 Niferex - Folic acid
 Niflan - Ketoprofen
 Niflan - Pranoprofen
 Nifluran - Niflumic acid
 Nifluril - Niflumic acid
 Niflux - Niflumic acid
 Nifolin - Folic acid
 Nifucin - Nitrofurazone
 Nifulidone - Furazolidone
 Nifuran - Furazolidone
 Nifuran - Nitrofurantoin
 Nifurantin - Nitrofurantoin
 Nifuzon - Nitrofurazone
 Night-Cast - Salicylic acid
 Nigloid - Tolbutamide
 Nilatin - Feprazone
 Nilerger - Isothipendyl HCl
 Nilevar - Norethandrolone
 Nilexina - Cephalixin
 Nilprin - Acetaminophen
 Nilstat - Nystatin
 Nilurid - Amiloride HCl
 Ninol - Methionine
 Niopam - Iopamidol
 Niplen - Isoniazid
 Nipocin - Dibekacin
 Nipolazin - Mequitazine
 Niramine - Diphenhydramine HCl
 Niratic-Pur-On - Levamisole HCl
 Niratron - Chlorpheniramine maleate
 Nirypan - Methylprednisolone
 Nisentil - Alphaprodine HCl
 Nisolone - Prednisolone acetate
 Nisone - Prednisone
 Nitan - Pemoline
 Nitocolin - Citicoline
 Nitobanil - Tegafur
 Nitoman - Tetrabenazine
 Nitorol R - Isosorbide dinitrate
 Nitrados - Nitrazepam
 Nitrempax - Nitrazepam
 Nitrodex - Pentaerythritol tetranitrate
 Nitrofur C - Nitrofurantoin
 Nitropent - Pentaerythritol tetranitrate
 Nitroret - Isosorbide dinitrate
 Nitrosit - Isosorbide dinitrate
 Nitrosorbide - Isosorbide dinitrate
 Nitro-Tabliten - Isosorbide dinitrate
 Nitrozone - Nitrofurazone
 Nitux - Morclofene
 Nivaquine - Chloroquine phosphate
 Nivelton - Medazepam
 Nivoman - Trifluopromazine
 Nixolan - Methylprednisolone
 Nizon - Prednisone
 Nizoral - Ketoconazole
 Noan - Diazepam
 Nobacter - Triclocarban
 Nobadorm - Methaqualone
 Nobese - Phenylpropanolamine HCl
 Nobesine-25 - Diethylpropion HCl
 Nobfelen - Ibuprofen
 Nobfen - Ibuprofen
 Nobgen - Ibuprofen
 Noblitina - Cephadrine
 Nobral - Medazepam
 Nobraskin - Medazepam
 Nobrium - Medazepam
 Nocbin - Disulfiram
 Nocertone - Oxetorone fumarate
 Noctamid - Lormetazepam
 Noctamine - Diphenhydramine HCl
 Noctan - Methyprylon
 Noctazepam - Oxazepam
 Noctem - Nitrazepam
 Noctene - Nitrazepam
 Noctran - Clorazepate dipotassium
 Noctynol - Mephesisin
 Nodapton - Glycopyrrrolate
 Noflevan - Etofibrate
 Nogedal - Noxiptilin
 Nogermin - Nalidixic acid
 Noiafren - Clobazam
 Nolahist - Phenindamine tartrate
 Nolamine - Phenindamine tartrate
 Nolamine - Phenylpropanolamine HCl
 Noleptan - Fominoben HCl
 Nollipax - Fenofibrate
 Noloten - Propranolol HCl
 Nolutar - Methyprylon
 Nolutate - Methyprylon
 Nolvadex - Tamoxifen
 Nolvasan - Chlorhexidine
 Nomaze - Naphazoline
 Normival - Nomifensine maleate
 Nomocramp - Dicyclomine HCl
 Nonflamin - Tinoridine
 Nootron - Piracetam
 Nootrop - Piracetam
 Nootropicon - Piracetam
 Nootropil - Piracetam
 Nootropyl - Piracetam
 No-Press - Mebutamate
 Nopron - Niaprazine
 Norabol - Nandrolone phenpropionate
 Noracycline - Mestranol
 Noralone - Nandrolone phenpropionate
 Noranat - Indapamide
 Norandrol - Nandrolone phenpropionate
 Norandras - Nandrolone phenpropionate
 Norbalin - Nandrolone phenpropionate
 Norcozine - Chlorpromazine HCl
 Nordecon - Nandrolone decanoate
 Nordotol - Carbamazepine
 Norfemac - Bufexamac
 Norfen - Octopamine HCl
 Norfin - Nalorphine
 Norflex - Orphenadrine citrate
 Norfor - Norethindrone
 Norgesic - Orphenadrine citrate
 Norgestin - Norethindrone
 Norglycin - Tolazamide
 No-Rheumar - Betamethasone
 Noriday - Mestranol
 Noriday - Norethindrone
 Norinyl - Mestranol
 Norinyl - Norethindrone
 Norisodrine - Isoproterenol sulfate
 Noritren - Nortriptyline
 Norlestrin - Ethinylestradiol

Norlestrin - Norethindrone
 Norlestrin - Norethindrone acetate
 Norlutin - Mestranol
 Norlutin - Norethindrone
 Norlutin-A - Norethindrone acetate
 Norma - Oxyphencyclimine
 Normabrain - Piracetam
 Normac - Bromazepam
 Normalin - Guanethidine sulfate
 Normalmin - Prochlorperazine
 Normaln - Amitriptyline HCl
 Normaln P - Trifluoperazine
 Normelin - Fonazine mesylate
 Normeran - Metolazone
 Normetolo - Norfenefrine
 Normide - Chlordiazepoxide HCl
 Normi-Nox - Methaqualone
 Normison - Temazepam
 Normiten - Atenolol
 Normodyne - Labetolol HCl
 Normoglic - Chlorpropamide
 Normolipol - Clofibrate
 Normopresan - Clonidine HCl
 Normorest - Methaqualone
 Normorytmin - Propafenone HCl
 Normosona - Prednisolone
 Normud - Zimelidine
 Normum - Sulpiride
 Normurat - Benzbromarone
 Norofren - Pimozide
 Noromon - Nandrolone phenpropionate
 Norotrop - Piracetam
 Noroxin - Norfloxacin
 Norpace - Disopyramide phosphate
 Norphen - Octopamine HCl
 Norpolake - Desipramine HCl
 Norpramine - Desipramine HCl
 Norpramine - Imipramine HCl
 Nor-Preds - Prednisolone phosphate sodium
 Norpron - Niazaprine
 Nor-QD - Norethindrone
 Norquen - Mestranol
 Norstenol - Nandrolone phenpropionate
 Nortimil - Desipramine HCl
 Nortrilen - Nortriptyline
 Nortylin - Nortriptyline
 Norval - Mianserin
 Norvedan - Fentiazac
 Norzepine - Nortriptyline
 Norzetam - Piracetam
 Nosim - Isosorbide dinitrate
 Nospan - Tybamate
 Nostel - Ethchlorvynol
 Nostril - Phenylophrine HCl
 Nostrilla - Oxymetazoline HCl
 Nostyn - Ectylurea
 Notens - Bendroflumethiazide
 Notense - Diazepam
 Notensyl - Dicyclomine HCl
 Notezine - Diethylcarbamazine citrate
 Notricel - Nalidixic acid
 Nourilax - Oxyphenisatin acetate
 Novacort - Cloprednol
 Novadral - Norfenefrine
 Novahistine - Chlorpheniramine maleate
 Novahistine - Guaifenesin
 Novamato - Meprobamate
 Novamin - Amikacin
 Novamin - Prochlorperazine
 Novamoxin - Amoxicillin
 Novapen - Dicloxacillin sodium
 Nova-phase - Aspirin
 Novaphenicol - Chloramphenicol
 Nova-Rubi - Cyanocobalamin
 Novasen - Aspirin
 Novasmasol - Metaproterenol sulfate
 Novatril - Metiazinic acid
 Novazam - Diazepam
 Novedopa - Levodopa
 Novelciclina - Doxycycline
 Noventabedoce - Cyanocobalamin
 Noveril - Dibenazepin HCl
 Novesin - Benoxinate hydrochloride
 Novesine - Benoxinate hydrochloride
 Novicet - Vincamine
 Novidorm - Triazolam
 Novobedouze - Hydroxocobalamin
 Novobetamet - Betamethasone valerate
 Novobutamide - Tolbutamide
 Novobutazone - Phenylbutazone
 Novochlorcap - Chloramphenicol
 Novocillin - Penicillin G procaine
 Novocloxin - Cloxacillin
 Novodimenate - Dimenhydrinate
 Novodipam - Diazepam
 Novodiurex - Hydrochlorothiazide
 Novodrin - Isoproterenol sulfate
 Novoexpacto - Ampicillin trihydrate
 Novofibrate - Clofibrate
 Novoflupam - Flurazepam
 Novoflurazine - Trifluoperazine
 Novofolac - Folic acid
 Novofumar - Ferrous fumarate
 Novofuran - Nitrofurantoin
 Novohexidyl - Trihexyphenidyl HCl
 Novohydrizide - Hydrochlorothiazide
 Novolax - Bisacodyl
 Novolin - Insulin
 Novolin N - Insulin isophane
 Novomedopa - Methyl dopa
 Novomepro - Meprobamate
 Novomethacin - Indomethacin
 Novomina - Dimenhydrinate
 Novonaprox - Naproxen
 Novonidazol - Metronidazole
 Novopentobarb - Pentobarbital sodium
 Novopheniram - Chlorpheniramine maleate
 Novophenyl - Phenylbutazone
 Novophenytol - Phenytoin
 Novophone - Dapsone
 Novopivam - Pivampicillin
 Novopoxide - Chlordiazepoxide HCl
 Novopramine - Imipramine HCl
 Novoprofanol - Propranolol HCl
 Novoprednisolone - Prednisolone
 Novoprednisone - Prednisone
 Novopropamide - Chlorpropamide
 Novopurol - Allopurinol
 Novopyrazone - Sulfonpyrazone
 Novoridazide - Thioridazine
 Novorin - Xylometazoline HCl
 Novorythro - Erythromycin estolate
 Novosecobarb - Secobarbital sodium
 Novoserpina - Syrosingopine
 Novosoxazole - Sulfisoxazole
 Novosulfon - Sulfamethoxypyridazine
 Novosulfina - Phthalylsulfathiazole
 Novoter - Fluocinonide
 Novothalidone - Chlorthalidone
 Novotriphyl - Choline theophyllinate

- Novotriptyn - Amitriptyline HCl
 Novotussil - Morclofone
 Novoxapin - Doxepin HCl
 Noxybel - Methaqualone
 Noxyflex - Noxytiolin
 Nozinan - Methotrimeprazine
 NP 30 - Prenylamine
 NPH-Iletin - Insulin isophane
 N-Toin - Nitrofurantoin
 Nubain - Nalbuphine
 Nucofed - Guaifenesin
 Nuctalon - Estazolam
 Nu-Iron - Folic acid
 Nulobes - Diethylpropion HCl
 Nulogyl - Nimorazole
 Numbon - Nitrazepam
 Numide - Naproxen
 Numorphan - Oxymorphone
 Nuran - Cyproheptadine
 Nuredal - Nialamide
 Nuril - Pipemidic acid
 Nuriphasic - Mestranol
 Nurison - Prednisone
 Nurofen - Ibuprofen
 Nutinal - Benactyzine hydrochloride
 Nutradine - Povidone-iodine
 Nutrasweet - Aspartame
 Nuvapen - Ampicillin
 Nuvosyl - Amoxicillin
 Nyaderm - Nystatin
 Nycott - Dextromethorphan hydrobromide
 Nyderal - Nyldrin
 Nydor - Trichlormethiazide
 Nydrane - Beclamide
 Nylin - Nyldrin
 Nyrazid - Isoniazid
 Nysert - Nystatin
 Nystacid - Nystatin
 Nysta-Dome - Nystatin
 Nystex - Nystatin
 Nyst-Olone - Gramicidin
 Nyst-Olone - Nystatin
 Nyst-Olone - Triamcinolone acetonide
 Nyuple - Prenylamine
- Oasil - Meprobamate
 Obaron - Benzbromarone
 Obe-Del - Phendimetrazine tartrate
 Obepar - Phendimetrazine tartrate
 Obesan - Phendimetrazine tartrate
 Obestat - Phenylpropanolamine HCl
 Obestin - Phentermine HCl
 Obetrol - Dextroamphetamine sulfate
 Obex-LA - Phendimetrazine tartrate
 Obazine - Phendimetrazine tartrate
 Oblioser - Methaqualone
 Obotan - Tanphetamin
 Obsidan - Propranolol HCl
 Obstilax - Bisacodyl
 Obstilax - Oxyphenisatin acetate
 Oby-Trim - Phentermine HCl
 Occlusal - Salicylic acid
 Ocelina - Metampicillin sodium
 Oceral - Oxiconazole nitrate
 Octapressin - Felypressin
 Octicair - Hydrocortisone
 Octicair - Neomycin
 Octicair - Polymyxin
 Octinum - Isomethheptene
 Octocaine - Lidocaine
- Octofene - Clofocetol
 Ocu-Cort - Hydrocortisone sodium phosphate
 Ocunasal - Naphazoline
 Oedemex - Furosemide
 Oedemin - Acetazolamide
 Oestradiol-Retard - Estradiol cypionate
 Oestrogen - Diethylstilbestrol
 Oestrogynal - Estradiol valerate
 Oestrol - Diethylstilbestrol
 Oestromon - Diethylstilbestrol
 Oestrovis - Dienestrol
 Oftakloram - Chloramphenicol
 Oftalent - Chloramphenicol
 Oftan-Idurin - Idoxuridine
 Oftan-Karbakol - Carbachol
 Oftan-Starine - Tetrahydrozoline HCl
 Oftan-Syklo - Cyclopentolate HCl
 Ogostac - Capreomycin sulfate
 OH-BIZ - Hydroxocobalamin
 Ohlexin - Cephalixin
 Oikamid - Piracetam
 Okilon - Fluorometholone
 Oksaren - Oxolinic acid
 Oksisikliin - Oxytetracycline
 Olatin - Cinnarizine
 Olbutam - Ethambutol
 Olcadil - Cloxazolam
 Oldagen - Homofenazine
 Oldren - Metolazone
 Oleandocyn - Oleandomycin
 Oleomycetin - Chloramphenicol
 Oleptan - Fominoben HCl
 Olmagran - Hydroflumethiazide
 Olmicina - Oleandomycin
 Olynth - Xylometazoline HCl
 Omca - Fluphenazine HCl
 Omeogen - Cyanocobalamin
 Omifin - Clomiphene dihydrogen citrate
 Omnalio - Chlordiazepoxide HCl
 Omnes - Nifuratel
 Omnibon - Sulfadimethoxine
 Omniderm - Fluocinolone acetonide
 Omnipen - Ampicillin
 Omnipress - Amoxapine
 Omnisan - Epicillin
 Omnopon - Papaverine monophosadenine
 Omperan - Sulpiride
 Ona Mast - Phentermine HCl
 Onca-Tiotepa - Thiotepa
 Onco-Carbide - Hydroxyurea
 Oncomercaptopurina - Mercaptopurine
 Oncovin - Vincristine sulfate
 Ondena - Daunorubicin
 Ondogyne - Cyclofenil
 Ondonvid - Cyclofenil
 One-Alpha - Alfalcaldol
 One-Kay - Phytonadione
 Onlemin - Prenylamine
 Ontosein - Orgotein
 Opacist - Iodamide
 Opalene - Trimetozine
 Opcon - Naphazoline
 Operidine - Phenoperidine HCl
 Ophidiase - Batroxobin
 Ophthagram - Gentamicin sulfate
 Ophthaphenicol - Chloramphenicol
 Ophthalmadine - Idoxuridine
 Ophthalmokalixan - Kanamycin sulfate
 Ophthocort - Polymyxin
 Ophthocortin - Medrysone

Ophthosol - Bromhexine
 Ophthovitol - Stanolone
 Ophthorenin - Bupranolol
 Opilon - Moxisylyte
 Opino - Nylidrin
 Opiran - Pimozide
 Oposim - Propranolol HCl
 Opren - Benoxaprofen
 Opridan - Bromopride
 Oprimol - Qpipramol
 Optalgin - Methadone HCl
 Optef - Hydrocortisone
 Opticron - Cromolyn sodium
 Optimal - Oxyphenbutazone
 Optimicine - Methacycline
 Optimil - Methaqualone
 Optimine - Azatadine maleate
 Optinoxan - Methaqualone
 Optipen - Phenethicillin potassium
 Optium - Amoxicillin
 Optival - Prednisolone phosphate sodium
 Optocillin - Mezlocillin
 Optone - Oxyphenbutazone
 Optovite B 12 - Cyanocobalamin
 Opturem - Ibuprofen
 Orabet - Chlorpropamide
 Orabines - Chlorpropamide
 Orabolin - Ethylestrenol
 Oracef - Cephalexin
 Oracefal - Cefadroxil
 Oracilline - Penicillin
 Oracocin - Cephalexin
 Oracon - Dimethisterone
 Oracon - Ethinylestradiol
 Oractine - Cyproheptadine
 Oradash - Methionine
 Oradiol - Ethinylestradiol
 Oradol - Domiphen bromide
 Oraflex - Benoxaprofen
 Oragest - Medroxyprogesterone acetate
 Orakanamicil - Kanamycin sulfate
 Oraldene - Hexetidine
 Oralep - Pimozide
 Oralexine - Cephalexin
 Oralmisetin - Chloramphenicol
 Oralsterone - Fluoxymesterone
 Oramide - Tolbutamide
 Oramycin - Cycloserine
 Oranixon - Mephesisin
 Orap - Pimozide
 Oraseptic - Hexetidine
 Orasone - Prednisone
 Oraspor - Cefroxadine
 Orasthin - Oxytocin
 Orastrep - Streptomycin
 Ora-Testryl - Fluoxymesterone
 Oratol - Dichlorophenamide
 Oratrim - Trimethoprim
 Orbenil - Cloxacillin
 Orbenin - Cloxacillin
 Orbenine - Cloxacillin
 Orbicin - Dibekacin
 Orbin - Chlorpropamide
 Orbinamon - Thiothixene
 Orbisan - Prazosin
 Orchisterone - Methyltestosterone
 Ordimal - Acetohexamide
 Orestralyn - Ethinylestradiol
 Oretic - Hydrochlorothiazide
 Oreticyl - Deserphlorite
 Oreton-M - Methyltestosterone
 Orferon - Ferroglycine sulfate
 Orfidal - Lorazepam
 Orfillina - Cycloacillin
 Orgabolin - Ethylestrenol
 Orgaboline - Ethylestrenol
 Orgadrone - Dexamethasone phosphate
 Orgaluton - Mestranol
 Organoderm - Malathion
 Organolax - Bisacodyl
 Organolipid - Gemfibrozil
 Orgastyptin - Estriol succinate
 Orgatrax - Hydroxyzine HCl
 Oribetic - Tolbutamide
 Oributol - Ethambutol HCl
 Oricur - Chlormerodrin
 Oriens - Acetoxolone aluminum salt
 Orientmycin - Cycloserine
 Orimercur - Chlormerodrin
 Orimeten - Aminoglutethimide
 Orinase - Tolbutamide
 Orisul - Sulfaphenazole
 Orisulf - Sulfaphenazole
 Orizina - Erythromycin
 Orlex - 4-Chloro-3,5-xyleneol
 Ormerdan - Chlormerodrin
 Ormodon - Nitrazepam
 Ornade - Isopropamide iodide
 Ornade - Phenylpropanolamine HCl
 Ornidal - Ornidazole
 Orobicin - Bacitracin
 Orocin - Ampicillin
 Oronine - Chlorhexidine
 Oroxin - Cephalexin
 Oroxin - Sulfamethoxypyridazine
 Orasanil - Thioridazine
 Orsinon - Tolbutamide
 Ortho-Creme - Nonoxynol
 Ortho-Delfen - Nonoxynol
 Ortho-Novum - Mestranol
 Ortho-Novum - Norethindrone
 Ortisporina - Cephalexin
 Ortodermine - Lidocaine
 Or-Tyl - Dicyclamine HCl
 Orudis - Ketoprofen
 Orvagil - Metronidazole
 Osmitrol - Mannitol
 Osmofundin - Mannitol
 Osmogit - Indomethacin
 Osmosol - Mannitol
 Osnervan - Procyclidine HCl
 Ospanox - Amoxicillin
 Oспен - Penicillin V
 Ospexin - Cephalexin
 Ossazin - Chlorthenoxazine
 Ossazone - Chlorthenoxazine
 Ossian - Oxolinic acid
 Ossion - Oxolinic acid
 Ossipirina - Chlorthenoxazine
 Ossirondil - Methacycline
 Ossiteta - Oxytetracycline
 Ossiurene - Dithiazanine iodide
 Ostrin Depo - Estradiol valerate
 Osyrol - Canrenoate potassium
 Osyrol - Spironolactone
 Otachron - Chloramphenicol
 Otall - 4-Chloro-3,5-xyleneol
 Oterben - Tolbutamide
 Otesolut - Oxytetracycline
 Otho - Choline salicylate

Otic-HC - Hydrocortisone
 Otic-HC - Pramoxine HCl
 Oticortrix - Triamcinolone
 Otobiotic - Hydrocortisone
 Otobiotic - Neomycin
 Otobiotic - Polymyxin
 Otocort - Hydrocortisone
 Otocort - Neomycin
 Otocort - Polymyxin
 Otokalixan - Kanamycin sulfate
 Otomycin - Chloramphenicol
 Otosone-F - Hydrocortisone
 Otrivin - Xylometazoline HCl
 Ottimal - Tiemonium iodide
 O.V. 28 - Mestranol
 Ovahormon - Ethinylestradiol
 Ovamin - Ethynodiol diacetate
 Ovanon - Mestranol
 Ovarid - Megestrol acetate
 Ovastol - Mestranol
 Ovcon - Norethindrone
 Overcillina - Ampicillin
 Ovestin - Estril succinate
 Ovex - Ethinylestradiol
 Ovrette - Norgestrel
 Ovulen - Ethynodiol diacetate
 Ovulen - Mestranol
 Oxabel - Oxacillin sodium
 Oxacycline - Oxytetracycline
 Oxadilene - Butalamine HCl
 Oxadol - Nefopam HCl
 Oxaflumine - Oxaflumazine disuccinate
 Oxaine - Oxethazine
 Oxal - Chlorphenoxazine
 Oxalid - Oxyphenbutazone
 Oxandrolone Spa - Oxandrolone
 Oxasulfa - Sulfamoxole
 Oxazina - Sulfadimethoxine
 Oxcord - Nifedipine
 Oxedix - Oxetorone fumarate
 Oxeten - Oxytetracycline
 Oxialum - Pyrvinium pamoate
 Oxiamin - Inosine
 Oxibutol - Oxyphenbutazone
 Oxidermiol Fuerte - Fluocinolone acetonide
 Oxidina - Pivampicillin
 Oxiklorin - Hydroxychloroquine sulfate
 Oximin - Oxyphenclimine
 Oxinorm - Orgotein
 Oxitocin - Oxytocin
 Oxlopar - Oxytetracycline
 Oxobemin - Hydroxocobalamin
 Oxoboi - Oxolinic acid
 Oxoinex - Oxolinic acid
 Oxol - Oxolinic acid
 Oxolin - Oxolinic acid
 Oxoralen - Methoxsalen
 Oxparm - Oxazepam
 Oxsoracen - Methoxsalen
 Oxybutazone - Oxyphenbutazone
 Oxybuton - Oxyphenbutazone
 Oxygeron - Vincamine
 Oxy-Kesso-Tetra - Oxytetracycline
 Oxylone - Fluorometholone
 Oxymeta - Oxymetazoline HCl
 Oxymycin - Oxytetracycline
 Oxyren - Chlorzoxazone
 Oxystat - Dyphylline
 Oxystin - Oxytocin
 Oxytal - Oxytocin
 Pabacyd - Aminobenzoic acid
 Pabafilm - Aminobenzoic acid
 Pabagel - Aminobenzoic acid
 Pabalate - Aminobenzoic acid
 Pabaminol - Aminobenzoic acid
 Pabanol - Aminobenzoic acid
 Pabasin - Aminobenzoic acid
 Pabenol - Deanol acetamidobenzoate
 Pabron - Chlorhexidine
 Pacatal - Mepazine
 Pacedol - Haloperidol
 Pacemo - Acetaminophen
 Pacet - Acetaminophen
 Pacinol - Fluphenazine HCl
 Pacipam - Diazepam
 Pacisyn - Nitrazepam
 Pacitran - Diazepam
 Pacyl - Isoxicam
 Padicor - Dipyridamole
 Paduden - Ibuprofen
 Pagitane - Cycrimine HCl
 Paidomicetina - Chloramphenicol palmitate
 Pain & Fever - Acetaminophen
 Painex - Acetaminophen
 Palafer - Ferrous fumarate
 Palison - Protokylol
 Palitrex - Cephalexin
 Pallace - Megestrol acetate
 Palmofen - Fosfomycin
 Pameion - Papaverine monophosphadenine
 Pamelor - Nortriptyline
 Pamine - Methscopolamine bromide
 Pamisyl - Aminosalicilic acid
 Pamocil - Amoxicillin
 Pamol - Acetaminophen
 Pamovin - Pyrvinium pamoate
 Pamoxan - Pyrvinium pamoate
 Panacain - Fomocaine
 Panacef - Cefaclor
 Panacelan-F - Dinoprost tromethamine
 Panacete - Acetaminophen
 Panacid - Piromidic acid
 Panacur - Fenbendazole
 Panadol - Acetaminophen
 Panadon - Acetaminophen
 Panafcort - Prednisone
 Panafcortelone - Prednisolone
 Panafil - Papain
 Panakiron - Dicyclomine HCl
 Panaldin - Ticlopidine HCl
 Panalgin - Ethoheptazine
 Panamax - Acetaminophen
 Panas - Clofezone
 Panasone - Dexamethasone acetate
 Panasorb - Acetaminophen
 Panazid - Isoniazid
 Panazone - Phenylbutazone
 Panbesy - Phentermine HCl
 Pancid - Sulfisoxazole
 Pancoral - Fenipentol
 Pancuronium - Pancuronium bromide
 Pandiuren - Amiloride HCl
 Panectyl - Trimeprazine
 Panerco - Piromidic acid
 Panergon - Papaverine monophosphadenine
 Panformin - Buformin HCl
 Panfugan - Mebendazole
 Panimit - Bupranolol
 Panimycin - Dibekacin
 Panmycin - Tetracycline

- Panmycin Phos - Tetracycline phosphate complex
 Panodil - Acetaminophen
 Panok - Acetaminophen
 Panoral - Cefaclor
 Panotile - Fludrocortisone acetate
 Panparnit - Caramiphen edisylate
 Panpuroil - Pipethanate ethobromide
 Pen-Rexin - Phendimetrazine tartrate
 Panseman - Furosemide
 Panshade - Phentermine HCl
 Pantalgin - Acetaminophen
 Pantemon - Hydrochlorothiazide
 Pantene - Dexpantenol
 Pantenyl - Dexpantenol
 Pantheline - Propantheline bromide
 Panthene - Propantheline bromide
 Panthenol-Drobena - Dexpantenol
 Panthoderm - Dexpantenol
 Pantol - Dexpantenol
 Pantopaque - Iophendylate
 Pantovernil - Chloramphenicol
 Panto-Viocine - Viomycin
 Pantrop - Ibuprofen
 Panuric - Probenecid
 Panwarfin - Warfarin sodium
 Papaverlumin - Papaverine monophosadenine
 Papaversan - Papaverine monophosadenine
 Parabaxin - Methocarbamol
 Parabolon - Trenbolone acetate
 Paracet - Acetaminophen
 Paracholin - Bethanechol chloride
 Paracort - Prednisone
 Paracortol - Prednisolone
 Paraden - Biperiden
 Paraderm - Bufenaxam
 Para-Dien - Dienestrol
 Paradione - Paramethasone
 Paradoxil - Amoxicillin
 Paraflex - Chlorzoxazone
 Paralen - Triamcinolone acetonide
 Paralest - Trihexyphenidyl HCl
 Paralgin - Acetaminophen
 Paramantin - Amantidine HCl
 Paramesone - Paramethasone acetate
 Paramezone - Paramethasone acetate
 Paramicina - Paromomycin
 Paramid Supra - Sulfamethoxy-pyridazine
 Paramisan - Aminosalicilic acid
 Paramol - Acetaminophen
 Paramolan - Acetaminophen
 Parantin - Methscopolamine bromide
 Paranausine - Dimenhydrinate
 Para-Pas - Aminosalicilic acid
 Parasaal - Aminosalicilic acid
 Parasan - Benactyzine hydrochloride
 Parasin - Acetaminophen
 Paraspem - Acetaminophen
 Para-Suppo - Acetaminophen
 Paratil - Sulpiride
 Paravale - Echonazole nitrate
 Paraxin - Chloramphenicol
 Parbetan - Betamethasone benzoate
 Parbinon - Ubidecarenone
 Paresinan - Rescinamine
 Parest - Methaqualone
 Parfenac - Bufenaxam
 Parfuran - Nitrofurantoin
 Pargitan - Trihexyphenidyl HCl
 Pariodel - Bromocriptine
 Parisolon - Prednisolone phosphate sodium
 Paritrel - Amantidine HCl
 Parkemed - Mefenamic acid
 Parkidopa - Levodopa
 Parkin - Ethopropazine HCl
 Parkinane - Trihexyphenidyl HCl
 Parkopan - Trihexyphenidyl HCl
 Parmedin - Levodopa
 Parmenison - Prednisone
 Parmilene - Methaqualone
 Parmine - Phentermine HCl
 Parmodalin - Tranylcypromine sulfate
 Parmol - Acetaminophen
 Parnate - Tranylcypromine sulfate
 Parol - Acetaminophen
 Parpon - Benactyzine hydrochloride
 Parsidol - Ethopropazine HCl
 Parsitan - Ethopropazine HCl
 Parsotil - Ethopropazine HCl
 Partane - Trihexyphenidyl HCl
 Partel - Dithiazanine iodide
 Parten - Acetaminophen
 Partocon - Oxytocin
 Partolact - Oxytocin
 Partusisten - Fenoterol hydrobromide
 Parvalex - Acetyl cysteine
 Pas - Aminosalicilic acid
 Pasaden - Homofenazine
 Pasetocin - Amoxicillin
 Pasido - Aminosalicilic acid
 Pasolind - Acetaminophen
 Pasotomin - Prochlorperazine
 Paspertin - Metoclopramide HCl
 Pastan - Valetthamate bromide
 Pastillas azules - Dimenhydrinate
 Pathilon - Tridihexethyl iodide
 Pathocil - Dicloxacillin sodium
 Pathomycin - Sisomicin
 Pathorysin - Chlorzoxazone
 Pavabid - Papaverine monophosadenine
 Pavacron - Papaverine monophosadenine
 Pavagrant - Papaverine monophosadenine
 Pavakey - Papaverine monophosadenine
 Pavalon - Pancuronium bromide
 Pavatym - Papaverine monophosadenine
 Paveciclina - Methacycline
 Paver - Papaverine monophosadenine
 Paveril - Dioxyline phosphate
 Paverone - Dioxyline phosphate
 Pavulon - Pancuronium bromide
 Pax - Diazepam
 Paxel - Diazepam
 Paxeladine - Oxeladin
 Paxidorm - Methaqualone
 Paxin - Meprobamate
 Paxipam - Halazepam
 Paxisyn - Nitrazepam
 Paxyl - Chlorprothixene
 Pbzital - Medazepam
 PBZ-SR - Tripelennamine
 PCM - Acetaminophen
 Peamezin - Cycloclillin
 Peast C - Chlordiazepoxide HCl
 Pecnon - Kebuzone
 Pectamol - Oxeladin
 Pectipront - Benpropriperine
 Pectolex - Pentaerythritol tetranitrate
 Pectolitan - Chlophedianol
 Pectox - Carbocysteine
 Pectussil - Oxeladin
 Pedia Care - Dextromethorphan hydrobromide

Pediafac - Phenylephrine HCl
 Peditamycin - Erythromycin
 Peditaphen - Acetaminophen
 Peditetracycline - Tetracycline
 Pediazole - Acetyl sulfisoxazole
 Pediazole - Sulfisoxazole
 Pedicort - Hydrocortisone
 Pedimycetin - Chloramphenicol
 Pedi-Pro Foot Powder - 4-Chloro-3,5-xyleneol
 Peganone - Ethotoin
 Pelanin - Estradiol valerate
 Pelestrol - Diethylstilbestrol
 Pellar - Pelargonic acid
 Pelpica - Promethazine HCl
 Pelson - Nitrazepam
 Peluces - Haloperidol
 Pemine - Penicillamine
 Pemix - Pirozadil
 Pen-200 - Phenethicillin potassium
 Pen-A - Ampicillin trihydrate
 Penacyl - Aminosalicilic acid
 Penamox - Amoxicillin
 Pen Ampil - Ampicillin
 Penantin - Spironolactone
 Penargyl - Clemizole
 Penbon - Pentobarbital sodium
 Penbristol - Ampicillin trihydrate
 Penbritin - Ampicillin
 Penbrock - Ampicillin
 Pen-Di-Ben - Penicillin G benzathine
 Pndramine - Penicillamine
 Pendysin - Penicillin G benzathine
 Penecort - Hydrocortisone
 Penglobe - Bacampicillin
 Penibrin - Ampicillin
 Penicline - Ampicillin
 Penidural - Penicillin G benzathine
 Penifasa - Penicillin G procaine
 Penimaster - Ampicillin trihydrate
 Penimenal - Pivampicillin
 Penimic - Ampicillin
 Penimox - Amoxicillin
 Peninovel - Ampicillin
 Peninovel - Ampicillin trihydrate
 Peniplus - Phenethicillin potassium
 Peniroger procain - Penicillin G procaine
 Peniroger Retard - Penicillin G benzathine
 Penisint B.G. - Ampicillin
 Penistafil - Oxacillin sodium
 Penitardon - Nyldrin
 Penopen - Phenethicillin potassium
 Penoral - Ampicillin
 Penorale - Phenethicillin potassium
 Penorline - Penicillin V
 Pensorsin - Ampicillin
 Penplenum - Metacillin potassium
 Penplus - Floxacillin
 Penritol - Pentaerythritol tetranitrate
 Penselin - Dipyrnidamole
 Pensive - Meprobamate
 Penstapho - Oxacillin sodium
 Penstapho-N - Cloxacillin
 Pensyn - Ampicillin trihydrate
 Pentabil - Fenipentol
 Pentadolil - Clorprenaline
 Pentafin - Pentaerythritol tetranitrate
 Pentalong - Pentaerythritol tetranitrate
 Pentamycetin - Chloramphenicol
 Pentanitrine - Pentaerythritol tetranitrate
 Pentazine - Trifluoperazine
 Pentacillin - Piperacillin sodium
 Penthasone - Dexamethasone phosphate
 Penthrane - Methoxyflurane
 Penticort - Amcinonide
 Pentocetine - Chloramphenicol
 Pentocillin - Piperacillin sodium
 Pentofuryl - Nifuroxazide
 Pentogen - Pentobarbital sodium
 Pentolair - Cyclopentolate HCl
 Pentona - Mazaticol HCl
 Pentone - Pentobarbital sodium
 Pentraspan - Pentaerythritol tetranitrate
 Pentrex - Ampicillin
 Pentrexyl - Ampicillin
 Pentrexyl Oral - Ampicillin trihydrate
 Pentricine - Ampicillin trihydrate
 Pentritol - Pentaerythritol tetranitrate
 Pentryate - Pentaerythritol tetranitrate
 Pen-Vee - Penicillin V
 Penysol - Methicillin sodium
 Pepleo - Peplomycin sulfate
 Peptavlon - Pentagastrin
 Peptol - Cimetide
 Peracon - Isoaminik
 Peragit - Trihexyphenidyl HCl
 Peralgon - Indomethacin
 Peraprin - Metoclopramide HCl
 Peratsin - Perphenazine
 Perazil - Chlorcyclizine
 Perbolin - Methandrostenolone
 Percase - Heparin
 Perciclina - Demeclocycline HCl
 Perclusone - Clofezone
 Perclustop - Clofezone
 Percoclide - Sulfamerazine
 Percutacrine - Diethylstilbestrol
 Percutina - Fluocinolone acetonide
 Perdilal - Nyldrin
 Perdilatal - Nyldrin
 Perdipin - Nicardipine
 Perdotat - Tilidine HCl
 Perduretas - Promethazine HCl
 Perdurine - Probenecid
 Perebral - Cyclandelate
 Peremesin - Meclizine HCl
 Perequil - Meprobamate
 Perfadex - Dextran 40
 Perfectochol - Iodoalphonic acid
 Perfenil - Perphenazine
 Pergestron - Hydroxyprogesterone caproate
 Periactin - Cyproheptadine
 Periaqtine - Cyproheptadine
 Periactol - Cyproheptadine
 Periblastine - Vinblastine sulfate
 Pericephal - Cinnarizine
 Pericristine - Vincristine sulfate
 Peridamol - Dipyrnidamole
 Peridex - Pentaerythritol tetranitrate
 Peridor - Haloperidol
 Perilax - Bisacodyl
 Perispan - Pentaerythritol tetranitrate
 Perista - Bethanechol chloride
 Peritard - Nicotiny alcohol
 Peritol - Cyproheptadine
 Peritrate - Pentaerythritol tetranitrate
 Peritrine - Pentaerythritol tetranitrate
 Perium - Pentapiperide methosulfate
 Perke One - Dextroamphetamine sulfate
 Perkod - Dipyrnidamole
 Perlatos - Dimethoxanate

Permapen - Penicillin G benzathine
 Permastril - Dromostanolone propionate
 Permatrim - Phenylpropranolamine HCl
 Permicipur - Cyanocobalamin
 Permilitin - Dipyrindamole
 Permiran - Viqualid
 Permithyn - Benzethonium chloride
 Permitil - Fluphenazine HCl
 Pernovin - Phenindamine tartrate
 Pernox - Salicylic acid
 Peroxinorm - Orgotein
 Perphal - Vincamine
 Perphenan - Perphenazine
 Perphoxene - Fenproporex
 Persantin - Dipyrindamole
 Persantine - Dipyrindamole
 Persedon - Pyrrithyldione
 Persopir - Nitrazepam
 Pertene Vita - Betamethasone
 Pertestis Dep. - Testosterone 17 β -cypionate
 Pertix-Hommel - Butamirate citrate
 Pertofran - Desipramine HCl
 Pertofrane - Desipramine HCl
 Pertoxil - Clobutinol
 Pertradiol - Estradiol cypionate
 Pervadil - Nyliidrin
 Pervagal - Propantheline bromide
 Pervancamine - Vincamine
 Pervasol - Tetracycline
 Pervetral - Oxypendyl
 Pervone - Vincamine
 Perycit - Niceritrol
 Perynitrate - Pentaerythritol tetranitrate
 Pesomax - Stanolone
 Peteha - Protionamide
 Pethidine Roche - Meperidine HCl
 Petimid - Phensuximide
 Petinamide - Ethosuximide
 Petinutin - Methsuximide
 Petnidan - Ethosuximide
 Petogen - Medroxyprogesterone acetate
 Petylyl - Desipramine HCl
 Pevaryl - Econazole nitrate
 Pevidine - Povidone-iodine
 Pexaqualone - Methaqualone
 Pexid - Perhexiline sulfate
 Pezatamid - Pyrazinamide
 PFD oral sol - Bentiromide
 PFT Roche - Bentiromide
 Phanurane - Canrenoate potassium
 Pharcillin - Ampicillin
 Pharmacin - Aspirin
 Pharmadil - Nyliidrin
 Pharmic - Tegafur
 Phazyme - Simethicone
 Phobex - Benactyzine hydrochloride
 Phemerol - Benzethonium chloride
 Phenamin - Dexchlorpheniramine maleate
 Phenaphen - Acetaminophen
 Phenazine - Phendimetrazine tartrate
 Phenazine - Perphenazine
 Phenazoline - Antazoline HCl
 Phenbutazol - Phenylbutazone
 Phencen - Promethazine HCl
 Phendex - Acetaminophen
 Phenergan - Phenylephrine HCl
 Phenergan - Promethazine HCl
 Phenhydhan - Phenytoin
 Phenipirin - Acetaminophen
 Pheniramidol - Phenyramidol
 Phenoxene - Chlorphenoxamine HCl
 Phenoxine - Pemoline
 Phentamine - Diphenhydramine HCl
 Phentermyl - Phentermine HCl
 Phenurin - Nitrofurantoin
 Phenyl Betazone - Phenylbutazone
 Phenylone - Phenylbutazone
 Phenyl-Pas-Teb-Amin - Phenyl aminosaliclylate
 Pheramin - Diphenhydramine HCl
 Phiaquin - Hydroquinone
 PhisoheX - Hexachlorophene
 Phlogase - Oxyphenbutazone
 Phlogistol - Oxyphenbutazone
 Phlogont - Oxyphenbutazone
 Phloguran - Oxyphenbutazone
 Phloguron - Kebuzone
 Phobex - Benactyzine hydrochlorite
 Pholtex - Phenyltoloxamine
 Phospholine iodide - Echothiopate iodide
 Phrenilin - Acetaminophen
 Phtalazol - Phthalylsulfathiazole
 Phylletten - Chlorquinaldol
 Physeptone - Methadone HCl
 Physiomyicine - Methacycline
 Pibena - Pivampicillin
 Picolax - Picosulfate sodium
 Pielos - Nalidixic acid
 Pietil - Oxolinic acid
 Pifazin - Pifarnine
 Pikorin - Oxymetazoline HCl
 Pilazon - Phenylbutazone
 Piloral - Clemastine fumarate
 Pimafucin - Natamycin
 Pimafucine - Natamycin
 Pimafucort - Natamycin
 Pimotid - Pimozide
 Pinase - Bromelain
 Pineroro - Diphenidol
 Pinex - Acetaminophen
 Piocaine - Chloroprocaine HCl
 Pioxel - Pemoline
 Pipanol - Trihexyphenidyl HCl
 Pipedac - Pipemidic acid
 Pipedase - Pipemidic acid
 Pipemid - Pipemidic acid
 Piper - Pipenzolate bromide
 Piperallin - Piperacillin sodium
 Piperacilina - Penicillin G benzathine
 Piperonil - Pipamperone
 Pipnodine - Perlapine
 Pipolphen - Promethazine HCl
 Pipracil - Piperacillin sodium
 Pipram - Pipemidic acid
 Pipril - Piperacillin sodium
 Piptal - Pipenzolate bromide
 Pipurin - Pipemidic acid
 Pirabutina - Oxyphenbutazone
 Piraflogin - Oxyphenbutazone
 Piral dina - Pyrazinamide
 Piralone - Lorazepam
 Piramox - Amoxicillin
 Piranver - Pyrantel pamoate
 Pirarremol - Phenylbutazone
 Pirasulfon - Sulfamethoxyppyridazine
 Pirazimida - Pyrazinamide
 Pirazone - Diphenylpyraline HCl
 Pirecin - Proxazole citrate
 Pirem - Carbuterol
 Pirexyl - Benproperine
 Piricef - Cephapirin sodium

- Piridolan - Piritramide
 Pirilene - Pyrazinamide
 Pirimicidan - Pyrimethamine
 Piritinol - Pyritinol
 Piritiomin - Pyritinol
 Piriton - Chlorpheniramine maleate
 Piroan - Dipyridamole
 Pirocrid - Protizinic acid
 Pirodal - Piromidic acid
 Pirok - Pyrvinium pamoate
 Pirroxil - Piracetam
 Pitocin - Oxytocin
 Pitrex - Tolnaftate
 Pituitan - Oxytocin
 Piva - Pivampicillin
 Pivabiot - Pivampicillin
 Pivadilon - Pivampicillin
 Pivalone - Tixocortol pivalate
 Pivambol - Pivampicillin
 Pivamkey - Pivampicillin
 Pivanol - Naphazoline
 Pivapen - Pivampicillin
 Pivastol - Pivampicillin
 Pivatil - Pivampicillin
 Piviotic - Pivampicillin
 Piziacina - Methacycline
 PK-Mertz - Amantidine HCl
 Placidex - Mephenoalane
 Placidia - Lorazepam
 Placidyl - Ethchlorvynol
 Placitril - Metoclopramide HCl
 Plac Out - Chlorhexidine
 Plactamin - Prenylamine
 Plak-Out - Chlorhexidine
 Plander R - Dextran 40
 Planovar - Norgestrel
 Planum - Temazepam
 Plaquenil - Hydroxychloroquine sulfate
 Plasil - Metoclopramide HCl
 Platocillina - Ampicillin
 Plausitin - Morclofone
 Plavolox - Pyridinol carbamate
 Plecton - Cicloxilic acid
 Plegine - Phendimetrazine tartrate
 Plegitux - Cinnarizine
 Pleiatensin - Bietaserpine
 Pleiazim - Dimethicone
 Plentasal - Cyanocobalamin
 Plesium - Bromopride
 Plesmet - Ferroglycine sulfate
 Pletil - Tinidazole
 Plisulfan - Sulfaphenazole
 Plitican - Alizapride
 Plube - Citicoline
 Plumericin - Ampicillin
 Plurexid - Chlorhexidine
 Pluriespec - Metampicillin sodium
 Plurigram - Metlacycline
 Plurine - Hydroflumethiazide
 Plurisemina - Gentamicin sulfate
 Pluryl - Bendroflumethiazide
 Pluvex - Trichlormethiazide
 PMB Ayerst - Meprobamate
 P-Medrate - Medroxyprogesterone acetate
 Pneumopen - Chlorpheniramine maleate
 Pneumorel - Fenspiride
 Poenbiotico - Ampicillin trihydrate
 Poenglausil - Ethoxzolamide
 Polagin - Sulfamerazine
 Polaramin - Dexchlorpheniramine maleate
 Polaramine - Dexchlorpheniramine maleate
 Polarmicina - Erythromycin
 Polaronic - Chlorpheniramine maleate
 Polaronil - Dexchlorpheniramine maleate
 Poleon - Nalidixic acid
 Policilin - Ampicillin
 Poliduril - Bendroflumethiazide
 Polik - Haloproglin
 Polinal - Methyldopa
 Polisilon - Dimethicone
 Polistin - Carbinoxamine maleate
 Polistina - Carbinoxamine maleate
 Poliurene - Bumetanide
 Poliuron - Bendroflumethiazide
 Pollival - Suloctidil
 Polixima - Cefuroxime
 Polmiror - Nifuratel
 Polognost - Iopanoic acid
 Polomigran - Pizotyline HCl
 Polybactrin - Bacitracin
 Polycartin - Carnitine
 Polycin - Bacitracin
 Polycillin - Ampicillin
 Polycillin - Ampicillin trihydrate
 Polycycline - Tetracycline
 Polydine - Povidone-iodine
 Polyfax - Bacitracin
 Polyfax - Polymyxin
 Poly Histine - Brompheniramine maleate
 Poly-Histine - Pheniramine maleate
 Poly-Histine - Phenylpropanolamine HCl
 Poly-Histine - Pyrilamine
 Polykol - Poloxalkol
 Polymox - Amoxicillin
 Polynase - Trichlormethiazide
 Polyregulon - Polythiazide
 Polysilo - Dimethicone
 Polysporin - Bacitracin
 Polysporin - Polymyxin
 Polysquall - Furosemide
 Ponalar - Mefenamic acid
 Pondex - PemoLine
 Pondinil - Mefenorex HCl
 Pondocillin - Pivampicillin
 Pondocillina - Pivampicillin
 Ponstan - Mefenamic acid
 Ponstel - Mefenamic acid
 Ponstyle - Mefenamic acid
 Poquil - Pyrvinium pamoate
 POR-B - Ornipressin
 Poracemin - Chlorpheniramine maleate
 Poricefal - Cephaloridine
 Porinabis - Cephalixin
 Posedrine - Beclamide
 Postafen - Meclizine HCl
 Potaba - Aminobenzoic acid
 Povadyne - Povidone-iodine
 Povan - Pyrvinium pamoate
 Povanyl - Pyrvinium pamoate
 Pracefal - Cephalixin
 Practon - Spironolactone
 Praecirheumin - Phenylbutazone
 Praecivenin - Heparin
 Pragmazone - Trazodone HCl
 Praiden - Bromopride
 Pralon - Practolol
 Pramet - Ferrous fumarate
 Pramet - Folic acid
 Pramidex - Tolbutamide
 Pramiel - Metoclopramide HCl

Pramilet - Folic acid
 Pramir - Metoclopramide HCl
 Pramolan - Opipramol
 Pramoxone - Pramoxine HCl
 Prandiol - Dipyridamole
 Pranolol - Propranolol HCl
 Prantal - Diphephanil methylsulfate
 Pratsiol - Prazosin
 Prax - Pramoxine HCl
 Praxilene - Naftronyl oxalate
 Praxis - Indoprofen
 Praxiten - Oxazepam
 Prazac - Prazosin
 Prazene - Prazepam
 Prazilene - Naftronyl oxalate
 Prean - Mebutamate
 Precopen - Amoxicillin
 Prectolact - Prenylamine
 Predartrina - Prednisolone
 Predate - Prednisolone acetate
 Predate S - Prednisolone phosphate sodium
 Predate TBA - Prednisolone tebutate
 Pred Cor 100 - Prednisolone acetate
 Predicort - Prednisolone acetate
 Predion - Hydroxydione sodium succinate
 Pred Mild - Prednisolone acetate
 Prednesol - Prednisolone phosphate sodium
 Predniartrit - Prednisone
 Prednicen - Prednisolone
 Prednicen-M - Prednisone
 Predni-Coelin - Prednisolone
 Prednicort - Prednisolone
 Prednifor - Prednisolone acetate
 Prednifor - Prednisone
 Predni-Helvacort - Prednisolone
 Predni-H-Tablinen - Prednisolone
 Prednilen - Methylprednisolone
 Prednilonga - Prednisone
 Predniretard - Prednisolone
 Prednis - Prednisolone
 Prednisol TBA - Prednisolone tebutate
 Predni-Tablinen - Prednisone
 Predni-Wolner - Prednisone
 Prednol - Desonide
 Prednol - Methylprednisolone
 Prednovister - Prednisone
 Pred-S - Prednisone
 Predsol - Prednisone
 Predsone - Prednisone
 Prefamone - Diethylpropion HCl
 Pregaday - Folic acid
 Preglandin - Gemeprost
 Prelin - Hexoprenaline
 Prelis - Metoprolol tartrate
 Prelone - Prednisolone
 Prelu-2 - Phendimetrazine tartrate
 Preludin - Phenmetrazine
 Premaspin - Aspirin
 Preminex - Mebutamate
 Premocillin - Penicillin G procaine
 Prempak - Norgestrel
 Prenacid - Desonide
 Prenate - Folic acid
 Prenazon - Feprazone
 Prenema - Prednisolone acetate
 Prenisol - Prednisolone stearoylglycolate
 Prenomiser - Isoproterenol sulfate
 Prent - Acebutolol
 Prentol - Diphephanil methyl sulfate
 Pre-Op - Hexachlorophene
 Pre-Par - Ritodrine
 Prep-Cort - Hydrocortisone
 Presamine - Imipramine HCl
 Prescaina - Benoxinate hydrochloride
 Presdate - Labetalol HCl
 Presidion - Pyrithyldione
 Presone - Prednisone
 Presotona - Etilefrine pivalate HCl
 Pressedin - Guanethidine sulfate
 Pressfall - Hydralazine HCl
 Pressionorm - Gepefrin
 Pressonex - Metaraminol
 Pressoral - Metaraminol
 Pressural - Indapamide
 Prestacilina - Ampicillin trihydrate
 Pre-Sun - Aminobenzoic acid
 Pretonine - Oxitriptan
 Pretor - Cefotaxime sodium
 Prevenzyme - Papain
 Prexan - Naproxen
 Prexidil - Minoxidil
 Prexion - Mecamylamine HCl
 Priamide - Isopropamide iodide
 Pricortin - Prednisolone acetate
 Primabalt - Cyanocobalamin
 Primafin - Cefotaxime sodium
 Primalan - Mequitazine
 Primasin - Amoxicillin
 Primatene - Pyrilamine
 Primex - Bumetanide
 Primobolan - Methenolone acetate
 Primogyn-Depot - Estradiol valerate
 Primoline - Primidone
 Primolut-Depot - Hydroxyprogesterone caproate
 Primolut N - Norethindrone
 Primolut-Nor - Norethindrone acetate
 Primonil - Imipramine HCl
 Primoteston - Testosterone enanthate
 Primoxin - Norfloxacin
 Primperan - Metoclopramide HCl
 Primperil - Metoclopramide
 Primron - Primidone
 Prinalgin - Alcofenac
 Principen - Ampicillin
 Principen - Ampicillin trihydrate
 Prindarl - Metoclopramide HCl
 Prinderin - Cephaloridine
 Prindex - Cephalixin
 Priodax - Iodoaliphonic acid
 Prioderm - Malathion
 Priomicina - Fostomycin
 Piper - Pipemidic acid
 Prisco - Tolazoline
 Priscoline - Tolazoline
 Privin - Naphazoline
 Privine - Naphazoline
 Privonium - Pyrvinium pamoate
 Pro-Actidil - Triprolidine
 Proaqua - Benzthiazide
 Probahist - Brompheniramine maleate
 Probahist - Chlorpheniramine maleate
 Probanthine - Propantheline bromide
 Pro-Banthis - Propantheline bromide
 Probasan - Meprobamate
 Probenid - Probenecid
 Probenemid - Probenecid
 Probenicid - Probenecid
 Probilin - Piprozolin
 Probital - Propantheline bromide
 Procalm - Chlorpromazine HCl

Procapen - Penicillin G procaine
 Procardia - Nifedipine
 Procardin - Proscillaridin
 Processine - Cinnarizine
 Proctetoken - Fenofibrate
 Prochel - Chlorpromazine HCl
 Prochlor-Iso - Isopropamide iodide
 Procid - Probenecid
 Procollan - Proscillaridin
 Proclival - Bufeniodo
 Procor - Amiodarone HCl
 Proctisone - Beclomethasone dipropionate
 Procto-Celestan - Betamethasone valerate
 Proctocort - Hydrocortisone
 Proctofoam - Pramoxine HCl
 Proculin - Naphazoline
 Procutene - Triclocarban
 Procyclid - Procyclidine HCl
 Procytox - Cyclophosphamide
 Prodictin - Pyridinol carbamate
 Prodepress - Imipramine HCl
 Prodermin - Fluocinolone acetonide
 Pro-Diaban - Glisoxepid
 Prodiaben - Chlorpropamide
 Prodisan - Apazone
 ProdiXamon - Propantheline bromide
 Prodopa - Levodopa
 Pro Dorm - Lorazepam
 Pro-Dorm - Methaqualone
 Prodormol - Pentobarbital sodium
 Prodox - Hydroxyprogesterone caproate
 Prodoxol - Oxolinic acid
 Prodryl - Diphenhydramine HCl
 Pro-Entra - Triprolidine
 Profemin - Furosemide
 Profenid - Ketoprofen
 Profetamine - Amphetamine phosphate
 Profura - Nitrofurantoin
 Progan - Promethazine HCl
 Proge - Hydroxyprogesterone caproate
 Progesic - Fenoprofen
 Progesteron-Depo - Hydroxyprogesterone caproate
 Progevera - Medroxyprogesterone acetate
 Proglycem - Diazoxide
 Proglycem - Diazoxide
 Progout - Allopurinol
 Progynon - Ethinylestradiol
 Progynon Depot - Estradiol valerate
 Progynova - Estradiol valerate
 Proherz - Proscillaridin
 Proinsul - Tolbutamide
 Pro-Iso - Isopropamide iodide
 Prokapen - Penicillin G procaine
 Proketazine - Carphenazine maleate
 Proladyl - Pyrrobutamine
 Prolamine - Phenylpropanolamine HCl
 Prolax - Mephesisin
 Prolifen - Clomiphene dihydrogen citrate
 Prolix - Apazone
 Prolixan - Apazone
 Prolixano - Apazone
 Prolixin - Fluphenazine HCl
 Prolopa - Benserazide
 Proloprim - Trimethoprim
 Promachlor - Chlorpromazine HCl
 Promacid - Chlorpromazine HCl
 Promactil - Chlorpromazine HCl
 Promanyl - Promazine HCl
 Promapar - Chlorpromazine HCl
 Promassolax - Oxyphenisatin acetate
 Promazettes - Promazine HCl
 Promecon - Benzquinamide
 Promedes - Furosemide
 Promet - Promethazine HCl
 Promethapar - Promethazine HCl
 Prometin - Metoclopramide HCl
 Promexin - Chlorpromazine HCl
 Promezerine - Promazine HCl
 Promid - Protionamide
 Promide - Chlorpropamide
 Promine - Promethazine HCl
 Promodor - Diphenidol
 Promosol - Chlorpromazine HCl
 Prompt - Acetaminophen
 Pronalgon F - Dinoprost tromethamine
 Pronemia - Folic acid
 Pronison - Prednisone
 Pronoctan - Lormetazepam
 Pronovan - Propranolol HCl
 Prontoformin - Phenformin
 Prontolax - Bisacodyl
 Prontomicina - Methacycline
 Prontosed - Chllophedianol
 Propaderm - Beclomethasone dipropionate
 Propadrine - Phenylpropanolamine HCl
 Propafenin - Chlorpromazine HCl
 Propagast - Phenylpropanolamine HCl
 Pro-Pam - Diazepam
 Propanthel - Propantheline bromide
 Propasa - Aminosilicylic acid
 Propavent - Beclomethasone dipropionate
 Propax - Oxazepam
 Prophen 65 - Propoxyphene HCl
 Prophyllen - Dyphylline
 Propine - Dipivefrin
 Propiociene - Erythromycin estolate
 Propitan - Pipamperone
 Propofan - Chlorpheniramine maleate
 Propoxychel - Propoxyphene HCl
 Propran - Clorprenaline
 Propranur - Propranolol HCl
 Propred - Prednisone
 Proptan - Tanphetamin
 Propynalin - Isoproterenol sulfate
 Proquinal - Secobarbital sodium
 Proresid - Mitopodozide
 Prorex - Promethazine HCl
 Proscillan - Proscillaridin
 Proscillar - Proscillaridin
 Proscomeide - Methscopolamine bromide
 Prosiladin - Proscillaridin
 Prosonno - Nitrazepam
 Prospectin - Hydralazine HCl
 Prostalmon F - Dinoprost tromethamine
 Prostaphlin - Oxacillin sodium
 Prostaphlin - Cloxacillin
 Prostarmon E - Dinoprostone
 Prostatin - Candicidin
 Prostetin - Oxendolone
 Prostin E₂ - Dinoprostone
 Prostin F2 Alpha - Dinoprost tromethamine
 Prostin F2A - Dinoprost tromethamine
 Prostosin - Proscillaridin
 Prosyli - Prothipendyl HCl
 Proszin - Proscillaridin
 Protactyl - Promazine HCl
 Protagen - Furosemide
 Protamine - Insulin zinc suspension
 Protangix - Dipyrindamole
 Protaphane - Insulin isophane

- Protasin - Proscillaridin
 Protector - Improsulfan tosylate
 Protector - Diphenoxylate HCl
 Protensin - Chlordiazepoxide HCl
 Proteolis - Bromelain
 Proteranol - Isoproterenol sulfate
 Proteroxyna - Oxytetracycline
 Proterytrin - Erythromycin estolate
 Proterytrin IV - Erythromycin lactobionate
 Protexin - Amantidine HCl
 Prothazine - Promethazine HCl
 Prothia - Promethazine HCl
 Prothiazine - Promethazine HCl
 Prothil - Medrogestone
 Prothionamide - Protionamide
 Prothromadin - Warfarin sodium
 Protid - Phenylephrine HCl
 Protionizina - Protionamide
 Protocef - Cephadrine
 Protocide - Tinidazole
 Protogen - Dapsone
 Protolipan - Fenofibrate
 Protona - Stanolone
 Protopam - Pralidoxime chloride
 Protophenicol - Chloramphenicol palmitate
 Protophylline - Dyphylline
 Protostat - Metronidazole
 Protran - Chlorpromazine HCl
 Protlyol - Dicyclomine HCl
 Proval - Acetaminophen
 Proventil - Albuterol
 Provera - Medroxyprogesterone acetate
 Provest - Ethinyl estradiol
 Provest - Medroxyprogesterone acetate
 Provigan - Promethazine HCl
 Provimicina - Demeclocycline HCl
 Providine - Povidone-iodine
 Proviron - Mesterolone
 Pro-Viron - Mesterolone
 Provismine - Visnadine
 Proxen - Naproxen
 Proxil - Proglumetacin maleate
 Prozil - Chlorpromazine HCl
 Prozin - Chlorpromazine HCl
 P.R.T. - Protizinic acid
 Prolet - Oxyphenisatin acetate
 Pruralgin - Dimethisoquin
 Prurisedine - Chlorcyclizine
 Pryleugan - Imipramine HCl
 Prysoline - Primidone
 Pseudocef - Cefsulodin
 Pseudomonil - Cefsulodin
 Psicofar - Chlordiazepoxide HCl
 Psicopax - Oxazepam
 Psicosen - Sulpiride
 Psicoterine - Chlordiazepoxide HCl
 Psicronizer - Nomifensine maleate
 Psiquium - Medazepam
 Psiquiwas - Oxazepam
 Psoritin - Methoxsalen
 PSP-IV - Prednisolone phosphate sodium
 Psychoforin - Imipramine HCl
 Psychopax - Diazepam
 Psychostyl - Nortriptyline
 Psychozine - Chlorpromazine HCl
 Psykatalil - Chlorpromazine HCl
 Psyquil - Triflupromazine
 Puernol - Acetaminophen
 Pularin - Heparin
 Pulmadil - Rimiterol
 Pulmex-DM - Dextromethorphan hydrobromide
 Pulmoclaste - Carbocysteine
 Pulsamin - Etilerfrine pivalate HCl
 Pulsan - Indenolol
 Purata - Oxazepam
 Purazine - Cinnarizine
 Pur-Bloka - Propranolol HCl
 Puresis - Furosemide
 Puricos - Allopurinol
 Purim - Piromidic acid
 Purinethol - Mercaptopurine
 Puri-Nethol - Mercaptopurine
 Purinol - Allopurinol
 Puritrid - Amiloride HCl
 Purososin-TC - Proscillaridin
 Putoprin - Metoclopramine HCl
 Puvalen - Methoxsalen
 P.V. Carbachol - Carbachol
 PV-Tussin - Pyrilamine
 PV-Tussin - Phenindamine tartrate
 PV-Tussin - Phenylephrine HCl
 Pyassan - Cephalixin
 Pycazide - Isoniazid
 Pyelokon-R - Acetrizoate sodium
 Pyknolepisium - Ethosuximide
 Pylapron - Propranolol HCl
 Pyocefalín - Cefsulodin
 Pyocianil - Carbenicillin disodium
 Pyocidin - Hydrocortisone
 Pyocidin - Polymyxin
 Pyopen - Carbenicillin disodium
 Pyoredol - Phenytoin
 Pyra - Pyrilamine
 Pyrafat - Pyrazinamide
 Pyramal - Pyrilamine
 Pyra-Maleate - Pyrilamine
 Pyramen - Piracetam
 Pyramistin - Trihexyphenidyl HCl
 Pyrathyn - Methapyrilene HCl
 Pyrazide - Pyrazinamide
 Pyrcon - Pyrvinium pamoate
 Pyrethia - Promethazine HCl
 Pyribenzamine - Tripelannamine
 Pyridamal - Chlorpheniramine maleate
 Pyrikapil - Sulpiride
 Pyrilax - Bisacodyl
 Pyrimethamin-Heyl - Pyrimethamine
 Pyrinazin - Acetaminophen
 Pyrital - Acetaminophen
 Pyrizidin - Isoniazid
 Pyrocard - Sulfinpyrazone
 Pyrogastone - Carbenoxolone
 Pyronil - Pyrrobutamine
 Pyronoval - Aspirin
 Pyrrolazote - Pyrazinamide
 Pyroxate - Chlorpheniramine maleate
 Pyrvin - Pyrvinium pamoate
 P.Z.A. - Pyrazinamide
 Q I Damp - Ampicillin trihydrate
 Quaalude - Methaqualone
 Quadnite - Promethazine HCl
 Quadraciclina - Rolitetracycline
 Quadrahist - Chlorpheniramine maleate
 Quadrahist - Phenyltoloxamine
 Quait - Lorazepam
 Qualigens - Lidocaine
 Quanto - Metoclopramide HCl
 Quantril - Benzquinamide
 Quarzan - Clidinium bromide

Quelidrine - Dextromethorphan hydrobromide
 Quelidrine - Phenylephrine HCl
 Quellada - Lindane
 Quen - Oxazepam
 Quenobilan - Chenodiol
 Quensyl - Hydroxychloroquine sulfate
 Quesil - Chlorquinaldol
 Quetiniil - Diazepam
 Quiadon - Oxazolam
 Quibron - Guaifenesin
 Quickmicina - Methacycline
 Quiess - Hydroxyzine HCl
 Quietidon - Meprobramate
 Quietim - Hydroxytryptophan
 Quietim - Oxitriptan
 Quievida - Diazepam
 Quilene - Pentapiperide methosulfate
 Quilibrex - Oxazepam
 Quill - Nitrazepam
 Quimetam - Ampicillin
 Quinachlor - Chloroquine phosphate
 Quinbar - Secobarbital sodium
 Quinercil - Chloroquine phosphate
 Quinilon - Chloroquine phosphate
 Quinnone - Hydroquinone
 Quiridil - Sulpiride
 Quitaxon - Doxepin HCl
 Quotane - Dimethisoquin

 R-1406 - Phenoperidine HCl
 Racenicol - Thiamphenicol
 Rachelamine - Chlorpheniramine maleate
 Radenarcon - Etomidate HCl
 Redepur - Chlordiazepoxide HCl
 Radeverm - Niclosamide
 Radiamin - Furosemide
 Radiocillina - Ampicillin
 Radiocin - Fluocinolone acetonide
 Radiomicina - Methacycline
 Radio-Selectan Biliare - Iodipamide
 Radiosone - Methylprednisolone
 Radonna - Furosemide
 Ralgro - Zeranol
 Rallicid - Indomethacin
 Ralone - Zeranol
 Ralopar - Cefotaxime sodium
 Ran - Naphazoline
 Rancedon - Clonazepam
 Randum - Metoclopramide HCl
 Rangozona - Feprazone
 Ranidil - Ranitidine
 Rankmin - Tolbutamide
 Rantudil - Acemetacin
 Rapenton - Mopidamol
 Raphetamine - Amphetamine phosphate
 Rapidocaine - Lidocaine
 Rapifen - Alfentanil HCl
 Rapostan - Oxyphenbutazone
 Rasedon - Hydroxocobalamin
 Raseltin - Clemastine fumarate
 Rasisemid - Furosemide
 Rastinon - Tolbutamide
 Rathimed N - Metronidazole
 Raudopen - Amoxicillin
 Raulen - Reserpine
 Raunans - Methixene HCl
 Raunormine - Deserpidine
 Raunova - Syrosingopine
 Raurine D-Lay - Reserpine
 Rausingle - Reserpine

 Rausan - Reserpine
 Rau-Sed - Reserpine
 Rausedan - Reserpine
 Rausetin - Prenylamine
 Rauvillid - Reserpine
 Rauwita - Reserpine
 Rauzide - Bendroflumethiazide
 Ravenil - Mepazine
 Ravenil - Pyridinol carbamate
 Raylina - Amoxicillin
 Rayvist-Meglumine Salt - Ioglycamic acid
 Razlin - Cinnarizine
 Razoxin - Razoxane
 Reactenol - Methylprednisolone
 Reactrol - Clemizole
 Reapam - Prazepam
 Reasec - Diphenoxylate HCl
 Rebugen - Ibuprofen
 Recenacillin - Ampicillin
 Recolip - Clofibrate
 Reconin - Clemastine fumarate
 Rectisol - Mannitol
 Recto-Betnesol - Betamethasone valerate
 Rectocenga - Cyanocobalamin
 Rectocort - Hydrocortisone
 Rectodelt - Prednisone
 Rectofasa - Phenylbutazone
 Rectoid - Hydrocortisone
 Rectoplexil - Oxomemazine
 Rectosaly - Aspirin
 Red - Hydroxocobalamin
 Redamin - Cyanocobalamin
 Red-B - Hydroxocobalamin
 Redeptin - Fluspirilene
 Redifal - Sulfadimethoxine
 Redisol - Cyanocobalamin
 Redisol H - Hydroxocobalamin
 Redomex - Amitriptyline HCl
 Reducdyn - Citalone
 Reducor - Propranolol HCl
 Reducto - Phendimetrazine tartrate
 Redul - Glymidine
 Redu-Pres - Debrisoquin
 Redupressin - Ethoxzolamide
 Reedvit - Cyanocobalamin
 Reelon - Piroimidic acid
 Refobacin - Gentamicin sulfate
 Refugal - Chlophedianol
 Regal - Oxyphenisatin acetate
 Regalen - Chenodiol
 Regastrol - Metoclopramide HCl
 Regenon - Diethylpropion HCl
 Regibon - Diethylpropion HCl
 Reginol - Dienestrol
 Regitine - Phentolamine HCl
 Reglan - Metoclopramide HCl
 Regletin - Alprenolol HCl
 Regonol - Pyridostigmine bromide
 Regresin - Fluorometholone
 Regretetron - Chlorthalidone
 Regulane - Loperamide HCl
 Regulin - Phentermine HCl
 Regulon - Benzthiazide
 Regulton - Amezinium methyl sulfate
 Regroton - Reserpine
 Regutol - Docusate calcium
 Reidamine - Dimenhydrinate

Reis-Fit - Cyclizine
 Rela - Carisoprodol
 Relact - Nitrazepam
 Relaksin - Meprobamate
 Relasom - Carisoprodol
 Relax - Methocarbamol
 Relaxan - Gallamine triethiodide
 Relaxar - Mephesisin
 Relaxo-Powel - Carisoprodol
 Release V - Valethamate bromide
 Releasin - Relaxin
 Reliberan - Chlordiazepoxide HCl
 Relium - Chlordiazepoxide HCl
 Reliv - Acetaminophen
 Relivan - Diazepam
 Reliveran - Metoclopramide HCl
 Relizon - Chlormezanone
 Reloxyl - Amoxicillin
 Relvene - Tubocurarine chloride
 Remauric - Ketoprofen
 Remdue - Flurazepam
 Remivox - Lorcaidine HCl
 Remnos - Nitrazepam
 Remoflex - Chlorzoxazone
 Removine - Dimenhydrinate
 Remoxil - Amoxicillin
 Remsed - Promethazine HCl
 Renamid - Acetazolamide
 Renasul - Sulfamethizole
 Renborin - Diazepam
 Rencal - Phytate sodium
 Renese - Polythiazide
 Renese-R - Reserpine
 Rengasil - Pirprofen
 Renogram - Nalidixic acid
 Renon - Chlorthalidone
 Renoquid - Sulfacytine
 Rentenac - Alcofenac
 Reocorin - Prenylamine
 Reodyn - Carbocysteine
 Reohem - Dextran 40
 Reomax - Ethacrynic acid
 Reomucil - Carbocysteine
 Reorganin - Guaifenesin
 Reoxyl - Hexobendine
 Repazine - Chlorpromazine HCl
 Repeltin - Trimeprazine
 Repestrogen - Estradiol valerate
 Repocal - Pentobarbital sodium
 Repo-Estra - Estradiol valerate
 Repos-E - Estradiol valerate
 Reposo-TMD - Testosterone enanthate
 Represil - Feprazone
 Reprosteron - Testosterone enanthate
 Repro Testro Med - Testosterone enanthate
 Reptilase - Batroxobin
 Resan - Ampicillin
 Rescamin - Rescinnamine
 Rescimin - Rescinnamine
 Rescinate - Rescinnamine
 Rescisan - Rescinnamine
 Rescitis - Rescinnamine
 Rescresl - Tegafur
 Resedril - Reserpine
 Rese-Lar - Reserpine
 Reser-Ar - Reserpine
 Resercen - Reserpine
 Reserocrine - Reserpine
 Reserfia - Reserpine
 Reserpoid - Reserpine
 Reserpur - Reserpine
 Resibion - Erythromycin stearate
 Resilioid - Rescinnamine
 Resimatil - Primidone
 Resine - Reserpine
 Resistopen - Oxacillin sodium
 Resitan - Valethamate bromide
 Resochin - Chloroquine phosphate
 Resolve - Dyclonine HCl
 Resolvit - Bromelain
 Resomine - Reserpine
 Respilene - Zipeprol
 Respirase - Zipeprol
 Respirax - Zipeprol
 Respiride - Fenspiride
 Respital - Reserpine
 Resplamin - Aminocaproic acid
 Resplen - Eprazinone HCl
 Restamin - Diphenhydramine HCl
 Restanil - Meprobamate
 Restanolon - Clorprenaline
 Restelon - Nalidixic acid
 Restin - Cephalothin sodium
 Reston - Diphenhydramine HCl
 Restoril - Temazepam
 Resulfon - Sulfaguanidine
 Resyl - Guaifenesin
 Retandros - Testosterone enanthate
 Retardillin - Penicillin G procaine
 Retardin - Diphenoxylate HCl
 Retarpen - Penicillin G benzathine
 Retcin - Erythromycin
 Retenema - Betamethasone valerate
 Retestrin - Estradiol valerate
 Reticus - Desonide
 Retidex B12 - Cyanocobalamin
 Retilian - Xanthinol niacinate
 Retin-A - Tretinoin
 Reton - Phendimetrazine tartrate
 Reuflos - Diflunisal
 Reugaril - Chlorthexoxazine
 Reulin - Chlorthexoxazine
 Reumacillin - Penicillamine
 Reumasyl - Phenylbutazone
 Reumazin - Phenylbutazone
 Reumital - Chlorthexoxazine
 Reumo Campil - Kebuzone
 Reumofil - Sulindac
 Reumuzol - Phenylbutazone
 Reunyl - Aspirin
 Reupolar - Phenylbutazone
 Reutol - Tolmetin
 Reverin - Rollitetracycline
 Revibol - Pemoline
 Revonal - Methaqualone
 Rexan - Chlormezanone
 Rexicilina - Corbenicillin disodium
 Rexpas - Aminosalicilic acid
 Rexitene - Guanabenz
 Rexort - Citicoline
 Rezamid - 4-Chloro-3,5-xyleneol
 Rezipas - Aminosalicilic acid
 Rheomacrodex - Dextran 40
 Rheoslander - Dextran 40
 Rheotran - Dextran 40
 Rheumacin - Indomethacin
 Rheumapax - Oxyphenbutazone
 Rheumaphen - Phenylbutazone
 Rheumatol - Bumadizon
 Rheumavincin - Choline salicylate

Rheumon - Etofenamate
 Rheumox - Apazone
 Rhex - Mephensesin
 Rhinalar - Flunisolide
 Rhinathiol - Carbocysteine
 Rhindecon - Phenylpropanolamine HCl
 Rhinetten - Cafaminol
 Rhinex S - Naphazoline
 Rhino-Blache - Chlorhexidine
 Rhinolar - Phenylpropanolamine HCl
 Rhinolitlan - Oxymetazoline HCl
 Rhinon - Naphazoline
 Rhinopront - Tetrahydrozoline HCl
 Rhinoptil - Cafaminol
 Rhodialothan - Halothane
 Rhodine - Aspirin
 Rhonal - Aspirin
 Rhumantin - Penicillamine
 Rhusal - Aspirin
 Rhythmolan - Disopyramide phosphate
 Rhyumapirine S - Hydroxychloroquine sulfate
 Riasin - Rifampin
 Riball - Allopurinol
 Ribomicin - Gentamicin sulfate
 Ribomycine - Ribostamicin
 Ribonosine - Inosine
 Ribostamin - Ribostamicin
 Ribrain - Cinnarizine
 Richina - Tegafur
 Ricridene - Nifurzide
 Ridaura - Auranofin
 Rideazin - Thioridazine
 Riedemil - Calusterone
 Rifa - Rifampin
 Rifadin - Rifampin
 Rifadine - Rifampin
 Rifagen - Rifampin
 Rifam - Rifampin
 Rifamate - Isoniazid
 Rifapiam - Rifampin
 Rifaprodin - Rifampin
 Rifarm - Rifampin
 Rifobac - Rifampin
 Rifonilo - Rifampin
 Riforal - Rifampin
 Rigelon - Thiamphenicol
 Rigenicid - Ethionamide
 Rigenox - Glutethimide
 Rigesol - Sulfamethazine
 Rikaverin - Tranexamic acid
 Rikospray - Bacitracin
 Rilaquil - Chlormezanone
 Rilaten - Rociverine
 Rilental - Carbachol
 Rimactan - Rifampin
 Rimactane - Rifampin
 Rimadyl - Carprofen
 Rimapen - Rifampin
 Rimetin - Metoclopramide HCl
 Rimidol - Naphazoline
 Rimifon - Isoniazid
 Rimso - Dimethyl sulfoxide
 Rincrol - Thiamphenicol
 Rindepres - Nitrazepam
 Rinderon - Betamethasone
 Rinderon - Betamethasone valerate
 Rinderon DP - Betamethasone dipropionate
 Rindex - Methacycline
 Rinesal - Cephalexin
 Rineton - Triamcinolone acetonide
 Rinisol - Phenylephrine HCl
 Rinlaxer - Chlorphenesin carbamate
 Rino-Clenil - Beclomethasone dipropionate
 Rinofluimucil - Acetylcysteine
 Rinofug - Naphazoline
 Rintal - Febantel
 Rinurel - Phenyltoloxamine
 Riol - Tegafur
 Riopan - Magaldrate
 Riopan-Plus - Simethicone
 Rioven - Diosmin
 Ripamisin - Rifampin
 Riphen - Aspirin
 Riphole N - Cyclobutylol
 Riself - Mephenoaxalone
 Risolid - Chlordiazepoxide HCl
 Risordan - Isosorbide dinitrate
 Rispan - Carbuterol
 Risulpir - Sulfadimethoxine
 Ritalin - Methylphenidate HCl
 Ritarsulfa - Sulfadimethoxine
 Ritmocardyl - Amiodarone HCl
 Ritmocar - Quinidine Polygalacturonate
 Ritmodan - Disopyramide phosphate
 Ritmusin - Aprindine HCl
 Ritromin - Erythromycin estolate
 Rival - Diazepam
 Rivalgyl - Acetaminophen
 Rivasin - Reserpine
 Rivivol - Iproniazid
 Rivocillin - Ampicillin
 Rivoclox - Cloxacillin
 Rivodex - Dextromethorphan hydrobromide
 Rivodine - Sulfamethazine
 Rivomycin - Chloramphenicol
 Rivopen V - Penicillin V
 Rivoquine - Chloroquine phosphate
 Rivosil - Hydromethiazide
 Rivostatin - Nystatin
 Rivotril - Clonazepam
 Rivotrocin - Erythromycin
 Rivoxicillin - Amoxicillin
 Rivozine - Promethazine HCl
 Rivozol - Metronidazole
 Rizaben - Tranilast
 Rize - Clotiazepam
 Ro-Ampen - Ampicillin trihydrate
 Robamol - Methocarbamol
 Robamox - Amoxicillin
 Robanul - Glycopyrrolate
 Robaxin - Methocarbamol
 Robaxisal - Methocarbamol
 Robezon - Hydroflomethiazide
 Robidex - Dextromethorphan hydrobromide
 Robigesic - Acetaminophen
 Robimycin - Erythromycin
 Robinul - Glycopyrrolate
 Robiociina - Novobiocin
 Robitussin - Guaifenesin
 Rocaltrol - Calcitriol
 Rocapoyl - 4-Chloro-3,5-xyleneol
 Rocephin - Ceftriaxone sodium
 Ro-Chlorozide - Chlorothiazide
 Ro-Cillin - Phenethicillin potassium
 Rocornal - Trapidil
 Rodavan - Chlorphenoxamine HCl
 Rodelta TBA - Prednisolone tebutate
 Rodenal - Trihexyphenidyl HCl
 Rodina - Aspirin
 Rodipal - Ethopropazine HCl

- Rodogyl - Metronidazole
 Rodostene - Metopramine
 Roeridorm - Ethchlorvynol
 Rofact - Rifampin
 Rogeridina - Cephalixin
 Rogeridina - Cephaloridine
 Rogitine - Phentolamine HCl
 Rogorin - Bromelain
 Ro-Hydrazide - Hydrochlorothiazide
 Rohypnol - Flunitrazepam
 Roidenin - Ibuprofen
 Roimal - Metiazinic acid
 Roim - Cinnarizine
 Roinin - Prenylamine
 Roipnol - Flunitrazepam
 Rolan - Mefenamic acid
 Rolazote - Betamethasone valerate
 Rolexa - Cephaloridine
 Rolicton - Amisometradine
 Roliderm - Fluocinolone acetonide
 Rollson - Prednisolone stearoylglycolate
 Romacid - Indomethacin
 Romanit - Inositol niacinate
 Romecor - Ethamivan
 Romethocarb - Methocarbamol
 Romezin - Sulfamerazine
 Romien - Clemastine fumarate
 Romilar HBR - Dextromethorphan hydrobromide
 Romin - Ketoprofen
 Rominophyllin - Dyphylline
 Romiven - Dobesilate calcium
 Romophenil - Chloramphenicol
 Rondec - Carbinoxamine maleate
 Rondimen - Mefenorex HCl
 Rondomycin - Methacycline
 Ronexine - Methotrimeprazine
 Roniacol - Nicotiny alcohol
 Ronicol - Nicotiny alcohol
 Ronpacon - Metrizoic acid
 Rontyl - Hydroflumethiazide
 Ronyl - Pemoline
 Ro-Orphena - Orphenadrine citrate
 Ropred - Prednisone
 Ropredlone - Prednisolone
 Rorasul - Sulfasalazine
 Rosampline - Ampicillin trihydrate
 Roscal - Dixyrazine
 Rosemid - Furosemide
 Roseramin - Thiamphenicol
 Rosex - Rescinnamine
 Rosidil - Syrosingopine
 Rossobivit - Hydroxocobalamin
 Rossomicina - Erythromycin stearate
 Ro-Sulfiran - Disulfiram
 Rotacaps - Albuterol
 Rotersept - Chlorhexidine
 Ro-Thyronine - Liothyronine
 Ro-Thyroxine - Levothyroxine sodium
 Rotilen - Methacycline
 Roucol - Allopurinol
 Rounox - Acetaminophen
 Rouphylline - Choline theophyllinate
 Rouqualone - Methaqualone
 Rovamycina - Spiramycin
 Rovamycine - Spiramycin
 Rowaprxin - Pipoxolan HCl
 Roxadyl - Roxoxacin
 Roxenol - 4-Chloro-3,5-xyleneol
 Roxinoid - Reserpine
 Royalcor - Dipyrindamole
 Royzolon - Tiaramide
 Rozex - Rescinnamine
 RP-Mycin - Erythromycin
 Rub-All T - Chlorquinaldol
 Rubesol - Cyanocobalamin
 Rubesol-LA - Hydroxocobalamin
 Rubifen - Methylphenidate HCl
 Rubitard B12 - Hydroxocobalamin
 Rubomycin - Daunorubicin
 Rubraluy - Cyanocobalamin
 Rubramin - Cyanocobalamin
 Rubramin-OH - Hydroxocobalamin
 Rudilin - Nylidrin
 Rudotel - Medazepam
 Rufen - Ibuprofen
 Rufol - Sulfamethizole
 Rumicine - Chlorpheniramine maleate
 Runova - Hydroxocobalamin
 Rupis - Citicoline
 Rupton - Brompheniramine maleate
 Ruticina - Metampicillin sodium
 Ru-Tuss - Guaifenesin
 Ru-Tuss - Pheniramine maleate
 Ru-Tuss - Phenylephrine HCl
 Ru-Tuss - Phenylpropanolamine HCl
 Ru-Vert M - Meclizine HCl
 Ruvite - Cyanocobalamin
 Rydrin - Nylidrin
 Ryegonovin - Methylergonovine maleate
 Rynacrom - Cromolyn sodium
 Rythmical - Disopyramide phosphate
 Rythmodan - Disopyramide phosphate
 Rythmodul - Disopyramide phosphate
 Rytmil - Bisacodyl
 Rytmilen - Disopyramide phosphate
 Rytmonorm - Propafenone HCl
 Sabidal S.R. - Choline theophyllinate
 Sachicoron - Mepenzolate bromide
 Sachol - Choline salicylate
 Sadamin - Xanthinol niacinate
 Sadocort - Triamcinolone
 Sadoreum - Indomethacin
 Safitex - Tolmetin
 Sagamicin - Micronomicin
 Sagisal - Spiro lactone
 Saicil - Ampicillin
 Saiclate - Cycloandelate
 Sainosine - Trimetazidine
 St. Joseph - Aspirin
 St. Joseph Aspirin - Acetaminophen
 St. Joseph Cough Syrup - Dextromethorphan hydrobromide
 Sakina - Chlordiazepoxide HCl
 Sal Ac - Salicylic acid
 Salactic - Salicylic acid
 Sal Adult - Aspirin
 Salandol - Medronidazole
 Salarizine - Cinnarizine
 Salazopyrin - Sulfasalazine
 Salazopyrine - Sulfasalazine
 Salbumol - Albuterol
 Salbutol - Albuterol
 Saibuvent - Albuterol
 Saldiuril - Hydrochlorothiazide
 Salex - Inositol niacinate
 Salicol - Choline salicylate
 Salient - Ketoprofen
 Saligel - Salicylic acid
 Salimol - Sulfamethizole

Salinac - Indomethacin
 Sal Infant - Aspirin
 Salinidol - Salicylanilide
 Salinite - Inosine
 Salipran - Benoxylate
 Sali-Presinol - Mefruside
 Salisan - Chlorothiazide
 Salisulf - Sulfasalazine
 Salitex - Cephalexin
 Salpax - Acetizoate sodium
 Saltucin - Butthiazide
 Salural - Bendroflumethiazide
 Saluran - Chlorothiazide
 Salures - Bendroflumethiazide
 Saluretil - Chlorothiazide
 Salurex - Bumetanide
 Saluric - Chlorothiazide
 Salurin - Bumetanide
 Saluron - Hydroflumethiazide
 Salutensin - Reserpine
 Salutrid - Chlorothiazide
 Samedrin - Cephadrine
 Sanamiron - Trichlormethiazide
 Sanapert - Oxyphenisatin acetate
 Sanasthmyl - Beclomethasone dipropionate
 Sanatrichom - Metronidazole
 Sanbetason - Betamethasone
 Sanbiotetra - Tetracycline
 Sanciline Procaina - Penicillin G procaine
 Sancixomal - Amoxicillin
 Sancoba - Cyanocobalamin
 Sancyclan - Cyclocladate
 Sandimmun - Cyclosporin
 Sandimmune - Cyclosporin
 Sandolanid - Acetyldigitoxin
 Sandomigran - Pizotyline HCl
 Sandoscil - Proscillaridin
 Sandril - Reserpine
 Sanestrepto - Dihydrostreptomycin sulfate
 Sangucillin - Pivampicillin
 Sanmigran - Pizotyline HCl
 Sannecit - Inositol niacinate
 Sanodin - Carbenoxolone
 Sanoma - Carisoprodol
 Sanomigran - Pizotyline HCl
 Sanorex - Mazindol
 Sanotus - Zipeprol
 Sanpas - Aminosalicilic acid
 Sansert - Methysergide maleate
 Santadin - Rifampin
 Santhimon - Dipyrindamole
 Santotensin - Guanethidine sulfate
 Sanvacual - Bisacodyl
 Sapratal - Cinnarizine
 Saprostan - Chlorquinaldol
 Saren - Ibuprofen
 Sargefal - Cephalexin
 Sargepirine - Aspirin
 Sargetina - Cephalexin
 Sarogesic - Prednisone
 Saromet - Diazepam
 Saroten - Amitriptyline HCl
 Sarotex - Amitriptyline HCl
 Sartosona - Cephalexin
 S.A.S.-500 - Sulfasalazine
 Sasperas - Cephalexin
 Saspryl - Aspirin
 Satanolon - Diphenidol
 Satibon - Choline salicylate
 Satinasept - 4-Chloro-3,5-xyleneol
 Sato - Sulpiride
 Satolax - Bisacodyl
 Satric - Metronidazole
 Sauran - Citicoline
 Savacort - Dexamethasone phosphate
 Savacort - Prednisolone acetate
 Savacort - Prednisolone phosphate sodium
 Savamine - Promazine HCl
 Sawacillin - Amoxicillin
 Sawagyl - Metronidazole
 Sawamezin - Amoxicillin
 Sawatal - Propranolol HCl
 Sawaxin - Pyritinol
 Sayamol - Promethazine HCl
 Sayra - Cephalexin
 Scabene - Lindane
 Scandicain - Mepivacaine
 Scandisil - Sulfadimethoxine
 Scarlene - Benoxinate hydrochloride
 Scarlene - Chlorhexidine
 Schebitran - Trichlormethiazide
 Schemergen - Phenylbutazone
 Scherisolon - Prednisolone
 Schlerofluron - Fludrocortisone acetate
 Schokolax - Oxyphenisatin acetate
 Schuvel - Amitriptyline HCl
 Scillaridin - Proscillaridin
 Scimanan - Rescinamine
 Scintidin - Pyritinol
 Sclane - Betamethasone
 Sclaenterol - Furazolidone
 Sclerofillina - Choline theophyllinate
 Sclerovasal - Clofibrate
 Scopolate - Methscopolamine bromide
 Scordin - Methscopolamine bromide
 Scot-Tussin - Dextromethorphan hydrobromide
 Scot-Tussin - Guaifenesin
 Scriptopam - Diazepam
 Scrobin - Clofibrate
 S-Dimidine - Sulfamethazine
 S.D.M. - Sulfamethoxyypyridazine
 Seamicin - Rifampin
 Sebar - Secobarbital sodium
 Sebercim - Norfloxacin
 Sebucares - Salicylic acid
 Sebulex - Salicylic acid
 Sebusan - Selenium sulfide
 Secalan - Chlorhexidine
 Secaps - Secobarbital sodium
 Seccidin - Prenylamine
 Seclar - Beclamide
 Seclopyrine - Aspirin
 Secocaps - Secobarbital sodium
 Secogen - Secobarbital sodium
 Seconal - Secobarbital sodium
 Secotinen - Inositol niacinate
 Secradex - Acebutolol
 Secrebil - Piprozolin
 Secretin - Carbachol
 Secrepan - Secretin
 Secretin-Boots - Secretin
 Secretine-Sinbio - Secretin
 Secretin-Kabi - Secretin
 Secretolin - Secretin
 Secrobil - Cyclobutylol
 Secrosteron - Dimethisterone
 Sectral - Acebutolol
 Securit - Lorazepam
 Securopen - Azlocillin
 Sedalone - Methaqualone

- Sedanoct - Methapyrilene HCl
 Sedansol "Iso" - Isoproterenol sulfate
 Sedanyl - Meprobamate
 Sedapam - Diazepam
 Seda-Ropicin - Bendroflumethiazide
 Sedaril - Diazepam
 Sedarkey - Lorazepam
 Sedatival - Lorazepam
 Sedatromin - Cinnarizine
 Sedatuss - Dextromethorphen hydrobromide
 Sedazole - Phenylbutazone
 Sedepam - Medazepam
 Sedestrol - Medrysone
 Sedicepan - Lorazepam
 Sedilene - Tripelennamine
 Sedipam - Diazepam
 Sedistal - Diphenoxylate HCl
 Seditin - Fluphenazine HCl
 Sediston - Promazine HCl
 Sedizine - Trifluoperazine
 Sednafen - Ibuprofen
 Sedodent - Lidocaine
 Sedo-Intensain - Chromonar HCl
 Sedokin - Oxazepam
 Sedomucol - Oxyphencyclimine
 Sedotosse - Isoaminile
 Sedotus - Dextromethorphan hydrobromide
 Sedozalona - Triamcinolone
 Sedral - Cefadroxil
 Sedrena - Trihexyphenidyl HCl
 Sedufen - Fenofibrate
 Seduxen - Diazepam
 Seeglu - Sulpiride
 Sefal - Cinnarizine
 Sefaleksin - Cephalexin
 Seffin - Cephalothin sodium
 Sefrii - Cephradine
 Segontin - Prenylamine
 Segontine - Prenylamine
 Segoramin - Cephalexin
 Segurex - Bumetanide
 Seki - Cloperastine
 Seksfort - Methyltestosterone
 Selacryn - Ticrynafen
 Seldiar - Loperamide HCl
 Selecten - Fluphenazine HCl
 Selectol - Celiprolol
 Selectomycin - Spiramycin
 Selectren - Fluprednisolone
 Selemicina - Fostomycin
 Selene - Meprobamate
 Selenol - Selenium sulfide
 Seles Beta - Atenolol
 Selexid - Pivmecillinam
 Selexidin - Mecillinam
 Selezyme - Haloperidol
 Seloken - Metoprolol tartrate
 Selomen - Metoprolol tartrate
 Sel-O-Rinse - Selenium sulfide
 Selsorin - Selenium sulfide
 Selsun - Selenium sulfide
 Selsun Blue - Selenium sulfide
 Selukos - Selenium sulfide
 Selvigon - Pipazethate
 Semap - Penfluridol
 Sematron - Silymarin
 Sembrina - Buthiazide
 Sembrina - Methyl dopa
 Semicid - Nonoxyol
 Semikon - Methapyrilene HCl
 Semilente - Insulin zinc suspension
 Semopen - Phenethicillin potassium
 Sencephalin - Cephalexin
 Sendoxan - Cyclophosphamide
 Sensaval - Nortriptyline
 Sensidyn - Dexchlorpheniramine maleate
 Sensit - Fendiline HCl
 Sensit F - Fendiline HCl
 Sensival - Amitriptyline HCl
 Sensorcaine - Bupivacaine
 Sentapent - Ampicillin
 Sentil - Clobazam
 Separin - Tolnaftate
 Sepazon - Cloxazolam
 Septalone - Chlorhexidine
 Septicol - Chloramphenicol
 Septiderm - 4-Chloro-3,5-xyleneol
 Septidron - Pipemidic acid
 Septilisin - Cephalexin
 Septivon-Lavril - Triclocarban
 Septosil - Sulfamerazine
 Septra - Sulfamethoxazole
 Septra - Trimethoprim
 Septural - Piroimidic acid
 Sepyron - Cyclandelate
 Seral - Secobarbital sodium
 Ser-Ap-Es - Hydrochlorothiazide
 Ser-Ap-Es - Hydralazine HCl
 Ser-Ap-Es - Reserpine
 Serax - Bisacodyl
 Serax - Oxazepam
 Sereen - Chlordiazepoxide HCl
 Serenace - Haloperidol
 Serenack - Diazepam
 Serenal - Oxazolam
 Serenamin - Diazepam
 Serenase - Haloperidol
 Serenesil - Ethchlorvynol
 Serenium - Medazepam
 Serentil - Mesoridazine besylate
 Serenzin - Diazepam
 Serepax - Oxazepam
 Sereprile - Tiapride
 Seresta - Oxazepam
 Serevirol - Fonazine mesylate
 Serfin - Reserpine
 Seriel - Tofisopam
 Serilone - Prednisolone
 Seripinin - Rescinnamine
 Sermaform - Flurandrenolide
 Sermaka - Flurandrenolide
 Sermion - Nicergoline
 Sernabiotic - Ampicillin
 Sernamicina - Methacycline
 Serolfia - Reserpine
 Seromycin - Cycloserine
 Serophene - Clomiphene dihydrogen citrate
 Serpalan - Reserpine
 Serpanray - Reserpine
 Serpasil - Hydralazine HCl
 Serpasil - Hydrochlorothiazide
 Serpasil - Reserpine
 Serpate - Reserpine
 Serpax - Oxazepam
 Serpax - Reserpine
 Serpedin - Reserpine
 Serpena - Reserpine
 Serpene - Reserpine
 Serpentil - Reserpine
 Serpiloid - Reserpine

Serpine - Reserpine
 Serpipur - Reserpine
 Serpivite - Reserpine
 Serpoid - Reserpine
 Serpone - Reserpine
 Serpresan - Reserpine
 Sertabs - Reserpine
 Sertan - Primidone
 Sertina - Reserpine
 Sertinon - Ethionamide
 Sertofren - Desipramine HCl
 Serunda D - Diphenhydramine HCl
 Servicillin - Ampicillin trihydrate
 Serviclofen - Chloramphenicol
 Serviderm - Chlorquinaldol
 Servidone - Chlorthalidone
 Servigesic - Acetaminophen
 Servilaryn - Xylometazoline HCl
 Servimazepine - Carbamazepine
 Servipramine - Imipramine HCl
 Serviprincol - Allopurinol
 Serviquin - Chloroquine phosphate
 Servisone - Prednisone
 Servisprin - Aspirin
 Servistrep - Streptomycin
 Servitamitone - Crotamiton
 Servitrocin - Erythromycin stearate
 Servizol - Medronidazole
 Servizolidin - Phenylbutazone
 Sesden - Timepidium bromide
 Sesquicillina - Ampicillin
 Setamol - Acetaminophen
 Setavax - Cycloserine
 Setol - Acetaminophen
 Setrol - Oxyphencyclimine
 SevinoI - Fluphenazine HCl
 Sexadien - Dienestrol
 Sexovid - Cyclofenil
 Shatorn - Nylidrin
 Shignol - Diclofenac sodium
 Shigrodin - Phenylbutazone
 Shikiot - Inositol niacinate
 Shikitan - Valerianate bromide
 Shinmetane - Valerianate bromide
 Shiomalin - Moxalactam disodium
 Shuabate - Chlorpropamide
 Shur-Seal - Nonoxonyl
 Sibelium - Flunarizine HCl
 Sicmylon - Nalidixic acid
 Sicofrenol - Sulpiride
 Sidenar - Lorazepam
 Sieromicin - Mepicycline
 Sieropresol - Methylprednisolone
 Sificetina - Chloramphenicol
 Sigacalm - Oxazepam
 Sigamopen - Amoxicillin
 Sigaperidol - Haloperidol
 Sigasalur - Furosemide
 Sigloto - Cyproheptadine
 Sigmacort - Hydrocortisone
 Sigmodyn - Pemoline
 Sigmafom - Mebutamate
 Sigmal - Cinnarizine
 Sigmamycin - Oleandomycin
 Signef - Hydrocortisone
 Signopam - Temazepam
 Sigpred - Prednisolone acetate
 Silain - Simethicone
 Silamarin A - Proscillaridin
 Silarine - Silymarin
 Silbephylline - Dyphylline
 Silbesan - Chloroquine phosphate
 Silepar - Silymarin
 Silgen - Silymarin
 Siljan - Dimethicone
 Silbancol - Silymarin
 Silicogamma - Dimethicone
 Silicote - Dimethicone
 Silies - Dimethicone
 Silimazu - Silymarin
 Sili-Met-San S - Dimethicone
 Silirex - Silymarin
 Silliver - Silymarin
 Silomat - Clobutinol
 Silopentol - Oxeladin
 Silubin - Bufornin HCl
 Simatin - Ethosuximide
 Simeco - Simethicone
 Simpamina - Dextroamphetamine sulfate
 Simplamox - Amoxicillin
 Simplotan - Tinidazole
 Sinacilin - Amoxicillin
 Sinalgin - Benorylate
 Sinalol - Alprenolol HCl
 Sincoden - Butamirate citrate
 Sincodix - Butamirate citrate
 Sincomen - Canrenoate potassium
 Sincomen - Spironolactone
 Sincurarina - Gallamine triethiodide
 Sindiatil - Bufornin HCl
 Sinecod - Butamirate citrate
 Sine-Fluor - Desonide
 Sinemet - Carbidopa
 Sinequan - Doxepin HCl
 Sinerol - Oxymetazoline HCl
 Sinesalin - Bendroflumethiazide
 Sinetens - Prazosin
 Singlet - Chlorpheniramine maleate
 Singlet - Phenylephrine HCl
 Singoserp - Syrosingopine
 Sinketol - Ketoprofen
 Sinkron - Citicoline
 Sinoflurol - Tegafur
 Sinogan - Methotrimeprazine
 Sinomin - Sulfamethoxazole
 Sinselpin - Rescinnamine
 Sintabolin - Nandrolone phenpropionate
 Sintecort - Paramethasone acetate
 Sintedix - Amoxicillin
 Sintespen - Methicillin sodium
 Sintiabil - Cicloxiilic acid
 Sintisone - Prednisolone stearoyl glycolate
 Sintobiilina - Menbutone
 Sintoclar - Citicoline
 Sintodian - Droperidol
 Sintofilina - Dyphylline
 Sintomicetina - Chloramphenicol palmitate
 Sintopenyl - Ampicillin
 Sintoplus - Amoxicillin
 Sintoridyn - Cephaloridine
 Sintrom - Acenocoumarol (Acenocoumarin)
 Sinubid - Phenylpropanolamine HCl
 Sinufed - Guaifenesin
 Sinulin - Phenylpropanolamine HCl
 Sinutab - Xylometazoline HCl
 Siogene - Chlorquinaldol
 Siogeno - Chlorquinaldol
 Siosteran - Chlorquinaldol
 Siparol - Flupentixol
 Sipcar - Noxiptilin

Sipraktin - Cyproheptadine
 Siprodin - Cyproheptadine
 Siptazin - Cinnarizine
 Siqualine - Fluphenazine HCl
 Siqualone - Fluphenazine HCl
 Siquent - Neomycin
 Siquil - Triflupromazine
 Siragon - Chloroquine phosphate
 Sirben - Mebendazole
 Sirdedi - Nimorazole
 Siroshuten - Syrosingopine
 Siroxyl - Carbocysteine
 Sisaal - Dextromethorphan hydrobromide
 Siseptin - Sisomicin
 Sisomin - Sisomicin
 Sissoliine - Sisomicin
 Sistalgin - Pramiverin
 Sitilon - Citiolone
 SK-65 - Propoxyphene HCl
 SK-Ampicillin - Ampicillin
 SK-APAP - Acetaminophen
 SK-Bamate - Meprobamate
 SK-Chlorothiazide - Chlorothiazide
 Skelaxin - Metaxalone
 Skiacol - Cyclopentolate HCl
 Skilar - Econazole nitrate
 Skilax - Picosulfate sodium
 Skincort - Betamethasone benzoate
 Skleromexe - Clofibrate
 Skleronorm - Etiroxate
 Sklero-Tablinen - Clofibrate
 SK-Lygen - Chlordiazepoxide HCl
 Skopyl - Methscopolamine bromide
 SK-Petin - Pentaerythritol tetranitrate
 SK-Pramine - Imipramine HCl
 SK-Reserpine - Reserpine
 SK-Soxazole - Sulfisoxazole
 SK-Tetracycline - Tetracycline
 Sleepinal - Methaqualone
 Siim-Plus - Diethylpropion HCl
 Slyn-LL - Phendimetrazine tartrate
 Smail - Chlordiazepoxide HCl
 Smedolin - Etomidolone
 S-Methizole - Sulfamethizole
 Sno-Paenicol - Chloramphenicol
 Sobelin - Clindamycin HCl
 Sobile - Oxazepam
 Sobrepin - Sobrerol
 Sodasone - Prednisolone phosphate sodium
 Sodelut G - Medroxyprogesterone acetate
 Sodium Cephalotin - Cephalothin sodium
 Sodiuretic - Bendroflumethiazide
 Sofalead - Diphenidol
 Sofarin - Diclufenac sodium
 Sofmin - Methotrimeprazine
 Sofro - Pemoline
 Solacen - Tybamate
 Solacil - Proxazole citrate
 Solantal - Tiaramide
 Solantyl - Phenytoin
 Solaquin - Hydroquinone
 Solaskil - Levamisole HCl
 Solatene - β -Carotene
 Solatran - Ketazolam
 Solaxin - Chlorzoxazone
 Solazine - Trifluoperazine
 Solbrine - Dimenhydrinate
 Solcillin-C - Cloxacillin
 Solco H - Hydroxocobalamin
 Soldactone - Canrenoate potassium
 Soldesam - Dexamethasone phosphate
 Soledoton M - Etilerfine pivalate HCl
 Solesorin - Hydralazine HCl
 Solgol - Nadolol
 Solimidin - Zolimidine
 Solis - Diazepam
 Solium - Chlordiazepoxide HCl
 Solnomin - Diphenidol
 Solone - Dexamethasone phosphate
 Soloxsalen - Methoxsalen
 Solpak - Diclloxacinilium sodium
 Solprin - Aspirin
 Solpurin - Probenecid
 Solpyron - Aspirin
 Solubacter - Triclocarban
 Solucetyl - Aspirin
 Solu-Contenton - Amantidine HCl
 Solucort - Prednisolone phosphate sodium
 Soludactone - Canrenoate potassium
 Soludecadron - Dexamethasone phosphate
 Soludeks - Dextran 40
 Solufyllin - Dyphylline
 Solu-Heks - Hexachlorophene
 Solumedine - Sulfamerazine
 Solu-Medrol - Methylprednisolone
 Solu-Pred - Prednisolone phosphate sodium
 Solurex - Dexamethasone acetate
 Solurex - Dexamethasone phosphate
 Solusal - Aspirin
 Soluspan - Carbaspirin calcium
 Soluston - Chenodiol
 Solustrast - Iopamidol
 Solvay - Fluvoxamine maleate
 Solvex - Bromhexine
 Solvocillin - Rolitetracycline
 Solvopect - Carbocysteine
 Solvo-Strep - Streptomycin
 Solvo-Strept - Dihydrostreptomycin sulfate
 Soma - Carisoprodol
 Somacton - Somatotropin
 Somadriil - Carisoprodol
 Somagest - Amixtrine HCl
 Somalgen - Tainiflumate
 Somalgit - Carisoprodol
 Somaligit Simple - Carisoprodol
 Somanil - Carisoprodol
 Somasedan - Diazepam
 Somatormone - Somatotropin
 Somatotrope - Somatotropin
 Somazina - Citicolone
 Sombrevin - Propanidid
 Sombriil - Iothalmate meglumine
 Sombutol - Pentobarbitol sodium
 Somenox - Diphenhydramine HCl
 Sominex - Diphenhydramine HCl
 Somipront - Dimethyl sulfoxide
 Somitran - Nitrazepam
 Somlan - Flurazepam
 Somnafac - Methaqualone
 Somnased - Nitrazepam
 Somnite - Nitrazepam
 Somnium - Methaqualone
 Somnothane - Halothane
 Somnotol - Pentobarbitol sodium
 Sompan - Flurazepam
 Sonacon - Diazepam
 Sone - Prednisone
 Songar - Triazolam
 Sonilyn - Sulfachlorpyridazine
 Soni-Slo - Isosorbide dinitrate

Sonnolin - Nitrazepam
 Sopamycetin - Chloramphenicol
 Sopenil - Meprobamate
 Soparon - Ferrous fumarate
 Sopental - Pentobarbital sodium
 Sophiamin - Chlordiazepoxide HCl
 Sopor - Methaqualone
 Soprodol - Carisoprodol
 Sorbangil - Isosorbide dinitrate
 Sorbevit B12 - Cyanocobalamin
 Sorbid - Isosorbide dinitrate
 Sorbigen B12 - Cyanocobalamin
 Sorbitrate - Isosorbide dinitrate
 Sorboquel - Thihexinol
 Sorbutuss - Dextromethorphan hydrobromide
 Sorbutuss - Guaifenesin
 Sordenac - Clopenthixol
 Sordinol - Clopenthixol
 Sorelmon - Diclofenac sodium
 Sorenor - Midazolam maleate
 Sorgoa - Tolnaftate
 Soridermal - Metiazinic acid
 Soripal - Metiazinic acid
 Soripan - Metiazinic acid
 Sorquad - Isosorbide dinitrate
 Sorquetan - Tinidazole
 Sosol - Sulfisoxazole
 Sospitan - Pyridinol carbamate
 Sostril - Ranitidine
 Souplens - Chlorhexidine
 Sovelin - Methaqualone
 Sovinal - Methaqualone
 Sowell - Meprobamate
 Soxo - Sulfisoxazole
 Soxomide - Sulfisoxazole
 Soy-Dome - Hexachlorophene
 Spacine - Parapanzolate bromide
 Spadelate - Cyclandelate
 Spaderizine - Cinnarizine
 Spaliln - Dimethicone
 Spametrin M - Methylergonovine maleate
 Spanbolet - Sulfamerazine
 Span-Est - Estradiol valerate
 Span R/D - Phentermine HCl
 Spantac - Mefenamic acid
 Span-Test - Testosterone enanthate
 Sparine - Promazine HCl
 Spascol - Dicyclomine HCl
 Spasmal - Flavoxate HCl
 Spasmenzyme - Methixene HCl
 Spasmione - Cyclandelate
 Spasmipront - Methaqualone
 Spasmoban - Dicyclomine HCl
 Spasmocyclon - Cyclandelate
 Spasmolyn - Mephenesin
 Spasmo-Urosulf - Sulfathiodole
 Spastin - Baclofen
 Spastretten - Papaverine monophosadenine
 Spasuret - Flavoxate HCl
 Spazamin - Oxyphen cyclimine
 Speciatensol - Clorexolone
 Specifin - Nalidixic acid
 Spectacillin - Epicillin
 Spectamedryn - Medrysone
 Spectanefran - Idoxuridine
 Spectazole - Echonazole nitrate
 Spectra-Sorb - Sulisobenzone
 Spectrobid - Bacampicillin
 Spendepiol - Estradiol cypionate
 Spersacarbachol - Carbachol
 Spersadex - Dexamethasone phosphate
 Spersanicol - Chloramphenicol
 Spiramin - Tranexamic acid
 Spirexis - Spironolactone
 Spiretic - Spironolactone
 Spiridon - Spironolactone
 Spirix - Spironolactone
 Spiroctan - Canrenoate potassium
 Spiroctan-M - Canrenoate potassium
 Spirolong - Spironolactone
 Spironazide - Hydrochlorothiazide
 Spironazide - Spironolactone
 Spiropal - Spironolactone
 Spiropent - Clenbuterol
 Spiroperidol - Spiperone
 Spiperone
 Spiropitan - Spiperone
 Spiro-Tabliten - Spironolactone
 Spirotone - Spironolactone
 Spondryil - Phenylbutazone
 Sporicum - Cephaloridine
 Spori-derm - Tolnaftate
 Sporilene - Tolnaftate
 Sporostacin - Chlordantoin
 Sprx 105 - Phendimetrazine tartrate
 ST 52 - Diethylstilbestrol diphosphate
 Stabilene - Ethyl biscoumacetate
 Stabinol - Chlorpropamide
 Stablon - Tianeptine
 Stadalax - Bisacodyl
 Stada-Reisedrages - Dimenhydrinate
 Stadol - Butorphanol
 Staficycn - Methicillin sodium
 Stafilon - Methacycline
 Stagural - Norfenefrine
 Stakane - Antrafenine
 Stalleril - Thioridazine
 Stambutol - Ethambutol HCl
 Stamine - Pyrilamine
 Stanaprol - Stanolone
 Standacillin - Ampicillin trihydrate
 Stanilo - Spectinomycin
 Sta-Pas - Aminosalicylic acid
 Stapenor - Oxacillin sodium
 Staphicillin - Methicillin sodium
 Staphicillin V - Oxacillin sodium
 Staphicillin - Dicloxacillin sodium
 Staphybiotic - Cloxacillin
 Staphylex - Floxacillin
 Staporos - Calcitonin
 Starazine - Promazine HCl
 Starisil - Sulfemethizole
 Startonyl - Citicoline
 Staticin - Erythromycin
 Statobex - Phendimetrazine tartrate
 Statocin - Cargutocin
 Statomin - Pyrilamine
 Stazepine - Carbamazepine
 Stecsolin - Oxytetracycline
 Stelazine - Trifluoperazine
 Stellamicina - Erythromycin estolate
 Stellarid - Proscillaridin
 Stemetil - Prochlorperazine
 Stemex - Paramethasone acetate
 Stenocor - Dipyridamole
 Stensolo - Meprobamate
 Sterane - Prednisolone
 Sterane - Prednisolone acetate
 Sterapred - Prednisone
 Sterax - Desonide
 Sterecyt - Prednimustine

Stereocidin - Bekanamycin sulfate
 Stereocyt - Prednimustine
 Stereomycin - Nystatin
 Sterilette - Benzethonium chloride
 Sterilone - Chlorhexidine
 Sterisil - Hexetidine
 Sterisol - Hexetidine
 Stermin - Prednisolone
 Sterobolin - Nandrolone decanoate
 Sterocort - Hydrocortisone
 Sterocort - Triamcinolone
 Sterocutan - Triamcinolone acetonide
 Steroderm - Desonide
 Sterolone - Fluocinolone acetonide
 Sterolone - Prednisolone
 Steronyl - Methyltestosterone
 Sterosan - Chlorquinaldol
 Steroxin - Chlorquinaldol
 Ster-Zac - Hexachlorophene
 S.T. Forte - Pheniramine maleate
 S-T Forte - Phenylephrine HCl
 Stibol - Diethylstilbestrol diphosphate
 Stie Vaa - Tretinoin
 Stigmonene - Benzpyrrolone bromide
 Stil-2 - Dextroamphetamine sulfate
 Stilbetin - Diethylstilbestrol
 Stilbetin - Diethylstilbestrol diphosphate
 Stilbiocina - Novobiocin
 Stilla - Tetrahydrozoline HCl
 Stilphostrol - Diethylstilbestrol diphosphate
 Stimata - Desmopressin
 Stimolcardio - Dipyridamole
 Stimolomens - Oxitriptan
 Stimovul - Epimastin
 Stimubral - Piracetam
 Stimucortex - Piracetam
 Stimul - Pemoline
 Stimulexin - Doxapram HCl
 Stodex - Phendimetrazine tartrate
 Stomacain - Oxethazine
 Stomakon - Cimetidine
 Stoxil - Idoxuridine
 Strabolene - Nandrolone phenpropionate
 Straderm - Fluocinolone acetonide
 Stranova - Betamethasone valerate
 Stratene - Cetiedil
 Streptaguaine - Streptomycin
 Streptase - Streptokinase
 Streptobretin - Streptomycin
 Streptomycine - Streptomycin
 Streptoral - Dihydrostreptomycin sulfate
 Streptosol - Streptomycin
 Stresam - Etifoxine
 Stresolid - Diazepam
 Stresson - Bunitrolol
 Stress-Pam - Diazepam
 Striadyne - Adenosine triphosphate
 Striatin - Emylcamate
 Strocain - Oxethazine
 Stromba - Stanozolol
 Strombaject - Stanozolol
 Strycin - Streptomycin
 Stuartnatal - Folic acid
 Study - Valethamate bromide
 Stugeron - Cinnarizine
 Stunarone - Cinnarizine
 Suavedol - Glaziovine
 Suavitil - Benactyzine hydrochloride
 Sublimaze - Fentanyl
 Sucaryl calcium - Cyclamate calcium
 Succitimal - Phensuximide
 Sucira N - Cephalothin sodium
 Sudac - Sulindac
 Sudil - Suloctidil
 Sufenta - Sufentanil
 Sufortanon - Penicillamine
 Suiclisin - Fenipentol
 Suismycetin - Chloramphenicol
 Sulamin - Sulfamethoxyypyridazine
 Sulamyd - Sulfacetamide
 Sulc - Suloctidil
 Sulcolon - Sulfasalazine
 Sulcrate - Sucralfate
 Sulene - Sulindac
 Sulfabid - Sulfaphenazole
 Sulfabon - Sulfadimethoxine
 Sulfabon - Sulfamethoxyypyridazine
 Sulfabutin - Busulfan
 Sulfacidin - Sulfacetamide
 Sulfaclozazina - Sulfachlorpyridazine
 Sulfactin - Dimercaprol
 Sulfadazina - Sulfamethoxyypyridazine
 Sulfadepot - Sulfamethoxyypyridazine
 Sulfadets - Sulfadiazine
 Sulfadin - Sulfamethoxyypyridazine
 Sulfadomus - Sulfadimethoxine
 Sulfaduran - Sulfadimethoxine
 Sulfagan - Sulfisoxazole
 Sulfa Gram - Sulfamethizole
 Sulfaintensa - Sulfamethoxyypyridazine
 Sulfalar - Sulfisoxazole
 Sulfalex - Sulfamethoxyypyridazine
 Sulfalon - Sulfadimethoxine
 Sulfamethin - Sulfisomidine
 Sulfametin - Sulfamethizole
 Sulfamizina - Sulfamethoxyypyridazine
 Sulfamyd - Sulfamethoxyypyridazine
 Sulfamylon - Mafenide acetate
 Sulfapadil - Sulfaphenazole
 Sulfa-Perlongit - Sulfathiodole
 Sulfapolar - Sulfisoxazole
 Sulfapyrazin - Sulfamethoxyypyridazine
 Sulfasol - Sulfamethizole
 Sulfastop - Sulfadimethoxine
 Sulfasuxidine - Succinylsulfathiazole
 Sulfatalyl - Phthalylsulfathiazole
 Sulfatar - Sulfamethoxyypyridazine
 Sulfathalidine - Phthalylsulfathiazole
 Sulfathox - Sulfadimethoxine
 Sulfatrim - Sulfamethoxazole
 Sulfazin - Sulfisoxazole
 Sulfazol - Sulfaphenazole
 Sulfazole - Sulfisoxazole
 Sulfenal - Sulfaphenazole
 Sulfizole - Sulfisoxazole
 Sulfocidan - Sulfamethoxyypyridazine
 Sulfolex - Sulfadiazine
 Sulfona Oral - Dapsona
 Sulfoflan - Sulfadimethoxine
 Sulforal - Sulfaphenazole
 Sulforetent - Sulfamethoxyypyridazine
 Sulfo-Rit - Sulfamethoxyypyridazine
 Sulfostat - Sulfaphenazole
 Sulfoxol - Sulfisoxazole
 Sulf-Reten - Sulfadimethoxine
 Sulfuno - Sulfamoxole
 Sulfurine - Sulfamethizole
 Suigemicin - Gentamicin sulfate
 Sulic - Sulindac
 Sulinol - Sulindac

Sulla - Sulfamer
 Sulmethon - Sulfadimethoxine
 Sulmetoxyn - Sulfadimethoxine
 Sulmycin - Gentamicin sulfate
 Sulocton - Suloctidil
 Sulodene - Suloctidil
 Suloktil - Suloctidil
 Sulphena - Sulfaphenazole
 Sulphix - Sulfamethazine
 Sulpiril - Sulpiride
 Sulpisidan - Sulpiride
 Sulsoxin - Sulfisoxazole
 Sul-Spansion - Sulfathiazole
 Sultanol - Albuterol
 Sultirene - Sulfamethoxypyridazine
 Sultrin - Sulfacetamide
 Sultroponium-B - Sultroponium
 Sulxin - Sulfadimethoxine
 Sumetamin - Sulfadimethoxine
 Sumifon - Isoniazid
 Sumipanto Oral - Ampicillin trihydrate
 Summer's Eve - Povidone-iodine
 Summicort - Methylprednisolone
 Sumox - Amoxicillin
 Sumycin - Tetracycline
 Sumycin - Tetracycline phosphate complex
 Sunbrella - Aminobenzoic acid
 Suncholin - Citicoline
 Sunfural - Tegafur
 Sungard - Sulisobenzene
 Supacal - Trepibutone
 Supase - Aspirin
 Superanbolon - Nandrolone phenpropionate
 Superbolin - Nandrolone phenpropionate
 Superinone - Tyloxapol
 Supermesin - Meclizine HCl
 Supero - Cefuroxime
 Superpeni - Amoxicillin
 Suplexedil - Fenoxedil
 Supopred - Prednisone
 Supotran - Chlormezanone
 Supposal - Meperidine HCl
 Supracort - Fluocinonide
 Suprametil - Methylprednisolone
 Supramol - Acetaminophen
 Suprantil - Propantheline bromide
 Supres - Hydralazine HCl
 Suprilent - Isoxsuprine HCl
 Suprimal - Meclizine HCl
 Suprium - Sulpiride
 Suracton - Spironolactone
 Sural - Ethambutol HCl
 Surem - Butalamine HCl
 Surem - Nitrazepam
 Surestryl - Moxestrol
 Surfaccaine - Cyclomethycaine
 Surfak - Docusate calcium
 Surgam - Tiaprofenic acid
 Surgamic - Tiaprofenic acid
 Surgestone - Promegestone
 Surgevit - Cyanocobalamin
 Surgex - Nialamide
 Surheme - Butalamine HCl
 Surimol - Metronidazole
 Surital - Thiamylal
 Surplix - Imipramine HCl
 Sursumid - Sulpiride
 Survector - Aminoptine HCl
 Suspendol - Allopurinol
 Sustac - Carbenoxolone
 Sustaverine - Papaverine monophosadenine
 Sustwelve - Hydroxocobalamin
 Sutedil - Suloctidil
 Sutilan - Tiopronin
 Suvren - Captodiamine
 Suxinutin - Ethosuximide
 Sween-Soft - 4-Chloro-3,5-xyleneol
 Sykiandal - Cyclandelate
 Symetra - Phendimetrazine tartrate
 Symmetrel - Amantidine HCl
 Sympal - Moxisylyte
 Sympatosan - Norfenefrine
 Symptom 1 - Dextrometorphan hydrobromide
 Symptom 3 - Brompheniramine maleate
 Synacort - Hydrocortisone
 Synadrin - Prenylamine
 Synalar - Fluocinonone acetonide
 Synandone - Fluocinonone acetonide
 Synandrets - Methyltestosterone
 Synapasa - Estriol succinate
 Synapause - Estriol succinate
 Synasal - Phenylephrine HCl
 Synatan - Tanphetamin
 Syncel - Cephalixin
 Syncillin - Azidocillin
 Syncillin - Phenethicillin potassium
 Synclopred - Cloprednol
 Synclotin - Cephalothin sodium
 Syncumar - Acenocoumarol (Acenocoumarin)
 Syndopa - Levodopa
 Synemol - Flucloronide
 Synemol - Fluocinonone acetonide
 Synestrol - Dienestrol
 Syngacillin - Cyclacillin
 Synistamine - Chlorpheniramine maleate
 Synkayvite - Menadiol sodium diphosphate
 Synmiol - Idoxuridine
 Syntaris - Flunisolide
 Syntaroid - Levothyroxine sodium
 Syntarpen - Cloxacillin
 Syntestan - Cloprednol
 Syntetrin - Rolitetracycline
 Syntex - Hexestrol
 Synthecilline - Phenethicillin potassium
 Synthepep - Phenethicillin potassium
 Synthex P - Phytonadione
 Synthomyccetin - Chloramphenicol
 Synthovo - Hexestrol
 Synthrome - Acenocoumarol (Acenocoumarin)
 Synticol - Thiamphenicol
 Syntocinon - Oxytocin
 Syntomen - Ethambutol HCl
 Synulox - Clavulanic acid
 Synzedrin - Isoxsuprine HCl
 Syracort - Fluocortolone
 Syrap - Choline salicylate
 Syraprim - Trimethoprim
 Syringia - Syrosingopine
 Systral - Chlorphenoxamine HCl
 Sytobex-X - Hydroxocobalamin
 Tabalgin - Acetaminophen
 Tabrien - Feprazone
 Tacaryl - Methdilazine HCl
 TACE - Chlorotriamisene
 Tacef - Cefmenoxime
 TACE FN - Chlorotriamisene
 Tachiciclina - Methacycline
 Tachionin - Trichlormethiazide
 Tachipirina - Acetaminophen

Tacholiquin - Tyloxapol
 Tachyrol - Dihydroxytachysterol
 Tachystin - Dihydroxytachysterol
 Tacitin - Benzoctamine HCl
 Tacitine - Benzoctamine HCl
 Tacodilydrin - Nylihydrin
 Tacosal - Phenytoin
 Tacryl - Methdilazine HCl
 Tagamet - Cimetidine
 Taicelexin - Cephalexin
 Taimoxin-F - Erythromycin
 Taizer - Meclizine HCl
 Takamarumin - Allopurinol
 Takas - Ceruletide
 Takazide - Tolbutamide
 Takesulin - Cefsulodin
 Takimetol - Metronidazole
 Takimetrin M - Methylethylergonovine maleate
 Takosashin S - Indomethacin
 Takus - Ceruletide
 Taladren - Ethacrynic acid
 Talampicillina - Talampicillin
 Talasa - Zipeprol
 Talat - Talampicillin
 Talidine - Phthalylsulfathiazole
 Talinsul - Cephalexin
 Talinsul - Cephaloridine
 Talisulfazol - Phthalylsulfathiazole
 Talmen - Talampicillin
 Talofen - Promazine HCl
 Talpen - Talampicillin
 Talusin - Proscillaridin
 Talwin - Naloxone
 Tambocor - Flecainide
 Tambutol - Ethambutol HCl
 Tam-Cilin - Pivampicillin
 Tametin - Cimetidine
 Tamid - Suloctidil
 Tamofen - Tamoxifen
 Tampovagan - Neomycin
 Tanafol - Chloromezanone
 Tandearil - Oxyphenbutazone
 Tanderil - Oxyphenbutazone
 Tannex - Indomethacin
 Tantal - Oxyphenbutazone
 TAO - Oleandomycin
 Taocin-O - Oleandomycin
 Tapar - Acetaminophen
 Tapiola - Cephaloridine
 Taractan - Chlorprothixene
 Tardamide - Sulfamoxole
 Tardocillin - Penicillin G benzathine
 Tardopenil - Penicillin G benzathine
 Tarocetyl - Chlorpromazine HCl
 Tarodyl - Glycopyrrrolate
 Tarozole - Metronidazole
 Taskil - Malathion
 Tasmaderm - Motretinide
 Tasmolin - Biperiden
 Tasprin - Aspirin
 Tatimil - Diphenidol
 Tauliz - Piretanide
 Taural - Ranitidine
 Tavegil - Clemastine fumarate
 Tavegyl - Clemastine fumarate
 Tavist - Clemastine fumarate
 Tavor - Lorazepam
 Tavor - Tofisopam
 TB-Phiogin - Isoniazid
 TCM - Meprobamate
 Tear-Efrin - Phenylephrine HCl
 Tebacin acid - Aminosalicilic acid
 Tebartin - Inosine
 Teberus - Ethionamide
 Tebesium - Isoniazid
 Tebilon - Isoniazid
 Tebloc - Loperamide HCl
 Tebrazid - Pyrazinamide
 Techlon - Pentoxifylline
 Teclinazets - Tetracycline
 T-E Cypionate - Estradiol cypionate
 Tedarol - Triamcinolone
 Tedarol - Triamcinolone acetonide
 Tedarol - Triamcinolone diacetate
 Teejel - Choline salicylate
 Tefsiel - Tegafur
 Tefunote - Fluocinolone acetonide
 Tega-Cort - Hydrocortisone
 Tega-Flex - Orphenadrine citrate
 Tegisec - Fenproporex
 Tegopen - Cloxacillin
 Tegretal - Carbamazepine
 Tegretol - Carbamazepine
 Tegunor - Choline salicylate
 Tejuntivo - Oxaceprol
 Telazin - Trifluoperazine
 Teldrin - Chlorpheniramine maleate
 Telemin - Bisacodyl
 Telepaque - Iopanoic acid
 Telesmin - Carbamazepine
 Telesol - Oxitriptan
 Teletrast - Iopanoic acid
 Telgin G - Clemastine fumarate
 Telmid - Dithiazanine iodide
 Temagin - Aspirin
 Tamaril - Trimiprazine
 Tementil - Prochlorperazine
 Temesta - Lorazepam
 Temet - Demeclocycline HCl
 Temetex - Diflucortolone valerate
 Temporal - Acetaminophen
 Tempodiazine - Sulfadimethoxine
 Temporal - Carbamazepine
 Tempra - Acetaminophen
 Tendalin - Mepenzolate bromide
 Tendor - Debrisoquin
 Teneral - Oxyphenbutazone
 Teniarene - Niclosamide
 Tenisid - Niclosamide
 Tenlap - Acetaminophen
 Tenoretic - Atenolol
 Tenormin - Atenolol
 Tensibar - Bietaserpine
 Tensilan - Propantheline bromide
 Tensilon - Edrophonium chloride
 Tensimic - Benthiazide
 Tensinase D - Etifelmine
 Tensinova - Clonidine HCl
 Tensionorm - Bendroflumethiazide
 Tensium - Diazepam
 Tensodilen - Dichlorphenamide
 Tensodiural - Cyclothiazide
 Tensopam - Diazepam
 Tenuate - Diethylpropion HCl
 Tenuate-Dospan - Diethylpropion HCl
 Tenutan - Doxycycline
 Tenzide - Hydrochlorothiazide
 Teocolina - Choline theophyllinate
 Teodelin - Fenspiride
 Teofilcolina - Choline theophyllinate

- Teonicol - Xanthinol niacinate
 Teonicon - Pimefylline nicotinate
 Teovent - Choline theophyllinate
 Tepanil - Diethylpropion HCl
 Tepavil - Sulpiride
 Teperin - Amitriptyline HCl
 Tepiita - Oxethazine
 Teramine - Phentermine HCl
 Terbasmin - Terbutaline
 Terckian - Cyamemazine
 Terekol - Ubidecarenone
 Terflurazine - Trifluoperazine
 Terfluzine - Trifluoperazine
 Teriam - Triamterene
 Teril - Carbamazepine
 Terion - Fominoben HCl
 Terolul - Dydrogesterone
 Teronac - Mazindol
 Terperan - Metoclopramide HCl
 Terramycin - Oxytetracycline
 Tertensil - Indapamide
 Tertroxin - Liothyronine
 Terulcon - Carbenoxolone
 Tesamurin - Syrosingopine
 Teslac - Testolactone
 Tesone - Testosterone enanthate
 Tespamin - Thiotepa
 Tessalon - Benzonatate
 Testadina - Cephaloridine
 Testamin - Dextromethorphan hydrobromide
 Testanate - Testosterone enanthate
 Testate - Testosterone enanthate
 Testaval - Estradiol valerate
 Testaxina - Cephalixin
 Testinon - Testosterone enanthate
 Testipron - Methyltestosterone
 Testisan Depo - Testosterone enanthate
 Testo-Enant - Testosterone enanthate
 Testomed P.A. - Testosterone 17 β -cypionate
 Testomest - Methyltestosterone
 Testone - Testosterone enanthate
 Testonic B - Methyltestosterone
 Testora - Methyltestosterone
 Testoral - Fluoxymesterone
 Testorit-Dep - Testosterone 17 β -cypionate
 Testostelets - Methyltestosterone
 Testostroval PA - Testosterone enanthate
 Testoviron - Testosterone enanthate
 Testovis - Methyltestosterone
 Testred - Methyltestosterone
 Testrin - Testosterone enanthate
 Testrone - Testosterone enanthate
 Tetidis - Disulfiram
 Tetnor - Phenylbutazone
 Tetrabios - Methacycline
 Tetra-Co - Tetracycline
 Tetracyn - Tetracycline
 Tetradek - Demeclocycline HCl
 Tetrafermed - Rolitetracycline
 Tetrafen - Oxytetracycline
 Tetraksilin - Tetracycline phosphate complex
 Tetraldina - Rolitetracycline
 Tetralet - Tetracycline phosphate complex
 Tetramide - Mianserin
 Tetramig - Tetracycline
 Tetramin - Tetracycline phosphate complex
 Tetranovo - Methacycline
 Tetra-Proter - Tetracycline
 Tetrasoline - Hydralazine HCl
 Tetrasolvina - Mepicycline
 Tetra-Tabliten - Oxytetracycline
 Tetraverin - Rolitetracycline
 Tetrzetas Retard - Tetracycline phosphate complex
 Tetrex - Tetracycline phosphate complex
 Tevacaine - Mepivacaine
 Tevcodyne - Phenylbutazone
 Tevocin - Chloramphenicol
 Texacort - Hydrocortisone
 Texcillin - Ampicillin trihydrate
 Texmeten - Diflucortolone valerate
 Thalamonal - Droperidol
 Thalamonal - Fentanyl
 Thalazole - Phthalylsulfathiazole
 Thalitone - Chlorthalidone
 Tham - Tromethamine
 Thamacetat - Tromethamine
 Thamesol - Tromethamine
 Thefylan - Dyphylline
 Thenalton - Dexpanthenol
 Thenylene - Methapyrilene HCl
 Theoral - Etilerfrine pivalate HCl
 Theourin - Dyphylline
 Theozine - Hydroxyzine HCl
 Thephorin - Phenindamine tartrate
 Therabloat - Poloxalkol
 Theradia - Sulfadiazine
 Theradiazine - Sulfadiazine
 Theralax - Bisacodyl
 Theralene - Trimeprazine
 Therapen I.M. - Penicillin G procaine
 Theratuss - Pipazethate
 Therazone - Phenylbutazone
 Theruhistin - Isothipendyl HCl
 Thevier - Levothyroxine sodium
 THF-FU - Tegafur
 Thiacyl - Succinylsulfathiazole
 Thiadril - Hydrochlorothiazide
 Thiametin - Thiamphenicol
 Thiamcol - Thiamphenicol
 Thiamyson - Thiamphenicol
 Thiancol - Thiamphenicol
 Thiantoin - Phethenylate sodium
 Thiapax - Clopenthixol
 Thiaretic - Hydrochlorothiazide
 Thiasin - Sulfisoxazole
 Thicataren - Diclofenac sodium
 Thilocanfol - Chloramphenicol
 Thilocombin - Nicotiny alcohol
 Thiobiline - Timonacic sodium
 Thiodantol - Isothipendyl HCl
 Thioderon - Mepitiostane
 Thiodrol - Epitiostanol
 Thiofact - Thiamphenicol
 Thiogenel - Methitural
 Thioguanin Wellcome - Thioguanine
 Thioguanine Tabloid - Thioguanine
 Thioguanine Wellcome - Thioguanine
 Thioinosie - Mercaptopurine
 Thiola - Tiopronin
 Thiomerin - Mercaptomerin sodium
 Thiomid - Ethionamide
 Thioncycline - Citiolone
 Thionicol - Thiamphenicol
 Thioniden - Ethionamide
 Thio-Novurit - Mercaptomerin sodium
 Thioperkin - Methixene HCl
 Thiophenicol - Thiamphenicol
 Thioril - Thioridazine
 Thiosol - Tiopronin
 Thiosulfil - Sulfamethizole

- Thiotol - Thiamphenicol
 Thio-Tepa - Thiotepa
 Thioxidrene - Citiolone
 Thiuretic - Hydrochlorothiazide
 Thixokon - Acetrizoate sodium
 Thombran - Trazodone HCl
 Thorazine - Chlorpromazine HCl
 Thrombareduct - Heparin
 Thromboclaste - Fibrinolysin
 Thrombolysin - Fibrinolysin
 Thrombophob - Heparin
 Thrombo-Vetren - Heparin
 Thybon - Liothyronine
 Thylogen - Pyrilamine
 Thylokay - Menadiol sodium phosphate
 Thymergix - Pyrovalerone HCl
 Thyradin-S - Levothyroxine sodium
 Thyrex - Levothyroxine sodium
 Thyronamin - Liothyronine
 Thyronine - Liothyronine
 Tiaclar - Tiadenol
 Tiaden - Tiadenol
 Tiapridal - Tiapride
 Tiapridex - Tiapride
 Tiazolidin - Timonacic sodium
 Tiberall - Ornidazole
 Tibericilina - Methacycline
 Tibinide - Isoniazid
 Tibizina - Isoniazid
 Ticalpenin - Ticarcillin disodium
 Ticar - Ticarcillin disodium
 Ticarpenin - Ticarcillin disodium
 Ticillin - Ticarcillin disodium
 Ticinil - Phenylbutazone
 Ticlid - Ticlopidine HCl
 Ticlobran - Clofibrate
 Ticlodone - Ticlopidine HCl
 Ticomicina - Methacycline
 Ticon - Trimethobenzamide HCl
 Tiempe - Trimethoprim
 Tiffen - Reproterol
 Tifomycine - Chloramphenicol
 Tigan - Trimethobenzamide HCl
 Tigason - Etretinate
 Tigonal - Chlophedianol
 Tiklid - Ticlopidine HCl
 Tiklidan - Ticlopidine HCl
 Tiazem - Diltiazem HCl
 Tildiem - Diltiazem HCl
 Tilitrate - Tilidine HCl
 Tilmapor - Cefsulodin
 Tilvis - Oxolinic acid
 Timacor - Timolol maleate
 Timadin - Fluorouracil
 Timaxel - Metopramine
 Timentin - Ticarcillin disodium
 Timolide - Hydrochlorothiazide
 Timonil - Carbamazepine
 Timoptic - Timolol maleate
 Timoptol - Timolol maleate
 Timostenil - Caroxazone
 Timoval - Oxyfedrine
 Timovan - Prothipendyl HCl
 Timserin - Timolol maleate
 Tinactin - Tolnaftate
 Tinaderm - Tolnaftate
 Tinarhinin - Tetrahydrozoline HCl
 Tinaroc - Phenylpropanolamine HCl
 Tinavet - Tolnaftate
 Tindal - Acetophenazine dimaleate
 Tindurin - Pyrimethamine
 Tinidil - Isoorbide dinitrate
 Tinigyn - Tinidazole
 Tinol - Dipyridamole
 Tinsset - Oxatamide
 Tintorane - Warfarin sodium
 Tinver - Salicylic acid
 T-Ionate P.A. - Testosterone 17 β -cypionate
 Tiozon - Thiamphenicol
 Tiqualone - Methaqualone
 Tiromel - Liothyronine
 Tisamid - Pyrazinamide
 Tisin - Isoniazid
 Tisiobutol - Ethambutol HCl
 Tisomyacin - Cycloserine
 Tisquibron - Metampicillin sodium
 Ti-Tre - Liothyronine
 TL-Azole - Sulfisoxazole
 Tocodrin - Nylidrin
 Todalgil - Phenylbutazone
 Today - Cephapirin sodium
 Tofalin - Tofenacin HCl
 Tofranil - Imipramine HCl
 Togestal - Pentapiperide methosulfate
 Togiren - Erythromycin estolate
 Togram - Ampicillin
 Toilax - Bisacodyl
 Toilex - Bisacodyl
 Tokiocillin - Ampicillin
 Tokiolexin - Cephalexin
 Tokugen - Phenylbutazone
 Tolanase - Tolazamide
 Tolapin - Pyrvinium pamoate
 Tolavad - Tolazoline
 Tolbusal - Tolbutamide
 Tolbutol - Tolbutamide
 Tolcasone - Trichlormethiazide
 Tolectin - Tolmetin
 Toleran - Ferrous fumarate
 Toleran - Polythiazide
 Tolesmin - Cinnarizine
 Tolestan - Cloxazolam
 Tolferain - Ferrous fumarate
 Tolifer - Ferrous fumarate
 Toliman - Cinnarizine
 Tolinase - Tolazamide
 Tollercin - Demeclocycline HCl
 Tolmicen - Tolciclate
 Tolnate - Prothipendyl HCl
 Tolodina - Amoxicillin
 Tolosate - Mephesisin
 Tolseram - Mephesisin carbamate
 Tolserol - Mephesisin
 Tolubetin - Tolbutamide
 Tolulox - Mephesisin
 Tolumid - Tolbutamide
 Toluvan - Tolbutamide
 Tolvin - Mianserin
 Tolycar - Cefotaxime sodium
 Tolyspaz - Mephesisin
 Tonamil - Thonzylamine HCl
 Toness - Proxazole citrate
 Tonestat - Dexpanthenol
 Tonilen - Demecarium bromide
 Tonobrein - Pyritinol
 Tonocard - Tocainide
 Tonocholin - Carbachol
 Tonofit - Sulpiride
 Tonofal - Tolnaftate
 Tonolift - Norfenefrine

- Tonomentis - Pyritinol
 Tonum - Propranolol HCl
 Tonus-Forte - Etilefrine pivalate HCl
 Topicaïn - Oxethazine
 Topicon - Halopredone acetate
 Topicort - Desoximetasone
 Topicorte - Desoximetasone
 Topicorten - Flumethasone
 Topifluor - Flucinolone acetonide
 Topifram - Desoximetasone
 Topilar - Flucloronide
 Topionic - Povidone-iodine
 Topisolon - Desoximetasone
 Topisporin - Neomycin
 Topisporin - Polymyxin
 Topitracin - Bacitracin
 Toplexil - Oxomemazine
 Topocaine - Cyclomethycaine
 Topolyn - Dexamethasone-21-linoleate
 Topral - Sultopride HCl
 Topsym - Fluocinonide
 Topsyne - Fluocinonide
 Topsyne - Fluocinonide
 Torecan - Thiethylperazine
 Toremonil - Hydroxychloroquine sulfate
 Torental - Pentoxifylline
 Toresten - Thiethylperazine
 Toricelolin - Cephalothin sodium
 Toriol - Ranitidine
 Torizin - Cinnarizine
 Torlasporin - Cephalixin
 Toruan - Doxepin HCl
 Toryn - Caramiphen edisylate
 Toscana - Rescimetol
 Tosmilen - Demecarium bromide
 Tossizid - Dimethoxanate
 Totacef - Cefazolin sodium
 Totacillin - Ampicillin
 Totacillin - Ampicillin trihydrate
 Totaclox - Ampicillin
 Totaclox - Cloxacillin
 Totalciclina - Ampicillin
 Totalmicina - Cephaloridine
 Totapen - Ampicillin
 Totifen - Ketotifen
 Totocillin - Dicloxacillin sodium
 Tovene - Diosmin
 Toxiferin - Alcuronium chloride
 Toyomelin - Chlorpropamide
 Trachitol - Chlorhexidine
 Tracilon - Triamcinolone diacetate
 Tracium - Atracurium besylate
 Tractor - Pipemidic acid
 Tradon - Pemoline
 Trafacilina - Ampicillin trihydrate
 Trafarbiar - Ampicillin trihydrate
 Trafarbiot - Ampicillin
 Trakipearl - Chlordiazepoxide HCl
 Tral - Hexocyclium methyl sulfate
 Tralanta - Mepenzolate bromide
 Trali - Picosulfate sodium
 Traline - Hexocyclium methyl sulfate
 Tramadol - Tramadol HCl
 Tramal - Tramadol HCl
 Tramensan - Trazodone HCl
 Trametol - Trichlormethiazide
 Tramisol - Levamisole HCl
 Tramycin - Triamcinolone acetonide
 Trancin - Fluphenazine HCl
 Trancocard - Dipyrindamole
 Trancolon - Mepenzolate bromide
 Trancopal - Chlormezanone
 Trancote - Chlormezanone
 Trancrol - Chlorzoxazone
 Trandate - Labetalol HCl
 Tranex - Clorazepate dipotassium
 Tranex - Tranexamic acid
 Tranexan - Tranexamic acid
 Trangorex - Amidodarone HCl
 Tranite D-Lay - Pentaerythritol tetranitrate
 Trankilin - Meprobamate
 Tranlisant - Meprobamate
 Tranoxa - Metronidazole
 Tranpoise - Mephenoxalone
 Tranquase - Diazepam
 Tranquazine - Promazine HCl
 Tranquis - Trifluoperazine
 Tranquit - Oxazolam
 Tranquilax - Medazepam
 Tranquo-Puren - Diazepam
 Tranquo-Tabliten - Diazepam
 Transamin - Tranexamic acid
 Transamlon - Tranexamic acid
 Transanate - Chlormezanone
 Transbilix - Iodipamide
 Transbronchin - Carbocysteine
 Transcylcline - Rolitetracycline
 Transit - Furosemide
 Trantoin - Nitrofurantoin
 Tranxene - Clorazepate dipotassium
 Tranxilen - Clorazepate dipotassium
 Tranxilium - Clorazepate dipotassium
 Tra-Quilan - Chlorprothixene
 Trasacor - Oxprenolol
 Trasacor - Oxprenolol
 Tratul - Cimetide
 Traumacut - Methocarbamol
 Traumanase - Bromelain
 Travamin - Dimenhydrinate
 Travamine - Dimenhydrinate
 Travel-Gum - Dimenhydrinate
 Travin - Dimenhydrinate
 Travocort - Diflucortolone valerate
 Travogon - Isoconazole nitrate
 Travogyn - Isoconazole nitrate
 Trawell - Dimenhydrinate
 Trecalmo - Clotiazepam
 Trecator - Ethionamide
 Trecator-SC - Ethionamide
 Tredemine - Niclosamide
 Treis-Ciclinc - Methacycline
 Trelmar - Meprobamate
 Tremaril - Methixene HCl
 Tremaril - Methixene HCl
 Tremblex - Dextetimide
 Tremin - Trihexyphenidyl HCl
 Tremonil - Methixene HCl
 Trenodin - Acetaminophen
 Trental - Pentoxifylline
 Trepidant - Prazepam
 Trepidone - Mephenoxalone
 Trepiline - Amitriptyline HCl
 Trescatyl - Ethionamide
 Tresochin - Chloroquine phosphate
 Tresortil - Methocarbamol
 Trest - Methixene HCl
 Tretin-M - Tretinoin
 Trevintix - Protonamide
 Tri - Nitrazepam
 Triacana - Tiratricol

- Triacort - Triamcinolone acetonide
 Triaderm - Triamcinolone acetonide
 Triadol - Benorylate
 Triafed - Triprolidine
 Triagen - Chlorotrianiisene
 Triaget - Triamcinolone acetonide
 Trialona - Triamcinolone
 Trialona - Triamcinolone acetonide
 Triamalone - Triamcinolone acetonide
 Triamcin - Triamcinolone diacetate
 Triamcort - Triamcinolone
 Triameline - Triethylenemelamine
 Triam Forte - Triamcinolone diacetate
 Triaminic - Pyrilamine
 Triaminicol - Dextromethorphan hydrobromide
 Triaminic - Guaifenesin
 Triaminic - Pheniramine maleate
 Triaminic - Phenylpropanolamine HCl
 Triam-Injekt - Triamcinolone acetonide
 Triam-Oral - Triamcinolone
 Triamoxil - Amoxicillin
 Triamteril - Triamterene
 Triamthiazid - Triamterene
 Triaphen - Aspirin
 Triavil - Amitriptyline HCl
 Triavil - Perphenazine
 Triazide - Trichlormethiazide
 Triazine - Trifluoperazine
 Tribil - Cyclobutylrol
 Tribilina - Cyclobutylrol
 Triburon - Triclobisonium chloride
 Tricanix - Tinidazole
 Trichazol - Metronidazole
 Trichex - Metronidazole
 Trichloridiuride - Trichlormethiazide
 Trichlorex - Trichlormethiazide
 Trichocide - Metronidazole
 Tricho Cordes - Metronidazole
 Trichogin - Tinidazole
 Tricho-Gynaedron - Metronidazole
 Trichomol - Metronidazole
 Trichostop - Metronidazole
 Trichozone - Metronidazole
 Tricilone - Triamcinolone acetonide
 Tricinolon - Triamcinolone acetonide
 Tricloran - Triclofos sodium
 Tricloretec - Trichlormethiazide
 Tricloryl - Triclofos sodium
 Triclos - Triclofos sodium
 Triclose - Azanidazole
 Tricofuron - Furazolidone
 Tri-Cone - Simethicone
 Tricortale - Triamcinolone
 Tricowas B - Metronidazole
 Tricurán - Gallamine triethiodide
 Tridesilon - Desonide
 Tridesonit - Desonide
 Tridione - Trimethadione
 Tri-Effortil - Etilefrine pivalate HCl
 Triethylene - Triethylenemelamine
 Trifamox - Amoxicillin
 Triflumen - Trichlormethiazide
 Trifluoper-Ez-Ets - Trifluoperazine
 Triflurin - Trifluoperazine
 Trifurox - Furazolidone
 Trigesic - Acetaminophen
 Trignost - Diatrizoate sodium
 Triherpine - α,α,α -Trifluorothymidine
 Trihexane - Trihexyphenidyl HCl
 Trihexy - Trihexyphenidyl HCl
 Trihistan - Chlorcyclizine
 Trijodthyronin - Liothyronine
 Trikamon - Metronidazole
 Trikozol - Metronidazole
 Trilafon - Perphenazine
 Trilan - Sulpiride
 Trilcin - Fluorometholone
 Trilifan - Perphenazine
 Trilisate - Choline salicylate
 Trilocarban - Triclocarban
 Trilon - Triamcinolone
 Trimanyl - Trimethoprim
 Trimax - Dimethicone
 Trimcaps - Phendimetrazine tartrate
 Trimecur - Trimethoprim
 Trimeperad - Trimetazidine
 Trimeton - Chlorpheniramine maleate
 Trimeton maleate - Pheniramine maleate
 Trimfect - Trimethoprim
 Trimoksilin - Amoxicillin
 Trimol - Piroheptine
 Trimonase - Tinidazole
 Trimopam - Trimethoprim
 Trimopan - Trimethoprim
 Trimox - Amoxicillin
 Trimox - Ampicillin trihydrate
 Trimpex - Trimethoprim
 Trimpus - Dextromethorphan hydrobromide
 Trimstat - Phendimetrazine tartrate
 Trimysten - Clotrimazole
 Trinalin - Azatadine maleate
 Trinalin - Aspirin
 Trinol - Paramethasone acetate
 Tri-Norinyl - Norethindrone
 Trinsicon - Folic acid
 Triolmicina - Oleandomycin
 Triomin - Perphenazine
 Trioxanona - Trimethadione
 Trioxazine - Trimetozine
 Tripervan - Vincamine
 Tripheninon - Trihexyphenidyl HCl
 Triphosphodine - Adenosine triphosphate
 Triple Sulfa - Sulfacetamide
 Tripodrine - Triprolidine
 Triprim - Trimethoprim
 Triptil - Protriptyline
 Tript-Oh - Hydroxytryptophan
 Tript-OH - Oxitriptan
 Triptyl - Amitriptyline HCl
 Trisaminol - Tromethamine
 Trisoralen - Trioxsalen
 Tritten - Dimethindene maleate
 Tri-Thalamic - Gramicidin
 Tri-Thalamic - Neomycin
 Tri-Thalamic - Polymyxin
 Trithyron - Liothyronine
 Triton WR - Tyloxapol
 Trittico - Trazodone HCl
 Triurol - Acetizoate sodium
 Trivaline - Amantidine HCl
 Trivastal - Pirobedil
 Trivastan - Pirobedil
 Trivazol - Metronidazole
 Trizma - Tromethamine
 Troberin - Clorprenaline
 Trobicin - Spectinomycin
 Trobicine - Spectinomycin
 Trocinate - Triphenamil HCl
 Trocurine - Nitrofurantoin
 Trofurit - Furosemide

- Trolovol - Penicillamine
 Trombostaz - Dipyrindamole
 Tromexan - Ethyl biscoumacetate
 Trommogallol - Cyclobutylol
 Tronolane - Pramoxine HCl
 Tronothane - Pramoxine HCl
 Trophenium - Phenactropinium chloride
 Tropicardyl - Inosine
 Trophodilan - Isosuprine HCl
 Tropimil - Tropicamide
 Tropium - Chlordiazepoxide HCl
 Tropodil - Oxolinic acid
 Trosyd - Tioconazole
 Troversin - Dimenhydrinate
 Tru - Pyrvinium pamoate
 Truxal - Chlorprothixene
 Truxaletten - Chlorprothixene
 Tryco - Pivampicillin
 Trymegen - Chlorpheniramine maleate
 Trymex - Triamcinolone acetoneid
 Tryptal - Amitriptyline HCl
 Tryptanol - Amitriptyline HCl
 Tryptar - Tropicamide
 Tryptizol - Amitriptyline HCl
 Trysul - Sulfacetamide
 T Stat - Erythromycin
 Tsudohmin - Diclofenac sodium
 Tsuerumin S - Hydroxocobalamin
 Tualone - Methaqualone
 Tubadil - Tubocurarine chloride
 Tubanox - Isoniazid
 Tubenamide - Ethionamide
 Tuberactin - Enviomycin
 Tuberamin - Protionamide
 Tuberex - Protionamide
 Tubermide - Protionamide
 Tubermin - Ethionamide
 Tuberoid - Ethionamide
 Tuberol - Ethambutol HCl
 Tuberon - Isoniazid
 Tuberoson - Ethionamide
 Tubilysin - Isoniazid
 Tubocin - Rifampin
 Tubocuran - Tubocurarine chloride
 Tuinal - Secobarbital sodium
 TUM - Enviomycin
 Turbinal - Beclomethasone dipropionate
 Turgex - Hexachlorophene
 Turinabol - Nandrolone phenpropionate
 Turinabol-Depot - Nandrolone decanoate
 Turisteron - Ethinylestradiol
 Tusasade - Dextromethorphan hydrobromide
 Tuss-Ade - Caramiphen edisylate
 Tussafug - Benproperine
 Tussafugsaft - Benproperine
 Tussar - Guaifenesin
 Tussar - Phenylephrine HCl
 Tussar D.M. - Dextromethorphan hydrobromide
 Tussend - Guaifenesin
 Tussidyl - Dextromethorphan hydrobromide
 Tussilislin - Oxeladin
 Tussimol - Oxeladin
 Tussionex - Phenyltoloxamine
 Tussi-Organidin - Dextromethorphan hydrobromide
 Tussiplegyl - Chlophedianol
 Tussirama - Fominoben HCl
 Tussirex - Pheniramine maleate
 Tussirex - Phenylephrine HCl
 Tuss-Ornade - Caramiphen edisylate
 Tuss-Ornade - Phenylpropanolamine HCl
 Tuxidin - Chlophedianol
 Tuxinil - Chlophedianol
 Twel-Be - Cyanocobalamin
 TwelvmIn - Hydroxocobalamin
 Tybatran - Tybamate
 Tydantil - Nifuratel
 Tyliciprine - Tranylcypromine sulfate
 Tylenol - Acetaminophen
 Tylosterone - Diethylstilbestrol
 Tymol - Acetaminophen
 Tympagesic - Phenylephrine HCl
 Tymtran - Ceruletide
 Typinal - Tetrahydrozoline HCl
 Tyrimide - Isopropamide iodide
 Tyropaque - Tyropanoate sodium
 Tyvid - Isoniazid
 Tyzine - Tetrahydrozoline HCl
 Ube-Q - Ubidecarenone
 Ubretid - Distigmine bromide
 Udekinon - Ubidecarenone
 Udicil - Cytarabine HCl
 Udip - Papaverine monophosadenine
 Udolac - Dapsone
 U-Gencin - Gentamicin sulfate
 U-Gono - Fluoxymesterone
 Ugorol - Tranexamic acid
 Ukidan - Urokinase
 Ulacort - Prednisolone
 Ulacort - Prednisolone acetate
 Ulban-Q - Valerthamate bromide
 Ulcadin - Cimetide
 Ulcadine - Cimetide
 Ulcemet - Cimetide
 Ulcferfen - Cimetide
 Ulcferlmin - Sucralfate
 Ulcesium - Fentonium bromide
 Ulcestop - Cimetide
 Ulcex - Ranitidine
 Ulcociclina - Oxyphencyclimine
 Ulcofer - Carbenoxolone
 Ulcogant - Sucralfate
 Ulcolax - Bisacodyl
 Ulcomin - Oxyphencyclimine
 Ulcus-Tabliten - Carbenoxolone
 Ulhys - Cimetide
 Ulkon - Carbenoxolone
 Ulmenid - Chenodiol
 Ulo - Chlophedianol
 Ulogant - Sucralfate
 Ulone - Chlophedianol
 Ulosagen - Fluorouracil
 Ulpir - Sulpiride
 Ulsanic - Sucralfate
 Ultandren - Fluoxymesterone
 Ultrabil - Iodipamide
 Ultrabion - Ampicillin
 Ultracain - Carticaine
 Ultracef - Cefadroxil
 Ultracillin - Cyclacillin
 Ultracortenol - Prednisolone acetate
 Ultraderm - Fluocinolone acetoneid
 Ultradiazin - Sulfadiazine
 Ultralan - Clemizole
 Ultralant - Fluocortolone
 Ultralente - Insulin zinc suspension
 Ultramycin - Minocycline
 Ultrtran - Phenaglycodol
 Ultraproct - Clemizole

Ultrason - Fluocortolone
 Ultrasul - Sulfamethizole
 Ultrax - Sulfameter
 Ultroxim - Cefuroxime
 Ulup - Fluorouracil
 Umbrim - Diazepam
 Unakalm - Ketazolam
 Un-Alfa - Alfacalcidol
 Unanap - Methionine
 Unaseran-D - Thiamphenicol
 Unaserus - Nalidixic acid
 Unazid - Hydrochlorothiazide
 Ungovac - Fluocinolone acetonide
 Unicare - Dimethicone
 Unicillin - Amoxicillin
 Unicort - Betamethasone
 Unidone - Anisindione
 Unimide - Tolbutamide
 Uninorm - Benzbromarone
 Unipen - Carbenicillin indanyl sodium
 Unipen - Nafcillin sodium
 Unipres - Hydrochlorothiazide
 Unipres - Reserpine
 Unipress - Hydralazine HCl
 Unisal - Diflunisal
 Unisomnia - Nitrazepam
 Unison - Medroxyprogesterone acetate
 Unisulf - Sulfisoxazole
 Unisulfa - Sulfamethoxypyridazine
 Unitensen - Cryptenamine tannates
 UniWash - Benzethonium chloride
 Uni Wash - Edetate disodium
 Untensin - Chlordiazepoxide HCl
 Upcyclin - Tetracycline phosphate complex
 Upstene - Indalpine
 Uracid - Methionine
 Uractone - Spironolactone
 Uralgin - Nalidixic acid
 Uramox - Acetazolamide
 Urantoin - Nitrofurantoin
 Urazole - Sulfisoxazole
 Urbac - Nifurfoline
 Urbadan - Clobazam
 Urbanil - Clobazam
 Urbanol - Clobazam
 Urbanul - Clobazam
 Urbanyl - Clobazam
 Urbason - Methylprednisolone
 Urbilat - Meprobamate
 Urbol - Allopurinol
 Urecholine HCl - Bethanechol chloride
 Urecid - Probenecid
 Uredimin - Allopurinol
 Uremide - Furosemide
 Urerubon - Tolbutamide
 Urese - Benzthiazide
 Uretoin - Nitrofurantoin
 Uretrene - Nalidixic acid
 Urex - Furosemide
 Urfadyn - Nifurtoinol
 Urfadyne - Nifurtoinol
 Urfamycine - Thiamphenicol
 Urfurine - Nifurtoinol
 Urgilan - Proscillaridin
 U.R.I. - Chlorpheniramine maleate
 Uribact - Flumequine
 Uriben - Nalidixic acid
 Uricemil - Allopurinol
 Uriclar - Nalidixic acid
 Uriclor - Piromidic acid
 Uriconorm - Allopurinol
 Uricovac - Benzbromarone
 Urid - Chlorthalidone
 Uridocid - Allopurinol
 Uridon - Chlorthalidone
 Uri-Flor - Nalidixic acid
 Urigram - Nalidixic acid
 Urimeth - Methionine
 Urinex - Chlorothiazide
 Urinox - Oxolinic acid
 Urirex - Hydrochlorothiazide
 Uriscel - Allopurinol
 Urisco - Nalidixic acid
 Urisept - Piromidic acid
 Urispan - Flavoxate HCl
 Urispas - Flavoxate HCl
 Uristeril - Nalidixic acid
 Urizid - Bendroflumethiazide
 Uro-Alvar - Oxolinic acid
 Urobac - Carbenicillin indanyl sodium
 Urobak - Sulfamethoxazole
 Urobac - Sulfamethoxazole
 Uroben - Probenecid
 Urobenyl - Allopurinol
 Urobiotic - Sulfamethizole
 Urocarb - Bethanechol chloride
 Urocaudal - Triamterene
 Uro-Clamoxyl - Amoxicillin
 Urodiazin - Hydrochlorothiazide
 Urodil - Nitrofurantoin
 Urodin - Nitrofurantoin
 Urodixin - Nalidixic acid
 Urofuran - Nitrofurantoin
 Urogan - Sulfisoxazole
 Urogram - Nalidixic acid
 Urokinon - Sulfamethizole
 Urokizol - Sulfamethizole
 Urokon sodium - Acetizoate sodium
 Urolax - Bethanechol chloride
 Urolex - Nalidixic acid
 Urolex - Sulfamethizole
 Urolgin N - Nalidixic acid
 Urolisa - Nitrofurantoin
 Uroliz - Allopurinol
 Urolong - Nitrofurantoin
 Uromina - Nalidixic acid
 Uromiro - Iodamide
 Uromitexan - Mesna
 Uronase - Urokinase
 Uroneg - Nalidixic acid
 Uropax - Oxolinic acid
 Uropen - Hetacillin potassium
 Urophenyl - Thiamphenicol
 Uropimid - Pipemidic acid
 Uro-Septra - Amiodarone HCl
 Urosin - Allopurinol
 Urosol - Sulfamethizole
 Urosonin - Spironolactone
 Urosul - Sulfamethizole
 Urosulf - Sulfaethiodole
 Urosulfon - Sulfacetamide
 Uro-Tabliten - Nitrofurantoin
 Urotractan - Methenamine hippurate
 Urotractin - Pipemidic acid
 Urotrate - Oxolinic acid
 Uroval - Pipemidic acid
 Urovist sodium - Diatrizoate sodium
 Uroxol - Oxolinic acid
 Urozide - Hydrochlorothiazide
 Urozyl-SR - Allopurinol

Ursinus - Carbaspirin calcium
 Ursnon - Fluorometholone
 Urtias - Allopurinol
 Urtilone - Prednisone
 Urupan - Dexpanthenol
 U.S.-67 - Sulfisoxazole
 Uskan - Oxazepam
 Ustimon - Hexobendine
 Utabon - Oxymetazoline HCl
 Utefos - Tegafur
 Uteracon - Oxytocin
 Uterin - Methylergonovine maleate
 Utibid - Oxolinic acid
 Uticort - Betamethasone benzoate
 Uticort Gel - Betamethasone benzoate
 Utimox - Amoxicillin
 Utopar - Ritodrine
 Utovlan - Norethindrone
 Utrasul - Sulfamethizole
 Uval - Sulisobenzone
 Uvamin - Nitrofurantoin
 Uvinul - Sulisobenzone
 Uvistat-L - Mexenone
 Uzone - Phenylbutazone

Vaben - Oxazepam
 Vaderm - Beclomethasone dipropionate
 Vagestrol - Diethylstilbestrol
 Vagidine - Povidone-iodine
 Vagilen - Metronidazole
 Vagimid - Metronidazole
 Vaginyl - Metronidazole
 Vagogastrin - Oxyphenyclimine
 Vagopax - Parapenzolate bromide
 Vagos - Ipratropium bromide
 Vahodilan - Isoxsuprine HCl
 Valadol Tablets - Acetaminophen
 Valamin - Ethinamate
 Valate - Valethamate bromide
 Val-Atux - Dextromethorphan hydrobromide
 Valbil - Febuprol
 Valcin - Methacycline
 Valcor - Droperidamine HCl
 Valdorm - Flurazepam
 Valdrene - Diphenhydramine HCl
 Valemate - Valethamate bromide
 Valemeton - Valethamate bromide
 Valemicino - Fosfomycin
 Valergen - Estradiol valerate
 Valetan - Diclofenac sodium
 Valethalin - Valethamate bromide
 Valethamin - Valethamate bromide
 Valibrin - Diazepam
 Validex - Ifenprodil tartrate
 Validil - Oxyphenbutazone
 Valisone - Betamethasone
 Valisone - Betamethasone valerate
 Valitran - Diazepam
 Valium - Diazepam
 Vallene - Mebutamate
 Vallergan - Trimeprazine
 Vallestriil - Methalleneestril
 Valmid - Ethinamate
 Valmiran - Cyclothiazide
 Valodex - Tamoxifen
 Valoid - Cyclizine
 Valontan - Dimenhydrinate
 Valopride - Bromopride
 Valorin - Acetaminophen
 Valoron - Tilidine HCl

Valpin - Anistropine methyl bromide
 Valpinax - Anistropine methyl bromide
 Valsyn - Furaltadone
 Valtomicina - Mepicycline
 Valtorin - Chloroethoxazine
 Valuren - Nalidixic acid
 Valvanol - 4-Chloro-3,5-xyleneol
 Valyten - Moxisylyte
 Vampen - Ampicillin trihydrate
 Vampi-Framan - Pivampicillin
 Vanabol - Methandrostenolone
 Vanadian - Alcofenac
 Vanay - Triacetin
 Vancenase - Beclomethasone dipropionate
 Vanceril - Beclomethasone dipropionate
 Vanceril - Betamethasone dipropionate
 Vancocin - Vancomycin
 Vandid - Ethamivan
 Vanobid - Candicidin
 Vanoxide - Hydrocortisone
 Vanquin - Pyrvinium pamoate
 Vansil - Oxamniquine
 Vapo-N-Iso - Isoproterenol sulfate
 Varbian - Prenalterol
 Variargil - Trimeprazine
 Varidase - Streptokinase
 Varinon - Diosmin
 Varson - Nicergoline
 Vasagin - Pyridinol carbamate
 Vasalgin - Proxibarbal
 Vasapril - Pyridinol carbamate
 Vascardin - Isosorbide dinitrate
 Vascopin - Isoxsuprine HCl
 Vasoray - Iothalmate meglumine
 Vascoril - Cinepazet maleate
 Vasculogene - Vincamine
 Vascumine - Vincamine
 Vasiten - Nylidrin
 Vasmol - Pyridinol carbamate
 Vasocet - Cetiedil
 Vasocil - Pyridinol carbamate
 Vasoclear - Naphazoline
 Vasoconstrictor - Naphazoline
 Vasodex - Dexamethasone phosphate
 Vasodiatol - Pentaerythritol tetranitrate
 Vasodilan - Isoxsuprine HCl
 Vaso-Dilatan - Tolazoline
 Vasodilene - Isoxsuprine HCl
 Vasodyl - Cyclandelate
 Vasoflex - Prazosin
 Vasoklin - Moxisylyte
 Vasolamin - Tranexamic acid
 Vasolan - Isoxsuprine HCl
 Vasolan - Verapamil
 Vasoplex - Isoxsuprine HCl
 Vasoprin - Xanthinol niacinate
 Vasorome - Oxandrolone
 Vasospan - Nicergoline
 Vasosuprina - Isoxsuprine HCl
 Vasosyklan - Cyclandelate
 Vasoverin - Pyridinol carbamate
 Vasoxy - Methoxamine HCl
 Vaspid - Fluocortin butyl
 Vaspit - Fluocortin butyl
 Vassarin-F - Trimetazidine
 Vastacyn - Ampicillin
 Vastarel - Trimetazidine
 Vastazin - Trimetazidine
 Vasticillin - Cycloacillin
 Vastollin - Cycloacillin

Vasurix - Acetrizoate sodium
 Vasylox - Methoxamine HCl
 Vatran - Diazepam
 V-Cillin - Penicillin V
 V-Cline - Meclizine HCl
 Vectrin - Minocycline
 Vedatan - Allopurinol
 Vedrin - Xanthinol niacinate
 Vegatar - Medazepam
 Vegesan - Nordazepam
 Vegolsen - Hexamethonium bromide
 Vehem - Teniposide
 Velacycline - Rolitetracycline
 Velamox - Amoxicillin
 Velbacil - Bacampicillin
 Velban - Vinblastine sulfate
 Velbe - Vinblastine sulfate
 Velocef - Cephadrine
 Velosef - Cephadrine
 Velosulin - Insulin
 Velzane - Brompheniramine maleate
 Vemas - Bisacodyl
 Venactone - Canrenoate potassium
 Venala - Cyclandelate
 Venalisin - Tribenoside
 Vencoll - Bisacodyl
 Ven-Detrex - Diosmin
 Venen - Triprolidine
 Venex - Diosmin
 Venex - Tribenoside
 Venodin - Tribenoside
 Venosmine - Diosmin
 Venotrex - Diosmin
 Venteaire - Protokylol
 Ventaval - Tiaramide
 Ventilat - Oxitropium bromide
 Ventolin - Albuterol
 Ventoline - Albuterol
 Ventroxol - Carbenoxolone
 Ventusasin - Benzonatate
 Venusmin - Diosmin
 Venzoquimpe - Metampicillin sodium
 Veraciclina - Demeclocycline HCl
 Veracillin - Dicloxacillin sodium
 Veractil - Methotrimeprazine
 Veradol - Naproxen
 Veralipral - Veralipride
 Veralydon - Acetaminophen
 Veramil - Verapamil
 Veranterol - Pyridinol carbamate
 Verben - Azatadine maleate
 Vercite - Pipobroman
 Vercyte - Pipobroman
 Vergentan - Alizapride
 Vergonil - Hydroflumethiazide
 Vericordin - Atenolol
 Verin - Aspirin
 Verina - Nylidrin
 Veripaque - Oxyphenisatin acetate
 Verisone - Prednisolone stearoylglycolate
 Veritab - Meclizine HCl
 Vermirax - Mebendazole
 Vermisol - Levamisole HCl
 Vermitiber - Pyrvinium pamoate
 Vermox - Mebendazole
 Verpamil - Verapamil
 Verpanil - Mebendazole
 Verrex - Salicylic acid
 Verrumal - Fluorouracil
 Verrusal - Salicylic acid
 Versacort - Bendacort
 Versapen - Hetacillin potassium
 Verstran - Prazepam
 Versus - Bendazac
 Vertigon - Prochlorperazine
 Vertirosan - Dimenhydrinate
 Vertizine - Meclizine HCl
 Vesadol - Haloperidol
 Vesitan - Thiopropazate
 Vesparax - Etodroxizine
 Vesprin - Triflupromazine
 Veteusan - Crotamiton
 Veticol - Chloramphenicol
 Vexampil - Ampicillin
 V-Gan - Promethazine HCl
 Viaben - Bromopride
 Viadril - Hydroxydione sodium succinate
 Viafen - Bufexamac
 Vialidin - Mefenamic acid
 Via-Quil - Chlordiazepoxide HCl
 Viarespan - Fenspiride
 Viarex - Beclomethasone dipropionate
 Viarox - Beclomethasone dipropionate
 Vibalt - Cyanocobalamin
 Vibeline - Visnadine
 Vibriomycin - Dihydrostreptomycin sulfate
 Vicapenbiz - Cyanocobalamin
 Viccillin - Ampicillin
 Viceton - Chloramphenicol
 Vicilan - Viloxazine HCl
 Vicon - Folic acid
 Victan - Loflazepate ethyl
 Victoril - Dibenzepin HCl
 Vidarabin - Vidarabine
 Videococan - Tegafur
 Vidil - Pemoline
 Vidopen - Ampicillin trihydrate
 Viemin 12 - Cyanocobalamin
 Vfazolin - Cefazolin sodium
 Vigigan - Mequitazine
 Vigocina - Metampicillin sodium
 Vigolatin - Hydroxocobalamin
 Viklorin - Chloramphenicol
 Vilbin - Diphenhydramine HCl
 Vilexin - Phenyramidol
 Viloksan - Viloxazine HCl
 Vimicon - Cyproheptadine
 Vi-Mycin - Chlortetracycline
 Vinactane - Viomycin
 Vinca - Vincamine
 Vincabiomar - Vincamine
 Vincabrain - Vincamine
 Vincachron - Vincamine
 Vincadar - Vincamine
 Vincadil - Vincamine
 Vinca-Ecobi - Vincamine
 Vincafarm - Vincamine
 Vincafolina - Vincamine
 Vincافر - Vincamine
 Vincagalup - Vincamine
 Vincagil - Vincamine
 Vincahexal - Vincamine
 Vincalen - Vincamine
 Vincamidol - Vincamine
 Vincamin - Vincamine
 Vincanor - Vincamine
 Vincapront - Vincamine
 Vinca-Tabliten - Vincamine
 Vinco - Bisacodyl
 Vincol - Tiopronin

Vincosid - Vincristine sulfate
 Vincristin - Vincristine sulfate
 Vincristina - Vincristine sulfate
 Vintop - Kebuzone
 Viobamate - Meprobamate
 Viocin - Viomycin
 Vioform - Hydrocortisone
 Viofuragyn - Furazolidone
 Viomicin - Viomycin
 Viomycin Pfizer - Viomycin
 Vio-Serpine - Reserpine
 Viosol - Hydrocortisone
 Vio-Thene - Oxyphenyclimine
 Vipicil - Cyclacillin
 Vipral - Sulpiride
 Vira-A - Vidarabine
 Viranol - Salicylic acid
 Viregyt - Amantidine HCl
 Virexin - Idoxuridine
 Virilon - Methyltestosterone
 Virofal - Amantidine HCl
 Viroptic - α,α,α -Trifluorothymidine
 Viosol - Amantidine HCl
 Viru-Merz - Tromantidine HCl
 Virunguent - Idoxuridine
 Virusan - Idoxuridine
 Viruserol - Tromantidine HCl
 Virusina - Inosine
 Viscal - Metoclopramide HCl
 Visceralgina - Tiemonium iodide
 Visceralgine - Tiemonium iodide
 Viscerol - Dicyclomine HCl
 Viscolyt - Bromhexine
 Viscor - Dipyridamole
 Viscotiol - Letosteine
 Visderm - Amcinonide
 Visine - Tetrahydrozoline HCl
 Visiokan - Kanamycin sulfate
 Visnamine - Visnadine
 Visobutina - Oxyphenbutazone
 Visopt - Phenylephrine HCl
 Visotrast - Diatrizoate sodium
 Vistalbalon - Naphazoline
 Vistamycin - Ribostamicin
 Vistapin - Dipivefrin
 Vistaril - Hydroxyzine HCl
 Vistaspectran - Idoxuridine
 Vistimon - Mesterolone
 Visudrisone - Medrysone
 Visumetazone antibiotica - Bekanamycin sulfate
 Visumicina - Bekanamycin sulfate
 Visumidriatic - Tropicamide
 Visutensil - Guanethidine sulfate
 Vitabiotic - Methacycline
 Vitac - Chlorpheniramine maleate
 Vitacarotene - β -Carotene
 Vitacid-A - Tretinoin
 Vitacontact - Chlorhexidine
 Vitacort - Prednisolone
 Vitafof - Folic acid
 Vita-K - Phytionadione
 Vitaklorin - Chloramphenicol
 Vitamin-A-Saure - Tretinoin
 Vitamine K1 - Phytionadione
 Vitarubin - Cyanocobalamin
 Vi-Twel - Cyanocobalamin
 Vivactil - Protriptyline
 Vival - Diazepam
 Vivalan - Viloxazine HCl
 Vividyl - Nortriptyline
 Vivol - Diazepam
 Vizerul - Ranitidine
 Vodol - Miconazole nitrate
 Volog - Halcinonide
 Volon - Triamcinolone
 Volon - Triamcinolone acetonide
 Volplan - Megestrol acetate
 Voltaren - Diclofenac sodium
 Voltarene - Diclofenac sodium
 Voltarol - Diclofenac sodium
 Vomex - Dimenhydrinate
 Vontil - Thioproperazine
 Vontrol - Diphenidol
 Vopop - Eprazinone HCl
 Voranil - Clortermine HCl
 Voyal - Dimenhydrinate
 V-Serp - Reserpine
 V-Sul - Sulfisoxazole
 V-Tablofen - Penicillin V
 Vumon - Teniposide
 Vytone - Hydrocortisone
 Wachtungshormon - Somatotropin
 Wagitran - Metronidazole
 Wakazepam - Oxazepam
 Wansar - Diphenidol
 Waran - Warfarin sodium
 Warcoumin - Warfarin sodium
 Warfilone - Warfarin sodium
 Wart-Off - Salicylic acid
 Wasangor - Prenylamine
 Wasseridina - Cephaloridine
 Wassermicina - Methacycline
 Wassermox - Amoxicillin
 Wasserporina - Cephalixin
 Wasserprofen - Ketoprofen
 WDD Tab - Imipramine HCl
 Wehdryl - Diphenhydramine HCl
 Wehless - Phendimetrazine tartrate
 Weifapenin - Penicillin V
 Weightrol - Phendimetrazine tartrate
 Weldopa - Levodopa
 Wellcoprim - Trimethoprim
 Wellferon - Interferon
 Wemid - Erythromycin stearate
 Wescohex - Hexachlorophene
 Wescomep - Meprobamate
 Wescopred - Prednisone
 Wescotol - Tolbutamide
 Wescozone - Phenylbutazone
 Westadone - Methadone HCl
 Westasept - Hexachlorophene
 Whitfield's Ointment - Salicylic acid
 Widecillin - Amoxicillin
 Wilpo - Phentermine HCl
 Wincoram - Amrinone
 Winobanin - Danazol
 Winorylate - Benorylate
 Winoxacin - Rosoxacin
 Winpred - Prednisone
 Winsprin - Aspirin
 Winstan - Triostane
 Winstol - Stanozolol
 Winstrol - Stanozolol
 Wintermin - Chlorpromazine HCl
 Wintomylon - Nalidixic acid
 Wintron - Nalidixic acid
 Winuron - Rosoxacin
 Wirnesin - Proscillaridin

- Wojtab - Prednisone
 Wyamine - Mephentermine
 Wyamycin-S - Erythromycin stearate
 Wybital - Cycloacillin
 Wycillin - Penicillin G procaine
 Wydora - Indoramin
 Wygesic - Propoxyphene HCl
 Wypax - Lorazepam
 Wytensin - Guanabenz
- Xahl - Cephalexin
 Xalogen - Meprobamate
 Xamamina - Dimenhydrinate
 Xanax - Alprazolam
 Xani - Apazone
 Xanidil - Xanthinol niacinate
 Xanturat - Allopurinol
 Xatolone - Inositol niacinate
 Xavin - Xanthinol niacinate
 Xenaione - Spironolactone
 Xenar - Naproxen
 Xerene - Mephenoaxalone
 Xibol - Xibornol
 Xolamin - Clemastine fumarate
 X-Otag - Orphenadrine citrate
 X-Trozine - Phendimetrazine tartrate
 Xuprin - Isoxsuprine HCl
 Xyduril - Clofibrate
 Xylanaest - Lidocaine
 Xylesin - Lidocaine
 Xylestesin - Lidocaine
 Xylocaine - Lidocaine
 Xylocard - Lidocaine
 Xylocitin - Lidocaine
 Xylonest - Prilocaine HCl
 Xyloneural - Lidocaine
 Xylonor - Lidocaine
 Xylotocan - Tocainide
 Xylotox - Lidocaine
- Yamacillin - Talampicillin
 Yamafur - Carmofur
 Yatrociclina - Methacycline
 Yatrocin - Nitrofurazone
 Yesdol - Diphenidol
 Ylestrol - Ethinylestradiol
 Yobir - Alprenolol HCl
 Yoclo - Clofibrate
 Yomesan - Niclosamide
 Yonomol - Inositol niacinate
 Yophadol - Diphenidol
 Yosimilon - Trimetazidine
 Youfural - Tegafur
 Ytrocin - Erythromycin
 Yubekinson - Ubidecarenone
 Yurinx - Bumetanide
 Yutopar - Ritodrine
 Yxin - Tetrahydrozoline HCl
- Zactane - Ethoheptazine
 Zactipar - Ethoheptazine
 Zactirin - Ethoheptazine
 Zaditen - Ketoprofen
 Zaditen - Ketotifen
- Zalbico - Indomethacin
 Zambesil - Chlorthalidone
 Zamocillin - Amoxicillin
 Zanchol - Florantyrone
 Zanosar - Streptozocin
 Zantac - Ranitidine
 Zantic - Ranitidine
 Zaomeal - Piroimidic acid
 Zariviz - Cefotaxime sodium
 Zarontin - Ethosuximide
 Zaroxolyn - Metolazone
 Zasten - Ketotifen
 Zelmid - Zimelidine
 Zenate - Folic acid
 Zentel - Albendazole
 Zentropil - Phenytoin
 Zepam - Diazepam
 Zepelin - Feprazone
 Zeph - Phenylephrine HCl
 Zephrex - Guaifenesin
 Zermicina - Methacycline
 Zesulan - Mequitazine
 Zetar - 4-Chloro-3,5-xyleneol
 Zetran - Chlordiazepoxide HCl
 Ziaetine - Buformin HCl
 Zidafimia - Isoniazid
 Zide - Hydrochlorothiazide
 Zideluy - Isoniazid
 Zildasac - Bendazac
 Zimox - Amoxicillin
 Zinacef - Cefuroxime
 Zinamide - Pyrazinamide
 Zinavit - Folic acid
 Zinoprost - Dinoprost tromethamine
 Zipan - Promethazine HCl
 Ziradryl - Diphenhydramine HCl
 Ziriton - Carbinoxamine maleate
 Zirkulat - Cyclandelate
 Zitoxil - Zipeprol
 Zohnox - Acetazolamide
 Zolicef - Cefazolin sodium
 Zolidinium - Phenylbutazone
 Zoline - Tolazoline
 Zomax - Zomepirac
 Zomaxin - Zomepirac
 Zomex - Zomepirac
 Zonase - Beclomethasone dipropionate
 Zone-A - Pramoxine HCl
 Zonide - Beclomethasone dipropionate
 Zontal - Feprazone
 Zoontal - Feprazone
 Zopirac - Zomepirac
 Zordel - Norfenefrine
 Zorpin - Aspirin
 Zostrum - Idoxuridine
 Zovirax - Acyclovir
 Zoxine - Zoxazolamine
 Zumaril - Alcofenac
 Zykolate - Cyclopentolate HCl
 Zylol - Allopurinol
 Zyloprim - Allopurinol
 Zyloric - Allopurinol
 Zynol - Sulfinpyrazone