

Vol. 20 No. 3

July 1986



# The Journal of Gemmology



GEMMOLOGICAL ASSOCIATION OF GREAT BRITAIN

## OFFICERS AND COUNCIL

*President:* Sir Frank Claringbull Ph.D., F.Inst.P., F.G.S.

*Vice-Presidents:* J. R. H. Chisholm, M.A., F.G.A.

R. K. Mitchell, F.G.A.

*Chairman:* D. J. Callaghan, F.G.A.

*Vice-Chairman:* N. W. Deeks, F.G.A.

*Honorary Treasurer:* N. B. Israel, F.G.A.

### *Fellows elected to Council:*

C. R. Cavey	B. Jackson	M. J. O'Donoghue,
L. F. Cole	C. B. Jones	M. A., F.G.S.
R. W. Croydon	D. M. Larcher	P. G. Read, C.Eng.,
P. J. E. Daly, B.Sc.	D. Morgan	M.I.E.E., M.I.E.R.E.
A. J. French	G. Neary	A. W. R. Round
S. E. Hiscox	J. B. Nelson, Ph.D., F.R.M.S.,	E. Stern
J. A. W. Hodgkinson	F. Inst.P., F.G.S.	C. H. Winter
D. Inkersole	W. Nowak, C.Eng., F.R.Ae.S.	

### *Branch Chairmen:*

*Midlands Branch:* P. West, F.G.A.

*North-West Branch:* S. Hill, F.G.A.

*South Yorkshire & District Branch:* J. I. Reynolds, F.G.A.

### *Examiners:*

E. A. Jobbins, B.Sc., F.I.M.M., F.G.A.	A. J. Allnut, M.Sc., Ph.D., F.G.A.
R. R. Harding, B.Sc., D.Phil., F.G.A.	G. H. Jones, B.Sc., Ph.D., F.G.A.
D. G. Kent, F.G.A.	E. M. Bruton, F.G.A.
P. Sadler, B.Sc., F.G.S., F.G.A.	C. Woodward, B.Sc., F.G.A.
A.E. Farn, F.G.A.	M. Font-Altaba, D.Sc.
J. M. Bosch-Figueroa, D.Sc.	M. Virkkunen, M.Phil., F.G.A.

### *Instructors:*

V. G. Hinton, F.G.A.	S. B. Nikon Cooper, B.D., F.G.A.
P. A. Waters, F.G.A.	J. Edwards, F.G.A.
D. Pratt, F.G.A.	R. J. Peace, B.Sc., F.G.A.

*Editor:* E. A. Jobbins, B.Sc., F.I.M.M., F.G.A.

*Consultant Editor:* J. R. H. Chisholm, M.A., F.G.A.

*Editorial Assistant:* Mary A. Burland

*Curator:* C. R. Cavey, F.G.A.

*Secretary:* Con Lenan, F.G.A.

*Deputy Secretary:* Jonathan Brown, Barrister-at-Law, F.G.A.

**Saint Dunstan's House, Carey Lane, London EC2V 8AB**  
**(By Goldsmith's Hall) Telephone: 01-726 4374**

# The Journal of Gemmology

VOLUME 20

NUMBER THREE     JULY 1986

## Cover Picture

Protogenetic crystals of altered hornblende were first coated with an initial layer of opal and then later were completely engulfed by this Mexican opal. Transmitted and oblique illumination.

45x. See 'Inclusions in opal', pp. 139-44.

*Photograph from 'Photomicrographs of inclusions in gemstones'.*

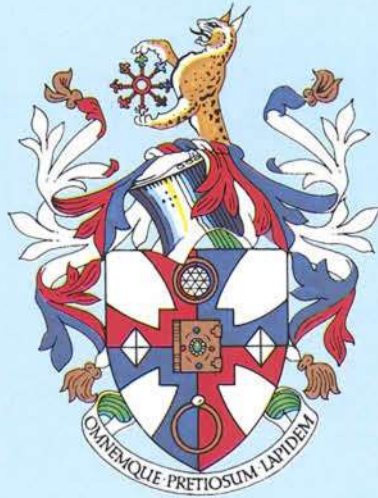

## NEW GEMMOLOGY COURSE

The Gemmological Association of Great Britain is proud to announce that from September 1986 it is introducing a new home study course in gemmology. This will prepare students for the examinations leading to the award of the Association's Fellowship Diploma.

The new course is radically different from other gemmological courses, and presents a new, friendly, step-by-step approach to learning that should be welcomed by students all over the world.

For further details, contact the Education Department, Gemmological Association of Great Britain, Saint Dunstan's House, Carey Lane, London, EC2V 8AB. Tel: 01-726 4374. Cables: GEMINST.

*The long-awaited new book about inclusions in gemstones by Dr E. Gübelin and Mr J.I. Koivula will appear on the market this Autumn under the title of 'Photoatlas of inclusions in gemstones'† and we are delighted to learn that this book is dedicated to Basil W. Anderson.*

*Dr E. Gübelin has been successful in securing the co-operation of Professor H.O.A. Meyer and Dr E. Roedder in the United States, and of Professor Dr H.A. Stalder in Switzerland.*

*The volume resulting from this collaboration reveals a spectacular triumph of colour photomicrography, and the work is obviously destined to become a classic in the field. We are therefore pleased to publish a foretaste of this work in the form of the chapter on inclusions in opal. It is especially appropriate to include it here, since the subject has not been presented in the Journal before.*

*We congratulate Dr Gübelin and his team on their great achievement.*

*The Editor*

## Inclusions in opal

*Dr Edward Gübelin, C.G., F.G.A.\* and John I. Koivula, C.G., F.G.A.\*\**

\*Ratna Mahal, Benzholzstrasse 11, CH-6045 Meggen LU, Switzerland

\*\*Gemological Institute of America, Santa Monica, CA 90406, USA

Precious opal, prized for its spectral play of colour, is commonly described as an amorphous silica gel. But the amorphous state of opal's structure is questionable. It is now known that opal is structurally composed of a more-or-less orderly, close-packed arrangement of submicroscopic spheres of two crystalline minerals – cristobalite and tridymite. In Mexican opal, which formed at higher temperatures than its Australian cousin, the spheres consist rather of cristobalite. In the Australian opal they are more commonly tridymite. The size of these spheres and the interstitial spaces between them dictate, through the diffraction of white light, the play of colours an opal will display. Formed in sedimentary or volcanic rocks, through the invasion of low-temperature silica-bearing solutions, opal is essentially composed of silica, with variable water of hydration. Opals may, in time, lose their water and dehydrate to chalcedony. A small percentage of additional elements such as aluminium, iron, calcium, magnesium and sodium in the form of submicroscopic mineral grains, may also be present.

The body colour of precious opals ranges from near colourless to milky-white, yellow, orange, red, grey to nearly black, and brown. As rapturously enchanting as the contrasts of the gay kaleidoscopy

and the satisfying harmony of the lively colour-play, is the contemplation of the manifold unique inclusions – mainly in opal from Mexico. This is especially so since the great majority of opals found all over the world either have no inclusions or these cannot be seen because the host gem is too opaque.

The brownish opal termed hyalite, found in Mexico, contains white spherulites as large as one millimetre in diameter. This hyalite is called iris opal when it displays an iridescence resulting from a finely layered internal botryoidal structure. Brazilian white opals may contain tiny dark grey octahedra of the nickel iron sulphide, bravoite. Fine particles of sand-like matrix and an uneven distribution of body-colour are noted in some Australian stones. As a result of their translucent to clear transparent opal-medium, one can see that the fire opals found in Mexico are alive with inclusions. Needles of hornblende, which once protruded from the rhyolite matrix, are often trapped. Quartz, goethite and even two- and three-phase inclusions are but a few of the inclusions identified. The following richly varying photomicrographs of opal inclusions offer an impressive show of their unsuspected beauty and wide variety.

[Manuscript received 31 March 1986.]

†Gübelin, E., Koivula, J.I. 1986. *Photoatlas of inclusions in gemstones*. ABC Edition, Zurich.



Fig. 1. Microscopic image showing the *flow-structure* in an opal from Querétaro, Mexico. Although usually present to some degree, flow zones are rarely as pronounced as here. Transmitted and oblique illumination. 15x.

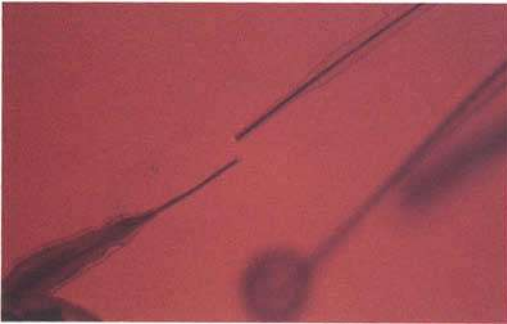

Fig. 2. The flowing motion of the silica-gel which produced this Mexican opal, had enough viscosity and force to break this *needle-like crystal* inclusion. Transmitted light. 40x.

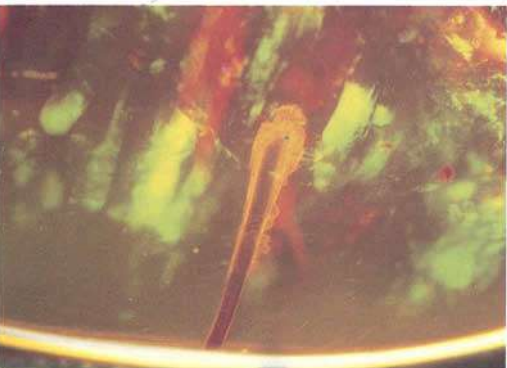

Fig. 4. Here, it is clearly apparent how, in the first phase of solidification, a 'sock' of *white opal* enveloped a *goethite needle* before the flaming Mexican fire opal enclosed this primary formation with a secondary growth-phase. Darkfield with overhead lighting. 20x.

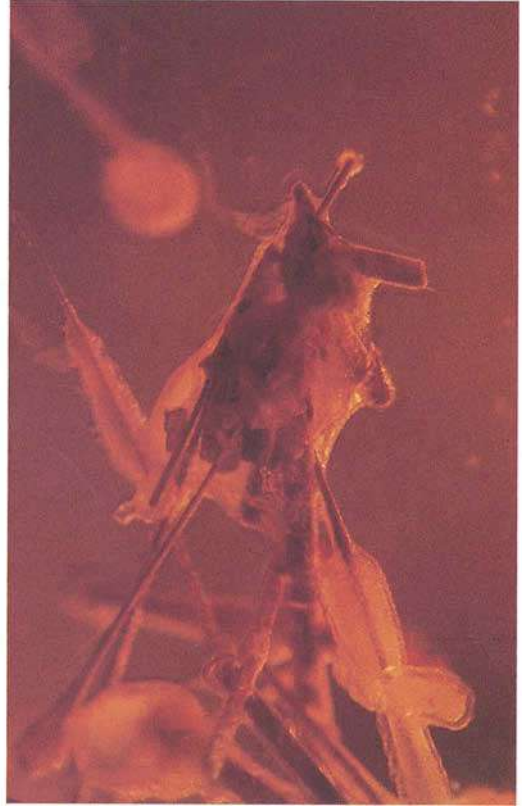

Fig. 3. A confusing mass of *acicular crystals of hornblende*, all displaying an *opal coating*. The entire grouping now resides in this Mexican opal as a *protogenic jumble*. Transmitted and oblique illumination. 20x.

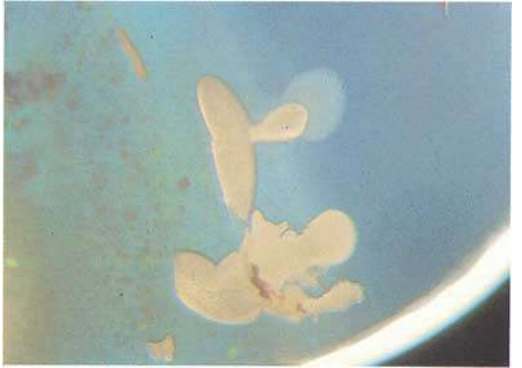

Fig. 5. Botryoidal shapes, like these in blue opal from Mexico, are preferred by *chalcidony inclusions*. Darkfield illumination. 18x.

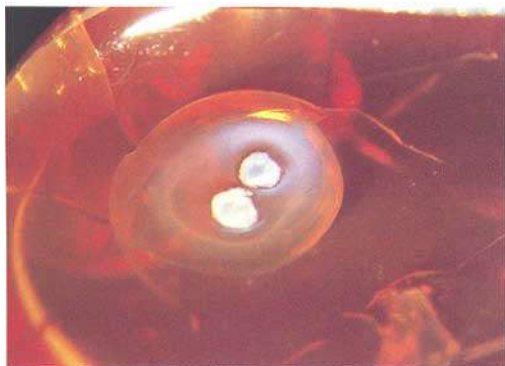

Fig. 6. A fire opal from Querétaro, Mexico, has equipped itself with an unmistakable identity-mark with the help of this pair of white *chalcedony* 'eyes'. Darkfield with overhead illumination. 10x.

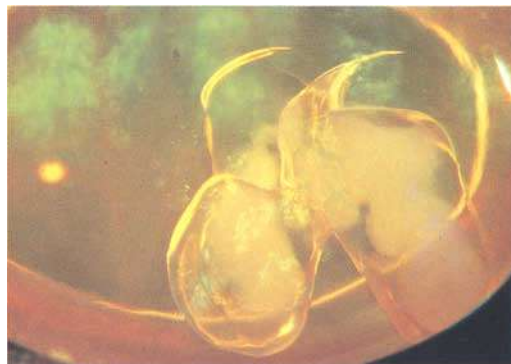

Fig. 7. *Chalcedony* inclusions, commonly resident in Mexican opal, often surround themselves with curved fissures as a result of internal tension. Darkfield illumination. 20x.



Fig. 8. Looking like glass, small aggregates of tiny plate-like *cristobalite* crystallites hover in a water opal from Querétaro, Mexico. Darkfield illumination. 150x.



Fig. 9. Translucent white *cristobalite* inclusions in a Mexican opal, are suspended against a background of a deep blue/orange/red play of colour. Oblique illumination. 20x.

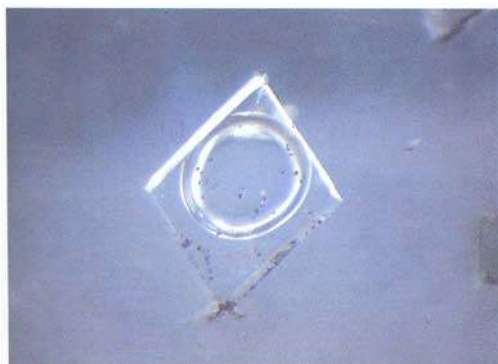

Fig. 10. This *three-phase inclusion* in a Mexican opal now occupies the area once filled by a rhombohedral crystal of a mineral such as calcite or dolomite. A volume of liquid, a large gas bubble and numerous small red solid phases now fill the void. Darkfield and oblique illumination. 35x.

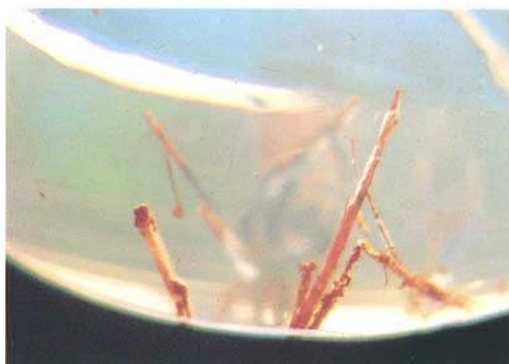

Fig. 11. Limonitized *goethite* needles once reached from the walls of the cavity in which this Mexican water opal solidified, thereby being embraced as protogenetic inclusions. Dark-field illumination. 20x.

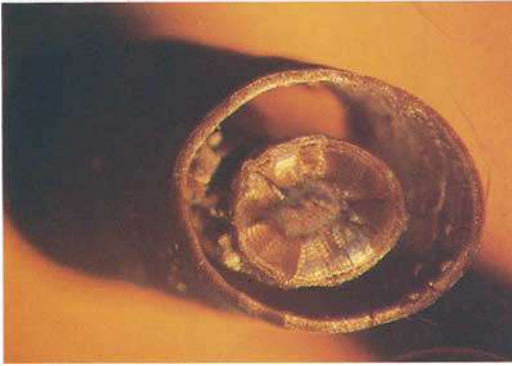

Fig. 12. Earthy-brown inclusions in a Mexican opal, of the iron hydroxide *goethite*, illustrate the 'tree-ring' form produced by the repeated cycles of opal deposition on pre-existing crystal inclusions. Transmitted and oblique illumination. 50x.



Fig. 13. A jumble of acicular crystals and thick black *hornblende* crystals projecting from the rhyolite matrix into the Mexican opal. Oblique illumination. 30x.



Fig. 14. A green-black *hornblende* crystal is covered with a crust of *limonite*. Note the thickness of the *limonite* layer at the top, near the fracture. Darkfield illumination. 34x.

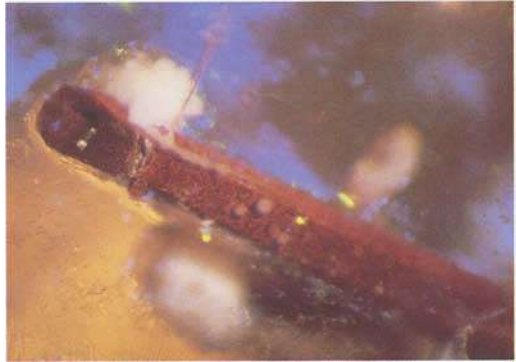

Fig. 15. Looking like billowy clouds, the dull white opaque masses associated with this brown *pseudomorph* of *limonite* after *hornblende* are inclusions of kaolinite, a clay mineral, in this Mexican opal. Oblique illumination. 40x.



Fig. 16. In a Mexican water opal, an unusual combination has occurred through the intergrowth of *hornblende*-fragments and *kaolinite*-platelets with some *rhyolite*-matrix. Darkfield illumination. 34x.



Fig. 17. *Limonite* *pseudomorphs* after *hornblende*, create a speleological image of stalagmites in a Mexican sherry opal. Darkfield with side illumination. 8x.





Fig. 18. A yellow opal from Tanzania is charmingly enlivened by numerous dendrites of *manganese oxide*, varying in size. Transmitted illumination. 25x.

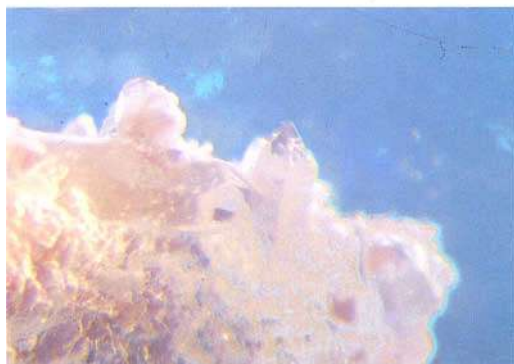

Fig. 19. Clear, transparent *pinnacles of rock-crystal* protrude from a crude mass of *kaolinite* in a Mexican blue opal. Darkfield. 50x.

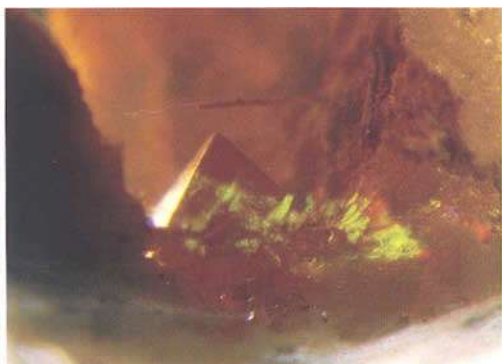

Fig. 20. A limonite-coated *rock-crystal peak* with flaming green colour-play, conjures up an ancient-Egyptian scene in a fire opal from Querétaro, Mexico. Darkfield with side illumination. 12x.



Fig. 21. Premising Nature has sketched the Pyramids of Gizeh, long before the Pharaohs of the IVth Dynasty erected them: peaks of *rock-crystal* coated with limonite, and *limonite rods*, pierce a Mexican fire opal from the rhyolite matrix. The reflection off the light-source gives the impression of a rising moon behind the pyramids. Darkfield with side illumination. 12x.



Fig. 22. An epigenetic pattern was produced when *iron-rich fluids* invaded the *fracture* in this Mexican opal and dried out. Transmitted light. 40x.

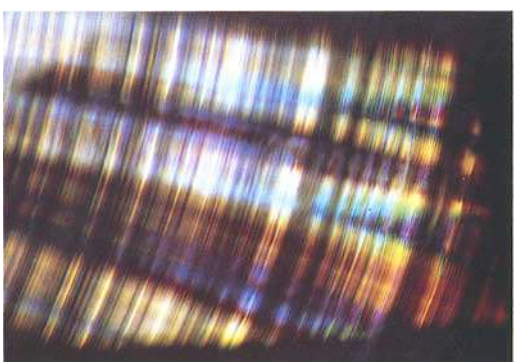

Fig. 23. The botryoidal finely laminated structure found in Mexican hyalite opals behaves as a diffraction grating and gives rise to bright interference colours. Darkfield illumination. 45x.

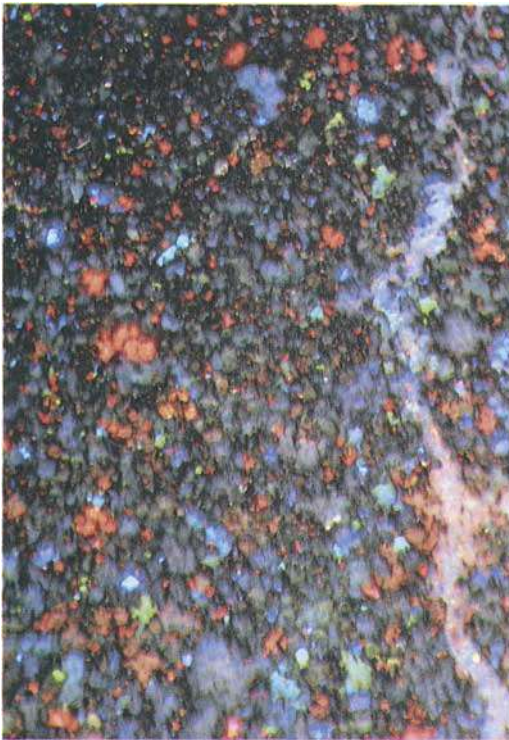
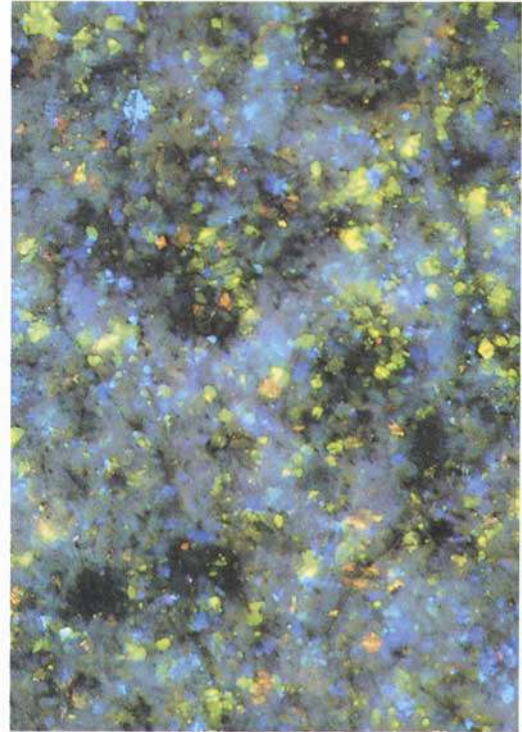
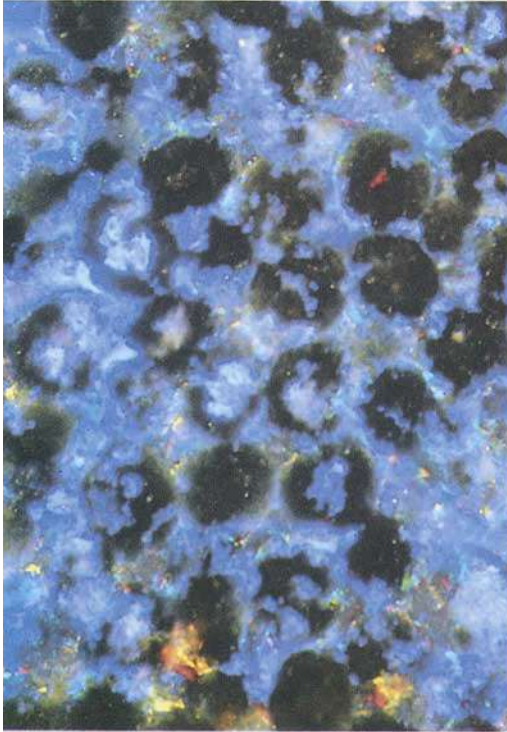

Fig. 24. (Top left.) The characteristic *circular structure* of Australian oolitic opal should not be confused with treated opals. Oblique illumination. 20x.

Fig. 25. (Top right.) The *black cloud-like patches* of subsurface soot characteristic of *smoke-treated* Mexican opals, are visible in this photomicrograph. Oblique illumination. 30x.

Fig. 26. (Left.) Porous Australian opals *treated* with sugar and sulphuric acid to give them a black body-colour. Under the microscope, such 'sugar-treated' opals have a *pepper-like* character. Oblique illumination. 30x.

## Notes from the Laboratory – 7

*Kenneth Scarratt, F.G.A.*

The Gem Testing Laboratory of Great Britain,  
27 Greville Street, London, EC1N 8SU

It has been said that as the Author has written 'Notes from the Laboratory' from what appear to be three different laboratories over the last five years, some explanation is needed.

It is not, as might be thought, that the author likes to flit from one laboratory to another, indeed he has remained in just one. It is the Laboratory's name that has changed, firstly from 'The Gem Testing Laboratory of the London Chamber of Commerce and Industry' and then to 'The British Gem Testing Laboratory of the London Chamber of Commerce and Industry'. The Laboratory is now known as 'The Gem Testing Laboratory of Great Britain'.

This latest change, however, has been a little more than just a change in name. The Laboratory is now no longer a part of the London Chamber of Commerce. It is an entity on its own and is administered by a committee made up from the Laboratory's members, and representatives from the Gemmological Association of Great Britain, the National Association of Goldsmiths and the British Jewellers Association. It is financed by its members and the above Associations, as well as the London Diamond Bourse, the London Diamond Club and others. The Laboratory, initially directed by B.W. Anderson from 1925 and then by A.E. Farn from 1972 to 1981 has now entered a new era in which the Associations have more influence over its operations.

\* \* \*

Whilst reading a newly published book on pearls<sup>(1)</sup> we noted a half page description of one of the most intriguing of all 'pearls', the 'Southern Cross'. This reminded us of our examination in 1981 of a group of pearls which were reputed to be the 'Southern Cross'.

*The Book of the Pearl* by Kunz and Stevenson<sup>(2)</sup> describes the 'Southern Cross' as '... nine attached pearls forming a Roman Cross about one and one half inches in length, seven pearls constituting the shaft or standard, while the arms are formed by one pearl on each side of the second one from the upper end'.

The group of pearls examined in 1981 meets with this description (Figures 1a,1b). Its length is approximately 37.2 mm, the width is approximately 18.3 mm and its weight is 24.79 ct.

The 'Southern Cross' is said to have been found in one piece by a boy named Clark, but before he could hand it over to his employer, James Kelly, it had broken into three distinct pieces.

Kunz and Stevenson further credit Henry Taunton as making a 'positive statement' that 'there were only eight pearls in the cluster when it was sold by Kelly in 1883, and to make it resemble a well-proportioned cross – the right arm being absent – another pearl of suitable size and shape was subsequently secured at Cossack and attached in the proper place to the others, which in the meantime, had been re-fastened together by diamond cement, thus making three artificial joints . . .'

If the group of pearls examined in 1981 is the 'Southern Cross', whilst all the pearls forming the cross are natural, there are now only two natural joints between the pearls (A and B in Figure 2). Joint 'A' has been strengthened by the addition of some adhesive on one side and all the remaining joints are now artificial.

The internal natural structures in the individual pearls are fine, and therefore the detail in the radiograph of this group will not reproduce well. The radiograph in Figure 3 displays the junctions between the pearls.

\* \* \*

At least to the unaided eye, glass can provide one of the most convincing imitations of jadeite. In the past this has been particularly true of glass which has a mottled green colouring and a profusion of spherical bubbles. This type was often used for bead necklaces.

Another glass which is proving to be a popular substitute for jadeite is the devitrified type. This material can be made to resemble jadeite closely in both colour and general appearance. When cabochons are set in rings they can be very convincing.

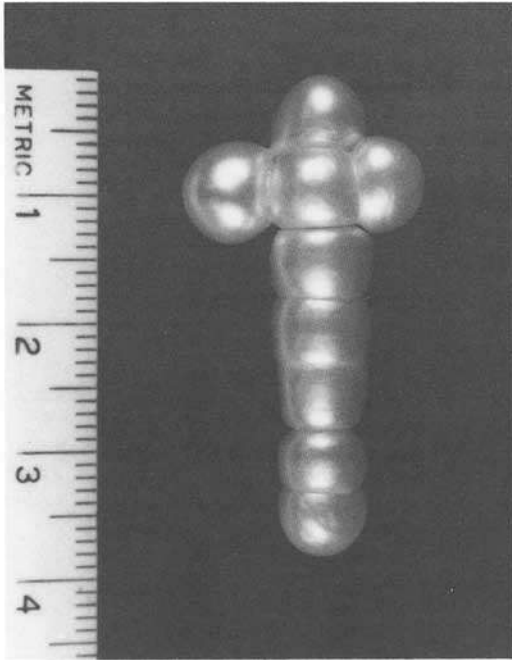
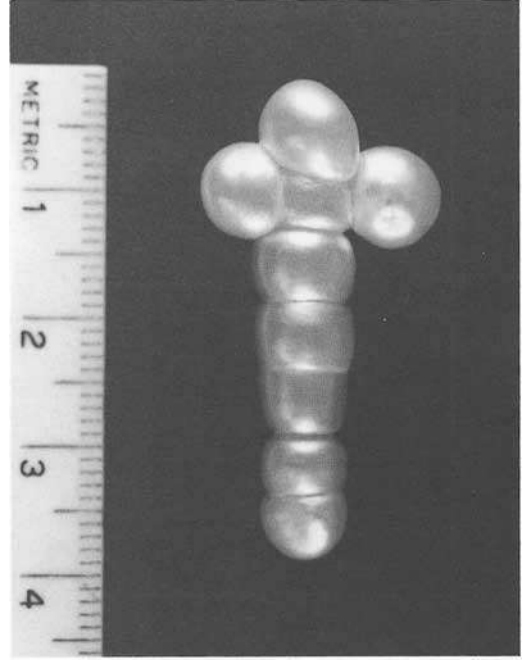

Fig. 1. (a) Group of natural pearls said to be the 'Southern Cross' (front).



(b) Group of natural pearls said to be the 'Southern Cross' (back).

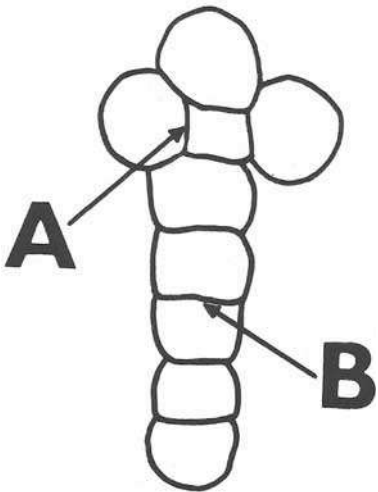

Fig. 2. Diagram of 'Southern Cross' (see Figure 1b) indicating the remaining natural junctions between the pearls (A and B). All the remaining joints are artificial.

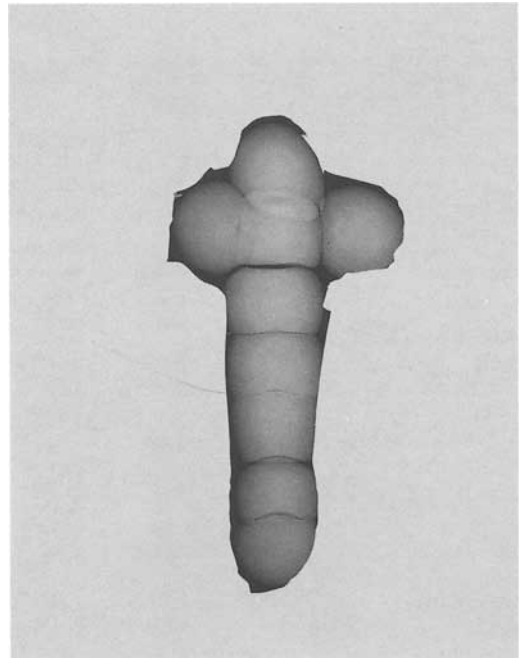

Fig. 3. Radiograph of the 'Southern Cross' displaying the junctions between the pearls.

The stones set in the ring in Figure 4 are examples of how plausible this material can be, particularly when seen in the 'correct' setting. Both cabochons are glass with RIs in the region of 1.52 and fibrous inclusions (Figure 5).



Fig. 4. Two pieces of devitrified green glass, cut as drop-shaped cabochons and set in a ring. The setting is similar to that commonly used for jadeite.



Fig. 5. Fibrous inclusions in the devitrified glass of Figure 4.

The introduction of the cultured pearl could have spelled disaster for the economies of the Gulf States which were reliant upon the pearl as one of their main sources of income. However, the discovery of oil and gas relegated the pearl, in terms of proportion of national income, to a much lower level, and therefore all was saved.

Even with this wealth, the old pearling nations have not altogether forgotten the traditions associated with producing some of the world's finest pearls. The pearling families have not deserted the pearl, and much of the trading flow in natural pearls is now in the opposite direction. The pearls that were fished in the Gulf and sold on the European markets are now returning to the Gulf.

Amongst the modern buildings which are the Bahrain of today, merchants can still be found trading in the age old way (Figure 6) and even a humble rubbish skip makes a passer-by aware of the country's history (Figure 7). Bahrain was one of the greatest pearling centres and is still a centre for natural pearls" it is said to be illegal to import a cultured pearl.

In about 1915, Qatar, a close neighbour of Bahrain and another of the great pearling nations, had 350 pearling boats based in its main town Doha. At that time Doha was a town of some 12 000 people with a *suq* of about 50 shops and a Ruler's palace. There were also 60 sea-going trading boats running to Oman and nearly 100 fishing boats.

This may seem a little out of place in 'Notes from the Laboratory', but many gemmologists make the journey to Sri Lanka or Thailand at least once in their lives, if not on a regular basis. Sadly only a few have taken the opportunity to break their flights either in Bahrain or Qatar, or any of the other Gulf States which are regular stops for most aircraft flying between the UK and the Far East.

There is much of gemmological interest in both Bahrain and Qatar. The National Museum in Qatar boasts an excellent display of the many qualities of natural pearl (Figure 8) and pearl diving and trading equipment (Figures 9 and 10). In the same museum a large aquarium brings home to the visitor the many natural dangers faced by the pearl divers each time they entered the Gulf waters.

Simply, this 'note' is a reminder to the organizers of gemmological tours which pass through the Gulf, and to the regular traveller, that a large slice of gemmological history evolved in the area.

\* \* \*

A green diamond brought into the Laboratory for testing (Figure 11) was found to be radioactive, and it was possible to detect this radioactivity through a sheet of lead 0.1 mm in thickness. Monitor measurements indicated that the degree of radioactivity in the pavilion area was much greater than that in the crown area.

Whilst still in its setting the stone was placed on its side, as in Figure 12, on a piece of X-ray film for 118 hours. This produced the autoradiograph in Figure 13.

As the stone aroused a little curiosity the client was asked if he would give his permission for it to be unset. This was necessary in order to obtain a clearer view of its pavilion surface and to record its spectrum.



Fig. 6. A pearl merchant in Bahrain with his natural pearls and the tools of his trade.



Fig. 7. Insignia on rubbish skips in Bahrain display the importance the pearling industry has had for the country.



Fig. 8. Yakkah or second quality natural pearls on display at the museum in Doha.



Fig. 9. Pearl diving equipment on display at the museum in Doha.



Fig. 10. Pearl merchants equipment on display in the museum in Doha.



Fig. 11. Radioactive green diamond set in a ring.



Fig. 12. Radioactive green diamond set in ring (as Figure 11), side view. Refer to Figure 13.

The spectrum displayed a weak GR1 band (Figure 14), and unlike a previously reported stone<sup>(3)</sup>, which had brown diamond characteristics, this appeared to be a Cape series stone.

When examined with a microscope, it could be seen that the green colour was located at and just below the surface of the pavilion facets. There was no green coloration in the crown facets. The colour in the pavilion facets was blotchy with many pin-point sized, and some slightly larger, near colourless areas (Figure 15). In addition there were many small deep green marks, which varied in size and shape, in the same area.

It would seem that this diamond had been treated on the pavilion only and not on the crown. This was confirmed by two further autoradiographs, the first of which (Figure 16) was taken with the table facet down on X-ray film. Here it can be seen that there has barely been any exposure of the film in the area which was in contact with, or close to, the crown of the stone. The second autoradiograph (Figure 17) was taken with one of the pavilion facets resting on the film. In comparing Figures 16 and 17 it should be noted that the exposure time for Figure 16 is 16½ hours whilst that used for Figure 17 is only 30 minutes.

With the stone in the same position, a similar and only slightly weaker exposure to that in Figure 17 was obtained in only 15 minutes.

A close examination of Figure 17 will reveal a number of intense black spots which appear to be associated with the deep green marks on the surface of the stone.

The stone measured 8.23–8.50 × 4.52 mm and weighed 1.91 ct.

\* \* \*

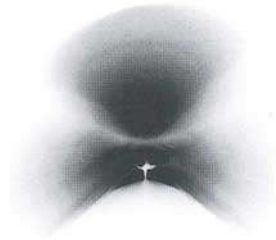

Fig. 13. Autoradiograph produced by the green diamond of Figure 11 when positioned on X-ray film in the manner of Figure 12 for a period of 118 hours.



Fig. 15. The blotchy coloration on the pavilion facets of the radioactive diamond in Figure 11. Note also the intense green spots.

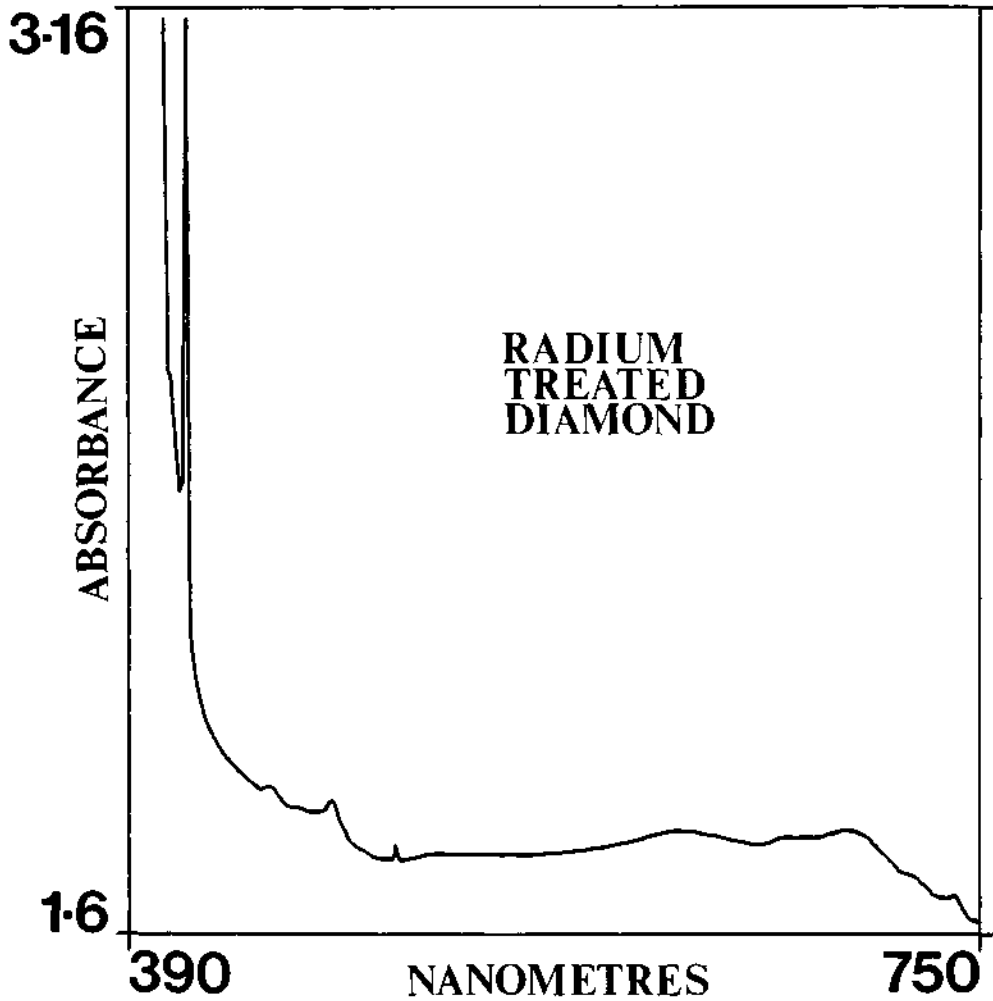

Fig. 14. The absorption curve of the radioactive green diamond in Figure 11 displaying a Cape series spectrum and a weak GR1 band. The curve was obtained using a Pye Unicam PU8800/03 UV/visible spectrophotometer (Basil Anderson model) with a speed of 0.5 nm/s and a bandwidth of 0.5 nm at approximately 120 K.

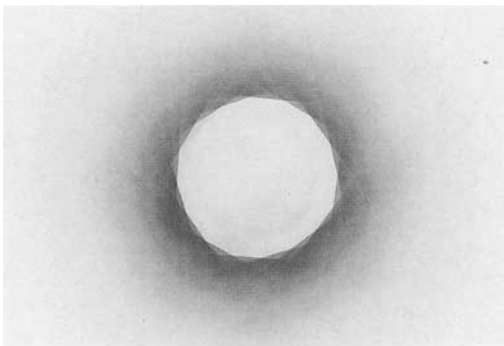

Fig. 16. Autoradiograph produced by the green diamond in Figure 11 when positioned with its table in contact with X-ray film. Exposure time 16½ hours.

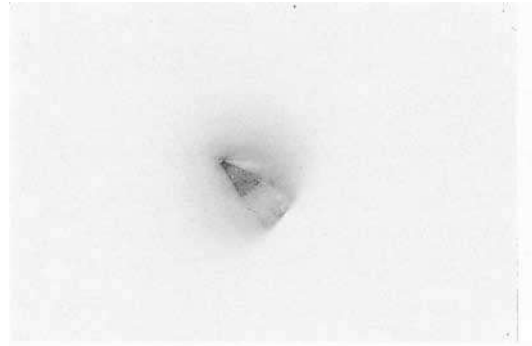

Fig. 17. Autoradiograph produced by the green diamond in Figure 11 when positioned with a pavilion facet in contact with X-ray film. Exposure time 30 minutes.



A recent gift to the Laboratory collection is seen in Figure 18. It is a fibrolite (sillimanite), the identity of which has been confirmed by X-ray powder diffraction.

The specimen is a 1.48 ct slice taken from a light yellowish water-worn crystal. The SG as determined by hydrostatic weighing, is 3.30 and the RIs are 1.660–1.682. Whilst the RI readings as determined on a Rayner Dialdex refractometer appear to be biaxial positive the difference between  $\alpha$  and  $\beta$  is so small as to make this determination difficult.

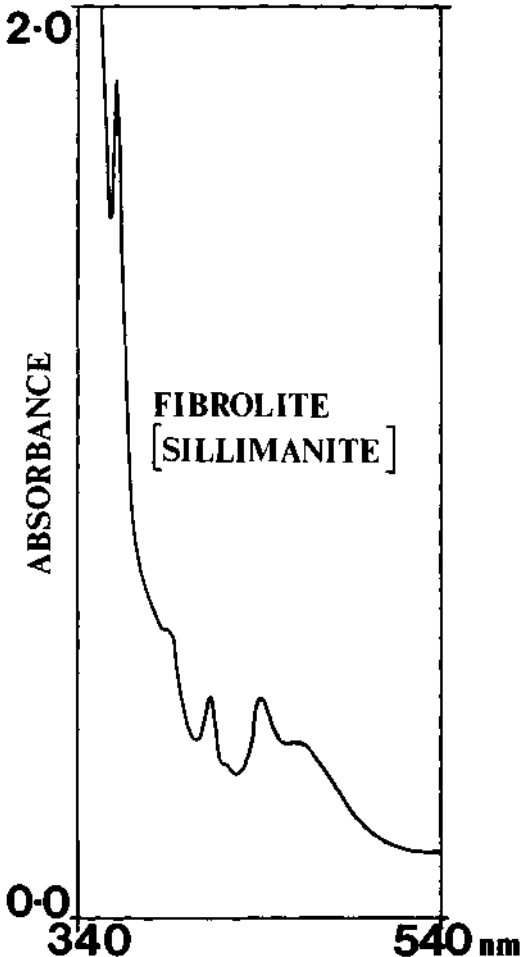

Fig. 19. The absorption curve of the fibrolite in Figure 18. The curve was obtained using a Pye Unicam PU8800/03 UV/visible spectrophotometer (Basil Anderson model) with a speed of 0.5 nm/s and a bandwidth of 0.5 nm at room temperature. The path length was 2.39 mm. The main peaks in the curve are at 460.2, 440.8, 412.8, 389 and 360.8 nm.



Fig. 18. A 1.48 ct fibrolite specimen given to the Laboratory collection.

Under both long-wave and short-wave ultraviolet light the stone fluoresces a weak orange. This fluorescence is stronger under long-wave ultraviolet than short-wave.

The pleochroism is strong, the colours being yellow, light yellow and colourless. The absorption spectrum is shown in Figure 19 and the main absorption peaks are at 460.2, 440.8, 412.8, 389 and 360.8 nm.

\* \* \*

We are fortunate in that at the same time as our benefactor donated the fibrolite to the Laboratory collection, he also gave us the opportunity to examine an interesting specimen of taaffeite.

The stone, which is a bluish, smoky grey colour in daylight, is shown photographed in artificial light in Figure 20. It weighs 0.70 ct and measures 5.19 × 4.68 × 2.78 mm.



Fig. 20. Four examples of taaffeite. (i) A round faceted stone weighing 0.86 ct from the British Museum (Natural History) collection (BM 1967.309). (ii) A 0.70 ct stone belonging to Mark L. Jones, F.G.A. (iii) Rough material weighing 2.78 cts from the BM (NH) collection (BM 1979.417). (iv) The 0.56 ct cushion-shaped, type specimen, owned by R.K. Mitchell, F.G.A. and on loan to the Geological Museum.

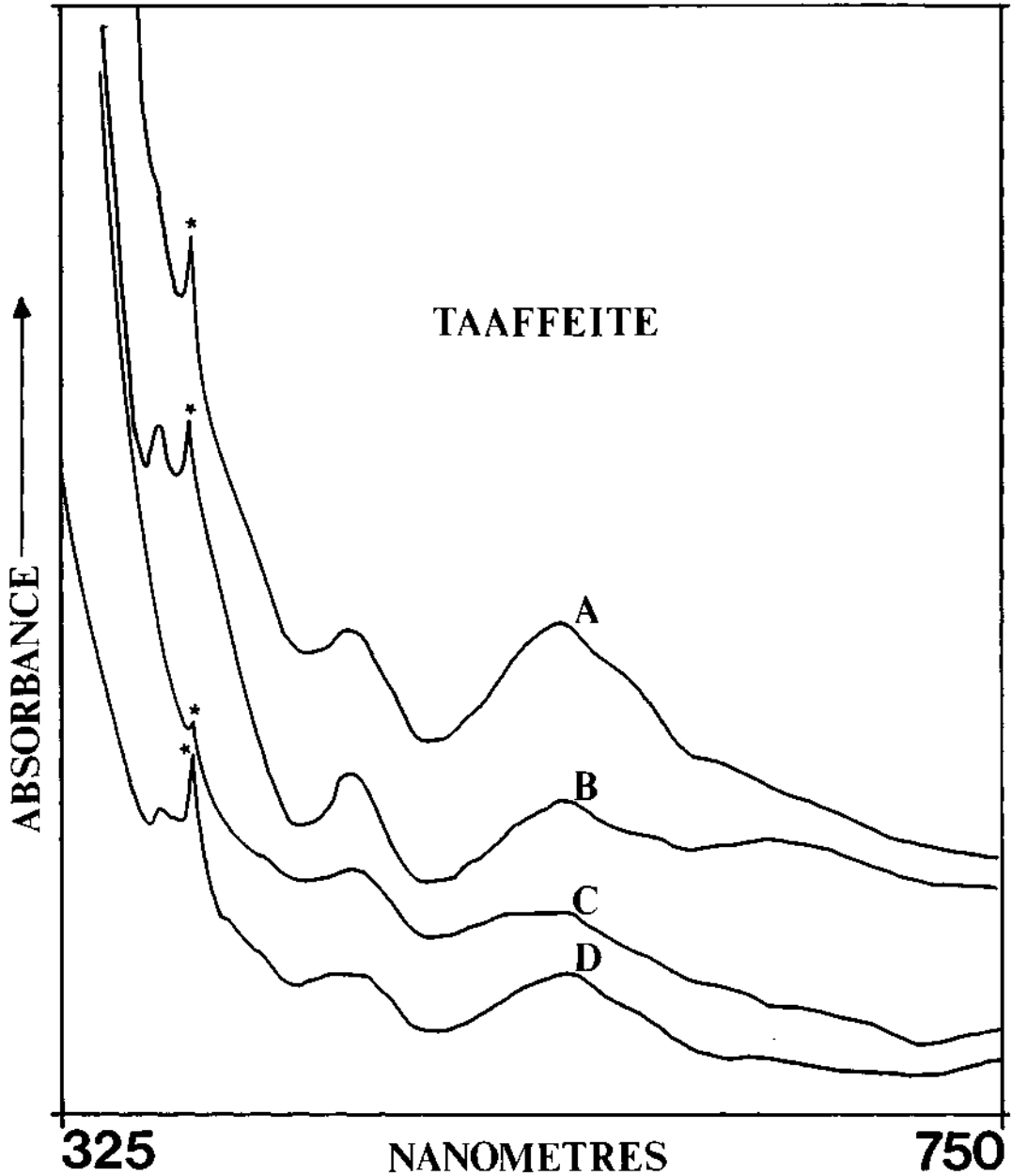

Fig. 21. The spectra produced by the four taaffeites in Figure 20. Curve A is that of the rough specimen (Figure 21 iii), curve B is that of the specimen belonging to Mark L. Jones, F.G.A. (Figure 21 ii), curve C is that of the type specimen (Figure 21 iv), and curve D is that of the round faceted stone (Figure 21 i). The peaks indicated by \* are at a slightly different wavelength for each specimen. These are, A, 385 nm, B, 383.4 nm, C, 384.4 nm, D, 384.8 nm. All curves were recorded under similar conditions using a Pye Unicam PU8800/03 UV/visible spectrophotometer (Basil Anderson model) with a speed of 1 nm/s for curves A, C and D and 0.5 nm/s for curve B. The bandwidth for each curve was 0.5 nm, the span 2A and each was recorded at room temperature. The path lengths were approximately A, 7.1 mm, B, 2.78 mm, C, 4.89 mm and D, 5.28 mm.

The refractive indices as determined with a Rayner Dialdex refractometer are 1.718–1.724 and the SG obtained by hydrostatic weighing is 3.67.

There is very little difference between the absorption spectrum produced by the ordinary ray and that produced by the extraordinary ray. The spectrum recorded at approximately 90° to the optic axis is reproduced as (B) in Figure 21. By way of comparison the spectra of three further taaffeites, including the type specimen, (Figure 21), were examined under similar conditions. These spectra are also reproduced in Figure 21.

\* \* \*



Fig. 22. Heavily included synthetic diamond grit with an average grain-size of 0.4 mm.

As explained by Anderson in his book *Gem Testing*<sup>(4)</sup> the Laboratory on many occasions has been asked to examine diamond grits and powders, when dealers in industrial diamond have been concerned about the purity or grit size of lots they propose to purchase.

Although we are not asked quite so often nowadays to examine these grits and powders, when we are they are usually composed of very fine-grained natural diamond and only occasionally are they synthetic diamond. When they have been synthetic diamond, the grain size has also been very small.

Recently we were asked to examine a sample of synthetic diamond grit weighing 1.33 ct in which the average grain size was 0.4 mm (Figure 22).

The sample was attracted to a hand magnet and, as is normal for synthetic diamond grit, the individual crystals were heavily included (Figure 22). It appeared also that the greater the amount of inclusions the greater the reaction there was to the magnet.

The examination to estimate the percentage of impurity present was carried out in the manner described by Anderson<sup>(4)</sup>. Two small samples from the larger sample were examined and the impurity percentages were found to be 9.78% and 0.78%. The impurity reacted strongly to a magnet.

#### Acknowledgements

It is with pleasure that the Laboratory gratefully acknowledges the gift of the fibrolite from Mark L. Jones, F.G.A. We are also indebted to Mr Jones for the sight of his taaffeite specimen, and to Dr R.R. Harding, and Mr R.K. Mitchell, F.G.A., for allowing us to examine the spectra of the other three specimens of taaffeite. Figures 1 and 2 were taken by Mr T.J. Rappitt, F.G.A., in 1981.

#### References

1. Taburiaux, J. 1985. *Pearls, Their Origin, Treatment and Identification*. NAG Press, Ipswich, England.
2. Kunz, G.F. and Stevenson, C.H. 1908. *The Book of the Pearl*. Macmillan and Co. Ltd., London.
3. Scarratt, K. 1985. Notes from the Laboratory. *J. Gemm.*, XIX, 8, 653.
4. Anderson, B.W. 1980. *Gem Testing*, 9th edn, 239–41. Butterworths, London.

[Manuscript received 14 April 1986.]

# Some observations on brown tourmalines from Elahera, Sri Lanka

Ulrich Henn and Martin Schramm

Institut für Edelsteinforschung, University of Mainz, West Germany

## Abstract

This paper deals with the description of brown tourmalines from Elahera, Sri Lanka. They were classified as uvite and dravite as a result of their chemical and optical properties.

## Introduction

In the Sinhalese linguistic usage, the name tourmaline is applied as a generic term to a number of coloured gemstones. But the mineral tourmaline itself is relatively rare and it occurs exclusively in the brown variety. Until now the known deposits are located in the Uva region, in the Ratnapura district and in the Tissamaharma area (Dunn, 1977 and Zwaan, 1982). These occurrences are always alluvial deposits.

All tourmalines are members of solid solution series with the general composition:  $XY_3Z_6[(OH)_4(BO_3)_3(Si_6O_{18})]$  with  $X=Na, Ca$ ;  $Y=Li, Al, Mg, Fe, Mn$ ;  $Z=Al, Fe, Mg$ .

Analyses from Dunn (1977) classified the brown tourmalines from Sri Lanka as uvite and dravite:

$Ca Mg_2 (Al_5, Mg) [(OH)_4(BO_3)_3(Si_6O_{18})]$  – Uvite  
 $Na Mg_3 Al_6 [(OH)_4(BO_3)_3(Si_6O_{18})]$  – Dravite

The occurrence of brown tourmalines of gemstone quality in the Elahera area was mentioned by Henn (1983), but more detailed studies were not made earlier.

## Results

For the analyses orientated slices from brown to dark brown tourmaline crystals were cut and polished. The following values for the refractive indices and densities were measured:

Dravite	Uvite
$n_o = 1.640$	$n_o = 1.635 - 1.648$
$n_e = 1.623$	$n_e = 1.619 - 1.631$
$n_e - n_o = -0.017$	$n_e - n_o = 0.016 - 0.021$
$D = 2.922 \text{ g/cm}^3$	$D = 2.85 - 3.24 \text{ g/cm}^3$

Under the microscope the tourmalines show their characteristic unorientated feathers, consisting mostly of elongated fluid and two-phase inclusions. Furthermore orientated hollow tubes are present, which are often filled with two immiscible fluids. As

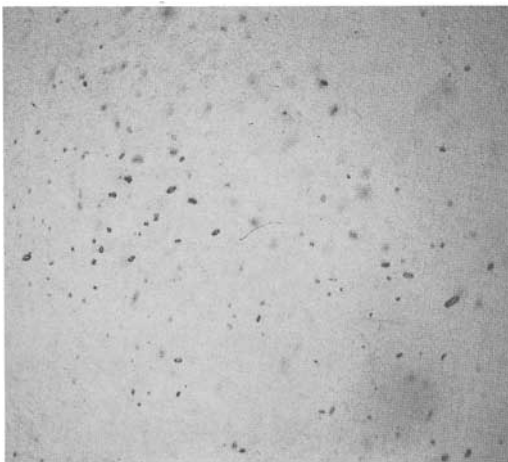

Fig. 1. Rounded zircon crystals in a brown tourmaline from Elahera, Sri Lanka. (25x)

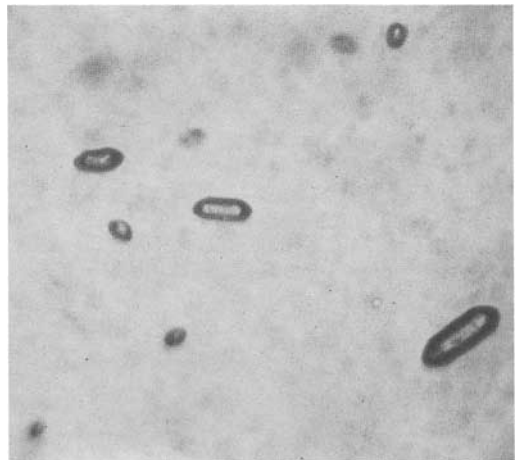

Fig. 2. Rounded zircon crystals in a brown tourmaline from Elahera, Sri Lanka. (125x)

mineral inclusions rounded zircon crystals (Figs. 1 and 2) were observed and their chemical compositions analysed with the electron microprobe. The results are listed in Table 1.

**Table 1. Electron microprobe analyses of zircon inclusions in brown tourmalines from Elahera, Sri Lanka (Wt %)**

	Inclusion 1	Inclusion 2	Inclusion 3
SiO <sub>2</sub>	29.76	32.42	29.80
Al <sub>2</sub> O <sub>3</sub>	0.03	0.06	0.08
Na <sub>2</sub> O	0.01	—	0.02
CaO	—	0.04	—
TiO <sub>2</sub>	0.19	0.03	0.03
V <sub>2</sub> O <sub>3</sub>	—	0.10	0.04
MnO	—	0.29	0.05
FeO	0.51	0.60	0.54
ZrO <sub>2</sub>	71.74	68.68	68.34
Total	102.25	102.19	98.90

**Table 2. Electron microprobe analyses of brown tourmalines from Elahera, Sri Lanka (Wt %)**

	Uvite		Dravite
	variation out of 11 samples	average	
SiO <sub>2</sub>	36.95–37.76	37.45	37.13
Al <sub>2</sub> O <sub>3</sub>	29.01–30.21	29.60	32.24
Na <sub>2</sub> O	0.77– 0.98	0.88	1.59
K <sub>2</sub> O	0.03– 0.15	0.07	0.06
MgO	11.22–13.45	12.23	11.27
CaO	3.80– 4.13	3.93	1.96
FeO	0.64– 1.50	1.11	0.78
MnO	n.d.– 0.07	0.04	0.04
TiO <sub>2</sub>	0.34– 1.06	0.63	0.59
Total	84.37–87.68	85.93	85.66

Chemical analyses of the tourmalines were also determined by the electron microprobe (Table 2). With one exception, all examined samples are uvites (Ca>Na) with the uvite forming 60.0 to 77.8% of the crystal. Only one sample was analysed as a dravite (Ca<Na), consisting of 62.5% dravite. The schorl variety forms between 2.9 and 6.9% of the uvites and 10% of the dravite. The terms Ca>Na and Ca<Na are related to the number of atoms. From the chemical analyses the following specific formulae for uvites and dravites from Elahera were calculated:

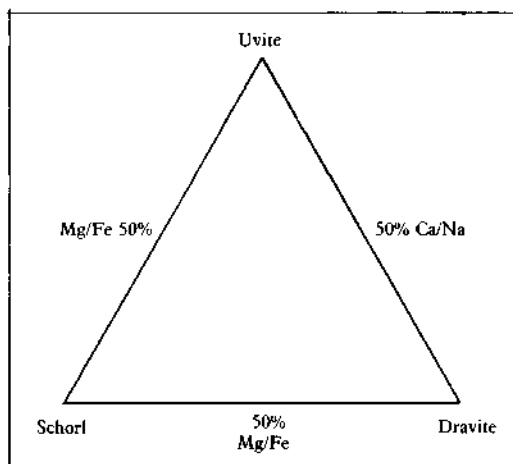
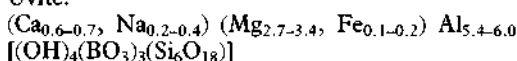

Fig. 3 System uvite-dravite-schorl with samples from Elahera plotted.

Uvite:



Dravite:

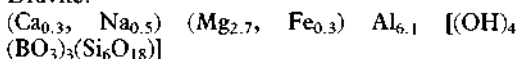

Fig. 3 shows the place of the tourmaline samples from Elahera in the system uvite-dravite-schorl.

Absorption spectra of tourmalines were described by Faye *et al.* (1968), Manning (1968), Faye *et al.* (1974) and Smith (1978). Fig. 4 shows absorption spectra with varying orientations of uvites from Elahera in polarized light. The absorption maxima and the corresponding charge-transfer processes are listed in Table 3. The absorption band, caused by the charge-transfer process  $\text{Fe}^{2+} \rightarrow \text{Fe}^{3+}$  has one maximum at 760 nm for E||c and one at 690 nm for E⊥c. These absorption bands were observed in

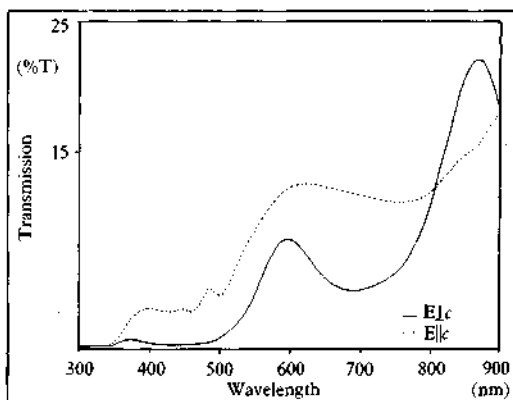

Fig. 4. Absorption spectra of a uvite from Elahera, Sri Lanka, in polarized light and different orientations.

**Table 3. Absorption maxima and charge-transfer processes of brown uvites from Elahera, Sri Lanka**

	absorption maxima (nm)	charge-transfer processes
E  c	760	Fe <sup>2+</sup> → Fe <sup>3+</sup>
	500	
	460	Fe <sup>2+</sup> → Ti <sup>4+</sup>
	430	
E⊥c	690	Fe <sup>2+</sup> → Fe <sup>3+</sup>
	440	Fe <sup>2+</sup> → Ti <sup>4+</sup>

brown and green tourmalines (Smith, 1978) and have only slight influence on the colour (Manning, 1968). The absorption responsible for the brown colour has a maximum at 440 nm for E⊥c. At E||c this band split in three maxima at 500, 460 and 430 nm. It is caused by the charge-transfer process Fe<sup>2+</sup> → Ti<sup>4+</sup> (Smith, 1978).

## References

- Dunn, P.J. 1977. Uvite, A Newly Classified Gem Tourmaline. *J. Gemm.* 15, 300-8.
- Faye, G.H., Manning, P.G. and Nickel, E.H. 1968. The Polarized Optical Absorption Spectra of Tourmaline, Cordierite, Chloritoid and Vivianite: Ferrous-Ferric Electronic Interaction as a Source of Pleochroism. *Amer. Miner.* 53, 1174-1201.
- Faye, G.H., Manning, P.G., Gosselin, J.R. and Tremblay, R.J. 1974. The Optical Absorption Spectra of Tourmaline: Importance of Charge-Transfer Processes. *Can. Mineral.* 12, 370-380.
- Henn, U. 1983. Einschlüsse in Edelsteinen aus Elahera, Sri Lanka. *Goldschmiede Zeitung*, 11, 76.
- Manning, P.G. 1968. An Optical Absorption Study of the Origin of Colour and Pleochroism in Pink and Brown Tourmalines. *Can. Mineral.*, 9, 678-90.
- Smith, G. 1978. A Reassessment of the Role of Iron in the 5000-30000 cm<sup>-1</sup> Region of the Electronic Absorption Spectra of Tourmaline. *Phys. Chem. Minerals*, 3, 343-73.
- Zwaan, P.C. 1982. Sri Lanka: The Gem Island. *Gems Gemol.* 18, 62-71.

[Manuscript received 4 July 1985.]

# A re-investigation of gahnospinels from Sri Lanka

By Dr Karl Schmetzer\* and Prof. Dr Hermann Bank†

\*Institute of Mineralogy and Petrography, University of Heidelberg, West Germany  
and Deutsche Stiftung Edelsteinforschung, Idar-Oberstein, West Germany.

†Idar-Oberstein, West Germany

## Abstract

The chemical composition and physical properties of zincian spinels (gahnospinels) from Sri Lanka were re-investigated. The samples were found to represent intermediate members of the spinelgahnite solid solution series with minor components of hercynite. Refractive indices and densities of the samples are closely correlated to the molecular proportions of the gemstones. Colour, absorption spectra, and inclusions of zinc-bearing gahnospinels were found to be similar to the properties of ordinary zinc-free spinels from Sri Lanka. The data published by Anderson *et al.* (1937) as well as the existence of a continuous solid solution series between spinel and gahnite, which was also assumed by Anderson and his co-workers, were confirmed by these investigations.

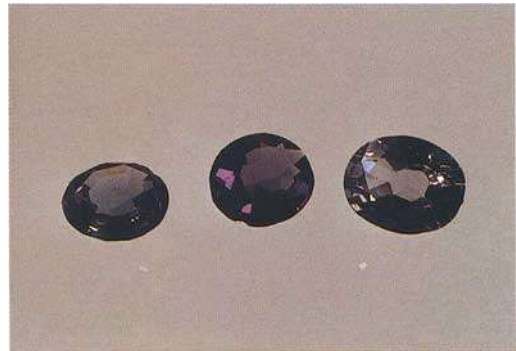

Fig. 1. Gahnospinels from Sri Lanka. Size of the samples approx. 8 × 10 mm. Photo by O. Medenbach, Bochum, FRG.

Table 1: Selected physical and chemical properties of gahnospinels from Sri Lanka\*

	d (g/cm <sup>3</sup> )	n	ZnO (wt%)	FeO (wt%)
1	3.60	1.716	0.14	2.34
2	3.60	1.715	0.86	1.34
3	3.72	1.723	7.18	1.92
4	3.75	1.724	7.36	1.69
5	3.77	1.731	10.27	2.52
6	3.80	1.733	11.55	1.74
7	3.86	1.737	12.98	1.47
8	4.00	1.741	18.74	0.78
A	3.967	1.7465	18.21	1.93
9	4.05	1.752	24.81	1.90
B	4.060	1.7542	not analysed	

\* for complete chemical data see Schmetzer & Bank (1985)

A sample analysed by Anderson *et al.* (1937)

B sample described by Anderson (1964) with extraordinarily high values for density and refractive index

Aluminous magnesium-zinc-spinels from Sri Lanka were first described by Anderson *et al.* (1937). The densities and refractive indices of 22 samples were found to range from 3.584 to 3.981 g/cm<sup>3</sup> and from 1.7153 to 1.7469, respectively. One sample was chemically analysed containing major amounts of Al<sub>2</sub>O<sub>3</sub>, ZnO and FeO (Table 1). The analysis represents a member of the aluminous spinel solid solution series with dominant molecular percentages of the idealized end members spinel MgAl<sub>2</sub>O<sub>4</sub> (62.4%) and gahnite ZnAl<sub>2</sub>O<sub>4</sub> (33.5%), as well as subordinate percentages of hercynite FeAl<sub>2</sub>O<sub>4</sub> (4.1%). According to a proposal of Anderson *et al.* (1937), zinc-bearing spinels are termed zincian spinels or gahnospinels in the literature.

Since that time gahnospinels have been frequently encountered in the gemmological laboratory of the London Chamber of Commerce. However, only one sample was recognized after 25 years of research, which exceeded the range for refractive indices and densities as described in the (1937) paper (Anderson, 1964). This sample showed outstandingly high figures for density and refractive index (Table 1) indicating an intermediate member of the isomorphous spinel-gahnite solid solution

series with molecular proportions of approximately 50% each of the gahnite and the spinel end member.

According to the physical data of Anderson *et al.* (1937), there is no evidence for a miscibility gap between both end members of the solid solution series, spinel and gahnite. However, chemical data of only one sample are available in the literature. Therefore, further investigations of chemical and physical properties of gahnospinel from Sri Lanka were carried out in order to complete the present knowledge on intermediate members of the spinel-gahnite solid solution series (Schmetzer & Bank, 1985).

All samples available to the authors were transparent, cut blue, bluish-violet or violet materials of gem quality (Figure 1). Most of the material was selected from cut gem spinels of ordinary parcels originating from Sri Lanka. Therefore, no further details about the exact localities for the zincian spinels are available.

Selected chemical and physical data of the samples are summarized in Table 1. Refractive

indices and densities are found to be within the range of the values published by Anderson *et al.* (1937) and Anderson (1964). The consistency of these properties (Figure 2) may indicate samples of similar chemical compositions in both investigations. Our microprobe analyses indicate that the spinels represent intermediate members of the spinelgahnite series within a compositional range of the predominant end members spinel (95.1–45.3 mol%) and gahnite (0.2–50.4 mol%) with minor components of hercynite (1.7–5.4 mol%). The physical properties are closely correlated to the molecular proportions of the samples, i.e. an increase of both density and refractive index is caused by an increasing Zn-component in the spinel-gahnite solid solution series. These physical data are also influenced by the slightly variable hercynite percentages of the samples (Table 1, Figure 2).

The colour of gahnospinel from Sri Lanka (Figure 1) is identical with the colour variation observed for ordinary blue, bluish-violet and violet

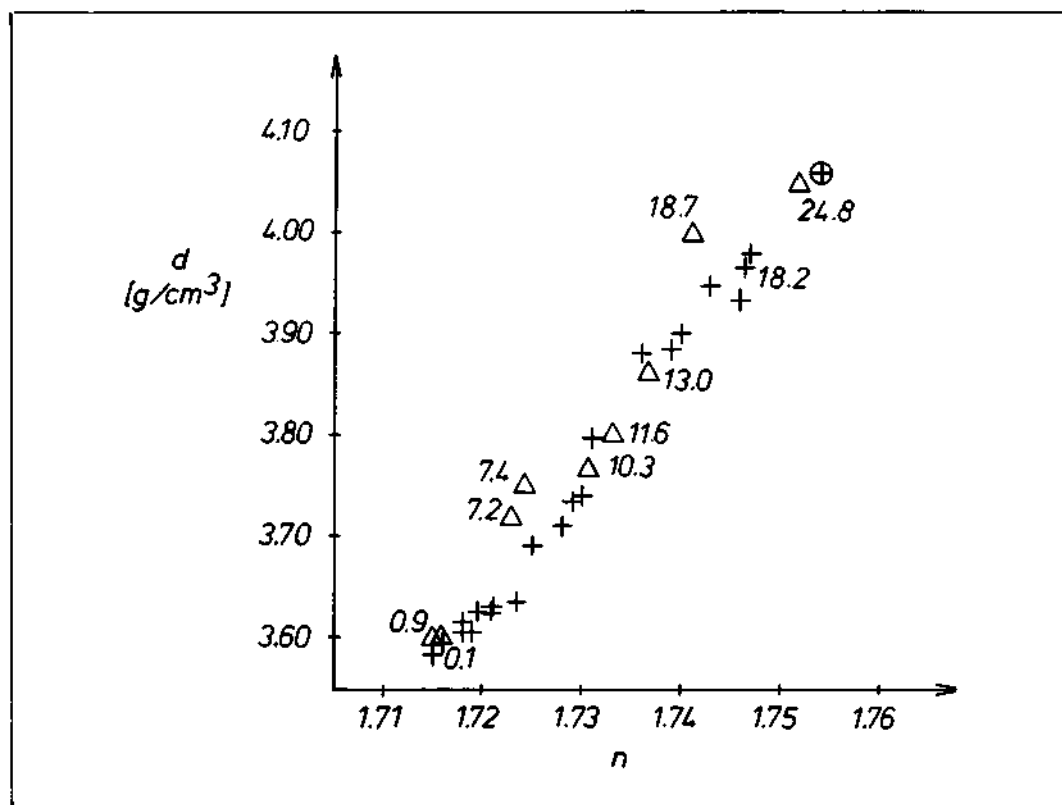

Fig. 2. Plot of densities vs refractive indices of gahnospinel from Sri Lanka; + indicates samples described by Anderson *et al.* (1937), ⊕ indicates the sample with extraordinarily high values for density and refractive index described by Anderson (1964), Δ indicates samples of Schmetzer & Bank (1985); the figures indicate weight percentages of ZnO.



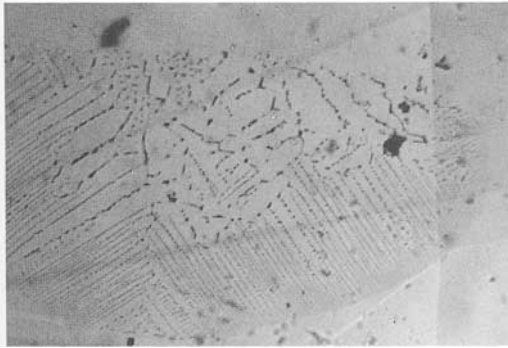

Fig. 3 Stringers of small particles in gahnospinel from Sri Lanka. 45x.



Fig. 4. Stringers of small particles in gahnospinel from Sri Lanka. 50x.

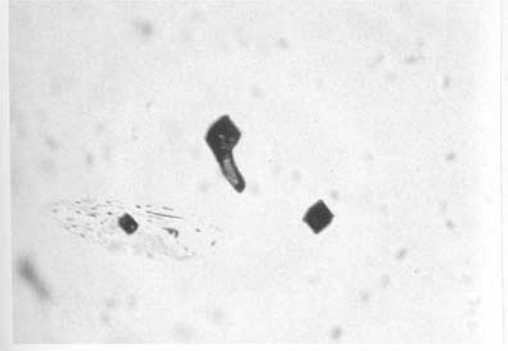

Fig. 5. Two octahedral crystals, one of them surrounded by a liquid feather, and one negative octahedron (middle) in gahnospinel from Sri Lanka. 60x.

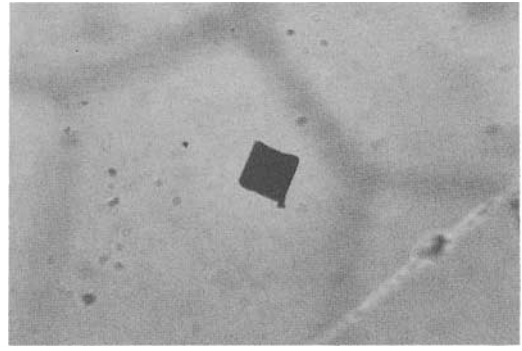

Fig. 6. Octahedral crystal in gahnospinel from Sri Lanka. 80x.

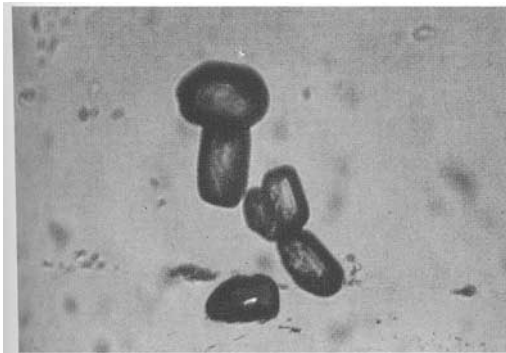

Fig. 7. Rounded mineral inclusions, most probably apatites, in gahnospinel from Sri Lanka. 100x.

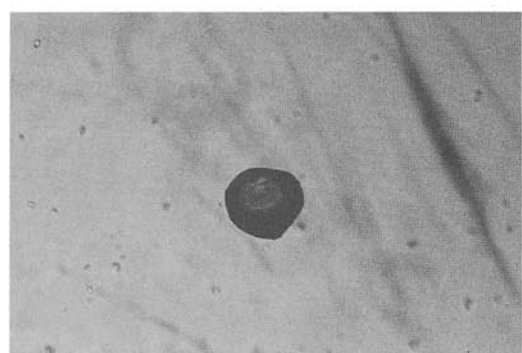

Fig. 8. Rounded mineral inclusion in gahnospinel from Sri Lanka. 65x.

gem spinels from Sri Lanka. The absorption spectra of gahnospinels and ordinary spinels do not show any significant differences. According to Dickson & Smith (1976) the absorption bands of natural blue spinels in the visible area are mainly due to spin-forbidden transitions of tetrahedrally co-ordinated  $\text{Fe}^{2+}$ . Thus, the colour of spinels of unknown composition, e.g. of rough spinels, is of no diagnostic value for a distinction between ordinary spinels and gahnospinels.

The inclusions observed in gahnospinels from Sri Lanka do not reveal any extraordinary properties compared to the inclusions which are common for ordinary gem spinels from this country (Figures 3–8). Most frequently stringers of small particles, either in straight lines or as fingerprints, were found. Individual octahedra, occasionally surrounded by a liquid feather, as well as mineral inclusions of various shapes were observed. In two samples, one solid inclusion was exposed on the table of the cut gemstone in each case. Both inclusions were determined as apatite by microprobe analysis.

The chemical composition and the physical data of gahnospinels from Sri Lanka confirm the assumptions of Anderson *et al.* (1937). These authors suggested that transparent blue or violet gem spinels from Sri Lanka with extraordinary high densities and refractive indices are members of a

complete solid solution series with major components of spinel and gahnite and minor components of hercynite. At present, the compositional range of gahnospinels from Sri Lanka is found to vary within the aluminous spinel solid solution series from about 95 to 45 mol% spinel, and from about 0.2 to 50 mol% gahnite with hercynite components of about 2–5 mol%. No significant difference is found between the absorption spectra and colour of gahnospinels and ordinary gem spinels from Sri Lanka nor between the inclusions in zinc-containing and zinc-free samples.

### References

- Anderson, B.W. 1964. Three Stones for the Record. *J. Gemm.*, **IX**, 7, 215–21.
- Anderson, B.W., Payne, C.J. & Hey, M.H. 1937. Magnesium-zinc-spinels from Ceylon. *Mineral. Mag.*, **24**, 547–54.
- Dickson, B.L. & Smith, G. 1976. Low-temperature optical absorption and Mössbauer spectra of staurolite and spinel. *Canad. Mineral.*, **14**, 206–15.
- Schmetzer, K. & Bank, H. 1985. Crystal chemistry of zincian spinels (gahnospinels) from Sri Lanka. *N. Jb. Miner. Mh.*, **1985**, **8**, 353–6.

[Manuscript received 18 June 1985.]

## Some unusual cat's-eyes

*Yasuhiro Ito, G.G., F.G.A.*

Osaka, Japan

Chatoyancy adds beauty and rarity to a gemstone. Some chatoyant gems, such as zircon, tanzanite and opal, may command a very high price, but they are not necessarily beautiful. In this short report I shall describe three unusual cat's-eyes from my collection.

*Sillimanite cat's-eyes* (which are now available) are mostly from India. Serious collectors can usually obtain them. They are commonly greyish-green in colour, with black inclusions proved to be magnetite and hematite (Zwaan, 1982). There

'eyes' are usually broad and dull, and they can often be identified at sight and without the use of instruments.

In 1984 I obtained a 0.73 ct stone, reputedly from Sri Lanka. This has a beautiful yellowish-green colour and a very sharp eye due to a good fibrous structure (Figure 1). The stone resembles chrysoberyl cat's-eye of good quality, so chatoyant sillimanite now has to be considered as a chrysoberyl simulant. The stone was identified as sillimanite from the refractive index (1.67 by the distant vision method) and its X-ray diffraction data.

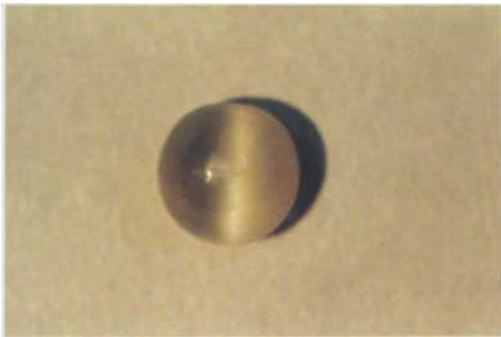

Fig. 1. Sillimanite (fibrolite) cat's-eye, 0.73 ct.



Fig. 2. Kyanite cat's-eye with tubular inclusions.



Fig. 3. Tubular inclusions in kyanite cat's-eye.



Fig. 4. Petalite cat's-eye possibly from South Africa, 17.03 ct.

*Kyanite cat's-eye* came into my possession in 1984 when I bought a few cabochons. They all had a royal blue colour but were of low quality due to heavy cleavage and inclusions. One flat cabochon weighing 5.26 ct (Figure 2) shows chatoyancy. It shows prominent cleavages and tubular inclusions running at right angles to the cleavages (Figure 3). The chatoyancy could be due to the tubular inclusions, and as these are coarse the 'eye' is not very sharp, although it can be seen under a normal fluorescent lamp without a penlight. Such a stone is a collectors' item only and is useless for jewellery on account of its fragility and inclusions.

*Petalite cat's-eye* was sold to me as analcime from an unknown locality. This pretty pale pink stone weighs 17.03 ct, is almost opaque and massive, but possesses a sharp but superficial chatoyancy. The refractive index was determined as 1.50 by the distant vision method. The X-ray diffraction data proved the stone to be petalite.

Petalite in the gem market is usually colourless and transparent, but massive pink material from

South Africa is sometimes cut en cabochon and may show chatoyancy. Petalite-analcime cat's-eyes, translucent and pinkish-brown in colour, have been found (Bank, 1982) in Zimbabwe. My stone (Figure 4) is pink, and no analcime lines were found in the X-ray diffraction pattern. Thus, this stone may be described as petalite cat's-eye, maybe from South Africa.

I wish to thank Mr S. Kinoshita, Mr S. Kihara and Mr K. Kuraya for their kind and useful advice, and Mr S. Fujiwara for taking X-ray diffraction photographs.

### References

- Bank, H. 1982. Petalite-analcime cat's-eyes from Zimbabwe. *Z. Di. Gemmol. Ges.*, 31, 3, 193-4.  
 Zwaan, P.C. 1982. Sillimanite cat's-eyes from Kangayam, Madras, India. *J. Gemm.*, XVIII, 4, 277-81.

[Manuscript received 26 July 1985, revised 31 January 1986.]

## A peculiar inclusion in a yellow corundum from Malawi

*Prof. Odino Grubessi\* and Dr Renata Marcon†*

\*Dipartimento di Scienze della Terra, Università degli Studi di Roma, Rome, Italy

†Istituto Gemmologico Italiano, Rome, Italy

In an investigation of a yellow crystal of Malawi corundum (gemmological and chemical characteristics are summarized in Table 1), a syngenetic inclusion, where 'necking-down' took place after trapping, was observed. The necking-down process can take place after the formation of crystals and primary inclusions, but at high temperature and pressure only (Roedder, 1984).

Indeed inclusions with large surface areas very often tend to split into two or more separate parts, and even to cause apparently isolated inclusions in the host mineral. Such inclusions may contain solid, liquid or gaseous phases or their mixtures.

Figure 1 schematically shows the development of necking-down with time by decreasing the temper-

ature. On the left one can see the primary inclusion at temperature  $T_4$ ; when temperature decreases the necking-down process takes place [ $T_3$  and  $T_2$ ] and causes the formation of separate inclusions which in our case contain both a liquid and a gaseous phase [ $T_1$ ].

Such inclusions are not unusual; they have been observed in amethysts from North Carolina (USA), sapphires from Montana (USA), and in many other minerals.

Figures 2-7 show photographs of the corundum taken under different conditions studied. From the necking-down process two cavities connected by a thin hollow and surrounded by other small cavities, apparently isolated, were formed.

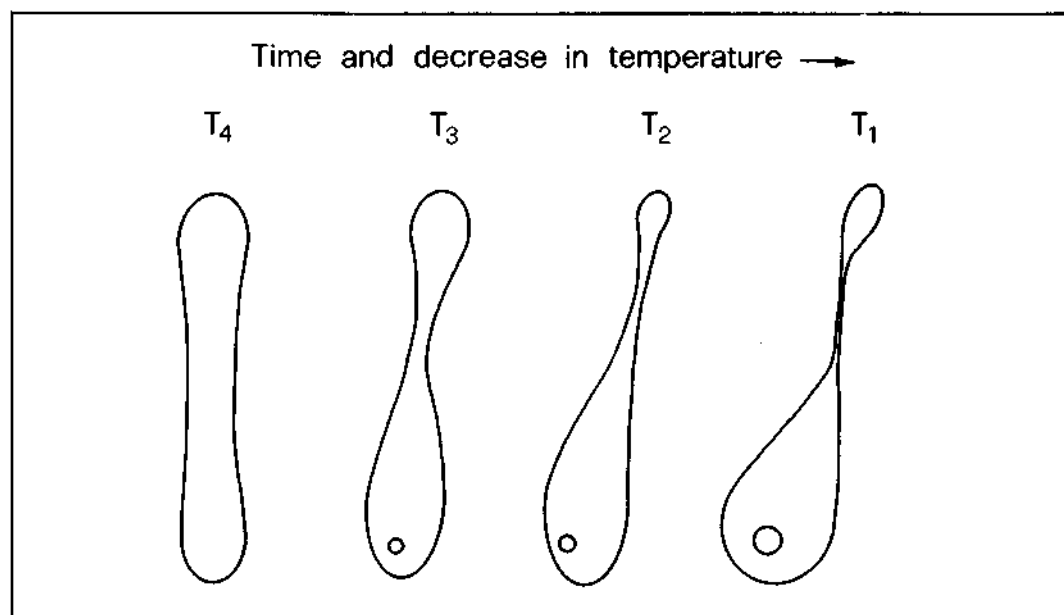

Fig. 1. Schematic development of 'necking-down' inclusion.



Fig. 2. The 'necked-down' three-phase inclusion. Within the cavity are seen the thin radiating needles, the gaseous phase and the small nuclei of crystallization. A fingerprint surrounds the three-phase inclusion. Direct illumination. 18x.



Fig. 3. The external fingerprint inclusion and the triangular or tetrahedral nuclei of crystallization show better. Reflected illumination. 20x.



Fig. 4. This picture shows the moving of a vapour bubble nearer the trapping. Direct illumination, polarized light. 40x.

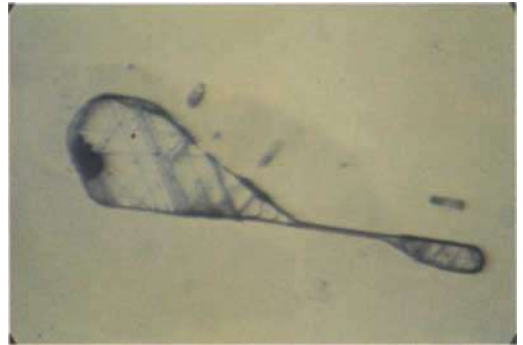

Fig. 5. The vapour bubble disappears owing to its re-absorption in the canal connecting the two cavities. Direct illumination, polarized light. 40x.

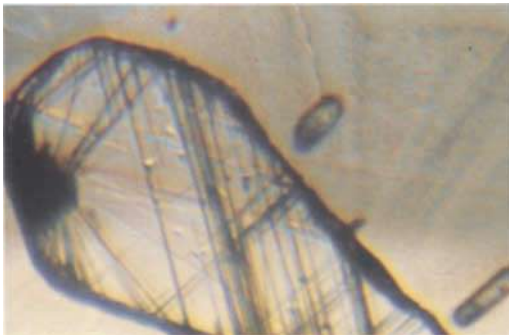

Fig. 6. The bigger part of the 'necked-down' inclusion, with thin radiating and crossed needles and small triangular or tetrahedral nuclei of crystallization. Direct illumination, closed diaphragm. 70x.

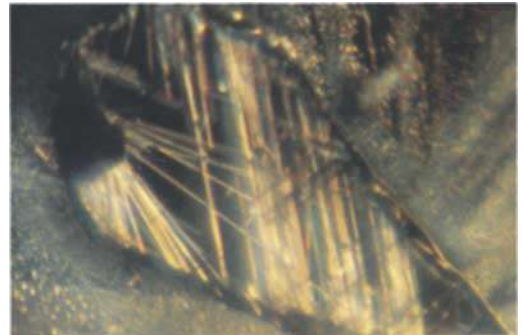

Fig. 7. The same subject as Figure 6. The needle-shaped inclusions are a reddish-golden colour; they are probably rutile. Reflected illumination. 70x.

**Table 1: Properties of yellow corundum (Malawi)**

COLOUR	: yellow
LUSTRE	: vitreous
HARDNESS	: 9
DENSITY	: 4.00 g/cm <sup>3</sup>
OPTICS	: n <sub>o</sub> = 1.769 n <sub>e</sub> = 1.759
BIREFRINGENCE	: 0.010
PLEOCHROISM	: none
ABSORPTION/ SPECTRUM	: absorption band at 690-700 nm (hand spectroscope)
LUMINESCENCE	: UVL-yellow weak: UVS -none
INCLUSIONS	: three-phase inclusion, cavities, fingerprint inclusion, fractures, twins

**Chemical analysis EDAX**

Al <sub>2</sub> O <sub>3</sub>	97.83
Fe <sub>2</sub> O <sub>3</sub>	0.82
MnO	0.02
MgO	0.89
Na <sub>2</sub> O	0.22
CaO	-
K <sub>2</sub> O	0.03
Cr <sub>2</sub> O <sub>3</sub>	0.04
NiO	0.02
CuO	0.10
CoO	-
H <sub>2</sub> O	-
Total	99.97

The two largest cavities, surrounded by a fingerprint, can be considered as a single inclusion. It contains three phases: a solid phase formed by thin radiating birefringent needles (possibly TiO<sub>2</sub>); a liquid phase (possibly CO<sub>2</sub>) and a gaseous phase outlined by a moving bubble (upper left in Figure 2) which disappears (homogenizes) by heating at 31°-32°C.

Within the largest cavity, small triangular or tetrahedral markings (Figures 5, 6) can be seen; they are likely to be small nuclei of crystallization.

**Acknowledgements**

The Authors wish to thank Professor E. Roedder for helpful suggestions. The work was supported by Centro di Mineralogia e Petrologia delle Formazioni Ignee, C.N.R., Italia 1984.

**Reference**

Roedder, E. (ed.). (1984) *Fluid inclusions*. Reviews in Mineralogy. Min. Soc. of America.

[Manuscript received 10 July 1985, revised 10 February 1986.]

## The very sphinx of diamonds

A.E. Farn, F.G.A.

Seaford, East Sussex, BN25 3HP

As a gemmologist I have always had a love of both coloured and colourless stones. I believed in my early days that gemmology was principally about coloured stones. Colourless stones, such as pure examples of beryl, quartz, topaz and corundum, lack that subtle touch of impurity so carelessly and inadequately bestowed by nature. Just a little touch of chromium alters considerably the beryl, the corundum or the topaz. However, as a gemmologist, I found that trade laboratory practice demanded a knowledge of all kinds and colours of gemstones, whether amorphous or crystalline, opaque or transparent, organic or inorganic. In the Laboratory I had a lovely long run of testing coloured stones year after year and became proficient in the use of the microscope, spectroscope and the  $\times 10$  lens. Because I was so busy with coloured stones I was somewhat detached from what was really our *raison d'être*, that is to say, *pearls*.

My world though was of gemstones, coloured for preference, with hard to find inclusions which were hallmarks in that sphere. The absorption spectra of gemstones examined by the hand spectroscope (Beck prism) and measured by the Beck wavelength measuring spectroscope were the tools of the trade.

We were testing around 60 000 pearls annually, with a tremendous peak of some 100 000 pearls in one particular year. Pearls were, and still are, a very important part of the Laboratory work and income. However, with the retirement of Anderson, Payne and Webster, my enjoyable gemmological (stone testing) days were numbered. I switched to pearl testing, simply because at that time with Laboratory moves and staff retirements there was no one else to do the job.

In my annual report I wrote of the 'wind of change', borrowing the phrase from one of our Prime Ministers who shall be nameless. The wind of change certainly blew, and one wonders whether change is sometimes for better or is to be deplored. For the major portion of my gem testing life and for the entire length of that of my colleagues Anderson, Payne and Webster, we never gave opinions or examined diamonds for colour or purity. That was a

Laboratory rule. I was faced with two major changes to accept, and to teach to new staff. Fashions change in gems, commercial outlook and in policies. In my earlier days we seldom looked at diamonds because diamond merchants did not need our help to tell them their stones were diamonds. Yellow or brown diamonds were not very saleable anyway. Much of the early work by Anderson on the absorption spectra of diamonds, together with C.J. Payne's contribution on the zoning of natural brown diamond, and Webster's work on fluorescence and phosphorescence under X-ray excitations formed a tremendous fund of knowledge. This knowledge was put to good use later when people became more aware of colour in diamonds. Or was it diversion of money to a new form of hedge against inflation?

Two factors for me had changed. Pearls *had* to be my metiers and we *had* to accept diamond grading as part of a Laboratory service. We became the CIBJO recognized Laboratory for diamond grading, and pearl and coloured stone testing, in Great Britain.

In pearl testing by X-ray methods, that is to say radiography, we often X-rayed pieces of jewellery set with pearls. On the negative film, due to the mass density of metal, i.e. gold or silver, the mount itself would stand out in sharp relief compared with the greater transparency of the pearls (calcium carbonate). The striking feature of many of these pieces of jewellery which contained diamonds also, was that the diamonds were all transparent to X-rays. This gave the picture or radiograph the appearance of empty settings. In this manner although not requested, we inadvertently proved the diamonds. The pearls could be much more difficult! Because of so much concentration on pearl testing by optical and X-ray methods I became specialized and in my retirement have given talks on pearls.

Writing recently upon pearls, I consulted various of my old books upon gemstones including 'Pearls and Pearl Life', by Edwin W. Streeter (London, 1886). Later, needing to consult this book again, I



inadvertently picked from my bookshelves another Edwin W. Streeter book, 'The Great Diamonds of the World' (London, 1882). Both books have gold leaf edging and somewhat similar sombre binding. I opened it out of curiosity, and as I turned the pages my eye was attracted to 'The Sancy Diamond'. Although not a diamond man, still less a diamond grading advocate, I was nevertheless intrigued because I remembered having personally handled the Sancy with Alan Jobbins. Readers will remember Alan Jobbins's article in the *Journal of Gemmology*, 1977, XV, 5, 240-2, entitled 'A brief look at the Sancy'.

In a report by De Beers dated 1966 the stone is stated to be 55ct, white, pear-shaped, named Sancy (Astor), an Indian stone belonging to the Astor family, England. Alan Jobbins's very full report giving accurate measurements and weight plus luminescent characteristics is dated 1976. The report which triggered my memory was in Edwin Streeter's book of 1882. Streeter describes the Sancy as 'the very Sphinx of diamonds'. He says 'the Sancy seems to be wrapped in a dense cloud of mystery, defying the most subtle analysis and impenetrable to the attacks of the keenest processes of reasoning'. The Sancy was purchased in 1892 by William Waldorf Astor, first Viscount Astor. He gave it as a wedding present to his son, whose wife Nancy, Lady Astor, wore it on state occasions in a tiara. It passed to her son after her death in 1964. It was on show in Paris in 1962.

This brings it almost up to date, or at least to January 1976 when tested by Alan Jobbins at the Geological Museum laboratory in full view of its then owner, Lord Astor. A good record now exists of its luminescent characteristics, density, weight and a contact immersion photograph showing its light transmission.

It rests now in France\*, where the authorities are active in re-assembling their own historic and notable jewels.

I cannot help hoping that the Sancy has reached its logical resting place, for if it cannot be England it must surely be Paris. Despite Edwin Streeter's description of 'the very Sphinx of diamonds' it does, nevertheless, have a truly French connection.

In 1976, during my time as Director of the Laboratory, I was invited to participate in the accurate recording of the Sancy diamond. It was a great honour, a considerable compliment to our Laboratory, and for me a feeling of excitement to feel that 'I was there'.

One of the smallest and least known vicissitudes suffered by the Sancy in its meandering occurred on that occasion. For a few seemingly endless moments in an unfamiliar dark room (cell) about the size of a telephone kiosk I was preparing to expose the Sancy to short-wave ultraviolet exposure to form a contact immersion photograph. I lost the stone in the complete darkness and fumbled around with adrenalin-charged imagination working overtime trying to locate it. Perhaps my colleagues never even noticed the pause which to me seemed endless. I finished the exposure and added metaphorically one more fascinating facet to the Sancy travelogue.

[Manuscript received 27 January 1986.]

\*The Sancy has been in the Louvre since 1978 - Verlet (Pierre), *Le 'Sancy' rentre au Louvre*, *Gazette des Beaux Arts*, November 1978, pp. 165-8. - Ed.

## A treatment procedure for improving colour and quality of zircons

*M.S. Rupasinghe, M.Sc. and Atula Senaratne, M.Sc.*

Department of Mineralogy, University of Mainz, West Germany

There are some types of gem minerals that appear in the jewellery market only after some kind of treatment which makes them more attractive or saleable than in their natural state.

Blue and colourless zircons occur in nature, they are not found in sufficient quantity, and rarely in good enough quality, for commercial purposes. But with the development of new methods, gemmologists have been able to convert less attractive zircons into colourless and also coloured stones.

For more than one hundred years workers have suggested the possibility of using zircons in place of diamonds. Today this industry is progressing on a very large scale.

**Table I. Treatment combinations**

Colours	TREATMENTS 1000°C, 15 hrs.			
	T 1	T 2	T 3	T 4
Yellow (a)	YT 1	YT 2	YT 3	YT 4
Green (b)	GT 1	GT 2	GT 3	GT 4
Violet (c)	VT 1	VT 2	VT 3	VT 4
Dark Green (d)	DGT 1	DGT 2	DGT 3	DGT 4

← oxidation → ← reduction →

T1 and T3 – rapid cooling at room temperature  
T2 and T4 – slow cooling inside the oven

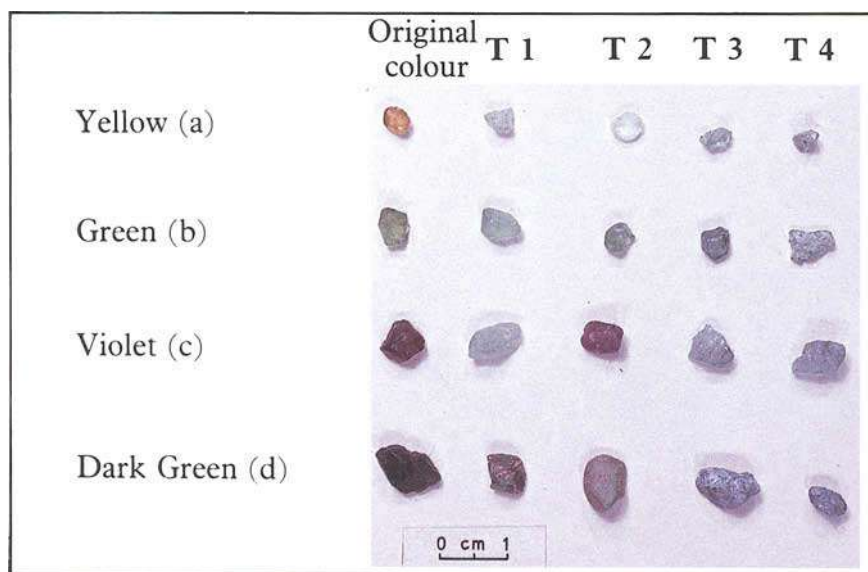

Fig. 1. Results of the treatments. (see Table I).

**Table II Concentrations of important elements in zircons from Sri Lanka**

Colour	No. of analyses	Si%	Fe%	Zr%	Hf%	Th%	U%
Yellow	36	15.67	0.02	48.25	1.19	0.07	0.14
Green	63	15.87	0.07	47.69	1.44	0.12	0.41
Violet	33	16.02	0.02	48.65	1.01	0.09	0.11

As an accessory mineral in rocks, zircon has been extensively studied by many previous workers (Vithanage 1957; Vance & Anderson 1972; Sahama 1981). Due to its wide range of occurrences in igneous and metamorphic rocks, it has also been used as an indicator mineral in petrogenesis.

In the present study, authors have experimented on the colour and quality variation in zircons of four different colours placing them in high temperature, under oxidizing or reducing conditions (Table I). The results obtained were fascinating and the findings have proved the success of producing high gem-quality stones from less valuable zircons.

#### Materials and methods

Sediment samples from different locations in Ratnapura gemming district of Sri Lanka were collected, washed and the zircon grains carefully selected using the following techniques in addition to visual identification.

- geiger - müller counter
- density measurements
- refractive index (RI) measurements
- X-ray diffractometer.

Separated zircon grains were then further divided into four different colours and representative specimens were finally analysed chemically using an electron-microprobe instrument (Cameca; Camebax microbeam). From each grain 3 points have been analysed and also great care has been taken to avoid inclusions and tiny holes on surfaces.

Three stones from each colour group were then subjected to the following heat treatment procedure.

To create an oxidizing environment, the alumina crucible, in which the stones were treated, is kept open. In the case of reducing treatments, stones were covered with a thin carbon and a thick alumina layer successively and the crucible kept tightly closed.

#### Results and Discussion

##### *Colour and Chemistry*

Table II clearly illustrates the compositional dependance of colours in zircons. Green zircons usually have higher (about 3 times) amounts of iron and uranium, while the other two shows similar chemical properties. The Th content in green stones is relatively higher than that of the other two.

Green zircons represented nearly 50% of the sample population subjected to analysis. The majority of them are of metamict type and one can expect maximum compositional irregularities, and hence an unusual correlation among elements in them. Their high representation in the present study may have masked the true correlations in other coloured stones (Table III) Sommerauer (1976) reported a possible tolerance of substitution of an element with  $\pm 15\%$  ionic size into the zircon lattice (Goldschmidt law). However the relationship between green colour and the U content is unmistakable, and therefore the relationships between colours and Th, Hf, and U content in zircons should be thoroughly investigated.

**Table III. Correlation coefficient matrix for the elements studied**

	Si	Fe	Zr	Hf	Th	U
Si	1.000					
Fe	+ 0.287	1.000				
Zr	- 0.308	- 0.329	1.000			
Hf	- 0.128	- 0.024	- 0.171	1.000		
Th	- 0.007	+ 0.017	+ 0.010	- 0.068	1.000	
U	- 0.049	- 0.041	- 0.166	+ 0.455	+ 0.040	1.000

### Quality of treated stones

The combination YT2 (see Table I and Fig. 1) is the most successful result obtained from the treatment, in order to produce a colourless and substitute for diamonds. The high reflective nature and the brilliant lustre are the attractive improvements made by this method on zircons. Yellow zircons which have been used for this combination of treatments are very often found in alluvial sediments. The cost of treatment is also very low and proves its economic feasibility.

By the treatment T2 the authors have been able to produce a reddish-violet stone from a honey-brown zircon, which shows an improved lustre.

Treatment T3 has been able to produce an aquamarine-type light blue and high lustre stone from a green zircon.

Further, dark green unattractive metamict zircons can also be changed by T3 into blue, translucent stones which possibly can be used as beads in jewellery.

The effects of these treatments on differently coloured stones can be seen in Fig. 1 and one can notice that the other treatment combinations do not improve the quality of stones. However, it is very interesting to note that all treatment combinations have been able to change the original colour, though they do not improve the quality.

The results of the present study and earlier studies suggest that the phenomenon behind the colour change is the variation in oxidation state and the sites of substitution of impurity ions (e.g.  $\text{Fe}^{2+}$ ,  $\text{Fe}^{3+}$  etc).

### Acknowledgements

This work forms part of the doctoral research work of M.S.R. Authors gratefully thanks the Otto Benecke Stiftung (M.S.R.) and Deutscher Akademische Austauschdienst (A.S.) for financing their doctoral research work at University of Mainz.

### References

1. Sahama, G.T. 1981. Growth structure in Ceylon Zircon *Bull. Mineral* **104**; 89-94.
2. Sommeraur, J. 1976. Die Chemisch- Physikalische Stabilität Natürlicher Zirkone und ihr U-(Th)-Pb system. Ph.D Thesis, Zürich Tech. University.
3. Vance, E.R. and Anderson, B.W. 1972. Differences among low Ceylon Zircons- *Mineralog. Mag.* **38**, 721-724.
4. Vitanage, W.P. 1957. Studies of Zircon types in Ceylon Precambrian complex - *Journ. Geol.* **65**, 117-128.

[Revised manuscript received 10 May 1985.]

# The brilliant cut – analysis of weight by calculation

S.J.A. Currie, F.G.A.

P.O. Box 566, Papakura, New Zealand

In the daily work of most gemmologists, who are involved in the jewellery trade, the requirement of having to calculate the weight of a mounted, round brilliant-cut diamond crops up all too regularly.

A look through the literature will reveal a variety of equations that have been used over the years and at first glance they look diverse and confusing.

It was the very appearance of these equations that first aroused the writer's interest with the thought that they cannot all be right.

After a very detailed study, in which the writer tried to forecast the most appropriate Shape (S) Factor for a variety of proportions, a method evolved in which the accuracy of the calculation is limited only by the ability of the gemmologist to measure the parameters of the stone.

Nowadays, the weight of a round brilliant-cut diamond is usually calculated using one of the following six equations, where D is the diameter, H is the total height and R is the radius of the stone.

## 1. Grodzinski's Equation

$$\text{Wt of stone in carats} = (D/6.42)^3 \quad (D \text{ measured in mm})$$

Grodzinski's equation represents a straight proportion calculation on a 1 ct brilliant-cut diamond and is quite accurate over a considerable range of sizes, but it takes no account of the actual depth, so it should be limited to diamonds of very good make.

$$2. \text{ Wt of stone in carats} = D^3 \times 0.59 \times 0.0060 \quad (D \text{ in mm})$$

This equation uses 0.0060 as a Shape (S) Factor and assumes that the depth is 0.59 times (59%) the girdle diameter, a fair assumption for well-cut stones.

$$3. \text{ Wt of stone in carats} = D^2 \times H \times 0.0060 \quad (D \text{ and } H \text{ in mm})$$

This is a refinement, where H, the total depth, is included as a measurement in its own right, overcoming earlier objections.

## 4. Anderson's Equation

$$\text{Wt of stone in carats} = D^2 \times H \times 6 \quad (D \text{ and } H \text{ in cm})$$

Anderson's equation is the same as 3. but as the measurements are in cm the 0.0060 factor becomes 6.0.

$$5. \text{ Wt of stone in carats} = D^2 \times H \times 3.52 \times 0.0018 \quad (D \text{ and } H \text{ in mm})$$

In this case the 'S' factor is split into the general shape factor for round brilliant-cut stones and multiplied by the specific gravity (3.52) of diamond. The product of these two is 0.006336, some 5.6% greater than 0.0060.

## 6. Leveridge's Equation

$$\text{Wt of stone in carats} = R^2 \times H \times 0.0245 \quad (R \text{ and } H \text{ in mm})$$

Although Leveridge's equation looks quite different, the use of the 'radius' instead of the usual 'diameter' produces the 0.0245 factor, which when divided by '4', equals 0.00615, making the answer 2.5% greater than if 0.0060 was used.

Essentially the carat/weight problem is one of elementary mathematics as the round brilliant-cut can, if the facets are disregarded, be represented by a series of three cones and a thin cylinder, as in Figure 1.

Where— $R_G$  = the radius at the girdle.  
 $H_P$  = the depth of the pavilion.  
 $H_G$  = thickness of the girdle.  
 $R_T$  = the radius of the table.  
 $h_1$  = total height of cone of crown.  
 $h_2$  = the height of the cone removed, the base of which is the table.

therefore  $h_1 - h_2 = H_c$ , the height of the crown.

By calculating the volume of each of the solids, i.e. the pavilion cone, the girdle cylinder and two crown cones, the volume of the stone may be obtained. The volume of the crown is the volume of the whole top cone less that of the smaller cone, the

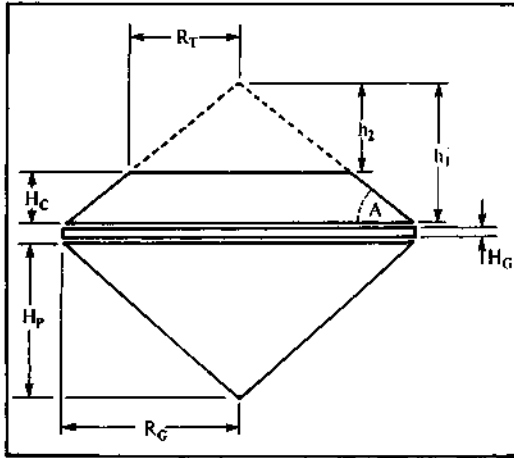

Fig. 1. Diagram illustrating that, if the facets are disregarded, a round brilliant-cut diamond may be represented as a series of cones and a thin cylinder.

base of which is the table.

Using this method, two equations, A and B, may be obtained. One of them (A) uses the crown angle whilst the other (B) makes use of the crown height.

*Equation A – using the crown angle*

$$\text{Wt of stone in carats} = 0.03686 (D/2)^3 [(H_P + 3H_G + 0.5 \tan \hat{A}) - (T_b^3 \times 0.5 \tan \hat{A})]$$

Where – D = diameter of girdle in mm

H<sub>P</sub> = % depth of pavilion written as a decimal (43%=0.43)

H<sub>G</sub> = % thickness of girdle written as a decimal (3%=0.03)

Ā = crown angle in degrees

T<sub>b</sub> = diameter of table as a decimal of the girdle (65%=0.65)

*Equation B – using the crown height*

$$\text{Wt of stone in carats} = 0.03686 (D/2)^3 [H_P + 3H_G + (H_C/1 - T_b)(1 - T_b^2)]$$

Where H<sub>C</sub> = % height of the crown written as a decimal (12%=0.12).

All of the other symbols remain the same as in Equation A.

It should be noted that in both equations, the term H<sub>G</sub>, the girdle thickness is multiplied by three and shows that the volume, and consequently the weight, is three times as sensitive to changes in girdle thickness as it is to changes in the other heights.

The following example will serve to demonstrate the use of these equations.

Example: Find the carat weight of a round brilliant-cut diamond of the following dimensions – Diameter, 6.5 mm, Crown angle 34.5°, Table 60%, Pavilion 43.1%, Girdle 2.3%.

Substituting in equation A where

D=6.5 mm, H<sub>P</sub>=0.431, H<sub>G</sub>=0.023, Ā=34.5°, T<sub>b</sub>=0.60 then

$$0.03686 (6.5/2)^3 \times [(0.431 + (3 \times 0.023) + 0.5 \times \tan 34.5^\circ) - (0.6^3 \times 0.5 \times \tan 34.5^\circ)] = 0.9736 \text{ ct.}$$

The total depth can be extracted from this equation by the calculation –

$$(H_P + H_G + (0.5 \times \tan 34.5^\circ)) - (T_b \times 0.5 \times \tan 34.5^\circ) = 0.591 \text{ (expressed as a decimal of the girdle diameter)}$$

Replacing the 0.59 in equation 2 with the figure 0.591 and rearranging, the correct ‘S’ factor can be calculated –

$$(6.5)^3 \times 0.591 \times \text{‘S’ factor} = \text{ct wt}$$

Therefore

$$\text{‘S’ factor} = 0.9736 / (6.5^3 \times 0.591) = 0.00599$$

It must be appreciated that, in using calculators, answers are given to many places of decimals. The accuracy of the results obtained is limited by several factors.

1. The regularity of the shape of the stone.
2. Slight variations in the SG of diamond.
3. The accuracy of the method of measurement.
4. The assumptions made in the derivation of the equations, e.g. ignoring the facets when calculating the volume of the cones.

By using a programmable calculator it is possible to investigate the effect on both the carat weight and the ‘S’ factor when any of the dimensions are changed either singularly or simultaneously.

Taking the previous example. Investigate the effect of a pavilion range from 39% to 47%.

Note: as the carat weight increases the ‘S’ factor decreases.

Pav.	39%	41%	43%	45%	47%
Ct Wt	0.9208	0.9461	0.9714	0.9966	1.0219
‘S’ factor	0.00609	0.00604	0.00599	0.00595	0.00592

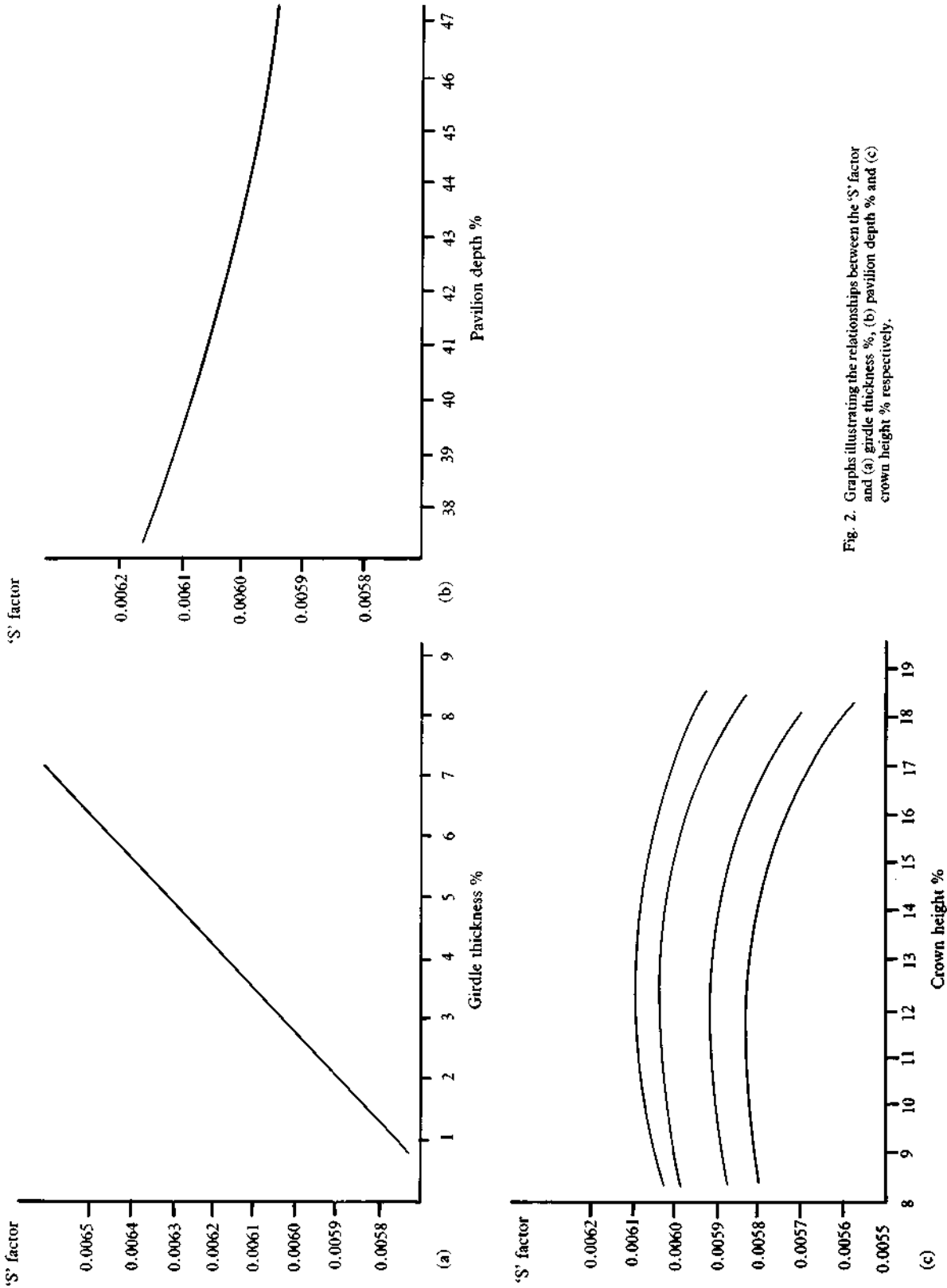

Fig. 2. Graphs illustrating the relationships between the 'S' factor and (a) girdle thickness %, (b) pavilion depth % and (c) crown height % respectively.

Tables of this type can be produced for the variation of the girdle thickness, crown height and crown angle but the results are easier to appreciate if presented in graph form as illustrated.

The graphs show clearly that the weight and the 'S' factor respond rapidly to changes in girdle thickness and crown angle. A small progressive change occurs in the factor with increasing pavilion depth, while simple changes to the crown height percentage are almost self-neutralizing as far as the 'S' factor is concerned. With a reduction in crown angle both the weight and the factor decrease rapidly.

It should be realized that each of the above graphs features only one variable at a time, i.e. the one featuring the pavilion variations from 37% to 47% relates only to a diamond with crown angle 34.5°, table 60%, girdle 2.3% but is irrespective of girdle diameter.

The author set out originally to establish a method of weight estimation by adding the separate components of these graphs but although this proved to be a mathematical nonsense, the graphs can be used independently.

The graph of the girdle thickness will probably find the greatest application as it applies to an otherwise well cut stone and can be used in conjunction with equation No. 3.

The diameter and total depth are inserted in the equation, and the 'S' factor for the appropriate girdle thickness is read off the graph and inserted in the equation instead of 0.0060, thereby making allowance for the one stone dimension which has the greatest single influence on the 'S' factor and consequently the weight.

The graphs also show that 0.0060 is quite accurate for any diamond within the following limits:

Pavilion between 41% and 44.5%.

Girdle between 2.0% and 2.7%.

Table between 55% and 75% provided the angle is 34.5°.

The 'S' factor of 0.0060 should not be applied to any diamond with a crown angle less than 34.5°.

There is also a practice in the cutting industry to thicken the girdle on smaller stones, which has the benefit of reducing the fragility of the stone for the setter. If diamonds of 3.0 mm, 4.0 mm, 5.0 mm and 6.0 mm are calculated out, the 'S' factor will be seen to start at approximately 0.0063 for 3.0 mm and 4.0 mm diamonds, reducing gradually to 0.0062 at 5.0 mm and 0.0061 at 6.0 mm.

Hence it can be seen that all of the equations Nos 1 to 6 can produce reasonably accurate results within limited circumstances and provided the crown angle is not less than 34.5°. The use of these

equations on spread cut stones introduces serious errors.

The particular value of the two equations A and B is that any diamond that can be measured as for a certificate, with either the crown angle or the crown depth, can be calculated to quite accurate limits. Experience has shown that an error less than 0.5% can be considered normal for diamonds of good symmetry.

As an aid to using the equations, any programmable calculator that can accommodate fifty steps and five variables, like the Sharp EL-5100, or equivalent Casio models, can be used to program-store and recall the equations at the touch of a button.

Equation B for instance can be stored in the EL-5100 in this form:

$$f(ABCDE) = 0.03686 \times (A \div 2) Y^3 \times (B + (3 \times C) + (D \div (1 - E)) \times (1 - EY^3))$$

Where - A = diameter in mm.

B = pavilion depth % expressed as a decimal

C = girdle thickness % expressed as a decimal

D = crown height % expressed as a decimal

E = table % expressed as a decimal

The term  $Y^3$  appearing twice in the equation is the terminology used by this particular machine to raise a function to the cube power.

Once stored, this equation can be recalled, the five measurements entered and the answer is delivered almost instantaneously.

The next problem is that of actually making the measurements. The obvious way would be with a Proportionscope, and the 'View-through' type might be suitable provided the culet and the girdle thickness can be seen and measured. A better method would be the use of a microscope with a Vernier calibrated stage. This would necessitate the taking of measurements and subsequently converting them to decimals of the girdle diameter.

The writer's preferred method is to use a zoom microscope fitted with a reticle in the eye-piece. The most convenient form of reticle is one that is divided into one hundred divisions and numbered one to ten. The piece of jewellery is clamped on the stage with the crown of the diamond under examination facing squarely upwards. The optics are then zoomed until the scale length exactly coincides with the girdle diameter.

Under these conditions the girdle diameter equals 100 divisions and the piece can then be moved or rotated so that the table, crown, girdle and pavilion can all be read directly in percentages



of the girdle diameter under the magnification of the microscope. It only remains to take a measurement of the girdle in mm to be able to solve equation B.

One final comment about the measuring of the table diameter and the girdle thickness. As the junction points of the star and girdle facets are outside the cone of the crown main facets, the table diameter can be taken as the 'point to point' distance. For the girdle it is necessary to take an average of several measurements at the base of the main facets.

Although this technique is not for the smaller stones, any set diamond of 0.75 ct or more, where the girdle and culet are visible, could warrant the full analysis of proportions. In this case the gemmologist would have all the information necessary to make an accurate calculation of carat weight by this method.

**Appendix**

The equations A and B are derived as follows: referring to Figure 1 -

- (a) pavilion volume is  $\frac{1}{3}\pi R_G^2 H_P$
- (b) the girdle volume is  $\pi R_G^2 H_G$

The volume of the crown is represented by the whole top cone minus the smaller cone, the base of which is the table - e.g.,  $\frac{1}{3}\pi R_G^2 h_1 - \frac{1}{3}\pi R_T^2 h_2$

Although the girdle DIAMETER is the measurement that gemmologists prefer to start with, the mathematics become awkward working with the term  $(D/2)^2$ , so it is better to stay with R (radius) for the time being.

Adding the four terms together and factorizing,  
 Volume =  $\frac{1}{3}\pi [R_G^2(H_P + 3H_G + h_1) - (R_T^2 \times h_2)]$  ... (X)

To convert this volume, which is expressed in cubic mm, to weight in carats, it is necessary to -

- (a) Divide by 1000 to convert it to cubic cm
  - (b) Multiply by 3.52 (SG of diamond) to convert the volume to grams
  - and finally
  - (c) Multiply by 5 to convert grams to carats
- i.e.  $1/1000 \times 3.52 \times 5 = 0.0176$

Thus

$$Ct\ wt = 0.0176 \times \frac{\pi}{3} [R_G^2(H_P + 3H_G + h_1) - (R_T^2 \times h_2)] \dots (Y)$$

Unfortunately this equation still includes the terms 'h<sub>1</sub>' and 'h<sub>2</sub>', neither of which can be measured as they both originate from a point beyond the top of the stone.

Conversion of equation Y into equations A and B for use with the crown angle and the crown height respectively are shown below.

*Details of proof of Equation A (crown angle) (see Figure 3).*

$$Volume = \frac{1}{3}\pi R_G^2 H_P + \pi R_G^2 H_G + \frac{1}{3}\pi R_G^2 h_1 - \frac{1}{3}\pi R_T^2 h_2$$

Substituting for  $R_T^2$  equals  $R_G^2 \times T_b^2\%$  and factorizing,  
 $\frac{\pi}{3} R_G^2 [(H_P + 3H_G + h_1) - (T_b^2 \times h_2)]$

Now in the right angle triangle ABC representing the crown -

$$h_1/\sin A = R_G/\sin B$$

$$\therefore h_1 = R_G \sin A/\sin B$$

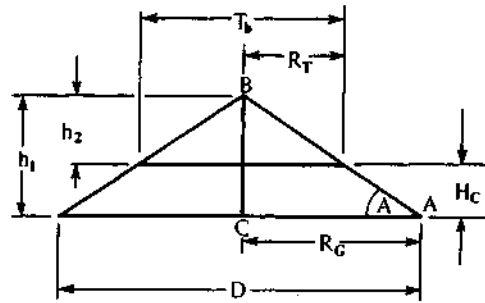

Fig. 3.

As  $\angle A$  and  $\angle B$  are complementary,  
 $\sin B = \sin(90^\circ - A) = \cos A$   
 and  $\sin A/\cos A = \tan A$

Therefore  $h_1 = R_G \tan A$  and  $h_2 = h_1 \times T_b\% = R_G \times \tan A \times T_b\%$

Substituting for  $h_1$  and  $h_2$ ,

$$\therefore Volume = \frac{\pi}{3} R_G^2 [(H_P + 3H_G + (R_G \times \tan A)) - (T_b^2 \times T_b \times R_G \times \tan A)]$$

At this stage  $H_P$  and  $H_G$  are in the form of actual measurements (mm), so if they are each divided by D (girdle diameter) they are in a much more usable form for the gemmologist.

$$Volume = \frac{\pi}{3} R_G^2 [(H_P \times D)/D + (3H_G \times D)/D + (R_G \times \tan A) D - (T_b^3 \times R_G \times \tan A)/D]$$

Substituting  $D/2$  for  $R_G$  and extracting D,

$$Volume = \frac{2\pi}{3} (D/2)^3 [(H_P + 3H_G + 0.5 \tan A) - (t_b^3 \times 0.5 \tan A)]$$

Converting this volume in cubic mm to carat weight and also taking in the  $\frac{2\pi}{3}$  gives the final multiplying constant of 0.03686.

$$\therefore \text{Ct Wt} = 0.03686 \times (D/2)^3 [(H_p + 3H_G + 0.5 \tan A) - (T_b^3 \times 0.5 \tan A)] \quad \dots(A)$$

*Details of proof of Equation B (crown height)*

Using the same diagram and introducing  $H_C$  to replace  $h_1 - h_2$  and starting at line No. 2 in the previous proof,

$$\text{Volume} = \frac{1}{3}\pi R_G^2 (H_p + 3H_G + h_1 - (T_b^2 \times h_2))$$

As  $H_C = h_1 (1 - T_b\%)$ , then  $h_1 = H_C/(1 - T_b\%)$  and  $h_2 = h_1 \times T_b\%$

Substituting for  $h_1$  and  $h_2$ ,

$$\text{Vol.} = \frac{1}{3}\pi R_G^2 [H_p + 3H_G + (H_C/(1 - T_b)) - ((T_b^3 - H_C)/(1 - T_b))]$$

$$\text{Vol.} = \frac{1}{3}\pi R_G^2 [H_p + 3H_G + (H_C/(1 - T_b))(1 - T_b^3)]$$

Now taking each of the measurements  $H_p$ ,  $H_G$  and  $H_C$  and representing them as a decimal of the diameter (Table has already been treated),

$$= \frac{1}{3}\pi R_G^2 [(H_p \times D/D) + (3H_G \times D/D) +$$

$$\frac{H_C \times D/D}{(1 - T_p)} (1 - T_b^3)]$$

Extracting the  $D$  and substituting  $(D/2)$  for  $R_G$ ,

$$\text{Vol} = \frac{2\pi}{3} (D/2)^3 [(H_p + 3H_G + ((1 - T_b)H_C)/(1 - T_b^3))]$$

Converting this volume in cubic mm to carat weight and also taking in the  $\frac{2\pi}{3}$  gives the final multiplying constant of 0.03686.

$$\therefore \text{Ct Wt} = 0.03686 \times (D/2)^3 [(H_p + 3H_G + ((1 - T_b)H_C)/(1 - T_b^3))] \quad \dots(B)$$

#### Acknowledgements

I should like to thank Dr G. Harrison-Jones for critically reading the paper and suggesting improvements.

[Manuscript received 8 August 1985, revised 16 January 1986.]

# Light, heavy and rare minerals in the washed gem gravels of Sri Lanka

*M.S. Rupasinghe, M.Sc.,\* Atula Senaratne, M.Sc.\* and C.B. Dissanayake, M.Sc.†*

\* Department of Mineralogy, University of Mainz, West Germany

† Department of Geology, University of Peradeniya, Peradeniya, Sri Lanka

## Abstract

Light, heavy and some rare minerals as found in the washed gem gravels from Sri Lanka have been studied for their abundance and chemical compositions. Among the rare minerals found were fergusonite, geikielite, niobian-rutile, radioactive rutile, allanite and thorite/thorianite. Analyses for rare-earth elements and 25 other elements were made, and among the noteworthy features are the abundances of Th and U in zircon and monazite.

## Introduction

Sri Lanka (Ceylon) is an island with an area of 69450 sq.km and is essentially a part of the shield area of peninsular India. Geologically and physically Sri Lanka is the southern continuation of the Indian sub-continent. It is believed to have separated in recent geological times due to shallow tectonic movements.

The greater part of the island (90%) is made up of Precambrian metamorphic rocks, which can be divided into four major divisions, viz. Highland Group, South-west Group, Eastern and Western Vijayan Complexes (Munasinghe and Dissanayake, 1982). Apart from the two small Jurassic sedimentary basins (Fig. 1) (together 8–10 sq.km) the rest of the island (10%) is covered by Tertiary (Miocene limestone), Quaternary (red beds, clastic sediments) and Recent (alluvial) sediments.

The Highland Group occupies the entire hill country of the island and is comprised of granulite facies metasediments, while the Vijayan complexes are comprised of granitoids, migmatites and migmatitic gneisses. The South-west Group is also made up of granulite facies metasediments and as indicated by the presence of cordierite (Katz 1972) represents different pressure/temperature conditions.

The high rate of weathering in this tropical island has denudated the land for the past few million years and given rise to thick and extensive piles of sediments in flood plains of all major rivers. One can also see buried streams, rivers and sediment-filled lakes. These vast alluvial plains are very fertile

and most of them have been cultivated for the past two thousand years.

The accidental discovery of gemstones in these deposits attracted people into gem mining and this practice has continued unbroken for more than a thousand years.

There are two main gemming areas in Sri Lanka, namely Ratnapura and Elahera, and also a few scattered locations; Rakwana, Tissamaharama, Okkampitiya and others. A noteworthy feature is that all these regions are located in the Highland and South-west Group meta-sedimentary formations.

The aim of this study is to identify all types of gemstones and other heavy minerals in the gem-bearing gravels from these areas, and also to identify the major differences among these deposits.

## Geology of the area studied

Fig. 1 illustrates the major gemming areas of Sri Lanka, and Fig. 2 illustrates the geology of the Ratnapura and Rakwana gem fields. Scattered alluvium is found lying on charnockite-metasedimentary rocks; namely charnockites, garnet-sillimanite granulites, amphibolites, and perthite-bearing garnet-biotite-granulitic gneisses. Here charnockite and pelitic garnet-sillimanite granulites are the predominant rock types. Further the occurrence of zircon granites, vein-quartz and pegmatites is a notable feature of the region.

Fig. 3 illustrates the geology of the Elahera gem field, situated in the north-east foot slopes of the Central Highlands, where a ridge and valley topography is predominant. Quartzite, marble, garnet-sillimanite-biotite gneisses, with tourmaline (Rupasinghe *et al.*, 1984) and charnockite are the major rock types lying in this region.

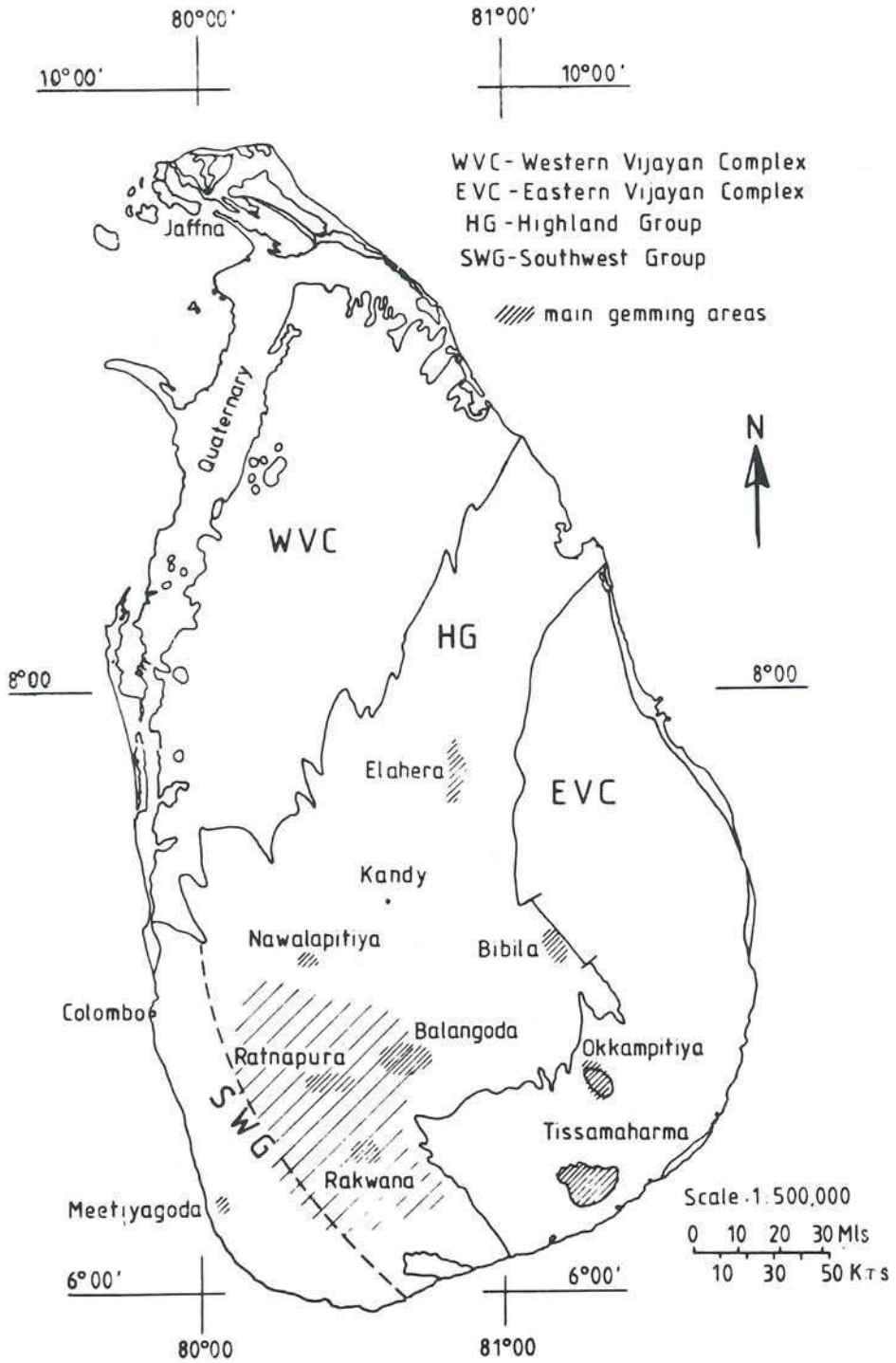

Fig. 1. Generalized geological map of Sri Lanka with major gemming areas.

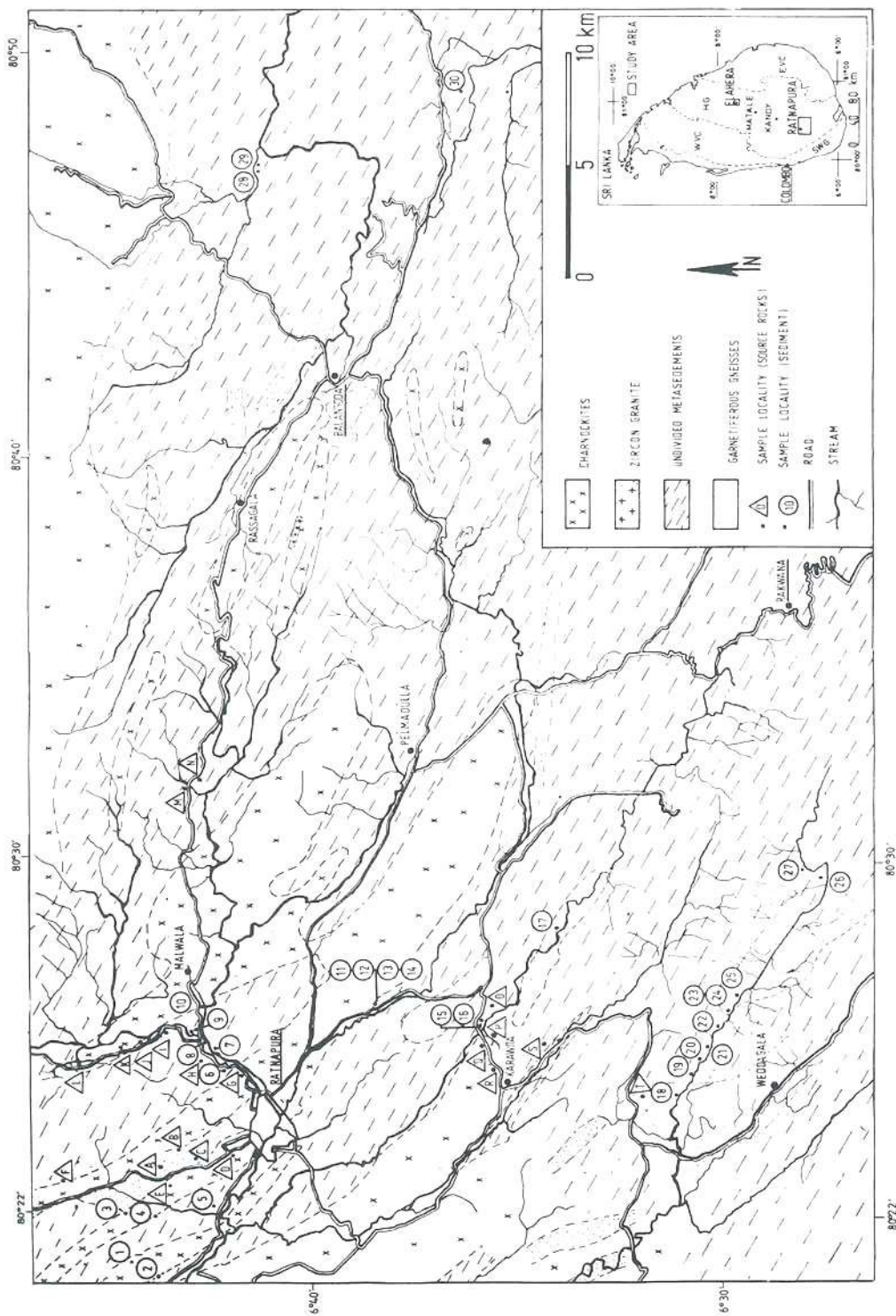

Fig. 2. Generalized geological map of the Ratnapura and Rakwana areas.

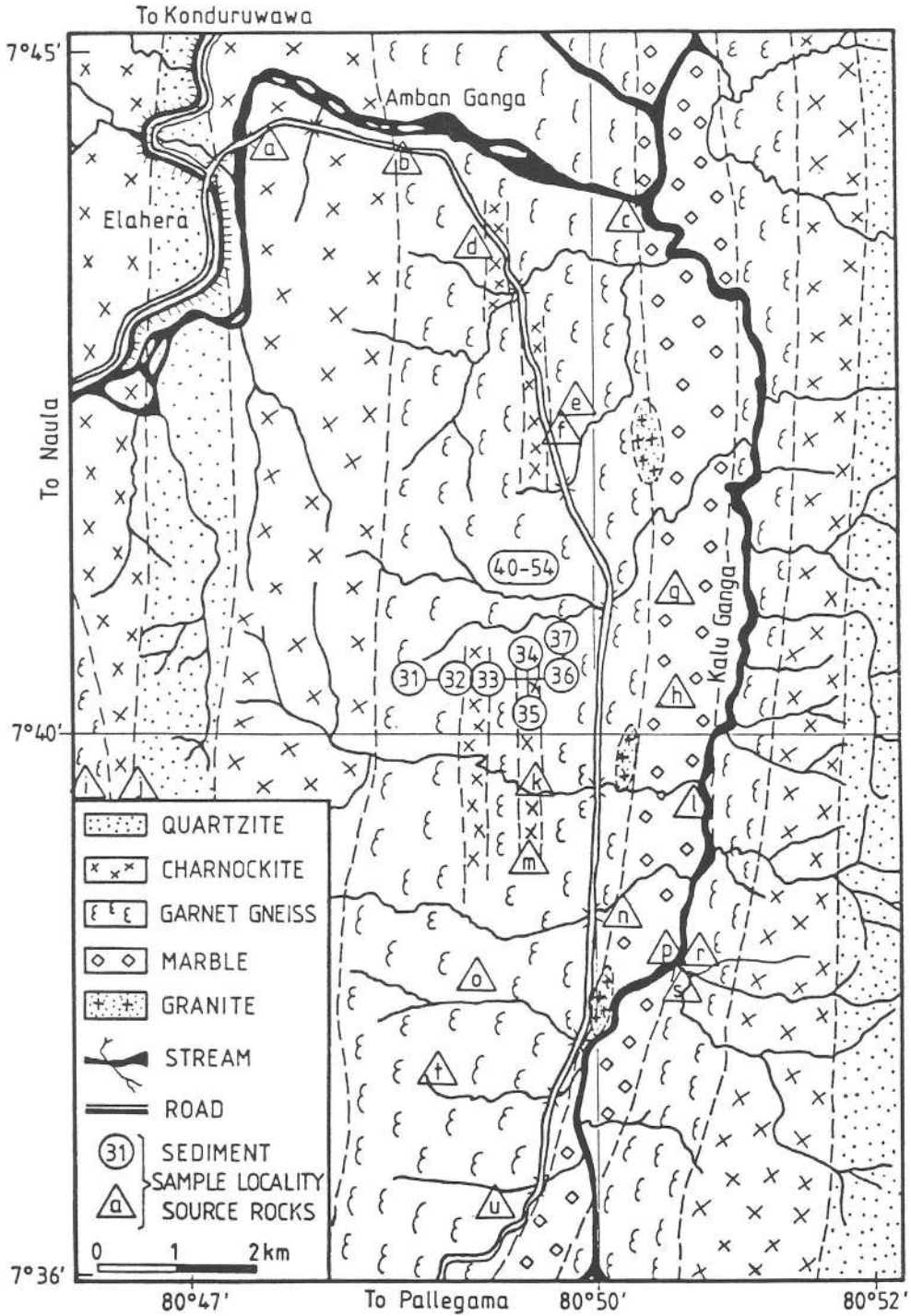

Fig. 3 Generalized geological map of the Elahera area.

## Materials and methods

### Sampling methods

Samples were collected from locations shown in Figs 2 and 3. All samples were taken from existing gem pits. The pay gravel layers, locally termed 'illam', are usually composed of rounded or subangular pebbles or boulders of quartz, heavy minerals and also gemstones.

15-25 buckets of clayey gravel (illam)\* were taken from each pit and washed until clay was removed. The remaining portion, locally termed 'nambuwa', was collected in polythene bags. The weight of an average sample varied in the range of 10-15 kg. However, during the process of washing light gem minerals such as beryl (SG 2.7), and amethyst (SG 2.65) are often washed away with other light minerals.

### Analyses

A quarter of a sample was taken for heavy/light mineral separation (Fig. 4) and the percentages of heavy and light fractions measured. Here the minerals having higher densities than tetrabromethane (SG 2.96) were considered as heavy minerals while the others were treated as light minerals.

Other liquids of varying densities are also used in determining densities of minerals. The remaining material of each sample was used in the following series (Fig. 5) of investigations (physical and chemical), for identification and also in the understanding of the processes involved in their formation.

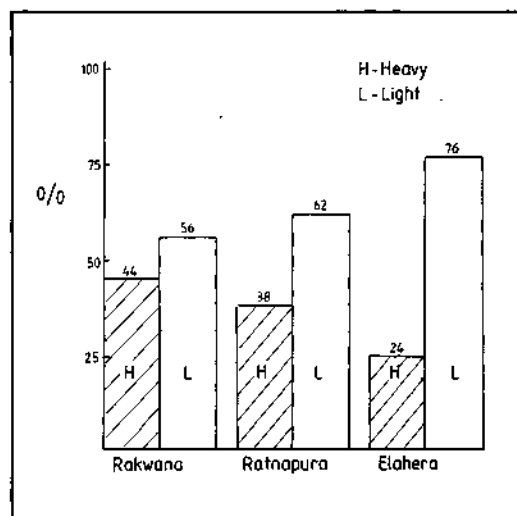

Fig. 4 Percentage of heavy and light minerals in the sediments from the three major gem fields.

\*Local miners use a cane basket shaped like a gold prospector's steel pan, which is easily rotated in water even when it is full of 'illam'.

## Heavy and light mineral contents of the gem sediments

The heavy mineral content of the Rakwana sediments is higher than that in Elahera. However a marked similarity exists between sediments from Rakwana and Ratnapura the heavy mineral content of the Rakwana sediments being approximately twice as high as that in Elahera (see Fig. 4).

The greater abundance of pegmatites in the SW region could well be a cause for the presence of high amounts of heavy minerals in that area. Minerals, very often found in pegmatites and in rocks associated with cordierite gneisses (Katz, 1972; Wadia and Fernando, 1944; Coomaraswamy, 1906), are found in greater amounts in sediments from the Rakwana and Ratnapura regions.

In the Elahera area, pegmatites are more felsic and the heavy mineral content is very low. Further, the area is flat and covered by thick alluvial sediments and the accumulation of heavy minerals is comparatively less. In the hilly south-west region, the high rate of erosion and transportation washes away the light minerals resulting in high concentrations of heavy minerals in the sediments.

### Radioactive minerals

The following minerals found in this study, were categorized as radioactive minerals: monazite; zircon; thorianite; thorite; allanite.

Among these, zircons are widely used in jewellery. It is of interest to note that radioactive zircons have also been found in jewellery. Jobbins *et al.* (1977) have reported a monazite crystal with high radioactivity found in a piece of Sri Lankan jewellery.

The radioactivity of gem-quality zircons varies according to their thorium and uranium contents.

Table 1. Th and U concentration of differently coloured zircons from Sri Lanka

Colour	Th %	U %
Green	0.11176	0.4095
Violet	0.0840	0.1131
Yellow	0.0740	0.1360
Rose	0.0600	0.1190

(Rupasinghe, 1984)

Table 1 shows the Th and U contents of some zircons from Sri Lanka. It is apparent that the green zircons contain greater amounts of Th and U. An average monazite contains about 8% Th and 0.4% U.

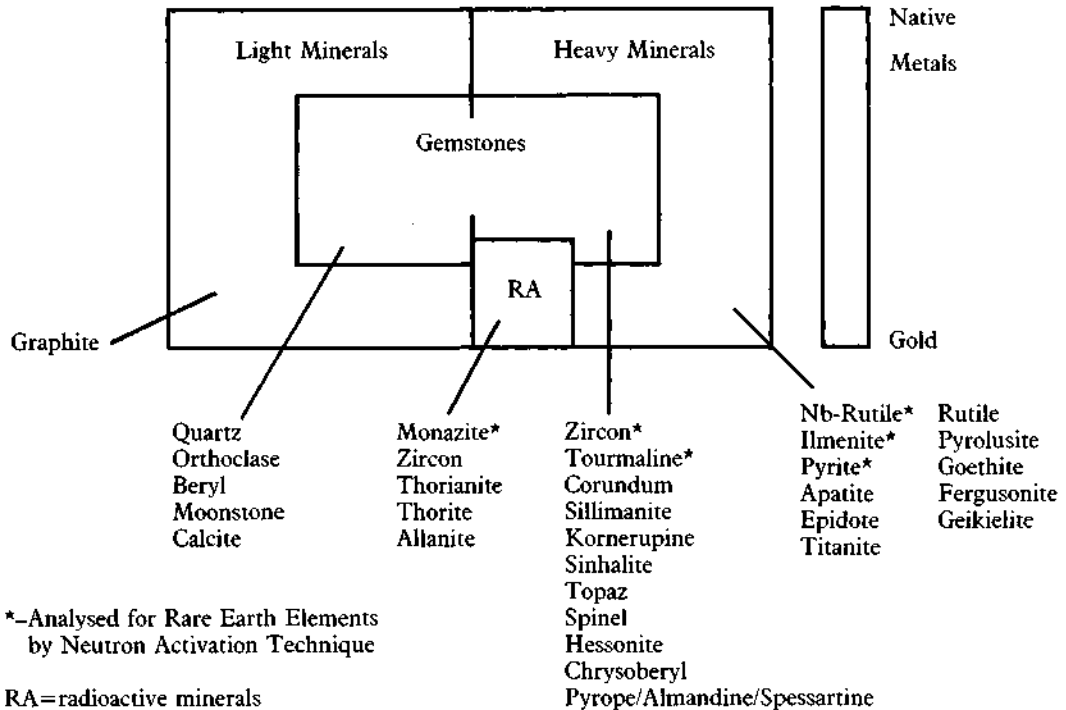

Fig. 5. A general classification of minerals found in washed gem sediments ('nambuwa').

#### Rare minerals

The following minerals found in the gem gravels of Sri Lanka can be grouped as rare minerals on the basis of their abundance: fergusonite; geikielite; niobian rutile; and also radioactive rutile; allanite; thorite/thorianite.

#### Fergusonite ( $Yt(Nb, Ta)O_4$ )

This mineral locally termed 'Gurupachcha'. This is found only in the south-west region. Coomaraswamy (1906) found some fergusonite containing about 2% thoria and over 4% of  $U_3O_8$ , and believed to be derived from granites and pegmatites. Generally fergusonite is found as rounded grains, black to brown in colour, and very rich in elements such as Nb, Ta and Be (Rosler, 1980).

#### Geikielite ( $Mg Ti O_3$ )

This mineral is only found in the Ratnapura gem sediments. It is black in colour, and has a fleshy-red streak. This may have been derived from the South-west Group calc-silicates. The X-ray diffractometer pattern is very similar to that of ilmenite and only chemical analysis or specific gravity tests enable one to distinguish this mineral from ilmenite.

#### Allanite

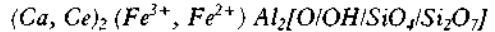

This mineral is found in the Elahera, Ratnapura and Rakwana gem sediments, but in small amounts. They are generally rounded in shape and are considered to be derived from pegmatites. It is worthy of note that allanites found in South-west Group sediments are less radioactive than those found in the Highland Group sediments.

#### Thorite/thorianite ( $ThSiO_4/(Th, U)O_2$ )

These minerals are found only in the South-west Group sediments and do not generally travel far away from source. Occurrences of rich sources of these minerals were found by previous workers (Coomaraswamy, 1906), in the Bambarabotuwa area. Searle (1962) reported thorianite with about 71.45% of ThO and 22.5%  $U_3O_8$ .

#### Niobian rutile

Niobian rutile in sediments was reported for the first time in Sri Lanka and is found only in the Rakwana sediments. It is very rich in Nb, and Ta, and also contains large amounts of Ce and La (270 ppm, 91 ppm respectively). The chemical composition of this mineral is shown in Table 2.



**Table 2. Microprobe analysis of six different points in a 'Niobian rutile'**

%	i	ii	iii	iv	v	vi
TiO <sub>2</sub>	58.19	50.27	49.66	48.57	58.44	49.36
FeO	8.08	10.53	10.05	10.44	8.43	10.68
Nb <sub>2</sub> O <sub>5</sub>	24.23	29.67	30.63	31.04	23.23	30.00
Ta <sub>2</sub> O <sub>5</sub>	9.50	9.54	9.59	9.95	9.90	9.96

Table 2 illustrates the compositional inhomogeneity in a single grain of niobian rutile. The specific gravity of this mineral varies according to the chemical composition, in the range of 4.2-5.6. The Nb content in this mineral is approximately three times higher than that of lunar Nb rutile (Hlava *et al.*, 1972).

**Table 3. Nb concentrations (ppm) in rocks and washed sediments ('nambuwa') from Ratnapura and Elahera**

	Rocks average Nb	Nambuwa average Nb	Accumulation Factor
Ratnapura	12	166	14
Elahera	10	88	9

**Table 4. Nb concentrations in different rock types from Ratnapura and Elahera**

Rock sample	No. of samples	Average Nb content
<i>Ratnapura</i>		
Acid charnockite	7	17 ppm
Basic charnockite	6	10 ppm
Intermediate charnockite	2	12 ppm
Biotite gneisses	3	17 ppm
Qtz Felds. Gneisses	2	4 ppm
Sediments	30	22 ppm
<i>Elahera</i>		
Charnockite	4	8 ppm
Gneisses	11	12 ppm
Marble	4	1 ppm
Sediments	6	24 ppm

Tables 3 and 4 show the Nb contents of 'nambuwa' and various rocks respectively. It can be seen from these tables that:-

- 1 acid charnockites contain nearly twice as much Nb as basic charnockites (17 ppm and 10 ppm respectively).
- 2 biotite gneisses contain Nb amounts similar to acid charnockites (17 ppm).
- 3 Nb content in Elahera nambuwa is less than that in Ratnapura and Rakwana (88 ppm, 113 ppm

and 158 ppm respectively).

4 the accumulation factor (Table 3) indicates that Nb minerals accumulate in the Ratnapura sediments more than in Elahera sediments.

The differences in physical, mineralogical and geochemical properties of sediments may be due to their geological, geomorphological and hydrological histories.

The Nb contents in the size fraction <0.63µm of gem sediments from Ratnapura, Rakwana (SW Group) and Elahera are about the same. But Nb in 'nambuwa' from SW region is higher than in 'nambuwa' from Elahera by a factor of two.

#### *Cuprite (CuO)*

This mineral has also been found for the first time in Sri Lanka, in the Rakwana sediments. This porous and earthy-grey mineral has been tested by X-ray diffractometry and its identification confirmed. Coomaraswamy (1906) has reported a few occurrences of native copper in the Pelmadulla area. These were found in laterites with ferruginous concretions. The presence of cuprite in this area is a clear indication of a possible occurrence of native copper.

#### *Gold*

The 'Mahawangsaya' (the written history of Sri Lanka - which runs back some 2600 years) states that Sri Lankans have used gold in their jewellery, religious monuments and thrones, for thousands of years.

Dissanayake and Karunaratne (1984) in their geo-archaeological study state that the ancient Sinhalese obtained native gold from many different locations throughout the island. During the course of this study, three native gold nuggets of about 0.6 g were found in 'nambuwa' from the SW region and the people in certain villages (e.g. Omatta) had made jewellery from this locally found gold. In the seventeenth century, planters in these areas found gold in some alluvial sediments, but due to technological constraints this industry has been abandoned. In order to evaluate the economic feasibility of these gold-bearing sediments, a detailed study is essential.

#### *Rare-earth element distribution in minerals*

Nb-rutile, monazite, zircon, tourmaline and pyrite have been analysed by neutron activation analysis for REE and 25 other elements (see Table 5). Zircon and monazite are rich in the REE as well as Th and U.

#### **Acknowledgements**

Grateful thanks are due to Messrs S.M.B. Amunugama, K. Dunuhappawa and Mrs J. Wijesekera for their assistance.

**Table 5. Neutron Activation Analytical data of some important minerals found in Sri Lankan gem sediments**

	Zircon	Ilmenite	Nb-rutile	Pyrite	Tourmaline	Monazite
Nb <sub>2</sub> O <sub>5</sub>	—	—	24.23%	—	—	—
Ti	—	32.6%	30.00%	—	—	—
Fe	0.1%	36.1%	8.25%	47.58%	11.65%	—
Na	6	18.4	370	29	1.86%	538
K	15	18	120	25	150	1.01%
Sc	11.6	53	130	25	162	2
Cr	—	350	—	9130	44	20
Mn	4	2300	154	4	4215	85
Co	3	55	—	158	—	100
Zn	—	470	—	—	360	—
Ga	—	4	33	—	383	—
As	—	1	—	13	3	—
Se	—	—	—	12	—	—
Br	—	—	44	5	3	—
Sr	—	—	40	—	—	—
Zr	47%	—	—	—	—	1.35%
Mo	—	15	—	—	—	—
In	—	—	2	—	—	—
Sb	—	1	—	1	1	25
Ba	—	—	220	—	—	5000
La	0.4	11	91	1	2	12
Ce	—	26	270	—	2	26%
Sm	—	1	—	0.04	436	1%
Eu	0.5	0.1	0.5	0.14	—	104
Tb	2.2	—	—	—	—	437
Dy	19	0.5	—	—	—	1032
Ho	8	—	—	—	—	—
Yb	74	0.3	—	—	—	123
Lu	16	0.9	—	—	—	35
Hf	2%	4.5	447	—	—	—
Ta	1	78	7%	—	1.40	—
W	—	22	2844	—	—	—
Au	—	—	—	0.03	—	—
Th	425	4	25	—	—	8.34%
U	2410	—	254	0.17	—	3640

Note: All values in ppm except those indicated as %.

## References

1. Coomaraswamy, A.K. 1906. *Administration Report*, Mineralogical Survey, Ceylon (Sri Lanka), 1-13.
2. Cooray, P.G., 1957. *The Geology of Ceylon*. p. 323, National Museums of Ceylon (Sri Lanka) Publication.
3. Dissanayake, C.B. and Karunaratne, W.M.A. 1984. A Geomorphological Study of Ancient Gold Deposits in Sri Lanka (in preparation).
4. Jobbins, E.A., Tresham, A.E. and Young, B.R. 1977. Gem Monazite from Sri Lanka, *J. Gemm.* XV, 295-9.
5. Katz, M.B. 1972. On the Origin of Ratnapura type Gem Deposits of Sri Lanka. *Econ. Geol.* 67, 13-15.
6. Munasinghe, T. and Dissanayake, C.B. 1982. A Plate-tectonic Model for the Geologic Evolution of Sri Lanka. *Jour. Geol. Soc. India*, 23, 369-80.
7. Röster, H.J. 1980. *Lehrbuch Der Mineralogie*, VEB Deutscher Verlag für Grundstoffindustrie, Leipzig. 833.
8. Rupasinghe, M.A., Banerjee, A., Pense, J. and Dissanayake, C.B. 1984. The Geochemistry of Beryllium and Fluorine in the Gem Fields of Sri Lanka, *Mineralium Deposita*, 19, 86-93.
9. Rupasinghe, M.S. 1984. *Ph.D. Thesis*, (in preparation) University of Mainz, West Germany.
10. Searle, D.L. 1964. *The Metamorphic History of Ceylon and the Origin of the Charnockite series*. Int. Geol. Congress, 22nd Session, New Delhi. 13, 45-58.
11. Wadia, D.N. and Fernando, L.J.D. 1944. Records of the Department of Mineralogy Ceylon (Sri Lanka). Professional Paper. 1-44.
12. Hlava, P.F., Prinz, M. and Keil, K. 1972. Niobian Rutile in an Apollo-14 KREEP Fragment, *Meteoritics*, 7, 4, 479-85.

[Manuscript received 4 April 1985.]

## Gemmological Abstracts

- ALIPRANDI, R. 1984. Qualche osservazione sulla presenza di inclusioni in rubini sintetici da fondente di recente produzione. (Observations on the presence of inclusions in synthetic ruby from the beginning to the latest productions.) *La Gemmologia*, 10, 3/4, 15-19, 5 figs in colour. Characteristic inclusions in different types of synthetic ruby are described and illustrated. M.O'D.
- ALIPRANDI, R., GUIDI, G. 1985. Berillo bicolore dell'Orissa (India). (Bi-colour beryl from Orissa, India.) *La Gemmologia*, 10, (sole issue of 1985), 27-31, 8 figs (3 in colour). A cut stone from Orissa, India, had colourless and golden yellow sections. RI of the two sections were 1.570, 1.575 and 1.574, 1.580, respectively. SG was 2.73-2.74. A much higher  $Fe^{3+}$  content was found in the golden sections (0.67% compared with 0.13%). M.O'D.
- BENAVIDES, M.E. 1985. Gemología. (Gemmology.) *Gaceta Mineralógica, Sociedad Mexicana de Mineralogía*, 1, 3, 12-14, 1 fig. A short account of what constitutes a gemstone. M.O'D.
- BORELLI, A. 1981. La 'turquerenite' o 'turchese afgana' (magnesite colorata artificialmente) un sostituto minore della turchese. ('Turquerenite' or 'Afghan turquoise' (artificially coloured magnesite) a minor turquoise substitute.) *La Gemmologia*, 7, 3/4, 14-17, 3 figs (2 in colour). Dyed magnesite with an SG of 2.69-2.77 and a hardness of between 4 and 5 has been used as a turquoise imitation. A strong absorption band at about 590nm is illustrated and there is also absorption in the violet with fainter bands in the blue. M.O'D.
- BORELLI, A. 1983. Turchese: proposta di classificazione e nomenclatura gemmologico-mercologica. (Turquoise: proposals for a classification and nomenclature for gemmology and commerce.) *La Gemmologia*, 9, 1/2, 22-8. A system of classification and nomenclature for turquoise is outlined which includes treated and imitation material as well as synthetic stones. M.O'D.
- BORELLI, A. 1984. Metodo rapido per la distinzione dell'ambra dai suoi sostituti naturali o artificiali. (A quick method of distinguishing amber from its natural and artificial substitutes.) *La Gemmologia*, 10, 3/4, 10-14. Simple tests are outlined. M.O'D.
- BORELLI, A., SBRANA, G. 1981. Uso della spettrografia I.R. per distinguere la turchese naturale da quella sintetica e dagli altri sostituti e per rilevarne eventuali sofisticazioni. (Use of infrared spectrography to distinguish between natural turquoise and synthetic material and various substitutes with means of increasing sophistication.) *La Gemmologia*, 7, 3/4, 9-13, 2 figs. Infrared spectroscopy can help to distinguish between natural and synthetic turquoise and some of its imitations. IR spectra are illustrated. M.O'D.
- BORELLI, A., TROSTI FERRONI, R. 1981. Metodo non distruttivo per la determinazione al diffrattometro a R.X. di gemme policristalline tipo giada e tipo turchese, delle loro imitazioni naturali e di certi sostituti artificiali. (A non-destructive method for the X-ray diffraction study of jade- or turquoise-like polycrystalline gems, their natural imitations and some artificial substitutes.) *La Gemmologia*, 7, 1/2, 5-10, 4 figs (1 in colour). X-ray diffraction has been used to identify natural, natural imitations and man-made imitations of jade- and turquoise-like polycrystalline minerals. Diffraction patterns are given. M.O'D.
- BORELLI, A., TROSTI FERRONI, R. 1981. Un inconsueto materiale tipo giada. (An unusual jade-like material.) *La Gemmologia*, 7, 1/2, 11-12, 3 figs (1 in colour). A green material resembling jade was found to be an amphibole of the glaucophane type. X-ray diffraction was used and the spectra obtained are given. M.O'D.
- BOSCARDIN, M., COLMELET, G., VIOLATI TESCARI, Q. 1982. Xonotlite: un nuovo minerale italiano di interesse gemmologico. (Xonotlite, a

- new Italian mineral of gemmological interest.) *La Gemmologia*, 8, 3/4, 12-16.
- Xonotlite, a calcium silicate with the composition  $\text{Ca}_3\text{Si}_3\text{O}_8(\text{OH})_2$  and a member of the monoclinic crystal system, has been found in an area of contact between monzonitic rocks and Triassic dolomites at Contrada, Molini di Laghi, Vicenza, Italy. The hardness is 6 and the colour pink and white veining. RI is  $\alpha = \beta = 1.583$ ,  $\gamma = 1.593$ . M.O'D.
- BOSCH-FIGUEROA, J.M. 1985. Características morfológicas de los diamantes. (Morphological characteristics of diamonds.) *Gemologia*, 23, 67/68, 14-22, 2 figs.
- Characteristics of diamond crystals from a number of South African mines are given. M.O'D.
- BOSCH-FIGUEROA, J.M. 1985. Tratamientos empleados para modificar el color del topacio. (Treatment used to modify the colour of topaz.) *Gemologia*, 23, 67/68, 23-8, 4 figs.
- The treatment of topaz by a variety of methods resulting in alteration of colour is described. M.O'D.
- BREITER, K., PASAVA, J. 1986. Bohemian quartz. *Lapidary Journal*, 39, 11, 54-5, 4 figs.
- Ferruginous quartz is found in some Ordovician volcano-sedimentary iron ore deposits south-west of Prague, Czechoslovakia. A star-like red and yellow quartz can be found on dumps near the mines at Zajecov and Svata Dobrotiva. M.O'D.
- BROWN, G. 1985. Conversion kits for built-in LED refractometer light sources. *Australian Gemmologist*, 15, 12, 456-8, 3 figs.
- An evaluation of Snow kits supplied for use with different makes of refractometer. Fitting in some instances requires disassembly of the instrument which might invalidate a guarantee. R.K.M.
- BROWN, G., HAMID, D., KELLY, S.M.B. 1985. Some information on the Kashmir sapphires. *Australian Gemmologist*, 15, 12, 448-9, 2 figs in colour.
- Features extracts from diary of Melbourne dealer, George Hamid, who visited the area in 1982 but found no Kashmir sapphires. Suggests that the day of the Kashmir sapphire is over. R.K.M.
- BROWN, G., SNOW, J. 1985. Green dyed 'crackled beryl'. *Australian Gemmologist*, 15, 12, 454-5, 6 figs.
- An 8.1 ct leek-green beryl which owed its colour to heating and quenching in green dye. R.K.M.
- BROWN, G., SNOW, J. 1985. The Relite refractometer light source. *Australian Gemmologist*, 15, 12, 458-9, 1 fig.
- An evaluation of an extra-bright LED source for use with batteries or 9V DC mains converter. Height of LED is adjustable. R.K.M.
- BURLS, J. 1985. Diamonds from the Emerald Isle. *Optima*, 33, 169-79, 5 figs.
- Historical survey of the development of the De Beers Shannon plant synthesizing diamond grit, producing syndite and syndie (for wire drawing) occasioned by its Silver Jubilee. E.S.
- BUTINI, E., ALIPRANDI, R. 1981. Corallo: imitazioni e trattamenti. (Coral: imitation and treatment.) *La Gemmologia*, 7, 1/2, 13-17.
- Descriptions and a table of coral and its imitations, including treated material, are given. Among the natural simulants palygorskite is suggested as a possibility. M.O'D.
- CAUCIA, F., SACCHETTI, A., SETTI, M., VENIALE, F. 1984. Studio di opali naturali e sintetici. (A study of natural and synthetic opal.) *La Gemmologia*, 10, 1/2, 16-21, 2 figs.
- Natural and synthetic opals were examined by X-ray diffraction, thermal analysis, IR spectrometry, electron microscopy and the electron microprobe. Different types of structure are identified. M.O'D.
- COLLINS, A.T., 1983. Centri di colore nei diamanti. (Colour centres in diamond.) *La Gemmologia*, 9, 3/4, 20-46, 19 figs.
- A detailed review of the role played by colour centres in the coloration of diamond with reproduction of absorption spectra. M.O'D.
- COUTY, R., VELDE, B. 1986. Pressure-induced band splitting in infrared spectra of sanidine and albite. *American Mineralogist*, 71, 99-104, 6 figs.
- In the infrared spectra of sanidine and albite under pressures of up to 40 kbar convergence was noted. New bands were seen in the sanidine spectra and these are attributed to changes in the position of the alkali ion in the structure as it influences the oxygens of the tetrahedral network. M.O'D.
- COZAR, J.S. 1981. Alejandrita sintetica. (Synthetic alexandrite.) *Boletín del Instituto Gemológico Español*, 21, 31-5, 8 figs in colour.
- Cut specimens of synthetic alexandrite grown by Creative Crystals Inc. of Concord, California, were examined. RI was 1.740-1.749 and SG 3.70. A

normal absorption spectrum for alexandrite was observed. Flux inclusions indicated the origin.

M.O'D.

COZAR, J.S. 1984. Enstítita 'Ojo de Gato' en el olivino de la isla de Lanzarote. (Cat's-eye enstatite in the olivine of the island of Lanzarote.) *Boletín del Instituto Gemológico Español*, 25, 30-50, 26 figs in colour.

Cat's-eye green enstatite is found at Lanzarote in the Canary Islands where olivine of gem quality occurs. The enstatite is found as macroscopic inclusions in the olivine.

M.O'D.

COZAR, J.S., RIVAS, P., FERNANDEZ, M. 1985. Alteraciones hidrotermales características de la kimberlita de la chimenea Dutoitspan. (Characteristic hydrothermal alterations of the Dutoitspan kimberlite pipe). *Boletín del Instituto Gemológico Español*, 26, 5-24, 12 figs (11 in colour).

A kimberlite sample from the Dutoitspan diamond mine and its composition assessed; pectolite is among the minerals identified.

M.O'D.

DE MICHELE, V. 1981. Materiali gemmiferi italiani. (Italian gem materials.) *La Gemmologia*, 7, 3/4, 17-25.

A list with brief descriptions of Italian gem and ornamental materials is given. Among them are adularia, albite, amber, andalusite, anglesite, apatite, axinite, beryl, varieties of quartz, chrysoberyl, datolite, diopside, epidote, euclase, garnets, leucite, olivine, opal varieties, prehnite, serpentine, tourmaline, vesuvianite and zircon.

M.O'D.

DONTENVILLE, S., CALAS, G., CERVELLE, B. 1986. Etude spectroscopique des turquoises naturelles et traitées. (Spectroscopic study of natural and treated turquoise.) *Revue de Gemmologie*, 86, 3-4, 3 figs.

Second part\* of a paper covering the spectra of Gilson turquoise and plastic-impregnated turquoise.

M.O'D.

DRAGSTED, O. 1985. Nummite. *Australian Gemmologist*, 15, 12, 461, 2 figs in colour.

A new ornamental variety of gedrite found at Godthab Fjord, Greenland, is brown with golden inclusions.

R.K.M.

FJORDGREN, O. 1986. Infrared detective. *Lapidary Journal*, 39, 12, 39-41, 1 fig.

Infrared photography can be used to detect heat treatment of geuda corundum.

M.O'D.

FLAMINI, A., GASTALDI, L., GRUBESSI, O., VITICOLI, S. 1983. Contributo della spettroscopia ottica ed EPR alla distinzione tra smeraldi naturali e sintetici. (The contribution of optical spectroscopy and EPR to the distinction between natural and synthetic emerald.) *La Gemmologia*, 9, 1/2, 6-11, 3 figs.

Studies using optical absorption spectroscopy and EPR on natural and synthetic emerald are discussed. Work was carried out in a wide temperature range. Spectra are reproduced and distinction said to be nearly conclusive.

M.O'D.

FLAMINI, A., GASTALDI, L., GRUBESSI, O., VITICOLI, S. 1983. Sulle caratteristiche particolari del berillo rosso dell'Utah. (Particular characteristics of red beryl from Utah.) *La Gemmologia*, 9, 1/2, 12-20, 20 figs (12 in colour).

Cut stones and crystals of red beryl from Wildhorse Spring and Wah Wah, Utah, USA, were studied with a variety of methods. Colour is related principally to divalent manganese and shows in cut stones in a variety of characteristic patterns. Concentric pyramidal zoning of colour is noted in many cut stones; the pyramids have orange cores with purple and light pink showing as the edges are reached.

M.O'D.

FLAMINI, A., GASTALDI, L., GRUBESSI, O., VITICOLI, S. 1983. Risultati preliminari di sintesi di smeraldi. (Preliminary results on the synthesis of emeralds.) *La Gemmologia*, 9, 3/4, 6-9, 6 figs (4 in colour).

Single crystals of emerald were grown from a  $\text{Li}_2\text{Mo}_2\text{O}_7$  flux. Transition metal ions were used as dopants. Cell dimensions are reported and optical absorption spectra given. A strong band was seen at 825nm and ascribed to iron.

M.O'D.

FLAMINI, A., GRUBESSI, O., MOTTANA, A. 1984. Il sistema chimico del berillo e le sue conseguenze sulle proprietà fisiche. (The chemical system of beryl and its significance for its physical properties.) *La Gemmologia*, 10, 1/2, 6-15, 6 figs.

Synthetic emeralds have smaller unit cell parameters than natural ones and in this paper the presence of water molecules is suggested as one of the causes of this.

M.O'D.

FRANCIS, P. 1986. Indian antiquity. *Lapidary Journal*, 39, 12, 45-55, 3 figs.

An account of the mining in India of amethyst and citrine and their shipment to the West as far back as the first century AD.

M.O'D.

FUENTES, J.C., ROSELLO, E.A. 1986. Topacios en la provincia de Catamarca, Argentina. (Topaz

\* The first part was abstracted in *J. Gemm.*, 1986, 20, 2, 125-6.

- from the province of Catamarca, Argentina.) *Boletín del Instituto Gemológico Española*, 27, 25–8, 5 figs (4 in colour).
- Topaz is found at the contact between a metamorphic rock and the host rock of the granitic Papachacra formation in the Belén Dept of Argentina. The mineral is formed hydrothermally; some crystals are up to 50mm in length, euhedral to subhedral and light greenish-yellow. M.O'D.
- FUMEY, P. 1986. L'opale précieuse en territoire du Sud-Australien: Coober Pedy. (Precious opal from South Australia: Coober Pedy.) *Revue de Gemmologie*, 86, 17–20, 4 figs (2 in colour).
- An account of the history and geology of the Coober Pedy opal deposit with a diagram of the formations in which it is found. M.O'D.
- GARCÍA GIMENEZ, R., LEGUEY JIMENEZ, S. 1981. Influencia de elementos cromóforos en elbaitas zonadas. (Influence of chromophores in zoned elbaite.) *Boletín del Instituto Gemológico Español*, 21, 21–8, 4 figs (2 in colour).
- Iron and manganese are shown by spectroscopy to be responsible for the different colours of elbaite tourmaline. Electron microscopy was used to examine the crystals. M.O'D.
- GARCÍA GUINEA, J. 1983. Materiales gemológicos españoles, minerales, perspectivas generales. (Spanish gemmological materials, minerals, general overview.) *Boletín del Instituto Gemológico Español*, 24, 9–18, 7 figs (6 in colour).
- Spanish gemmological minerals include beryl, topaz, olivine, rose quartz, citrine and variscite. M.O'D.
- GARCÍA GUINEA, J. 1986. Materiales gemológicos españoles: los zafiros de Goyán (Pontevedra). (Spanish gemmological materials: sapphires from Goyán (Pontevedra).) *Boletín del Instituto Gemológica Español*, 27, 16–24, 14 figs (9 in colour).
- Blue sapphires are found in andalusite masses in mica schist segregation veins at Goyán, Pontevedra, Spain. M.O'D.
- GARCÍA GUINEA, J., GALÁN HUERTOS, E. 1985. Materiales gemológicos españoles: yacimientos de cuarzo. (Spanish gemmological materials: quartz deposits.) *Boletín del Instituto Gemológico Español*, 26, 27–40, 18 figs (12 in colour).
- The main Spanish quartz deposits of gemmological importance are listed and described. Some examples are analysed. M.O'D.
- GARZON JIMENEZ, J. 1983. El color de las gemas. (The colour of gems.) *Boletín del Instituto Gemológico Español*, 24, 21–47, 22 figs in colour.
- A comprehensive review of the various causes of colour in gemstones with diagrams of the processes involved. M.O'D.
- GAUTHIER, J.-P. 1986. L'opale noble au microscope électronique. (Precious opal under the electron microscope.) *Revue de Gemmologie*, 86, 21–6, 20 figs.
- A study of the structure of precious opal as seen with the electron microscope. High quality illustrations are provided. M.O'D.
- GRAETSCH, H., FLÖRKE, O.W., MIEHE, G. 1985. The nature of water in chalcedony and opal-C from Brazilian agate geodes. *Physics and Chemistry of Minerals*, 12, 300–6, 10 figs.
- Water species  $H_2O_{(SiOH)}$  and  $H_2O_{(mol)}$  in chalcedony and opal-C (a type of opal occurring with chalcedony in Brazilian agates) were studied by a variety of techniques. Both chalcedony and opal-C have fully hydrated surfaces at the open porosity and contain additional water at inner surfaces which are closed micropores in the case of opal-C and regions of accumulated defects in chalcedony. Tests indicated that chalcedony is formed at low temperatures. M.O'D.
- GRECO, S. 1982. Notizie sull'ambra di Santo Domingo. (Note on amber from Santo Domingo.) *La Gemmologia*, 8, 1/2, 25–34, 8 figs in colour.
- Characteristics of amber from Santo Domingo (Dominican Republic) are described and illustrated. M.O'D.
- GÜBELIN, E. 1985. Il riconoscimento dei nuovo rubini sintetici. (The recognition of the new synthetic rubies.) *La Gemmologia*, 10, (sole issue of 1985), 6–18, 42 figs (41 in colour).
- Translation into Italian of a paper first published in *J. Gemm.*, 1983, XVIII, 6, 477–99. M.O'D.
- GÜBELIN, E. 1986. Deux nouveaux produits artificiels sur le marché des pierres précieuses: le rubis synthétique 'Ramaura' et le gallo-aluminate d'yttrium. (Two new artificial products on the gem market: Ramaura synthetic ruby and yttrium gallium aluminate.) *Revue de Gemmologie*, 86, 15, 8 figs in colour.
- Second part of a paper translated from the German and covering characteristic inclusions in the materials concerned, which are illustrated. M.O'D.

GUILLÉN, P. 1986. El coral. (Coral.) *Boletín del Instituto Gemológico Español*, 27, 6-15, 14 figs in colour.

An attractively illustrated account of the use of coral as an ornamental material. M.O'D.

HOFMEISTER, A.M., ROSSMAN, G.R. 1985. A model for the irradiative coloration of smoky feldspar and the inhibiting influence of water. *Physics and Chemistry of Minerals*, 12, 324-32, 6 figs.

Radiation induced smoky colour and associated EPR signals were found to develop in potassium feldspar when free from structurally bound water. Fluid inclusion water does not affect coloration.

M.O'D.

HOFMEISTER, A.M., ROSSMAN, G.R. 1986. A spectroscopic study of blue radiation coloring in plagioclase. *American Mineralogist*, 71, 95-8, 4 figs.

Blue in sodic plagioclase arises from electronic transitions of Pb: a similar transition gives the colour in amazonite. Both types of feldspar have elevated Pb concentrations, structurally incorporated hydrogen, similar response of the colour to heating and irradiation and similar features in the absorption spectrum, including band shape, position and polarization.

M.O'D.

HUANG, Z.H., GANDAIS, M. 1985. Some physical properties of a labradorite single crystal from Mexico. *Bulletin de Mineralogie*, 108, 829-33, 3 figs.

A gem-quality labradorite crystal was shown to have a plagioclase structure and refractive indices of  $\gamma$  1.5689,  $\beta$  1.563 and  $\alpha$  1.5598. These values correspond to a composition of An<sub>62</sub> which was confirmed by the electron microprobe. Some albite twin lamellae were seen but otherwise the crystal was transparent with no compositional zoning or inclusions. The size was 2 × 2 × 1 cm.

M.O'D.

KANKA, A. 1986. Achate von Waldhambach. (Agate from Waldhambach.) *Lapis*, 11, 4, 25-7, 7 figs (6 in colour).

Fine agate, with some amethyst, is found at Waldhambach, north-west of Karlsruhe, West Germany.

M.O'D.

KOURIMSKY, J. 1980. Pietre preziose della Cecoslovacchia. (Precious stones of Czechoslovakia.) *La Gemmologia*, 6, 3/4, 5-13, 11 figs.

The different geological areas of Czechoslovakia are reviewed: amethyst, rose quartz and agate, aquamarine and golden beryl, are found as well as moldavite which is probably the best-known ornamental material.

M.O'D.

LANDAIS, E. 1981. Assorbimento del berillo nell'infrarosso: suo contributo alla distinzione fra smeraldi naturali e sintetici. (Absorption of beryl in the infrared: its role in distinguishing between natural and synthetic emerald.) *La Gemmologia*, 7, 3/4, 5-14, 6 figs.

Details of the IR absorption spectra for a number of natural and synthetic emeralds are given. It is possible to distinguish the natural and hydrothermal product from that grown by the flux-melt method, since the latter shows no water IR spectrum, whereas the other two show the characteristic bands.

M.O'D.

LEGUEY, S., MORANTE, M., MEDINA, J.A. 1982. Inclusiones piramidales en berilos relacionadas con fenomenos de corrosion. (Pyramidal inclusions in beryl related to corrosion phenomena.) *Boletín del Instituto Gemológico Español*, 23, 17-27, 14 figs (6 in colour).

Inclusions in a beryl crystal from Minas Gerais, Brazil, show pseudo-pyramidal form. Some also display zoning and others a differing coloration and degree of transparency. The differences observed are related to the degree of corrosion encountered during formation.

M.O'D.

LIND, T., SCHMETZER, K., BANK, H. 1985. Methods for the distinction of natural and synthetic amethyst. *Australian Gemmologist*, 15, 12, 463-70, 7 figs in colour.

Several methods are discussed: conoscopic examination for complete uniaxial centre cross; angular colour zones; polysynthetic twinning; fluid, two-phase and ripple-fracture inclusions; sharp lamellar and angular colour zoning; fingerprint pattern on lightly polished surfaces - all denote natural amethyst. Synthetics are untwinned and show none of these features. Infrared spectroscopy shows that absorption line in region of 3500<sup>cm</sup><sup>-1</sup> occurs only in the synthetic amethyst. Further methods of discrimination are being sought.

R.K.M.

MANGIAGALLI, G., ROSEO, I. 1985. Una rodingite a vesuviana della Valtournenche (Aosta) come materiale di interesse gemmologico. (A vesuvianite rodingite from Valtournenche (Aosta) as a material of gemmological interest.) *La Gemmologia*, 10 (sole issue of 1985, 19-23, 8 figs in colour).

A vesuvianite rodingite resembling jade is reported from Valtournenche (Aosta). RI is about 1.700; SG ranges from 3.07 to 3.32 and there is an absorption line near 460nm. The colour is light to dark green.

M.O'D.

- MARENSI DE MOURA, O.J., GARCÍA GUINEA, J. 1984. Pegmatitas españolas con berilo y otras similares de Minas Gerais (Brasil). (Beryl-bearing Spanish pegmatites and other similarities with Minas Gerais, Brazil.) *Boletín del Instituto Gemológico Español*, 25, 9-28, 6 figs.  
Spanish beryl-bearing pegmatites are related to the Centro Iberica and Ossa-Morena structural units. Beryl occurs in the intermediate zones associated with microcline-perthite, quartz and muscovite, or in metasomatic phases. Similarities with beryl-bearing pegmatites in Minas Gerais, Brazil, are recorded. M.O'D.
- MOLINE SALA, A. 1985. Aparato para la observación de fluorescencias en materiales gemológicos. (Apparatus for the observation of fluorescence in gem materials.) *Gemología*, 23, 67/68, 5-13, 7 figs.  
A device operating with intermittent production of long-wave and short-wave ultraviolet light and of white light is used for gem testing. Construction and results are described. M.O'D.
- NASSAU, K. 1982. Quarzo ametista-citrino naturale, trattato e sintetico. (Natural amethyst-citrine quartz, treated and synthetic.) *La Gemmologia*, 8, 3/4, 17-28, 9 figs (7 in colour).  
A translation into Italian and adaptation of papers by the author in *Lapidary Journal*, 1981, 35, 1, 52-60\*. M.O'D.
- O'DONOGHUE, M. 1986. Gems and gemmology. *Watchmaker, Jeweller and Silversmith*, March 1986, pp. 54-7, 3 figs in colour.  
The first of a new series, this column includes notes on jade and its simulants, the gem minerals of Pakistan, impregnated opal and some new synthetic materials. (Author's abstract.) M.O'D.
- O'DONOGHUE, M. 1986. Gems and gemmology. *Watchmaker, Jeweller and Silversmith*, April 1986, pp. 46-8.  
The gemstones of Pakistan, methods of gemstone weighing, notes on new synthetic materials and on freshwater pearls from China, are included in this month's column. (Author's abstract.) M.O'D.
- PEARSON, G. 1985. The role of water in cracking of opal. *Australian Gemmologist*, 15, 12, 435-45, 3 figs.  
In an attempt to assess cracking potential in Australian opal the author used samples from Coober Pedy (3 areas), Mintabie, Lightning Ridge and White Cliffs (2 areas) in a series of experiments which included heating in various fluids. At 100°C, held for four hours, no cracking occurred. At 200°C cracking occurred quickly in all specimens, the more so in that from the Coober Pedy Eleven Mile mine. Unresolved anomalies were found and the experiments do not appear to have contributed answers as to why some opals crack at ambient temperatures. R.K.M.
- POIROT, J.-P. 1986. Pierres précieuses. (Precious stones.) *Monde et Minéraux*, 71, 28-41, 12 figs in colour.  
First part of a very general though beautifully-illustrated guide to the gem varieties of minerals. M.O'D.
- POUGH, F.H. 1986. Ammolite: grandmother of pearl. *Lapidary Journal*, 39, 10, 35-41, 9 figs in colour.  
Fossilized ammonite shell from a location near Lethbridge, Alberta, Canada, shows an attractive play of colour and has been used ornamentally. The play of colour is more directional than that shown by opal and the spectral succession is less pronounced. Stones have been capped with synthetic spinel. M.O'D.
- PRING, A., DIN, V.K., JEFFERSON, D.A., THOMAS, J.M. 1986. The crystal chemistry of rhodizite: a re-examination. *Mineralogical Magazine*, 50, 355, 163-72, 6 figs.  
An analysis of rhodizite using high-resolution electron microscopy, magic angle spinning nuclear magnetic resonance, single crystal X-ray structure refinement and fresh chemical investigation has given the formula  $(K_{0.46}Cs_{0.36}Rb_{0.06}Na_{0.02}) \Sigma 0.90 Al_{3.99}Be_4(B_{11.35}Be_{0.55}Li_{0.02})O_{28}$ . M.O'D.
- PROUT, B.A.W. 1986. Jet. *Wahroongai News*, 20, 1, 6-7.  
A brief account of the history and rise and fall in fashion of this rather gloomy mourning gem. The introduction of the cheaper black glass, vulcanite and ebonite contributed to its decline as much as did changes in fashion. R.K.M.
- SAMUELS, S.K. 1986. Burma's jade. *Lapidary Journal*, 39, 12, 20-5, 1 fig.  
Short account of Burmese history as it affects jade recovery and use. M.O'D.
- SARMIENTO CARPINTERO, L. 1985. La importancia de las inclusiones en la gemología. (The importance of inclusions in gemmology.) *Boletín del Instituto Gemológico Español*, 26, 41-9, 11 figs in colour.  
A well-illustrated survey of the more important inclusions in gemstones. M.O'D.

\* Abstracted in *J. Gemm.*, 1981, XVII, 8, 638.



SAVASCIN, Y. 1986. Anatolia. *Lapidary Journal*, 39, 12, 42-4, 5 figs in colour.

Gem materials found in Anatolia (Turkey) include fire opal from Simaw and chalcedony from Eskisehir-Saricakaya. Obsidian is also found.

M.O'D.

SCHMETZER, K., BANK, H. 1984. Crystal chemistry of tsilaisite (manganese tourmaline) from Zambia. *N. Jb. Miner. Mh.*, 2, 61-9.

Chemical, optical and X-ray data of manganese-bearing tourmaline from Zambia are given. The tourmalines have manganese contents of approximately 6-7% MnO and iron contents 0.1% FeO, and they represent intermediate members of a solid solution series between the idealized end members elbaite,  $\text{Na}(\text{Li}_{1.5}\text{Al}_{1.5})\text{Al}_6(\text{BO}_3)_3\text{Si}_6\text{O}_{18}(\text{OH},\text{F})_4$ , and tsilaisite,  $\text{Na}(\text{Mn}_{1.5}\text{Al}_{1.5})\text{Al}_6(\text{BO}_3)_3\text{Si}_6\text{O}_{18}\text{O}_{1.5}(\text{OH},\text{F})_{2.5}$ . An isomorphic replacement of  $\text{Li}^+ + (\text{OH})^- \rightarrow \text{Mn}^{2+} + \text{O}^{2-}$  is found to be dominant in natural manganese tourmalines over a second type of coupled substitution  $\text{Al}^{3+} + \text{O}^{2-} \rightarrow \text{Mn}^{2+} + (\text{OH})^-$ , which is present only in a minor amount. Tourmaline from Zambia has a composition of about 70% of the tsilaisite end member, and the physical properties of this intermediate tourmaline ( $a_0$  15.915,  $c_0$  7.123 Å;  $n_e$  1.623,  $n_o$  1.647; D 3.13 g/cm<sup>3</sup>) are close to the data published for members of the elbaite-schorl solid solution series.

Author's abstract. K.S.

STELLER, E.T. 1985. Angles. *Australian Gemmologist*, 15, 12, 450-3, 1 fig.

Criticism of the Australian Ideal Design for round Brilliant for diamond (*Australian Gemmologist*, 1984, 15, 7, 219-26, 243-6\*) which presented the peculiar idea of sixteen pavilion facets. Dr Steller, a retired University mathematician, also criticises a paper by Dr Suzuki (*Australian Gemmologist*, 1970). †

R.K.M.

SUNAGAWA, I. 1983. Diamanti, naturali e sintetici. (Natural and synthetic diamond.) *La Gemmologia*, 9, 3/4, 10-19, 3 figs.

A general review of natural and synthetic diamonds with discussion of their formation.

M.O'D.

SWOBODA, E.R. 1986. Green phantoms. *Lapidary Journal*, 39, 11, 19-24, 4 figs (1 in colour).

Phantom inclusions in various types of quartz are described with anecdotes of the author's field trips in Brazil.

M.O'D.

TALAVERA ESCUDERO, A. 1981. Perlas cultivadas de agua dulce. (Freshwater cultured pearls.) *Boletín del Instituto Gemológico Español*, 21, 9-10, 4 figs in colour.

A brief description of freshwater cultured pearls with a note on Spanish occurrences.

M.O'D.

THEMELIS T. 1986. Oven fresh sapphires. *Lapidary Journal*, 39, 11, 49-53, 3 figs in colour.

The author describes the heating of colourless corundum to produce blue sapphire in Sri Lanka.

M.O'D.

TOMBS, G. 1985. Jade: the gemstone material enigma. *Australian Gemmologist*, 15, 12, 445-7.

The author describes this as an appreciation exercise. It is little more.

R.K.M.

TURREL, M. 1986. Découverte de l'Autriche. (Discovered in Austria.) *Revue de Gemmologie*, 86, 16, 1 fig. in colour.

A short review of Austrian minerals which include emerald from the Habachtal.

M.O'D.

VINK, B.W. 1986. Stability relations of malachite and azurite. *Mineralogical Magazine*, 50, 355, 41-7, 4 figs.

Azurite is formed only under relatively acid conditions at fairly high carbonate activities, these taking place under basic conditions. Malachite is thus the commoner form of copper carbonate. Small changes in carbonate/bicarbonate activities explain the common alteration of azurite to malachite. Eh-pH diagrams show stability relations of the two minerals.

M.O'D.

WALTERS, J. 1986. Agate, fact and fantasy. *Lapidary Journal*, 39, 11, 38-9.

A brief introduction to agate lore.

M.O'D.

WOODRUFF, R.E. 1986. Larimar. *Lapidary Journal*, 39, 10, 26-32, 8 figs (4 in colour).

The name is given to a blue mineral of volcanic origin tentatively identified as a variety of pectolite. It is found in the Dominican Republic about 10km north of the road from Barahona to Bahoruco.

M.O'D.

YAMAMOTO, T. 1982. Ostras períferas Akoya. (Akoya pearl oysters.) *Boletín del Instituto Gemológico Español*, 23, 8-16 6 figs in colour.

A useful review of the various activities of Japanese cultured pearl manufacturers.

M.O'D.

\* Abstracted in *J. Gemm.*, 1985, XIX, 5, 438.

† Abstracted in *J. Gemm.*, 1971, XII, 5, 180-1.

ZANCANELLA, R. 1981. Nuovi metodi di analisi degli elementi qualitativi del diamante. (New methods of analysis of qualitative elements in diamond.) *La Gemmologia*, 7, 3/4, 18-24, 1 fig.

A method of plotting and assessing the role of inclusions in the clarity of diamond is suggested. Micron-sized inclusions are noted using appropriate microscopic techniques and are placed in arbitrary shapes (circle, rectangle, square, rhombus) to form a basis for clarity assessment. M.O'D.

ZAPATERO RAMOS, L. 1981. Diapositivos que aumentan el contraste microscópico y su utilización en gemología. (The use of diapositives to augment microscopic contrast and its utilization in gemmology.) *Boletín del Instituto Gemológico Español*, 21, 13-19, 11 figs in colour.

An explanation of the use of phase contrast microscopy for the study of gemstones. M.O'D.

ZEITNER, J.C. 1986. Quartz, the lapidary favorite. *Lapidary Journal*, 39, 11, 26-32, 5 figs in colour.

A brief introduction to the quartz minerals with special reference to their ornamental usage. M.O'D.

ZEITNER, J.C. 1986. Rare among rare. *Lapidary Journal*, 39, 12, 26-34, 4 figs in colour.

A short illustrated survey of some of the less common gemstones to be found in Asia. Stones discussed include painite, manganotantalite, kornerupine, sinhalite, cymophane, zircon, jadeite, sapphirine, demantoid garnet, iolite, cassiterite and spodumene. M.O'D.

*Gem Bulletinen*. 1986. 1. Published by Stockholms Gemmologiska Förening, Stockholm, Sweden.

This new journal is reproduced from typescript and contains papers on turquoise and andalusite, with shorter notes. M.O'D.

## Book Reviews

BRICE, J.C. 1986. *Crystal growth processes*. Blackie, Glasgow: Halsted Press, New York, pp. x, 298. Illus. in black-and-white. £29.00.

Before this book was published there was no single place in which the student could look for detailed accounts of crystal growth processes; the literature contains many such descriptions but they are nearly always in expensive journals which are hard to locate or in even more elusive conference proceedings. Many descriptions assume some degree of prior knowledge on the part of the reader and most are concerned with specific materials.

In this book the processes themselves are examined after an introductory section dealing with the need for single-crystal materials and with the basic concepts of crystallization. Up to 15 000 tonnes of single crystals are produced world-wide each year for electronics and similar applications as well as for ornament in jewellery. There is thought to be an annual increase in the rate of demand for these substances in the order of 7%. The chapter on basic concepts explains the nature of crystals, their structures and imperfections, and gives particularly valuable notes on phase relations, growth kinetics and transport processes.

Descriptions of the different growth processes come next and deal with the Bridgman and related processes first, followed by the Czochralski and other melt growth techniques. Apparently overall 80% of melt-grown crystals are available from Bridgman and Czochralski methods of growth, but the other 20% can only be obtained by other methods (flux-melt growth, skull-melting, Verneuil, chemical vapour transport, hydrothermal, growth from solid phases). All these methods are described and each section has its own bibliography.

A useful and interesting concluding chapter explains why particular methods of growth are chosen and a postscript suggests that while the demand for single crystal materials is likely to increase, automation of much of the growth process will mean that there will not be a corresponding increase in the number of workers in the field. Those already in it will be concerned with furthering study on the complex interactions of growth parameters on the characteristics of the crystal that they grow. These topics are treated in

the book which is highly recommended for anyone with an abiding interest in the formation of crystals. The text is not too rigorous for general consumption. M.O'D.

BURCH, C.R. 1986. *Gemstone inclusions*. Sunderland Polytechnic, Sunderland. Unpaginated. Price on application.

This is a short descriptive catalogue of an exhibition of photographs of gemstone inclusions, the display being held at the Geological Museum, London, from 25 March to 31 May 1986. Exhibits were 100mm × 120mm on Kodak Ektachrome 50 Professional EPY 135 transparency film. M.O'D.

DIETRICH, R.V. 1985 *The tourmaline group*. Van Nostrand Reinhold, New York. pp. xiii, 300. Illus. in black-and white and in colour. £38.45.

There has been no separate monograph on the tourmaline group of minerals since the two books by A.C. Hamlin, *The History of Mount Mica and The tourmaline*, both published in the last century and now highly desirable collectors' pieces. Both were enthusiastic reports by a collector and as the state of mineralogy at the time did not allow for the grouping of the tourmaline group minerals into the classes which we know today the present book is particularly welcome. With all the techniques of modern laboratories at his disposal, the author briefly reviews nomenclature and then outlines the different species comprising the tourmaline group. Gemmologists may be surprised to learn that there are eight species with distinct compositions and many more names which have been assigned to colour varieties and hypothetical end-member compositions. The author feels that some old-established names, particularly the colour-based ones, should now be abandoned in the interests of clarity.

Crystal form and habit are treated next and some interesting diagrams have been taken from several early authorities. Structure and chemical composition are then discussed with a most useful account of solid solutions – a topic still not completely understood. Inclusions and the intergrowth of tourmaline with other minerals have a chapter of their own, which is followed by a

discussion of colour. In this and the following sections on physical and optical properties a number of useful tables and diagrams are provided; in particular those of absorption spectra should be consulted when the question of colour alteration arises. The remainder of the book deals with the occurrence of tourmaline; there are appendices, one of them listing localities which have yielded notable specimens or gem quality material, and a fine bibliography of nearly 1,000 general and cited references. A more complete bibliography, of some 2,500 entries, can be consulted on cards at the Department of Mineral Sciences at the National Museum of Natural History, Washington, DC.

This is a book which I hope will be the forerunner of others dealing in this kind of depth with individual gem species. The quality of production is high and the colour pictures, though few in number, quite magnificent.

M.O'D.

MAI, P. 1983. *La connaissance des gemmes et de leurs substituts*. Part 1. (The knowledge of gems and their substitutes.) Published by the author at Anvers. pp. 158. Price on application.

This work forms part of a course on gemmology and is unexceptional.

M.O'D.

SINKANKAS, J. (READ, P., ed.) 1986. *Beryl*. Butterworths, London. pp. xiii, 225. Illus. in black-and-white and in colour. £24.00.

This is an abridgement of the author's *Emerald and other beryls\**, 1981, Chilton Book Co., Radnor, Pa., USA. The material has been up-dated in some places and the over-all emphasis is on the gemmological aspects of the beryl minerals. The abridgement has been very successful and the presentation and price are very good.

M.O'D.

\* Reviewed in *J. Gemm.*, 1982, XVIII, 3, 252-3.

## Proceedings of the Gemmological Association of Great Britain and Association Notices

### OBITUARY

FRANCIS SIDNEY HOPE TISDALL was born on 10 August, 1899, and died on 23 January, 1986. To his colleagues and friends he was known as Sid, and will be well remembered by that name. He was born in England, but his family emigrated shortly after his birth to New Zealand where he lived until he was 14 years old. During this time he attended Wellington College where 'mens sana in corpore sano' (as he would have said) was the rule.

His father being in the sports outfitting business, Sid needed no encouragement to become the keen cyclist and walker that characterized him during the whole of his life.

He also showed considerable scholastic ability. Just before the First World War he returned to England where he attended Four Oaks College, near Sutton Coldfield, Warwicks. Although a good academic scholar, he was attracted to a more adventurous life, and giving his age as 16, in 1914 he enlisted in the Forces so that he could join an Army Band and enjoy his pursuits of drum, piccolo and flute playing. He was on active service for four years and may have remained longer in the army, but his grandfather, the jeweller Samuel Hope, wrote to his Commanding Officer telling him that a job for young Sidney was awaiting him in the family business.

Sid duly joined the family company, but to quote from a personal letter, he says '... when Works Manager, Gem Ring Department Manager, Designer and Gemmologist (yes the lot!) at my late grandfather's firm . . . I preferred to be a "back-room" boy'.

In 1939 he left the company to start his own business buying and selling second-hand jewellery in Manchester and Liverpool. At the end of the Second World War he moved to Rhos-on-Sea which enabled him to be nearer to his beloved mountain scenery, but after an unsuccessful business venture returned to Walmley. Here he worked as a jewellery designer and consultant, retiring from the firm of Deakin and Francis at the age of 67.

Sid was a man of many parts. Although a fine



Sid Tisdall

athlete winning awards for ice dancing, acrobatic diving and walking 50 miles on his 60th birthday, in common with many others denied the luxury of a university education, he continued to pursue his studies with great diligence and concentration. He obtained the Fellowship Diploma with Distinction in 1935, and the Diamond Diploma in 1966. In 1938 he was awarded the Certificate of Merit for Jewellery Design at the then Vittoria Street School for Jewellers and Silversmiths, Birmingham.

His keen interest in gemmology enabled him to obtain the post of Lecturer in Gemmology at this College and he began teaching in 1938. This activity, although to be his main interest for the rest of his life, did not prevent him from teaching classical Greek, taking vigorous exercise hill walk-

ing, pursuing his keen interest in photography and forming the North Birmingham Cycling Club.

He was a prolific writer. Many of his old students will recall his beautifully written RI and SG tables and his 'full answers to questions likely to appear in the next examinations'. The latter would sometimes occupy three pages of meticulous handwriting. As would be expected, bad spelling was an anathema to him and he was much troubled by the decline in the writing ability of his students.

As gemmological correspondent of the *British Jewellery and Watch Buyer*, he contributed many useful and interesting articles and published many papers in *The Gemmologist*, *The Journal of Gemmology* and *Gems*. He was a thorough gemmologist of the old practical school, being a great advocate of the X10 lens and down-to-earth commonsense. In some circles in London he was known as the 'Robert Webster of the Midlands'.

In 1977 on the 25th Anniversary of the formation of the Birmingham Branch of the Gemmological Association, he was given the Sir James Walton Memorial Library Award 'in sincere recognition of many years hard work for gemmology in Birmingham'.

His wife Violet died in 1979 after a long period of decline during which time Sid attended devotedly to her needs. He was a religious, God-fearing man, who knew his Bible well and did his best to live by its teaching.

Those of us who knew him closely will remember his intense interest in and dedication to his subject, his enthusiasm for teaching, his forthright manner and his kindness.

An attack of shingles in later life dealt a severe blow since his eyesight became impaired. This was followed shortly by a severe stroke. He struggled to continue with an active life for three years, but died peacefully from heart failure.

He leaves two sons, Neil and David, and a daughter Barbara. Sid was buried on 30 January at Sutton Coldfield Cemetery. He will be missed by his many friends, but he will not be forgotten.

A.D.M.

\* \* \*

Miss Jean Isobel Platts, F.G.A. (D.1970), Sheffield, died in hospital on 25 February, 1986.

Jean was a founder member of the South Yorkshire and District Branch of the Gemmological Association which was formed in 1977. She gave continuing and devoted service as a committee member, Secretary and Chairman.

She was formerly a teacher of Gemmology and Diamond Diploma courses at the Sheffield City Polytechnic, where she was directly responsible for

the increase and improvement of the specimen collection and the instrumentation in the department.

Jean was the principal organizer for the South Yorkshire Branch and a diplomatic co-ordinator. Her quiet efficiency and gentle manner will be greatly missed by all the members.

\* \* \*

It is with great regret that we announce the death of Mr Harry Wheeler, F.G.A., former Secretary of the Association, on 5 June, 1986. A full obituary notice will appear in the October issue of the *Journal*.

#### GIFTS TO THE ASSOCIATION

The Council of the Association is indebted to Mr R. Holt, London, for the following gifts: an agate engraved with the head of a queen; a specimen of rough African emerald of 103.5 ct; an andradite variety melanite garnet crystal group on matrix from Italy; a cleavage piece of chrome fluorite from Zambia; garnet and tourmaline rough from Africa.

#### NEWS OF FELLOWS

Mr Alan Hodgkinson, F.G.A., toured Hong Kong and Bangkok in March 1986. He organized two two-day practical gemmology courses, as well as giving several lectures to the Hong Kong Gemmological Association and the Asian Institute of Gemmology.

On 9 May, 1986, Dr J.B. Nelson, Ph.D., F.G.S., C.Phys., F.Inst.P., F.G.A., gave a lecture with demonstrations using large scale atomic structure models on 'The structure and chemistry of gemstone minerals' to the Sussex Mineral and Lapidary Society at Haywards Heath.

On 4 June, 1986, Dr Nelson gave a talk to the Brent Geological Society, Brent, entitled 'Diagnostic inclusions in faceted gemstones'. He employed a gemstone immersion microscope of his own design to project images of the internal microstructures of some thirty stones directly on to a screen. Its most valuable feature proved to be its ability to isolate a particular image from the general 'optical noise' by making controlled movements of the stone while immersed in the matching liquid.

On 28 May, 1986, at the Annual Conference of the National Association of Goldsmiths held at the Hythe Imperial Hotel, Hythe, Mr Kenneth Scarratt, F.G.A., gave an illustrated lecture entitled 'Contrasting gem mining techniques'.

## MEMBERS' MEETINGS

### London

On 22 April, 1986, at the Flett Theatre, Geological Museum, Exhibition Road, South Kensington, London S.W.7, Dr Charles E.S. Arps, F.G.A., of the National Museum of Geology and Mineralogy, Leiden, The Netherlands, gave an illustrated talk entitled 'Gemstones from Indonesia'.

On 13 May, 1986, at the Flett Theatre, following the Annual General Meeting (see p.198), a Gemmological Forum was held, chaired by Mr David J. Callaghan, F.G.A., Chairman of the Association. The panel consisted of the following: Mr Alan Jobbins, B.Sc., F.I.M.M., F.G.A., Dr Roger Harding, B.Sc., D.Phil., F.G.A., Mr Kenneth Scarratt, F.G.A., Dr George Harrison-Jones, B.Sc., Ph.D., F.G.A., Ms Diana Foley and Mr Christopher R. Cavey, F.G.A. Subjects covered included the following: how to identify jade in the shop; the glass infilling of rubies and sapphires; understanding the relationship between the various ways of presenting absorption spectra; faceting easily cleavable material; eighteenth and nineteenth century cut steel jewellery as a substitute for gold and diamonds; and how one might attempt to date carved intaglios.

On 27 May, 1986, at the Flett Theatre, Mr Gunnar Raade, Curator of Minerals at the Mineralogisk-Geologisk Museum, Oslo, Norway, gave an illustrated talk entitled 'Gemstones of Norway'.

### Midlands Branch

On 21 March, 1986, at Dr Johnson House, Bull Street, Birmingham, Mr Alec Farn, F.G.A., gave an illustrated talk entitled 'Jade and its simulants'.

On 25 April, 1986, at Dr Johnson House, the Annual General Meeting was held, at which Mr P. West, F.G.A., was elected Chairman and Mr D.M. Larcher, F.G.A., re-elected Secretary. Following the Annual General Meeting, Mr Owen Smyth, of Town Talk Polish, gave an illustrated talk entitled 'The scientific approach to cleaning metals and gemstones'.

### North West Branch

On 17 April, 1986, at Church House, Hanover Street, Liverpool 1, Dr J.B. Nelson, Ph.D., F.G.S., C.Phys., F.Inst.P., F.G.A., gave a talk entitled 'How can I identify this transparent euhedral crystal?'. Using a vertical optical goniometer, he was able to demonstrate the practical measurement of all the interfacial angles of a crystal, thus leading to its identification by the Barker Method. The same device was used to show how the RIs and dispersions of faceted stones could be determined by means of the minimum deviation

method. He also illustrated the optical ray paths followed within a polished perspex model of the profile of a brilliant-cut gemstone.

On 15 May, 1986, at Church House, Mr Alec Farn, F.G.A., gave a talk entitled 'Gemmological recollections'.

### South Yorkshire and District Branch

On 22 May, 1986, at the Sheffield City Polytechnic, Pond Street, Sheffield, Mr G.A. Massie gave a practical demonstration of his lapidary skills. There was also a range of gemstones available for identification.

Mrs Susan E. Payne, B.A., F.G.A., has succeeded Miss Jean Platts (see Obituary p.196) as Hon. Secretary of the Branch.

## COUNCIL MEETING

At the meeting of the Council held on 22 April, 1986, at the Royal Automobile Club, 89 Pall Mall, London S.W.1, the business transacted included the election of the following:

### Fellowship

Abbot, Anita M., Phoenix, Ariz., USA. 1985  
 Arroyo Llorens, Maria C., Madrid, Spain. 1985  
 Coleman, Walter D., Valley Falls, Kan., USA. 1968

Ellis, John R., Norwich. 1961  
 Gascon Cuello, Fernando, Zaragoza, Spain. 1985  
 Kai, Kock M., Kowloon, Hong Kong. 1985  
 Little, Derek, Dundee, Scotland. 1981  
 Liyanaarachchi, Tudor P., Colombo, Sri Lanka. 1985

Spreckley, Vaughan G.M., London. 1985

### Transfers from Ordinary Membership to Fellowship

Niklewicz, Danusia, Santa Monica, Calif., USA. 1985  
 Perera, G.H.A.P., Mount Lavinia, Sri Lanka. 1979  
 Waddington, Clive, Harrogate. 1985

### Ordinary Membership

Amemiya, Tamami, Saitama Pref., Japan.  
 Asano, Kimiko, Bromley.  
 Barber, Roxey L., Encinitas, Calif., USA.  
 Bateman, Linda D., Vancouver, BC, Canada.  
 Becker, Thomas, Berlin, Germany.  
 Beaver, Richard H., Orpington.  
 Beizer, Sameul, New York, NY, USA. 1985  
 Blake-Eckstein, Adrienne, Indianapolis, Ind., USA.

Bonds, Bobbye F., Magnolia, Ariz., USA.  
 Bramsdon, Manny, Maidenhead.  
 Canty, Jess, London.

Chapman, Janet E., Poole.  
 Collin, Alan A., Billingshurst.  
 Cooper, Malcolm D., Standon.  
 Davoudi, Vivien, Troinex, Switzerland.  
 Doland, Gregory S., Farnham.  
 Edwards, Charlton T.K., Harpenden.  
 Eguchi, Yukio, Osaka City, Japan.  
 Ekman, Anders, Malmoe, Sweden.  
 Epa, Widanagamage, Mount Lavinia, Sri Lanka.  
 Fatalas Papadopoulos, Costas, Athens, Greece.  
 Furukawa, Junko, Kyoto City, Japan.  
 Genot, Luc, Brussels, Belgium.  
 Goddard, John D., Hastings.  
 Gordon, Don D., Warwick, WA, Australia.  
 Hagnas, Lloyd, San Diego, Calif., USA.  
 Hagon, Clive L., London.  
 Hallinan, John W., Crecora, Co. Limerick, Ireland.  
 Harrison, Rouer F.J., Kings Langley.  
 Head, Judy E., Newdigate.  
 Hirai, Junko, Tokyo, Japan.  
 Hiram, Katsunori, Tokyo, Japan.  
 Hirose, Sairi, Nagasaka Pref., Japan.  
 Holmes, Christopher W., Stockport.  
 Ishimoto, Kazuko, Hyogo Pref., Japan.  
 Kato, Kuniako, Osaka City, Japan.  
 Kenna, Sean N., Leixlip, Co. Kildare, Ireland.  
 Kent, Jeni, Hyde Park, SA, Australia.  
 Kinder, Lawrence V., Bangor, Co. Down,  
 N. Ireland.  
 Kunishima, Ikuko, Osaka City, Japan.  
 Logan, Joan A., Hounslow.  
 Masuoka, Yoshima, Matsubara City, Japan.  
 Matsubara, Yoshiko, Hirakata City, Japan.  
 Matsuyama, Yasuo, Osaka City, Japan.  
 Mellor, Karen, Pinner.  
 Miyabayashi, Yuki, Kawachi-negano City, Japan.  
 Mochinaga, Schoichi, Aira-gun, Japan.  
 Morrison, Laurence, Upminster.  
 Murata, Fumiko, Osaka, Japan.  
 Nakagawa, Kyoko, Kobe City, Japan.  
 Nonaka, Chikako, Kuki City, Japan.  
 Ono, Takahiro, Tokyo, Japan.  
 Ozaki, Keiko, Kawanishi City, Japan.  
 Pay, Duncan L., Fife, Scotland.  
 Penfold, Edward., Jeddah, Saudi Arabia.  
 Perkins, Sarah, London.  
 Pitre, Judith M., Imperial Beach, Calif., USA.  
 Rockwell, Alan M., Southfield, Mich., USA.  
 Rubilotta, Michel, Rousset, France.  
 Sano, Jun, Hiroshima Pref., Japan.  
 Shaw, Patricia V., Leeds.  
 Silvestre, Jean-Claude, Nimes, France.  
 Skinner, Graham D., Worthing.  
 Spuida, Bernhard, Pfronten, W. Germany.  
 Takizawa, Toshiko, Tokyo, Japan.  
 Tohyama, Masuo, Osaka, Japan.  
 Twigg, Fiona, Mount Kennedy, Co. Wicklow,  
 Ireland.

Ushio, Tsutae, Fukuoka Pref., Japan.  
 Ushio, Yoshiko, Tokyo, Japan.  
 Wackerlig, Marc O., Winterthur, Switzerland.  
 Yaku, Mihoko, Osaka, Japan.  
 Yamasa, Toshiko, Tokyo, Japan.  
 Yoshimoto, Misako, Munakata-gun, Japan.

#### ANNUAL GENERAL MEETING 1986

The 55th Annual General Meeting of the Association was held on Tuesday, 13 May, 1986, at the Flett Theatre, Geological Museum, Exhibition Road, South Kensington, London S.W.7.

Mr David J. Callaghan, F.G.A., the Chairman of the Association, presided over the meeting. He referred to some of the items mentioned in the Annual Report, and announced that the Basil Anderson Appeal launched in November 1984 for the purchase of the Basil Anderson Spectrophotometer had reached its target figure of £25 000.

Referring to the examinations, Mr Callaghan said that he was pleased to report that the Tully Medal had been awarded two years consecutively. In 1985 this Medal was awarded to Mrs Gwyneth Green, who is the first student to be awarded both the Anderson and Tully medals. The awards had been presented by Mr Richard T. Liddicoat, Jr., Hon. F.G.A., Chairman of the Board of the Gemological Institute of America.

The Chairman paid tribute to the work of Mr J.R.H. Chisholm for his years of editorship of the *Journal*, who retired at the end of the year. He then thanked Mr Alan Jobbins who had succeeded John Chisholm as Editor, and referred to the new format of the *Journal*, which had been well received by members.

Continuing, Mr Callaghan reported that the Preliminary section of the new home study course in gemmology would be commencing in September 1986. He thanked Mr Jonathan Brown for his tremendous achievement in obtaining a grant of £30 000 for the course from the Distributive Industry Training Board Trust.

During the year a new Executive Committee had been formed, and the Chairman thanked all members of the Council, Examiners and Instructors, for their help and support during the year.

Mr Nigel Israel, the Honorary Treasurer, presented the audited accounts for the year ended 31 December, 1985, illustrated by coloured charts. The adoption of the Report and Accounts was duly proposed, seconded by Mr Alan Jobbins and carried.

Sir Frank Claringbull, Mr David Callaghan, Mr Noel Deeks and Mr Nigel Israel were then re-elected as President, Chairman, Vice-Chairman and Honorary Treasurer respectively. Mrs S. Hiscox and Messrs. D. Inkersole, B. Jackson, M.



O'Donoghue, P. Read and C. Winter were re-elected to the Council.

Messrs. Ernst and Whinney were reappointed Auditors, and the proceedings then terminated.

### GEMSTONES UNDER THE MICROSCOPE

An exhibition of photographs by Mr C.R. Burch, B.Sc., F.G.S., was held at the Geological Museum, Exhibition Road, South Kensington, London S.W.7, from 25 March to 31 May, 1986. Characteristic inclusions occurring in both natural and man-made gemstones were illustrated in 30 full-colour enlargements.

### GEMMOLOGICAL COURSES

#### Retail Jeweller

The *Retail Jeweller* continues its residential courses on gem identification this autumn at Upton Hall, Newark, Notts. Mr Alan Hodgkinson, F.G.A., is the course leader, assisted by Mr Patrick Daly, F.G.A. The dates are as follows:

29-30 September, 1986. Two-day introduction to practical gem identification.

1-3 October, 1986. Three-day practical gem identification for second year students and refresher course for Diploma holders.

Full details from the *Retail Jeweller*, 100 Avenue Road, London NW3 3TP.

#### Genesis

Courses for overseas students or those home students wishing to complete the full course for the Gemmological Association's Diploma examination in one year are offered by Genesis. Courses start in mid-September and continue to the following June. Tuition occupies two full days per week and is intensive. Courses are limited to eight students and include visits to gem centres such as Idar-Oberstein and Antwerp. Full details from Colin Winter, F.G.A., Genesis Design Jewellery Ltd, 21 West Street, Epsom, Surrey, KT18 7RL.

### INDIA GEMS AND JEWELLERY FAIR

The 1986 Fair is to be held from 4 to 8 September at the Taj Mahal Hotel, Bombay, India. For details contact IGJ Fair 1986, c/o Hindustan Diamond Co. Ltd, 15 Atlanta, Nariman Point, Bombay 400 021, India. Telex 011-4710 HDCL IN.

### FAKED EMERALD CRYSTALS FROM AMERICA

Three 'emerald' crystals weighing 52, 33 and 20 grams were offered to Bernice Backler, a jeweller in Pinetown, South Africa. The locality was given as Chitanti District, Zambia. The crystals appeared to have a coating of mica-schist and on cutting a

'window' and drying a specimen on paper a vivid yellow stain was noted and an acidic liquid oozed from the crystal. Washing the specimen with dilute detergent caused it to come apart, revealing a green dye on flat pieces of quartz(?) which had been gummed together to form the fake. Readers should beware of such imitations.

### CORRIGENDA

On p. 52 above, the caption to the photograph uses the term 'etch pits'. In fact, they are raised tetrahedral formations sometimes known as 'quadrons'.

On p. 103 above, the caption to the photograph at the top of the left-hand column has been omitted. It should read: 'Fig. 4. Paragenetic hornblende crystal (NMNS 46661) from Soper River, Baffin Island, NWT, Canada, with facetable rough and 3.00 ct emerald cut hornblende (NMNS 20896)'.

On p. 116 above, right-hand column, line 11, for 'and' read 'end'.

# GEMMOLOGICAL INSTRUMENTS LTD.

A wholly owned subsidiary of the Gemmological Association of Great Britain



## The Rayner Dichroscope

A useful portable instrument which will easily detect pleochroism within a gemstone or mineral. Rigidly made in tubular metal for durability.

Can be used with either a clip-on attachment or Scopelight for hand held use or table stand with rotating platform.

Dichroscope **£32.65** + p & p + VAT.

Clip-on stone holder **£11.95** + p & p + VAT.

Table stand **£18.00** + p & p + VAT.

## The Rayner Scopelight

A versatile, portable battery-operated light source designed to facilitate the inspection of gemstones when away from the laboratory or work-bench and is suitable for use by the professional gemmologist and student alike. The 'light drum' is fitted with a metal disc with holes of varying diameters to accommodate gemstones of any size. When rotated over the light, the gemstone is illuminated. The light produces a good useable image for both the spectroscope and dichroscope.

The pen torch is fitted with a 9mm MES lens-end lamp rate at 2.5V, 0.3A, with MN 2400 batteries.

Unit supplied complete. **£12.95** + p & p + VAT.

Gemmological Instruments Ltd.

Saint Dunstan's House, Carey Lane, Cheapside, London EC2V 8AB, England.

Telephone: 01-726 4374 Cables: Geminst, London EC2.

# GEMMOLOGICAL ASSOCIATION OF GREAT BRITAIN

The Arms and Crest of the Association, conferred by a grant of Arms made by the Kings of Arms under royal authority. The cross is a variation of that in the Arms of the National Association of Goldsmiths of Great Britain and Ireland. In the middle is a gold jewelled book representing the study of gemmology and the examination work of the Association. Above it is a top plan of a rose-cut diamond inside a ring, suggesting the scrutiny of gems by magnification under a lens. The lozenges represent uncut



octahedra and the gem-set ring indicates the use of gems in ornamentation. The lynx of the crest at the top was credited, in ancient times, with being able to see through opaque substances. He represents the lapidary and the student scrutinizing every aspect of gemmology. In the paws is one of the oldest heraldic emblems, an escarbuncle, to represent a very brilliant jewel, usually a ruby. The radiating arms suggest light diffused by the escarbuncle and their tips are shown as jewels representing the colours of the spectrum.

## Historical Note

The Gemmological Association of Great Britain was originally founded in 1908 as the Education Committee of the National Association of Goldsmiths and reconstituted in 1931 as the Gemmological Association. Its name was extended to Gemmological Association of Great Britain in 1938, and finally in 1944 it was incorporated in that name under the Companies Acts as a company limited by guarantee (registered in England, no. 433063).

Affiliated Associations are the Gemmological Association of Australia, the

Canadian Gemmological Association, the Gem and Mineral Society of Zimbabwe, the Gemmological Association of Hong Kong, the Gemmological Association of South Africa and the Singapore Gemologist Society.

The *Journal of Gemmology* was first published by the Association in 1947. It is a quarterly, published in January, April, July, and October each year, and is issued free to Fellows and Members of the Association. Opinions expressed by authors are not necessarily endorsed by the Association.

## Notes for Contributors

The Editors are glad to consider original articles shedding new light on subjects of gemmological interest for publication in the *Journal*. Articles are not normally accepted which have already been published elsewhere in English, and an article is accepted only on the understanding that (1) full information as to any previous publication (whether in English or another language) has been given, (2) it is not under consideration for publication elsewhere and (3) it will not be published elsewhere without the consent of the Editors.

Papers should be submitted in duplicate on A4 paper. They should be typed with double line spacing with ample margins of at least 25mm all round. The title should be as brief as

is consistent with clear indication of the content of the paper. It should be followed by the names (with initials) of the authors and by their addresses. A short abstract of 50–100 words should be provided. Papers may be of any length, but long papers of more than 10 000 words (unless capable of division into parts or of exceptional importance) are unlikely to be acceptable, whereas a short paper of 400–500 words may achieve early publication.

Twenty five copies of individual papers are provided on request free of charge; additional copies may be supplied, but they must be ordered at first proof stage or earlier.

The Journal of  
Gemmology

# Contents

Inclusions in opal	<i>E. Gübelin and J.I. Koivula</i>	139
Notes from the Laboratory - 7	<i>K. Scarratt</i>	145
Some observations on brown tourmalines from Elahera, Sri Lanka	<i>U. Henn and M. Schramm</i>	154
A re-investigation of gahnospinel from Sri Lanka	<i>K. Schmetzer and H. Bank</i>	157
Some unusual cat's-eyes	<i>Y. Ito</i>	161
A peculiar inclusion in a yellow corundum from Malawi	<i>O. Grubessi and R. Marcon</i>	163
The very sphinx of diamonds	<i>A.E. Farn</i>	166
A treatment procedure for improving colour and quality of zircons	<i>M.S. Rupasinghe and A. Senaratne</i>	168
The brilliant cut - analysis of weight by calculation	<i>S.J.A. Currie</i>	171
Light, heavy and rare minerals in the washed gem gravels of Sri Lanka	<i>M.S. Rupasinghe, A. Senaratne and C.B. Dissanayake</i>	177
Gemmological abstracts		185
Book reviews		193
Proceedings of the Gemmological Association of Great Britain and Association Notices		195

Copyright © 1986

Gemmological Association of Great Britain

Registered Office: Saint Dunstan's House, Carey Lane, London EC2V 8AB

ISSN: 0022-1252