

Gemmology Course Outline

Lewton-Brain ©86/95/10

Table of contents

Gemmology course outline	
Introductory Gemmology	
Minerals, crystals, systems and the polariscope	3
Crystal Systems	7
Crystal System Symmetry	9
Gemstones by crystal system	10
Polariscope	11
Physical properties of gemstones	15
Specific Gravity	18
Optics	26
Optical Effects	32
Fluorescence	36
Gem Enhancement and imitation gemstones	40

Appendices

Essay Questions as weekly assignments	
Midterm examination example	
Final examination example	

Minerals, crystals, systems and the polariscope

Lewton-Brain©86/94/10

A Mineral may be defined as a homogenous substance produced by the processes of inorganic nature having a chemical composition and physical properties which are constant within narrow limits. Its structure is crystalline. (from G.A. course material)

It is composed of the same substance throughout. Except for impurities it has the same chemical formula for all specimens of the mineral. Its atoms usually have a definite and ordered crystal structure. What makes a mineral (or an organic product) a gemstone is cultural and partly subjective: beauty, durability and rarity.

Minerals often occur in geometrical forms bounded by plane surfaces. These are crystals and the internal structure determines properties which allow the identification of the gem material; its differentiation from other minerals, imitations and sometimes synthetics.

Crystals have:

1. An orderly and symmetrical atomic structure.
2. A definite external geometrical shape bounded by plane faces.
3. Physical (and optical) properties which vary with direction.

Glass has:

1. No regular atomic structure.
2. No tendency to assume a definite external shape.
3. Properties which are the same in all directions.

Crystalline Material: Possesses the regular structure and directional properties of a crystal but not the regular geometrical shape. Also called massive. e.g. rose quartz.

Crypto-crystalline Material: Material which consists of a multitude of tiny, often submicroscopic crystals. e.g. Chalcedony.

Symmetry:

Crystal symmetry refers to the balanced pattern of the atomic structure which is reflected in the external (crystal) shape. Different species vary in the symmetrical arrangement of faces. These arrangements have certain 'planes' and 'axes' of symmetry. These form part of the definition of the crystal system to which specific gemstones belong.

Plane of symmetry:

An imaginary plane dividing a body into two parts such that each is the reflected image of the other. Crystals may have more than one plane of symmetry. i.e. a cube has nine planes of symmetry.

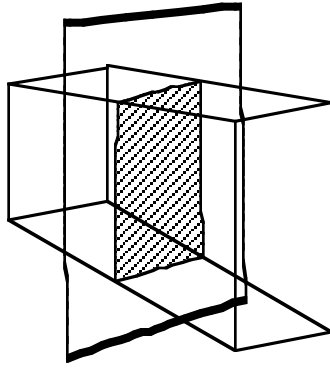

Axis of symmetry:

An imaginary axis is placed through a perfect crystal so that during a single rotation about this axis the outline of the crystal form appears identically more than once; 2, 3, 4 or 6 times.

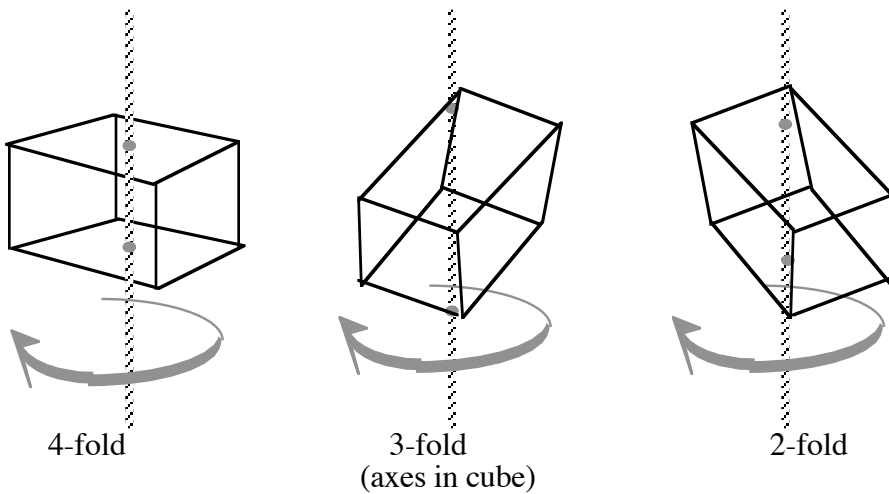

Centre of symmetry: (centro-symmetry)

Often present, it exists when every face of a perfect crystal is exactly opposite a similar face on the other side of the crystal.

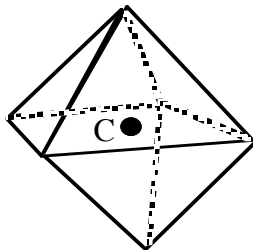

Crystal axes: (Crystallographic axes)

To describe crystals imaginary lines are used intersecting at 0 (the origin). These are specific to the various crystal systems, intersecting at given angles and being of

given lengths specific to each crystal system.

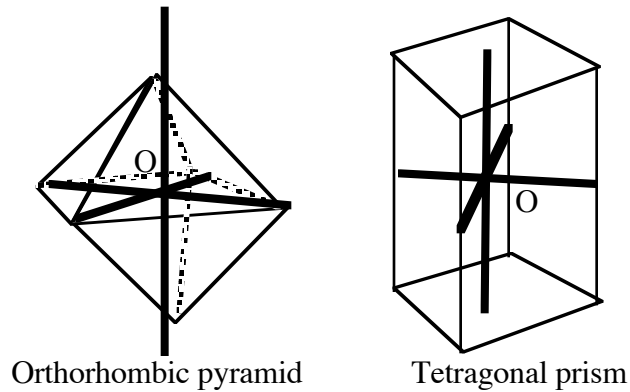

Origin:

The intersection of the crystal axes.

Habit:

Gemstone species tend to occur in characteristic shapes which relate to one or more of the forms common to the crystal system of the gemstone in question. The crystal form or forms which a gemstone most often appear are its habit. e.g. diamond: octahedron, emerald: 6 sided prism.

Form:

Those faces of a crystal which are identically related to the crystal axes. When the space so defined is completely enclosed (cube, octahedron) it is a closed form. When identical faces do not completely enclose the space (four or six sided prism; top and bottom open) it is an open form.

Twinned crystals: (compound crystals)

A twin is a single crystal composed of two or more parts with any part in reversed structural orientation to the next, or interpenetrated.

Contact twin:
Sharing a common plane.

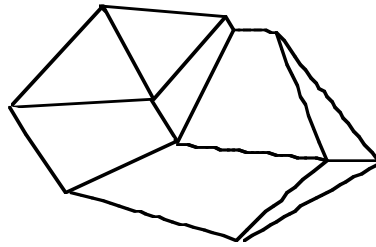

zircon contact twin

Interpenetrant twin:
Two individuals have grown from a common origin and appear to penetrate each other. e.g. cross stones.

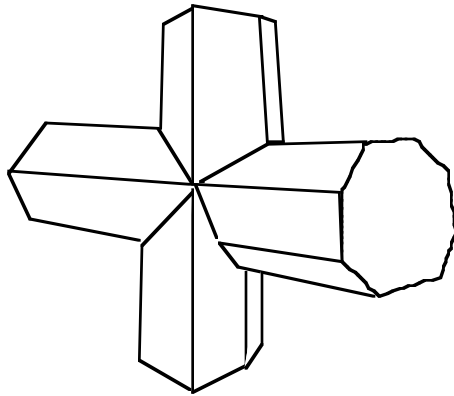

staurolite twin

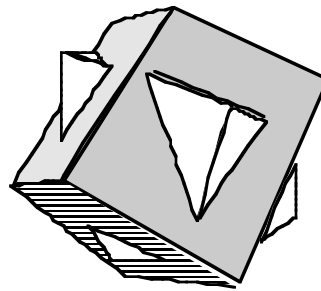

fluor

Lamellar twinning:
A series of contact twins often as extremely thin plates. Atoms in adjacent sheets are reversed, i.e. alternate plates are in the same order. This can give rise to special optical effects as in the feldspar labradorite.

Secondary twinning or parting:
The crystal is composed of very thin plates parallel to definite crystallographic directions. e.g. ruby, this gives rise to 'false cleavage'.

CRYSTAL SYSTEMS

Cubic

Three crystal axes of equal length intersect at right angles to each other. e.g. diamond, spinel, garnets.

Tetragonal

Three axes intersect at right angles to each other. The vertical axis is of unequal length while the two horizontal axes are of equal length. e.g. zircon, rutile.

Hexagonal

Four crystal axes. Three are of equal length and intersect at 60° to form a horizontal plane which the fourth intersects at right angles. The vertical fourth is of unequal length and forms an axis of 6-fold symmetry. e.g. Beryl, apatite.

Trigonal

Four crystal axes. Three of equal length intersecting to form a horizontal plane which is intersected at right angles by the fourth axis. The vertical fourth is of unequal length and forms an axis of 3-fold symmetry. e.g. quartz, corundum, tourmaline, diopside, haematite. (Trigonal and Hexagonal are combined in the US approach)

Orthorhombic (Rhombic)

Three crystal axes of unequal length intersect each other at right angles. e.g. topaz, peridot, Chrysoberyl, iolite, sinhalite, andalusite.

Monoclinic

Three axes. Two of unequal length intersect each other obliquely to form a plane which is intersected by the vertical third (of unequal length) at right angles. e.g. jadeite, nephrite, diopside, orthoclase feldspar, serpentine, sphene, malachite, spodumene.

Triclinic

Three axes of unequal length intersect each other at oblique angles. e.g. turquoise, labradorite.

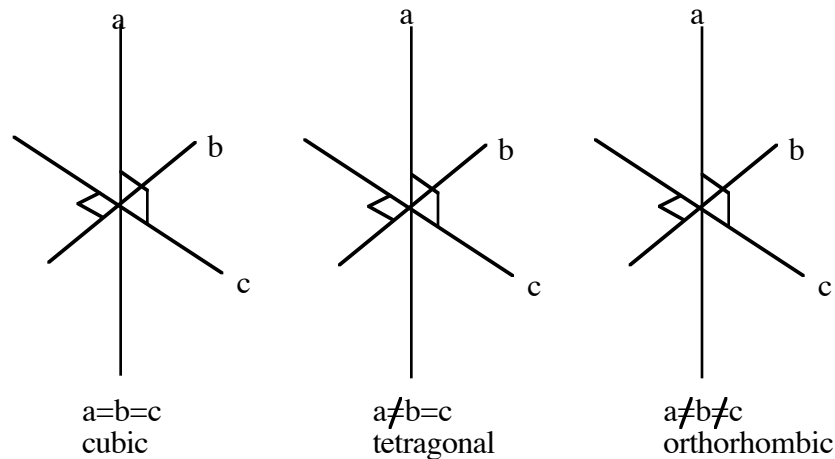

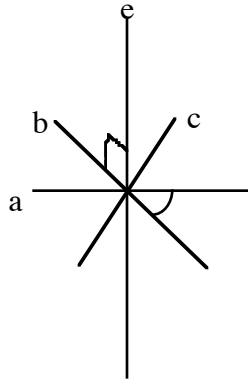

$a=b=c \neq e$
 hexagonal
 a, b, c angles 60°

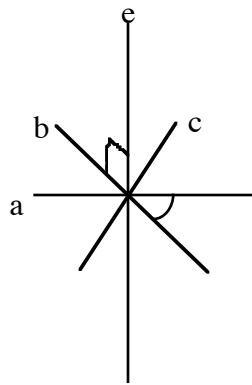

$a=b=c \neq e$
 trigonal
 a, b, c angles 60°

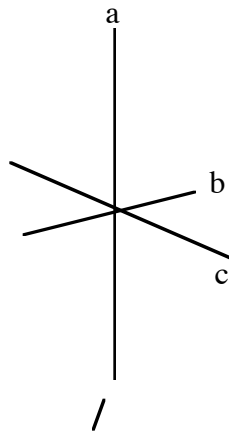

$a \neq b \neq c$
 triclinic
 a, b, c angles not equal

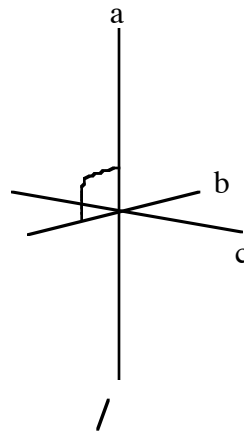

$a \neq b \neq c$
 monoclinic

CRYSTAL SYSTEM SYMMETRY

<u>Axis</u>			<u>Optic</u>
Singly Refractive: Amorphous -- no crystal structure			
Cubic	9 planes	4 3-fold	-
	13 axes	3 4-fold	-
	a centre	6 2-fold	-
Doubly Refractive:			
Tetragonal	5 planes	1 4-fold	uniaxial
	5 axes	4 2-fold	
	a centre		
Hexagonal	7 planes	6 2-fold	uniaxial
	7 axes	1 6-fold	
	a centre		
Trigonal	3 planes	3 2-fold	uniaxial
	4 axes	1 3-fold	
	a centre		
Orthorhombic	3 planes	3 2-fold	biaxial
	3 axes		
	a centre		
Monoclinic	1 plane	2-fold	biaxial
	1 axis		
	a centre		
Triclinic	no planes		biaxial
	no axes		
	a centre		

Uniaxial

The optic axis of the crystal is parallel to the main crystal axis. One direction of single refraction.

Biaxial

There are two directions of single refraction. (optic axes)

GEMSTONES BY CRYSTAL SYSTEM (major ones)

Cubic

Diamond
Fluorite
GGG*
Garnet
Lazurite (Lapis Lazuli)
Pyrites

Sodalite
Spinel
Strontium Titanate*
Yttrium Aluminate*
Yttrium oxide*
Cubic Zirconia*

Tetragonal (U)

Idocrase
Rutile
Zircon

Hexagonal (U)

Benitoite
Apatite
Beryl (Aquamarine, emerald, heliodor, morganite etc)

Trigonal (U) (Trigonal is a subset of the Hexagonal system)

Calcite (marble)
Corundum
Diopside
Hematite

Quartz
Rhodochrosite
Tourmaline
Moissanite

Orthorhombic (B)

Andalusite
Chrysoberyl
Danburite
Enstatite
Iolite
Kornerupine

Marcasite
Peridot
Sinhelite
Staurolite
Topaz
Zoisite

Monoclinic (B)

Azurite
Diopside
Epidote
Euclase
Jadeite
Malachite

Nephrite
Orthoclase Feldspar
Serpentine
Sphene
Spodumene

Triclinic (B)

Axinite
Kyanite
Microcline Feldspar

Plagioclase Feldspar
Rhodonite
Turquoise

*Diamond simulants, man-made (U) = uniaxial, (B) = biaxial

Polariscope

This is one piece of gemological equipment that is fairly expensive and can be made very easily and cheaply. Prices for polariscopes start around \$65.00 and go up. Hanneman has a very basic model (two sheets of polaroid and a tube) for around \$4.00 and supplies two 2" x 2" sheets of polaroid filter material for \$1.00. I have made one using two polaroid sunglass lenses on a stick and a student I had (Dennis O'Hanley) used sunglasses and an empty underarm deodorant tube container with holes cut in top and bottom to fit the lenses. He cut an access port in the side to permit manipulation of the gemstone (1.3). One could rotate the top of the deodorant tube to cross the filters as needed. My own polariscope was made using two 49mm camera polarizing filters (\$14.00 total) and a length of appropriately sized PVC pipe. Two rings were cut off the end of the pipe, small segments cut out of these rings so that they could be forced together and slid into the pipe where they formed ledges upon which the camera filter sit. An access port was then cut in the side of the PVC pipe. An advantage of using camera filters is that they rotate freely when in place. The GIA microscope immersion cell (about \$18.00) just fits in the filter so that several gems at once may be examined in polarized light conditions by rotating the strain-free glass cell.

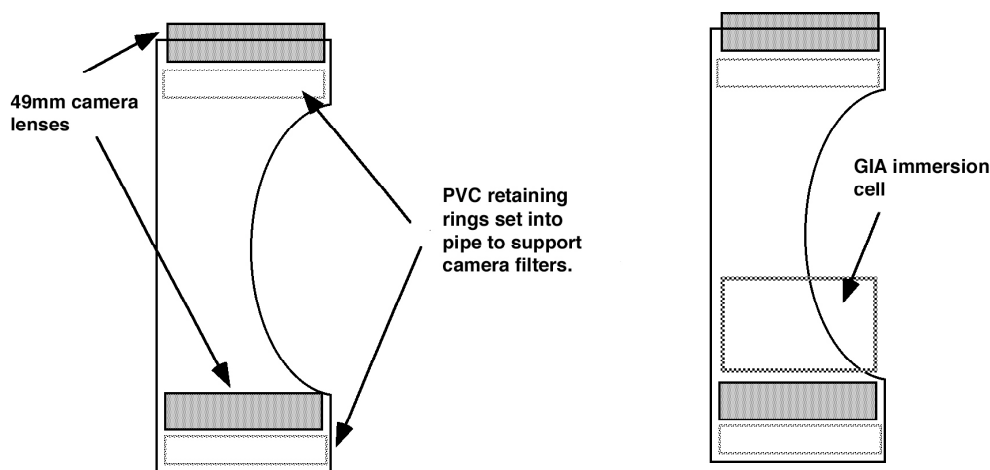

A light source can be a flashlight, which fits in the tube also. I use my microprojector as a light source – a slide projector can be used or IKEA round cupboard lights. A paper disc can be placed just below the lower polarizing filter to diffuse the light somewhat. A stainless glass sphere on a rod is available for resolving interference figures of gems with the polariscope. This would identify quartz and tell whether a gem is biaxial or uniaxial in crystal system. GIA and Hanneman sell them. I have used plastic stir sticks with a ball on the end to good affect, and a loupe may be used in a pinch.

Finally, Mr. Hamilton Stitt, F.G.A. described a very simple field polariscope in the *Journal of Gemmology*. A polaroid filter is placed over the glass in the well of a small flashlight. One then dons polaroid sunglasses and has an instant polariscope with an adjustable distance between lower (flashlight well) and upper (sunglasses) filters to examine stones. The rim of the flashlight prevents stone loss and interference figures may be resolved with a 10X hand lens. This is really a pocket polariscope.⁵

Using the Polariscope

To use the polariscope the top polarizing filter is turned to the extinction position (dark) allowing the least amount of light to pass through the two filters. The stone is placed between the two filters and rotated around a vertical axis. If it darkens evenly at exactly 90° intervals (4x per rotation) it indicates double refraction. It is important to test each stone in more than two positions as a doubly refractive stone may have one or two directions of single refraction (optic axes) in it. If it remains dark throughout its rotation single refraction is indicated. Cryptocrystalline material remains bright during rotation (jade, chalcedony) but some glass with textured backs does the same so it is best to use this test for transparent stones only. Note that large numbers of doubly refractive inclusions would have a similar effect. Brilliant cut stones should not be tested table up or down as they may reflect out all the light entering the table giving a false reading (if cut properly).

Anomalous double refraction may occur in singly refractive materials with internal strains such as diamond, garnet, synthetic spinel, amber, plastic, opal and glass. The extinction patterns here however do not occur at precisely 90° intervals although rarely they may be close. The darkness may appear to move diagonally through the gem while it is rotated. Plastic and amber may show bright interference colours. “Ambroid” type reconstituted amber will show swirls of strain rather than geometric angular strains shown in natural amber. Glass may show a characteristic cross like shadow, or two approaching bars which almost form a cross during rotation. (glass objects are routinely inspected this way for strain by glass blowers) Synthetic spinel shows a characteristic 'tabby' extinction, a sort of fine, mottled cross hatching of parallel silk-like lines which change during rotation.

In a doubly refractive stone rainbow interference colours will appear when the gem is turned to within a few degrees of an optic axis. To produce diagnostic interference figures one obtains the optic axis position by watching for rainbow colors to appear and placed a condensing lens above the stone or in contact with it. This can be a 10X lens (viewed from 18" or so distance), a drop of viscous liquid or a strainless glass sphere. Even plastic ball stir sticks will work. This will divulge whether the stone is uniaxial or biaxial. It is also possible to tell whether a gem is uniaxial positive or negative using a piece of clear plastic from a polycarbonate box with a method devised by Dr. Hanneman. See “Guide to Affordable Gemology”, pages 41-43.

The characteristic interference figure for uniaxial gems is:

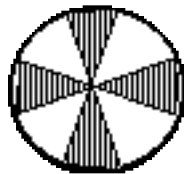

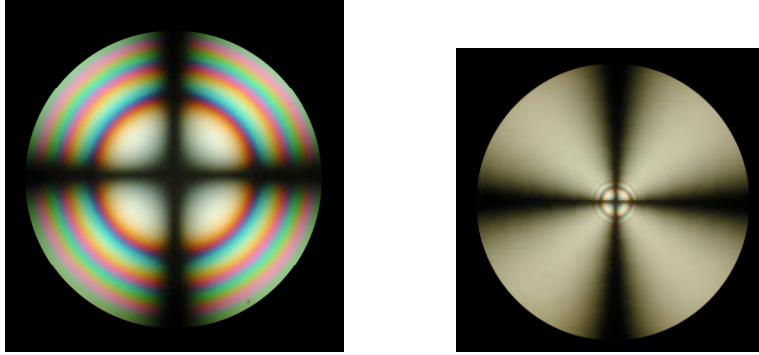

(from <http://homepage.rub.de/olaf.medenbach/eng.html>)

Quartz has a special variety of this uniaxial figure called a bullseye uniaxial figure and this is, if seen clearly, diagnostic for quartz. The centre circle is often red.

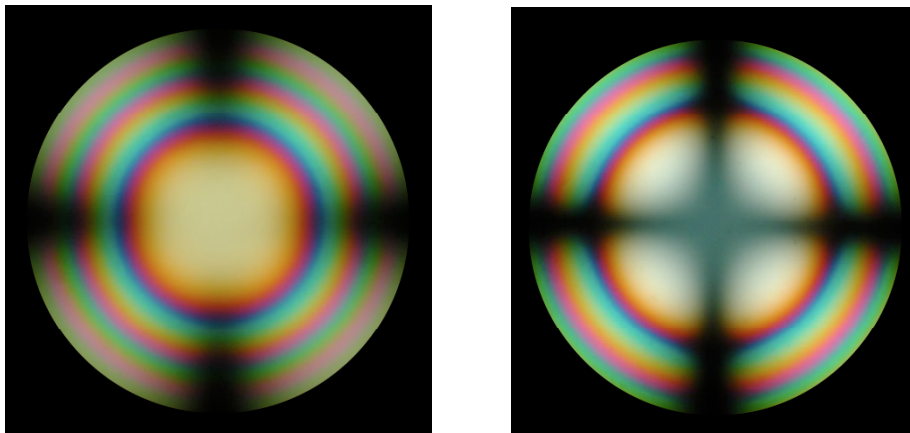

(from <http://homepage.rub.de/olaf.medenbach/eng.html>)

Biaxial figures vary somewhat but are quite distinctive having usually only two arms or brushes from a centre or oval. As the gem is rotated the brushes will come apart and together, depending on how the gem is held.

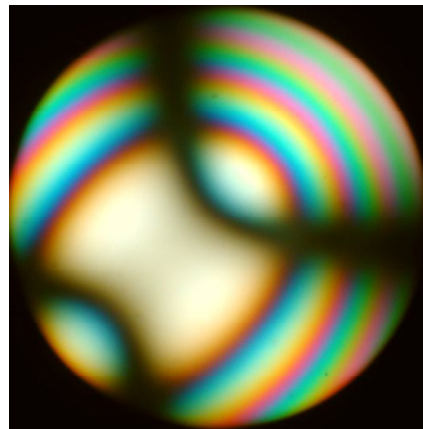
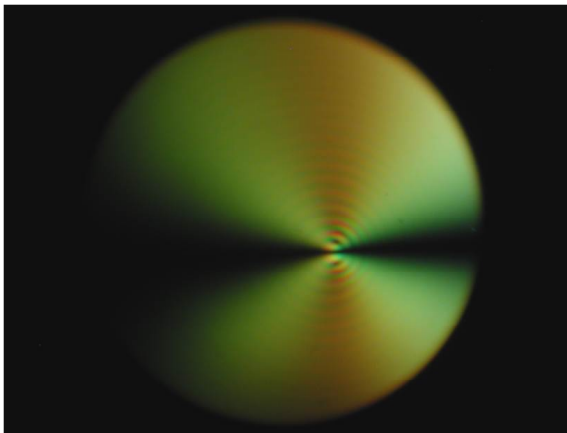
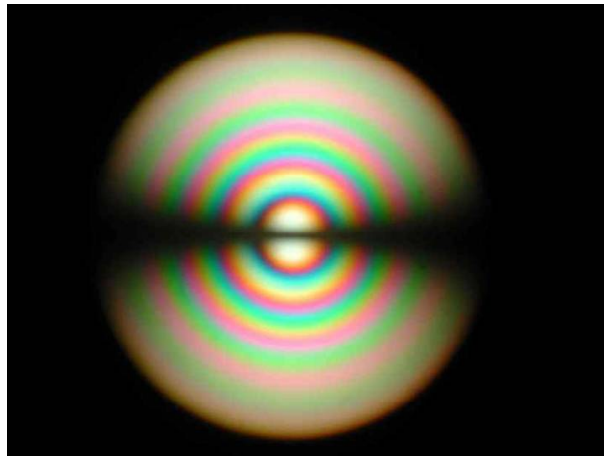

(from <http://homepage.rub.de/olaf.medenbach/eng.html>)

It may be noted that cabachon gems or beads often need no condensing lens as they function as one themselves. Interference figures may be resolved more easily if the gem is immersed in water or bromoform (toxic). Be sure that the transparent container for your liquid does not itself add shadow lines to your image, especially if merely testing for double refraction. **Interference figures may be used to rapidly distinguish between: moonstone (orthoclase) and chalcedonic quartz which shows no figure resolution, topaz and tourmaline, andalusite and tourmaline, corundum and chrysoberyl.**

INTRODUCTORY GEMMOLOGY

Lewton-Brain©86/94/10

Physical Properties of Gemstones

Crystal Structure

A perfect crystal is bounded by plane faces which meet at angles specific for each kind of material (angle analysis can identify minerals). A crystal may be cleaved in directions related to the external form or to a possible crystal form for the mineral. Sometimes two distinct minerals can have the same chemical composition with their differing properties being due to their different crystal structure. Crystal structure affects mineral properties more than their chemical nature. Examples here include diamond (carbon, cubic) and graphite (carbon, hexagonal) and Calcite (trigonal) and aragonite (orthorhombic), both forms of calcium carbonate.

Properties Related to Crystal Structure

Optical: In the cubic system a light ray is refracted (bent), passes through the crystal and emerges as a single ray. This is known as an isotropic (singly refractive) material. Of the doubly refractive crystal systems three (tetragonal, hexagonal, trigonal) are uniaxial and have a single direction (not a line but an entire direction) of single refraction in the doubly refractive (anisotropic or birefringent) crystal. The orthorhombic, monoclinic and triclinic systems are biaxial and have two directions of single refraction in the double refractive (anisotropic or birefringent) crystal. In uniaxial crystals the isotropic direction is that of the main crystal axis.

Pleochroism (Dichroism, trichroism): In doubly refractive gemstones the light ray is split and each part refracted (bent) to a different degree. Assuming this ray is made up of white light (which is composed of all colours) each ray has various colours absorbed (filtered) so that each ray as it emerges from the gemstone is a different (residual) colour. This is called dichroism (means two colours). Thus depending upon the direction one looks at the stone relative to the crystal and optical axes a different colour is seen. Both colours are often present at the same time however and it requires a dichroscope to separate the colours to see them. The dichroscope allows each ray's colour to be viewed separately and at the same time to compare them. A good example that is clear to the eye is andalusite.

Uniaxial gemstones are dichroic and two colours may be observed. Biaxial stones are trichroic and three colours may be seen.

Heat Conductivity: Heat is conducted differently in various minerals according to their crystal system. This is used in Thermal Conductivity instruments to differentiate diamond which conducts heat very well from its simulants and imitations (see note on moissanite). Some instruments use it to identify other gemstones but they are expensive and of value only when used with care and some gemmological knowledge. The use of standard stones is suggested and drafts to be avoided as they can change the readings. At its simplest this is the temperature test using tongue or lips for glass and plastic.

Electrical Effects: Atomic structure and the related crystal structure influence electrical properties. Some crystals possess pyro-electricity. Tourmaline for

example when heated to between 100 - 100°C possesses polarity like a magnet needle. Another effect of some polar crystals is piezo-electricity-pressure on a crystal slab induces electrical charges on opposite faces. This is used in piezo-electric gas lighters. If an alternating current is applied to the crystal it oscillates. This is used in controlling radio wavelengths, usually using synthetic quartz. Quartz watches use these properties. Silicon chips depend upon the directional crystal properties to function. Electrical current is conducted better in some gemstones than others. Natural blue diamonds conduct electricity while the irradiated blue ones do not. A simple circuit with a battery and a flashlight bulb can be constructed to test this. Moissanite also conducts electricity – the basis of new diamond detectors which measure electrical conductivity in addition the heat conductivity.

Magnetism: Early synthetic diamonds were slightly magnetic and could be determined by floating the gem on a chip of Styrofoam and affecting the gem with a magnet. Some garnets exhibit magnetism and sources can be indicated this way.

Cleavage: This is the tendency of a crystallized mineral to break in definite directions related to the crystal structure producing relatively smooth cleavage break surfaces. Cleavage planes are always parallel to a particular cleavage face, i.e. diamond cleaves in any of the four directions parallel to the faces of the octahedron. Almost all crystals have a tendency to cleave. Those with the least tendency to cleave include garnets, quartz, spinel (natural), beryl and zircon. Gemstones with a strong tendency to cleave include diamond, fluorite, topaz, peridot, kunzite (spodumene), euclase, sphene, axinite, feldspars, synthetic spinel, diopside and calcite. This is vital information for gem setting.

Cleavage is described by the crystal face to which it is parallel; diamond has octahedral cleavage, topaz has basal (parallel to the base of the topaz crystal prism). The ease with which cleavage occurs and the resultant smoothness of the cleavage break is described as perfect in topaz, indistinct and difficult in beryl. Cleavage can be used in cutting diamonds and it should be noted that stones with a strong tendency to cleave can be easily cleaved in polishing and setting procedures.

Fracture: Defines the type of surface obtained by breaking a crystal in a direction other than that of cleavage. Types include conchoidal, shell-like as in glass and often in gemstones. Also even, uneven and hackly or splintery as in nephrite. Identification applications of cleavage/fracture include:

Nephrite cleavage cracks occur as 124° and jadeite at 93°.

Synthetic spinel imitating aquamarine may show cracks at right angles and aquamarine does not.

Feldspars cleave and chalcedony does not. Tiny chips or breaks on the girdle of cabachon feldspars (sunstone, moonstone, amazonite, etc.) are flat and have a vitreous lustre while in chalcedony they are conchoidal with a waxy lustre.

Splintery fracture is seen in nephrite and hematite.

Hematite fracture is splintery and hematite (a substitute) is not.

Conchoidal fractures are a strong indicator of glass. I've seen quartz do it too to some degree.

Hardness: “The power a stone possesses to resist abrasion when a pointed fragment of another substance is drawn across its smooth surface without sufficient pressure to develop cleavage” (GA course material).

Harder stones will scratch softer ones. Stones of the same hardness may scratch

each other (a diamond can scratch a diamond). The Mohs scale is used for gemstone hardnesses. This scale is purely relative as shown by the fact that the difference in hardness between corundum (9) and diamond (10) is 140 times the difference between talc (1) and corundum (9).

Mohs Scale

- | | |
|-------------|------------------------|
| 1. Talc | 6. Orthoclase feldspar |
| 2. Gypsum | 7. Quartz |
| 3. Calcite | 8. Topaz |
| 4. Fluorite | 9. Corundum |
| 5. Apatite | 10. Diamond |

Other reference points include:

Finger nail	2 1/2
Copper penny	3 or so
Window glass	5 1/2 or so
Knife blade	6
Steel file	6 1/2 - 7
Silicon carbide	9 1/4
Carborundum	9 1/4

Hardness testing is not often used as the chance of damaging a good stone or even an imitation of value to the owner is too high. It is normally only used on rough material or on an inconspicuous spot on large carvings as a confirmatory test.

Any scratch detracts from the value of a gem. It will not tell if something is synthetic or natural. Gems have more than mere monetary value.

Hardness points Sets of standard pieces of Mohs hardness 7, 8, 9, 10 mounted in rods used to scratch gem materials.

Hardness Plates Sheets or slabs of standard hardness materials. The gem to be tested is rubbed on the plate using the girdle so that hopefully the plate suffers the damage. Again, material can scratch itself although it is true that the feel of the “bite” in hardness testing can tell a great deal.

It is also not necessary to file chunks from gems or scratch whole facets; a 1 mm scratch can suffice and if the plate and stone is wiped clean and inspected with a loupe one can tell which was scratched. Diamond is the only colourless gemstone which will produce a scratch in a polished corundum plate.

A lapidary can make a set of small plates quite easily and synthetic corundum can supply the #9 plate.

Reading: look up hardness and hardness testing. in Gem Testing and Gem Identification, and online.

SPECIFIC GRAVITY

Lewton-Brain©86/94/10

Archimedes is said to have discovered that when a body is placed in water the volume of water displaced is equal to the volume of the body and that when the body is placed in water that it undergoes an apparent loss of weight. This loss of weight is equal to the weight of the water displaced. When a gem is weighed in air and then weighed in water the loss of weight is equal to the weight of its volume in water displaced. **The weight of the gem in air divided by the loss of weight in water gives the specific gravity** of the stone or material.

Specific gravity is then defined as “The weight of a body compared with the weight of an equal amount of pure water at 4°C” (4°C is essentially the temperature at which water is densest). In practice room temperature water is used. What this means is that a given volume of ruby weighs 4 times as much as an equal volume of water or a given volume of diamond weighs 3.52 times as much as an equal volume of water. An example of using this is: gem weighs 5 ct in air, loss of weight is 1.25 ct. in water (weight units do not matter, grams, carats).

$$\frac{\text{wt in air}}{\text{loss of wt in water}} = \text{SG} \qquad \frac{5.00}{1.25} = \text{SG} \qquad \text{SG} = 4.00$$

The gem is then corundum with an SG of 4.00 (3.99).

The specific gravity for each mineral is the same within narrow limits (except in species like topaz or garnet and zircon where subgroups with definite specific gravities occur). If one can determine the specific gravity of a gem one can usually identify it. In practice however because of time constraints and other factors specific gravity determination is usually used as a corroborative test or for large, rough or carved samples.

There are a number of SG balances made for measuring specific gravity. These allow the SG of the sample to be read directly from their scales. Two are the Westphal and the Hanneman. The Hanneman balance is extremely inexpensive (\$10.00 US), fairly fast and easy to use. It is very accurate and can give accurate results on stones as small as .5 ct with care while other balances are not accurate below 3.0 cts. There are 5 cts to the gram.

A regular diamond or chemical balance, mechanical or electronic may be adapted for hydrostatic SG determinations by devising a way of weighing the stone in air, then in water, using the same pan. The conditions required are:

1. A bridge is constructed for the left hand side of the balance. This sits above the pan without touching or otherwise interfering with the operation of the balance at any time in its use. The bridge should not be magnetized.
2. A beaker of water (distilled, deionized, degassed) is placed on the bridge. A **tiny** drop of wetting agent, alcohol, or better photo-flo or dishwashing liquid is added to the water to decrease surface tension which can adversely affect the results. This too may not hinder or touch the operation of the balance.
3. An extremely thin lightweight metal spiral wire ‘cage’ is constructed which

hangs from the left hand side of the balance arm. The spiral 'cage' is submerged in water. It should be of rustproof metal like brass, copper, stainless steel, titanium or tungsten.

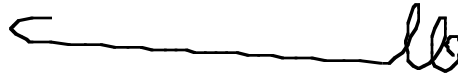

4. A counterbalance wire is hung from the opposite side of the balance arm at the same position. This is cut so as to balance the 'cage' wire as completely as possible.

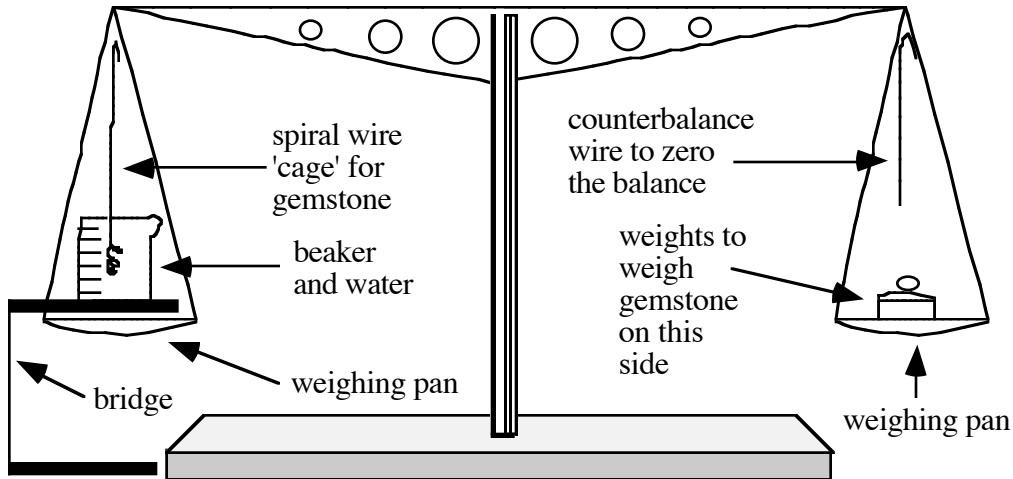

diamond or chemical balance accurate to 3 decimal places (.001g)

Procedure to Determine SG of a Gemstone Over 3 ct

1. Zero the balance. If your counterbalance wire does not do this you have to add some weights to the right hand pan (for right handed people) to get the indicator needle of the balance to register zero or perfect balance. This weight must of course then be subtracted from your later additions of weights to this pan.
2. Clean the stone very carefully with a gem cloth. If it has wax or grease on it this must be removed. Use alcohol and wipe clean. Examine it for large flaws or inclusions which might affect the accuracy of the results.
3. Place it on the left hand pan underneath the bridge and weight the stone. Record the result. Weighings are done to three decimal places.
4. Place the stone in the spiral cage and weigh it in water. Record the result. Brush off any bubbles on the stone or wire with a fine brush.
5. Subtract the second result from the first to find the difference. (The loss of weight in water).
6. Perform the calculation:
$$\frac{\text{wt of stone}}{\text{difference in wt}} = \text{SG}$$

7. For more accurate results repeat the procedure at least three times and average the results. Make sure the stone is **dry** before repeating the air weighing.

With an electronic balance the procedure is similar except that only one balance pan is used. As you will not be able to zero the balance the weight of the spiral cage suspended in water **is the zero weight** and all calculations are done from this reference point. eg. if it weighs .3 grams then subtract .3 grams from all calculations.

There are several other methods of determining specific gravity hydrostatically. For large specimens a spring balance and a bucket of water may be used. The larger the object the more accurate the results.

Other Balance Methods (Sinkakas, Gemstone and Mineral Databook, pp 123 - 126)

For large samples, sculptures, rough.

1. Weigh specimen in grams.
2. Partly fill a graduated cylinder (cc) with water.
3. Drop in sample, note new volume.
4. Difference between volumes = volume of water displaced **in grams**.
5. Calculate:
$$\frac{\text{wt of stone}}{\text{number of cc's displaced}} = \text{SG}$$
 This method is rough.

Also:

1. Weigh specimen.
2. Place a beaker partly filled with water on balance and weigh.
3. Leaving beaker and water in place submerge the sample with a **very thin** thread or nylon monofilament in the water.
4. The beaker and water gain weight, rebalance and note new reading.
5. The difference between new weight and earlier weight is the weight of the water displaced by the sample. This too is a rough method.

Causes of Error in Hydrostatic SG Determination

1. Too small a specimen.
2. Surface tension of water. One drop of detergent liquid the size of a pin head destroys surface tension in 1 liter of water.
3. Failure to degas water. Use boiled, deionized water that has been sitting for a time.
4. Failure to record and compensate for temperature corrections when using liquids other than water.

5. Failure to multiply SG by density of liquid other than water.

To avoid problems of surface tension other liquids than water may be used. Examples are Carbon Tetrachloride, toluene and alcohol. Ethylene dibromide was used but is now considered too dangerous. Recommended is toluene or alcohol. Because temperature affects the SG of these liquids one must refer to the literature for each temperature change when using them. In practice it may be better to find the exact SG of the liquid you are using at the time of use and then refer to your SG and temperature correlations as you build them up with time. Such liquids are used for small stones to increase accuracy. To find the SG of a liquid use a very clean piece of quartz which has a constant SG of 2.651 (a gemstone and weigh as if to obtain the SG. Then solve the equation:

$$\text{SG of fluid} = \frac{\text{SG of quartz (2.651)} \times \text{loss of weight in fluid}}{\text{Weight of quartz sample}}$$

Heavy Liquid Methods

Various liquids and chemicals have a wide range of SGs. When a stone is placed in a liquid of the same SG it suspends, and stays where it was placed (or sinks or rises very slowly). If it has a lower SG (is 'lighter') than the liquid it floats. If it is denser (has a higher SG, is 'heavier') it sinks. Therefore, given a range of liquids of known SGs it is possible to estimate or even determine the SG of a stone by its behavior in the liquids.

The Advantages of Heavy Liquids Include:

1. **Speed.** It is very fast. One usually begins with the densest liquid and goes to the next less dense until the stone sinks to the bottom. If you are lucky it suspends.
2. One can use them for stones under 3 ct. Stone size makes no difference.
3. As an ancillary method it may be very rapid to check or corroborate other tests.
4. Very quick for separating different types of similar appearing stones from the same package. For example checking beryl (emerald) one might make up a liquid with the density of 2.71 (Indicator is calcite).

Disadvantages:

1. Stones must be unmounted.
2. Cracked, flawed stones may give inaccurate readings.
3. The liquids used are messy, smelly, poisonous and in some cases corrosive.
4. Porous stones may not be tested (opal, turquoise, organic gemstones).
5. The liquids attack many plastics.

There are three liquids recommended for general use.

Bromoform SG 2.88

Methylene Iodide SG 3.33

Monobromonaphthalene SG 1.49 This is used to dilute and lower the SGs of the other two. Liddicoat suggests the use of toluene which is very flammable and evaporates faster than monobromonaphthalene but is cheaper.

Liquid Number
Indicator

#1 2.65 SG Quartz	Bromoform diluted with monobromonaphthalene. Quartz, feldspars, iolite float, most other stones sink.
#2 2.88 SG	Bromoform, undiluted. Beryl floats, other green blue stones sink.
#3 3.05 SG Tourmaline	Methylene iodide diluted with monobromonaphthalene. Tourmaline floats, nephrite floats, jadeite sinks.
#4 3.33 SG	Methylene iodide undiluted. Jadeite, peridot suspend or float or sink very slowly, topaz sinks, tourmaline floats, etc.

There are also solutions made up with an SG of 3.52 (diamond indicator) and 4.00 (corundum indicator) using a liquid called Clerici solution which may be diluted with water.

Indicators of clear gemstones may be used as a check on the liquid SG before use as evaporation etc. can change the SG. Manufactured glass SG indicators in a wide range are also available. It should be noted that **relative speed** of sinking is a good indication of SG range. If a stone sinks very rapidly then it is a lot denser than the liquid, slowly it is similar. The degree to which it floats on a liquid can also tell something about its SG. High floating means it is a lot less dense, low floating similar, suspends - the same. Make sure to **tap or dunk a stone** with tweezers to ensure that surface tension is not holding it up.

Although Clerici solution offers many advantages to the gem tester it is no longer recommended as it is extremely toxic, corrosive and recently shown to be carcinogenic. Nasty stuff. It's use requires strict laboratory safety precautions and use. It's special characteristic is that it demonstrates an exact correlation between SG and RI as it is diluted. It may be diluted until a gemstone suspends and then a drop of it placed on a refractometer and the RI found. Then one looks at a straight line graph and reads off the SG of the solution and the stone. To reconcentrate it water is simply allowed to evaporate. At full concentration its SG is 4.28. The less toxic liquids can also be used in the same way to obtain a correlation between SG and RI. However they are not easy to reconcentrate. There are also other methods of obtaining the SG of a stone using heavy liquids.

Using Heavy Liquids

1. Adequate ventilation is necessary.

2. All tweezers, stones, etc. in contact with the liquids must be very carefully cleaned; perhaps with toluene as a solvent; between liquids to prevent contamination or corrosion of tools. Clean them extra carefully after finishing.
3. They are **poison**. No food, smoking or drinking is allowed when using heavy liquids.
4. Hands must be washed right after use whether or not they were in contact with the liquids.

The Hanneman Balance

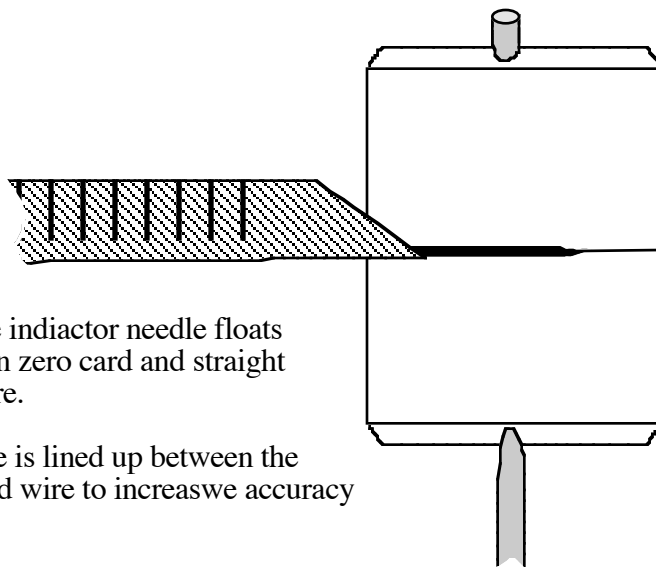
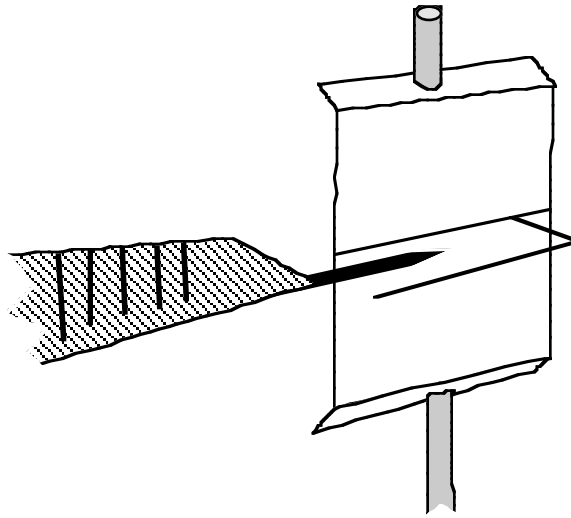
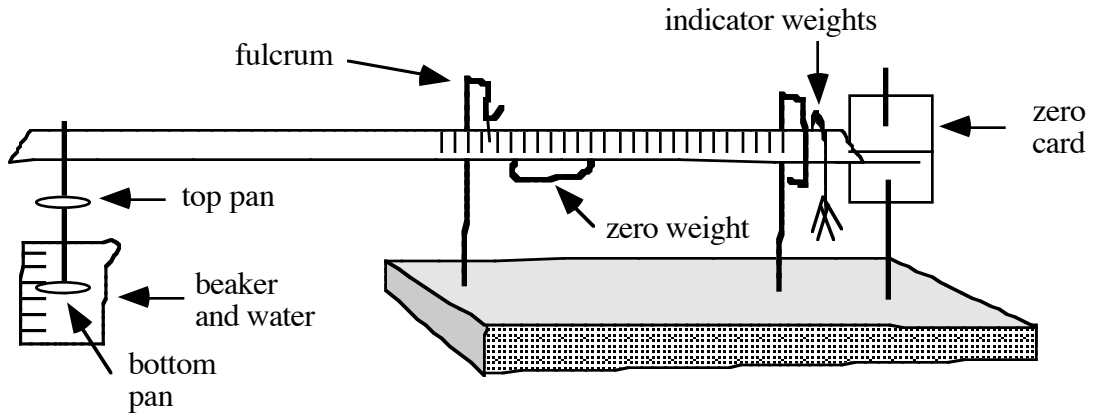

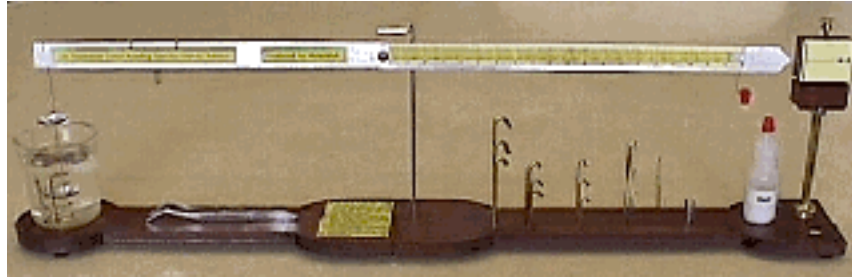

<http://www.mineralab.com/Hanneman.html>

To use the Hanneman Balance: (A tiny amount of detergent in the water will increase accuracy)

1. Set up balance as described.
2. Clean the stone, check for flaws.
3. Slide zero weight to a position where the indicator needle registers zero on the zero card. If necessary adjust the zero card slightly. The balance should be as horizontal as possible.
4. Place stone in top left hand pan. Place indicator weight wires on the notch at the right of the balance until the needle registers zero again.
5. Place the stone carefully in the lower pan under water. Brush off any air bubbles. The needle will rise as the weight is less.
6. Slide the indicator weights wire to the left on the scale until the needle registers zero again.
7. Read the SG value (top scale). Repeat twice more and average for increased accuracy.

Reading pages 71 - 86 in Gem Testing, pp. 7-9, The loupe, pp. 87-97 Microscope

Optics

Lewton-Brain©1986/94

The optical characteristics and properties of gemstones often provide the fastest and best methods of identification. A certain amount of theory is necessary as optical principles determine cutting methods, gemstone attributes and the function of gem testing instruments.

Light

Light and our perception of it play a crucial role in our appreciation of and identification of gemstones. Visible light however comprises only a small part of what is referred to as the **electromagnetic spectrum**.

While the wave or undulatory theory of light has been mostly superseded by the quantum (particle) theory the wave theory best serves the purpose of describing light for gemmology. We can consider the electromagnetic spectrum to consist of an infinite number of types of wavelengths, from short to very long. Different wavelengths have different powers of penetration dependent upon their length relative to the medium they pass through. X-rays for example with a wavelength near atomic sizes pass through or between most atoms. The amount passed depends upon the mass of the atom concerned. Dense atoms like lead for instance provide a screen against x-rays. An application of this is a test for diamonds, whether set or unset, where the suspect stones are x-rayed for ten seconds over photographic paper. Carbon atoms are small (low mass) and so diamond is transparent to x-rays and is invisible on the photograph while all diamond simulants show up as positive, opaque shapes.

A rough wavelength scale follows:

10-16	10-14	10-12	10-8	10-6	10-4	10-2	1 meter	10/2	10/4	10/6	10/8	10/10
cosmic rays	gamma rays	x-rays	U.V. light	visible light	infrared	short radio	broadcast	long wave radio				

Note what a small portion of the spectrum comprises visible light. Light can be thought of as progressing outward in a single path (a ray). The ray forms a wave vibrating in all planes at right angles to the direction of travel, the line of the ray.

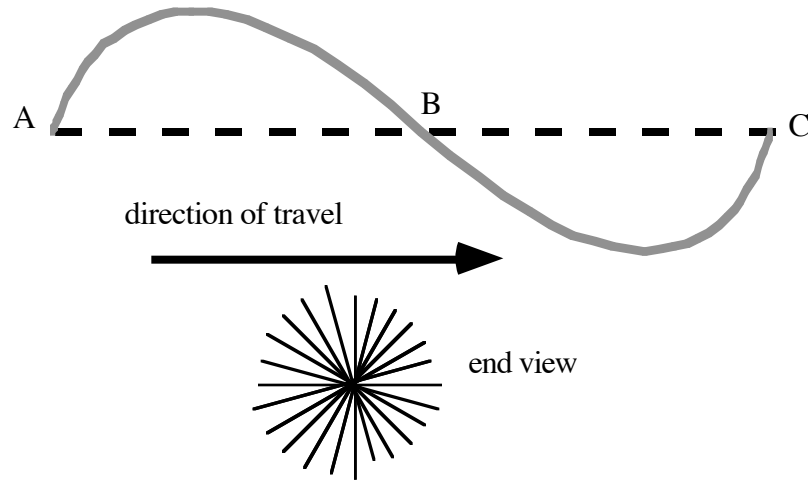

White light is composed of a mixture of a great many wavelengths each of which is perceived as a different colour. The wavelength of violet light for example is about half that of red light. The wavelengths of white light may be divided into:

Red	700.0 nm	to	640.0 nm
Orange	640.0 nm	to	595.0 nm
Yellow	595.0 nm	to	575.0 nm
Green	575.0 nm	to	500.0 nm
Blue	500.0 nm	to	440.0 nm
Violet	440.0 nm	to	400.0 nm

Transparency

Refers to the ease with which light is transmitted through a substance. Classifications of transparency in cut gemstones include:

1. Transparent stones. An object viewed through the gem shows outlines clearly and distinctly (diamond, topaz, corundum).
2. Semi-transparent. Blurred outlines of object but a great deal of light still passes through the stone, i.e. chalcedony.
3. Translucent. Some light passes through, no object can be seen through stone, i.e. opal, some jades, much cryptocrystalline quartz.
4. Semi-translucent. Light is only transmitted through edges, where they are thin, i.e. turquoise.
5. Opaque. No light passes through, i.e. malachite, pyrites.

Colour and degree of colour will affect transparency as will inclusions, flaws, etc. Quality will also affect it. The characteristics are subjective in nature and overlap exists.

Reflection of Light

If a ray of light falls onto a plane mirror the light is reflected away from the surface. The angle of incidence NOI equals the angle of reflection NOR and IO, NO and RO are in the same plane. All angles in optics are measured from the '**normal**', an imaginary line at right angles to the surface at the point of incidence (where the light

ray strikes the surface).

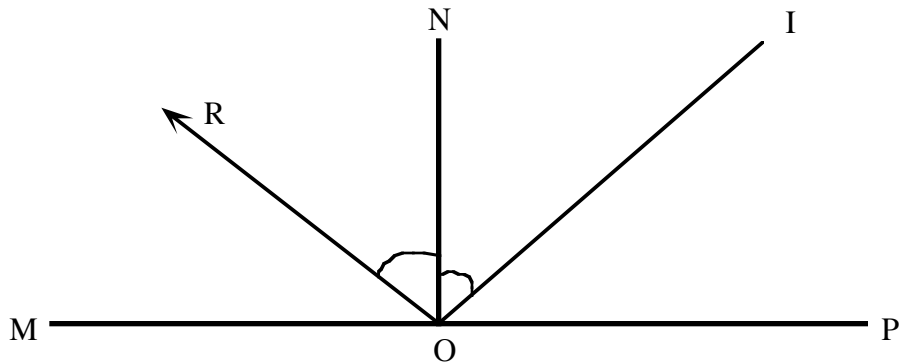

NO = the normal to the surface MP
 NO is at right angles to surface MP
 NOI = the angle of incidence
 RON = the angle of reflection
 angle NOI = angle RON

Refraction

A ray light entering an **optically denser** medium is bent (refracted) **towards** the normal. The greater the bending (refraction) for a given angle of incidence the greater is the refractive power of the stone.

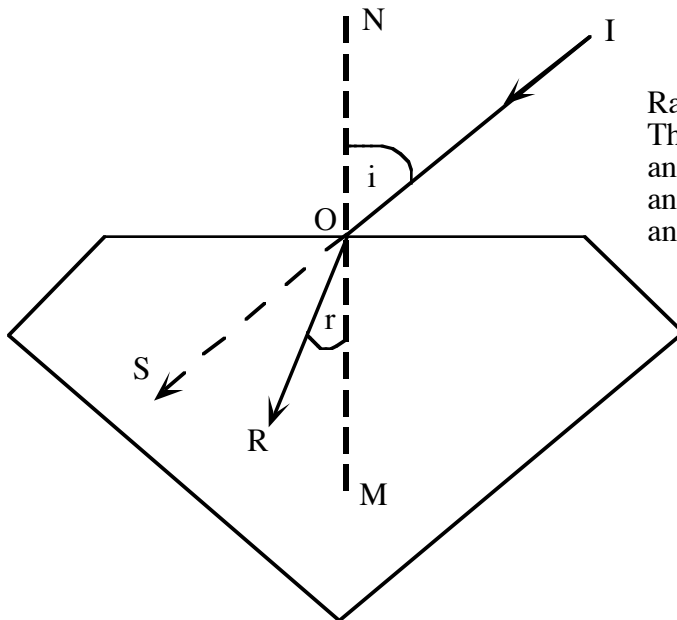

Ray IS is refracted towards the normal at O (IOR)
 The normal is at right angles to the (gems) surface
 angle ION = the angle of incidence (i)
 angle ROM = the angle of refraction (r)
 angle ION is greater than angle ROM

The cause of refraction is that the light waves (300,000 km/second) are slowed down as they enter the optically denser medium. In the 17th century Snell (Dutch scientist) described laws relating angles of incidence and refraction for two media. There is a constant ratio between the sines of these angles for any given two media. The constant ratio obtained is called the **refractive index**. Air is chosen as the rarer medium and yellow sodium light is the standard for refractive index measurements. Refractive index is a measure of a gem's refractive power. **It is the ratio of the sine of the angle of incidence divided by the sine of the angle of refraction when light passes from air into the denser medium.**

Another definition is: $\frac{\text{Velocity of light in air}}{\text{Velocity of light in denser medium}}$ (300,000 km/sec)

Velocity of light in denser medium

Gems refractive indices range from under 1.5 to over 2.8.

Total Internal Reflection

A ray passing in the opposite direction, from the denser to the rarer (gem to air) medium is bent (refracted) **away** from the normal.

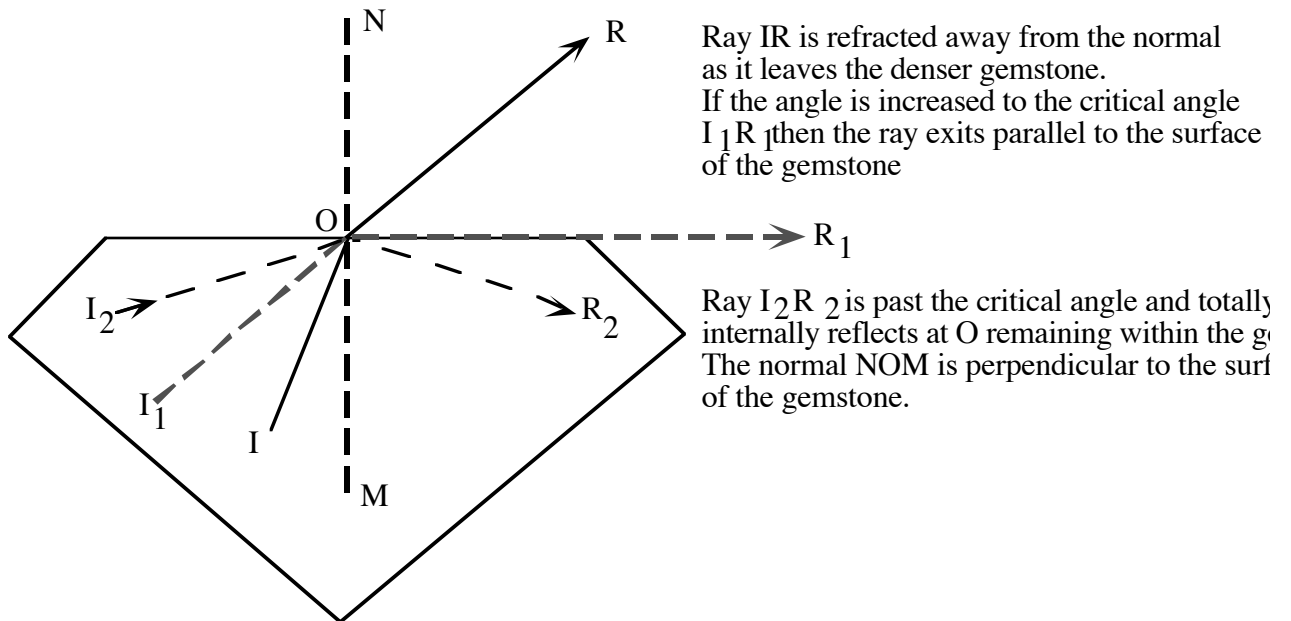

Ray IR is refracted away from the normal as it leaves the denser gemstone. If the angle is increased to the critical angle I_1R_1 then the ray exits parallel to the surface of the gemstone

Ray I_2R_2 is past the critical angle and totally internally reflects at O remaining within the gem. The normal NOM is perpendicular to the surface of the gemstone.

As the angle of incidence is increased the angle of refraction away from the normal increases until a point is reached when the ray I_1OR_1 exits parallel to the table of the stone. Any further increase in this angle causes the ray to be **totally reflected** back into the gem. Ray I_2OR_2 has been reflected back into the gemstone. This is called total internal reflection and the angle I_1OM is called the critical angle for the medium in question. The brilliant cut of diamonds uses total internal reflection and the critical angle for diamond and air to ensure that all light entering the stone is totally reflected and passes out the table or crown facets of the stone. The critical angle is also what enables a refractometer to differentiate gemstones of different species. When you are underwater in a swimming pool, look up and see the surface as a perfect mirror your head in in the area being totally reflected back into the pool.

Dispersion

A white light ray entering an optically denser medium and leaving by a plane inclined to that of entry will have its colours separated, analyzed, spread out. This is because each colour has a different wavelength and so is differently slowed down (refracted) by the medium. Red (longest wavelength) is slowed the least and violet (shortest wavelength) the most.

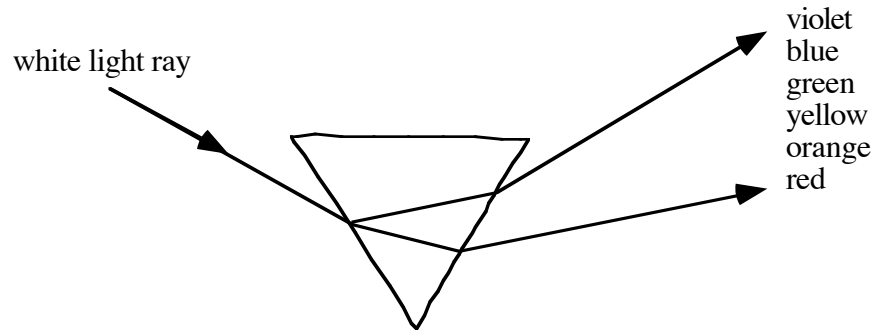

This spreading is termed dispersion. In gemstones the effect gives rise to the stone's 'fire'. It may be measured with complex equipment and numerical values given. The higher the number the greater the fire where the stone's colour does not mask the effect, as in demantoid (green) garnet with a greater dispersion (.057) than diamond (.044). With practice and standard stones numerical estimates of dispersion may be made with the Hanneman/Hodgkinson slit technique.

Plane Polarized Light

When a light ray passes through a doubly refractive gemstone it is split into two rays with different amounts of refraction. Each ray is plane polarized, that is instead of the wave vibrating all directions about the line of the ray it vibrates in a single plane only. Each ray is **plane polarized at right angles to the other**. As each ray is differently refracted so it is differently absorbed by the stone and possesses in coloured gems a different hue or colour.

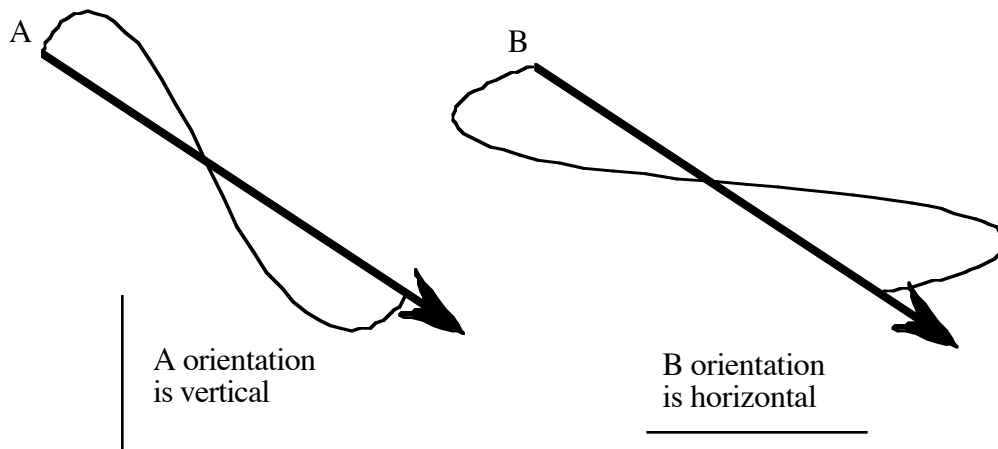

The Dichroscope



<http://www.faceters.com/askjeff/answer36.shtml>

The dichroscope picks up each ray at the same time and allows one to view them side by side. A simple dichroscope is a block of calcite with black paper glued to one end which has a small rectangular hole cut in it. The viewer sees two images because the light ray has been split by the high double refraction of calcite. Each image is of a different ray (each ray is also plane polarized at right angles to the other - this is what allows the calcite to present them separately). If a difference in colour exists it will be visible by comparison. One must always test in several directions in case one was accidentally looking down an optic axis (in which case there would be no dichroism – this is how cutters find an optic axis). This can be of some use in identifying gemstones by their characteristic dichroic or trichroic colours but is usually used as a method of detecting double refraction. Presence of dichroism proves double refraction. Absence does not mean a material is not doubly refractive - it may be that the dichroism is very weak, or in transparent stones there is none evident. It can be used to find an optic axis. If three colours (trichroic) are seen it means the stone is biaxial. If two only are seen it is uniaxial. Transmitted, not reflected light must be used as reflected light may be partly polarized. Most natural corundum is cut with the table oriented to the optic axis and will show no dichroism through the table. Most synthetic corundum has the table parallel to the optic axis and dichroism is strongest through the table. This is then an indication of synthetic origin.

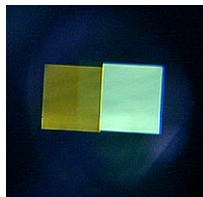

<http://www.faceters.com/askjeff/answer36.shtml>

Reading: *Gem Testing*, pp. 15-35 refractometer, pp. 39-48 immersion methods, pp. 49-56 polariscope, pp. 66-70 dichroscope

OPTICAL EFFECTS

Lewton-Brain©1986/94

Lustres (repeated from early in the course)

Lustre (or the American spelling Luster) refers to the amount and quality of light reflecting from a gem's surface to the eye. It is partially a subjective measurement but can be helped by comparison with a standard set of gems with known lustres. The hardness of a material, its refractive index and the degree to which it has been polished will have a bearing on the lustre. In general the harder a material is the higher the lustre, the softer it is the lower the lustre. The Americans and the British use slightly different nomenclature for lustres.

The American Liddicoat terms the categories: "metallic, submetallic, adamantine, subadamantine, vitreous, subvitreous, waxy, greasy, silky, dull." He goes on to say: "The first three reflect the presence of refractive indices over the refractometer scale. Subadamantine suggests an index high on the scale; vitreous, midscale; and subvitreous, low. Waxy and greasy lusters are usually associated with poorly polished surfaces, while silky refers to stones with many needle like inclusions." (Liddicoat, 'Handbook of Gem Identification', pp 216, 1993 ed.)

Britain's Webster says that many gems have a glassy or vitreous lustre. He gives examples and lists the lustre types as: "Metallic: silver, Adamantine: diamond, Subadamantine: demantoid garnet, Resinous adamantine: certain zircons, Vitreous: quartz, Resinous: amber, Silky: fibrous materials such as satin-spar, Pearly: usually seen only on cleavage faces, Waxy: turquoise". (Webster, "Gems: Their Sources, Descriptions and Identification" .pp 670)

John Sinkakas makes a correlation between refractive index and luster (he's American). Refractive index is given first, then the corresponding comment on luster.

1.3-1.4	Poor reflections, inclined to be greasy or oily in appearance
1.5-1.78	Brightly reflective, like glass
1.6-1.9	Resinous in appearance
1.9-2.5	Very brightly reflective, adamantine, sometimes appearing as if

the mineral is lightly coated with a metal film.
2.5 + Submetallic, bright luster, definitely metallic in appearance

(Sinkakas, John., "Gemstone and Mineral Data Book", pp 336)

Sheen

Sheen is due to the reflection of light from material below the surface of a gem. Moonstone, spectrolite and other feldspars are examples. Sheen in moonstone is also called schiller or adularescence. Pearls too have sheen as light reflects from below the surface of the pearl.

Interference of Light

refracted into the films. The ray then reflects from film levels below the top surface and reenters the air. As it does so it **interferes** with; either intensifying or quenching certain wavelengths (colors) in other light rays reflecting from the top of

the film. This produces color and light effects like that of oil on water, soap bubbles, Titanium and Niobium coloring, labradorite, tempering colors on steel and so on. In the diagram below a single ray is shown but in reality an infinite number of rays are doing the same thing simultaneously at all points on the surface of the partially reflective top layer or film.

The part of the light reflecting from the top surface and being interfered with by a light ray reflecting from a lower surface produces quenched or intensified colors to our eyes

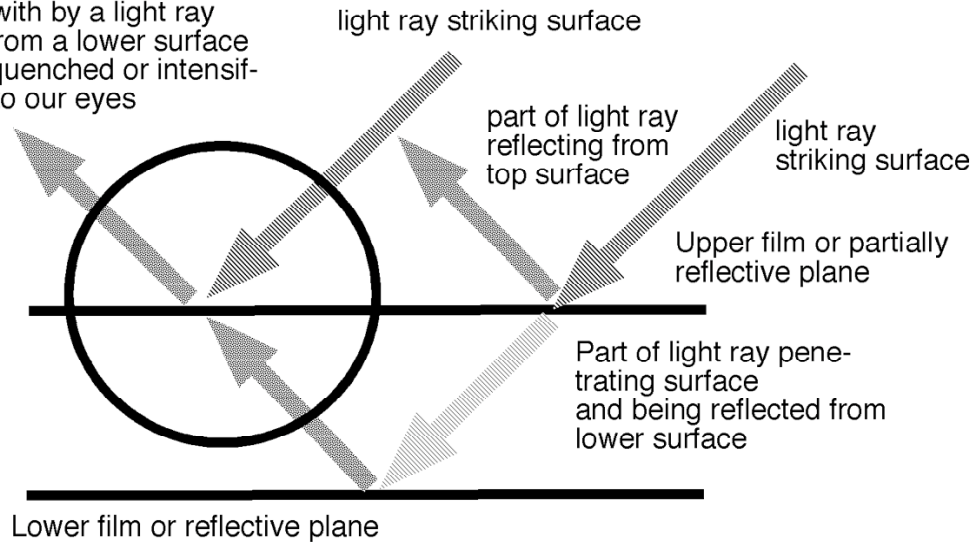

Iridescence

A general term for colour effects produced by interference or by diffraction. Colour play in opals, mother of pearl etc. are examples.

Play of Colour

A term used to describe the colours seen in opal. This is caused by light diffraction from a regular structure of silica spheres in opals.

Diffraction

When light passes over many tiny sharp edges or between many repeated points of differently refracting media an interference like phenomenon occurs; light is spread out into specific colors. You can see this on music CDs and sometimes on mesh between you and a light source. This principle is used in the diffraction grating spectroscope. This is what causes the play of color in opals, light being bent and diffracted as it passes innumerable regular stacked layers of minuscule silica gel spheres.

Opalescence

The milkiness of opals. Sometimes it is used to describe play of colour.

Chatoyancy

When a gem material contains many minute fibrous inclusions oriented in one direction and it is cut en cabachon a streak of light or 'eye' can be seen at right angles to the direction of the inclusions. An example used to explain this is the light streak visible on a spool of silk thread or on an old 35 RPM record. Examples include chrysoberyl (cymophane), crocidolite (tigers eye) and quartz. Many gems can exhibit an 'eye' including tourmaline, beryl, nephrite, jadeite etc.

Asterism

Star stones, these are most commonly sapphire and ruby but may include garnet, spinel, diopside and other gems. It is a special type of chatoyancy as the cause is due to many small fibrous inclusions oriented at set angles to each other. Examples are ruby (60°), garnet (70°). These inclusions in the case of corundum are all parallel to the lateral axes of the crystal and at right angles to the vertical crystal axis. When the stone is cut with the top of the cabachon dome oriented with the main crystal axis passing vertically through it and the silk inclusions parallel to the girdle of the stone asterism results. Each set of silk has a streak of light at right angles to it and a star is seen.

Spectroscope

Along with the microscope and refractometer this is a major identification tool in gemmology. Note that books will either have the red on the right (USA) or on the left (Britain).

As light passes through a gem the presence of certain chemicals will cause specific wavelengths of light to be absorbed. Instances also occur where wavelengths are intensified or the stone actually emits them (fluorescence wavelengths - rubies, spinel). When light is spread out by a spectroscope into a wide band these wavelengths show up as lines or areas of darkness in the spectrum. While the actual wavelength numbers can be used in identification usually only a pattern of lines is used to identify the stone. There are two types of spectroscope, prism and diffraction grating. Prism ones bunch up the spectrum so the red is tight and the blue area is spread out. It is brighter than a diffraction grating one, and lets you see lines better in the blue area. The diffraction grating kind has the spectrum evenly distributed but because of light absorption is dimmer than a prism one.

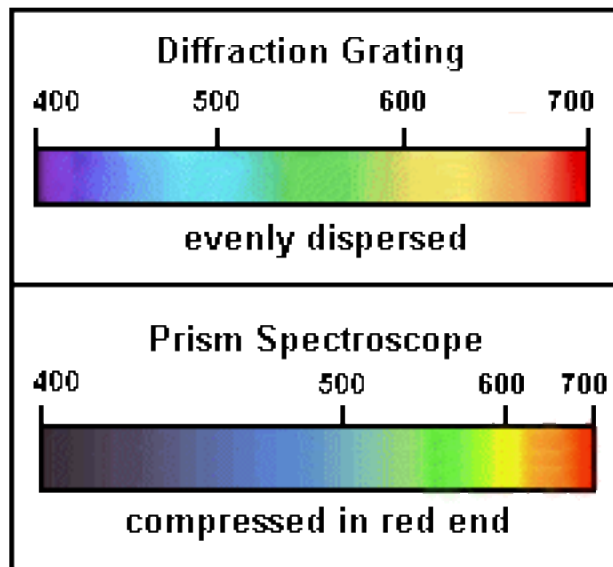

<http://www.gemsociety.org/info/agem5.htm>

A spectroscope can be the fastest way of checking out large numbers of stones, especially red ones, as spinel, ruby and tourmaline have distinctive spectra. It can be used to identify synthetic verneuil sapphire, blue synthetic spinel, almandine garnet to name a few.

Here is a ruby spectrum on a diffraction grating spectroscope:

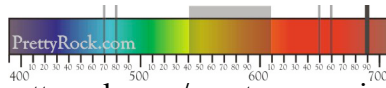

<http://www.prettyrock.com/spectroscope-instructions.htm>

Reading: (Gem Testing), Spectroscope, pp. 158-173, Reflectivity meters pp. 35-39, Colour Filters pp. 63-66, Spectroscopes pp. 158-173, Garnets pp. 326-338, Handbook of Gem Identification, pp. 187-338 This is the best group of drawings available on what spectra look like, very fuzzy, hard to see at times. Note that British gemmologists have the red on the left and Americans have it on the right when looking at spectra.

See the spectrum information at

<http://www.brainpress.com/gemlinks.html>

Fluorescence

Lewton-Brain©1986/94

Fluorescence is the emission of visible light from a substance under the stimulation of radiation of a shorter wavelength. It may be stimulated by (visible) light but most useful are blue light, short wave ultra-violet (UV) light, long wave UV and x-rays. Daylight contains some ultraviolet light and some artificial light sources (i.e. photoflood lamps) put out a considerable amount of UV light. An example of the effects of such light is blue fluorescing diamonds. Diamonds which fluoresce blue in UV light may have a yellow tint to them in UV free white light which is cancelled by the blue fluorescence in (daylight) conditions.

Crossed Filters

A strong light (500W) is filtered through a saturated solution of CuSO_4 on to a specimen. When a red filter is used to observe stones in the blue light only red light actually emitted (fluoresced) by the stones under the stimulation of the blue light is observed. Stones that show up red include: ruby, synthetic ruby (verneuil), emerald, synthetic emerald, red spinel, synthetic red spinel, pink topaz, alexandrite.

Used with a spectroscope the following observations/differentiations may be made:

1. Corundum (ruby) from red spinel which shows (organ-pipe) lines in the red end.
2. Red spinel from synthetic red spinel. The synthetic has a single line in the red (like ruby) and lacks the 'organ-pipe' fluorescence lines. To differentiate ruby from synthetic red spinel one looks in the blue where the lines characteristic of corundum are lacking.

Synthetic (verneuil) rubies and synthetic emeralds often show a brighter red than the natural stones. The effect is apparently stronger using an infrared filter to view them with. Where iron is present it acts as a damper on the red fluorescence, i.e. Siam rubies and emeralds from South Africa and India may be almost inert.

Natural black pearls show a dim red glow while dyed ones (using AgNO_3) are inert.

Long Wave UV 365.0 nm

Similar to crossed filters in some instances.

Natural yellow sapphires fluoresce yellow, synthetic yellow ones are inert. Natural colourless fluoresce orange, synthetic colourless are inert. Synthetic orange sapphire fluoresces red (from chromium).

Yellow-green synthetic spinels fluoresce bright green. Blue synthetic spinels fluoresce red, most naturals do not.

White zircon shows a yellow fluorescence (UV may cause a reversion of colour to original yellow or brown, heat may remedy this).

Fluorspar fluoresces brightly.

Natural emerald is usually inert, most synthetic glows bright red. Ultra long wave

UV (410.0 nm - 310.0 nm) shows a pronounced difference in fluorescence between most natural emeralds (inert) and synthetic emeralds (bright red fluorescence).

Diamond fluoresces in all colours, the fluorescence may be analyzed with a spectroscope in some cases for identification. When cooled with dry ice or liquid nitrogen some diamonds show fluorescence lines at 415.0 nm and 504.0 nm. Irradiated diamonds may show a line at 594.0 nm which is diagnostic. Diamonds that fluoresce bright blue show a yellow phosphorescence when held in cupped hands after the light is turned off - the only blue fluorescing gemstone to do so. Photographs of the pattern and colour of fluorescing diamond set jewellery may serve to identify it for insurance or other purposes.

Short Wave UV, 253.7 nm (NB: is harmful to skin and eyes)
Many stones show similar reactions as to long wave.

Synthetic blue sapphires show a greenish-blue or white-blue glow, synthetic white stones a deep blue glow or a 'chalky bluish white, naturals in both cases are usually inert. Some yellow sapphires fluoresce green at the surface. If suitable precautions are taken synthetics examined with a lens while fluorescing will often show curved structure lines. Many blue and yellow sapphires, especially from Sri Lanka and Madagascar fluoresce an apricot orange.

Benitoite which resembles sapphire fluoresces bright blue while natural sapphires are inert.

“Many heat-treated rubies and sapphires will display chalky short-wave (SW) fluorescence. This reaction is practically never found in untreated corundums and was first noted by Robert Crowningshield (1966, 1970). It is actually the colorless portions of the stone that fluoresce (a reaction similar to Verneuil synthetic sapphires). Since colorless areas follow the original crystal's growth structure, the fluorescence will follow the same pattern as the gem's color zoning. If it is inert, that *does not* mean it's unheated. “ (Hughes)

http://www.ruby-sapphire.com/heat_seeker_uv_fluorescence.htm

Synthetic rubies and emeralds both often glow brighter red than their natural counterparts. Both are much more transparent to 253.7 nm radiation than the naturals and this forms a test using contact immersion photography or by using a piece of (blue fluorescing) scheelite as an indicator. The suspect stone is placed over a hole in an opaque material with the scheelite below the stone and a short wave UV source above. If the scheelite fluoresces it is receiving light through the suspect stone and it is a synthetic stone. It should be noted that some new synthetics do not pass UV light.

Most danburite (1.63 RI) fluoresces bright blue while topaz (1.63 RI) is inert or glows orange and yellow.

Garnet-topped doublets: glass fluoresces yellow (or greenish) and garnet remains

dark. In some triplets the cement layer fluoresces brightly providing rapid identification. Many composite stones can be fairly easily identified as such in this manner.

White synthetic spinels glow bluish-white, useful for rapidly picking them out in set jewellery.

Natural amber glows patchily while 'ambroid' may show swirls.

Notes on fluorescence in Corundum from

http://www.geo.utexas.edu/courses/347K/redesign/gem_notes/Corundum/corundum_triple_frame.htm

Burmese Ruby - strong red (Cr); best stones fluoresce in strong sunlight.

Thai Ruby - less intense red (Cr+Fe); may show patchy blue fluorescence if heat treated.

Sri Lankan Ruby - strong orange red in long u.v., less strong in short u.v. (Cr).

Pink Sapphire - same as above.

Padparadscha - same as above. Heat treated may show strong reddish orange in short and long u.v..

Green and most yellow Sapphire - none (Fe + Ni + Ti).

Blue Sapphire - none (most; Fe + Ti) to red or orange (Kashmir, Sri Lanka, Montana) in long wavelength u.v.. Heat treated stones may show a dull chalky green fluorescence in short u.v..

Colorless - moderate light red to orange.

X-rays (Complex lab equipment, health hazard)

Most synthetic rubies and emeralds fluoresce brighter red than most natural ones. Synthetic rubies phosphoresce for ten seconds or so while the natural rubies are inert or nearly so.

Hydrogrossular garnet glows bright orange serving to separate it from idocrase (occurs at times in carving identifications). Colourless, yellow and orange synthetic sapphire may fluoresce red due to chromium.

Cultured pearls show a yellowish fluorescence, natural salt-water pearls are usually inert. Fresh water (natural) pearls fluoresce yellow but only at the surface cultured fresh water pearls glow from within.

Fresh water Biwa pearls glow bright yellow.

Synthetic emeralds may phosphoresce a dull red while naturals are inert.

Gilson synthetic emeralds glow bright red.

Some synthetic corundum manufacturers (Ramaura) have in the past 'doped' their products to allow identification using fluorescence as an indicator. Some of the new hydrothermal and flux-melt products however act very much like natural stones under all stimulation. It is necessary to review the literature to find references to new developments.

There are a number of other tools used currently relating to fluorescence. One is

laser tomography: see <http://www.cigem.ca/363.html>

Reading: (*Gem Testing*), pp. 104-126 *The Verneuil Process*, pp. 366-374
Cats eyes, star stones and others, the following articles on reserve:
“Have you ever tried to sell a Diamond?”, Epstein, Edward, from *Atlantic Magazine*, “Detecting Diamond Simulants”, Hobbs, Jill, pp. 125-139.
International Gemological Symposium 1982

Gem Enhancement and Imitations

Lewton-Brain 1986/94

Gemstone colour enhancement

There are a number of methods of changing a gem material's colour. The primary methods are heat, staining and irradiation.

Heat is the most important method. Up to 90% of corundum on the current market is supposed to have been heat treated as have a number of other gem materials (tanzanite, citrine). It is applied in carefully controlled kilns or primitive ovens in the source countries. Even heating is essential.

Examples include:

Brown zircon may be turned to white (transparent) by heating. These may fade with exposure to light (caution when using Ultraviolet light equipment) and turn a yellowish brown. Reheating will remedy this. All white zircon is heat treated.

Brown carnelian turns orange-red.

Aquamarine may go from green-blue to blue.

Rubies may lose a purplish tint.

Sapphires may have their colour deepened or reduced depending on the material used.

Iolite may be turned a deep blue.

Unethical/fraudulent methods (when undisclosed) include:

(induced, usually surface colourings)

Synthetic corundum is treated with (titanium) to diffuse into the surface to increase blue, induce or increase asterism or heated to reduce silk or colour zoning. These treatments are also applied to natural stones. Some verneuil synthetics are also fractured and the fractures healed to produce naturalistic 'fingerprint' inclusions and stained with iron oxide which penetrates the stone and adds to the naturalistic effect.

Diffusion treatment (corundum) may be identified by immersion in methylene iodide where facet edges and girdles may be strongly coloured while the rest may be patchy due to uneven repolishing after the heating/diffusion procedure. Surfaces may be pock-marked and girdles have 'scabs' on them. Heat treatment also shows up in the inclusion scene with 'atoll-like' rings and circular 'lily pad' inclusions, rounded melted crystals, intensified colour banding, zoning, natural structures and intensified cloudiness.

Diamond may be coated with various chemicals or even dyes. The coating used (similar in some cases to that used on camera lenses to improve colour) may be removed and checked for by boiling the stone in sulphuric acid. There are reports that techniques are being developed to allow diamond to be applied as a 'coating' or in a thin layer to other materials, metals and by inference gemstones. This, if developed will no doubt introduce a new set of problems to identification.

Staining

Used for softer, porous stones that includes:

Chalcedony-green dyed to represent chrysoprase (see spectrum).

Jadeite stained, may show broad line in red not present in most natural absorption

spectra (except Yunnan jade), colour collects in fissures and veins at the surface.

Crocidolite, in unnatural colours.

Onyx, various colours, dyes, carbonizing treatment (sugar/acid).

Opal, carbonizing treatment: microscope shows pattern of carbon spots and a possibly greyish look to the stone.

Turquoise, often dyed, oiled, impregnated with plastics or silica. Note that opal may also be silica-stabilized or plasticized by various companies.

Emerald, dyed, most often oiled to hide cracks.

Quartz, crackled and dyed to resemble emerald, a technique which goes back to the Egyptians. Note that a usual test for dyes is a swab with acetone or alcohol.

Ruby, emerald and sapphire beads stained to improve their color.

Irradiation

This concerns primarily diamonds. Methods include: (diamonds) Radium: green to black, strongly radioactive, no longer done. Test is exposure on photographic film or paper, or geiger counter.

Electromagnetic radiation: (cyclotron), green to black, heated afterwards to produce yellows to golden brown. A surface treatment, may show a ring around the girdle according to the direction irradiated as well as an 'umbrella' on the culet. Test by immersion, dark outline of the stone, etc. Diagnostic absorption line at 594.0 nm for the yellow and browns.

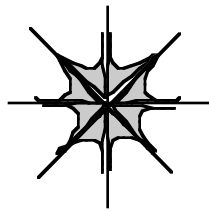

Neutrons: green to black, yellow and browns with subsequent heat treatment, colour permeates stone, greens not readily identifiable as treated. Line at 594.0 nm in brown and yellow.

Electron radiation: (accelerator) Blue to blue-green. Natural type IIb stones are electroconductive and this supplies the test for the stone as the treated stones are non-conductive ordinary diamonds. Beryl, topaz, blues are intensified, beryl blue similar to Maxixe stones with colour in ordinary ray (unlike the natural with colour in the extraordinary ray) and they fade on exposure to ultra-violet light (sunlight).

These colourations are accepted commercially where the stone is sold as a treated stone and the treatment is permanent so that chipping, repolishing and wear will not remove the colour. Surface treatments are usually relatively fragile and are in the main used fraudulently.

Laser Drilling

This concerns diamonds, and the removal of carbon spots by drilling from behind or the girdle. Needs to be disclosed, and are sometimes filled with glasses.

Infilling

Originally done with glasses, now also with plastics, fills cracks, firstly with

diamonds but now widespread with rubies and sapphires. See <http://www.yehuda.com/>.

Further reading:

If interested in the subject one should read the GIA and GA journals regularly for new developments. Useful books are:

Gems Made by Man, Nassau, Kurt, 1980, Chilton Books, Radnor, Pa.

Gemstone Enhancement, Nassau, Kurt, 1984, Butterworths, London.

Identifying Man-made Gems, O'Donoghue, Michael, 1983, NAG Press, London.

(This last has some inaccuracies and badly written passages but still contains useful information when read carefully. It has very nice inclusion photographs).

Readings in Gem Testing are: pp. 99-104, pp. 126-157 Detection of synthetic, imitation and composite stones, pp. 225-227 Diamond substitutes, pp. 231-238 Colour inducement in diamonds, pp. 245-253 Synthetic ruby, pp. 259-264 Synthetic sapphire, pp. 270-263 Synthetic emerald

Further reading:

If interested in the subject one should read the GIA and GA journals regularly for new developments. Useful books are:

Gems Made by Man, Nassau, Kurt, 1980, Chilton Books, Radnor, Pa.

Gemstone Enhancement, Nassau, Kurt, 1984, Butterworths, London.

Identifying Man-made Gems, O'Donoghue, Michael, 1983, NAG Press, London.

(This last has some inaccuracies and badly written passages but still contains useful information when read carefully. It has very nice inclusion photographs).

Final Reading assignments:

Readings in Gem Testing:

Amber, tortoiseshell, coral, jet, ivory, pp 375-383, Pearls, pp 384-402, The identification of diamond, pp 215-241 (review), quartz, chalcedony, opal pp 311-325, Gems by Webster, please read sections on pearls and gemstones of organic origin.

Gem Testing Aquamarine and alexandrite, pp 276-283, topaz and other yellow stones, pp 293-300, jade and jade-like minerals, pp 350-359, turquoise and lapis lazuli, pp 360-365.