



ESBORNE

JOE WOLF. SC. NY

JEWELLER AND HOROLOGICAL REVIEW.

D.F. FOPKINSON, EDITOR & PROPRIETOR.

Staatliche Uhrmacherschule

IV 1926



WATERBURY CLOCK CO.,

MANUFACTURERS OF

CLOCKS,

Novelties and Materials,

No. 10 CORTLANDT ST., N. Y.

— AND —

No. 63 WASHINGTON ST., CHICAGO.

Factories, **WATERBURY, CONN.**

M. BAILEY, Treasurer.



SNOWDEN.

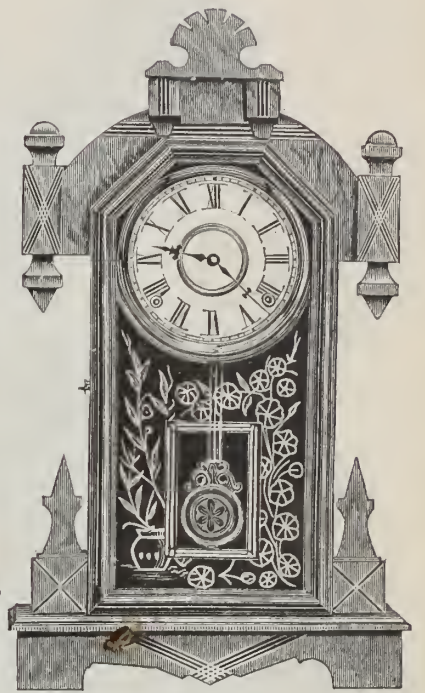

BARNET.



REGULATOR No. 4.

THE ANSONIA CLOCK CO.

HANGING CLOCKS AND MANTEL CLOCKS

OF EVERY DESCRIPTION.

A LARGE AND COMPLETE STOCK OF

Tower Clocks } **HANGING AND STANDING** } Street Clocks
REGULATORS
 AT LOW PRICES.

CHICAGO,
64 Washington St.

NEW YORK,
11 to 19 Cliff St.

LONDON,
128 Minories.

W. L. GILBERT CLOCK CO.,

GEORGE B. OWEN, General Manager.



LEBANON.—Walnut.
8 Day Strike.
Height 20½ inches. 6 inch Dial.

Salesrooms:

No. 6 Murray St., N. Y.
54 & 56 Madison St., Chicago.

Factories:

WINSTED,
Conn.

MANUFACTURERS OF

Walnut, Veneered and Other Clocks

IMPORTERS OF

Marble and Cuckoo Clocks.



ENID.—Walnut.
One Day Strike.
Height, 21½ inches. 6 inch Dial.

Catalogue and Price List Furnished upon application.

Grout's Excelsior Louis XIV.

WATCH SIGN,

Manufactured only by the

Excelsior Sign Co.,

CHICAGO.

Finished with the Best

XX GOLD LEAF,

AND

WARRANTED

To Stand in

Any Climate.



Handsome,
Cheap
AND
Durable.

SIZES AND PRICES.

12 Inch.....	\$6 00	24 Inch.....	\$13 50
14 ".....	7 50	26 ".....	16 00
16 ".....	9 50	28 ".....	18 50
18 ".....	10 50	30 ".....	19 50
22 ".....	11 75	36 ".....	27 00

A Full Line of these Signs now on hand and for Sale by

A. I. HALL & SON,

SAN FRANCISCO, CAL.

GROUT'S EXCELSIOR CARVED IRON OCTAGON SPECTACLE SIGN

Carved in the Most Beautiful Manner and Finished with Best XX Gold Leaf.

Everyone



Warranted.

SIZES

And PRICES

18 Inches, Glass Panels.....	\$2 50	48 Inches, Glass Panels.....	\$9 00
24 " " " ".....	4 00	60 " " " ".....	13 00
36 " " " ".....	6 75	EXCELSIOR SIGN CO., CHICAGO.	

GROUT'S EXCELSIOR IRON NOSE GLASS SIGN,

Gilded with the

Best XX Gold Leaf.

EXCELSIOR SIGN CO.,

GLASS PANELS.

CHICAGO.

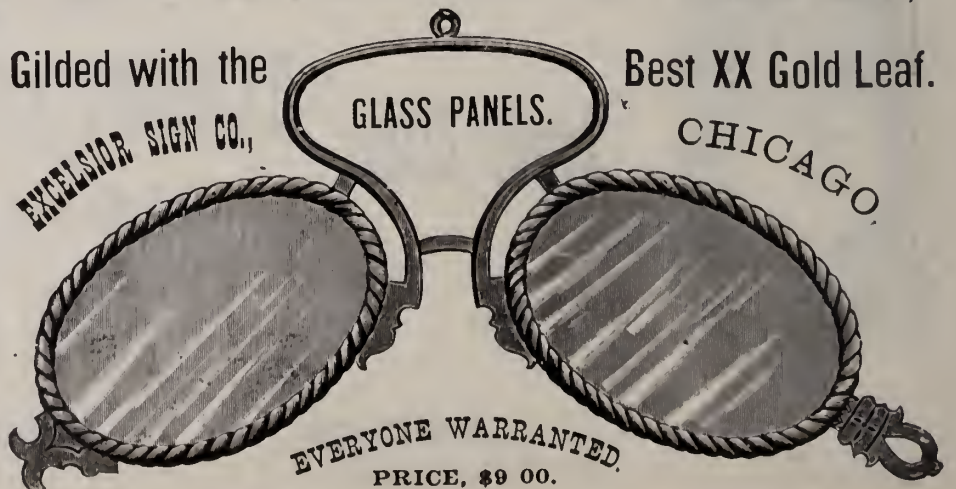

EVERYONE WARRANTED.
PRICE, \$9 00.

"THE SARATOGA."—Patented.



— MADE BY —

ROGERS & BROTHER,

690 BROADWAY,

NEW YORK.

WORKS, WATERBURY, CONN.

SIMONS, BRO. & CO.

MANUFACTURERS.



CHAIN.



Fine Jewelry.

ILLUSTRATED CATALOGUE

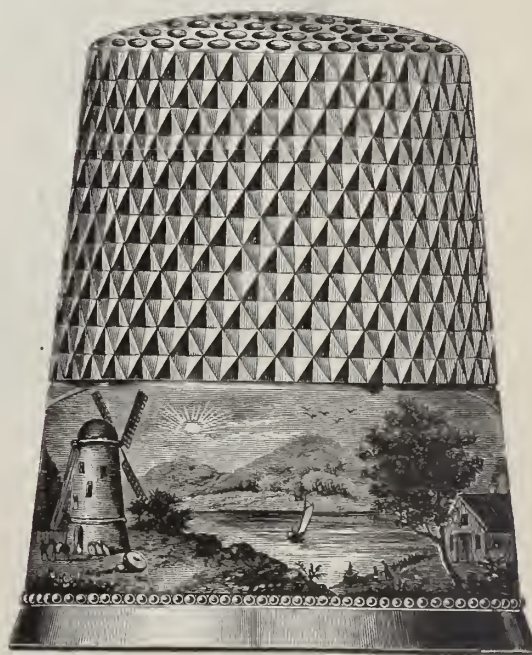

611 and 613 SANSON STREET, PHILADELPHIA, OR NEAREST JOBBER.

LOUIS STRASBURGER & CO.

DIRECT IMPORTERS OF

WATCHES AND DIAMONDS,

WE MAKE EVERY KIND
OF WATCH IN
OUR OWN
FACTORY.

WE GET THE ROUGH
DIRECT AND CUT
OUR OWN
GOODS.

No. 15 MAIDEN LANE,

→ NEW YORK ←

Rue Leopold Robert,
CHAUX-DE-FONDS.

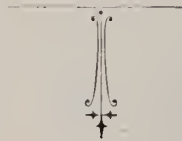

Boulevard Haussman, 30,
PARIS.

Superior Silver Plated Ware,

MANUFACTURED BY THE

MIDDLETOWN



PLATE CO.

MIDDLETOWN, CONNECTICUT.



Hammered Gilt Cup and Slop, \$34.00.



Chased Gilt Slop and Cup, \$30.00.

OFFICES.

*Middletown, Conn.,
120 Sutter Street, San Francisco, Cal.*

*13 John Street, New York,
101 & 103 State Street, Chicago, Illinois.*

Illustrated Catalogues and Photograph Albums sent to responsible Dealers.

DAVID F. CONOVER & CO.

(SUCCESSORS TO WM. B. WARNE & Co.)

Manufacturers and Wholesale Dealers in

WATCHES and JEWELRY.

Wholesale Agents For

Rogers & Brother's Flat and Hollow Ware



Celluloid Eye-Glasses.

And Sole Agents for the

Patent Railroad Train Watch Chains, Nickel.

WHOLESALE AGENTS FOR

T. A. WILLSON & CO.'S Optical Goods.

Would invite attention to the following new grades of Steel Spectacles lately introduced in the market.

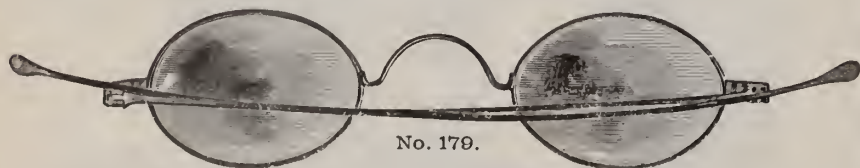

No. 179.

They are Steel, Full Tempered. Parts Interchangeable. Joints so constructed that wear is compensated for. Temple will not work loose and fall down as in old style joints. Nose-piece on No 155 reinforced where it joins eye, giving extra strength with neatness.

PRIZE MEDALS AT ALL EXHIBITIONS WHERE EXHIBITED.

Patented July 31, 1877.

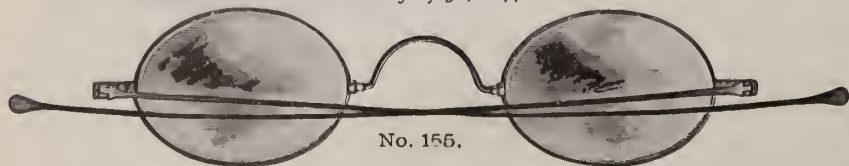

No. 155.

A SPECTACLE TEMPLE THAT WILL NOT WEAR LOOSE.

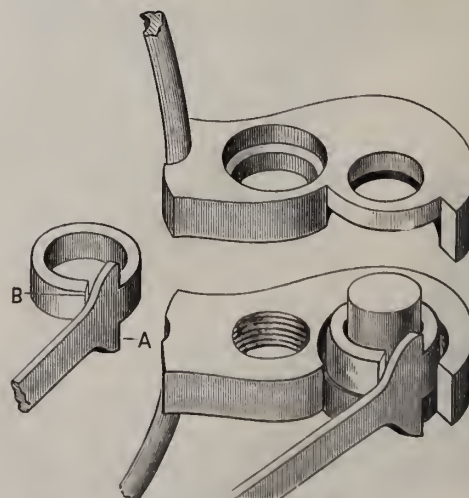

Patented May 13th, 1879. Re-issued June 8th, 1880.

- A.—Stop for Temple, preventing Strain on Joint.
- B.—Compensating eye, for taking up wear of joint. The eye of Temple is smaller than Stubb Steel Joint Pin on which it works, and is left open at B, exerting a Spring Tension on Pin.

American Watch Wholesale Salesroom:
Southeast Cor. Chestnut and Seventh Sts., First Floor,

PHILADELPHIA.

DAVID F. CONOVER,
C FRANK WILLIAMS
B. EDGAR RIGHTER.

OPPENHEIMER BROS. & VEITH, WATCHES, DIAMONDS, JEWELRY.

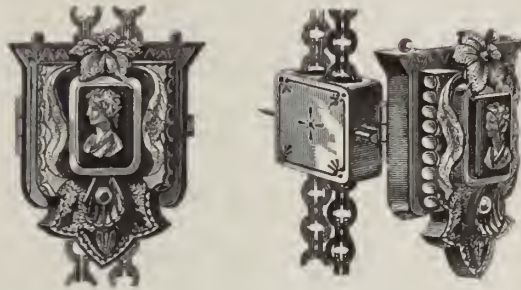

We are the Manufacturers and Patentees of the Combination Slide, Pendant and Locket, and the Combination Necklace, Lace Pin and Pendant.



We can furnish quite a variety of Styles, and are prepared to fill all Orders at once.

35 MAIDEN LANE, NEW YORK.

JOSEPH FAHYS & CO.,
 MANUFACTURERS OF
 WATCH CASES,
 38 MAIDEN LANE,

78 Monroe Street, Chicago.

NEW YORK.

Attention is directed to the increased facilities introduced in our Factories for the manufacture of Watch Cases, and the superior class of goods we are now making. It is not too much to say that we are now producing the largest and most complete line of Silver Watch Cases in the country, and that for style, quality, workmanship and finish are not excelled by any other makers.



All cases of our manufacture are stamped with a fac-simile of this Trade Mark.

These goods are offered at a much lower price than any other cases sold in this market.

New styles and designs constantly appearing.

A Full Line of Cases always in Stock.

JOSEPH FAHYS & CO.,
 38 MAIDEN LANE, N. Y.

FOR SALE BY ALL THE LEADING JOBBERS IN THE COUNTRY.

— THE —

BROOKLYN WATCH CASE CO.



EAGLE CASE.

In order to meet an imperative and growing demand in the Trade for a reliable grade of Low Karat Cases, this Company, seven years ago, was induced to place upon the market their since Celebrated **EAGLE CASES**, which are made of full 8-k. gold in all their parts, joints and bearings, the backs and caps free from solder, saving that which holds the joints. Since their introduction, these cases have achieved a wide spread reputation for the reliable and standard quality maintained in their manufacture. It has been demonstrated that the wearing qualities of the **EAGLE CASES** are unexcelled by any 12-k. case in the market, while their color is permanent and the appearance equal to that of the best cases made of this grade. The 8-k. **EAGLE CASES** will stand the severest acid test and will not tarnish when exposed in the show case or worn in the pocket.

All these goods are Stamped in the Cap with the Trade Mark of the Company,

— B. W. C. Co. —

and are guaranteed to be of the uniform standard designated.

A LARGE AND WELL ASSORTED STOCK OF 18-K., 14-K. AND EAGLE CASES IN THE LATEST AND MOST ARTISTIC DESIGNS, KEPT CONSTANTLY ON HAND.

— For Sale by all the Principal Jobbers. —



1380

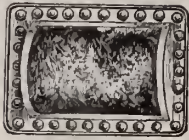

1162



1687



93



1476



0027



864

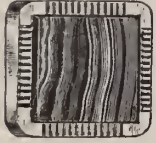

1206

THE

ACME LEVER BUTTON



OPEN.



OPEN.



OPEN.



CLOSED.



CLOSED.



CLOSED.



1479



0041



1234



0024



1420



1369



1239

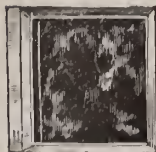

1321



1235



1340



017



93



02

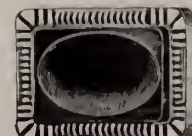

1182



634



1257

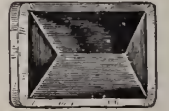

1582



0025

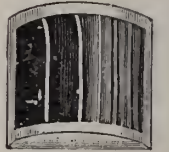

1003



020C



869



1437



1269

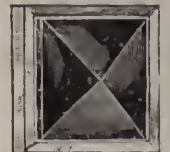

1502

Always was, is now, ever shall be
THE MOST CONVENIENT,
STRONG, RELIABLE and PERFECT SLEEVE BUTTON MADE

It Overcomes
ALL TROUBLE WITH STIFF CUFFS.

ASK YOUR JEWELER FOR THE
ACME LEVER SLEEVE AND COLLAR BUTTON,
AND TAKE NO OTHER.

For Sale by all Jobbers of Jewelry.

TAYLOR & BROTHER,
676 BROADWAY, NEW YORK.
IMPORTERS OF
Diamonds and other Precious Stones,
Clocks, Bronzes and Fancy Goods,
AND
MANUFACTURERS OF DIAMOND JEWELRY.

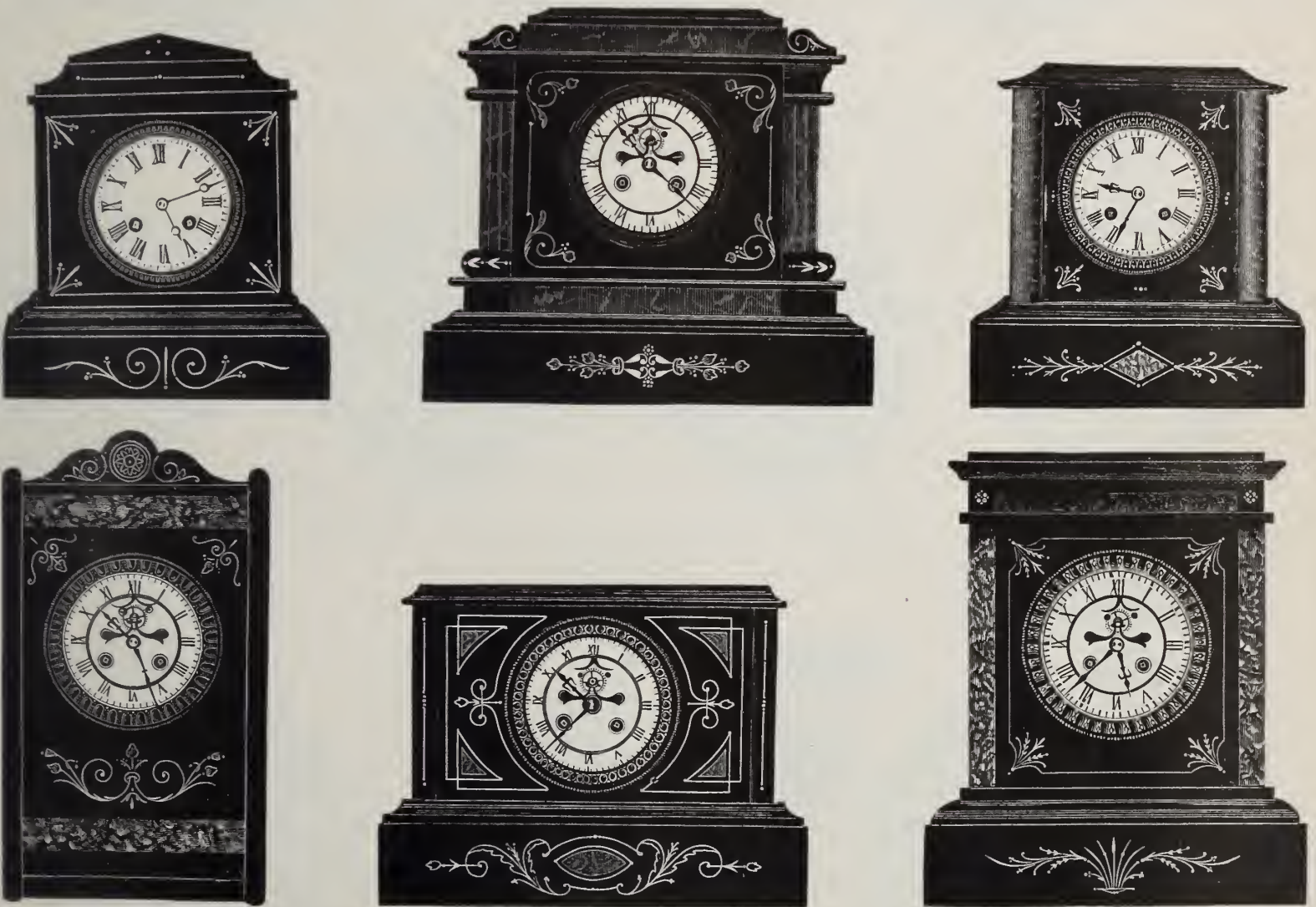

*Especial attention is directed to our Recent Invoices of FRENCH CLOCKS,
Sold at EXTREMELY LOW PRICES.*

ORIGINAL PACKAGES OF DIAMONDS CONSTANTLY ARRIVING.

CAUTION.

Dealers will observe the fact that all Cases of our manufacture have our Name and Trade Mark stamped upon them, and that any Case, offered as a Dueber Case, and not having our Name and Trade Mark so stamped, is not a genuine Dueber Case, and we do not hold ourselves responsible for either its manufacture or quality.

Carefully examine all Stamps and Marks in Cases offered as Dueber Cases, compare them with the Dueber Trade Marks as given below, and a great deal of annoyance and imposition will be avoided.

REGISTERED TRADE MARKS FOR ALL DUEBER CASES.



Trade Mark for 18-K. Gold Cases.

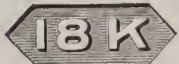

Trade Mark for 14-K. Gold Cases.

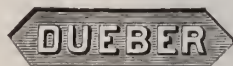

Trade Mark for 10-K. Gold Cases.

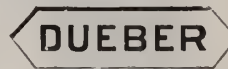

Trade Mark for all Silver Cases.



We use but Three Qualities of Gold—10-K., 14-K., 18-K.;—use no Trade Mark or Stamp but our own; and guarantee Fineness and Workmanship in every particular.

The Dueber Watch Case Mfg. Co.

CHICAGO.

4 Tribune Building.

CINCINNATI.

P. O. Box 13321.

NEW YORK.

20 Bryant Building.

THE BEST, THE DUEBER WATCH CASE.



381869



381878



381817



381880



381859



381877



381870



381816



381874



381879

THE BEST, THE DUEBER WATCH CASE.

IMPROVED CROWN FILLED CASE.

THE BEST FOR THE LEAST MONEY

The gold contained in the Crown Cases which are now being turned out under our supervision is fully equal to that of any Filled Case on the market.

This fact can be attested to the satisfaction of any dealer who will go to the trouble of having one of these Cases assayed with one of corresponding size and style of any other make.

The United States Mint at Philadelphia will make a complete assay for the sum of one dollar each, and we will return a New Case to the dealer in place of the one of our make destroyed, upon receipt of the Assay Certificates and the gold contained in the Crown Case assayed.

SOLID GOLD JOINTS,
SOLID GOLD PLUGS.
GOLD THE NATURAL COLOR.
ABSOLUTELY NO GILDING.



Raised Gold Ornamentation.



Raised Gold Ornamentation.

SOLD ONLY BY THE JOBBING TRADE.

H. MUHR'S SONS, PHILADELPHIA.

NEW YORK OFFICE, 1½ Maiden Lane.

CHICAGO OFFICE, 137 State Street.

CHARLES GLATZ,

MANUFACTURER OF

GOLD & SILVER WATCH CASES

Formerly 10 MAIDEN LANE,
NOW,
N. W. Cor. Nassau & Liberty Sts.
Half Block from Maiden Lane.



BRANCH OFFICE:
100-104 STATE ST.,
Jewelers' Exchange,
CHICAGO, ILL.
S. GOLDSMITH, Manager.

A SPECIALTY OF FULL WARRANTED 8 KARAT GOLD CASES,

Made in a Larger Variety than any other house, and Workmanship fully equal to the best in the Market.

JOBBER IN ALL AMERICAN MOVEMENTS.

We Call the Attention of the Trade to the Line of LOUIS XIV. Cases, in Gold and Silver, which we have Constantly on Hand.

N. W. COR. NASSAU and LIBERTY STREETS, Bryant Building, N. Y. CITY.

EXCLUSIVELY FOR THE JOBBING TRADE.

SIMPSON, HALL, MILLER & CO.,**WALLINGFORD, CONN.**

MANUFACTURERS OF

ARTISTIC & USEFUL HOLLOW WARE,⇒* **ELECTRO PLATED UPON FINE HARD WHITE METAL.** *⇒

Spoons, Forks, etc., plated upon the Finest Nickel Silver in **Extra Double, Triple, and Sectional Plates.** Full lines of over **Forty Staple and Fancy Pieces** in each Pattern in Geneva, St. James, Countess, Windsor, Oval Thread, etc. Made under the supervision, and quality guaranteed and controlled by Wm. Rogers, formerly of Hartford and Meriden. (Wm. Rogers, Sr., died 1873).

WM. ROGERS, Wallingford, Conn.

No connection with any concern in Waterbury, Meriden or Hartford using name of Rogers in any form.

Store and Stock of Goods for Delivery in N. Y. and Vicinity,

No. 36 East Fourteenth Street, Union Square.

Philadelphia, 506 Commerce St.—San Francisco, Cal., 530 Market St.

Montreal, Canada.—Baltimore, 6 German St.

JOBBERS IN CINCINNATI, CHICAGO, ST. LOUIS, Etc.**BROWN & BROTHERS,****Finest Silver Plated Flat Ware,****SPRING TEMPERED SHANK. NEW AND CHOICE PATTERNS.****"FLORAL."**

We guarantee all our goods to be made of full quality 18 per cent. Nickel Silver, and weight of plate to be as indicated on the labels.

GOODS PACKED ONE DOZEN IN EACH BOX.

Factories, Waterbury, Conn.

Salesroom, 80 & 82 Chambers Street, N. Y.

THE DERBY SILVER COMPANY,

Birmingham, Conn.,

▷ **BEST** ✦ **MAKERS** ✦ **OF** ✦ **THE** ✦
QUADRUPLE ◁

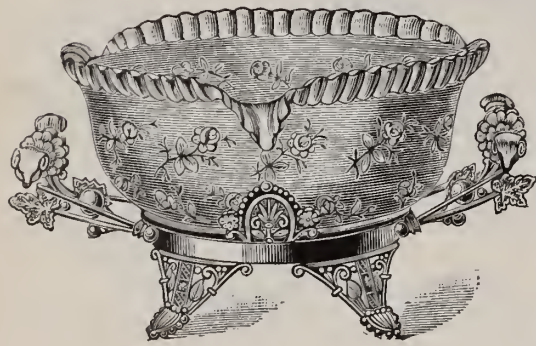

Illustrated Catalogues sent to dealers upon application.

COX & SEDGWICK,

26 John Street, N. Y.

MAKERS OF

BLACK ONYX BEAD

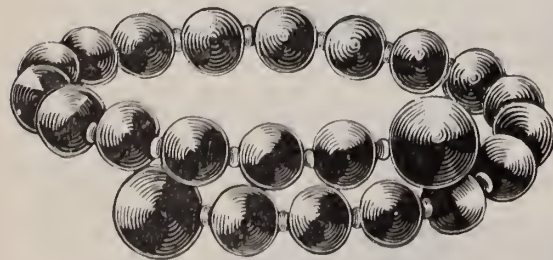
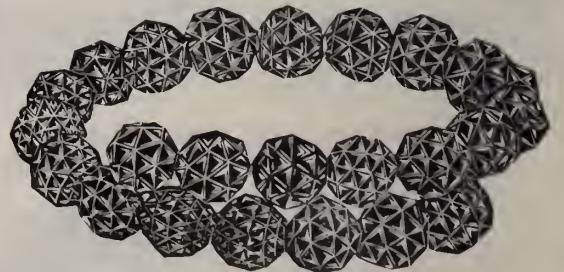
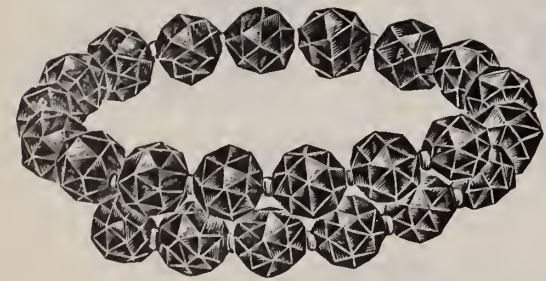

BRACELETS

WITH AND WITHOUT

GOLD RINGS BETWEEN EACH BEAD,

ALSO MAKERS OF

Rich Gold and Onyx

JEWELRY.

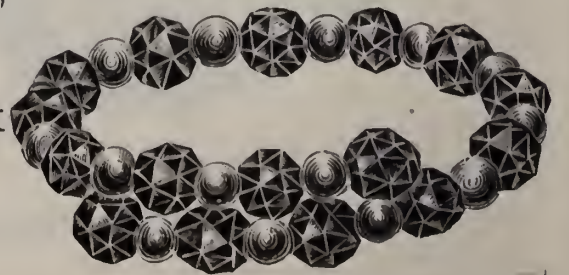
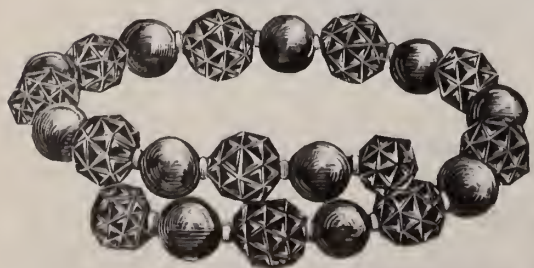



CRESCENT FILLED CASES.



The special attention of the Trade is called to our new line of 18 Size Stem Winding Gold Filled Cases made under Goe's Patent.

INTERCHANGEABLE,

to fit all 18 Size Stem Winding American Movements.

All Gold Filled Cases made by this company have Solid Gold Bows, Joints, Plugs and Thumb Catches, are unequalled in Shape and Color, and are guaranteed by special certificate to wear 20 years.

Order of your Jobber the

"CRESCENT" CASE,

And save carrying two lines of cases.

CHICAGO WATCH CASE CO.,

Cor. Michigan Ave. and Madison St.,

CHICAGO, ILLS.



J. T. SCOTT.

S. C. SCOTT.

J. T. SCOTT, JR.

ESTABLISHED 1847.

J. T. SCOTT & CO.,
7 MAIDEN LANE, N. Y.

Importers of Watches and Wholesale Dealers in all grades of American Movements and Cases, Jewelry, Chains, Diamonds, &c.

ALSO IMPORTERS OF THE CELEBRATED
TRIUMPH-ROSKOPF WATCH.

WITH INTERCHANGEABLE
AND ADJUSTABLE
ESCAPEMENT.

Cased in Superior Nickel, Open
Face, Stem Wind and Set.

ALSO THE OLD RELIABLE
ROSKOPF WATCH,

FOR SALE BY ALL THE LEADING JOBBERS.

All Orders Committed to our Care will receive
Prompt and Careful Attention.

We have additional Facilities for doing our Jobbing; being done on the premises will receive our Personal Supervision. ESTIMATES GIVEN ON SPECIAL WORK.

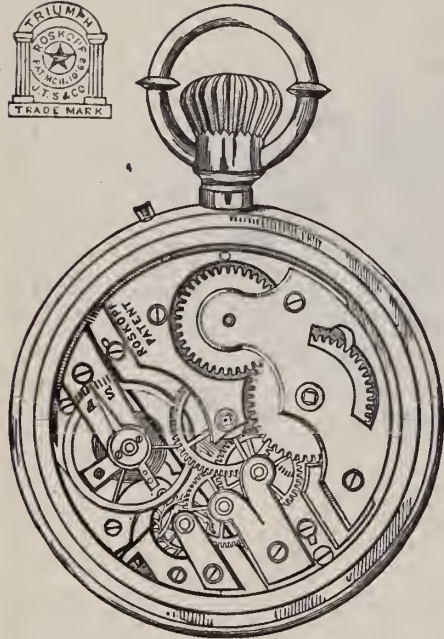

MATHEY BROS. & MATHEZ,
NO. 16 MAIDEN LANE.

IMPORTERS OF ALL GRADES OF

Plain and Complicated Watches and Movements

SOLE AGENTS FOR THE WELL-KNOWN

H. L. MATILE

Fine Watches of Astronomical Precision.



REPEATERS.



CHRONOGRAPHS.

In order to facilitate the handling of our Stem-Winding Movements, we have adopted a standard of sizes to fit American Cases. Of these we have a complete line from the medium grade to the highest class goods of fine adjustment and precision. As all our Movements, complicated and plain, are perfectly uniform in quality according to their respective grades, we can furnish material for any parts that may be required, with the positive assurance of accurate interchangeability.

An Extensive Line of all Grades of

CHRONOGRAPHS,
SPLIT SECONDS AND REPEATERS.
WATCHES DEMAGNETIZED.



Manufactory, 47, 49 & 51 Franklin Street, Newark, N. J.

MILLER BROS.,

No. 7 MAIDEN LANE, NEW YORK,

» IMPORTERS OF DIAMONDS »

AND

Manufacturers of Fine Jewelry.

INITIAL GOODS A SPECIALTY.

All goods exclusively of our own manufacture, many of which are protected by MECHANICAL and DESIGN PATENTS.

CROSS & BEQUELIN,

21 MAIDEN LANE, N. Y.

P. O. BOX No. 531.

MANUFACTURERS OF THE CENTENNIAL

» CHRONOGRAPH »

THE BEST AND CHEAPEST HORSE TIMER

AND THE

Most Accurate Time Keeper in the World for the Money.

IN GOLD AND SILVER CASES.

CHEAP AND RELIABLE.

See Cut. THE EXACT SIZE.



WHOLESALE DEALERS IN ALL GRADES OF

AMERICAN AND SWISS WATCHES, JEWELRY, MATERIALS, ETC.

SOLE AGENTS IN NEW YORK FOR THE SALE OF THE ENGLE ENGRAVING MACHINE.

WM. SMITH & CO.,

MANUFACTURERS OF

**GOLD and SILVER
Chains & Jewelry,**

Also a Large Line of SILVER RINGS.

OFFICE :

No. 25 Maiden Lane, New York.

MANUFACTORY—No 61 PECK STREET, PROVIDENCE, R. I.

W. & S. BLACKINTON,

MANUFACTURERS OF

ONLY

FINE ROLLED PLATE CHAINS,

Necklaces, Polished and Roman, of Latest Gold Designs. Also a Complete Line of Gents' and Ladies' Locketts and Pendants.

In consequence of the first-class reputation our goods have obtained, unscrupulous dealers have been selling goods of an inferior quality, represented as our manufacture. In order to protect ourselves, as well as dealers, all goods of our manufacture will hereafter bear this

TRADE MARK. **W&S B** ★ TRADE MARK.*These Goods are for sale by all Wholesale Dealers.*

ESTABLISHED 1873.

CHAS. P. HEROLD,

916 CHESTNUT STREET,

PHILADELPHIA,

(SECOND FLOOR).

Manufacturer of

DIAMOND JEWELRY.

18 K.

DIAMOND**MOUNTINGS****A SPECIALTY.**

And Exclusively of my own Designs.

ESTABLISHED 1833.

FOR THE FALL TRADE.

E. IRA RICHARDS & CO.,

MANUFACTURERS (Exclusively) OF

FINE ROLLED PLATED JEWELRY.

The Largest and Choicest Stock in the Country.

SPECIALTY FOR THE COMING FALL,

BAND & BANGLE BRACELETS & Extra Quality ROLLED PLATED CHAINS.These Vest Chains are produced to meet the demand for a **ROLLED PLATED CHAIN** that will wear for years.
*Each Chain bears the initial letters of our firm.***No. 200 BROADWAY, NEW YORK.
2d STORY, FRONT.**

GOODS SENT ON SELECTION TO RESPONSIBLE PARTIES.

HASKELL & MUEGGE,**SOLE AGENTS FOR PACIFIC COAST,
208 Kearney Street, SAN FRANCISCO, CAL.****CHESTER MANCHESTER & CO.,**

MANUFACTURERS OF

Gold & Silver Chains,**No. 13 HANOVER STREET,****PROVIDENCE, R. I.**Waltham, Elgin, Illinois,
Hampden, E. Howard & Co.
and Special Movements.**392 WASHINGTON ST.,
BOSTON.**

P. O. Box 5259.

Watches, Jewelry,
Gold Chains, Gold,
Filled and Silver Cases,
Spectacles, Eye - Glasses,
Gold Head Canes, and Rogers &
Bro.'s Flat Ware.

Price List of Movements and Cases

Sent on Receipt of Business Card.

D. C. PERCIVAL & CO.,
**WHOLESALE
DEALERS.**

LOUIS A. SCHERR & CO.

Importers and Wholesale Dealers in

Watches, Jewelry,

WATCH MATERIALS, TOOLS, GLASSES, &c.

Spectacles, Silk Guards, &c.

Wholesale Agents for American Watches.

**No. 726 CHESTNUT STREET
PHILADELPHIA.**

AGENTS FOR THE WHITCOMB LATHE

AGENTS FOR W. F. NYE'S WATCH AND CLOCK OILS.

TO THE TRADE.

Your attention is called to the Improved Awalt Patent Watch Regulator, Style B. It is made of Nickel, Index and all combined, with Nut C and Screw B made of Fine Steel, to fit all full plate watches, by removing the Index and using the same screw holes and screws on the watch.

Style D Regulators have been improved in shape and finish, and fit

both full plate and bridge watches, are made in Gilt and Nickel, with Nut C and Screw B of Fine Steel. Try them, and it will surprise you to find how much they will aid in making a watch realize you a nice profit.

JOHN A. AWALT, Manufacturer,

ALSO JOBBER IN

WATCHES, CLOCKS, JEWELRY, Etc.,

177 Vine Street, CINCINNATI, OHIO.

Watchmakers who have no Lathe cannot apply

Abbott's Patent Stem-Winding Devices

to Watches. They should either buy a Lathe or send their Watches to

HENRY ABBOTT,

No. 7 MAIDEN LANE, NEW YORK,

MANUFACTURER OF

Abbott's Patent Stem-Winding Devices

FOR WATCHES.

ABOUT TEN THOUSAND NOW IN USE.

ALSO FOR SALE BY JOBBERS.

YALE CLOCK CO.

NEW HAVEN, CONN., U. S. A.



NOVELTIES

IN

CLOCKS.

A. I. HALL & SON,

General Agents,

528 & 530 Market St.

San Francisco, Cal.

52 Maiden Lane,

New York.

JOHN W. STEELE,

MANUFACTURER OF

FINE GOLD JEWELRY,

—AND—

BRAINERD'S

PATENT

LOCKETS

Patented June 17, 1874.

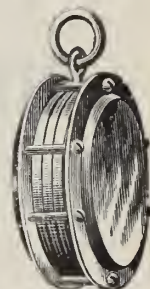

No. 9 Maiden Lane, NEW YORK.

MATERIALS
AND
OPTICAL GOODS.

Agents for the

LANCASTER, PA., WATCHES.

A. FRIEDENTHAL & CO.

Manufacturing Jewelers,

AND IMPORTERS OF

WATCHES,

43 MAIDEN LANE, NEW YORK.

COLBY & JOHNSON,

Manufacturers and Jobbers,
17 MAIDEN LANE, NEW YORK.

WATCH CASES,
FINE JEWELRY,
AMERICAN WATCHES.

SOLE MANUFACTURERS OF
CELLULOID WATCH CASES,
MOUNTED IN
GOLD, SILVER OR NICKEL.

DAY & CLARK,

MAKERS OF

FINE ROMAN GOODS,

HAVE REMOVED TO

10 MAIDEN LANE,

FACTORY, NEWARK, N. J.

NEW YORK.

ESTABLISHED 1835.

WELCH & MILLER,

**JEWELRY
Case Manufacturers,**

Of Morocco, Velvet, Russia, Brocade and Plush.

SHOW CASE TRAYS OF ALL DESCRIPTIONS.

LOCK RING TRAYS FOR DIAMOND RINGS.

Agents for Jewelers' Cotton and Twine.

All Goods of our Own Manufacture, and a Large Stock
Always on Hand.

169 BROADWAY, NEW YORK.

SUSSFELD, LORSCH & NORDLINGER,

IMPORTERS OF

Optical & Mathematical Instruments,

Watchmakers' Tools, Materials, Etc.

SPECIALTIES:

BARDOU & SONS' Universal Opera Glasses. U. S. Army and Navy Glasses.
Rifle Range Telescopes, Etc., Etc.

LA REINE Opera and Marine Glasses.

CROWN Spectacles and Eye-Glasses.

PARADIS MAINSPRINGS.

PARAGON TOOLS.

13 MAIDEN LANE, NEW YORK.

16 Rue D'Enghien, PARIS.

FRANK O. LODWICK.

CHAS. A. NOLTING.

LODWICK & NOLTING, WHOLESALE JEWELERS,

JOBBER OF

Gold, Silver & Nickel
WATCHES,

Gold and Roll Plate

JEWELRY

MOVEMENTS

AND

Watch Cases,

SPECTACLES,

Clocks and Silverware.

Positively will all Orders, In-
quiries and Repairs receive im-
mediate and reliable attention.

CINCINNATI.



ESTABLISHED 1850.

JOHN T. MAURAN,

MANUFACTURER OF

FINE ROLLED PLATE GOODS

15 MAIDEN LANE, NEW YORK.

SPECIALTIES FOR THE FALL.

FULL LINE OF

STONE LACE PINS IN RUBY AND SAPPHIRE DOUBLETS,
GARNETS AND FOILED WHITE STONES,

Jet Lace Pins, Sets and Ear Knobs, Solid Gold White Stone Knobs.

ALSO

Full Line of Coral and Wire Sets, Lace Pins, Knobs, &c.

These Goods, which are so well and favorably known to the Trade, bear this

TRADE MARK



as well as the same being stamped on the cards.

PEARCE & HOAGLAND,

MANUFACTURERS OF

Gold Pens, Pencils, Pen Holders, Tooth Picks,
OF EVERY DESCRIPTION.



CLOSED

SOLE MANUFACTURERS OF THE

QUILL RESERVE TOOTH PICK,



OPEN



CLOSED

The Holder of this Case is made in various styles in Gold Plate, Celluloid, Ivory, etc., while the Pick is of ordinary Goose Quill, and can be easily replaced by a new one, at any time, from the Reserve in the end of the Holder, and is the only Pick that will not injure the Teeth.

FOR SALE BY ALL JOBBERS.

Office and Factory, 29 Point Street, Providence, R. I.

Webster's Silver Solution,

PREPARED BY

E. G. WEBSTER & BROTHER,

(Established 1859.)

Manufacturers of Quadruple

Electro Silver Plated Ware

14 MAIDEN LANE, N. Y.,

Expressly for Cleaning Silver and Silver
Plated Ware.

Jewelers will find this a valuable adjunct for
cleaning their stock, and a reliable article to
recommend to their customers.

Guaranteed entirely free from Cyanide, Acid,
Grit, or anything detrimental to the Finest
Wares.

Packed in Boxes containing 2 Doz. Bottles.

Price. \$1.25 per Doz., NET.



R. WALLACE & SONS M'FG Co.,

MANUFACTURERS OF

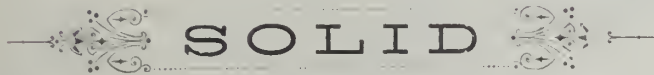

SILVERWARE,

GUARANTEED $\frac{925}{1000}$ FINE.

WALLINGFORD, CONN.

WOOD & HUGHES,
STERLING

SILVERWARE MANUFACTURERS,

New York Agents for the Derby Silver Co.'s

Fine Quadruple Plated Ware,

No. 16 John Street, N. Y.

206 Kearney Street, San Francisco, Cal.

HASKELL & MUEGGE, Agents.

H. P. HILDRETH,

MANUFACTURER OF

SOLID GOLD RINGS,

PLAIN AND ORNAMENTAL,

10 JOHN STREET, NEW YORK.

Factory, 1305 ATLANTIC AVENUE, Brooklyn.

Best Quality of Goods at Lowest Cash Prices.

Send for Price List, as I have no Agents.

J. B. & S. M. KNOWLES,

MANUFACTURERS OF

Sterling Silver Ware,

No. 20 MAIDEN LANE,

NEW YORK.

FACTORY, PROVIDENCE, R. I.



GORHAM & CO.
SILVERSMITHS

NEW YORK CHICAGO SAN FRANCISCO
Union Square, 170 State St. 120 Sutter St.

Alfred H. Smith & Co.,

DIAMONDS,

33 Abchurch Lane,
London.

125 State Street,
Chicago.

182 Broadway,
New York.

❖ To Dealers Visiting Europe. ❖

We take pleasure in directing the attention of the Trade to our London Office as above, where we hope to see those who may visit Europe this season.

Any letters addressed to our care (33 Abchurch Lane, London,) will be retained or forwarded promptly to Continental points, in accordance with instructions left with us.

Alfred H. Smith & Co.

182 Broadway, N. Y.

May 15th, 1853.

THE NEW HAVEN CLOCK CO.

MANUFACTURERS,
IMPORTERS,
DEALERS.

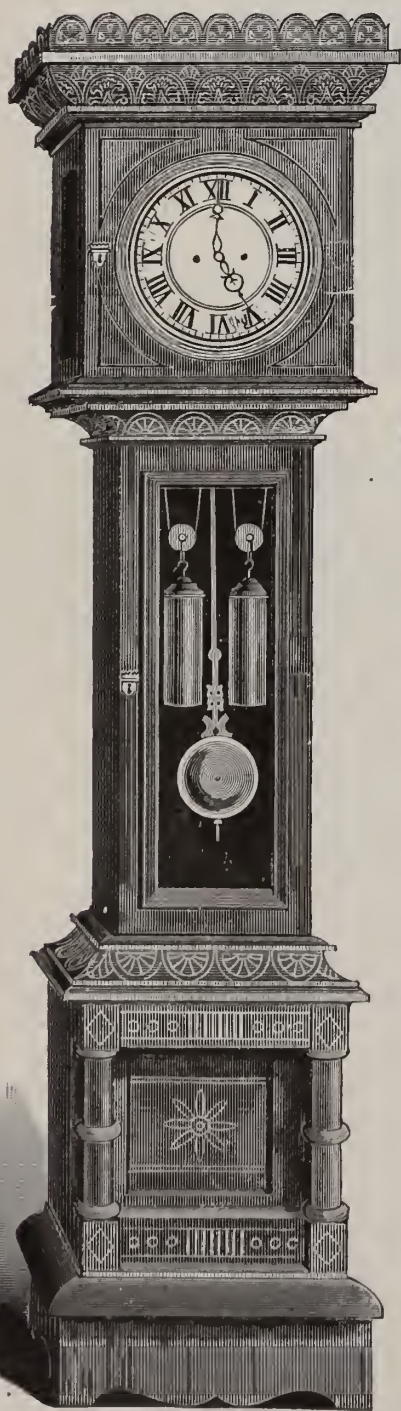

CARVED WOOD,
English Regulator.

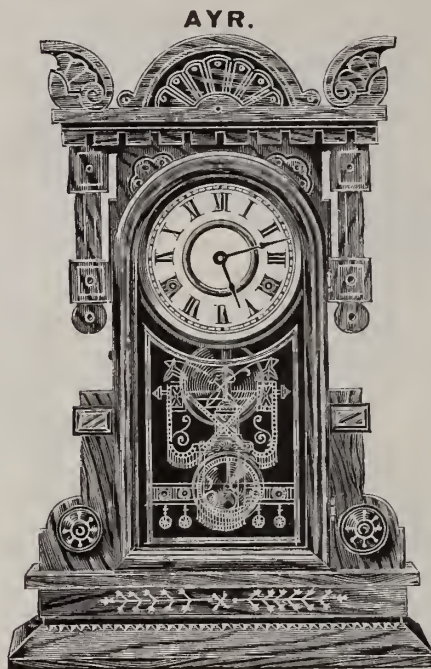

A.Y.R.

FACTORIES.
NEW HAVEN, CONN.

GENERAL OFFICE AND SALESROOMS.
16 & 18 PARK PLACE,
New York.

WESTERN OFFICE AND SALESROOMS.
31 WASHINGTON ST.,
Chicago, Ill.

EUROPEAN OFFICE AND SALESROOMS.
16 PITT STREET,
Cleveland Sq., Liverpool,
England.

WE have again introduced many Popular Improvements as well as New Designs, combining the most desirable effects and thorough construction with moderate prices. Among these will be found our new 8-day Pendulum Movements, striking hours and half hours on Gong Bells with Cathedral tones. By this means we bring within the reach of all the best selling points of the most expensive imported clocks.

We also call attention to the fact that we sell these Cathedral Gongs either separately or fitted in any of our Visible Pendulum Clocks at a moderate extra charge.

We now have the greatest facilities for

IMPORTING all kinds of **French Clocks** and **BRONZES,**

and are pleased to ask our patrons to give this fact their careful attention and allow us, by a trial, to show them that we can offer a better and cheaper assortment than any other house.

Send for Complete Catalogue of All Styles.



No. 1035.

MARBLE,
Imported.

REED & BARTON,

MANUFACTURERS OF

Fine

Silver

Plated

Ware,

SALESROOM:

686 Broadway, N. Y.

Factories, Taunton, Mass.



WATER SET, No. 38.



CARTER, SLOAN & CO.,
MANUFACTURERS OF ALL KINDS OF

GOLD JEWELRY,

No. 15 MAIDEN LANE,
NEW YORK.

A. CARTER, JR.
A. K. SLOAN,

C. E. HASTINGS,
G. R. HOWE.

BALDWIN, SEXTON & PETERSON,

IMPORTERS OF

DIAMONDS and all PRECIOUS STONES,

MANUFACTURERS OF

DIAMOND AND RICH JEWELRY.

Cutters and Polishers of

DIAMONDS

692 & 694 BROADWAY, NEW YORK.

120 SUTTER ST., SAN FRANCISCO, CAL.

J. F. Chatellier,
Manufacturing Jeweler,

692 & 694 Broadway,

New York.



TRADE

MARK.

STERLING.

Whiting Manufacturing Co.

SILVERSMITHS,

BROADWAY & FOURTH ST., N. Y.

ESTABLISHED 1837.

TAYLOR & BROTHER,

Old House READ, TAYLOR & CO.,

Importers of Diamonds and Pearls,

—)AND(—

MANUFACTURERS OF DIAMOND JEWELRY,

21 Holborn Viaduct, 676 Broadway,

LONDON.

NEW YORK.

ESTABLISHED 1813.

THOMAS G. BROWN & SONS,
Newark, N. J., & 5 Bond Street, New York.

MANUFACTURERS OF

ARTISTIC JEWELRY
FOR PRESENTATION,

Including Prizes for ROWING, RIFLE SHOOTING, ARCHERY and
all ATHLETIC SPORTS.

COLLEGE SOCIETY PINS AND CLASS RINGS, ALSO BADGES FOR MILITARY
AND CIVIC BODIES IN ALL METALS.

Employing able Designers, and having all work, both in Designing and Manu-
facturing, done in our own factory, we can submit, for the inspection of those
interested, entirely original designs, appropriate in style, and not to be seen else-
where.

Estimates and Designs will be sent to Reputable Dealers when desired.

ESTABLISHED 1834.

G. & S. OWEN & CO.,

—MAKERS OF—

FINE ROMAN JEWELRY,

—BOX and GLASS PINS,

—AND—

Black Onyx and Pearl Goods,

OF EVERY DESCRIPTION.

All Goods sold by us are exclusively of our own manufacture and are warranted 14 K. Fine, and stamped as such when possible.

No. 3 Maiden Lane, New York.

W. H. SHEAFER & Co.,

MAKERS OF

BRACELETS,

BANGLES,

LACE PINS,

SCARF PINS, ETC.

No. 15 JOHN STREET,

NEW YORK.

RIPLEY HOWLAND M'F'G CO.,

MAKERS OF

FINE JEWELRY,

SPECIALTIES:

DIAMOND MOUNTINGS, with Platinum Tips.
ENGRAVED RINGS, STONE RINGS,

OFFICE, 17 MAIDEN LANE,
NEW YORK.

FACTORY, 383 WASHINGTON ST.,
BOSTON, MASS.

SAXTON, SMITH & CO.,

Manufacturers of

GOLD CHAIN

SOLE AGENTS

FOR THE

NEW PATENTED CHAIN BAR,

Containing a Detachable Pencil.

FACTORY:
183 EDDY ST.,
PROVIDENCE, R. I.

OFFICE:
14 JOHN ST.,
NEW YORK.

A. J. HEDGES & CO.,

MANUFACTURING

JEWELERS,

No. 6 MAIDEN LANE,

NEW YORK.

Factory, No. 90 MECHANIC ST.,

NEWARK, N. J.

A. W. FABER'S

CELEBRATED

Gold Pens & Pencil Cases.
TOOTH PICKS AND NOVELTIES.

Manufactured by

EBERHARD FABER,
Nos. 718 and 720 Broadway,
NEW YORK.

FOWLER BROS.,

MANUFACTURERS OF

JET & ONYX JEWELRY.

Offer a large and varied stock of desirable goods of original designs, especially manufactured for the coming Fall Trade.

These goods are elegant in design, beautifully finished, and must be seen to be appreciated.



Pat. March 27, 1883.

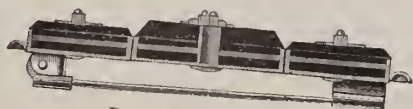

Pat. March 27, 1883.

Are carried

by all the leading

Jobbing Houses

throughout the country.

MOORE & HORTON,

No. 11 Maiden Lane,

NEW YORK.

JEWELERS.

SPECIALTIES:

Stone Cameo, Onyx, Amethyst, Topaz and Pearl Rings.

Studs, Collar and Sleeve Buttons.

Also our fac-simile of Fine African Diamonds, with Foile Back, Mounted in Rings, Studs, Pins, Ear Rings, Scarf Pins, Lace Pins, &c.

JOHN F. SAUNDERS,
Of the late firm of Buckenham, Cole & Saunders.

CHAUNCEY IVES.

SAUNDERS & IVES,

IMPORTERS OF

DIAMONDS, PEARLS,

And Other Precious Stones.

Manufacturers of Diamond Mountings.

No. 26 MAIDEN LANE, NEW YORK.

A Large Stock of FINE DIAMONDS, Mounted and Unmounted, kept constantly on hand.

Goods sent on approval to any part of the country on receipt of satisfactory reference. All our goods ARE INSURED by us while in transit.

DORRANCE, EDGE & CO.,

Makers of the Celebrated

Woven Fabric Gold Chain,

And Patentees of the

Embossed Inlaid Jewelry.

The Latest and Most Effective Styles of Decoration Introduced.

15 JOHN ST., NEW YORK.

FACTORY, 46 GREENE ST., NEWARK, N. J.

G. W. PRATT & Co.,

Manufacturers and Dealers in

Watches and Jewelry

OF EVERY DESCRIPTION.

ELGIN AND ILLINOIS MOVEMENTS
IN ALL GRADES.

Gold, Silver and Ladd Patent Cases.

No. 14 JOHN STREET, NEW YORK.

C. ROSSWOG & SON,

MANUFACTURERS OF

Rich Jewelry and Diamond Goods,

NOS. 5 & 7 MAIDEN LANE,

—NEW YORK—

CHURCHILL, LEWIS & CO.,
Manufacturing Jewelers,
 692 BROADWAY, NEW YORK.

S. W. HALE & CO.,
 SUCCESSORS TO HALE & MULFORD,
 MANUFACTURERS OF
FINE JEWELRY

692 BROADWAY, N. Y.
 SETH W. HALE. WILLIAM A. LEE. WILLIS H. HOWES.

JULIEN CALLET & CO.,
 IMPORTERS OF
WATCHES
 OF EVERY GRADE,
 No. 1 MAIDEN LANE,
 — NEW YORK. —

LEROY W. FAIRCHILD,
GOLD PENS.

NOVELTIES IN
 CHARM
 PENCILS, TOOTH-PICKS,
 Whistles, etc.

SALESROOM,
 18 JOHN ST., NEW YORK.

SMITH & KNAPP,
 WHOLESALE DEALERS IN
 AMERICAN AND SWISS WATCHES,
DIAMONDS.
 Gold & Plated Jewelry & Gold Chain,
No. 182 BROADWAY,
 COR. OF JOHN STREET, NEW YORK.

OFFICE:
 14 JOHN STREET, N. Y.

E. STITES' SONS.

FACTORY:
 NEWARK, NEW JERSEY.

MANUFACTURERS OF Everything in **BLACK ONYX JEWELRY** PLAIN, and {Ornamented with Pearls and Diamonds.

Our manufacturing facilities have been for the past ten years devoted exclusively to the production of fine Black Onyx Jewelry. We carry in stock the largest variety of articles made in our specialty, well made, finely finished, uniformly 14 karats, at medium and low prices.

WOGLOM & MILLER,
Office & Factory, 32 & 34 JOHN STREET,
NEW YORK.

W. M. GREENE & CO.
GOLDSMITHS
MANUFACTURERS OF

RICH SETS IN TAPER WIRE CORAL

Factory 95 PINE ST. Providence, R. I. Stone Cameo Amethyst Coral Cameo Engraved & Enamel Brooches Sleeve Buttons Studs & Crosses EAR & C. DROPS New York Office 192 BROADWAY.

WM C GREENE B. W. GREENE GEO. D. BRIGGS

KETCHAM & McDOUGALL,
Bryant Building, (55 Liberty St.) New York.
MANUFACTURERS OF **COLD AND SILVER THIMBLES.**



THE AUTOMATIC EYE-GLASS HOLDER,
It Reels Up Cord Itself.
A—Shows position of Glasses with cord Reeled up.



ESTABLISHED 1859.

STURDY BROS. & CO.
MANUFACTURERS OF

Fine Rolled Plate Jewelry,
GRADUATED WIRE CORAL GOODS,
STERLING SILVER JEWELRY.

Bangles, Sleeve Buttons, Cuff Buttons, Baby Pins, Sets in Stone, Cameo, Enamel, Chased, and Polished, Drops and Knobs, Bar Pins, Children's Sets, Locketts, Studs, Charms, Etc.

Only Wholesale Dealers' Trade Solicited. **ATTLEBORO, MASS.**

Flexible Bracelets,
Diamond Mountings,
Strung Pearl Work,
Repairing,

Flexible Braided
Bracelets,
White Stone Goods,
Strung Pearl Repa'ng

Thos. M. Guilbert & Co.,
SUCCESSORS TO CARROW, DUBOSQ & Co.
908 Chestnut Street, Philadelphia, Pa.



This cut represents the exact size and style of the **Jewelers' League Badge,** as adopted by the League at the last annual meeting. Badges can be had by sending \$3.00 to JOHN FRICK & CO., 23 MAIDEN LANE, (P. O. Box 2070), NEW YORK.

The circle is blue enamel, and the League number can be added, if required, on a small piece of gold affixed to the bottom of the badge.

ORDERS FOR MEDALS, BADGES, ETC., SOLICITED.

B. A. BALLOU & CO.,
61 Peck St., Providence, R. I.
MANUFACTURERS OF **GOLD JEWELRY.**



We call special attention to our **PATENT FASTENING FOR EAR RINGS,** which is free from the objections raised to ordinary ear wire or screw fastenings. They present a very neat and attractive appearance, are perfectly secure, and much more convenient than ordinary ear wires which always annoy the wearer by catching the hair, veil, or lace about the neck. These Goods are for Sale by all Wholesale Dealers.

Gold Studs, Small Chains for Eye-Glasses, Bracelets, Etc.
a Specialty.

McCarty & Hurlburt,
WHOLESALE DEALERS IN
WALTHAM, ELGIN & ILLINOIS
WATCHES.
MANUFACTURERS OF
Jewelry, Gold Spectacles, Silver Thimbles, &c
131 North Second St.,
PHILADELPHIA, Pa.

CLOCKS

ESTABLISHED 1853.



AMERICAN
AND
FRENCH CLOCKS
AND
BRONZES.

B. J. COOKE'S SONS,
137 N. 3d Street, PHILADELPHIA.
Catalogues and Price Lists furnished to the Trade only, on application.

BOOZ & CO.,

MANUFACTURERS OF FINE GOLD Watch Cases AND PLAIN GOLD RINGS.



Jobbers in American Movements.

DIAMONDS.

108 South Eighth St., (2d Story) Philadelphia.

Samples of our goods sent on approval when satisfactory reference is furnished.
Old Gold and Silver Bought or Exchanged.

PARTICULAR ATTENTION PAID TO REPAIRING.



The ORIGINAL GOLD CROWN FILLED RINGS.

For the past thirteen years we have manufactured as a specialty, the well known "CROWN GOLD FILLED RING," with the high standing of which the trade is already perfectly familiar. In consequence of the above fact, and in justice to ourselves, we feel it a duty to make the announcement to the trade that there are now being offered in the market several other makes of filled rings, each of which has a CROWN in some way connected with its STAMP.

We Manufacture for the Jobbing Trade Only.

McCALL & NEWMAN,
625 Arch Street, Philadelphia

SAMUEL LAWSON,

No. 18 JOHN STREET,

Manufacturer of Black Onyx Goods,

CONSISTING OF

- Breast Pins,
- Ear Rings,
- Lace Pins,
- Ear Studs,
- Bracelets,
- Scarf Pins,
- Buttons,
- Medallions,
- Studs,
- Collar Buttons,
- Vest Chains,
- Guards.

BLANCARD & OBERLANDER,
MANUFACTURERS OF
Settings and Galleries,
IN THE LATEST STYLE.

BALL WIRE, Solid and Hollow, in 14 and 10 karat, also single Hollow Balls without joint, of all sizes, in Silver and 14 karat alloy and upwards.
Made in any thickness of Gold to order.

Platinum, Platinum-Lined and Fancy Settings a Specialty.

PLATINUM SCRAPS EXCHANGED OR PURCHASED.

36 & 38 JOHN STREET, N. Y.

PLEASE SEND FOR SAMPLE CARD.

Mansfield Watch Tool Co.

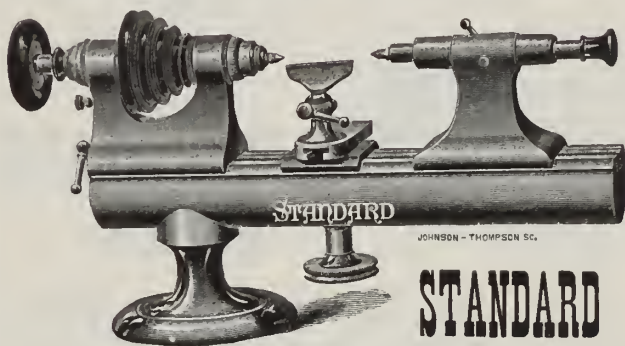

Mansfield MASS.,
Makers of the

STANDARD LATHE,

Chucks, and Watchmakers' FINE Tools of all kinds.

SEND FOR NEW PRICE LIST.

REMOVAL.

HENRY CARTER,
DIAMONDS, ❖

❖ WATCHES, ❖

❖ JEWELRY.

TO BRYANT BUILDING,

Cor. Nassau and Liberty Streets,

NEW YORK.

CELEBRATED H. C.

★ BRAND ROLLED GOLD CHAINS

William T. Smith,
ASSAYER, REFINER AND SWEEP SMELTER.

ESTABLISHED IN 1855.

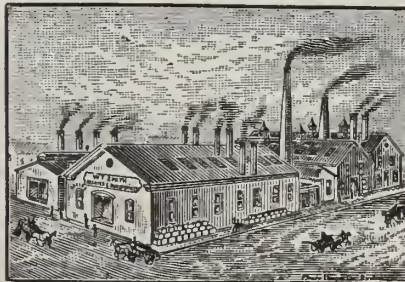

Cor. Blackstone & Hawkins Sts

PROVIDENCE, R. I.

BOSTON, Mar. 15, 1883.

To whom it may Concern :

Mr. Wm. T. Smith, of Providence, R. I., has done refining for us for years, as well as his father before him, and we take pleasure in saying we have never received anything but satisfaction in our dealings with him.

RIPLEY HOWLAND MFG. CO., R. Crosby, Treasurer.

JEWELRY AND WATCHES.

ROGERS' SILVERWARE.

MATERIALS AND TOOLS.

S. F. MYERS & CO.,
Manufacturers and Jobbers,
179 BROADWAY, NEW YORK.

ILLUSTRATED CATALOGUE FOR THE TRADE.

W. E. WHITE & CO.,
Manufacturing Jewelers.

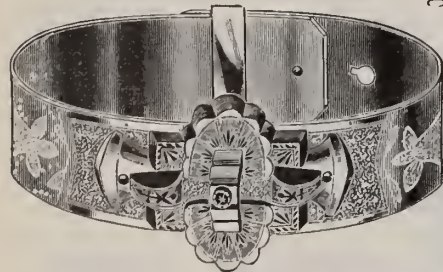

**FINE
ROLLED PLATE
GOODS.**

B.acelets---Engraved, Enamelled, Flat Band and Buckle.

Ladies' Goods---Lace Pins, Drops, Crosses, Sets, Collar Buttons, &c.

FOR SALE BY JOBBERS ONLY.

New York Office, 25 MALDEN LANE, Corner Nassau Street.

Factory 54 Page St., Providence, R. I.

Represented by S. A. BALDWIN.

ALEX. MILNE,
Manufacturer of Stem-Winding Watch Crowns



ALSO GOLD AND SILVER THIMBLES.



19 Ward Street, NEWARK, N. J.

PFORZHEIMER, KELLER & CO.

MANUFACTURERS OF

FINE JEWELRY,

AND DEALERS IN

Diamonds, American and Swiss Watches,

No. 24 JOHN STREET,

NEW YORK.

I. PFORZHEIMER,
D. KELLER.

(I. B. ETTINGER,
H. J. FINK.

Henry Fera,

Importer of Rough & Polished Diamonds,

DIAMOND CUTTING AND POLISHING WORKS:

21, 23, 25 Looijersgracht.



4 & 6 JOHN ST.,

Amsterdam, Holland.

New York.

Diamonds repaired and matched by some of the finest workmen in the world.

Diamond Bort and Powder always on hand.

ESTABLISHED 1830.

TRADE



MARK

PETER L. KRIDER,
MANUFACTURER OF

STERLING SILVERWARE

Medal and Diploma Awarded, &c. Striking Society Medals in Gold, Silver or Bronze a Specialty.

Artisan Hall, 618 Chestnut St., Philadelphia.



KING JAMES,
MARQUIS, } RINGS.
GLOVE, }

*Quality Guaranteed.
Prices Close.*

BARNET BROS. & POWELL,

—Manufacturers,—

Newark, N. J., & 15 JOHN ST., NEW YORK.

R. & K.'S PATENT GAS FURNACES FOR MELTING, PLATING, ENAMELING, ANNEALING, &c., &c.

Reichhelm & Koester,

Importers and Manufacturers of

Jewelers' Tools, Files, Materials, &c.,

Manufacturers of
Bristle Brushes of all kinds,
Cotton and Wool Buffs,
Felt Polishing Wheels,
Walrus Lea her Polishing
Wheels,
Jewelers' Satin Finish and
Scratch Brushes,
Brass & Steel Wire Brushes
Jewelers' Standard Saw
Frames,
Plain & Fancy Draw Plates,
Improved Jewelers' Ingots,
R. & K.'s Jewelers' Combi-
nation Gas Burners.

80 Nassau St.

NEW YORK.

Importers of
French, English & German
Tools and Files,
Piercing Saws,
Renard & Vautier Gravers,
Steel and Brass Wires,
Vienna and Ruby Draw
Plates,
Alloying Copper Wire,
Felt, Walrus Leather,
Vienna Lime, Tripoli,
&c., &c., &c.

JOSEPH STERN.

JACOB STERN.

SIMON STERN.

STERN & STERN,
Wholesale Dealers in
WATCHES & DIAMONDS

And Manufacturers of
GOLD JEWELRY,
6 MAIDEN LANE, NEW YORK.

AGENTS FOR THE CELEBRATED
MELVILLE & NEW BRIGHTON WATCHES.



Send for Illustrated Catalogue.

ESTABLISHED 1848.

GEO. W. DUBOIS.

F. N. NAUMAN.

GEO. W. DUBOIS & CO.,

IMPORTERS OF

Watches & Optical Goods.

ALL STYLES AND QUALITIES OF
SPECTACLES AND EYE-GLASSES.

LONGINES' WATCHES AND MOVEMENTS.

The Watches in Gold, Silver and Nickel Cases of New and Handsome Patterns. The Movements fit 18 size Waltham Stem Winding Hunting Cases.

36 MAIDEN LANE, NEW YORK.

Orders by Mail Receive Prompt Attention.

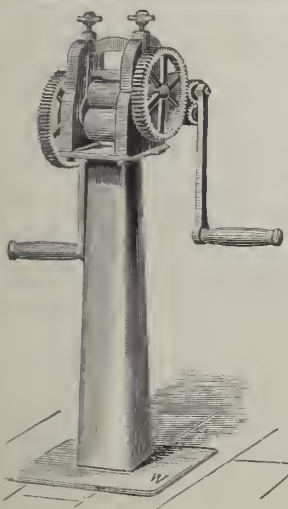

W. W. OLIVER,

MANUFACTURER OF

Hand and Power
Rolling Mills,

For Jewelers and Silversmiths.

The "Little Giant" Ring Bender

Hollow Spindle Lathes, Punching and Drop Presses, Polishing Heads, Dies, Metal Laps, Etc.

39 CLINTON STREET,
BUFFALO, NEW YORK.

Illustrated Price List mailed free upon application.

EXCELSIOR'S

PRACTICAL TREATISE ON THE
Balance Spring,

INCLUDING MAKING AND FITTING HAIR SPRINGS,
REGULATING, ETC.

Also containing the Adjustment of Watches and Chronometers for Isochronism,
Positions, Heat and Cold and Rate.

Price, \$3.50.

D. H. HOPKINSON,

42 Nassau St., New York.

BELMONTYLE OIL

Will Prevent Steel from Rusting.

PRICE, 25 CENTS PER BOTTLE.

FOR SALE BY ALL LEADING JOBBERS.

Send for Complete Circular, also Catalogue of Fine Watchmakers' Tools,

MANUFACTURED BY

J. G. HALL M'F'G CO.,
ROXBURY, VT.

SNYDER'S CHUCK,

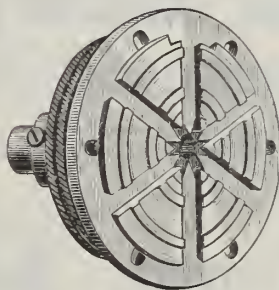

For Holding Bezels, Wheels, Barrels, Watch Plates and Drills.

Will hold any piece of a Watch, from a Jewel to the largest size Bezel.

PRICE, \$8.00.

Indispensable to Watchmakers and Watch Case Repairers. Will do a greater variety of work than any other Chuck made. They are self-centering and positively accurate.

FOR SALE BY MATERIAL DEALERS,

Who will furnish Testimonials and Circulars.

JAMES J. FISHER,

DEALER IN

WATCHMAKERS' and JEWELERS' MATERIALS,

Files, Tools, Silk Guards, Watch Glasses, Spectacles, Rolled Plate, Fire Gilt, Nickel and Silver Chain, Charms, &c.

No. 697 BROADWAY,
Corner Fourth Street, NEW YORK.

All kinds of Job Work for the Trade Promptly attended to.

The "Acme" French Clock Movement Support.
(Pat. Nov. 1st, 1881.)

This Support is adapted to the holding in position of any French Clock Movement while regulating or adjusting, and will be found very desirable on account of its simplicity of action and the small space it occupies. To be had of any respectable jobbing house, or sent, post paid, to any address, on receipt of 60 cents.



WHEELER, PARSONS & HAYES,

MANUFACTURERS OF

WATCH CASES, GOLD CHAINS & FINE JEWELRY

Importers of Diamonds and Manufacturers of Diamond Jewelry,

And Dealers in American and Swiss Watches,

No. 2 MAIDEN LANE, NEW YORK.

Established 1841.

Enos Richardson & Co.,

Manufacturers of Gold Jewelry and Chains,

23 Maiden Lane, New York.

Goods sent on approval to Dealers in any part of the U. S. upon receipt of order with satisfactory references.

San Francisco Office, 206 Kearny St.,

Hashell & Muegge, Agents,

Where a full line of our goods can always be found at Eastern Prices.

Established 1828.

JACOB BENNETT & SON,

Diamond Setters and Manufacturing Jewelers,

No. 923 CHESTNUT STREET, PHILADELPHIA.

WE MANUFACTURE AND MAKE A SPECIALTY OF
EVERY DESCRIPTION OF

DIAMOND MOUNTINGS,

SUPERIOR IN DESIGN AND WORKMANSHIP.



Dealers in

DIAMONDS

And all kinds of Precious Stones.

Of which we keep a Large Assortment Constantly on Hand.

Masonic Marks Society and School Badges, Made to Order Only. Designs and Estimates Furnished.

PARTICULAR ATTENTION GIVEN TO ALL KINDS OF JOBBING.

EDWIN A. THRALL,

1 MAIDEN LANE,

NEW YORK.

—o JOBBER IN o—

American Watches, Diamonds, Fine Jewelry, Etc.

AT LOW PRICES, AND FOR CASH ONLY.

I employ no Travelers, therefore can furnish select goods of the newest designs at the very lowest market price. Every Watch warranted to keep time when delivered. The new system introduced by the American Watch Co., of selling a complete watch, will be adopted. Agent for the new Mascot Bracelet, Patented. Orders filled immediately on receipt. Repairing and Adjusting Fine Watches and Chronometers for the Trade a Specialty.

A NEW PIN TONGUE VISEFOR JEWELERS and DEALERS  in JEWELERS' SUPPLIES.

This New Device for securely holding Pin Tongues while being fitted, will commend itself to every Practical Workman.

The joint of the tongue is placed in one of the graduated grooves and firmly secured by tightening the screw, enabling the workman to either file the joint to any required thickness, brooch the hole, shorten the pin or correct such defects as he may desire with ease and dispatch.

These tools are made of Hardened Steel, Nickel Plated, and is a useful and handy tool.

Price, \$1.25. For Sale to the Trade by

HENRY GINNEL & CO., Wholesale Agents,
31 Maiden Lane, NEW YORK.

A. J. WARNER & CO.,
WHOLESALE JEWELERS,

309 Nicollet Avenue, Minneapolis, Minn.

We carry a Large and Elegant Stock of Jewelry, Watches, Cases, Etc., Etc.

North-western Agents of the WATERBURY CLOCK CO., and carry a Complete Line of their Goods.

OUR TRADE IS EXCLUSIVELY WITH THE JEWELERS.

ESTABLISHED 1810.

VACHERON & CONSTANTIN,
WATCH MANUFACTURERS,
GENEVA, SWITZERLAND.

These celebrated Watches and Movements are adjusted to Heat, Cold and Position. Movements Fitting ready made Stem-winding, Open Face and Hunting Cases of Waltham and Elgin Sizes.

SOLE AGENT IN UNITED STATES AND CANADA,

CHAS. LEO ABRY,

P. O. BOX 611.

63 NASSAU STREET, NEW YORK.

→ † M. FOX & CO., † ←

Practical Lapidaries and Importers of

D I A M O N D S .

Rubies, Sapphires and Fancy Gems.

→ † PEARLS, † † TURQUOISE, † † INTAGLIOS, † † ONYX, † † AMETHYST, † † ETC. † ←

No. 1 MAIDEN LANE, NEW YORK.

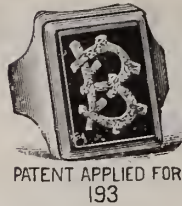

812

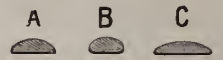

THE ABOVE CUTS ARE THREE DIFFERENT SHAPES IN THE SAME WEIGHT OF PLAIN RINGS. TO BE USED IN ORDERING.

J. B. BOWDEN & Co.,
MANUFACTURERS OF SOLID RINGS
OF EVERY DESCRIPTION.

No. 1 MAIDEN LANE, cor. Broadway, NEW YORK.

SINNOCK & SHERRILL,
SEAL & STONE RING MANUFACTURERS,

3 Maiden Lane, New York.

Factory, Goldsmith Hall, Maple Place,
Green Street, Newark.

CHICAGO OFFICE,
182 State Street.



Richly incrustated with Diamonds.
14 K. Fine.
Design of Shank Patented.



Sapphire and Diamond.
Heavily Carved Shank. 14 K. Fine.



Garnet and Whole Pearls.
14 K. Fine.



Raised Initial in Diamonds.
14 K. Fine.

THE NUMBER OF THOUSANDTHS FINE STAMPED IN EACH RING.

THEUERNER & CHURCH,
MANUFACTURERS OF FINE RINGS,

No. 9 MAIDEN LANE,

NEW YORK.

FACTORY, COR. MULBERRY & DURAND STS., NEWARK, N. J.

LEON JEANNE.

PAUL JEANNE

JEANNE BROTHERS

MANUFACTURERS OF

DIAMOND MOUNTINGS,

AND RICH JEWELRY.

No. 1 MAIDEN LANE, NEW YORK

Designs Furnished and Estimates Given.

JEANNE BROS PAT. DIAMOND SETTINGS.

A PLATINUM SETTING WITH A COLD SURFACE OUTSIDE

IN THIS WAY THE REFLECTION OF COLD THROUGH THE DIAMOND IS ENTIRELY AVOIDED.

PAT. AUG. 15TH 1882

WM. S. HEDGES & CO.,

IMPORTERS OF



COPYRIGHT SECURED. Entered according to Act of Congress in the year 1880, by WM. S. HEDGES & CO., in the Office of the Librarian of Congress, at Washington.

170 BROADWAY,

Corner Maiden Lane, New York.

CHOICE BRILLIANTS IN SINGLE STONES AND MATCHED PAIRS A SPECIALTY.

Fresh invoices of Goods in all Grades constantly arriving. Also choice parcels of exceptionally Fine Gems ESPECIALLY Selected for critical purchasers. A full line of Mounted Goods, Artistically Designed.

GOODS SENT ON APPROVAL.



NEW

CHRONOGRAPH

STOP WATCHES,



MADE TO

START, STOP AND FLY BACK,

With or Without Split Seconds,

MANUFACTURED BY THE

AMERICAN WATCH CO.,

WALTHAM, MASS.



By Patented Improvements in Construction, and considerable Diminution of the Parts required, as well as by the application of American Machinery, the AMERICAN WATCH CO. has so simplified the manufacture of Chronograph Watches as to greatly reduce their cost. They can now be obtained at prices which make them the MOST DESIRABLE timepieces for Sporting Purposes, AS WELL AS FOR GENERAL USE. Dealers can depend upon these goods giving satisfaction, as they will not require the constant repairs, nor subject the dealer to the annoyance experienced in most of the foreign watches of this class. In case of accidents, Duplicates of Broken Parts can be furnished by return mail. Cased complete in 16 Size Gold and Silver Open Face and Hunting Cases. (Open Face made to wind at figure XII).

SPECIAL NET PRICE LIST,

Issued for the TRADE ONLY, will be sent on application, which will not be regarded unless accompanied by Business Card.

ANNOUNCEMENT.

The New Price List for complete 3-4 plate, 8, 14 and 16-size Gold Watches, issued under date of February 1st, 1883, by the American Watch Co., of Waltham, is now ready for distribution. We will forward a copy upon application, accompanied by business card, from any regular dealer in watches.

Jobbers who wish copies sent to their customers will please notify us by sending the names and addresses of the same, but such customers must be regular Watch Dealers. We shall take special precaution in the distribution of this list, in order to keep it out of the hands of the general public, and we beg to request that the Trade will co-operate with us in this undertaking, it being entirely in their interests.

We also beg to call particular attention to the fact that the cases quoted in this list are entirely of our own manufacture, and that we are directly responsible for the quality of the same.

By 18 K. or 14 K. or 10 K. we mean 18 K. or 14 K. or 10 K. and not 16½ K. or 12 K. or 8 K. We offer you actual value for your money.

ROBBINS & APPLETON,

NEW YORK:

5 BOND STREET.

BOSTON, MASS.:

403 WASHINGTON STREET.

CHICAGO, ILL.:

102 STATE STREET.

LONDON, ENGLAND:

HOLBORN CIRCUS.

AUSTRALIA:

SYDNEY, NEW SOUTH WALES.



Randel, Barmore & Billings,

Importers of

Diamonds

and Manufacturers of

Diamond Jewelry.

*58 Nassau Street,
8 29 Maiden Lane,
New York.*

*1 St. Andrews Street,
Holborn Circus,
London, E. C.*



278D.
Patented.



389D.
Patented.



351D.



347R.



251.

SPECIAL LINE INITIAL RINGS, SEALS, ETC.

INCORUSTED-DIAMOND-PEARL-OR RUSTIC LETTERS.

DESIGNS PATENTED.

Illustrated Plate sent to Dealers upon request.

HENRY C. HASKELL,

MAKER OF FINE GOLD JEWELRY.

No. 12 John St., New York.

Goods sent on approval to any part of the country, upon receipt of satisfactory references.

House Established 1837,

Successor to J. A. ABRY.

CHARLES LEO ABRY,

Importer and Manufacturer of all Grades of

SWISS WATCHES,

And dealer in Elgin, Springfield, Ill., and Lancaster Movements.

Specialties in Gilt, Nickered and Nickel Stem-Winding Movements, Ladies' Sizes, to Fit Elgin Cases.

IMPORTER OF THE FOLLOWING WELL-KNOWN SWISS WATCHES:

Geo. Mayor, A. Ames Droz, Chas. Estine, F. Richard, Huguenin Nardin and Ernest Duval, as well as all kinds of Watches for the Jobbing Trade, including Nickered, Open-Face and Hunting Stem-Winders, Anchors and Cylinders, 16, 18 and 19 lines. Silver Key and Stem-Winders, Hunting and Open Face, all sizes and qualities, from low to highest grades. Silver and Nickel 13 and 14 line Watches for Chatelaines, Gold, Silver, Nickel & Rolled Plate Chatelaines of good styles & designs always in stock.

P. O. Box 611.

63 NASSAU STREET, NEW YORK.

Factory, Neuchatel, Switzerland.



COMET.

SOLE IMPORTER.

Fits 8 Size Elgin Cases.

JOHN A. RILEY & CO.,

MANUFACTURING JEWELERS,

NOS. 7 & 9 BOND STREET,

NEW YORK.

A. BERNHARDT & CO.
MANUFACTURERS OF
DIAMOND & FINE JEWELRY
ORNAMENTAL HAIRWORK

OFFICE & FACTORIES
3, 4 & 5 FLOOR,
P. O. BOX 1111.

MAIDEN LANE,
NEW YORK.

LUDWIG LEHMANN,

MANUFACTURER OF

JEWELERS' FINDINGS,

Paper Jewelry Boxes, Jewelers' Cards, Cotton of all Shades, a Rich Assortment of Cases in Plush, Velvet and Morocco.

Also Importer of the Celebrated Grass Bleached Tissue Paper, Mill 39.

Specialties:—Imitation Morocco Boxes and Cases, Plush and Satin Lined.

122 FULTON STREET, near Nassau, NEW YORK.

THE HOPKINS LATHE.

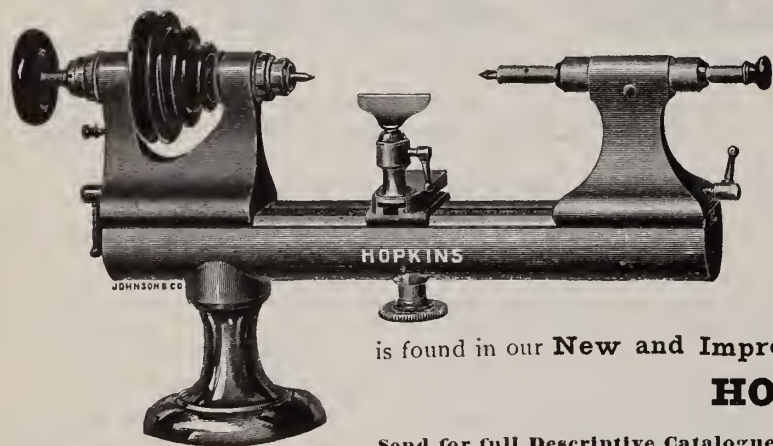

These Lathes are **Unsurpassed in Quality and Workmanship.**

In **Special Features of Practical Value**, peculiarly adapted to Watch Repairing, they excel all others. The attachments are made **interchangeable** in all the sizes.

The only absolute substitute for wax, in Watch Repairing,

is found in our **New and Improved Pivoting Chuck**, represented in the above sectional view.

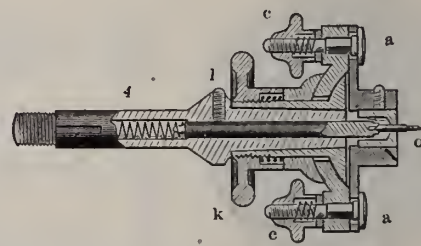

HOPKINS WATCH TOOL CO.,

WALTHAM, MASS.

Send for full Descriptive Catalogue.

S. KOHN & CO.,

43 MAIDEN LANE,

NEW YORK.

*Manufacturers of
Fine Morocco, Plush and
Velvet Boxes.*



*Trays and Silverware
Boxes of all Description
Made to Order.*

A Full Line of Boxes Constantly on Hand, and Samples sent on Selection.

ORDERS FROM THE JOBBING TRADE RESPECTFULLY SOLICITED.

R. & L. FRIEDLANDER,

IMPORTERS OF

Watchmakers' & Jewelers' Supplies, Optical Goods, Etc.

Sole Ag'ts for the G. & K. Polishing Lathe, Price \$10.50

65 & 67 NASSAU ST.,

Branch, 264 Bowery, Factory, 50 Bond St.,

NEW YORK.

This Cut represents the Latest Design in
Watch Glass Cases.

PRICE OF CASE	
With 9 Drawers,	\$9.00
" 11 "	10.00
" 13 "	11.00



N. H. WHITE,
 JOBBER IN
AMERICAN-WALTHAM WATCHES,
 EXCLUSIVELY.

Waltham make of gold and silver cases a Specialty. Ladd, Boss, and the Patent Screw Bezel Filled Cases to fit Waltham movements only

No. 11 MAIDEN LANE, NEW YORK.

I not only advertise that I have the Waltham Goods, but **have constantly on hand** the Largest Stock carried by any jobber in the trade. Gold Cases of all Weights and Styles. Memorandum Packages with pleasure to dealers furnishing satisfactory reference.

COMPLETE PRICE LIST TO THE TRADE.

ESTABLISHED 1859.

RINGS A SPECIALTY.

BRYANT & BENTLEY,

12 MAIDEN LANE,

Up-Stairs,

NEW YORK.

AMONG OUR LATEST PATTERNS OF FINE SOLID RINGS ARE



587



591



584



504



589



490

No. 587—Made in Topaz and Amethyst. No. 591—Cluster of Garnets, Doublets or Turquoise, with Pearls and Diamonds. No. 584—Cameo or Garnet with Pearls and Diamonds. No. 504—Misses' Turquoise Rings. Nos. 490 and 589—Represent two patterns only of our Engraved Band Rings.

We also continue to make a full line of our well known 16 K. HARD SOLDER RINGS.

Goods sent on approval to responsible parties.

L. A. CUPPIA,

Manufacturing Jeweler,

19 Union Square, N. Y.

SILVER CANE HEADS,

A Large and Comprehensive Assortment of New and Original Designs.

AND IMPORTER OF

SILVER FILIGREE JEWELRY

Embracing a Large and Varied Assortment of Popular Designs.

SILVER JEWELRY.

SILVER BRACELETS A SPECIALTY.

SELECTION PACKAGES SENT ON APPROVAL

HAMPDEN WATCHES.

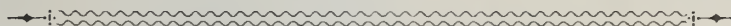

We respectfully offer to the Trade a line of Nameless goods, which will appear on our new lists of June 1st, 1883, at which time we shall be ready to furnish our new illustrated Material price lists to all of our customers who may desire them.

Hampden Watch Co.,

General Office and Factories, SPRINGFIELD, MASS.

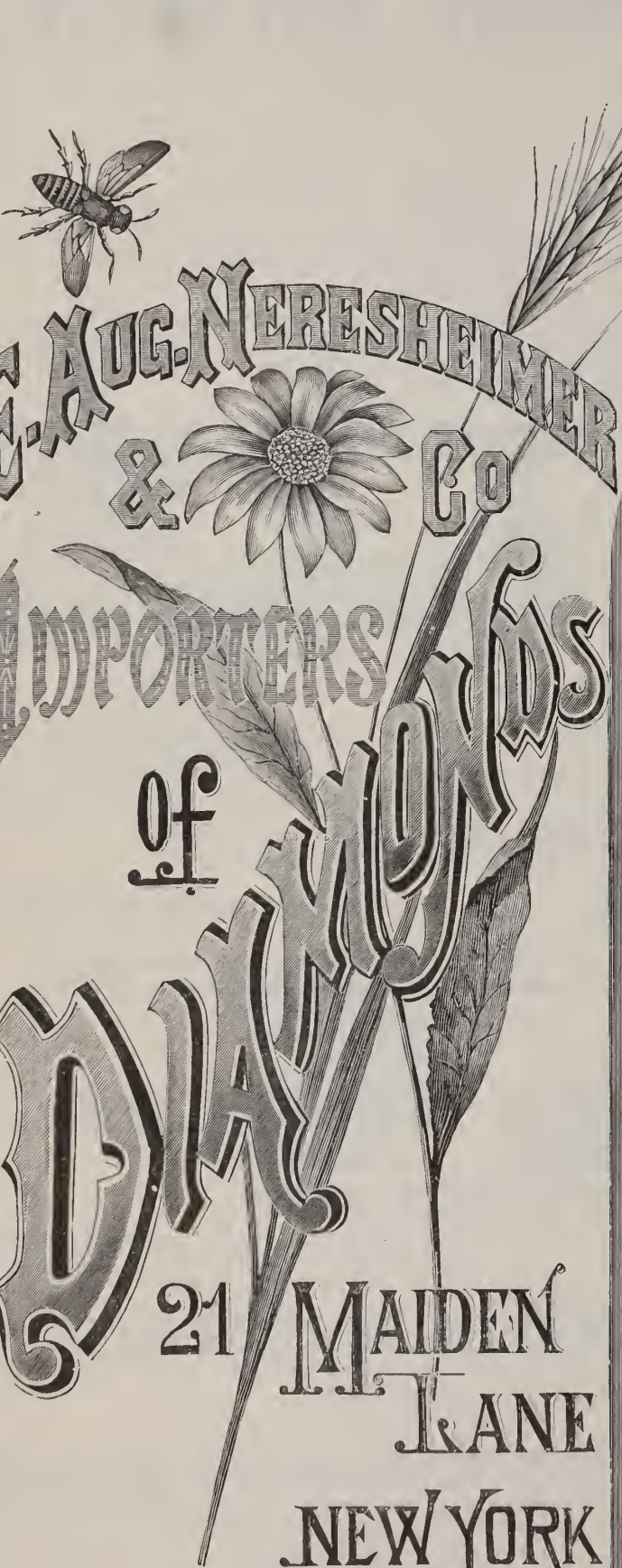

F. AUG. NERESHEIMER
 & Co
 IMPORTERS
 of
DIAMONDS
 21 MAIDEN
 LANE
 NEW YORK

NO 66 SARPHATI STRAAT
 AMSTERDAM HOLL.



Falkenau Oppenheimer & Co.
Importers of
Diamonds



40 Maiden Lane N. Y.

Post Office Box 3314.

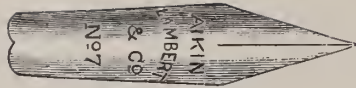

AIKIN, LAMBERT & CO.,

23 MAIDEN LANE, NEW YORK.

MANUFACTURERS OF

GOLD PENS, PENCIL CASES, HOLDERS, PENCILS, TOOTH PICKS

AND LATEST "NOVELTIES" IN PENCIL CHARMS.



"GRAVITY" PENCIL.

In addition to our Large Assortment of Gold Pen and Pencil Goods, we offer this season many *New* and *Novel* Patterns, all of our *Exclusive* Manufacture and Sale.



Our Line of Richly *Ornamented Engraved* Holders in all styles, suitable for Presentation purposes, show many Patterns *New* to the Trade.



New Styles of Pencil Charms in *Solid Gold*, *Silver* and *Rolled Plate*.



Our Line in Tooth Picks embraces the *Latest* Designs in *Solid Gold*, *Silver*, *Pearl*, *Celluloid* (*Fancy* and *Plain*) and *Plated*.



Goods Sent on **APPROVAL** when desired.

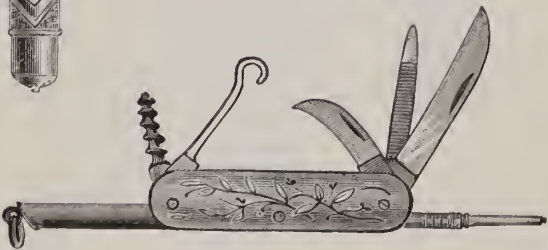

SEND FOR
Catalogue and Price List.



—:o ALSO IMPORTERS AND JOBBERS OF ALL GRADES OF o:—

WATCHES.

Including a Large Variety of *Desirable* Metal Cased Stem-Winders, and the *best* Low-Priced "Chronograph" Watch in the market.

Agents for *AGASSIZ* Movements fitting 8 and 16 Size Elgin Cases, and the *LONGINES* Movements fitting 18 Size Waltham Cases. Sole Agents for *PAUL BRETON* Celebrated Geneva Watches.

Jobbers of all kinds of *AMERICAN MOVEMENTS AND CASES*, including the Dueber and Keystone Silver Cases, and Boss' and Ladd's Filled Cases.

Manufacturers of *STONE RINGS*, all leading kinds, Band Rings, &c. Gold and Silver Thimbles, Plain, Chased, Octagon, &c. Bracelets, a large assortment in Gold and Plate. Gold and Plated Chains, Locketts, Seals, &c. A large variety of new and stylish Patterns in *GOLD* and *PLATED JEWELRY* are constantly being added to our stock. *Prompt attention to Orders and Repairs.*

JAS. C. AIKIN,
H. A. LAMBERT,
J. B. SHEA,
D. F. FOLEY.

Western Branch, 113 EAST MADISON STREET, CHICAGO, ILLS.

GEO. H. RICHARDS, JR.,

383 Washington Street, Boston, Mass., U. S. A.,

JOBBER

American Movements and Cases a Specialty.

WE GUARANTEE TO HAVE **ALL GRADES** IN STOCK.

MOVEMENTS.

WALTHAM.

SPRINGFIELD, ILLS.

HAMPDEN.

ELGIN.

HOWARD.

CASES.

❖GOLD❖

❖FILLED❖

❖SILVER❖

WALTHAM.

"BOSS."

WALTHAM.

DUEBER.

CROWN.

DUEBER.

BROOKLYN.

LADD.

FAHYS.

G. H. R., Jr.

KEYSTONE.

Watches, Jewelry and Silver Plated Ware. Rogers & Bro.'s Flat Ware.

HOLLOW AND FLAT WARE SOLD AT MANUFACTURERS' DISCOUNTS.

Our Stock is positively the Largest, Finest and Best Assorted of any Jobbing House in the Country. All Orders Promptly Executed.

Sole Agent for Gould's Patent Regulator and Elliott's Watch Oiler.

FOR SALE BY ALL JOBBERS AND MATERIAL DEALERS.

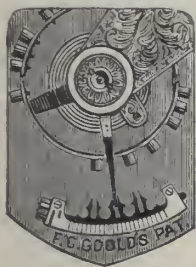

For 18 Size Movements, K. W. & S. W.

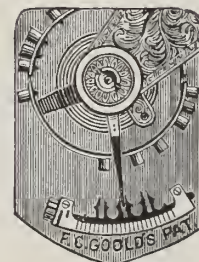

For 18 Size Movements, K. W. & S. W.

THE REGULATOR WILL BE IN THE MARKET JULY 1st, Price, \$1.25.

ELLIOTT'S AUTOMATIC WATCH OILER.

NEW THING. EVERY WATCHMAKER SHOULD POSSESS ONE.

THE GOODS ARE READY FOR DELIVERY, Price, \$1.00.

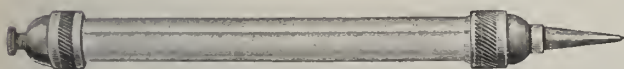

WATCH SIZE.

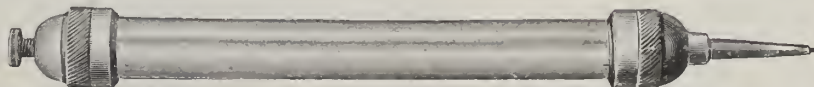

CLOCK SIZE.

SENT BY MAIL TO ANY PART OF THE COUNTRY.

GEO. H. RICHARDS, Jr., 383 Washington Street, Boston, Mass.

W. WESLEY MOORE

hopes to add to his many friends in Ohio, Tennessee, Arkansas, Kentucky, Missouri, Illinois, Iowa, Kansas, Nebraska, Colorado, New Mexico, Wyoming, Utah, Montana, Nevada, California, Arizona and Oregon.



NEW DESIGNS.

Mr. BRADLEY

will call at regular intervals in

Illinois, Wisconsin,
Michigan, Minnesota,
Dakota, Montana,
Iowa and Indiana.

Headquarters,
Chicago. . . Illinois.

**J. L. CLARK**

hopes to receive the favors of his patrons in

New York,

Massachusetts,

Connecticut

and Vermont.

We, the undersigned, representatives of the above well-known house, would announce to our respective friends that we will show them this Spring many new attractions, in addition to our usually large and varied stock.

We aim to merit your continued patronage and confidence.

Very Respectfully,

W. Wesley Moore
Mr. Bradley
J. L. Clark
J. C. Address
H. C. Barnum
H. S. Colyer

J. C. ADDRESS

will continue to call on his friends in Maryland, Delaware, District Columbia, Virginia, W. Virginia, North Carolina, South Carolina, Georgia, Florida, Alabama, Mississippi, Louisiana, Texas Tennessee, Kentucky and Ohio.

H. C. BARNUM

will renew his many acquaintances in

Massachusetts,

New York, Ohio,

Indiana, Illinois

and Michigan.

Headquarters,

Syracuse, . . . N. Y.

ATTRACTIONE GOODS.

FRESH STOCK.

LOW PRICES.

H. S. COLYER

will represent the house in

Massachusetts,

Maine,

New Hampshire,

New Jersey,

Pennsylvania,

Ohio and

West Virginia.

Ladd Watch Case Company,

(ORGANIZED 1883.)

SUCCESSORS TO J. A. BROWN & CO.,

(ESTABLISHED 1858.)

MANUFACTURERS OF THE

LADD PATENT GOLD WATCH CASES.

EXAMINE

THE

NEW MODEL

ACME!

Ladd Case.



Design No. 750.



Design No. 702.

Which is universally pronounced on sight to be the Most Elegant and the Best Article in this line yet brought out.

It has all the Late Improvements,

Including Solid Gold Bows and Solid Gold Linings,

AND FOR WORKMANSHIP, STYLE AND FINISH IT IS UNEQUALED.

Its Shape is such as to admit of the most elaborate ornamentation, or any intermediate style down to the plainest, without loss of effectiveness, in accordance with the taste of the purchaser.

For Sale by the Leading Wholesale Jobbing Trade.

THE CLIMAX REVERSIBLE WATCH CASES.

MANUFACTURED BY THE

Northwestern Watch Case Co.

OF

ROCKFORD, ILLINOIS.



MANUFACTURED BY THE

Northwestern Watch Case Co.

OF

ROCKFORD, ILLINOIS.

ABSOLUTELY DUST PROOF

AND

POSSESSING REAL MERIT.

ABSOLUTELY DUST PROOF

AND

POSSESSING REAL MERIT.

Patented April 3d, 1883, No. 275,251.

A MARVEL OF INGENUOUS MECHANISM.

—Descriptive Circulars Furnished Upon Application.—

THE WINDSOR SLEEVE LINK.

PATENTED MARCH 13, 1883.

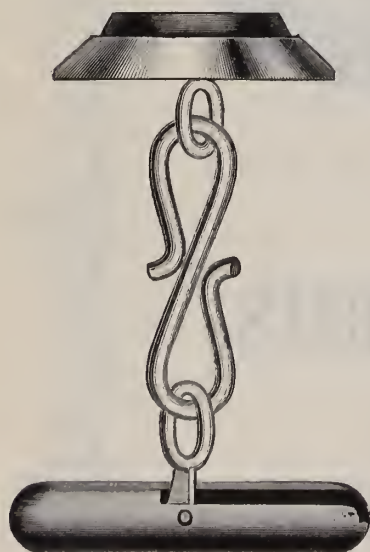

This Cut represents the Button with the Eye properly adjusted in the center of the Bar.

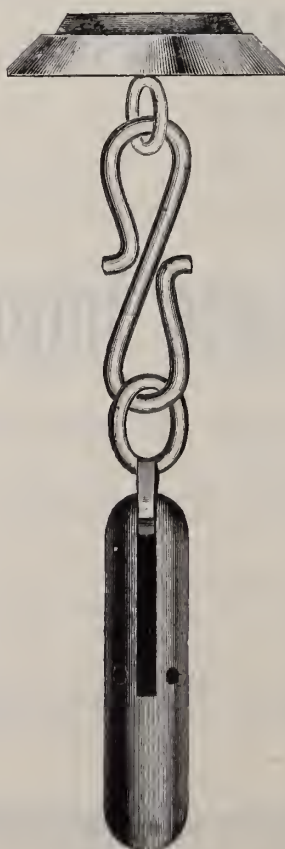

OPENED.

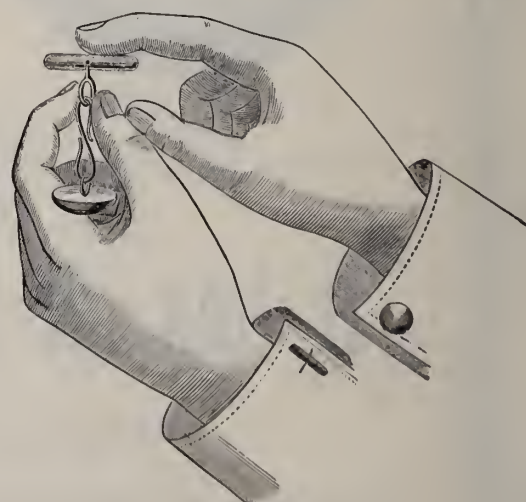

This Cut represents the proper manner of detaching the Eye and sliding the same to the end of the Bar.

SOLD BY ALL LEADING JOBBERS.

Important Notice to the Jewelry Trade.

FINDING that many of the general designs for art workers given in the pages of THE ART AMATEUR are used freely by jewelers, and recognizing that no publication in this country furnishes special designs for that very important body of art workers, the publisher has determined to supply the want. With this view, he has engaged the services of Mr. Henri L. Bouché, (with Messrs. Tiffany & Co.) one of the best jewelry designers in the United States. Beginning with the May number, this gentleman will furnish exclusively for publication in this magazine practical models for Pins, Bracelets, Bangles, Chains, Locketts, Pencil Cases, etc.

A complete series of very artistic Monograms, including the most varied simple combinations, is now running through THE ART AMATEUR, at least a page of them being given each month.

In addition to the original designs for jewelry, carefully selected designs will be given from the best foreign sources.

The May number (which will be sent to any address on receipt of 35 cents,) contains, besides its usual wealth of information relating to art matters in general, fourteen original and very attractive designs by Mr. Bouché, all easy of execution. The first lace pin would be appropriate for an engagement pin; the center is a Roman Coin, but a cameo or a fine enamel could easily be used instead; two pearls and two diamonds form part of this jewel, the whole being entwined with a bow of chased gold. The locket next to it is in the shape of a fruit with the leaves as ornaments, the whole chased on gold; the ground is rough, but produces a very rich effect. Silver

lace pins will be much in demand for summer wear. The grasshopper design, oxidized of different colors, would have a pleasing effect on a light dress. The two scarf pins may have a ground of dark blue champlevé enamel, or of silver with the ornament in soft enamel. The central design is for a pendant attached to a necklace, and is made of diamonds and gold. Of the two lozenge-shaped pendants, one is made of gold of different colors, with laurel leaves as ornaments; in shape it is somewhat Gothic, and entirely new. The other is of a Roman character, with a beautiful coin in the center. Both should be chased. The bracelet, through which passes a vine of flowers, would make an attractive wedding present, the gold chain being an emblem of marriage and the flowers of happiness. The two other bracelets may be executed in either gold or silver with fine effect. The two pairs of gold sleeve-links are entirely new in design and easily made. Designs appropriate for bridesmaids are often asked for. The pin made of the links of a chain, ornamented with orange blossoms, would answer very well for this purpose.

Some very interesting illustrations of jewelry, prepared especially for the Vanderbilt ball, are given in the May number; and also a page of valuable suggestive bits taken from the most artistic models and useful to the jeweler for a variety of purposes.

In the June issue of THE ART AMATEUR, Mr. Bouché's designs will include ideas for badges, class-pins and rings.

Subscription, \$4.00 a year; single copies, 35 cents.

MONTAGUE MARKS, Publisher, 23 Union Square, New York.

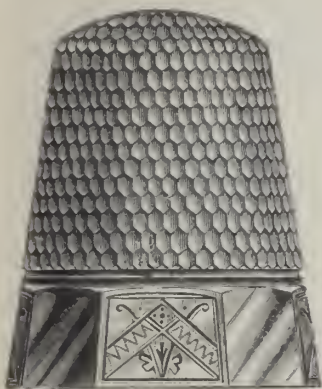

13 Maiden Lane,
NEW YORK.

FRANK S. KENNEDY,

Manufacturer and Wholesale Dealer in

JEWELRY

OF EVERY DESCRIPTION.

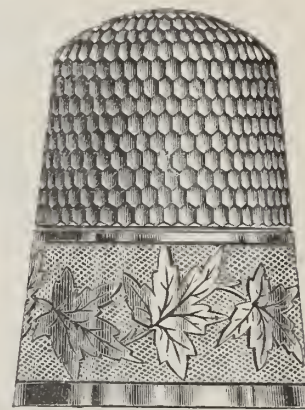

13 Maiden Lane,
NEW YORK.

In addition to my stock of Jewelry, which is complete in all lines of Gold, Silver and Roll Plate, I am now making a Full Assortment of

THIMBLES,

in Solid Silver, 10 karat and 14 karat Gold. These Thimbles are Superior in Finish to any now in the market, and are as near perfection as long practical experience can make them. Will send Samples if desired.

The Assortments of Jewelry I send on Memorandum for Special and Stock Orders have an increasingly high reputation.

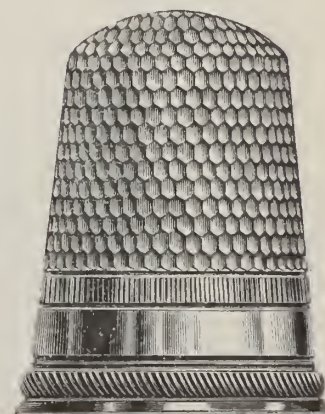
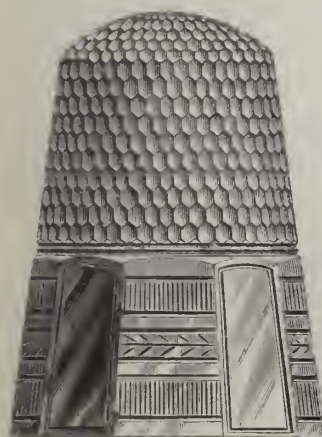

**THE
E. HOWARD WATCH AND CLOCK CO.,**

—MANUFACTURERS OF—

Fine Stem-Winding Watches,

FINE REGULATORS, OFFICE CLOCKS, TOWER CLOCKS,

And Electric Watch Clocks.



LADIES'
6 Size.

**STEM-WINDING
AND**



GENT'S
16 Size.

**Stem-Setting
Movements.**



GENT'S
18 Size.

114 TREMONT ST., BOSTON.

29 MAIDEN LANE, New York.

J. W. J. PIERSON, Agent.



WILLEMID WATCH CASE CO.,

109 Sands Street, Brooklyn, N. Y.



Our Engine Turned (Jurgensen Cases), a Specialty with us, have achieved a high reputation in the Trade, and are, without any exception, the Best and Cleanest Cut Engine Turned Cases in the market.

We ask you to compare these Cases with those of any other manufacture, as they are so made that they will stand the closest criticism. We also invite especial attention to our Raised Gold Ornamentation Work, Escalloped, Enameled and other styles of decoration.

NEW YORK OFFICE, 15 MAIDEN LANE, N. Y.

ROGERS, SMITH & CO.,

MANUFACTURERS OF

Electro Gold
AND
Silver Plated
Ware.



SALESROOMS:

46 EAST 14th STREET,
UNION SQUARE, N. Y.

FOR THE TRADE ONLY.

FACTORY, - - - - MERIDEN, CONN.

INVALUABLE.



Patented March 20th, 1883.



SELF SIZING,

WITHOUT CUTTING or SOLDERING.

Simple, Durable, Handsome, Inexpensive.

*

MANUFACTURED BY

R. HENRICH,

Manufacturer of SEAL and STONE RINGS in all Varieties.

35 Maiden Lane, NEW YORK.

FOR SALE BY ALL JOBBERS.

ESTABLISHED 1844.

DENNISON MFG CO.,

BOSTON, NEW YORK, PHILADELPHIA, CHICAGO, CINCINNATI AND ST. LOUIS.

JEWELERS' FINDINGS.

PAPER JEWELRY BOXES IN ALL STYLES AND QUALITIES. IMITATION MOROCCO BOXES, SATIN LINED. TAGS, JEWELERS' CARDS, PINK AND WHITE COTTON, &c., &c.

MOROCCO CASES.

Manufacturing in our own Shops Every Description of Morocco, Plush and Velvet Jewelry and Silverware Cases in large quantities, we are enabled to sell lower than other goods of equal quality can be offered, and we carry in all our Stores FULL Stock of our whole line.

Catalogue on Application.



308



306

ELLISON & VESTER'S
PATENT BAND AND BANGLE FINE ROLLED PLATE

BRACELETS.

FOR SALE BY EVERY JOBBER.



304



310½

KREMENTZ & CO.,

MANUFACTURERS OF

GOLD, PEARL AND DIAMOND JEWELRY,

Nos. 182 and 184 BROADWAY,

Corner of John Street,

NEW YORK.

(Elevator Entrance on John Street.)

NOVELTIES IN SILVER JEWELRY.

FACTORY, NEWARK, N. J.

LONGINES CHRONOGRAPH

Fly-Back & Horse-Timing

STEM-WINDING

WATCHES.

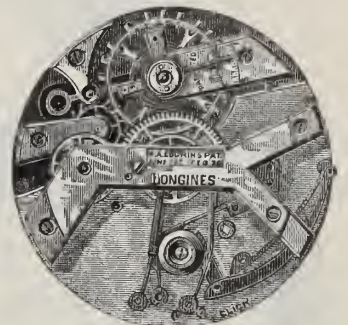

The most reliable, accurate and substantial LOW PRICE Timing Watch made. The improved method of mechanism in their construction renders these goods superior to any low price Timing Watch in the market, and the Best Selling Goods offered to the Trade.

J. EUGENE ROBERT,

30 MAIDEN LANE,

NEW YORK.

FOR SALE BY THE LEADING JOBBERS.

Duplicate Parts and Finished Material for these Goods always in Stock.



Established
1841.



JOHN HOLLAND,

19 and 21 WEST 4th STREET,

CINCINNATI, OHIO.

Manufacturer of All Styles of Best Quality

GOLD PENS, PENCIL CASES, FINE PEN HOLDERS, GOLD TOOTH PICKS, &c.

A Large Variety of New Designs in Staples and Novelties.



Received the Award "For Great Elasticity and General Excellence of Gold Pens," at Phila. Ex., '76.

Catalogues mailed free. Handsome show cases loaned for display of goods.

STANDARD WATCH CO.



STANDARD CALENDAR

'STANDARD CALENDAR.'

20 Line, Open Face, in Nickel and Silver, showing the date and day of the week, Full Jeweled, Finished Movement. The Latest Novelty offered.



"STANDARD."

18 Size, Low Price Movement, will fit Waltham and Elgin Cases.



"VESTA."

8 Size, Low Price Movement, fits Elgin Cases.



"STANDARD."

8 Size, Full Jeweled, Ladies, Fits Waltham Cases.

REGISTERED.



"STANDARD."

Nickel, 17, 19 and 20 Line. Lever, Full Jeweled.

Max Freund & Co., Sole Agents, 8 Maiden Lane, N. Y.

LOUIS KAHN.

MOSES KAHN.

SAMUEL H. LEVY.

I. W. FRIEDMAN.

L. & M. KAHN,

IMPORTERS OF

Watches, Diamonds & Precious Stones,

10 MAIDEN LANE, NEW YORK.

11 Corrairie, Geneva, Switzerland.

17 Rue de Chateaudun, Paris.

WATCHES,

Stem and Key-Winding, from the Lowest Priced Nickel and Silver to the Finest Gold and Complicated.

A Full Assortment of these Goods always in Stock.

DIAMONDS,

Loose and Mounted, in all Sizes and Qualities.

Gold, Silver, Nickel and Celluloid Chatelaines in Great Variety.

E. E. KIPLING,

— IMPORTER OF —

PRECIOUS AND IMITATION STONES,

No. 6 Maiden Lane, New York.

For the protection of the trade I find it necessary to issue the following **TRADE MARK.**

TRADE MARK.



which will hereafter be embossed or printed on all cards containing Jewelry in which is set my Patent Foiled Solid Metal Back Rhine Stone Brilliants, in place of the below stamps, which were formerly employed and which have been **ABOLISHED.**

PATENT FOILED SOLID METAL BACK
RHINE STONE BRILL'S.
PATENTED FEB. 28, 1882.



PATENT FOILED
SOLID METAL BACK
RHINE STONE BRILL'S.
PAT. FEB. 28, 82.

All Jewelry containing my Patent Foils, made after this date, will bear my **TRADE MARK.**

Very Important to Jobbers and Retail Jewelers.

In buying White Stone Jewelry, be sure to get "**Patent Foil Solid Metal Back Rhine Stone Brilliant.**" The Cards must be stamped as above. The advantages over the PAINTED FOILS ARE:

- They are more Durable.
- are not affected by washing or dampness of air.
- retain their Lustre.
- preserve their Purity of Color.
- are sold at the same price as the Painted Foils.
- are sure to give satisfaction.

See that all the Jewelry Cards are Stamped with my Trade Mark.

All violations of my rights, whether under my patent or my trade mark, will be prosecuted to the full extent of the law.

My customers are respectfully requested to inform me of any infringements that may come to their knowledge, so that I may be the better able to protect them from unlawful competition.

E. E. KIPLING.

J. M. CHANDLER & CO.,

—MANUFACTURERS OF THE—

PATENT EMBOSSED BRACELET.



These cuts represent examples of one of the many styles of our New Patent Embossed Bracelet.



Chain Bracelets either in Gold or Plate are necessarily weak, as a small rivet is used to connect the links; when one rivet fails, the whole comes apart. The Embossed Bracelet is an exact imitation of a chain made from a solid piece of stock by a patent process, and while the goods are of the best quality, the price is much lower.

The stock from which these goods are made is plated in our factory, and we **GUARANTEE** each and every pair to wear and give satisfaction. They are adjustable and will fit any arm.

We will send Selection Packages of the Goods to Dealers on Approval.

ADDRESS ALL ORDERS TO

J. M. CHANDLER & CO.,

JOBBER IN ALL KINDS OF

CLOCKS, WATCHES, JEWELRY, AND ALL KINDS OF TOOLS AND MATERIALS,

185 Superior Street, Cleveland, O.

PARTIES INFRINGING ON OUR RIGHTS WILL BE VIGOROUSLY PROSECUTED.

CLEMENS HELLEBUSH,

MANUFACTURER, IMPORTER AND WHOLESALE JEWELER,

Dealer in everything required by the Jewelry Trade.

DIAMONDS.—Dealers will find in my stock an assortment of Diamonds unequalled in the West, embracing a choice variety of loose and mounted Stones in all qualities.

WATCH CASES.—In Gold and Silver, of all makers, to fit American Movements.

WATCH MOVEMENTS.—Include always a full stock of Waltham, Springfield, Hampden and Howard, together with a large assortment of fine and low-priced Swiss Watches.

SILVER PLATED WARE.—I have an unusually fine assortment of the choicest patterns of Flat and Hollow Ware of the best known manufacturers.

SOLID GOLD AND ROLLED PLATE JEWELRY.—This department is replete with Staple Goods and Novelties.

FRENCH CLOCKS.—Of our own importation, including all grades, with prices exceedingly low.

AMERICAN CLOCKS.—I am the General Agent in Cincinnati for the celebrated Seth Thomas Clocks, a full line of which will always be found in stock.

TOOLS AND MATERIALS.—In this department will be found everything required by Watch Makers.

Illustrated Catalogues sent to Dealers only upon Application.

CLEMENS HELLEBUSH,

77 West 4th Street,

CINCINNATI, O.

“The Waterbury.” The New “Series B,”

NEW SERIES B.

Bezel Off,

Showing Index Plate and Regulator.

With **FULL DIAL** and **SOLID PLATES.**

In this new **SOLID PLATE** movement the position of the regulator has been changed; it will be found projecting beyond the plate, immediately under the bezel. The **FULL DIAL** enables the position of the hands to be readily seen.

The danger of injuring the Hair Spring in regulating is obviated in this new movement.

SERIES A.—Open Dial, Skeleton Plates, - \$48.00 per doz.

SERIES B.—Full Dial, Solid Plates, - - - 48 00 “

Discount to the Trade.

We can supply either Pattern as ordered.

WATERBURY WATCH CO.,

WATERBURY, CONN.

NEW YORK OFFICE, 52 MAIDEN LANE.

GEO. MERRITT, GENERAL SELLING AGENT,

To whom all Orders and Correspondence as to Prices and Terms should be addressed.

FOR SALE BY DEALERS GENERALLY.

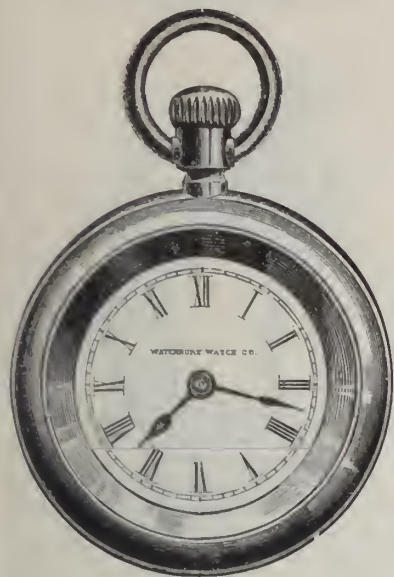

NEW SERIES B.
Solid Plates and Full Dial.

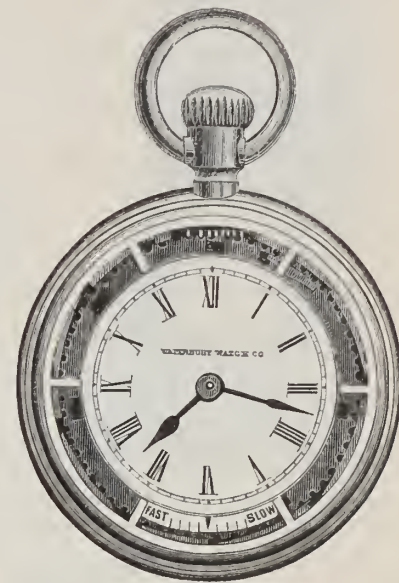

STANDARD DUST-PROOF WATCH KEYS.

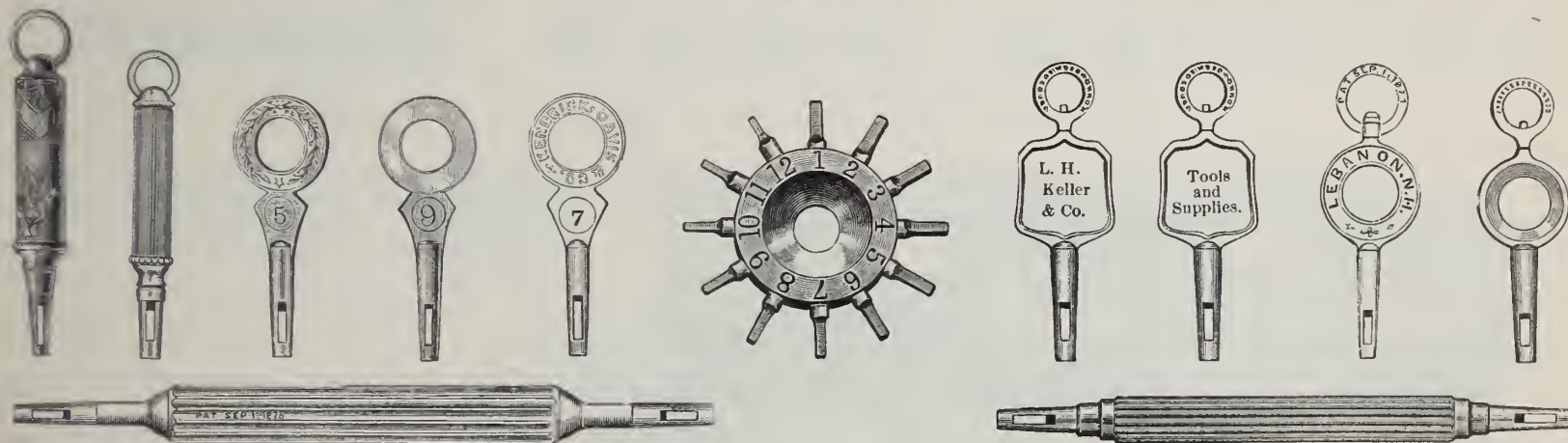

FOR SALE BY  THE TRADE.

KENDRICK & DAVIS,

Sole Owners and Manufacturers, Lebanon, N. H.

ILLUSTRATED CATALOGUE AND PRICE LIST SENT ON APPLICATION.

JOHN BLISS & CO.,

Standard Marine

CHRONOMETERS AND TRANSITS

FOR WATCHMAKERS' USE.

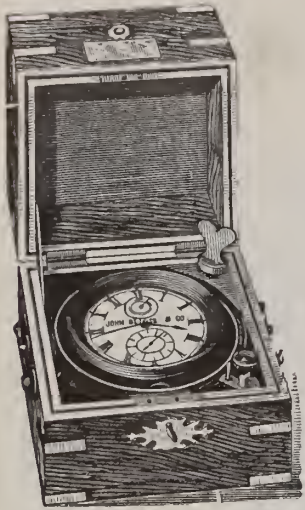

Standard Marine Chronometer,
FOR KEEPING CORRECT TIME.

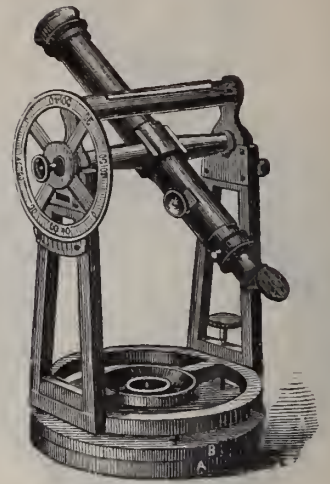

No. 10.

128 FRONT STREET,

Near Wall Street,

NEW YORK.

NOTICE.—*These Transits are readily set in position without the aid of strictly correct time as a basis for that purpose. Printed instructions, easily understood, accompany each Instrument, and no calculations are required preliminary to setting in position.*

SEND FOR ILLUSTRATED CIRCULAR WITH PRICES.

PATENT IMPROVEMENT IN COUNTER † SHOW † CASES, WITH PERPENDICULAR SLIDING DOORS. DUST PROOF.

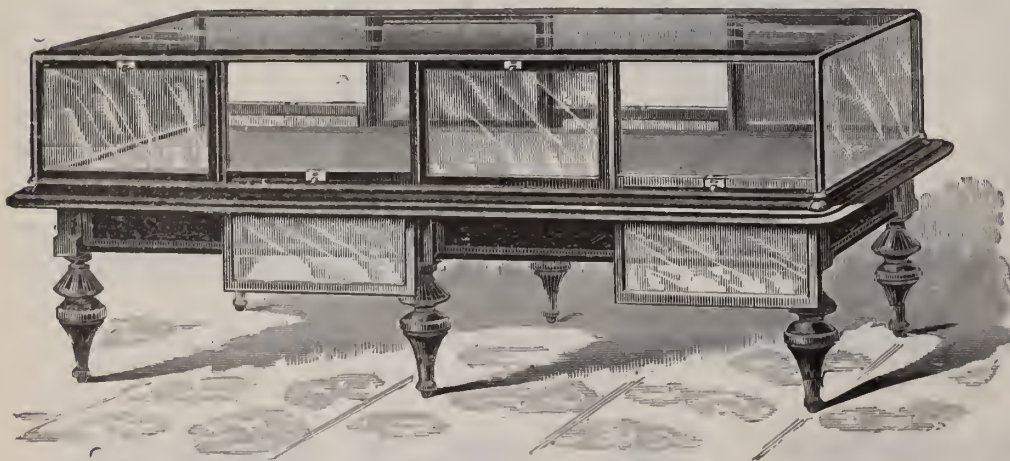

The Advantage and Convenience of these Show Cases will be apparent to everyone.

The doors are more conveniently opened and closed, less liable to get out of repair or broken, articles are more easily reached in wide cases, mirrors are more safe, it dispenses with hinges, economizes room, excludes dust, and is air tight when closed.

Drawings furnished and estimates given for fitting stores in cabinet work complete.

Letters Patent having been granted us for the construction of these doors, we shall prosecute all parties using Cases which infringe on our Patents.

REFERENCES:—Gorham Mfg Co., Rogers & Bro., Mitchell Vance & Co.,
Meriden Britannia Co., M. S. Smith & Co., Detroit, Mich.
D. Valentine, Syracuse, N. Y.

B. & W. B. SMITH,
220 West 29th Street, New York.

M. Anderson, No. 57 State Street, Chicago, has the exclusive right to manufacture and sell our Improved Cases for the States of Wisconsin, Illinois, Missouri, Mississippi, Arkansas, and all States West of same.

CATALOGUE OF STYLES SENT ON APPLICATION.

T. A. WILLSON & Co's CELEBRATED SPECTACLES AND EYE-GLASSES.

ALBERT BERGER & CO.,
47 MAIDEN LANE, N. Y.

We desire to announce to the Trade that we have this day acquired the exclusive **WHOLESALE CONTROL** of the T. A. Willson & Co.'s Celebrated Spectacles and Eye-glasses, and will continue to keep in stock a full and complete assortment in all the various grades and sizes of these goods

AT FACTORY PRICES.

A Spectacle Temple that will not Wear Loose.

Explanation of Compensating Temple, Patented May 13th, 1879. Re-issued June 8th, 1880.

A.—Stop for Temple, preventing Strain on Joint.

B.—Compensating Eye, for taking up wear of joint. The Eye of Temple is smaller than Stubb Steel Joint Pin on which it works, and is left open at B, exerting a Spring Tension on Pin.

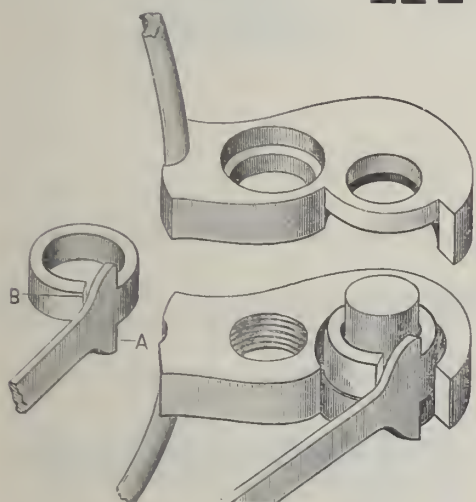

No. 179.



No. 155.

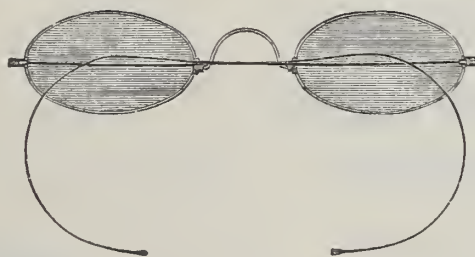

No. 128.

All goods of this manufacture are offered at a great reduction, the Factory Prices being uniform with ours.

ALBERT BERGER & CO.,

SOLE WHOLESALE AGENTS,

47 Maiden Lane, N. Y.

May 1st, 1883.

PRICE LIST SENT ON APPLICATION.

PETER B. SIMONS & CO.,

MANUFACTURERS AND IMPORTERS OF

FINE JEWELRY, GOLD CHAIN,

Gold and Silver Thimbles, Canes, Sets, Etc.,

FOR THE TRADE ONLY.

No. 120 SUTTER STREET,
SAN FRANCISCO.

FACTORY:
611 & 613 SANSOM STREET,
PHILADELPHIA.

SALESROOM:
120 SUTTER STREET,
SAN FRANCISCO.

DEALERS IN AMERICAN AND IMPORTED

❖ GOLD ❖ AND ❖ SILVER ❖ WATCHES. ❖

KEY
Patented Jan. 25,
1881.

TAG
Patented Jan. 25,
1881.

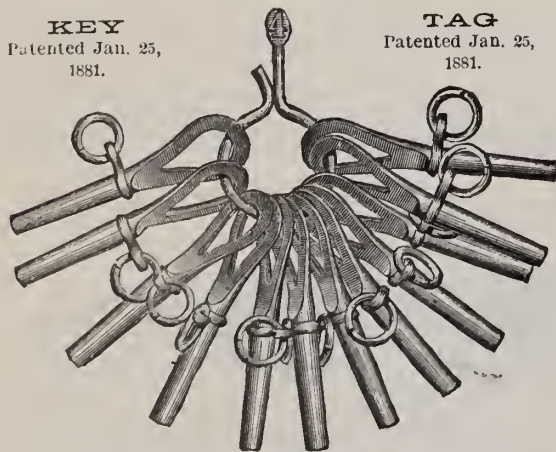

**A. N.
CLARK**
PLAINVILLE,
CONN.,

Manufacturer of

Watch Case Springs, Watchmakers' & Jewelers' Bench Tools,
CROSBY'S JEWELING TOOLS, &c.

STOP IMPORTING KEYS!

For Low Price Key Use the

New Style Loop Key.



A plain Steel Key of good appearance, and excellent quality. It will not wear the pocket. It has a swivel, and is much better made than the imported plain steel or iron keys.

PRICE PER GROSS, FINE NICKEL FINISH, \$2.25
Postage, 10 Cents Per Gross Additional.

This Key is good and cheap enough to become universal. Send business card for illustrated price list. Enclose three cent stamp for sample key.

SOLD BY JOBBERS IN WATCH MATERIALS AND NOTIONS.

A. N. CLARK, Plainville, Conn.

Patented November 18, 1873.

MORRISON'S Gold & Silver Solutions

For Electro-Plating Without a Battery.

Invaluable for Watchmakers and Jewelers. So simple that any one can use them.

Price, Gold Solution, - - \$3.00 Silver Solution, - - \$1.50

MANUFACTURED BY

ARTHUR B. MORRISON, Portland, Maine.

FOR SALE BY

Sussfeld, Lorsch & Co., New York; Henry Ginnel, New York; Cross & Beguelin, New York; Kearney & Swartzchild, Chicago, Ill.; Louis A. Scherr & Co., Philadelphia, Pa.; Duhme & Co., Cincinnati, O.; Harwood Bros., A. Paul & Co., Palmer, Bachelder & Co. Boston, Mass., and material dealers generally.

BEWARE OF BASE IMITATIONS put up by unprincipled persons. None are genuine without the Trade Mark which consists of the letters A. B. M. in monogram and fac simile of Medal awarded by U. S. Centennial Commission.

The Burbank Manufacturing Company

Manufacturers of GOLD & SILVER



GOLD
SILVER,
STEEL,
RUBBER,
And SHELL,

Thimbles,



EYE GLASS
Self Adjusting.

SPECTACLES AND EYE-GLASSES



OF ALL DESCRIPTIONS.

SOLID GOLD RINGS

Office, 14 MAIDEN LANE. NEW YORK.

Manufactory, Springfield, Mass.

AMERICAN WATCH TOOL CO.,

WALTHAM, MASS.

MANUFACTURE THE

WHITCOMB LATHE,

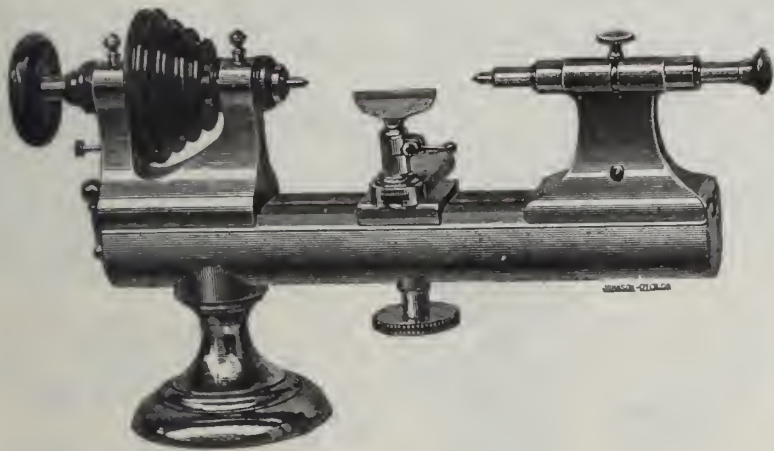

AND THE

"Webster" Foot Wheel,

We guarantee it to be a worthy companion to the Whitcomb Lathe.

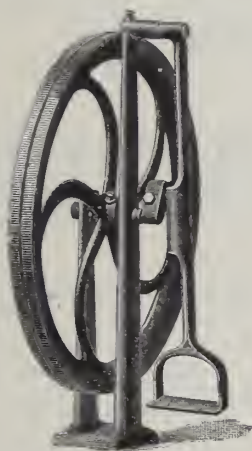

It is **not** a cheap made wheel but **First-class** in every respect.

PRICES:

30 ll. Wheel, for No. 1 Lathe, 20 inches in diameter,	\$12.00
40 " " " 1½ " 20¼ " "	13.00
50 " " " 2 " 21½ " "	14.00

DESCRIPTION.—The wheel runs on a hard steel arbor. It is clamped to the arbor by a set screw against a split bushing. This does not bend the arbor as is the case where the set screw is against the arbor. On the crank pin is a friction roll, having a hardened steel bushing, which runs on a hard steel pin. The swinging treadle is the **easiest** motion, and effects the body **less** than the foot treadle.

SEND FOR NEW CATALOGUE.

Our No. 1½ Lathes are Fast Superseding all other Sizes.

Soft Lathes have Hard Mouths, Hard Wire Chucks and Hard Tail Stock Spindles.

MARTINS & TISSOT,

Manufacturers of

GOLD WATCH CASES,

AND JOBBERS IN AMERICAN MOVEMENTS,

15 MAIDEN LANE, NEW YORK.

8 KARAT CASES A SPECIALTY.



Our 8 Karat Cases are of Superior

STYLE,

CONSTRUCTION

AND FINISH

to any now made, (as our constantly increasing production will attest), and are made also in large variety of styles.

LARGE STOCK

Constantly on Hand.

JOBGING TRADE SOLD ONLY.

Birch's Patent Self-Adjusting Watch Keys.

FOR SALE BY THE TRADE GENERALLY.



2.—POCKET KEY. (Brass.)



3.—POCKET KEY. (Nickel Plated.)



4.—POCKET KEY. (Nickel Plated, Hexagon Shell.)



5.—POCKET KEY. (Heavy Rolled Gold Plate Mountings.)



6.—CELLULOID MOUNTED KEY. (With Heavy Rolled Gold Plate Tips.)



35.—POCKET KEY. CELLULOID MOUNTINGS. (Imitation Malachite, with Extra Heavy Rolled Gold Plate Tips. 18. K.)



7.—BENCH KEY. (Brass Handle.)



8.—SHORT WOOD HANDLE KEY. (Nickel Plated, for Bench or Pocket Use.)



9.—LONG WOOD HANDLE BENCH KEY. (Nickel Plated.)

Made in 37 Styles. Circulars on Application.

J. S. BIRCH & CO., 38 Dey Street, N. Y.

HUTCHISON & HUESTIS,

❖ SOLID ❖ GOLD ❖

RING MAKERS

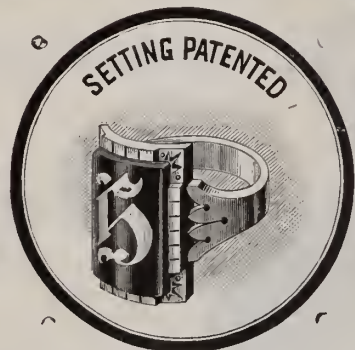

QUALITY GUARANTEED.

FOR JOBBERS ONLY.

No. 185 EDDY STREET,
—❖ PROVIDENCE, R. I. ❖—

New York Office, . . . 196 Broadway.

WM. M. FISHER & CO.

Sole Manufacturers of the



PATENT INTERCHANGEABLE
Combination Necklace,
And Ladies' Brooch or Lace Pin

PATENTED

JULY 16, 1872

GOLD
AND
SILVER
CHAINS,
—:—
Gold Chain
TRIMMINGS.
—:—

Complete
Assortment of
14-k.

Ribbon Fobs.

FOR SALE BY THE LEADING JOBBERS

H. MUHR'S SONS,

MANUFACTURING JEWELERS,

224, 226 & 228 SOUTH FIFTH ST.,

PHILADELPHIA, PA.

SOLID GOLD RINGS AND LOCKETS.

SOLID GOLD BAND RINGS.

— ALSO —

THE STANDARD CROWN 18 LION FILLED RINGS,

PLAIN, CHASED AND BAND.

REMOVAL NOTICE.

NEW YORK OFFICE,

From No. 1½ to No. 14 MAIDEN LANE,

CHICAGO OFFICE,

From 137 to 101 & 103 STATE ST.



GILES, BRO. & CO.

Wholesale,
Importing and
Manufacturing

➤ JEWELERS, ➤

101 and 103 STATE STREET,

CHICAGO, ILLS.

Complete Illustrated Catalogue Furnished the
Trade upon Application.

LANCASTER WATCH CO.

MANUFACTURERS OF

A. BETNER'S
Patent.

DUST PROOF WATCHES,

Patented
Nov. 28, 1882.

Fine Nickel and Gilt Stem-Winders.

These Watches meet a want long felt by the Trade generally. The balance being entirely closed meets the point taken by Jurgensen in his remarks upon the Resistance of the Air, as found in the CIRCULAR AND REVIEW, January No., 1883, page 414. This movement is guaranteed to be Dust-Proof, no matter in what case it may be placed. It is interchangeable with our regular case, or can be put into the Regular 18-size cases in the hands of Jewelers or Watch Dealers everywhere.

FOR SALE BY LEADING JOBBERS THROUGHOUT THE UNITED STATES.

WILLIAM H. BALL,

—MAKER OF—

GOLD BRACELETS

WITH THE PATENT GUARD.

IMPOSSIBLE TO LOSE THIS BRACELET.

A FULL LINE OF

BANDS, BANGLES, PADLOCK AND KEY, AND BRAIDED GOODS,

9 JOHN ST., NEW YORK.

SAN FRANCISCO OFFICE, 120 SUTTER ST.

FACTORY, NEWARK, N. J.

Goods Sent on Selection to Responsible Parties.



NEW YORK OPTICAL CO.,
 Manufacturers of all kinds of
 Spectacle Lenses, Spectacles,
 Eye-Glasses
 AND
 SPECTACLE AND EYE-GLASS CASES.
 OFFICE AND SALESROOM:
 No. 43 MAIDEN LANE, N. Y.
 FACTORIES: BROOKLYN, N. Y.

E. J. BOYCE,
 (Formerly Boyce & Wainwright.)
 MANUFACTURING JEWELER
 SOLID GOLD RINGS A SPECIALTY.
 My BAND RING Specialties, for PRICE,
 QUALITY and FINISH, are not equaled by
 any in the Trade,
 383 WASHINGTON ST.,
 Room 26, BOSTON, MASS.

CHURCH'S PATENT IMPROVED
 DOUBLE SPEED INDICATOR
 Either Right or Left.



MONTGOMERY & CO.,
 Importers of Stubs' Files, Tools & Steel,
 GROBET SWISS FILES, CHESTERMAN'S TAPES, RULES, &c.
 Horse Shoe Magnets, Hubert's French Emery Paper.
WM. SMITH & SONS' CELEBRATED MUSIC WIRE.
 105 Fulton Street, N. Y.

RINGS
 With the Inscription,
 Dr. Martin Luther—Catharina
 von Boren,"
 For the 400th Anniversary.
 Perfect imitations of the betrothal ring of Dr. Martin
 Luther, which was preserved in his ancestral home.
 SILVER, Heavily Gilded, \$2.00
 FINE GOLD, 8.00
 FOR SALE BY
CARL RECKE,
 GOLDSMITH,
 Eisleben, Prussian Saxony, Germany.
 Orders Solicited. References Given.

H. WUNDOEHL,
 GOLD & SILVER REFINER,
 Assayer and Sweep Smelter,
 21 JOHN ST.,
 Bet. Broadway & Nassau St., NEW YORK.
 The highest price paid for Gold, Silver and Platinum.
 Fine Gold, Silver and Copper always on hand.

JACOB STRAUSS,
WATCHES & JEWELRY
 AT WHOLESALE.
 REMOVED FROM
 18 TO 25 JOHN STREET, N. Y.
 Rings and Rolled Plated Chains
 A SPECIALTY.

J. B. LAURENCOT,
 IMPORTER OF
 WATCH GLASSES,
 Optical and Fancy Goods
 French Clocks, Musical Boxes, &c.
 No. 33 MAIDEN LANE.
 5 Rue D'Enghien, Paris. Box 2954, P. O. NEW YORK.

W. H. LUDEMAN,
 No. 75 & 77 Nassau Street,
 NEW YORK.
FINE AND COMPLICATED
 WATCHES
 Of every description repaired and regulated.
 Stem Winding and Escape Wheels
 Cut and finished to order with accuracy
 and promptness.

J. J. COHN,
 IMPORTER OF
 WHITBY JET,
 MANUFACTURER OF
 Gold & Rolled Plate Jewelry,
 Bracelets, Charms & Locketts a Specialty.
 12 MAIDEN LANE, N. Y.
 Goods Sent on Selection if Satisfactory References are
 Given.

THE JEWELER'S BOAT.

OSGOOD FOLDING CANVAS BOAT
 Is the boat to buy; you can fold it up and carry it in your buggy,
 or on your back; it is light, safe, and strong; it rows so easily,
 you can't blister your hands, or unsettle it without considerable
 effort; the best portable or sportsmen's boat made in the world.
SATISFACTION GUARANTEED. Send for Illustrated Circular,
 giving full particulars and references. Manufactured by
 N. A. OSGOOD, Battle Creek, Mich.
 DEALER IN
 Fine Jewelry, Diamonds & Sportsmen's Goods.

L. SAUTER.
 1 MAIDEN LANE,
 Manufacturer of
Fine and Diamond Jewelry
 AS
 Rings, Studs, Buttons, Scarf Pins, Etc.
Hair Jewelry in all its branches.
 Jobbing of every description promptly attended to.

JOHN D. LENNON,
 142 Fulton Street,
 NEW YORK,
 Manufacturing Jeweler,
 Masonic Pins, Rings & Charms,
 School Athletic, Fine
 Presentation Medals,
 —AND—
 JEWELS OF EVERY DESCRIPTION
 Designs furnished free upon
 application.

HIBBARD G. GILL,
 GOLD AND SILVER
 Watch Case Manufacturer,
 Dealer in Watches,
 American Watch Movements Always on Hand.
 618 Chestnut Street,
 Fifth Floor. PHILADELPHIA.

HENRY TROEMNER,
 710 Market Street,
 PHILADELPHIA.
 Manufacturer of Fine Gold Scales,
 DIAMOND SCALES,
 Bullion Balances and
 Weights, in use at all the
 U. S. Mints and Assay
 Offices.
 PRICED CATALOGUE ON APPLICATION.

JNO. F. LUTHER,
 MANUFACTURER OF

 Masonic Jewelry.
 79 Nassau Street, N. Y.
 Illustrated Catalogue sent on application.

PLATINUM
—FOR—
Scientific and Mechanical Purposes,
IMPORTED AND FOR SALE BY
The S. S. White Dental Manufacturing Co.
SCRAP PURCHASED.

PHILADELPHIA, Chestnut St., cor. Twelfth.
NEW YORK, - 767 and 769 Broadway.
BOSTON, - - - 160 Tremont Street.
CHICAGO, - - 13 and 14 E. Madison St.

ADOPTED AND IN USE BY
RANDEL, BAREMORE & BILLINGS,
58 Nassau Street, N. Y.

THE TRADE SUPPLIED.
Descriptive Circulars Furnished
on Application to
George W. Washburn, Patentee,
58 Nassau St.,
NEW YORK.

SAFETY
EAR FASTENING, 
Pat. May 10, '81—Oct. 11, '81.

Jointed
EAR WIRE
AND
BAR BETWEEN CRAMPS
OF SETTINGS. 
Patented March 1, 1881.

TELESCOPIC
SAFETY PIN CATCH, 
Pat. Sep. 20, '81—Jan. 10, '82.

C. KNAPP,
Manufacturer of
**Superior Band
and Children's
Stone & Fancy
RINGS**
And Enameled Goods,
41 Maiden Lane,
NEW YORK.

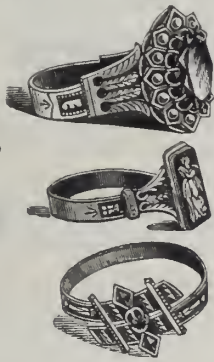

Solid Gold Rings a Specialty.
WM. H. ELY,
SOLID GOLD RINGS,
MANUFACTURER.
Viz., Plain, Chased, Engraved, Enameled,
Engine Turned, Shield and Scale. All
qualities guaranteed. Orders
Promptly Executed.
58 Nassau Street, New York.



C. B. WILKINSON,
Manufacturing Jeweler,
8 JOHN ST., N. Y.
Medals, Badges and
Masonic Jewelry
A SPECIALTY.
Designs furnished free
upon application,

J. H. LOGUE. A. C. BARD.
LOGUE & BARD,
104 STATE ST., COR. WASHINGTON,
—CHICAGO.—
WHOLESALE DEALERS IN
Watches, Clocks and Jewelry.
AN ENTIRELY NEW AND CAREFULLY
SELECTED STOCK OF GOODS.

WM. RAWLINGS, JR.,
Manufacturing Jeweler,
FACTORY:
913 Arch Street, Phila.
FINE GOLD RINGS A SPECIALTY.
Goods sent on approval to any part of the
country upon receipt of satisfactory reference.

Mansard English Geneve Louis XV.

HENRY LEFORT,
Stem-Winding Watch Crown Manufacturer,
Crowns and Pushers in gold, all sizes, quality and color,
made to order. Silver crowns and pushers always on hand.
60 Arlington Street,
Corner William Street,
NEWARK, N. J.

We give **Special Attention** to effecting
Settlements by **Compromise** between
Debtor and Creditor.

COLLECTIONS.

BANKING AND COLLECTION HOUSE OF
HENRY McCABE & CO.,
Principal Office:
287 BROADWAY, Cor. Reade St.
Attorneys and Correspondents at Every Point.
The Collection of Notes, Drafts, Current
and Overdue Accounts made in all
parts of the United States and
Canada by our unrivaled system.
UNEXCEPTIONABLE REFERENCES AS TO
PROMPTNESS and RESPONSIBILITY.

P. JANDORF & BRO.,
Watches and Jewelry,
196 BROADWAY,
Bet. John & Fulton Sts., NEW YORK.
We Publish No Price Lists.

H. WASDELL,
RUBBER STAMPS,
BRASS STAMPS,
Brushes, Inks, &c.
Stencil Plates, 
Burning Brands,
SEALS & PRESSES,
No. 7 North William St.
First house South of East River Bridge, N. Y.
STEEL STAMPS.
FINE STEEL STAMPS A SPECIALTY.

S. KOPELOWICH & BRO.,
THE ONLY EXCLUSIVELY
Jobbing Jewelry House
Between New York and Chicago.
Jobbers of American and Swiss Watches,
Jewelry, Silverware, Spectacles, &c.
A large assortment of which we have constantly
on hand.
Selection packages sent to responsible parties.
Room 1, Larned Building, Syracuse, N. Y.

The Finest Line of High-Class English
Watches in the U. S.
GEO. E. WILKINS,
SYRACUSE, N. Y.
Agent for the Celebrated Watches of
Chas. Frodsham & Co., London,
W. G. Schoof, London,
Karl Zimmerman, Liverpool.
Timing and Adjusting done for the Trade.
Correspondence Solicited from the Trade.

→ **SOLID GOLD** ←
AND
STONE INLAID
Cigar Cutter,
Pat'd Oct. 5, 1880.
J. WIENHOLD,
Manufacturer of FINE JEWELRY.
DIAMOND MOUNTINGS A SPECIALTY.
24 John St., N. Y. City.

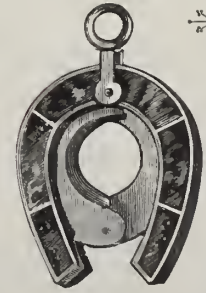

All parts furnished separately when desired. The Springs will never rust, and are much more durable than steel.

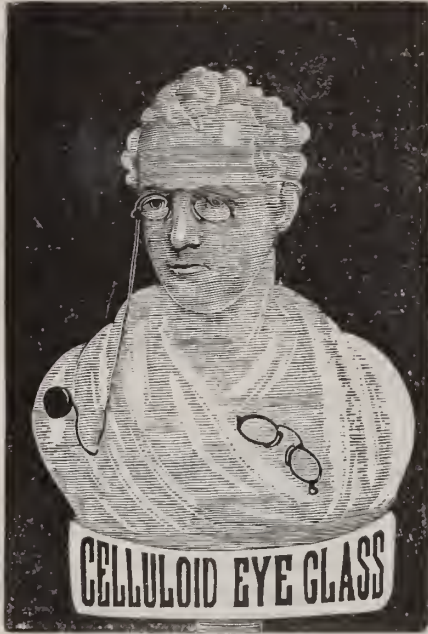

Please note a reduction of 50 cents per dozen on 286 and 288 Celluloid Eye-Glasses, No. 7 Catalogue.

The above cut represents a fine bust of Lord Byron, about twenty-five inches high, which will be furnished to parties purchasing 6 dozen Celluloid Eye-Glasses. It is securely packed, ready for shipment, and will make a very handsome ornament for the show window.

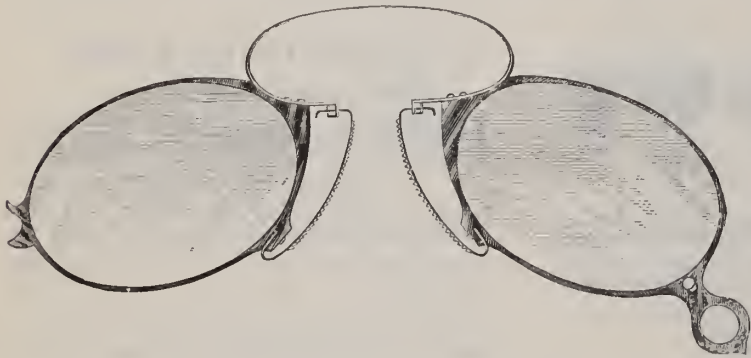

The above cut represents No. 306 Eye-Glass with an Adjustable Nose Piece, which we make in

Gold, Nickel, Celluloid, Rubber, Steel and Frameless.

This style of Eye-Glass is very popular. We make many NEW and EXCLUSIVE Styles that give a Dealer handling our goods an immense advantage over those who sell the ordinary line of goods in the market.

Special Goods, with Trade Mark, made for Dealers to Order.

Great Variety! Novel Styles! Attractive Goods!

While many houses have complained of dull trade this Spring, we have been increasing our force.

ACTIONS SPEAK PLAINER THAN WORDS.

Spencer Optical Manufacturing Co.,

13 MAIDEN LANE, NEW YORK.

Established 1853.

L. H. KELLER & CO.

Successors to G. A. HUGUENIN,

IMPORTERS OF

WATCHMAKERS' and JEWELERS'

TOOLS AND MATERIALS.

GENERAL AGENTS FOR

The Philadelphia Watch Company,

— AND —

American Watch Tool Co.,

MANUFACTURERS OF

THE WHITCOMB LATHE.

SOLE AGENTS IN THE UNITED STATES FOR THE SALE OF

LUTZ'S

**CELEBRATED ROLL HARDENED HAIR SPRINGS,
MOEBIUS OIL**

For Chronometers, Watches, Clocks, Telegraph Instruments and all other delicate machinery. Made from Pure Refined Neatsfoot Oil, and Warranted to Excel anything in the market as a Lubricator. **SAMPLES GRATIS.**

OUR OWN GRADUATED

AND JURGENSEN RECOILING MAINSPRINGS, pronounced by all experts Superior to all. Sold in Separate Strengths or Force.

Extra Fine Pinions cut from Solid Steel Wire. Gauged Hole Jewels of First-class Workmanship. A Full Line of Materials, for the PATEK, PHILIPPE & CO. GENEVA WATCHES, and all other Celebrated Makers.

THE BOLEY LATHES AND TOOLS,

Celebrated for their Practical, Substantial and Workmanlike Construction, Superior Design and Finish.

Our aim is to furnish nothing but First-class Serviceable Goods, especially manufactured for the Consumer, and not solely for the Market, like the cheap trash advertised in highly illustrated catalogues with which the country is flooded.

TREATISE ON MODERN HOROLOGY IN THEORY AND PRACTICE. By M. CLAUDIUS SAUNIER, Ex-Director of the School of Horology at Macon, France; Knight of the Legion of Honor, etc.; Hon. Sec. to the Paris Society of Horologists. Translated from the French by JULIEN TRIPPLIN, Besançon Watch Manufacturer, and EDWARD RIGG, M. A., Assayer in the Royal Mint, London.

This Work comprises 832 large octavo pages, with 78 wood cuts and 21 colored double-page copper-plate engravings. Bound in half calf, with an appropriate and handsome ornament in gold on front cover.

Price, \$15.00.

THE WATCHMAKER'S HAND BOOK. By the same author and translators. Intended as a companion to the Treatise. Bound in cloth.

PRICE, \$4.00.

64 Nassau Street,

NEAR MAIDEN LANE,

NEW YORK.

L. H. KELLER,
EDWARD HUNZIKER,
F. J. BOESSE.

We do not publish Price Lists.

SPECIAL NOTICES.

WANTED—A good jeweler's amalgamator and crusher. Address P. O. Box 3534, N. Y.

WANTED—First-class watchmaker and engraver combined. Address Freeman & Crankshaw, Atlanta, Ga.

WANTED—A competent watchmaker and engraver, also to act as salesman. Address W. G. Bailey, Helena, Montana.

WANTED—A situation by a young man as watch repairer and salesman. Best of references given. Address 11 N. 1st Hill, Batavia, N. Y.

WANTED—A first-class watchmaker immediately. State wages expected. Address with references, David R. Crosby, Minneapolls, Kausas.

WHAT IS the use of purchasing an imitation celluloid eye-glass and all its defects, when you can buy the genuine article at the same price.

WANTED—A situation by a watchmaker, jeweler and watch case repairer. Can do all kinds of jobbing and repairing as good as any other man. Address Thos. H.aner, Montgomery, N. Y.

ONE OF THE most skilled watchmakers of Philadelphia will take an apprentice for \$100 in advance, or one who will work one year free and give security. Address Pivot, care Jewelers' Circular.

A GENTLEMAN of ten years' experience in the manufacture and sale of watches and jewelry, desires a position to represent a reliable house on the road. Address Traveler, care Jewelers' Circular.

MAIER & DELKIN, Atlanta, Ga., wholesale dealers in watchmakers' and jewelers' tools and materials. Manufacturing, repairing and engraving done for the trade. Medals and badges a specialty.

WANTED—A reliable and experienced traveling salesman to travel for a first-class jobbing house. One who is familiar with the jewelry trade in N. Y., Penn. and Ohio. Address A. and C., care Jewelers' Circular.

MOSELEY & CO., Elgin, Ill., manufacturers of the "Moseley" Lathe, with full line of fixtures and attachments. Designed especially for the watchmaker and repairer. Combining accuracy, durability, convenience and style.

WANTED—A situation by a first-class watch repairer where there is plenty work and plenty pay. 21 years' experience at the bench most of the time at trade work. Satisfactory reference. Address H. E. J., care Jewelers' Circular.

FOR SALE—Splendid regulator, good as new, French movement in walnut case; 7 feet long, 22 inches wide; has gridiron pendulum, beats seconds, sweep second hand will take \$45.00 cash for it. Address Jeweler, box 2116, Aurora, Ill.

WANTED—A situation by a fine workman of 15 years' experience, accustomed to the fine watch work in city stores. Is sober and steady. Best of references and can come immediately. Address and state your price, Clyde, Jr., care this paper.

FOR SALE—A well established jewelry business in a town of 2,000 situated in Northern Illinois. Stock invoices about \$2,000. No competition. Good reason for selling. Good opening for any one wishing to start into business. Address for particulars Biz. care of Jewelers' Circular.

OUR NEW PLATING—Cannot be told from silver, wears longer and does not tarnish. One dozen pieces can be plated in five minutes for eight cents. Receipt for 50 cents, or receipt with receipts for gold, silver and nickel plating, \$1.00. Address O. S. Judd, spencerville, Ohio.

I AM NOW receiving difficult work from the finest jewelry stores in America, by the case, and very complimentary letters. Thanks, gentlemen, I will try to please you and merit all you say. Yours, truly, W. F. A. Woodcock, fine watchmaker to the trade, 83 Balto street, Cumberland, Md.

WANTED—A live, active young man to repair watches, jewelry and clocks. Prefer one that can engrave and sell goods, willing to work and take an interest in the business. None need apply but first-class workman who can give best of references. Thomas B. Fenton, Daubury, Conn.

WATCHMAKER—Wanted by September 1st, in a large retail jewelry house, an experienced practical man of good address to take charge of the watch repairing department, to receive and deliver work. Address in hand-writing of applicant, Retail Jeweler, office of The Jewelers' Circular.

GEORGE E. WILKINS, manufacturer and importer of cutters for watchmakers' use, stem-winding cutters of all the different forms, rounding up cutters of the finest quality, also ratchet cutters. A large stock of second hand and new marine chronometers. No. 21 South Salina street, Syracuse, N. Y.

EUREKA—A new tool that every watchmaker must have. "Hair Spring Collet Remover." It will remove the collet without defacing balance arm, or damaging hair spring. Try one and you will not be without it. Sent to any address on receipt of 25 cents. Every tool warranted. F. A. Hubbard, Brattleboro Vt.

FOR SALE—Watch and jewelry business, located at Prattsburgh, N. Y. New store; best location in the village; rent low; large run of repairing; no competition within 10 miles. Must sell at once as I have business interests in the west which demand my immediate attention. Address Wm. Tall, Prattsburgh, N. Y.

WANTED—A traveling man who has had experience selling a general line of watches, gold and plated jewelry, spectacles and goods usually kept in retail stores. Must be familiar with the trade in central and southern New York and northern Pennsylvania. Address with reference, Joseph Seymour, Sons & Co., Syracuse, N. Y.

WANTED—A competent salesman, engraver and jeweler, or watchmaker and engraver. Must be a good salesman. Permanent position by the year. Will pay from \$100 to \$150. None but reliable and experienced men need apply. Prefer a man who has been in business for himself. Address E. Hertzberg, San Antonio, Texas.

WANTED—A competent watch repairer and engraver will be furnished with use of boat and his lug tackle and board in a comfortable home on Blue Mountain Lake, in the Adirondack Wilderness, in return for instruction in watch repairing and engraving. Must be a practical man. Address F. H. Bassett, Blue Mountain Lake, Hamilton Co., N. Y.

FOR SALE—A watch, clock and jewelry business, twenty years established in the thriving village Jamaica Plain, ward 23, Boston, Mass. 15,000 inhabitants; good run of work and trade; plate glass windows; low rent. I wish to sell on or to engage in other business. Apply to E. H. Fairbanks, watchmaker, Centre street, Jamaica Plain, Mass.

ON RECEIPT of one dollar (\$1.00), I will send to any address a tool by mail, post paid, such as we used at the Elgin Watch Factory. It is invaluable to a practical or amateur watchmaker. It makes staff and pivot work easy, and is within the reach of all. Address F. P. Bishop, Pres't Michigan Retail Jewelers' Association, Litchfield, Hillsdale Co., Mich.

FOR SALE AT A BARGAIN—A good little jewelry store, 12 x 35, well fitted up for business, gas for lights and fuel; best location in city; 10,000 inhabitants; six railroads, manufacturing, etc. N. Y. time received every day at noon in store by private wire. Will reduce stock and fixtures to \$1,500 if necessary. Address, Jeweler, Lock Box 1334, Brautord, Pa.

READ THIS—\$5,000 to \$8,000 will buy a jewelry and fancy goods business, which paid over 50 per cent. on investment last year, ending May 1st, 1883. Situated at Caro, county seat of Tuscola Co., Michigan. Very thriving town; several new brick blocks in course of erection now. Population about 2,000. For particulars call or address Lock Box No. 6, Caro, Mich.

FOR SALE—The stock and fixtures of a jewelry store in a thriving town of 6,000 in central Pennsylvania. Stock and fixtures about \$4,000, but can be reduced to \$2,500. A splendid opportunity for the right man. Good trade and work enough for two men. Reason for selling poor health. Must have an out-door business. Address F. A. Fiedler, Jeweler, Milton, Penna.

FOR SALE—Stock and fixtures of the oldest established jewelry house in Des Moines, Iowa. City of 35,000. The stock will invoice about \$7,000, and is clean, new and in good shape. Can transfer a valuable lease of an elegant brick house, heated with steam, and all other modern improvements. The best location in the city. Best reasons given for selling. Address T. L. Rogg, Des Moines, Iowa.

FOR SALE—The one-half interest of a thoroughly established jewelry, watch and diamond business in a manufacturing and commercial city of over 200,000 inhabitants. Cash capital required, \$15,000 to \$25,000. The object is to increase the business and to be relieved of the responsibility somewhat. Only a thoroughly reliable competent party would be accepted. Address Business, care Jewelers' Circular.

NEW TOOLS—We now have ready for the trade a set of 15 different size millers for countersinking, end snaking, etc., price 25 cents each, \$3.00 per set. Also F. W. Hall's new material case, will hold 55 different kinds with each space numbered and indexed. Finished in soft wood, \$1.00 each; hard wood polished, \$1.50. Ask your jobber for them or send direct to manufacturers, J. G. Hall Mfg Co., Roxbury, Vermont.

FOR SALE—The stock and fixtures of the leading jewelry store in an Ohio town of 8,000 inhabitants. Stock of watches, clocks, jewelry, silverware and optical goods. Fixtures, fire and burglar proof safe, fine show cases, regulators, etc. All the work two men can do for railroads, coal mining and manufacturing. Doing a paying business, but will sell at a bargain, in order to change climate on account of asthma. Address M. T. W., care Jewelers' Circular.

FOR SALE—The best opportunity for a watchmaker who may wish to step into a good steady paying business, and have things his own way, and in one of the healthiest and best business towns in southern Kentucky, of 1500 population and no competition within twenty miles. Business established eighteen years. Stock and fixtures reduced to about \$2,000. This is a very rare opportunity and will not be offered after the 15th of August. Address Watchmaker, care of Jewelers' Circular.

A VERY SUPERIOR quality of watch and clock oil, pronounced to be the best by competent authorities, and awarded the first prizes at the exhibitions held at Halle, Germany, in 1881, Chaux-de-Fonds, Switzerland, in 1882, Paris, France, in 1881, and Munich, Germany, in 1882, and tested at the Governmental Chemical Laboratories in Dresden, Carlsruhe and Paris, and found to leave absolutely nothing to be desired. Is manufactured by Wilhelm Cuyper, Dresden, Germany, and to be had of the representative in the United States, H. Horeud, 15 Malden Lane, New York.

BUYERS' DIRECTORY.

NEW YORK.

Assayers and Sweep Smelters.

Wundoehl, H.—Gold and Silver Refiner, Assayer and Sweep Smelter. 21 John Street, N. Y.

Badges and Medals.

Stockwell & Newman—19 John Street. Manufacturers of Badges, Medals and Presentation Pieces in Gold and Silver. Also Jewelry and Mounters of Diamonds. Designs supplied.

Wilkinson, C. B.—Manufacturing Jeweler, 8 John Street, N. Y. Medals, Badges and Masonic Jewelry a Specialty. Designs furnished free upon application.

Band Rings.

Knapp, Charles, 41 Maiden Lane, N. Y. Specialty: Superior Band Rings, also Ring Shanks & Heads for Seal and Diamond Rings.

Black Onyx Jewelry.

Cox & Sedgwick—Manufacturers of Black Onyx Jewelry, No. 26 John St. New York.

Lawson, Samuel—No. 18 John Street. Manufacturer of Black Onyx Jewelry. Coral repaired for the trade. Goods sent on approval to responsible dealers.

Woglom & Miller—Manufacturers of (exclusively) Black Onyx Jewelry, 32 & 34 John St., N. Y.

Blue Enameled Lockets.

Bissinger, Philip & Co.—Importers of Diamonds, Pearls and Precious Stones. Agent for the Bohemian Garnet Goods. Blue Enameled Lockets, 22 John St., N. Y.

Hess & Schliesser—Importers of Diamonds, Fine Jewelry and Novelties in French Goods. Specialties: Gold and Blue Enameled Lockets, Charms and Crosses. 25 Maiden Lane.

Bohemian Garnet Jewelry.

Bissinger, Philip & Co.—Importers of Diamonds, Pearls and Precious Stones. Sole Agent for the Bohemian Garnet Jewelry. Blue Enameled Lockets. 22 John St.

Boxes, Wood Mailing and Nested.

Maine Manufacturing Co.—Successors to Swift Mfg Co., makers of Wood Mailing and Nested Boxes for Mailing and Express purposes. J. Spencer Taylor, Agent, 18 Courtlandt St., N. Y.

Wiesbauer, J.—Manufacturer of the Sliding Cover Wood Mailing Boxes. All Sizes Made to Order. Buffalo, N. Y.

Clock Companies.

Ansonia Clock Co.—Manufacturers of every description of Clocks. 11 to 21 Cliff street, New York.

Kroeber, F.—Manufacturer and Dealer in American and French Clocks, No. 8 Cortlandt Street.

New Haven Clock Co.—16 and 18 Park Place, N. Y.

Seth Thomas Clock Co.—20 Murray Street, N. Y.

Waterbury Clock Co.—M. Bailey, Treasurer, Manuf and Jobbers, No. 4 Cortland St., N. Y., and No. 197 State Street, Chicago.

Wm. L. Gilbert Clock Co.—No. 6 Murray Street, Manufacturers of Clocks. Factories, Winsted, Conn.

Yale Clock Co.—Manufacturers of Novelties in Clocks, 52 Maiden Lane, N. Y.

Corals and Coral Jewelry.

Cuppia, L. A.—Importer of Coral and Silver Filigree Jewelry, 19 Union Square, N. Y.

Cameo Cutters, Etc.

Peiter, Theodore—Cameo and Intaglio Engraver. Patentee of the Cameo-Intaglio. No. 2 Bond Street, near Broadway, Room 4 New York.

Charms & Gold Watch Keys.

Rupp & Held—Manufacturing Jewelers, Charms and Gold Watch Keys, with French and English Ratchets, a specialty. 15 John St., N. Y.

Crucibles.

Berge, J. & H.—Established 1850, Manufacturers and Importers of Sand Crucibles, Covers, Chemical Porcelain, Glassware, and Jewelers' and Assayers' Supplies, 95 John Street, N. Y.

Berge, J. & Son—Importers of Sand Crucibles and Covers, Jewelers' Tools and Materials. Manufacturers of Berge's Improved Assay and Enamel Furnace, Assay and Enamel Muffles, &c. 32 and 34 John Street, N. Y.

Cutlery.

Harrison Bros. & Howson—Manufacturers of Fine Ivory and Pearl Table and Pocket Cutlery, Carvers in Cases; Nutpicks, Nutcracks and goods suitable for the jewelry trade. 126 Chambers Street. W. C. Burkinshaw, Sole Agent.

Diamond Brokers.

Anderson, Otis—Diamond Merchant and Broker, always ready to pay cash for bargains in Diamonds and Precious Stones, 4 & 6 John Street, N. Y.

Bernhardt, Richard—Diamond Broker and Importer, 65 Nassau Street (Room 6), N. Y. Paris, 20, rue des Petites-Écuries.

Friend S. & Son—Brokers and dealers in Diamonds 33 John Street, cor. Nassau St. New York.

Herbert, R. J.—Diamond Broker and Dealer. 26 Maiden Lane.

Diamond Importers.

Bissinger, Philip & Co.—Importers of Diamonds, Pearls and Precious Stones. Agent for the Bohemian Garnet Goods. Blue Enamelled Lockets. No. 22 John St., N. Y.

Bruhl, D. & M.—Established 1848. Importers of Diamonds and Precious Stones. 14 Maiden Lane, New York. Branch office, Paris. Also 111 Broad Street, Providence, R. I.

Brunswick, S. & Co.—Importers of Diamonds. 17 Maiden Lane, New York. Paris, Rue Lafayette. Amsterdam, Damstraat.

Citroen, L. B., & Co.—Diamonds. 21 John St., N. Y. Cutting Works, 57 & 61 Rapenburgerstraat, Amsterdam. House in Paris, 44 Rue Laffitte.

Engelmann, M. & Co.—Importers of Diamonds, Pearls and Precious Stones. Specialties in Fine Colored Stones. 192 Broadway and 1 and 3 John Street, N. Y. Paris, 1 Boulevard St. Denis.

Faulkenau, Oppenheimer & Co.—Manufacturers. Diamonds and Diamond Jewelry. 40 Maiden Lane, N. Y.

Fera, Henry—Importer of Diamonds, and Manufacturer of Fine Diamond Jewelry. 4 & 6 John Street, New York. Amsterdam, Holland, 23 Loojersgracht.

Fox, M. & Co.—Importers of Diamonds, Rubies, Sapphires and Fancy Gems. No. 1 Maiden Lane, New York.

Hedges, Wm. S. & Co.—Importers of Diamonds, No. 170 Broadway, corner Maiden Lane.

Kuhn, Doerflinger, & Co.—Manufacturing Jewelers and Importers of Diamonds, 18 John Street, New York.

Neresheimer, E. Aug. & Co.—Importer of Diamonds. No. 21 Maiden Lane, New York.

Randel, Baremore & Billings—Importers of Diamonds, corner Maiden Lane and Nassau St.

Saunders & Ives—Importers of Diamonds and other Precious Stones. No. 26 Maiden Lane.

Smith, Alfred H. & Co.—Importers of Diamonds, No. 182 Broadway.

Taylor & Brother—Importers of Diamonds and Diamond Jewelry. 676 Broadway.

Wickham, D. H. & Co.—Importer of Diamonds. No. 31 Holborn Viaduct, London, 24 Maiden Lane, New York.

Wolff, G. A.—Importer of Diamonds, Rubies, Sapphires, Pearls, and other Precious Stones, 65 Maiden Lane, New York. 12 Rue de Chateaudun, Paris.

Diamond Jewelry.

Bernhard, A. & Co.—Importers of Diamonds and Manufacturers of First-Class Diamond Jewelry. Diamond Settings for Manufacturing Jewelers. Design Sheets for the Trade free of charge. 2 Maiden Lane, New York.

Bornemann, Louis—Importer of Diamonds and Manufacturer of Rich Diamond Jewelry, 19 John Street, New York.

Chalumeau, D.—Diamond Jeweler and Manufacturer of Mountings. Novelties and Artistic Jewelry. No. 3 Maiden Lane, New York.

Hartje, G. & F.—Manufacturers of Diamond and Fine Jewelry, 39 Union Square, N. Y.

Heller & Bardel—Manufacturers of Diamond and Pearl Jewelry, and Dealers in Diamonds, Pearls, &c. 13 John Street.

Jeanne Brothers—Manufacturers of Diamond Mountings & Rich Jewelry. 1 Maiden Lane.

Lacroix & Verpillier—Manufacturers of Fine Gold Jewelry. Diamonds a specialty. 173 Broadway, N. Y.

Schilling & Nissen—Dealers in Diamonds and Diamond Jewelry. No. 51 Nassau Street, New York, near Maiden Lane.

Voelker, C. T.—Manufacturer of 18-k. Diamond Mountings, Diamond Jewelry and Roller Chain Bracelets. 189 Broadway, New York.

Waterman & Lehmann—Manufacturing Jewelers and Dealers in Diamonds. Diamond Work, and Fine fancy Rings a specialty, any piece of single work made to order. 37 Maiden Lane, N. Y.

Diamond and Pearl Setter, &c.

Archibald, Wm.—Diamond Setter for the Trade. Cameos, Pearls, Turquoises, Garnets, Amethysts, Doublets, Foil Backs, white and colored, Imitation Stones. 73 Nassau Street, N. Y., room 7.

Diamond Cutters.

Levy, Herman—Importer, Cutter and Polisher of Diamonds. 105 Fulton Street, New York.

Dials, &c.

Farnsworth, C. E. & Co.—Successors to Jno. T. Gold, Manufacturers and Jobbers in Fine Watch Dials. 81 Nassau St., N. Y.

New York Dial Co.—Manufacturers of Fine Watch Dials. Henry Abbott, Agent, No. 7 Maiden Lane, N. Y.

Enameled Clock Dials and Figures.

Caeser Bros.—Manufacturers of Enameled Clock Dials, also letters and numbers for signs. 230 and 232 East 25th Street, New York.

Enamelers, Etc.

Nutt, J. D.—Enameler on Gold, Silver, and Copper. Linen finished Buttons and Studs. Enameling in colors. 32 and 34 John Street, New York.

Orr, J. C.—Enameler on Fine Jewelry. Enameled in Colors. Linen Finished Buttons and Studs. Band Bracelets. No. 75 Nassau Street, N. Y.

Electroplaters, &c.

Jeandheur, F. & Son—Gold and Silver Electro Platers & Fire Gilders, coloring Etruscan and Gold Jewelry a specialty. 125 Fulton St.

Engravers—Stone Seal, Etc.

Fackner, Edward—Carver, Engraver and Chaser on Jewelry and Pencil Cases, lettering, &c., 19 John Street.

Holland & Gosling—Stone Seal Engravers. Precious Stones inlaid and encrusted with Diamonds. No. 176 Broadway, New York, (fifth floor per elevator). Cameos cut and repaired.

Knapp, Chas. Engraver, Die Sinker & Stamper for Jewelry purposes. Ring Shanks & superior Band rings, 41 Maiden Lane, N. Y.

Meister, H.—Engraver and Chaser on Fine Jewelry, Badges, Monograms, Coats of Arms, etc.; also Enameling, Coloring and Polishing. No. 59 Nassau Street, New York.

Park, Wm.—The Stone Seal Engraver. Arms, Crests, Monograms, etc., engraved on precious stones, 26 John Street, New York.

Weston, James F.—Stone Seal Engraver and in-cruster of Precious Stones. Coats of Arms, Masonic, Odd Fellows, and other devices engraved. 32 John Street.

Fancy Goods, Clocks, Bronzes, Etc.

Le Boutillier & Co.—Importers of Fancy Goods, Clocks, Bronzes, &c., 3 Union Square.

Straus, L. & Sons—Importers of Potteries, Faïences, Bisque Figures and Rich Fancy Goods especially adapted for the Jewelry Trade. 40, 42 and 44 Warren Street, New York.

Taylor & Bro.—Importers of French Clocks, Bronzes, etc. 676 Broadway, N. Y.

Gold and Silver Cane Heads.

Simons, Bro. & Co.—Manufacturers of Gold Headed Canes. 611 and 613 Sansom street, Philadelphia.

Gold and Silver Plating, Etc.

Bantle, A.—Gold, Silver and Electro-Plating, 130 Fulton and 89 Nassau Streets, cor. Fulton Street, (Room 36), N. Y. Watch Case Polishing.

Gold Chains, Etc.

Beck, J. & Son, Manufacturers of Fine Gold Chains and Chain Bracelets, 10 Liberty Place, near Maiden Lane, N. Y.

Carter, Sloan & Co.—Manufacturers of Fine Gold Chain, 15 Maiden Lane, New York.

Dorrance, Edge & Co.—Manufacturers of the Celebrated Woven Fabric Gold Chain, No. 15 John Street.

Kaufmann Bros.—Manufacturers of Gold Chains, and Chain Bracelets, 26 John Street; Factory, 331 and 333 Bowery, N. Y.

Kohn, Alois & Co.—Manufacturers of Gold Chains. 9 Maiden Lane, N. Y.

Nordt, Charles—Successor to Nordt & Schlag, manufacturer of Gold Chains and Chain Bracelets. Jobbing and Refilling Old Chains promptly attended to. No. 17 Maiden Lane, N. Y.

Saxton, Smith & Co.—Manufacturers of Fine Gold Chain, No. 14 John Street, N. Y.

Schlag, Chas.—Late Nordt & Schlag, Manufacturer of Gold Chains, Chain Bracelets, and Fine Jewelry, 177 Broadway, N. Y.

Smith, W. & Co.—Manufacturers of Gold and Silver Chains, Jewelry, etc. No. 25 Maiden Lane, N. Y.

Gold Pens, Etc.

Aikin, Lambert & Co.—Manufacturers of Choice Gold Pens, Cases, Holders, Toothpicks, etc., 23 Maiden Lane, N. Y.

Faber, Eberhard—Manufacturer of 16-karat Gold Pens and Pencil Cases, Nos. 718 and 720 Broadway, N. Y.

Fairchild, Leroy W.—Manufacturer of Gold Pens, Pencil Cases, Tooth Picks and Novelties in Charms. No. 18 John St., N. Y.

Johnson, E. S. & Co.—Manufacturers of Gold Pens, Pen Holders and Pencils. Cor. Maiden Lane and Nassau Street, New York.

Ray Manufacturing Co.—Gold Pens Manufactured and Stamped for the Trade. Also Pencil and Pen Cases, Tooth-picks, etc. Office, Sales-rooms and Factories, 94 and 96 Nassau street, 129, 131 and 133 Fulton street.

Smith, H. M. & Co.—Manufacturers of Gold Pens and Holders, Tooth Picks, Pencils, etc. Sole Manufacturers of Sprague's Patent Gold Fountain Pen. Importers of Nickel and Silver Watches. 173 Broadway, New York.

Gold Rings.

Barnet Bros. & Powell—Manufacturers of Stone and Seal Rings, 15 John Street, New York. Factory, Newark, N. J.

Bowden, J. B. & Co.—Manufacturing Jeweler.—Solid Gold Rings a specialty, 1 Maiden Lane.

Ely, W. H.—Manufacturer of Solid Gold Rings of every description. No. 58 Nassau Street.

Henrich, R.—Manufacturer of Gold Rings. No. 35 Maiden Lane, N. Y.

Hildreth, H. P.—Manufacturer of Solid Gold Rings, Plain and Ornamental. No. 10 John St.

Kroll, H.—Manufacturing Jeweler. 78 Nassau Street, New York. Specialty: Solid Gold Stone Rings. All kinds of Fine Jewelry made to order, also Repairing for the Trade.

Ostby & Barton—Manufacturers of Plain and Engraved Solid Gold Band Rings. Office, 176 Broadway, N. Y. Factory, 80 Clifford Street, Providence, R. I.

Peckham, Wm. H.—Manufacturers of Solid Gold Seamless Rings, and Fancy Embossed Rings, Patent Spectacles, Jewelry, etc. No. 4 Liberty Place N. Y.

Radler, K.—Manufacturing Jeweler. Gold Rings and Lockets a specialty. No. 39 Maiden Lane, New York.

Sauter, L.—No. 1 Maiden Lane, New York, Manufacturer of Stone Rings of every description, as Diamond, Cameo, Onyx Turquoise, etc., Scarf Pins, Scarf Rings, Studs and Buttons.

Shafer & Douglass—Manufacturers of all kinds of Seal, Stone, Turquoise, and fancy rings. No. 7 Maiden Lane, N. Y.

Sinnock & Sherrill—Manufacturers of Stone Rings. No. 3 Maiden Lane, N. Y.

Thurner & Church—Manufacturers of Fine Gold Rings. No. 9 Maiden Lane, N. Y.

Hair Jewelry.

Bernhard, A. & Co.—Manufacturers of Fine Hair Jewelry. Pattern Book of 2,700 designs free of charge to the First-class Trade. 2 Maiden Lane, New York.

Moutoux, Wm. E. & Co.—Manufacturers of Fine Hair Mountings in Gold. Grand catalogues for the trade. 81 Nassau St., Rooms 1 and 2. Finest work and lowest prices.

Sauter, L.—Manufacturer of Fine Gold and Hair Jewelry and Device Work. Pattern Book sent on application. No. 1 Maiden Lane, N. Y.

Schwencke O.—Manufacturer of Fine Hair Jewelry Orders from the country promptly attended to. No. 43 Maiden Lane.

Jewelry Cases, Fancy Boxes, Etc.

American Morocco Case Co.—7 and 9 Bond St., N. Y., make a specialty of Rich Jewelry and Silverware Cases for the fine Retail Trade. Also Improved Trays for Watches, Rings, etc.

Bleyle, A.—Manufacturer of Jewelry and Silverware Boxes, Jewelers' Traveling Cases, etc. Trays for Show Cases and Trunks, Ladies' and Gent's Jewel, Glove and Handkerchief Boxes, &c., &c., 80 Nassau street, N. Y.

Braun, Chr. E.—Manufacturer of Fine Jewelry Boxes and Trays for Show Cases and Trunks. No. 62 Chatham Street, New York. Trays for Show Cases and Trunks a Specialty.

Bricka, C. A.—Manufacturer of Morocco Cases for Cutlery, Silverware, Jewelry, etc. Sample Cards and Rolls. Cases in Rosewood, Black Walnut, etc. 52 Nassau Street, New York.

Dennison Mfg Co.—Manufacturers of Morocco, Plush and Velvet Jewelry and Silverware cases. New York, Boston, Philadelphia, Chicago, Cincinnati and St. Louis.

Ettlinger, L. & Sons.—Manufacturers of Fine Cases for Jewelry, Watches and Silverware. Trays for Travelers and Show Cases. Cases to Order a Specialty. No. 80 Nassau St., N. Y.

Haensler, Chas. C.—Manufacturer of Fine Morocco Cases for Jewelry and Silverware. Toilet Boxes, etc. Trays for Show Cases and Windows. 14 John Street, New York.

Jackson, S. C., 180 Broadway, N. Y., Manufacturer of Fine Cases for Jewelry, Silverware, &c.

Kohn, Solomon & Co.—Manufacturers of Fine Morocco Cases for Jewelry, Watches, etc. 43 Maiden Lane, New York.

Krumpel, C.—Manufacturer of Fine Morocco and Plush Cases for Watches, Jewelry, Silverware, etc. 169 William Street, Room 11, New York. Trays for Jewelers and Sample Trays for Travelers a specialty.

Lauten, Edw. A. & Co.—No. 4 Great Jones St., Manufacturers of Fine Velvet, Brocade, Plush and Morocco Boxes, Patent Ring, Ear Ring and Gent's Scarf Pin Trays, Patent Watch and Bracelet Blocks, Window Decorations, etc.

Loehr & Koerner—Manufacturers of Morocco, Velvet, Satin, Jewelry, Watches and Silverware Cases, Jewel, Work Boxes, etc., Fancy Trays and Store Fittings to order. 96 Liberty St.

Metropolitan Fancy Box and Leather Goods Manufactory—Makers of Plush, Velvet, Satin and Leather Cases for Watches, Jewelry, Silverware, etc. 75 and 77 Nassau Street, N. Y.

New York Morocco Case Co.—Cases for Jewelry, Watches, Silverware. Boxes and Trays for Jewelers' Travelers. Show Cases and Window Fittings. No. 69 Nassau Street, New York.

Schien, Charles E.—Manufacturer of Cases for Jewelry and Silverware, No. 85 Nassau St., N. Y. Show Case Trays, etc., at short notice.

Schwarz, N.—Manufacturer of fine Cases for Jewelry and Silverware, 866 Broadway, near 17th street, N. Y.

Steinle, E.—Manufacturer of Cases for Jewelry of all kinds. Also Cases for Mathematical and Surgical Instruments and for Trays for Travelers' Trunks, etc. 66 Nassau Street, N. Y.

Welch & Miller—169 Broadway. Manufacturers of fine Morocco, Velvet, Russia, Brocade and Plush Jewelry Cases. Trays of every description; Jeweler's Cotton and Twine; Telescope Sample Cases with Flexible Trays. 169 Broadway, N. Y.

Wiggers & Froelich—No. 60 Nassau street—Manufacturers of Cases for Jewelry, &c., of every description. Trays for Show-cases, Stands for Show-windows, etc.

Jewelers' Findings.

Dennison Mfg Co.—Paper Jewelry Boxes, cards, tags, pink and white cotton, etc. etc. New York, Boston, Chicago, Cincinnati, Philadelphia, St. Louis.

Ettlinger, L. & Sons.—Manufacturers of Jewelers' Paper Boxes and Findings. Morocco Paper, Satin or Plush Lined Wooden Corner Stops Jewelry and Silverware Boxes. 80 Nassau Street, New York.

Lehmann, Ludwig.—Manufacturer of Jewelers' Findings. Tags, Pink and White Cotton, and Tissue Paper. Specialty, Fine Paper Boxes for Jewelers and Silversmiths. 122 Fulton Street.

Valfer, S. & Co.—Manufacturers and Dealers in Jewelers' Boxes, Tags, Cards, Paper and Findings. Trays a specialty. Office and Salesroom, 66 Nassau street, New York.

Jewelry Manufacturers.

Aikin, Lambert & Co.—Manufacturers General stock of Reliable Jewelry, 23 Maiden Lane.

Alford, C. G. & Co.—Manufacturers. General line fine and Reliable Goods. Specialties in Onyx Goods and Chain. 200 Broadway, New York.

Alling, Isaac A. & Co.—Manufacturers of Fine Gold Jewelry. Sets, Lace Pins, Ear Rings, Studs, Collar Buttons and Scarf Pins. Specialties: Wire Bracelets, Bangles, American Lever Sleeve Buttons. Bryant Building, Nassau and Liberty Streets, N. Y. Factory, Newark, N. J.

Baldwin, Sexton & Peterson—Makers of Fine Jewelry and Importers of Diamonds, etc., corner Broadway and Fourth Street.

Ball, W. H.—Manufacturer of Gold Jewelry. Bracelets and Bangles of all kinds a specialty. 9 John Street, N. Y.

Barthman, Straat & Co.—Manufacturers of Fine Jewelry. Roman Goods, Rings, Diamonds. No. 43 Maiden Lane.

Bernhard, A. & Co.—Manufacturers of General Fine Work. Specialties: Diamond Jewelry, Diamond Settings, Hair Jewelry, Fancy Rings, Rose Diamond Monogram and Onyx Work. 2 Maiden Lane, New York.

Brown, Thos. G. & Sons—Man'rs of Rich Jewelry Necklaces, Locketts, Bracelets, Sleeve Buttons, etc., 5 Bond Street, N. Y.

Bryant & Bentley—Manufacturing Jewelers. Rings a specialty. 12 Maiden Lane

Carter, Sloan & Co.—Manufacturing Jewelers, 15 Maiden Lane, New York.

Champanois & Co.—No. 5 Maiden Lane, manufacturers of Engraved and Enameled Gold goods, in Sets, Ear Knobs, Bracelets, Studs, Lace and Shawl Pins, Jet cluster and Onyx goods, also "Best Lever" Sleeve Buttons.

Chatellier, Joseph F.—Manufacturing Jeweler, No. 694 Broadway, N. Y.

Churchill, Lewis & Co.—Manufacturers of Fine Jewelry. 692 Broadway, cor. Fourth St., N. Y.

Cook, Groeschel & Co.—Manufacturers of Fine Jewelry and Locketts, 191 Broadway (over Mercantile Bank,) N. Y.

Cottle S. Co.—Manufacturers of Fine Jewelry. Waltham Building, 5 Bond Street, N. Y.

Cox & Sedgwick—Manufacturers of fine Onyx and Colored Jewelry. 26 John St., New York

Day & Clark—Manufacturers of Fine Jewelry, Lace Pins, Ear Rings, Studs, Locketts, &c., 10 Maiden Lane, New York.

Geoffroy, Arthur R. & Co.—Manufacturing Jewelers. Novelties in Diamond Goods. No. 23 Maiden Lane, N. Y.

Goddard, John M.—Manufacturing Jeweler,—Seal Rings and Fine Locketts a specialty, No. 3 Maiden Lane, N. Y.

Goldsmith & Cohen—Manufacturing Jewelers, 3 Maiden Lane, New York.

Greason J. R. & Co.—Successors to Arthur, Rumrill & Co., 182 Broadway. Manufacturers of Fine Jewelry and Gold Chains, also Diamond Mountings.

Greene Wm. C. & Co.—Goldsmiths; Manufacturers of Rich Sets in Taper Wire Coral. Office, 192 Broadway.

Hale, S. W. & Co.—Manufacturers Rich Jewelry, Whiting Building, Broadway and 4th Street.

Hartmann, P.—Manufacturer & Importer of Fine Gold, Diamond, and Filigree Silver Jewelry, No. 36 Maiden Lane. P. O. Box 2,454.

Haskell, H. C.—Manufacturing Jeweler. Seal Rings a specialty. Special attention to Jobbing of every description. 12 John street.

Hedges, A. J. & Co.—Manufacturing Jewelers, 6 Maiden Lane.

Henderson & Winter—Jewelers, No. 15 Maiden Lane, New York. Specialties—Stone, Cameo, Onyx, Amethyst, Topaz, Pearl and Turquoise Rings.

Hunt & Owen.—Manufacturing Jewelers. Office 3 Maiden Lane.

Kennedy, Frank S.—Manufacturer and Wholesale Dealer in Jewelry and Gold and Silver Thimbles. No. 13 Maiden Lane, New York.

Kremetz & Co.—Manufacturing Jewelers. No. 182 Broadway. N. Y.

Kuhn, Doerflinger & Co.—Manufacturers of Enameled and Roman Band Bracelets, also Fine Locketts Pendants and Lace Pins. 18 John street.

Lennon, John D.—Manufacturing Jeweler, 142 Fulton Street. Stone Locketts and Rings; also Badges and Emblems of all kinds.

Miller Bros.—Manufacturers of Fine Jewelry, Locketts, Sleeve Buttons, Studs, &c., 7 Maiden Lane, N. Y.

Moore & Horton.—11 Maiden Lane, Manufacturing Jewelers, Rings, Studs, Collars and Sleeve Buttons, Pins, Ear-rings, &c.

Muhr's, H., Sons.—Manufacturing Jewelers. Solid Gold and Filled Rings a specialty. Also Manufacturers of the celebrated Crown Filled Watch Case. 1½ Maiden Lane, N. Y.

Owen, G. & S. & Co.—Manufacturing Jewelers. Office, No. 3 Maiden Lane.

Richardson, Enos & Co.—Manufacturers of Fine Gold Jewelry, Gold Chains, Locketts, Crosses and Necklaces. Colored and Etruscan Work. No. 23 Maiden Lane, New York.

Richardson, J. W. & Co.—Manufacturers of Jewelry. Masonic and other Emblems. 196 Broadway, N. Y. Manufactory, Providence, R. I.

Riley, J. A. & Co.—Manufacturing Jewelers. Etruscan Gold and Roman Bracelets, Lace Pins, Ear Rings, Scarf Pins, Brooch Pins, etc. Nos. 7 and 9 Bond Street, N. Y.

Ripley, Howland & Co.—Manufacturers of Fine Jewelry and Platinum Tipped Diamond Settings. No. 17 Maiden Lane, N. Y.

Sauter, L.—Manufacturer of Fine Jewelry, Solid Stone Rings and Studs a specialty. Jobbing for the trade. 1 Maiden Lane, New York.

Sexton & Cole—Manufacturing Jewelers, Colored Gold and Onyx Goods a specialty. No. 30 Maiden Lane.

Shafer & Douglas, Manufacturing Jewelers—Roman Goods, Lace Pins, Cameo Sets, etc., Stone Rings, etc. No. 7 Maiden Lane, N. Y.

Sheafer, W. H. & Co.—Manufacturing Jewelers, Specialty Bangles and Bracelets, 15 John St., N. Y.

Steele, J. W.—Successor to Brainerd, Steele & Co., Manufacturer of Fine Jewelry and Brainerd's Patent Locketts. No. 9 Maiden Lane, N. Y.

Stites, D. H. & Son—Manufacturers of Fine Jewelry, Rolled Plated Goods and Chains, Parisian Diamond Rings, Studs and Earrings a specialty. 41 Maiden Lane, N. Y.

Stites' Sons, E.—Manufacturers of Fine Jewelry. No. 14 John Street, N. Y.

Street, Geo. O. & Sons.—Established 1837. Makers of Fine Jewelry, strictly first-class goods of our own make. No. 15 John Street, New York.

Terhune, Charles F.—Manufacturing Jeweler, 194 Broadway, N. Y.

Thoma, Ernest—Manufacturer of Fine Jewelry, Sleeve Buttons, Rings, Ear-rings, &c. No. 173 Broadway, N. Y. Factory, Hackensack, N. J.

Ward, Thos. M.—Manufacturer of Fine Jewelry, Diamond Mountings a specialty. No. 25 John Street, N. Y.

Wheeler, Parsons & Hays.—Manufacturers of Fine Jewelry, Watch Cases, Gold Chains, &c. and Dealer in American and Swiss Watches, No. 2 Maiden Lane, N. Y.

Wienhold, Joseph—Manufacturer of Fine Jewelry Diamond Mountings a specialty. 24 John St.

Woglom & Miller—Manufacturers of Black Onyx Goods exclusively. 32 & 34 John Street, N. Y.

Jewelry—Rolled Plate.

- Frick, John & Co.**—Fine Rolled Plate Jewelry of all kinds. Repairing of every description. 21 and 23 Maiden Lane, N. Y.
- Mauran, J. T.**—Manufacturer of Fine Rolled Plate Jewelry, No. 15 Maiden Lane, N. Y.
- Richards, E. Ira & Co.**—Manufacturers of Fine Rolled Plate Jewelry, No. 200 Broadway, N. Y.
- Weil, Leopold & Co.**—Manufacturers of Rolled Plate Jewelry of every description, 35 Maiden Lane, N. Y.

Jewelers' Tools, etc.

- Fisher, James J.**—Dealer in Watchmakers' and Jewelers' Materials, Files, Tools, Silk Guards, Spectacles, etc., 697 Broadway, N. Y.
- Frasse & Co.**—Importers of Stubb' French, Swiss, German and Sheffield Tools, Files and Steel Wire for Watchmakers, Jewelers, etc., 62 Chatham street, N. Y.
- Friedenthal, A. & Co.**—Importers and jobbers of Watchmakers' and Jewelers' Tools, Materials, etc. 43 Maiden Lane, N. Y.
- Friedlander, R. & L.**—Importers of Watchmakers Tools and Materials. 65 & 67 Nassau Street. Branch Office, 264 Bowery.
- Kurtz, F. P.**—Manufacturer of Jewelers Machinery, Tools, Rolling Mills, Presses, Polishing Lathes, &c. 97 Cliff St., N. Y.
- Levy, Dreyfus & Co.**—Importers and Jobbers of Watchmakers' and Jewelers tools and materials of every description. 11 Maiden Lane, N. Y.
- Montgomery & Co.**—Importers of and Dealers in Manufacturing Jewelers' Tools and Materials of every description, 105 Fulton street, New York.
- Reichhelm & Koester.**—Importers of Jewelers' Tools, Files, etc. Manufacturers of Brushes and Buffing wheels; also Patent Gas Furnaces for Melting, Plating, Enamelling, Annealing, etc. 80 Nassau St., N. Y.

Lapidaries.

- Fox, M. & Co.**—Practical Lapidaries, No. 1 Maiden Lane, New York.
- Graham & Co.**—Practical Lapidaries, Cutters and Polishers of all kinds of Precious Stones. Miners' Relics Cut, Polished and Mounted. Miniature, Locket and Clock Glasses. 80 Nassau St., N. Y.
- Kordmann & Michel.**—Lapidaries. Dealers in Precious Stones. Cutting and Polishing Rubies, Sapphires and other Gems a specialty. Drilling done promptly. 59 Nassau St., N. Y.
- Korn, Ph.**—Lapidary. Importer of Precious and Imitation Stones, No. 63 Nassau street, between Maiden Lane and John street, New York.

Masonic Jewelry.

- Lennon, John D.**—Manufacturer of Masonic, Odd Fellows, Athletic Clubs and other Jewelry, No. 142 Fulton Street, New York.
- Luther, John F.**—79 Nassau Street. Manufacturer of Fine Presentation Jewels for all Societies. Knights Templars, Crosses, Badges, &c.
- Popper, H.**—Manufacturer of Medals and Badges for Military, G. A. R., Shooting, Masonic, Odd Fellows, Knights of Pythias, etc. 91 Essex St., New York.
- Wilkinson, C. B.**—Manufacturing Jeweler, 8 John St., N. Y. Medals, Badges and Masonic Jewelry, a specialty. Designs furnished free upon application.

Optical Goods.

- Friedlander, R. & L.**—65 and 67 Nassau Street. Dealers in Optical Goods.

Opticians.

- Burbank Manf'g Co.**—Manufacturers of Spectacles and Eye Glasses of all descriptions, in gold, silver, etc., 14 Maiden Lane, N. Y.
- DuBois, Geo. W. & Co.**—Importers of Watches and Optical Goods. 36 Maiden Lane, N. Y.
- Hellfeld, B.**—Manufacturer of Gold Eye-Glasses and Spectacles, 69 Nassau street, New York. Repairs of all kinds for the trade done in the best possible manner.
- Kahn, Hanover & Co.**—Importers of Spectacles, Eye-Glasses and Optical Goods generally, and Scientific Instruments of every description. 32 Maiden Lane, New York.
- Laurencott, J. B.**—Importer of Watch Glasses, Optical and Fancy Goods, Clocks, Bronzes, etc., 33 Maiden Lane, N. Y.

Levy, Dreyfus & Co.—Importers of Spectacles and Eye Glasses and Optical Instruments of every description, No. 11 Maiden Lane, N. Y.

Lorsch, Albert—Manufacturer of the Patent Accommodating Spectacles and Eye Glasses in Gold, Silver and Steel, and other Optical Goods, 37 Maiden Lane, N. Y.

Major, W. E.—Importer of Optical and Fancy Goods, Spectacles, Eye-Glasses, Silk Guards, Opera Glasses, Field Glasses, Telescopes, Etc. Also Dealer in Chains and Jewelers' Findings. No. 42 Maiden Lane, New York.

New York Optical Co.—Manufacturers of Spectacles, Eye-Glasses and Cases, No. 43 Maiden Lane, New York. (P. O. Box 2309).

Spencer Optical Manufacturing Co.—Gold, Silver, Steel, Nickel and Plated Spectacles; Gold, Celluloid, Steel, Nickel and Rubber Eye Glass and Opera Glasses. 13 Maiden Lane, N. Y.

Paper Boxes.

Waterbury Paper and Box Co., 27 to 35 Canal St., Waterbury, Conn., Manufacture Jewelers' and Silversmiths' Fine Paper Boxes. Quality guaranteed to be equal to the best made.

Precious Stones, &c.

Bishop, Victor & Co.—33 Maiden Lane, Importers of Precious Stones, Cameos, &c. Also Manufacturers of Coral Jewelry.

Bissinger, Philip & Co.—Importer of Diamonds, Pearls and Precious Stones. Agent for the Bohemian Garnet Goods. Blue Enameled Lockets. No. 22 John St., N. Y.

Breidenbach, R. A.—Importer of Black Onyx, Cameos, Turquoise, Pearls, Sardonyx, Amethysts, Topaz, Garnets, Opals, Rubies, Sapphires, Cat's Eyes, Hematites, Brilliants, Doublets, etc. 85 Nassau St., N. Y.

Daue, Wm. & Co.—Importer of Precious and Imitation Stones. No. 202 Broadway New York.

Fox, M. & Co.—Importers of Diamonds and other Precious Stones, No. 1 Maiden Lane, N. Y.

Gaet, Jules.—Importer of all Grades of Real and Imitation Stones. 14 John St., N. Y.

Guntzburger Bros.—Manufacturers and importers of Precious Stones—Amethysts, Topaz, Cameos, Garnets, Imitation Diamonds, &c. No. 9 Maiden Lane.

Hahn & Co.—Importers of Precious Stones, Cameos, Onyx, Pearls, Intaglios, Amethysts, Garnets, etc. 64 Nassau Street, New York.

Kahn, L. & M.—Importers of precious and imitation stones. 10 Maiden Lane, N. Y.

Kipling, E. E.—Importer of Precious and Imitation Stones. Manufacturer of the Patent Foil Solid Metal Back Rhine Stone Brilliant. No. 6 Maiden Lane, N. Y.

Kipling, R. A.—Precious and Imitation Stones, No. 24 Maiden Lane, N. Y. Manufacturer Cameos, Agates, Onyx, Etc., Oberstein, Germany. Commission Merchant, 49 Rue De L'Echiquier, Paris.

Tannenbaum, L. & Co.—Importers of Diamonds and Precious Stones. Steam Lapidary Works. Oriental Stones Cut and Polished a specialty. 65 Nassau St., N. Y.

Silverware.

Gorham Manufacturing Co.—Union Square.

Knowles, J. P. & S. M.—Manufacturers of Sterling Silverware, 20 Maiden Lane, N. Y. Factory, Providence, R. I.

Shiebler, Geo. W.—Manufacturer of Sterling Silverware. No. 8 Liberty Place, near Maiden Lane, N. Y.

Whiting Manufacturing Co.—Makers of Sterling Silver Ware. Broadway cor. 4th Street, N. Y.

Wood & Hughes.—Manufacturers of Fine Silverware. 16 John Street, N. Y.

Silver Filigree Jewelry.

Cuppia, L. A.—Manufacturer of Solid Silver Novelties, and Importer of Silver Filigree, 19 Union Square.

Hartmann, P.—Manufacturer of Silver Filigree Jewelry. 36 Maiden Lane, N. Y.

Silver Plated Ware.

Holmes, Booth & Haydens—Manufacturers of Silver-Plated Ware. 47 Chambers Street.

Manhattan Silver Plate Co.—Manufacturers of Silver Plated Ware. Showrooms, 23 John St. Factory, 301 to 305 East 22d St., cor. 2d Ave. Address all communications to Factory.

Meriden Silver Plate Co.—Manufacturers of Fine Silver Plated Ware. No. 30 E. 14th Street, New York.

Middletown Plate Co.—Manufacturers of Superior Electro-Plate. Factories, Middletown, Conn., salesroom, 13 John Street.

Rogers & Bro—Manufacturers of the finest quality of Electro-Plated Ware. 690 Broadway.

Rogers, Smith & Co.—Manufacturers of Fine Electro Plated Ware. No. 46 E. 14th St., N. Y.

Simpson, Hall, Miller & Co.—Manufacturers of fine Silver-Plated Ware. No. 36 E. 14th Street.

Schade, Henry.—Manufacturer of White Metal and Plated Ware. No. 84 John St., N. Y. Price list and catalogue furnished on application.

Webster, E. G. & Bro.—Manufacturers of Fine Silver-Plated Ware. Office and warerooms, 14 Maiden Lane, N. Y.

Show Cases, Etc.

Smith, B. & W. B.—Manufacturers of Patent Improved Dust Proof Show Cases, with Perpendicular Sliding Doors, No. 220 W. 29th St., N. Y.

Spectacle Case Manufacturers.

Bertine, P. D.—Manufacturer of Spectacle Cases, 139 William Street, near Fulton St., New York.

Koenen, A. & Bro.—Manufacturers of Leather Spectacle and Eye-Glass Cases. 81 Nassau St., N. Y.

Stem Winding Attachments.

Abbott, Henry Maker of Stem Winding Attachments, No. 7 Maiden Lane, N. Y.

Thermometers, Etc.

Tagliabue, Giuseppe.—manufacturer of Thermometers, Barometers and Hydrometers. Patentee and sole manufacturer of the U. S. Standard Hydrometer. 302 Pearl Street, near Beekman.

Thimble Manufacturers.

Barker Manuf'g Co.—Makers of Patent Graduated Thimbles, Stiffened Gold, Filled Gold and Rolled Gold, 36 Maiden Lane, N. Y. A. Lyons, Ag't. Factory, 129 Eddy St., Providence, R. I.

Burbank Manuf'g Co.—Manufacturers of Gold and Silver Thimbles, 14 Maiden Lane, N. Y.

Ketcham & McDougall.—Improved Gold and Silver Thimbles, Bryant Building, N. Y.

Simons Bro. & Co.—Manufacturers of Gold and Silver Thimbles, 611 and 613 Sansom Street, Philadelphia.

Woglom & Miller.—Sole Agents for the "Prime" Thimbles in Gold and Silver, manufactured by Ezra C. Prime. 34 John Street, N. Y.

Watch Companies.

American Watch Co.—Robbins & Appleton, No. 5 Bond Street, N. Y.

Lancaster Watch Co.—Manufacturers of Watches. Lancaster, Pa.

The E. Howard Watch and Clock Co.—Cor. Maiden Lane and Nassau Street, N. Y.

Waterbury Watch Co.—Manufacturers of the Waterbury Watch. Factory, Waterbury. Office, 52 Maiden Lane, N. Y.

Watch and Chronometer Jeweler.

Queen, James.—Watch and Chronometer Jeweler and Pallet Maker, 78 Nassau Street, room 8. Pivots inserted in Pinions, Balance, Staffs, etc.

Wennstrom, John.—Watch, Chronometer and Clock Jeweling, Jewel Guages, Ruby and Sapphire Draw Plates; Diamonds Dressed; Polishing Stones for Jewel Settings. 2 Dutch St., N. Y.

Watch Importers, Etc.

Abry, Chas. Leo—Importer and Manufacturer of Swiss Watches of all grades. 63 Nassau Street.

Ailkin, Lambert & Co.—Importers of Watches. Sole Agents for Paul Breton & Chas. Latour, Geneva. A general line of reliable Swiss Watches, Watch Cases, etc. 23 Maiden Lane, N. Y.

Bartens & Rice—20 John Street, Importers of Watches and sole agents in the United States for the celebrated Nicole, Nielsen & Co. Watches.

Cross & Beguelin.—Importers of Watches, Watch Tools and Materials, dealers in American Watches, No. 21 Maiden Lane, N. Y.

Droz, Henry E.—Importer of Watches, and Watch Case Manufacturer. Agent for the "E. Perregaux" Watch, and jobber in American Watches. No. 92 Fulton Street, N. Y.

Durfey & Reynolds—Successors to Durfey & Shiebler, Watches, Diamonds, Jewelry. No. 9 John Street, (up-stairs) New York.

Freund Max & Co.—Importers of Watches, Jewelry and Precious Stones, 8 Maiden Lane, N. Y.

Gagnebin, Chas.—Importer of all kinds of Swiss, and Dealer in American Watches. 4 Maiden Lane, N. Y. Agent for Ulysse Breting's Fine Chronometers, Chronographs, Anchors, &c.

Gallet, Julien.—Importer of Watches. No. 1 Maiden Lane.

GINNEL, Henry—Importer of Watches, Tools and Materials, 31 Maiden Lane, N. Y. P. O. Box, 2967

Heinrich, H. H. & Co.—Sole Agents for the Karl Zimmerman Watch, and Importers of Fine Watches and Marine Chronometers. 12 John Street, N. Y.

Herzog, Louis & Co.—Importers of Watches, Dealers in Diamonds and Jewelry, 52 Maiden Lane, N. Y.

Hirsch Bros.—Dealers in Watches and Diamonds and Manufacturers of Jewelry, No. 23 Maiden Lane, N. Y.

Hyde's Sons, John E.—Wholesale Commission Agents, only for Jules Jurgensen, of Copenhagen; Jules Monard, of Geneva; and for other makers of all qualities of Watches, 22 Maiden Lane.

Jandorf, P. & Bro.—Importers of Watches and Jewelry, 196 Broadway.

Keller, L. H. & Co.—Successors to G. A. Huguenin, Importers of Fine Watch and French Clock Materials, No. 64 Nassau Street, N. Y.

Mathey Bros. & Mathez.—Importers of Fine Watches and Sole Agents for the **H. L. Matile's** Watches. No. 16 Maiden Lane.

Oppenheimer Bros. & Veith.—Dealers in Watches and Diamonds, and Manufacturing Jewelers, No. 35 Maiden Lane.

Robert, J. Eugene—No. 30 Maiden Lane, New York. Agent for Louis Audemar's celebrated watches.

Schwob, Adolphe—Manufacturer and Importer of Watches, 11 Maiden Lane, N. Y.

Stern Brothers & Co.—Importers of Swiss Watches and wholesale dealers in American Watches, &c., 39 Maiden Lane.

Scott, J. T. & Co.—Importers of Watches, and Manufacturers of Jewelry, and Jobbers of all Grades of American Watches, 11 Maiden Lane.

Strasburger, Louis & Co.—Importers and Makers of Watches of every description, 15 Maiden Lane.

Watch Cases.

Dueber Watch Case Mfg Co.—Manufacturers of Gold and Silver Watch Cases. Bryant Building, N. Y. Factory, Newport, Ky.

Fahys, Joseph—Manufacturer of Watch Cases and Dealer in American Movements, 38 Maiden Lane.

Glatz, Chas.—Manufacturer of Silver Watch Cases. Bryant Building, cor. Nassau and Liberty Sts.

Keller & Untermeyer.—Manufacturers of Watch Cases with Raised Gold Ornaments. 9 Maiden Lane, N. Y.

Ladd Watch Case Co.—Manufacturers of the Ladd Patent Stiffened Gold Watch Cases, etc., 11 Maiden Lane, N. Y. Factory, 58 Eddy Street, Providence, R. I.

Willemin Watch Case Co.—Makers of Gold Watch Cases. Raised Gold Ornamentation and Jurgensen style of Engine Turning. 109 Sands Street, Brooklyn, N. Y. 1½ Maiden Lane, N. Y.

Watch and Chronometer Repairers.

Cerf, B.—Practical Watchmaker and Repairer, No. 10 John Street, N. Y. Repairing and adjusting of Fine Watches done for the trade. All kinds of escape and stem-winding wheels cut to order.

Heinrich, H. H. & Co.—Sole Manufacturers of H. H. Heinrich's Patent Auxiliary Balance, and Adjusters and Repairers of Fine Watches and Chronometers. 12 John Street, N. Y.

Lesperance, Theo.—Watchmaker and Wheel Cutter. Also Stoning Nickel Movements. No. 1 Maiden Lane, New York. With Julien Gallet.

Ludeman, W. H.—Chronometer and Watch Maker. Repairing of every description for the trade, 75 and 77 Nassau Street.

Watch Case Repairers.

Feinier, Joseph A.—Watch Case Maker and General Repairer. Specialty in fine Gold and Silver Cases. Jobbing promptly attended to. Nos. 4 and 6 John St., N. Y.

Tarbox, Hiram—Watch Case Repairing, Springing, Polishing and Engine Turning. 1874 North Fourth Ave., bet. 176th and 177th Sts., N. Y.

Watch Glasses, Shades, Etc.

Brown, Edwin H.—No. 85 Nassau Street, Imported and Own Manufacture Watch Glasses, Flat, Flat Concave, Concave, Convex and fine Genevas. Fine fitting solicited.

Watches, Jewelry, etc.

Cohn, J. J.—Importer and Manufacturer of Whitby Jet, Rubber and Pearl goods. Gold and Rolled-plate Jewelry, etc. 12 Maiden Lane, New York.

Friedman, Saml.—Wholesale Dealer in Watches and Jewelry, 42 Maiden Lane, N. Y.

Fry & Schieber—Manufacturers of Fine Gold and Plated Jewelry and Importers of Watches, 201 Broadway, N. Y.

Leberthon, L. M.—Importer of diamonds and watches. Manufacturer of jewelry. 14 John St. Fine stones a specialty.

Lissauer & Sondheim—Wholesale Jewelers and Jobbers in American Watches, No. 12 Maiden Lane, N. Y.

Marx, Kossuth & Co.—Importers of Watches and Dealers in Jewelry. 39 Maiden Lane, N. Y.

Mayer, B.—Manufacturer of Fine Jewelry, and Dealer in Watches, 71 Nassau street, cor. John street, New York.

Mayer, Max.—Dealer in Gold and Fine Rolled Plate Jewelry of every description. 71 Nassau St., N. Y.

Myers, S. F. & Co.—Manufacturing and Wholesale Jewelers—all grades. Importers of Watches. Illustrated Catalogue to the trade. 179 Broadway, N. Y.

Smith & Knapp—Wholesale Dealers in American and Swiss Watches, Diamonds, Gold and Plated Jewelry and Gold Chain. 182 Broadway, N. Y.

Stern & Stern—Dealers in Watches, Jewelry and Diamonds. No. 6 Maiden Lane, N. Y.

Strauss, Jacob.—Full Line of Gold and Plated Jewelry, and Importer of Watches. 18 John Street, New York.

Thrall, E. A.—Wholesale Dealer in Watches and Jewelry. No. 1 Maiden Lane, N. Y.

Trier Bros.—Importers of Garnet, Whitby Jet and Amber Jewelry, Silk Guards, Opera, Field and Marine Glasses, Pearl Card Cases. Also a full line of Gold and Plated Jewelry. 15 Maiden Lane, N. Y.

White, N. H.—Jobber in American-Waltham Watches and Chronographs. Waltham make of 10-k., 14-k. and 18-k. Gold and Sterling Silver Cases; Filled Gold Cases. 11 Maiden Lane.

Watch Tools, etc.

Keller, L. H. & Co.—Importers of Watchmakers' and Jewelers' Tools, Materials, etc. 64 Nassau Street, N. Y.

Zimmern, Henry—Importer of Watch Materials, Tools, and Optical Goods, No. 8 Maiden Lane, (first floor.) Sole Agent for A. Hugenin & Gravier. Mainsprings, New York.

PHILADELPHIA

Booz & Co.—Manufacturers of Gold and Silver Watch Cases and Jewelry, 108 South 8th St., Philadelphia.

Bennett, Jacob & Son.—Diamond Setters and Manufacturing Jewelers, 925 Chestnut St.

Bernard & Co.—Manufacturers of fine Roman and Etruscan Jewelry. Designs of every description made to order, 123 & 125 South Eleventh Street, Philadelphia.

Birmingham, Wm. & Co.—Morocco Case Manufacturers. Spectacle and Eye-Glass Cases a specialty, 626 Arch Street, Philadelphia, Pa.

Conover David F. & Co.—American Watches, Wholesale Salesroom, Southeast corner 7th and Chestnut Streets, Philadelphia.

Dubosq, J. Carrow—Manufacturer of Fine Jewelry. Particular attention given to repairing Strung Pearl work. 108 South Eighth St., Phila.

Fick, Chas. M.—Seal Engraver and Designer. Sketches furnished Free of Charge for Coat of Arms, Crests, Monograms, Initial Letters and Masonic Emblems, to be engraved on all kinds of Precious Stones. 618 Chestnut St., Philadelphia, Pa.

Guilbert, Thos. M., & Co.—Manufacturing Jewelers. Flexible Bracelets and Strung Pearl Repairing. 908 Chestnut St., Philadelphia.

Herold, Chas P.—Successor to Hildebrandt, Herold & Co., Manufacturing Jeweler and Diamond Setter. Diamonds. 916 Chestnut Street.

Krieder, Peter L.—Manufacturer of Sterling Silver Ware. 618 Chestnut Street, Philadelphia.

McCarty & Hurlburt—Manufacturers of Gold Spectacles, Silver Thimbles and Plain Rings. Wholesale dealers in American Watches, Jewelry, etc. 131 North Second Street.

Morgan & Headly.—Manufacturing Jewelers, Cameo Sets, Gold Sets, Roman Lockets, Rings, Coral Sets and a general line of rich goods. Corner 10th and Chestnut Streets, Philadelphia.

Muhr's, H., Sons.—Manufacturing Jewelers. Solid Gold and Filled Rings a specialty. 633 and 635 Chestnut Street, Philadelphia. 1½ Maiden Lane, New York.

Peters, Reese S.—Manufacturer of Patent Rolled Plate or Filled Watch Cases, Dealer in American Movements, 308 Chestnut Street, Philadelphia.

Robeth, A.—Wholesale Optician, and Dealer in Fine and Plated Jewelry, also Diamonds and Swiss Watches. 825 Market St., Philadelphia.

Rosenthal, G. F. C.—Manufacturing Jeweler and Diamond Setter. Engraving and Designing of Monograms a Specialty. No. 917 Sansom Street.

Scherr, L. A. & Co.—Wholesale Dealers in Watches Silver-Plated Ware, Spectacles, Fancy Goods, Watch Materials, etc. 726 Chestnut Street.

Sheaffer, W. H. & Co.—Manufacturing Jewelers. Specialty: Band Bracelets. Factory. 612 and 614 Chestnut street, Philadelphia. Office, 15 John street, New York.

Simons, Brother & Co.—Manufacturers of Fine Jewelry, Canes, Thimbles, Chains. 611 and 613 Sansom Street.

Vansant, John T. & Co.—611 and 613 Sansom Street, Artisan Hall, Manufacturers and Wholesale Dealers in English Sterling Silverware. Specialties: Tea Sets, Knives, Forks, Spoons, Cups and Napkin Rings.

CHICAGO.

American Watch Company,—of Waltham, Mass. No. 102 State Street, Chicago.

Chicago Watch Case Co.—Manufacturers of Patent Dust Proof Screw Bezel Watch Cases. Cor. Madison Street and Michigan Avenue, Chicago, Ills.

Clapp & Davies—Wholesale Jewelers, 63 and 65 Washington Street. Catalogue and price list issued to watchmakers and jewelers.

Dennison Manufacturing Co.—Manufacturers of Jewelers' Paper Boxes, Morocco Cases, Tags, Cards, Pink and White Cotton, Tissue Papers, Sealing Wax, &c., &c., 102 Madison St., Chicago. Boston, New York, St. Louis, and Philadelphia.

Excelsior Sign Co.—Manufacturers of (Grout's Excelsior) Iron Watch and Spectacle Signs. 124 Fifth Avenue, Chicago, Ills.

Gilbert, Wm. L., Clock Co.—Manufacturers of Clocks, Regulators, and Time Pieces, and Clock Material of every description, 54 and 56 Madison Street, Chicago.

Giles, Bro. & Co.—Manufacturers and Jobbers in Watches, all classes of Jewelry, Materials, Clocks, Silver Ware, &c. Illustrated catalogues furnished to dealers on application. 101 & 103 State St.

Stein & Ellbogen—Wholesale Dealers in Watches and Jewelry, 127 State Street, Chicago, Ill. Specialty, repairing for the trade.

Wathier, Joseph P.—Watchmakers and Jewelers for the trade, and Wholesale Dealers in Watch Materials, Tools, etc. 178 West Madison Street, Chicago, Ill. Send for price list.

Wendell, Charles & Son—Wholesale Watches, Jewelry, etc. 170 State street, Chicago.

NEWARK.

Baker & Co.—Gold, Silver and Platinum Refiners, Assayers and Sweep Smelters. 408 New Jersey Railroad Avenue, cor. Murray St., Newark, N. J.

Diefenthaler Bros. & O'Donnell—Manufacturers of Fine Jewelry, Lace Pins, Ear Rings and Patent Spring Bangles a Specialty. 36 Crawford Street, Newark, N. J.

Felger, F. & F.—Manufacturing Jewelers. Specialties:—Roman Band Bracelets, Lace Pins, Scarf Pins, Ball and Fancy Ear Rings. No. 477 Washington Street, Newark, N. J.

Fiedler, Herrman—Successor to Kunze & Fiedler, Engraver, Die Sinker and Press Tool Maker, 363 Market Street, Opposite Pennsylvania R. R. Depot, Newark, N. J.

Hopper & Valentine—Manufacturers of Fine Jewelry, No. 8 Maple Place, Rear 44 Green St., Newark, N. J.

Hüger & Heitlinger—Manufacturers to the Jobbing Trade only. Makers of Roman Stone, Engraved and Enameled Lockets, also Sets, Lace Pins and Ear Rings. Rear 477 Washington St.

Krippendorf, C. & Schuller, F.—Machinists and Jewelers' Tool Makers. 19 Greene Street, Newark, N. J. Rolls, Dies, Cutters, and Draw-plates of every Description made and repaired.

Lefort, Henry—Stem-winding Watch Crown Manufacturer. 60 Arlington Street.

Lelong, L. & Bro.—Gold and Silver Refiners Assayers and Sweep Smelters, Southwest corner of Halsey and Marshall Streets, Newark, N. J.

Miller & Beam—Manufacturers of Enameled Sets, Ear Rings, Lace Pins, etc. Guard Slides and Pendants a Specialty. 21 and 23 Green Street.

Milne, Alex.—Manufacturer of Stem-winding Watch Crowns. 19 Ward Street.

Plumb & Marcus—Manufacturers of Traveling and Marine Clocks, Electric Appliances. 289 Washington St., Newark, N. J.

Pollock, T. H.—Manufacturer of Jewelers' and Silversmiths' Wheel Brushes, Buffs, etc. No. 36 Crawford Street, Newark, N. J.

Regad, E. D.—Lapidary. Specialty—Sardonyx, Black Onyx and Agates. 14 Oliver St., Newark.

PROVIDENCE

Irons, Chas. F.—Manufacturer of Solid Gold Jewelry. Specialty, Emblems, Pins and Charms, Masonic, Odd Fellows, etc. 102 Friendship St.

Lederer, S. & B.—Manufacturers of Fire Gilt, Nickel, Electro and Silver Plated Chains, Necklaces, Charms, etc. Opera, Matinee and Guard Chains. 66 to 72 Stewart St., Providence, R. I.

Pearce & Hoagland—Manufacturers of Gold Pens, Holders, Pencils, Tooth Picks, etc. Also the Quill Reserve Tooth Pick. 29 Point Street, Providence, R. I.

Presbrey & Tuttle—Manufacturers of a large variety of Fine Bracelet and Eye-Glass Chain in Gold Plate and Silver, Spring Rings, Holders, Hooks, Snaps, etc. 35 Point St., Providence, R. I.

Seery Mfg. Co.—Manufacturers of Fire Gilt, Nickel and Electro Plated Chains, Vest, Neck, Opera and Guard. 33 Beverly St., Providence, R. I.

Smith, Wm. T.—Assayer, Refiner and Sweep Smelter. Established 1855. Blackstone and Hawkins Streets, Providence, R. I.

Taylor, Geo. H. & Co.—Watchmakers and Wholesale Dealers in Watches, Clocks, Watch and Clock Material, Tools, Spectacles, Eye Glasses, &c. Particular attention given to trade work. 136 Westminster Street (Room 1), Providence, R. I.

PAWTUCKET.

Draper, J. O. & Co.—Manufacturers of Jewelers' Fig Soap, adapted for Washing Jewelry, Scratch Brushing and Drawing Wire. Pawtucket, R. I.

Fuller, Geo. H. & Son—Jewelers' Findings, Gold, Silver, Gold Plated and Fire Gilt. Pin Stems, Joints, Catches, Split Rings, Chain Hooks and Swivels, Ear Wires, Chain Bars, etc. 99 Exchange Street, Pawtucket, R. I.

Thayer, Ellis & Son—Brush Manufacturers, and Wholesale Dealers in all kinds of Brushes. Sole manufacturers of Ellis Thayer's Patent Polishing Wheels. Manufacturing Jewelers' and Machine Brushes a Specialty. 80 North Main Street, Pawtucket, R. I.

Thayer, P. E. & Co.—Manufacturers of Brushes. Jewelry and Machine Brushes a Specialty. All kinds of Wire Scratch Brushes on hand. Orders by mail or otherwise promptly attended to. 34 East Avenue, Pawtucket, R. I.

CINCINNATI.

Awalt, John A.—Jobber in Watches, Clocks, Jewelry, etc., 173 Vine Street, Cincinnati.

Hellebush, Clemens—Manufacturer, Importer and Wholesale Dealer in everything required by the Jewelry Trade. 77 W. Fourth St., Cincinnati, O.

Lodwick & Nolting—Wholesale Jewelers, S. W. cor. 4th & Walnut Streets, Cincinnati.

Noterman & Jonas—Manufacturing Jewelers, cor. 4th and Main Streets. Manufacturers of the Ophir Diamond Jewelry.

BALTIMORE.

Gruebel & Kesmodel—Manufacturers of Fine Diamond Etruscan, Enameled, Plain and Rhine Stone Jewelry to order. Repairing a specialty. Orders by Mail solicited. 212 & 214 W. Baltimore St., Balto., Md.

Morris, Wm. & Co.—Importers and Jobbers of Watch Materials, Tools, Optical Goods, Plated and White Metal Chains. Agents for American Lathes, &c. The attention of Southern Trade is requested. 207 and 209 West Baltimore Street.

BOSTON.

Boyce, E. J.—Manufacturer of Solid Gold Jewelry. Rings a Specialty. 383 Washington St., Boston, Mass.

Smith, Wm. A.—Importer of Diamonds and Precious Stones. Diamonds mounted and unmounted and Diamond Mountings. 383 Washington St., Boston, Mass.

BUFFALO.

King & Eisele—Manufacturers of Solid Gold Jewelry, and Agents for American and Foreign Watches; also Jobbers in Roll Plate Jewelry. Office and Salesrooms, 283 Main St. Factory, 2, 4, 6 and 8 Swan St.

CLEVELAND.

Chandler, J. M. & Co.—Manufacturers of the Patent Embossed Bracelet and Jobbers in all kinds of Clocks, Watches, Jewelry, Tools, Materials, etc. 185 Superior St., Cleveland, O.

NORTH ATTLEBORO.

Whiting, F. M. & Co.—Manufacturers of Sterling Silver Ware and Jewelry, North Attleboro, Mass.

LANCASTER.

Bowman & Musser—Jobbers in Watches, Clocks, Chains, Fine Tools and Materials. 20 East Chestnut Street, Lancaster, Pa.

PITTSBURGH.

Goddard, Hill & Co.—Wholesale Dealers in American Watches, Jewelry, Silverware, Clocks, Materials, &c., 43 Fifth Avenue, Pittsburgh, Pa.

SPRINGFIELD.

Bullock, O. W.—Springfield, Mass. Manufacturer of Fine Nickel Plated Watch and Jeweling Tools, Keys, and Light Metallic Goods.

CANADA.

Ellis, P. W. & Co., No. 31 King street, East Toronto, Ontario, Manufacturing Jewelers, Watchmakers, importers and Jobbers of Watchmakers, and Jewelers' Tools, Materials, General Supplies and American Jewelry. Correspondence solicited with manufacturers of Novelties or specialties in American Tools and Jewelry.

POSITIVELY NO GOODS RETAILED.

BOWMAN & MUSSER,

SUCCESSORS TO

E. F. BOWMAN,

JOBBERS IN

Watches, Clocks, Chains,

Fine Tools and Materials,

20 E. CHESTNUT STREET,

Opp. P. R. R. Passenger Depot,

LANCASTER, PA.

Selection Packages sent to Regular Jewelers on Request.

BARNES'

No. 4 LATHE,

For the Heavier Work of Jewelers.

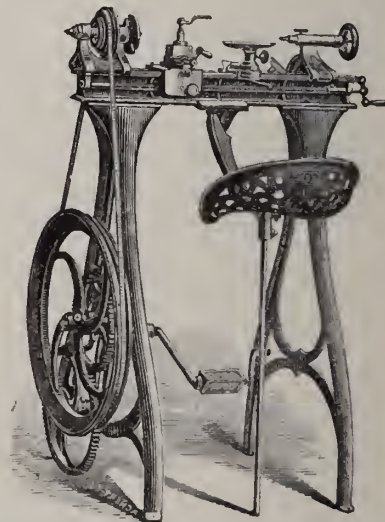

Barnes' Patent Foot and Steam Power Machinery. Complete outfits for Actual Workshop Business. Lathes for wood or metal. Circular Saws, Scroll Saws, Formers, Mortisers, Tenoners, etc., etc. Machines on trial if desired. Descriptive Catalogue and Price List Free.

W. F. & JOHN BARNES,
2088 Main Street, ROCKFORD, ILL.

EXCELSIOR'S

Practical Treatise

ON THE

BALANCE SPRING

Including Making and Fitting Hair Springs, Regulating, etc.

Also containing the Adjustment of Watches and Chronometers for Isochronism, Positions, Heat and Cold and Rate.

PRICE, \$3.50.

D. H. HOPKINSON,

42 Nassau Street, New York

THE
METALLURGIST,

A MONTHLY TRADE JOURNAL,

DEVOTED TO

→❖Jewelers, Metallurgists, Watchmakers,❖←

AND KINDRED INTERESTS.

HAVING A CIRCULATION OF 5,000 COPIES

*Among the Jewelers of Ohio, Indiana, Illinois, Michigan, Wisconsin, Minnesota, Iowa, Missouri, Kansas, Nebraska, Colorado, Texas, and **ALL** the North Western and South Western Territories, **IS THEREFORE THE** most valuable medium for advertisers wishing to reach the wholesale and retail jewelry trade of the Great West.*

Address

"THE METALLURGIST,"

138 & 140 LAKE STREET,

CHICAGO, ILLS.

ESTABLISHED 1869.

THE JEWELERS' CIRCULAR

—AND—

HOROLOGICAL REVIEW.

THE RECOGNIZED ORGAN OF THE

Watch, Clock, Jewelry and Kindred Organizations of the U. S.

And Official Representative of the Jewelers' League.

Published Monthly at \$2.00 Per Annum to all parts of the United States and Canada, and \$3.00 Per Annum to all Foreign Countries.

To the Country Dealer THE JEWELERS' CIRCULAR affords thorough, correct and perfect information as to Staple and Original Articles of Trade. From it he can learn what to order and where to obtain supplies, he can discover the best source of materials in common use, while the latest novelties are without exception first announced in its columns.

To the Practical Workman THE JEWELERS' CIRCULAR is invaluable as a Text-Book and Work of Reference. It furnishes him with the Latest Scientific and Mechanical Ideas, set forth in plain, comprehensive language by specialists of ability and experience. The technical information contained in its columns represents the progress of the age, and every intelligent workman in the country acknowledges the advantages resulting from a study of its pages.

The XIV. VOLUME of THE JEWELERS' CIRCULAR commenced with the FEBRUARY, 1883, issue, and will surpass in interest all previous volumes.

D. H. HOPKINSON,

Editor and Proprietor,

42 NASSAU STREET, N. Y.

ROLLED PLATE JEWELRY.

LEOPOLD WEIL & CO.

HAVE

REMOVED

TO

No. 35 MAIDEN LANE,

May 1st, 1883.

New York.

The Best Goods. Original Designs. Low Prices.

A NEW DEPARTURE.



14 KARAT GOLD CHAIN, SILVER LINED,

— MADE BY —

✦ A NEW PROCESS ✦

Guaranteed to wear as well as the best 14 karat Gold Chain made.

Every Chain warranted to assay one-third ($\frac{1}{3}$) its entire weight in gold.

Each Chain stamped with registered trade mark:

“M.” “3.”

Money refunded if test is unsatisfactory.

KOSSUTH MARX & CO.,

Proprietors and Manufacturers,

39 Maiden Lane, New York.

In introducing our new Chain we aim to supply a want which we believe the Trade can place before the public in a legitimate manner without deception, and no detriment to the standard of the most scrupulous dealer.

We offer these goods strictly upon their merits, and give but a few reasons why they can take the place of the older styles of manufacture, viz.:

- 1st.—*In the make up there is no base metal, excepting such as is necessary in standard 14 karat.*
- 2d.—*It makes a larger and more showy appearance for its corresponding weight than the old standard.*
- 3d.—*The cost is materially reduced, bringing it within reach of a greater number who desire a good article.*
- 4th.—*It is a well known fact that the principal cause of wear in chain is the friction produced by its own weight, consequently, being light weight to the extent of a large percentage, their better wear is assured.*

By a strict adherence to quality we hope to create a popular demand for a meritorious article.

Send for selection package, as our travelers do not carry any in stock.

KOSSUTH MARX & CO.

WATERBURY CLOCK CO.,

MANUFACTURERS OF

CLOCKS,

Novelties & Materials,

No. 10 CORTLANDT ST., N.Y.

— AND —

No. 63 WASHINGTON ST., CHICAGO.

Factories, **WATERBURY, CONN.**

M. BAILEY, Treasurer.



ANTWERP.

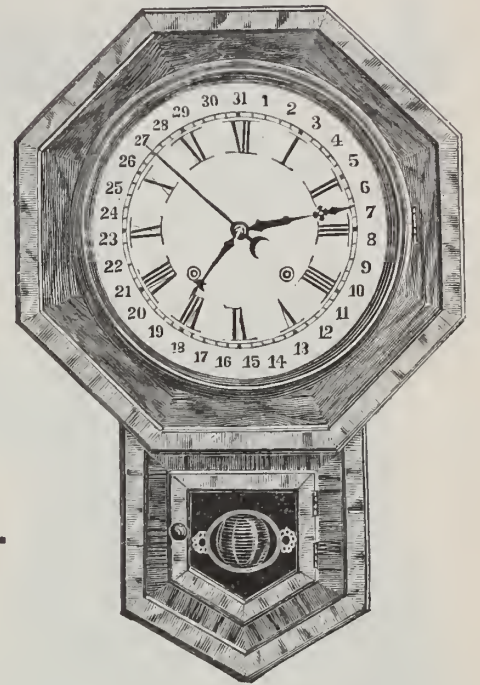

10 INCH DROP OCTAGON,
FULL GILT, CALENDAR.

THE ANSONIA CLOCK CO.

HANGING CLOCKS AND MANTEL CLOCKS

OF EVERY DESCRIPTION.

A LARGE AND COMPLETE STOCK OF

Tower Clocks	}	HANGING AND STANDING	}	Street Clocks
		REGULATORS		
		AT LOW PRICES.		



REGULATOR No. 4.

CHICAGO, 64 Washington St.	NEW YORK, 11 to 19 Cliff St.	LONDON, 128 Minories.
--------------------------------------	--	---------------------------------

W. L. GILBERT CLOCK CO.,

GEORGE B. OWEN, General Manager.

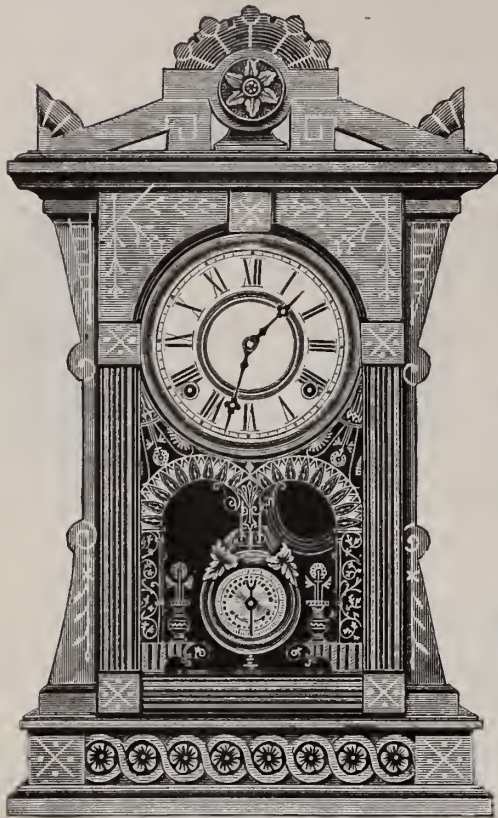

HELIOS.—Walnut.
8 Day Strike.
Height 20¾ inches. 6 inch Dial.

Salesrooms:
No. 6 Murray St., N. Y.
54 & 56 Madison St., Chicago.

Factories:
WINSTED,
Conn.

MANUFACTURERS OF

Walnut, Veneered and Other Clocks

IMPORTERS OF

Marble and Cuckoo Clocks.

*Catalogue and Price List Fur-
nished upon application.*



ERSA.—Walnut.
8 Day Strike.
Height, 19½ inches. 6 inch Dial.

MATHEY BROS. & MATHEZ,

NO. 16 MAIDEN LANE.

IMPORTERS OF ALL GRADES OF

Plain and Complicated Watches and Movements

SOLE AGENTS FOR THE WELL-KNOWN

H. L. MATILE

Fine Watches of Astronomical Precision.



REPEATERS.



CHRONOGRAPHS.

In order to facilitate the handling of our Stem-Winding Movements, we have adopted a standard of sizes to fit American Cases. Of these we have a complete line from the medium grade to the highest class goods of fine adjustment and precision. As all our Movements, complicated and plain, are perfectly uniform in quality according to their respective grades, we can furnish material for any parts that may be required, with the positive assurance of accurate interchangeability.

An Extensive Line of all Grades of

**CHRONOGRAPHS,
SPLIT SECONDS AND REPEATERS.**

WATCHES DEMAGNETIZED.

"THE SARATOGA."—Patented.



— MADE BY —

ROGERS & BROTHER,

690 BROADWAY,

NEW YORK.

WORKS, WATERBURY, CONN.

SIMONS, BRO. & CO.

MANUFACTURERS.



CHAIN.



Fine Jewelry.

ILLUSTRATED CATALOGUE



611 and 613 SANSON STREET, PHILADELPHIA, OR NEAREST JOBBER.

LOUIS STRASBURGER & CO.

DIRECT IMPORTERS OF

WATCHES AND DIAMONDS,

WE MAKE EVERY KIND
OF WATCH IN
OUR OWN
FACTORY.

WE GET THE ROUGH
DIRECT AND CUT
OUR OWN
GOODS.

No. 15 MAIDEN LANE,

NEW YORK.

Rue Leopold Robert,
CHÂUX-DE-FONDS.



Boulevard Haussman, 30,
PARIS.

Superior Silver Plated Ware,

MANUFACTURED BY THE

MIDDLETOWN



PLATE CO.

MIDDLETOWN, CONNECTICUT.



Hammered Gilt Cup and Slop, \$34.00.



Chased Gilt Slop and Cup, \$30.00.

OFFICES.

*Middletown, Conn.,
120 Sutter Street, San Francisco, Cal.*

*13 John Street, New York,
101 & 103 State Street, Chicago, Illinois.*

Illustrated Catalogues and Photograph Albums sent to responsible Dealers.

DAVID F. CONOVER & CO.

(SUCCESSORS TO WM. B. WARNE & CO.)

Manufacturers and Wholesale Dealers in

WATCHES and JEWELRY.

Wholesale Agents For

Rogers & Brother's Flat and Hollow Ware



Celluloid Eye-Glasses.

And Sole Agents for the

Patent Railroad Train Watch Chains, Nickel.

WHOLESALE AGENTS FOR

T. A. WILLSON & CO.'S Optical Goods.

Would invite attention to the following new grades of Steel Spectacles lately introduced in the market.

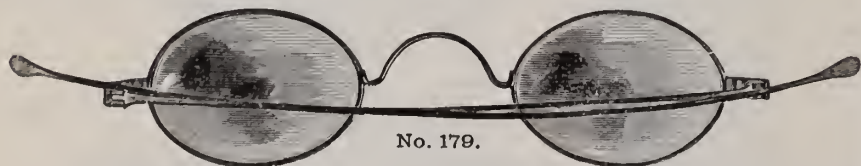

No. 179.

They are Steel, Full Tempered. Parts Interchangeable. Joints so constructed that wear is compensated for. Temple will not work loose and fall down as in old style joints. Nose-piece on No. 155 reinforced where it joins eye, giving extra strength with neatness.

PRIZE MEDALS AT ALL EXHIBITIONS WHERE EXHIBITED.

Patented July 31, 1877.

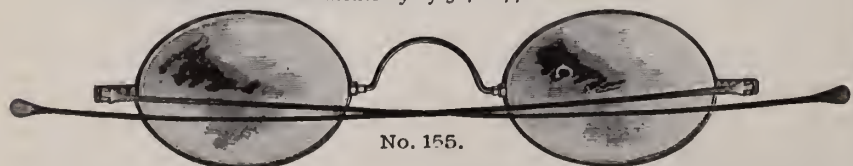

No. 155.

American Watch Wholesale Salesroom:

Southeast Cor. Chestnut and Seventh Sts., First Floor,

PHILADELPHIA.

DAVID F. CONOVER,
C. FRANK WILLIAMS
B. EDGAR RIGHTER.

A SPECTACLE TEMPLE

THAT WILL

NOT WEAR LOOSE.

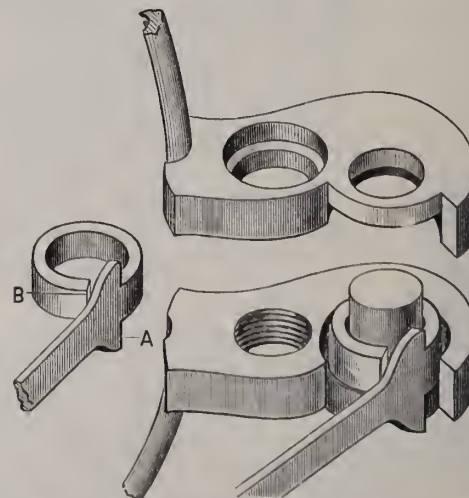

Patented May 13th, 1879. Re-issued June 5th, 1880.

- A.—Stop for Temple, preventing Strain on Joint.
- B.—Compensating eye, for taking up wear of joint. The eye of Temple is smaller than Stubb Steel Joint Pin on which it works, and is left open at B, exerting a Spring Tension on Pin.



CRESCENT FILLED CASES.



The special attention of the Trade is called to our new line of 18 Size Stem Winding Gold Filled Cases made under Coe's Patent.

INTERCHANGEABLE,

to fit all 18 Size Stem Winding American Movements.

All Gold Filled Cases made by this company have Solid Gold Bows, Joints, Plugs and Thumb Catches, are unequalled in Shape and Color, and are guaranteed by special certificate to wear 20 years.

Order of your Jobber the
"CRESCENT" CASE,
 And save carrying two lines of cases.

CHICAGO WATCH CASE CO.,

Cor. Michigan Ave. and Madison St.,

CHICAGO, ILLS.



“THE BEST”

THE DUEBER

GOLD WATCH CASES.



381869



381895



381817

Quality Guaranteed as per following U. S. Registered Trade Marks:



Trade Mark for 14-K. Gold Cases.

Trade Mark for 18-K. Gold Cases.

Trade Mark for 10-K. Gold Cases.

We use but Three Qualities of Gold—18-K., 14-K., and 10-K.;—use no Trade Mark or Stamp but our own; and invite inspection of Finish and Workmanship in every particular.

The Dueber Watch Case Mfg. Co.

❖ CHICAGO, ❖
4 Tribune Building.

❖ CINCINNATI, ❖
P. O. Box 1334.

❖ NEW YORK, ❖
20 Bryant Building.

“THE BEST”

THE DUEBER

ROLLED GOLD PLATE WATCH CASES.



381874

WITH

SOLID GOLD CENTERS,
SOLID GOLD PENDANT,
Solid Gold Bow,
Solid Gold Joints,
Solid Gold Thumb Pieces,
Solid Gold Plugs,
Solid Gold Bearings,
And Gold Crown.



381876

Warranted by Special Certificate to wear for twenty years, and to contain from three to five dollars more gold, to be better finished, better engraved, and in every particular superior to all other plated cases sold under the name of “Filled,” “Perfected Gold,” “Patent Gold,” or “Stiffened Gold,” now in use. The most perfect case of its kind ever manufactured. We lead in this as well as in everything else we undertake or manufacture.

The Dueber Watch Case Mfg. Co.

• CHICAGO, •
4 Tribune Building.

• CINCINNATI, •
P. O. Box 1334.

• NEW YORK, •
20 Bryant Building.

THE BEST
THE DUEBER
 COIN SILVER WATCH CASES

WITH

Solid Soldered Edges and Joint Bearings Throughout.

For Twenty Years, as to-day, the Leading Watch Case in the
 American Market.

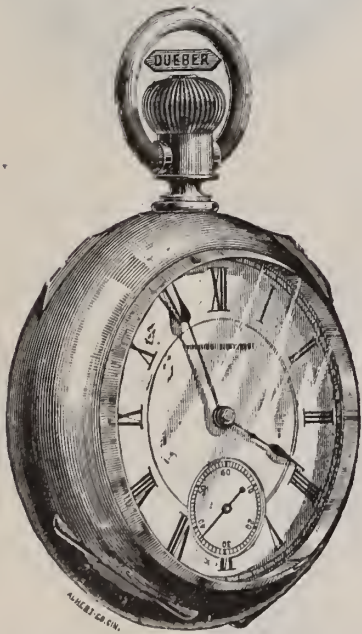

381842—Full Bassine Style.



Pat. July 6th, 1880. No. 229,681.

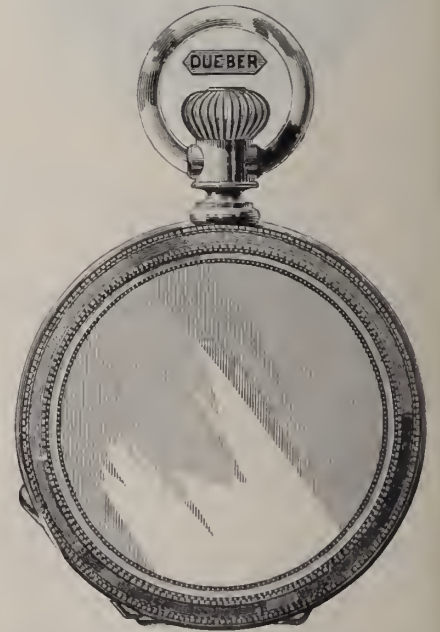

381888—Bourbon Style, with Gold Crown.

Their Equal in Construction, Finish or Intrinsic Value has never been Produced.

THE DUEBER WATCH CASE MFG. CO.

4 Tribune Building, Chicago.

Box 1334, Cincinnati, Ohio.

20 Bryant Building, New York.

THE CHEAPEST

THE NEWPORT

COIN SILVER WATCH CASE.

We have placed upon the market a Two-ounce Case with Albata Cap stamped



Fig. A.



A Watch Case with folded over edges all made except putting on the Pendant and Joints.

This Case is made in the extensively advertised seamless method as shown in Figure B. Each piece is cut from solid metal and struck into the shape here shown, and not one grain of solder is used to put a case into the condition as shown in Figure A.

Fig. B.

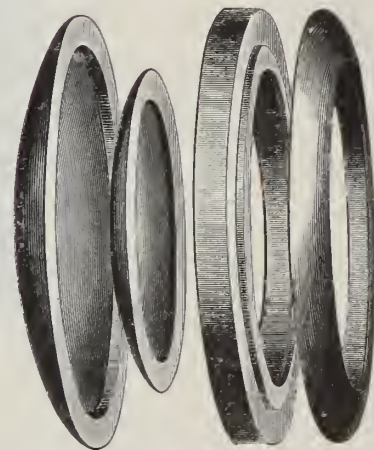

Four parts necessary to make the body of a Watch Case with a folded over edge.

This process of Case Making has been in use for years by makers of "cheap silver," and "improved" silver cases. Swiss silver anchors and low karat gold cases have always been made in this manner, but no watch case with this style of folded over edge has ever gained any reputation with practical watchmakers, and it only requires time and use to show its worthlessness, this fact having been demonstrated in the wear of a former, very extensively used, line of cases made in this same method. A watch case can be made more quickly and at less expense by this method than by any other, and we have adopted it in the construction of our Two-ounce Newport throughout, cheapness being the only object sought for in this instance, no regard being given to wearing qualities. We do not, therefore, guarantee anything about this case except the quality of silver used.

The Dueber Watch Case Mfg. Co.

Chicago, 4 Tribune Bldg.

Cincinnati, P. O. Box 1334.

New York, 20 Bryant Bldg.



THE
 BROOKLYN WATCH CASE CO.

 EAGLE CASE.



In order to meet an imperative and growing demand in the Trade for a reliable grade of Low Karat Cases, this Company, seven years ago, was induced to place upon the market their since Celebrated **EAGLE CASES**, which are made of full 8-k. gold in all their parts, joints and bearings, the backs and caps free from solder, saving that which holds the joints. Since their introduction, these cases have achieved a wide spread reputation for the reliable and standard quality maintained in their manufacture. It has been demonstrated that the wearing qualities of the **EAGLE CASES** are unexcelled by any 12-k. case in the market, while their color is permanent and the appearance equal to that of the best cases made of this grade. The 8-k. **EAGLE CASES** will stand the severest acid test and will not tarnish when exposed in the show case or worn in the pocket.

All these goods are Stamped in the Cap with the Trade Mark of the Company,

B. W. C. Co.

and are guaranteed to be of the uniform standard designated.

A LARGE AND WELL ASSORTED STOCK OF 18-K., 14-K. AND EAGLE CASES IN THE LATEST AND MOST ARTISTIC DESIGNS, KEPT CONSTANTLY ON HAND.

For Sale by all the Principal Jobbers.

IMPROVED CROWN FILLED CASE.

→ THE BEST FOR THE LEAST MONEY ←

The gold contained in the Crown Cases which are now being turned out under our supervision is fully equal to that of any Filled Case on the market.

This fact can be attested to the satisfaction of any dealer who will go to the trouble of having one of these Cases assayed with one of corresponding size and style of any other make.

The United States Mint at Philadelphia will make a complete assay for the sum of one dollar each, and we will return a New Case to the dealer in place of the one of our make destroyed, upon receipt of the Assay Certificates and the gold contained in the Crown Case assayed.

SOLID GOLD JOINTS,
SOLID GOLD PLUGS.
GOLD THE NATURAL COLOR.
ABSOLUTELY NO GILDING.



Raised Gold Ornamentation.



Raised Gold Ornamentation.

SOLD ONLY BY THE JOBBING TRADE.

H. MUHR'S SONS, PHILADELPHIA.

NEW YORK OFFICE, 14 & 16 Maiden Lane.

CHICAGO OFFICE, 101 & 103 State Street.

CHARLES GLATZ,

MANUFACTURER OF

GOLD & SILVER WATCH CASES

Formerly 10 MAIDEN LANE,
NOW,
N. W. Cor. Nassau & Liberty Sts.
Half Block from Maiden Lane.



BRANCH OFFICE:
100-104 STATE ST.,
Jewelers' Exchange,
CHICAGO, ILL.
S. GOLDSMITH, Manager.

A SPECIALTY OF FULL WARRANTED 8 KARAT GOLD CASES,

Made in a Larger Variety than any other house, and Workmanship fully equal to the best in the Market.

JOBBER IN ALL AMERICAN MOVEMENTS.

We Call the Attention of the Trade to the Line of LOUIS XIV. Cases, in Gold and Silver, which we have Constantly on Hand.

N. W. COR. NASSAU and LIBERTY STREETS, Bryant Building, N. Y. CITY.

EXCLUSIVELY FOR THE JOBBING TRADE.

SIMPSON, HALL, MILLER & CO.,

WALLINGFORD, CONN.

MANUFACTURERS OF

ARTISTIC & USEFUL HOLLOW WARE,

→* ELECTRO PLATED UPON FINE HARD WHITE METAL. *←



Spoons, Forks, etc., plated upon the Finest Nickel Silver in **Extra Double, Triple, and Sectional Plates.** Full lines of over **Forty Staple and Fancy Pieces** in each Pattern in Geneva, St. James, Countess, Windsor, Oval Thread, etc. Made under the supervision, and quality guaranteed and controlled by Wm. Rogers, formerly of Hartford and Meriden. (Wm. Rogers, Sr., died 1873).

WM. ROGERS, Wallingford, Conn.

No connection with any concern in Waterbury, Meriden or Hartford using name of Rogers in any form.

Store and Stock of Goods for Delivery in N. Y. and Vicinity,

No. 36 East Fourteenth Street, Union Square.

Philadelphia, 506 Commerce St.—San Francisco, Cal., 530 Market St.

Montreal, Canada.—Baltimore, 6 German St.

JOBBERS IN CINCINNATI, CHICAGO, ST. LOUIS, Etc.

BROWN & BROTHERS,

Finest Silver Plated Flat Ware,

SPRING TEMPERED SHANK. NEW AND CHOICE PATTERNS.

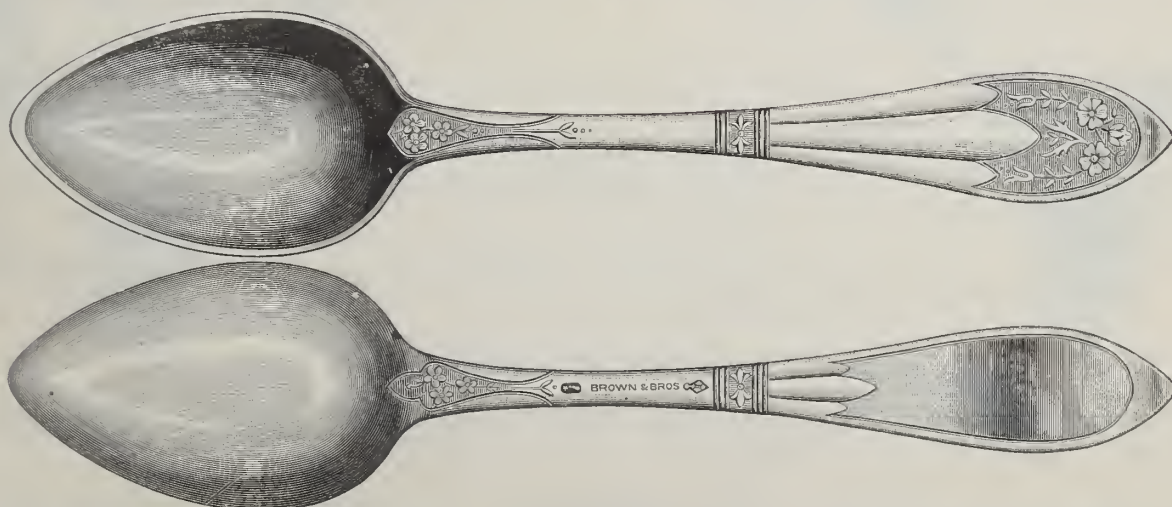

“FLORAL.”

We guarantee all our goods to be made of full quality 18 per cent. Nickel Silver, and weight of plate to be as indicated on the labels.

GOODS PACKED ONE DOZEN IN EACH BOX.

Factories, Waterbury, Conn.

Salesroom, 80 & 82 Chambers Street, N. Y.

OPPENHEIMER BROS. & VEITH,
 WATCHES,
 DIAMONDS,
 JEWELRY.

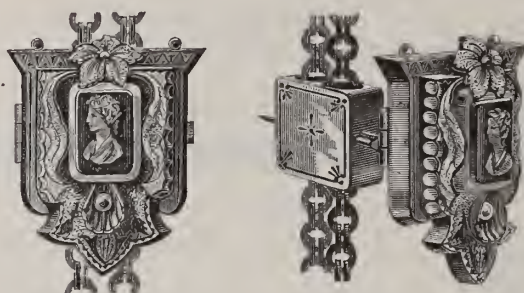

We are the Manufacturers and Patentees of the Combination Slide, Pendant and Locket, and the Combination Necklace, Lace Pin and Pendant.



We can furnish quite a variety of Styles, and are prepared to fill all Orders at once.

35 MAIDEN LANE, NEW YORK.

"THE BEST," THE DUEBER WATCH CASE.

Office of H. M. HECKART, Watches, Jewelry and Diamonds,
Springfield, Mo., June 11th, 1883.

Gents: I have received a few of your new Filled Gold Cases and think they surpass any filled case in the market, as they show the gold that is in them. Please send advertising matter.

H. M. HECKART.

Office of W. T. IRVINE, Watchmaker and Jeweler,
Cresco, Iowa, June 13th, 1883.

DUEBER WATCH CASE M'F'G Co., Newport, Ky.

Gents: Your circular in regard to your New Filled Case came duly to hand, and all your circulars are appreciated. Your plan of building a filled case with solid gold centers is the correct way to secure a perfect fit and will be appreciated with Jewelers wishing to sell a good article on their true merits. Wishing you great success in your new departure, I remain as always, a friend to the Dueber Case.

Very truly,

W. T. IRVINE.

This Case is made with Solid Gold Centers and Pendant, contains from three to five dollars more gold than any other so-called filled or perfected gold case made; is sold for two dollars less price, and warranted by us per special certificate in each case to wear for twenty years.

↔ The Dueber Watch Case Manufacturing Company ↔

NEW YORK.

CINCINNATI.

CHICAGO.

MANUFACTURERS OF THE CELEBRATED DUEBER GOLD AND SILVER WATCH CASES.



SPECIALTIES.
DUPLICATE WEDDING
PRESENTS.
DIAMONDS, WATCHES,
FINGER RINGS.



THE REPAIRING OF
FINE
WATCHES AND JEWELRY
A SPECIALTY.

150 BOWERY,

NEW YORK.

HEADQUARTERS FOR THE PURCHASE, SALE AND EXCHANGE OF

DUPLICATE WEDDING PRESENTS,

Diamonds, Watches, Jewelry, Bronzes and Paintings.

I have constantly on hand the largest stock of Solid Silver Tea Sets and elegantly cased Wedding Presents of every description to be found in New York, and so much below manufacturers' prices that jewelers throughout the country will find it to their advantage, whenever they have special wedding orders, to drop me a line. I now have 12 Elegant Solid Tea Sets, Three Splendid Antique Sets over 100 years old, and 500 Sets and Pieces of every description of Silverware. My facilities for obtaining bargains in Diamonds are such that I can often fill orders much below Importers' prices.

"THE JEWELERS' MERCANTILE AGENCY."

D. L. SAFFORD,

Mercantile and Collection Agency

214 & 216 BROADWAY, N. Y.

AND 5 CUSTOM HOUSE ST.,

PROVIDENCE, R. I.

**Our New Reference Book
FOR JULY, 1883,**

Revised and Corrected to Date, is now ready for delivery to Subscribers.

IT CONTAINS the names of nearly every Jeweler in the United States and Canadas, with ratings of Capital and Credit; street addresses in cities, &c.

WE FURNISH TO SUBSCRIBERS a Weekly sheet of changes and corrections, and special detailed Reports as to financial standing and credit of customers.

CONFINING OUR BUSINESS entirely to the Jewelry and kindred trades, we feel that we are qualified to furnish more accurate Reports than other Agencies.

OUR SYSTEM OF RATINGS is different from other Agencies, as we give especial attention to ratings for Credit, which we believe should not be based or dependent on Capital alone.

*Our Terms of Subscription are less than those of other Agencies,
and will be made known on application.*

J. T. SCOTT.

S. C. SCOTT.

J. T. SCOTT, JR.

ESTABLISHED 1847.

J. T. SCOTT & CO., 7 MAIDEN LANE, N. Y.

Importers of Watches and Wholesale Dealers in all grades of American Movements and Cases, Jewelry, Chains, Diamonds, &c.

ALSO IMPORTERS OF THE CELEBRATED TRIUMPH-ROSKOPF WATCH.

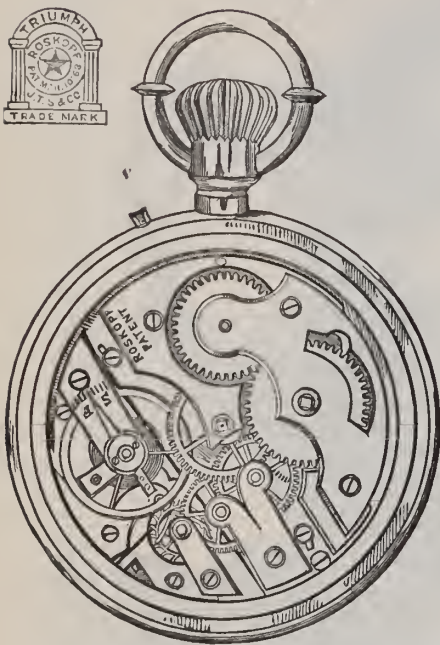

WITH INTERCHANGEABLE
AND ADJUSTABLE
ESCAPEMENT.

Cased in Superior Nickel, Open
Face, Stem Wind and Set.

ALSO THE OLD RELIABLE
ROSKOPF WATCH,
OUR TRIUMPH-ROSKOPF AND ROSKOPF WATCHES

FOR SALE BY ALL THE LEADING JOBBERS.

All Orders Committed to our Care will receive
Prompt and Careful Attention.

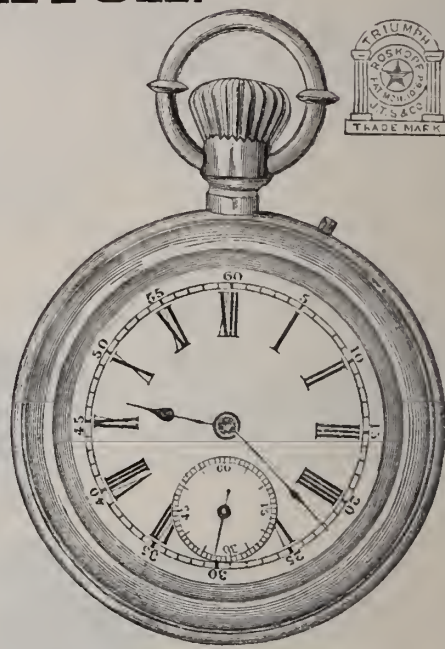

We have additional Facilities for doing our Jobbing; being done on the premises will receive our Personal Supervision. ESTIMATES GIVEN ON SPECIAL WORK.

COX & SEDGWICK,

26 John Street, N. Y.

MAKERS OF

BLACK ONYX BEAD

BRACELETS

WITH AND WITHOUT

GOLD RINGS BETWEEN EACH BEAD,

ALSO MAKERS OF

Rich Gold and Onyx

JEWELRY.

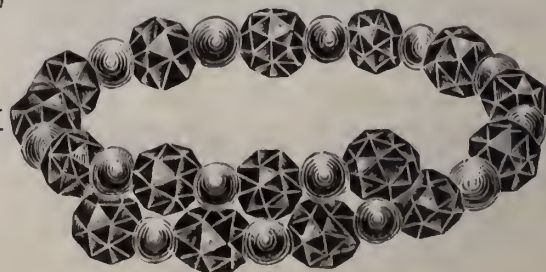
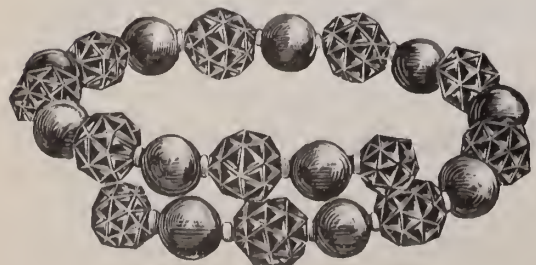
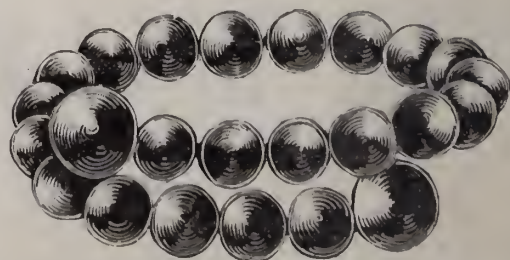
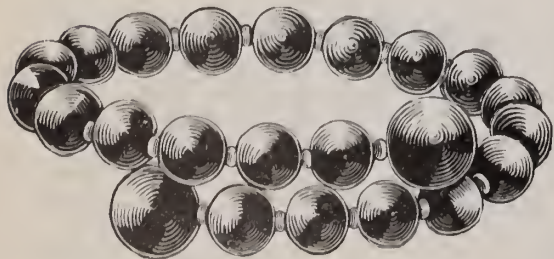
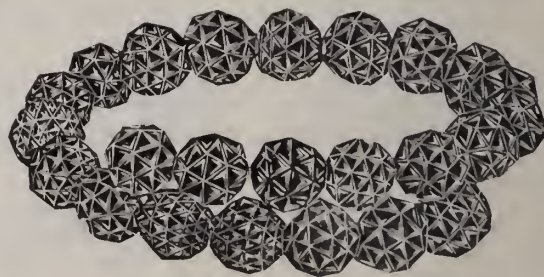
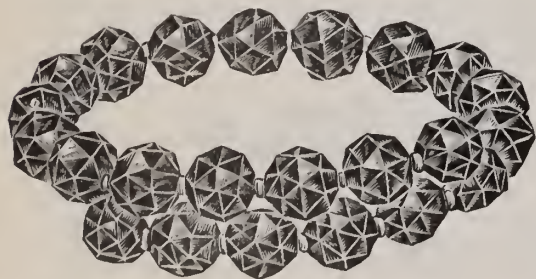

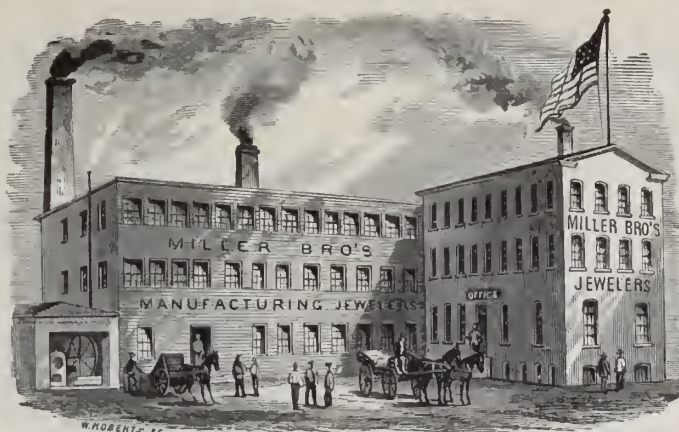

Manufactory, 47, 49 & 51 Franklin Street, Newark, N. J.

MILLER BROS.,

No. 7 MAIDEN LANE, NEW YORK,

IMPORTERS OF DIAMONDS

AND

Manufacturers of Fine Jewelry.

INITIAL GOODS A SPECIALTY.

All goods exclusively of our own manufacture, many of which are protected by MECHANICAL and DESIGN PATENTS.

CROSS & BEQUELIN,

21 MAIDEN LANE, N. Y.

P. O. BOX No. 531.

MANUFACTURERS OF THE CENTENNIAL

CHRONOGRAPH

THE BEST AND CHEAPEST HORSE TIMER

AND THE

Most Accurate Time Keeper in the World for the Money.

IN GOLD AND SILVER CASES.

CHEAP AND RELIABLE.

See Cut.

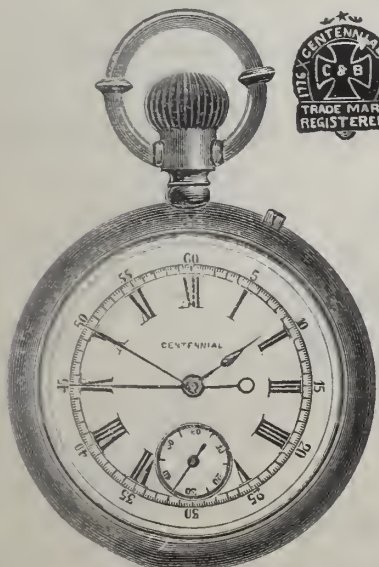

WHOLESALE DEALERS IN ALL GRADES OF

AMERICAN AND SWISS WATCHES, JEWELRY, MATERIALS, ETC.

SOLE AGENTS IN NEW YORK FOR THE SALE OF THE ENGLE ENGRAVING MACHINE.

WM. SMITH & CO.,

MANUFACTURERS OF

GOLD and SILVER Chains & Jewelry,

Also a Large Line of SILVER RINGS.

OFFICE :

No. 25 Maiden Lane, New York.

MANUFACTORY—No 61 PECK STREET, PROVIDENCE, R. I.

W. & S. BLACKINTON,

MANUFACTURERS OF

ONLY

FINE ROLLED PLATE CHAINS,

Necklaces, Polished and Roman, of Latest Gold Designs. Also a Complete Line of Gents' and Ladies' Locketts and Pendants.

In consequence of the first-class reputation our goods have obtained, unscrupulous dealers have been selling goods of an inferior quality, represented as our manufacture. In order to protect ourselves, as well as dealers, all goods of our manufacture will hereafter bear this

TRADE MARK. **W&S.B** ★ TRADE MARK.

These Goods are for sale by all Wholesale Dealers.

ESTABLISHED 1873.

CHAS. P. HEROLD,

916 CHESTNUT STREET,

PHILADELPHIA,

(SECOND FLOOR).

Manufacturer of

DIAMOND JEWELRY.

18 K.

DIAMOND

MOUNTINGS

A SPECIALTY.

And Exclusively of my own Designs.

Webster's Silver Solution,

PREPARED BY

E. G. WEBSTER & BROTHER,

(Established 1859.)

Manufacturers of Quadruple

Electro Silver Plated Ware

14 MAIDEN LANE, N. Y.,

Expressly for Cleaning Silver and Silver Plated Ware.

Jewelers will find this a valuable adjunct for cleaning their stock, and a reliable article to recommend to their customers.

Guaranteed entirely free from Cyanide, Acid, Grit, or anything detrimental to the Finest Wares.

Packed in Boxes containing 2 Doz. Bottles.

Price, \$1.25 per Doz., NET.



CHESTER MANCHESTER & CO.,

MANUFACTURERS OF

Gold & Silver Chains,

No. 13 HANOVER STREET,

PROVIDENCE, R. I.

Waltham, Elgin, Illinois, Hampden, E. Howard & Co. and Special Movements.

392 WASHINGTON ST., BOSTON.

P. O. BOX 5259.

D. C. PERCIVAL & CO., WHOLESALE DEALERS.

Watches, Jewelry, Gold Chains, Gold, Filled and Silver Cases, Spectacles, Eye - Glasses, Gold Head Canes, and Rogers & Bro.'s Flat Ware.

Price List of Movements and Cases

Sent on Receipt of Business Card.

LOUIS A. SCHERR & CO.

Importers and Wholesale Dealers in

Watches, Jewelry,

WATCH MATERIALS, TOOLS, GLASSES, &c.

Spectacles, Silk Guards, &c.

Wholesale Agents for American Watches.

**No. 726 CHESTNUT STREET
PHILADELPHIA.**

AGENTS FOR THE WHITCOMB LATHE

AGENTS FOR W. F. NYE'S WATCH AND CLOCK OILS.

TO THE TRADE.

Your attention is called to the Improved Awalt Patent Watch Regulator, Style B. It is made of Nickel, Index and all combined, with Nut C and Screw B made of Fine Steel, to fit all full plate watches, by removing the Index and using the same screw holes and screws on the watch.

Style D Regulators have been improved in shape and finish, and fit both full plate and bridge watches, are made in Gilt and Nickel, with Nut C and Screw B of Fine Steel. Try them, and it will surprise you to find how much they will aid in making a watch realize you a nice profit.

JOHN A. AWALT, Manufacturer,

ALSO JOBBER IN

WATCHES, CLOCKS, JEWELRY, Etc.,

177 Vine Street, CINCINNATI, OHIO.

THE LETTERS OF COMMENDATION

And praise of our Stem Winding Devices that we have received from watch-makers and others who use them, if published *would fill* THE JEWELERS' CIRCULAR. We started out with the intention of publishing a series of these letters, but the space required to publish all of them would be too expensive for us, and we find it difficult to select from so many; we shall therefore refrain. But any of our friends who call on us are welcome to look over our

BARREL OF TESTIMONIALS.

We will also send samples of our Winding Devices on approval to parties furnishing satisfactory references.

HENRY ABBOTT,

No. 7 MAIDEN LANE,

FACTORY JOHN ST., NEW YORK.

MANUFACTURER OF

Abbott's Patent Stem-winding Devices for Watches.

ALSO PROPRIETOR OF THE

NEW YORK DIAL CO., MAKERS OF FINE WATCH DIALS.

PRICES ON APPLICATION.

YALE CLOCK CO.

NEW HAVEN, CONN., U. S. A.

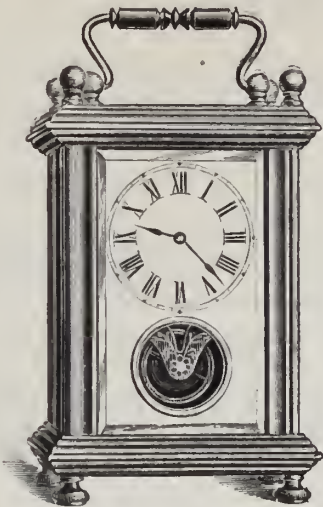

NOVELTIES

IN

CLOCKS.

A. I. HALL & SON,

General Agents,

528 & 530 Market St.
San Francisco, Cal.

52 Maiden Lane,
New York.

JOHN W. STEELE,

MANUFACTURER OF

FINE GOLD JEWELRY,

—AND—

BRAINERD'S

PATENT

LOCKETS

Patented June 17, 1874.

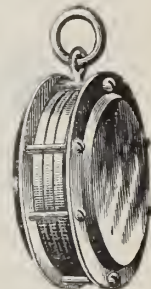

No. 9 Maiden Lane, NEW YORK.

Agents for the Lancaster, Pa., Watches.

A. FRIEDENTHAL & CO.

MANUFACTURING JEWELERS,

AND IMPORTERS OF WATCHES.

43 Maiden Lane, New York.

MATERIALS and OPTICAL GOODS.

COLBY & JOHNSON,

Manufacturers and Jobbers,
17 MAIDEN LANE, NEW YORK.

WATCH CASES,
FINE JEWELRY,
AMERICAN WATCHES.

SOLE MANUFACTURERS OF
CELLULOID WATCH CASES,
MOUNTED IN
GOLD, SILVER OR NICKEL.

DAY & CLARK,

MAKERS OF

FINE ROMAN GOODS,

HAVE REMOVED TO

10 MAIDEN LANE,

FACTORY, NEWARK, N. J.

NEW YORK.

ESTABLISHED 1855.

WELCH & MILLER,

JEWELRY
Case Manufacturers,

Of Morocco, Velvet, Russia, Brocade and Plush.

SHOW CASE TRAYS OF ALL DESCRIPTIONS.

LOCK RING TRAYS FOR DIAMOND RINGS.

Agents for Jewelers' Cotton and Twine.

All Goods of our Own Manufacture, and a Large Stock
Always on Hand.

169 BROADWAY, NEW YORK.

SUSSFELD, LORSCH & NORDLINGER,

IMPORTERS OF

Optical & Mathematical Instruments,

Watchmakers' Tools, Materials, Etc.

SPECIALTIES:

BARDOU & SONS' Universal Opera Glasses U. S. Army and Navy Glasses.
Rifle Range Telescopes, Etc., Etc.

LA REINE Opera and Marine Glasses.

CROWN Spectacles and Eye-Glasses.

PARADIS MAINSPRINGS.

PARAGON TOOLS.

13 MAIDEN LANE, NEW YORK.

16 Rue D'Enghien, PARIS.

FRANK O. LODWICK.

CHAS. A. NOLTING.

LODWICK & NOLTING, WHOLESALE JEWELERS,



JOBBERS OF
Gold, Silver & Nickel
WATCHES,

Gold and Roll Plate
JEWELRY

MOVEMENTS
AND
Watch Cases,

SPECTACLES,
Clocks and Silverware.

Positively will all Orders, In-
quiries and Repairs receive im-
mediate and reliable attention.

CINCINNATI.

ESTABLISHED 1850.

JOHN T. MAURAN,

MANUFACTURER OF

→ FINE ROLLED PLATE GOODS ←

15 MAIDEN LANE, NEW YORK.

SPECIALTIES FOR THE FALL.

FULL LINE OF

STONE LACE PINS IN RUBY AND SAPPHIRE DOUBLETS,
GARNETS AND FOILED WHITE STONES.

Jet Lace Pins, Sets and Ear Knobs, Solid Gold White Stone Knobs.

ALSO

Full Line of Coral and Wire Sets, Lace Pins, Knobs, &c.

These Goods, which are so well and favorably known to the Trade, bear this

TRADE MARK

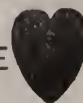

as well as the same being stamped on the cards.

PEARCE & HOAGLAND,

MANUFACTURERS OF

Gold Pens, Pencils, Pen Holders, Tooth Picks,
OF EVERY DESCRIPTION.



CLOSED

SOLE MANUFACTURERS OF THE

QUILL RESERVE TOOTH PICK,



OPEN



CLOSED

The Holder of this Case is made in various styles in Gold Plate, Celluloid, Ivory, etc., while the Pick is of ordinary Goose Quill, and can be easily replaced by a new one, at any time, from the Reserve in the end of the Holder, and is the only Pick that will not injure the Teeth.

FOR SALE BY ALL JOBBERS.

Office and Factory, 29 Point Street, Providence, R. I.

R. WALLACE & SONS M'FG CO.,

MANUFACTURERS OF

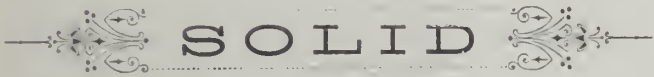

SILVERWARE,

GUARANTEED $\frac{925}{1000}$ FINE.

WALLINGFORD, CONN.

USE GOLD STOCK PLATED CHAINS

With Swivels Stamped

"R. F. S. & CO."

Every Chain Guaranteed by the Makers.

R. F. SIMMONS & CO.

ATTLEBORO FALLS, MASS.

Sold ONLY through Wholesale Houses.

LEROY C. FAIRCHILD & CO.,

14 MAIDEN LANE,

LEROY C. FAIRCHILD. NEW YORK. G. HARRY ALLEN.

In introducing ourselves to your notice as makers of Fine GOLD PENS, PEN and PENCIL CASES, ETC., we beg to solicit a share of your patronage, feeling confident of our ability to furnish desirable styles of the best quality and workmanship at the lowest market prices.

WOOD & HUGHES,

STERLING

SILVERWARE MANUFACTURERS,

New York Agents for the Derby Silver Co.'s

Fine Quadruple Plated Ware,

No. 16 John Street, N. Y.

206 Kearney Street, San Francisco, Cal.

HASKELL & MUEGGE, Agents.

J. B. & S. M. KNOWLES,

MANUFACTURERS OF

Sterling Silver Ware,

No. 20 MAIDEN LANE,

NEW YORK.

FACTORY, PROVIDENCE, R. I.



GORHAM MFG CO.
 SILVERSMITHS.
 NEW YORK CHICAGO SAN FRANCISCO
 Union Square. 170 State St. 120 Sutter St.

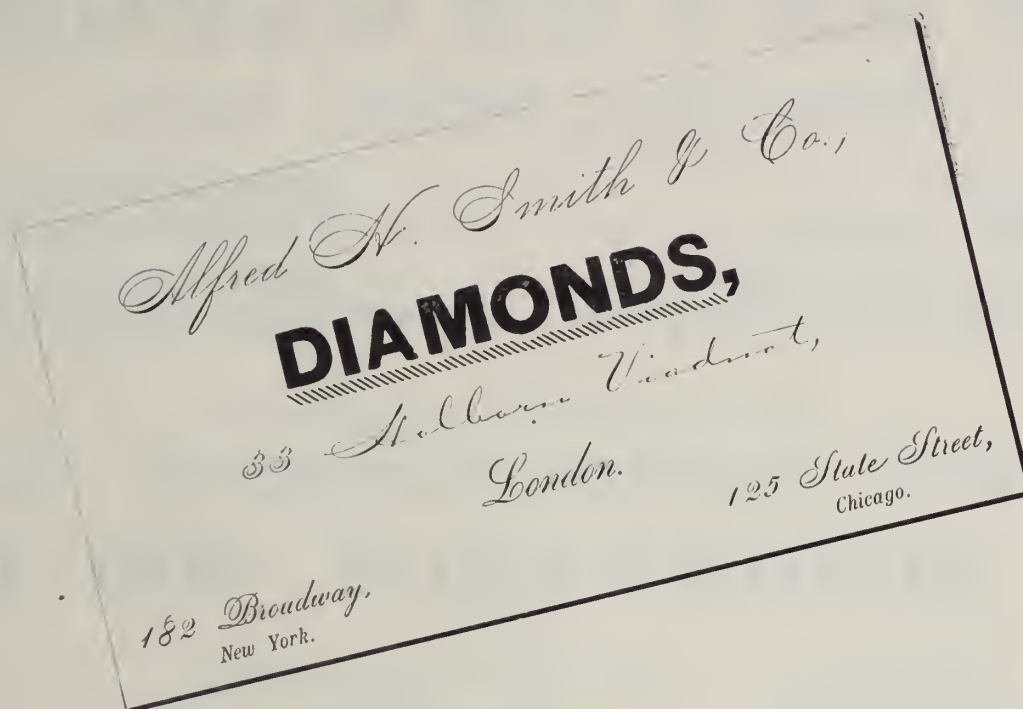

—To Dealers Visiting Europe,—

We take pleasure in directing the attention of the Trade to our London Office as above, where we hope to see those who may visit Europe this season.

Any letters addressed to our care (33 Abchurch Lane, London,) will be retained or forwarded promptly to Continental points, in accordance with instructions left with us.

Alfred N. Smith & Co.

182 Broadway, N. Y.

May 15th, 1883.

THE

NEW HAVEN CLOCK CO.

MANUFACTURERS, IMPORTERS, DEALERS,

FACTORIES.
NEW HAVEN, CONN.

WESTERN OFFICE AND SALESROOMS.
31 WASHINGTON ST., Chicago, Ill.

GENERAL OFFICE AND SALESROOMS.
16 & 18 PARK PLACE, New York.

EUROPEAN OFFICE AND SALESROOMS.
VICTORIA ST., Liverpool, England.

~~~~~

WE CALL ESPECIAL ATTENTION TO

## **HARDER'S TORSION-PENDULUM CLOCKS,**

# **RUN ACCURATELY 400 DAYS.**

Patented in America & Europe.

Sole Agents for the United States,

### **THE NEW HAVEN CLOCK CO.**

**16 & 18 Park Place,**

NEW YORK.

~~~~~

THESE CUTS ARE ONE-HALF SIZE.

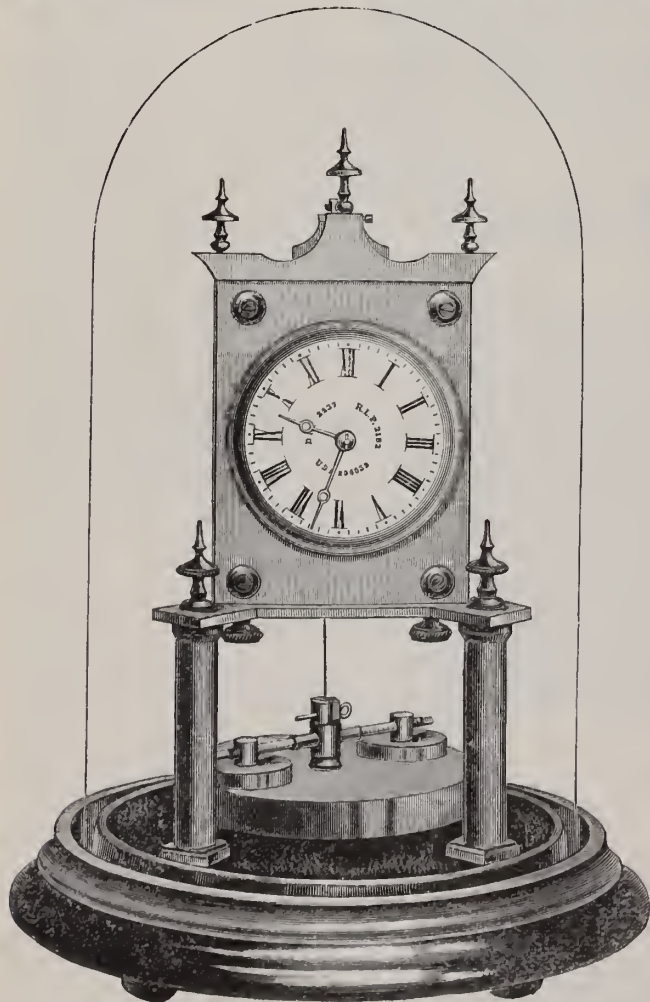

However astonishing the improvements recorded in the history of clock making since the days of Huygens, *i. e.*, 250 years ago, no one until now ever succeeded in producing clocks of plain construction and general usefulness that would run longer than a week, or a fortnight at the utmost. This Clock has astounded everybody wherever it has been introduced, for it is of very simple construction, and runs with great accuracy throughout the whole 400 days, and it has an enormous sale in other countries. There have been former inventions of clock movements to run as long a time, but never on any such principle, or with any success, as they were never found to be at all accurate, and could only be bought at a very high price. Harder's patent does away with both of these objections, and we guarantee it to perform all that we claim for it.

The Clock, with rotary torsion-pendulum, owes its origin to the ingenious idea of replacing the swinging pendulum by a time measure of equal exactitude, *viz.*, the rotary disc, which, in its rotation, meets with hardly any impediment from atmospheric resistance. The Clock makes a very handsome showing in itself, and is a very great novelty; for this reason every jeweler should have at least one. It attracts an unusual amount of attention in show rooms and windows. The price is such as will enable the jeweler to sell it with heavy profit to himself. Each Clock is securely packed by itself in a strong wooden box, with full directions for setting up. See articles among editorials on this Clock.

Prices to the Trade and any additional information given upon application.



CARTER, SLOAN & CO.,
MANUFACTURERS OF ALL KINDS OF

GOLD JEWELRY,

No. 15 MAIDEN LANE,
NEW YORK.

A. CARTER, JR.
A. K. SLOAN,

C. E. HASTINGS,
G. R. HOWE.

BALDWIN, SEXTON & PETERSON,

IMPORTERS OF

DIAMONDS and all PRECIOUS STONES,

MANUFACTURERS OF

DIAMOND AND RICH JEWELRY.

Cutters and Polishers of

DIAMONDS

692 & 694 BROADWAY, NEW YORK.

120 SUTTER ST., SAN FRANCISCO, CAL.

J. F. Chatellier,
Manufacturing Jeweler,

692 & 694 Broadway,

New York.



TRADE

MARK.

STERLING.

Whiting Manufacturing Co.

SILVERSMITHS,

BROADWAY & FOURTH ST., N. Y.

ESTABLISHED 1837.

TAYLOR & BROTHER,

Old House READ, TAYLOR & CO.,

Importers of Diamonds and Pearls,

—:AND:—

MANUFACTURERS OF DIAMOND JEWELRY,

21 Holborn Viaduct, 676 Broadway,

LONDON.

NEW YORK.

ESTABLISHED 1813.

THOMAS G. BROWN & SONS,
Newark, N. J., & 5 Bond Street, New York.

MANUFACTURERS OF

ARTISTIC JEWELRY
FOR PRESENTATION,

Including Prizes for ROWING, RIFLE SHOOTING, ARCHERY and
all ATHLETIC SPORTS.

COLLEGE SOCIETY PINS AND CLASS RINGS, ALSO BADGES FOR MILITARY
AND CIVIC BODIES IN ALL METALS.

Employing able Designers, and having all work, both in Designing and Manu-
facturing, done in our own factory, we can submit, for the inspection of those
interested, entirely original designs, appropriate in style, and not to be seen else-
where.

Estimates and Designs will be sent to Reputable Dealers when desired.

ESTABLISHED 1834.

G. & S. OWEN & CO.,

—MAKERS OF—

FINE ROMAN JEWELRY, &

—BOX and GLASS PINS,

—AND—

Black Onyx and Pearl Goods,
OF EVERY DESCRIPTION.All Goods sold by us are exclusively of our own manufacture and
are warranted 14 K. Fine, and stamped as such when possible.

No. 3 Maiden Lane, New York.

W. H. SHEAFER & Co.,

MAKERS OF

BRACELETS,

BANGLES,

LACE PINS,

SCARF PINS, ETC.

No. 15 JOHN STREET,
NEW YORK.

RIPLEY HOWLAND M'F'G CO.,

MAKERS OF

FINE JEWELRY,

SPECIALTIES:

DIAMOND MOUNTINGS, with Platinum Tips.
ENGRAVED RINGS, STONE RINGS,OFFICE, 17 MAIDEN LANE,
NEW YORK.FACTORY, 383 WASHINGTON ST.,
BOSTON, MASS.

GOLD

SAXTON, SMITH & CO.,

Manufacturers of



SOLE AGENTS

FOR THE

NEW PATENTED CHAIN BAR,

Containing a Detachable Pencil.

FACTORY:
183 EDDY ST.,
PROVIDENCE, R. I.OFFICE:
14 JOHN ST.,
NEW YORK.

CHAIN



A. J. HEDGES & CO.,

MANUFACTURING

JEWELERS,

No. 6 MAIDEN LANE,

NEW YORK.

Factory, No. 90 MECHANIC ST.,
NEWARK, N. J.

A. W. FABER'S

CELEBRATED

Gold Pens & Pencil Cases.
TOOTH PICKS AND NOVELTIES.

Manufactured by

EBERHARD FABER,
Nos. 718 and 720 Broadway,
NEW YORK.

FOWLER BROS.,
MANUFACTURERS OF

JET & ONYX JEWELRY.

Offer a large and varied stock of desirable goods of original designs, especially manufactured for the coming Fall Trade. These goods are elegant in design, beautifully finished, and must be seen to be appreciated.

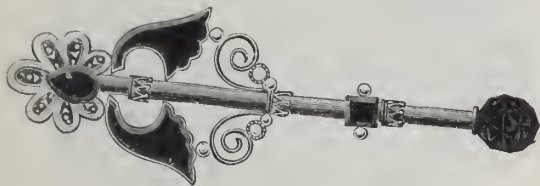

Pat. March 27, 1883.

Are Carried by all the Leading Jobbing Houses
Throughout the Country.

MOORE & HORTON,

No. 11 Maiden Lane,
NEW YORK.

JEWELERS,

SPECIALTIES:

Stone Cameo, Onyx, Amethyst, Topaz
and Pearl Rings.

Studs, Collar and Sleeve Buttons.

Also our fac-simile of Fine African Diamonds,
with Foile Back, Mounted in Rings, Studs,
Pins, Ear Rings, Scarf Pins, Lace Pins, &c.

JOHN F. SAUNDERS,
Of the late firm of Buckenham, Cole & Saunders.

CHAUNCEY IVES.

SAUNDERS & IVES,
IMPORTERS OF

DIAMONDS, PEARLS,
And Other Precious Stones.

Manufacturers of Diamond Mountings.
No. 26 MAIDEN LANE, NEW YORK.

A Large Stock of FINE DIAMONDS, Mounted and
Unmounted, kept constantly on hand.

Goods sent on approval to any part of the country on receipt of
satisfactory reference. All our goods ARE IN-
SURED by us while in transit.

DORRANCE, EDGE & CO.,

Makers of the Celebrated

Woven Fabric Gold Chain,

And Patentees of the

Embossed Inlaid Jewelry.

The Latest and Most Effective Styles of Decoration
Introduced.

15 JOHN ST., NEW YORK.
FACTORY, 46 GREENE ST., NEWARK, N. J.

G. W. PRATT & Co.,

Manufacturers and Dealers in

Watches and Jewelry

OF EVERY DESCRIPTION.

ELGIN AND ILLINOIS MOVEMENTS
IN ALL GRADES.

Gold, Silver and Ladd Patent Cases.
No. 14 JOHN STREET, NEW YORK.

C. ROSSWOG & SON,
MANUFACTURERS OF

Rich Jewelry and Diamond Goods,

NOS. 5 & 7 MAIDEN LANE,

—NEW YORK.—

CHURCHILL, LEWIS & CO.,
 Manufacturing Jewelers,
 692 BROADWAY, NEW YORK.

— S. W. HALE & CO., —
 SUCCESSORS TO HALE & MULFORD,
 MANUFACTURERS OF
FINE JEWELRY

692 BROADWAY, N. Y.
 SETH W. HALE. WILLIAM A. LEE. WILLIS H. HOWES.

JULIEN GALLET & CO.,
 IMPORTERS OF
WATCHES
 OF EVERY GRADE,
 No. 1 MAIDEN LANE,
 — NEW YORK. —

LEROY W. FAIRCHILD,
GOLD PENS.

NOVELTIES IN
 CHARM
 PENCILS.

TOOTH-PICKS,
 Whistles, etc.

SALESROOM,
 18 JOHN ST., NEW YORK.

SMITH & KNAPP,
 WHOLESALE DEALERS IN
 AMERICAN AND SWISS WATCHES,
DIAMONDS.
 Gold & Plated Jewelry & Gold Chain,
No. 182 BROADWAY,
 COR OF JOHN STREET, NEW YORK.

OFFICE:
 14 JOHN STREET, N. Y.

E. STITES' SONS.

FACTORY:
 NEWARK, NEW JERSEY.

H. DUHME.

R. H. GALBREATH.

DUHME & CO.

MANUFACTURERS OF

GOLD AND SILVER WATCH CASES,

Workshops and Salesrooms,

Carlisle Block, Fourth & Walnut, Cincinnati.

By the introduction of the very finest machinery and the employment of the most competent workmen and artisans, DUHME & CO. are now producing Watch Cases that, in strength, beauty and cheapness, are absolutely unsurpassed.

Dealers wishing to purchase Cases that are strictly first-class and at the lowest prices should examine those manufactured by DUHME & CO.

These Cases are, in all respects, meeting the views of the most exacting.

DUHME & CO. are also Jobbers of all lines of Goods required in first-class Jewelry Stores.

HAUG & LUTHY,

MANUFACTURERS OF

FINE DIAMOND MOUNTINGS, ETC.,

130 FULTON STREET,

Cor. Nassau St., NEW YORK.

N. B.—All Diamond Mountings of our Manufacture have a Patented

♦SELF-CLOSING ♦ SAFETY ♦ CATCH♦

ESTABLISHED 1867.

F. JEANDHEUR, Jr.,

125 FULTON STREET, N. Y.

Gold and Silver Electro-Plating,

Mr. Jeandheur begs to notify the Trade that he has made more improvements with his new process of Electro-Plating Watches, Jewelry, Etc. By having introduced an Electro-Plating Machine instead of using the old method of plating with Chemical Battery, he is able to plate with a far greater depth of gold than before, and for wear it is equal to rolled plate. The Trade can rely on this statement, as a trial will abundantly prove, and his well-earned reputation amongst the leading houses in the Trade will be sustained.

P. S.—He also begs to notify the Trade that he has no connection with any other house or person using his name, for the purpose of soliciting work.

PRICE LISTS SENT UPON APPLICATION.

HELLER & BARDEL

MANUFACTURERS OF



JEWELRY,

13 John St., New York.

A Full Line of DIAMONDS, Mounted and Unmounted, Always on hand, which we will send for Selection to Responsible Houses.

All Goods Ordered on Selection or for Stock are Insured while in the Hands of the Express Companies.

EXCELSIOR'S

Practical Treatise

ON THE

BALANCE SPRING

Including Making and Fitting Hair Springs, Regulating, etc.

Also containing the Adjustment of Watches and Chronometers for Isochronism, Positions, Heat and Cold and Rate.

PRICE, \$3.50.

D. H. HOPKINSON,
42 Nassau Street, New York

JOSEPH STERN.

JACOB STERN.

SIMON STERN.

STERN & STERN,

Wholesale Dealers in

WATCHES & DIAMONDS

And Manufacturers of

GOLD JEWELRY,

6 MAIDEN LANE, NEW YORK.

AGENTS FOR THE CELEBRATED
MELVILLE & NEW BRIGHTON WATCHES.

MANUFACTURERS
OF
Everything in
BLACK ONYX JEWELRY
PLAIN, and {Ornamented with
 { Pearls and
 { Diamonds.

Our manufacturing facilities have been for the past ten years devoted exclusively to the production of fine Black Onyx Jewelry. We carry in stock the largest variety of articles made in our specialty, well made, finely finished, uniformly 14 karats, at medium and low prices.

WOGLOM & MILLER,
Office & Factory, 32 & 34 JOHN STREET,
NEW YORK.

W. C. GREENE & CO.
GOLDSMITHS
MANUFACTURERS of
RICH SETS IN TAPER WIRE CORAL

Factory 95 PINE ST. Providence, R. I.
Stone-Cameo
A. Methyl's
Coral Cameo
Engraved
Enamel Sets
Brooches
Sleeve Buttons
Stud Buttons
&c. New York Office 192 BROADWAY.

WM. C. GREENE. B. W. GREENE. GEO. D. BRIGGS.

KETCHAM & McDOUGALL,
Bryant Building, (55 Liberty St.) New York.
MANUFACTURERS OF
GOLD AND SILVER THIMBLES.



THE AUTOMATIC EYE-GLASS HOLDER,
It Reels Up Cord Itself.
A—Shows position of Glasses with cord Reeled up.

ESTABLISHED 1859.
STURDY BROS. & CO.
MANUFACTURERS OF
Fine Rolled Plate Jewelry,
GRADUATED WIRE CORAL GOODS,
STERLING SILVER JEWELRY.

Bangles, Sleeve Buttons, Cuff Buttons, Baby Pins, Sets in Stone, Cameo, Enamel, Chased, and Polished, Drops and Knobs, Bar Pins, Children's Sets, Locketts, Studs, Charms, Etc.

Only Wholesale Dealers' Trade Solicited. ATTLEBORO, MASS.

Flexible Bracelets,
Diamond Mountings,
Strung Pearl Work,
Repairing,

Flexible Braided
Bracelets,
White Stone Goods,
Strung Pearl Repa'ng

Thos. W. Guilbert & Co.,
SUCCESSORS TO CARROW, DUBOSQ & Co.
908 Chestnut Street, Philadelphia, Pa.

TRADE MARK.
The ORIGINAL GOLD CROWN FILLED RINGS.

For the past thirteen years we have manufactured as a specialty, the well known "CROWN GOLD FILLED RING," with the high standing of which the trade is already perfectly familiar. In consequence of the above fact, and in justice to ourselves, we feel it a duty to make the announcement to the trade that there are now being offered in the market several other makes of filled rings, each of which has a CROWN in some way connected with its STAMP.

We Manufacture for the Jobbing Trade Only.
McCALL & NEWMAN,
625 Arch Street, Philadelphia

B. A. BALLOU & CO.,
61 Peck St., Providence, R. I.
MANUFACTURERS OF
GOLD JEWELRY.

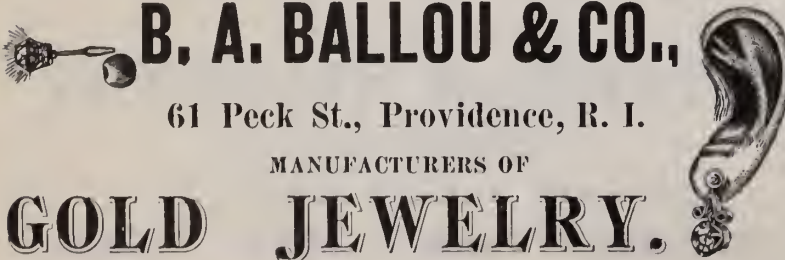

We call special attention to our PATENT FASTENING FOR EAR RINGS, which is free from the objections raised to ordinary ear wire or screw fastenings. They present a very neat and attractive appearance, are perfectly secure, and much more convenient than ordinary ear wires which always annoy the wearer by catching the hair, veil, or lace about the neck. These Goods are for Sale by all Wholesale Dealers.

Gold Studs, Small Chains for Eye-Glasses, Bracelets, Etc. a Specialty.

McCarty & Hurlburt,
WHOLESALE DEALERS IN
WALTHAM, ELGIN & ILLINOIS
WATCHES.
MANUFACTURERS OF
Jewelry, Gold Spectacles, Silver Thimbles, &c
131 North Second St.,
PHILADELPHIA, Pa.

CLOCKS

ESTABLISHED 1853.



AMERICAN
AND
FRENCH CLOCKS
AND
BRONZES.

B. J. COOKE'S SONS,
137 N. 3d Street, PHILADELPHIA.
Catalogues and Price Lists furnished to the Trade only, on application.

BOOZ & CO.,

MANUFACTURERS OF FINE GOLD Watch Cases AND PLAIN GOLD RINGS.



Jobbers in American Movements.
DIAMONDS.

108 South Eighth St., (2d Story) Philadelphia.
Samples of our goods sent on approval when satisfactory reference is furnished.
Old Gold and Silver Bought or Exchanged.

PARTICULAR ATTENTION PAID TO REPAIRING.

BOSTON WATCH CASE COMPANY

WATCH CASE MANUFACTURERS,
Nos. 1, 3 and 5 Province Court, Boston, Mass.,
ENTRANCE COR. PROVINCE STREET.

Especial Attention given to Watch Case Repairing, Springing, Re-engine Turning, Engraving, Polishing, &c.

Particular Attention given to Orders by Express.

WE OFFER THE LARGEST VARIETY OF ORIGINAL DESIGNS IN WATCH CASES EVER PRESENTED TO THE TRADE.

Mansfield Watch Tool Co.

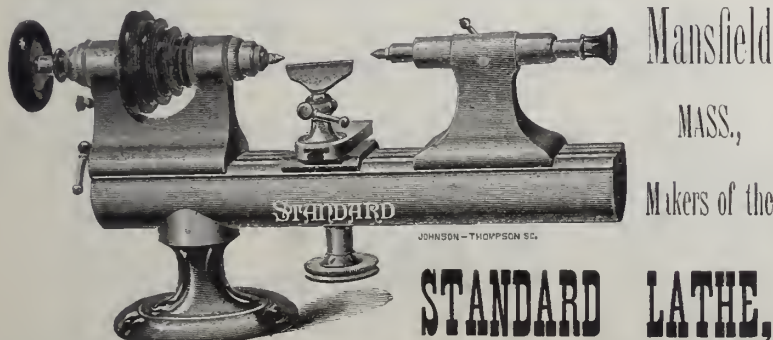

Chucks, and Watchmakers' FINE Tools of all kinds.
SEND FOR NEW PRICE LIST.

REMOVAL.
HENRY CARTER,
DIAMONDS, WATCHES, JEWELRY.
TO BRYANT BUILDING,
Cor. Nassau and Liberty Streets, NEW YORK.
CELEBRATED H. C.
★ BRAND ROLLED GOLD CHAINS

SAMUEL LAWSON,
No. 18 JOHN STREET,
Manufacturer of Black Onyx Goods,
CONSISTING OF
Breast Pins, Ear Rings, Lace Pins, Ear Studs, Bracelets, Scarf Pins, Buttons, Medallions, Studs, Collar Buttons, Vest Chains, Guards.

ESTABLISHED 1850.
TRADE MARK

PETER L. KRIDER,
MANUFACTURER OF
STERLING SILVERWARE
Medal and Diploma Awarded. &c. Striking Society Medals in Gold, Silver or Bronze a Specialty.
Artisan Hall, 618 Chestnut St., Philadelphia.

William T. Smith,
ASSAYER, REFINER AND SWEEP SMELTER.
ESTABLISHED IN 1855.
Cor. Blackstone & Hawkins Sts
PROVIDENCE, R. I.
BOSTON, Mar. 15, 1883.
To whom it may Concern :
Mr. Wm. T. Smith, of Providence, R. I., has done refining for us for years, as well as his father before him, and we take pleasure in saying we have never received anything but satisfaction in our dealings with him.
RIPLEY HOWLAND MFG. CO., R. Crosby, Treasurer.

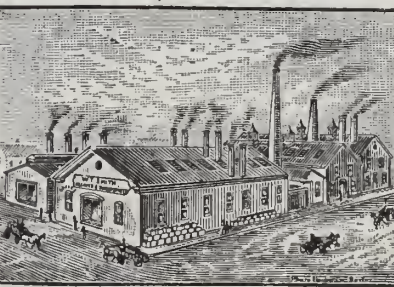

JEWELRY AND WATCHES.

ROGERS' SILVERWARE.

MATERIALS AND TOOLS.

S. F. MYERS & CO.,
Manufacturers and Jobbers,
179 BROADWAY, NEW YORK.

ILLUSTRATED CATALOGUE FOR THE TRADE.

W. E. WHITE & CO.,
Manufacturing Jewelers.

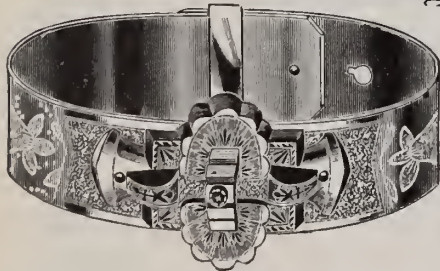

**FINE
ROLLED PLATE
GOODS.**

Bracelets---Engraved, Enamelled, Flat Band and Buckle.

Ladies' Goods---Lace Pins, Drops, Crosses, Sets, Collar Buttons, &c.

FOR SALE BY JOBBERS ONLY.

New York Office, 26 MAIDEN LANE, Corner Nassau Street.

Factory 54 Page St., Providence, R. I.

Represented by S. A. BALDWIN.

ALEX. MILNE,
Manufacturer of Stem-Winding Watch Crowns



ALSO GOLD AND SILVER THIMBLES.



19 Ward Street, NEWARK, N. J.

PFORZHEIMER, KELLER & CO.

MANUFACTURERS OF

FINE JEWELRY,

AND DEALERS IN

Diamonds, American and Swiss Watches,

No. 24 JOHN STREET,

I. PFORZHEIMER,
D. KELLER.

NEW YORK.

J. B. ETTINGER,
H. J. FINK.

Henry Fera,

Importer of Rough & Polished Diamonds,

DIAMOND CUTTING AND POLISHING WORKS:

21, 23, 25 Looijersgracht,



4 & 6 JOHN ST.,

Amsterdam, Holland.

New York.

Diamonds repaired and matched by some of the finest workmen in the world.

Diamond Bort and Powder always on hand.



KING JAMES, }
MARQUIS, } RINGS.
GLOVE, }

*Quality Guaranteed.
Prices Close.*

BARNET BROS. & POWELL,

—Manufacturers,—

Newark, N. J., & 15 JOHN ST., NEW YORK.

GEO. W. DUBOIS.

F. N. NAUMAN.

GEO. W. DUBOIS & CO.,

IMPORTERS OF

Watches & Optical Goods.

ALL STYLES AND QUALITIES OF

SPECTACLES AND EYE-GLASSES.

LONGINES' WATCHES AND MOVEMENTS.

The Watches in Gold, Silver and Nickel Cases of New and Handsome Patterns. The Movements fit 18 size Waltham Stem Winding Hunting Cases.

36 MAIDEN LANE, NEW YORK.

Orders by Mail Receive Prompt Attention.

R. & K.'S PATENT GAS FURNACES FOR MELTING, PLATING,
ENAMELING, ANNEALING, &c., &c.

Reichhelm & Koester,

Importers and Manufacturers of

Jewelers' Tools, Files, Materials, &c.,

Manufacturers of
Bristle Brushes of all kinds,
Cotton and Wool Buffs,
Felt Polishing Wheels,
Walrus Lea her Polishing
Wheels,
Jewelers' Satin Finish and
Scratch Brushes,
Brass & Steel Wire Brushes
Jewelers' Standard Saw
Frames,
Plain & Fancy Draw Plates,
Improved Jewelers' Ingots,
R. & K.'s Jewelers' Combi-
nation Gas Burners.

80 Nassau St.

NEW YORK.

Importers of
French, English & German
Tools and Files,
Piercing Saws,
Renard & Vautier Gravers,
Steel and Brass Wires,
Vienna and Ruby Draw
Plates,
Alloying Copper Wire,
Felt, Walrus Leather,
Vienna Line, Tripoli,
&c., &c., &c.

JOHN A. RILEY & CO.,

MANUFACTURING JEWELERS,

NOS. 7 & 9 BOND STREET,

NEW YORK.

O. A. GAGER,

Successor to CHAS. FIELD HAVILAND & CO.,

IMPORTER OF

Porcelain and Ornamental Ceramics,

29 BARCLAY STREET.

A Fine Line of FANCY POTTERY of all grades, specially adapted for Jewelers.

PARIAN, BISQUE, TERRE COTTA, FAIENCE, PORCELAIN, ETC.

VASES, PLAQUES, STATUETTES, BUSTS, ETC., ETC.

HENRY ZIMMERN,

IMPORTER OF

Watch Materials,

TOOLS,

AND OPTICAL GOODS,

No. 8 Maiden Lane, New York.

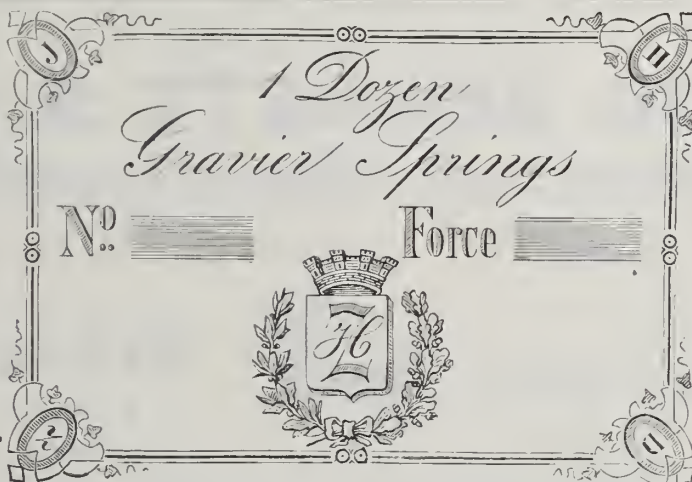

WHITE METAL CHAINS A SPECIALTY.

SOLE AGENT

FOR THE CELEBRATED

GRAVIER

MAINSPRINGS.

The cut is a fac simile of trade mark with my monogram on wrapper, adopted by me to prevent the trade from being imposed upon with imitation springs. A brass tag attached to each spring indicates the number and strength according to Dennison's United States Standard Gauge. These Springs are to be obtained at all leading Jobbing Houses.

W. W. OLIVER,

MANUFACTURER OF

Hand and Power

Rolling Mills,

For Jewelers and Silversmiths.

The "Little Giant" Ring Bender

Hollow Spindle Lathes, Punching and Drop Presses, Polishing Heads, Dies, Metal Laps, Etc.

39 CLINTON STREET,

BUFFALO, NEW YORK.

Illustrated Price List mailed free upon application.

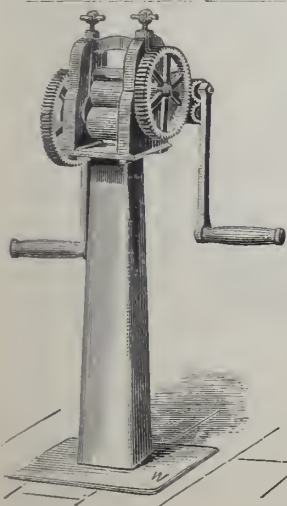

JAMES J. FISHER,

DEALER IN

WATCHMAKERS' and JEWELERS' MATERIALS,

Files, Tools, Silk Guards, Watch Glasses, Spectacles, Rolled Plate, Fire Gilt, Nickel and Silver Chain, Charms, &c.

No. 697 BROADWAY,

Corner Fourth Street, NEW YORK.

All kinds of Job Work for the Trade Promptly attended to.

The "Acme" French Clock Movement Support.

(Pat. Nov. 1st, 1881.)

This Support is adapted to the holding in position of any French Clock Movement while regulating or adjusting, and will be found very desirable on account of its simplicity of action and the small space it occupies. To be had of any respectable jobbing house, or sent, post paid, to any address, on receipt of 60 cents.



WHEELER, PARSONS & HAYES,

MANUFACTURERS OF

WATCH CASES, GOLD CHAINS & FINE JEWELRY

Importers of Diamonds and Manufacturers of Diamond Jewelry,
And Dealers in American and Swiss Watches,
No. 2 MAIDEN LANE, NEW YORK.

Established 1841.

Enos Richardson & Co.,
 Manufacturers of Gold Jewelry and Chains,
 23 Maiden Lane, New York.

Goods sent on approval to Dealers in any part of the U. S. upon receipt of order with satisfactory references.

San Francisco Office, 206 Kearny St., Haskell & Muegge, Agents,
 Where a full line of our goods can always be found at Eastern Prices.

Established 1828.

JACOB BENNETT & SON,

Diamond Setters and Manufacturing Jewelers,
 No. 923 CHESTNUT STREET, PHILADELPHIA.

WE MANUFACTURE AND MAKE A SPECIALTY OF
 EVERY DESCRIPTION OF

DIAMOND MOUNTINGS,

SUPERIOR IN DESIGN AND WORKMANSHIP.



Dealers in

DIAMONDS

And all kinds of Precious Stones.

Of which we keep a Large Assortment Constantly on Hand.

Masonic Marks Society and School Badges, Made to Order Only. Designs and Estimates Furnished.
 PARTICULAR ATTENTION GIVEN TO ALL KINDS OF JOBBING.

EDWIN A. THRALL,

1 MAIDEN LANE,

NEW YORK.

—o JOBBER IN o—

American Watches, Diamonds, Fine Jewelry, Etc.

AT LOW PRICES, AND FOR CASH ONLY.

I employ no Travelers, therefore can furnish select goods of the newest designs at the very lowest market price. Every Watch warranted to keep time when delivered. The new system introduced by the American Watch Co., of selling a complete watch, will be adopted. Agent for the new Mascot Bracelet, Patented. Orders filled immediately on receipt. Repairing and Adjusting Fine Watches and Chronometers for the Trade a Specialty.

A NEW PIN TONGUE VISEFOR JEWELERS and DEALERS  in JEWELERS' SUPPLIES.

This New Device for securely holding Pin Tongues while being fitted, will commend itself to every Practical Workman.

The joint of the tongue is placed in one of the graduated grooves and firmly secured by tightening the screw, enabling the workman to either file the joint to any required thickness, brooch the hole, shorten the pin or correct such defects as he may desire with ease and dispatch.

These tools are made of Hardened Steel, Nickel Plated, and is a useful and handy tool.

Price, \$1.25. For Sale to the Trade by

HENRY GINNEL & CO., Wholesale Agents,
31 Maiden Lane, NEW YORK.

A. J. WARNER & CO.,
WHOLESALE JEWELERS,

309 Nicollet Avenue, Minneapolis, Minn.

We carry a Large and Elegant Stock of Jewelry, Watches, Cases, Etc., Etc.

North-western Agents of the WATERBURY CLOCK CO., and carry a Complete Line of their Goods.

OUR TRADE IS EXCLUSIVELY WITH THE JEWELERS.

ESTABLISHED 1810.

VACHERON & CONSTANTIN,
WATCH MANUFACTURERS,
GENEVA, SWITZERLAND.

These celebrated Watches and Movements are adjusted to Heat, Cold and Position. Movements Fitting ready made Stem-winding, Open Face and Hunting Cases of Waltham and Elgin Sizes.

SOLE AGENT IN UNITED STATES AND CANADA,

CHAS. LEO ABRY,

P. O. BOX 611.

63 NASSAU STREET, NEW YORK.

↔ **M. FOX & CO.,** ↔

Practical Lapidaries and Importers of

D I A M O N D S .

Rubies, Sapphires and Fancy Gems.

↔ PEARLS, ↔ TURQUOISE, ↔ INTAGLIOS, ↔ ONYX, ↔ AMETHYST, ↔ ETC. ↔

No. 1 MAIDEN LANE. NEW YORK.



181



193



PATENT APPLIED FOR 193



214



218



219



812



THE ABOVE CUTS ARE THREE DIFFERENT SHAPES IN THE SAME WEIGHT OF PLAIN RINGS. TO BE USED IN ORDERING.

J. B. BOWDEN & Co.,
MANUFACTURERS OF SOLID RINGS
OF EVERY DESCRIPTION.

No. 1 MAIDEN LANE, cor. Broadway, NEW YORK.

SINNOCK & SHERRILL,
SEAL & STONE RING MANUFACTURERS,



Richly incrustated with Diamonds.
14 K. Fine.
Design of Shank Patented.

3 Maiden Lane, New York.

Factory, Goldsmith Hall, Maple Place,

Green Street, Newark.

CHICAGO OFFICE.

182 State Street.



Raised Initial in Diamonds.
14 K. Fine.

THE NUMBER OF THOUSANDTHS FINE STAMPED IN EACH RING.

THEUERNER & CHURCH,
MANUFACTURERS OF FINE RINGS,

No. 9 MAIDEN LANE,

NEW YORK.

FACTORY, COR. MULBERRY & DURAND STS., NEWARK, N. J.

LEON JEANNE.

PAUL JEANNE

JEANNE BROTHERS

MANUFACTURERS OF

DIAMOND MOUNTINGS,

AND RICH JEWELRY.

No. 1 MAIDEN LANE, NEW YORK

Designs Furnished and Estimates Given.

JEANNE BROS PAT. DIAMOND SETTINGS.

A PLATINUM SETTING WITH A GOLD SURFACE OUTSIDE

IN THIS WAY THE REFLECTION OF GOLD THROUGH THE DIAMOND IS ENTIRELY AVOIDED.

PAT. AUG. 15th 1882

WM. S. HEDGES & CO.,

IMPORTERS OF



COPYRIGHT SECURED. Entered according to Act of Congress in the year 1880, by WM. S. HEDGES & Co., in the Office of the Librarian of Congress, at Washington.

170 BROADWAY,

Corner Maiden Lane, New York.

CHOICE BRILLIANTS IN SINGLE STONES AND MATCHED PAIRS A SPECIALTY.

 Fresh invoices of Goods in all Grades constantly arriving. Also choice parcels of exceptionally Fine Gems ESPECIALLY Selected for critical purchasers. A full line of Mounted Goods, Artistically Designed.

GOODS SENT ON APPROVAL.

NEW

CHRONOGRAPH

STOP WATCHES,

MADE TO



START, STOP AND FLY BACK,

With or Without Split Seconds,

MANUFACTURED BY THE

AMERICAN WATCH CO.,

WALTHAM, MASS.

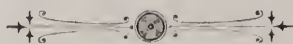

By Patented Improvements in Construction, and considerable Diminution of the Parts required, as well as by the application of American Machinery, the AMERICAN WATCH CO. has so simplified the manufacture of Chronograph Watches as to greatly reduce their cost. They can now be obtained at prices which make them the MOST DESIRABLE timepieces for Sporting Purposes, AS WELL AS FOR GENERAL USE. Dealers can depend upon these goods giving satisfaction, as they will not require the constant repairs, nor subject the dealer to the annoyance experienced in most of the foreign watches of this class. In case of accidents, Duplicates of Broken Parts can be furnished by return mail. Cased complete in 16 Size Gold and Silver Open Face and Hunting Cases. (Open Face made to wind at figure XII).

SPECIAL NET PRICE LIST,

Issued for the TRADE ONLY, will be sent on application, which will not be regarded unless accompanied by Business Card.

ANNOUNCEMENT.

The New Price List for complete 3-4 plate, 8, 14 and 16-size Gold Watches, issued under date of February 1st, 1883, by the American Watch Co., of Waltham, is now ready for distribution. We will forward a copy upon application, accompanied by business card, from any regular dealer in watches.

Jobbers who wish copies sent to their customers will please notify us by sending the names and addresses of the same, but such customers must be regular Watch Dealers. We shall take special precaution in the distribution of this list, in order to keep it out of the hands of the general public, and we beg to request that the Trade will co-operate with us in this undertaking, it being entirely in their interests.

We also beg to call particular attention to the fact that the cases quoted in this list are entirely of our own manufacture, and that we are directly responsible for the quality of the same.

By 18 K. or 14 K. or 10 K. we mean 18 K. or 14 K. or 10 K., and not 16½ K. or 12 K. or 8 K. We offer you actual value for your money.

ROBBINS & APPLETON,

NEW YORK:

5 BOND STREET.

CHICAGO, ILL.:

102 STATE STREET.

BOSTON, MASS.:

403 WASHINGTON STREET.

LONDON, ENGLAND:

HOLBORN CIRCUS.

AUSTRALIA:

SYDNEY, NEW SOUTH WALES.



Randel, Baremore & Billings
Importers of
Diamonds
and Manufacturers of
Diamond Jewelry.

*58 Nassau Street,
& 29 Maiden Lane,
New York.*

*1 St. Andrews Street,
Holborn Circus,
London, E. C.*



278D.
Patented.



389D.
Patented.



351D.



347R.



251.

SPECIAL LINE INITIAL RINGS, SEALS, ETC.

INCURSTED—DIAMOND—PEARL—OR RUSTIC LETTERS.

DESIGNS PATENTED.

Illustrated Plate sent to Dealers upon request.

HENRY C. HASKELL,

MAKER OF FINE GOLD JEWELRY.

No. 12 John St., New York.

Goods sent on approval to any part of the country, upon receipt of satisfactory references.

House Established 1837,

Successor to J. A. ABRY.

CHARLES LEO ABRY,

Importer and Manufacturer of all Grades of

SWISS WATCHES,

And dealer in Elgin, Springfield, Ill., and Lancaster Movements.

Specialties in Gilt, Nickered and Nickel Stem-Winding Movements, Ladies' Sizes, to Fit Elgin Cases.

IMPORTER OF THE FOLLOWING WELL-KNOWN SWISS WATCHES:

Geo. Mayor, A. Ames Droz, Chas. Estine, F. Richard, Huguenin Nardin and Ernest Duval, as well as all kinds of Watches for the Jobbing Trade, including Nickered, Open-Face and Hunting Stem-Winders, Anchors and Cylinders, 16, 18 and 19 lines. Silver Key and Stem-Winders, Hunting and Open Face, all sizes and qualities, from low to highest grades Silver and Nickel 13 and 14 line Watches for Chatelaines, Gold, Silver, Nickel & Rolled Plate Chatelaines of good styles & designs always in stock.

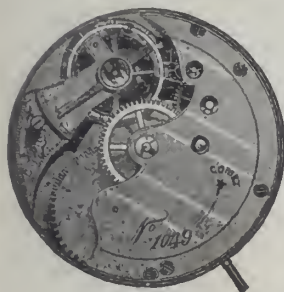

COMET.

SOLE IMPORTER.

Fits 8 Size Elgin Cases.

P. O. Box 611.

63 NASSAU STREET, NEW YORK.

Factory, Neuchatel, Switzerland.

A SPECIALTY
PATENT CATCH BRACELETS.



PAT. SEPT. 30 1882.

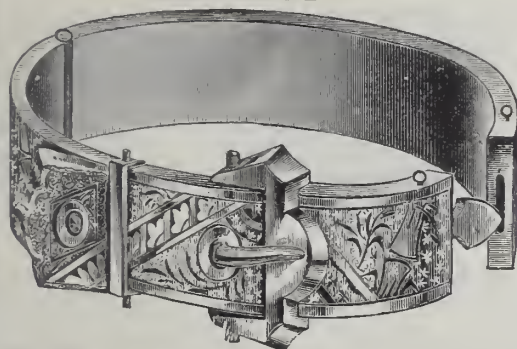

The most Convenient and Complete Catch ever invented. Not liable to get out of Order. Very Durable.

C. I. RICHARDS BROWN & CO.,

MANUFACTURERS OF

GOLD AND PLATED JEWELRY,

202 BROADWAY,

Factory, Providence, R. I.

NEW YORK.

We now offer to the Trade a Fine Assortment of Rolled Plate Jewelry, Patent Catch Bracelets in First and Second Quality, Enameled, Chased and Roman, with and without Buckle and Fancy Ornaments. Bangles and Hat Bands in great variety. Our Patent Lever and Separable Buttons and Studs, Ladies' and Gent's Collar Buttons, Charms, Lace and Scarf Pins, Sets, Chains, etc., etc.

ALSO A FULL LINE OF BRILLIANT JEWELRY IN GOLD

Goods Sent on Approval upon Application with Satisfactory Reference.

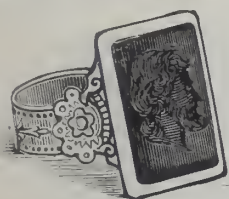

R. HENRICH, "SELF-SIZING RING,"

(PATENTED MARCH 20th, 1883.)



NEW PATTERNS FOR FALL TRADE.

FOR SALE BY ALL JOBBERS.

SEAL AND STONE RINGS IN ALL VARIETIES.

35 Maiden Lane,

NEW YORK.

HAMPDEN WATCHES.



We respectfully offer to the Trade a line of Nameless goods, which will appear on our new lists of June 1st, 1883, at which time we shall be ready to furnish our new illustrated Material price lists to all of our customers who may desire them.

Hampden Watch Co.,
General Office and Factories, **SPRINGFIELD, MASS.**

THE HOPKINS LATHE.

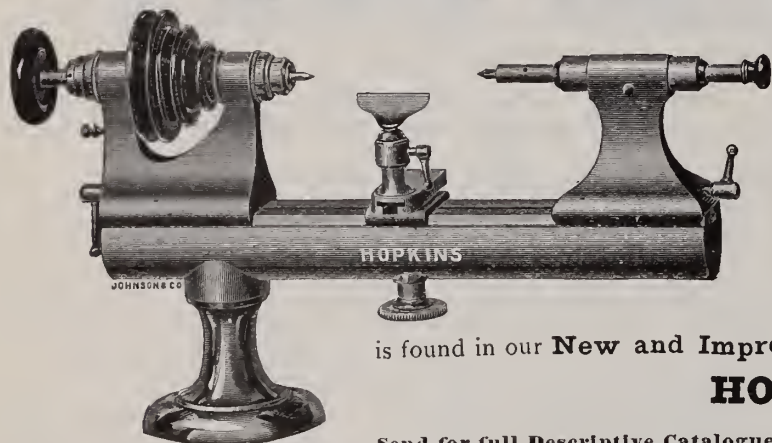

These Lathes are **Unsurpassed in Quality and Workmanship.**

In **Special Features of Practical Value**, peculiarly adapted to Watch Repairing, they excel all others. The attachments are made **interchangeable** in all the sizes.

The only absolute substitute for wax, in Watch Repairing,

is found in our **New and Improved Pivoting Chuck**, represented in the above sectional view.

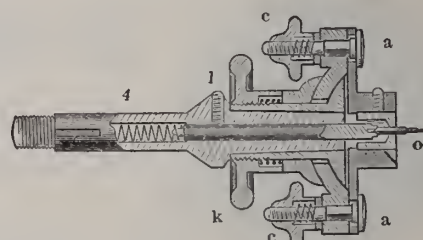

HOPKINS WATCH TOOL CO.,
WALTHAM, MASS.

Send for full Descriptive Catalogue.

S. KOHN & CO.,

43 MAIDEN LANE,

NEW YORK.

*Manufacturers of
Fine Morocco, Plush and
Velvet Boxes.*

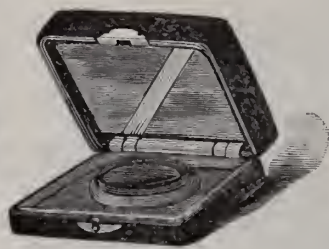

*Trays and Silverware
Boxes of all Description
Made to Order.*

A Full Line of Boxes Constantly on Hand, and Samples sent on Selection.

ORDERS FROM THE JOBBING TRADE RESPECTFULLY SOLICITED.

R. & L. FRIEDLANDER,

IMPORTERS OF

Watchmakers' & Jewelers' Supplies, Optical Goods, Etc.

Sole Ag'ts for the G. & K. Polishing Lathe, Price \$10.50

65 & 67 NASSAU ST.,

Branch, 264 Bowery, Factory, 50 Bond St.,

NEW YORK.

This Cut represents the Latest Design in
Watch Glass Cases.

PRICE OF CASE	
With 9 Drawers,	\$9.00
" 11 "	10.00
" 13 "	11.00



N. H. WHITE,
 JOBBER IN
AMERICAN-WALTHAM WATCHES,
 EXCLUSIVELY.

Waltham make of gold and silver cases a Specialty. Ladd, Boss, and the Patent Screw Bezel Filled Cases to fit Waltham movements only

No. 11 MAIDEN LANE, NEW YORK.

I not only advertise that I have the Waltham Goods, but **have constantly on hand** the Largest Stock carried by any jobber in the trade. Gold Cases of all Weights and Styles. Memorandum Packages with pleasure to dealers furnishing satisfactory reference.

COMPLETE PRICE LIST TO THE TRADE.

ESTABLISHED 1859.

RINGS A SPECIALTY.

BRYANT & BENTLEY,

12 MAIDEN LANE, Up-Stairs, NEW YORK.

AMONG OUR LATEST PATTERNS OF FINE SOLID RINGS ARE



587



591



584



504



589



490

No. 587—Made in Topaz and Amethyst. No. 591—Cluster of Garnets, Doublets or Turquoise, with Pearls and Diamonds. No. 584—Cameo or Garnet with Pearls and Diamonds. No. 504—Misses' Turquoise Rings. Nos. 490 and 589—Represent two patterns only of our Engraved Band Rings.

We also continue to make a full line of our well known 16 K. HARD SOLDER RINGS.

Goods sent on approval to responsible parties.

L. A. CUPPIA,

Manufacturing Jeweler, 19 Union Square, N. Y.

SILVER CANE HEADS,

A Large and Comprehensive Assortment of New and Original Designs.

AND IMPORTER OF

SILVER FILIGREE JEWELRY

Embracing a Large and Varied Assortment of Popular Designs.

SILVER JEWELRY.

SILVER BRACELETS A SPECIALTY.

SELECTION PACKAGES SENT ON APPROVAL.

LUDWIG LEHMANN,

MANUFACTURER OF

JEWELERS' FINDINGS,

Paper Jewelry Boxes, Jewelers' Cards, Cotton of all Shades, a Rich Assortment of Cases in Plush, Velvet and Morocco.

Also Importer of the Celebrated Grass Bleached Tissue Paper, Mill 39.

Specialties:—Imitation Morocco Boxes and Cases, Plush and Satin Lined.

122 FULTON STREET, near Nassau, NEW YORK.

FLAT NECKS.
 *
 GOLD
 FRONT
 NECK
 CHAINS

CURB CHAINS.
 *
 EXTRA
 QUALITY
 CURB
 CHAINS

ESTABLISHED
 1853

H. F. BARROWS & CO.
 1½ MAIDEN LANE,
 NEW YORK.

MANUFACTURERS OF FINE ROLLED PLATE

Chains, Bracelets, Etc.

NEW PATENT, PERFECT EDGE AND
 FLEXIBLE ROLLER NECK CHAINS,
 AND BRACELETS.

LAPPED FRONT ROLLER BRACELETS.

Roller Bracelets,
 Lapped Roller Bracelets,
 Woven Bracelets,
 Langtry Bracelets,
 Braided Wire Bracelets.

H. F. B. & CO.

ROMAN
 NECK CHAINS,
 GUARD CHAINS,
 Chatelaine Chains.

Fancy Vest Chains,
 DICKENS CHAINS,
 Ladies' Vest Chains,
 MATINEE CHAINS.



E. AUG. NERESHEIMER

 &  **CO**

IMPORTERS

 of



DIAMONDS

21 MAIDEN LANE
 NEW YORK

NO 66 SARPHATI STRAAT
 AMSTERDAM HOLL.

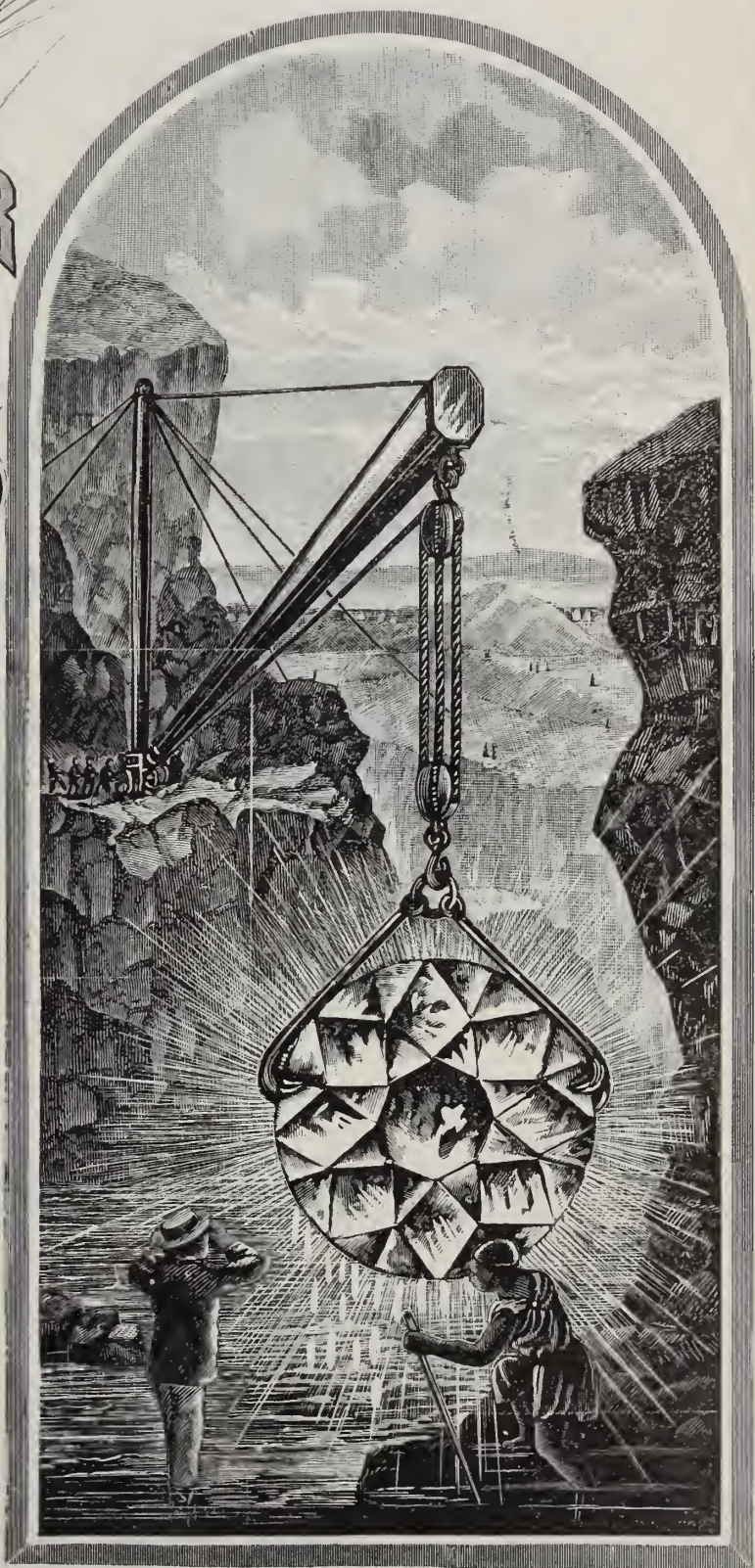

Falkenau Oppenheimer & Co.
Importers of Diamonds



40 Maiden Lane N. Y.

Post Office Box 3314.

AIKIN, LAMBERT & CO.

23 MAIDEN LANE, NEW YORK,

MANUFACTURERS, IMPORTERS, JOBBERS.

❖ JEWELRY. ❖

A Large Assortment of all Leading Styles in GOLD, SILVER and ROLL PLATE, including

- | | |
|-------------------|------------------------|
| <i>Diamonds,</i> | <i>Buttons,</i> |
| <i>Bracelets,</i> | <i>Studs,</i> |
| <i>Rings,</i> | <i>Lace Pins,</i> |
| <i>Chains,</i> | <i>Drops and Sets,</i> |
| <i>Charms,</i> | <i>Scarf Pins,</i> |
| <i>Locketts,</i> | <i>Emblems,</i> |
| | <i>Thimbles, Etc.</i> |

❖ WATCHES. ❖

PAUL BRETON

Fine Movements, In Gold Cases.

AGASSIZ AND LONGINES

Stem Winding Movements, Fitting American Cases.

CHRONOGRAPHS, in Silver and Gold Cases.

Reliable Swiss Silver and Nickel Stem Winders.

ALL LEADING AMERICAN MOVEMENTS AND CASES.

GOLD PENS,

HOLDERS, PENCILS, TOOTH PICKS.

“NOVELTIES” IN PENCIL CHARMS.

Show Case and Fancy Tray Assortments, in New and Tasty Designs for Jewelers, A SPECIALTY.

Catalogues and Price Lists sent to Dealers when request is accompanied by Business Card.



Branches: { 113 EAST MADISON STREET, CHICAGO, ILLS.
{ 41 WEST FOURTH STREET, CINCINNATI, O.

Factories: { 14, 16 & 18 MAIDEN LANE, N. Y.
{ 12 VESEY AND 6 BARCLAY ST., N. Y.

❖ Novelties Continually Being Introduced. ❖

SELECTION PACKAGES SENT.

JAMES C. AIKIN. {
H. A. LAMBERT. }

PROMPT ATTENTION TO ORDERS AND REPAIRS.

{ J. B. SHEA.
{ D. F. FOLEY.

GEO. H. RICHARDS, JR.,

383 Washington Street, Boston, Mass., U. S. A.,

JOBBER

American Movements and Cases a Specialty.

WE GUARANTEE TO HAVE **ALL GRADES** IN STOCK.

MOVEMENTS.

WALTHAM.

SPRINGFIELD, ILLS.

HAMPDEN.

ELGIN.

HOWARD.

CASES.

❖GOLD❖

➤FILLED❖

❖SILVER❖

WALTHAM.

"BOSS."

WALTHAM.

DUEBER.

CROWN.

DUEBER.

BROOKLYN.

LADD.

FAHYS.

G. H. R., Jr.

KEYSTONE.

Watches, Jewelry and Silver Plated Ware. Rogers & Bro.'s Flat Ware.

HOLLOW AND FLAT WARE SOLD AT MANUFACTURERS' DISCOUNTS.

Our Stock is positively the Largest, Finest and Best Assorted of any Jobbing House in the Country. All Orders Promptly Executed.

Sole Agent for Gould's Patent Regulator and Elliott's Watch Oiler.

FOR SALE BY ALL JOBBERS AND MATERIAL DEALERS.

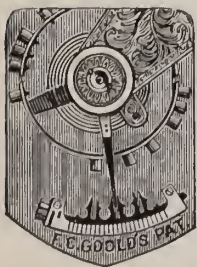

For 18 Size Movements, K. W. & S. W.



For 18 Size Movements, K. W. & S. W.

THE REGULATOR WILL BE IN THE MARKET JULY 1st, Price, \$1.25.

ELLIOTT'S AUTOMATIC WATCH OILER.

NEW THING. EVERY WATCHMAKER SHOULD POSSESS ONE.

THE GOODS ARE READY FOR DELIVERY, Price, \$1.00.



WATCH SIZE.

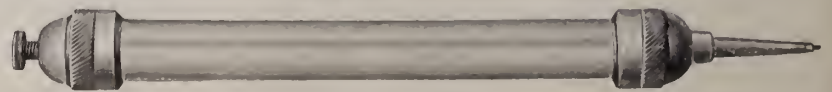

CLOCK SIZE.

SENT BY MAIL TO ANY PART OF THE COUNTRY.

GEO. H. RICHARDS, Jr., 383 Washington Street, Boston, Mass.

W. WESLEY MOORE

hopes to add to his many friends in Ohio, Tennessee, Arkansas, Kentucky, Missouri, Illinois, Iowa, Kansas, Nebraska, Colorado, New Mexico, Wyoming, Utah, Montana, Nevada, California, Arizona and Oregon.

NEW DESIGNS.

Mr. BRADLEY

will call at regular intervals in

Illinois, Wisconsin, Michigan, Minnesota, Dakota, Montana, Iowa and Indiana.

Headquarters, Chicago, - - Illinois.



J. L. CLARK

hopes to receive the favors of his patrons in New York, Massachusetts, Connecticut and Vermont.

We, the undersigned, representatives of the above well-known house, would announce to our respective friends that we will show them this Spring many new attractions, in addition to our usually large and varied stock.

We aim to merit your continued patronage and confidence.

Very Respectfully,

J. C. ANDRESS

will continue to call on his friends in Maryland, Delaware, District Columbia, Virginia, W. Virginia, North Carolina, South Carolina, Georgia, Florida, Alabama, Mississippi, Louisiana, Texas Tennessee, Kentucky and Ohio.

W. Wesley Moore
Mr. Bradley
J. L. Clark
J. C. Andress
H. C. Barnum
H. S. Colyer

H. C. BARNUM

will renew his many acquaintances in Massachusetts, New York, Ohio, Indiana, Illinois and Michigan. Headquarters, Syracuse, . . . N. Y.

ATTRACTIVE GOODS.

FRESH STOCK.

LOW PRICES.

H. S. COLYER

will represent the house in Massachusetts, Maine, New Hampshire, New Jersey, Pennsylvania, Ohio and West Virginia.

Ladd Watch Case Company,

(ORGANIZED 1883.)

SUCCESSORS TO J. A. BROWN & CO.,

(ESTABLISHED 1858.)

MANUFACTURERS OF THE

LADD PATENT GOLD WATCH CASES.

EXAMINE

THE

NEW MODEL

WALLET

Ladd Case.



Design No. 743.



Design No. 749.

Which is universally pronounced on sight to be the Most Elegant and the Best Article in this line yet brought out.

It has all the Late Improvements,

Including Solid Gold Bows and Solid Gold Linings,

AND FOR WORKMANSHIP, STYLE AND FINISH IT IS UNEQUALED.

Its Shape is such as to admit of the most elaborate ornamentation, or any intermediate style down to the plainest, without loss of effectiveness, in accordance with the taste of the purchaser.

For Sale by the Leading Wholesale Jobbing Trade.

THE CLIMAX REVERSIBLE WATCH CASES.

MANUFACTURED BY THE

Northwestern Watch Case Co.

MANUFACTURED BY THE

Northwestern Watch Case Co.



CHANGED FROM AN OPEN FACE TO A HUNTING CASE AT WILL.

MADE TO FIT THE 18 SIZE STEM WIND AMERICAN MOVEMENTS.

Patented April 3d, 1883, No. 275,251.

ABSOLUTELY DUST PROOF. A PERFECT WATCH CASE.

A MARVEL OF INGENUOUS MECHANISM.

—Descriptive Circulars Furnished Upon Application.—

THE WINDSOR SLEEVE LINK.

PATENTED MARCH 13, 1883.

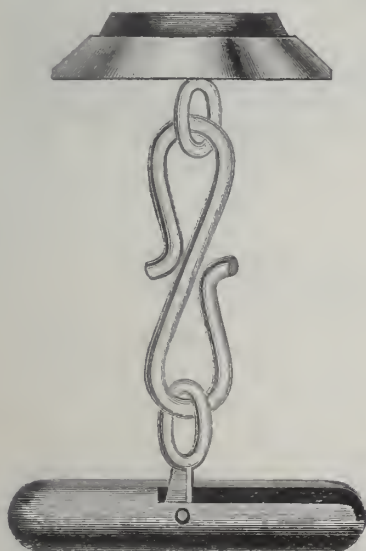

This Cut represents the Button with the Eye properly adjusted in the center of the Bar.

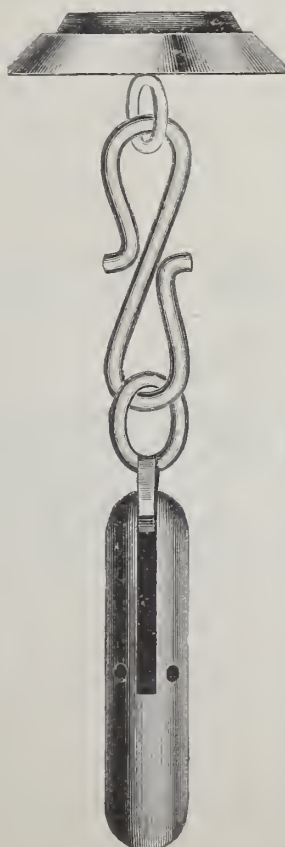

OPENED.

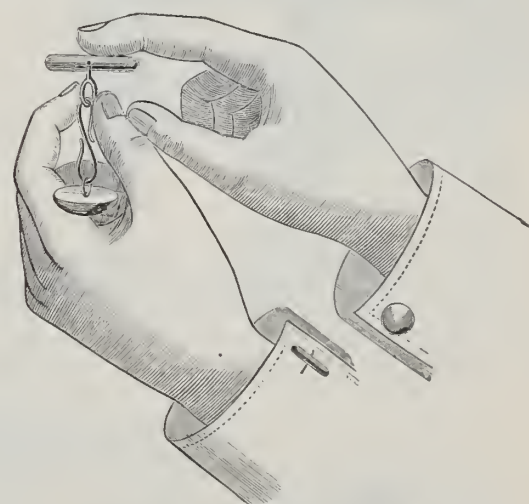

This Cut represents the proper manner of detaching the Eye and sliding the same to the end of the Bar.

SOLD BY ALL LEADING JOBBERS.

ESTABLISHED 1844.

DENNISON MFG CO.,

BOSTON, NEW YORK, PHILADELPHIA, CHICAGO, CINCINNATI AND ST. LOUIS.

JEWELERS' FINDINGS.

PAPER JEWELRY BOXES IN ALL STYLES AND QUALITIES. IMITATION MOROCCO BOXES, SATIN LINED. TAGS, JEWELERS' CARDS, PINK AND WHITE COTTON, &c., &c.

MOROCCO CASES.

Manufacturing in our own Shops Every Description of Morocco, Plush and Velvet Jewelry and Silverware Cases in large quantities, we are enabled to sell lower than other goods of equal quality can be offered, and we carry in all our Stores FULL Stock of our whole line.

Catalogue on Application.



308



306

ELLISON & VESTER'S
PATENT BAND AND BANGLE FINE ROLLED PLATE

BRACELETS.

FOR SALE BY EVERY JOBBER.

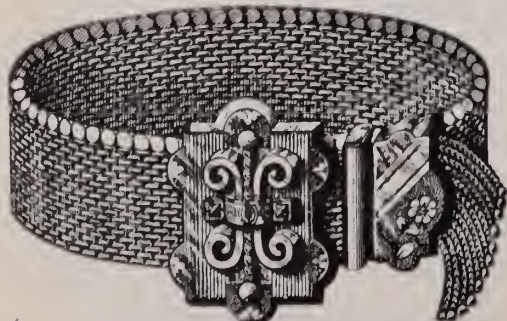

304



310 1/2

ROGERS, SMITH & CO.,

MANUFACTURERS OF

Electro Gold
AND
Silver Plated
Ware.



SALESROOMS:

46 EAST 14th STREET,

UNION SQUARE, N. Y.

FOR THE TRADE ONLY.

FACTORY, - - - - MERIDEN, CONN.

FRANK S. KENNEDY,

Manufacturer and Wholesale Dealer in

JEWELRY

OF EVERY DESCRIPTION.

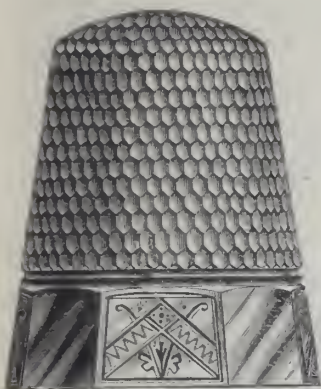

13 Maiden Lane,
NEW YORK.

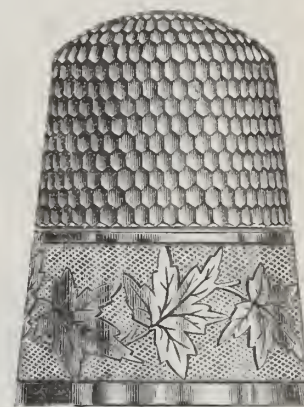

13 Maiden Lane,
NEW YORK.

In addition to my stock of Jewelry, which is complete in all lines of Gold, Silver and Roll Plate, I am now making a Full Assortment of

✦ THIMBLES, ✦

in Solid Silver, 10 karat and 14 karat Gold. These Thimbles are Superior in Finish to any now in the market, and are as near perfection as long practical experience can make them. Will send Samples if desired.

The Assortments of Jewelry I send on Memorandum for Special and Stock Orders have an increasingly high reputation.

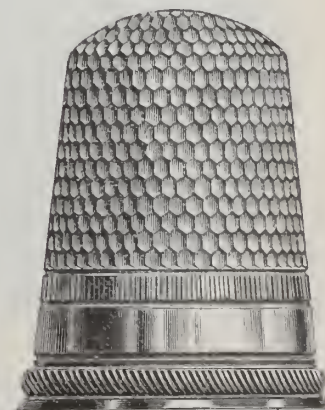
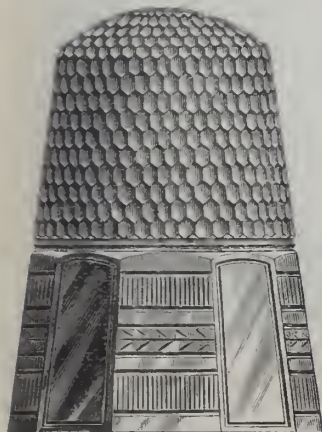

T H E

E. HOWARD WATCH AND CLOCK CO.,

—MANUFACTURERS OF—

Fine Stem-Winding Watches,

FINE REGULATORS, OFFICE CLOCKS, TOWER CLOCKS,

And Electric Watch Clocks.



LADIES'
6 Size.

STEM-WINDING
AND



CENT'S
16 Size.

Stem-Setting
Movements.



CENT'S
18 Size.

114 TREMONT ST., BOSTON.

29 MAIDEN LANE, New York.

J. W. J. PIERSON, Agent.



WILLEMIN WATCH CASE CO.,

109 Sands Street, Brooklyn, N. Y.

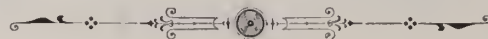

Patent 278,282 issued to

G. Willemin, May 22, 1883.

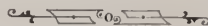

These Cuts represent the Patent Swivel Guards, and we respectfully call attention of the Trade to it as the only Swivel Guard that is practical, as it is utterly impossible for the Swivel to come in contact with the Crown.

They are made in two styles, one plain, suitable to our Celebrated Engine Turned Jurgensen Case, the other engraved to correspond to the designs of our Engraved Cases.

As the sales of these Cases will undoubtedly be very large, Dealers will please send in their orders early for the Fall Trade.

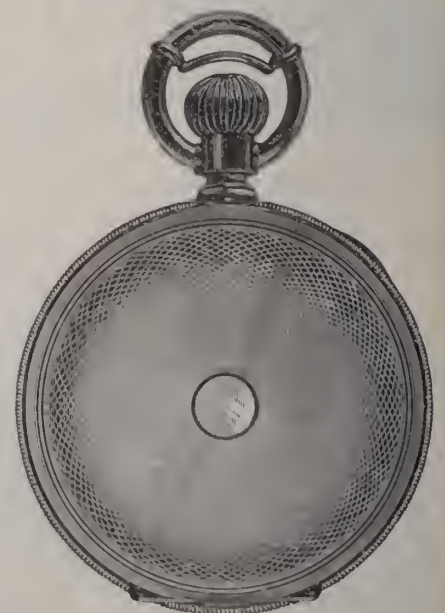

NEW YORK OFFICE REMOVED FROM

No. 1¹/₂ TO Nos. 14 & 16 Maiden Lane.

KREMENTZ & CO.,

MANUFACTURERS OF

GOLD, PEARL AND DIAMOND JEWELRY,

Nos. 182 and 184 BROADWAY,

Corner of John Street,

NEW YORK.

(Elevator Entrance on John Street.)

NOVELTIES IN SILVER JEWELRY.

FACTORY, NEWARK, N. J.

LONGINES CHRONOGRAPHS

Fly-Back & Horse-Timing

STEM-WINDING

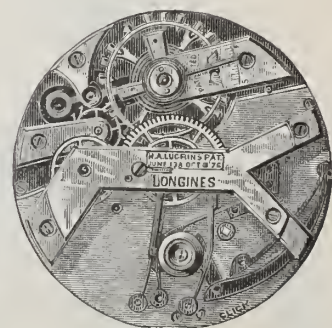

The most reliable, accurate and substantial LOW PRICE Timing Watch made. The improved method of mechanism in their construction renders these goods superior to any low price Timing Watch in the market, and the Best Selling Goods offered to the Trade.

J. EUGENE ROBERT,

30 MAIDEN LANE,

NEW YORK.

FOR SALE BY THE LEADING JOBBERS.

Duplicate Parts and Finished Material for these Goods always in Stock.

STERN BROS. & CO.,

No. 30 Maiden Lane, New York,

Importers of Diamonds,

MANUFACTURERS OF FINE JEWELRY.

Jobbers in American Movements of all grades, Gold & Silver Cases, Gold & Plated Chains.

THE FOLLOWING ARE OUR **SPECIALTIES:**

SEAL and STONE RINGS. GENT'S LOCKETS. The most complete and largest line of GOLD INITIAL RINGS and LOCKETS made in the United States. The celebrated DOUBLE CROWN Plain Filled Rings, which are universally acknowledged the MOST RELIABLE in the market. Made in seven different widths.

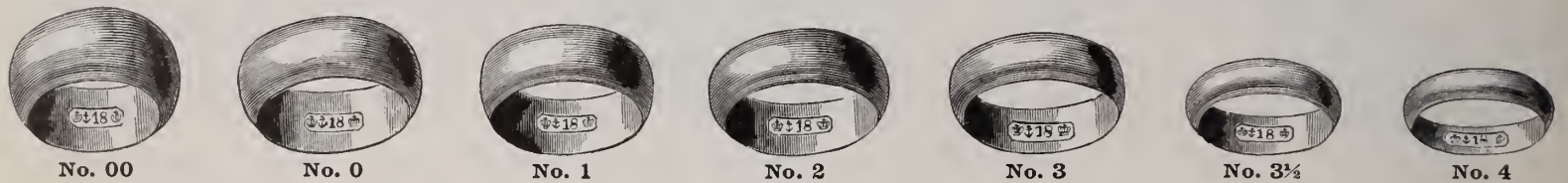

EVERY RING IS WARRANTED TO GIVE SATISFACTION.

Goods sent on selection to Dealers upon application with satisfactory reference.

STANDARD WATCH CO.

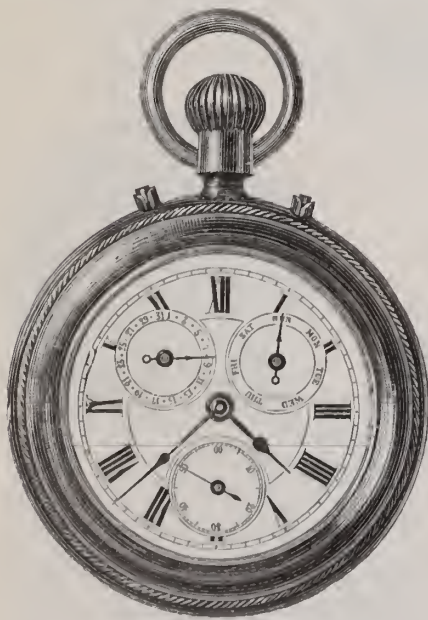

STANDARD CALENDAR.

"STANDARD CALENDAR."

20 Line, Open Face, in Nickel and Silver, showing the date and day of the week, Full Jeweled, Finished Movement. The Latest Novelty offered.



"STANDARD."

18 Size, Low Price Movement, will fit Waltham and Elgin Cases.



"VESTA."

8 Size, Low Price Movement, fits Elgin Cases.



"STANDARD."

8 Size, Full Jeweled, Ladies. Fits Waltham Cases.



"STANDARD."

Nickel, 17, 19 and 20 Line. Lever, Full Jeweled.

Max Freund & Co., Sole Agents, 8 Maiden Lane, N. Y.

LOUIS KAHN.

MOSES KAHN.

SAMUEL H. LEVY.

I. W. FRIEDMAN.

L. & M. KAHN,

IMPORTERS OF

Watches, Diamonds & Precious Stones,

10 MAIDEN LANE, NEW YORK.

11 Corrairie, Geneva, Switzerland.

17 Rue de Chateaudun, Paris.

WATCHES,

Stem and Key-Winding, from the Lowest Priced Nickel and Silver to the Finest Gold and Complicated.

A Full Assortment of these Goods always in Stock.

DIAMONDS,

Loose and Mounted, in all Sizes and Qualities.

Gold, Silver, Nickel and Celluloid Chatelaines in Great Variety.

THE LATEST DESIGN IN SEAL RINGS.

THE "PRINCESS," THE "PRINCESS," THE "PRINCESS,"

Design Patented, No. 13,840.

Design Patented, No. 13,840.

Design Patented, No. 13,840.

RAISED INITIALS IN DIAMONDS on a Curved or Dome Shaped Stone.

Notwithstanding the dullness of trade, the demand for these goods,

THE "PRINCESS" RING.



14-K.FINE
1647

Raised Initial in Diamonds.

THE "PRINCESS" RING.



PATENTED
1853

Raised Initial in Diamonds.

THE "PRINCESS" RING.



14.K.U.S.ASSAY
1647
PAT.D.

Raised Initial in Diamonds.
PATENTED.

THE "PRINCESS" RING.



14-K.FINE
1757

Raised Initial in Diamonds.
PATENTED.

THE "PRINCESS" RING.



14-K.FINE
1780

Raised Initial in Diamonds.
PATENTED.

has continued uninterrupted during the entire Spring, with a prospect of a very large business during the Fall. Retailers will find either a stock or samples of the "Princess" Ring in the hands of nearly every prominent house in the country. The Patent consists of a RAISED INITIAL on a curved or dome shaped stone, regardless of style of shank. Any dealer handling this Ring, unless stamped "Patented April 3, 1883," renders himself liable to prosecution.

The growing popularity of the "Princess" Ring renders them the most desirable goods for dealers to carry. They are Unique, Beautiful and Attractive, entirely new and moderate in price.

FOR SALE BY MANUFACTURERS AND JOBBERS.

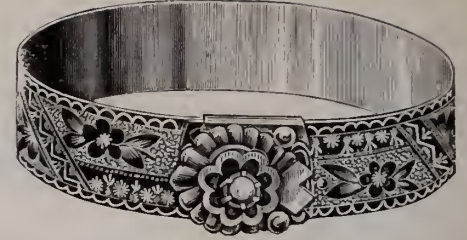
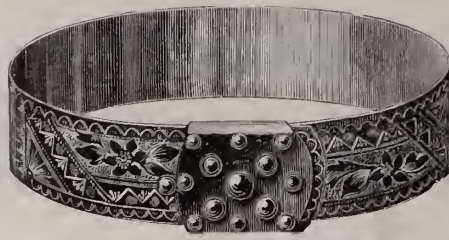
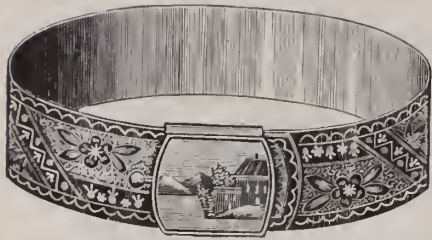

**J. M. CHANDLER & CO.,
MANUFACTURING JEWELERS.**

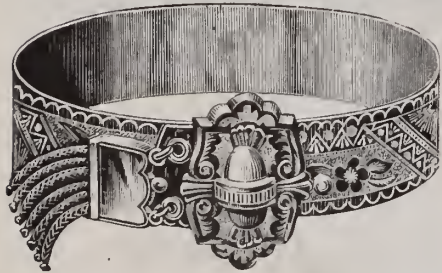

We especially call the attention of the Trade to our new Patent Band Bracelet Catch. The design of the Catch is to make a Band Bracelet adjustable to any size without the slightest difficulty—leaving the band clean and smooth, and make a secure fastening. These goods are pronounced by all who have seen them to be the *Ne Plus Ultra* of all Band Bracelets. The goods must be seen to be appreciated. We will send Selection Package of these goods to the Regular Trade.

J. M. CHANDLER & CO.

Manufactured at our own Factory, 111 Broad Street, Providence, R. I.

Office and Salesroom, 185 Superior Street, Cleveland, Ohio.

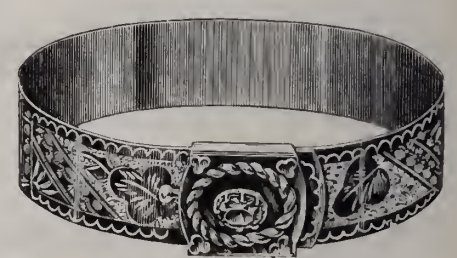
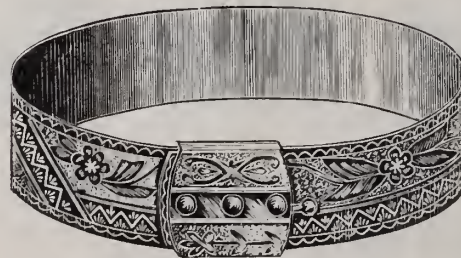
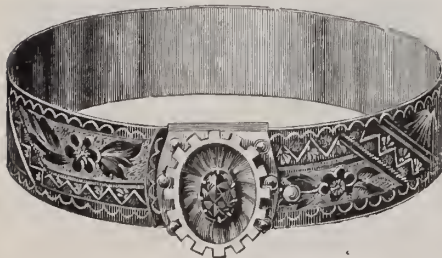

CLEMENS HELLEBUSH,

MANUFACTURER, IMPORTER AND WHOLESALE JEWELER,

Dealer in everything required by the Jewelry Trade.

DIAMONDS.—Dealers will find in my stock an assortment of Diamonds unequalled in the West, embracing a choice variety of loose and mounted Stones in all qualities.

WATCH CASES.—In Gold and Silver, of all makers, to fit American Movements.

WATCH MOVEMENTS.—Include always a full stock of Waltham, Springfield, Hampden and Howard, together with a large assortment of fine and low-priced Swiss Watches.

SILVER PLATED WARE.—I have an unusually fine assortment of the choicest patterns of Flat and Hollow Ware of the best known manufacturers.

SOLID GOLD AND ROLLED PLATE JEWELRY.—This department is replete with Staple Goods and Novelties.

FRENCH CLOCKS.—Of our own importation, including all grades, with prices exceedingly low.

AMERICAN CLOCKS.—I am the General Agent in Cincinnati for the celebrated Seth Thomas Clocks, a full line of which will always be found in stock.

TOOLS AND MATERIALS.—In this department will be found everything required by Watch Makers.

Illustrated Catalogues sent to Dealers only upon Application.

CLEMENS HELLEBUSH,

77 West 4th Street,

CINCINNATI, O.



Copyright Secured.

"The Waterbury." The New "Series B,"

NEW SERIES B.

Bezel Off,

Showing Index Plate and Regulator.



NEW SERIES B.
Solid Plates and Full Dial.

With FULL DIAL and SOLID PLATES.

In this new SOLID PLATE movement the position of the regulator has been changed; it will be found projecting beyond the plate, immediately under the bezel. The FULL DIAL enables the position of the hands to be readily seen.

The danger of injuring the Hair Spring in regulating is obviated in this new movement.

SERIES A.—Open Dial, Skeleton Plates, - \$48.00 per doz.

SERIES B.—Full Dial, Solid Plates, - - - 48 00 "

Discount to the Trade.

We can supply either Pattern as ordered.

WATERBURY WATCH CO.,
WATERBURY, CONN.



NEW YORK OFFICE, 52 MAIDEN LANE.

GEO. MERRITT, GENERAL SELLING AGENT,

To whom all Orders and Correspondence as to Prices and Terms should be addressed.

FOR SALE BY DEALERS GENERALLY.

STANDARD DUST-PROOF WATCH KEYS.

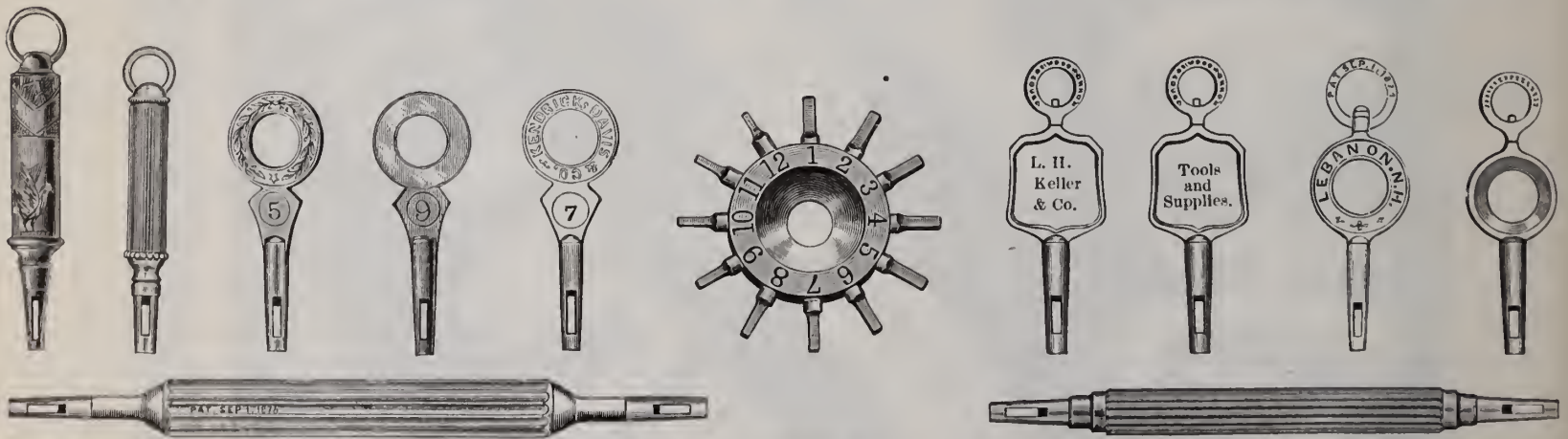

FOR SALE BY THE TRADE.

KENDRICK & DAVIS,

Sole Owners and Manufacturers, Lebanon, N. H.

ILLUSTRATED CATALOGUE AND PRICE LIST SENT ON APPLICATION.



99



1162



93



28



94



0027



0045

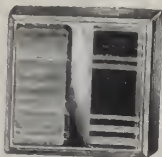

1336

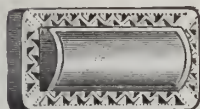

1840

THE

ACME LEVER BUTTON



1741



1016



1094



0001



OPEN.



OPEN.



OPEN.



0025



43



CLOSED.



CLOSED.



CLOSED.



1091



VENI + VICI.

Always was, is now, ever shall be
**THE MOST CONVENIENT,
STRONG, RELIABLE and PERFECT SLEEVE BUTTON MADE**

**It Overcomes
ALL TROUBLE WITH STIFF CUFFS.**

ASK YOUR JEWELER FOR THE
**ACME LEVER SLEEVE AND COLLAR BUTTON,
AND TAKE NO OTHER.**

For Sale by all Jobbers of Jewelry.



1420



1369

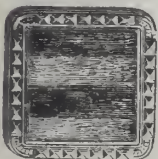

319



50



58



1585



046



321



57



1545



1269

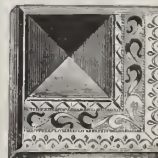

1335



1235



1340



315



1238

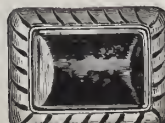

02

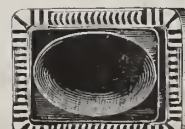

1182



634

JOHN BLISS & CO.,

Standard Marine

CHRONOMETERS AND TRANSITS

FOR WATCHMAKERS' USE.

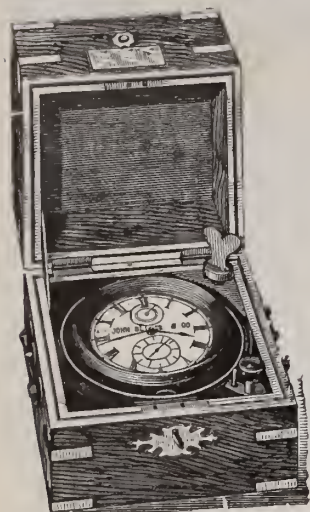

Standard Marine Chronometer,
FOR KEEPING CORRECT TIME.

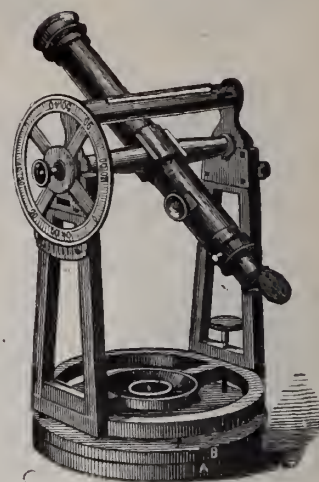

No. 10.

128 FRONT STREET,

Near Wall Street,

NEW YORK.

NOTICE.—These Transits are readily set in position without the aid of strictly correct time as a basis for that purpose. Printed instructions, easily understood, accompany each Instrument, and no calculations are required preliminary to setting in position.

SEND FOR ILLUSTRATED CIRCULAR WITH PRICES.

PATENT IMPROVEMENT IN COUNTER + SHOW + CASES, WITH PERPENDICULAR SLIDING DOORS. DUST PROOF.



The Advantage and Convenience of these Show Cases will be apparent to everyone.

The doors are more conveniently opened and closed, less liable to get out of repair or broken, articles are more easily reached in wide cases, mirrors are more safe, it dispenses with hinges, economizes room, excludes dust, and is air tight when closed.

Drawings furnished and estimates given for fitting stores in cabinet work complete.

Letters Patent having been granted us for the construction of these doors, we shall prosecute all parties using Cases which infringe on our Patents.

REFERENCES:—Gorham Mfg Co., Rogers & Bro., Mitchell Vance & Co.,
Meriden Britannia Co., M. S. Smith & Co., Detroit, Mich.
D. Valentine, Syracuse, N. Y.

B. & W. B. SMITH,
220 West 29th Street, New York.

M. Anderson, No. 57 State Street, Chicago, has the exclusive right to manufacture and sell our Improved Cases for the States of Wisconsin, Illinois, Missouri, Mississippi, Arkansas, and all States West of same.

CATALOGUE OF STYLES SENT ON APPLICATION.

W. B. & CO.

WATCH GLASSES.

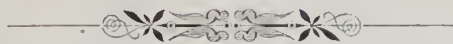

TO THE TRADE.

The W. B. & Co. Watch Glasses are universally acknowledged by unbiased judges to be the best sold in this country; nay, in the world! While a child with slight experience can gauge a watch glass as accurately as any grown person, it has taken over one hundred years to give to the W. B. & Co. Watch Glass that Elasticity, that Temper which no other glasses possess, and for which they have taken the lead and received the MEDALS over all competitors, at all public exhibitions in every part of the world.

EVERY LEADING JOBBER KEEPS THEM.

NO WATCHMAKER SHOULD BE WITHOUT THEM.

Some Material Houses for a number of years have advertised and sold exclusively the W. B. & Co. Glasses, correctly claiming for them superiority over all others. Lately, and without any apparent reason, these same houses have stopped advertising the W. B. & Co. Glasses and have adopted glasses of other manufacture unheard of before, and claiming for them the same qualities they did for the W. B. & Co.

The reason why these houses do not continue selling the W. B. & Co. Glasses are, we were unwilling to have our Glasses put upon a par with the cheaper grades. We were unwilling to let the MATERIAL HOUSES make unnecessary reductions, leading the Trade to believe they could control the W. B. & Co. Glasses as easily as they do the cheaper grades, and which, of course, everybody can keep and handle, in this they found they were mistaken.

For this reason and no other they are trying to run down the W. B. & Co. Glasses.

To prove how successful their efforts have been, we would state the sale of the W. B. & Co. Glasses is and has been steadily increasing, and the sales are and have been larger than the combined sales of all other manufacturers; thus proving that watchmakers have discovered the difference between the W. B. & Co. Glasses and the inferior grades.

ALBERT BERGER & CO.,

Manufacturers and Importers of the W. B. & Co. Watch Glasses.

THE Olin Adjustable Chuck.

CONVENIENT, DURABLE, EFFICIENT.
THE ONLY CHUCK THAT ADJUSTS THE SPLIT CHUCK.

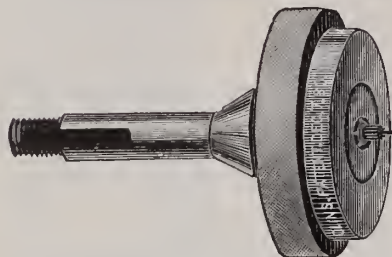

Emphatically THE chuck for accurate watch-work. Made of the finest steel and nickel plated. Can be applied to any watchmakers' lathe in use. Fitted free of charge. No chuck has ever been offered to the trade that so fully meets all the requirements as the OLIN.

Every wheel, pinion or staff in a watch is easily and quickly brought to a perfect center, and held true and firm.

Every One Warranted as Represented.

PRICES.

- Chuck complete, with combination for wheel chuck, nickel plated, with Five-split chucks, all in neat turned wood box, \$15.00
- Wheel chuck, put up the same way, 8.00
- Additional parts to make up complete chuck, 7.00
- Extra split chucks of any number, each, 1.00

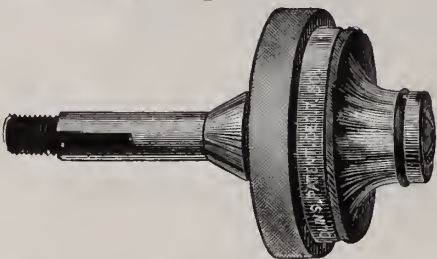

Our Split Chucks are all Tempered and Ground True.

Orders for Chucks to be fitted to American Lathes must be accompanied by a Split Chuck to fit by. If for Swiss Lathe, send the Lathe and Pulley Spindle.

Parties having Second Hand Lathes cheap, will find it to their advantage to address

THE OLIN CHUCK CO.,
MASON, MICH., U. S. A.

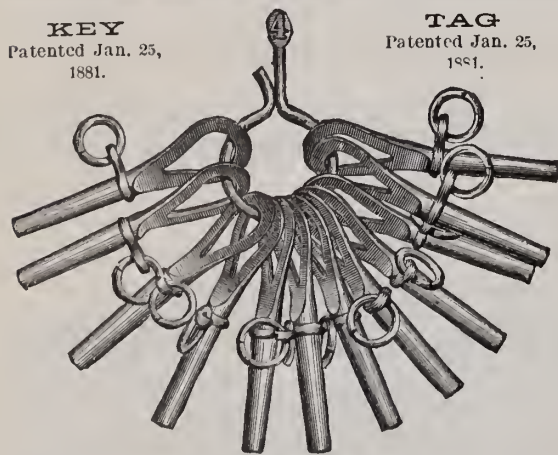

KEY
Patented Jan. 25,
1881.

TAG
Patented Jan. 25,
1881.

A. N. CLARK
PLAINVILLE,
CONN.,

Manufacturer of

Watch Case Springs, Watchmakers' & Jewelers' Bench Tools,
CROSBY'S JEWELING TOOLS, &c.

STOP IMPORTING KEYS!

For Low Price Key Use the

New Style Loop Key.



A plain Steel Key of good appearance, and excellent quality. It will not wear the pocket. It has a swivel, and is much better made than the imported plain steel or iron keys.

PRICE PER CROSS, FINE NICKEL FINISH, \$2.25
Postage, 10 Cents Per Gross Additional.

This Key is good and cheap enough to become universal. Send business card for illustrated price list. Enclose three cent stamp for sample key.

SOLD BY JOBBERS IN WATCH MATERIALS AND NOTIONS.

A. N. CLARK, Plainville, Conn.

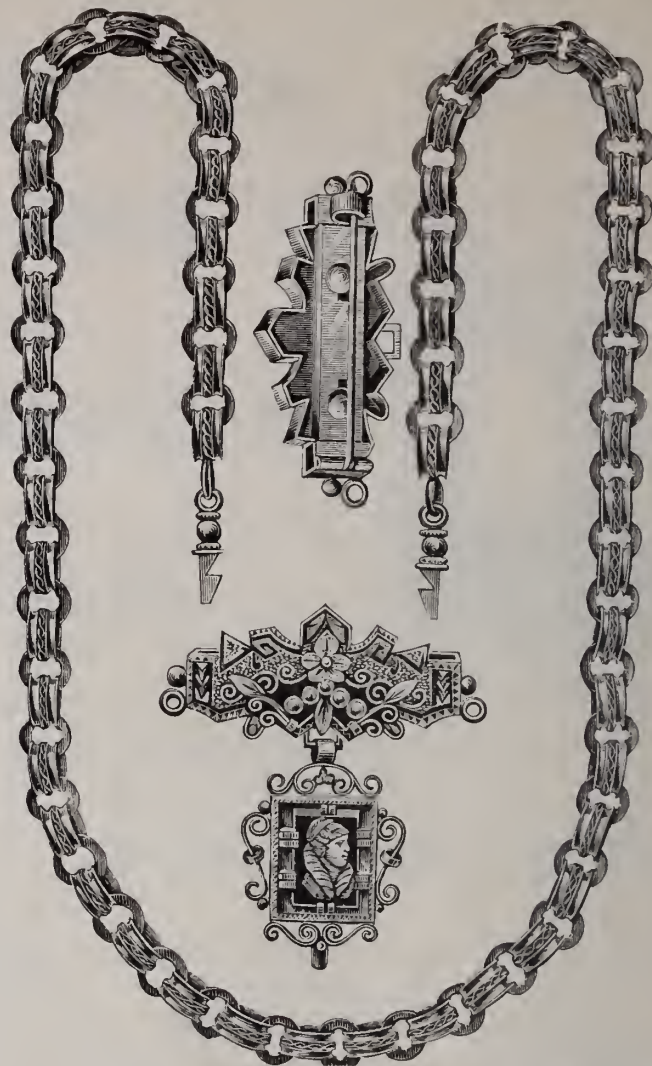

L. F. CAHEN,

Manufacturer of all kinds of Gold Chains, Chain Bracelets; also a full line of Seal and Fancy Rings, and Patented of Cahen's Patent Chain Snap. These goods are made in 10 and 14 karat gold, and can be obtained through any Jobber in the U. S., or direct from me. A large stock of Gold Chains constantly on hand. Goods sent on approval to responsible houses.

The Burbank Manufacturing Company

Manufacturers of GOLD & SILVER

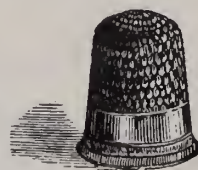

GOLD
SILVER,
STEEL,
RUBBER,
And SHELL,

Thimbles,



Eye Glass
Self Adjusting.

SPECTACLES AND EYE-GLASSES

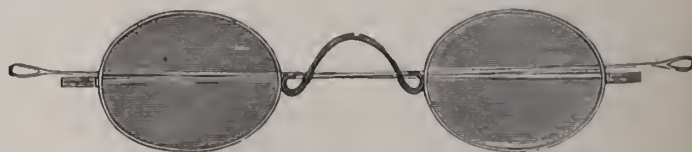

OF ALL DESCRIPTIONS.

SOLID GOLD RINGS

Office, 14 MAIDEN LANE. NEW YORK.

Manufactory, Springfield, Mass.

AMERICAN WATCH TOOL CO.,

WALTHAM, MASS.

MANUFACTURE THE

WHITCOMB LATHE,

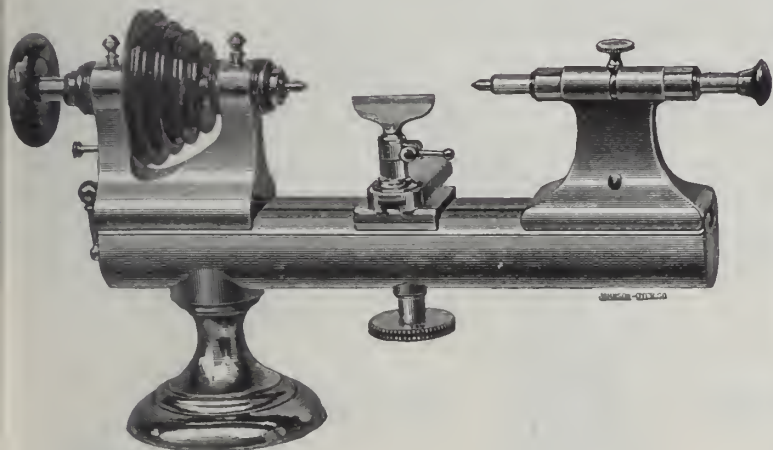

AND THE

"Webster" Foot Wheel,

We guarantee it to be a worthy companion to the Whitcomb Lathe.

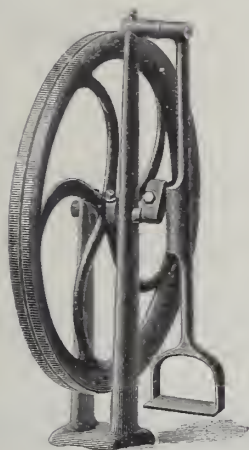

It is **not** a cheap made wheel but **First-class** in every respect.

PRICES:

30 lb. Wheel, for No. 1 Lathe, 20 inches in diameter,	\$12 00
40 " " " 1½ " 20¾ " "	13.00
50 " " " 2 " 21½ " "	14.00

DESCRIPTION.—The wheel runs on a hard steel arbor. It is clamped to the arbor by a set screw against a split bushing. This does not bend the arbor as in the case where the set screw is against the arbor. On the crank pin is a friction roll, having a hardened steel bushing, which runs on a hard steel pin. The swinging treadle is the **easiest** motion, and effects the body **less** than the foot treadle.

SEND FOR NEW CATALOGUE.

Our No. 1½ Lathes are Fast Superseding all other Sizes.

Soft Lathes have Hard Mouths, Hard Wire Chucks and Hard Tail Stock Spindles.

MARTINS & TISSOT,

Manufacturers of

GOLD WATCH CASES,

15 MAIDEN LANE, NEW YORK.

8 KARAT CASES A SPECIALTY



Our 8 Karat Cases are of Superior

STYLE, CONSTRUCTION AND FINISH

to any now made, (as our constantly increasing production will test), and are made also in large variety of styles.

LARGE STOCK
Constantly on Hand.

Also 14 KARAT CASES in Large Variety.

JOBGING TRADE SOLD ONLY.

Birch's Patent Self-Adjusting Watch Keys.

FOR SALE BY THE TRADE GENERALLY.

- 2.—POCKET KEY. (Brass.)
- 3.—POCKET KEY. (Nickel Plated.)
- 4.—POCKET KEY. (Nickel Plated, Hexagon Shell.)
- 5.—POCKET KEY. (Heavy Rolled Gold Plate Mountings.)
- 6.—CELLULOID MOUNTED KEY. (With Heavy Rolled Gold Plate Tips.)
- 35.—POCKET KEY. CELLULOID MOUNTINGS. (Imitation Malachite, with Extra Heavy Rolled Gold Plate Tips. 18. K.)
- 7.—BENCH KEY. (Brass Handle.)
- 8.—SHORT WOOD HANDLE KEY. (Nickel Plated, for Bench or Pocket Use.)
- 9.—LONG WOOD HANDLE BENCH KEY. (Nickel Plated.)

Made in 37 Styles. Circulars on Application.

J. S. BIRCH & CO., 38 Dey Street, N. Y.

HUTCHISON & HUESTIS,

❖ SOLID ❖ GOLD ❖

RING MAKERS

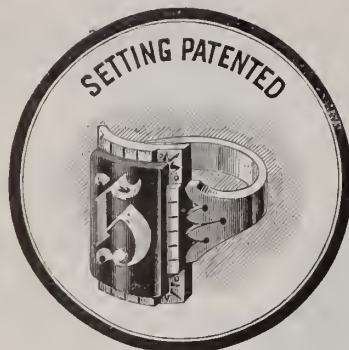

QUALITY
GUARANTEED.

FOR
JOBBER ONLY.

No. 185 EDDY STREET,
PROVIDENCE, R. I.

New York Office, . . . 196 Broadway.



J. F. FRADLEY & CO.,

Manufacturers of Fine

Gold and Silver Headed Canes

AND SPECIALTIES.

23 JOHN STREET, NEW YORK.

Designs furnished for Presentation Canes. Illustrated Catalogues sent upon application.

Special Inducements to the Jobbing Trade.

WM. M. FISHER & CO.

Sole Manufacturers of the

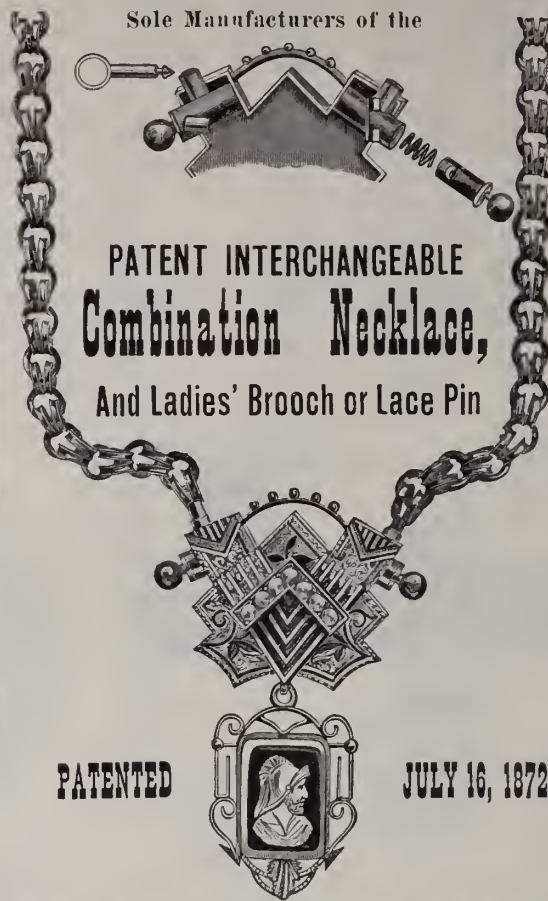

PATENT INTERCHANGEABLE
Combination Necklace,
And Ladies' Brooch or Lace Pin

PATENTED

JULY 16, 1872

GOLD
AND
SILVER
CHAINS,
Gold Chain
TRIMMINGS.

Complete
Assortment of
14-k.

Ribbon Fobs.

FOR SALE BY THE LEADING JOBBER

Vol. XIV.

ESTABLISHED 1869.

Vol. XIV.

THE

JEWELERS' CIRCULAR

AND HOROLOGICAL REVIEW.

The XIV Volume began with the February Issue.

\$2.00 per Annum to all parts of the United States and Canada,
and all Foreign Subscriptions \$3.00.

D. H. HOPKINSON,

42 Nassau Street,

NEW YORK.

GILES, BRO. & CO.



GILES, BRO. & CO.

Wholesale,
Importing and
Manufacturing

JEWELERS,

101 and 103 STATE STREET,

CHICAGO, ILLS.

Complete Illustrated Catalogue Furnished the
Trade upon Application.

WILLIAM H. BALL,

—MAKER OF—

GOLD BRACELETS

WITH THE PATENT GUARD.

IMPOSSIBLE TO LOSE THIS BRACELET.

A FULL LINE OF

BANDS, BANGLES, PADLOCK AND KEY, AND BRAIDED GOODS,

9 JOHN ST., NEW YORK.

SAN FRANCISCO OFFICE, 120 SUTTER ST.

FACTORY, NEWARK, N. J.

Goods Sent on Selection to Responsible Parties.



— Louis Audemars Celebrated Watches. —

SPECIALTIES:

CHRONOGRAPHS,

CHRONOGRAPH AND SPLIT SECONDS,

MINUTE REPEATERS,

CHRONOGRAPH AND SPLIT SECONDS AND MINUTE REPEATERS.

The reputation of these well-known Watches is established for their Excellence.

J. EUGENE ROBERT,

30 MAIDEN LANE,

NEW YORK.

NEW YORK OPTICAL CO.,

Manufacturers of all kinds of

Spectacle Lenses, Spectacles,

→ Eye-Glasses →

AND

SPECTACLE AND EYE-GLASS CASES.

OFFICE AND SALESROOM:

No. 43 MAIDEN LANE, N. Y.

FACTORIES: BROOKLYN, N. Y.

E. J. BOYCE,

(Formerly Boyce & Wainwright.)

→ MANUFACTURING JEWELER →

SOLID GOLD RINGS A SPECIALTY.

My BAND RING Specialties, for PRICE, QUALITY and FINISH, are not equaled by any in the Trade,

383 WASHINGTON ST.,
BOSTON, MASS.



→ **RINGS** →

With the Inscription,

"Dr. Martin Luther—Catharina von Boren,"

For the 400th Anniversary.

Perfect imitations of the betrothal ring of Dr. Martin Luther, which was preserved in his ancestral home.

SILVER, Heavily Gilded, - - - - - \$2.00

FINE GOLD, - - - - - \$8.00

FOR SALE BY

CARL RECKE,
GOLDSMITH,

→ i-Eisleben, Prussian Saxony, Germany. i →
Orders Solicited. References Given.

JACOB STRAUSS,
WATCHES & JEWELRY

AT WHOLESALE.

REMOVED FROM

18 TO 25 JOHN STREET, N. Y.

Rings and Rolled Plated Chains
A SPECIALTY.

New + York + Morocco + Case + Co.

CASES FOR
Jewelry, Silverware & Watches
OF EVERY DESCRIPTION.

Boxes and Trays for Jewelry Travelers.
TRUNKS FITTED UP WITH TRAYS.

Show Cases and Window Fittings
a Specialty.

No. 69 NASSAU STREET, NEW YORK.

W. H. LUDEMAN,

No. 75 & 77 Nassau Street,
NEW YORK.

**FINE AND COMPLICATED
WATCHES**

Of every description repaired and regulated.

Stem Winding and Escape Wheels

Cut and finished to order with accuracy
and promptness.

J. J. COHN,

IMPORTER OF

→ WHITBY JET, →

MANUFACTURER OF

Gold & Rolled Plate Jewelry,

Bracelets, Charms & Locketts a Specialty.

12 MAIDEN LANE, N. Y.

Goods Sent on Selection if Satisfactory References are
Given.

WM. SCHWENKE,

Manufacturing & Jobbing Jeweler.

43 MAIDEN LANE, N. Y.

Gives particular attention to the
Repairing and Jobbing Department
of the Jewelry Business. Prompt
Attention, Moderate Prices and First-
Class Workmanship Guaranteed to
all. Country Orders Promptly attended to.

L. SAUTER.

1 MAIDEN LANE,

Manufacturer of

Fine and Diamond Jewelry

AS

Rings, Studs, Buttons, Scarf Pins, Etc.

Hair Jewelry in all its branches.

Jobbing of every description promptly attended to.

JOHN D. LENNON,

142 Fulton Street,

NEW YORK,

Manufacturing Jeweler,

Masonic Pins, Rings & Charms,

School, Athletic, Fine

Presentation Medals,

—AND—

JEWELS OF EVERY DESCRIPTION

Designs furnished free upon ap-
plication.



HIBBARD G. GILL,

GOLD AND SILVER

Watch Case Manufacturer,

Dealer in Watches,

American Watch Movements Always on Hand.

618 Chestnut Street,

Fifth Floor.

PHILADELPHIA.

HENRY TROEMNER,

710 Market Street,

PHILADELPHIA.

Manufacturer of Fine Gold Scales,

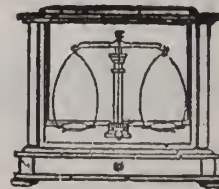

DIAMOND SCALES,

→ Bullion Balances and

Weights, in use at all the

U. S. Mints and Assay

Offices.

PRICED CATALOGUE ON APPLICATION.

S. KOPELOWICH & BRO.,

THE ONLY EXCLUSIVELY

Jobbing Jewelry House

Between New York and Chicago.

Jobbers of American and Swiss Watches,
Jewelry, Silverware, Spectacles, &c.

A large assortment of which we have constantly
on hand.

Selection packages sent to responsible parties.

Room 1, Larned Building, Syracuse, N. Y.

JNO. F. LUTHER,

MANUFACTURER OF



Masonic Jewelry.

79 Nassau Street, N. Y.

Illustrated Catalogue sent on application.

PLATINUM

—FOR—

Scientific and Mechanical Purposes,

IMPORTED AND FOR SALE BY

The S. S. White Dental Manufacturing Co.

SCRAP PURCHASED.

PHILADELPHIA, Chestnut St., cor. Twelfth.
 NEW YORK, - 767 and 769 Broadway.
 BOSTON, - - - 160 Tremont Street.
 CHICAGO, - - 13 and 11 E. Madison St.

ADOPTED AND IN USE BY

RADEL, BAREMORE & BILLINGS,
 58 Nassau Street, N. Y.

THE TRADE SUPPLIED.
 Descriptive Circulars furnished
 on Application to
 George W. Washburn, Patentee,
 58 Nassau St.,
 NEW YORK

SAFETY
EAR FASTENING. 
 Pat. May 10, '81—Oct. 11, '81.

Jointed
EAR WIRE
 AND
BAR BETWEEN CRAMPS
OF SETTINGS. 
 Patented March 1, 1881.
 TELESCOPIC

SAFETY PIN CATCHER. 
 Pat. Sep. 20, '81 Jan. 10, '82.

C. KNAPP,
 Manufacturer of
Superior Band
and Children's
Stone & Fancy
RINGS
 And Enameled Goods,
 41 Maiden Lane,
NEW YORK.

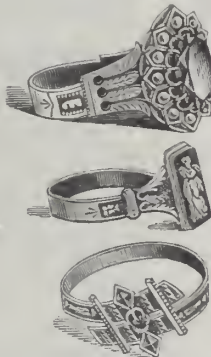

Solid Gold Rings a Specialty.

WM. H. ELY,
SOLID GOLD RINGS,
 MANUFACTURER.

Viz., Plain, Chased, Engraved, Enameled,
 Engine Turned, Shield and Scale. All
 qualities guaranteed. Orders
 Promptly Executed.
 58 Nassau Street, New York.

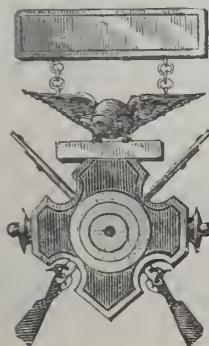

C. B. WILKINSON,
 Manufacturing Jeweler,
 8 JOHN ST., N. Y.
 Medals, Badges and
 Masonic Jewelry
A SPECIALTY.
 Designs furnished free
 upon application.

LOGUE & BARD,

Wholesale Jewelers,
104 State St., Chicago.

Our Stock is entirely New and Complete, Gold
 and Silver American Watches, Gold and Rolled
 Plate Chain, and Jewelry in all leading styles, and
 best quality guaranteed. Our motto is promptness
 and square dealing in every ca e.

WM. RAWLINGS, JR.,
 Manufacturing Jeweler,
FACTORY:
913 Arch Street, Phila.

FINE GOLD RINGS A SPECIALTY.

Goods sent on approval to any part of the
 country upon receipt of satisfactory reference.

Mansard English Geneve Louis XV.



HENRY LEFORT,
Stem-Winding Watch Crown Manufacturer,
 Crowns and Pushers in gold, all sizes, quality and color,
 made to order. Silver crowns and pushers always on hand.
60 Arlington Street,
 Corner William Street,
NEWARK, N. J.

We give **Special Attention** to effecting
 Settlements by **Compromise** between
 Debtor and Creditor.

COLLECTIONS.



BANKING AND COLLECTION HOUSE OF
HENRY McCABE & CO.,
 Principal Office:
 287 BROADWAY, Cor. Reade St.
 Attorneys and Correspondents at Every Point.

The Collection of Notes, Drafts, Current
 and Overdue Accounts made in all
 parts of the United States and
 Canada by our unrivaled system.

UNEXCEPTIONABLE REFERENCES AS TO
PROMPTNESS and RESPONSIBILITY.

H. WASEDELL,
RUBBER STAMPS,
BRASS STAMPS,
 Brushes, Inks, &c.
 Stencil Plates,

STEEL STAMPS.
 Burning Brands,
SEALS & PRESSES,
 No. 7 North William St.
 First house South of East River Bridge, N. Y.
FINE STEEL STAMPS A SPECIALTY.

P. JANDORF & BRO.,
Watches and Jewelry,
 196 BROADWAY,
 Bet. John & Fulton Sts., **NEW YORK.**

We Publish No Price Lists.

CHURCH'S PATENT IMPROVED
DOUBLE SPEED INDICATOR
Either Right or Left.

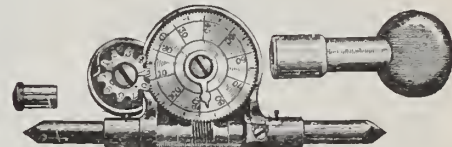

MONTGOMERY & CO.,
 Importers of Stubs' Files, Tools & Steel,
 GROBET SWISS FILES. CHESTERMAN'S TAPES, RULES, &c.
 Horse Shoe Magnets. Hubert's French Emery Paper.
WM. SMITH & SONS' CELEBRATED MUSIC WIRE.
 105 Fulton Street, N. Y.

The Finest Line of High-Class English
 Watches in the U. S.

GEO. E. WILKINS,
 SYRACUSE, N. Y.
 Agent for the Celebrated Watches of
 Chas. Frodsham & Co., London,
 W. G. Schoof, London,
 Karl Zimmerman, Liverpool.

Timing and Adjusting done for the Trade.
 Correspondence Solicited from the Trade.

→ **SOLID GOLD** ←
 AND
STONE INLAID
Cigar Cutter,

 Pat'd Oct. 5, 1880.
J. WIENHOLD,
 Manufacturer of FINE JEWELRY.
DIAMOND MOUNTINGS A SPECIALTY.
 24 John St., N. Y. City.

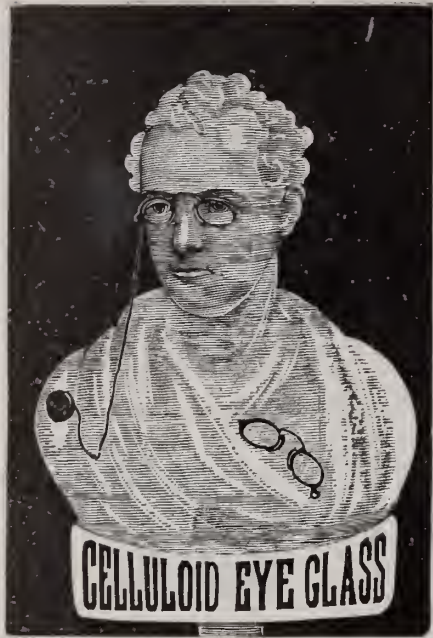

All parts furnished separately when desired. The Springs will never rust, and are much more durable than steel.

Please note a reduction of 50 cents per dozen on 286 and 288 Celluloid Eye-Glasses, No. 7 Catalogue.

The above cut represents a fine bust of Lord Byron, about twenty-five inches high, which will be furnished to parties purchasing 6 dozen Celluloid Eye-Glasses. It is securely packed, ready for shipment, and will make a very handsome ornament for the show window.

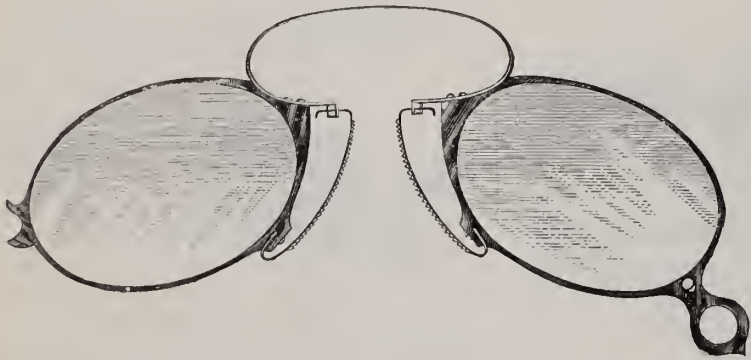

The above cut represents No. 306 Eye-Glass with an Adjustable Nose Piece, which we make in

Gold, Nickel, Celluloid, Rubber, Steel and Frameless.

This style of Eye-Glass is very popular. We make many NEW and EXCLUSIVE Styles that give a Dealer handling our goods an immense advantage over those who sell the ordinary line of goods in the market.

Special Goods, with Trade Mark, made for Dealers to Order.

Great Variety! Novel Styles! Attractive Goods!

While many houses have complained of dull trade this Spring, we have been increasing our force.

ACTIONS SPEAK PLAINER THAN WORDS.

Spencer Optical Manufacturing Co.,

13 MAIDEN LANE, NEW YORK.

Established 1853.

L. H. KELLER & CO.

Successors to G. A. HUGUENIN,

IMPORTERS OF

WATCHMAKERS' and JEWELERS'

TOOLS AND MATERIALS.

GENERAL AGENTS FOR

The Philadelphia Watch Company,

— AND —

American Watch Tool Co.,

MANUFACTURERS OF

THE WHITCOMB LATHE.

SOLE AGENTS IN THE UNITED STATES FOR THE SALE OF

LUTZ'S

**CELEBRATED ROLL HARDENED HAIR SPRINGS,
MOEBIUS OIL**

For Chronometers, Watches, Clocks, Telegraph Instruments and all other delicate machinery. Made from Pure Refined Neatsfoot Oil, and Warranted to Excel anything in the market as a Lubricator. SAMPLES GRATIS.

OUR OWN GRADUATED

AND JURGENSEN RECOILING MAINSPRINGS, pronounced by all experts Superior to all. Sold in Separate Strengths or Force.

Extra Fine Pinions cut from Solid Steel Wire. Gauged Hole Jewels of First-class Workmanship. A Full Line of Materials, for the PATEK, PHILIPPE & CO. GENEVA WATCHES, and all other Celebrated Makers.

THE BOLEY LATHES AND TOOLS,

Celebrated for their Practical, Substantial and Workmanlike Construction, Superior Design and Finish.

Our aim is to furnish nothing but First-class Serviceable Goods, especially manufactured for the Consumer, and not solely for the Market, like the cheap trash advertised in highly illustrated catalogues with which the country is flooded.

TREATISE ON MODERN HOROLOGY IN THEORY AND PRACTICE. By M. CLAUDIUS SAUNIER, Ex-Director of the School of Horology at Macon, France; Knight of the Legion of Honor, etc.; Hon. Sec. to the Paris Society of Horologists. Translated from the French by JULIEN TRIPPLIN, Besançon Watch Manufacturer, and EDWARD RIGG, M. A., Assayer in the Royal Mint, London.

This Work comprises 832 large octavo pages, with 78 wood cuts and 21 colored double-page copper-plate engravings. Bound in half calf, with an appropriate and handsome ornament in gold on front cover.

Price, \$15.00.

THE WATCHMAKER'S HAND BOOK. By the same author and translators. Intended as a companion to the Treatise. Bound in cloth.

PRICE, \$4.00.

64 Nassau Street,

NEAR MAIDEN LANE,

NEW YORK.

L. H. KELLER,
EDWARD HUNZIKER,
F. J. BOESSE.

We do not publish Price Lists.

SPECIAL NOTICES.

FOR SALE—Telescope, brass, extra well made, 36 in. focus, 4-eye-pieces, table stand. Address J. L. Flinn, Elgin, Ohio.

PARTNER WANTED—In a well paying jewelry business. \$5,000 cash required. Object to enlarge business. Address "F," this office.

WHAT IS the use of purchasing an imitation celluloid eye-glass and all its defects, when you can buy the genuine article at the same price.

WANTED—An experienced traveling jewelry and watch salesman with an established trade in the west and north-west. Address L. & B., care Jewelers' Circular.

WANTED—A first-class watchmaker, one who is a good salesman preferred. Must be sober, honest and industrious. Address, giving reference and terms, J. W. King, Jacksonville, Illinois.

MAYER & DELKIN, Atlanta, Ga., wholesale dealers in watchmakers' and jewelers' tools and materials. Manufacturing, repairing and engraving done for the trade. Medals and badges a specialty.

WANTED—A good watchmaker to go to Leadville, Col. One who can engrave preferred. Permanent situation and fair salary to the right man. Address Diamond, P. O. Box 990, Leadville, Colorado.

FOR SALE—A Swiss Universal Lathe, 4 1/4 inch face plate, with uprighting attachment, slide and T rest. In good order. Price, \$30. Cost when new \$60. Address Chas. M. Hoffman, White River Junction Vt.

MOSELEY & CO., Elgin, Ill., manufacturers of the "Moseley" Lathe, with full line of fixtures and attachments. Designed especially for the watchmaker and repairer. Combining accuracy, durability, convenience and style.

NOTICE—A young man, 21 years old, who has worked 3 years at the bench and as salesman in a first-class store, desires situation to travel for any branch of the jewelry business. Address H. M. T., care Wilbur & Winans, Galesburg, Ill.

A YOUNG MAN, 25 years of age, desires a situation as salesman, is capable of taking charge of a store. Can give help in watch, clock and jewelry repairing. Can furnish first-class reference. Address F. C. B., care Jewelers' Circular.

SITUATION WANTED—By a practical jeweler, one who understands making and repairing thoroughly. Can engrave and color. Western city preferred. Good references. Can take charge of a shop. Address J. P., care of Jewelers' Circular.

WANTED—Watchmaker, one who can do engraving preferred. None but a first-class workman and one who can come well recommended as to honesty and ability need apply. A permanent place and good wages to the right man. Address Jas. M. Howe, Hopkinsville, Ky.

A LIVE BUSINESS MAN, with nine years' practical experience, would like a position with a first-class wholesale house handling watches and jewelry, tools and materials, either on the road in charge of stock or in office. For particulars address "Expert," care Jewelers' Circular.

RARE OPPORTUNITY—For sale, long established jewelry store in the golden wheat and stock growing state of Minnesota. 7,000 energetic people, 5 railroads, elegant schools. Fixtures new, stock fresh and stable, will invoice 5 to 7 thousand. Address North-west, care Jewelers' Circular.

GEORGE E. WILKINS, manufacturer and importer of cutters for watchmakers' use, stem-winding cutters of all the different forms, rounding up cutters of the finest quality, also ratchet cutters. A large stock of second hand and new marine chronometers. No. 21 South Salina street, Syracuse, N. Y.

EUREKA—A new tool that every watchmaker must have. "Hair Spring Collet Remover." It will remove the collet without defacing balance arm, or damaging hair spring. Try one and you will not be without it. Sent to any address on receipt of 25 cents. Every tool warranted. F. A. Hubbard, Brattleboro, Vt.

ON RECEIPT of one dollar (\$1.00), I will send to any address a tool by mail, post paid, such as we used at the Elgin Watch Factory. It is invaluable to a practical or amateur watchmaker. It makes staff and pivot work easy, and is within the reach of all. Address F. P. Bishop, Pres't Michigan Retail Jewelers' Association, Litchfield, Hillsdale Co., Mich.

READ THIS—\$5,000 to \$6,000 will buy a jewelry and fancy goods business, which paid over 50 per cent. on investment last year, ending May 1st, 1883. Situated at Caro, county seat of Tuscola Co., Michigan. Very thriving town; several new brick blocks in course of erection now. Population about 2,000. For particulars call or address Lock Box No. 6, Caro, Mich.

FOR SALE—Stock and fixtures of the oldest established jewelry house in Des Moines, Iowa. City of 35,000. The stock will invoice about \$7,000, and is clean, new and in good shape. Can transfer a valuable lease of an elegant new brick store room, heated with steam, and all other modern improvements. The best location in the city. Best reasons given for selling. Address T. L. Rogg, Des Moines, Iowa.

FOR SALE—The Stock and fixtures of a good jewelers' business in Michigan town of 12,000 inhabitants. Stock of watches, clocks, jewelry and silverware, and optical goods. Three railroads; three large threshing machine works; two machine shops; R. R. shops. Stock and fixtures about \$6,500. Will sell at cost. Good reasons for selling. Address Mrs. Sarah H. Ford, care of Jewelers' Circular.

NEW TOOLS—We now have ready for the trade a set of 15 different size millers for countersinking, end shaking, etc., price 25 cents each, \$3.00 per set. Also F. W. Hall's new material case, will hold 55 different kinds with each space numbered and indexed. Finished in soft wood, \$1.00 each; hard wood polished, \$1.50. Ask your jobber for them or send direct to manufacturers. J. G. Hall M'g Co., Roxbury, Vermont.

JEWELRY STORE FOR SALE—The stock, fixtures, lease, etc. of the leading jeweler in a five manufacturing western city for sale. The present owner desires to retire on account of poor health. Sum required for the purchase from \$8,000 to \$12,000. Positive proof given of a very profitable and increasing business for over 15 years. For information, address Robert M. Wilcox, care Rogers, Smith & Co., Meriden, Conn.

ONE MOSELEY UNIVERSAL CHUCK HEAD for No. 1 Moseley Lathe, new and perfect, price, \$15. One gold leaf watch sign, 16 in., cost \$10 will sell for \$4. One new pair scales, 2 set weights, in box, cost \$7.50, price, \$5. One Vienna regulator, fine and in good order, cost \$25, price, \$15. One 3-center Jacot pivot lathe, new, \$3. Anyone wanting will write immediately as we will close the above articles out at the bargains offered less 10 per cent. for cash. Address Dutton & Worstel, Chester Hill, Morgan Co.

A VERY SUPERIOR quality of watch and clock oil, pronounced to be the best by competent authorities, and awarded the first prizes at the exhibitions held at Halle, Germany, in 1881, Chaux-de-Fonds, Switzerland, in 1881, Paris, France, in 1881, and Munich, Germany, in 1882, and tested at the Governmental Chemical Laboratories in Dresden, Carlsruhe and Paris, and found to leave absolutely nothing to be desired. Is manufactured by Wilhelm Cuyper, Dresden, Germany, and to be had of the representative in the United States, H. Horend, 15 Maiden Lane, New York.

BUYERS' DIRECTORY.

NEW YORK.

Assayers and Sweep Smelters.

Wundoehl, H.—Gold and Silver Refiner, Assayer and Sweep Smelter. 21 John Street, N. Y.

Badges and Medals.

Stockwell & Newman—19 John Street. Manufacturers of Badges, Medals and Presentation Pieces in Gold and Silver. Also Jewelry and Mounters of Diamonds. Designs supplied.

Wilkinson, C. B.—Manufacturing Jeweler, 8 John Street, N. Y. Medals, Badges and Masonic Jewelry a Specialty. Designs furnished free upon application.

Band Rings.

Knapp, Charles, 41 Maiden Lane, N. Y. Specialty: Superior Band Rings, also Ring Shanks & Heads for Seal and Diamond Rings.

Black Onyx Jewelry.

Cox & Sedgwick—Manufacturers of Black Onyx Jewelry, No. 26 John St. New York.

Lawson, Samuel—No. 18 John Street. Manufacturer of Black Onyx Jewelry. Coral repaired for the trade. Goods sent on approval to responsible dealers.

Woglom & Miller—Manufacturers of (exclusively) Black Onyx Jewelry, 32 & 34 John St., N. Y.

Blue Enameled Locketts.

Bissinger, Philip & Co.—Importers of Diamonds, Pearls and Precious Stones. Agent for the Bohemian Garnet Goods. Blue Enameled Locketts, 22 John St., N. Y.

Hess & Schliesser—Importers of Diamonds, Fine Jewelry and Novelties in French Goods. Specialties: Gold and Blue Enameled Locketts, Charms and Crosses. 25 Maiden Lane.

Bohemian Garnet Jewelry.

Bissinger, Philip & Co.—Importers of Diamonds, Pearls and Precious Stones. Sole Agent for the Bohemian Garnet Jewelry. Blue Enameled Locketts. 22 John St.

Boxes, Wood Mailing and Nested.

Maine Manufacturing Co.—Successors to Swift M'g Co., makers of Wood Mailing and Nested Boxes for Mailing and Express purposes. J. Spencer Taylor, Agent, 18 Courtlandt St., N. Y.

Wiesbauer, J.—Manufacturer of the Sliding Cover Wood Mailing Boxes. All Sizes Made to Order. Buffalo, N. Y.

Clock Companies.

Ansonia Clock Co.—Manufacturers of every description of Clocks. 11 to 21 Cliff street, New York.

Kroeber, F.—Manufacturer and Dealer in American and French Clocks, No. 8 Cortlandt Street.

New Haven Clock Co.—16 and 18 Park Place, N. Y.

Seth Thomas Clock Co.—20 Murray Street, N. Y.

Waterbury Clock Co.—M. Bailey, Treasurer, Manufs and Jobbers, No. 4 Cortland St., N. Y., and No. 197 State Street, Chicago.

Wm. L. Gilbert Clock Co.—No. 6 Murray Street, Manufacturers of Clocks. Factories, Winsted, Conn.

Yale Clock Co.—Manufacturers of Novelties in Clocks, 52 Maiden Lane, N. Y.

Corals and Coral Jewelry.

Cuppia, L. A.—Importer of Coral and Silver Filigree Jewelry, 19 Union Square, N. Y.

Cameo Cutters, Etc.

Peiter, Theodore—Cameo and Intaglio Engraver. Patentee of the Cameo-Intaglio. No. 2 Bond Street, near Broadway, Room 4 New York.

Charms & Gold Watch Keys.

Rupp & Held—Manufacturing Jewelers, Charms and Gold Watch Keys, with French and English Rachets, a specialty. 15 John St., N. Y.

Crucibles.

Berge, J. & H.—Established 1850, Manufacturers and Importers of Sand Crucibles, Covers, Chemical Porcelain, Glassware, and Jewelers' and Assayers' Supplies, 95 John Street, N. Y.

Berge, J. & Son.—Importers of Sand Crucibles and Covers, Jewelers' Tools and Materials. Manufacturers of Berge's Improved Assay and Enamel Furnace, Assay and Enamel Muffles, &c. 32 and 34 John Street, N. Y.

Cutlery.

Harrison Bros. & Howson—Manufacturers of Fine Ivory and Pearl Table and Pocket Cutlery, Carvers in Cases; Nutpicks, Nutcracks and goods suitable for the jewelry trade. 126 Chambers Street. W. C. Burkinshaw, Sole Agent.

Diamond Brokers.

Anderson, Otis—Diamond Merchant and Broker, always ready to pay cash for bargains in Diamonds and Precious Stones, 4 & 6 John Street, N. Y.

Bernhardt, Richard—Diamond Broker and Importer, 65 Nassau Street (Room 6), N. Y. Paris, 20, rue des Petites-Écuries.

Friend S. & Son—Brokers and dealers in Diamonds 33 John Street, cor. Nassau St. New York.

Herbert, R. J.—Diamond Broker and Dealer. 26 Maiden Lane.

Diamond Importers.

Bissinger, Philip & Co.—Importers of Diamonds, Pearls and Precious Stones. Agent for the Bohemian Garnet Goods. Blue Enameled Locketts. No. 22 John St., N. Y.

Bruhl, D. & M.—Established 1848. Importers of Diamonds and Precious Stones. 14 Maiden Lane, New York. Branch office, Paris. Also 111 Broad Street, Providence, R. I.

Brunswick, S. & Co.—Importers of Diamonds. 17 Maiden Lane, New York. Paris, Rue Lafayette. Amsterdam, Damsstraat.

Citroen, L. B., & Co.—Diamonds. 21 John St., N. Y. Cutting Works, 57 & 61 Rapenburgerstraat, Amsterdam. House in Paris, 44 Rue Laffitte.

Engelmann, M. & Co.—Importers of Diamonds, Pearls and Precious Stones. Specialties in Fine Colored Stones. 192 Broadway and 1 and 3 John Street, N. Y. Paris, 1 Boulevard St. Denis.

Faulkenau, Oppenheimer & Co.—Manufacturers. Diamonds and Diamond Jewelry. 40 Maiden Lane, N. Y.

Fera, Henry—Importer of Diamonds, and Manufacturer of Fine Diamond Jewelry. 4 & 6 John Street, New York. Amsterdam, Holland, 23 Loojersgracht.

Fox, M. & Co.—Importers of Diamonds, Rubies, Sapphires and Fancy Gems. No. 1 Maiden Lane, New York.

Hedges, Wm. S. & Co.—Importers of Diamonds, No. 170 Broadway, corner Maiden Lane.

Kuhn, Doerflinger, & Co.—Manufacturing Jewelers and Importers of Diamonds, 18 John street, New York.

Neresheimer, E. Aug. & Co.—Importer of Diamonds. No. 21 Maiden Lane, New York.

Randel, Baremore & Billings—Importers of Diamonds, corner Maiden Lane and Nassau St.

Saunders & Ives.—Importers of Diamonds and other Precious Stones. No. 26 Maiden Lane.

Smith, Alfred H. & Co.—Importers of Diamonds, No. 182 Broadway.

Taylor & Brother.—Importers of Diamonds and Diamond Jewelry. 676 Broadway.

Wickham, D. H. & Co.—Importer of Diamonds. No. 31 Holborn Viaduct, London, 24 Maiden Lane, New York.

Wolff, G. A.—Importer of Diamonds, Rubies, Sapphires, Pearls, and other Precious Stones, 65 Maiden Lane, New York. 12 Rue de Chateaudun, Paris.

Diamond Jewelry.

Bernhard, A. & Co.—Importers of Diamonds and Manufacturers of First-Class Diamond Jewelry. Diamond Settings for Manufacturing Jewelers. Design Sheets for the Trade free of charge. 2 Maiden Lane, New York.

Bornemann, Louis.—Importer of Diamonds and Manufacturer of Rich Diamond Jewelry, 19 John Street, New York.

Chalumeau, D.—Diamond Jeweler and Manufacturer of Mountings. Novelties and Artistic Jewelry. No. 3 Maiden Lane, New York.

Hartje, G. & F.—Manufacturers of Diamond and Fine Jewelry, 39 Union Square, N. Y.

Haug & Luthy—Manufacturers of Fine Diamond Mountings, etc. No. 130 Fulton St., N. Y.

Heller & Bardel.—Manufacturers of Diamond and Pearl Jewelry, and Dealers in Diamonds, Pearls, &c. 13 John Street.

Jeanne Brothers.—Manufacturers of Diamond Mountings & Rich Jewelry. 1 Maiden Lane.

Lacroix & Verpillier.—Manufacturers of Fine Gold Jewelry. Diamonds a specialty. 173 Broadway, N. Y.

Schilling & Nissen—Dealers in Diamonds and Diamond Jewelry. No. 51 Nassau Street, New York, near Maiden Lane.

Voelker, C. T.—Manufacturer of 18-k. Diamond Mountings, Diamond Jewelry and Roller Chain Bracelets. 189 Broadway, New York.

Waterman & Lehmann.—Manufacturing Jewelers and Dealers in Diamonds. Diamond Work, and Fine fancy Rings a specialty, any piece of single work made to order. 37 Maiden Lane, N. Y.

Diamond and Pearl Setter, &c.

Archibald, Wm.—Diamond Setter for the Trade. Cameos, Pearls, Turquoises, Garnets, Amethysts, Doublets, Foil Backs, white and colored, Imitation Stones. 73 Nassau Street, N. Y., room 7.

Diamond Cutters.

Levy, Herman.—Importer, Cutter and Polisher of Diamonds. 105 Fulton Street, New York.

Dials, &c.

Farnsworth, C. E. & Co.—Successors to Jno. T. Gold, Manufacturers and Jobbers in Fine Watch Dials. 81 Nassau St., N. Y.

New York Dial Co.—Manufacturers of Fine Watch Dials. Henry Abbott, Agent, No. 7 Maiden Lane, N. Y.

Enameled Clock Dials and Figures.

Caeser Bros.—Manufacturers of Enameled Clock Dials, also letters and numbers for signs. 230 and 232 East 25th Street, New York.

Enamelers, Etc.

Nutt, J. D.—Enameler on Gold, Silver, and Copper. Linen finished Buttons and Studs. Enameling in colors. 32 and 34 John Street, New York.

Orr, J. C.—Enameler on Fine Jewelry. Enameled in Colors. Linen Finished Buttons and Studs. Band Bracelets. No. 75 Nassau Street, N. Y.

Orr, William N.—Enameler on Fine Jewelry. Masonic Jewels and Badges a specialty. Linen Finished Work. 79 Nassau Street, Room 18, New York.

Electroplaters, &c.

Jeandheur, F. & Son,—Gold and Silver Electro Platers & Fire Gilders, coloring Etruscan and Gold Jewelry a specialty. 125 Fulton St.

Engravers—Stone Seal, Etc.

Fackner, Edward—Carver, Engraver and Chaser on Jewelry and Pencil Cases, lettering, &c., 19 John Street.

Holland & Gosling—Stone Seal Engravers. Precious Stones inlaid and encrusted with Diamonds. No. 176 Broadway, New York, (fifth floor per elevator). Cameos cut and repaired.

Knapp, Chas. Engraver, Die Sinker & Stamper for Jewelry purposes. Ring Shanks & superior Band rings, 41 Maiden Lane, N. Y.

Meister, H.—Engraver and Chaser on Fine Jewelry, Badges, Monograms, Coats of Arms, etc.; also Enameling, Coloring and Polishing. No. 59 Nassau Street, New York.

Park, Wm.—The Stone Seal Engraver. Arms, Crests, Monograms, etc., engraved on precious stones, 26 John Street, New York.

Weston, James F.—Stone Seal Engraver and inluster of Precious Stones. Coats of Arms, Masonic, Odd Fellows, and other devices engraved. 32 John Street.

Fancy Goods, Clocks, Bronzes, Etc.

Le Boutillier & Co.—Importers of Fancy Goods, Clocks, Bronzes, &c., 3 Union Square.

Straus, L. & Sons—Importers of Potteries, Faïences, Bisque Figures and Rich Fancy Goods especially adapted for the Jewelry Trade. 40, 42 and 44 Warren Street, New York.

Taylor & Bro.—Importers of French Clocks, Bronzes, etc. 676 Broadway, N. Y.

Gold and Silver Cane Heads.

Simons, Bro. & Co.—Manufacturers of Gold Headed Canes. 611 and 613 Sansom street, Philadelphia.

Gold and Silver Plating, Etc.

Bantle, A.—Gold, Silver and Electro-Plating, 130 Fulton and 89 Nassau Streets, cor. Fulton Street, (Room 36.) N. Y. Watch Case Polishing.

Gold Chains, Etc.

Beck, J. & Son, Manufacturers of Fine Gold Chains and Chain Bracelets, 10 Liberty Place, near Maiden Lane, N. Y.

Carter, Sloan & Co.—Manufacturers of Fine Gold Chain, 15 Maiden Lane, New York.

Dorrance, Edge & Co.—Manufacturers of the Celebrated Woven Fabric Gold Chain, No. 15 John Street.

Kaufmann Bros.—Manufacturers of Gold Chains, and Chain Bracelets, 26 John Street; Factory, 331 and 333 Bowery, N. Y.

Kohn, Alois & Co.—Manufacturers of Gold Chains, 9 Maiden Lane, N. Y.

Nordt, Charles.—Successor to Nordt & Schlag, manufacturer of Gold Chains and Chain Bracelets. Jobbing and Refilling Old Chains promptly attended to. No. 17 Maiden Lane, N. Y.

Saxton, Smith & Co.—Manufacturers of Fine Gold Chain, No. 14 John Street, N. Y.

Schlag, Chas.—Late Nordt & Schlag, Manufacturer of Gold Chains, Chain Bracelets, and Fine Jewelry, 177 Broadway, N. Y.

Smith, W. & Co.—Manufacturers of Gold and Silver Chains, Jewelry, etc. No. 25 Maiden Lane, N. Y.

Gold Pens, Etc.

Aikin, Lambert & Co.—Manufacturers of Choice Gold Pens, Cases, Holders, Toothpicks, etc., 23 Maiden Lane, N. Y.

Faber, Eberhard,—Manufacturer of 16-karat Gold Pens and Pencil Cases, Nos. 718 and 720 Broadway, N. Y.

Fairchild, Leroy W.—Manufacturer of Gold Pens, Pencil Cases, Tooth Picks and Novelties in Charms. No. 18 John St., N. Y.

Johnson, E. S. & Co.—Manufacturers of Gold Pens, Pen Holders and Pencils. Cor. Maiden Lane and Nassau Street, New York.

Ray Manufacturing Co.—Gold Pen Manufactured and Stamped for the Trade. Also Pencil and Pen Cases, Tooth-picks, etc. Office, Sales-rooms and Factories, 94 and 96 Nassau street, 129, 131 and 133 Fulton street.

Smith, H. M. & Co.—Manufacturers of Gold Pens and Holders, Tooth Picks, Pencils, etc. Sole Manufacturers of Sprague's Patent Gold Fountain Pen. Importers of Nickel and Silver Watches. 173 Broadway, New York.

Gold Rings.

Barnet Bros. & Powell—Manufacturers of Stone and Seal Rings, 15 John Street, New York. Factory, Newark, N. J.

Bowden, J. B. & Co.—Manufacturing Jeweler.—Solid Gold Rings a specialty, 1 Maiden Lane.

Ely, W. H.—Manufacturer of Solid Gold Rings of every description. No. 58 Nassau Street.

Henrich, R.—No. 35 Maiden Lane, Manufacturer of Gold Rings; also Patentee and Manufacturer of the Celebrated Self-Sizing Ring.

Hildreth, H. P.—Manufacturer of Solid Gold Rings, Plain and Ornamental. No. 10 John St.

Kroll, H.—Manufacturing Jeweler. 78 Nassau Street, New York. Specialty: Solid Gold Stone Rings. All kinds of Fine Jewelry made to order, also Repairing for the Trade.

Ostby & Barton—Manufacturers of Plain and Engraved Solid Gold Band Rings. Office, 176 Broadway, N. Y. Factory, 80 Clifford Street, Providence, R. I.

Peckham, Wm. H.—Manufacturers of Solid Gold Seamless Rings, and Fancy Embossed Rings, Patent Spectacles, Jewelry, etc. No. 4 Liberty Place N. Y.

Radler, K.—Manufacturing Jeweler. Gold Rings and Locketts a specialty. No. 39 Maiden Lane, New York.

Sauter, L.—No. 1 Maiden Lane, New York, Manufacturer of Stone Rings of every description, as Diamond, Cameo, Onyx Turquoise, etc., Scarf Pins, Scarf Rings, Studs and Buttons.

Shafer & Douglass.—Manufacturers of all kinds of Seal, Stone, Turquoise, and fancy rings. No. 7 Maiden Lane, N. Y.

Sinnock & Sherrill.—Manufacturers of Stone Rings. No. 3 Maiden Lane, N. Y.

Thuerner & Church—Manufacturers of Fine Gold Rings. No. 9 Maiden Lane, N. Y.

Hair Jewelry.

Bernhard, A. & Co.—Manufacturers of Fine Hair Jewelry. Pattern Book of 2,700 designs free of charge to the First-class Trade. 2 Maiden Lane, New York.

Moutoux, Wm. E. & Co.—Manufacturers of Fine Hair Mountings in Gold. Grand catalogues for the trade. 81 Nassau St., Rooms 1 and 2. Finest work and lowest prices

Sauter, L.—Manufacturer of Fine Gold and Hair Jewelry and Device Work. Pattern Book sent on application. No. 1 Maiden Lane, N. Y.

Schwencke O.—Manufacturer of Fine Hair Jewelry Orders from the country promptly attended to. No. 43 Maiden Lane.

Jewelry Cases, Fancy Boxes, Etc.

American Morocco Case Co.—7 and 9 Bond St., N. Y., make a specialty of Rich Jewelry and Silverware Cases for the fine Retail Trade. Also Improved Trays for Watches, Rings, etc.

Bleyle, A.—Manufacturer of Jewelry and Silverware Boxes, Jewelers' Traveling Cases, etc. Trays for Show Cases and Trunks, Ladies' and Gent's Jewel, Glove and Handkerchief Boxes, &c., &c., 80 Nassau street, N. Y.

Braun, Chr. E.—Manufacturer of Fine Jewelry Boxes and Trays for Show Cases and Trunks. No. 62 Chatham Street, New York. Trays for Show Cases and Trunks a Specialty.

Bricka, C. A.—Manufacturer of Morocco Cases for Cutlery, Silverware, Jewelry, etc. Sample Cards and Rolls. Cases in Rosewood, Black Walnut, etc. 52 Nassau Street, New York.

Dennison Mfg Co.—Manufacturers of Morocco, Plush and Velvet Jewelry and Silverware cases. New York, Boston, Philadelphia, Chicago, Cincinnati and St. Louis.

Ettlinger, L. & Sons.—Manufacturers of Fine Cases for Jewelry, Watches and Silverware. Trays for Travelers and Show Cases. Cases to Order a Specialty. No. 80 Nassau St., N. Y.

Haensler, Chas. C.—Manufacturer of Fine Morocco Cases for Jewelry and Silverware. Toilet Boxes, etc. Trays for Show Cases and Windows. 14 John Street, New York.

Jackson, S. C., 180 Broadway, N. Y., Manufacturer of Fine Cases for Jewelry, Silverware, &c.

Kohn, Solomon & Co.—Manufacturers of Fine Morocco Cases for Jewelry, Watches, etc. 43 Maiden Lane, New York.

Lauten, Edw. A. & Co.—No. 4 Great Jones St., Manufacturers of Fine Velvet, Brocade, Plush and Morocco Boxes, Patent Ring, Ear Ring and Gent's Scarf Pin Trays, Patent Watch and Bracelet Blocks, Window Decorations, etc.

Loehr & Koerner—Manufacturers of Morocco, Velvet, Satin, Jewelry, Watches and Silverware Cases, Jewel, Work Boxes, etc., Fancy Trays and Store Fittings to order. 96 Liberty St.

Metropolitan Fancy Box and Leather Goods Manufactory—Makers of Plush, Velvet, Satin and Leather Cases for Watches, Jewelry, Silverware, etc. 75 and 77 Nassau Street, N. Y.

New York Morocco Case Co.—Cases for Jewelry, Watches, Silverware. Boxes and Trays for Jewelers' Travelers. Show Cases and Window Fittings. No. 69 Nassau Street, New York.

Schien, Charles E.—Manufacturer of Cases for Jewelry and Silverware, No. 85 Nassau St., N. Y. Show Case Trays, etc., at short notice.

Schwarz, N.—Manufacturer of fine Cases for Jewelry and Silverware, 866 Broadway, near 17th street, N. Y.

Steinle, E.—Manufacturer of Cases for Jewelry of all kinds. Also Cases for Mathematical and Surgical Instruments and for Trays for Travelers' Trunks, etc. 66 Nassau Street, N. Y.

Welch & Miller—169 Broadway. Manufacturers of fine Morocco, Velvet, Russia, Brocade and Plush Jewelry Cases. Trays of every description; Jeweler's Cotton and Twine; Telescope Sample Cases with Flexible Trays. 169 Broadway, N. Y.

Wiggers & Froelick—No. 60 Nassau street—Manufacturers of Cases for Jewelry, &c., of every description. Trays for Show-cases, Stands for Show-windows, etc.

Jewelers' Findings.

Dennison Mfg Co.—Paper Jewelry Boxes, cards, tags, pink and white cotton, etc. etc. New York, Boston, Chicago, Cincinnati, Philadelphia, St. Louis.

Ettlinger, L. & Sons.—Manufacturers of Jewelers' Paper Boxes and Findings. Morocco Paper, Satin or Plush Lined Wooden Corner Stops Jewelry and Silverware Boxes. 80 Nassau Street, New York.

Lehmann, Ludwig.—Manufacturer of Jewelers' Findings. Tags, Pink and White Cotton, and Tissue Paper. Specialty, Fine Paper Boxes for Jewelers and Silversmiths. 122 Fulton Street.

Valfer, S. & Co.—Manufacturers and Dealers in Jewelers' Boxes, Tags, Cards, Paper and Findings. Trays a specialty. Office and Salesroom, 66 Nassau street, New York.

Jewelry Manufacturers.

Aikin, Lambert & Co.—Manufacturers General stock of Reliable Jewelry, 23 Maiden Lane.

Alford, C. G. & Co.—Manufacturers. General line fine and Reliable Goods. Specialties in Onyx Goods and Chain. 200 Broadway, New York.

Alling, Isaac A. & Co.—Manufacturers of Fine Gold Jewelry. Sets, Lace Pins, Ear Rings, Studs, Collar Buttons and Scarf Pins. Specialties: Wire Bracelets, Bangles, American Lever Sleeve Buttons. Bryant Building, Nassau and Liberty Streets, N. Y. Factory, Newark, N. J.

Baldwin, Sexton & Peterson—Makers of Fine Jewelry and Importers of Diamonds, etc., corner Broadway and Fourth Street.

Ball, W. H.—Manufacturer of Gold Jewelry. Bracelets and Bangles of all kinds a specialty. 9 John Street, N. Y.

Barthman, Straat & Co.—Manufacturers of Fine Jewelry. Roman Goods, Rings, Diamonds. No. 43 Maiden Lane.

Bernhard, A. & Co.—Manufacturers of General Fine Work. Specialties: Diamond Jewelry, Diamond Settings, Hair Jewelry, Fancy Rings, Rose Diamond Monogram and Onyx Work. 2 Maiden Lane, New York.

Brown, Thos. G. & Sons—Man'rs of Rich Jewelry Necklaces, Locketts, Bracelets, Sleeve Buttons, etc., 5 Bond Street, N. Y.

Bryant & Bentley—Manufacturing Jewelers. Rings a specialty. 12 Maiden Lane

Carter, Sloan & Co.—Manufacturing Jewelers, 15 Maiden Lane, New York.

Champenois & Co.—No. 5 Maiden Lane, manufacturers of Engraved and Enameled Gold goods, in Sets, Ear Knobs, Bracelets, Studs, Lace and Shawl Pins, Jet cluster and Onyx goods, also "Best Lever" Sleeve Buttons.

Chatellier, Joseph F.—Manufacturing Jeweler, No. 694 Broadway, N. Y.

Churchill, Lewis & Co.—Manufacturers of Fine Jewelry. 692 Broadway, cor. Fourth St., N. Y.

Cook, Groeschel & Co.—Manufacturers of Fine Jewelry and Locketts, 191 Broadway (over Mercantile Bank,) N. Y.

Cottle S. Co.—Manufacturers of Fine Jewelry. Waltham Building, 5 Bond Street, N. Y.

Cox & Sedgwick—Manufacturers of fine Onyx and Colored Jewelry. 26 John St., New York

Day & Clark—Manufacturers of Fine Jewelry, Lace Pins, Ear Rings, Studs, Locketts, &c., 10 Maiden Lane, New York.

Geoffroy, Arthur R. & Co.—Manufacturing Jewelers. Novelties in Diamond Goods. No. 23 Maiden Lane, N. Y.

Goddard, John M.—Manufacturing Jeweler,—Seal Rings and Fine Locketts a specialty, No. 3 Maiden Lane, N. Y.

Goldsmith & Cohen—Manufacturing Jewelers, 3 Maiden Lane, New York.

Greason J. R. & Co.—Successors to Arthur, Rumrill & Co., 182 Broadway. Manufacturers of Fine Jewelry and Gold Chains, also Diamond Mountings.

Greene Wm. C. & Co.—Goldsmiths; Manufacturers of Rich Sets in Taper Wire Coral. Office, 192 Broadway.

Hale, S. W. & Co.—Manufacturers Rich Jewelry, Whiting Building, Broadway and 4th Street.

Hartmann, P.—Manufacturer & Importer of Fine Gold, Diamond, and Filigree Silver Jewelry, No. 36 Maiden Lane. P. O. Box 2,454.

Haskell, H. C.—Manufacturing Jeweler. Seal Rings a specialty. Special attention to Jobbing of every description. 12 John street.

Hedges, A. J. & Co.—Manufacturing Jewelers, 6 Maiden Lane.

Henderson & Winter—Jewelers, No. 15 Maiden Lane, New York. Specialties—Stone, Cameo, Onyx, Amethyst, Topaz, Pearl and Turquoise Rings.

Hunt & Owen.—Manufacturing Jewelers. Office 3 Maiden Lane.

Kennedy, Frank S.—Manufacturer and Wholesale Dealer in Jewelry and Gold and Silver Thimbles. No. 13 Maiden Lane, New York.

Kremetz & Co.—Manufacturing Jewelers, No. 182 Broadway, N. Y.

Kuhn, Doerflinger & Co.—Manufacturers of Enameled and Roman Band Bracelets, also Fine Locketts Pendants and Lace Pins. 18 John street.

Lennon, John D.—Manufacturing Jeweler, 142 Fulton Street. Stone Locketts and Rings; also Badges and Emblems of all kinds.

Miller Bros.—Manufacturers of Fine Jewelry, Locketts, Sleeve Buttons, Studs, &c., 7 Maiden Lane, N. Y.

Moore & Horton.—11 Maiden Lane, Manufacturing Jewelers, Rings, Studs, Collars and Sleeve Buttons, Pins, Ear-rings, &c.

Muhr's, H., Sons.—Manufacturing Jewelers. Solid Gold and Filled Rings a specialty. Also Manufacturers of the celebrated Crown Filled Watch Case. 16 Maiden Lane, N. Y.

Owen, G. & S. & Co.—Manufacturing Jewelers. Office, No. 3 Maiden Lane.

Richardson, Enos & Co.—Manufacturers of Fine Gold Jewelry, Gold Chains, Locketts, Crosses and Necklaces. Colored and Etruscan Work. No. 23 Maiden Lane, New York.

Richardson, J. W. & Co.—Manufacturers of Jewelry. Masonic and other Emblems. 196 Broadway, N. Y. Manufactory, Providence, R. I.

Riley, J. A. & Co.—Manufacturing Jewelers. Etruscan Gold and Roman Bracelets, Lace Pins, Ear Rings, Scarf Pins, Brooch Pins, etc. Nos. 7 and 9 Bond Street, N. Y.

Ripley, Howland & Co.—Manufacturers of Fine Jewelry and Platinum Tipped Diamond Settings. No. 17 Maiden Lane, N. Y.

Sauter, L.—Manufacturer of Fine Jewelry, Solid Stone Rings and Studs a specialty. Jobbing for the trade. 1 Maiden Lane, New York.

Sexton & Cole—Manufacturing Jewelers, Colored Gold and Onyx Goods a specialty. No. 30 Maiden Lane.

Shafer & Douglas, Manufacturing Jewelers—Roman Goods, Lace Pins, Cameo Sets, etc., Stone Rings, etc. No. 7 Maiden Lane, N. Y.

Sheafer, W. H. & Co.—Manufacturing Jewelers, Specialty Bangles and Bracelets, 15 John St., N. Y.

Steele, J. W.—Successor to Brainerd, Steele & Co., Manufacturer of Fine Jewelry and Brainerd's Patent Locketts. No. 9 Maiden Lane, N. Y.

Stites, D. H. & Son—Manufacturers of Fine Jewelry, Rolled Plated Goods and Chains, Parisian Diamond Rings, Studs and Earrings a specialty. 41 Maiden Lane, N. Y.

Stites' Sons, E.—Manufacturers of Fine Jewelry. No. 14 John Street, N. Y.

Street, Geo. O. & Sons.—Established 1837. Makers of Fine Jewelry, strictly first-class goods of our own make. No. 15 John Street, New York.

Terhune, Charles F.—Manufacturing Jeweler, 194 Broadway, N. Y.

Thoma, Ernest—Manufacturer of Fine Jewelry, Sleeve Buttons, Rings, Ear-rings, &c. No. 173 Broadway, N. Y. Factory, Hackensack, N. I.

Ward, Thos. M.—Manufacturer of Fine Jewelry, Diamond Mountings a specialty. No. 25 John Street, N. Y.

Wheeler, Parsons & Hays.—Manufacturers of Fine Jewelry, Watch Cases, Gold Chains, &c. and Dealer in American and Swiss Watches, No. 2 Maiden Lane, N. Y.

Wienhold, Joseph—Manufacturer of Fine Jewelry Diamond Mountings a specialty. 24 John St.

Woglom & Miller—Manufacturers of Black Onyx Goods exclusively. 32 & 34 John Street, N. Y.

Jewelry—Rolled Plate.

Frick, John & Co.—Fine Rolled Plate Jewelry of all kinds. Repairing of every description. 21 and 23 Maiden Lane, N. Y.

Mauran, J. T.—Manufacturer of Fine Rolled Plate Jewelry, No. 15 Maiden Lane, N. Y.

Richards, E. Ira & Co.—Manufacturers of Fine Rolled Plate Jewelry, No. 200 Broadway, N. Y.

Weil, Leopold & Co.—Manufacturers of Rolled Plate Jewelry of every description, 35 Maiden Lane, N. Y.

Jewelers' Tools, etc.

Fisher, James J.—Dealer in Watchmakers' and Jewelers' Materials, Files, Tools, Silk Guards, Spectacles, etc., 697 Broadway, N. Y.

Frasse & Co.—Importers of Stubb' French, Swiss, German and Sheffield Tools, Files and Steel Wire for Watchmakers, Jewelers, etc., 62 Chatham street, N. Y.

Friedenthal, A. & Co.—Importers and jobbers of Watchmakers' and Jewelers' Tools, Materials, etc. 43 Maiden Lane, N. Y.

Friedlander, R. & L.—Importers of Watchmakers' Tools and Materials. 65 & 67 Nassau Street. Branch Office, 264 Bowery.

Kurtz, F. P.—Manufacturer of Jewelers Machinery, Tools, Rolling Mills, Presses, Polishing Lathes, &c. 97 Cliff St., N. Y.

Levy, Dreyfus & Co.—Importers and Jobbers of Watchmakers' and Jewelers tools and materials of every description. 11 Maiden Lane, N. Y.

Montgomery & Co.—Importers of and Dealers in Manufacturing Jewelers' Tools and Materials of every description, 105 Fulton street, New York.

Reichhelm & Koester.—Importers of Jewelers' Tools, Files, etc. Manufacturers of Brushes and Buffing wheels; also Patent Gas Furnaces for Melting, Plating, Enamelling, Annealing, etc. 80 Nassau St., N. Y.

Lapidaries.

Fox, M. & Co.—Practical Lapidaries, No. 1 Maiden Lane, New York.

Graham & Co.—Practical Lapidaries, Cutters and Polishers of all kinds of Precious Stones. Miners' Relics Cut, Polished and Mounted. Miniature, Locket and Clock Glasses. 80 Nassau St., N. Y.

Kordmann & Michel.—Lapidaries. Dealers in Precious Stones. Cutting and Polishing Rubies, Sapphires and other Gems a specialty. Drilling done promptly. 59 Nassau St., N. Y.

Korn, Ph.—Lapidary. Importer of Precious and Imitation Stones, No. 63 Nassau street, between Maiden Lane and John street, New York.

Masonic Jewelry.

Lennon, John D.—Manufacturer of Masonic, Odd Fellows, Athletic Clubs and other Jewelry, No. 142 Fulton Street, New York.

Luther, John F.—79 Nassau Street. Manufacturer of Fine Presentation Jewels for all Societies. Knights Templars, Crosses, Badges, &c.

Popper, H.—Manufacturer of Medals and Badges for Military, G. A. R., Shooting, Masonic, Odd Fellows, Knights of Pythias, etc. 91 Essex St., New York.

Wilkinson, C. B.—Manufacturing Jeweler, 8 John St., N. Y. Medals, Badges and Masonic Jewelry, a specialty. Designs furnished free upon application.

Optical Goods.

Friedlander, R. & L.—65 and 67 Nassau Street. Dealers in Optical Goods.

Opticians.

Burbank Man'g Co.—Manufacturers of Spectacles and Eye Glasses of all descriptions, in gold, silver, etc., 14 Maiden Lane, N. Y.

DuBois, Geo. W. & Co.—Importers of Watches and Optical Goods. 36 Maiden Lane, N. Y.

Kahn, Hanover & Co.—Importers of Spectacles, Eye-Glasses and Optical Goods generally, and Scientific Instruments of every description. 32 Maiden Lane, New York.

Laurencott, J. B.—Importer of Watch Glasses, Optical and Fancy Goods, Clocks, Bronzes, etc., 33 Maiden Lane, N. Y.

Levy, Dreyfus & Co.—Importers of Spectacles and Eye Glasses and Optical Instruments of every description, No. 11 Maiden Lane, N. Y.

Lorsch, Albert—Manufacturer of the Patent Accommodating Spectacles and Eye Glasses in Gold, Silver and Steel, and other Optical Goods, 37 Maiden Lane, N. Y.

New York Optical Co.—Manufacturers of Spectacles, Eye-Glasses and Cases, No. 43 Maiden Lane, New York. (P. O. Box 2309).

Spencer Optical Manufacturing Co.—Gold, Silver, Steel, Nickel and Plated Spectacles; Gold, Celluloid, Steel, Nickel and Rubber Eye Glass and Opera Glasses. 13 Maiden Lane, N. Y.

Paper Boxes.

Waterbury Paper and Box Co., 27 to 35 Canal St., Waterbury, Conn., Manufacture Jewelers' and Silversmiths' Fine Paper Boxes. Quality guaranteed to be equal to the best made.

Precious Stones, &c.

Bishop, Victor & Co.—33 Maiden Lane, Importers of Precious Stones, Cameos, &c. Also Manufacturers of Coral Jewelry.

Bissinger, Philip & Co.—Importer of Diamonds, Pearls and Precious Stones. Agent for the Bohemian Garnet Goods. Blue Enameled Locketts. No. 22 John St., N. Y.

Breidenbach, R. A.—Importer of Black Onyx, Cameos, Turquoise, Pearls, Sardonyx, Amethysts, Topaz, Garnets, Opals, Rubies, Sapphires, Cat's Eyes, Hematites, Brilliants, Doublets, etc. 85 Nassau St., N. Y.

Daue, Wm. & Co.—Importer of Precious and Imitation Stones. No. 202 Broadway New York.

Fox, M. & Co.—Importers of Diamonds and other Precious Stones, No. 1 Maiden Lane, N. Y.

Gruet, Jules.—Importer of all Grades of Real and Imitation Stones. 14 John St., N. Y.

Guntzburger Bros.—Manufacturers and importers of Precious Stones—Amethysts, Topaz, Cameos, Garnets, Imitation Diamonds, &c. No. 9 Maiden Lane.

Hahn & Co.—Importers of Precious Stones. Cameos, Onyx, Pearls, Intaglios, Amethysts, Garnets, etc. 64 Nassau Street, New York.

Kahn, L. & M.—Importers of precious and imitation stones. 10 Maiden Lane, N. Y.

Kipling, E. E.—Importer of Precious and Imitation Stones. Manufacturer of the Patent Foil Solid Metal Back Rhine Stone Brilliant. No. 6 Maiden Lane, N. Y.

Kipling, R. A.—Precious and Imitation Stones, No. 24 Maiden Lane, N. Y. Manufacturer Cameos, Agates, Onyx, Etc., Oberstein, Germany. Commission Merchant, 49 Rue De L'Echiquier, Paris.

Tannenbaum, L. & Co.—Importers of Diamonds and Precious Stones. Steam Lapidary Works. Oriental Stones Cut and Polished a specialty. 65 Nassau St., N. Y.

Silverware.

Gorham Manufacturing Co.—Union Square.

Knowles, J. P. & S. M.—Manufacturers of Sterling Silverware, 20 Maiden Lane, N. Y. Factory, Providence, R. I.

Shiebler, Geo. W.—Manufacturer of Sterling Silverware. No. 8 Liberty Place, near Maiden Lane, N. Y.

Whiting Manufacturing Co.—Makers of Sterling Silver Ware. Broadway cor. 4th Street, N. Y.

Wood & Hughes.—Manufacturers of Fine Silverware. 16 John Street, N. Y.

Silver Filigree Jewelry.

Cuppia, L. A.—Manufacturer of Solid Silver Novelties, and Importer of Silver Filigree, 19 Union Square.

Hartmann, P.—Manufacturer of Silver Filigree Jewelry. 36 Maiden Lane, N. Y.

Silver Plated Ware.

Holmes, Booth & Haydens—Manufacturers of Silver-Plated Ware. 47 Chambers Street.

Manhattan Silver Plate Co.—Manufacturers of Silver Plated Ware. Showrooms, 23 John St. Factory, 301 to 305 East 22d St., cor. 2d Ave. Address all communications to Factory.

Meriden Silver Plate Co.—Manufacturers of Fine Silver Plated Ware. No. 30 E. 14th Street, New York.

Middletown Plate Co.—Manufacturers of Superior Electro-Plate. Factories, Middletown, Conn., salesroom, 13 John Street.

Rogers & Bro.—Manufacturers of the finest quality of Electro-Plated Ware. 690 Broadway.

Rogers, Smith & Co.—Manufacturers of Fine Electro Plated Ware. No. 46 E. 14th St., N. Y.

Simpson, Hall, Miller & Co.—Manufacturers of fine Silver-Plated Ware. No. 36 E. 14th Street.

Schade, Henry.—Manufacturer of White Metal and Plated Ware. No. 84 John St., N. Y. Price list and catalogue furnished on application.

Webster, E. G. & Bro.—Manufacturers of Fine Silver-Plated Ware. Office and warerooms, 14 Maiden Lane, N. Y.

Show Cases, Etc.

Smith, B. & W. B.—Manufacturers of Patent Improved Dust Proof Show Cases, with Perpendicular Sliding Doors, No. 220 W. 29th St., N. Y.

Spectacle Case Manufacturers.

Bertine, P. D.—Manufacturer of Spectacle Cases, 139 William Street, near Fulton St., New York.

Koenen, A. & Bro.—Manufacturers of Leather Spectacle and Eye-Glass Cases. 81 Nassau St., N. Y.

Stem Winding Attachments.

Abbott, Henry Maker of Stem Winding Attachments. No. 7 Maiden Lane, N. Y.

Thermometers, Etc.

Tagliabue, Giuseppe.—manufacturer of Thermometers, Barometers and Hydrometers. Patentee and sole manufacturer of the U. S. Standard Hydrometer. 302 Pearl Street, near Beekman.

Thimble Manufacturers.

Barker Manuf'g Co.—Makers of Patent Graduated Thimbles, Stiffened Gold, Filled Gold and Rolled Gold, 36 Maiden Lane, N. Y. A. Lyons, Ag't. Factory, 129 Eddy St., Providence, R. I.

Burbank Manuf'g Co.—Manufacturers of Gold and Silver Thimbles, 14 Maiden Lane, N. Y.

Ketcham & McDougall.—Improved Gold and Silver Thimbles, Bryant Building, N. Y.

Simons Bro. & Co.—Manufacturers of Gold and Silver Thimbles. 611 and 613 Sansom Street, Philadelphia.

Wogom & Miller.—Sole Agents for the "Prime" Thimbles in Gold and Silver, manufactured by Ezra C. Prime. 34 John Street, N. Y.

Watch Companies.

American Watch Co.—Robbins & Appleton, No. 5 Bond Street, N. Y.

Lancaster Watch Co.—Manufacturers of Watches. Lancaster, Pa.

The E. Howard Watch and Clock Co.—Cor. Maiden Lane and Nassau Street, N. Y.

Waterbury Watch Co.—Manufacturers of the Waterbury Watch. Factory, Waterbury. Office, 52 Maiden Lane, N. Y.

Watch and Chronometer Jeweler.

Queen, James.—Watch and Chronometer Jeweler and Pallet Maker, 78 Nassau Street, room 8. Pivots inserted in Pinions, Balance, Staffs, etc.

Wennstrom, John.—Watch, Chronometer and Clock Jeweler, Jewel Guages, Ruby and Sapphire Draw Plates; Diamonds Dressed; Polishing Stones for Jewel Settings. 2 Dutch St., N. Y.

Watch Importers, Etc.

Abry, Chas. Leo.—Importer and Manufacturer of Swiss Watches of all grades. 63 Nassau Street.

Atkin, Lambert & Co.—Importers of Watches. Sole Agents for Paul Breton & Chas. Latour, Geneva. A general line of reliable Swiss Watches, Watch Cases, etc. 23 Maiden Lane, N. Y.

Bartens & Rice.—20 John Street, Importers of Watches and sole agents in the United States for the celebrated Nicole, Nielsen & Co. Watches.

Cross & Beguelin.—Importers of Watches, Watch Tools and Materials, dealers in American Watches, No. 21 Maiden Lane, N. Y.

Droz, Henry E.—Importer of Watches, and Watch Case Manufacturer. Agent for the "E. Perregaux" Watch, and jobber in American Watches. No. 92 Fulton Street, N. Y.

Durfey & Reynolds—Successors to Durfey & Shiebler, Watches, Diamonds, Jewelry. No. 9 John Street, (up-stairs) New York.

Freund Max & Co.—Importers of Watches, Jewelry and Precious Stones, 8 Maiden Lane, N. Y.

Gagnebin, Chas.—Importer of all kinds of Swiss, and Dealer in American Watches. 4 Maiden Lane, N. Y. Agent for Ulysse Breting's Fine Chronometers, Chronographs, Anchors, &c

Gallet, Julien.—Importer of Watches. No. 1 Maiden Lane.

Ginnel, Henry—Importer of Watches, Tools and Materials, 31 Maiden Lane, N. Y. P. O. Box, 2967

Heinrich, H. H. & Co.—Sole Agents for the Karl Zimmerman Watch, and Importers of Fine Watches and Marine Chronometers. 12 John Street, N. Y.

Herzog, Louis & Co.—Importers of Watches, Dealers in Diamonds and Jewelry, 52 Maiden Lane, N. Y.

Hirsch Bros.—Dealers in Watches and Diamonds and Manufacturers of Jewelry, No. 23 Maiden Lane, N. Y.

Hyde's Sons, John E.—Wholesale Commission Agents, only for Jules Jurgensen, of Copenhagen; Jules Monard, of Geneva; and for other makers of all qualities of Watches, 22 Maiden Lane.

Jandorf, P. & Bro.—Importers of Watches and Jewelry, 196 Broadway.

Keller, L. H. & Co.—Successors to G. A. Huguenin, Importers of Fine Watch and French Clock Materials, No. 64 Nassau Street, N. Y.

Mathey Bros. & Mathez.—Importers of Fine Watches and Sole Agents for the **H. L. Matile's** Watches. No. 16 Maiden Lane.

Oppenheimer Bros. & Veith.—Dealers in Watches and Diamonds, and Manufacturing Jewelers, No. 35 Maiden Lane.

Robert, J. Eugene—No. 30 Maiden Lane, New York. Agent for Louis Audemar's celebrated watches.

Schwob, Adolphe—Manufacturer and Importer of Watches, 11 Maiden Lane, N. Y.

Stern Brothers & Co.—Importers of Swiss Watches and wholesale dealers in American Watches, &c., 39 Maiden Lane.

Scott, J. T. & Co.—Importers of Watches, and Manufacturers of Jewelry, and Jobbers of all Grades of American Watches, 11 Maiden Lane.

Strasburger, Louis & Co.—Importers and Makers of Watches of every description, 15 Maiden Lane.

Watch Cases.

Dueber Watch Case Mfg Co.—Manufacturers of Gold and Silver Watch Cases, Bryant Building, N. Y. Factory, Newport, Ky.

Duhme & Co.—Manufacturers of Gold and Silver Watch Cases. Carlisle Block, Fourth and Walnut Streets, Cincinnati.

Fahys, Joseph—Manufacturer of Watch Cases and Dealer in American Movements, 38 Maiden Lane.

Glatz, Chas.—Manufacturer of Silver Watch Cases. Bryant Building, cor. Nassau and Liberty Sts.

Keller & Untermeyer.—Manufacturers of Watch Cases with Raised Gold Ornaments. 9 Maiden Lane, N. Y.

Ladd Watch Case Co.—Manufacturers of the Ladd Patent Stiffened Gold Watch Cases, etc., 11 Maiden Lane, N. Y. Factory, 58 Eddy Street, Providence, R. I.

Willemin Watch Case Co.—Makers of Gold Watch Cases. Raised Gold Ornamentation and Jurgensen style of Engine Turning. 109 Sands Street, Brooklyn, N. Y. 16 Maiden Lane, N. Y.

Watch and Chronometer Repairers.

Cerf, B.—Practical Watchmaker and Repairer, No. 10 John Street, N. Y. Repairing and adjusting of Fine Watches done for the trade. All kinds of escape and stem-winding wheels cut to order.

Heinrich, H. H. & Co.—Sole Manufacturers of H. H. Heinrich's Patent Auxiliary Balance, and Adjusters and Repairers of Fine Watches and Chronometers. 12 John Street, N. Y.

Lesperance, Theo.—Watchmaker and Wheel Cutter. Also Stoning Nickel Movements. No. 1 Maiden Lane, New York. With Julien Gallet.

Ludeman, W. H.—Chronometer and Watch Maker. Repairing of every description for the trade, 75 and 77 Nassau Street.

Watch Case Repairers.

Feinier, Joseph A.—Watch Case Maker and General Repairer. Specialty in fine Gold and Silver Cases. Jobbing promptly attended to. Nos. 4 and 6 John St., N. Y.

Tarbox, Hiram—Watch Case Repairing, Springing, Polishing and Engine Turning. 1874 North Fourth Avenue, bet. 176th and 177th Sts., N. Y. Express Packages should be sent to 92 Fulton Street.

Watch Glasses, Shades, Etc.

Brown, Edwin H.—No. 85 Nassau Street, Imported and Own Manufacture Watch Glasses, Flat, Flat Concave, Concave, Convex and fine Geneva's. Fine fitting solicited.

Watches, Jewelry, etc.

Cohn, J. J.—Importer and Manufacturer of Whitby Jet, Rubber and Pearl goods. Gold and Rolled-plate Jewelry, etc. 12 Maiden Lane, New York.

Friedman, Saml.—Wholesale Dealer in Watches and Jewelry, 42 Maiden Lane, N. Y.

Fry & Schieber—Manufacturers of Fine Gold and Plated Jewelry and Importers of Watches, 201 Broadway, N. Y.

Leberthon, L. M.—Importer of diamonds and watches. Manufacturer of jewelry. 14 John St. Fine stones a specialty.

Lissauer & Sondheim—Wholesale Jewelers and Jobbers in American Watches, No. 12 Maiden Lane, N. Y.

Marx, Kossuth & Co.—Importers of Watches and Dealers in Jewelry. 39 Maiden Lane, N. Y.

Mayer, B.—Manufacturer of Fine Jewelry, and Dealer in Watches, 71 Nassau street, cor. John street, New York.

Myers, S. F. & Co.—Manufacturing and Wholesale Jewelers—all grades. Importers of Watches. Illustrated Catalogue to the trade. 179 Broadway, N. Y.

Smith & Knapp—Wholesale Dealers in American and Swiss Watches, Diamonds, Gold and Plated Jewelry and Gold Chain. 182 Broadway, N. Y.

Stern & Stern—Dealers in Watches, Jewelry and Diamonds. No. 6 Maiden Lane, N. Y.

Strauss, Jacob.—Full Line of Gold and Plated Jewelry, and Importer of Watches. 18 John Street, New York.

Thrall, E. A.—Wholesale Dealer in Watches and Jewelry. No. 1 Maiden Lane, N. Y.

Trier Bros.—Importers of Garnet, Whitby Jet and Amber Jewelry, Silk Guards, Opera, Field and Marine Glasses, Pearl Card Cases. Also a full line of Gold and Plated Jewelry. 15 Maiden Lane, N. Y.

White, N. H.—Jobber in American-Waltham Watches and Chronographs. Waltham make of 10-k., 14-k. and 18-k. Gold and Sterling Silver Cases; Filled Gold Cases. 11 Maiden Lane.

Watch Tools, etc.

Keller, L. H. & Co.—Importers of Watchmakers' and Jewelers' Tools, Materials, etc. 64 Nassau Street, N. Y.

Zimmern, Henry—Importer of Watch Materials, Tools, and Optical Goods, No. 8 Maiden Lane, (first floor.) Sole Agent for A. Hugenin & Gravier. Mainsprings, New York.

PHILADELPHIA

Booz & Co.—Manufacturers of Gold and Silver Watch Cases and Jewelry, 108 South 8th St., Philadelphia.

Bennett, Jacob & Son.—Diamond Setters and Manufacturing Jewelers, 925 Chestnut St.

Bernard & Co.—Manufacturers of fine Roman and Etruscan Jewelry. Designs of every description made to order, 123 & 125 South Eleventh Street, Philadelphia.

Birmingham, Wm. & Co.—Morocco Case Manufacturers. Spectacle and Eye-Glass Cases a specialty, 626 Arch Street, Philadelphia, Pa.

Conover David F. & Co.—American Watches, Wholesale Salesroom, Southeast corner 7th and Chestnut Streets, Philadelphia.

Dubosq, J. Carrow—Manufacturer of Fine Jewelry. Particular attention given to repairing Strung Pearl work. 108 South Eighth St., Phila.

Fick, Chas. M.—Seal Engraver and Designer. Sketches furnished Free of Charge for Coat of Arms, Crests, Monograms, Initial Letters and Masonic Emblems, to be engraved on all kinds of Precious Stones. 618 Chestnut St., Philadelphia, Pa.

Guilbert, Thos. M., & Co.—Manufacturing Jewelers. Flexible Bracelets and Strung Pearl Repairing. 908 Chestnut St., Philadelphia.

Herold, Chas P.—Successor to Hildebrandt, Herold & Co., Manufacturing Jeweler and Diamond Setter. Diamonds. 916 Chestnut Street.

Krieder, Peter L.—Manufacturer of Sterling Silver Ware. 618 Chestnut Street, Philadelphia.

McCarty & Hurlburt—Manufacturers of Gold Spectacles, Silver Thimbles and Plain Rings. Wholesale dealers in American Watches, Jewelry, etc. 131 North Second Street.

Morgan & Headly.—Manufacturing Jewelers, Cameo Sets, Gold Sets, Roman Lockets, Rings, Coral Sets and a general line of rich goods. Corner 10th and Chestnut Streets, Philadelphia.

Muhr's, H., Sons.—Manufacturing Jewelers. Solid Gold and Filled Rings a specialty. 633 and 635 Chestnut Street, Philadelphia. 1½ Maiden Lane, New York.

Peters, Reese S.—Manufacturer of Patent Rolled Plate or Filled Watch Cases, Dealer in American Movements, 308 Chestnut Street, Philadelphia.

Robeth, A.—Wholesale Optician, and Dealer in Fine and Plated Jewelry, also Diamonds and Swiss Watches. 825 Market St., Philadelphia.

Rosenthal, G. F. C.—Manufacturing Jeweler and Diamond Setter. Engraving and Designing of Monograms a Specialty. No. 917 Sansom Street.

Scherr, L. A. & Co.—Wholesale Dealers in Watches Silver-Plated Ware, Spectacles, Fancy Goods, Watch Materials, etc. 726 Chestnut Street.

Sheafer, W. H. & Co.—Manufacturing Jewelers. Specialty: Band Bracelets. Factory, 612 and 614 Chestnut street, Philadelphia. Office, 15 John street, New York.

Simons, Brother & Co.—Manufacturers of Fine Jewelry, Canes, Thimbles, Chains. 611 and 613 Sansom Street.

Vansant, John T. & Co.—611 and 613 Sansom Street, Artisan Hall, Manufacturers and Wholesale Dealers in English Sterling Silverware. Specialties: Tea Sets, Knives, Forks, Spoons, Cups and Napkin Rings.

CHICAGO.

American Watch Company,—of Waltham, Mass. No. 102 State Street, Chicago.

Chicago Watch Case Co.—Manufacturers of Patent Dust Proof Screw Bezel Watch Cases. Cor. Madison Street and Michigan Avenue, Chicago, Ills.

Clapp & Davies—Wholesale Jewelers, 63 and 65 Washington Street. Catalogue and price list issued to watchmakers and jewelers.

Dennison Manufacturing Co.—Manufacturers of Jewelers' Paper Boxes, Morocco Cases, Tags, Cards, Pink and White Cotton, Tissue Papers, Sealing Wax, &c., &c., 102 Madison St., Chicago. Boston, New York, St. Louis, and Philadelphia.

Excelsior Sign Co.—Manufacturers of (Grout's Excelsior) Iron Watch and Spectacle Signs. 124 Fifth Avenue, Chicago, Ills.

Gilbert, Wm. L., Clock Co.—Manufacturers of Clocks, Regulators, and Time Pieces, and Clock Material of every description, 54 and 56 Madison Street, Chicago.

Giles, Bro. & Co.—Manufacturers and Jobbers in Watches, all classes of Jewelry, Materials, Clocks, Silver Ware, &c. Illustrated catalogues furnished to dealers on application. 101 & 103 State St.

Stein & Ellbogen—Wholesale Dealers in Watches and Jewelry, 127 State Street, Chicago, Ill. Specialty, repairing for the trade.

Wathier, Joseph P.—Watchmakers and Jewelers for the trade, and Wholesale Dealers in Watch Materials, Tools, etc. 178 West Madison Street, Chicago, Ill. Send for price list.

Wendell, Charles & Son—Wholesale Watches, Jewelry, etc. 170 State street, Chicago.

NEWARK.

Baker & Co.—Gold, Silver and Platinum Refiners, Assayers and Sweep Smelters. 408 New Jersey Railroad Avenue, cor. Murray St., Newark, N. J.

Diefenthaler Bros. & O'Donnell—Manufacturers of Fine Jewelry, Lace Pins, Ear Rings and Patent Spring Bangles a Specialty. 36 Crawford Street, Newark, N. J.

Felger, F. & F.—Manufacturing Jewelers. Specialties:—Roman Band Bracelets, Lace Pins, Scarf Pins, Ball and Fancy Ear Rings. No. 477 Washington Street, Newark, N. J.

Fiedler, Herrman—Successor to Kunze & Fiedler, Engraver, Die Sinker and Press Tool Maker, 363 Market Street, Opposite Pennsylvania R. R. Depot, Newark, N. J.

Hopper & Valentine—Manufacturers of Fine Jewelry, No. 8 Maple Place, Rear 44 Green St., Newark, N. J.

Huger & Heitlinger—Manufacturers to the Jobbing Trade only. Makers of Roman Stone, Engraved and Enameled Locketts, also Sets, Lace Pins and Ear Rings. Rear 477 Washington St.

Krippendorf, C. & Schuller, F.—Machinists and Jewelers' Tool Makers. 19 Greene Street, Newark, N. J. Rolls, Dies, Cutters, and Draw-plates of every Description made and repaired.

Lefort, Henry—Stem-winding Watch Crown Manufacturer. 60 Arlington Street.

Lelong, L. & Bro.—Gold and Silver Refiners Assayers and Sweep Smelters, Southwest corner of Halsey and Marshall Streets, Newark, N. J.

Miller & Beam—Manufacturers of Enameled Sets, Ear Rings, Lace Pins, etc. Guard Slides and Pendants a Specialty. 21 and 23 Green Street.

Milne, Alex.—Manufacturer of Stem-winding Watch Crowns. 19 Ward Street.

Plumb & Marcus—Manufacturers of Traveling and Marine Clocks, Electric Appliances. 289 Washington St., Newark, N. J.

Pollock, T. H.—Manufacturer of Jewelers' and Silversmiths' Wheel Brushes, Buffs, etc. No. 36 Crawford Street, Newark, N. J.

Regad, E. D.—Lapidary. Specialty—Sardonyx, Black Onyx and Agates. 14 Oliver St., Newark.

PROVIDENCE

Irons, Chas. F.—Manufacturer of Solid Gold Jewelry. Specialty, Emblems, Pins and Charms, Masonic, Odd Fellows, etc. 102 Friendship St.

Lederer, S. & B.—Manufacturers of Fire Gilt, Nickel, Electro and Silver Plated Chains, Necklaces, Charms, etc. Opera, Matinee and Guard Chains. 66 to 72 Stewart St., Providence, R. I.

Pearce & Hoagland—Manufacturers of Gold Pens, Holders, Pencils, Tooth Picks, etc. Also the Quill Reserve Tooth Pick. 29 Point Street, Providence, R. I.

Presbrey & Tuttle—Manufacturers of a large variety of Fine Bracelet and Eye-Glass Chain in Gold Plate and Silver, Spring Rings, Holders, Hooks, Snaps, etc. 35 Point St., Providence, R. I.

Seery Mfg. Co.—Manufacturers of Fire Gilt, Nickel and Electro Plated Chains, Vest, Neck, Opera and Guard. 33 Beverly St., Providence, R. I.

Smith, Wm. T.—Assayer, Refiner and Sweep Smelter. Established 1855. Blackstone and Hawkins Streets, Providence, R. I.

Taylor, Geo. H. & Co.—Watchmakers and Wholesale Dealers in Watches, Clocks, Watch and Clock Material, Tools, Spectacles, Eye Glasses, &c. Particular attention given to trade work. 136 Westminster Street (Room 1), Providence, R. I.

PAWTUCKET.

Draper, J. O. & Co.—Manufacturers of Jewelers' Fig Soap, adapted for Washing Jewelry, Scratch Brushing and Drawing Wire. Pawtucket, R. I.

Fuller, Geo. H. & Son—Jewelers' Findings, Gold, Silver, Gold Plated and Fire Gilt. Pin Stems, Joints, Catches, Split Rings, Chain Hooks and Swivels, Ear Wires, Chain Bars, etc. 99 Exchange Street, Pawtucket, R. I.

Thayer, Ellis & Son—Brush Manufacturers, and Wholesale Dealers in all kinds of Brushes. Sole manufacturers of Ellis Thayer's Patent Polishing Wheels. Manufacturing Jewelers' and Machine Brushes a Specialty. 80 North Main Street, Pawtucket, R. I.

Thayer, P. E. & Co.—Manufacturers of Brushes. Jewelry and Machine Brushes a Specialty. All kinds of Wire Scratch Brushes on hand. Orders by mail or otherwise promptly attended to. 34 East Avenue, Pawtucket, R. I.

CINCINNATI.

Awalt, John A.—Jobber in Watches, Clocks, Jewelry, etc., 173 Vinc Street, Cincinnati.

Hellebusl, Clemens—Manufacturer, Importer and Wholesale Dealer in everything required by the Jewelry Trade. 77 W. Fourth St., Cincinnati, O.

Lodwick & Nolting—Wholesale Jewelers, S. W. cor. 4th & Walnut Streets, Cincinnati.

Noterman & Jonas—Manufacturing Jewelers, cor. 4th and Main Streets. Manufacturers of the Ophir Diamond Jewelry.

BALTIMORE.

Gruebel & Kesmodel—Manufacturers of Fine Diamond Etruscan, Enameled, Plain and Rhine Stone Jewelry to order. Repairing a specialty. Orders by Mail solicited. 212 & 214 W. Baltimore St., Balto., Md.

Morris, Wm. & Co.—Importers and Jobbers of Watch Materials, Tools, Optical Goods, Plated and White Metal Chains. Agents for American Lathes, &c. The attention of Southern Trade is requested. 207 and 209 West Baltimore Street.

BOSTON.

Boyce, E. J.—Manufacturer of Solid Gold Jewelry. Rings a Specialty. 383 Washington St., Boston, Mass.

Smith, Wm. A.—Importer of Diamonds and Precious Stones. Diamonds mounted and unmounted and Diamond Mountings. 383 Washington St., Boston, Mass.

BUFFALO.

King & Eisele—Manufacturers of Solid Gold Jewelry, and Agents for American and Foreign Watches; also Jobbers in Roll Plate Jewelry. Office and Salesrooms, 283 Main St. Factory, 2, 4, 6 and 8 Swan St.

CLEVELAND.

Chandler, J. M. & Co.—Manufacturers of the Patent Embossed Bracelet and Jobbers in all kinds of Clocks, Watches, Jewelry, Tools, Materials, etc. 185 Superior St., Cleveland, O.

NORTH ATTLEBORO.

Whiting, F. M. & Co.—Manufacturers of Sterling Silver Ware and Jewelry, North Attleboro, Mass.

LANCASTER.

Bowman & Musser—Jobbers in Watches, Clocks, Chains, Fine Tools and Materials. 20 East Chestnut Street, Lancaster, Pa.

PITTSBURGH.

Goddard, Hill & Co.—Wholesale Dealers in American Watches, Jewelry, Silverware, Clocks, Materials, &c., 43 Fifth Avenue, Pittsburgh, Pa.

SPRINGFIELD.

Bullock, O. W.—Springfield, Mass. Manufacturer of Fine Nickel Plated Watch and Jeweling Tools, Keys, and Light Metallic Goods.

CANADA.

Ellis, P. W. & Co., No. 31 King street, East Toronto, Ontario, Manufacturing Jewelers, Watchmakers, importers and Jobbers of Watchmakers, and Jewelers' Tools, Materials, General Supplies and American Jewelry. Correspondence solicited with manufacturers of Novelties or specialties in American Tools and Jewelry.

POSITIVELY NO GOODS RETAILED.

BOWMAN & MUSSER,

SUCCESSORS TO

E. F. BOWMAN,

JOBBERS IN

Watches, Clocks, Chains,

Fine Tools and Materials,

20 E. CHESTNUT STREET,

Cpp. P. R. R. Passenger Depot,

LANCASTER, PA.

Selection Packages sent to Regular Jewelers on Request.

BARNES'

No. 4 LATHE,

For the Heavier Work of Jewelers.

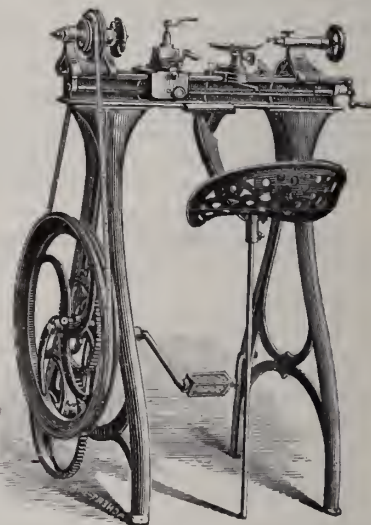

Barnes' Patent Foot and Steam Power Machinery. Complete outfits for Actual Workshop Business. Lathes for wood or metal. Circular Saws, Scroll Saws, Formers, Mortisers, Tenoners, etc., etc. Machines on trial if desired. Descriptive Catalogue and Price List Free.

W. F. & JOHN BARNES,
2088 Main Street, ROCKFORD, ILL.

EXCELSIOR'S

Practical Treatise

ON THE

BALANCE SPRING

Including Making and Fitting Hair Springs, Regulating, etc.

Also containing the Adjustment of Watches and Chronometers for Isochronism, Positions, Heat and Cold and Rate.

PRICE, \$3.50.

D. H. HOPKINSON,

42 Nassau Street, New York.

A NEW DEPARTURE.



14 KARAT GOLD CHAIN, SILVER LINED,

— MADE BY —

A NEW PROCESS.

Guaranteed to wear as well as the best 14 karat Gold Chain made.

Every Chain warranted to assay one-third ($\frac{1}{3}$) its entire weight in gold.

Each Chain stamped with registered trade mark:



*Showing the Relative Thickness
OF THE GOLD AND SILVER.*



*Showing the Relative Thickness
OF THE GOLD AND SILVER.*

Money refunded if test is unsatisfactory.

KOSSUTH MARX & CO.,

Proprietors and Manufacturers,

39 Maiden Lane, New York.

In introducing our new Chain we aim to supply a want which we believe the Trade can place before the public in a legitimate manner without deception, and no detriment to the standard of the most scrupulous dealer.

We offer these goods strictly upon their merits, and give but a few reasons why they can take the place of the older styles of manufacture, viz.:

- 1st.—*In the make up there is no base metal, excepting such as is necessary in standard 14 karat.*
- 2d.—*It makes a larger and more showy appearance for its corresponding weight than the old standard.*
- 3d.—*The cost is materially reduced, bringing it within reach of a greater number who desire a good article.*
- 4th.—*It is a well known fact that the principal cause of wear in chain is the friction produced by its own weight, consequently, being light weight to the extent of a large percentage, their better wear is assured.*

By a strict adherence to quality we hope to create a popular demand for a meritorious article.

Send for selection package, as our travelers do not carry any in stock.

KOSSUTH MARX & Co.

THE STANDARD FILLED RINGS.

SOLD BY ALL LEADING JOBBERS.

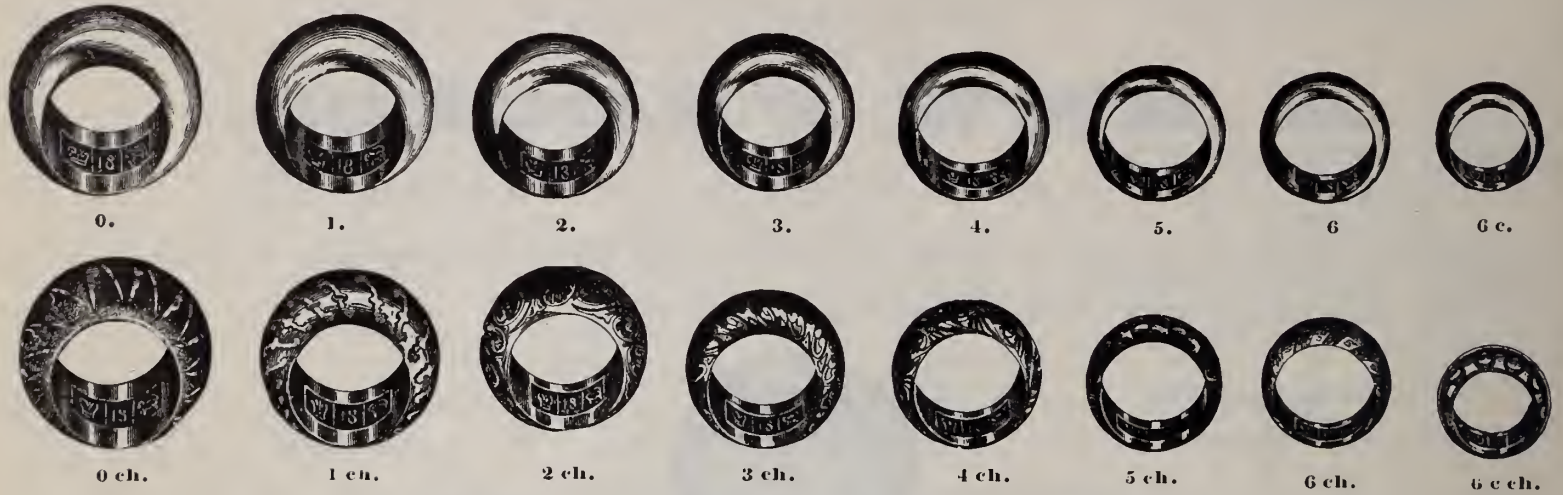

The New Solid Gold Edge Filled Band Rings.



Certain Manufacturers have Imitated our Stamps so closely as to deceive, *UNLESS YOU CAREFULLY EXAMINE THE TRADE MARK.*

H. MUHR'S SONS,

PHILADELPHIA.

CHICAGO.

NEW YORK.

WATERBURY CLOCK CO.,

MANUFACTURERS OF

CLOCKS,

Novelties & Materials,

No. 10 CORTLANDT ST., N. Y.

— AND —

No. 63 WASHINGTON ST., CHICAGO.

Factories, **WATERBURY, CONN.**

M. BAILEY, Treasurer.

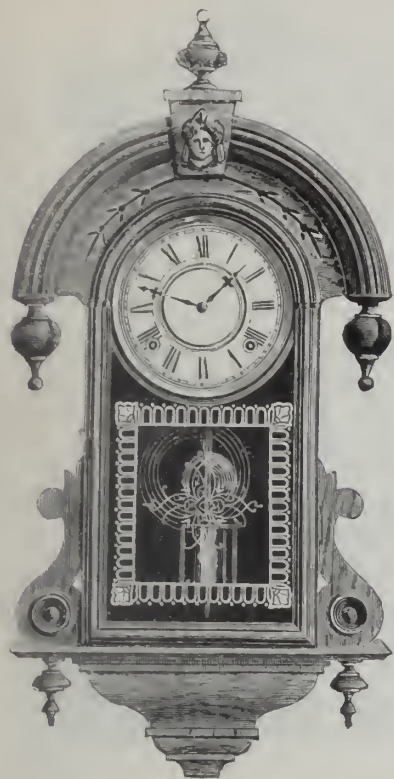

ANTWERP.

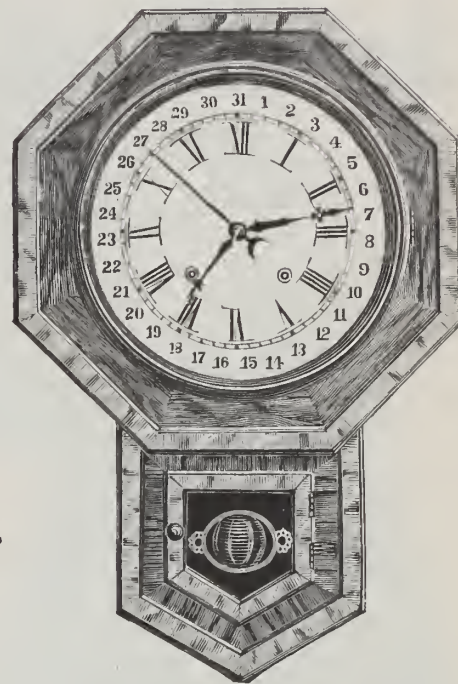

10 INCH DROP OCTAGON,
FULL GILT, CALENDAR.

THE ANSONIA CLOCK CO.

HANGING CLOCKS AND MANTEL CLOCKS

OF EVERY DESCRIPTION.



REGULATOR No. 4.

A LARGE AND COMPLETE STOCK OF

Tower Clocks } **HANGING AND STANDING** } Street Clocks

REGULATORS

AT LOW PRICES.

CHICAGO, 64 Washington St. **NEW YORK,** 11 to 19 Cliff St. **LONDON,** 128 Minories.

W. L. GILBERT CLOCK CO.,

GEORGE B. OWEN, General Manager.

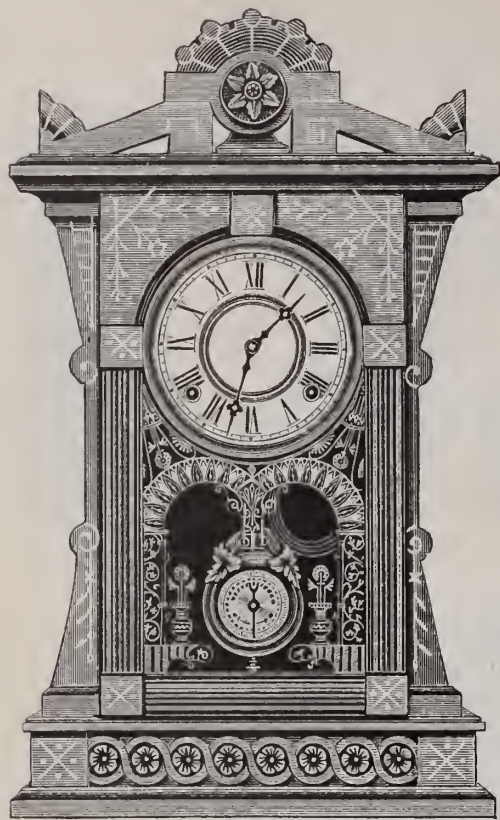

HELIOS.—Walnut,
8 Day Strike.
Height 20¾ inches. 6 inch Dial.

Salesrooms:
No. 6 Murray St., N. Y.
54 & 56 Madison St., Chicago.

Factories:
WINSTED,
Conn.

MANUFACTURERS OF

Walnut, Veneered and Other Clocks

IMPORTERS OF

Marble and Cuckoo Clocks.

*Catalogue and Price List Fur-
nished upon application.*



ERSA.—Walnut,
8 Day Strike.
Height, 19½ inches. 6 inch Dial.

ESTABLISHED 1833.
(30 YEARS.)

E. IRA RICHARDS & CO.

EXCLUSIVELY MANUFACTURERS.

FINE ROLLED PLATED JEWELRY,

The Largest and Choicest Stock in the Country.

Factories, NORTH ATTLEBORO, MASS. Salesrooms, 200 BROADWAY, NEW YORK.

HASKELL & MUEGGE, Agents, 206 Kearney St., San Francisco, Cal.

Goods Sent on Selection to Responsible Parties.

"THE SARATOGA."—Patented.



—: MADE BY —:

ROGERS & BROTHER,

690 BROADWAY,

NEW YORK.

WORKS, WATERBURY, CONN.

SIMONS, BRO. & CO.

MANUFACTURERS.



CHAIN.

Fine Jewelry.

ILLUSTRATED CATALOGUE



611 and 613 SANSOM STREET, PHILADELPHIA, OR NEAREST JOBBER.

LOUIS STRASBURGER & CO.

DIRECT IMPORTERS OF

WATCHES AND DIAMONDS,

WE MAKE EVERY KIND
OF WATCH IN
OUR OWN
FACTORY.

WE GET THE ROUGH
DIRECT AND CUT
OUR OWN
GOODS.

No. 15 MAIDEN LANE,

→NEW-YORK←

Rue Leopold Robert,
CHÂUX-DE-FONDS.

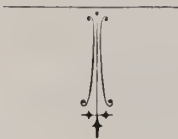

Boulevard Haussman, 30,
PARIS.

THE MIDDLETOWN PLATE COMP'Y,

Factories, MIDDLETOWN, CONN.

—SALESROOMS—

13 JOHN ST., NEW YORK.

120 SUTTER ST., SAN FRANCISCO,



Offer to the Trade a **LARGER** Assortment than ever, for Fall of 1883, of Elegant New Designs in Electro-Plate, finished in Plain Burnished Surface, (with Elegant Borders), Satin, Hammered, Fancy Gilt, New Satin, Etc., Etc.

“THE BEST”

THE DUEBER

GOLD WATCH CASES.



Quality Guaranteed as per following U. S. Registered Trade Marks:



Trade Mark for 14-K. Gold Cases.

Trade Mark for 18-K. Gold Cases.

Trade Mark for 10-K. Gold Cases.

We use but Three Qualities of Gold—18-K., 14-K., and 10-K.;—use no Trade Mark or Stamp but our own; and invite inspection of Finish and Workmanship in every particular.

The Dueber Watch Case Mfg. Co.

❖ CHICAGO, ❖
4 Tribune Building.

❖ CINCINNATI, ❖
P. O. Box 1334.

❖ NEW YORK, ❖
20 Bryant Building.

“THE BEST”

THE DUEBER

ROLLED GOLD PLATE WATCH CASES.



381874

WITH

SOLID GOLD CENTERS,
SOLID GOLD PENDANT,
Solid Gold Bow,
Solid Gold Joints,
Solid Gold Thumb Piece,
Solid Gold Plugs,
Solid Gold Bearings,
And Gold Crown.



381876

Warranted by Special Certificate to wear for twenty years, and to contain from three to five dollars more gold, to be better finished, better engraved, and in every particular superior to all other plated cases sold under the name of “Filled,” “Perfected Gold,” “Patent Gold,” or “Stiffened Gold,” now in use. The most perfect case of its kind ever manufactured. We lead in this as well as in everything else we undertake or manufacture.

The Dueber Watch Case Mfg. Co.

•CHICAGO,•

4 Tribune Building.

•CINCINNATI,•

P. O. Box 1334.

•NEW YORK,•

20 Bryant Building.

THE BEST

THE DUEBER

COIN SILVER WATCH CASES

WITH

Solid Soldered Edges and Joint Bearings Throughout.

For Twenty Years, as to-day, the Leading Watch Case in the American Market.

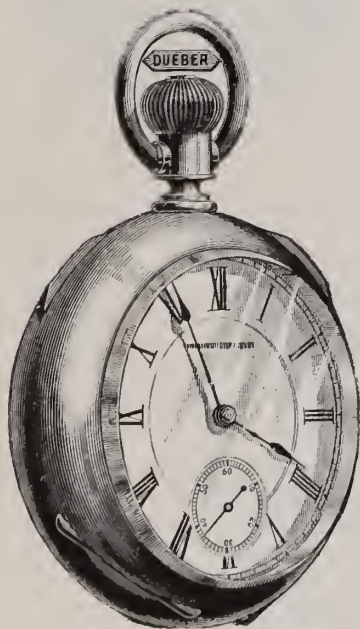

381842—Full Bass'ne Style.



Pat. July 6th, 1880. No. 229,681.



381888—Bourbon Style, with Gold Crown.

Their Equal in Construction, Finish or Intrinsic Value has never been Produced.

THE DUEBER WATCH CASE MFG. CO.

4 Tribune Building, Chicago.

Box 1334, Cincinnati, Ohio.

20 Bryant Building, New York.

THE CHEAPEST

THE NEWPORT

COIN SILVER WATCH CASE.

We have placed upon the market a Two-ounce Case with Albata Cap stamped



Fig. A.



A Watch Case with folded over edges all made except putting on the Pendant and Joints.



This Case is made in the extensively advertised seamless method as shown in Figure B. Each piece is cut from solid metal and struck into the shape here shown, and not one grain of solder is used to put a case into the condition as shown in Figure A.

Fig. B.

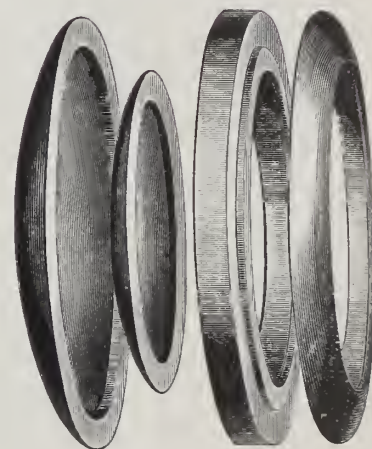

Four parts necessary to make the body of a Watch Case with a folded over edge.

This process of Case Making has been in use for years by makers of "cheap silver," and "improved" silver cases. Swiss silver anchors and low karat gold cases have always been made in this manner, but no watch case with this style of folded over edge has ever gained any reputation with practical watchmakers, and it only requires time and use to show its worthlessness, this fact having been demonstrated in the wear of a former, very extensively used, line of cases made in this same method. A watch case can be made more quickly and at less expense by this method than by any other, and we have adopted it in the construction of our Two-ounce Newport throughout, cheapness being the only object sought for in this instance, no regard being given to wearing qualities. We do not, therefore, guarantee anything about this case except the quality of silver used.

The Dueber Watch Case Mfg. Co.

Chicago, 4 Tribune Bldg.

Cincinnati, P. O. Box 1334.

New York, 20 Bryant Bldg.

"THE BEST," THE DUEBER WATCH CASE.

Office of H. M. HECKART, Watches, Jewelry and Diamonds,
Springfield, Mo., June 11th, 1883.

Gents:—I have received a few of your new Filled Gold Cases and think they surpass any filled case in the market, as they show the gold that is in them. Please send advertising matter.

(Copy.) H. M. HECKART.

Office of W. T. IRVINE, Watchmaker and Jeweler,
Cresco, Iowa, June 13th, 1883.

DUEBER WATCH CASE M'FG CO., Newport, Ky.

Gents:—Your circular in regard to your New Filled Case came duly to hand, and all your circulars are appreciated. Your plan of building a filled case with solid gold centers is the correct way to secure a perfect fit and will be appreciated with Jewelers wishing to sell a good article on their true merits. Wishing you great success in your new departure, I remain as always, a friend to the Dueber Case.

Very truly, W. T. IRVINE.

(Copy.)

Ludington, Mich., June 25th, 1883.

DUEBER WATCH CASE CO., Cincinnati, O.

Gentlemen:—Please to forward price list of filled cases. I am quite tired of selling the Boss Filled Case, as they do not give satisfaction. I returned one with four years use worn through in many places, and the answer from the Company, which I have, was, "that was one of some cases finished up by some inexperienced workman," and they sent new case. Yesterday two more of these cases came in the store with places worn through and the customers were out of all patience; they have been in use only about 2½ years, and worn so badly that they show through. Now, if your cases are no better, I would rather never sell a Filled Case. Please let me hear from you and oblige,

W. G. BUDD, Jeweler.

(Copy.)

Fremont, Nebraska, June 1st, 1883.

DUEBER WATCH CASE MFG. CO., Cincinnati, O.

Gents:—We have been waiting for a long time for your filled case, and to-day our eyes were delighted with the sight of a few of them. This last product of your factory is no less a success than the gold and silver ones we have constantly sold, and which, we believe, have no equal.

PRATT & WHEELER.

(Copy.)

Sandusky, O., June 27th, 1883.

DUEBER WATCH CASE CO., Newport, Ky.

Allow me to congratulate you on the new rolled gold plate case. It is a handsome piece of work and very hard to tell from solid goods; in point of finish it is as good as anybody's gold case. You cannot help having a good sale on them.

(Copy.) Yours truly, GEORGE ZEWIN.

Maynette, Mich., June 15th, 1883.

DUEBER WATCH CASE MFG. CO.

Gents:—You are right, The Dueber Plated Case "takes the whole bakery." They are, without exception, the finest finished cases I ever saw of the kind, and should suppose they would kill the sale of all other "filled" cases. Have always said "The Dueber" would be the Boss.

Respectfully, GEO. N. CONKLIN.

(Copy.)

Office of S. W. MORGAN, Diamonds, Jewelry and Watches,
Winona, Minn., June 23d, 1883.

DUEBER WATCH CASE CO.

Dear Sirs:—I have just received two of your filled rolled gold cases. I think they are very nice.

(Copy.) Yours, S. W. MORGAN.

Office of HENRY PEETZ,
Rock Island, Ills., May 3d, 1883.

DUEBER WATCH CASE CO.

Gents:—Perused with satisfaction your late circular regarding those "improved gold filled cases," as also those cheap "patent" silver cases. Keep only Dueber Cases, both silver and gold, in stock.

(Copy.) Respectfully, HENRY PEETZ.

P. H. SPERRY, Practical Jeweler,
Neenah, Wis., June 20th, 1883.

DUEBER WATCH CASE CO., Cincinnati, O.

Gents:—Have handled your cases of silver and gold manufacture ever since they were in market, and, of course, "swear by them." Please send new price list of Rolled Gold Plate Case. I have on hand eighty-three of your cases at present, therefore you can see I handle them.

(Copy.) Yours respectfully, P. H. SPERRY.

Niagara Falls, April 2d, 1883.

DUEBER WATCH CASE CO.

Gents:—I congratulate you upon your success in really exposing an up and down fraud upon the watchmakers or dealers in such goods, regarding the Boss, or the Ladd, or any other plated case. In my establishment there is no other, nor has there been any other, than The Dueber Case sold for the last 12 years. When you kept in 14 John street, and I had hard work to battle against the watchmakers selling ——— cases, but I done it, and now, by your expose, it will make it easier for me. I give my customers the best case for same price as others give inferior, and still have paid 100 cents on every dollar I ever bought. *The Dueber Case suits me.*

(Copy.) Very truly, HENRY ELBE.

This Case is made with Solid Gold Centers and Pendant, contains from three to five dollars more gold than any other so-called filled or perfected gold case made; is sold for two dollars less price, and warranted by us per special certificate in each case to wear for twenty years.

—*The Dueber Watch Case Manufacturing Company*—

NEW YORK.

CINCINNATI.

CHICAGO

MANUFACTURERS OF THE CELEBRATED DUEBER GOLD AND SILVER WATCH CASES.

AIKIN, LAMBERT & CO.

23 MAIDEN LANE, NEW YORK,

MANUFACTURERS, IMPORTERS, JOBBERS.

➤: JEWELRY. :➤

A Large Assortment of all Leading Styles in GOLD, SILVER and ROLL PLATE, including

<i>Diamonds,</i>	<i>Buttons,</i>
<i>Bracelets,</i>	<i>Studs,</i>
<i>Rings,</i>	<i>Lace Pins,</i>
<i>Chains,</i>	<i>Drops and Sets,</i>
<i>Charms,</i>	<i>Scarf Pins,</i>
<i>Locketts,</i>	<i>Emblems,</i>
	<i>Thimbles, Etc.</i>

➤: WATCHES. :➤

PAUL BRETON

Fine Movements, In Gold Cases.

AGASSIZ AND LONGINES

Stem Winding Movements, Fitting American Cases.

CHRONOGRAPHS, in Silver and Gold Cases.

Reliable Swiss Silver and Nickel Stem Winders.

ALL LEADING AMERICAN MOVEMENTS AND CASES.

GOLD PENS,

HOLDERS, PENCILS, TOOTH PICKS.

“NOVELTIES” IN PENCIL CHARMS.

Show Case and Fancy Tray Assortments, in New and Tasty Designs for Jewelers, A SPECIALTY.

Catalogues and Price Lists sent to Dealers when request is accompanied by Business Card.



Branches: { 113 EAST MADISON STREET, CHICAGO, ILLS.
41 WEST FOURTH STREET, CINCINNATI, O.

Factories: { 14, 16 & 18 MAIDEN LANE, N. Y.
12 VESEY AND 6 BARCLAY ST., N. Y.

➤: Novelties Continually Being Introduced. :➤

SELECTION PACKAGES SENT.

PROMPT ATTENTION TO ORDERS AND REPAIRS.

{ JAMES C. AIKIN.
H. A. LAMBERT. }

{ J. B. SHEA.
D. F. FOLEY. }

SILVER



WATCH CASES.

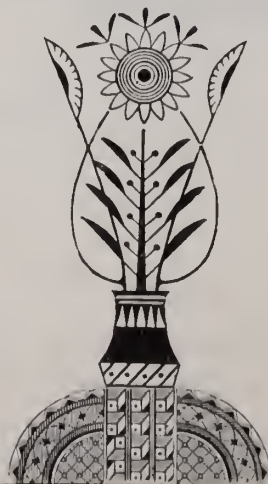

THE
 BROOKLYN WATCH CASE CO.
 EAGLE CASE.



In order to meet an imperative and growing demand in the Trade for a reliable grade of Low Karat Cases, this Company, seven years ago, was induced to place upon the market their since Celebrated **EAGLE CASES**, which are made of full 8-k. gold in all their parts, joints and bearings, the backs and caps free from solder, saving that which holds the joints. Since their introduction, these cases have achieved a wide spread reputation for the reliable and standard quality maintained in their manufacture. It has been demonstrated that the wearing qualities of the **EAGLE CASES** are unexcelled by any 12-k. case in the market, while their color is permanent and the appearance equal to that of the best cases made of this grade. The 8-k. **EAGLE CASES** will stand the severest acid test and will not tarnish when exposed in the show case or worn in the pocket.

All these goods are Stamped in the Cap with the Trade Mark of the Company,

B. W. C. Co.

and are guaranteed to be of the uniform standard designated.

A LARGE AND WELL ASSORTED STOCK OF 18-K., 14-K. AND EAGLE CASES IN THE LATEST AND MOST ARTISTIC DESIGNS, KEPT CONSTANTLY ON HAND.

For Sale by all the Principal Jobbers.

DAVID F. CONOVER & CO.

(SUCCESSORS TO WM. B. WARNE & Co.)

Manufacturers and Wholesale Dealers in

WATCHES and JEWELRY.

Wholesale Agents For

Rogers & Brother's Flat and Hollow Ware



Celluloid Eye-Glasses.

And Sole Agents for the

Patent Railroad Train Watch Chains, Nickel.

WHOLESALE AGENTS FOR

T. A. WILLSON & CO.'S Optical Goods.

Would invite attention to the following new grades of Steel Spectacles lately introduced in the market.

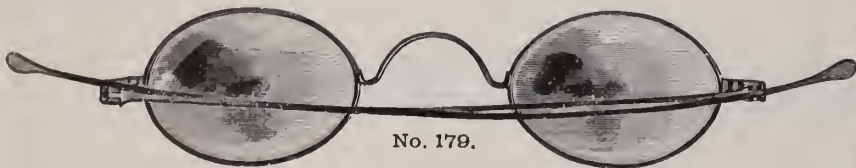

No. 179.

They are Steel, Full Tempered. Parts Interchangeable. Joints so constructed that wear is compensated for. Temple will not work loose and fall down as in old style joints. Nose-piece on No. 155 reinforced where it joins eye, giving extra strength with neatness.

PRIZE MEDALS AT ALL EXHIBITIONS WHERE EXHIBITED.

Patented July 31, 1877.

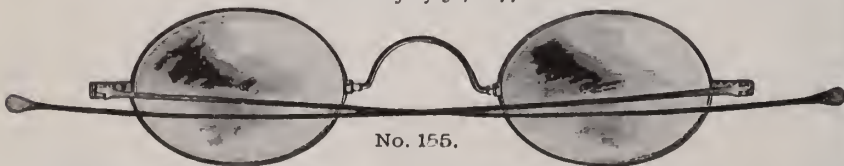

No. 155.

A SPECTACLE TEMPLE

THAT WILL

NOT WEAR LOOSE.

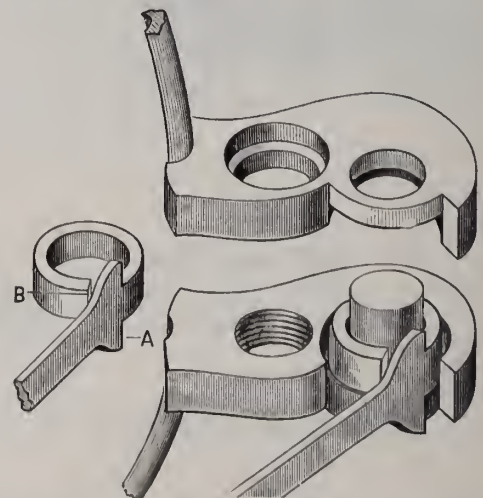

Patented May 13th, 1879. Re-issued June 8th, 1880.

- A.—Stop for Temple, preventing Strain on Joint.
- B.—Compensating eye, for taking up wear of joint. The eye of Temple is smaller than Stubb Steel Joint Pin on which it works, and is left open at B, exerting a Spring Tension on Pin.

American Watch Wholesale Salesroom:

Southeast Cor. Chestnut and Seventh Sts., First Floor,

PHILADELPHIA.

DAVID F. CONOVER,
C. FRANK WILLIAMS
B. EDGAR RIGHTER.



CRESCENT FILLED CASES.



The special attention of the Trade is called to our new line of 18 Size Stem Winding Gold Filled Cases made under Coe's Patent.

INTERCHANGEABLE,

to fit all 18 Size Stem Winding American Movements.

All Gold Filled Cases made by this company have Solid Gold Housings, Joints, Plugs and Thumb Catches, are unequalled in Shape and Color, and are guaranteed by special certificate to wear 20 years.

Order of your Jobber the
"CRESCENT" CASE,
 And save carrying two lines of cases.

CHICAGO WATCH CASE CO.,

Cor. Michigan Ave. and Madison St.,

CHICAGO, ILLS.



ADOLPH GOLDSMITH,

SOLE AGENT FOR THE

RELIANCE WATCH COMPANY,

38 MAIDEN LANE,

NEW YORK.

FULL LINE OF

Gold and Plated Jewelry.

EVERY DESCRIPTION OF

SWISS WATCHES

A SPECIALTY.



"RELIANCE,"
18 Size, to Fit Waltham Cases.



"RELIANCE,"
Nickel Stem Winder in all Sizes.



"RELIANCE,"
Ladies' 8 Size, to Fit Waltham Cases.

TXB
TRADE MARK

OUR RINGS ARE ALL STAMPED

T14K B
TRADE MARK

WITH OUR TRADE MARKS

NO. 195 NO. 174 IN NO. 304 PAT. AP. ID 1883 NO. 2231 PAT. AP. ID 1883 NO. 315 PAT APPLIED FOR NO. 299 NO. 300 NO. 297 NO. 298

TRITTEL BROTHERS
SOLID GOLD
RING-MAKERS

MAKERS OF HANDSOMEST, MOST ORIGINAL, & COMPLETE, LINE OF INITIAL, & OTHER RINGS, IN STANDARD QUALITIES OF GOLD
 OUR INITIALS ON ONYX, ARE RIVETED, ON THE STONE, NOT SOFT SOLDERED, THROUGH BOX OF RING
 OUR RAISED LETTERS, [WITHOUT DIAMONDS] SHOW VARIOUS COLORS, OF GOLD - RED, GREEN, & WHITE
 NOS. 297 298 315 RINGS ARE ALL GOLD . . NO ONYX. INITIALS WITH OR WITH OUT DIAMONDS

299 195 ONYX ENCRUSTED WITH DIAMONDS 226 DI. 223 DI.
 RAISED LETTER ON ONYX SET WITH DIAMONDS 223 I. 174 IN. 300
 RAISED LETTER ON ONYX WITHOUT DIAMONDS 304 RAISED LETTER
 ON ONYX SET WITH DIAMONDS IN CUVE-TTE SHAPED STONE.

OUR GOODS ARE TO BE HAD OF ALL JOBBERS

TRITTEL BROS.
NO. 40 MAIDEN LANE NEW YORK



A few Samples of raised gold ornamented Watch Cases, from original designs introduced by Keller & Untermeyer, Manufacturers, 9 Maiden Lane, N. Y.



SIMPSON, HALL, MILLER & CO.,

WALLINGFORD, CONN.

MANUFACTURERS OF

ARTISTIC & USEFUL HOLLOW WARE,

→: **ELECTRO PLATED UPON FINE HARD WHITE METAL.** ←:



Spoons, Forks, etc., plated upon the Finest Nickel Silver in **Extra Double, Triple, and Sectional Plates.** Full lines of over **Forty Staple and Fancy Pieces** in each Pattern in Geneva, St. James, Countess, Windsor, Oval Thread, etc. Made under the supervision, and quality guaranteed and controlled by Wm. Rogers, formerly of Hartford and Meriden. (Wm. Rogers, Sr., died 1873).

WM. ROGERS, Wallingford, Conn.

No connection with any concern in Waterbury, Meriden or Hartford using name of Rogers in any form.

Store and Stock of Goods for Delivery in N. Y. and Vicinity,

No. 36 East Fourteenth Street, Union Square.

Philadelphia, 506 Commerce St.—San Francisco, Cal., 530 Market St.

Montreal, Canada.—Baltimore, 6 German St.

JOBBER IN CINCINNATI, CHICAGO, ST. LOUIS, Etc.

STERN BROS. & CO.,

No. 30 Maiden Lane, New York,

Importers of **Diamonds,**

MANUFACTURERS OF FINE JEWELRY.

Jobbers in American Movements of all grades, Gold & Silver Cases, Gold & Plated Chains.

THE FOLLOWING ARE OUR **SPECIALTIES:**

SEAL and STONE RINGS. GENT'S LOCKETS. The most complete and largest line of GOLD INITIAL RINGS and LOCKETS made in the United States. The celebrated DOUBLE CROWN Plain Filled Rings, which are universally acknowledged the MOST RELIABLE in the market. Made in seven different widths.



No. 00



No. 0



No. 1



No. 2



No. 3



No. 3½



No. 4

EVERY RING IS WARRANTED TO GIVE SATISFACTION.

Goods sent on selection to Dealers upon application with satisfactory reference.

J. T. SCOTT.

S. C. SCOTT.

J. T. SCOTT, JR.

ESTABLISHED 1847.

J. T. SCOTT & CO., 7 MAIDEN LANE, N. Y.

Importers of Watches and Wholesale Dealers in all grades of American Movements and Cases, Jewelry, Chains, Diamonds, &c.

ALSO IMPORTERS OF THE CELEBRATED TRIUMPH-ROSKOPF WATCH.



WITH INTERCHANGEABLE
AND ADJUSTABLE
ESCAPEMENT.

Cased in Superior Nickel, Open
Face, Stem Wind and Set.



ALSO THE OLD RELIABLE
ROSKOPF WATCH,



OUR TRIUMPH-ROSKOPF AND ROSKOPF WATCHES

FOR SALE BY ALL THE LEADING JOBBERS.

All Orders Committed to our Care will receive
Prompt and Careful Attention.

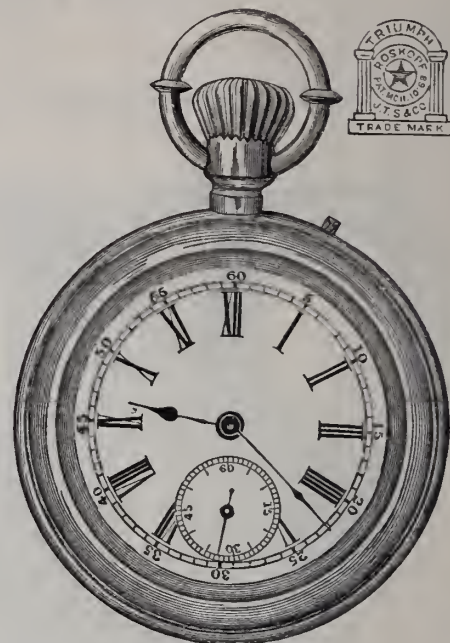

We have additional Facilities for doing our Jobbing; being done on the premises will receive our Personal Supervision. ESTIMATES GIVEN ON SPECIAL WORK.

"The Waterbury." The New "Series B,"

With FULL DIAL and SOLID PLATES.

In this new SOLID PLATE movement the position of the regulator has been changed; it will be found projecting beyond the plate, immediately under the bezel. The FULL DIAL enables the position of the hands to be readily seen.

The danger of injuring the Hair Spring in regulating is obviated in this new movement.

SERIES A.—Open Dial, Skeleton Plates, - - \$48.00 per doz.
SERIES B.—Full Dial, Solid Plates, - - - 48 00 "

Discount to the Trade.

We can supply either Pattern as ordered.

WATERBURY WATCH CO.,

WATERBURY, CONN.

NEW YORK OFFICE, 52 MAIDEN LANE.

GEO. MERRITT, GENERAL SELLING AGENT,

To whom all Orders and Correspondence as to Prices and Terms should be addressed.

FOR SALE BY DEALERS GENERALLY.



NEW SERIES B.
Solid Plates and Full Dial.

NEW SERIES B.
Bezel Off,
Showing Index Plate and Regulator.





Manufactory, 47, 49 & 51 Franklin Street, Newark, N. J.

MILLER BROS.,

No. 7 Maiden Lane,

NEW YORK.

IMPORTERS OF DIAMONDS

— AND —

MANUFACTURERS OF FINE JEWELRY.



We would call the attention of the Trade to our Newly Patented TURN OVER CAP SLEEVE BUTTON. The mechanical device by which the cap is turned is by a spring working in the pillar, which makes a much stronger and more durable cap than any other in the market.



INITIAL GOODS A SPECIALTY.

CROSS & BEQUELIN,

21 MAIDEN LANE, N. Y.

P. O. BOX No. 531.

MANUFACTURERS OF THE CENTENNIAL

CHRONOGRAPH

THE BEST AND CHEAPEST HORSE TIMER

AND THE

Most Accurate Time Keeper in the World for the Money.

IN GOLD AND SILVER CASES.

CHEAP AND RELIABLE.

See Cut.



WHOLESALE DEALERS IN ALL GRADES OF

AMERICAN AND SWISS WATCHES, JEWELRY, MATERIALS, ETC.

SOLE AGENTS IN NEW YORK FOR THE SALE OF THE ENGLE ENGRAVING MACHINE.

WM. SMITH & CO.,

MANUFACTURERS OF

GOLD and SILVER Chains & Jewelry,

Also a Large Line of SILVER RINGS.

OFFICE :

No. 25 Maiden Lane, New York.

MANUFACTORY—No 61 PECK STREET, PROVIDENCE, R. I.

W. & S. BLACKINTON,

MANUFACTURERS OF

ONLY

FINE ROLLED PLATE CHAINS,

Necklaces, Polished and Roman, of Latest Gold Designs. Also a Complete Line of Gents' and Ladies' Locketts and Pendants.

In consequence of the first-class reputation our goods have obtained, unscrupulous dealers have been selling goods of an inferior quality, represented as our manufacture. In order to protect ourselves, as well as dealers, all goods of our manufacture will hereafter bear this

TRADE MARK. **W&S.B** ★ TRADE MARK.

These Goods are for sale by all Wholesale Dealers.

WM. J. SUTTIE,

MANUFACTURER AND JOBBER OF

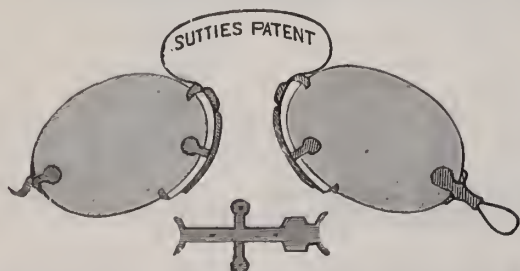

Eye-Glasses and Spectacles,

In GOLD, SILVER, STEEL and SHELL,

No. 39 Maiden Lane, New York.

CYLINDRICAL AND PRISMATIC GLASSES.

REPAIRING A SPECIALTY,

Webster's Silver Solution,

PREPARED BY

E. G. WEBSTER & BROTHER,

(Established 1859.)

Manufacturers of Quadruple

Electro Silver Plated Ware

14 MAIDEN LANE, N. Y.,

Expressly for Cleaning Silver and Silver Plated Ware.

Jewelers will find this a valuable adjunct for cleaning their stock, and a reliable article to recommend to their customers.

Guaranteed entirely free from Cyanide, Acid, Grit, or anything detrimental to the Finest Wares.

Packed in Boxes containing 2 Doz. Bottles.

Price, \$1.25 per Doz., NET.



CHESTER MANCHESTER & CO.,

MANUFACTURERS OF

Gold and Silver Chains,

No. 13 HANOVER STREET,

PROVIDENCE, R. I.

Waltham, Elgin, Illinois, Hampden, E. Howard & Co. and Special Movements.

**392 WASHINGTON ST.,
BOSTON.**

P. O. Box 5259.

Watches, Jewelry,
Gold Chains, Gold,
Filled and Silver Cases,
Spectacles, Eye - Glasses,
Gold Head Canes, and Rogers &
Bro.'s Flat Ware.

Price List of Movements and Cases

Sent on Receipt of Business Card.

D. C. PERCIVAL & CO.,
WHOLESALE
DEALERS.

LOUIS A. SCHERR & CO.

Importers and Wholesale Dealers in

Watches, Jewelry,

WATCH MATERIALS, TOOLS, GLASSES, &c.

Spectacles, Silk Guards, &c.

Wholesale Agents for American Watches.

**No. 726 CHESTNUT STREET
PHILADELPHIA.**

AGENTS FOR THE WHITCOMB LATHE
AGENTS FOR W. F. NYE'S WATCH AND CLOCK OILS.

TO THE TRADE.

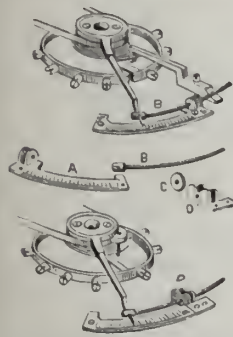

Your attention is called to the Improved Awalt Patent Watch Regulator, Style B. It is made of Nickel, Index and all combined, with Nut C and Screw B made of Fine Steel, to fit all full plate watches, by removing the Index and using the same screw holes and screws on the watch.



Style D Regulators have been improved in shape and finish, and fit both full plate and bridge watches, are made in Gilt and Nickel, with Nut C and Screw B of Fine Steel. Try them, and it will surprise you to find how much they will aid in making a watch realize you a nice profit.

JOHN A. AWALT, Manufacturer,

ALSO JOBBER IN

WATCHES, CLOCKS, JEWELRY, Etc.,

177 Vine Street, CINCINNATI, OHIO.

Abbott's Stem Hinding Devices

Are for sale and are applied to watches by all reputable jobbers, and by the manufacturer,

HENRY ABBOTT,

7 MAIDEN LANE, NEW YORK.

FACTORY, JOHN STREET.

ALSO MANUFACTURER OF

Fine Enamel Watch Dials.

YALE CLOCK CO.

NEW HAVEN, CONN., U. S. A.

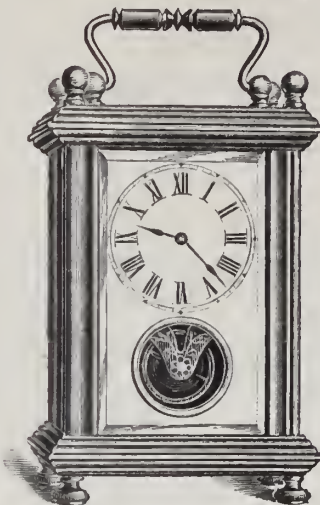

NOVELTIES
IN
CLOCKS.

A. I. HALL & SON,

General Agents,

528 & 530 Market St.
San Francisco, Cal.

52 Maiden Lane,
New York.

JOHN W. STEELE,

MANUFACTURER OF

FINE GOLD JEWELRY,

—AND—

BRAINERD'S

PATENT

LOCKETS

Patented June 17, 1874.



No. 9 Maiden Lane, NEW YORK.

Agents for the Lancaster, Pa., Watches.

A. FRIEDENTHAL & CO.

MANUFACTURING JEWELERS,

AND IMPORTERS OF WATCHES.

43 Maiden Lane, New York.

MATERIALS and OPTICAL GOODS.

COLBY & JOHNSON,

Manufacturers and Jobbers,

17 MAIDEN LANE, NEW YORK.

WATCH CASES,
FINE JEWELRY,
AMERICAN WATCHES.

SOLE MANUFACTURERS OF

CELLULOID WATCH CASES,

MOUNTED IN

GOLD, SILVER OR NICKEL.

DAY & CLARK,

10 MAIDEN LANE, NEW YORK.

Fine Roman Goods

In Vermicella and Hammered Ornamentation.

BANGLES, DIAMOND BALL COVERS,
LACE PINS AND EAR DROPS.
Bead Necklaces, Ear Hoops, Scarf Pins.

SEND FOR SELECTION PACKAGE.

FACTORY, NEWARK, N. J.

ESTABLISHED 1833.

WELCH & MILLER,

JEWELRY Case Manufacturers,

Of Morocco, Velvet, Russia, Brocade and Plush.

SHOW CASE TRAYS OF ALL DESCRIPTIONS.

LOCK RING TRAYS FOR DIAMOND RINGS.

Agents for Jewelers' Cotton and Twine.

All Goods of our Own Manufacture, and a Large Stock
Always on Hand.

169 BROADWAY, NEW YORK.

SUSSFELD, LORSCH & NORDLINGER,

IMPORTERS OF

Optical & Mathematical Instruments,

Watchmakers' Tools, Materials, Etc.

SPECIALTIES:

BARDOU & SONS' Universal Opera Glasses. U. S. Army and Navy Glasses.
Rifle Range Telescopes, Etc., Etc.

LA REINE Opera and Marine Glasses.

CROWN Spectacles and Eye-Glasses.

PARADIS MAINSPRINGS.

PARAGON TOOLS.

13 MAIDEN LANE, NEW YORK.

16 Rue D'Enghien, PARIS.

FRANK O. LODWICK.

CHAS. A. NOLTING.

LODWICK & NOLTING, WHOLESALE JEWELERS,



JOBBERS OF
Gold, Silver & Nickel
WATCHES,
Gold and Roll Plate
JEWELRY
MOVEMENTS
AND
Watch Cases,
SP. CT CLES,
Clocks and Silverware.
Positively will all Orders, In-
quiries and Repairs receive im-
mediate and reliable attention.
CINCINNATI.

ESTABLISHED 1830.

JOHN T. MAURAN,

MANUFACTURER OF

FINE ROLLED PLATE GOODS

15 MAIDEN LANE, NEW YORK.

SPECIALTIES FOR THE FALL.

FULL LINE OF

STONE LACE PINS IN RUBY AND SAPPHIRE DOUBLET.
GARNETS AND FOILED WHITE STONES,

Jet Lace Pins, Sets and Ear Knobs, Solid Gold White Stone Knobs.

ALSO

Full Line of Coral and Wire Sets, Lace Pins, Knobs, &c.

These Goods, which are so well and favorably known to the Trade, bear this

TRADE MARK

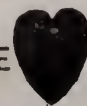

as well as the same being stamped on the cards.

PEARCE & HOAGLAND,

MANUFACTURERS OF

Gold Pens, Pencils, Pen Holders, Tooth Picks,

OF EVERY DESCRIPTION.



CLOSED

SOLE MANUFACTURERS OF THE

QUILL RESERVE TOOTH PICK,

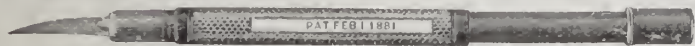

OPEN



CLOSED

The Holder of this Case is made in various styles in Gold Plate, Celluloid, Ivory, etc., while the Pick is of ordinary Goose Quill, and can be easily replaced by a new one, at any time, from the Reserve in the end of the Holder, and is the only Pick that will not injure the Teeth.

FOR SALE BY ALL JOBBERS.

Office and Factory, 29 Point Street, Providence, R. I.

R. WALLACE & SONS M'FG Co.,

MANUFACTURERS OF



SILVERWARE,

GUARANTEED $\frac{925}{1000}$ FINE.

WALLINGFORD, CONN.

JAMES W. TODD,

SUCCESSOR TO GEO. W. PLATT,

→ Wholesale Dealer in ←

WATCHES & JEWELRY,

GOLD AND SILVER SPECTACLES

And Eye-Glasses,

No. 6 LIBERTY PLACE,

NEW YORK.

LEROY C. FAIRCHILD & CO.,

14 MAIDEN LANE,

LEROY C. FAIRCHILD. NEW YORK. G. HARRY ALLEN.

In introducing ourselves to your notice as makers of Fine GOLD PENS, PEN and PENCIL CASES, ETC., we beg to solicit a share of your patronage, feeling confident of our ability to furnish desirable styles of the best quality and workmanship at the lowest market prices.

WOOD & HUGHES,

STERLING

SILVERWARE MANUFACTURERS,

New York Agents for the Derby Silver Co.'s

Fine Quadruple Plated Ware,

No. 16 John Street, N. Y.

206 Kearney Street, San Francisco, Cal.

HASKELL & MUEGGE, Agents.

J. B. & S. M. KNOWLES,

MANUFACTURERS OF

Sterling Silver Ware,

No. 20 MAIDEN LANE,

NEW YORK.

FACTORY, PROVIDENCE, R. I.

Salad Spoon and Fork.

THE
"FONTAINEBLEAU,"

(Design Copyrighted.)

Gorham M'fg Company,

SILVERSMITHS,

37 UNION SQUARE, NEW YORK.

MANUFACTORY, PROVIDENCE, R. I.

CHICAGO, - - 170 STATE STREET.

SAN FRANCISCO, 120 SUTTER STREET.

IN SUCH patterns as the "Fontainebleau" the effect of oxidizing is to wonderfully enhance its beauty, by bringing out the delicate lights and shades, and rendering more readily discernible the picture which the artist has sought to produce in silver.

In addition to the regular dozen work and the numerous small case combinations in this pattern, Bridal and other presentation sets, comprising 43, 44, 57 and 72 pieces, and also 84, 100, 101 and 129 pieces, including Cutlery, consisting of Table Knives, Breakfast Knives, Desert Knives, and Carving and Game Carving Sets, all with Fontainebleau handles, are encased in substantial and elegant chests.

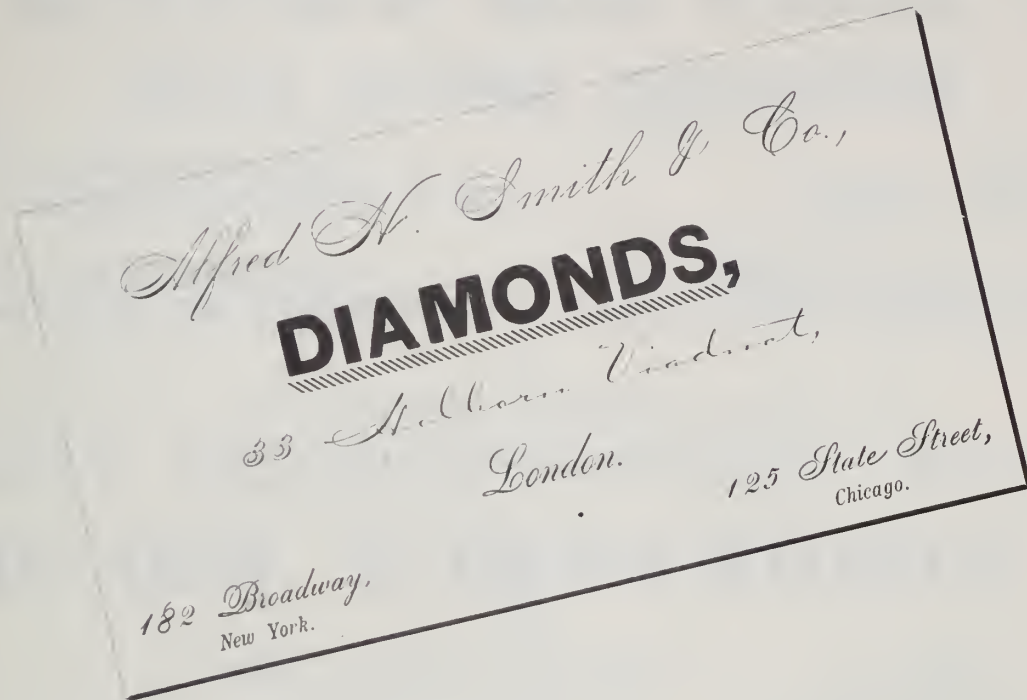

—❖ To Dealers Visiting Europe, ❖—

We take pleasure in directing the attention of the Trade to our London Office as above, where we hope to see those who may visit Europe this season.

Any letters addressed to our care (33 St. Albans Viaduct, London,) will be retained or forwarded promptly to Continental points, in accordance with instructions left with us.

Alfred W. Smith & Co.

182 Broadway, N. Y.

May 15th, 1883.

THE
NEW HAVEN CLOCK CO.

MANUFACTURERS, IMPORTERS, DEALERS,

FACTORIES.
NEW HAVEN, CONN.

GENERAL OFFICE AND SALESROOMS.
16 & 18 PARK PLACE, New York.

WESTERN OFFICE AND SALESROOMS.
31 WASHINGTON ST., Chicago, Ill.

EUROPEAN OFFICE AND SALESROOMS.
VICTORIA ST., Liverpool, England.

~~~~~  
WE CALL ESPECIAL ATTENTION TO

**HARDER'S TORSION-PENDULUM CLOCKS,**  
**RUN ACCURATELY 400 DAYS.**

Patented in America & Europe.

Sole Agents for the United States,

**THE NEW HAVEN CLOCK CO.**

**16 & 18 Park Place,**

NEW YORK.

~~~~~  
THESE CUTS ARE ONE-HALF SIZE.

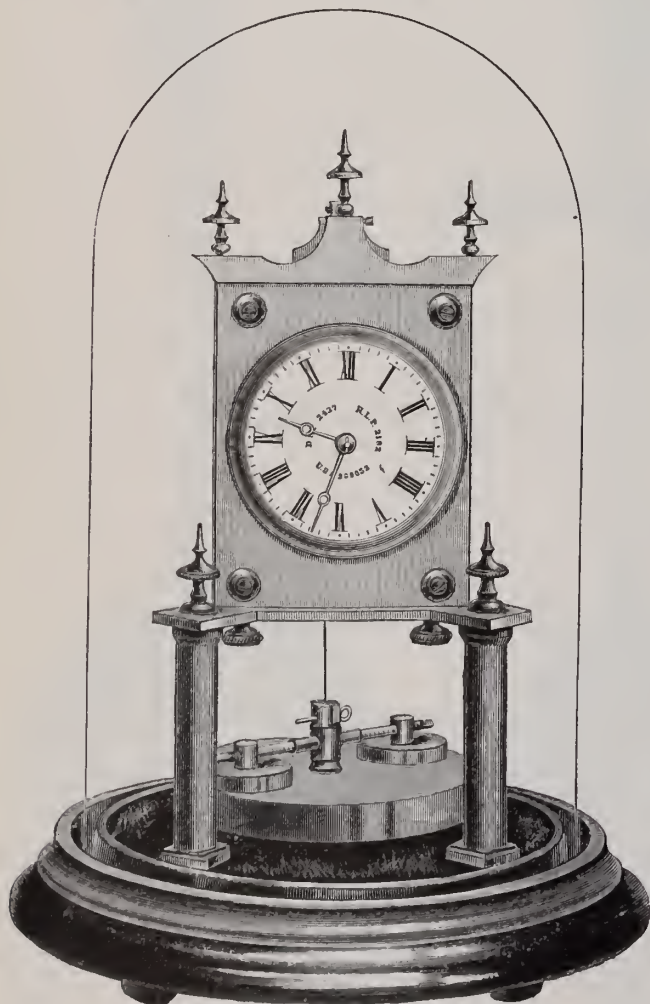

However astonishing the improvements recorded in the history of clock making since the days of Huygens, *i. e.*, 250 years ago, no one until now ever succeeded in producing clocks of plain construction and general usefulness that would run longer than a week, or a fortnight at the utmost. This Clock has astounded everybody wherever it has been introduced, for it is of very simple construction, and runs with great accuracy throughout the whole 400 days, and it has an enormous sale in other countries. There have been former inventions of clock movements to run as long a time, but never on any such principle, or with any success, as they were never found to be at all accurate, and could only be bought at a very high price. Harder's patent does away with both of these objections, and we guarantee it to perform all that we claim for it.

The Clock, with rotary torsion-pendulum, owes its origin to the ingenious idea of replacing the swinging pendulum by a time measure of equal exactitude, *viz.*, the rotary disc, which, in its rotation, meets with hardly any impediment from atmospheric resistance. The Clock makes a very handsome showing in itself, and is a very great novelty; for this reason every jeweler should have at least one. It attracts an unusual amount of attention in show rooms and windows. The price is such as will enable the jeweler to sell it with heavy profit to himself. Each Clock is securely packed by itself in a strong wooden box, with full directions for setting up. See articles among editorials on this Clock.

Prices to the Trade and any additional information given upon application.



CARTER, SLOAN & CO.,
MANUFACTURERS OF ALL KINDS OF

GOLD JEWELRY,

No. 15 MAIDEN LANE,
NEW YORK.

A. CARTER, JR.
A. K. SLOAN,

C. E. HASTINGS,
G. R. HOWE.

BALDWIN, SEXTON & PETERSON,

IMPORTERS OF

DIAMONDS and all PRECIOUS STONES,

MANUFACTURERS OF

DIAMOND AND RICH JEWELRY.

Cutters and Polishers of

DIAMONDS

692 & 694 BROADWAY, NEW YORK.

120 SUTTER ST., SAN FRANCISCO, CAL.

J. G. Chatellier,

Manufacturing Jeweler,

692 & 694 Broadway,

New York.



TRADE

MARK.

STERLING.

Whiting Manufacturing Co.

SILVERSMITHS,

BROADWAY & FOURTH ST., N. Y.

ESTABLISHED 1837.

TAYLOR & BROTHER,

Old House READ, TAYLOR & CO.,

Importers of Diamonds and Pearls,

—)AND(—

MANUFACTURERS OF DIAMOND JEWELRY,

21 Holborn Viaduct, 676 Broadway,

LONDON.

NEW YORK.

ESTABLISHED 1813.

THOMAS G. BROWN & SONS,
Newark, N. J., & 5 Bond Street, New York.

MANUFACTURERS OF

ARTISTIC JEWELRY
FOR PRESENTATION,

Including Prizes for ROWING, RIFLE SHOOTING, ARCHERY and
all ATHLETIC SPORTS.

COLLEGE SOCIETY PINS AND CLASS RINGS, ALSO BADGES FOR MILITARY
AND CIVIC BODIES IN ALL METALS.

Employing able Designers, and having all work, both in Designing and Manu-
facturing, done in our own factory, we can submit, for the inspection of those
interested, entirely original designs, appropriate in style, and not to be seen else-
where.

Estimates and Designs will be sent to Reputable Dealers when desired.

REED & BARTON,

MANUFACTURERS OF

Fine

Silver

Plated

Ware

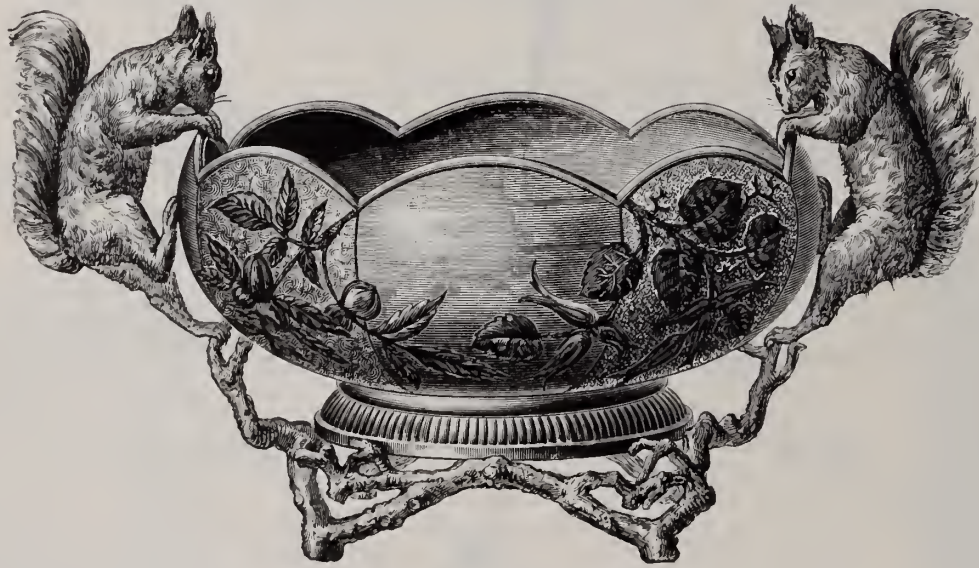

SALESROOM:

686 BROADWAY, NEW YORK.

—◆—
· FACTORIES:

TAUNTON, MASS.

ESTABLISHED 1834.

G. & S. OWEN & CO.,

—MAKERS OF—

FINE ROMAN JEWELRY, &—

—& BOX and GLASS PINS,

—AND—

Black Onyx and Pearl Goods,

OF EVERY DESCRIPTION.

All Goods sold by us are exclusively of our own manufacture and are warranted 14 K. Fine, and stamped as such when possible.

No. 3 Maiden Lane, New York.

W. H. SHEAFER & Co.,

MAKERS OF

BRACELETS,

BANGLES,

LACE PINS,

SCARF PINS, ETC.

No. 15 JOHN STREET,

NEW YORK.

RIPLEY HOWLAND M'F'G CO.,

MAKERS OF

FINE JEWELRY,

SPECIALTIES:

DIAMOND MOUNTINGS, with Platinum Tips.
ENGRAVED RINGS, STONE RINGS,

OFFICE, 17 MAIDEN LANE,
NEW YORK.

FACTORY, 383 WASHINGTON ST.,
BOSTON, MASS.



GOLD

SAXTON, SMITH & CO.,

Manufacturers of



SOLE AGENTS

FOR THE

NEW PATENTED CHAIN BAR,

Containing a Detachable Pencil.

FACTORY:
183 EDDY ST.,
PROVIDENCE, R. I.

OFFICE:
14 JOHN ST.,
NEW YORK.

CHAIN



A. J. HEDGES & CO.,

MANUFACTURING

JEWELERS,

No. 6 MAIDEN LANE,

NEW YORK.

Factory, No. 90 MECHANIC ST.,
NEWARK, N. J.

A. W. FABER'S

CELEBRATED

Gold Pens & Pencil Cases.
TOOTH PICKS AND NOVELTIES.



Manufactured by

EBERHARD FABER,

Nos. 718 and 720 Broadway,
NEW YORK.

FOWLER BROS.,

MANUFACTURERS OF

JET & ONYX JEWELRY.

Offer a large and varied stock of desirable goods of original designs, especially manufactured for the coming Fall Trade. These goods are elegant in design, beautifully finished, and must be seen to be appreciated.



PATENTED MARCH 27th 1893.

Are Carried by all the Leading Jobbing Houses
Throughout the Country.

MOORE & HORTON,

No. 11 Maiden Lane,
NEW YORK.

JEWELERS'

SPECIALTIES:

Stone Cameo, Onyx, Amethyst, Topaz
and Pearl Rings.

Studs, Collar and Sleeve Buttons.

Also our fac-simile of Fine African Diamonds,
with Foile Back, Mounted in Rings, Studs,
Pins, Ear Rings, Scarf Pins, Lace Pins, &c.

JOHN F. SAUNDERS,
Of the late firm of Buckenham, Cole & Saunders.

CHAUNCEY IVES.

SAUNDERS & IVES,

IMPORTERS OF

DIAMONDS, PEARLS,

And Other Precious Stones.

Manufacturers of Diamond Mountings.

No. 26 MAIDEN LANE, NEW YORK.

A Large Stock of FINE DIAMONDS, Mounted and
Unmounted, kept constantly on hand.

Goods sent on approval to any part of the country on receipt of
satisfactory reference. All our goods ARE IN-
SURED by us while in transit.

DORRANCE, EDGE & CO.,

Makers of the Celebrated

Woven Fabric Gold Chain,

And Patentees of the

Embossed Inlaid Jewelry.

The Latest and Most Effective Styles of Decoration
Introduced.

15 JOHN ST., NEW YORK.
FACTORY, 46 GREENE ST., NEWARK, N. J.

G. W. PRATT & Co.,

Manufacturers and Dealers in

Watches and Jewelry

OF EVERY DESCRIPTION.

ELGIN AND ILLINOIS MOVEMENTS
IN ALL GRADES.

Gold, Silver and Ladd Patent Cases.
No. 14 JOHN STREET, NEW YORK.

C. ROSSWOG & SON,

MANUFACTURERS OF

Rich Jewelry and Diamond Goods,

NOS. 5 & 7 MAIDEN LANE,

NEW YORK.

CURCHILL, LEWIS & CO.,
Manufacturing Jewelers,
 692 BROADWAY, NEW YORK.

—❖ S. W. HALE & CO., ❖—
 SUCCESSORS TO HALE & MULFORD,
 MANUFACTURERS OF
FINE JEWELRY

692 BROADWAY, N. Y.
 SETH W. HALE. WILLIAM A. LEE. WILLIS H. HOWES.

JULIEN GALLET & CO.,
 IMPORTERS OF
WATCHES
 OF EVERY GRADE,
 No. 1 MAIDEN LANE,
 —NEW YORK.—

JAMES F. ANGELL,
 WHOLESALE DEALER IN
SOLID GOLD
 AND
 Rolled Plated Jewelry,
 176 BROADWAY,
 NEW YORK CITY.

SMITH & KNAPP,
 WHOLESALE DEALERS IN
 AMERICAN AND SWISS WATCHES,
DIAMONDS.
 Gold & Plated Jewelry & Gold Chain,
No. 182 BROADWAY,
 COR. OF JOHN STREET, NEW YORK.

OFFICE:
 14 JOHN STREET, N. Y.

—❖—
E. STITES' SONS.
 —❖—

FACTORY:
 NEWARK, NEW JERSEY.

H. DUHME.

R. H. GALBREATH.

DUHME & CO.

MANUFACTURERS OF

GOLD AND SILVER WATCH CASES,

Workshops and Salesrooms,

Carlisle Block, Fourth & Walnut, Cincinnati.

By the introduction of the very finest machinery and the employment of the most competent workmen and artisans, DUHME & CO. are now producing Watch Cases that, in strength, beauty and cheapness, are absolutely unsurpassed.

Dealers wishing to purchase Cases that are strictly first-class and at the lowest prices should examine those manufactured by DUHME & CO.

These Cases are, in all respects, meeting the views of the most exacting.

DUHME & CO. are also Jobbers of all lines of Goods required in first-class Jewelry Stores.

HAUG & LUTHY,

MANUFACTURERS OF

FINE DIAMOND MOUNTINGS, ETC.,

130 FULTON STREET,

Cor. Nassau St., NEW YORK.

N. B.—All Diamond Mountings of our Manufacture have a Patented

SELF-CLOSING SAFETY CATCH

HILLER & BARDEL

MANUFACTURERS OF



JEWELRY,

13 John St., New York.

A Full Line of DIAMONDS, Mounted and Unmounted, Always on hand, which we will send for Selection to Responsible Houses.

All Goods Ordered on Selection or for Stock are Insured while in the Hands of the Express Companies.

CHAS. F. TERHUNE & CO.,

Manufacturing Jewelers,

Swiss & American Watches,

194 Broadway

NEW YORK.

Sets, Drops, Lace Pins, Bracelets, Neck Chains,
 Vest Chains, Locketts, Charms, Rings, Etc.

Best Onyx, Black and White for Lettering.
 Locket Rings: a Perfect Joint when Closed.
 Raised Initial in Diamonds.

Our stock of Plated Jewelry and Rolled Plate Chains represent fully the best and newest designs of all the leading manufacturers. Goods sent on selection on receipt of business card and satisfactory New York references.

COX & SEDGWICK,

26 JOHN STREET, N. Y.,

Makers of Patent Black Onyx Bracelets

Also Black Onyx Faceted Bead Bracelets,

AT THE LOWEST PRICES.

COLORED AND

Turquoise

Lace Pins, Ear Rings, Locketts, Bracelets, Sleeve

Buttons, Scarf Pins,

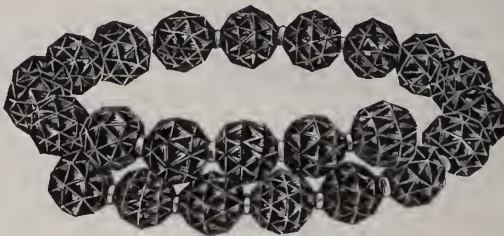

ONYX

Lace Pins, Ear Rings, Medallions, Necklaces, Chatelaines, Sleeve Buttons, Ladies & Gents Vest and Guard Chain.

Black Onyx Pins, Ear Rings and Locketts for 1, 3 and 5 Diamonds.

GOODS SENT ON APPROVAL TO RESPONSIBLE FIRMS.

JOHN M. GODDARD,

Manufacturing Jeweler,

3 MAIDEN LANE, NEW YORK.

- BRACELETS,
- BANGLES,
- SEAL RINGS,
- DIAMOND RINGS,
- STONE Locketts,
- Roman Locketts,
- Engraved Locketts,
- CHAINS, Etc.,
- Etc., Etc., in
- ALL QUALITIES

JOBGING DEPARTMENT.

Jewelry Repaired, Colored or Matched Promptly.

Designs & Estimates Furnished for Ordered Work.

MANUFACTURERS
OF
Everything in
BLACK ONYX JEWELRY
PLAIN, and {Ornamented with
 Pearls and
 Diamonds.

Our manufacturing facilities have been for the past ten years devoted exclusively to the production of fine Black Onyx Jewelry. We carry in stock the largest variety of articles made in our specialty, well made, finely finished, uniformly 14 karats, at medium and low prices.

WOGLOM & MILLER,
Office & Factory, 32 & 34 JOHN STREET,
NEW YORK.

W. C. GREENE & CO.
GOLDSMITHS.
MANUFACTURERS OF

RICH SETS IN TAPER WIRE CORAL

Factory 95 PINE ST. Providence, R. I.
Stone-Cameo Amethysts Coral-Cameo Engraved Enamel Brooches Sleeve Studs EAR DROPS &c. New York Office 192 BROADWAY.

WM. C. GREENE. B. W. GREENE. GEO. D. BRIGGS.

KETCHAM & McDOUGALL,
Bryant Building, (55 Liberty St.) New York.
MANUFACTURERS OF
COLD AND SILVER THIMBLES.



THE AUTOMATIC EYE-GLASS HOLDER,
It Reels Up Cord Itself.
A—Shows position of Glasses with cord Reel'd up.

ESTABLISHED 1859.
STURDY BROS. & CO.
MANUFACTURERS OF
Fine Rolled Plate Jewelry,
GRADUATED WIRE CORAL GOODS,
STERLING SILVER JEWELRY.

Bangles, Sleeve Buttons, Cuff Buttons, Baby Pins, Sets in Stone, Cameo, Enamel, Chased, and Polished, Drops and Knobs, Bar Pins, Children's Sets, Lockets, Studs, Charms, Etc.

Only Wholesale Dealers' Trade Solicited. **ATTLEBORO, MASS.**

Flexible Bracelets,
Diamond Mountings,
Strung Pearl Work,
Repairing,

Flexible Braided
Bracelets,
White Stone Goods,
Strung Pearl Repa'ng

Thos. W. Guilbert & Co.,

SUCCESSORS TO CARROW, DUBOSQ & Co.

908 Chestnut Street, Philadelphia, Pa.

TRADE MARK.
The ORIGINAL GOLD CROWN FILLED RINGS.

For the past thirteen years we have manufactured as a specialty, the well known "CROWN GOLD FILLED RING," with the high standing of which the trade is already perfectly familiar. In consequence of the above fact, and in justice to ourselves, we feel it a duty to make the announcement to the trade that there are now being offered in the market several other makes of filled rings, each of which has a CROWN in some way connected with its STAMP.

We Manufacture for the Jobbing Trade Only.
McCALL & NEWMAN,
625 Arch Street, Philadelphia

B. A. BALLOU & CO.,
61 Peck St., Providence, R. I.
MANUFACTURERS OF
GOLD JEWELRY.



We call special attention to our PATENT FASTENING FOR EAR RINGS, which is free from the objections raised to ordinary ear wire or screw fastenings. They present a very neat and attractive appearance, are perfectly secure, and much more convenient than ordinary ear wires which always annoy the wearer by catching the hair, veil, or lace about the neck. These Goods are for Sale by all Wholesale Dealers.

Gold Studs, Small Chains for Eye-Glasses, Bracelets, Etc.
a Specialty.

McCarty & Hurlburt,
WHOLESALE DEALERS IN
WALTHAM, ELGIN & ILLINOIS
WATCHES.
MANUFACTURERS OF
Jewelry, Gold Spectacles, Silver Thimbles, &c
131 North Second St.,
PHILADELPHIA, Pa.

CLOCKS

ESTABLISHED 18 3.



AMERICAN

AND

FRENCH CLOCKS

AND

BRONZES.

B. J. COOKE'S SONS,

137 N. 3d Street, PHILADELPHIA.

Catalogues and Price Lists furnished to the Trade only, on application.

BOOZ & CO.,

MANUFACTURERS OF

AND

FINE GOLD Watch Cases  PLAIN GOLD RINGS.

Jobbers in American Movements.

DIAMONDS.

108 South Eighth St., (2d Story) Philadelphia.

Samples of our goods sent on approval when satisfactory reference is furnished. Old Gold and Silver Bought or Exchanged.

PARTICULAR ATTENTION PAID TO REPAIRING.

BOSTON WATCH CASE COMPANY

WATCH CASE MANUFACTURERS,

Nos. 1, 3 and 5 Province Court, Boston, Mass.,

ENTRANCE COR. PROVINCE STREET.

Special Attention given to Watch Case Repairing, Springing, Re-cugine Turning, Engraving, Polishing, &c.

Particular Attention given to Orders by Express.

WE OFFER THE LARGEST VARIETY OF ORIGINAL DESIGNS IN WATCH CASES EVER PRESENTED TO THE TRADE.

SAMUEL LAWSON,

No. 18 JOHN STREET,

Manufacturer of Black Onyx Goods.

CONSISTING OF

- Breast Pins,
- Ear Rings,
- Lace Pins,
- Ear Studs,
- Bracelets,
- Scarf Pins,
- Buttons,
- Medallions,
- Studs,
- Collar Buttons,
- Vest Chains,
- Guards.



KING JAMES, }
MARQUIS, } RINGS.
GLOVE, }

Quality Guaranteed,
Prices Close.

BARNET BROS. & POWELL,

—Manufacturers,—

Newark, N. J., & 15 JOHN ST., NEW YORK.

TRIER BROS.,

IMPORTERS,

13 MAIDEN LANE, NEW YORK.

SPECIALTIES:

Bohemian Garnet, Whitby Jet, Steel and Amber Jewelry, Opera, Marine and Field Glasses, Telescopes, Pearl Card Cases, Silk Guards, Etc.

Also a Complete Line of

GOLD AND GOLD PLATED JEWELRY.

ESTABLISHED 1850.

TRADE



MARK

PETER L. KRIDER,

MANUFACTURER OF

STERLING SILVERWARE

Medal and Diploma Awarded. &c. Striking Society Medals in Gold, Silver or Bronze a Specialty.

Artisan Hall, 618 Chestnut St., Philadelphia.

William T. Smith,
ASSAYER, REFINER AND SWEEP SMELTER.

ESTABLISHED IN 1855.

Cor. Blackstone & Hawkins St.

PROVIDENCE, R. I.

BOSTON, Mar. 15, 1883.



To whom it may Concern :

Mr. Wm. T. Smith, of Providence, R. I., has done refining for us for years, as well as his father before him, and we take pleasure in saying we have never received anything but satisfaction in our dealings with him.

RIPLEY HOWLAND MFG. CO., R. Crosby, Treasurer.

JEWELRY AND WATCHES.

ROGERS' SILVERWARE.

MATERIALS AND TOOLS.

S. F. MYERS & CO.,
Manufacturers and Jobbers,
179 BROADWAY, NEW YORK.

ILLUSTRATED CATALOGUE FOR THE TRADE.

W. E. WHITE & CO.,
Manufacturing Jewelers.

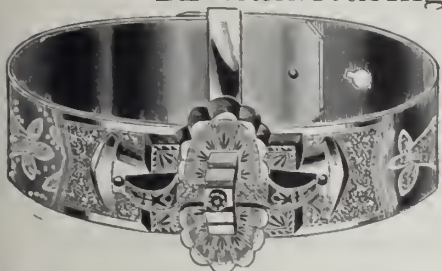

FINE
ROLLED PLATE
GOODS.

Bracelets---Engraved, Enamelled, Flat Band and Buckle.

Ladies' Goods—Lace Pins, Drops, Crosses, Sets, Collar Buttons, &c.

FOR SALE BY JOBBERS ONLY.

New York Office, 26 MAIDEN LANE, Corner Nassau Street.

Factory 54 Page St., Providence, R. I.

Represented by S. A. BALDWIN.

ALEX. MILNE,
Manufacturer of Stem-Winding Watch Crowns



ALSO GOLD AND SILVER THIMBLES.



19 Ward Street, NEWARK, N. J.

JAMES J. FISHER,

DEALER IN

WATCHMAKERS' and JEWELERS' MATERIALS,

Files, Tools, Silk Guards, Watch Glasses, Spectacles, Rolled Plate, Fire Gilt, Nickel and Silver Chain, Charms, &c.

No. 697 BROADWAY,

Corner Fourth Street, NEW YORK.

All kinds of Job Work for the Trade Promptly attended to.

The "Acme" French Clock Movement Support.
(Pat. Nov. 1st, 1881.)

This Support is adapted to the holding in position of any French Clock Movement while regulating or adjusting, and will be found very desirable on account of its simplicity of action and the small space it occupies. To be had of any respectable jobbing house, or sent, post paid, to any address, on receipt of 60 cents.



Henry Sera,
Importer of Rough & Polished Diamonds,
DIAMOND CUTTING AND POLISHING WORKS:
21, 23, 25 Looijersgracht, Amsterdam, Holland. 4 & 6 JOHN ST., New York.

Diamonds repaired and matched by some of the finest workmen in the world.
Diamond Bort and Powder always on hand.

G. W. SCHUMANN,

No. 26 JOHN STREET,
NEW YORK.

Sole Licensee in the United States for the manufacture of

TRENOR'S DIFFERENTIAL DIAL,

by which the time in two cities can be recorded at once.

The Dial can be applied to any Watch.

GEO. W. DUBOIS.

F. N. NAUMAN.

GEO. W. DUBOIS & CO.,

IMPORTERS OF

Watches & Optical Goods.

ALL STYLES AND QUALITIES OF

SPECTACLES AND EYE-GLASSES.

LONGINES' WATCHES AND MOVEMENTS.

The Watches in Gold, Silver and Nickel Cases of New and Handsome Patterns. The Movements fit 18 size Waltham Stem Winding Hunting Cases.

36 MAIDEN LANE, NEW YORK.

Orders by Mail Receive Prompt Attention.

R. & K.'S PATENT GAS FURNACES FOR MELTING, PLATING, ENAMELING, ANNEALING, &c., &c.

Reichhelm & Koester,

Importers and Manufacturers of

Jewelers' Tools, Files, Materials, &c.,

Manufacturers of
Bristle Brushes of all kinds,
Cotton and Wool Buffs,
Felt Polishing Wheels,
Walrus Leather Polishing
Wheels,
Jewelers' Satin Finish and
Scratch Brushes,
Brass & Steel Wire Brushes
Jewelers' Standard Saw
Frames,
Plain & Fancy Draw Plates,
Improved Jewelers' Ingols,
R. & K.'s Jewelers' Combi-
nation Gas Burners.

Importers of
French, English & German
Tools and Files,
Piercing Saws,
Renard & Vautier Gravers,
Steel and Brass Wires,
Vienna and Ruby Draw
Plates,
Alloying Copper Wire,
Felt, Walrus Leather,
Vienna Lime, Tripoli,
&c., &c., &c.

80 Nassau St.

NEW YORK.

WHEELER, PARSONS & HAYES,

MANUFACTURERS OF

WATCH CASES, GOLD CHAINS & FINE JEWELRY

Importers of Diamonds and Manufacturers of Diamond Jewelry,
And Dealers in American and Swiss Watches,
No. 2 MAIDEN LANE, NEW YORK.

Established 1841.

Enos Richardson & Co.,
 Manufacturers of Gold Jewelry and Chains,
 23 Maiden Lane, New York.

Goods sent on approval to Dealers in any part of the U. S. upon receipt of order with satisfactory references.

San Francisco Office, 206 Kearny St., Haskell & Muegge, Agents,
 Where a full line of our goods can always be found at Eastern Prices.

Established 1828.

JACOB BENNETT & SON,

Diamond Setters and Manufacturing Jewelers,
 No. 923 CHESTNUT STREET, PHILADELPHIA.

WE MANUFACTURE AND MAKE A SPECIALTY OF
 EVERY DESCRIPTION OF
DIAMOND MOUNTINGS,
 SUPERIOR IN DESIGN AND WORKMANSHIP.



Dealers in
DIAMONDS

And all kinds of Precious Stones.

Of which we keep a Large Assortment Constantly on Hand.

Masonic Marks Society and School Badges, Made to Order Only. Designs and Estimates Furnished.
 PARTICULAR ATTENTION GIVEN TO ALL KINDS OF JOBBING.

SINNOCK & SHERRILL,

SEAL & STONE RING MANUFACTURERS.



Richly incrust with Diamonds.
 14 K. Fine.
 Design of Shank Patented.

3 Maiden Lane, New York.

Factory, Goldsmith Hall, Maple Place,

Green Street, Newark.

CHICAGO OFFICE,

182 State Street.



Raised Initial in Diamonds.
 14 K. Fine.

THE NUMBER OF THOUSANDTHS FINE STAMPED IN EACH RING.

A NEW PIN TONGUE VISEFOR JEWELERS and DEALERS  in JEWELERS' SUPPLIES.

This New Device for securely holding Pin Tongues while being fitted, will commend itself to every Practical Workman.

The joint of the tongue is placed in one of the graduated grooves and firmly secured by tightening the screw, enabling the workman to either file the joint to any required thickness, brooch the hole, shorten the pin or correct such defects as he may desire with ease and dispatch.

These tools are made of Hardened Steel, Nickel Plated, and is a useful and handy tool.

Price, \$1.25. For Sale to the Trade by

HENRY GINNEL & CO., Wholesale Agents,
31 Maiden Lane, NEW YORK.

JOHN A. RILEY & CO.,

MANUFACTURING JEWELERS,

NOS. 7 & 9 BOND STREET,

NEW YORK.

ESTABLISHED 1810.

VACHERON & CONSTANTIN,
WATCH MANUFACTURERS,

GENEVA,

SWITZERLAND.

These celebrated Watches and Movements are adjusted to Heat, Cold and Position. Movements Fitting ready made Stem-winding, Open Face and Hunting Cases of Waltham and Elgin Sizes.

SOLE AGENT IN UNITED STATES AND CANADA,

CHAS. LEO ABRY,

P. O. BOX 611.

63 NASSAU STREET, NEW YORK.

EDWIN A. THRALL,

1 MAIDEN LANE,

NEW YORK.

—o JOBBER IN o—

American Watches, Diamonds, Fine Jewelry, Etc.

AT LOW PRICES, AND FOR CASH ONLY.

I employ no Travelers, therefore can furnish select goods of the newest designs at the very lowest market price. Every Watch warranted to keep time when delivered. The new system introduced by the American Watch Co., of selling a complete watch, will be adopted. Agent for the new Mascot Bracelet, Patented. Orders filled immediately on receipt. Repairing and Adjusting Fine Watches and Chronometers for the Trade a Specialty.



181



193



PATENT APPLIED FOR 193



214

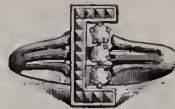

218



219



812



THE ABOVE CUTS ARE THREE DIFFERENT SHAPES IN THE SAME WEIGHT OF PLAIN RINGS. TO BE USED IN ORDERING.

J. B. BOWDEN & Co.,
MANUFACTURERS OF SOLID RINGS
OF EVERY DESCRIPTION.

No. 1 MAIDEN LANE, cor. Broadway, NEW YORK.

A. J. WARNER & CO.,
WHOLESALE JEWELERS,
309 Nicollet Avenue, Minneapolis, Minn.

We carry a Large and Elegant Stock of Jewelry, Watches, Cases, Etc., Etc.

North-western Agents of the WATERBURY CLOCK CO., and carry a Complete Line of their Goods.

OUR TRADE IS EXCLUSIVELY WITH THE JEWELERS.

O. A. GAGER,

Successor to CHAS. FIELD HAVILAND & CO.,

IMPORTER OF

Porcelain and Ornamental Ceramics,

29 BARCLAY STREET.

A Fine Line of FANCY POTTERY of all grades, specially adapted for Jewelers.

PARIAN, BISQUE, TERRE COTTA, FAIENCE, PORCELAIN, ETC.

VASES, PLAQUES, STATUETTES, BUSTS, ETC., ETC.

M. FOX & CO.,

Practical Lapidaries and Importers of

D I A M O N D S .

Rubies, Sapphires and Fancy Gems.

PEARLS, TURQUOISE, INTAGLIOS, ONYX, AMETHYST, ETC.

No. 1 MAIDEN LANE NEW YORK.

WM. S. HEDGES & CO.,

IMPORTERS OF



COPYRIGHT SECURED. Entered according to Act of Congress in the year 1880, by WM. S. HEDGES & Co., in the Office of the Librarian of Congress, at Washington.

170 BROADWAY,

Corner Maiden Lane, New York.

CHOICE BRILLIANTS IN SINGLE STONES AND MATCHED PAIRS A SPECIALTY.

Fresh invoices of Goods in all Grades constantly arriving. Also choice parcels of exceptionally Fine Gems ESPECIALLY Selected for critical purchasers. A full line of Mounted Goods, Artistically Designed.

GOODS SENT ON APPROVAL.

— NEW —

CHRONOGRAPH

STOP WATCHES,

— MADE TO —



START, STOP AND FLY BACK,

With or Without Split Seconds,

MANUFACTURED BY THE

AMERICAN WATCH CO.,

WALTHAM, MASS.



By Patented Improvements in Construction, and considerable Diminution of the Parts required, as well as by the application of American Machinery, the AMERICAN WATCH CO. has so simplified the manufacture of Chronograph Watches as to greatly reduce their cost. They can now be obtained at prices which make them the MOST DESIRABLE timepieces for Sporting Purposes, AS WELL AS FOR GENERAL USE. Dealers can depend upon these goods giving satisfaction, as they will not require the constant repairs, nor subject the dealer to the annoyance experienced in most of the foreign watches of this class. In case of accidents, Duplicates of Broken Parts can be furnished by return mail. Cased complete in 16 Size Gold and Silver Open Face and Hunting Cases. (Open Face made to wind at figure X11).

SPECIAL NET PRICE LIST,

Issued for the TRADE ONLY; will be sent on application, which will not be regarded unless accompanied by Business Card.



ANNOUNCEMENT.



The New Price List for complete 3-4 plate, 8, 14 and 16-size Gold Watches, issued under date of February 1st, 1883, by the American Watch Co., of Waltham, is now ready for distribution. We will forward a copy upon application, accompanied by business card, from any regular dealer in watches.

Jobbers who wish copies sent to their customers will please notify us by sending the names and addresses of the same, but such customers must be regular Watch Dealers. We shall take special precaution in the distribution of this list, in order to keep it out of the hands of the general public, and we beg to request that the Trade will co-operate with us in this undertaking, it being entirely in their interests.

We also beg to call particular attention to the fact that the cases quoted in this list are entirely of our own manufacture, and that we are directly responsible for the quality of the same.

By 18 K. or 14 K. or 10 K. we mean 18 K. or 14 K. or 10 K., and not 16½ K. or 12 K. or 8 K. We offer you actual value for your money.

ROBBINS & APPLETON,

NEW YORK:

5 BOND STREET.

BOSTON, MASS.:

403 WASHINGTON STREET.

CHICAGO, ILL.:

102 STATE STREET.

LONDON, ENGLAND:

HOLBORN CIRCUS.

AUSTRALIA:

SYDNEY, NEW SOUTH WALES.



Randel, Baremore & Billings,

Importers of

Diamonds

and Manufacturers of

Diamond Jewelry.

*58 Nassau Street,
& 29 Maiden Lane,
New York.*

*1 St. Andrews Street,
Holborn Circus,
London, E. C.*



278D.
Patented.



389D.
Patented.



351D.



347R.



291.

HENRY C. HASKELL,

MAKER OF FINE GOLD JEWELRY.

No. 12 John St., New York.

Goods sent on approval to any part of the country, upon receipt of satisfactory references.

SPECIAL LINE INITIAL RINGS, SEALS, ETC.

INCURSTED-DIAMOND-PEARL-OR RUSTIC LETTERS.

DESIGNS PATENTED.

Illustrated Plate sent to Dealers upon request.

House Established 1837,

Successor to J. A. ABRY.

CHARLES LEO ABRY,

Importer and Manufacturer of all Grades of

SWISS WATCHES,

And dealer in Elgin, Springfield, Ill., and Lancaster Movements.

Specialties in Gilt, Nickered and Nickel Stem-Winding Movements, Ladies' Sizes, to Fit Elgin Cases.

IMPORTER OF THE FOLLOWING WELL-KNOWN SWISS WATCHES:

Geo. Mayor, A. Ames Droz, Chas. Estine, F. Richard, Huguenin Nardin and Ernest Duval, as well as all kinds of Watches for the Jobbing Trade, including Nickered, Open-Face and Hunting Stem-Winders, Anchors and Cylinders, 16, 18 and 19 lines. Silver Key and Stem-Winders, Hunting and Open Face, all sizes and qualities, from low to highest grades. Silver and Nickel 13 and 14 line Watches for Chatelaines, Gold, Silver, Nickel & Rolled Plate Chatelaines of good styles & designs always in stock.

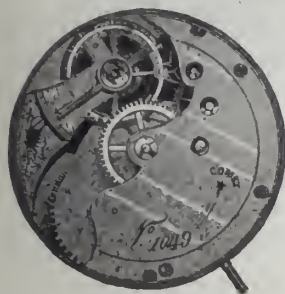

COMET.

SOLE IMPORTER.

Fits 8 Size Elgin Cases.

P. O. Box 611.

63 NASSAU STREET, NEW YORK.

Factory, Neuchatel, Switzerland.

THEUERNER & CHURCH, MANUFACTURERS OF FINE RINGS,

No. 9 MAIDEN LANE,

NEW YORK.

FACTORY, COR. MULBERRY & DURAND STS., NEWARK, N. J.

LEON JEANNE.

PAUL JEANNE

JEANNE BROTHERS

MANUFACTURERS OF

DIAMOND MOUNTINGS,

AND RICH JEWELRY.

No. 1 MAIDEN LANE, NEW YORK

Designs Furnished and Estimates Given.

JEANNE BROS PAT. DIAMOND SETTINGS.

A PLATINUM SETTING WITH A GOLD SURFACE OUTSIDE

IN THIS WAY THE REFLECTION OF GOLD THROUGH THE DIAMOND IS ENTIRELY AVOIDED.

PAT. AUG. 15TH 1882

JAMES H. HART,

4 MAIDEN LANE,

NEW YORK.

IMPORTER AND JOBBER.

Diamonds, Watches, French Clocks and Bronzes. Faience, Porcelain and Royal Worcester Ware. Opera Glasses, Silk Guards, Etc.

I have constantly on hand a FULL line of **WALTHAM WATCHES**, comprising EVERYTHING made by the AMERICAN WATCH CO. Also Gold and Silver Canes and Pencils. Best Quality Rolled Plate Chain. Silver Plated Ware of all the Best Makers. Catalogue and Price List furnished to the Trade Only.

GOODS SENT ON SELECTION TO RESPONSIBLE HOUSES.

ESTABLISHED 1859.

RINGS A SPECIALTY.

BRYANT & BENTLEY,

12 MAIDEN LANE,

Up-Stairs,

NEW YORK.

AMONG OUR LATEST PATTERNS OF FINE SOLID RINGS ARE



587



591



584



504



589



490

No. 587—Made in Topaz and Amethyst. No. 591—Cluster of Garnets, Doublets or Turquoise, with Pearls and Diamonds. No. 584—Cameo or Garnet with Pearls and Diamonds. No. 504—Misses' Turquoise Rings. Nos. 490 and 589—Represent two patterns only of our Engraved Band Rings.

We also continue to make a full line of our well known 16 K. HARD SOLDER RINGS.

Goods sent on approval to responsible parties.

N. H. WHITE,

JOBBER IN

**AMERICAN-WALTHAM WATCHES,
EXCLUSIVELY.**

Waltham make of gold and silver cases a Specialty. Ladd, Boss, and the Patent Screw Bezel Filled Cases to fit Waltham movements only

No. 11 MAIDEN LANE, NEW YORK.

I not only advertise that I have the Waltham Goods, but **have constantly on hand** the Largest Stock carried by any jobber in the trade. Gold Cases of all Weights and Styles. Memorandum Packages with pleasure to dealers furnishing satisfactory reference.

COMPLETE PRICE LIST TO THE TRADE.

C. ROGERS & BROS.,

MERIDEN,

WESTMINSTER.

CONN.



PATENTED.

We Guarantee all goods bearing our stamp to be made of 18 per cent. Nickel Silver, and plated equal to the very best in market.

A SPECIALTY.
PATENT CATCH BRACELETS.



PAT. SEPT. 30 1882.

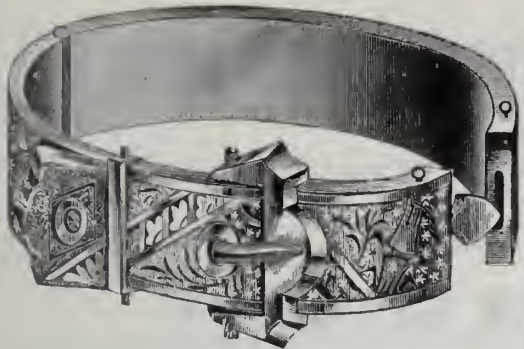

The most Convenient and Complete Catch ever invented. Not liable to get out of Order. Very Durable.

C. I. RICHARDS, BROWN & CO.,

MANUFACTURERS OF

Gold and Plated Jewelry,

202 BROADWAY,

Factory, Providence, R. I.

NEW YORK.

We now offer to the Trade a Fine Assortment of Rolled Plate Jewelry, Patent Catch Bracelets in First and Second Quality, Enameled, Chased and Roman, with and without Buckle and Fancy Ornaments. Bangles and Flat Bands in great variety. Our Patent Lever and Separable Buttons and Studs, Ladies' and Gent's Collar Buttons, Charms, Lockets, Lace and Scarf Pins, Sets, Chains, etc., etc.

ALSO A FULL LINE OF BRILLIANT JEWELRY IN GOLD.

Goods Sent on Approval upon Application with Satisfactory Reference.



R. HENRICH,

"SELF-SIZING RING,"

(PATENTED MARCH 20th, 1883.)

NEW PATTERNS FOR FALL TRADE.



FOR SALE BY ALL JOBBERS.

SEAL AND STONE RINGS IN ALL VARIETIES.

35 Maiden Lane,

NEW YORK.

HENRY ZIMMERN,

IMPORTER OF

Watch Materials,

TOOLS,

AND OPTICAL GOODS,

No. 8 Maiden Lane, New York.



WHITE METAL CHAINS A SPECIALTY.

SOLE AGENT

FOR THE CELEBRATED

GRAVIER

MAINSPRINGS.

The cut is a fac simile of trade mark with my monogram on wrapper, adopted by me to prevent the trade from being imposed upon with imitation springs. A brass tag attached to each spring indicates the number and strength according to Dennison's United States Standard Gauge. These Springs are to be obtained at all leading Jobbing Houses.

R. & L. FRIEDLANDER,

IMPORTERS OF

WATCHMAKERS' & JEWELERS' SUPPLIES,

OPTICAL GOODS, SILK GUARDS, Etc., Etc.

WE KEEP ON HAND A LARGE STOCK OF

**Rolled Plate and Fire Gilt Chains,
CHARMS AND LOCKETS.**

GENERAL AGENTS FOR



No. 1, having an oblong hole in the Base Plate (which is secured by a Special Patent), fits all Waltham, Elgin, Hampden and Rockford Movements.

No. 2, having also an oblong hole but F. S. on the opposite sides of No. 1, fits all Illinois and Old Model Waltham.

No. 3 is made expressly for New Model Waltham, with Movement-Screw near the Index.

TESKE'S PATENT WATCH REGULATORS, PRICE \$18.00 PER DOZEN.

ESTABLISHED 1849.

KOCH & DREYFUS,

WHOLESALE DEALERS IN

WATCHES, JEWELRY, CLOCKS, DIAMONDS, SPECTACLES, ETC.

ALSO JEWELERS' AND WATCHMAKERS' TOOLS AND MATERIALS AT MANUFACTURERS' PRICES.

18 CHARTRES ST., NEW ORLEANS.

BRANCH OFFICE, 20 MAIDEN LANE, N. Y.

THE HOPKINS LATHE.

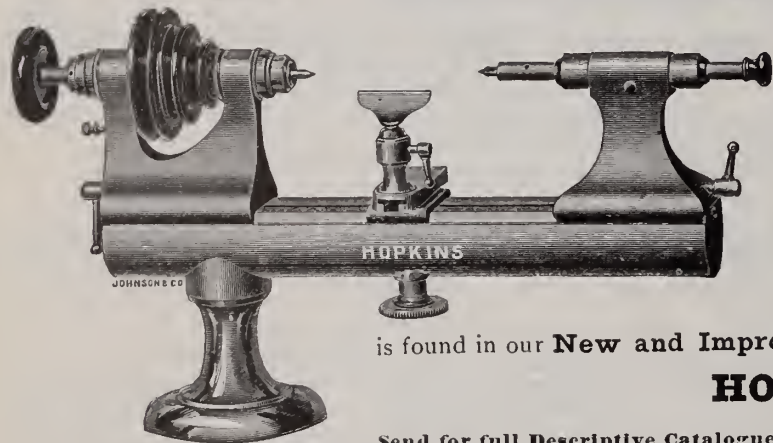

These Lathes are Unsurpassed in Quality and Workmanship.

In Special Features of Practical Value, peculiarly adapted to Watch Repairing, they excel all others. The attachments are made interchangeable in all the sizes.

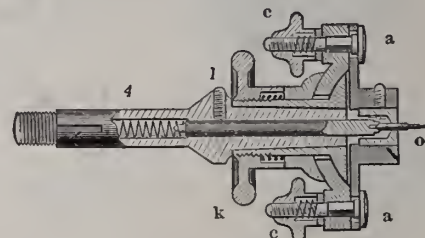

The only absolute substitute for wax, in Watch Repairing, is found in our New and Improved Pivoting Chuck, represented in the above sectional view.

HOPKINS WATCH TOOL CO.,

WALTHAM, MASS.

Send for full Descriptive Catalogue.

S. KOHN & CO.,

43 MAIDEN LANE,

NEW YORK.

Manufacturers of Fine Morocco, Plush and Velvet Boxes.



Trays and Silverware Boxes of all Description Made to Order.

A Full Line of Boxes Constantly on Hand, and Samples sent on Selection.

ORDERS FROM THE JOBBING TRADE RESPECTFULLY SOLICITED.

THE SELF-LOCKING TAG.

Patented May 29, 1883.

FOR ALL KINDS OF JEWELRY.

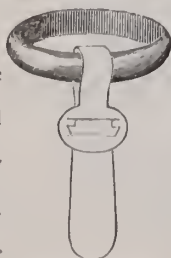

To introduce this Novel Invention, I will send five gross by mail to any address on receipt of \$1.00. A trial order will convince you that this is

When attached, the BEST TAG now in Use!

J. WIESBAUER,

MANUFACTURER OF

Jewelers' Findings,

Morocco, Plush and Velvet Cases, Trays, Paper Boxes, Wood Mailing Boxes, Etc.,

OFFICE: 414 Main St.

FACTORY: Cor. Oak & Clinton,

BUFFALO.

JOBBING TRADE SOLICITED.

PATENTED JAN. 23, 1883.



What Every Jeweler Needs.

Will Keep Cards Clean.

The above useful device contains over 1200 of the various size Cards and 1000 Tags.

PRICE, \$4.50.



E. AUG. NERESHEIMER
& Co
IMPORTERS
of
DIAMONDS
21 MAIDEN
LANE
NEW YORK

NO 66 SARPHATI STRAAT
AMSTERDAM HOLL.

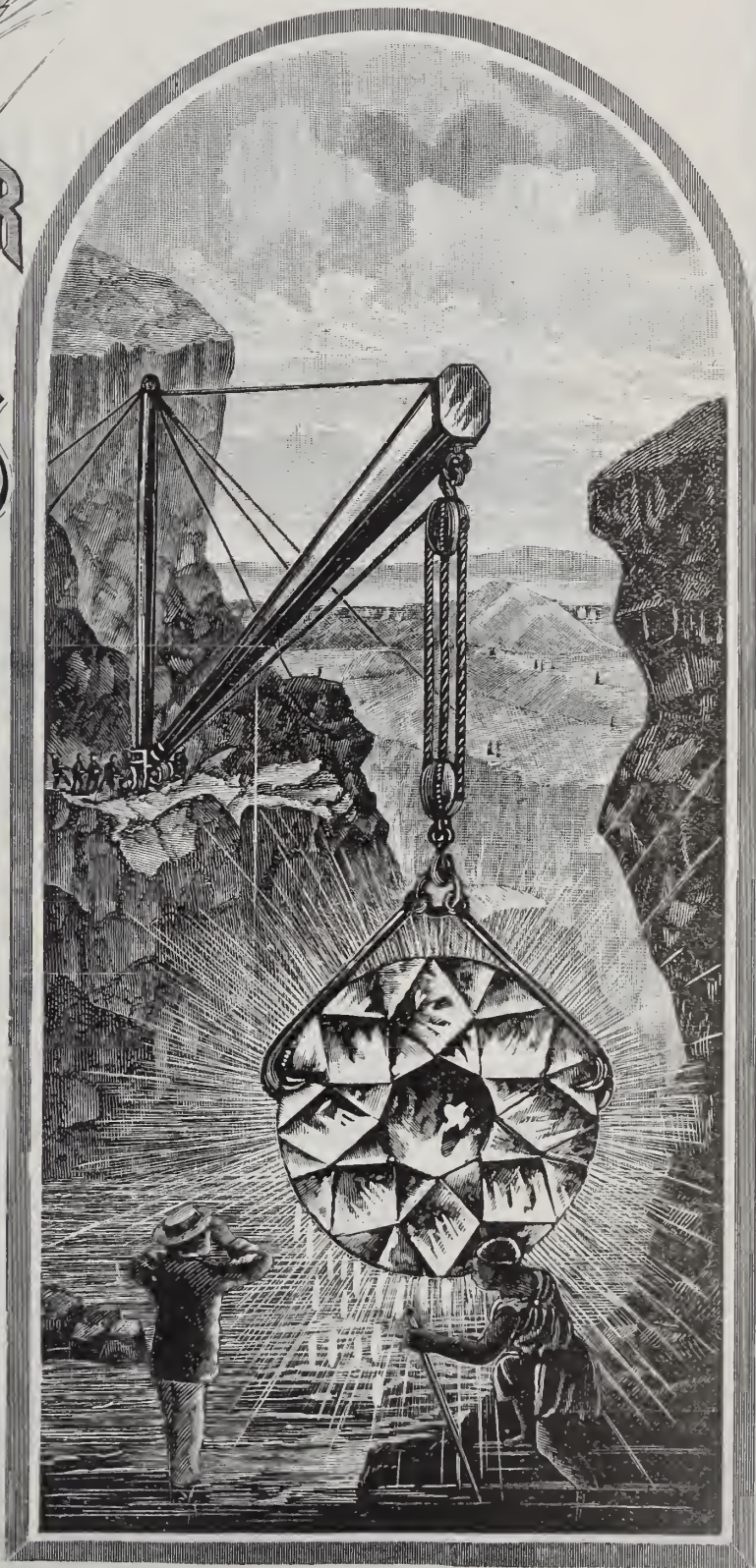

Ladd Watch Case Company,

(ORGANIZED 1883.)

SUCCESSORS TO J. A. BROWN & CO.

(ESTABLISHED 1858.)

MANUFACTURERS OF THE

LADD PATENT GOLD WATCH CASES.

EXAMINE

THE

NEW MODEL

TO BUY!

Ladd Case.



Design No. 701.



Design No. 739.

Which is universally pronounced on sight to be the Most Elegant and the Best Article in this line yet brought out.

IT HAS ALL THE LATE IMPROVEMENTS

Including Solid Gold Bows and Solid Gold Linings,

AND FOR WORKMANSHIP, STYLE AND FINISH IT IS UNEQUALED.

Its Shape is such as to admit of the most elaborate ornamentation, or any intermediate style down to the plainest, without loss of effectiveness, in accordance with the taste of the purchaser.

The **GOLD** in all of the **LADD CASES**, in the **COVERS** and **CENTER RIM** and **PEN-DANT**, is plump 14 Kt. fine, **POLISHED** to its natural color, a most **ESSENTIAL FEATURE** in the **WEAR** of a **WATCH CASE**.

For Sale by the Leading Wholesale Jobbing Trade.

Falkenau Oppenheimer & Co.
Importers of
Diamonds



40 Maiden Lane N. Y.

Post Office Box 3314.



No. 3126. Spoon Holder.
CHASÉD.
Niello and Gold, \$3.50. (ENHAND)



No. 2125. Butter Dish.
Plain, \$6.25. (VOLLEY) Chased, \$6.75. (VOLCANO)



No. 3522. Card Receiver.
Chased, Niello and Gold, \$7.50. (THEREBY)

**DERBY SILVER CO.'S
CELEBRATED WARES,**

Original and Novel Designs, for the Fall Season of 1883.

SALESROOMS,

25 Maiden Lane, New York. 170 State Street, Chicago, Ills.

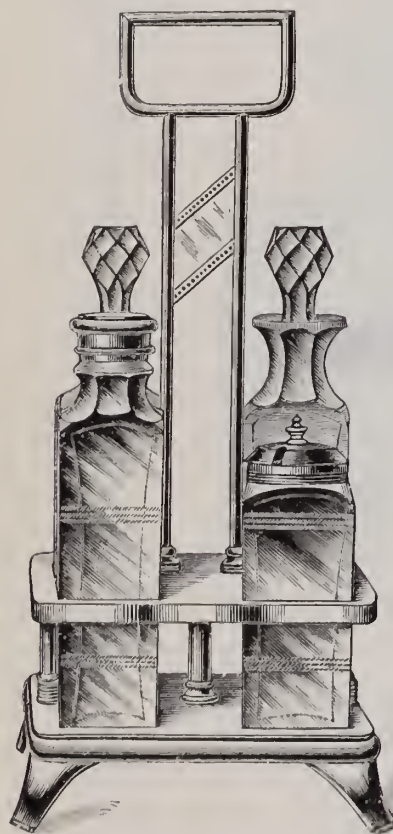

No. 835. Caster.
Plain, 4 No. 4423 Bottles, \$16.50. (WILL)

On or about September 1st, 1883, shall open our New Salesroom,

No. 3 UNION SQUARE, NEW YORK.

Canadian Branch Factory, No. 31 Adelaide Street East, Toronto, Ont.



No. 807. Caster with 626 Bottles.
Chased, 6 No. 626 Bottles, \$7.50.
Chased, 6 No. 4097 Bottles, 8.50. (WIFE)
Chased, 6 No. 3741 Bottles, 6.50. (WIG)
With Bell Handle, \$1.50 extra.

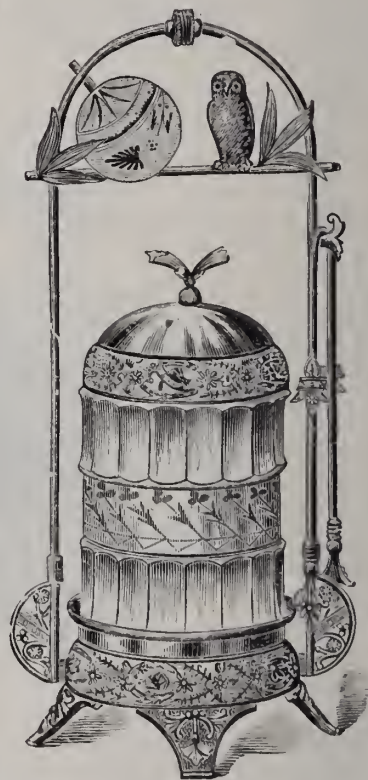

No. 119. Pickle Caster.
\$4.75. (WORTH)

Main Factories at Birmingham, Conn., U. S. A.,
Where all Communications should be Addressed.



No. 3226. Berry.
Fancy Gold, Decorated Glass, \$9.00. (THRUST)



No. 2017. Pitcher.
Chased, Silver, \$11.00. (WHISKY)
Chased, Gold Inlaid, 13.00. (WHISPER)

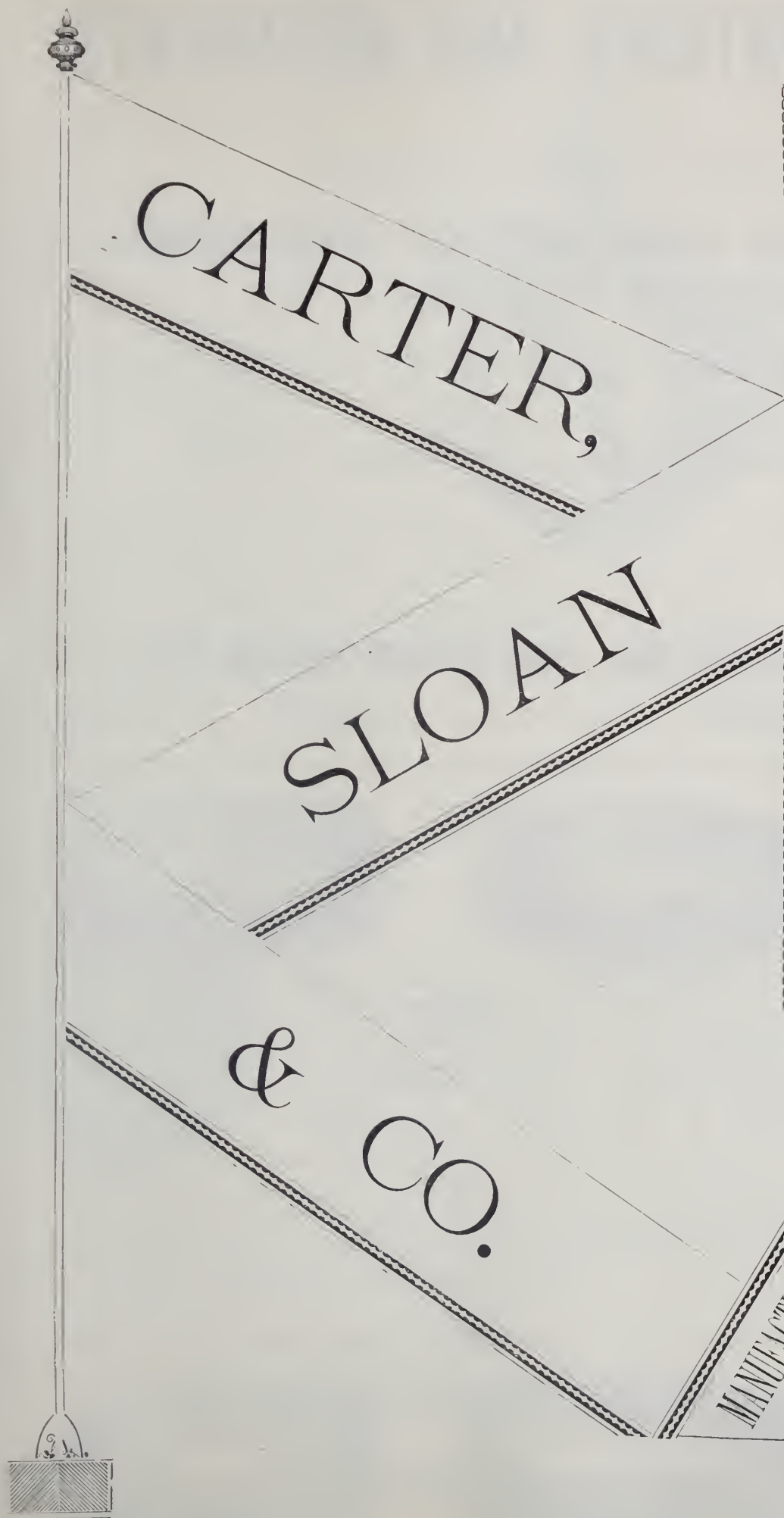

WE desire to announce to the Jewelry Trade of the United States, the completion of extensive improvements in our factory at Newark, N. J., which will enable us to execute with promptness all business we may be favored with. Through these extra facilities we shall have on hand at all times a larger and more varied stock than ever shown before of

→*Gold Jewelry*←

Bracelets, Bangles & Fine Chains

in all the newest and most desirable styles. Orders solicited for such goods as we are unable to display by representatives. Any commissions intrusted to our care will receive prompt attention.

CARTER, SLOAN & Co.,

15 MAIDEN LANE,

P. O. Box 90,

NEW YORK.

MANUFACTURING JEWELERS,
15 Maiden Lane,
P. O. Box 90,
NEW YORK.

A. CARTER, JR.
A. K. SLOAN.
C. E. HASTINGS,
G. R. HOWE.

COMPLICATED WATCHES AND MOVEMENTS.

CHRONOGRAPHS,
CHRONOGRAPH AND SPLIT SECONDS,
Minute Repeaters,

CHRONOGRAPH AND SPLIT SECONDS WITH MINUTE REPEATERS.

OF DIFFERENT GRADES AND AT VARIOUS PRICES.

ABSOLUTELY RELIABLE AND ACCURATE.

J. EUGENE ROBERT,

30 MAIDEN LANE,

NEW YORK

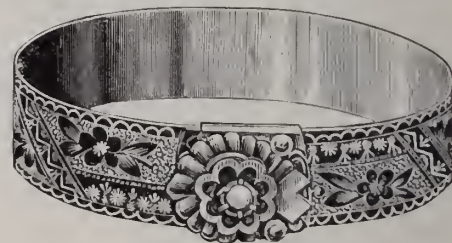
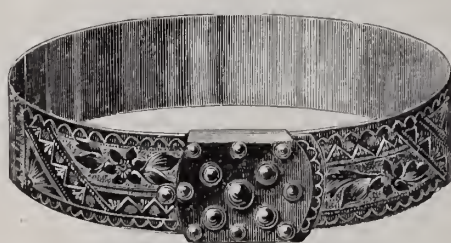
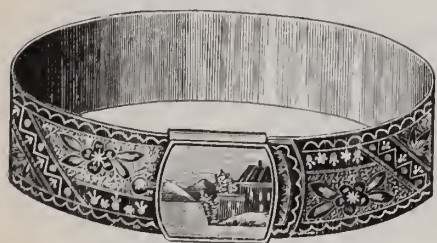

J. M. CHANDLER & CO.,

MANUFACTURING JEWELERS.

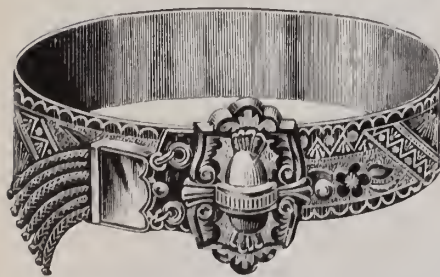

We especially call the attention of the Trade to our new Patent Band Bracelet Catch. The design of the Catch is to make a Band Bracelet adjustable to any size without the slightest difficulty—leaving the band clean and smooth, and make a secure fastening. These goods are pronounced by all who have seen them to be the *Ne Plus Ultra* of all Band Bracelets. The goods must be seen to be appreciated. We will send Selection Package of these goods to the Regular Trade.

J. M. CHANDLER & CO.

Manufactured at our own Factory, 111 Broad Street, Providence, R. I.

Office and Salesroom, 185 Superior Street, Cleveland, Ohio.

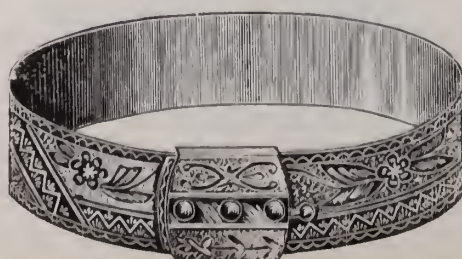
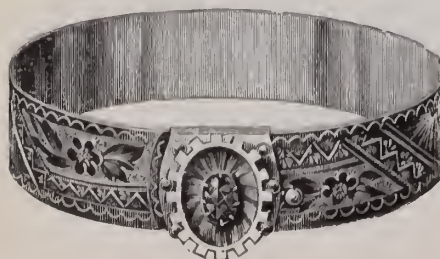

THE CLIMAX REVERSIBLE WATCH CASES.

MANUFACTURED BY THE

Northwestern Watch Case Co.

MANUFACTURED BY THE

Northwestern Watch Case Co.



CHANGED FROM AN OPEN FACE TO A HUNTING CASE AT WILL.

MADE TO FIT THE 18 SIZE STEM WIND AMERICAN MOVEMENTS.

Patented April 3d, 1883, No. 275,251.

ABSOLUTELY DUST PROOF. A PERFECT WATCH CASE.

A MARVEL OF INGENUOUS MECHANISM.

—Descriptive Circulars Furnished Upon Application.—

MATHEY BROS. & MATHEZ,

NO. 16 MAIDEN LANE.

IMPORTERS OF ALL GRADES OF

Plain and Complicated Watches and Movements

SOLE AGENTS FOR THE WELL-KNOWN

H. L. MATILE

Fine Watches of Astronomical Precision.



REPEATERS.



CHRONOGRAPHS.

In order to facilitate the handling of our Stem-Winding Movements, we have adopted a standard of sizes to fit American Cases. Of these we have a complete line from the medium grade to the highest class goods of fine adjustment and precision. As all our Movements, complicated and plain, are perfectly uniform in quality according to their respective grades, we can furnish material for any parts that may be required, with the positive assurance of accurate interchangeability.

An Extensive Line of all Grades of

CHRONOGRAPHS, SPLIT SECONDS AND REPEATERS. WATCHES DEMAGNETIZED.

ESTABLISHED 1844.

DENNISON MFG CO.,

BOSTON, NEW YORK, PHILADELPHIA, CHICAGO, CINCINNATI AND ST. LOUIS.

JEWELERS' FINDINGS.

PAPER JEWELRY BOXES IN ALL STYLES AND QUALITIES. IMITATION MOROCCO BOXES, SATIN LINED. TAGS, JEWELERS' CARDS, PINK AND WHITE COTTON, &c., &c.

MOROCCO CASES.

Manufacturing in our own Shops Every Description of Morocco, Plush and Velvet Jewelry and Silverware Cases in large quantities, we are enabled to sell lower than other goods of equal quality can be offered, and we carry in all our Stores FULL Stock of our whole line.

Catalogue on Application.

BAKER, PRATT & CO.,

IMPORTERS OF JEWELERS' FANCY GOODS,

No. 19 BOND STREET, NEW YORK.

Our success during the past season in importing a Special Line of Fancy Goods for Jewelers has encouraged us to make greater efforts to present this season EXCLUSIVE NOVELTIES, suitable for the Jewelry Trade. The following wares are just received and now open for inspection:

—* Brass, + Forged Iron, + and + Antique Silver,*—

In Mirrors, Candles, Card Trays, Inkstands, Ash Receivers, Library Knives, Jewel Caskets, Gem Trays, etc.

(WRITE TO US FOR PARTICULARS.)

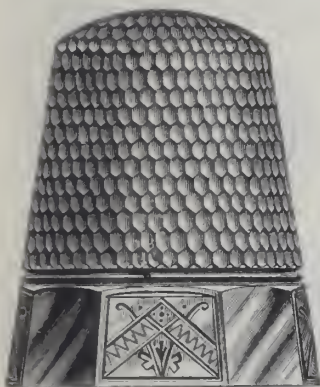

13 Maiden Lane,
NEW YORK.

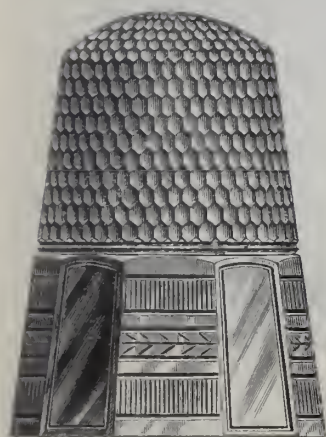

FRANK S. KENNEDY,

Manufacturer and Wholesale Dealer in

JEWELRY

OF EVERY DESCRIPTION.

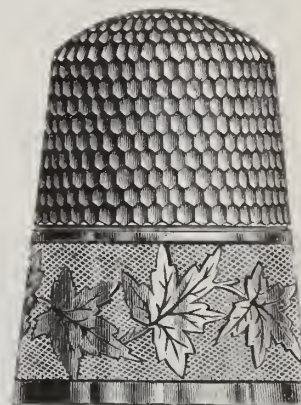

13 Maiden Lane,
NEW YORK.

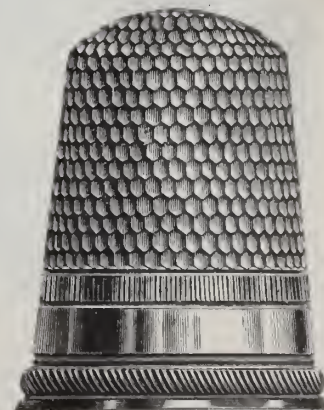

In addition to my stock of Jewelry, which is complete in all lines of Gold, Silver and Roll Plate, I am now making a Full Assortment of

THIMBLES,

in Solid Silver, 10 karat and 14 karat Gold. These Thimbles are Superior in Finish to any now in the market, and are as near perfection as long practical experience can make them. Will send Samples if desired.

The Assortments of Jewelry I send on Memorandum for Special and Stock Orders have an increasingly high reputation.



E. HOWARD WATCH AND CLOCK CO.,

—MANUFACTURERS OF—

Fine Stem-Winding Watches,

FINE REGULATORS, OFFICE CLOCKS, TOWER CLOCKS,

And Electric Watch Clocks.



LADIES'
6 Size.

STEM-WINDING
AND



GENT'S
16 Size.

Stem-Setting
Movements.



GENT'S
18 Size.

114 TREMONT ST., BOSTON.

29 MAIDEN LANE, New York.

J. W. J. PIERSON, Agent.



WILLEMEN WATCH CASE CO.,

109 Sands Street, Brooklyn, N. Y.



Patent 278,282 issued to

G. Willemin, May 22, 1883.

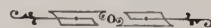

These Cuts represent the Patent Swivel Guards, and we respectfully call attention of the Trade to it as the only Swivel Guard that is practical, as it is utterly impossible for the Swivel to come in contact with the Crown.

They are made in two styles, one plain, suitable to our Celebrated Engine Turned Jurgensen Case, the other engraved to correspond to the designs of our Engraved Cases.

As the sales of these Cases will undoubtedly be very large, Dealers will please send in their orders early for the Fall Trade.



NEW YORK OFFICE REMOVED FROM

No. 1 $\frac{1}{2}$ to Nos. 14 & 16 Maiden Lane.

KREMENTZ & CO.,

MANUFACTURERS OF

GOLD, PEARL AND DIAMOND JEWELRY,

Nos. 182 and 184 BROADWAY,

Corner of John Street,

NEW YORK.

(Elevator Entrance on John Street.)

NOVELTIES IN SILVER JEWELRY.

FACTORY, NEWARK, N. J.

LONGINES CHRONOGRAPHES

Fly-Back & Horse-Timing

STEM-WINDING

WATCHES.

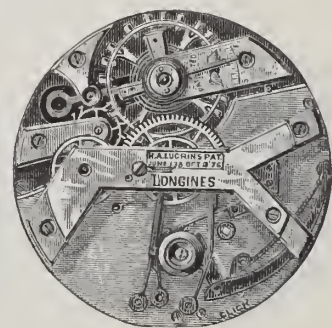

The most reliable, accurate and substantial LOW PRICE Timing Watch made. The improved method of mechanism in their construction renders these goods superior to any low price Timing Watch in the market, and the Best Selling Goods offered to the Trade.

J. EUGENE ROBERT,

30 MAIDEN LANE,

NEW YORK.

FOR SALE BY THE LEADING JOBBERS.

Duplicate Parts and Finished Material for these Goods always in Stock.

GEO. H. RICHARDS, JR.,

383 Washington Street, Boston, Mass., U. S. A.,

JOBBER

American Movements and Cases a Specialty.

WE GUARANTEE TO HAVE **ALL GRADES** IN STOCK.

MOVEMENTS.

WALTHAM.

SPRINGFIELD, ILLS.

HAMPDEN.

ELGIN.

HOWARD.

CASES.

•GOLD•

•FILLED•

•SILVER•

WALTHAM.

"BOSS."

WALTHAM.

DUEBER.

CROWN.

DUEBER.

BROOKLYN.

LADD.

FAHYS.

G. H. R., Jr.

KEYSTONE.

Watches, Jewelry and Silver Plated Ware. Rogers & Bro.'s Flat Ware.

HOLLOW AND FLAT WARE SOLD AT MANUFACTURERS' DISCOUNTS.

Our Stock is positively the Largest, Finest and Best Assorted of any Jobbing House in the Country. All Orders Promptly Executed.

Sole Agent for Gold's Patent Regulator and Elliott's Watch Oiler.

FOR SALE BY ALL JOBBERS AND MATERIAL DEALERS.

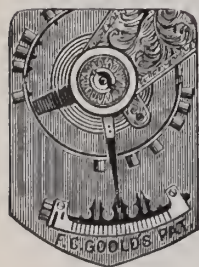

For 18 Size Movements, K. W. & S. W.

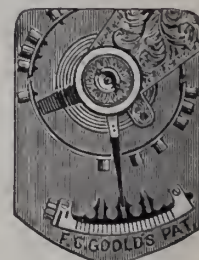

For 18 Size Movements, K. W. & S. W.

THE REGULATOR WILL BE IN THE MARKET JULY 1st, Price, \$1.25.

ELLIOTT'S AUTOMATIC WATCH OILER.

NEW THING. EVERY WATCHMAKER SHOULD POSSESS ONE.

THE GOODS ARE READY FOR DELIVERY, Price, \$1.00.

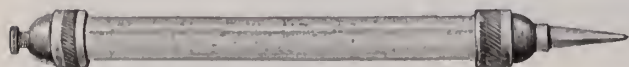

WATCH SIZE.

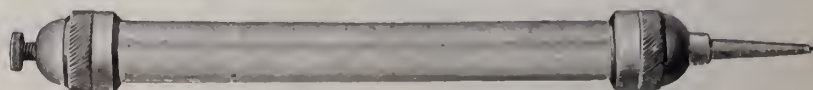

CLOCK SIZE.

SENT BY MAIL TO ANY PART OF THE COUNTRY.

GEO. H. RICHARDS, Jr., 383 Washington Street, Boston, Mass.

LERROY W. FAIRCHILD,
GOLD PENS.



NOVELTIES IN
CHARM
PENCILS,

TOOTH-PICKS.
Whistles, etc.

SALESROOM,
18 JOHN ST., NEW YORK.

ESTABLISHED BY
SPENCER & RENDELL IN 1843,
AND SUCCEEDED BY
LERROY W. FAIRCHILD
IN 1851.

OPPENHEIMER BROS. & VEITH,
 WATCHES,
 DIAMONDS,
 JEWELRY.

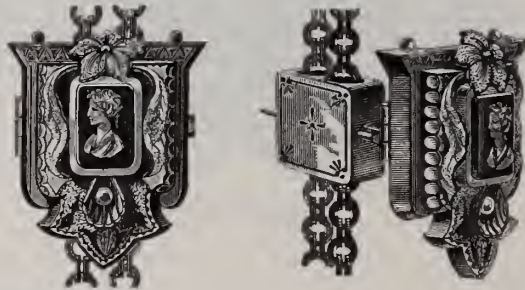

We are the Manufacturers and Patentees of the Combination Slide, Pendant and Loeket, and the Combination Necklacc, Lacc Pin and Pendant.



We can furnish quite a variety of Styles, and are prepared to fill all Orders at once.

35 MAIDEN LANE, NEW YORK.

STERN & STERN,

MANUFACTURERS,

JOBBER,

AND IMPORTERS OF

JEWELRY, WATCHES & DIAMONDS,

No. 6 MAIDEN LANE, N. Y.

We offer this season one of the Largest, Most Complete and Varied Stock of

JEWELRY,

mounted in 14 k. and 10 k. Gold, and the Best Grade of Roll Plate Goods made, comprising the Newest and Most Desirable Designs.

RINGS, BRACELETS, CHAINS, LOCKETS, CHARMS,
SETS, EAR RINGS, LACE PINS, BUTTONS, STUDS,
GOLD AND SILVER THIMBLES, Etc., Etc.

WATCHES.

We are Sole Agents for the Celebrated "Manhattan" and "Lady Washington" Movements, fitting American Cases,

AND THE CELEBRATED

S. S. MELVILLE WATCHES,

universally acknowledged by our Southern Trade to be the Best Swiss Watch for the money made. Cased in 2 and 3 oz. Silver Cases, Key and Stem Wind

AND

Jobbers in all the Leading American Movements and Cases.

DIAMONDS.

In this Department our Stock is UNUSUALLY LARGE and COMPLETE, consisting of Rich and Elegant Designs in Rings, Lace Pins and Ear Rings, as well as Loose Stones.

Goods Sent on Approval, and Prompt Attention Given to Orders and Repairs.

STERN & STERN,

No. 6 MAIDEN LANE.



99

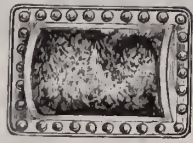

1162



93



28



94



0027



0045



1336

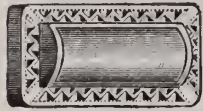

1340

THE

ACME LEVER BUTTON



1741



1016



1094



0001



OPEN.



OPEN.



OPEN.



0025



43



CLOSED.



CLOSED.



CLOSED.



1092



323



VENI + VICI.

Always was, is now, ever shall be
**THE MOST CONVENIENT,
STRONG, RELIABLE and PERFECT SLEEVE BUTTON MADE**

**It Overcomes
ALL TROUBLE WITH STIFF CUFFS.**

ASK YOUR JEWELER FOR THE
**ACME LEVER SLEEVE AND COLLAR BUTTON,
AND TAKE NO OTHER.**

For Sale by all Jobbers of Jewelry.



1420



1196



1369



1316



319



1269



50



58



1585



046



321



57



1545



1338



1235



1340



315



1238



02

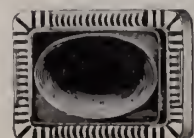

1182



634



HELIOLA!!



(PATENTED)

FOIL BACK BRILLIANTS

With Invisible Foil.

OLD STYLE
IN SETTING.

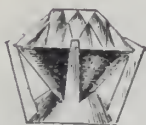

OLD STYLE
UNSET.

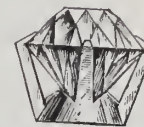

HELIOLA
IN SETTING.



HELIOLA
UNSET.

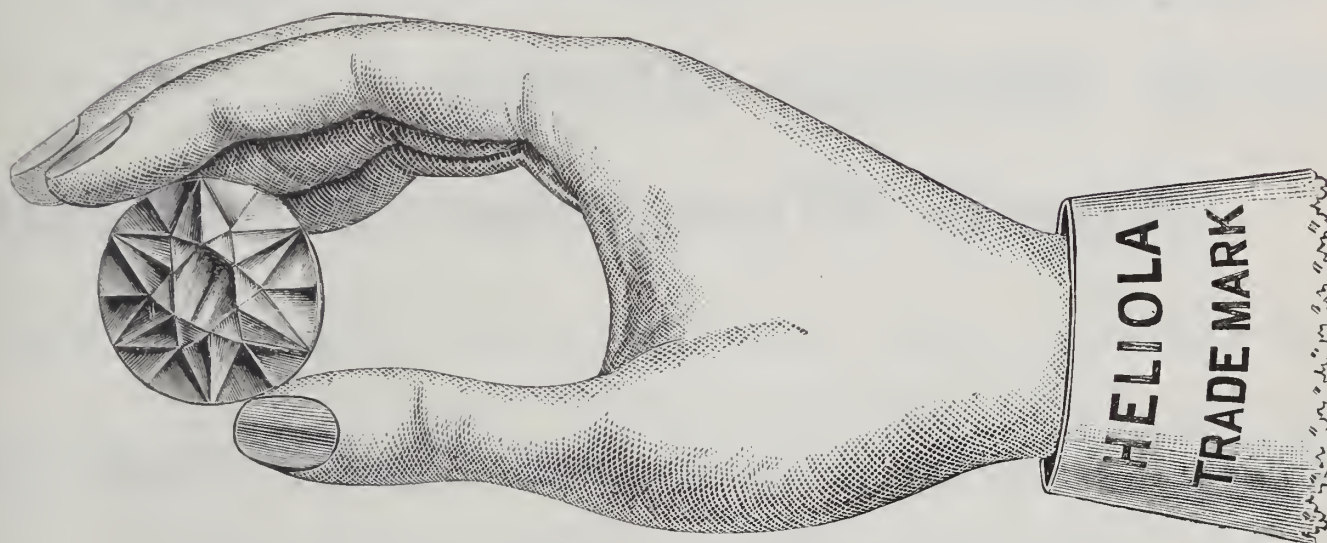

PATENTED 1880.

Ever since Foil Back Stones were offered for sale the great objection to them has been the appearance of the back of the stone, which is ENTIRELY covered with a coating of gold or bronze.

Any novice can, at a glance, distinguish the finest FOIL BACK, when mounted, from a REAL DIAMOND, by simply looking through the sides of the setting.

This great drawback is entirely overcome by the "HELIOLA," which is only foiled at the lower tip or culet (marked A), and, as the brilliancy is unimpaired, the result is a perfect Imitation Diamond.

WE CLAIM FOR THE HELIOLA:

- 1st.—That it is Whiter than the Old Style Foil.
- 2d.—That it has not the looking glass appearance of the Old Style Foil.
- 3d.—That it is Foiled in a Durable Manner, and can be cleaned at any time.
- 4th.—That an expert cannot distinguish the HELIOLA from a Genuine Diamond without making the Closest Examination.

ASK YOUR JOBBER FOR THE HELIOLA.

THE HELIOLA IS PATENTED, and Manufacturers and Jobbers are warned not to buy any which have not the Patentees' Trade Mark  on the Stone Packages or Jewelry Cards.

LE BOUTILLIER & CO.,

of 3 Union Square, desire to inform their friends and the Trade that they will remove their entire business, about August 1st, to the spacious lofts

31 & 33 WEST 23^D STREET,

where they will display an IMMENSE ASSORTMENT of

French Marble Clocks,

Royal Worcester Porcelains,

and other NOVELTIES, all of this Summer's Importation, which will be offered at VERY CLOSE PRICES.

Special inducements will be made to close out balance of stock carried from Union Square House. The stock consists of

BISQUE STATUETTES,

BRASS GOODS,

VIENNA GILT GOODS,

LEATHER GOODS,

PORCELAIN PLAQUES,

BARBOTINE VASES,

TERRA COTTAS,

REAL & IMITATION BRONZES

And a Large Lot of FRENCH MARBLE CLOCKS.

It is their intention to CLOSE out this entire stock as speedily as possible, and early buyers will get substantial bargains.

A Fine Jeweler's Safe and Glass Show Cases

FOR SALE CHEAP.

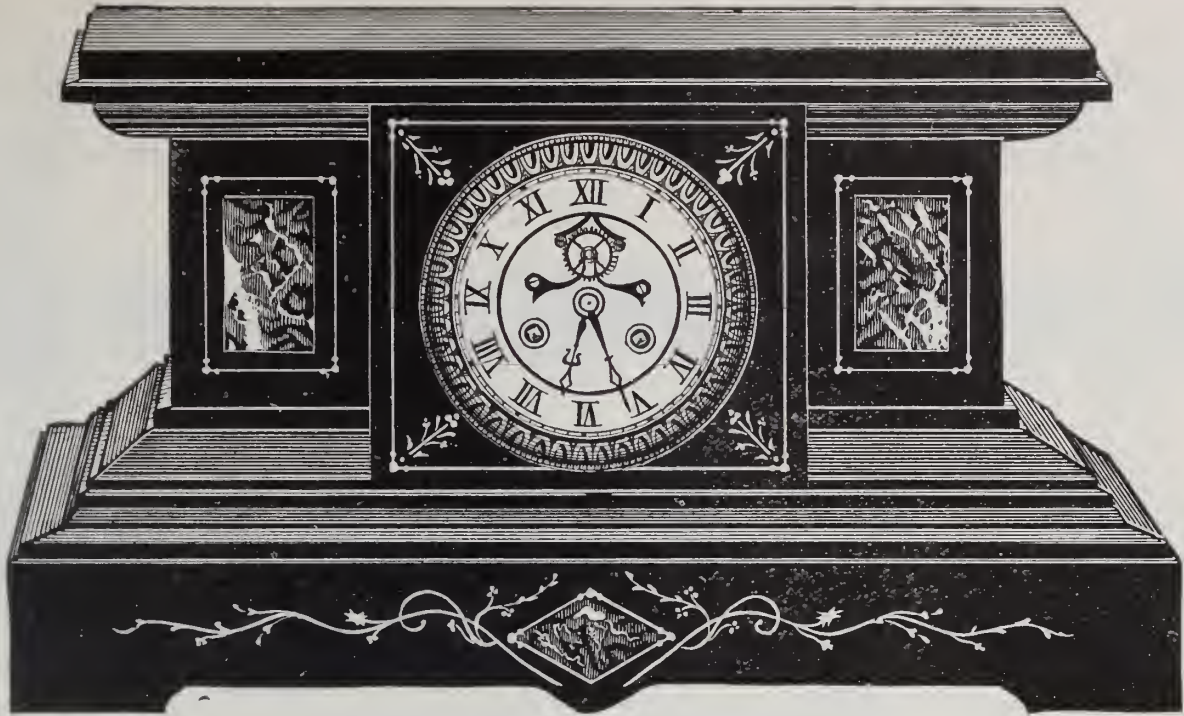

LE BOUTILLIER & CO.,

Importers and Jobbers.

31 & 33 West 23d Street, (Second Loft,) NEW YORK.

OFFER A SPLENDID ASSORTMENT OF

FRENCH MARBLE CLOCKS,

Of this Summer's Importation, at VERY CLOSE PRICES.

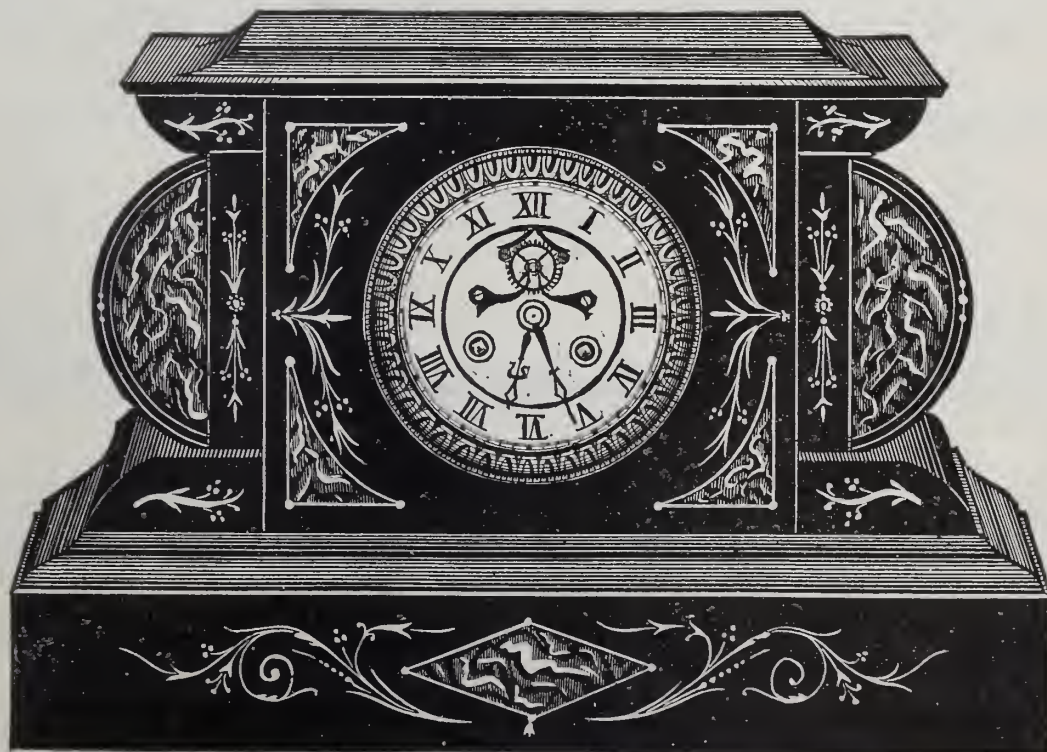

SPECIAL NOTICE!



The Opportunity of the Season to buy
Goods Cheap.

The Bankrupt Stock of Jewelry of W. M. Shepherd will be sold at a large sacrifice. The goods were all bought late last Fall at Lowest Jobbing Rates, and are Fresh and Clean.

The stock consists of

Watches, Diamonds, Rings, Bracelets, Gold Sets, Plated Sets,

→Emblem Pins and Charms, Silver Plated Ware,←

and a full assortment of Cheap Jewelry; also the fixtures, consisting of

Safe, Show Cases, Office Furniture, and a large lot of Dies and Wood Cuts.

TERMS MADE SATISFACTORY.

Call and see the goods, or address

E. J. DERAISMES,

WM. BARDEL, } Committee
WM. H. BALL, } of
L. BORNEMAN, } Creditors.

200 Broadway, Room 8, New York.

JOHN BLISS & CO.,



Standard Marine Chronometer,
FOR KEEPING CORRECT TIME.

Standard Marine

CHRONOMETERS AND TRANSITS

FOR WATCHMAKERS' USE.

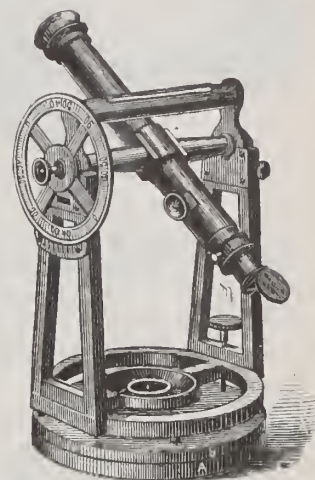

No. 10.

128 FRONT STREET,

Near Wall Street,

NEW YORK.

NOTICE.—These Transits are readily set in position without the aid of strictly correct time as a basis for that purpose. Printed instructions, easily understood, accompany each Instrument, and no calculations are required preliminary to setting in position.

SEND FOR ILLUSTRATED CIRCULAR WITH PRICES.

STANDARD DUST-PROOF WATCH KEYS.

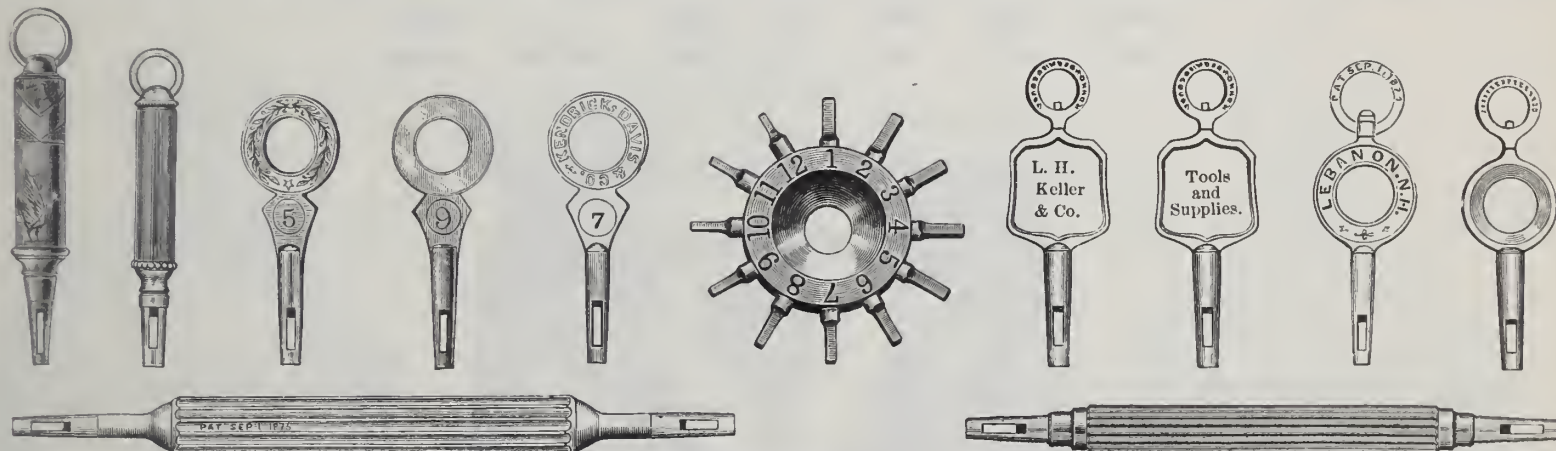

FOR SALE BY  THE TRADE.

KENDRICK & DAVIS,

Sole Owners and Manufacturers, Lebanon, N. H.

ILLUSTRATED CATALOGUE and PRICE LIST SENT ON APPLICATION.



308



306

ELLISON & VESTER'S
PATENT BAND AND BANGLE FINE ROLLED PLATE
BRACELETS.
 FOR SALE BY EVERY JOBBER.

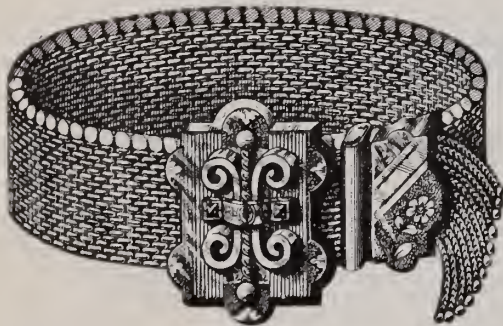

304



310 1/2

KAHN, HANOVER & CO.,

IMPORTERS AND MANUFACTURERS OF

OPTICAL

METEOROLOGICAL,

MATHEMATICAL,

ENGINEERING,

ELECTRICAL,

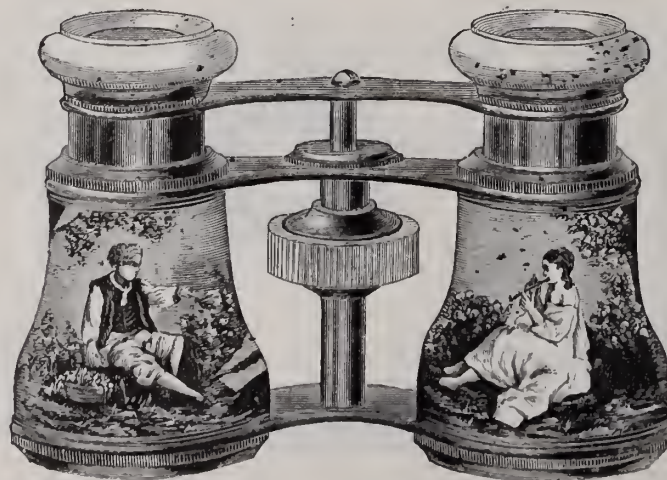

INSTRUMENTS,

32 MAIDEN LANE, NEW YORK.

We are the *only* Importers dealing *exclusively* in Optical, Meteorological, Engineering, Mathematical, Electrical and other Scientific Instruments. We keep the best selected Stock of Specialties in this line, and are constantly advised of all important Scientific Improvements, which enables us to present to our patrons the best results and latest achievements in the reach of science.

Our New Descriptive Catalogue and Price List of 210 pages, with over 400 Illustrations, forwarded to the Trade on application,

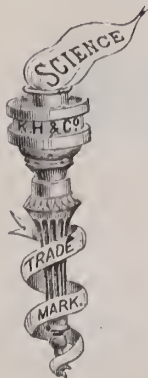

LOUIS KAHN.

MOSES KAHN.

SAMUEL H. LEVY.

I. W. FRIEDMAN.

L. & M. KAHN,

IMPORTERS OF

Watches, Diamonds & Precious Stones,

10 MAIDEN LANE, NEW YORK.

11 Corrairie, Geneva, Switzerland.

17 Rue de Chateaudun, Paris.

WATCHES,

Stem and Key-Winding, from the Lowest Priced Nickel and Silver to the Finest Gold and Complicated.

A Full Assortment of these Goods always in Stock.

DIAMONDS,

Loose and Mounted, in all Sizes and Qualities.

Gold, Silver, Nickel and Celluloid Chatelaines in Great Variety.

STANDARD WATCH CO.



STANDARD CALENDAR.

"STANDARD CALENDAR."

20 Line, Open Face, in Nickel and Silver, showing the date and day of the week, Full Jeweled, Finished Movement. The Latest Novelty offered.



"STANDARD."

18 Size, Low Price Movement, will fit Waltham and Elgin Cases.



"VESTA."

8 Size, Low Price Movement, fits Elgin Cases.



"STANDARD."

8 Size, Full Jeweled, Ladies. Fits Waltham Cases.

REGISTERED.



"STANDARD."

Nickel, 17, 19 and 20 Line. Lever, Full Jeweled.

Max Freund & Co., Sole Agents, 8 Maiden Lane, N. Y.

THE WINDSOR SLEEVE LINK.

PATENTED MARCH 13, 1883.

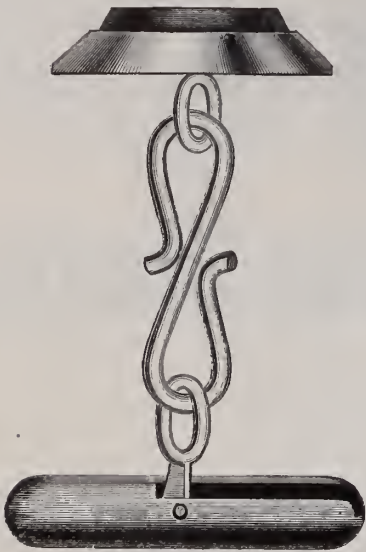

This Cut represents the Button with the Eye properly adjusted in the center of the Bar.



OPENED.

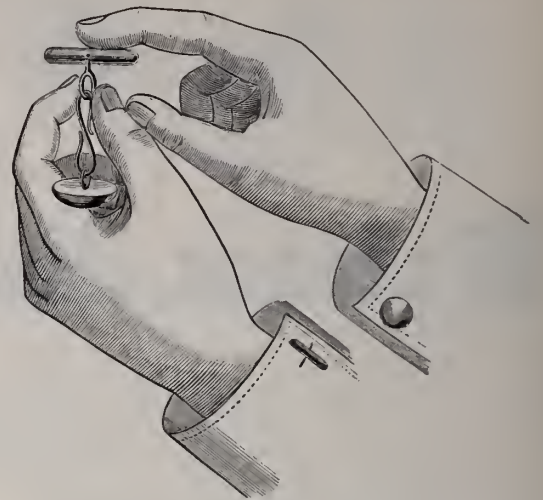

This Cut represents the proper manner of detaching the Eye and sliding the same to the end of the Bar.

SOLD BY ALL LEADING JOBBERS.



Established
1841.



JOHN HOLLAND,

19 and 21 WEST 4th STREET,

CINCINNATI, OHIO.

Manufacturer of All Styles of Best Quality

GOLD PENS, PENCIL CASES, FINE PEN HOLDERS, GOLD TOOTH PICKS, &c.

A Large Variety of New Designs in Staples and Novelties.



Received the Award "For Great Elasticity and General Excellence of Gold Pens," at Phila. Ex., '76.

Catalogues mailed free. Handsome show cases loaned for display of goods.

GILES, BRO. & CO.



GILES, BRO. & CO.

Wholesale,
Importing and
Manufacturing

JEWELERS,

101 and 103 STATE STREET,

CHICAGO, ILLS.

Complete Illustrated Catalogue Furnished the
Trade upon Application.

WILLIAM H. BALL,

—MAKER OF—

GOLD BRACELETS

WITH THE PATENT GUARD.

IMPOSSIBLE TO LOSE THIS BRACELET.

A FULL LINE OF

BANDS, BANGLES, PADLOCK AND KEY, AND BRAIDED GOODS,

9 JOHN ST., NEW YORK.

SAN FRANCISCO OFFICE, 120 SUTTER ST.

FACTORY, NEWARK, N. J.

Goods Sent on Selection to Responsible Parties.



L. A. CUPPIA,

Manufacturing Jeweler,

19 Union Square, N. Y.

SILVER CANE HEADS,

A Large and Comprehensive Assortment of New and Original Designs.

AND IMPORTER OF

SILVER FILIGREE JEWELRY

Embracing a Large and Varied Assortment of Popular Designs.

SILVER JEWELRY.

SILVER BRACELETS A SPECIALTY.

SELECTION PACKAGES SENT ON APPROVAL.

CLEMENS HELLEBUSH,

MANUFACTURER, IMPORTER AND WHOLESALE JEWELER,

Dealer in everything required by the Jewelry Trade.

DIAMONDS.—Dealers will find in my stock an assortment of Diamonds unequalled in the West, embracing a choice variety of loose and mounted Stones in all qualities.

WATCH CASES.—In Gold and Silver, of all makers, to fit American Movements.

WATCH MOVEMENTS.—Include always a full stock of Waltham, Springfield, Hampden and Howard, together with a large assortment of fine and low-priced Swiss Watches.

SILVER PLATED WARE.—I have an unusually fine assortment of the choicest patterns of Flat and Hollow Ware of the best known manufacturers.

SOLID GOLD AND ROLLED PLATE JEWELRY.—This department is replete with Staple Goods and Novelties.

FRENCH CLOCKS.—Of our own importation, including all grades, with prices exceedingly low.

AMERICAN CLOCKS.—I am the General Agent in Cincinnati for the celebrated Seth Thomas Clocks, a full line of which will always be found in stock.

TOOLS AND MATERIALS.—In this department will be found everything required by Watch Makers.

Illustrated Catalogues sent to Dealers only upon Application.

CLEMENS HELLEBUSH,

77 West 4th Street, CINCINNATI, O.

PATENT IMPROVEMENT IN COUNTER + SHOW + CASES, WITH PERPENDICULAR SLIDING DOORS. DUST PROOF.

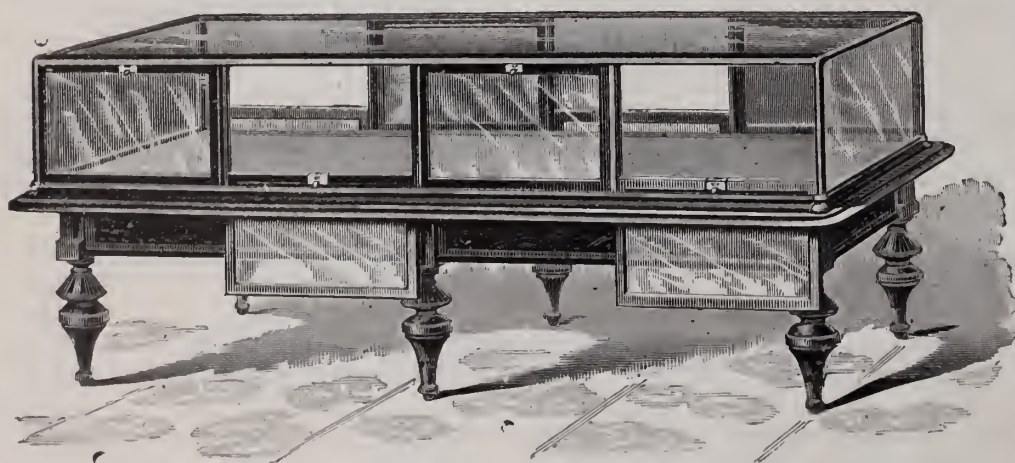

The Advantage and Convenience of these Show Cases will be apparent to everyone.

The doors are more conveniently opened and closed, less liable to get out of repair or broken, articles are more easily reached in wide cases, mirrors are more safe, it dispenses with hinges, economizes room, excludes dust, and is air tight when closed.

Drawings furnished and estimates given for fitting stores in cabinet work complete.

Letters Patent having been granted us for the construction of these doors, we shall prosecute all parties using Cases which infringe on our Patents.

REFERENCES:—Gorham Mfg Co., Rogers & Bro., Mitchell Vance & Co.,
Meriden Britannia Co., M. S. Smith & Co., Detroit, Mich.
D. Valentine, Syracuse, N. Y.

B. & W. B. SMITH,
220 West 29th Street, New York.

M. Anderson, No. 57 State Street, Chicago, has the exclusive right to manufacture and sell our Improved Cases for the States of Wisconsin, Illinois, Missouri, Mississippi, Arkansas, and all States West of same.

CATALOGUE OF STYLES SENT ON APPLICATION.

AMERICAN WATCH TOOL CO.,

WALTHAM, MASS.

MANUFACTURE THE

WHITCOMB LATHE,

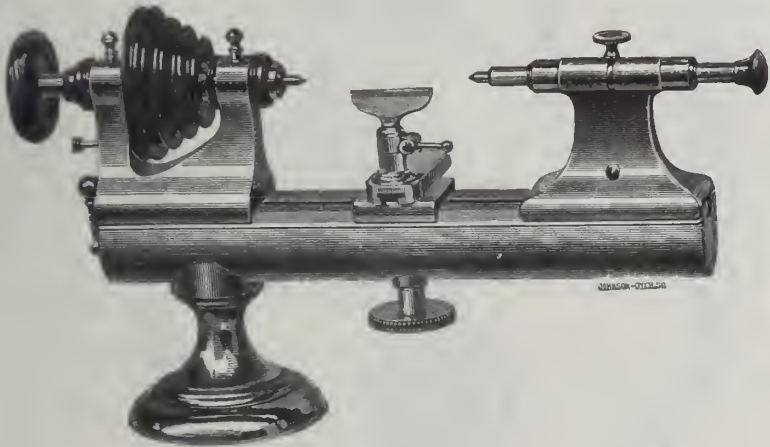

AND THE

"Webster" Foot Wheel,

We guarantee it to be a worthy companion to the Whitcomb Lathe.

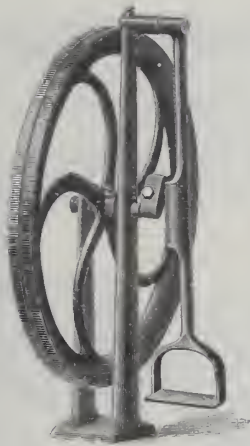

It is **not** a cheap made wheel but **First-class** in every respect.

PRICES:

30 lb. Wheel, for No. 1 Lathe, 20 inches in diameter,	\$12.00
40 " " " 1½ " 20¾ " "	13.00
50 " " " 2 " 21½ " "	14.00

DESCRIPTION.—The wheel runs on a hard steel arbor. It is clamped to the arbor by a set screw against a split bushing. This does not bend the arbor as in the case where the set screw is against the arbor. On the crank pin is a friction roll, having a hardened steel bushing, which runs on a hard steel pin. The swinging treadle is the **easiest** motion, and effects the body **less** than the foot treadle.

SEND FOR NEW CATALOGUE.

Our No. 1½ Lathes are Fast Superseding all other Sizes.

Soft Lathes have Hard Mouths, Hard Wire Chucks and Hard Tail Stock Spindles.

MARTINS & TISSOT,

Manufacturers of

GOLD WATCH CASES,

15 MAIDEN LANE, NEW YORK.

8 KARAT CASES A SPECIALTY



Our 8 Karat Cases are of Superior

STYLE,
CONSTRUCTION
AND FINISH

to any now made, (as our constantly increasing production will attest), and are made also in large variety of styles.

LARGE STOCK
Constantly on Hand.

Also 14 KARAT CASES in Large Variety.

JOBGING TRADE SOLD ONLY.

Birch's Patent Self-Adjusting Watch Keys.

FOR SALE BY THE TRADE GENERALLY.



2.—POCKET KEY.
(Brass.)



3.—POCKET KEY.
(Nickel Plated.)



4.—POCKET KEY.
(Nickel Plated, Hexagon Shell.)



5.—POCKET KEY.
(Heavy Rolled Gold Plate Mountings.)



6.—CELLULOID MOUNTED KEY.
(With Heavy Rolled Gold Plate Tips.)



35.—POCKET KEY, CELLULOID MOUNTINGS.
(Imitation Malachite, with Extra Heavy Rolled Gold Plate Tips. 18. K.)



7.—BENCH KEY. (Brass Handle.)



8.—SHORT WOOD HANDLE KEY.
(Nickel Plated, for Bench or Pocket Use.)



9.—LONG WOOD HANDLE BENCH KEY. (Nickel Plated.)

Made in 37 Styles. Circulars on Application.

J. S. BIRCH & CO., 38 Dey Street, N. Y.

F. P. LOCKLIN & BRO.,



MANUFACTURERS OF
**GOLD & SILVER
HEADED
CANES**
— AND —
BRACELETS.

142 FULTON STREET,

NEW YORK CITY.

KEY
Patented Jan. 25,
1881.

TAG
Patented Jan. 25,
1881.

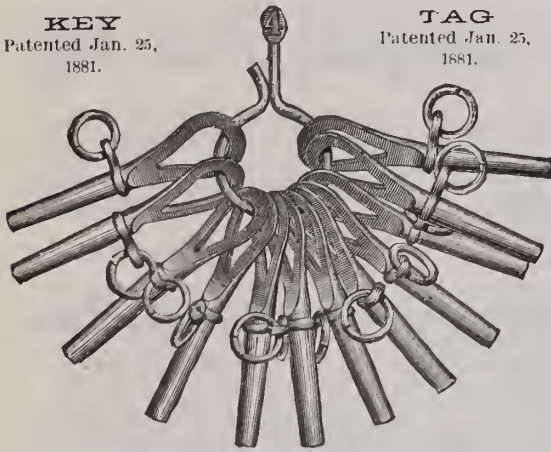

**A. N.
CLARK**
PLAINVILLE,
CONN.,

Manufacturer of

**Watch Case Springs, Watchmakers' & Jewelers' Bench Tools,
CROSBY'S JEWELING TOOLS, &c.**

STOP IMPORTING KEYS!

For Low Price Key Use the

New Style Loop Key.



A plain Steel Key of good appearance, and excellent quality. It will not wear the pocket. It has a swivel, and is much better made than the imported plain steel or iron keys.

PRICE PER CROSS, FINE NICKEL FINISH, \$2.25
Postage, 10 Cents Per Cross Additional.

This Key is good and cheap enough to become universal. Send business card for illustrated price list. Enclose three cent stamp for sample key.

SOLD BY JOBBERS IN WATCH MATERIALS AND NOTIONS.

A. N. CLARK, Plainville, Conn.

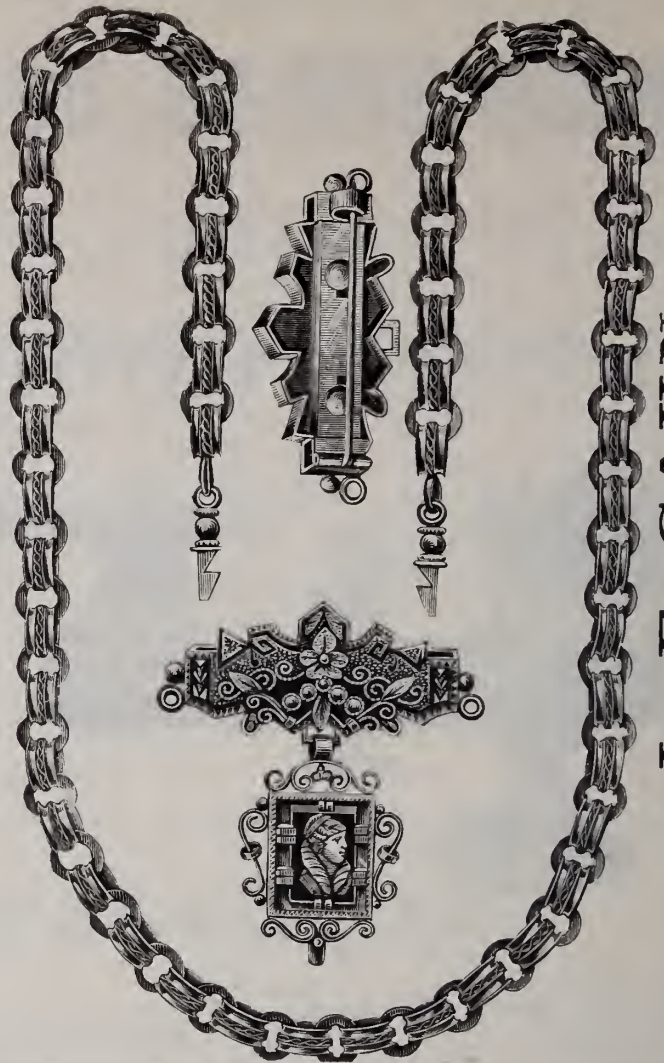

L. F. CAHN,

Manufacturer of all kinds of Gold Chains, Chain Bracelets; also a full line of Seal and Fancy Rings, and Patentee of Cahn's Patent Chain Snap. These goods are made in 10 and 14 karat gold, and can be obtained through any Jobber in the U. S., or direct from me. A large stock of Gold Chains constantly on hand. Goods sent on approval to responsible houses.

The Burbank Manufacturing Company

Manufacturers of **GOLD & SILVER**



**GOLD
SILVER,
STEEL,
RUBBER,
And SHELL,**

Thimbles,



**EYE GLASS
Self Adjusting.**

SPECTACLES AND EYE-GLASSES



OF ALL DESCRIPTIONS.

SOLID GOLD RINGS

Office, 14 MAIDEN LANE. NEW YORK.

Manufactory, Springfield, Mass.

HUTCHISON & HUESTIS,

❖ SOLID ❖ GOLD ❖

RING MAKERS

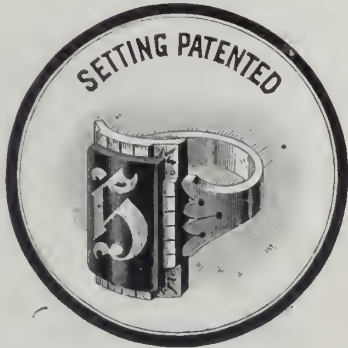

QUALITY
GUARANTEED.

FOR
JOBBER ONLY.

No. 185 EDDY STREET,
PROVIDENCE, R. I.

New York Office, . . . 196 Broadway.

WM. M. FISHER & CO

Sole Manufacturers of the

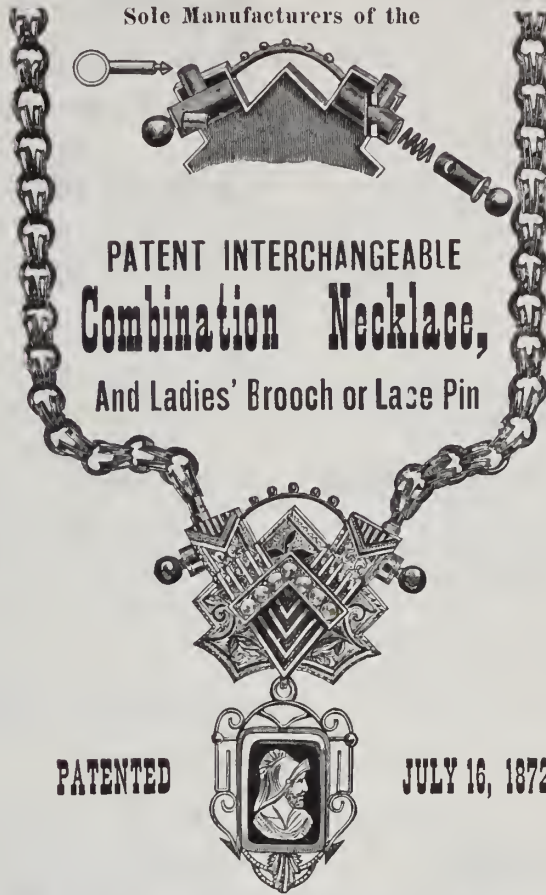

GOLD
AND
SILVER
CHAINS.

Gold Chain
TRIMMINGS.

Complete
Assortment of
14-k.

Ribbon Fobs.

FOR SALE BY THE LEADING JOBBERS

Patented November 18, 1873.

MORRISON'S Gold & Silver Solutions

For Electro-Plating Without a Battery.

Invaluable for Watchmakers and Jewelers. So simple that any one can use them.
Price, Gold Solution, - - \$3.00 Silver Solution, - - \$1.50

MANUFACTURED BY

ARTHUR B. MORRISON, Portland, Maine.

FOR SALE BY

Jussfeld, Lorsch & Co., New York; Henry Ginnel, New York; Cross & Beguelin, New York; Kearney & Swartchild, Chicago, Ill.; Louis A. Scherr & Co., Philadelphia, Pa.; Duhme & Co., Cincinnati, O.; Harwood Bros., A. Paul & Co., Palmer, Bachelder & Co. Boston, Mass., and material dealers generally.

BEWARE OF BASE IMITATIONS put up by unprincipled persons. None are genuine without the Trade Mark which consists of the letters A. B. M. in monogram and fac simile of Medal awarded by U. S. Centennial Commission.

To Advertise Over the Whole Country with a Small List.

Advertisers desiring to reach every section of the country, without investing a very large amount of money, will find the following a good list of papers:

Weekly. Price per line.		Weekly. Price per line.	
Boston, Mass.,	Journal \$ 15	Baltimore, Md.	American \$ 20
	Congregationalist 25	Louisville, Ky.	Courier-Journal 60
	American Cultivator 30	Cincinnati, Ohio	Times 50
	Youth's Companion 2 00		Enquirer 75
New York City	Sun 50		Commercial-Gazette 65
	Tribune 1 00	Toledo, Ohio	Blade 50
	Christian Advocate 50	Chicago, Ill.	Inter-Ocean 75
	Harper's Weekly 1 00		News 40
	Observer 30	St. Louis, Mo.	Tribune 25
	Witness 75		Republican 50
Philadelphia, Pa.	Times 25		Globe-Democrat 50
	Press 25	San Francisco, Cal.	Chronicle 37
		Toronto, Ont.	Globe 25

Price per line in all the Papers \$14.47
Ten lines one time costs \$144.70.

A DEFINITE OFFER.

For \$140 net cash we will insert 10 lines, agate space, one time, in all of the above 26 papers, and give one insertion, without further charge, of the same advertisement in 350 country weeklies, with a guaranteed circulation of more than 175,000 copies. For \$75 we will insert 5 lines once, or 3 lines for \$50. Catalogue of the weeklies sent on application.

If the advertisement is already appearing in any of above papers, we will substitute others of similar circulation and value. Address
GEO. P. ROWELL & CO.,
NEWSPAPER ADVERTISING BUREAU, 10 Spruce St., New York.



J. F. FRADLEY & CO.,

Manufacturers of Fine

Gold and Silver Headed Canes

AND SPECIALTIES.

23 JOHN STREET, NEW YORK.

Designs furnished for Presentation Canes. Illustrated Catalogues sent upon application.

Special Inducements to the Jobbing Trade.

E. J. BOYCE,

(Formerly Boyce & Walnwright.)

→ **MANUFACTURING + JEWELER** ←

SOLID GOLD RINGS A SPECIALTY.

My **BAND RING** Specialties, for **PRICE, QUALITY** and **FINISH**, are not equaled by any in the Trade,

383 WASHINGTON ST.,
BOSTON, MASS.

S. KOPELOWICH & BRO.,

THE ONLY EXCLUSIVELY

Jobbing Jewelry House

Between New York and Chicago.

Jobbers of American and Swiss Watches, Jewelry, Silverware, Spectacles, &c.

A large assortment of which we have constantly on hand.

Selection packages sent to responsible parties.

Room 1, Larned Building, Syracuse, N. Y.

Solid Gold Rings a Specialty.

WM. H. ELY,

SOLID GOLD RINGS,
MANUFACTURER.

Viz., Plain, Chased, Engraved, Enameled, Engine Turned, Shield and Scale. All qualities guaranteed. Orders Promptly Executed.

58 Nassau Street, New York.



C. B. WILKINSON,
Manufacturing + Jeweler,

8 JOHN ST., N. Y.

Medals, Badges and Masonic Jewelry
A SPECIALTY.

Designs furnished free upon application.

H. WUNDOEHL,

GOLD & SILVER REFINER,

Assayer and Sweep Smelter,

21 JOHN ST.,

Bct. Broadway & Nassau St., **NEW YORK.**

The highest price paid for Gold, Silver and Platinum.
Fine Gold, Silver and Copper always on hand,

JACOB STRAUSS,
WATCHES & JEWELRY

AT WHOLESALE.

REMOVED FROM

18 TO 25 JOHN STREET, N. Y.

Rings and Rolled Plated Chains
A SPECIALTY.

New + York + Morocco + Case + Co.

CASES FOR

Jewelry, Silverware & Watches

OF EVERY DESCRIPTION.

Boxes and Trays for Jewelry Travelers,

TRUNKS FITTED UP WITH TRAYS.

Show Cases and Window Fittings
a Specialty.

No. 69 NASSAU STREET, NEW YORK.

W. H. LUDEMAN,

No. 75 & 77 Nassau Street,
NEW YORK.

FINE AND COMPLICATED
WATCHES

Of every description repaired and regulated.

Stem Winding and Escape Wheels

Cut and finished to order with accuracy
and promptness.

J. J. COHN,

IMPORTER OF

→ **WHITBY JET,** ←

MANUFACTURER OF

Gold & Rolled Plate Jewelry,

Bracelets, Charms & Lockets a Specialty.

12 MAIDEN LANE, N. Y.

Goods Sent on Selection if Satisfactory References are Given.

WM. SCHWENCKE,

Manufacturing & Jobbing Jeweler,

43 MAIDEN LANE, N. Y.

Gives particular attention to the Repairing and Jobbing Department of the Jewelry Business. Prompt Attention, Moderate Prices and First-Class Workmanship Guaranteed to all. Country Orders Promptly attended to.

L. SAUTER.

1 MAIDEN LANE,

Manufacturer of

Fine and Diamond Jewelry

Rings, Studs, Buttons, Scarf Pins, Etc.

Hair Jewelry in all its branches.

Jobbing of every description promptly attended to.

The Finest Line of High-Class English
Watches in the U. S.

GEO. E. WILKINS,

SYRACUSE, N. Y.

Agent for the Celebrated Watches of

Chas. Frodsham & Co., London,

W. G. Schoof, London,

Karl Zimmerman, Liverpool.

Timing and Adjusting done for the Trade.

Correspondence Solicited from the Trade.

HIBBARD G. GILL,

GOLD AND SILVER

Watch Case Manufacturer,

Dealer in Watches,

American Watch Movements Always on Hand.

618 Chestnut Street,

Fifth Floor.

PHILADELPHIA.

HENRY TROEMNER,

710 Market Street,

PHILADELPHIA.

Manufacturer of Fine Gold Scales,

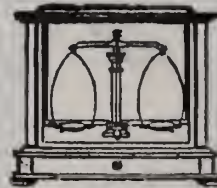

DIAMOND SCALES,

Bullion Balances and Weights, in use at all the U. S. Mints and Assay Offices.

PRICED CATALOGUE ON APPLICATION.

JNO. F. LUTHER,

MANUFACTURER OF

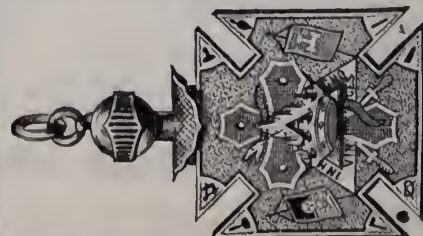

Masonic Jewelry.

79 Nassau Street, N. Y.

Illustrated Catalogue sent on application.

PLATINUM

—FOR—

Scientific and Mechanical Purposes,

IMPORTED AND FOR SALE BY

The S. S. White Dental Manufacturing Co.
SCRAP PURCHASED.

PHILADELPHIA, Chestnut St., cor. Twelfth.
NEW YORK, - 767 and 769 Broadway.
BOSTON, - - - 160 Tremont Street.
CHICAGO, - - 13 and 14 E. Madison St.

ADOPTED AND IN USE BY

RANDEL, BAREMORE & BILLINGS,
88 Nassau Street, N. Y.

THE TRADE SUPPLIED.
Descriptive Circulars Furnished
on Application to
George W. Washburn, Patentee,
88 Nassau St.,
NEW YORK.

SAFETY
EAR FASTENING,
Pat. May 10, '81—Oct. 11, '81. 

Jointed
EAR WIRE
AND
BAR BETWEEN CRAMP'S
OF SETTINGS. 

Patented March 1, 1881.

TELESCOPIC
SAFETY PIN CATCH. 
Pat. Sep. 20, '81—Jan 10, '82.

CHURCH'S PATENT IMPROVED
DOUBLE SPIND INDICATOR
Either Right or Left.

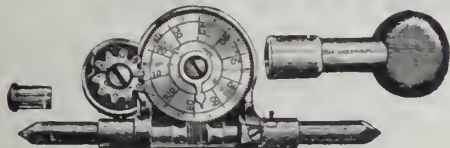

MONTGOMERY & CO.,

Importers of Stubs' Files, Tools & Steel,
GROBET SWISS FILES. CHESTERMAN'S TAPES, RULES, &c.
Horse Shoe Magnets. Hubert's French Emery Paper.
WM. SMITH & SON'S CELEBRATED MUSIC WIRE.
105 Fulton Street, N. Y.

W. W. OLIVER,
Manufacturer of Hand and Power
Rolling Mills,
For Jewelers and Silversmiths.

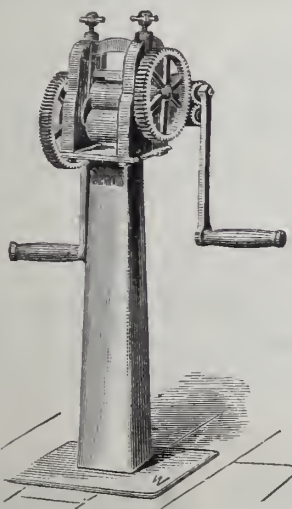

The "Little Giant" Ring Bender
Hollow Spindle Lathes, Punching and Drop Presses, Polishing
Heads, Dies, Metal Laps, Etc.
39 Clinton St., Buffalo, N. Y.
Illustrated Price List mailed free upon application.

LOGUE & BARD,

Wholesale Jewelers,
104 State St., Chicago.

Our Stock is entirely New and Complete, Gold and Silver American Watches, Gold and Rolled Plate Chain, and Jewelry in all leading styles, and best quality guaranteed. Our motto is promptness and square dealing in every case.

WM. RAWLINGS, JR.,
Manufacturing Jeweler,
FACTORY:
913 Arch Street, Phila.

FINE GOLD RINGS A SPECIALTY.

Goods sent on approval to any part of the country upon receipt of satisfactory reference.



HENRY LEFORT,
Stem-Winding Watch Crown Manufacturer,
Crowns and Pushers in gold, all sizes, quality and color, made to order. Silver crowns and pushers always on hand.
60 Arlington Street,
Corner William Street,
NEWARK, N. J.

I. PFORZHEIMER,
D. KELLER.

I. B. ETTINGER,
H. J. FINK.

Pforzheimer, Keller & Co.

Manufacturers of

—* FINE —*

JEWELRY,

And Dealers in

American and Swiss Watches,

No. 24 JOHN ST., NEW YORK.

H. WASEDELL,

RUBBER STAMPS,
BRASS STAMPS,
Brushes, Inks, &c.

Stencil Plates,

STEEL STAMPS.

Burning Brands,

SEALS & PRESSES,

No. 7 North William St.

First house South of East River Bridge, N. Y.

FINE STEEL STAMPS A SPECIALTY.

P. JANDORF & BRO.,

Watches and Jewelry,

196 BROADWAY,

Bet. John & Fulton Sts., NEW YORK.

We Publish No Price Lists.

C. KNAPP,

Manufacturer of

Superior Band
and Children's
Stone & Fancy
RINGS

And Enameled Goods,
41 Maiden Lane,
NEW YORK.



WILLIAM ERNST MOUTOUX,
Leading Artist in Hair of the World

AND MANUFACTURER OF

GOLD AND HAIR JEWELRY,

OFFICE AND FACTORY,
81 Nassau St., Rooms 1 & 2,

BRANCH,
18 Lawrence St. West of 126th,
Near Ninth Ave., NEW YORK.

My New Catalogue of 1700 New Designs of Monuments with Weeping Willows, Wreaths, Bouquets, Crosses, Churches, Sceneries, Portraits, Pet Animals, Engravings of the Most Difficult Description, Etc. Wholesale prices for Hair Chain Braids in Assorted Colors, by the gross or dozen at half of book prices. Devices made at half of book prices if necessary. 15-5 per cent. cash discount on the prices of the old book.

ESTABLISHED 1873.

CHAS. P. HEROLD,

MANUFACTURER OF

18 K. DIAMOND MOUNTINGS,
DIAMOND JEWELRY,

916 Chestnut St.,

Second Floor. Philadelphia.

The
Spirings will never rust, and are much more durable
than steel.



Please note a reduction of 50 cents per dozen on
286 and 288 Celluloid Eye-Glasses, No. 7 Catalogue.

The above cut represents a fine bust of Lord Byron, about twenty-five inches high, which will be furnished to parties purchasing 6 dozen Celluloid Eye-Glasses. It is securely packed, ready for shipment, and will make a very handsome ornament for the show window.

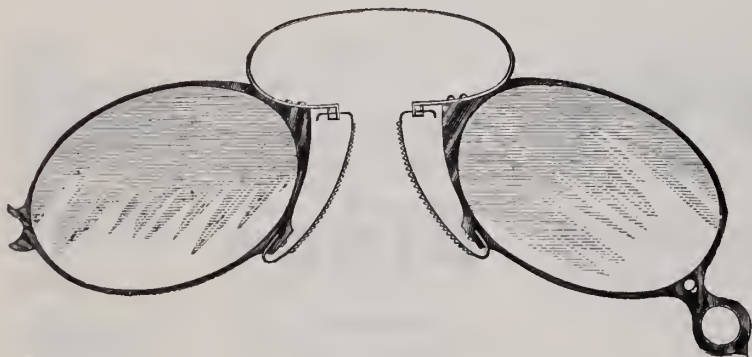

The above cut represents No. 306 Eye-Glass with an Adjustable Nose Piece, which we make in

Gold, Nickel, Celluloid, Rubber, Steel and Frameless.

This style of Eye-Glass is very popular. We make many NEW and EXCLUSIVE Styles that give a Dealer handling our goods an immense advantage over those who sell the ordinary line of goods in the market.

Special Goods, with Trade Mark, made for Dealers to Order.

Great Variety! Novel Styles! Attractive Goods!

While many houses have complained of dull trade this Spring, we have been increasing our force.

ACTIONS SPEAK PLAINER THAN WORDS.

Spencer Optical Manufacturing Co.,

13 MAIDEN LANE, NEW YORK.

Established 1853.

L. H. KELLER & CO.

Successors to G. A. HUGUENIN,

IMPORTERS OF

**WATCHMAKERS' and JEWELERS'
TOOLS AND MATERIALS.**

GENERAL AGENTS FOR

The Philadelphia Watch Company,

— AND —

American Watch Tool Co.,

MANUFACTURERS OF

THE WHITCOMB LATHE.

SOLE AGENTS IN THE UNITED STATES FOR THE SALE OF

LUTZ'S

**CELEBRATED ROLL HARDENED HAIR SPRINGS,
MOEBIUS OIL**

For Chronometers, Watches, Clocks, Telegraph Instruments and all other delicate machinery. Made from Pure Refined Neatsfoot Oil, and Warranted to Excel anything in the market as a Lubricator. **SAMPLES GRATIS.**

OUR OWN GRADUATED

AND JURGENSEN RECOILING MAINSPRINGS, pronounced by all experts Superior to all. Sold in Separate Strengths or Force.

Extra Fine Pinions cut from Solid Steel Wire. Gauged Hole Jewels of First-class Workmanship. A Full Line of Materials, for the PATEK, PHILIPPE & CO. GENEVA WATCHES, and all other

Celebrated Makers.

THE BOLEY LATHES AND TOOLS,

Celebrated for their Practical, Substantial and Workmanlike Construction, Superior Design and Finish.

Our aim is to furnish nothing but First-class Serviceable Goods, especially manufactured for the Consumer, and not solely for the Market, like the cheap trash advertised in highly illustrated catalogues with which the country is flooded.

TREATISE ON MODERN HOROLOGY IN THEORY AND PRACTICE. By M. CLAUDIUS SAUNIER, Ex-Director of the School of Horology at Macon, France; Knight of the Legion of Honor, etc.; Hon. Sec. to the Paris Society of Horologists. Translated from the French by JULIEN TRIPPLIN, Besançon Watch Manufacturer, and EDWARD RIGG, M. A., Assayer in the Royal Mint, London.

This Work comprises 832 large octavo pages, with 78 wood cuts and 21 colored double-page copper-plate engravings. Bound in half calf, with an appropriate and handsome ornament in gold on front cover.

Price, \$15.00.

THE WATCHMAKER'S HAND BOOK. By the same author and translators. Intended as a companion to the Treatise. Bound in cloth.

PRICE, \$4.00.

64 Nassau Street,

NEAR MAIDEN LANE,

NEW YORK.

L. H. KELLER,
EDWARD HUNZIKER,
F. J. BOESSE.

We do not publish Price Lists.

SPECIAL NOTICES.

PERMANENT situation is offered to a good manufacturing jeweler and hard solder jobber. Address Burdick & Otero Manufacturing Jewelers, Pueblo, Col.

WANTED—A situation by a young man of five years' experience in watch work and repairing jewelry. Engraver and manufacturing jeweler. Address B. B. C., care Jewelers' Circular.

PERMANENT situation is offered to a good watch repairer and soft solder jobber and can wait on customers occasionally. Address Burdick & Otero, Manufacturing Jewelers, Pueblo, Col.

WANTED—A good watchmaker to go to Leadville, Col. One who can engrave preferred. Permanent situation and fair salary to the right man. Address Diamond, P. O. Box 990, Leadville, Colorado.

JEWELRY STORE FOR SALE—In thriving western city of 7,000 inhabitants. Leading store. Good reasons for selling. Will sell stock, fixtures and tools, or without tools. Address Y, care Jewelers' Circular.

FOR SALE CHEAP—S. & C. A. Baker's stock of jewelry, fixtures, Fessold's astronomical regulator, safe, etc., will be sold low if applied for at once. For particulars address H. P. Guyer, Assignee, 92 State St., Albany, N. Y.

SITUATION wanted by a first-class watchmaker, can also repair jewelry very well. Will work in the U. S. or South America. Salary expected from \$20 to \$30 per week, according to locality. Address Call Box 53, Frederick, Md.

MOSELEY & CO., Elgin, Ill., manufacturers of the "Moseley" Lathe, with full line of fixtures and attachments. Designed especially for the watchmaker and repairer. Combining accuracy, durability, convenience and style.

WANTED—A situation by an experienced watchmaker, 13 years' constant experience at the bench. Good set tools. Good reference. Age 21 years. South or west preferred. Address D. S. Porter, Fergusonville, Del. Co., N. Y.

FOR SALE—Stock and fixtures of a jewelry store well located. Established 13 years. Doing a good business. Fine chance for a man with small capital. Stock clean. Will reduce stock, etc. to \$1,500. Address W., care Jewelers' Circular, or J. E. Spencer, 13 Maiden Lane, N. Y.

GEORGE E. WILKINS, manufacturer and importer of cutters for watchmakers' use, stem-winding cutters of all the different forms, rounding up cutters of the finest quality, also ratchet cutters. A large stock of second hand and new marine chronometers. No. 21 South Salina street, Syracuse, N. Y.

FOR SALE—POSSESSION IMMEDIATE—The stock and fixtures of jewelry store on one of the leading thoroughfares of Philadelphia. Large watch and diamond retail and jobbing trade. Owner going to retire. Stock or fixtures alone. Great sacrifice. H. Mulligan, 33 and 35 S. Eighth Street, Philadelphia, Pa.

AGENTMAN, twenty-six years old, and of ten years experience in the watch and jewelry business, experienced on the road, wishes to connect himself with a good jobbing house to sell goods in North Carolina, South Carolina or Georgia. Best of reference given. Address Salesman, care Jewelers' Circular.

JEWELRY STORE FOR SALE—The stock, fixtures, lease, etc. of the leading jeweler in a live manufacturing western city for sale. The present owner desires to retire on account of poor health. Sum required for the purchase from \$8,000 to \$12,000. Positive proof given of a very profitable and increasing business for over 15 years. For information, address Robert M. Wilcox, care Rogers, Smith & Co., Meriden, Conn.

WANTED—By a competent, live business man, a position to travel or be stationed as European buyer with a large sold house. Understands the business in all its various branches. Understands diamonds and watches of all kinds, etc. Practically and theoretically could superintend a factory, or control the products of good factories in Europe, and get goods suited to the American market. There is scarcely any goods used by our trade but what I understand, etc. Address (Sold,) care Jewelers' Circular.

FOR SALE—We will sell the safe and fixtures of a well-established jewelry business and as many goods as a man desires to buy. \$500 will give a man a good start. This is one of the best towns in Nebraska, 75 miles west of Omaha on the N. P. R. R., 2,000 inhabitants. County seat of one of the best counties. All the watch work one man can do. Cheap rent. No competition for 16 miles. We would also take a partner for this same business with a small capital, or we would pay a good workman good wages to run it. Thus you will see 3 chances for some good man. For further explanation address to The Leading Jeweler of Columbus, Neb., Lock Box 100.

WM. DOWNEY,

Successor to Downey & Smith,

Manufacturing Jeweler,

24 John Street, N. Y.

Fine Stone Locket, Seals and Rings, Flexible Bracelets, Rich Diamond Mountings, etc.

BUYERS' DIRECTORY.

NEW YORK.

Assayers and Sweep Smelters.

Wundoehl, H.—Gold and Silver Refiner, Assayer and Sweep Smelter. 21 John Street, N. Y.

Badges and Medals.

Stockwell & Newman—19 John Street. Manufacturers of Badges, Medals and Presentation Pieces in Gold and Silver. Also Jewelry and Mounters of Diamonds. Designs supplied.

Wilkinson, C. B.—Manufacturing Jeweler, 8 John Street, N. Y. Medals, Badges and Masonic Jewelry a Specialty. Designs furnished free upon application.

Band Rings.

Knapp, Charles, 41 Maiden Lane, N. Y. Specialty: Superior Band Rings, also Ring Shanks & Heads for Seal and Diamond Rings.

Black Onyx Jewelry.

Cox & Sedgwick—Manufacturers of Black Onyx Jewelry, No. 26 John St. New York.

Lawson, Samuel—No. 18 John Street. Manufacturer of Black Onyx Jewelry. Coral repaired for the trade. Goods sent on approval to responsible dealers.

Woglom & Miller—Manufacturers of (exclusively) Black Onyx Jewelry, 32 & 34 John St., N. Y.

Blue Enameled Locket.

Bissinger, Philip & Co.—Importers of Diamonds, Pearls and Precious Stones. Agent for the Bohemian Garnet Goods. Blue Enameled Locket, 22 John St., N. Y.

Hess & Schliesser—Importers of Diamonds, Fine Jewelry and Novelties in French Goods. Specialties: Gold and Blue Enameled Locket, Charms and Crosses. 25 Maiden Lane.

Bohemian Garnet Jewelry.

Bissinger, Philip & Co.—Importers of Diamonds, Pearls and Precious Stones. Sole Agent for the Bohemian Garnet Jewelry. Blue Enameled Locket, 22 John St.

Boxes, Wood Mailing and Nested.

Maine Manufacturing Co.—Successors to Swift M'fg Co., makers of Wood Mailing and Nested Boxes for Mailing and Express purposes. J. Spencer Taylor, Agent, 18 Courtlandt St., N. Y.

Wiesbauer, J.—Manufacturer of the Sliding Cover Wood Mailing Boxes. All Sizes Made to Order. Buffalo, N. Y.

Clock Companies.

Ansonia Clock Co.—Manufacturers of every description of Clocks. 11 to 21 Cliff street, New York.

Kroeber, F.—Manufacturer and Dealer in American and French Clocks, No. 8 Cortlandt Street.

New Haven Clock Co.—16 and 18 Park Place, N. Y.

Seth Thomas Clock Co.—20 Murray Street, N. Y.

Waterbury Clock Co.—M. Bailey, Treasurer, Manuf. and Jobbers, No. 4 Cortlandt St., N. Y., and No. 197 State Street, Chicago.

Wm. L. Gilbert Clock Co.—No. 6 Murray Street, Manufacturers of Clocks. Factories, Winsted, Conn.

Yale Clock Co.—Manufacturers of Novelties in Clocks, 52 Maiden Lane, N. Y.

Corals and Coral Jewelry.

Cuppia, L. A.—Importer of Coral and Silver Filigree Jewelry, 19 Union Square, N. Y.

Cameo Cutters, Etc.

Peiter, Theodore—Cameo and Intaglio Engraver. Patentee of the Cameo-Intaglio. No. 2 Bond Street, near Broadway, Room 4 New York.

Charms & Gold Watch Keys.

Rupp & Held,—Manufacturing Jewelers, Charms and Gold Watch Keys, with French and English Ratchets, a specialty. 15 John St., N. Y.

Crucibles.

Berge, J. & H.—Established 1850, Manufacturers and Importers of Sand Crucibles, Covers, Chemical Porcelain, Glassware, and Jewelers' and Assayers' Supplies, 95 John Street, N. Y.

Berge, J. & Son.—Importers of Sand Crucibles and Covers, Jewelers' Tools and Materials. Manufacturers of Berge's Improved Assay and Enamel Furnace, Assay and Enamel Muffles, &c. 32 and 34 John Street, N. Y.

Cutlery.

Harrison Bros. & Howson,—Manufacturers of Fine Ivory and Pearl Table and Pocket Cutlery, Carvers in Cases; Nutpicks, Nutcracks and goods suitable for the jewelry trade. 126 Chambers Street. W. C. Burkinshaw, Sole Agent.

Diamond Brokers.

Anderson, Otis—Diamond Merchant and Broker, always ready to pay cash for bargains in Diamonds and Precious Stones, 4 & 6 John Street, N. Y.

Bernhardt, Richard—Diamond Broker and Importer, 65 Nassau Street (Room 6), N. Y. Paris, 20, rue des Petites-Écuries.

Friend S. & Son—Brokers and dealers in Diamonds 33 John Street, cor. Nassau St. New York.

Herbert, R. J.—Diamond Broker and Dealer, 26 Maiden Lane.

Diamond Importers.

Bissinger, Philip & Co.—Importers of Diamonds, Pearls and Precious Stones. Agent for the Bohemian Garnet Goods. Blue Enameled Locket, No. 22 John St., N. Y.

Bruhl, D. & M.—Established 1848. Importers of Diamonds and Precious Stones. 14 Maiden Lane, New York. Branch office, Paris, Also 111 Broad Street, Providence, R. I.

Brunswick, S. & Co.—Importers of Diamonds, 17 Maiden Lane, New York. Paris, Rue Lafayette. Amsterdam, Damstraat.

Citroen, L. B., & Co.—Diamonds. 21 John St., N. Y. Cutting Works, 57 & 61 Rapenburgerstraat, Amsterdam. House in Paris, 44 Rue Laffitte.

Engelmann, M. & Co.—Importers of Diamonds, Pearls and Precious Stones. Specialties in Fine Colored Stones. 192 Broadway and 1 and 3 John Street, N. Y. Paris, 1 Boulevard St. Denis.

Faulkenau, Oppenheimer & Co.—Manufacturers. Diamonds and Diamond Jewelry. 40 Maiden Lane, N. Y.

Fera, Henry—Importer of Diamonds, and Manufacturer of Fine Diamond Jewelry. 4 & 6 John Street, New York. Amsterdam, Holland, 23 Loojersgracht.

Fox, M. & Co.—Importers of Diamonds, Rubies, Sapphires and Fancy Gems. No. 1 Maiden Lane, New York.

Hedges, Wm. S. & Co.—Importers of Diamonds, No. 170 Broadway, corner Maiden Lane.

Kuhn, Doerflinger, & Co.—Manufacturing Jewelers and Importers of Diamonds, 18 John Street, New York.

Leberthon, L. M.—Importer of Diamonds and Manufacturer of Fine Jewelry. 14 John Street, N. Y.

Neresheimer, E. Aug. & Co.—Importer of Diamonds. No. 21 Maiden Lane, New York.

Randel, Baremore & Billings—Importers of Diamonds, corner Maiden Lane and Nassau St.

Saunders & Ives.—Importers of Diamonds and other Precious Stones. No. 26 Maiden Lane.

Smith, Alfred H & Co.—Importers of Diamonds, No. 182 Broadway.

Taylor & Brother.—Importers of Diamonds and Diamond Jewelry. 676 Broadway.

Wickham, D. H. & Co.—Importer of Diamonds. No. 31 Holborn Viaduct, London, 24 Maiden Lane, New York.

Wolff, G. A.—Importer of Diamonds, Rubies, Sapphires, Pearls, and other Precious Stones, 65 Maiden Lane, New York. 12 Rue de Chateaudun, Paris.

Diamond Jewelry.

Bornemann, Louis.—Importer of Diamonds and Manufacturer of Rich Diamond Jewelry, 19 John Street, New York.

Chalumeau, D.—Diamond Jeweler and Manufacturer of Mountings. Novelties and Artistic Jewelry. No. 3 Maiden Lane, New York.

Hartje, G. & F.—Manufacturers of Diamond and Fine Jewelry, 39 Union Square, N. Y.

Haug & Luthy.—Manufacturers of Fine Diamond Mountings, etc. No. 130 Fulton St., N. Y.

Heller & Bardel.—Manufacturers of Diamond and Pearl Jewelry, and Dealers in Diamonds, Pearls, &c. 13 John Street.

Jeanne Brothers.—Manufacturers of Diamond Mountings & Rich Jewelry. 1 Maiden Lane.

Lacroix & Verpillier.—Manufacturers of Fine Gold Jewelry. Diamonds a specialty. 173 Broadway, N. Y.

Rosswog, C. & Son.—Manufacturers of Rich Diamond Goods. Nos. 5 and 7 Maiden Lane, N. Y.

Schilling & Nissen.—Dealers in Diamonds and Diamond Jewelry. No. 51 Nassau Street, New York, near Maiden Lane.

Voelker, C. T.—Manufacturer of 18-k. Diamond Mountings, Diamond Jewelry and Roller Chain Bracelets. 189 Broadway, New York.

Waterman & Lehmann.—Manufacturing Jewelers and Dealers in Diamonds. Diamond Work, and Fine fancy Rings a specialty, any piece of single work made to order. 37 Maiden Lane, N. Y.

Diamond and Pearl Setter, &c.

Archibald, Wm.—Diamond Setter for the Trade. Cameos, Pearls, Turquoises, Garnets, Amethysts, Doublets, Foil Backs, white and colored, Imitation Stones. 73 Nassau Street, N. Y., room 7.

Diamond Cutters.

Levy, Herman.—Importer, Cutter and Polisher of Diamonds. 105 Fulton Street, New York.

Dials, &c.

Farnsworth, C. E. & Co.—Successors to Jno. T. Gold, Manufacturers and Jobbers in Fine Watch Dials. 81 Nassau St., N. Y.

New York Dial Co.—Manufacturers of Fine Watch Dials. Henry Abbott, Agent, No. 7 Maiden Lane, N. Y.

Enameled Clock Dials and Figures.

Caeser Bros.—Manufacturers of Enameled Clock Dials, also letters and numbers for signs. 230 and 232 East 25th Street, New York.

Enamelers, Etc.

Nutt, J. D.—Enameler on Gold, Silver, and Copper. Linen finished Buttons and Studs. Enameling in colors. 32 and 34 John Street, New York.

Orr, J. O.—Enameler on Fine Jewelry. Enameled in Colors. Linen Finished Buttons and Studs. Band Bracelets. No. 75 Nassau Street, N. Y.

Orr, William N.—Enameler on Fine Jewelry. Masonic Jewels and Badges a specialty. Linen Finished Work. 79 Nassau Street, Room 18, New York.

Electroplaters, &c.

Jeanheur, F. & Son.—Gold and Silver Electro Platers & Fire Gilders, coloring Etruscan and Gold Jewelry a specialty. 125 Fulton St.

Engravers—Stone Seal, Etc.

Fackner, Edward.—Carver, Engraver and Chaser on Jewelry and Pencil Cases, lettering, &c., 19 John Street.

Holland & Gosling.—Stone Seal Engravers. Precious Stones inlaid and encrusted with Diamonds. No. 176 Broadway, New York, (fifth floor per elevator). Cameos cut and repaired.

Knapp, Chas. Engraver, Die Sinker & Stamper for Jewelry purposes. Ring Shanks & superior Band rings, 41 Maiden Lane, N. Y.

Park, Wm.—The Stone Seal Engraver. Arms, Crests, Monograms, etc., engraved on precious stones, 26 John Street, New York.

Weston, James F.—Stone Seal Engraver and incruiter of Precious Stones. Coats of Arms, Masonic, Odd Fellows, and other devices engraved. 32 John Street.

Fancy Goods, Clocks, Bronzes, Etc.

Baker, Pratt & Co.—Importers and Dealers in Jewelers' Fancy Goods. 19 Bond Street, N. Y.

Hart, James H.—Importer of French Clocks, Bronzes, Faïences and Porcelain Ware, and Dealer in Diamonds, Watches, Jewelry and Silver Plated Wares. 4 Maiden Lane, N. Y.

Le Boutillier & Co.—Importers of Fancy Goods, Clocks, Bronzes, &c., 3 Union Square.

Straus, L. & Sons.—Importers of Potteries, Faïences, Bisque Figures and Rich Fancy Goods especially adapted for the Jewelry Trade. 40, 42 and 44 Warren Street, New York.

Taylor & Bro.—Importers of French Clocks, Bronzes, etc. 676 Broadway, N. Y.

Gold and Silver Cane Heads.

Simons, Bro. & Co.—Manufacturers of Gold Headed Canes. 611 and 613 Sansom street, Philadelphia.

Gold and Silver Plating, Etc.

Bantle, A.—Gold, Silver and Electro-Plating, 130 Fulton and 89 Nassau Streets, cor. Fulton Street, (Room 36,) N. Y. Watch Case Polishing.

Gold Chains, Etc.

Beck, J. & Son, Manufacturers of Fine Gold Chains and Chain Bracelets, 10 Liberty Place, near Maiden Lane, N. Y.

Carter, Sloan & Co.—Manufacturers of Fine Gold Chain, 15 Maiden Lane, New York.

Dorrance, Edge & Co.—Manufacturers of the Celebrated Woven Fabric Gold Chain, No. 15 John Street.

Kaufmann Bros.—Manufacturers of Gold Chains, and Chain Bracelets, 26 John Street; Factory, 331 and 333 Bowery, N. Y.

Kohn, Alois & Co.—Manufacturers of Gold Chains. 9 Maiden Lane, N. Y.

Nordt, Charles.—Successor to Nordt & Schlag, manufacturer of Gold Chains and Chain Bracelets. Jobbing and Refilling Old Chains promptly attended to. No. 17 Maiden Lane, N. Y.

Saxton, Smith & Co.—Manufacturers of Fine Gold Chain, No. 14 John Street, N. Y.

Schlag, Chas.—Late Nordt & Schlag, Manufacturer of Gold Chains, Chain Bracelets, and Fine Jewelry, 177 Broadway, N. Y.

Smith, W. & Co.—Manufacturers of Gold and Silver Chains, Jewelry, etc. No. 25 Maiden Lane, N. Y.

Gold Pens, Etc.

Aitkin, Lambert & Co.—Manufacturers of Choice Gold Pens, Cases, Holders, Toothpicks, etc., 23 Maiden Lane, N. Y.

Faber, Eberhard.—Manufacturer of 16-karat Gold Pens and Pencil Cases, Nos. 718 and 720 Broadway, N. Y.

Fairchild, Leroy W.—Manufacturer of Gold Pens, Pencil Cases, Tooth Picks and Novelties in Charms. No. 18 John St., N. Y.

Johnson, E. S. & Co.—Manufacturers of Gold Pens, Pen Holders and Pencils. Cor. Maiden Lane and Nassau Street, New York.

Ray Manufacturing Co.—Gold Pens Manufactured and Stamped for the Trade. Also Pencil and Pen Cases, Tooth-picks, etc. Office, Sales-rooms and Factories, 94 and 96 Nassau street, 129, 131 and 133 Fulton street.

Smith, H. M. & Co.—Manufacturers of Gold Pens and Holders, Tooth Picks, Pencils, etc. Sole Manufacturers of Sprague's Patent Gold Fountain Pen. Importers of Nickel and Silver Watches. 173 Broadway, New York.

Gold Rings.

Barnet Bros. & Powell.—Manufacturers of Stone and Seal Rings, 15 John Street, New York. Factory, Newark, N. J.

Bowden, J. B. & Co.—Manufacturing Jeweler.—Solid Gold Rings a specialty, 1 Maiden Lane.

Ely, W. H.—Manufacturer of Solid Gold Rings of every description. No. 58 Nassau Street.

Henrich, R.—No. 35 Maiden Lane, Manufacturer of Gold Rings; also Patentee and Manufacturer of the Celebrated Self-Sizing Ring.

Hutchison & Huestis.—Makers of Solid Gold Rings. Quality guaranteed. For the Jobbing Trade only. 196 Broadway, N. Y.

Kroll, H.—Manufacturing Jeweler. 78 Nassau Street, New York. Specialty: Solid Gold Stone Rings. All kinds of Fine Jewelry made to order, also Repairing for the Trade.

Ostby & Barton.—Manufacturers of Plain and Engraved Solid Gold Band Rings. Office, 176 Broadway, N. Y. Factory, 80 Clifford Street, Providence, R. I.

Peckham, Wm. H.—Manufacturers of Solid Gold Seamless Rings, and Fancy Embossed Rings, Patent Spectacles, Jewelry, etc. No. 4 Liberty Place N. Y.

Radler, K.—Manufacturing Jeweler. Gold Rings and Lockets a specialty. No. 39 Maiden Lane, New York.

Sauter, L.—No. 1 Maiden Lane, New York, Manufacturer of Stone Rings of every description, as Diamond, Cameo, Onyx Turquoise, etc., Scarf Pins, Scarf Rings, Studs and Buttons.

Shafer & Douglass.—Manufacturers of all kinds of Seal, Stone, Turquoise, and fancy rings. No. 7 Maiden Lane, N. Y.

Sinnock & Sherrill.—Manufacturers of Stone Rings. No. 3 Maiden Lane, N. Y.

Thuerner & Church.—Manufacturers of Fine Gold Rings. No. 9 Maiden Lane, N. Y.

Hair Jewelry.

Moutoux, Wm. E. & Co.—Manufacturers of Fine Hair Mountings in Gold. Grand catalogues for the trade. 81 Nassau St., Rooms 1 and 2. Finest work and lowest prices

Sauter, L.—Manufacturer of Fine Gold and Hair Jewelry and Device Work. Pattern Book sent on application. No. 1 Maiden Lane, N. Y.

Schwencke O.—Manufacturer of Fine Hair Jewelry Orders from the country promptly attended to. No. 43 Maiden Lane.

Jewelry Cases, Fancy Boxes, Etc.

American Morocco Case Co.—7 and 9 Bond St., N. Y., make a specialty of Rich Jewelry and Silverware Cases for the fine Retail Trade. Also Improved Trays for Watches, Rings, etc.

Bleyle, A.—Manufacturer of Jewelry and Silverware Boxes, Jewelers' Traveling Cases, etc. Trays for Show Cases and Trunks, Ladies' and Gent's Jewel, Glove and Handkerchief Boxes, &c., &c., 80 Nassau street, N. Y.

Braun, Chr. E.—Manufacturer of Fine Jewelry Boxes and Trays for Show Cases and Trunks. No. 62 Chatham Street, New York. Trays for Show Cases and Trunks a Specialty.

Bricka, C. A.—Manufacturer of Morocco Cases for Cutlery, Silverware, Jewelry, etc. Sample Cards and Rolls. Cases in Rosewood, Black Walnut, etc. 52 Nassau Street, New York.

Dennison Mfg Co.—Manufacturers of Morocco, Plush and Velvet Jewelry and Silverware cases. New York, Boston, Philadelphia, Chicago, Cincinnati and St. Louis.

Ettlinger, L. & Sons.—Manufacturers of Fine Cases for Jewelry, Watches and Silverware. Trays for Travelers and Show Cases. Cases to Order a Specialty. No. 80 Nassau St., N. Y.

Haensler, Chas. C.—Manufacturer of Fine Morocco Cases for Jewelry and Silverware. Toilet Boxes, etc. Trays for Show Cases and Windows. 14 John Street, New York.

Jackson, S. C., 180 Broadway, N. Y., Manufacturer of Fine Cases for Jewelry, Silverware, &c.

Kohn, Solomon & Co.—Manufacturers of Fine Morocco Cases for Jewelry, Watches, etc. 43 Maiden Lane, New York.

Lauten, Edw. A. & Co.—No. 4 Great Jones St., Manufacturers of Fine Velvet, Brocade, Plush and Morocco Boxes, Patent Ring, Ear Ring and Gent's Scarf Pin Trays, Patent Watch and Bracelet Blocks, Window Decorations, etc.

Loehr & Koerner—Manufacturers of Morocco, Velvet, Satin, Jewelry, Watches and Silverware Cases, Jewel, Work Boxes, etc., Fancy Trays and Store Fittings to order. 96 Liberty St.

Metropolitan Fancy Box and Leather Goods Manufactory—Makers of Plush, Velvet, Satin and Leather Cases for Watches, Jewelry, Silverware, etc. 75 and 77 Nassau Street, N. Y.

New York Morocco Case Co.—Cases for Jewelry, Watches, Silverware. Boxes and Trays for Jewelers' Travelers. Show Cases and Window Fittings. No. 69 Nassau Street, New York.

Schien, Charles E.—Manufacturer of Cases for Jewelry and Silverware, No. 85 Nassau St., N. Y. Show Case Trays, etc., at short notice.

Schwarz, N.—Manufacturer of fine Cases for Jewelry and Silverware, 866 Broadway, near 17th street, N. Y.

Steinle, E.—Manufacturer of Cases for Jewelry of all kinds. Also Cases for Mathematical and Surgical Instruments and for Trays for Travelers' Trunks, etc. 66 Nassau Street, N. Y.

Welch & Miller—169 Broadway. Manufacturers of fine Morocco, Velvet, Russia, Brocade and Plush Jewelry Cases. Trays of every description; Jeweler's Cotton and Twine; Telescope Sample Cases with Flexible Trays. 169 Broadway, N. Y.

Wiggers & Froelick—No. 60 Nassau street—Manufacturers of Cases for Jewelry, &c., of every description. Trays for Show-cases, Stands for Show-windows, etc.

Jewelers' Findings.

Dennison Mfg Co.—Paper Jewelry Boxes, cards, tags, pink and white cotton, etc. etc. New York, Boston, Chicago, Cincinnati, Philadelphia, St. Louis.

Ettlinger, L. & Sons.—Manufacturers of Jewelers' Paper Boxes and Findings. Morocco Paper, Satin or Plush Lined Wooden Corner Stops Jewelry and Silverware Boxes. 80 Nassau Street, New York.

Valfer, S. & Co.—Manufacturers and Dealers in Jewelers' Boxes, Tags, Cards, Paper and Findings. Trays a specialty. Office and Salesroom, 66 Nassau street, New York.

Jewelry Manufacturers.

Aikin, Lambert & Co.—Manufacturers General stock of Reliable Jewelry, 23 Maiden Lane.

Alford, C. G. & Co.—Manufacturers. General line fine and Reliable Goods. Specialties in Onyx Goods and Chain. 200 Broadway, New York.

Alling, Isaac A. & Co.—Manufacturers of Fine Gold Jewelry. Sets, Lace Pins, Ear Rings, Studs, Collar Buttons and Scarf Pins. Specialties: Wire Bracelets, Bangles, American Lever Sleeve Buttons. Bryant Building, Nassau and Liberty Streets, N. Y. Factory, Newark, N. J.

Baldwin, Sexton & Peterson—Makers of Fine Jewelry and Importers of Diamonds, etc., corner Broadway and Fourth Street.

Ball, W. H.—Manufacturer of Gold Jewelry. Bracelets and Bangles of all kinds a specialty. 9 John Street, N. Y.

Barthman, Straat & Co.—Manufacturers of Fine Jewelry. Roman Goods, Rings, Diamonds. No. 43 Maiden Lane.

Brown, Thos. G. & Sons—Man'rs of Rich Jewelry Necklaces, Locketts, Bracelets, Sleeve Buttons, etc., 5 Bond Street, N. Y.

Bryant & Bentley—Manufacturing Jewelers. Rings a specialty. 12 Maiden Lane

Carter, Sloan & Co.—Manufacturing Jewelers, 15 Maiden Lane, New York.

Champerois & Co.—No. 5 Maiden Lane, manufacturers of Engraved and Enameled Gold goods, in Sets, Ear Knobs, Bracelets, Studs, Lace and Shawl Pins, Jet cluster and Onyx goods, also "Best Lever" Sleeve Buttons.

Chatellier, Joseph F.—Manufacturing Jeweler, No. 694 Broadway, N. Y.

Churchill, Lewis & Co.—Manufacturers of Fine Jewelry. 692 Broadway, cor. Fourth St., N. Y.

Cook, Groeschel & Co.—Manufacturers of Fine Jewelry and Locketts, 191 Broadway (over Mercantile Bank,) N. Y.

Cottle S. Co.—Manufacturers of Fine Jewelry. Waltham Building, 5 Bond Street, N. Y.

Cox & Sedgwick—Manufacturers of fine Onyx and Colored Jewelry. 26 John St., New York

Day & Clark—Manufacturers of Fine Jewelry, Lace Pins, Ear Rings, Studs, Locketts, &c., 10 Maiden Lane, New York.

Geoffroy, Arthur R. & Co.—Manufacturing Jewelers. Novelties in Diamond Goods. No. 23 Maiden Lane, N. Y.

Joddard, John M.—Manufacturing Jeweler, — Seal Rings and Fine Locketts a specialty, No. 3 Maiden Lane, N. Y.

Goldsmith & Cohen—Manufacturing Jewelers, 3 Maiden Lane, New York.

Greason J. R. & Co.—Successors to Arthur, Rumrill & Co., 182 Broadway. Manufacturers of Fine Jewelry and Gold Chains, also Diamond Mountings.

Greene Wm. C. & Co.—Goldsmiths; Manufacturers of Rich Sets in Taper Wire Coral. Office, 192 Broadway.

Hale, S. W. & Co.—Manufacturers Rich Jewelry, Whiting Building, Broadway and 4th Street.

Hartmann, P.—Manufacturer & Importer of Fine Gold, Diamond, and Filigree Silver Jewelry, No. 36 Maiden Lane. P. O. Box 2,454.

Haskell, H. C.—Manufacturing Jeweler. Seal Rings a specialty. Special attention to Jobbing of every description. 12 John street.

Hedges, A. J. & Co.—Manufacturing Jewelers, 6 Maiden Lane.

Henderson & Winter—Jewelers, No. 15 Maiden Lane, New York. Specialties—Stone, Cameo, Onyx, Amethyst, Topaz, Pearl and Turquoise Rings.

Hunt & Owen.—Manufacturing Jewelers. Office 3 Maiden Lane.

Kennedy, Frank S.—Manufacturer and Wholesale Dealer in Jewelry and Gold and Silver Thimbles. No. 13 Maiden Lane, New York.

Kremetz & Co.—Manufacturing Jewelers, No. 182 Broadway, N. Y.

Kuhn, Doerflinger & Co.—Manufacturers of Enameled and Roman Band Bracelets, also Fine Locketts Pendants and Lace Pins. 18 John street.

Miller Bros.—Manufacturers of Fine Jewelry, Locketts, Sleeve Buttons, Studs, &c., 7 Maiden Lane, N. Y.

Moore & Horton.—11 Maiden Lane, Manufacturing Jewelers, Rings, Studs, Collars and Sleeve Buttons, Pins, Ear-rings, &c.

Muhr's, H., Sons.—Manufacturing Jewelers. Solid Gold and Filled Rings a specialty. Also Manufacturers of the celebrated Crown Filled Watch Case. 16 Maiden Lane, N. Y.

Owen, G. & S. & Co.—Manufacturing Jewelers. Office, No. 3 Maiden Lane.

Richardson, Enos & Co.—Manufacturers of Fine Gold Jewelry, Gold Chains, Locketts, Crosses and Necklaces. Colored and Etruscan Work. No. 23 Maiden Lane, New York.

Richardson, J. W. & Co.—Manufacturers of Jewelry. Masonic and other Emblems. 196 Broadway, N. Y. Manufactory, Providence, R. I.

Riley, J. A. & Co.—Manufacturing Jewelers. Etruscan Gold and Roman Bracelets, Lace Pins, Ear Rings, Scarf Pins, Brooch Pins, etc. Nos. 7 and 9 Bond Street, N. Y.

Ripley, Howland & Co.—Manufacturers of Fine Jewelry and Platinum Tipped Diamond Settings. No. 17 Maiden Lane, N. Y.

Sauter, L.—Manufacturer of Fine Jewelry, Solid Stone Rings and Studs a specialty. Jobbing for the trade. 1 Maiden Lane, New York.

Schwencke, Wm.—Manufacturing and Jobbing Jeweler. Repairing a specialty. Orders promptly attended to. No. 43 Maiden Lane, N. Y.

Sexton & Cole—Manufacturing Jewelers, Colored Gold and Onyx Goods a specialty. No. 30 Maiden Lane.

Shafer & Douglas, Manufacturing Jewelers—Roman Goods, Lace Pins, Cameo Sets, etc., Stone Rings, etc. No. 7 Maiden Lane, N. Y.

Sheaffer, W. H. & Co.—Manufacturing Jewelers, Specialty Bangles and Bracelets, 15 John St., N. Y.

Steele, J. W.—Successor to Brainerd, Steele & Co., Manufacturer of Fine Jewelry and Brainerd's Patent Locketts. No. 9 Maiden Lane, N. Y.

Stites, D. H. & Son—Manufacturers of Fine Jewelry, Rolled Plated Goods and Chains, Parisian Diamond Rings, Studs and Earrings a specialty. 41 Maiden Lane, N. Y.

Stites' Sons, E.—Manufacturers of Fine Jewelry. No. 14 John Street, N. Y.

Street, Geo. O. & Sons.—Established 1837. Makers of Fine Jewelry, strictly first-class goods of our own make. No. 15 John Street, New York.

Terhune, Charles F.—Manufacturing Jeweler, 194 Broadway, N. Y.

Thoma, Ernest—Manufacturer of Fine Jewelry, Sleeve Buttons, Rings, Ear-rings, &c. No. 173 Broadway, N. Y. Factory, Hackensack, N. I.

Ward, Thos. M.—Manufacturer of Fine Jewelry, Diamond Mountings a specialty. No. 25 John Street, N. Y.

Wheeler, Parsons & Hays.—Manufacturers of Fine Jewelry, Watch Cases, Gold Chains, &c. and Dealer in American and Swiss Watches, No. 2 Maiden Lane, N. Y.

Wiendhold, Joseph—Manufacturer of Fine Jewelry Diamond Mountings a specialty. 24 John St.

Woglom & Miller—Manufacturers of Black Onyx Goods exclusively. 32 & 34 John Street, N. Y.

Jewelry—Rolled Plate.

Frick, John & Co.—Fine Rolled Plate Jewelry of all kinds. Repairing of every description. 21 and 23 Maiden Lane, N. Y.

Mauran, J. T.—Manufacturer of Fine Rolled Plate Jewelry, No. 15 Maiden Lane, N. Y.

Richards, E. Ira & Co.—Manufacturers of Fine Rolled Plate Jewelry, No. 200 Broadway, N. Y.

Weil, Leopold & Co.—Manufacturers of Rolled Plate Jewelry of every description, 35 Maiden Lane, N. Y.

Jewelers' Tools, etc.

Fisher, James J.—Dealer in Watchmakers' and Jewelers' Materials, Files, Tools, Silk Guards, Spectacles, etc., 697 Broadway, N. Y.

Friedenthal, A. & Co.—Importers and jobbers of Watchmakers' and Jewelers' Tools, Materials, etc. 43 Maiden Lane, N. Y.

Friedlander, R. & L.—Importers of Watchmakers' Tools and Materials. 65 & 67 Nassau Street. Branch Office, 264 Bowery.

Kurtz, F. P.—Manufacturer of Jewelers Machinery, Tools, Rolling Mills, Presses, Polishing Lathes, &c. 97 Cliff St., N. Y.

Levy, Dreyfus & Co.—Importers and Jobbers of Watchmakers' and Jewelers tools and materials of every description. 11 Maiden Lane, N. Y.

Montgomery & Co.—Importers of and Dealers in Manufacturing Jewelers' Tools and Materials of every description, 105 Fulton street, New York.

Reichhelm & Koester.—Importers of Jewelers' Tools, Files, etc. Manufacturers of Brushes and Buffing wheels; also Patent Gas Furnaces for Melting, Plating, Enamelling, Annealing, etc. 80 Nassau St., N. Y.

Lapidaries.

Fox, M. & Co.—Practical Lapidaries, No. 1 Maiden Lane, New York.

Graham & Co.—Practical Lapidaries, Cutters and Polishers of all kinds of Precious Stones. Miners' Relics Cut, Polished and Mounted. Miniature, Locket and Clock Glasses. 80 Nassau St., N. Y.

Kordmann & Michel.—Lapidaries. Dealers in Precious Stones. Cutting and Polishing Rubies, Sapphires and other Gems a specialty. Drilling done promptly. 59 Nassau St., N. Y.

Korn, Ph.—Lapidary. Importer of Precious and Imitation Stones, No. 63 Nassau street, between Maiden Lane and John street, New York.

Masonic Jewelry.

Luther, John F.—79 Nassau Street. Manufacturer of Fine Presentation Jewels for all Societies. Knights Templars, Crosses, Badges, &c.

Popper, H.—Manufacturer of Medals and Badges for Military, G. A. R., Shooting, Masonic, Odd Fellows, Knights of Pythias, etc. 91 Essex St., New York.

Wilkinson, C. B.—Manufacturing Jeweler, 8 John St., N. Y. Medals, Badges and Masonic Jewelry, a specialty. Designs furnished free upon application.

Optical Goods.

Friedlander, R. & L.—65 and 67 Nassau Street. Dealers in Optical Goods.

Opticians.

Burbank Manf'g Co.—Manufacturers of Spectacles and Eye Glasses of all descriptions, in gold, silver, etc., 14 Maiden Lane, N. Y.

DuBois, Geo. W. & Co.—Importers of Watches and Optical Goods. 36 Maiden Lane, N. Y.

Kahn, Hanover & Co.—Importers of Spectacles, Eye-Glasses and Optical Goods generally, and Scientific Instruments of every description. 32 Maiden Lane, New York.

Laurencott, J. B.—Importer of Watch Glasses, Optical and Fancy Goods, Clocks, Bronzes, etc., 33 Maiden Lane, N. Y.

Levy, Dreyfus & Co.—Importers of Spectacles and Eye Glasses and Optical Instruments of every description, No. 11 Maiden Lane, N. Y.

Lorsch, Albert—Manufacturer of the Patent Accommodating Spectacles and Eye Glasses in Gold, Silver and Steel, and other Optical Goods, 37 Maiden Lane, N. Y.

Spencer Optical Manufacturing Co.—Gold, Silver, Steel, Nickel and Plated Spectacles; Gold, Celluloid, Steel, Nickel and Rubber Eye Glass and Opera Glasses. 13 Maiden Lane, N. Y.

Paper Boxes.

Waterbury Paper and Box Co., 27 to 35 Canal St., Waterbury, Conn., Manufacture Jewelers' and Silversmiths' Fine Paper Boxes. Quality guaranteed to be equal to the best made.

Precious Stones, &c.

Bishop, Victor & Co.—33 Maiden Lane, Importers of Precious Stones, Cameos, &c. Also Manufacturers of Coral Jewelry.

Bissinger, Philip & Co.—Importer of Diamonds, Pearls and Precious Stones. Agent for the Bohemian Garnet Goods. Blue Enamelled Locketts. No. 22 John St., N. Y.

Breidenbach, R. A.—Importer of Black Onyx, Cameos, Turquoise, Pearls, Sardonyx, Amethysts, Topaz, Garnets, Opals, Rubies, Sapphires, Cat's Eyes, Hematites, Brilliants, Doublets, etc. 85 Nassau St., N. Y.

Daue, Wm. & Co.—Importer of Precious and Imitation Stones. No. 202 Broadway New York.

Fox, M. & Co.—Importers of Diamonds and other Precious Stones, No. 1 Maiden Lane, N. Y.

Gruet, Jules.—Importer of all Grades of Real and Imitation Stones. 14 John St., N. Y.

Guntzburger Bros.—Manufacturers and importers of Precious Stones—Amethysts, Topaz, Cameos, Garnets, Imitation Diamonds, &c. No. 9 Maiden Lane.

Hahn & Co.—Importers of Precious Stones, Cameos, Onyx, Pearls, Intaglios, Amethysts, Garnets, etc. 64 Nassau Street, New York.

Kahn, L. & M.—Importers of precious and imitation stones. 10 Maiden Lane, N. Y.

Kipling, E. E.—Importer of Precious and Imitation Stones. Manufacturer of the Patent Foil Solid Metal Back Rhine Stone Brilliant. No. 6 Maiden Lane, N. Y.

Kipling, R. A.—Precious and Imitation Stones, No. 24 Maiden Lane, N. Y. Manufacturer Cameos, Agates, Onyx, Etc, Oberstein, Germany. Commission Merchant, 49 Rue De L'Echiquier, Paris.

Tannenbaum, L. & Co.—Importers of Diamonds and Precious Stones. Steam Lapidary Works. Oriental Stones Cut and Polished a specialty. 65 Nassau St., N. Y.

Silverware.

Gorham Manufacturing Co.—Union Square.

Knowles, J. B. & S. M.—Manufacturers of Sterling Silverware, 20 Maiden Lane, N. Y. Factory, Providence, R. I.

Shiebler, Geo. W.—Manufacturer of Sterling Silverware. No. 8 Liberty Place, near Maiden Lane, N. Y.

Whiting Manufacturing Co.—Makers of Sterling Silver Ware. Broadway cor. 4th Street, N. Y.

Wood & Hughes.—Manufacturers of Fine Silverware. 16 John Street, N. Y.

Silver Filigree Jewelry.

Cuppla, L. A.—Manufacturer of Solid Silver Novelties, and Importer of Silver Filigree, 19 Union Square.

Hartmann, P.—Manufacturer of Silver Filigree Jewelry. 36 Maiden Lane, N. Y.

Silver Plated Ware.

Holmes, Booth & Haydens—Manufacturers of Silver-Plated Ware. 47 Chambers Street.

Manhattan Silver Plate Co.—Manufacturers of Silver Plated Ware. Showrooms, 23 John St. Factory, 301 to 305 East 22d St., cor. 2d Ave. Address all communications to Factory.

Middletown Plate Co.—Manufacturers of Superior Electro-Plate. Factories, Middletown, Conn., salesroom, 13 John Street.

Rogers & Bro—Manufacturers of the finest quality of Electro-Plated Ware. 690 Broadway.

Rogers, Smith & Co.—Manufacturers of Fine Electro Plated Ware. No. 46 E. 14th St., N. Y.

Simpson, Hall, Miller & Co.—Manufacturers of fine Silver-Plated Ware. No. 36 E. 14th Street.

Schade, Henry.—Manufacturer of White Metal and Plated Ware. No. 84 John St., N. Y. Price list and catalogue furnished on application.

Webster, E. G. & Bro.—Manufacturers of Fine Silver-Plated Ware. Office and warerooms, 14 Maiden Lane, N. Y.

Show Cases, Etc.

Smith, B. & W. B.—Manufacturers of Patent Improved Dust Proof Show Cases, with Perpendicular Sliding Doors, No. 220 W. 29th St., N. Y.

Spectacle Case Manufacturers.

Bertine P. D.—Manufacturer of Spectacle Cases, 139 William Street, near Fulton St., New York.

Koenen, A. & Bro.—Manufacturers of Leather Spectacle and Eye-Glass Cases. 81 Nassau St., N. Y.

Stem Winding Attachments.

Abbott, Henry Maker of Stem Winding Attachments, No. 7 Maiden Lane, N. Y.

Thermometers, Etc.

Tagliabue, Giuseppe.—manufacturer of Thermometers, Barometers and Hydrometers. Patentee and sole manufacturer of the U. S. Standard Hydrometer. 302 Pearl Street, near Beckman.

Thimble Manufacturers.

Barker Manuf'g Co.—Makers of Patent Graduated Thimbles, Stiffened Gold, Filled Gold and Rolled Gold, 36 Maiden Lane, N. Y. A. Lyons, Ag't. Factory, 129 Eddy St., Providence, R. I.

Burbank Manuf'g Co.—Manufacturers of Gold and Silver Thimbles, 14 Maiden Lane, N. Y.

Ketcham & McDougall.—Improved Gold and Silver Thimbles, Bryant Building, N. Y.

Simons Bro. & Co.—Manufacturers of Gold and Silver Thimbles. 611 and 613 Sansom Street, Philadelphia.

Woglom & Miller.—Sole Agents for the "Prime" Thimbles in Gold and Silver, manufactured by Ezra C. Prime. 34 John Street, N. Y.

Watch Companies.

American Watch Co.—Robbins & Appleton, No. 5 Bond Street, N. Y.

Lancaster Watch Co.—Manufacturers of Watches. Lancaster, Pa.

The E. Howard Watch and Clock Co.—Cor. Maiden Lane and Nassau Street, N. Y.

Waterbury Watch Co.—Manufacturers of the Waterbury Watch. Factory, Waterbury. Office, 52 Maiden Lane, N. Y.

Watch and Chronometer Jeweler.

Queen, James.—Watch and Chronometer Jeweler and Pallet Maker, 78 Nassau Street, room 8. Pivots inserted in Pinions, Balance, Staffs, etc.

Wennstrom, John.—Watch, Chronometer and Clock Jeweler, Jewel Gauges, Ruby and Sapphire Draw Plates; Diamonds Dressed; Polishing Stones for Jewel Settings. 2 Dutch St., N. Y.

Watch Importers, Etc.

Abry, Chas. Leo—Importer and Manufacturer of Swiss Watches of all grades. 63 Nassau Street.

Aikin, Lambert & Co.—Importers of Watches. Sole Agents for Paul Breton & Chas. Latour, Geneva. A general line of reliable Swiss Watches, Watch Cases, etc. 23 Maiden Lane, N. Y.

Bartens & Rice—20 John Street, Importers of Watches and sole agents in the United States for the celebrated Nicole, Nielsen & Co. Watches.

Cross & Beguelin.—Importers of Watches, Watch Tools and Materials, dealers in American Watches, No. 21 Maiden Lane, N. Y.

Droz, Henry E.—Importer of Watches, and Watch Case Manufacturer. Agent for the "E. Perregaux" Watch, and jobber in American Watches No. 92 Fulton Street, N. Y.

Durfey & Reynolds—Successors to Durfey & Shiebler, Watches, Diamonds, Jewelry. No. 9 John Street, (up-stairs) New York.

Freund Max & Co.—Importers of Watches, Jewelry and Precious Stones, 8 Maiden Lane, N. Y.

Gagnebin, Chas.—Importer of all kinds of Swiss, and Dealer in American Watches. 4 Maiden Lane, N. Y. Agent for Ulysse Breting's Fine Chronometers, Chronographs, Anchors, &c

Gallet, Julien.—Importer of Watches. No. 1 Maiden Lane.

Glneel, Henry—Importer of Watches, Tools and Materials, 31 Maiden Lane, N. Y. P.O. Box, 2967

Heinrich, H. H. & Co.—Sole Agents for the Karl Zimmerman Watch, and Importers of Fine Watches and Marine Chronometers. 12 John Street, N. Y.

Herzog, Louis & Co.—Importers of Watches, Dealers in Diamonds and Jewelry, 52 Maiden Lane, N. Y.

Hirsch Bros.—Dealers in Watches and Diamonds and Manufacturers of Jewelry, No. 23 Maiden Lane, N. Y.

Hyde's Sons, John E.—Wholesale Commission Agents, only for Jules Jurgensen, of Copenhagen; Jules Monard, of Geneva; and for other makers of all qualities of Watches, 22 Maiden Lane.

Jandorf, P. & Bro.—Importers of Watches and Jewelry, 196 Broadway.

Keller, L. H. & Co.—Successors to G. A. Huguenin, Importers of Fine Watch and French Clock Materials, No. 64 Nassau Street, N. Y.

Mathey Bros. & Mathez.—Importers of Fine Watches and Sole Agents for the **H. L. Matile's** Watches. No. 16 Maiden Lane.

Oppenheimer Bros. & Veith.—Dealers in Watches and Diamonds, and Manufacturing Jewelers, No. 35 Maiden Lane.

Robert, J. Eugene—No. 30 Maiden Lane, New York. Agent for Louis Audemar's celebrated watches.

Schwob, Adolphe—Manufacturer and Importer of Watches, 11 Maiden Lane, N. Y.

Stern Brothers & Co.—Importers of Swiss Watches and wholesale dealers in American Watches, &c., 39 Maiden Lane.

Scott, J. T. & Co.—Importers of Watches, and Manufacturers of Jewelry, and Jobbers of all Grades of American Watches, 11 Maiden Lane.

Strasburger, Louis & Co.—Importers and Makers of Watches of every description, 15 Maiden Lane.

Watch Cases.

Dueber Watch Case Mfg Co.—Manufacturers of Gold and Silver Watch Cases. Bryant Building, N. Y. Factory, Newport, Ky.

Duhme & Co.—Manufacturers of Gold and Silver Watch Cases, Carlisle Block, Fourth and Walnut Streets, Cincinnati.

Fahys, Joseph—Manufacturer of Watch Cases and Dealer in American Movements, 38 Maiden Lane.

Glatz, Chas.—Manufacturer of Silver Watch Cases. Bryant Building, cor. Nassau and Liberty Sts.

Keller & Untermeyer.—Manufacturers of Watch Cases with Raised Gold Ornaments. 9 Maiden Lane, N. Y.

Ladd Watch Case Co.—Manufacturers of the Ladd Patent Stiffened Gold Watch Cases, etc., 11 Maiden Lane, N. Y. Factory, 58 Eddy Street, Providence, R. I.

Willemin Watch Case Co.—Makers of Gold Watch Cases. Raised Gold Ornamentation and Jurgensen style of Engine Turning. 109 Sands Street, Brooklyn, N. Y. 16 Maiden Lane, N. Y.

Watch and Chronometer Repairers.

Cerf, B.—Practical Watchmaker and Repairer, No. 10 John Street, N. Y. Repairing and adjusting of Fine Watches done for the trade. All kinds of escape and stem-winding wheels cut to order.

Heinrich, H. H. & Co.—Sole Manufacturers of H. H. Heinrich's Patent Auxiliary Balance, and Adjusters and Repairers of Fine Watches and Chronometers. 12 John Street, N. Y.

Lesperance, Theo.—Watchmaker and Wheel Cutter. Also Stoning Nickel Movements. No. 1 Maiden Lane, New York. With Julien Gallet.

Ludeman, W. H.—Chronometer and Watch Maker. Repairing of every description for the trade, 75 and 77 Nassau Street.

Watch Case Repairers.

Feinier, Joseph A.—Watch Case Maker and General Repairer. Specialty in fine Gold and Silver Cases. Jobbing promptly attended to. Nos. 4 and 6 John St., N. Y.

Tarbox, Hiram—Watch Case Repairing, Springing, Polishing and Engine Turning. 1874 North Fourth Avenue, bet. 176th and 177th Sts., N. Y. Express Packages should be sent to 92 Fulton Street.

Watch Classes, Shades, Etc.

Brown, Edwin H.—No. 85 Nassau Street, Imported and Own Manufacture Watch Glasses, Flat, Flat Concave, Concave, Convex and fine Geneva. Fine fitting solicited.

Watches, Jewelry, etc.

Cohn, J. J.—Importer and Manufacturer of Whitby Jet, Rubber and Pearl goods. Gold and Rolled-plate Jewelry, etc. 12 Maiden Lane, New York.

Friedman, Saml.—Wholesale Dealer in Watches and Jewelry, 42 Maiden Lane, N. Y.

Fry & Schieber—Manufacturers of Fine Gold and Plated Jewelry and Importers of Watches, 201 Broadway, N. Y.

Lissauer & Sondheim—Wholesale Jewelers and Jobbers in American Watches, No. 12 Maiden Lane, N. Y.

Marx, Kossuth & Co.—Importers of Watches and Dealers in Jewelry. 39 Maiden Lane, N. Y.

Mayer, B.—Manufacturer of Fine Jewelry, and Dealer in Watches, 71 Nassau street, cor. John street, New York.

Myers, S. F. & Co.—Manufacturing and Wholesale Jewelers—all grades. Importers of Watches. Illustrated Catalogue to the trade. 179 Broadway, N. Y.

Smith & Knapp—Wholesale Dealers in American and Swiss Watches, Diamonds, Gold and Plated Jewelry and Gold Chain. 182 Broadway, N. Y.

Stern & Stern—Dealers in Watches, Jewelry and Diamonds. No. 6 Maiden Lane, N. Y.

Strauss, Jacob.—Full Line of Gold and Plated Jewelry, and Importer of Watches. 18 John Street, New York.

Thrall, E. A.—Wholesale Dealer in Watches and Jewelry. No. 1 Maiden Lane, N. Y.

Trier Bros.—Importers of Garnet, Whitby Jet and Amber Jewelry, Silk Guards, Opera, Field and Marine Glasses, Pearl Card Cases. Also a full line of Gold and Plated Jewelry. 15 Maiden Lane, N. Y.

White, N. H.—Jobber in American-Waltham Watches and Chronographs. Waltham make of 10-k., 14-k. and 18-k. Gold and Sterling Silver Cases; Filled Gold Cases. 11 Maiden Lane.

Watch Tools, etc.

Keller, L. H. & Co.—Importers of Watchmakers' and Jewelers' Tools, Materials, etc. 64 Nassau Street, N. Y.

Zimmer, Henry—Importer of Watch Materials, Tools, and Optical Goods, No. 8 Maiden Lane, (first floor.) Sole Agent for A. Huguenin & Gravier, Mainsprings, New York.

PHILADELPHIA

Booz & Co.—Manufacturers of Gold and Silver Watch Cases and Jewelry, 108 South 8th St., Philadelphia.

Bennett, Jacob & Son.—Diamond Setters and Manufacturing Jewelers, 925 Chestnut St.

Bernard & Co.—Manufacturers of fine Roman and Etruscan Jewelry. Designs of every description made to order, 123 & 125 South Eleventh Street, Philadelphia.

Birmingham, Wm. & Co.—Morocco Case Manufacturers. Spectacle and Eye-Glass Cases a specialty, 626 Arch Street, Philadelphia, Pa.

Conover David F. & Co.—American Watches, Wholesale Salesroom, Southeast corner 7th and Chestnut Streets, Philadelphia.

Dubosq, J. Carrow—Manufacturer of Fine Jewelry. Particular attention given to repairing Strung Pearl work. 108 South Eighth St., Phila.

Fick, Chas. M.—Seal Engraver and Designer. Sketches furnished Free of Charge for Coat of Arms, Crests, Monograms, Initial Letters and Masonic Emblems, to be engraved on all kinds of Precious Stones. 618 Chestnut St., Philadelphia, Pa.

Guilbert, Thos. M., & Co.—Manufacturing Jewelers. Flexible Bracelets and Strung Pearl Repairing. 908 Chestnut St., Philadelphia.

Herold, Chas P.—Successor to Hildebrandt, Herold & Co., Manufacturing Jeweler and Diamond Setter. Diamonds. 916 Chestnut Street.

Krieder, Peter L.—Manufacturer of Sterling Silver Ware. 618 Chestnut Street, Philadelphia.

McCarty & Hurlburt—Manufacturers of Gold Spectacles, Silver Thimbles and Plain Rings. Wholesale dealers in American Watches, Jewelry, etc. 131 North Second Street.

Morgan & Headly.—Manufacturing Jewelers, Cameo Sets, Gold Sets, Roman Lockets, Rings, Coral Sets and a general line of rich goods. Corner 10th and Chestnut Streets, Philadelphia.

Muhr's, H., Sons.—Manufacturing Jewelers. Solid Gold and Filled Rings a specialty. 633 and 635 Chestnut Street, Philadelphia. 1½ Maiden Lane, New York.

Peters, Reese S.—Manufacturer of Patent Rolled Plate or Filled Watch Cases, Dealer in American Movements, 308 Chestnut Street, Philadelphia.

Robeth, A.—Wholesale Optician, and Dealer in Fine and Plated Jewelry, also Diamonds and Swiss Watches. 825 Market St., Philadelphia.

Rosenthal, G. F. C.—Manufacturing Jeweler and Diamond Setter. Engraving and Designing of Monograms a Specialty. No. 917 Sansom Street.

Scherr, L. A. & Co.—Wholesale Dealers in Watches Silver-Plated Ware, Spectacles, Fancy Goods, Watch Materials, etc. 726 Chestnut Street.

Sheafer, W. H. & Co.—Manufacturing Jewelers. Specialty: Band Bracelets. Factory, 612 and 614 Chestnut street, Philadelphia. Office, 15 John street, New York.

Simons, Brother & Co.—Manufacturers of Fine Jewelry, Canes, Thimbles, Chains. 611 and 613 Sansom Street.

Vansant, John T. & Co.—611 and 613 Sansom Street. Artisan Hall, Manufacturers and Wholesale Dealers in English Sterling Silverware. Specialties: Tea Sets, Knives, Forks, Spoons, Cups and Napkin Rings.

CHICAGO.

American Watch Company,—of Waltham, Mass. No. 102 State Street, Chicago.

Chicago Watch Case Co.—Manufacturers of Patent Dust Proof Screw Bezel Watch Cases. Cor. Madison Street and Michigan Avenue, Chicago, Ills.

Clapp & Davies—Wholesale Jewelers, 63 and 65 Washington Street. Catalogue and price list issued to watchmakers and jewelers.

Dennison Manufacturing Co.—Manufacturers of Jewelers' Paper Boxes, Morocco Cases, Tags, Cards, Pink and White Cotton, Tissue Papers, Sealing Wax, &c., &c., 102 Madison St., Chicago. Boston, New York, St. Louis, and Philadelphia.

Excelsior Sign Co.—Manufacturers of (Grout's Excelsior) Iron Watch and Spectacle Signs. 124 Fifth Avenue, Chicago, Ills.

Gilbert, Wm. L., Clock Co.—Manufacturers of Clocks, Regulators, and Time Pieces, and Clock Material of every description, 54 and 56 Madison Street, Chicago.

Giles, Bro. & Co.—Manufacturers and Jobbers in Watches, all classes of Jewelry, Materials, Clocks, Silver Ware, &c. Illustrated catalogues furnished to dealers on application. 101 & 103 State St.

Stein & Ellbogen—Wholesale Dealers in Watches and Jewelry. 127 State Street, Chicago, Ill. Specialty, repairing for the trade.

Wathier, Joseph P.—Watchmakers and Jewelers for the trade, and Wholesale Dealers in Watch Materials, Tools, etc. 178 West Madison Street, Chicago, Ill. Send for price list.

Wendell, Charles & Son—Wholesale Watches, Jewelry, etc. 170 State street, Chicago.

NEWARK.

Baker & Co.—Gold, Silver and Platinum Refiners, Assayers and Sweep Smelters. 408 New Jersey Railroad Avenue, cor. Murray St., Newark, N. J.

Diefenthaler Bros. & O'Donnell—Manufacturers of Fine Jewelry, Lacc Pins, Ear Rings and Patent Spring Bangles a Specialty. 36 Crawford Street, Newark, N. J.

Felger, F. & F.—Manufacturing Jewelers. Specialties:—Roman Band Bracelets, Lace Pins, Scarf Pins, Ball and Fancy Ear Rings. No. 477 Washington Street, Newark, N. J.

Fiedler, Herrman—Successor to Kunze & Fiedler, Engraver, Die Sinker and Press Tool Maker, 363 Market Street, Opposite Pennsylvania R. R. Depot, Newark, N. J.

Glorieux, W. L.—Assayer, Refiner and Sweep Smelter. 13 and 15 Franklin Street, Newark, N. J.

Hopper & Valentine—Manufacturers of Fine Jewelry, No. 8 Maple Place, Rear 44 Green St., Newark, N. J.

Hüger & Heitlinger—Manufacturers to the Jobbing Trade only. Makers of Roman Stone, Engraved and Enameled Locketts, also Sets, Lace Pins and Ear Rings. Rear 477 Washington St.

Krippendorf, C. & Schuller, F.—Machinists and Jewelers' Tool Makers. 19 Greene Street, Newark, N. J. Rolls, Dies, Cutters, and Draw-plates of every Description made and repaired.

Lefort, Henry.—Stem-winding Watch Crown Manufacturer. 60 Arlington Street.

Lelong, L. & Bro.—Gold and Silver Refiners. Assayers and Sweep Smelters, Southwest corner of Halsey and Marshall Streets, Newark, N. J.

Miller & Beam.—Manufacturers of Enameled Sets, Ear Rings, Lace Pins, etc. Guard Slides and Pendants a Specialty. 21 and 23 Green Street.

Milne, Alex.—Manufacturer of Stem-winding Watch Crowns. 19 Ward Street.

Plumb & Marcus—Manufacturers of Traveling and Marine Clocks, Electric Appliances. 289 Washington St., Newark, N. J.

Pollock, T. H.—Manufacturer of Jewelers' and Silversmiths' Wheel Brushes, Buffs, etc. No. 36 Crawford Street, Newark, N. J.

Regad, E. D.—Lapidary. Specialty—Sardonyx, Black Onyx and Agates. 14 Oliver St., Newark.

PROVIDENCE

Hutchison & Huestis—Makers of Solid Gold Rings. Quality guaranteed. For the Jobbing Trade only. 185 Eddy Street, Providence, R. I.

Irons, Chas. F.—Manufacturer of Solid Gold Jewelry. Specialty, Emblems, Pins and Charms, Masonic, Odd Fellows, etc. 102 Friendship St.

Lederer, S. & B.—Manufacturers of Fire Gilt, Nickel, Electro and Silver Plated Chains, Necklaces, Charms, etc. Opera, Matinee and Guard Chains. 66 to 72 Stewart St., Providence, R. I.

Pearce & Hoagland.—Manufacturers of Gold Pens, Holders, Pencils, Tooth Picks, etc. Also the Quill Reserve Tooth Pick. 29 Point Street, Providence, R. I.

Presbrey & Tuttle—Manufacturers of a large variety of Fine Bracelet and Eye-Glass Chain in Gold Plate and Silver, Spring Rings, Holders, Hooks, Snaps, etc. 35 Point St., Providence, R. I.

Seery Mfg. Co.—Manufacturers of Fire Gilt, Nickel and Electro Plated Chains, Vest, Neck, Opera and Guard. 33 Beverly St., Providence, R. I.

Smith, Wm. T.—Assayer, Refiner and Sweep Smelter. Established 1855. Blackstone and Hawkins Streets, Providence, R. I.

Taylor, Geo. H. & Co.—Watchmakers and Wholesale Dealers in Watches, Clocks, Watch and Clock Material, Tools, Spectacles, Eye Glasses, &c. Particular attention given to trade work. 136 Westminster Street (Room 1), Providence, R. I.

PAWTUCKET.

Draper, J. O. & Co.—Manufacturers of Jewelers' Fig Soap, adapted for Washing Jewelry, Scratch Brushing and Drawing Wire. Pawtucket, R. I.

Fuller, Geo. H. & Son—Jewelers' Findings, Gold, Silver, Gold Plated and Fire Gilt. Pin Stems, Joints, Catches, Split Rings, Chain Hooks and Swivels, Ear Wires, Chain Bars, etc. 99 Exchange Street, Pawtucket, R. I.

Thayer, Ellis & Son—Brush Manufacturers, and Wholesale Dealers in all kinds of Brushes. Sole manufacturers of Ellis Thayer's Patent Polishing Wheels. Manufacturing Jewelers' and Machine Brushes a Specialty. 80 North Main Street, Pawtucket, R. I.

Thayer, P. E. & Co.—Manufacturers of Brushes. Jewelry and Machine Brushes a Specialty. All kinds of Wire Scratch Brushes on hand. Orders by mail or otherwise promptly attended to. 34 East Avenue, Pawtucket, R. I.

CINCINNATI.

Awalt, John A.—Jobber in Watches, Clocks, Jewelry, etc., 173 Vine Street, Cincinnati.

Hellebush, Clemens—Manufacturer, Importer and Wholesale Dealer in everything required by the Jewelry Trade. 77 W. Fourth St., Cincinnati, O.

Lodwick & Nolting—Wholesale Jewelers, S. W. cor. 4th & Walnut Streets, Cincinnati.

Noterman & Jonas—Manufacturing Jewelers, cor. 4th and Main Streets. Manufacturers of the Ophir Diamond Jewelry.

BALTIMORE.

Gruebel & Kesmodel—Manufacturers of Fine Diamond Etruscan, Enameled, Plain and Rhine Stone Jewelry to order. Repairing a specialty. Orders by Mail solicited. 212 & 214 W. Baltimore St., Balto., Md.

Morris, Wm. & Co.—Importers and Jobbers of Watch Materials, Tools, Optical Goods, Plated and White Metal Chains. Agents for American Lathes, &c. The attention of Southern Trade is requested. 207 and 209 West Baltimore Street.

BOSTON.

Boyce, E. J.—Manufacturer of Solid Gold Jewelry. Rings a Specialty. 383 Washington St., Boston, Mass.

Smith, Wm. A.—Importer of Diamonds and Precious Stones. Diamonds mounted and unmounted and Diamond Mountings. 383 Washington St., Boston, Mass.

BUFFALO.

King & Eisele—Manufacturers of Solid Gold Jewelry, and Agents for American and Foreign Watches; also Jobbers in Roll Plate Jewelry. Office and Salesrooms, 283 Main St. Factory, 2, 4, 6 and 8 Swan St.

CLEVELAND.

Chandler, J. M. & Co.—Manufacturers of the Patent Embossed Bracelet and Jobbers in all kinds of Clocks, Watches, Jewelry, Tools, Materials, etc. 185 Superior St., Cleveland, O.

NORTH ATTLEBORO.

Whiting, F. M. & Co.—Manufacturers of Sterling Silver Ware and Jewelry, North Attleboro, Mass.

LANCASTER.

Bowman & Musser—Jobbers in Watches, Clocks, Chains, Fine Tools and Materials. 20 East Chestnut Street, Lancaster, Pa.

PITTSBURGH.

Goddard, Hill & Co.—Wholesale Dealers in American Watches, Jewelry, Silverware, Clocks, Materials, &c., 43 Fifth Avenue, Pittsburgh, Pa.

SPRINGFIELD.

Bullock, O. W.—Springfield, Mass. Manufacturer of Fine Nickel Plated Watch and Jeweling Tools, Keys, and Light Metallic Goods.

CANADA.

Ellis, P. W. & Co., No. 31 King street, East Toronto, Ontario, Manufacturing Jewelers, Watchmakers, importers and Jobbers of Watchmakers, and Jewelers' Tools, Materials, General Supplies and American Jewelry. Correspondence solicited with manufacturers of Novelties or specialties in American Tools and Jewelry.

POSITIVELY NO GOODS RETAILED.

BOWMAN & MUSSER,

SUCCESSORS TO

E. F. BOWMAN,

JOBBERS IN

Watches, Clocks, Chains,

Fine Tools and Materials,

20 E. CHESTNUT STREET

Opp. P. R. R. Passenger Depot,

LANCASTER, PA.

Selection Packages sent to Regular Jewelers on Request.

BARNES'

No. 4 LATHE,

For the Heavier Work of Jewelers.

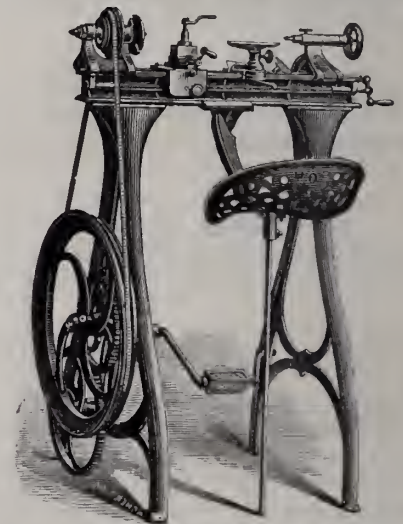

Barnes' Patent Foot and Steam Power Machinery. Complete outfits for Actual Workshop Business. Lathes for wood or metal. Circular Saws, Scroll Saws, Formers, Mortisers, Tenoners, etc., etc. Machines on trial if desired. Descriptive Catalogue and Price List Free.

W. F. & JOHN BARNES,
2088 Main Street, ROCKFORD, ILL.

→ **SOLID GOLD** ←

AND

STONE INLAID

Cigar Cutter,

Pat'd Oct. 5, 1880.



J. WIENHOLD,

Manufacturer of FINE JEWELRY.

DIAMOND MOUNTINGS A SPECIALTY.

24 John St., N. Y. City.



CROSSCUP & WEST - PHILA

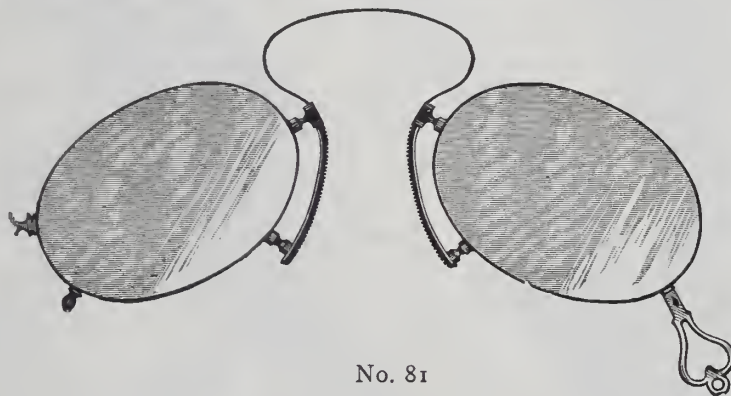

No. 81



MORGAN & HEADLY,

MANUFACTURERS OF GOLD, SILVER AND STEEL

Spectacles & Eye-Glasses.

OUR TRADE GROWS APACE.

We are constantly improving our patterns and machinery and educating our employees, thereby advancing the standard of our business.

The coming season will prove us to be still going ahead in our Special Line. With more extensive stock and facilities, and everything advanced except prices, which are uniformly low, we invite a continuance of your patronage.



LARGEST ROLLED PEARL JEWELRY HOUSE IN THE WORLD

LEOPOLD WELLS & CO. 429 - BRUNSWICK ST. & COR. N.Y.

Copyright Secured.

A NEW DEPARTURE.



14 KARAT GOLD CHAIN, SILVER LINED,

— MADE BY —

A NEW PROCESS.

Guaranteed to wear as well as the best 14 karat Gold Chain made.

Every Chain warranted to assay one-third ($\frac{1}{3}$) its entire weight in gold.

Each Chain stamped with registered trade mark:



*Showing the Relative Thickness
OF THE GOLD AND SILVER.*



*Showing the Relative Thickness
OF THE GOLD AND SILVER.*

Money refunded if test is unsatisfactory.

KOSSUTH MARX & CO.,

Proprietors and Manufacturers,

39 Maiden Lane, New York.

In introducing our new Chain we aim to supply a want which we believe the Trade can place before the public in a legitimate manner without deception, and no detriment to the standard of the most scrupulous dealer.

We offer these goods strictly upon their merits, and give but a few reasons why they can take the place of the older styles of manufacture, viz.:

- 1st.—*In the make up there is no base metal, excepting such as is necessary in standard 14 karat.*
- 2d.—*It makes a larger and more showy appearance for its corresponding weight than the old standard.*
- 3d.—*The cost is materially reduced, bringing it within reach of a greater number who desire a good article.*
- 4th.—*It is a well known fact that the principal cause of wear in chain is the friction produced by its own weight, consequently, being light weight to the extent of a large percentage, their better wear is assured.*

By a strict adherence to quality we hope to create a popular demand for a meritorious article.

Send for selection package, as our travelers do not carry any in stock.

KOSSUTH MARX & Co.

KOSSUTH MARX & CO.,

39 MAIDEN LANE, NEW YORK.

IMPORTERS OF

D I A M O N D S.

A Large Assortment of Fine MOUNTED and UNMOUNTED Stones
CONSTANTLY ON HAND.

→ Fine Single Stones and Matched Pairs. ←

KOSSUTH MARX & CO.,

IMPORTERS OF EVERY GRADE OF

SWISS WATCHES,

FROM THE LOWEST PRICED TO
FINE COMPLICATED MOVEMENTS.
CASED AND UNCASD.

KOSSUTH MARX & CO.,

MANUFACTURERS OF

GOLD RINGS

IN LARGE VARIETY.

We have in stock this season the Largest and Most Varied Assortment of Rings ever offered in the market.

OUR STOCK OF

JEWELRY

IS COMPLETE IN EVERY DETAIL.

MANUFACTURERS OF

GOLD, ENAMELED & ENGRAVED

BRACELETS.

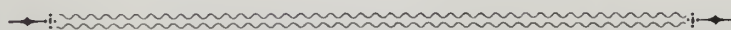

Dealers will find it to their advantage to send for a selection of these goods.

KOSSUTH MARX & CO.,

No. 39 Maiden Lane,

NEW YORK.

MANUFACTURERS OF

GOLD CHAIN

OF EVERY VARIETY,

For Ladies and Gentlemen.

Vest, Neck and Guard Chains, Necklaces, etc., embracing the latest

— **NOVELTIES** —

and the most elegant designs in this line of goods.

We offer this season a full line of

GOLD CASES,

Ladies' and Gent's, Plain and Engraved, to fit American Movements,

MADE BY THE CELEBRATED

WILLEMUN WATCH CASE CO.,

Who are the acknowledged manufacturers of the

FINEST CASES MADE.

WATERBURY CLOCK CO.,

MANUFACTURERS OF

CLOCKS,

Novelties & Materials,

No. 10 CORTLANDT ST., N. Y.

— AND —

No. 63 WASHINGTON ST., CHICAGO.

Factories, **WATERBURY, CONN.**

M. BAILEY, Treasurer.



STANHOPE.

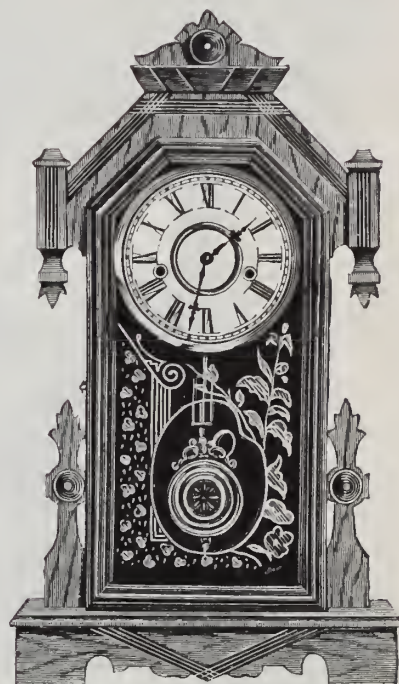

MINSTER.



REGULATOR No. 4.

THE ANSONIA CLOCK CO.

HANGING CLOCKS AND MANTEL CLOCKS

OF EVERY DESCRIPTION.

A LARGE AND COMPLETE STOCK OF

Tower Clocks } **HANGING AND STANDING** } Street Clocks

REGULATORS

AT LOW PRICES.

CHICAGO, 64 Washington St. **NEW YORK,** 11 to 19 Cliff St. **LONDON,** 128 Minories.



“AMPHION.”—Walnut.

Cut Glass Mirror Panels in Side and Base. Improved Equalizing, Adjustable, Slow Strike Movement. Eight Day Strike on Gong only. Height, 25 inches. 6 inch Dial.

W. L. Gilbert Clock Co.

GEORGE B. OWEN, General Manager.

Salesrooms:
 No. 6 Murray St., N. Y.
 54 & 56 Madison St., Chicago.

Factories:
WINSTED,
 Conn.

MANUFACTURERS OF
Walnut, Veneered and Other Clocks.

IMPORTERS OF
Marble and Cuckoo Clocks.

Catalogue and Price List Furnished upon application.

E. N. WELCH MANUFACTURING CO.

AND

WELCH, SPRING & CO.,

6 Warren Street,

New York, U. S. A.

W. H. ATWATER, Agent.

MANUFACTURERS OF

SUPERIOR AMERICAN CLOCKS & REGULATORS.

IMPORTERS OF

FINE FRENCH CLOCKS.

CHICAGO,
 SAN FRANCISCO.

CHINA AND JAPAN.

LONDON,
 GLASGOW.

Factories, **FORESTVILLE, CONN., U. S. A.**

ROGERS & BROTHER,

No. 690 BROADWAY,

WORKS AT
WATERBURY, CONN. }

NEW YORK.



Invite Dealers to Inspect their FULL Line of STAPLES and NOVELTIES in

ELECTRO SILVER PLATED WARE

made for the present Fall and Holiday Season.

Price List on receipt of Business Card from Jewelers.

NICHOLAS MULLER'S SONS,

117 CHAMBERS STREET, NEW YORK.

MANUFACTURERS OF

Fine Clocks and Ornamental Bronzes.



New Regulating Attachment (Patented).

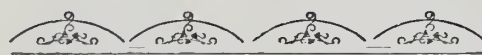

BRASS AND BRONZE

Fancy Goods

—FOR THE—

JEWELRY TRADE.

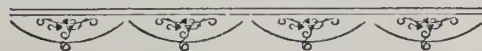

"ROYAL," Embroidered Satin and Bronze.

LOUIS STRASBURGER & CO.

DIRECT IMPORTERS OF

WATCHES AND DIAMONDS,

WE MAKE EVERY KIND
OF WATCH IN
OUR OWN
FACTORY.

WE GET THE ROUGH
DIRECT AND CUT
OUR OWN
GOODS.

No. 15 MAIDEN LANE,

→NEW-YORK←

Rue Leopold Robert,
CEAUX-DE-FONDS.

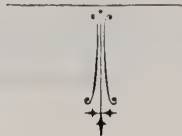

Boulevard Haussman, 30,
PARIS.

THE MIDDLETOWN PLATE COMP'Y,

Factories, MIDDLETOWN, CONN.

→SALESROOMS←

13 JOHN ST., NEW YORK.

120 SUTTER ST., SAN FRANCISCO,



Offer to the Trade a **LARGER** Assortment than ever, for Fall of 1883, of Elegant New Designs in Electro-Plate, finished in Plain Burnished Surface, (with Elegant Borders), Satin, Hammered, Fancy Gilt, New Satin, Etc., Etc.

“THE BEST”

THE DUEBER

ROLLED GOLD PLATE WATCH CASES.

WITH

SOLID GOLD CENTERS,
SOLID GOLD PENDANT,
Solid Gold Bow,
Solid Gold Joints,
Solid Gold Thumb Pieces,
Solid Gold Plugs,
Solid Gold Bearings,
And Gold Crown.



381874



331876

Warranted by Special Certificate to wear for twenty years, and to contain from three to five dollars more gold, to be better finished, better engraved, and in every particular superior to all other plated cases sold under the name of “Filled,” “Perfected Gold,” “Patent Gold,” or “Stiffened Gold,” now in use. The most perfect case of its kind ever manufactured. We lead in this as well as in everything else we undertake or manufacture.

The Dueber Watch Case Mfg. Co.

↳ CHICAGO, ↳

4 Tribune Building.

↳ CINCINNATI, ↳

P. O. Box 1334.

↳ NEW YORK, ↳

20 Bryant Building.

THE CHEAPEST

THE NEWPORT

COIN SILVER WATCH CASE.

We have placed upon the market a Two-ounce Case with Albata Cap stamped



Fig. A.



A Watch Case with folded over edges all made except putting on the Pendant and Joints.

This Case is made in the extensively advertised seamless method as shown in Figure B. Each piece is cut from solid metal and struck into the shape here shown, and not one grain of solder is used to put a case into the condition as shown in Figure A.

Fig. B.

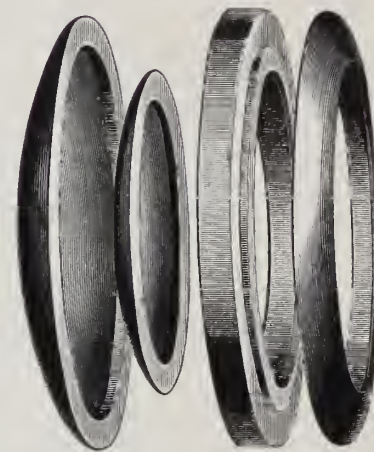

Four parts necessary to make the body of a Watch Case with a folded over edge.

This process of Case Making has been in use for years by makers of "cheap silver," and "improved" silver cases. Swiss silver anchors and low karat gold cases have always been made in this manner, but no watch case with this style of folded over edge has ever gained any reputation with practical watchmakers, and it only requires time and use to show its worthlessness, this fact having been demonstrated in the wear of a former, very extensively used, line of cases made in this same method. A watch case can be made more quickly and at less expense by this method than by any other, and we have adopted it in the construction of our Two-ounce Newport throughout, cheapness being the only object sought for in this instance, no regard being given to wearing qualities. We do not, therefore, guarantee anything about this case except the quality of silver used.

The Dueber Watch Case Mfg. Co.

Chicago, 4 Tribune Bldg.

Cincinnati, P. O. Box 1334.

New York, 20 Bryant Bldg.

DAVID F. CONOVER & CO.

(SUCCESSORS TO WM. B. WARNE & Co.)

Manufacturers and Wholesale Dealers in

WATCHES and JEWELRY.

Wholesale Agents For

Rogers & Brother's Flat and Hollow Ware



Celluloid Eye-Glasses.

And Sole Agents for the

Patent Railroad Train Watch Chains, Nickel.

WHOLESALE AGENTS FOR

T. A. WILLSON & CO.'S Optical Goods.

Would invite attention to the following new grades of Steel Spectacles lately introduced in the market.

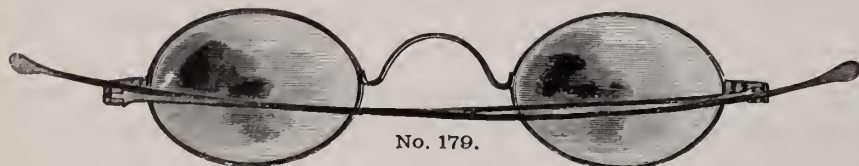

No. 179.

They are Steel, Full Tempered. Parts Interchangeable. Joints so constructed that wear is compensated for. Temple will not work loose and fall down as in old style joints. Nose-piece on No. 155 reinforced where it joins eye, giving extra strength with neatness.

PRIZE MEDALS AT ALL EXHIBITIONS WHERE EXHIBITED.

Patented July 31, 1877.

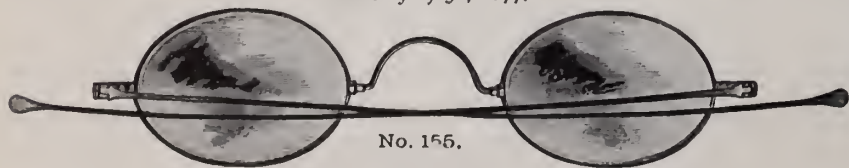

No. 155.

A SPECTACLE TEMPLE

THAT WILL

NOT WEAR LOOSE.

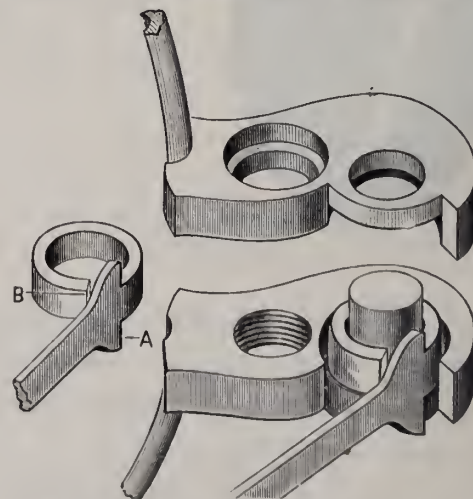

Patented May 13th, 1879. Re-issued June 8th, 1880.

- A.—Stop for Temple, preventing Strain on Joint.
- B.—Compensating eye, for taking up wear of joint. The eye of Temple is smaller than Stub Steel Joint Pin on which it works, and is left open at B, exerting a Spring Tension on Pin.

American Watch Wholesale Salesroom:

Southeast Cor. Chestnut and Seventh Sts., First Floor,

PHILADELPHIA.

DAVID F. CONOVER,
C. FRANK WILLIAMS
B. EDGAR RIGHTER.

STERN & STERN,

MANUFACTURERS,

JOBBER,

AND IMPORTERS OF

JEWELRY, WATCHES & DIAMONDS,
No. 6 MAIDEN LANE, N. Y.*We offer this season one of the Largest, Most Complete and Varied Stock of***JEWELRY,***mounted in 14 k. and 10 k. Gold, and the Best Grade of Roll Plate Goods made, comprising the Newest and Most Desirable Designs.*RINGS, BRACELETS, CHAINS, LOCKETS, CHARMS,
SETS, EAR RINGS, LACE PINS, BUTTONS, STUDS,
GOLD AND SILVER THIMBLES, Etc., Etc.**WATCHES.***We are Sole Agents for the Celebrated "Manhattan" and "Lady Washington" Movements, fitting American Cases,*

AND THE CELEBRATED

• S. S. MELVILLE WATCHES,

universally acknowledged by our Southern Trade to be the Best Swiss Watch for the money made. Cased in 2 and 3 oz. Silver Cases, Key and Stem Wind

AND

Jobbers in all the Leading American Movements and Cases.

DIAMONDS.*In this Department our Stock is UNUSUALLY LARGE and COMPLETE, consisting of Rich and Elegant Designs in Rings, Lace Pins and Ear Rings, as well as Loose Stones.*

Goods Sent on Approval, and Prompt Attention Given to Orders and Repairs.

STERN & STERN,

No. 6 MAIDEN LANE

JOSEPH FAHYS & CO.,

MANUFACTURERS OF

WATCH CASES,

38 Maiden Lane, NEW YORK.

78 MONROE STREET, CHICAGO.



654321



654322



654323



654324



654326



654325

Electrotypes of any of the above cuts, for advertising purposes, will be furnished the Trade, free of charge, upon application.

THE
 BROOKLYN WATCH CASE CO.
 EAGLE CASE.



In order to meet an imperative and growing demand in the Trade for a reliable grade of Low Karat Cases, this Company, seven years ago, was induced to place upon the market their since Celebrated **EAGLE CASES**, which are made of full 8-k. gold in all their parts, joints and bearings, the backs and caps free from solder, saving that which holds the joints. Since their introduction, these cases have achieved a wide spread reputation for the reliable and standard quality maintained in their manufacture. It has been demonstrated that the wearing qualities of the **EAGLE CASES** are unexcelled by any 12-k. case in the market, while their color is permanent and the appearance equal to that of the best cases made of this grade. The 8-k. **EAGLE CASES** will stand the severest acid test and will not tarnish when exposed in the show case or worn in the pocket.

All these goods are Stamped in the Cap with the Trade Mark of the Company,

B. W. C. Co.

and are guaranteed to be of the uniform standard designated.

A LARGE AND WELL ASSORTED STOCK OF 18-K., 14-K. AND EAGLE CASES IN THE LATEST AND MOST ARTISTIC DESIGNS, KEPT CONSTANTLY ON HAND.

For Sale by all the Principal Jobbers.

AIKIN, LAMBERT & CO.

23 MAIDEN LANE, NEW YORK,

MANUFACTURERS, IMPORTERS, JOBBERS.

➤: JEWELRY. :➤

A Large Assortment of all Leading Styles in GOLD, SILVER and ROLL PLATE, including

- | | |
|-------------------|------------------------|
| <i>Diamonds,</i> | <i>Buttons,</i> |
| <i>Bracelets,</i> | <i>Studs,</i> |
| <i>Rings,</i> | <i>Lace Pins,</i> |
| <i>Chains,</i> | <i>Drops and Sets,</i> |
| <i>Charms,</i> | <i>Scarf Pins,</i> |
| <i>Locketts,</i> | <i>Emblems,</i> |
| | <i>Thimbles, Etc.</i> |

➤: WATCHES. :➤

PAUL BRETON

Fine Movements, In Gold Cases.

AGASSIZ AND LONGINES

Stem Winding Movements, Fitting American Cases.

CHRONOGRAPHS, in Silver and Gold Cases.

Reliable Swiss Silver and Nickel Stem Winders.

ALL LEADING AMERICAN MOVEMENTS AND CASES.



GOLD PENS, HOLDERS, PENCILS, TOOTH PICKS.



“NOVELTIES” IN PENCIL CHARMS.

Show Case and Fancy Tray Assortments, in New and Tasty Designs for Jewelers,
A SPECIALTY.

Catalogues and Price Lists sent to Dealers when request is accompanied by Business Card.



Branches: } 113 EAST MADISON STREET, CHICAGO, ILLS.
 } 41 WEST FOURTH STREET, CINCINNATI, O.

Factories: } 14, 16 & 18 MAIDEN LANE, N. Y.
 } 12 VESEY AND 6 BARCLAY ST., N. Y.

➤: Novelties Continually Being Introduced. :➤

SELECTION PACKAGES SENT.

JAMES C. AIKIN. }
H. A. LAMBERT. }

PROMPT ATTENTION TO ORDERS AND REPAIRS.

{ J. B. SHEA.
{ D. F. FOLEY.

THE AMERICAN LEVER

THIS BUTTON IS THE EPITOME OF
CONVENIENCE AND UTILITY.

NONE GENUINE WITHOUT THE FAMOUS
HORSE-SHOE AND CLOVER TRADE-MARK.



THE FAULTLESS CUFF BUTTON

SOLD BY JOBBERS EVERYWHERE.

Derby Silver Co.'s Celebrated Wares,

Original and Novel Designs for the Fall Season of 1883.

SALESROOMS:

25 MAIDEN LANE,
170 STATE STREET,

New York.

Chicago.



Main Factories at BIRMINGHAM, CONN.

Where all Communications should be Addressed.

CANADIAN BRANCH FACTORY:

No. 31 Adelaide Street East, Toronto, Ont.



On or about September 1st shall open our New Salesroom,
No. 3 UNION SQUARE, NEW YORK.



99



1162



93



28



94



0027



0045



1336

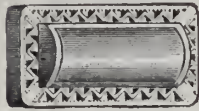

1840

THE

ACME LEVER BUTTON



1741



1016



1094

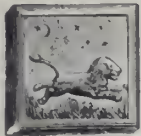

0091



OPEN.



OPEN.



OPEN.



0025



43



CLOSED.



CLOSED.



CLOSED.



1091



323

VENI + VICI.

Always was, is now, ever shall be
THE MOST CONVENIENT,
STRONG, RELIABLE and PERFECT SLEEVE BUTTON MADE

It Overcomes
ALL TROUBLE WITH STIFF CUFFS.

ASK YOUR JEWELER FOR THE
ACME LEVER SLEEVE AND COLLAR BUTTON,
AND TAKE NO OTHER.

For Sale by all Jobbers of Jewelry.



1420



1166



1369



1316



319



1269



50



58



1585



046



321

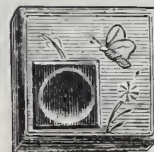

57



1545



1333



1235



1340



315



1238



02

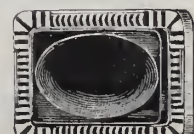

1182



634

GREAT SACRIFICE OF JEWELRY AND DIAMONDS.

To close out our entire stock at once, and for cash, we offer about \$10,000 of Fine Goods from the following makers:

CARTER, SLOAN & CO.

BALDWIN, SEXTON & PETERSON.

JOS. F. CHATELLIER.

CHURCHILL, LEWIS & CO.

GORHAM MFG. CO.

JOHN A. RILEY & CO.

CARROW, BISHOP & CO.

BERNARD & CO.

DURAND & CO.

S. COTTLE & CO.

COOK, GROESCHELL & CO.

TAYLOR & BRO.

S. W. HALE & CO.

PEARSE, KURSH & CO.

D. C. DODD, Jr.

SEXTON & COLE, and others.

at heavy discounts from NET CASH PRICES.

This is a Very Choice little stock of Fresh, New Goods and will well repay an inspection. Also a large lot of

RHINE STONE JEWELRY,

Silver Bangles, Collarettes, Locketts,

Buttons, Pins, etc., etc.

LE BOUTILLIER & CO.,

IMPORTERS AND JOBBERS,

31 & 33 West 23d Street, Second Loft, New York.

MERIDEN^Y BRITANNIA CO.,

MANUFACTURERS OF

ELECTRO GOLD AND SILVER PLATED WARE.

Also a Complete Line of more than 200 Styles of
ARTISTIC LAMPS, Furnished in Old Silver and Gold or Copper.



485



450

SALESROOMS :

46 East 14th Street, Union Square, N. Y.
Canada Branch, Hamilton, Ont.

145 State Street, Chicago.
134 Sutter Street, San Francisco.

And at the Manufactory, Meriden, Conn.

T. B. HAGSTOZ & CO.,

Successors to MORGAN & HEADLY,

Mutual Life Insurance Building, Tenth and Chestnut Streets, Philadelphia.

Diamonds,

Rubies,

Pearls,

Sapphires

AND

Emeralds.

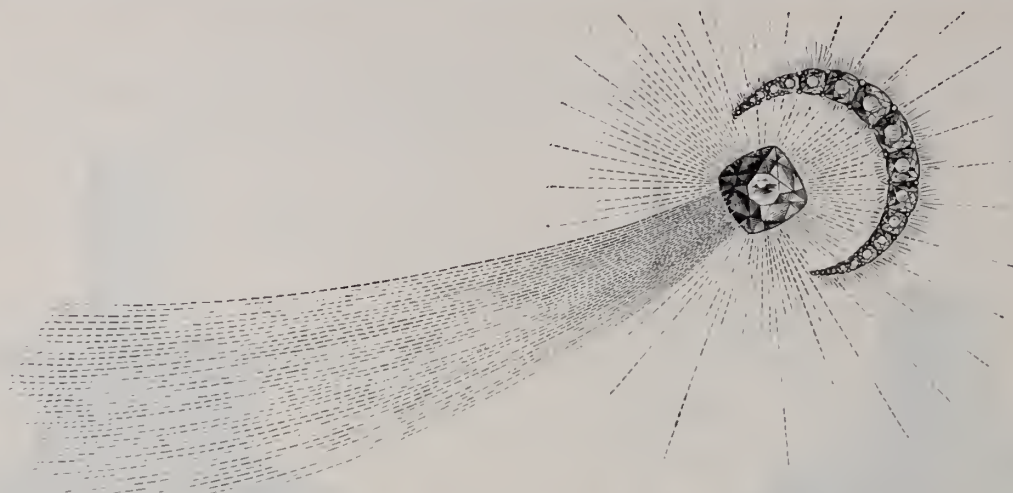

Mounted,

OR

Loose

IN

Original Lots.

18 KARAT MOUNTINGS IN GREAT VARIETY.

ALSO GOLD, SILVER AND STEEL SPECTACLES AND EYE-GLASSES.

Goods sent on approval upon application and satisfactory reference.

*Cutting Works,
57-61 Rapenburgerstraat,
Amsterdam.*

*House in
Paris,
44 Rue Laffitte.*

T. B. Citizen & Co.

DIAMONDS

21 John Street,

New York.

*L. B. Citron, Paris.
Gustave Kuhn, N. Y.*

ADOLPH GOLDSMITH,

SOLE AGENT FOR THE

RELIANCE WATCH COMPANY,

38 MAIDEN LANE,

NEW YORK.

FULL LINE OF

Gold and Plated Jewelry.

EVERY DESCRIPTION OF

SWISS WATCHES

A SPECIALTY.

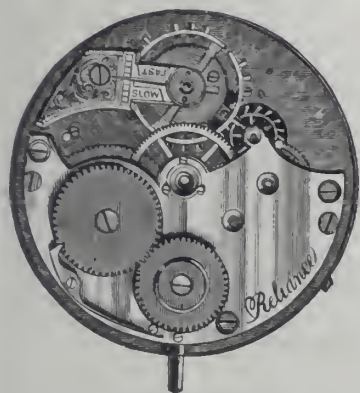

"RELIANCE,"
18 Size, to Fit Waltham Cases.



"RELIANCE,"
Nickel Stem Winder in all Sizes.

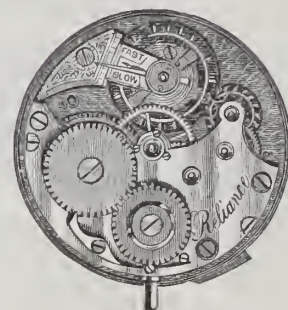

"RELIANCE,"
Ladies' 8 Size, to Fit Waltham Cases.

STERN BROS. & CO.,

No. 30 Maiden Lane, New York,

Importers of Diamonds,

MANUFACTURERS OF FINE JEWELRY.

Jobbers in American Movements of all grades, Gold & Silver Cases, Gold & Plated Chains.

THE FOLLOWING ARE OUR SPECIALTIES:

SEAL and STONE RINGS. GENT'S LOCKETS. *The most complete and largest line of GOLD INITIAL RINGS and LOCKETS made in the United States. The celebrated DOUBLE CROWN Plain Filled Rings, which are universally acknowledged the MOST RELIABLE in the market. Made in seven different widths.*



No. 00



No. 0



No. 1



No. 2



No. 3



No. 3½



No. 4

EVERY RING IS WARRANTED TO GIVE SATISFACTION.

Goods sent on selection to Dealers upon application with satisfactory reference.

A. PINOVER & CO
 MANUFACTURERS
 OF SEAL RINGS & DIAMOND MOUNTINGS. A FULL LINE OF DIAMOND MOUNTED GOODS CONSTANTLY ON HAND. WE CALL SPECIAL ATTENTION TO OUR RAISED INITIAL GLOVE RINGS

OFFICE 16 MAIDEN LANE.

CHARLES GLATZ,

Cor. Nassau & Liberty Sts., Bryant Building, N. Y. 100, 102 & 104 State Street, Chicago.

MANUFACTURER OF

WATCH CASES.

NOTICE.—Our Eight Karat Case is to-day Superior to any made in the market, as it is made in greater variety of design, and stands acid test as well as the best made. Also, we claim superiority as we do not have to sacrifice or alter the color of our gold to make it acid proof, so it still stands at the head of any case made.



GOLD.
COMMON [C.S.] SENSE.

TRADE MARK



SILVER.
WARRANTED COIN.

TRADE MARK

FOR THE
JOBBER TRADE ONLY.

SIMONS, BRO. & CO.

MANUFACTURERS.



CHAIN.



Fine Jewelry.

ILLUSTRATED CATALOGUE



611 and 613 SANSON STREET, PHILADELPHIA, OR NEAREST JOBBER.

ESTABLISHED 1833.
(50 YEARS.)

❖ E. IRA RICHARDS & CO. ❖

❖ EXCLUSIVELY MANUFACTURERS. ❖

FINE ROLLED PLATED JEWELRY,

The Largest and Choicest Stock in the Country.

Factories, NORTH ATTLEBORO, MASS. Salesrooms, 200 BROADWAY, NEW YORK.

HASKELL & MUEGGE, Agents, 206 Kearney St., San Francisco, Cal.

Goods Sent on Selection to Responsible Parties.

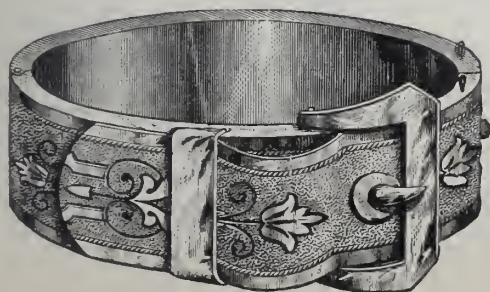

Examples of Medium Quality Bands, made in all the Widths, Sizes, etc., and acknowledged to be the Cheapest for Quality and Finish in the market.

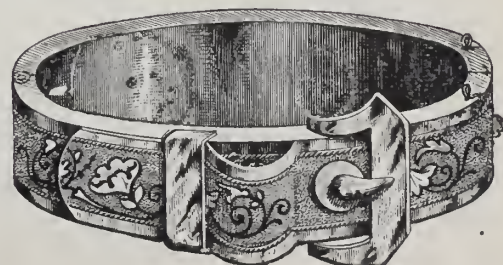

WATCHES



TRIUMPH-ROSKOPF WATCH.



JEWELRY



ESTABLISHED 1847.

J. T. SCOTT & CO.

7 Maiden Lane, New York.

Would respectfully invite the attention of Buyers to our

LARGE AND COMPREHENSIVE STOCK,

which is now more attractive than ever before. Buyers visiting the city will find it to their interest to give us a call.

Orders committed to our care will receive prompt and careful attention.

DIAMONDS



ROSKOPF WATCH.



CHAINS, &c.





W. ROBERT, SC.
Manufactory, 47, 49 & 51 Franklin Street, Newark, N. J.

MILLER BROS.,

No. 7 Maiden Lane,

NEW YORK.

IMPORTERS OF DIAMONDS

— AND —

MANUFACTURERS OF FINE JEWELRY.



OPEN.

We would call the attention of the Trade to our Newly Patented TURN OVER CAP SLEEVE BUTTON. The mechanical device by which the cap is turned is by a spring working in the pillar, which makes a much stronger and more durable cap than any other in the market.



CLOSED.

INITIAL GOODS A SPECIALTY.

CROSS & BEQUELIN,

21 MAIDEN LANE, N. Y.

P. O. BOX No. 531.

MANUFACTURERS OF THE CENTENNIAL

CHRONOGRAPH

THE BEST AND CHEAPEST HORSE TIMER

AND THE

Most Accurate Time Keeper in the World for the Money.

IN GOLD AND SILVER CASES.

CHEAP AND RELIABLE.

See Cut.



WHOLESALE DEALERS IN ALL GRADES OF
AMERICAN AND SWISS WATCHES, JEWELRY, MATERIALS, ETC.

SOLE AGENTS IN NEW YORK FOR THE SALE OF THE ENGLE ENGRAVING MACHINE.

WM. SMITH & CO.,

MANUFACTURERS OF

GOLD and SILVER Chains & Jewelry,

Also a Large Line of SILVER RINGS.

OFFICE :

No. 25 Maiden Lane, New York.

MANUFACTORY—No 61 PECK STREET, PROVIDENCE, R. I.

W. & S. BLACKINTON,

MANUFACTURERS OF

ONLY

FINE ROLLED PLATE CHAINS,

Necklaces, Polished and Roman, of Latest Gold Designs. Also a Complete Line of Gents' and Ladies' Locketts and Pendants.

In consequence of the first-class reputation our goods have obtained, unscrupulous dealers have been selling goods of an inferior quality, represented as our manufacture. In order to protect ourselves, as well as dealers, all goods of our manufacture will hereafter bear this

TRADE MARK. **W&S.B**★ TRADE MARK.

These Goods are for sale by all Wholesale Dealers.

WM. J. SUTTIE,

MANUFACTURER AND JOBBER OF

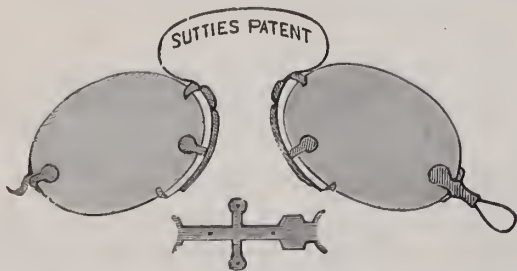

Eye-Glasses and Spectacles,

In GOLD, SILVER, STEEL and SHELL,

No. 39 Maiden Lane, New York.

CYLINDRICAL AND PRISMATIC GLASSES.

REPAIRING A SPECIALTY,

Webster's Silver Solution,

PREPARED BY

E. G. WEBSTER & BROTHER,

(Established 1859.)

Manufacturers of Quadruple

Electro Silver Plated Ware

14 MAIDEN LANE, N. Y.,

Expressly for Cleaning Silver and Silver Plated Ware.

Jewelers will find this a valuable adjunct for cleaning their stock, and a reliable article to recommend to their customers.

Guaranteed entirely free from Cyanide, Acid, Grit, or anything detrimental to the Finest Wares.

Packed in Boxes containing 2 Doz. Bottles.

Price, \$1.25 per Doz., NET.



CHESTER MANCHESTER & CO.,

MANUFACTURERS OF

Gold ♦ and ♦ Silver ♦ Chains,

No. 13 HANOVER STREET,

PROVIDENCE, R. I.

Waltham, Elgin, Illinois, Hampden, E. Howard & Co. and Special Movements.

**392 WASHINGTON ST.,
BOSTON.**

P. O. Box 5259.

D. C. PERCIVAL & CO., WHOLESALE DEALERS.

Watches, Jewelry,
Gold Chains, Gold,
Filled and Silver Cases,
Spectacles, Eye - Glasses,
Gold Head Canes, and Rogers &
Bro.'s Flat Ware.

Price List of Movements and Cases

Sent on Receipt of Business Card.

LOUIS A. SCHERR & CO.

Importers and Wholesale Dealers in

Watches, Jewelry,

WATCH MATERIALS, TOOLS, GLASSES, &c.

Spectacles, Silk Guards, &c.

Wholesale Agents for American Watches.

**No. 726 CHESTNUT STREET
PHILADELPHIA.**

AGENTS FOR THE WHITCOMB LATHE

AGENTS FOR W. F. NYE'S WATCH AND CLOCK OILS.

ESTABLISHED 1867.

F. JEANDHEUR, Jr.,

125 FULTON STREET, N. Y.

Gold and Silver Electro-Plating,

Mr. Jeandheur begs to notify the Trade that he has made more improvements with his new process of Electro-Plating Watches, Jewelry, Etc. By having introduced an Electro-Plating Machine instead of using the old method of Plating with Chemical Battery, he is able to plate with a far greater depth of gold than before, and for wear it is equal to rolled plate. The Trade can rely on this statement, as a trial will abundantly prove, and his well-earned reputation amongst the leading houses in the Trade will be sustained.

P. S.—He also begs to notify the Trade that he has no connection with any other house or person using his name, for the purpose of soliciting work.

PRICE LISTS SENT UPON APPLICATION.

Abbott's Stem Winding Devices

Are for sale and are applied to watches by all reputable jobbers, and by the manufacturer,

HENRY ABBOTT,

7 MAIDEN LANE, NEW YORK.

FACTORY, JOHN STREET.

ALSO MANUFACTURER OF

Fine Enamel Watch Dials.

YALE CLOCK CO.

NEW HAVEN, CONN., U. S. A.

NOVELTIES IN CLOCKS.

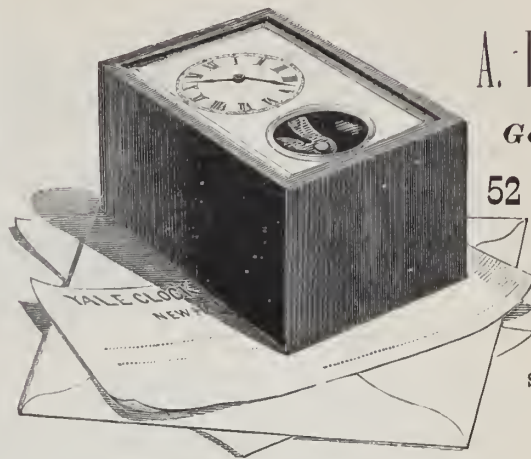

A. I. HALL & SON,

General Agents,

52 Maiden Lane,
New York.

528 & 530 Market St.,

SAN FRANCISCO,
CAL.

JOHN W. STEELE,

MANUFACTURER OF

FINE GOLD JEWELRY,

—AND—

BRAINERD'S

PATENT

LOCKETS

Patented June 17, 1874.

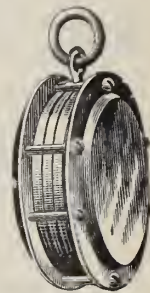

No. 9 Maiden Lane, NEW YORK.

Agents for the Lancaster, Pa., Watches.

A. FRIEDENTHAL & CO.

MANUFACTURING JEWELERS,

AND IMPORTERS OF WATCHES.

43 Maiden Lane, New York.

MATERIALS and OPTICAL GOODS.

COLBY & JOHNSON,

Manufacturers and Jobbers,
17 MAIDEN LANE, NEW YORK.

WATCH CASES,
FINE JEWELRY,
AMERICAN WATCHES.

SOLE MANUFACTURERS OF
CELLULOID WATCH CASES,
MOUNTED IN
GOLD, SILVER OR NICKEL.

USE GOLD STOCK PLATED CHAINS

(With Swivels Stamped

"R. F. S. & CO."

Every Chain Guaranteed by the Makers.

R. F. SIMMONS & CO.
ATTLEBORO FALLS, MASS.

Sold ONLY through Wholesale Houses.

ESTABLISHED 1855.

WELCH & MILLER,

JEWELRY Case Manufacturers,

Of Morocco, Velvet, Russia, Brocade and Plush.

SHOW CASE TRAYS OF ALL DESCRIPTIONS.

LOCK RING TRAYS FOR DIAMOND RINGS.

Agents for Jewelers' Cotton and Twine.

All Goods of our Own Manufacture, and a Large Stock
Always on Hand.

169 BROADWAY, NEW YORK.

SUSSFELD, LORSCH & NORDLINGER,

IMPORTERS OF

Optical & Mathematical Instruments,

Watchmakers' Tools, Materials, Etc.

SPECIALTIES:

BARDOU & SONS' Universal Opera Glasses. U. S. Army and Navy Glasses.
Rifle Range Telescopes, Etc., Etc.

LA REINE Opera and Marine Glasses.

CROWN Spectacles and Eye-Glasses.

PARADIS MAINSPRINGS.

PARAGON TOOLS.

13 MAIDEN LANE, NEW YORK.

16 Rue D'Enghien, PARIS.

FRANK O. LODWICK.

CHAS. A. NOLTING.

LODWICK & NOLTING, WHOLESALE JEWELERS,



JOBBER OF

Gold, Silver & Nickel

WATCHES,

Gold and Roll Plate

JEWELRY

MOVEMENTS

AND

Watch Cases,

SPECTACLES,

Clocks and Silverware.

Positively will all Orders. In-
quiries and Repairs receive im-
mediate and reliable attention.

CINCINNATI.

ESTABLISHED 1850.

JOHN T. MAURAN,

MANUFACTURER OF

FINE ROLLED PLATE GOODS

15 MAIDEN LANE, NEW YORK.

SPECIALTIES FOR THE FALL.

FULL LINE OF

STONE LACE PINS IN RUBY AND SAPPHIRE DOUBLETS,
GARNETS AND FOILED WHITE STONES,

Jet Lace Pins, Sets and Ear Knobs, Solid Gold White Stone Knobs.

ALSO

Full Line of Coral and Wire Sets, Lace Pins, Knobs, &c.

These Goods, which are so well and favorably known to the Trade, bear this

TRADE MARK



as well as the same being stamped on the cards.

PEARCE & HOAGLAND,

MANUFACTURERS OF

Gold Pens, Pencils, Pen Holders, Tooth Picks,

OF EVERY DESCRIPTION.



CLOSED

SOLE MANUFACTURERS OF THE

QUILL RESERVE TOOTH PICK,

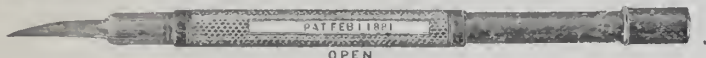

OPEN



CLOSED

The Holder of this Case is made in various styles in Gold Plate, Celluloid, Ivory, etc., while the Pick is of ordinary Goose Quill, and can be easily replaced by a new one, at any time, from the Reserve in the end of the Holder, and is the only Pick that will not injure the Teeth.

FOR SALE BY ALL JOBBERS.

Office and Factory, 29 Point Street, Providence, R. I.

R. WALLACE & SONS M'FG Co.,

MANUFACTURERS OF

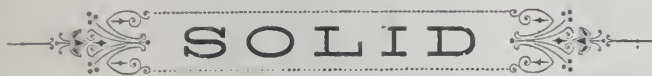

SILVERWARE,

GUARANTEED $\frac{92.5}{1000}$ FINE.

WALLINGFORD, CONN.

JAMES W. TODD,

SUCCESSOR TO GEO. W. PLATT,

Wholesale Dealer in

WATCHES & JEWELRY,

GOLD AND SILVER SPECTACLES

And Eye-Glasses,

No. 6 LIBERTY PLACE,

NEW YORK.

LEROY C. FAIRCHILD & CO.

MAKERS OF

GOLD PENS, PEN & PENCIL CASES,

No. 14 MAIDEN LANE,

LEROY C. FAIRCHILD.
G. HARRY ALLEN.

NEW YORK.

WOOD & HUGHES,

STERLING

SILVERWARE MANUFACTURERS,

New York Agents for the Derby Silver Co.'s

Fine Quadruple Plated Ware,

No. 16 John Street, N. Y.

206 Kearney Street, San Francisco, Cal.

HASKELL & MUEGGE, Agents.

J. B. & S. M. KNOWLES,

MANUFACTURERS OF

Sterling Silver Ware,

No. 20 MAIDEN LANE,

NEW YORK.

FACTORY, PROVIDENCE, R. I.

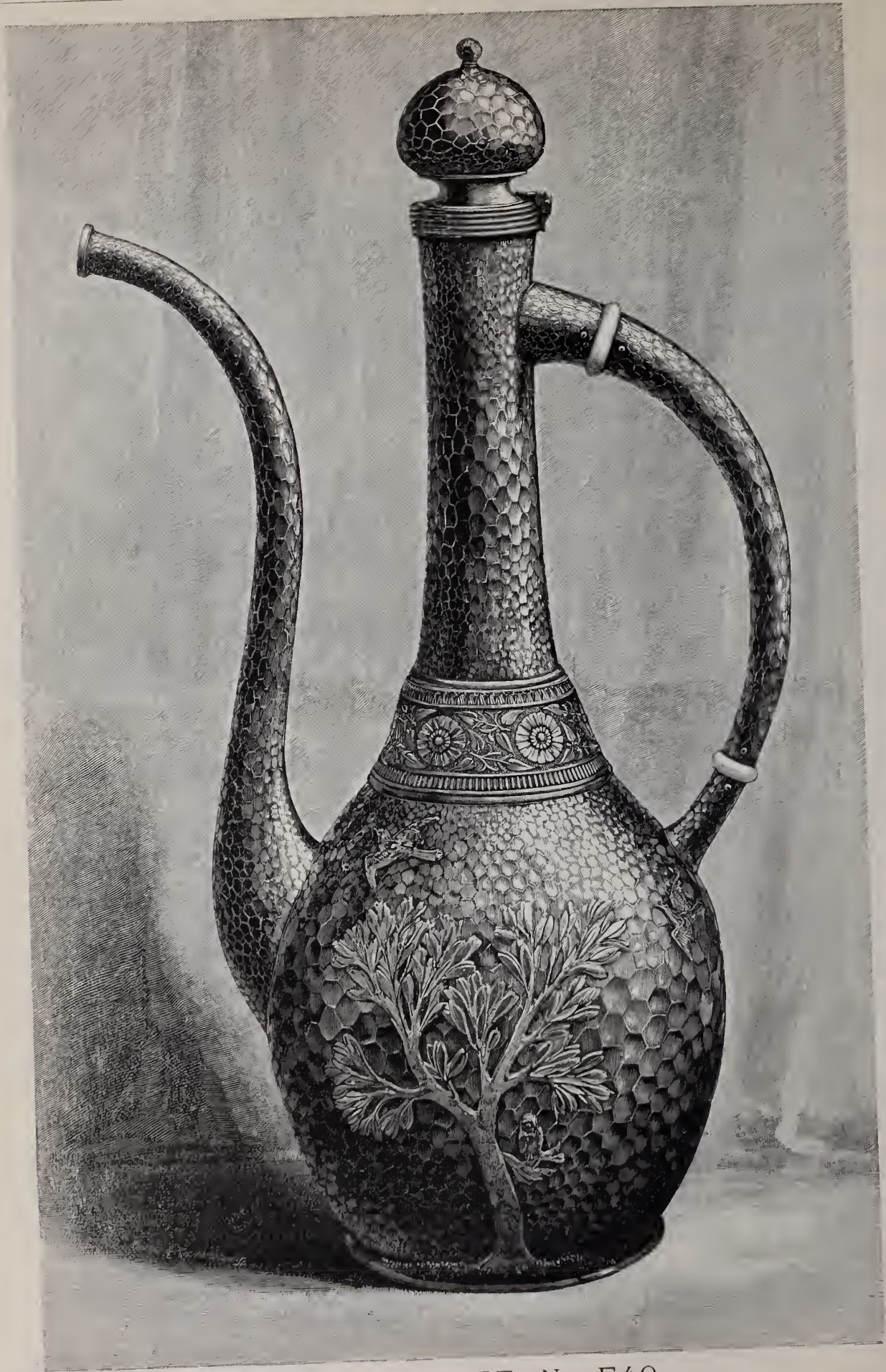

BLACK COFFEE, No. E40.

BY THE

Gorham M'g Company,

37 UNION SQUARE,

NEW YORK.

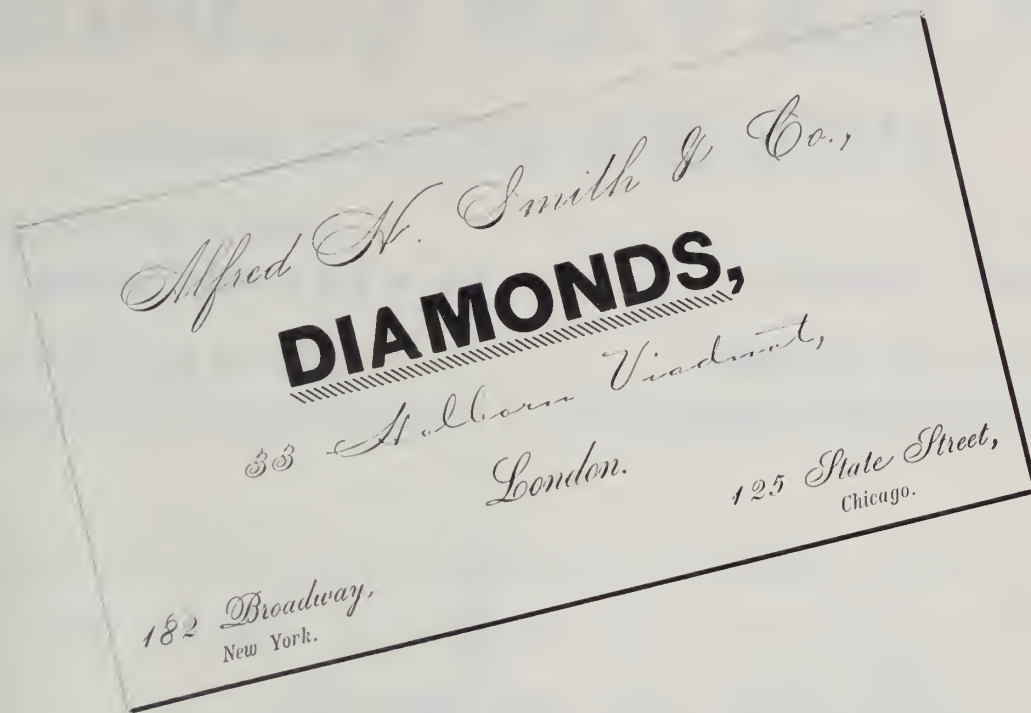

→ To Dealers Visiting Europe. ←

We take pleasure in directing the attention of the Trade to our London Office as above, where we hope to see those who may visit Europe this season.

Any letters addressed to our care (33 Abchurch Lane, London,) will be retained or forwarded promptly to Continental points, in accordance with instructions left with us.

Alfred N. Smith & Co.

182 Broadway, N. Y.

May 15th, 1883.

THE
NEW HAVEN CLOCK CO.

MANUFACTURERS, IMPORTERS, DEALERS,

FACTORIES.
NEW HAVEN, CONN.

GENERAL OFFICE AND SALESROOMS.
16 & 18 PARK PLACE, New York.

WESTERN OFFICE AND SALESROOMS.
31 WASHINGTON ST., Chicago, Ill.

EUROPEAN OFFICE AND SALESROOMS.
VICTORIA ST., Liverpool, England.

~~~~~

We are adding New and Novel Designs for the Fall Season of 1883 in Bamboo, Walnut, Ash, Porcelain, Nickel, Gilt and Plush

**CASES.**

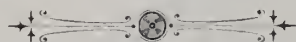

**PETREL.**

Light Wood. Bamboo.

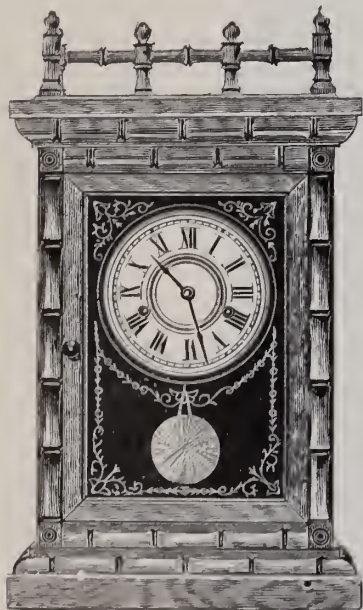

Height, 18½ inches; Dial, 5 inches. 1 Day Strike; 1 Day Strike Alarm. 8 Day Strike; 8 Day Strike Alarm. 8 Day ½ hour Strike, with Cathedral Gong.

**LARK.**

Porcelain and Plush Cases.



1 Day Lever Time. Nickel Plate Movement.  
A Reliable Timepiece.

**TAMAR.—Walnut.**



Height, 21¼ inches; Dial 6 inches.  
8 Day Strike.  
8 Day Strike Alarm.  
8 Day ½ hour Strike, with Cath. Gong.

**CATALOGUES AND PRICE LISTS FURNISHED THE TRADE UPON APPLICATION.**





CARTER, SLOAN & CO.,  
MANUFACTURERS OF ALL KINDS OF

GOLD JEWELRY,

No. 15 MAIDEN LANE,  
NEW YORK.

A. CARTER, JR.  
A. K. SLOAN,

C. E. HASTINGS,  
G. R. HOWE.

BALDWIN, SEXTON & PETERSON,

IMPORTERS OF

DIAMONDS and all PRECIOUS STONES,

MANUFACTURERS OF

DIAMOND AND RICH JEWELRY.

Cutters and Polishers of

DIAMONDS

692 & 694 BROADWAY, NEW YORK.

120 SUTTER ST., SAN FRANCISCO, CAL.

*J. F. Chatellier,*  
Manufacturing Jeweler,

*692 & 694 Broadway,*

*New York.*



TRADE

MARK.

STERLING.

Whiting Manufacturing Co.

SILVERSMITHS,

BROADWAY & FOURTH ST., N. Y.

ESTABLISHED 1837.

TAYLOR & BROTHER,

Old House READ, TAYLOR & CO.,

Importers of Diamonds and Pearls,

—)AND(—

MANUFACTURERS OF DIAMOND JEWELRY,

21 Holborn Viaduct, 676 Broadway,

LONDON.

NEW YORK.

ESTABLISHED 1813.

THOMAS G. BROWN & SONS,  
Newark, N. J., & 5 Bond Street, New York.

MANUFACTURERS OF

ARTISTIC JEWELRY  
FOR PRESENTATION,

Including Prizes for ROWING, RIFLE SHOOTING, ARCHERY and  
all ATHLETIC SPORTS.

COLLEGE SOCIETY PINS AND CLASS RINGS, ALSO BADGES FOR MILITARY  
AND CIVIC BODIES IN ALL METALS.

Employing able Designers, and having all work, both in Designing and Manu-  
facturing, done in our own factory, we can submit, for the inspection of those  
interested, entirely original designs, appropriate in style, and not to be seen else-  
where.

Estimates and Designs will be sent to Reputable Dealers when desired.



ESTABLISHED 1834.

G. & S. OWEN & CO.,

—MAKERS OF—

FINE ROMAN JEWELRY, &—

—& BOX and GLASS PINS,

—AND—

Black Onyx and Pearl Goods,

OF EVERY DESCRIPTION.

All Goods sold by us are exclusively of our own manufacture and are warranted 14 K. Fine, and stamped as such when possible.

No. 3 Maiden Lane, New York.

W. H. SHEAFER & Co.,

MAKERS OF

BRACELETS,

BANGLES,

LACE PINS,

SCARF PINS, ETC.

No. 15 JOHN STREET,

NEW YORK.

RIPLEY HOWLAND M'F'G CO.,

MAKERS OF

FINE JEWELRY,

SPECIALTIES:

DIAMOND MOUNTINGS, with Platinum Tips.  
ENGRAVED RINGS, STONE RINGS,

OFFICE, 17 MAIDEN LANE,  
NEW YORK.

FACTORY, 383 WASHINGTON ST.,  
BOSTON, MASS.



GOLD

SAXTON, SMITH & CO.,

Manufacturers of

SOLE AGENTS

FOR THE

NEW PATENTED CHAIN BAR,

Containing a Detachable Pencil.

FACTORY:  
183 EDDY ST.,  
PROVIDENCE, R. I.

OFFICE:  
14 JOHN ST.,  
NEW YORK.

CHAIN



A. J. HEDGES & CO.,

MANUFACTURING

JEWELERS,

No. 6 MAIDEN LANE,

NEW YORK.

Factory, No. 90 MECHANIC ST.,

NEWARK, N. J.

A. W. FABER'S

Gold Pens,

Pen and Pencil Cases

EBERHARD FABER, MANUFACTURER,

718 & 720 BROADWAY,

NEW YORK.



**FOWLER BROS.,**  
MANUFACTURERS OF

**JET & ONYX JEWELRY.**

Offer a large and varied stock of desirable goods of original designs, especially manufactured for the coming Fall Trade. These goods are elegant in design, beautifully finished, and must be seen to be appreciated.

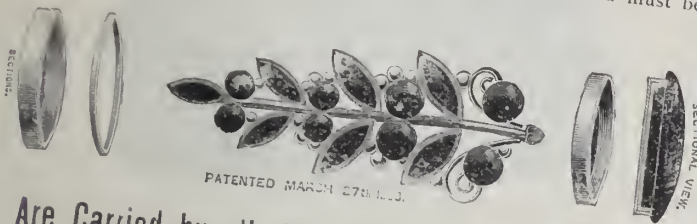

Are Carried by all the Leading Jobbing Houses  
Throughout the Country.

**MOORE & HORTON,**

No. 11 Maiden Lane,  
NEW YORK.

**JEWELERS'**

SPECIALTIES:

Stone Cameo, Onyx, Amethyst, Topaz  
and Pearl Rings.

Studs, Collar and Sleeve Buttons.

Also our fac-simile of Fine African Diamonds,  
with Foile Back, Mounted in Rings, Studs,  
Pins, Ear Rings, Scarf Pins, Lace Pins, &c.

JOHN F. SAUNDERS,  
Of the late firm of Buckenham, Cole & Saunders.

CHAUNCEY IVES.

**SAUNDERS & IVES,**  
IMPORTERS OF

**DIAMONDS, PEARLS,**  
And Other Precious Stones.

Manufacturers of Diamond Mountings.  
No. 26 MAIDEN LANE, NEW YORK.

A Large Stock of FINE DIAMONDS, Mounted and  
Unmounted, kept constantly on hand.

Goods sent on approval to any part of the country on receipt of  
satisfactory reference. All our goods ARE IN-  
SURED by us while in transit.

**DORRANCE, EDGE & CO.,**

Makers of the Celebrated

**Woven Fabric Gold Chain,**

And Patentees of the

**Embossed Inlaid Jewelry.**

The Latest and Most Effective Styles of Decoration  
Introduced.

15 JOHN ST., NEW YORK.  
FACTORY, 46 GREENE ST., NEWARK, N. J.

**G. W. PRATT & Co.,**

Manufacturers and Dealers in

**Watches and Jewelry**

OF EVERY DESCRIPTION.

ELGIN AND ILLINOIS MOVEMENTS  
IN ALL GRADES.

Gold, Silver and Ladd Patent Cases.

No. 14 JOHN STREET, NEW YORK.

**C. ROSSWOG & SON,**  
MANUFACTURERS OF

Rich Jewelry and Diamond Goods,

NOS. 5 & 7 MAIDEN LANE,

NEW YORK.



CHURCHILL, LEWIS & CO.,  
 Manufacturing Jewelers,  
 692 BROADWAY, NEW YORK.

S. W. HALE & CO.,  
 SUCCESSORS TO HALE & MULFORD,  
 MANUFACTURERS OF  
**FINE JEWELRY**



692 BROADWAY, N. Y.

SETH W. HALE. WILLIAM A. LEE. WILLIS H. HOWES.

JULIEN CALLET & CO.,  
 IMPORTERS OF  
**WATCHES**  
 OF EVERY GRADE,  
 No. 1 MAIDEN LANE,  
 NEW YORK.

JAMES F. ANGELL,  
 WHOLESALE DEALER IN  
**SOLID GOLD**  
 AND  
 Rolled Plated Jewelry,  
 176 BROADWAY,  
 NEW YORK CITY.

SMITH & KNAPP,  
 WHOLESALE DEALERS IN  
 AMERICAN AND SWISS WATCHES,  
**DIAMONDS.**  
 Gold & Plated Jewelry & Gold Chain,  
**No. 182 BROADWAY,**  
 COR. OF JOHN STREET, NEW YORK.

OFFICE:  
 14 JOHN STREET, N. Y.

**E. STITES' SONS.**

FACTORY:  
 NEWARK, NEW JERSEY.



**HODENPYL, TUNISON & CO.,**  
 MANUFACTURERS OF  
**FINE GOLD JEWELRY**  
 OF ALL DESCRIPTIONS IN  
**Roman and Enamel.**  
 ALSO THE  
**PATENT SPRING DIAMOND COVERS IN ALL STYLES.**

OFFICE, 170 BROADWAY.  
 Factory, 95 & 97 Cliff St., **NEW YORK.**

**GEO. O. STREET & SONS,**  
 ESTABLISHED 1837.  
 OFFICE AND FACTORY,  
 15 JOHN STREET, NEW YORK.

*Fine Intaglio and Platina and Gold  
 Lockets, Seals, Ladies' Gent's and Chil-  
 dren's Rings in Great Variety. Stone But-  
 tons, Lace Pins, Scarf Pins, Etc.*

STRICTLY FIRST-CLASS GOODS OF OUR OWN MAKE.

**DAY & CLARK,**  
 No. 10 MAIDEN LANE, NEW YORK.

*Fine Roman Goods.*

IN VERMICELLA AND HAMMERED ORNAMENTATION.

BANGLES, DIAMOND BALL COVERS, LACE PINS  
 AND EAR DROPS. BEAD NECKLACES,  
 EAR HOOPS, SCARF PINS.

Send for Selection Package.

FACTORY, NEWARK, N. J.

**G. B. BARRETT & CO.,**

IMPORTERS AND WHOLESALE DEALERS IN

**Watches, Diamonds, Jewelry,**  
 Clocks, Bronzes, Silver and Plated Ware,  
 Watch Materials, Etc.

A Full and Complete Line of all goods handled  
 by the Trade, constantly on hand. Lowest  
 Prices Guaranteed.

WHOLESALE EXCLUSIVELY.

238 & 240 Liberty St., **PITTSBURGH, PA.**

ESTABLISHED 1837.

**VICTOR BISHOP & CO.,**  
 IMPORTERS OF  
**DIAMONDS,**  
 RUBIES, SAPPHIRES,  
 EMERALDS AND PEARLS.

ENAMEL PAINTINGS, ROMAN PEARLS,  
 Copper, Platinum and Iridium.

**33 MAIDEN LANE, NEW YORK.**

House in Paris, 66 Boulevard de Sebastopol.

**JOHN A. RILEY & CO.,**  
 9 BOND STREET, N. Y.

SOLE MANUFACTURERS OF THE POPULAR

→ PATENT → SPRING → BRACELETS →

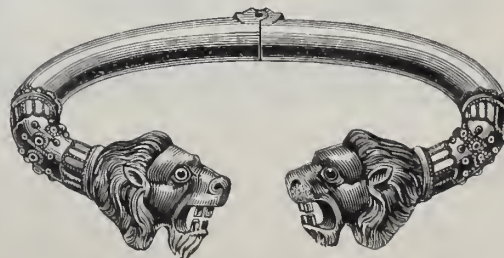

Also Lace Pins, Ear Rings, Scarf Pins, Etc.



H. DUHME.

R. H. GALBREATH.

# DUHME & CO.

MANUFACTURERS OF

## GOLD AND SILVER WATCH CASES,

Workshops and Salesrooms,

Carlisle Block, Fourth & Walnut, Cincinnati.

By the introduction of the very finest machinery and the employment of the most competent workmen and artisans, DUHME & CO. are now producing Watch Cases that, in strength, beauty and cheapness, are absolutely unsurpassed.

Dealers wishing to purchase Cases that are strictly first-class and at the lowest prices should examine those manufactured by DUHME & CO.

These Cases are, in all respects, meeting the views of the most exacting.

DUHME & CO. are also Jobbers of all lines of Goods required in first-class Jewelry Stores.

# HAUG & LUTHY,

MANUFACTURERS OF

## FINE DIAMOND MOUNTINGS, ETC.,

130 FULTON STREET,

Cor. Nassau St., NEW YORK.

N. B.—All Diamond Mountings of our Manufacture have a Patented

—SELF-CLOSING — SAFETY — CATCH—

# HELLER & BARDEL

MANUFACTURERS OF



13 John St., New York.

A Full Line of DIAMONDS. Mounted and Unmounted, Always on hand, which we will send for Selection to Responsible Houses.

All Goods Ordered on Selection or for Stock are Insured while in the Hands of the Express Companies.

CHAS. F. TERHUNE & CO.,

Manufacturing Jewelers,

Swiss & American Watches,

194 Broadway

NEW YORK.

Sets, Drops, Lace Pins, Bracelets, Neck Chains,  
Vest Chains, Locketts, Charms, Rings, Etc.

Light Onyx, Black and White for Lettering.  
Locket Ring: A Perfect Joint when Closed.  
Raised Initial in Diamonds.

Our stock of Plated Jewelry and Rolled Plate Chains represent fully the best and newest designs of all the leading manufacturers. Goods sent on selection on receipt of business card and satisfactory New York references.

# COX & SEDGWICK,

26 JOHN STREET, N. Y.,

## Makers of Patent Black Onyx Bracelets

Also Black Onyx Faceted Bead Bracelets,

AT THE LOWEST PRICES.

COLORED

AND

Turquoise

Lace Pins,  
Ear Rings,  
Locketts,  
Bracelets,  
Sleeve Buttons,  
Scarf Pins,



ONYX

Lace Pins,  
Ear Rings,  
Medallions,  
Necklaces,  
Chatelaines  
Sleeve Buttons  
Ladies & Gents  
Vest and  
Guard Chain.

Black Onyx Pins, Ear Rings and Locketts for 1, 3 and 5 Diamonds.

GOODS SENT ON APPROVAL TO RESPONSIBLE FIRMS.

# JOHN M. GODDARD,

Manufacturing Jeweler,

3 MAIDEN LANE, NEW YORK.

BRACELETS,  
BANGLES,  
SEAL RINGS,  
DIAMOND RINGS,  
STONE Locketts,  
Roman Locketts,  
Engraved Locketts,  
CHAINS, Etc.,  
Etc., Etc., in  
ALL QUALITIES

## JOBGING DEPARTMENT.

Jewelry Repaired, Colored or Matched Promptly.

Designs & Estimates Furnished for Ordered Work.



MANUFACTURERS OF Everything in

# BLACK ONYX JEWELRY

PLAIN, and {Ornamented with Pearls and Diamonds.

Our manufacturing facilities have been for the past ten years devoted exclusively to the production of fine Black Onyx Jewelry. We carry in stock the largest variety of articles made in our specialty, well made, finely finished, uniformly 14 karats, at medium and low prices.

**WOGLOM & MILLER,**  
Office & Factory, 32 & 34 JOHN STREET,  
NEW YORK.



**Wm. C. GREENE & Co.**  
GOLDSMITHS

MANUFACTURERS OF

RICH SETS IN TAPER WIRE CORAL

Factory 95 PINE ST. Providence, R. I.

Stone-Cameo Amethyst Coral Cameo Engraved Enamel Brooches Sleeve Buttons Studs & Ear Drops &c. New York Office 192 BROADWAY.

WM. C. GREENE. B. W. GREENE. GEO. D. BRIGGS.

**KETCHAM & McDOUGALL,**  
Bryant Building, (55 Liberty St.) New York.  
MANUFACTURERS OF  
**COLD AND SILVER THIMBLES.**





**THE AUTOMATIC EYE-GLASS HOLDER,**  
It Reels Up Cord Itself.  
A—Shows position of Glasses with cord reeled up.



ESTABLISHED 1859.

## STURDY BROS. & CO.

MANUFACTURERS OF

### Fine Rolled Plate Jewelry,

GRADUATED WIRE CORAL GOODS,  
STERLING SILVER JEWELRY.

Bangles, Sleeve Buttons, Cuff Buttons, Baby Pins, Sets in Stone, Cameo, Enamel, Chased, and Polished, Drops and Knobs, Bar Pins, Children's Sets, Locketts, Studs, Charms, Etc.

Only Wholesale Dealers' Trade Solicited. ATTLEBORO, MASS.

Flexible Bracelets,  
Diamond Mountings,  
Strung Pearl Work,  
Repairing,

Flexible Braided  
Bracelets,  
White Stone Goods,  
Strung Pearl Repa'ng

**Thos. M. Guilbert & Co.,**  
SUCCESSORS TO CARROW, DUBOSQ & Co.  
908 Chestnut Street, Philadelphia, Pa.

TRADE MARK.



## The ORIGINAL GOLD CROWN FILLED RINGS.

For the past thirteen years we have manufactured as a specialty, the well known "CROWN GOLD FILLED RING," with the high standing of which the trade is already perfectly familiar. In consequence of the above fact, and in justice to ourselves, we feel it a duty to make the announcement to the trade that there are now being offered in the market several other makes of filled rings, each of which has a CROWN in some way connected with its STAMP.

We Manufacture for the Jobbing Trade Only.

**McCALL & NEWMAN,**  
625 Arch Street, Philadelphia

**B. A. BALLOU & CO.,**

61 Peck St., Providence, R. I.

MANUFACTURERS OF

## GOLD JEWELRY.



We call special attention to our PATENT FASTENING FOR EAR RINGS, which is free from the objections raised to ordinary ear wire or screw fastenings. They present a very neat and attractive appearance, are perfectly secure, and much more convenient than ordinary ear wires which always annoy the wearer by catching the hair, veil, or lace about the neck. These Goods are for Sale by all Wholesale Dealers.

Gold Studs, Small Chains for Eye-Glasses, Bracelets, Etc.  
a Specialty.

**McCarty & Hurlburt,**  
WHOLESALE DEALERS IN  
WALTHAM, ELGIN & ILLINOIS

## WATCHES.

MANUFACTURERS OF

Jewelry, Gold Spectacles, Silver Thimbles, &c

**131 North Second St.,**  
PHILADELPHIA, Pa.



CLOCKS

ESTABLISHED 1853.



AMERICAN

AND

FRENCH CLOCKS

AND

BRONZES.

**B. J. COOKE'S SONS,**

137 N. 3d Street, PHILADELPHIA.

Catalogues and Price Lists furnished to the Trade only, on application.

**BOOZ & CO.,**

MANUFACTURERS OF

FINE GOLD



AND

PLAIN GOLD

Watch Cases RINGS.

Jobbers in American Movements.

**DIAMONDS.**

108 South Eighth St., (2d Story) Philadelphia.

Samples of our goods sent on approval when satisfactory reference is furnished.  
Old Gold and Silver Bought or Exchanged.

PARTICULAR ATTENTION PAID TO REPAIRING.

**BOSTON WATCH CASE COMPANY**

WATCH CASE MANUFACTURERS,

Nos. 1, 3 and 5 Province Court, Boston, Mass.,

ENTRANCE COR. PROVINCE STREET.

Especial Attention given to Watch Case Repairing, Springing, Re-engine Turning, Engraving, Polishing, &c.

Particular Attention given to Orders by Express.

WE OFFER THE LARGEST VARIETY OF ORIGINAL DESIGNS IN WATCH CASES EVER PRESENTED TO THE TRADE.

**CHAS. S. PLATT,**

Successor to George W. Platt,

GOLD AND SILVER

Refiner, Assayer and Sweep Smelter,

No. 4 LIBERTY PLACE,

Refinery, 67 and 69 Thomas St., NEW YORK.

Platers' and Electro-Platers' Silver Platinum and Aluminum.



KING JAMES, }  
MARQUIS, } RINGS.  
GLOVE, }

Quality Guaranteed.  
Prices Close.

BARNET BROS. & POWELL,  
—Manufacturers,—

Newark, N. J. & 15 JOHN ST., NEW YORK.

**TRIER BROS.,**

**IMPORTERS,**

15 MAIDEN LANE, NEW YORK.

**SPECIALTIES:**

*Bohemian Garnet, Whitby Jet, Steel and Amber Jewelry, Opera, Marine and Field Glasses, Telescopes, Pearl Card Cases, Silk Guards, Etc.*

Also a Complete Line of

GOLD AND GOLD PLATED JEWELRY.

ESTABLISHED 1850.

TRADE



MARK

**PETER L. KRIDER,**

MANUFACTURER OF

**STERLING SILVERWARE**

Medal and Diploma Awarded. &c. Striking Society Medals in Gold, Silver or Bronze a Specialty.

Artisan Hall, 618 Chestnut St., Philadelphia.

**William T. Smith,**  
ASSAYER, REFINER AND SWEEP SMELTER.

ESTABLISHED IN 1855.



**Cor. Blackstone & Hawkins Sts**

PROVIDENCE, R. I.

BOSTON, Mar. 15, 1883.

To whom it may Concern :

Mr. Wm. T. Smith, of Providence, R. I., has done refining for us for years, as well as his father before him, and we take pleasure in saying we have never received anything but satisfaction in our dealings with him.

RIPLEY HOWLAND MFG. CO., K. Crosby, Treasurer.



**JEWELRY AND WATCHES.**

ROGERS' SILVERWARE.

MATERIALS AND TOOLS.

S. F. MYERS & CO.,  
Manufacturers and Jobbers,  
179 BROADWAY, NEW YORK.

ILLUSTRATED CATALOGUE FOR THE TRADE.

**W. E. WHITE & CO.,**  
Manufacturing Jewelers.

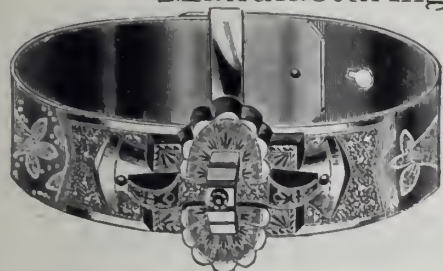

**FINE  
ROLLED PLATE  
GOODS.**

Bracelets---Engraved, Enamelled, Flat Band and Buckle.

Ladies' Goods—Lace Pins, Drops, Crosses, Sets, Collar Buttons, &c.

FOR SALE BY JOBBERS ONLY.

New York Office, 26 MAIDEN LANE, Corner Nassau Street.

Factory 54 Page St., Providence, R. I.

Represented by S. A. BALDWIN.

**ALEX. MILNE,**  
Manufacturer of Stem-Winding Watch Crowns



**ALSO GOLD AND SILVER THIMBLES.**



19 Ward Street, NEWARK, N. J.

**JAMES J. FISHER,**

DEALER IN

**WATCHMAKERS' and JEWELERS' MATERIALS,**

Files, Tools, Silk Guards, Watch Glasses, Spectacles, Rolled Plate, Fire Gilt, Nickel and Silver Chain, Charms, &c.

**No. 697 BROADWAY,**

Corner Fourth Street, NEW YORK.

All kinds of Job Work for the Trade Promptly attended to.

**The "Acme" French Clock Movement Support.**

(Pat. Nov. 1st, 1881.)

This Support is adapted to the holding in position of any French Clock Movement while regulating or adjusting, and will be found very desirable on account of its simplicity of action and the small space it occupies. To be had of any respectable jobbing house, or sent, post paid, to any address, on receipt of 60 cents.



*Henry Sera,*

*Importer of Rough & Polished Diamonds,*

DIAMOND CUTTING AND POLISHING WORKS:

21, 23, 25 Looijersgracht.  4 & 6 JOHN ST.,  
Amsterdam, Holland. New York.

Diamonds repaired and matched by some of the finest workmen in the world.

Diamond Bort and Powder always on hand.

**G. W. SCHUMANN,**

No. 24 JOHN STREET,  
NEW YORK.

*Sole Licensee in the United States for the manufacture of*

**TRENOR'S DIFFERENTIAL DIAL,**

*by which the time in two cities can be recorded at once.*

**The Dial can be applied to any Watch.**

GEO. W. DUBOIS.

F. N. NAUMAN.

**GEO. W. DUBOIS & CO.,**

IMPORTERS OF

**Watches & Optical Goods.**

ALL STYLES AND QUALITIES OF

SPECTACLES AND EYE-GLASSES.

**LONGINES' WATCHES AND MOVEMENTS.**

The Watches in Gold, Silver and Nickel Cases of New and Handsome Patterns. The Movements fit 18 size Waltham Stem Winding Hunting Cases.

**36 MAIDEN LANE, NEW YORK.**

Orders by Mail Receive Prompt Attention.

**R. & K.'S PATENT GAS FURNACES FOR MELTING, PLATING, ENAMELING, ANNEALING, &c., &c.**

**Reichhelm & Koester,**

Importers and Manufacturers of

**Jewelers' Tools, Files, Materials, &c.,**

**Manufacturers of**  
Bristle Brushes of all kinds,  
Cotton and Wool Buffs,  
Felt Polishing Wheels,  
Walrus Leather Polishing  
Wheels,  
Jewelers' Satin Finish and  
Scratch Brushes,  
Brass & Steel Wire Brushes  
Jewelers' Standard Saw  
Frames,  
Plain & Fancy Draw Plates,  
Improved Jewelers' Ingots,  
R. & K.'s Jewelers' Combi-  
nation Gas Burners.

**Importers of**  
French, English & German  
Tools and Files,  
Piercing Saws,  
Renard & Vautier Gravers,  
Steel and Brass Wires,  
Vienna and Ruby Draw  
Plates,  
Alloying Copper Wire,  
Felt, Walrus Leather,  
Vienna Lime, Tripoli,  
&c., &c., &c.

**80 Nassau St.**

NEW YORK.



# WHEELER, PARSONS & HAYES,

MANUFACTURERS OF

## WATCH CASES, GOLD CHAINS & FINE JEWELRY

Importers of Diamonds and Manufacturers of Diamond Jewelry,  
**And Dealers in American and Swiss Watches,**  
**No. 2 MAIDEN LANE, NEW YORK.**

### L. A. CUPPIA,

Manufacturing Jeweler, 19 Union Square, N. Y.

## SILVER CANE HEADS,

A Large and Comprehensive Assortment of New and Original Designs.

AND IMPORTER OF

## SILVER FILIGREE JEWELRY

Embracing a Large and Varied Assortment of Popular Designs.

### SILVER JEWELRY.

SILVER BRACELETS A SPECIALTY.

SELECTION PACKAGES SENT ON APPROVAL.

Established 1828.

# JACOB BENNETT & SON,

Diamond Setters and Manufacturing Jewelers,  
 No. 923 CHESTNUT STREET, PHILADELPHIA.

WE MANUFACTURE AND MAKE A SPECIALTY OF  
 EVERY DESCRIPTION OF

## DIAMOND MOUNTINGS,

SUPERIOR IN DESIGN AND WORKMANSHIP.



Dealers in

## DIAMONDS

And all kinds of Precious Stones.

Of which we keep a Large Assortment Constantly on Hand.

Masonic Marks Society and School Badges, Made to Order Only. Designs and Estimates Furnished.

PARTICULAR ATTENTION GIVEN TO ALL KINDS OF JOBBING.

# SINNOCK & SHERRILL,

## SEAL & STONE RING MANUFACTURERS.



Richly incrustated with Diamonds.  
 14 K. Fine.  
 Design of Shank Patented.

3 Maiden Lane, New York.

Factory, Goldsmith Hall, Maple Place,

Green Street, Newark.



Raised Initial in Diamonds,  
 14 K. Fine.

CHICAGO OFFICE.

182 State Street.

THE NUMBER OF THOUSANDTHS FINE STAMPED IN EACH RING.





181



193



PATENT APPLIED FOR  
193



214

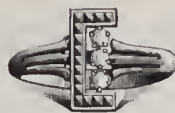

218



219

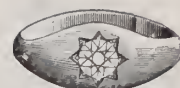

812



THE ABOVE CUTS ARE THREE DIFFERENT  
SHAPES IN THE SAME WEIGHT OF PLAIN  
RINGS. TO BE USED IN ORDERING.

**J. B. BOWDEN & Co.,**

MANUFACTURERS OF SOLID RINGS

OF EVERY DESCRIPTION.

No. 1 MAIDEN LANE, cor. Broadway, NEW YORK.

ESTABLISHED 1849.

**KOCH & DREYFUS,**

WHOLESALE DEALERS IN

**WATCHES, JEWELRY, CLOCKS, DIAMONDS, SPECTACLES, ETC.**

ALSO JEWELERS' AND WATCHMAKERS' TOOLS AND MATERIALS AT MANUFACTURERS' PRICES.

18 CHARTRES ST.,

NEW ORLEANS.

BRANCH OFFICE, 20 MAIDEN LANE, N. Y.

THEUERNER & CHURCH,

MANUFACTURERS OF FINE RINGS,

No. 9 MAIDEN LANE,

NEW YORK.

FACTORY, COR. MULBERRY & DURAND STS., NEWARK, N. J.

LEON JEANNE.

PAUL JEANNE

**JEANNE BROTHERS**

MANUFACTURERS OF

**DIAMOND MOUNTINGS,**

**AND RICH JEWELRY.**

No. 1 MAIDEN LANE, NEW YORK

Designs Furnished and Estimates Given.

**JEANNE BROS PAT. DIAMOND  
SETTINGS.**

A PLATINUM SETTING WITH A GOLD SURFACE  
OUTSIDE

IN THIS WAY THE REFLECTION OF GOLD  
THROUGH THE DIAMOND IS ENTIRELY  
PAT. AUG. 15<sup>TH</sup> 1892  
**AVOIDED.**



# A NEW PIN TONGUE VISE

FOR JEWELERS and DEALERS  in JEWELERS' SUPPLIES.

*This New Device for securely holding Pin Tongues while being fitted, will commend itself to every Praetieal Workman.*

*The joint of the tongue is plaeced in one of the graduated grooves and firmly secured by tightening the serew, enabling the workman to either file the joint to any required thickness, brooeh the hole, shorten the pin or correet such defects as he may desire with ease and dispatch.*

*These tools are made of Hardened Steel, Nickel Plated, and is a useful and handy tool.*

Price, \$1.25. For Sale to the Trade by

**HENRY GINNEL & CO., Wholesale Agents,  
31 Maiden Lane, NEW YORK.**

**F. W. GESSWEIN,**

No. 39 JOHN STREET,

NEW YORK.

MANUFACTURER OF

MACHINERY AND TOOLS FOR

*Jewelers, Watch, Clock, Chronometer,  
Watch Case and Fine Instrument  
Makers. Wire and Bristle  
Brushes. Polishing Im-  
plements.*

IMPORTER OF

TOOLS, FILES AND SUPPLIES FOR

*Jewelers, Silversmiths, Engravers, Watch  
and Watch Case Manufacturers,  
Clock and Chronometer Makers,  
Platers, Polishers, Machin-  
ists, Dentists, etc., etc.*

MANUFACTURER OF HAND CUT FILES.

Factory, PATERSON FILE WORKS, PATERSON, N. J.

—+ ESTABLISHED 1874. +—

**JOSEPH P. WATHIER,**

Successor to JOSEPH P. WATHIER & BRO.,

178 WEST MADISON ST., CHICAGO, ILL.

**WHOLESALE JEWELER & WATCHMAKER & JEWELER FOR THE TRADE,**

Changing of Key Winding Movements into Stem Winding and Hand Setting,

AND MAKING STEM WINDING PARTS A SPECIALTY.

*All Work Intrusted to me will receive PROMPT ATTENTION, and Satisfaction Warranted, at Prices Always the Lowest.*

**EDWIN A. THRALL,**

1 MAIDEN LANE,

NEW YORK.

—o JOBBER IN o—

**American Watches, Diamonds, Fine Jewelry, Etc.**

AT LOW PRICES, AND FOR CASH ONLY.

I employ no Travelers, therefore can furnish select goods of the newest designs at the very lowest market price. Every Watch warranted to keep time when delivered. The new system introduced by the American Watch Co., of selling a complete watch, will be adopted. Agent for the new Mascot Bracelet, Patented. Orders filled immediately on receipt. Repairing and Adjusting Fine Watches and Chronometers for the Trade a Specialty.



# WM. S. HEDGES & CO.,

IMPORTERS OF



COPYRIGHT SECURED. Entered according to Act of Congress in the year 1880, by WM. S. HEDGES & Co., in the Office of the Librarian of Congress, at Washington.

170 BROADWAY,

Corner Maiden Lane, New York.

---

CHOICE BRILLIANTS IN SINGLE STONES AND MATCHED PAIRS A SPECIALTY.

---

 Fresh invoices of Goods in all Grades constantly arriving. Also choice parcels of exceptionally Fine Gems ESPECIALLY Selected for critical purchasers. A full line of Mounted Goods, Artistically Designed.

GOODS SENT ON APPROVAL.



THE CELEBRATED  
**PATENT DUST PROOF**  
 SCREW BEZEL



MANUFACTURED BY

**THE AMERICAN WATCH CO.,**



**WALTHAM, MASS.,**

Are now made in the following styles:



No. 301. Regular Weight (about 3 oz.), with Patent Screw Bezel and Cap.

This case has been favorably known to the Trade for the past four years, and is regarded as the STANDARD for this style of goods.



No. 302. Extra Weight (about 4 oz.), with Patent Screw Bezel and Cap.

This case is now offered to the Trade with the view of supplying the demand for a heavier and larger case than our Standard, No. 301.



No. 303. Regular Weight (about 3 oz.), with Patent Screw Bezel and Cap, and INLAID DECORATION of 14 karat Gold, pressed into the Silver, flush with the surface, preventing all wear on the decoration.

**ROBBINS & APPLETON,**

**GENERAL AGENTS,**

NEW YORK.

CHICAGO.

BOSTON.

LONDON, ENG.

SYDNEY, N. S. W., AUSTRALIA.



8 AND 14 SIZE

# Waltham Movements

— IN —

“CRESCENT” GOLD FILLED CASES,

Also 18 Size Gold Filled Cases

**IN HUNTING, OPEN FACE AND PATENT DUST PROOF SCREW BEZEL.**



The above Cases are Manufactured by the

CHICAGO WATCH CASE CO.,

and we take pleasure in recommending them to the Trade generally as the Best Gold Filled Cases made.

Special Net Price List of the above, and all goods manufactured by The American Watch Co., will be forwarded to Dealers only. Applicants must inclose BUSINESS CARD.

## **ROBBINS & APPLETON,**

GENERAL AGENTS,

New York.

Chicago.

Boston.

London, Eng.

Sydney, N. S. W., Australia.





*Randel, Barmore & Billings*

*Importers of*

*Diamonds*

*and Manufacturers of*

*Diamond Jewelry.*

*58 Nassau Street,  
& 29 Maiden Lane,  
New York.*

*1 St. Andrews Street,  
Holborn Circus,  
London, E. C.*



MAKER OF FINE

Jewelry.



889D.  
Patented.

SEND FOR REDUCED PRICES

INITIAL RINGS.



DEALERS WISHING TO ADVERTISE CAN BE FURNISHED

WITH ELECTROTYPES OF DESIGNS,

WITHOUT CHARGE,

BY ADDRESSING THIS HOUSE.

HENRY C. HASKELL,  
12  
JOHN STREET,  
NEW YORK.

Goods sent on approval upon receipt  
of Satisfactory References.

# A. J. WARNER & CO., WHOLESALE JEWELLERS,

309 Nicollet Avenue, Minneapolis, Minn.

We carry a Large and Elegant Stock of Jewelry, Watches, Cases, Etc., Etc.

North-western Agents of the WATERBURY CLOCK CO., and carry a Complete Line of their Goods.

OUR TRADE IS EXCLUSIVELY WITH THE JEWELERS.

## O. A. GAGER,

Successor to CHAS. FIELD HAVILAND & CO.,

IMPORTER OF

### Porcelain and Ornamental Ceramics,

29 BARCLAY STREET.

A Fine Line of FANCY POTTERY of all grades, specially adapted for Jewelers.

PARIAN, BISQUE, TERRE COTTA, FAIENCE, PORCELAIN, ETC.

VASES, PLAQUES, STATUETTES, BUSTS, ETC., ETC.

## M. FOX & CO.,

Practical Lapidaries and Importers of

# DIAMONDS.

Rubies, Sapphires and Fancy Gems.

PEARLS, TURQUOISE, INTAGLIOS, ONYX, AMETHYST, ETC.

No. 1 MAIDEN LANE, NEW YORK.



**N. H. WHITE,**  
 JOBBER IN  
**AMERICAN-WALTHAM WATCHES,**  
 EXCLUSIVELY.

Waltham make of gold and silver cases a Specialty. Ladd, Boss, and the Patent Screw Bezel Filled Cases to fit Waltham movements only  
 No. 11 MAIDEN LANE, NEW YORK.

I not only advertise that I have the Waltham Goods, but **have constantly on hand** the Largest Stock carried by any jobber in the trade. Gold Cases of all Weights and Styles. Memorandum Packages with pleasure to dealers furnishing satisfactory reference.

**COMPLETE PRICE LIST TO THE TRADE.**

**HERMAN TROST & CO.,**  
**IMPORTERS,**

50, 52, 54 MURRAY STREET, NEW YORK.

**PARIS:**

**YOKOHAMA.**

**LIMOGES:**

130 Rue du Faubourg St. Denis.

38 Avenue du Crucifix.

*Fine China Ware, Vases, Figures, &c., Biscuit Statuettes, &c., Sevres, Dresden and Worcester Porcelain, Vienna Fancy Goods. Very Fine Collection of PAINTINGS and PLAQUES on China and Faience. JAPANESE and CHINESE GOODS. Capo di Monte China Articles, Vases, Tankards, &c. Specialty of Fine China Articles, suitable for Jewelry Stores.*

The Largest Assortment in the United States at Lowest Prices.

ESTABLISHED 1859.

**RINGS A SPECIALTY.**

**BRYANT & BENTLEY,**

**12 MAIDEN LANE, Up-Stairs, NEW YORK.**

AMONG OUR LATEST PATTERNS OF FINE SOLID RINGS ARE



587



591



584



504



589



490

No. 587—Made in Topaz and Amethyst. No. 591—Cluster of Garnets, Doublets or Turquoise, with Pearls and Diamonds. No. 584—Cameo or Garnet with Pearls and Diamonds. No. 504—Misses' Turquoise Rings. Nos. 490 and 589—Represent two patterns only of our Engraved Band Rings.

We also continue to make a full line of our well known 16 K. HARD SOLDER RINGS.

Goods sent on approval to responsible parties.

**C. ROGERS & BROS.,**  
**MERIDEN, CONN.**  
 WESTMINSTER.

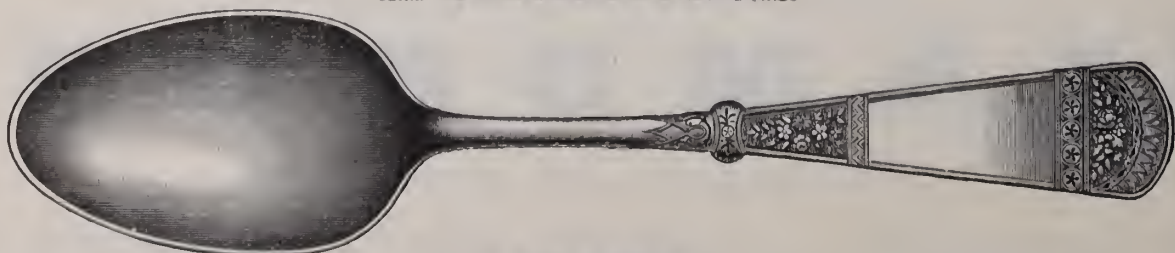

**PATENTED.**

We Guarantee all goods bearing our stamp to be made of 18 per cent. Nickel Silver, and plated equal to the very best in market.



A SPECIALTY.  
PATENT CATCH BRACELETS.



PAT. SEPT. 30 1882.

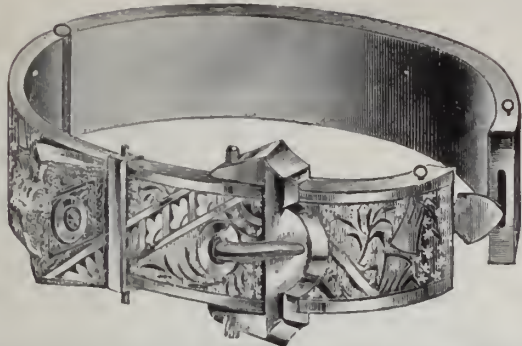

The most Convenient and Complete Catch ever invented. Not liable to get out of Order. Very Durable.

C. I. RICHARDS, BROWN & CO.,

MANUFACTURERS OF

**Gold and Plated Jewelry,**

202 BROADWAY,

Factory, Providence, R. I.

NEW YORK.

We now offer to the Trade a Fine Assortment of Rolled Plate Jewelry, Patent Catch Bracelets in First and Second Quality, Enameled, Chased and Roman, with and without Buckle and Fancy Ornaments. Bangles and Flat Bands in great variety. Our Patent Lever and Separable Buttons and Studs, Ladies' and Gent's Collar Buttons, Charms, Lockets, Lace and Scarf Pins, Sets, Chains, etc., etc.

ALSO A FULL LINE OF BRILLIANT JEWELRY IN GOLD.

Goods Sent on Approval upon Application with Satisfactory Reference.

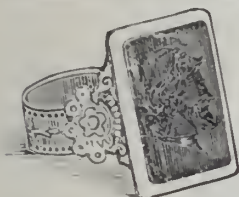

**R. HENRICH,**

**"SELF-SIZING RING,"**

(PATENTED MARCH 20th, 1883.)

NEW PATTERNS FOR FALL TRADE.



FOR SALE BY ALL JOBBERS.

SEAL AND STONE RINGS IN ALL VARIETIES.

35 Maiden Lane,

NEW YORK.

**HENRY ZIMMERN,**

IMPORTER OF

Watch Materials,

TOOLS,

AND OPTICAL GOODS,

No. 8 Maiden Lane, New York.

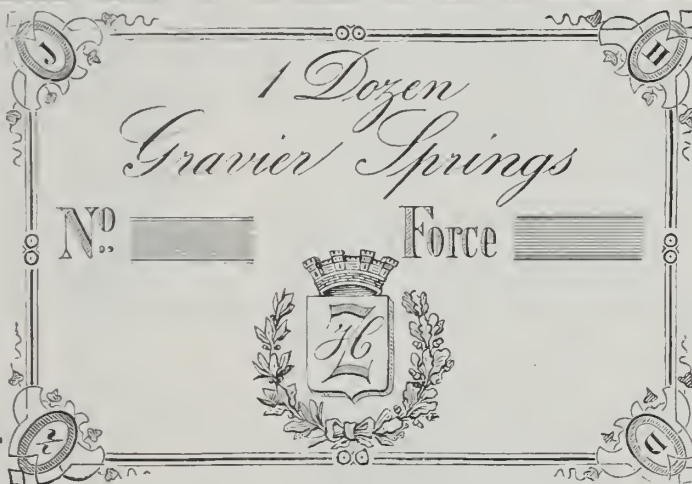

WHITE METAL CHAINS A SPECIALTY.

SOLE AGENT

FOR THE CELEBRATED

GRAVIER

**MAINSPRINGS.**

The cut is a fac simile of trade mark with my monogram on wrapper, adopted by me to prevent the trade from being imposed upon with imitation springs. A brass tag attached to each spring indicates the number and strength according to Dennison's United States Standard Gauge. These Springs are to be obtained at all leading Jobbing Houses.

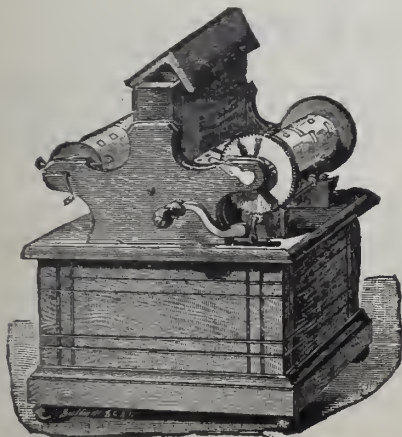

Reed Pipe Clariona, \$8.

**CLARIONAS. AUREPHONAS.**

ATTRACTIVE AND SALABLE **STOCK.**

Both Instruments of Superior Tone, Beautiful in Finish, thoroughly Durable and Salable.

We make a Specialty of the Sale of Mechanical Musical Instruments, and keep the Largest Variety in the world. Send for Catalogue and Discounts to

**WM. BLASIUS,** 923 & 925 Chestnut St.,

Gen'l Agent.

Philadelphia, Pa.



**Aurephone, \$10.**

17 Full Sized Reeds. Durability Guaranteed. All Music on Spools, at 4c. a Foot.



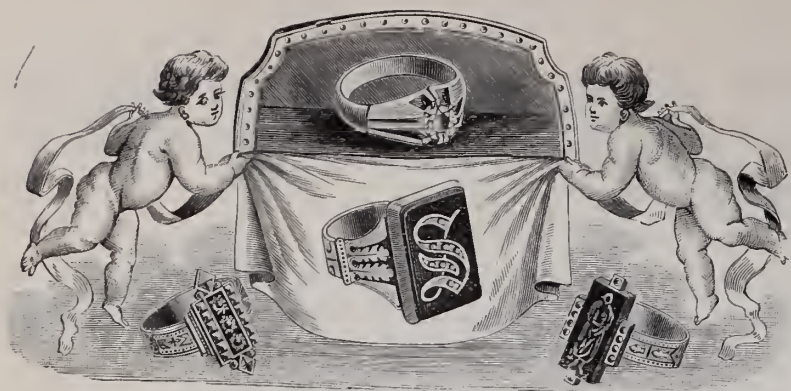

SPECIALTY.—Solid Gold Rings of Every Description, Scarf Pins, Studs, Etc.

**L. SAUTER,**

1 MAIDEN LANE, Cor. Broadway, NEW YORK.

MANUFACTURER OF

Fine and Diamond Jewelry,

HAIR JEWELRY and DEVICE WORK.

JOBGING FOR THE TRADE.

**JAMES H. HART,**

4 MAIDEN LANE,

NEW YORK.

**IMPORTER AND JOBBER.**

*Diamonds, Watches, French Clocks and Bronzes. Faience, Porcelain and Royal Worcester Ware. Opera Glasses, Silk Guards, Etc.*

**AMERICAN-WALTHAM WATCHES.**

I have just received a very large line of **WHITBY JET GOODS**, comprising all the Novelties, at very low prices.

GOODS SENT ON SELECTION TO RESPONSIBLE HOUSES.

**H. H. HEINRICH & CO.,**

12 JOHN ST., NEW YORK,

Manufacturers of the

**PATENT SELF-ADJUSTING BALANCE**

FOR EXTREME HIGH AND LOW TEMPERATURE.

Marine Chronometers  
AND  
Zimmerman Watches  
are provided with  
this Balance.

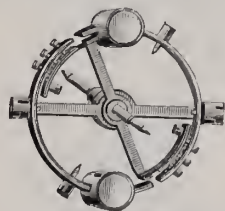

Tried by three  
Observatories with  
the best results.

We are also agents for the Celebrated K. Zimmerman Watch, which we can recommend to the Trade. Send for Circular containing information in regard to the Patent Balance Zimmerman Watches and Marine Chronometers.

**BLANCARD & OBERLANDER,**

MANUFACTURERS OF

**Settings and Galleries,**

IN THE LATEST STYLE.

**BALL WIRE**, Solid and Hollow, in 14 and 10 karat, also single **Hollow Balls** without joint, of all sizes, in Silver and 14 karat alloy and upwards. Made in any thickness of Gold to order.

**Platinum, Platinum-Lined and Fancy Settings a Specialty.**

PLATINUM SCRAPS EXCHANGED OR PURCHASED.

36 & 38 JOHN STREET, N. Y.

PLEASE SEND FOR SAMPLE CARD.

**TESKE'S PATENT WATCH REGULATORS,**

For Sale by all Principal Jobbers in U. S. and Canada.



1.

No. 1, having an oblong hole in the Base Plate (which is secured by a Special Patent), fits all **Waltham, Elgin, Hampden and Rockford** Movements.



2.

Over 5,000 in Use and Indorsed by the Best Jewelers.

**CHAS. TESKE & CO., Manufacturers,**

214 ASYLUM ST., HARTFORD, CONN.

Show Cards sent free upon application. Orders sent to us by Retailers should be accompanied with Cash, \$1.50 each, less 10 per cent. per doz.



3.

No. 2, having also an oblong hole but F. S. on the opposite sides of No. 1, fits all **Illinois and Old Model Waltham**.

Patented November 18, 1873.

**MORRISON'S**

**GOLD AND SILVER SOLUTIONS**

For Electro-Plating Without a Battery.

Invaluable for Watchmakers and Jewelers. So simple that any one can use them.

Price, **Gold Solution, \$3.00**

**Silver Solution, \$1.50**

MANUFACTURED BY



**ARTHUR B. MORRISON, Portland, Maine.**

FOR SALE BY

Sussfeld, Lorsch & Co., New York; Henry Ginnel, New York; Cross & Beguelin, New York; Kearney & Swartzchild, Chicago, Ill.; Louis A. Scherr & Co., Philadelphia, Pa.; Duhme & Co., Cincinnati, O.; Harwood Bros., A. Paul & Co., Palmer, Bachelder & Co., Boston, Mass., and material dealers generally.

*BEWARE OF BASE IMITATIONS put up by unprincipled persons. None are genuine without the Trade Mark which consists of the letters A. B. M. in monogram and fac simile of Medal awarded by U. S. Centennial Commission.*





**E. AUG. NERESHEIMER**  
**& Co**  
**IMPORTERS**  
**of**  
**DIA MONDS**  
**21 MAIDEN LANE**  
**NEW YORK**

NO 66 SARPHATI STRAAT  
AMSTERDAM HOLL.

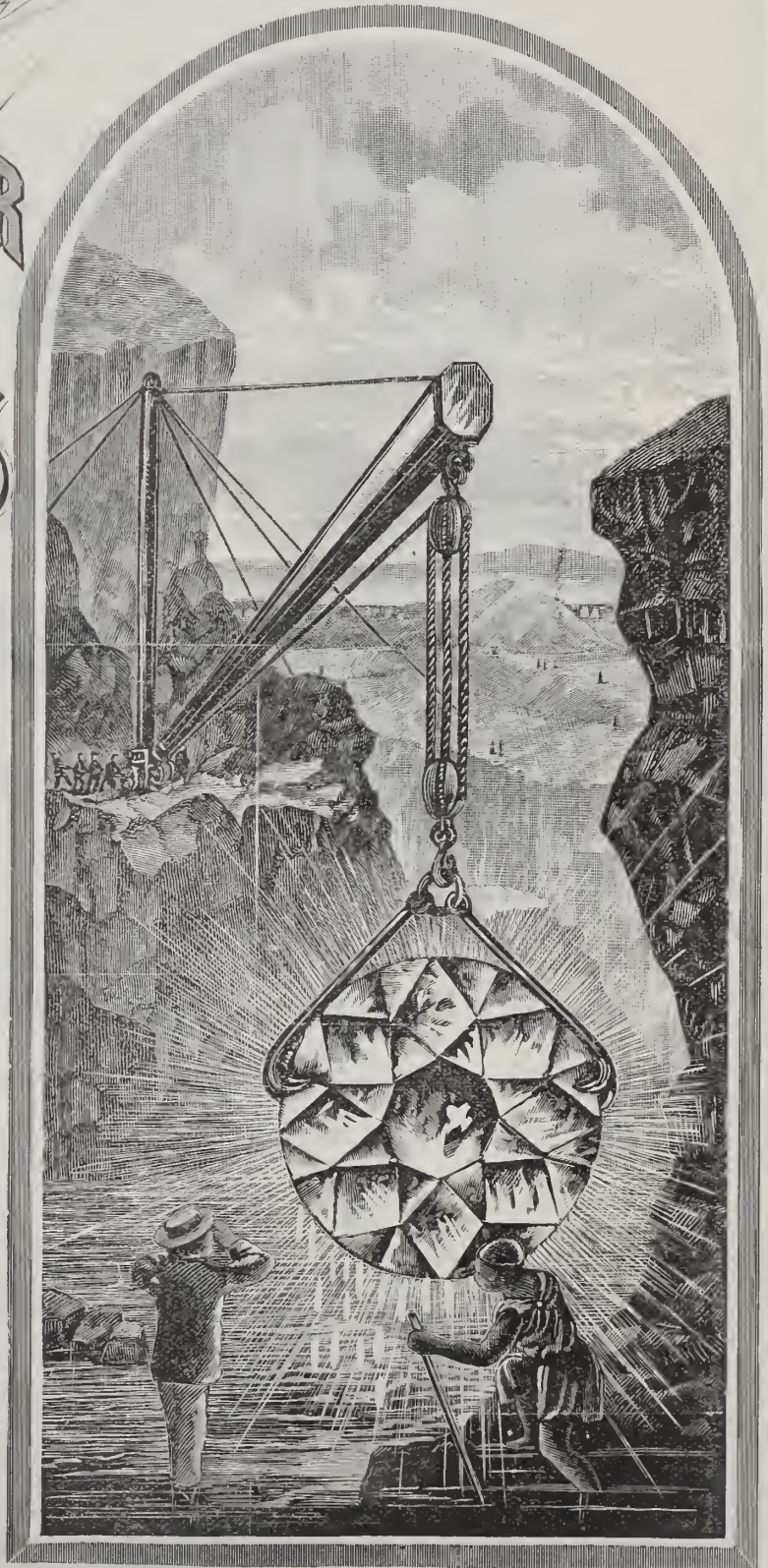



# Ladd Watch Case Company,

(ORGANIZED 1883.)

SUCCESSORS TO J. A. BROWN & CO.

(ESTABLISHED 1858.)

MANUFACTURERS OF THE

## LADD PATENT GOLD WATCH CASES.

### EXAMINE

THE

### NEW MODEL

### A C A S E !

### Ladd Case.



Design No. 661.



Design No. 803.

*Which is universally pronounced on sight to be the Most Elegant and the Best Article in this line yet brought out.*

### IT HAS ALL THE LATE IMPROVEMENTS

Including Solid Gold Bows and Solid Gold Linings,

AND FOR WORKMANSHIP, STYLE AND FINISH IT IS UNEQUALED.

Its Shape is such as to admit of the most elaborate ornamentation, or any intermediate style down to the plainest, without loss of effectiveness, in accordance with the taste of the purchaser.

The **GOLD** in all of the **LADD CASES**, in the **COVERS** and **CENTER RIM** and **PEN-DANT**, is plump 14 Kt. fine, **POLISHED** to its natural color, a most **ESSENTIAL FEATURE** in the **WEAR** of a **WATCH CASE**.

For Sale by the Leading Wholesale Jobbing Trade.



A Line of Novelties Suitable for Fall and Holiday Trade.

ARTISTIC POTTERY

BAWDO &  
PLAQUES.

ITALIAN  
MARBLE

DOTTER,

FAIENCE.

MANUFACTURERS  
AND  
IMPORTERS.

BISQUE.

The Best Workshops of Europe

HAVE THIS SEASON

Been carefully searched to give us an assortment of Rich and Desirable Novelties unequalled by any Importing House in America.

Jewelers and others desiring a line of **FINE GOODS** to sell at a moderate price will find with us the following lines in great variety:

Articles to retail at from \$5.00 to \$40.00 a Specialty.

**VASES.**—Hungarian, French, China, Faience and Paris Barbotine.

Choice Line of Royal Worcester Goods.

**PLAQUES** of all values from Paris, Dresden, Vienna, Hungary, &c.

**CARLSBAD FLOWER WARE.**

**ITALIAN MARBLE.**—Groups, Figures, Busts, &c., hand carved and nice.

**BISQUE.**—Groups, Figures, Busts, &c., all prices, and a nice assortment of small articles.

**PARIAN WARE** in large variety.

**DRESDEN CHINA** and **AUGUSTUS REX** Vases, Cups and Saucers, Plates, Figures, &c., &c.

**LAVA GOODS.**—Figures, Animals, Smoke Sets, &c.

**BLUE FLEMISH WARE,** for Use and Ornament.

**CLOUD GOLD WARE,** with Raised Heron Decorations.

**FOR WEDDING AND BIRTHDAY GIFTS.**—Dresden, Old Vienna, Sevres, Limoges and other Novelties in Satin Lined Cases.

**FRENCH CHINA DECORATED WARE.**—An immense variety, entirely from our own works at Limoges. Gift Cups and Saucers, Tea, Chamber, Dinner, Breakfast, Ice Cream, Fruit, Game, Fish, Tom and Jerry, Tete-a-Tete sets, Fruit Plates, Cuspadores, Jardinières, &c.; Articles for Practical Use.

**MISCELLANEOUS.**—Wax and Bisque Dolls, Bohemian Glass Ware in great variety. Table Glass Ware, Cut and Engraved, Italian Figures, Wedgewood Ware, Minton Ware, &c.

Be sure and see our stock before you place your orders. Mail orders will receive particular attention. Name the articles wanted and prices you wish to pay, and we guarantee satisfaction in every instance.

NEW YORK WAREHOUSES AND OFFICE,  
30 & 32 Barclay Street.

P. O. BOX, 1872.

LIMOGES, FRANCE.  
RUE RICHER, PARIS.  
STEINSCHONAU, BOHEMIA.



# French Clocks, GILT AND MARBLE.

---

*Wm. Wilson's Sons*  
*31 Maiden Lane New York.*

---

CATALOGUES NOW READY.



Falkenau Oppenheimer & Co.  
Importers of  
Diamonds



40 Maiden Lane N. Y.

Post Office Box 3314.



ADOLF J. GRINBERG  
HENRY GOODMAN

LEOPOLD GOODMAN  
WM. L. POLLACK.

**GRINBERG, GOODMAN & POLLACK,**

MANUFACTURERS OF  
**FINE JEWELRY**  
AND  
**IMPORTERS OF DIAMONDS,**

PARIS *No. 32 Maiden Lane,*  
*44, rue de Lafayette* **NEW YORK.**

DIAMOND MOUNTINGS A SPECIALTY.

Goods Sent on Approval upon Application.

Value need not be put upon Packages sent by us, as we carry an  
OPEN INSURANCE POLICY.



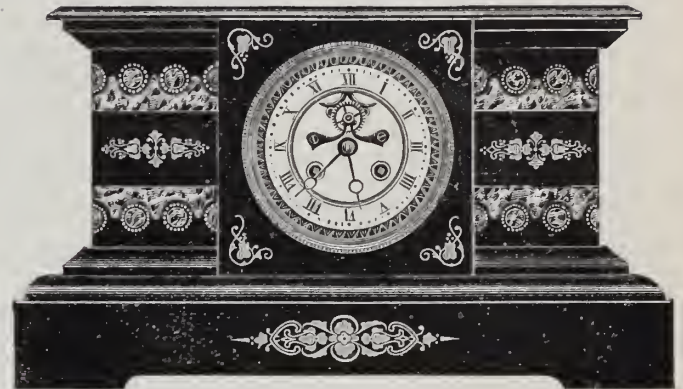
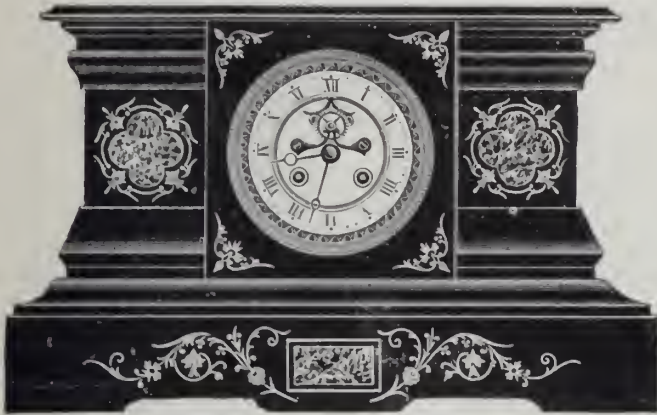
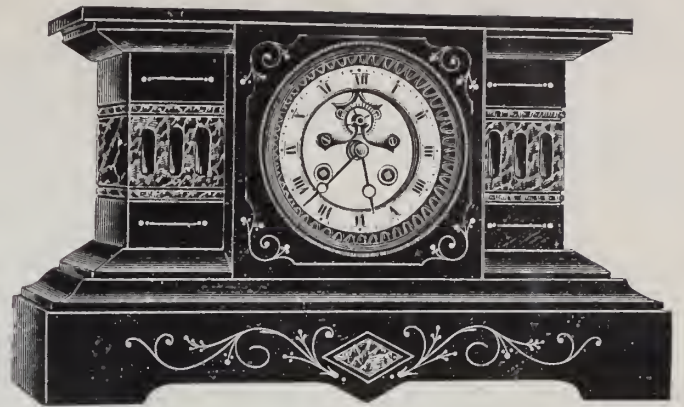
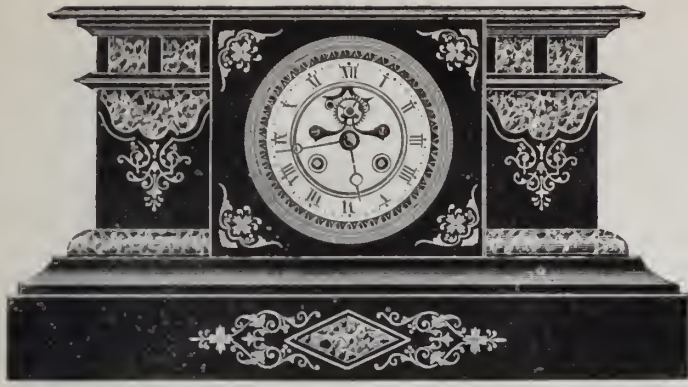

**F. KROEBER,**  
**IMPORTER,**

No. 14 Cortlandt Street,

**NEW YORK.**

LARGE ASSORTMENT OF  
FRENCH MARBLE CLOCKS,  
GILT CLOCKS,  
GILT AND ALABASTER CLOCKS.

*GILT and PORCELAIN' CLOCKS, and NOVELTIES FROM PARIS for the Fall Season, 1883,  
at Low Prices.*

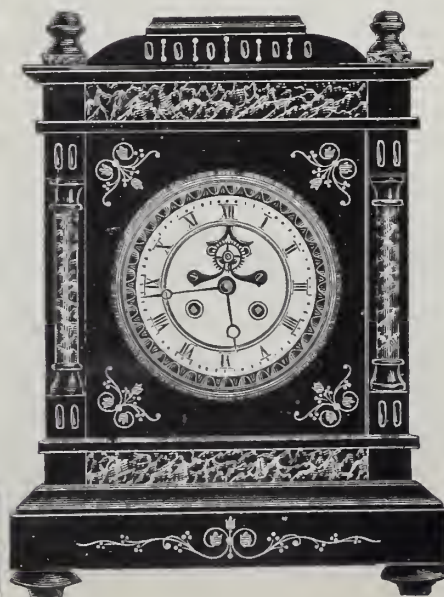

*Marble Clocks with Cathedral Gongs, at \$13.75 and upwards.*



The Third Annual Report of the Astronomer of Yale College Observatory awards the **Celebrated VACHERON & CONSTANTIN Geneva Watches** the highest average ever recorded at this Observatory. Below is given a copy of Report of Movements subjected to the severest Observatory tests during 1883:

**TABLE No. 1.**—WATCH MOVEMENTS OBSERVED FOR 42 DAYS, IN FIVE POSITIONS, AND IN THE OVEN AND REFRIGERATOR, AND WHICH RECEIVED CLASS I. CERTIFICATES.

| Rank. | Maker's Number. | Name engraved on the face of the watch. | Escapement.  | Spring.      | Mean daily rate. | Mean daily variation. | Variation for 1° Fahr. | Diff. bet. Pendant up and Dial up. | Diff. Pend't up and Pend't right. | Diff. Pend't up and Pend't left. | Diff. Dial up and Dial down. | Diff. bet. extremes of rate. | Mark com-<br>pared for. |           |              | Total. |
|-------|-----------------|-----------------------------------------|--------------|--------------|------------------|-----------------------|------------------------|------------------------------------|-----------------------------------|----------------------------------|------------------------------|------------------------------|-------------------------|-----------|--------------|--------|
|       |                 |                                         |              |              |                  |                       |                        |                                    |                                   |                                  |                              |                              | Daily variation.        | Position. | Temperature. |        |
| 1     | 2               | 3                                       | 4            | 5            | 6                | 7                     | 8                      | 9                                  | 10                                | 11                               | 12                           | 13                           | 14                      | 15        | 16           | 17     |
| 1     | 263137          | Vacheron & Constantin,                  | Anchor.      | Breguet.     | -0.38            | 0.40                  | +0.06                  | -1.94                              | -0.49                             | +1.36                            | +1.40                        | 4.5                          | 32                      | 37        | 16           | 85     |
| 2     | 999995          | American Watch Co.                      | Anchor.      | Breguet.     | -0.87            | 0.44                  | +0.01                  | +1.96                              | -0.27                             | +4.63                            | +2.32                        | 5.7                          | 31                      | 33        | 19           | 83     |
| 3     | 1436            | Johnson.                                | Chronometer. | Cylindrical. | +0.74            | 0.36                  | +0.07                  | +5.56                              | +1.52                             | +4.01                            | -1.44                        | 8.9                          | 33                      | 33        | 15           | 81     |
| 4     | 263136          | Vacheron & Constantin.                  | Anchor.      | Breguet.     | +4.36            | 0.65                  | -0.05                  | -0.04                              | +2.53                             | +4.33                            | +0.02                        | 7.0                          | 27                      | 33        | 17           | 77     |
| 5     | 1583692         | American Watch Co.                      | Anchor.      | Flat.        | -2.19            | 0.40                  | -0.05                  | +5.76                              | -2.2                              | -0.25                            | -13.55                       | 14.7                         | 32                      | 27        | 17           | 76     |
| 6     | 871104          | American Watch Co.                      | Anchor.      | Breguet.     | -4.35            | 0.62                  | +0.13                  | -2.48                              | +2.16                             | -0.06                            | +3.47                        | 7.3                          | 28                      | 35        | 11           | 74     |
| 7     | 13533           | J. Jurgensen.                           | Anchor.      | Breguet.     | +2.18            | 0.81                  | +0.08                  | +0.70                              | -4.20                             | +2.40                            | +0.80                        | 8.1                          | 24                      | 33        | 15           | 72     |
| 8     | 6049            | Schoof.                                 | Lever.*      | Breguet.     | -0.06            | 0.63                  | -0.19                  | +0.95                              | +3.96                             | -4.71                            | -3.34                        | 11.0                         | 27                      | 29        | 7            | 63     |

\*Resilient attachment.

The Highest Distinction awarded the *Vacheron & Constantin* Watch in competition with other distinguished makers of Watches, as shown in the above table is sufficiently eloquent to speak for itself, considering the fact that the two movements mentioned above are known as our *No. 9 Grade, or Medium Quality*. The different grades made by Vacheron & Constantin are as follows:

|           | BALANCE.     | ESCAPEMENT.                                       | LEVER.       | HAIR SPRING. | JEWELS.                                             | CENTER JEWEL.                               | FINISH-ING.      | ADJUST-ING.                                                | SPECIAL SIGNS.                                           | Waltham Size. | Elgin Size. | Elgin Size. | Arabic, Roman and Gothic Dials. |
|-----------|--------------|---------------------------------------------------|--------------|--------------|-----------------------------------------------------|---------------------------------------------|------------------|------------------------------------------------------------|----------------------------------------------------------|---------------|-------------|-------------|---------------------------------|
| No. I.    | Compensated. | Straight line double roller exposed Ruby Pallets. | Contrepoids. | Breguet.     | Full Jeweled, best ruby.                            | Set center Jewel.                           | Highly finished. | Accurately adjusted to isochronism, cold, heat & position. | None.                                                    | 14 & 18       | 16          |             |                                 |
| No. II.   | "            | "                                                 | Polished.    | "            | "                                                   | Center Jewel.                               | "                | "                                                          |                                                          | "             | "           |             |                                 |
| No. VIII. | "            | "                                                 | Plain.       | "            | Full Jeweled, ruby.                                 | "                                           | Fine finishing   |                                                            |                                                          | "             | "           | 6           |                                 |
| No. IX.   | "            | "                                                 | "            | "            | Ruby Jeweled, no end stone at the escapement wheel. | "                                           | "                | "                                                          | The center bridge has a cut opposite to the crown wheel. | "             | "           | "           |                                 |
| No. X.    | "            | "                                                 | "            | Flat.        | "                                                   | Without center Jewel, or with center Jewel. | "                | "                                                          |                                                          | "             | "           | "           | "                               |

The Movements are interchangeable in all their parts. All those qualities are manufactured to fit Waltham and Elgin cases, both Open Face and Hunting. The ladies' watches are not manufactured in No. 1, and only the 6 size fits the Elgin cases. The 12, 13 and 14 lines are Swiss sizes and case on blocks but are generally cased abroad. No. 1 is a watch of the highest grade of precision. No. II, VIII and IX give nearly the same results, but are not adjusted so close, all those three grades have nevertheless the same limits of running. No. X has an ordinary fine adjusting.

All parts of Movements or Materials are always in stock and can be supplied entirely finished. Also any desired information cheerfully given as well as copies of a large number of letters and testimonials from dealers who use and have the Vacheron & Constantin Watches and Movements constantly in their stocks. Prices furnished to the Trade on application to

## CHAS. LEO ABRY,

Sole Agent for United States and Canada,



ESTABLISHED IN 1841.

# EROS RICHARDSON & CO.

Manufacturers of  
**Gold Jewelry & Chains.**

23 MAIDEN LANE NEW YORK.

SAN FRANCISCO, 206 KEARNEY ST. HASKELL & MUEGGE AGT'S.



## MATHEY BROS. & MATHEZ,

NO. 16 MAIDEN LANE.

IMPORTERS OF ALL GRADES OF

Plain and Complicated Watches and Movements

SOLE AGENTS FOR THE WELL-KNOWN

# H. L. MATILE

Fine Watches of Astronomical Precision.



REPEATERS.



CHRONOGRAPHS.

In order to facilitate the handling of our Stem-Winding Movements, we have adopted a standard of sizes to fit American Cases. Of these we have a complete line from the medium grade to the highest class goods of fine adjustment and precision. As all our Movements, complicated and plain, are perfectly uniform in quality according to their respective grades, we can furnish material for any parts that may be required, with the positive assurance of accurate interchangeability.

An Extensive Line of all Grades of

# CHRONOGRAPHS, SPLIT SECONDS AND REPEATERS.

WATCHES DEMAGNETIZED.





# WILHELM & GRAEF,

IMPORTERS OF

## Ceramic Specialties

### FOR FINE JEWELRY TRADE.

After a six months' personal search we are now prepared to offer choice selections from 1883 Exhibitions of Rome, Amsterdam and Zurich, and Novelties from England, France, Germany, Austria and Italy. Fine Figures and Cabinet Pieces from Worcester, Derby, Copeland, Mintons, Royal Dresden, Vienna and Ginori manufactories. Unequaled collection of Porcelain Paintings and Fine Plates. Antique and Modern Rich Enameled Glass. Own Designs and Models of Rich Decorated Duplex Lamps.

**INSPECTION AND COMPARISON SOLICITED.**

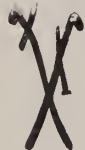

Broadway and 26th Street,  
**NEW YORK CITY.**



# ROGERS, SMITH & CO.,

MANUFACTURERS OF

## ELECTRO GOLD & SILVER PLATED WARE,

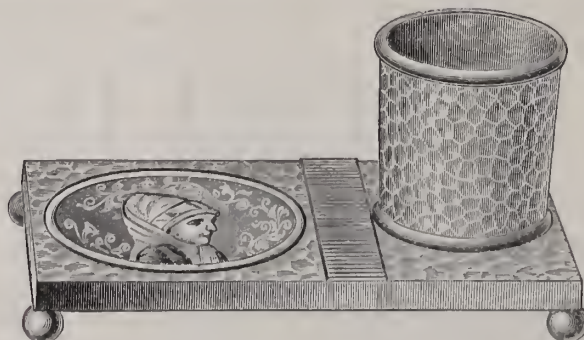

MATCH AND CIGAR ASH RECEIVER.

SALESROOMS, 46 EAST 14th STREET, UNION SQUARE, N. Y.

FOR THE TRADE ONLY.

FACTORY, - - - - MERIDEN, CONN.



# THE CLIMAX REVERSIBLE WATCH CASES.

MANUFACTURED BY THE

Northwestern Watch Case Co.

MANUFACTURED BY THE

Northwestern Watch Case Co.



CHANGED FROM AN OPEN FACE TO A HUNTING CASE AT WILL.

MADE TO FIT THE 18 SIZE STEM WIND AMERICAN MOVEMENTS.

Patented April 3d, 1883, No. 275,251.

ABSOLUTELY DUST PROOF. A PERFECT WATCH CASE.

**A MARVEL OF INGENUOUS MECHANISM.**

—Descriptive Circulars Furnished Upon Application.—

# STANDARD WATCH CO.

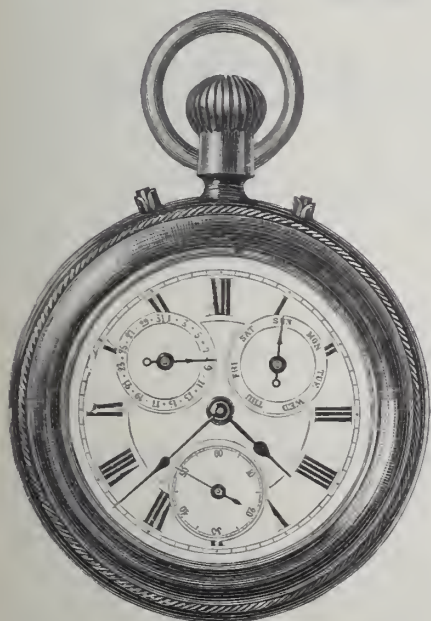

STANDARD CALENDAR

'STANDARD CALENDAR.'

20 Line, Open Face, in Nickel and Silver, showing the date and day of the week, Full Jeweled, Finished Movement. The Latest Novelty offered.



"STANDARD."

18 Size, Low Price Movement, will fit Waltham and Elgin Cases.

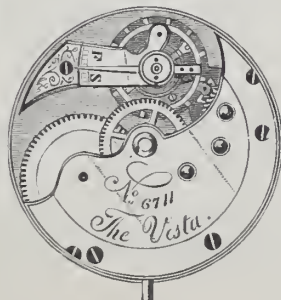

"VESTA."

8 Size, Low Price Movement, fits Elgin Cases.



"STANDARD."

8 Size, Full Jeweled, Ladies, Fits Waltham Cases.

REGISTERED.



"STANDARD."

Nickel, 17, 19 and 20 Line. Lever, Full Jeweled.

Max Freund & Co., Sole Agents, 8 Maiden Lane, N. Y.



ESTABLISHED 1844.

**DENNISON MFG CO.,**

BOSTON, NEW YORK, PHILADELPHIA, CHICAGO, CINCINNATI AND ST. LOUIS.

**JEWELERS' FINDINGS.**

**PAPER JEWELRY BOXES IN ALL STYLES AND QUALITIES. IMITATION MOROCCO BOXES, SATIN LINED. TAGS, JEWELERS' CARDS, PINK AND WHITE COTTON, &c., &c.**

**MOROCCO CASES.**

Manufacturing in our own Shops Every Description of Morocco, Plush and Velvet Jewelry and Silverware Cases in large quantities, we are enabled to sell lower than other goods of equal quality can be offered, and we carry in all our Stores FULL Stock of our whole line.

Catalogue on Application.

**BAKER, PRATT & CO.,**

IMPORTERS OF JEWELERS' FANCY GOODS,

MANUFACTURERS OF FINE LEATHER WARES,

No. 19 BOND STREET, NEW YORK.

Our success during the past season in manufacturing a Special Line of FINE LEATHER GOODS has encouraged us to make greater efforts to present this season designs particularly for the Jewelry Trade. Our line embraces all known leathers, such as Seal, Alligator, Calf, Russia, Morocco, and our two ORIGINAL SPECIALTIES in leather,

**"ANTIQUE" AND "HAMMERED."**

The collection consists of all articles of personal belongings in leather, such as Promenade Bags, Card, Letter and Bank Bill Cases, Pocket and Betting Books, Coin Purses, Note Blocks, Dressing Cases, etc. Our line is now being handled by many leading jewelers.

(WRITE TO US FOR PARTICULARS.)





FRANK S. KENNEDY,

Manufacturer and Wholesale Dealer in

# JEWELRY

OF EVERY DESCRIPTION.



13 Maiden Lane,  
NEW YORK.



13 Maiden Lane,  
NEW YORK.

*In addition to my stock of Jewelry, which is complete in all lines of Gold, Silver and Roll Plate, I am now making a Full Assortment of*

## THIMBLES,

*in Solid Silver, 10 karat and 14 karat Gold. These Thimbles are Superior in Finish to any now in the market, and are as near perfection as long practical experience can make them. Will send Samples if desired.*

*The Assortments of Jewelry I send on Memorandum for Special and Stock Orders have an increasingly high reputation.*

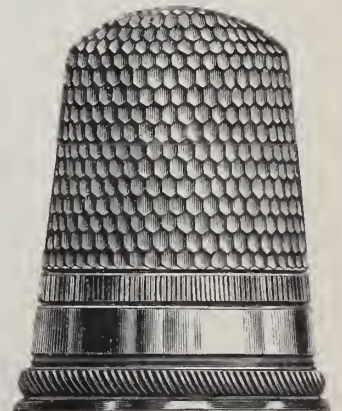



**THE**  
**E. HOWARD WATCH AND CLOCK CO.,**  
 —MANUFACTURERS OF—  
**Fine Stem-Winding Watches,**  
 FINE REGULATORS, OFFICE CLOCKS, TOWER CLOCKS,  
 And Electric Watch Clocks.



LADIES'  
6 Size.

STEM-WINDING  
AND



GENT'S  
16 Size.

Stem-Setting  
Movements.



GENT'S  
18 Size.

114 TREMONT ST., BOSTON.

29 MAIDEN LANE, New York.

J. W. J. PIERSON, Agent.



**WILLEMID WATCH CASE CO.,**

109 Sands Street, Brooklyn, N. Y.

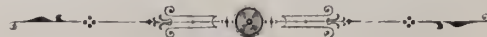

Our Engine Turned (Jurgensen Cases), a Specialty with us, have achieved a high reputation in the Trade, and are, without any exception, the Best and Cleanest Cut Engine Turned Cases in the market.

We ask you to compare these Cases with those of any other manufacture, as they are so made that they will stand the closest criticism. We also invite especial attention to our Raised Gold Ornamentation Work, Escalloped, Enameled and other styles of decoration.

New York Office, 14 & 16 Maiden Lane.



# KREMENTZ & CO.,

MANUFACTURERS OF

GOLD, PEARL AND DIAMOND JEWELRY,

Nos. 182 and 184 BROADWAY,

Corner of John Street,

NEW YORK.

(Elevator Entrance on John Street.)

NOVELTIES IN SILVER JEWELRY.

FACTORY, NEWARK, N. J.

---

## J. EUGENE ROBERT,

IMPORTER OF

MOVEMENTS & WATCHES,

**No. 30 Maiden Lane, New York.**

Ladies' and Gent's Stem Winding Movements, Fitting American Cases,  
all fully warranted.

Ladies' Small Sized Watches in Fancy Gold Cases of every Variety and  
Style of Decoration.

—: SOLE AGENT FOR :—

**LOUIS AUDEMARS**

Superior Watches. Plain and Complicated Stem Winders of every style, man-  
ufactured with the Latest Improvements.

**CHRONOGRAPHS WITH OR WITHOUT SPLIT SECONDS.**



# SIMPSON, HALL, MILLER & CO.,

36 E. 14TH ST., UNION SQUARE, N. Y.      FACTORIES, WALLINGFORD, CONN.

EXTENSIVE MANUFACTURERS OF

## Highest Quality of Artistic and Useful Silver Electro-plated Hollow-Ware.

BRANCH FACTORY, MONTREAL, CANADA.

AGENCIES: Philadelphia, Baltimore, Cincinnati, Chicago, San Francisco, Australia, Etc.

Exceeded by no manufacturers in the United States in facilities for the production of Fine Goods. Spoons and Forks sold by Simpson, Hall, Miller & Co., Wallingford, Conn., bearing my individual name, to authenticate the quality, are all made in their Factories, of Finest Nickel Silver, under my personal supervision, and by my ideas of Style, Pattern and Finish, and control of quality.

The patterns are made exclusively by them and patented, and are the Highest Quality Goods in market.



My individual name, Wallingford, Conn., is a positive guarantee of the quality of the goods, and in buying them the Trade do so upon my personal guarantee of quality.

WM. ROGERS, PERSONALLY,  
Since May, 1878, with SIMPSON, HALL, MILLER & Co., Wallingford, Conn.



# JAMES W. TUFTS,

MANUFACTURER OF

# FINE SILVER PLATED WARE.

FACTORIES, BOSTON, MASS.

OFFICE AND WAREROOMS:

33 to 45 Bowker Street, Boston, Mass., and 70 Park Place, New York.

---

In Design, Material, Plating and Finish I guarantee my goods equal to the best made.

I am now preparing an

**ILLUSTRATED CATALOGUE,**  
which will be furnished free to customers.





OPPENHEIMER BROS. & VEITH,  
 WATCHES,  
 DIAMONDS,  
 JEWELRY.



*We are the Manufacturers and Patentees of the Combination Slide, Pendant and Locket, and the Combination Necklace, Lace Pin and Pendant.*



*We can furnish quite a variety of Styles, and are prepared to fill all Orders at once.*

35 MAIDEN LANE, NEW YORK.



ESTABLISHED 1854.

# HENRY MAY,

19 John Street,

New York.

IMPORTER OF

## WATCHES AND DIAMONDS,

WHOLESALE DEALER IN

# American Movements and Cases, AND MANUFACTURER OF JEWELRY.

A FULL LINE OF

Gold, Swiss and Nickel Watches,  
Domestic Movements,  
Gold, Patent, Silver and Nickel Cases,  
10 and 14 K. Jewelry,  
And Best Rolled Plate Jewelry,

CONSTANTLY ON HAND AND  
QUALITY WARRANTED.

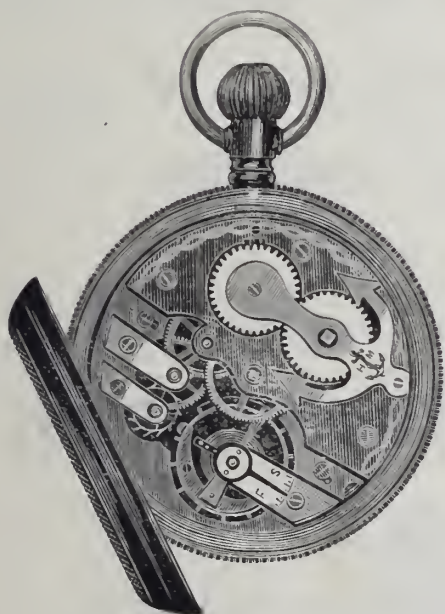

### SPECIALTIES:

## The C. Melville Watch, and Brighton Movements,

Of which I am SOLE MANUFACTURER, are well and favorably known to the Trade.

### BEWARE OF IMITATIONS.

Each Watch and Movement is accompanied with a Fac-simile of this Certificate:

NEW YORK,



19 JOHN ST.

This is to Certify that Watch Movement No. .... bearing the above Trade-mark, has been manufactured by me, and is warranted a good Timekeeper.

HENRY MAY.



# LE BOUTILLIER & CO.,

Nos. 31 and 33 WEST 23d STREET,

Invite the attention of buyers of FINE WARES to the choicest assortment of

## Royal Worcester Porcelains

ever shown in one lot in this city. This collection includes a carefully selected line of inexpensive articles, from \$2 each, as well as the most expensive pierced and decorated Jugs and Vases. All have been made expressly for us, and will be offered at close prices.

## French Marble Clocks,

## Brass Clock Sets.

BISQUE STATUETTES,

TERRA COTTAS,

VIENNA FANCIES,

BARBOTINE VASES,

PORCELAIN PLAQUES,

BRASS GOODS.

Special bargains are offered in the above lines to CLOSE OUT the stock carried up from Union Square.

Nos. 31 and 33 WEST 23d STREET,

Half a Block from 6th Avenue Elevated Station.

SECOND LOFT.

**ELEVATOR IN BUILDING.**



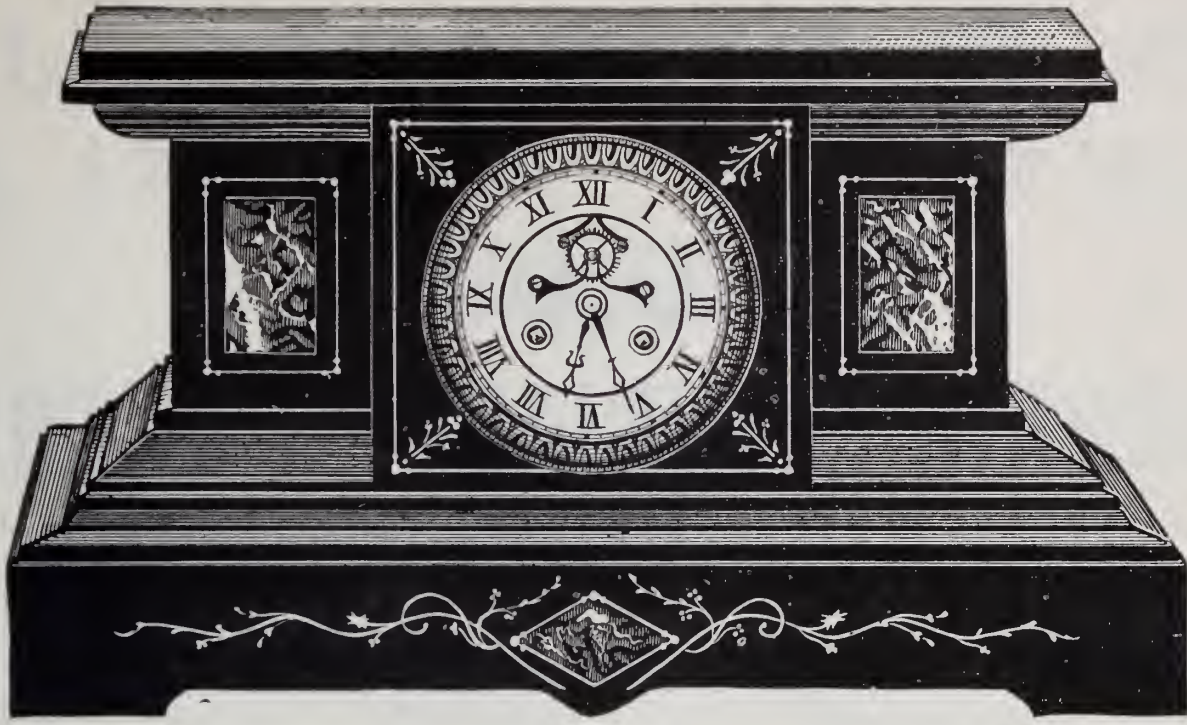

LE BOUTILLIER & CO.,

**Importers and Jobbers.**

31 & 33 West 23d Street, (Second Loft,) NEW YORK.

Half a Block from Sixth Avenue Elevated Station.

**FRENCH MARBLE CLOCKS,**

Of this Summer's Importation, at VERY CLOSE PRICES.





# GEO. H. RICHARDS, JR.,

383 Washington Street, Boston, Mass., U. S. A.,

## JOBBER

# AMERICAN MOVEMENTS & CASES

A SPECIALTY.

WE GUARANTEE TO HAVE ALL GRADES IN STOCK.

### MOVEMENTS.

WALTHAM. SPRINGFIELD, ILLS. HAMPDEN. ELGIN. HOWARD.

### CASES.

#### GOLD

WALTHAM.  
DUEBER.  
BROOKLYN.  
G. H. R., Jr.

#### FILLED

"BOSS."  
CROWN.  
LADD.

#### SILVER

WALTHAM.  
DUEBER.  
FAHYS.  
KEYSTONE.

## Watches, Jewelry and Silver Plated Ware.

ROGERS & BRO.'S FLAT WARE.

HOLLOW AND FLAT WARE SOLD AT MANUFACTURERS' DISCOUNTS.

Our Stock is positively the Largest, Finest and Best Assorted of any Jobbing House in the Country. All Orders Promptly Executed.

SOLE AGENT FOR

## GOOLD'S PATENT REGULATOR,

FOR SALE BY ALL JOBBERS AND MATERIAL DEALERS.

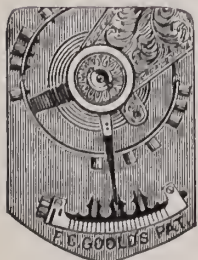

For 18 Size Movements, K. W. & S. W.

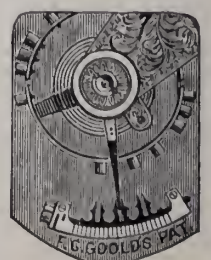



For 18 Size Movements, K. W. & S. W.

THE REGULATOR WILL BE IN THE MARKET JULY 1st, Price, \$1.25.

GEO. H. RICHARDS, Jr., 383 Washington Street, Boston, Mass.





*We would respectfully solicit an inspection of our Stock of Gold Jewelry, Bracelets and Chains, and call attention to examples designed especially for the Fall Trade. We will endeavor to retain the confidence extended to us for so many years, as to Workmanship and Moderate Price of Goods.*

CARTER, SLOAN & CO.,

NO. 15 MAIDEN LANE,

P. O. Box 90.

NEW YORK.





**IMPROVED CROWN FILLED CASE.**

→ **THE BEST FOR THE LEAST MONEY.** ←

The Gold contained in the Crown Cases which are now being turned out under our supervision is **fully equal to that of any Filled Case on the market.**

This fact can be attested to the satisfaction of any dealer who will go to the trouble of having one of these Cases assayed with one of corresponding size and style of **any other make.**

The United States Mint at Philadelphia will make a complete assay for the sum of one dollar each, and we will return a New Case to the dealer in place of the one of our make destroyed, upon receipt of the Assay Certificates and the gold contained in the Crown Case assayed.

**SOLID GOLD JOINTS,  
SOLID GOLD PLUGS,  
GOLD THE NATURAL COLOR,  
ABSOLUTELY NO GILDING.**



IMPROVED CROWN FILLED.

Raised Gold Ornamentation.



IMPROVED CROWN FILLED.

Raised Gold Ornamentation.

**SOLD ONLY BY THE JOBBING TRADE.**

**H. MUHR'S SONS, PHILADELPHIA.**

NEW YORK OFFICE, 14 & 16 Maiden Lane.

CHICAGO OFFICE, 101 & 103 State Street.

**PATENT IMPROVEMENT IN**

**COUNTER + SHOW + CASES,**

**WITH PERPENDICULAR SLIDING DOORS. DUST PROOF.**

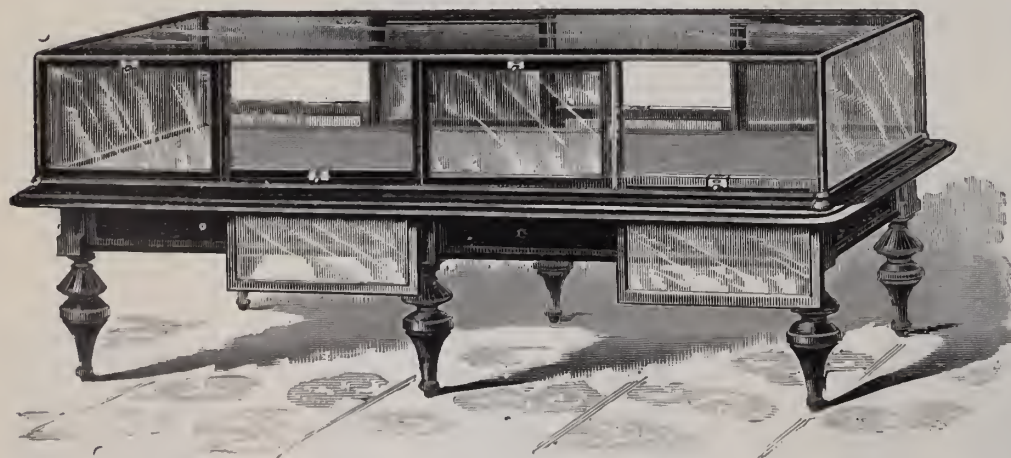

**The Advantage and Convenience of these Show Cases will be apparent to everyone.**

The doors are more conveniently opened and closed, less liable to get out of repair or broken, articles are more easily reached in wide cases, mirrors are more safe, it dispenses with hinges, economizes room, excludes dust, and is air tight *when closed.*

Drawings furnished and estimates given for fitting stores in cabinet work complete.

Letters Patent having been granted us for the construction of these doors, we shall prosecute all parties using Cases which infringe on our Patents.

**B. & W. B. SMITH,**

**220 West 29th Street, New York.**

REFERENCES:—Gorham Mfg Co., Rogers & Bro., Mitchell Vance & Co.,  
Meriden Britannia Co., M. S. Smith & Co., Detroit, Mich.  
D. Valentine, Syracuse, N. Y.

M. Anderson, No. 57 State Street, Chicago, has the exclusive right to manufacture and sell our Improved Cases for the States of Wisconsin, Illinois, Missouri, Mississippi, Arkansas, and all States West of same.

CATALOGUE OF STYLES SENT ON APPLICATION.





My Illustrated Catalogue and Price List combined will be ready for distribution by the 15th September.

It will contain illustrations of my New Designs in Staple Styles, and an exceedingly fine line of Novelties in Charm Pencils, Whistles, Knives, Cigar Perforators, Automatic Pen Cases, Cigarette Holders, Tooth Picks, Match Boxes, etc., etc., and Ornamentations of Japanese Gold Bronze Figures and Fancy French Work in Gold, Platina, Silver and Fine Rolled Gold Plate.

Making all these articles in my factory enables me to offer the very best advantages.

LERROY W. FAIRCHILD.



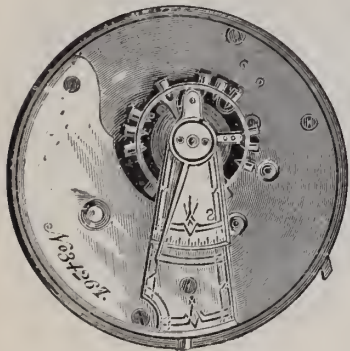
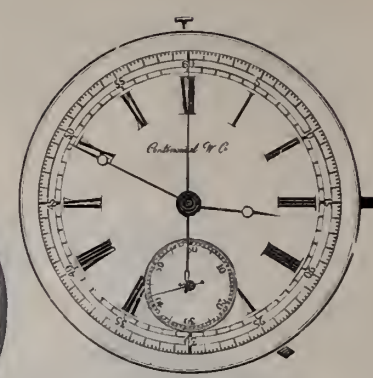
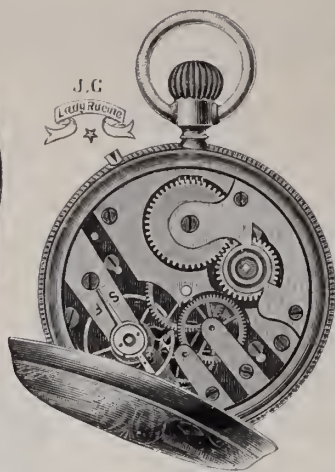

# CONTINENTAL WATCH CO. MOVEMENTS

6, 8, 10, 16 & 18 Sizes.



Fitting Waltham and Elgin Cases, and are the Most Reliable Movements in the market.

For Sale by all the Leading Jobbers in the Country.



Would call the attention of the Trade to our Eureka, Lady Racine, Railroad Regulator and Continental Watches, in Silver and Nickel Cases in all sizes.



## JULIEN GALLET & CO.,

No. 1 MAIDEN LANE, NEW YORK.

SOLE AGENCY FOR THE CELEBRATED JAMES NARDIN WATCHES.

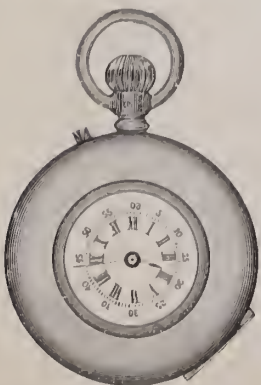
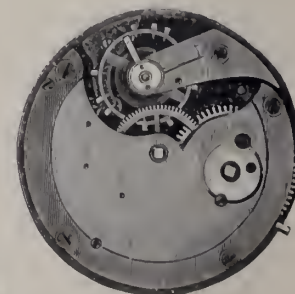
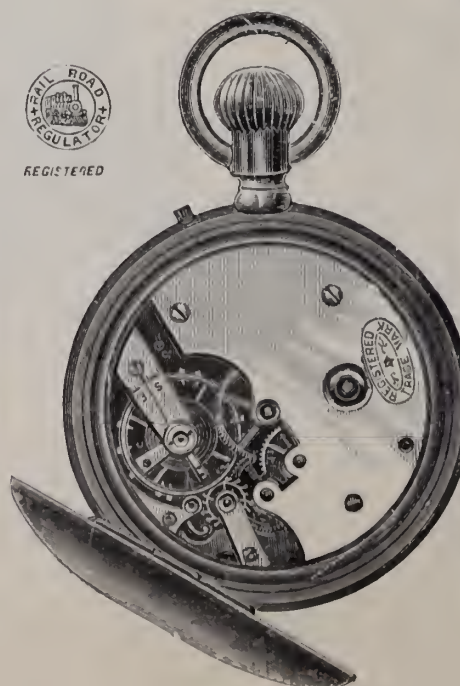
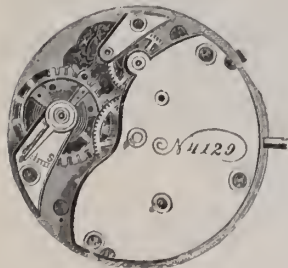
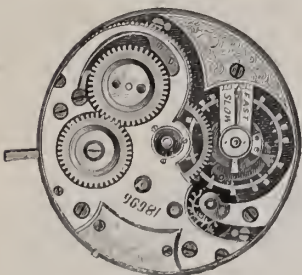



# HENRY SCHADE,

MANUFACTURER OF

## Fine Silver Plated Ware.

FACTORY:

56 & 58 AINSLIE ST., BROOKLYN, E. D., N. Y.

New York Office, 84 JOHN STREET.

*Address all Communications to the Factory.*



No. 183.

List, \$2.75



No. 192.

Chased, Gold Lined.

List, \$2.00



No. 179.—Communion Service. Paten can be added if desired.

6 Pieces. List, \$22.00.

### ANNOUNCEMENT.

I am now at work in my New Factory and can furnish the Trade with the largest and most complete line of Cheap and Medium Priced Goods in the country. Would say for the benefit of those with whom I have had no business transaction, that while I do not claim that my ware is triple plated, I have no hesitation in stating that it has as heavy a coat of silver as any in the market at the same prices, while for style and finish it will compare favorably with higher priced goods.

My Latest Catalogue (now in press) sent on receipt of Business Card.



No. 185.

Chased, Gold Lined

List, \$1.50,



No. 186.

Chased, Gold Lined

List, \$1.50.



# A NEW DEPARTURE.

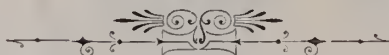

## 14 KARAT GOLD CHAIN, SILVER LINED,

— MADE BY —

### A NEW PROCESS.

Guaranteed to wear as well as the best 14 karat Gold Chain made.  
 Every Chain warranted to assay one-third ( $\frac{1}{3}$ ) its entire weight in gold.  
 Each Chain stamped with registered trade mark:



*Showing the Relative Thickness*  
OF THE GOLD AND SILVER.



*Showing the Relative Thickness*  
OF THE GOLD AND SILVER.

Money refunded if test is unsatisfactory.

### KOSSUTH MARX & CO.,

Proprietors and Manufacturers,

39 Maiden Lane, New York.

In introducing our new Chain we aim to supply a want which we believe the Trade can place before the public in a legitimate manner without deception, and no detriment to the standard of the most scrupulous dealer.

We offer these goods strictly upon their merits, and give but a few reasons why they can take the place of the older styles of manufacture, viz.:

- 1st.—*In the make up there is no base metal, excepting such as is necessary in standard 14 karat.*
- 2d.—*It makes a larger and more showy appearance for its corresponding weight than the old standard.*
- 3d.—*The cost is materially reduced, bringing it within reach of a greater number who desire a good article.*
- 4th.—*It is a well known fact that the principal cause of wear in chain is the friction produced by its own weight, consequently, being light weight to the extent of a large percentage, their better wear is assured.*

By a strict adherence to quality we hope to create a popular demand for a meritorious article.

Send for selection package, as our travelers do not carry any in stock.

KOSSUTH MARX & CO.



NEW YORK:

No. 676 Broadway.

LONDON:

21 Holborn Viaduct.

ESTABLISHED 1847

OLD HOUSE, READ, TAYLOR & CO.

**TAYLOR & BROTHER,**  
IMPORTERS OF

French Marble Clocks and Bronzes,

AND NOVELTIES IN

French, Vienna, English and other Fancy Goods.

We invite the attention of the Trade to our Latest Importations, personally selected by one of our firm now in Europe.

See also our advertisement of

Diamonds, &c.

Watches, etc.

Sole Agents

Jaques Le Coultre

RAZORS.



**JACOT & SON,**  
**49 MAIDEN LANE, NEW YORK.**  
 IMPORTERS, AND SOLE AGENTS FOR  
**MERMOD FRÈRES, St. Croix, Switzerland,**  
 MANUFACTURERS OF  
**MUSICAL BOXES AND WATCHES.**

ESTABLISHED IN 1840.

MEDALS RECEIVED AT THE EXPOSITIONS OF

PARIS,  
 VIENNA,  
 BERNE.



LONDON.  
 ZURICH,  
 CHAUX-DE-FONDS.

We have now a very large stock of Musical Boxes of all descriptions, such as the Mandoline, Sublime-Harmonic, Guitar-Tremolo, Eolian-Harp. Musical Boxes with several cylinders, also with bells, drums and castanetts. Musical Novelties, Toy Musical Boxes, etc., at the Lowest Prices. Price List sent on application. **WHOLESALE ONLY.**

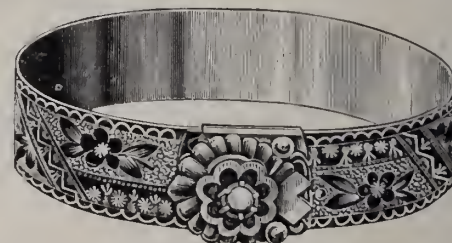
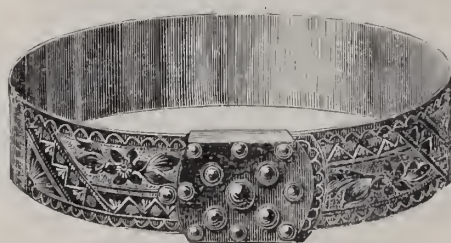
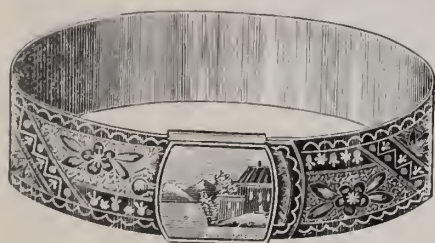

**J. M. CHANDLER & CO.,**  
**MANUFACTURING JEWELERS.**

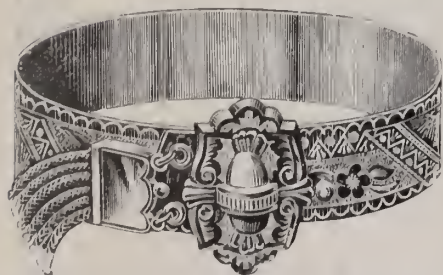

We especially call the attention of the Trade to our new Patent Band Bracelet Catch. The design of the Catch is to make a Band Bracelet adjustable to any size without the slightest difficulty—leaving the band clean and smooth, and make a secure fastening. These goods are pronounced by all who have seen them to be the *Ne Plus Ultra* of all Band Bracelets. The goods must be seen to be appreciated. We will send Selection Package of these goods to the Regular Trade.

**J. M. CHANDLER & CO.**

Manufactured at our own Factory, 111 Broad Street, Providence, R. I.

Office and Salesroom, 185 Superior Street, Cleveland, Ohio.







308

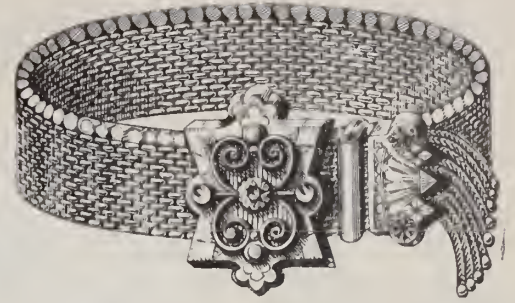

306

ELLISON & VESTER'S  
 PATENT BAND AND BANGLE FINE ROLLED PLATE  
 BRACELETS,  
 FOR SALE BY EVERY JOBBER.

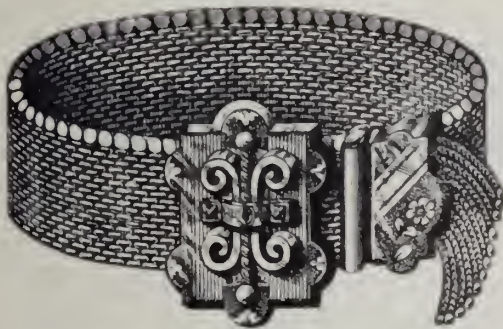

304



310 1/2

**KAHN, HANOVER & CO.,**

IMPORTERS AND MANUFACTURERS OF

**OPTICAL**

METEOROLOGICAL,

MATHEMATICAL,

ENGINEERING,

ELECTRICAL,

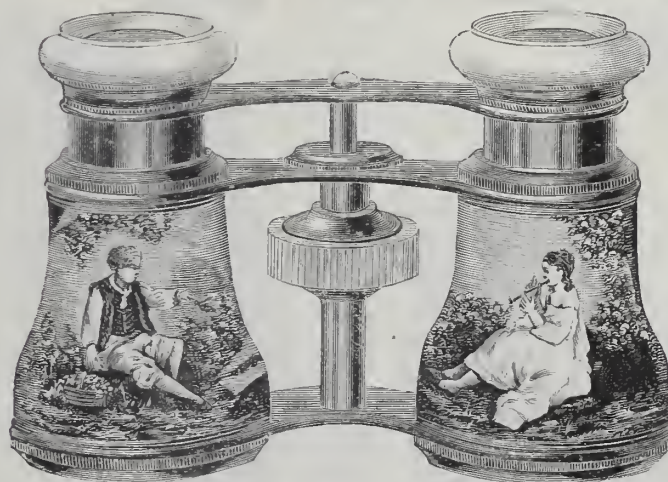

**INSTRUMENTS,**

32 MAIDEN LANE,

NEW YORK.

We are the *only* Importers dealing *exclusively* in Optical, Meteorological, Engineering, Mathematical, Electrical and other Scientific Instruments. We keep the best selected Stock of Specialties in this line, and are constantly advised of all important Scientific Improvements, which enables us to present to our patrons the best results and latest achievements in the reach of science.

Our New Descriptive Catalogue and Price List of 210 pages, with over 400 Illustrations, forwarded to the Trade on application.





LOUIS KAHN.

MOSES KAHN.

SAMUEL H. LEVY.

I. W. FRIEDMAN.

# L. & M. KAHN,

IMPORTERS OF

## Watches, Diamonds & Precious Stones,

10 MAIDEN LANE, NEW YORK.

11 Corrairie, Geneva, Switzerland.

17 Rue de Chateaudun, Paris.

### WATCHES,

*Stem and Key-Winding, from the Lowest Priced Nickel and Silver to the Finest Gold and Complicated.*

A Full Assortment of these Goods always in Stock.

### DIAMONDS,

*Loose and Mounted, in all Sizes and Qualities.*

*Gold, Silver, Nickel and Celluloid Chatelaines in Great Variety.*



Send for Illustrated Catalogue.

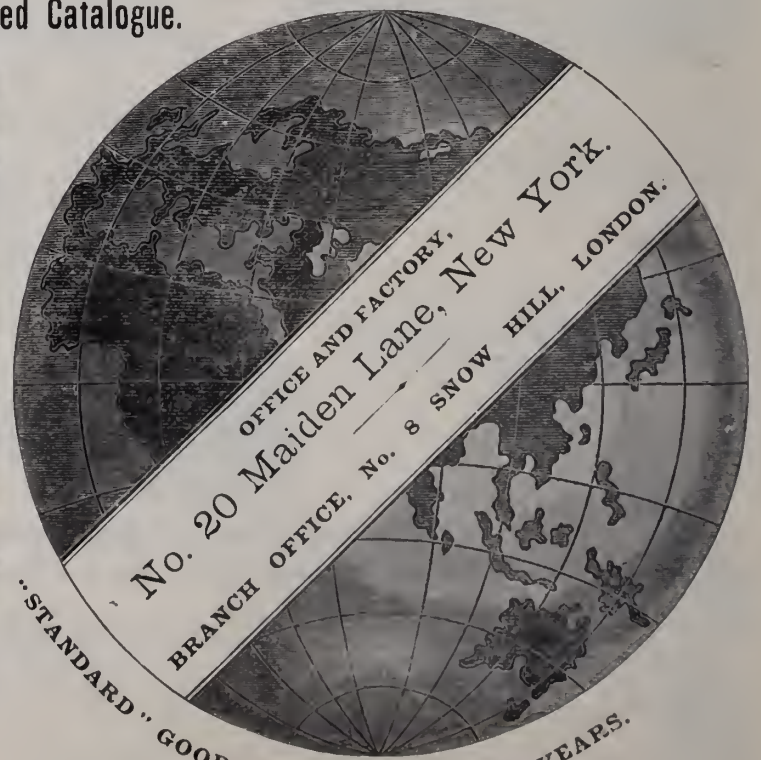
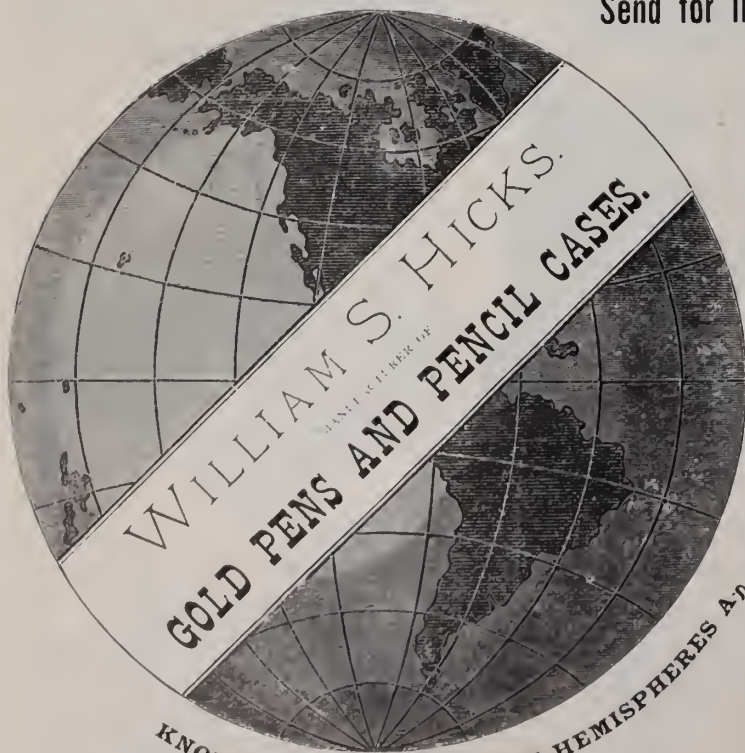

ESTABLISHED 1848.



# STANDARD DUST-PROOF WATCH KEYS.

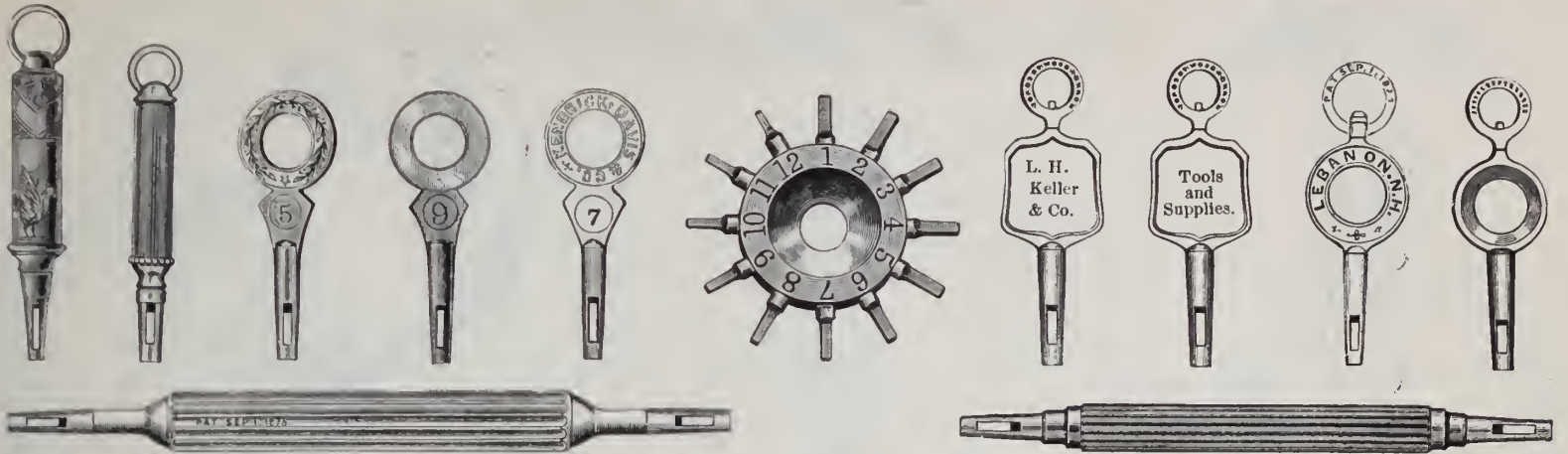

FOR SALE BY  THE TRADE.

## KENDRICK & DAVIS,

Sole Owners and Manufacturers, Lebanon, N. H.

ILLUSTRATED CATALOGUE and PRICE LIST SENT ON APPLICATION.

**TXB**  
TRADE MARK

OUR RINGS ARE ALL STAMPED

**TI4KB**  
TRADE MARK

WITH OUR TRADE MARKS



**ARISTEL BROTHERS**  
**SOLID GOLD**  
**RING-MAKERS**

MAKERS OF HANDSOMEST, MOST ORIGINAL, & COMPLETE, LINE OF INITIAL, & OTHER RINGS, IN STANDARD QUALITIES OF GOLD . . . . .

OUR INITIALS ON ONYX, ARE RIVETED, ON THE STONE, NOT SOFT SOLDERED, THROUGH BOX OF RING . . . . .

OUR RAISED LETTERS, [WITHOUT DIAMONDS] SHOW VARIOUS COLORS, OF GOLD - RED. GREEN. & WHITE . . . . .

NOS. 297 298 315 RINGS ARE ALL GOLD . . NO ONYX. INITIALS WITH OR WITH OUT DIAMONDS . . . . .

NO. 195

NO. 223 DI PAT. APR. 10 83

NO. 304

PAT. AP. ID 1883

NO. 226 DI PAT. APR. 10 83

NO. 299

NO. 297

NO. 315 PAT APPLIED FOR

NO. 300

NO. 298

299 195 ONYX ENCRUSTED WITH DIAMONDS . . . . . 226 DI. 223 DI. RAISED LETTER ON ONYX SET WITH DIAMONDS . . . . . 223 I. 174 IN. 300 RAISED LETTER ON ONYX WITHOUT DIAMONDS . . . . . 304 RAISED LETTER ON ONYX SET WITH DIAMONDS IN CUVE-TTE SHAPED STONE.

OUR GOODS ARE TO BE HAD OF ALL JOBBERS **ARISTEL BROS.**  
NO. 10 MAIDEN LANE NEW YORK



# THE WINDSOR SLEEVE LINK.

PATENTED MARCH 13, 1883.

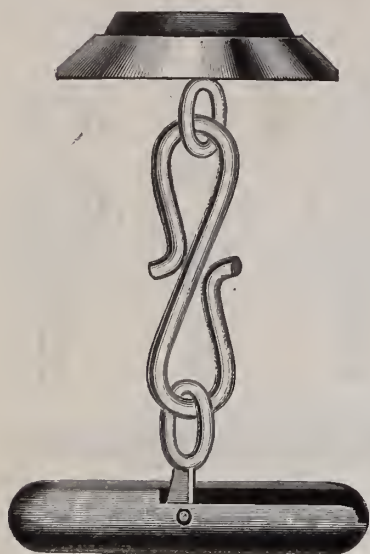

This Cut represents the Button with the Eye properly adjusted in the center of the Bar.



OPENED.

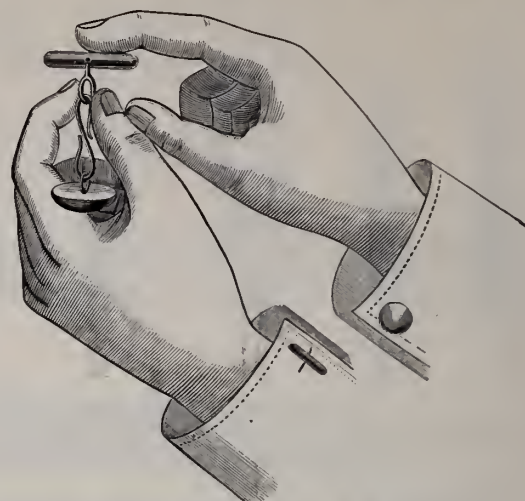

This Cut represents the proper manner of detaching the Eye and sliding the same to the end of the Bar.

**SOLD BY ALL LEADING JOBBERS.**

## CLEMENS HELLEBUSH,

MANUFACTURER, IMPORTER AND WHOLESALE JEWELER,

Dealer in everything required by the Jewelry Trade.

**DIAMONDS.**—Dealers will find in my stock an assortment of Diamonds unequalled in the West, embracing a choice variety of loose and mounted Stones in all qualities.

**WATCH CASES.**—In Gold and Silver, of all makers, to fit American Movements.

**WATCH MOVEMENTS.**—Include always a full stock of Waltham, Springfield, Hampden and Howard, together with a large assortment of fine and low-priced Swiss Watches.

**SILVER PLATED WARE.**—I have an unusually fine assortment of the choicest patterns of Flat and Hollow Ware of the best known manufacturers.

**SOLID GOLD AND ROLLED PLATE JEWELRY.**—This department is replete with Staple Goods and Novelties.

**FRENCH CLOCKS.**—Of our own importation, including all grades, with prices exceedingly low.

**AMERICAN CLOCKS.**—I am the General Agent in Cincinnati for the celebrated Seth Thomas Clocks, a full line of which will always be found in stock.

**TOOLS AND MATERIALS.**—In this department will be found everything required by Watch Makers.

Illustrated Catalogues sent to Dealers only upon Application.

## CLEMENS HELLEBUSH,

77 West 4th Street,

CINCINNATI, O.



**"The Waterbury." The New "Series B,"**

**With FULL DIAL and SOLID PLATES.**

In this new SOLID PLATE movement the position of the regulator has been changed; it will be found projecting beyond the plate, immediately under the bezel. The FULL DIAL enables the position of the hands to be readily seen.

The danger of injuring the Hair Spring in regulating is obviated in this new movement.

SERIES A.—Open Dial, Skeleton Plates, - - \$48.00 per doz.  
 SERIES B.—Full Dial, Solid Plates, - - - 48 00 "

**Discount to the Trade.**

We can supply either Pattern as ordered.

**WATERBURY WATCH CO.,**  
 WATERBURY, CONN.

**NEW YORK OFFICE, 52 MAIDEN LANE.**

GEO. MERRITT, GENERAL SELLING AGENT,

To whom all Orders and Correspondence as to Prices and Terms should be addressed.

**FOR SALE BY DEALERS GENERALLY.**



NEW SERIES B.  
 Solid Plates and Full Dial.



NEW SERIES B.  
 Bezel Off,  
 Showing Index Plate and Regulator.

**JOHN BLISS & CO.,**

**Standard Marine**

**CHRONOMETERS AND TRANSITS**

**FOR WATCHMAKERS' USE.**

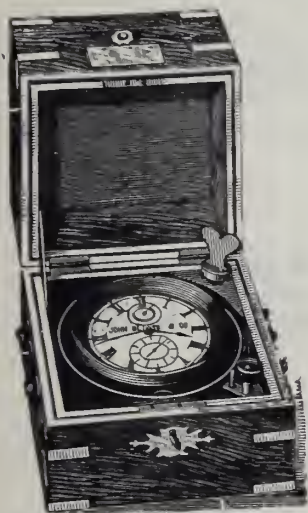

Standard Marine Chronometer,  
 FOR KEEPING CORRECT TIME.

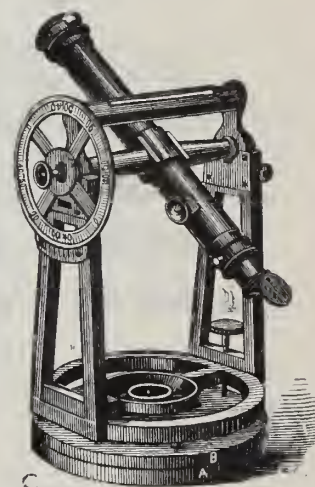

No. 10.

**128 FRONT STREET,**

**Near Wall Street,**

**NEW YORK.**

**NOTICE.**—These Transits are readily set in position without the aid of strictly correct time as a basis for that purpose. Printed instructions, easily understood, accompany each Instrument, and no calculations are required preliminary to setting in position.

SEND FOR ILLUSTRATED CIRCULAR WITH PRICES.





GILES, BRO. & CO.  
 Wholesale,  
 Importing and  
 Manufacturing  
 JEWELERS,  
 101 and 103 STATE STREET,  
 CHICAGO, ILLS.

Complete Illustrated Catalogue Furnished the  
 Trade upon Application.

# WILLIAM H. BALL,

—MAKER OF—

## GOLD BRACELETS

WITH THE PATENT GUARD.

IMPOSSIBLE TO LOSE THIS BRACELET.

A FULL LINE OF

BANDS, BANGLES, PADLOCK AND KEY, AND BRAIDED GOODS,

9 JOHN ST., NEW YORK.

SAN FRANCISCO OFFICE, 120 SUTTER ST.

FACTORY, NEWARK, N. J.

Goods Sent on Selection to Responsible Parties.



# THE OLIN ADJUSTABLE CHUCK.

CONVENIENT, DURABLE, EFFICIENT.

THE ONLY CHUCK THAT ADJUSTS THE SPLIT CHUCK.

EVERY ONE WARRANTED AS REPRESENTED.

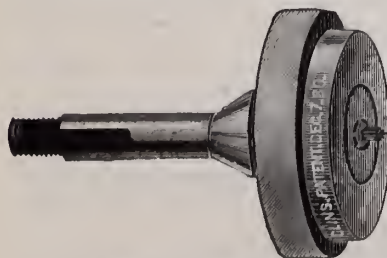

Emphatically the chuck for accurate watch-work. Made of the finest steel and nickel plated. Can be applied to any watch-makers' lathe in use. Fitted free of charge. No chuck has ever been offered to the trade that so fully meets all the requirements as the OLIN.

Every wheel, pinion or staff in a watch is easily and quickly brought to a perfect center, and held true and firm.

### PRICES.

- Chuck complete, with combination for wheel chuck, nickel plated, with five split chucks, all in neat turned wood box, \$ 15.00
- Wheel chuck, put up the same way, 8.00
- Additional parts to make up complete chuck, 7.00
- Extra split chucks of any number, each, 1.00

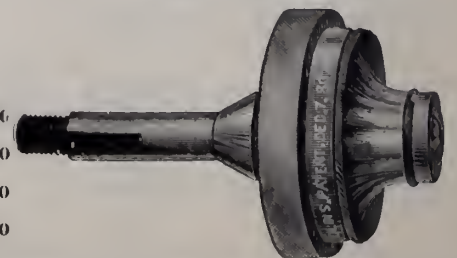

Our Split Chucks are all Tempered and Ground True. to fit by. If for Swiss Lathe, send the Lathe and Pulley Spindle. address

Orders for Chucks to be fitted to American Lathes must be accompanied by a Split Chuck. Parties having Second Hand Lathes cheap, will find it to their advantage to

THE OHIO WATCH TOOL CO., PIQUA, OHIO, U. S. A.



# THE HOPKINS LATHE.



These Lathes are **Unsurpassed in Quality and Workmanship.**

In **Special Features of Practical Value**, peculiarly adapted to Watch Repairing, they excel all others. The attachments are made **inter-changeable** in all the sizes.

The only absolute substitute for wax, in Watch Repairing,

is found in our **New and Improved Pivoting Chuck**, represented in the above sectional view.

**HOPKINS WATCH TOOL CO.,**

**WALTHAM, MASS.**

Send for full Descriptive Catalogue.

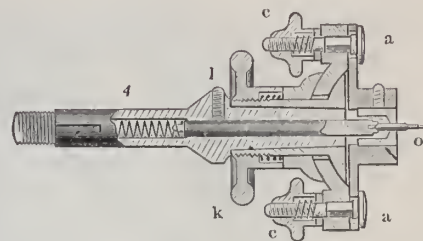

## S. KOHN & CO.,

**43 MAIDEN LANE,**

**NEW YORK.**

Manufacturers of  
Fine Morocco, Plush and  
Velvet Boxes.



Trays and Silverware  
Boxes of all Description  
Made to Order.

*A Full Line of Boxes Constantly on Hand, and Samples sent on Selection.*

ORDERS FROM THE JOBBING TRADE RESPECTFULLY SOLICITED.

### THE SELF-LOCKING TAG.

Patented May 29, 1883.

FOR ALL KINDS OF JEWELRY.

To introduce  
vention, I will  
by mail to any  
receipt of \$1.00.  
will convince

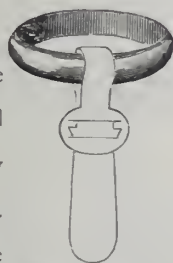

When attached.

this Novel In-  
send five gross  
address on re-  
A trial order  
you that this is

**The BEST TAG now in Use!**

### J. WIESBAUER,

MANUFACTURER OF

### Jewelers' Findings,

Morocco, Plush and Velvet Cases, Trays,  
Paper Boxes, Wood Mailing Boxes, Etc.,

OFFICE:

414 Main St.

FACTORY:

Cor. Oak & Clinton,

BUFFALO.

**JOBBING TRADE SOLICITED.**

PATENTED JAN. 23, 1883.

What Every Jeweler Needs.



Will Keep Cards Clean.

The above useful device contains over 1200 of the various size Cards and 1000 Tags.

**PRICE, \$4.50.**

## R. & L. FRIEDLANDER,

IMPORTERS OF

### WATCHMAKERS' & JEWELERS' SUPPLIES,

OPTICAL GOODS, SILK GUARDS, Etc., Etc.

WE KEEP ON HAND A LARGE STOCK OF

Rolled Plate and Fire Gilt Chains,  
CHARMS AND LOCKETS.

GENERAL AGENTS FOR

**TESKE'S PATENT WATCH REGULATORS, PRICE \$18.00 PER DOZEN.**



No. 1, having an oblong hole in the Base Plate (which is secured by a Special Patent), fits all Waltham, Elgin, Hampden and Rockford Movements.

No. 2, having also an oblong hole but F. S. on the opposite sides of No. 1, fits all Illinois and Old Model Waltham.

No. 3 is made expressly for New Model Waltham, with Movement-Screw near the Index.



# THE LIGHTNING CLEANSER.

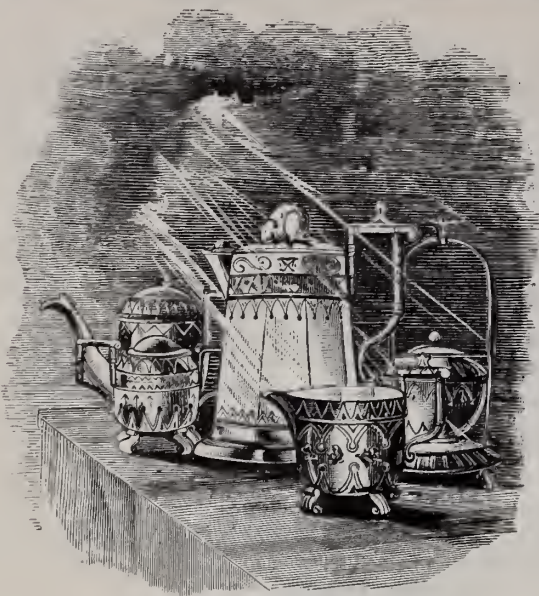

IS THE BEST, QUICKEST, EASIEST, CHEAPEST, CLEANEST AND MOST RELIABLE CLEANSER EVER KNOWN

## FOR REMOVING TARNISH

From Gold, Silver, Plated Ware, Nickel and Glass.

It is entirely different from all polishes, as it does its work by absorption, and does not require rubbing and labor to get the article cleansed, thus leaving the natural surface of the goods uninjured. It contains **No Acid, Mercury, Poison or Alkali** (including Ammonia and Cyanide). It is prepared in solid cakes, and does not waste by dusting or blowing away.

For sale by Jobbers and Manufacturers of Jewelry and Silver-Plated Ware.

Price per Gross, \$12.00; or One Dozen sent, postpaid, to any address on receipt of \$1.50; or One Package for 25c.

W. M. SCOTT & CO., Manufacturers,  
1205 Chestnut St., Philadelphia, Pa.

KEY  
Patented Jan. 25,  
1881.

TAG  
Patented Jan. 25,  
1881.

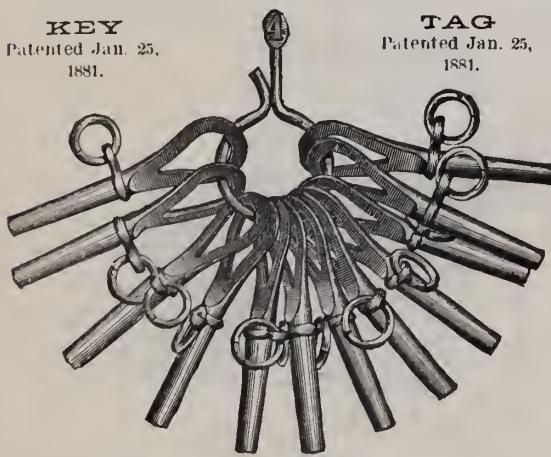

# A. N. CLARK

PLAINVILLE,  
CONN.,

Manufacturer of

Watch Case Springs, Watchmakers' & Jewelers' Bench Tools,  
CROSBY'S JEWELING TOOLS, &c.

STOP IMPORTING KEYS!

For Low Price Key Use the

## New Style Loop Key.



A plain Steel Key of good appearance, and excellent quality. It will not wear the pocket. It has a swivel, and is much better made than the imported plain steel or iron keys.

PRICE PER GROSS, FINE NICKEL FINISH, \$2.25  
Postage, 10 Cents Per Gross Additional.

This Key is good and cheap enough to become universal. Send business card for illustrated price list. Enclose three cent stamp for sample key.

SOLD BY JOBBERS IN WATCH MATERIALS AND NOTIONS,

A. N. CLARK, Plainville, Conn.

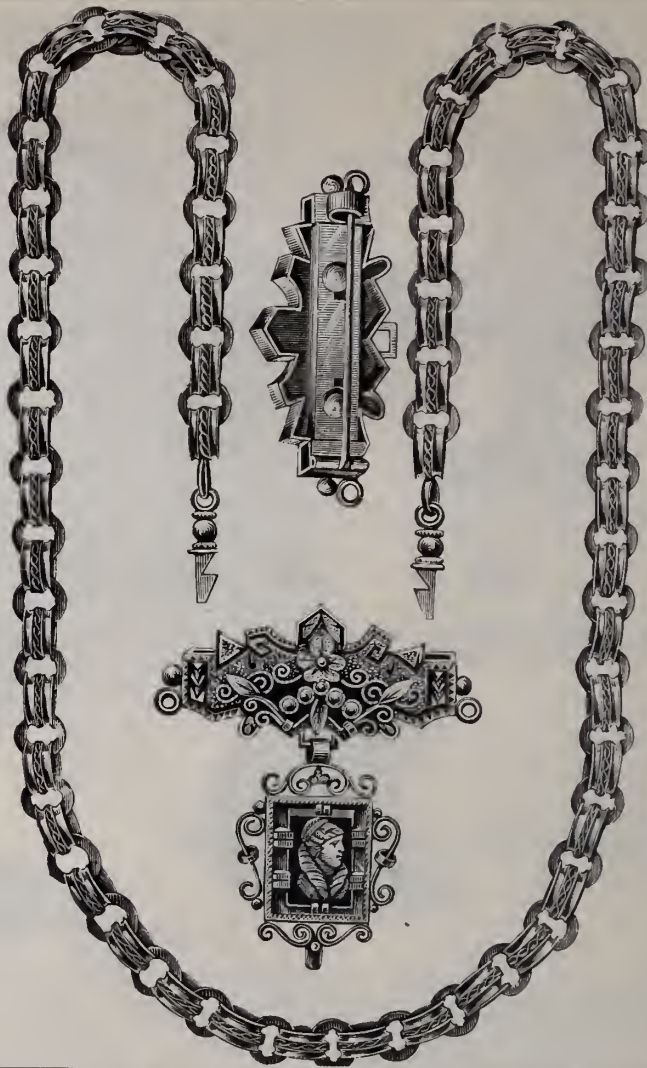

L. F. CAHIN,

Manufacturer of all kinds of Gold Chains, Chain Bracelets; also a full line of Seal and Fancy Rings, and Patentee of Cahin's Patent Chain Snap. These goods are made in 10 and 14 karat gold, and can be obtained through any Jobber in the U. S., or direct from me. A large stock of Gold Chains constantly on hand. Goods sent on approval to responsible houses.

# The Burbank Manufacturing Company

Manufacturers of GOLD & SILVER

## Thimbles,



GOLD  
SILVER,  
STEEL,  
RUBBER,  
And SHELL,



EYE GLASS  
Self Adjusting.

## SPECTACLES AND EYE-GLASSES



OF ALL DESCRIPTIONS.

## SOLID GOLD RINGS

Office, 14 MAIDEN LANE, NEW YORK.

Manufactory, Springfield, Mass.



# HUTCHISON & HUESTIS,

❖ SOLID ❖ GOLD ❖

## RING MAKERS



QUALITY  
GUARANTEED.

FOR  
JOBBER'S ONLY.

No. 185 EDDY STREET,  
❖ PROVIDENCE, R. I. ❖

New York Office, . . . 196 Broadway.



### J. F. FRADLEY & CO.,

Manufacturers of Fine

### Gold and Silver Headed Canes

AND SPECIALTIES.

### 23 JOHN STREET, NEW YORK!

Designs furnished for Presentation Canes. Illustrated Catalogues sent upon application.

Special Inducements to the Jobbing Trade.

# WM. M. FISHER & CO.

Sole Manufacturers of the

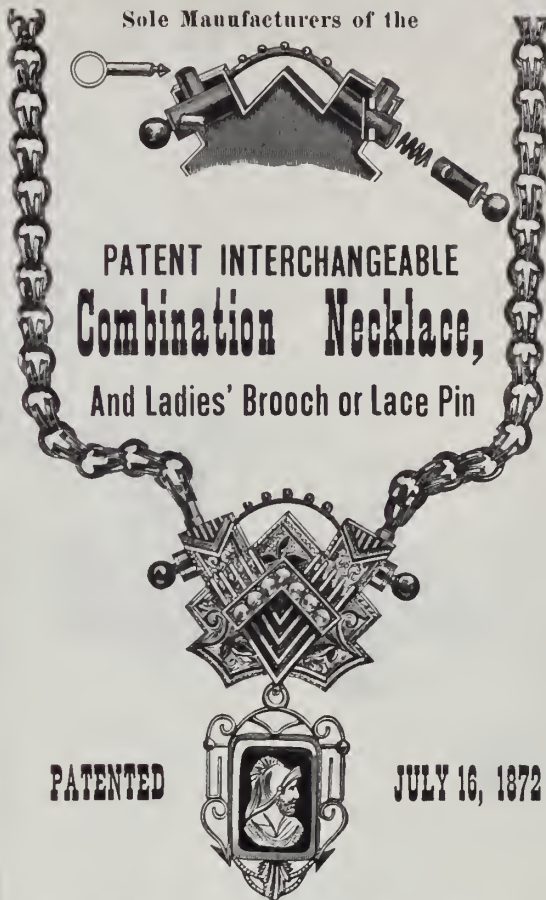

### PATENT INTERCHANGEABLE Combination Necklace,

And Ladies' Brooch or Lace Pin

PATENTED

JULY 16, 1872

GOLD

AND

SILVER

### CHAINS.

—:o:—

Gold Chain

### TRIMMINGS.

—:o:—

Complete

Assortment of

14-k.

### Ribbon Fobs.

FOR SALE BY THE LEADING JOBBER'S

## S. C. JACKSON, 180 BROADWAY, N. Y.

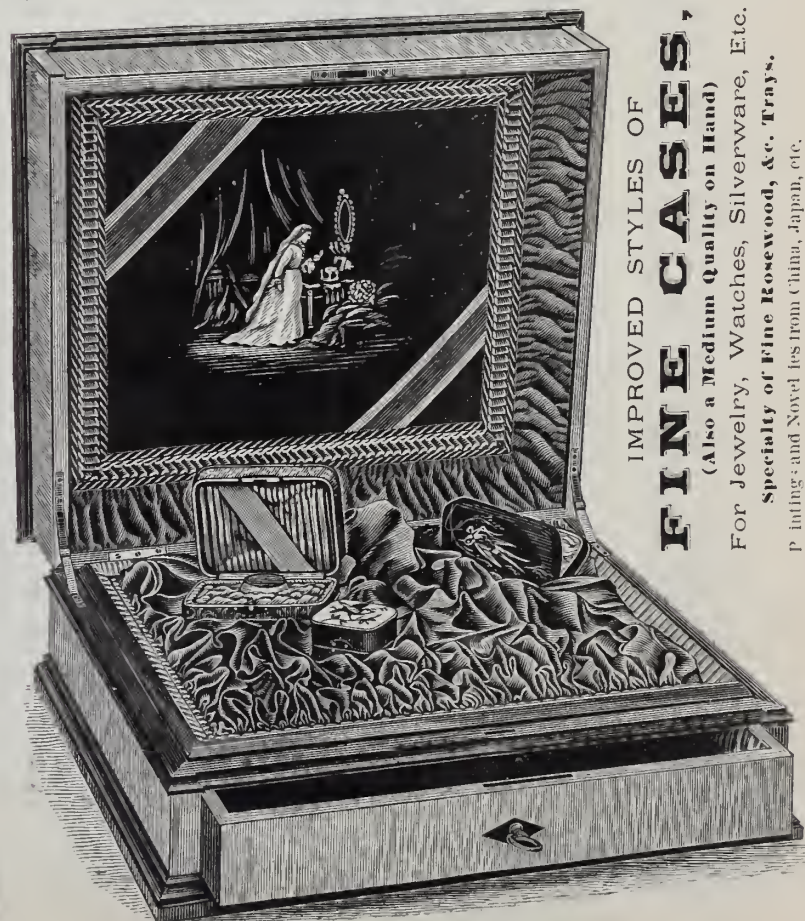

IMPROVED STYLES OF  
**FINE CASES,**  
(Also a Medium Quality on Hand)  
For Jewelry, Watches, Silverware, Etc.  
Specialty of Fine Rosewood, &c. Trays.  
Patented and Novel Sets from China, Japan, etc.



# AMERICAN WATCH TOOL CO.,

WALTHAM, MASS.

MANUFACTURE THE

## WHITCOMB LATHE,

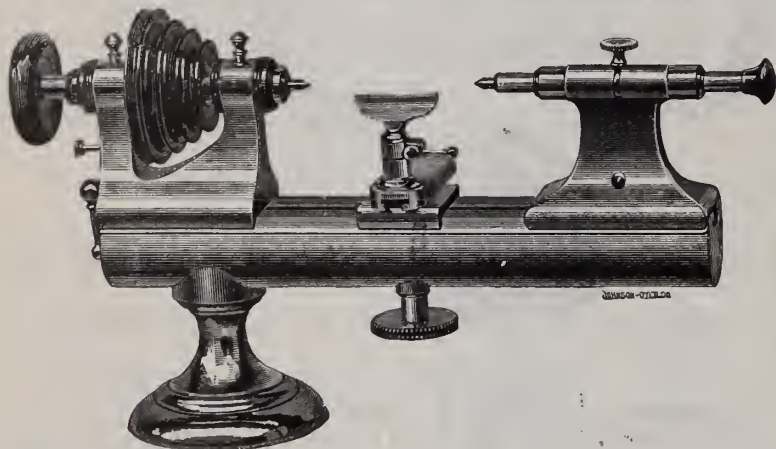

AND THE

## "Webster" Foot Wheel,

We guarantee it to be a worthy companion to the Whitcomb Lathe.

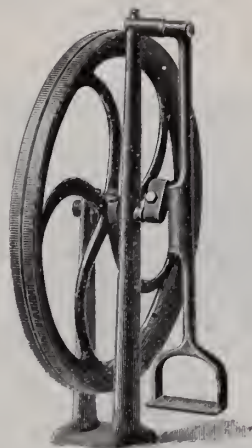

It is **not** a cheap made wheel but **First-class** in every respect.

### PRICES:

|                                                       |         |
|-------------------------------------------------------|---------|
| 30 lb. Wheel, for No. 1 Lathe, 20 inches in diameter, | \$12 00 |
| 40 " " " 1 1/2 " 20 1/2 " "                           | 13.00   |
| 50 " " " 2 " 21 1/2 " "                               | 14.00   |

DESCRIPTION.—The wheel runs on a hard steel arbor. It is clamped to the arbor by a set screw against a split bushing. This does not bend the arbor as in the case where the set screw is against the arbor. On the crank pin is a friction roll, having a hardened steel bushing, which runs on a hard steel pin. The swinging treadle is the **easiest** motion, and effects the body **less** than the foot treadle.

SEND FOR NEW CATALOGUE.

Our No. 1 1/2 Lathes are Fast Superseding all other Sizes.

Soft Lathes have Hard Mouths, Hard Wire Chucks and Hard Tail Stock Spindles.

# MARTINS & TISSOT,

Manufacturers of

## GOLD WATCH CASES,

15 MAIDEN LANE, NEW YORK.

## 8 KARAT CASES A SPECIALTY



Our 8 Karat Cases are of Superior

STYLE, CONSTRUCTION AND FINISH

to any now made, (as our constantly increasing production will attest), and are made also in large variety of styles.

LARGE STOCK Constantly on Hand.

Also 14 KARAT CASES in Large Variety.

JOBGING TRADE SOLD ONLY.

## Birch's Patent Self-Adjusting Watch Keys.

FOR SALE BY THE TRADE GENERALLY.



2.—POCKET KEY. (Brass.)

3.—POCKET KEY. (Nickel Plated.)

4.—POCKET KEY. (Nickel Plated, Hexagon Shell.)

5.—POCKET KEY. (Heavy Rolled Gold Plate Mountings.)

6.—CELLULOID MOUNTED KEY. (With Heavy Rolled Gold Plate Tips.)

35.—POCKET KEY. CELLULOID MOUNTINGS. (Imitation Malachite, with Extra Heavy Rolled Gold Plate Tips. 18. K.)

7.—BENCH KEY. (Brass Handle.)

8.—SHORT WOOD HANDLE KEY. (Nickel Plated, for Bench or Pocket Use.)

9.—LONG WOOD HANDLE BENCH KEY. (Nickel Plated.)

Made in 37 Styles. Circulars on Application.

J. S. BIRCH & CO., 38 Dey Street, N. Y.





Copyright Secured.



**E. J. BOYCE,**

(Formerly Boyce & Walnwright.)

→ **MANUFACTURING + JEWELER** ←

*SOLID GOLD RINGS A SPECIALTY.*

My **BAND RING** Specialties, for **PRICE, QUALITY** and **FINISH**, are not equaled by any in the Trade,

**383 WASHINGTON ST.,**  
BOSTON, MASS.

**NEW ENGLAND MOROCCO CASE CO.,**

MANUFACTURERS OF

JEWELRY and SILVERWARE

**CASES,**

OF EVERY DESCRIPTION.

NO. 220 CHAPEL STREET  
NEW HAVEN, CONN.

Solid Gold Rings a Specialty.

**WM. H. ELY,**

**SOLID GOLD RINGS,**  
MANUFACTURER.

Viz., Plain, Chased, Engraved, Enameled, Engine Turned, Shield and Scale. All qualities guaranteed. Orders Promptly Executed.

58 Nassau Street, New York.

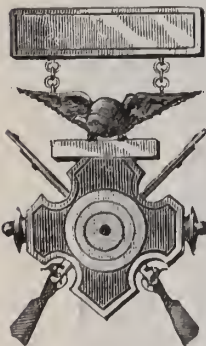

**C. B. WILKINSON,**  
Manufacturing + Jeweler,

8 JOHN ST., N. Y.

Medals, Badges and Masonic Jewelry  
**A SPECIALTY.**

Designs furnished free upon application.

**H. WUNDOEHL,**

**GOLD & SILVER REFINER,**

Assayer and Sweep Smelter,

21 JOHN ST.

Bet. Broadway & Nassau St., **NEW YORK.**

The highest price paid for Gold, Silver and Platinum.  
*Fine Gold, Silver and Copper always on hand.*

**JACOB STRAUSS,**  
**WATCHES & JEWELRY**

AT WHOLESALE.

REMOVED FROM

**18 TO 25 JOHN STREET, N. Y.**

Rings and Rolled Plated Chains  
A SPECIALTY.

New + York + Morocco + Case + Co.

CASES FOR

Jewelry, Silverware & Watches  
OF EVERY DESCRIPTION.

Boxes and Trays for Jewelry Travelers,  
TRUNKS FITTED UP WITH TRAYS.

Show Cases and Window Fittings  
a Specialty.

No. 69 NASSAU STREET, NEW YORK.

**W. H. LUDEMAN,**  
No. 75 & 77 Nassau Street,  
NEW YORK.

**FINE AND COMPLICATED  
WATCHES**

Of every description repaired and regulated.  
**Stem Winding and Escape Wheels**

Cut and finished to order with accuracy  
and promptness.

**J. J. COHN,**

IMPORTER OF

→ **WHITBY JET,** ←

MANUFACTURER OF

**Gold & Rolled Plate Jewelry,**

Bracelets, Charms & Locketts a Specialty.

12 MAIDEN LANE, N. Y.

Goods Sent on Selection if Satisfactory References are Given.

**WM. SCHWENCKE,**

Manufacturing & Jobbing Jeweler,

43 MAIDEN LANE, N. Y.

Gives particular attention to the Repairing and Jobbing Department of the Jewelry Business. Prompt Attention, Moderate Prices and First-Class Workmanship Guaranteed to all. Country Orders Promptly attended to.

**CHURCH'S PATENT IMPROVED  
DOUBLE SPEED INDICATOR**  
*Either Right or Left.*

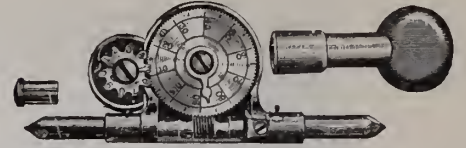

**MONTGOMERY & CO.,**  
Importers of *Stubs' Files, Tools & Steel,*  
GROBET SWISS FILES. CHESTERMAN'S TAPES, RULES, &c.  
Horse Shoe Magnets. Hubert's French Emery Paper.  
**WM. SMITH & SONS' CELEBRATED MUSIC WIRE.**  
105 Fulton Street, N. Y.

The Finest Line of High-Class English  
Watches in the U. S.

**GEO. E. WILKINS,**  
SYRACUSE, N. Y.

Agent for the Celebrated Watches of

Chas. Frodsham & Co., London,  
W. G. Schoof, London,  
Karl Zimmerman, Liverpool.

Timing and Adjusting done for the Trade.

Correspondence Solicited from the Trade.

**HIBBARD G. GILL,**  
GOLD AND SILVER

**Watch Case Manufacturer,**

Dealer in Watches,

American Watch Movements Always on Hand.

618 Chestnut Street,

Fifth Floor.

PHILADELPHIA.

**HENRY TROEMNER,**  
710 Market Street,  
PHILADELPHIA.

Manufacturer of Fine Gold Scales,

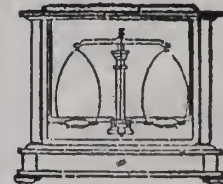

DIAMOND SCALES,

Bullion Balances and Weights, in use at all the U. S. Mints and Assay Offices.

PRICED CATALOGUE ON APPLICATION.

**JNO. F. LUTHER,**

MANUFACTURER OF

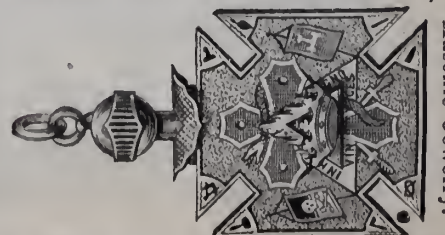

Masonic Jewelry.

**79 Nassau Street, N. Y.**

Illustrated Catalogue sent on application.



# PLATINUM

—FOR—

Scientific and Mechanical Purposes,

IMPORTED AND FOR SALE BY

The S. S. White Dental Manufacturing Co.  
SCRAP PURCHASED.

PHILADELPHIA, Chestnut St., cor. Twelfth.  
NEW YORK, - 767 and 769 Broadway.  
BOSTON, - - - 160 Tremont Street.  
CHICAGO, - - 13 and 14 E. Madison St.

ADOPTED AND IN USE BY

**RANDEL, BAREMORE & BILLINGS,**  
58 Nassau Street, N. Y.

THE TRADE SUPPLIED.  
Descriptive Circulars Furnished  
on Application to  
**George W. Washburn, Patentee,**  
88 Nassau St.,  
NEW YORK.

SAFETY

EAR FASTENING,

Pat. May 10, '81—Oct. 11, '81.



Jointed

EAR WIRE

AND

BAR BETWEEN CRAMPS  
OF SETTINGS.

Patented March 1, 1881.

TELESCOPIC

SAFETY PIN CATCH.

Pat. Sep. 20, '81—Jan. 10, '82.



## A. BANTLE,

Gold, Silver and Platinum

Electro-Plating

FINE WORK A SPECIALTY.

130 Fulton Street,  
89 Nassau Street,

ROOM 36,

NEW YORK.

WATCH CASE POLISHING.

## W. W. OLIVER,

Manufacturer of Hand and Power

# Rolling Mills,

For Jewelers and Silversmiths.

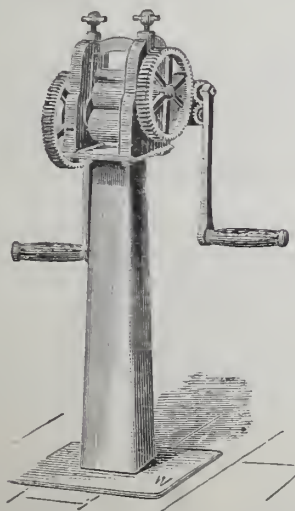

The "Little Giant" Ring Bender

Hollow Spindle Lathes, Punching and Drop Presses, Polishing Heads, Dies, Metal Laps, Etc.

39 Clinton St., Buffalo, N. Y.

Illustrated Price List mailed free upon application.

## WM. DOWNEY,

Successor to Downey & Smith,

# Manufacturing Jeweler,

24 John Street, N. Y.

Fine Stone Locketts, Seals and Rings, Flexible  
Bracelets, Rich Diamond Mountings, etc.

## WM. RAWLINGS, JR.,

# Manufacturing Jeweler,

FACTORY:

913 Arch Street, Phila.

FINE GOLD RINGS A SPECIALTY.

Goods sent on approval to any part of the  
country upon receipt of satisfactory reference.



## HENRY LEFORT,

# Stem-Winding Watch Crown Manufacturer,

Crowns and Pushers in gold, all sizes, quality and color,  
made to order. Silver crowns and pushers always on hand.

60 Arlington Street,

Corner William Street,

NEWARK, N. J.

## Diamond Broker.

R. J. Herbert, 26 Maiden Lane,

New York City,

Solicits Commissions,  
Buying, Selling, Matching.

Prompt Attention.

References.

## EXCELSIOR'S

Practical Treatise

ON THE

## BALANCE SPRING

Including Making and Fitting Hair Springs,  
Regulating, etc.

Also containing the Adjustment of Watches  
and Chronometers for Isochronism, Posi-  
tions, Heat and Cold and Rate.

PRICE, \$3.50.

D. H. HOPKINSON,

42 Nassau Street, New York.

## H. WASELL,

RUBBER STAMPS,  
BRASS STAMPS,  
Brushes, Inks, &c.

Stencil Plates,



Burning Brands,

SEALS & PRESSES,

No. 7 North William St.

First house South of East River Bridge, N. Y.

FINE STEEL STAMPS A SPECIALTY.

## P. JANDORF & BRO.,

# Watches and Jewelry,

196 BROADWAY,

Bet. John & Fulton Sts., NEW YORK.

We Publish No Price Lists.

## C. KNAPP,

Manufacturer of

Superior Band  
and Children's

Stone & Fancy  
**RINGS**

And Enameled Goods,  
41 Maiden Lane,  
NEW YORK.



## WILLIAM ERNST MOUTOUX,

Leading Artist in Hair of the World

AND MANUFACTURER OF

# GOLD AND HAIR JEWELRY,

OFFICE AND FACTORY,

81 Nassau St., Rooms 1 & 2,

BRANCH,

18 Lawrence St. West of 126th,

Near Ninth Ave., NEW YORK.

My New Catalogue of 1700 New Designs of Monuments  
with Weeping Willows, Wreaths, Bouquets, Crosses, Churches,  
Sceneries, Portraits, Pet Animals, Engravings of the Most  
Difficult Description, Etc. Wholesale prices for Hair Chain  
Braids in Assorted Colors, by the gross or dozen at half of  
book prices. Devices made at half of book prices if necessary.  
15-5 per cent. cash discount on the prices of the old book.

ESTABLISHED 1873.

## CHAS. P. HEROLD,

MANUFACTURER OF

# 18 K. DIAMOND MOUNTINGS,

# DIAMOND JEWELRY,

916 Chestnut St.,

Second Floor.

Philadelphia.



All parts furnished separately when desired. The Springs will never rust, and are much more durable than steel.

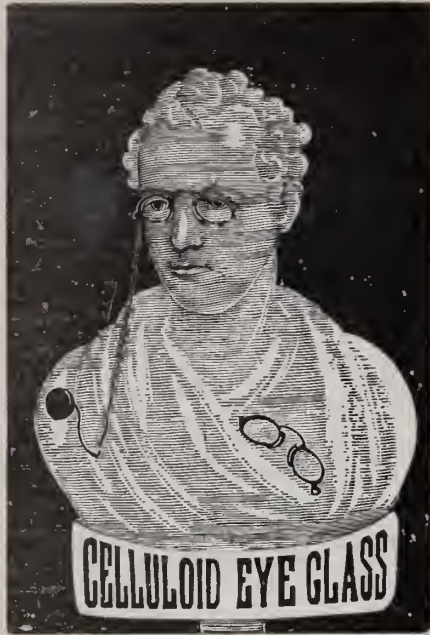

Please note a reduction of 50 cents per dozen on 286 and 288 Celluloid Eye-Glasses, No. 7 Catalogue.

The above cut represents a fine bust of Lord Byron, about twenty-five inches high, which will be furnished to parties purchasing 6 dozen Celluloid Eye-Glasses. It is securely packed, ready for shipment, and will make a very handsome ornament for the show window.

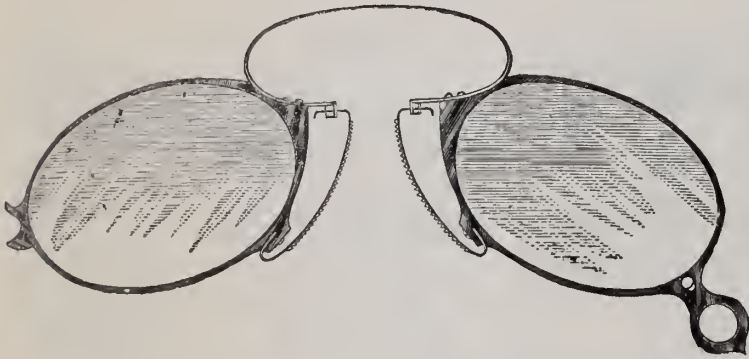

The above cut represents No. 306 Eye-Glass with an Adjustable Nose Piece, which we make in

**Gold, Nickel, Celluloid, Rubber, Steel and Frameless.**

This style of Eye-Glass is very popular. We make many New and EXCLUSIVE Styles that give a Dealer handling our goods an immense advantage over those who sell the ordinary line of goods in the market.

**Special Goods, with Trade Mark, made for Dealers to Order.**

**Great Variety! Novel Styles! Attractive Goods!**

While many houses have complained of dull trade this Spring, we have been increasing our force.

*ACTIONS SPEAK PLAINER THAN WORDS.*

**Spencer Optical Manufacturing Co.,**

**13 MAIDEN LANE, NEW YORK.**

Established 1853.

**L. H. KELLER & CO.**

Successors to G. A. HUGUENIN,

IMPORTERS OF

WATCHMAKERS' and JEWELERS'

**TOOLS AND MATERIALS.**

GENERAL AGENTS FOR

The Philadelphia Watch Company,

— AND —

American Watch Tool Co.,

MANUFACTURERS OF

**THE WHITCOMB LATHE.**

SOLE AGENTS IN THE UNITED STATES FOR THE SALE OF

**LUTZ'S**

**CELEBRATED ROLL HARDENED HAIR SPRINGS,**

**MOEBIUS OIL**

For Chronometers, Watches, Clocks, Telegraph Instruments and all other delicate machinery. Made from Pure Refined Neatsfoot Oil, and Warranted to Excel anything in the market as a Lubricator. **SAMPLES GRATIS.**

**OUR OWN GRADUATED**

AND JURGENSEN RECOILING MAINSPRINGS, pronounced by all experts Superior to all. Sold in Separate Strengths or Force.

Extra Fine Pinions cut from Solid Steel Wire. Gauged Hole Jewels of First-class Workmanship. A Full Line of Materials, for the PATEK, PHILIPPE & CO. GENEVA WATCHES, and all other Celebrated Makers.

**THE BOLEY LATHES AND TOOLS,**

Celebrated for their Practical, Substantial and Workmanlike Construction, Superior Design and Finish.

*Our aim is to furnish nothing but First-class Serviceable Goods, especially manufactured for the Consumer, and not solely for the Market, like the cheap trash advertised in highly illustrated catalogues with which the country is flooded.*

**TREATISE ON MODERN HOROLOGY IN THEORY AND PRACTICE.** By M. CLAUDIUS SAUNIER, Ex-Director of the School of Horology at Macon, France; Knight of the Legion of Honor, etc.; Hon. Sec. to the Paris Society of Horologists. Translated from the French by JULIEN TRIPPLIN, Besançon Watch Manufacturer, and EDWARD RIGG, M. A., Assayer in the Royal Mint, London.

This Work comprises 832 large octavo pages, with 78 wood cuts and 21 colored double-page copper-plate engravings. Bound in half calf, with an appropriate and handsome ornament in gold on front cover.

**Price, \$15.00.**

**THE WATCHMAKER'S HAND BOOK.** By the same author and translators. Intended as a companion to the Treatise. Bound in cloth.

**PRICE, \$4.00.**

**64 Nassau Street,**

NEAR MAIDEN LANE,

**NEW YORK.**

L. H. KELLER,  
EDWARD HUNZIRER,  
F. J. BOESSE.

We do not publish Price Lists.



## SPECIAL NOTICES.

**WANTED**—A traveler with from 3 to 4 thousand dollars. Address J., care Jewelers' Circular.

**WATCHMAKER** wants a situation. Has had long experience in fine and complicated watches. Address Bridgeport, care Jewelers' Circular.

**WANTED**—A first-class watchmaker and competent engraver to go to a large southern city. Good wages guaranteed. Address O. B. & V., care Jewelers' Circular.

**WANTED**—A first-class jeweler and engraver. One who can do letter and monogram engraving and good jewelry work. Address Freeman & Crankshaw, Atlanta, Ga.

**SITUATION WANTED** by a watchmaker of 13 years' experience. Good set of tools, good reference. South or west preferred. Address D. S. Porter, Fergusonville, Del. Co., N. Y.

**SITUATION WANTED** by a competent watchmaker. Fifteen years' experience with better class of trade. Can also do very good engraving. Address "Advertiser," care Jewelers' Circular.

**FOR SALE**—At a heavy discount for cash, a large lot of Lemaire's best quality rock crystal spectacles. These are all new and fresh goods. Address "Spectacle," care Jewelers' Circular.

**WANTED**—By P. F. Egan & Co., St. Paul, Minn., a first-class watchmaker and willing to act as salesman when required. Permanent position and first-class wages. Address above.

**JEWELRY STORE FOR SALE**—Stock, lease, etc. of the only store in a growing town of 2,700. Good reason for selling. A rare chance for a good business. Address A. E. Axman, Franklin, Warren Co., Ohio.

**WANTED**—To represent a first-class wholesale jewelry house. Have had experience on the road; have also had management of a New York office for two years. Address "Traveler," care Jewelers' Circular.

**SITUATION WANTED** by a jeweler that has thirteen years' experience buying and selling goods and at the bench. Has a first-class set of tools and can give the best of references. Address Box 87, Mooers, N. Y.

**JEWELRY STORE FOR SALE**—In thriving western city of 7,000 inhabitants. Leading store. Good reasons for selling. Will sell stock, fixtures and tools, or without tools. Address Y., care Jewelers' Circular.

**SITUATION WANTED**—By a practical jeweler, one who understands making and repairing thoroughly. Can engrave and color. Good references. Can take charge of a shop. Address J. P., care Jewelers' Circular.

**WANTED**—A position to travel, by a man who has had 15 years' experience at the bench in a retail store. Can furnish good references as to habits and qualifications. Address J. A. C., care Jewelers' Circular.

**MOSELEY & CO.**, Elgin, Ill., manufacturers of the "Moseley" Lathe, with full line of fixtures and attachments. Designed especially for the watchmaker and repairer. Combining accuracy, durability, convenience and style.

**FOR SALE**—A well-established watch and jewelry business in a thriving town of 1,000 inhabitants. Only store in the place. Will invoice \$1,500. A rare chance for a young man. Address Lock Box 16, Richmond Co., Belleville, O.

**WANTED**—A watchmaker. Will pay \$12 a week to fair workman. Good board can be had here for \$12.50 a month. Will furnish party with transportation also wanted a good second-hand regulator. Address C. T. Postley, Durham, N. C.

**WANTED**—A situation by the 1st of October by a good watchmaker who can do all kinds of watch work, job work and gold coloring, and is capable of taking charge of store. Good reference. Tools and Hopkins lathe. Address X. X., care Jewelers' Circular.

**SITUATION WANTED** by a first-class watchmaker and salesman, over twenty years' experience, best of reference, full set of tools, good address. At present employed. Western states or territories preferred. Address, for particulars, Practical Watchmaker, Jewelers' Circular.

**FOR SALE**—Stock and fixtures of a jewelry store well located. Established 15 years. Doing a good business. Fine chance for a man with small capital. Stock clean. Will reduce stock, etc. to \$1,500. Address W., care Jewelers' Circular, or J. E. Spencer, 13 Maiden Lane, N. Y.

**WANTED**—Situation by a young man 25 years of age who has worked at the watchmaking business 3 years. Have a good lot of tools, including a new Whitcomb lathe. Can wait on customers and can do some engraving. Good reference given. Address H. S. B., care Jewelers' Circular.

**WANTED**—A first-class workman on watches, clocks, jewelry, a fair engraver, and a good salesman who understands the jewelry business, with a No. 1 set of tools, wants a situation, wages depending on location. Good references given and required. Address W. G. Scott, Dardanelle, Arkansas.

**GEORGE E. WILKINS**, manufacturer and importer of cutters for watchmakers' use, stem-winding cutters of all the different forms, rounding up cutters of the finest quality, also ratchet cutters. A large stock of second hand and new marine chronometers. No. 21 South Salina street, Syracuse, N. Y.

**WANTED**—Situation as traveling salesman for some watch and jewelry house or clock company. Have had twelve years' experience in the watch and jewelry line. Can give best Chicago references. Would travel in Illinois, Iowa or Wisconsin, or any territory desired. Address Traveler, care Jewelers' Circular.

**WANTED**—A competent salesman, engraver and jeweler, or watchmaker and engraver. Must be a good salesman. Permanent position by the year. Will pay from \$100 to \$150. None but reliable and experienced men need apply. Prefer a man who has been in business for himself. Address E. Hertzberg, San Antonio, Texas.

**WANTED**—In N. Y. City or vicinity, situation by an experienced watchmaker. Can do all kinds of watch repairing and hard soldering, is capable of taking charge of store and purchasing goods. Have first-class tools and references. Or would accept a situation as traveling salesman with a good jewelry jobbing house. Address C., care Station D, Jersey City, N. J.

**FOR SALE**—An old-established jewelry business. The L. O. Dunning stock and business at Penn Yan, N. Y., established over forty years, with a good reputation, in a thrifty village, one of the very best locations. An opportunity for an enterprising man to make a success. Stock, cases and fixtures in good condition and suitable for the business. For terms address Frank M. Raymond, Penn Yan, N. Y.

**JEWELRY STORE FOR SALE**—The stock, fixtures, lease, etc. of the leading jeweler in a five manufacturing western city for sale. The present owner desires to retire on account of poor health. Sum required for the purchase from \$8,000 to \$12,000. Positive proof given of a very profitable and increasing business for over 15 years. For information, address Robert M. Wilcox, care Rogers, Smith & Co., Meriden, Conn.

**TO WATCHMAKERS AND JEWELERS**—A re-engagement by a first-class workman of 20 years' experience, accustomed to the finer grades of watches and chronometers, and adjustments of same, to take charge of department or to manage a business. The highest references as to ability, character and length of services. State salary. Open for 3 months. Address G. S. M., care Jewelers' Circular.

[Will G. S. M. please send his address to this office.]

**FOR SALE**—A rare opportunity is offered to secure two elegant front window show cases, made by Messrs. Smith of New York. Outside measurement—length, 6 feet 3/4 inch; height, 2 feet 10 1/2 inches; width at bottom, 23 1/2 inches. Bent glass top and front, all heavy French plate. Three doors and glass shelf each. A movable track to move case in and out of window position. They are first-class in all appointments, and will be disposed of at a bargain. Address Joseph Seymour, Sons & Co., White Memorial Building, Syracuse, N. Y.

**TO THE TRADE**—We have obtained the sole and exclusive right to import and sell real or imitation gems or stones, having the back partly covered with a reflective substance, under letters patent of the United States numbered 223,237, 229,328, 233,364 and 250,379. We hereby notify the trade that any person or persons, firm or firms, corporation or corporations, who have in their possession, or hereafter obtain, manufacture or sell, any gem made or imported in violation of or in infringement upon any of the foregoing Patents, will be prosecuted to the full extent of the law. L. & M. KAHN.

## BUYERS' DIRECTORY.

## NEW YORK.

## Assayers and Sweep Smelters.

**Wundoehl, H.**—Gold and Silver Refiner, Assayer and Sweep Smelter. 21 John Street, N. Y.

## Badges and Medals.

**Stockwell & Newman**—19 John Street. Manufacturers of Badges, Medals and Presentation Pieces in Gold and Silver. Also Jewelry and Mounters of Diamonds. Designs supplied.

**Wilkinson, C. B.**—Manufacturing Jeweler, 8 John Street, N. Y. Medals, Badges and Masonic Jewelry a Specialty. Designs furnished free upon application.

## Band Rings.

**Knapp, Charles**, 41 Maiden Lane, N. Y. Specialty: Superior Band Rings, also Ring Shanks & Heads for Seal and Diamond Rings.

## Black Onyx Jewelry.

**Cox & Sedgwick**—Manufacturers of Black Onyx Jewelry, No. 26 John St. New York.

**Lawson, Samuel**—No. 13 John Street. Manufacturer of Black Onyx Jewelry. Coral repaired for the trade. Goods sent on approval to responsible dealers.

**Woglom & Miller**—Manufacturers of (exclusively) Black Onyx Jewelry, 32 & 34 John St., N. Y.

## Blue Enameled Locketts.

**Bissinger, Philip & Co.**—Importers of Diamonds, Pearls and Precious Stones. Agent for the Bohemian Garnet Goods. Blue Enameled Locketts. 22 John St., N. Y.

**Hess & Schliesser**—Importers of Diamonds, Fine Jewelry and Novelties in French Goods. Specialties: Gold and Blue Enameled Locketts, Charms and Crosses. 25 Maiden Lane.

## Bohemian Garnet Jewelry.

**Bissinger, Philip & Co.**—Importers of Diamonds, Pearls and Precious Stones. Sole Agent for the Bohemian Garnet Jewelry. Blue Enameled Locketts. 22 John St.

## Boxes, Wood Mailing and Nested.

**Maine Manufacturing Co.**—Successors to Swift M'fg Co., makers of Wood Mailing and Nested Boxes for Mailing and Express purposes. J. Spencer Taylor, Agent, 18 Courtlandt St., N. Y.

**Wiesbauer, J.**—Manufacturer of the Sliding Cover Wood Mailing Boxes. All Sizes Made to Order. Buffalo, N. Y.

## Clock Companies.

**Ansonia Clock Co.**—Manufacturers of every description of Clocks. 11 to 21 Cliff street, New York.

**Kroeber, F.**—Manufacturer and Dealer in American and French Clocks, No. 8 Cortlandt Street.

**New Haven Clock Co.**—16 and 18 Park Place, N. Y.

**Seth Thomas Clock Co.**—20 Murray Street, N. Y.

**Waterbury Clock Co.**—M. Bailey, Treasurer, Manufs and Jobbers, No. 4 Cortland St., N. Y., and No. 197 State Street, Chicago.

**Wm. L. Gilbert Clock Co.**—No. 6 Murray Street, Manufacturers of Clocks. Factories, Winsted, Conn.

**Yale Clock Co.**—Manufacturers of Novelties in Clocks, 52 Maiden Lane, N. Y.

## Corals and Coral Jewelry.

**Cuppia, L. A.**—Importer of Coral and Silver Filigree Jewelry, 19 Union Square, N. Y.

## Cameo Cutters, Etc.

**Peiter, Theodore**—Cameo and Intaglio Engraver. Patentee of the Cameo-Intaglio. No. 2 Bond Street, near Broadway, Room 4 New York.

## Charms &amp; Gold Watch Keys.

**Rupp & Held**—Manufacturing Jewelers, Charms and Gold Watch Keys, with French and English Ratchets, a specialty. 15 John St., N. Y.

## Crucibles.

**Berge, J. & H.**—Established 1850, Manufacturers and Importers of Sand Crucibles, Covers, Chemical Porcelain, Glassware, and Jewelers' and Assayers' Supplies, 95 John Street, N. Y.

**Berge, J. & Son.**—Importers of Sand Crucibles and Covers, Jewelers' Tools and Materials. Manufacturers of Berge's Improved Assay and Enamel Furnace, Assay and Enamel Muffles, &c. 32 and 34 John Street, N. Y.

## Cutlery.

**Harrison Bros. & Howson**—Manufacturers of Fine Ivory and Pearl Table and Pocket Cutlery, Carvers in Cases; Nutpicks, Nutcracks and goods suitable for the jewelry trade. 126 Chambers Street. W. C. Burkinshaw, Sole Agent.

## Diamond Brokers.

**Anderson, Otis**—Diamond Merchant and Broker, always ready to pay cash for bargains in Diamonds and Precious Stones, 4 & 6 John Street, N. Y.

**Bernhardt, Richard**—Diamond Broker and Importer, 65 Nassau Street (Room 6), N. Y. Paris, 20, rue des Petites-Écuries.

**Friend S. & Son**—Brokers and dealers in Diamonds 33 John Street, cor. Nassau St. New York.

**Herbert, R. J.**—Diamond Broker and Dealer, 26 Maiden Lane.

## Diamond Importers.

**Bissinger, Philip & Co.**—Importers of Diamonds, Pearls and Precious Stones. Agent for the Bohemian Garnet Goods. Blue Enameled Locketts. No. 22 John St., N. Y.

**Bruhl, D. & M.**—Established in 1848. 14 Maiden Lane, N. Y.; 111 Broad Street, Providence, R. I.; 14 Rue Bleue, Paris.



**Brunswick, S. & Co.**—Importers of Diamonds. 17 Maiden Lane, New York. Paris, Rue Lafayette. Amsterdam, Damstraat.

**Citroen, L. B., & Co.**—Diamonds. 21 John St., N. Y. Cutting Works, 57 & 61 Rapenburgerstraat, Amsterdam. House in Paris, 44 Rue Laffitte.

**Engelmann, M. & Co.**—Importers of Diamonds, Pearls and Precious Stones. Specialties in Fine Colored Stones. 192 Broadway and 1 and 3 John Street, N. Y. Paris, 1 Boulevard St. Denis.

**Faulkenau, Oppenheimer & Co.**—Manufacturers. Diamonds and Diamond Jewelry. 40 Maiden Lane, N. Y.

**Fera, Henry**—Importer of Diamonds, and Manufacturer of Fine Diamond Jewelry. 4 & 6 John Street, New York. Amsterdam, Holland, 23 Loojersgracht.

**Fox, M. & Co.**—Importers of Diamonds, Rubies, Sapphires and Fancy Gems. No. 1 Maiden Lane, New York.

**Hedges, Wm. S. & Co.**—Importers of Diamonds, No. 170 Broadway, corner Maiden Lane.

**Kuhn, Doerflinger, & Co.**—Manufacturing Jewelers and Importers of Diamonds, 18 John street, New York.

**Leberthon, L. M.**—Importer of Diamonds and Manufacturer of Fine Jewelry. 14 John Street, N. Y.

**Neresheimer, E. Aug. & Co.**—Importer of Diamonds. No. 21 Maiden Lane, New York.

**Randel, Baremore & Billings**—Importers of Diamonds, corner Maiden Lane and Nassau St.

**Saunders & Ives.**—Importers of Diamonds and other Precious Stones. No. 26 Maiden Lane.

**Smith, Alfred H. & Co.**—Importers of Diamonds, No. 182 Broadway.

**Taylor & Brother.**—Importers of Diamonds and Diamond Jewelry. 676 Broadway.

**Wickham, D. H. & Co.**—Importer of Diamonds. No. 31 Holborn Viaduct, London, 24 Maiden Lane, New York.

**Wolf, G. A.**—Importer of Diamonds, Rubies, Sapphires, Pearls, and other Precious Stones, 65 Maiden Lane, New York. 12 Rue de Chateaudun, Paris.

#### Diamond Jewelry.

**Bornemann, Louis.**—Importer of Diamonds and Manufacturer of Rich Diamond Jewelry, 19 John Street, New York.

**Chalumeau, D.**—Diamond Jeweler and Manufacturer of Mountings. Novelty and Artistic Jewelry. No. 3 Maiden Lane, New York.

**Goldsmith & Co.**—Manufacturers of Diamond Mountings and Diamond Jewelry, 3 Maiden Lane, New York.

**Hartje, G. & F.**—Manufacturers of Diamond and Fine Jewelry, 39 Union Square, N. Y.

**Haug & Luthy**—Manufacturers of Fine Diamond Mountings, etc. No. 130 Fulton St., N. Y.

**Heller & Bardel.**—Manufacturers of Diamond and Pearl Jewelry, and Dealers in Diamonds, Pearls, &c. 13 John Street.

**Jeanne Brothers.**—Manufacturers of Diamond Mountings & Rich Jewelry. 1 Maiden Lane.

**Lacroix & Verpillier.**—Manufacturers of Fine Gold Jewelry. Diamonds a specialty. 173 Broadway, N. Y.

**Rosswog, C. & Son**—Manufacturers of Rich Diamond Goods. Nos. 5 and 7 Maiden Lane, N. Y.

**Schilling & Nissen**—Dealers in Diamonds and Diamond Jewelry. No. 51 Nassau Street, New York, near Maiden Lane.

**Voelker, C. T.**—Manufacturer of 18-k. Diamond Mountings, Diamond Jewelry and Roller Chain Bracelets. 189 Broadway, New York.

**Waterman & Lehmann.**—Manufacturing Jewelers and Dealers in Diamonds, Diamond Work, and Fine fancy Rings a specialty, any piece of single work made to order. 37 Maiden Lane, N. Y.

#### Diamond and Pearl Setter, &c.

**Archibald, Wm.**—Diamond Setter for the Trade. Cameos, Pearls, Turquoises, Garnets, Amethysts, Doublets, Foil Backs, white and colored, Imitation Stones. 73 Nassau Street, N. Y., room 7.

**Danziger, H.**—Diamond and Pearl Setter, 116 Nassau Street, (Second Floor,) Room 6, N. Y.

#### Diamond Cutters.

**Levy, Herman.**—Importer, Cutter and Polisher of Diamonds. 105 Fulton Street, New York.

#### Dials, &c.

**Farnsworth, C. E. & Co.**—Successors to Jno. T. Gold, Manufacturers and Jobbers in Fine Watch Dials. 81 Nassau St., N. Y.

**New York Dial Co.**—Manufacturers of Fine Watch Dials. Henry Abbott, Agent, No. 7 Maiden Lane, N. Y.

#### Enameled Clock Dials and Figures.

**Caeser Bros.**—Manufacturers of Enameled Clock Dials, also letters and numbers for signs. 230 and 232 East 25th Street, New York.

#### Enamelers, Etc.

**Nutt, J. D.**—Enameler on Gold, Silver, and Copper. Linen finished Buttons and Studs. Enameling in colors. 32 and 34 John Street, New York.

**Orr, J. C.**—Enameler on Fine Jewelry. Enameled in Colors. Linen Finished Buttons and Studs. Band Bracelets. No. 75 Nassau Street, N. Y.

**Orr, William N.**—Enameler on Fine Jewelry. Masonic Jewels and Badges a specialty. Linen Finished Work. 79 Nassau Street, Room 18, New York.

#### Electroplaters, &c.

**Jeandheur, F. & Son,**—Gold and Silver Electro Platers & Fire Gilders, coloring Etruscan and Gold Jewelry a specialty. 125 Fulton St.

#### Engravers—Stone Seal, Etc.

**Fackner, Edward**—Carver, Engraver and Chaser on Jewelry and Pencil Cases, lettering, &c., 19 John Street.

**Holland & Gosling**—Stone Seal Engravers. Precious Stones inlaid and encrusted with Diamonds. No. 176 Broadway, New York, (fifth floor per elevator). Cameos cut and repaired.

**Knapp, Chas.** Engraver, Die Sinker & Stamper for Jewelry purposes. Ring Shanks & superior Band rings, 41 Maiden Lane, N. Y.

**Park, Wm.**—The Stone Seal Engraver. Arms, Crests, Monograms, etc., engraved on precious stones. 26 John Street, New York.

**Weston, James F.**—Stone Seal Engraver and inlaid of Precious Stones. Coats of Arms, Masonic, Odd Fellows, and other devices engraved. 32 John Street.

#### Fancy Goods, Clocks, Bronzes, Etc.

**Baker, Pratt & Co.**—Importers and Dealers in Jewelers' Fancy Goods. 19 Bond Street, N. Y.

**Hart, James H.**—Importer of French Clocks, Bronzes, Faïences and Porcelain Ware, and Dealer in Diamonds, Watches, Jewelry and Silver Plated Wares. 4 Maiden Lane, N. Y.

**Le Boutillier & Co.**—Importers of Fancy Goods, Clocks, Bronzes, &c., 3 Union Square.

**Straus, L. & Sons**—Importers of Pottery, Faïences, Bisque Figures and Rich Fancy Goods especially adapted for the Jewelry Trade. 40, 42 and 44 Warren Street, New York.

**Taylor & Bro.**—Importers of French Clocks, Bronzes, etc. 676 Broadway, N. Y.

#### Gold and Silver Cane Heads.

**Simons, Bro. & Co.**—Manufacturers of Gold Headed Canes. 611 and 613 Sansom street, Philadelphia.

#### Gold and Silver Plating, Etc.

**Bantle, A.**—Gold, Silver and Electro-Plating, 130 Fulton and 89 Nassau Streets, cor. Fulton Street, (Room 36), N. Y. Watch Case Polishing.

#### Gold Chains, Etc.

**Beck, J. & Son,** Manufacturers of Fine Gold Chains and Chain Bracelets, 10 Liberty Place, near Maiden Lane, N. Y.

**Carter, Sloan & Co.**—Manufacturers of Fine Gold Chain, 15 Maiden Lane, New York.

**Dorrance, Edge & Co.**—Manufacturers of the Celebrated Woven Fabric Gold Chain, No. 15 John Street.

**Kaufmann Bros.**—Manufacturers of Gold Chains, and Chain Bracelets, 26 John Street; Factory, 331 and 333 Bowery, N. Y.

**Kohn Alois & Co.**—Manufacturers of Gold Chains. 9 Maiden Lane, N. Y.

**Nordt, Charles.**—Successor to Nordt & Schlag, manufacturer of Gold Chains and Chain Bracelets. Jobbing and Refilling Old Chains promptly attended to. No. 17 Maiden Lane, N. Y.

**Saxton, Smith & Co.**—Manufacturers of Fine Gold Chain, No. 14 John Street, N. Y.

**Schlag, Chas.**—Late Nordt & Schlag, Manufacturer of Gold Chains, Chain Bracelets, and Fine Jewelry, 177 Broadway, N. Y.

**Smith, W. & Co.**—Manufacturers of Gold and Silver Chains, Jewelry, etc. No. 25 Maiden Lane, N. Y.

#### Gold Pens, Etc.

**Aikin, Lambert & Co.**—Manufacturers of Choice Gold Pens, Cases, Holders, Toothpicks, etc., 23 Maiden Lane, N. Y.

**Faber, Eberhard,**—Manufacturer of 16-karat Gold Pens and Pencil Cases, Nos. 718 and 720 Broadway, N. Y.

**Fairchild, Leroy W.**—Manufacturer of Gold Pens, Pencil Cases, Tooth Picks and Novelties in Charms. No. 18 John St., N. Y.

**Gerow, Joseph U.**—Manufacturer of Pencil and Pen Cases for the Jobbing Trade only. No. 44 State Street, (near South Ferry,) Brooklyn, N. Y.

**Johnson, E. S. & Co.**—Manufacturers of Gold Pens, Pen Holders and Pencils. Cor. Maiden Lane and Nassau Street, New York.

**Ray Manufacturing Co.**—Gold Pens Manufactured and Stamped for the Trade. Also Pencil and Pen Cases, Tooth-picks, etc. Office, Sales-rooms and Factories, 94 and 96 Nassau street, 129, 131 and 133 Fulton street.

**Smith, H. M. & Co.**—Manufacturers of Gold Pens and Holders, Tooth Picks, Pencils, etc. Sole Manufacturers of Sprague's Patent Gold Fountain Pen. Importers of Nickel and Silver Watches. 173 Broadway, New York.

#### Gold Rings.

**Barnet Bros. & Powell**—Manufacturers of Stone and Seal Rings, 15 John Street, New York. Factory, Newark, N. J.

**Bowden, J. B. & Co.**—Manufacturing Jeweler.—Solid Gold Rings a specialty, 1 Maiden Lane.

**Cable, Geo. W.**—Manufacturing Jeweler. Plain and Band Rings a Specialty. No. 104 Fulton Street, N. Y.

**Ely, W. H.**—Manufacturer of Solid Gold Rings of every description. No. 58 Nassau Street.

**Henrich, R.**—No. 35 Maiden Lane, Manufacturer of Gold Rings; also Patentee and Manufacturer of the Celebrated Self-Sizing Ring.

**Hutchison & Huestis**—Makers of Solid Gold Rings. Quality guaranteed. For the Jobbing Trade only. 196 Broadway, N. Y.

**Kroll, H.**—Manufacturing Jeweler. 78 Nassau Street, New York. Specialty: Solid Gold Stone Rings. All kinds of Fine Jewelry made to order, also Repairing for the Trade.

**Ostby & Barton**—Manufacturers of Plain and Engraved Solid Gold Band Rings. Office, 176 Broadway, N. Y. Factory, 80 Clifford Street, Providence, R. I.

**Peckham, Wm. H.**—Manufacturers of Solid Gold Seamless Rings, and Fancy Embossed Rings, Patent Spectacles, Jewelry, etc. No. 4 Liberty Place N. Y.

**Radler, K.**—Manufacturing Jeweler. Gold Rings and Lockets a specialty. No. 39 Maiden Lane, New York.

**Sauter, L.**—No. 1 Maiden Lane, New York, Manufacturer of Stone Rings of every description, as Diamond, Cameo, Onyx Turquoise, etc., Scarf Pins, Scarf Rings, Studs and Buttons.

**Shafer & Douglass.**—Manufacturers of all kinds of Seal, Stone, Turquoise, and fancy rings. No. 7 Maiden Lane, N. Y.



**Sinnock & Sherrill**—Manufacturers of Stone Rings. No. 3 Maiden Lane, N. Y.

**Thuerner & Church**—Manufacturers of Fine Gold Rings. No. 9 Maiden Lane, N. Y.

#### Hair Jewelry.

**Moutoux, Wm. E. & Co.**—Manufacturers of Fine Hair Mountings in Gold. Grand catalogues for the trade. 81 Nassau St., Rooms 1 and 2. Finest work and lowest prices

**Sauter, L.**—Manufacturer of Fine Gold and Hair Jewelry and Device Work. Pattern Book sent on application. No. 1 Maiden Lane, N. Y.

**Schwencke O.**—Manufacturer of Fine Hair Jewelry Orders from the country promptly attended to. No. 43 Maiden Lane.

#### Jewelry Cases, Fancy Boxes, Etc.

**American Morocco Case Co.**—7 and 9 Bond St., N. Y., make a specialty of Rich Jewelry and Silverware Cases for the fine Retail Trade. Also Improved Trays for Watches, Rings, etc.

**Bleyle, A.**—Manufacturer of Jewelry and Silverware Boxes, Jewelers' Traveling Cases, etc. Trays for Show Cases and Trunks, Ladies' and Gent's Jewel, Glove and Handkerchief Boxes, &c., &c., 80 Nassau street, N. Y.

**Braun, Chr. E.**—Manufacturer of Fine Jewelry Boxes and Trays for Show Cases and Trunks. No. 62 Chatham Street, New York. Trays for Show Cases and Trunks a Specialty.

**Bricka, C. A.**—Manufacturer of Morocco Cases for Cutlery, Silverware, Jewelry, etc. Sample Cards and Rolls. Cases in Rosewood, Black Walnut, etc. 52 Nassau Street, New York.

**Dennison Mfg Co.**—Manufacturers of Morocco, Plush and Velvet Jewelry and Silverware cases. New York, Boston, Philadelphia, Chicago, Cincinnati and St. Louis.

**Ettlinger, L. & Sons.**—Manufacturers of Fine Cases for Jewelry, Watches and Silverware. Trays for Travelers and Show Cases. Cases to Order a Specialty. No. 80 Nassau St., N. Y.

**Haensler, Chas. C.**—Manufacturer of Fine Morocco Cases for Jewelry and Silverware. Toilet Boxes, etc. Trays for Show Cases and Windows. 14 John Street, New York.

**Jackson, S. C.**, 180 Broadway, N. Y., Manufacturer of Fine Cases for Jewelry, Silverware, &c.

**Kohn, Solomon & Co.**—Manufacturers of Fine Morocco Cases for Jewelry, Watches, etc. 43 Maiden Lane, New York.

**Lauten, Edw. A. & Co.**—No. 4 Great Jones St., Manufacturers of Fine Velvet, Brocade, Plush and Morocco Boxes, Patent Ring, Ear Ring and Gent's Scarf Pin Trays, Patent Watch and Bracelet Blocks, Window Decorations, etc.

**Loehr & Koerner**—Manufacturers of Morocco, Velvet, Satin, Jewelry, Watches and Silverware Cases, Jewel, Work Boxes, etc., Fancy Trays and Store Fittings to order. 96 Liberty St.

**Metropolitan Fancy Box and Leather Goods Manufactory**—Makers of Plush, Velvet, Satin and Leather Cases for Watches, Jewelry, Silverware, etc. 75 and 77 Nassau Street, N. Y.

**New England Morocco Case Co.**—Makers of Jewelry and Silverware Cases of every description. 220 Chapel Street, New Haven, Conn.

**New York Morocco Case Co.**—Cases for Jewelry, Watches, Silverware. Boxes and Trays for Jewelers' Travelers. Show Cases and Window Fittings. No. 69 Nassau Street, New York.

**Schien, Charles E.**—Manufacturer of Cases for Jewelry and Silverware, No. 85 Nassau St., N. Y. Show Case Trays, etc., at short notice.

**Schwarz, N.**—Manufacturer of fine Cases for Jewelry and Silverware, 866 Broadway, near 17th street, N. Y.

**Steinle, E.**—Manufacturer of Cases for Jewelry of all kinds. Also Cases for Mathematical and Surgical Instruments and for Trays for Travelers' Trunks, etc. 66 Nassau Street, N. Y.

**Welch & Miller**—169 Broadway. Manufacturers of fine Morocco, Velvet, Russia, Brocade and Plush Jewelry Cases. Trays of every description; Jeweler's Cotton and Twine; Telescope Sample Cases with Flexible Trays. 169 Broadway, N. Y.

**Wiggers & Froelick**—No. 60 Nassau street—Manufacturers of Cases for Jewelry, &c., of every description. Trays for Show-cases, Stands for Show-windows, etc.

#### Jewelers' Findings.

**Dennison Mfg Co.**—Paper Jewelry Boxes, cards, tags, pink and white cotton, etc. etc. New York, Boston, Chicago, Cincinnati, Philadelphia, St. Louis.

**Ettlinger, L. & Sons.**—Manufacturers of Jewelers' Paper Boxes and Findings. Morocco Paper, Satin or Plush Lined Wooden Corner Stops Jewelry and Silverware Boxes. 80 Nassau Street, New York.

**Valfer, S. & Co.**—Manufacturers and Dealers in Jewelers' Boxes, Tags, Cards, Paper and Findings. Trays a specialty. Office and Salesroom, 66 Nassau street, New York.

#### Jewelry Manufacturers.

**Aikin, Lambert & Co.**—Manufacturers General stock of Reliable Jewelry, 23 Maiden Lane.

**Alford, C. G. & Co.**—Manufacturers. General line fine and Reliable Goods. Specialties in Onyx Goods and Chain. 200 Broadway, New York.

**Alling, Isaac A. & Co.**—Manufacturers of Fine Gold Jewelry. Sets, Lacc Pins, Ear Rings, Studs, Collar Buttons and Scarf Pins. Specialties: Wire Bracelets, Bangles, American Lever Sleeve Buttons. Bryant Building, Nassau and Liberty Streets, N. Y. Factory, Newark, N. J.

**Baldwin, Sexton & Peterson**—Makers of Fine Jewelry and Importers of Diamonds, etc., corner Broadway and Fourth Street.

**Ball, W. H.**—Manufacturer of Gold Jewelry. Bracelets and Bangles of all kinds a specialty. 9 John Street, N. Y.

**Barthman, Straat & Co.**—Manufacturers of Fine Jewelry. Roman Goods, Rings, Diamonds. No. 43 Maiden Lane.

**Brown, Thos. G. & Sons**—Man'rs of Rich Jewelry Necklaces, Locketts, Bracelets, Sleeve Buttons, etc., 5 Bond Street, N. Y.

**Bryant & Bentley**—Manufacturing Jewelers. Rings a specialty. 12 Maiden Lane

**Carter, Sloan & Co.**—Manufacturing Jewelers, 15 Maiden Lane, New York.

**Champerois & Co.**—No. 5 Maiden Lane, manufacturers of Engraved and Enameled Gold goods, in Sets, Ear Knobs, Bracelets, Studs, Lace and Shawl Pins, Jet cluster and Onyx goods, also "Best Lever" Sleeve Buttons.

**Chatellier, Joseph F.**—Manufacturing Jeweler, No. 694 Broadway, N. Y.

**Churchill, Lewis & Co.**—Manufacturers of Fine Jewelry. 692 Broadway, cor. Fourth St., N. Y.

**Cook, Groeschel & Co.**—Manufacturers of Fine Jewelry and Locketts, 191 Broadway (over Mercantile Bank,) N. Y.

**Cottle S. Co.**—Manufacturers of Fine Jewelry. Waltham Building, 5 Bond Street, N. Y.

**Cox & Sedgwick**—Manufacturers of fine Onyx and Colored Jewelry. 26 John St., New York

**Day & Clark**—Manufacturers of Fine Jewelry, Lace Pins, Ear Rings, Studs, Locketts, &c., 10 Maiden Lane, New York.

**Geoffroy, Arthur R. & Co.**—Manufacturing Jewelers. Novelties in Diamond Goods. No. 23 Maiden Lane, N. Y.

**Goddard, John M.**—Manufacturing Jeweler,—Seal Rings and Fine Locketts a specialty, No. 3 Maiden Lane, N. Y.

**Greason J. R. & Co.**—Successors to Arthur, Rumrill & Co., 182 Broadway. Manufacturers of Fine Jewelry and Gold Chains, also Diamond Mountings.

**Greene Wm. C. & Co.**—Goldsmiths; Manufacturers of Rich Sets in Taper Wire Coral. Office, 192 Broadway.

**Hale, S. W. & Co.**—Manufacturers Rich Jewelry, Whiting Building, Broadway and 4th Street.

**Hartmann, P.**—Manufacturer & Importer of Fine Gold, Diamond, and Filigree Silver Jewelry, No. 36 Maiden Lane. P. O. Box 2,454.

**Haskell, H. C.**—Manufacturing Jeweler. Seal Rings a specialty. Special attention to Jobbing of every description. 12 John street.

**Hedges, A. J. & Co.**—Manufacturing Jewelers, 6 Maiden Lane.

**Henderson & Winter**—Jewelers, No. 15 Maiden Lane, New York. Specialties—Stone, Cameo, Onyx, Amethyst, Topaz, Pearl and Turquoise Rings.

**Hunt & Owen.**—Manufacturing Jewelers. Office 3 Maiden Lane.

**Kennedy, Frank S.**—Manufacturer and Wholesale Dealer in Jewelry and Gold and Silver Thimbles. No. 13 Maiden Lane, New York.

**Krementz & Co.**—Manufacturing Jewelers, No. 182 Broadway, N. Y.

**Kuhn, Doerflinger & Co.**—Manufacturers of Enameled and Roman Band Bracelets, also Fine Locketts Pendants and Lace Pins. 18 John street.

**Miller Bros.**—Manufacturers of Fine Jewelry, Locketts, Sleeve Buttons, Studs, &c., 7 Maiden Lane, N. Y.

**Moore & Horton.**—11 Maiden Lane, Manufacturing Jewelers, Rings, Studs, Collars and Sleeve Buttons, Pins, Ear-rings, &c.

**Muhr's, H., Sons.**—Manufacturing Jewelers. Solid Gold and Filled Rings a specialty. Also Manufacturers of the celebrated Crown Filled Watch Case. 16 Maiden Lane, N. Y.

**Owen, G. & S. Co.**—Manufacturing Jewelers. Office, No. 3 Maiden Lane.

**Richardson, Enos & Co.**—Manufacturers of Fine Gold Jewelry, Gold Chains, Locketts, Crosses and Necklaces. Colored and Etruscan Work. No. 23 Maiden Lane, New York.

**Richardson, J. W. & Co.**—Manufacturers of Jewelry. Masonic and other Emblems. 106 Broadway, N. Y. Manufactory, Providence, R. I.

**Riley, J. A. & Co.**—Manufacturing Jewelers. Etruscan Gold and Roman Bracelets, Lace Pins, Ear Rings, Scarf Pins, Brooch Pins, etc. Nos. 7 and 9 Bond Street, N. Y.

**Ripley, Howland & Co.**—Manufacturers of Fine Jewelry and Platinum Tipped Diamond Settings. No. 17 Maiden Lane, N. Y.

**Sauter, L.**—Manufacturer of Fine Jewelry, Solid Stone Rings and Studs a specialty. Jobbing for the trade. 1 Maiden Lane, New York.

**Schwencke, Wm.**—Manufacturing and Jobbing Jeweler. Repairing a specialty. Orders promptly attended to. No. 43 Maiden Lane, N. Y.

**Sexton & Cole**—Manufacturing Jewelers, Colored Gold and Onyx Goods a specialty. No. 30 Maiden Lane.

**Shafer & Douglas,** Manufacturing Jewelers—Roman Goods, Lace Pins, Cameo Sets, etc., Stone Rings, etc. No. 7 Maiden Lane, N. Y.

**Sheafer, W. H. & Co.**—Manufacturing Jewelers, Specialty Bangles and Bracelets, 15 John St., N. Y.

**Steele, J. W.**—Successor to Brainerd, Steele & Co., Manufacturer of Fine Jewelry and Brainerd's Patent Locketts. No. 9 Maiden Lane, N. Y.

**Stites, D. H. & Son**—Manufacturers of Fine Jewelry, Rolled Plated Goods and Chains, Parisian Diamond Rings, Studs and Earrings a specialty. 41 Maiden Lane, N. Y.

**Stites' Sons, E.**—Manufacturers of Fine Jewelry. No. 14 John Street, N. Y.

**Street, Geo. O. & Sons.**—Established 1837. Makers of Fine Jewelry, strictly first-class goods of our own make. No. 15 John Street, New York.

**Terhune, Charles F.**—Manufacturing Jeweler, 194 Broadway, N. Y.

**Thoma, Ernest**—Manufacturer of Fine Jewelry. Sleeve Buttons, Rings, Ear-rings, &c. No. 173 Broadway, N. Y. Factory, Hackensack, N. J.

**Ward, Thos. M.**—Manufacturer of Fine Jewelry, Diamond Mountings a specialty. No. 25 John Street, N. Y.

**Wheeler, Parsons & Hays.**—Manufacturers of Fine Jewelry, Watch Cases, Gold Chains, &c. and Dealer in American and Swiss Watches, No. 2 Maiden Lane, N. Y.

**Wienhold, Joseph**—Manufacturer of Fine Jewelry Diamond Mountings a specialty. 24 John St.

**Woglom & Miller**—Manufacturers of Black Onyx Goods exclusively. 32 & 34 John Street, N. Y.



**Jewelry—Rolled Plate.**

- Frick, John & Co.**—Fine Rolled Plate Jewelry of all kinds. Repairing of every description. 21 and 23 Maiden Lane, N. Y.
- Mauran, J. T.**—Manufacturer of Fine Rolled Plate Jewelry, No. 15 Maiden Lane, N. Y.
- Richards, E. Ira & Co.**—Manufacturers of Fine Rolled Plate Jewelry, No. 200 Broadway, N. Y.
- Weil, Leopold & Co.**—Manufacturers of Rolled Plate Jewelry of every description, 35 Maiden Lane, N. Y.

**Jewelers' Tools, etc.**

- Fisher, James J.**—Dealer in Watchmakers' and Jewelers' Materials, Files, Tools, Silk Guards, Spectacles, etc., 697 Broadway, N. Y.
- Friedenthal, A. & Co.**—Importers and jobbers of Watchmakers' and Jewelers' Tools, Materials, etc. 43 Maiden Lane, N. Y.
- Friedlander, R. & L.**—Importers of Watchmakers' Tools and Materials. 65 & 67 Nassau Street. Branch Office, 264 Bowery.
- Kurtz, F. P.**—Manufacturer of Jewelers Machinery, Tools, Rolling Mills, Presses, Polishing Lathes, &c. 97 Cliff St., N. Y.
- Levy, Dreyfus & Co.**—Importers and Jobbers of Watchmakers' and Jewelers tools and materials of every description. 11 Maiden Lane, N. Y.
- Montgomery & Co.**—Importers of and Dealers in Manufacturing Jewelers' Tools and Materials of every description, 105 Fulton street, New York.
- Reichhelm & Koester.**—Importers of Jewelers' Tools, Files, etc. Manufacturers of Brushes and Buffing wheels; also Patent Gas Furnaces for Melting, Plating, Enamelling, Annealing, etc. 80 Nassau St., N. Y.

**Lapidaries.**

- Fox, M. & Co.**—Practical Lapidaries, No. 1 Maiden Lane, New York.
- Graham & Co.**—Practical Lapidaries, Cutters and Polishers of all kinds of Precious Stones. Miners' Relics Cut, Polished and Mounted. Miniature, Locket and Clock Glasses. 80 Nassau St., N. Y.
- Kordmann & Michel.**—Lapidaries. Dealers in Precious Stones. Cutting and Polishing Rubies, Sapphires and other Gems a specialty. Drilling done promptly. 59 Nassau St., N. Y.
- Korn, Ph.**—Lapidary. Importer of Precious and Imitation Stones, No. 63 Nassau street, between Maiden Lane and John street, New York.

**Masonic Jewelry.**

- Luther, John F.**—79 Nassau Street. Manufacturer of Fine Presentation Jewels for all Societies. Knights Templars, Crosses, Badges, &c.
- Popper, H.**—Manufacturer of Medals and Badges for Military, G. A. R., Shooting, Masonic, Odd Fellows, Knights of Pythias, etc. 91 Essex St., New York.
- Wilkinson, C. B.**—Manufacturing Jeweler, 8 John St., N. Y. Medals, Badges and Masonic Jewelry, a specialty. Designs furnished free upon application.

**Optical Goods.**

- Friedlander, R. & L.**—65 and 67 Nassau Street. Dealers in Optical Goods.

**Opticians.**

- Burbank Man'g Co.**—Manufacturers of Spectacles and Eye Glasses of all descriptions, in gold, silver, etc., 14 Maiden Lane, N. Y.
- DuBois, Geo. W. & Co.**—Importers of Watches and Optical Goods. 36 Maiden Lane, N. Y.
- Kahn, Hanover & Co.**—Importers of Spectacles, Eye-Glasses and Optical Goods generally, and Scientific Instruments of every description. 32 Maiden Lane, New York.
- Levy, Dreyfus & Co.**—Importers of Spectacles and Eye Glasses and Optical Instruments of every description, No. 11 Maiden Lane, N. Y.

**Lorsch, Albert**—Manufacturer of the Patent Accommodating Spectacles and Eye Glasses in Gold, Silver and Steel, and other Optical Goods, 37 Maiden Lane, N. Y.

**Spencer Optical Manufacturing Co.**—Gold, Silver, Steel, Nickel and Plated Spectacles; Gold, Celluloid, Steel, Nickel and Rubber Eye Glass and Opera Glasses. 13 Maiden Lane, N. Y.

**Paper Boxes.**

**Waterbury Paper and Box Co.**, 27 to 35 Canal St., Waterbury, Conn., Manufacture Jewelers' and Silversmiths' Fine Paper Boxes. Quality guaranteed to be equal to the best made.

**Precious Stones, &c.**

- Bishop, Victor & Co.**—33 Maiden Lane, Importers of Precious Stones, Cameos, &c. Also Manufacturers of Coral Jewelry.
- Bissinger, Philip & Co.**—Importer of Diamonds, Pearls and Precious Stones. Agent for the Bohemian Garnet Goods. Blue Enamelled Locket. No. 22 John St., N. Y.
- Breidenbach, R. A.**—Importer of Black Onyx, Cameos, Turquoise, Pearls, Sardonyx, Amethysts, Topaz, Garnets, Opals, Rubies, Sapphires, Cat's Eyes, Hematites, Brilliants, Doublets, etc. 85 Nassau St., N. Y.
- Daue, Wm. & Co.**—Importer of Precious and Imitation Stones. No. 202 Broadway New York.
- Fox, M. & Co.**—Importers of Diamonds and other Precious Stones, No. 1 Maiden Lane, N. Y.
- Gruet, Jules.**—Importer of all Grades of Real and Imitation Stones. 14 John St., N. Y.
- Guntzburger Bros.**—Manufacturers and importers of Precious Stones—Amethysts, Topaz, Cameos, Garnets, Imitation Diamonds, &c. No. 9 Maiden Lane.
- Hahn & Co.**—Importers of Precious Stones. Cameos, Onyx, Pearls, Intaglios, Amethysts, Garnets, etc. 64 Nassau Street, New York.
- Kahn, L. & M.**—Importers of precious and imitation stones. 10 Maiden Lane, N. Y.
- Kipling, E. E.**—Importer of Precious and Imitation Stones. Manufacturer of the Patent Foil Solid Metal Back Rhine Stone Brilliant. No. 6 Maiden Lane, N. Y.
- Kipling, R. A.**—Precious and Imitation Stones, No. 24 Maiden Lane, N. Y. Manufacturer Cameos, Agates, Onyx, Etc., Oberstein, Germany. Commission Merchant, 49 Rue De L'Echiquier, Paris.
- Tannenbaum, L. & Co.**—Importers of Diamonds and Precious Stones. Steam Lapidary Works. Oriental Stones Cut and Polished a specialty. 65 Nassau St., N. Y.

**Silverware.**

- Gorham Manufacturing Co.**—Union Square.
- Knowles, J. E. & S. M.**—Manufacturers of Sterling Silverware, 20 Maiden Lane, N. Y. Factory, Providence, R. I.
- Shiebler, Geo. W.**—Manufacturer of Sterling Silverware. No. 8 Liberty Place, near Maiden Lane, N. Y.
- Whiting Manufacturing Co.**—Makers of Sterling Silver Ware. Broadway cor. 4th Street, N. Y.
- Wood & Hughes.**—Manufacturers of Fine Silverware. 16 John Street, N. Y.

**Silver Filigree Jewelry.**

- Cuppia, L. A.**—Manufacturer of Solid Silver Novelties, and Importer of Silver Filigree, 19 Union Square.
- Hartmann, P.**—Manufacturer of Silver Filigree Jewelry. 36 Maiden Lane, N. Y.

**Silver Plated Ware.**

**Holmes, Booth & Haydens**—Manufacturers of Silver-Plated Ware. 47 Chambers Street.

**Manhattan Silver Plate Co.**—Manufacturers of Silver Plated Ware. Showrooms, 23 John St. Factory, 301 to 305 East 22d St., cor. 2d Ave. Address all communications to Factory.

**Middletown Plate Co.**—Manufacturers of Superior Electro-Plate. Factories, Middletown, Conn., salesroom, 13 John Street.

**Rogers & Bro.**—Manufacturers of the finest quality of Electro-Plated Ware. 690 Broadway.

**Rogers, Smith & Co.**—Manufacturers of Fine Electro Plated Ware. No. 46 E. 14th St., N. Y.

**Simpson, Hall, Miller & Co.**—Manufacturers of fine Silver-Plated Ware. No. 36 E. 14th Street.

**Schade, Henry.**—Manufacturer of White Metal and Plated Ware. Nos. 56 & 58 Ainslie Street, Brooklyn, E. D., N. Y. Price list and catalogue furnished on application.

**Webster, E. G. & Bro.**—Manufacturers of Fine Silver-Plated Ware. Office and warerooms, 14 Maiden Lane, N. Y.

**Show Cases, Etc.**

**Smith, B. & W. B.**—Manufacturers of Patent Improved Dust Proof Show Cases, with Perpendicular Sliding Doors, No. 220 W. 29th St., N. Y.

**Spectacle Case Manufacturers.**

- Bertine, P. D.**—Manufacturer of Spectacle and Eye-Glass Cases. 139 William Street, near Fulton St., New York.
- Koenen, A. & Bro.**—Manufacturers of Leather Spectacle and Eye-Glass Cases. 81 Nassau St., N. Y.

**Stem Winding Attachments.**

**Abbott, Henry** Maker of Stem Winding Attachments, No. 7 Maiden Lane, N. Y.

**Thermometers, Etc.**

**Tagliabue, Giuseppe.**—manufacturer of Thermometers, Barometers and Hydrometers. Patentee and sole manufacturer of the U. S. Standard Hydrometer. 302 Pearl Street, near Beekman.

**Thimble Manufacturers.**

- Barker Manuf'g Co.**—Makers of Patent Graduated Thimbles, Stiffened Gold, Filled Gold and Rolled Gold, 36 Maiden Lane, N. Y. A. Lyons, Ag't. Factory, 129 Eddy St., Providence, R. I.
- Burbank Manuf'g Co.**—Manufacturers of Gold and Silver Thimbles, 14 Maiden Lane, N. Y.
- Ketcham & McDougall.**—Improved Gold and Silver Thimbles, Bryant Building, N. Y.
- Simons Bro. & Co.**—Manufacturers of Gold and Silver Thimbles. 611 and 613 Sansom Street, Philadelphia.
- Woglom & Miller.**—Sole Agents for the "Prime" Thimbles in Gold and Silver, manufactured by Ezra C. Prime. 34 John Street, N. Y.

**Watch Companies.**

- American Watch Co.**—Robbins & Appleton, No. 5 Bond Street, N. Y.
- Lancaster Watch Co.**—Manufacturers of Watches. Lancaster, Pa.
- The E. Howard Watch and Clock Co.**—Cor. Maiden Lane and Nassau Street, N. Y.
- Waterbury Watch Co.**—Manufacturers of the Waterbury Watch. Factory, Waterbury. Office, 52 Maiden Lane, N. Y.

**Watch and Chronometer Jeweler.**

- Queen, James.**—Watch and Chronometer Jeweler and Pallet Maker, 78 Nassau Street, room 8. Pivots inserted in Pinions, Balance, Staffs, etc.
- Wennstrom, John.**—Watch, Chronometer and Clock Jeweling, Jewel Gauges, Ruby and Sapphire Draw Plates; Diamond Charged Polishing Stones for Jewel Settings; Pivots inserted in Pinions. 2 Dutch Street, N. Y.



**Watch Importers, Etc.**

- Abry, Chas. Leo**—Importer and Manufacturer of Swiss Watches of all grades. 63 Nassau Street.
- Aikin, Lambert & Co.**—Importers of Watches. Sole Agents for Paul Breton & Chas. Latour, Geneva. A general line of reliable Swiss Watches, Watch Cases, etc. 23 Maiden Lane, N. Y.
- Bartens & Rice**—20 John Street, Importers of Watches and sole agents in the United States for the celebrated Nicole, Nielsen & Co. Watches.
- Coss & Beguelin**—Importers of Watches, Watch Tools and Materials, dealers in American Watches, No. 21 Maiden Lane, N. Y.
- Droz, Henry E.**—Importer of Watches, and Watch Case Manufacturer. Agent for the "E. Perregaux" Watch, and jobber in American Watches No. 92 Fulton Street, N. Y.
- Durfey & Reynolds**—Successors to Durfey & Shiebler, Watches, Diamonds, Jewelry. No. 9 John Street, (up-stairs) New York.
- Freund Max & Co.**—Importers of Watches, Jewelry and Precious Stones, 8 Maiden Lane, N. Y.
- Gagnebin, Chas.**—Importer of all kinds of Swiss, and Dealer in American Watches. 4 Maiden Lane, N. Y. Agent for Ulysse Breting's Fine Chronometers, Chronographs, Anchors, &c.
- Gallet, Julien**—Importer of Watches. No. 1 Maiden Lane.
- Ginnel, Henry**—Importer of Watches, Tools and Materials, 31 Maiden Lane, N. Y. P. O. Box, 2967
- Herzog, Lou's & Co.**—Importers of Watches, Dealers in Diamonds and Jewelry, 52 Maiden Lane, N. Y.
- Hirsch Bros.**—Dealers in Watches and Diamonds and Manufacturers of Jewelry. No. 23 Maiden Lane, N. Y.
- Hyde's Sons, John E.**—Wholesale Commission Agents, only for Jules Jurgensen, of Copenhagen; Jules Monard, of Geneva; and for other makers of all qualities of Watches, 22 Maiden Lane.
- Jandorf, P. & Bro.**—Importers of Watches and Jewelry, 196 Broadway.
- Keller, L. H. & Co.**—Successors to G. A. Huguenin, Importers of Fine Watch and French Clock Materials, No. 64 Nassau Street, N. Y.
- Mathey Bros. & Mathez**—Importers of Fine Watches and Sole Agents for the **H. L. Matile's** Watches. No. 16 Maiden Lane.
- Oppenheimer Bros. & Veith**—Dealers in Watches and Diamonds, and Manufacturing Jewelers, No. 35 Maiden Lane.
- Robert, J. Eugene**—No. 30 Maiden Lane, New York. Agent for Louis Audemar's celebrated watches.
- Schwob, Adolphe**—Manufacturer and Importer of Watches, 11 Maiden Lane, N. Y.
- Stern Brothers & Co.**—Importers of Swiss Watches and wholesale dealers in American Watches, &c., 39 Maiden Lane.
- Scott, J. T. & Co.**—Importers of Watches, and Manufacturers of Jewelry, and Jobbers of all Grades of American Watches, 11 Maiden Lane.
- Strasburger, Louis & Co.**—Importers and Makers of Watches of every description, 15 Maiden Lane.

**Watch Cases.**

- Dueber Watch Case Mfg Co.**—Manufacturers of Gold and Silver Watch Cases. Bryant Building, N. Y. Factory, Newport, Ky.
- Duhme & Co.**—Manufacturers of Gold and Silver Watch Cases, Carlisle Block, Fourth and Walnut Streets, Cincinnati.
- Fahys, Joseph**—Manufacturer of Watch Cases and Dealer in American Movements, 38 Maiden Lane.
- Glatz, Chas.**—Manufacturer of Silver Watch Cases. Bryant Building, cor. Nassau and Liberty Sts.
- Keller & Untermeyer**—Manufacturers of Watch Cases with Raised Gold Ornaments. 9 Maiden Lane, N. Y.
- Ladd Watch Case Co.**—Manufacturers of the Ladd Patent Stiffened Gold Watch Cases, etc., 11 Maiden Lane, N. Y. Factory, 58 Eddy Street, Providence, R. I.

**Willemin Watch Case Co.**—Makers of Gold Watch Cases. Raised Gold Ornamentation and Jurgensen style of Engine Turning. 109 Sands Street, Brooklyn, N. Y. 16 Maiden Lane, N. Y.

**Watch and Chronometer Repairers.**

- Cerf, B.**—Practical Watchmaker and Repairer, No. 10 John Street, N. Y. Repairing and adjusting of Fine Watches done for the trade. All kinds of escape and stem-winding wheels cut to order.
- Heinrich, H. H. & Co.**—Sole Manufacturers of H. H. Heinrich's Patent Auxiliary Balance, and Adjusters and Repairers of Fine Watches and Chronometers. 12 John Street, N. Y.
- Lesperance, Theo.**—Watchmaker and Wheel Cutter. Also Stoning Nickel Movements. No. 1 Maiden Lane, New York. With Julien Gallet.
- Ludeman, W. H.**—Chronometer and Watch Maker. Repairing of every description for the trade, 75 and 77 Nassau Street.

**Watch Case Repairers.**

- Feinier, Joseph A.**—Watch Case Maker and General Repairer. Specialty in fine Gold and Silver Cases. Jobbing promptly attended to. Nos. 4 and 6 John St., N. Y.
- Tarbox, Hiram**—Watch Case Repairing, Springing, Polishing and Engine Turning. 1874 North Fourth Avenue, bet. 176th and 177th Sts., N. Y. Express Packages should be sent to 92 Fulton Street.

**Watch Glasses, Shades, Etc.**

- Brown, Edwin H.**—No. 85 Nassau Street, Imported and Own Manufacture Watch Glasses, Flat, Flat Concave, Concave, Convex and fine Genevas. Fine fitting solicited.

**Watches, Jewelry, etc.**

- Cohn, J. J.**—Importer and Manufacturer of Whitby Jet, Rubber and Pearl goods. Gold and Rolled-plate Jewelry, etc. 12 Maiden Lane, New York.
- Friedman, Saml.**—Wholesale Dealer in Watches and Jewelry, 42 Maiden Lane, N. Y.
- Fry & Schieber**—Manufacturers of Fine Gold and Plated Jewelry and Importers of Watches, 201 Broadway, N. Y.
- Lissauer & Sondheim**—Wholesale Jewelers and Jobbers in American Watches, No. 12 Maiden Lane, N. Y.
- Marx, Kossuth & Co.**—Importers of Watches and Dealers in Jewelry. 39 Maiden Lane, N. Y.
- Mayer, B.**—Manufacturer of Fine Jewelry, and Dealer in Watches, 71 Nassau street, cor. John street, New York.
- Myers, S. F. & Co.**—Manufacturing and Wholesale Jewelers—all grades. Importers of Watches. Illustrated Catalogue to the trade. 179 Broadway, N. Y.
- Smith & Knapp**—Wholesale Dealers in American and Swiss Watches, Diamonds, Gold and Plated Jewelry and Gold Chain. 182 Broadway, N. Y.
- Stern & Stern**—Dealers in Watches, Jewelry and Diamonds. No. 6 Maiden Lane, N. Y.
- Strauss, Jacob**—Full Line of Gold and Plated Jewelry, and Importer of Watches. 18 John Street, New York.
- Thrall, E. A.**—Wholesale Dealer in Watches and Jewelry. No. 1 Maiden Lane, N. Y.
- Trier Bros.**—Importers of Garnet, Whitby Jet and Amber Jewelry, Silk Guards, Opera, Field and Marine Glasses, Pearl Card Cases. Also a full line of Gold and Plated Jewelry. 15 Maiden Lane, N. Y.
- White, N. H.**—Jobber in American-Waltham Watches and Chronographs. Waltham make of 10-k., 14-k. and 18-k. Gold and Sterling Silver Cases; Filled Gold Cases. 11 Maiden Lane.

**Watch Tools, etc.**

- Keller, L. H. & Co.**—Importers of Watchmakers' and Jewelers' Tools, Materials, etc. 64 Nassau Street, N. Y.
- Zimmern, Henry**—Importer of Watch Materials, Tools, and Optical Goods, No. 8 Maiden Lane, (first floor.) Sole Agent for A. Huguenin & Gravier, Mainsprings, New York.

**PHILADELPHIA**

- Booz & Co.**—Manufacturers of Gold and Silver Watch Cases and Jewelry, 108 South 8th St., Philadelphia.
- Bennett, Jacob & Son**—Diamond Setters and Manufacturing Jewelers, 925 Chestnut St.
- Conover David F. & Co.**—American Watches. Wholesale Salesroom, Southeast corner 7th and Chestnut Streets, Philadelphia.
- Guilbert, Thos. M., & Co.**—Manufacturing Jewelers. Flexible Bracelets and Strung Pearl Repairing. 908 Chestnut St., Philadelphia.
- Herold, Chas P.**—Successor to Hildebrandt, Herold & Co., Manufacturing Jeweler and Diamond Setter. Diamonds. 916 Chestnut Street.
- Krieder, Peter L.**—Manufacturer of Sterling Silver Ware. 618 Chestnut Street, Philadelphia.
- McCarty & Hurlburt**—Manufacturers of Gold Spectacles, Silver Thimbles and Plain Rings. Wholesale dealers in American Watches, Jewelry, etc. 131 North Second Street.
- Morgan & Headly**—Manufacturing Jewelers, Cameo Sets, Gold Sets, Roman Locketts, Rings, Coral Sets and a general line of rich goods. Corner 10th and Chestnut Streets, Philadelphia.
- Muh's, H., Sons**—Manufacturing Jewelers. Solid Gold and Filled Rings a specialty. 633 and 635 Chestnut Street, Philadelphia. 1½ Maiden Lane, New York.
- Scherr, L. A. & Co.**—Wholesale Dealers in Watches Silver-Plated Ware, Spectacles, Fancy Goods, Watch Materials, etc. 726 Chestnut Street.
- Sheafer, W. H. & Co.**—Manufacturing Jewelers. Specialty: Band Bracelets. Factory, 612 and 614 Chestnut street, Philadelphia. Office, 15 John street, New York.
- Simons, Brother & Co.**—Manufacturers of Fine Jewelry, Canes, Thimbles, Chains. 611 and 613 Sansom Street.
- Vansant, John T. & Co.**—611 and 613 Sansom Street, Artisan Hall, Manufacturers and Wholesale Dealers in English Sterling Silverware. Specialties: Tea Sets, Knives, Forks, Spoons, Cups and Napkin Rings.

**CHICAGO.**

- American Watch Company**,—of Waltham, Mass. No. 102 State Street, Chicago.
- Clapp & Davies**—Wholesale Jewelers, 63 and 65 Washington Street. Catalogue and price list issued to watchmakers and jewelers.
- Dennison Manufacturing Co**—Manufacturers of Jewelers' Paper Boxes, Morocco Cases, Tags, Cards, Pink and White Cotton, Tissue Papers, Sealing Wax, &c., &c., 102 Madison St., Chicago, Boston, New York, St. Louis, and Philadelphia.
- Excelsior Sign Co.**—Manufacturers of (Grout's Excelsior) Iron Watch and Spectacle Signs. 124 Fifth Avenue, Chicago, Ills.
- Gilbert, Wm. L., Clock Co.**—Manufacturers of Clocks, Regulators, and Time Pieces, and Clock Material of every description, 54 and 56 Madison Street, Chicago.
- Giles, Bro. & Co.**—Manufacturers and Jobbers in Watches, all classes of Jewelry, Materials, Clocks, Silver Ware, &c. Illustrated catalogues furnished to dealers on application. 101 & 103 State St.
- Stein & Ellbogen**—Wholesale Dealers in Watches and Jewelry. 127 State Street, Chicago, Ill. Specialty, repairing for the trade.
- Wathier, Joseph P.**—Watchmakers and Jewelers for the trade, and Wholesale Dealers in Watch Materials, Tools, etc. 178 West Madison Street, Chicago, Ill. Send for price list.
- Wendell, Charles & Son**—Wholesale Watches, Jewelry, etc. 170 State street, Chicago.

**NEWARK.**

- Baker & Co.**—Gold, Silver and Platinum Refiners, Assayers and Sweep Smelters. 408 New Jersey Railroad Avenue, cor. Murray St., Newark, N. J.
- Diefenthaler Bros. & O'Donnell**—Manufacturers of Fine Jewelry, Lace Pins, Ear Rings and Patent Spring Bangles a Specialty. 36 Crawford Street, Newark, N. J.



**Felger, F. & F.**—Manufacturing Jewelers. Specialties:—Roman Band Bracelets, Lace Pins, Scarf Pins, Ball and Fancy Ear Rings. No. 477 Washington Street, Newark, N. J.

**Fiedler, Herrman**—Successor to Kurze & Fiedler, Engraver, Die Sinker and Press Tool Maker, 363 Market Street, Opposite Pennsylvania R. R. Depot, Newark, N. J.

**Glorieux, W. L.**—Assayer, Refiner and Sweep Smelter. 13 and 15 Franklin Street, Newark, N. J.

**Hopper & Valentine**—Manufacturers of Fine Jewelry, No. 8 Maple Place, Rear 44 Green St., Newark, N. J.

**Huger & Heitlinger**—Manufacturers to the Jobbing Trade only. Makers of Roman Stone, Engraved and Enameled Locketts, also Sets, Lace Pins and Ear Rings. Rear 477 Washington St.

**Krippendorf, C. & Schuller, F.**—Machinists and Jewelers' Tool Makers. 19 Greene Street, Newark, N. J. Rolls, Dies, Cutters, and Draw-plates of every Description made and repaired.

**Lefort, Henry.**—Stem-winding Watch Crown Manufacturer. 60 Arlington Street.

**Lelong, L. & Bro.**—Gold and Silver Refiners Assayers and Sweep Smelters, Southwest corner of Halsey and Marshall Streets, Newark, N. J.

**Miller & Beam.**—Manufacturers of Enameled Sets, Ear Rings, Lace Pins, etc. Guard Slides and Pendants a Specialty. 21 and 23 Green Street.

**Milne, Alex.**—Manufacturer of Stem-winding Watch Crowns. 19 Ward Street.

**Piomb & Marcus**—Manufacturers of Traveling and Marine Clocks, Electric Appliances. 289 Washington St., Newark, N. J.

**Pollock, T. H.**—Manufacturer of Jewelers' and Silversmiths' Wheel Brushes, Buffs, etc. No. 36 Crawford Street, Newark, N. J.

**Regad, E. D.**—Lapidary. Specialty—Sardonyx, Black Onyx and Agates. 14 Oliver St., Newark.

### PROVIDENCE

**Hutchison & Huestis**—Makers of Solid Gold Rings. Quality guaranteed. For the Jobbing Trade only. 185 Eddy Street, Providence, R. I.

**Lederer, S. & B.**—Manufacturers of Fire Gilt, Nickel, Electro and Silver Plated Chains, Necklaces, Charms, etc. Opera, Matinee and Guard Chains. 66 to 72 Stewart St., Providence, R. I.

**Pearce & Hoagland.**—Manufacturers of Gold Pens, Holders, Pencils, Tooth Picks, etc. Also the Quill Reserve Tooth Pick. 29 Point Street, Providence, R. I.

**Presbrey & Tuttle**—Manufacturers of a large variety of Fine Bracelet and Eye-Glass Chain in Gold Plate and Silver, Spring Rings, Holders, Hooks, Snaps, etc. 35 Point St., Providence, R. I.

**Serry Mfg. Co.**—Manufacturers of Fire Gilt, Nickel and Electro Plated Chains, Vest, Neck, Opera and Guard. 33 Beverly St., Providence, R. I.

**Smith, Wm. T.**—Assayer, Refiner and Sweep Smelter. Established 1855. Blackstone and Hawkins Streets, Providence, R. I.

**Taylor, Geo. H. & Co.**—Watchmakers and Wholesale Dealers in Watches, Clocks, Watch and Clock Material, Tools, Spectacles, Eye Glasses, &c. Particular attention given to trade work. 136 Westminster Street (Room 1), Providence, R. I.

### PAWTUCKET.

**Draper, J. O. & Co.**—Manufacturers of Jewelers' Pig Soap, adapted for Washing Jewelry, Scratch Brushing and Drawing Wire. Pawtucket, R. I.

**Fuller, Geo. H. & Son**—Jewelers' Findings, Gold, Silver, Gold Plated and Fire Gilt. Pin Stems, Joints, Catches, Split Rings, Chain Hooks and Swivels, Ear Wires, Chain Bars, etc. 99 Exchange Street, Pawtucket, R. I.

**Thayer, Ellis & Son**—Brush Manufacturers, and Wholesale Dealers in all kinds of Brushes. Sole manufacturers of Ellis Thayer's Patent Polishing Wheels. Manufacturing Jewelers' and Machine Brushes a Specialty. 80 North Main Street, Pawtucket, R. I.

**Thayer, P. E. & Co.**—Manufacturers of Brushes. Jewelry and Machine Brushes a Specialty. All kinds of Wire Scratch Brushes on hand. Orders by mail or otherwise promptly attended to. 34 East Avenue, Pawtucket, R. I.

### CINCINNATI.

**Hellebusch, Clemens**—Manufacturer, Importer and Wholesale Dealer in everything required by the Jewelry Trade. 77 W. Fourth St., Cincinnati, O.

**Lodwick & Nolting**—Wholesale Jewelers, S. W. cor. 4th & Walnut Streets, Cincinnati.

### BALTIMORE.

**Gruebel & Kesmodel**—Manufacturers of Fine Diamond Etruscan, Enameled, Plain and Rhine Stone Jewelry to order. Repairing a specialty. Orders by Mail solicited. 212 & 214 W. Baltimore St., Balto., Md.

### BOSTON.

**Boston Watch Case Co.**, makers of Watch Cases. Especial attention given to Repairing. 1, 3 & 5 Province Court, Boston, Mass.

**Boyce, E. J.**—Manufacturer of Solid Gold Jewelry. Rings a Specialty. 383 Washington St., Boston, Mass.

**Smith, Wm. A.**—Importer of Diamonds and Precious Stones. Diamonds mounted and unmounted and Diamond Mountings. 383 Washington St., Boston, Mass.

### BUFFALO.

**King & Eisele**—Manufacturers of Solid Gold Jewelry, and Agents for American and Foreign Watches; also Jobbers in Roll Plate Jewelry. Office and Salesrooms, 283 Main St. Factory, 2, 4, 6 and 8 Swan St.

**Oliver, W. W.**—Manufacturer of Hand and Power Rolling Mills for Jewelers and Silversmiths, 39 Clinton Street, Buffalo, N. Y.

### CLEVELAND.

**Chandler, J. M. & Co.**—Manufacturers of the Patent Embossed Bracelet and Jobbers in all kinds of Clocks, Watches, Jewelry, Tools, Materials, etc. 185 Superior St., Cleveland, O.

### NORTH ATTLEBORO.

**Whiting, F. M. & Co.**—Manufacturers of Sterling Silver Ware and Jewelry, North Attleboro, Mass.

### LANCASTER.

**Bowman & Musser**—Jobbers in Watches, Clocks, Chains, Fine Tools and Materials. 20 East Chestnut Street, Lancaster, Pa.

### PITTSBURGH.

**Goddard, Hill & Co.**—Wholesale Dealers in American Watches, Jewelry, Silverware, Clocks, Materials, &c., 43 Fifth Avenue, Pittsburgh, Pa.

### SPRINGFIELD.

**Bullock, O. W.**—Springfield, Mass. Manufacturer of Fine Nickel Plated Watch and Jewelry Tools, Keys, and Light Metallic Goods.

### CANADA.

**Ellis, P. W. & Co.**, No. 31 King street, East Toronto, Ontario, Manufacturing Jewelers, Watchmakers, importers and Jobbers of Watchmakers, and Jewelers' Tools, Materials, General Supplies and American Jewelry. Correspondence solicited with manufacturers of Novelties or specialties in American Tools and Jewelry.

**POSITIVELY NO GOODS RETAILED.**

**BOWMAN & MUSSER,**

SUCCESSORS TO

**E. F. BOWMAN,**

JOBBERS IN

**Watches, Clocks, Chains,**

Fine Tools and Materials,

**20 E. CHESTNUT STREET,**

Cpp. P. R. R. Passenger Depot,

**LANCASTER, PA.**

Selection Packages sent to Regular Jewelers on Request.

**BARNES' No. 4 LATHE,**  
For the Heavier Work of Jewelers.

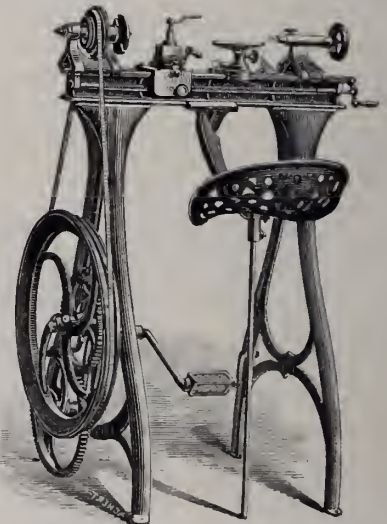

Barnes' Patent Foot and Steam Power Machinery. Complete outfits for Actual Workshop Business. Lathes for wood or metal. Circular Saws, Scroll Saws, Formers, Mortisers, Tenoners, etc., etc. Machines on trial if desired. Descriptive Catalogue and Price List Free.

**W. F. & JOHN BARNES,**  
2088 Main Street, ROCKFORD, ILL.



**SOLID GOLD**

AND

**STONE INLAID**

**Cigar Cutter,**

Pat'd Oct. 5, 1880.

**J. WIENHOLD,**

Manufacturer of FINE JEWELRY.

DIAMOND MOUNTINGS A SPECIALTY.

24 John St., N. Y. City.





CROSSCUP & WEST - PHILA

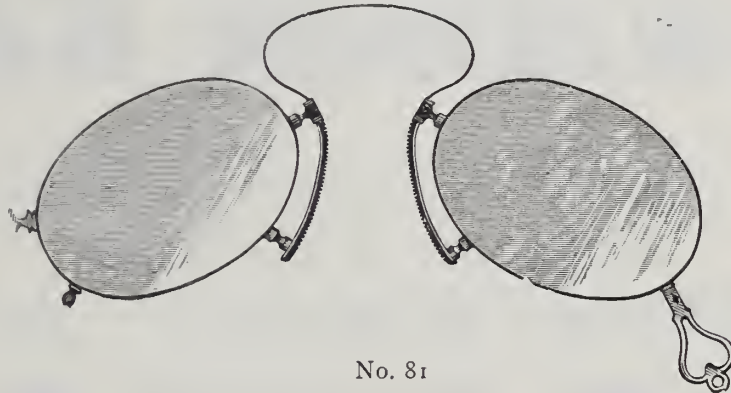

No. 81



# MORGAN & HEADLY,

MANUFACTURERS OF GOLD, SILVER AND STEEL

## Spectacles & Eye-Glasses.

### OUR TRADE GROWS APACE.

*We are constantly improving our patterns and machinery and educating our employees, thereby advancing the standard of our business.*

*The coming season will prove us to be still going ahead in our Special Line. With more extensive stock and facilities, and everything advanced except prices, which are uniformly low, we invite a continuance of your patronage.*



WATCH CASES.

SOLID GOLD,  
FILLED GOLD,  
COIN SILVER,  
NICKEL.

WATCH MOVEMENTS.

ELGIN,  
SPRINGFIELD,  
WALTHAM,  
TROY.

**DIAMOND JEWELRY.**

UNIQUE PATTERNS  
OF  
Rings, Lace Pins, Ear Rings,  
Studs, Collar Buttons,  
Etc.

ESTABLISHED 1866.

**LISSAUER & SONDHEIM**

MANUFACTURERS, IMPORTERS, JOBBERS,

**12 MAIDEN LANE,**

(P. O. Box 2516.)

**NEW YORK.**

REPRESENTED ON THE ROAD BY

Mr. A. Krailsheimer, Mr. M. Lissauer, Mr. M. Daniel,  
Mr. D. H. Lowman, Mr. G. Silberberg, Mr. I. Smith.  
Mr. E. M. Bracher.

**SPECIALTIES:**

A COMPLETE LINE OF  
"DUEBER" WATCH CASES

In Gold, Silver and Rolled Plate, and

"L. & S." 14 Kt. Ladies' Cases,  
With Raised Gold Ornamentation.

GOODS SENT on Selection to RESPONSIBLE JEWELERS.

Solid Gold Jewelry.

RINGS,  
LOCKETS,  
BRACELETS,  
BUTTONS, ETC.

Rolled Plate Jew. lry.

CHAINS,  
CHARMS,  
BANGLES,  
NECKLACES, ETC.

PRICE LISTS UPON APPLICATION, TO THE TRADE ONLY.



# WATERBURY CLOCK CO.,

MANUFACTURERS OF

## CLOCKS,

Novelties & Materials,

No. 10 CORTLANDT ST., N. Y.

— AND —

No. 63 WASHINGTON ST., CHICAGO.

Factories, **WATERBURY, CONN.**

M. BAILEY, Treasurer.



STANHOPE.

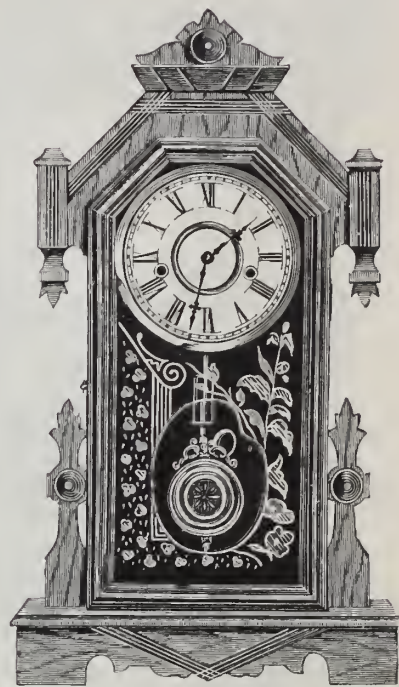

MINSTER.



REGULATOR No. 4.

# THE ANSONIA CLOCK CO.

## HANGING CLOCKS AND MANTEL CLOCKS

### OF EVERY DESCRIPTION.

A LARGE AND COMPLETE STOCK OF

Tower Clocks } **HANGING AND STANDING** } Street Clocks  
**REGULATORS**  
 AT LOW PRICES.

CHICAGO,

64 Washington St.

NEW YORK,

11 to 19 Cliff St.

LONDON,

128 Minories.



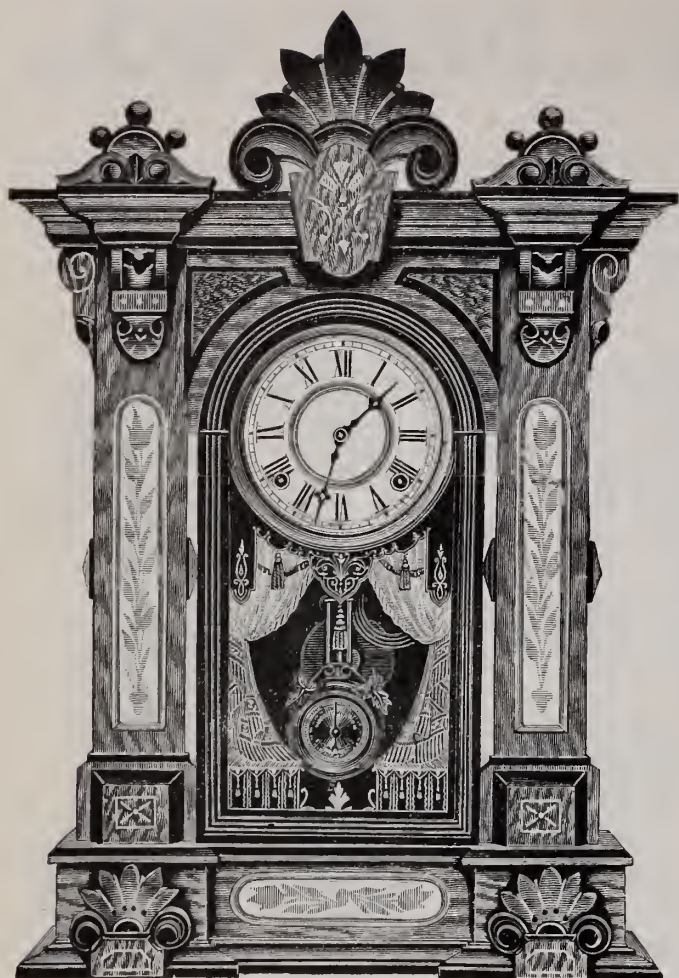

"AMPHION."—Walnut.

Cut Glass Mirror Panels in Side and Base. Improved Equalizing, Adjustable, Slow Strike Movement. Eight Day Strike on Gong only. Height, 25 inches. 6 inch Dial.

# W. L. Gilbert Clock Co.

GEORGE B. OWEN, General Manager.

Salesrooms :

No. 6 Murray St., N. Y.  
54 & 56 Madison St., Chicago.

Factories :

WINSTED,  
Conn.

MANUFACTURERS OF

Walnut, Veneered and Other Clocks.

IMPORTERS OF

Marble and Cuckoo Clocks.

*Catalogue and Price List Furnished upon application.*

# E. N. WELCH MANUFACTURING CO.

AND

## WELCH, SPRING & CO.,

6 Warren Street,

New York, U. S. A.

W. H. ATWATER, Agent.

MANUFACTURERS OF

# SUPERIOR AMERICAN CLOCKS & REGULATORS.

IMPORTERS OF

## FINE FRENCH CLOCKS.

CHICAGO,  
SAN FRANCISCO.

CHINA AND JAPAN.

LONDON,  
GLASGOW.

Factories, FORESTVILLE, CONN., U. S. A.



# ROGERS & BROTHER,

No. 690 BROADWAY,

WORKS AT  
WATERBURY, CONN. }

**NEW YORK.**

Invite Dealers to Inspect their FULL Line of STAPLES and NOVELTIES in

## ELECTRO SILVER PLATED WARE

made for the present Fall and Holiday Season.

Price List on receipt of Business Card from Jewelers.

# NICHOLAS MULLER'S SONS,

117 CHAMBERS STREET, NEW YORK.

MANUFACTURERS OF

## Fine Clocks and Ornamental Bronzes.



New Regulating Attachment (Patented).

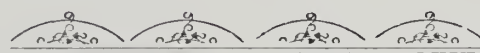

BRASS AND BRONZE

Fancy Goods

—FOR THE—

JEWELRY TRADE.

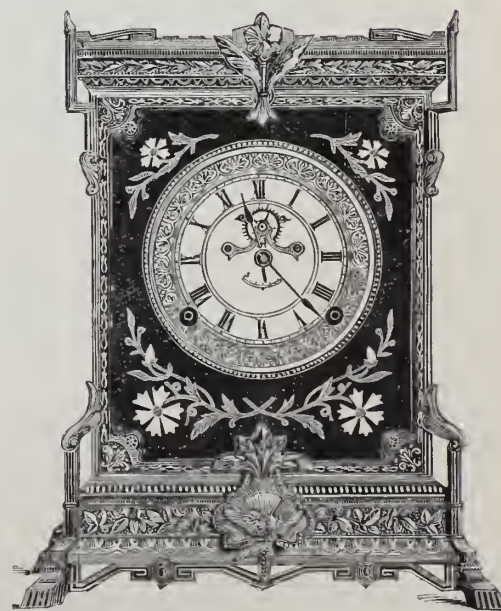

"ROYAL," Embroidered Satin and Bronze.



LOUIS STRASBURGER & CO.

DIRECT IMPORTERS OF

WATCHES AND DIAMONDS,

WE MAKE EVERY KIND  
OF WATCH IN  
OUR OWN  
FACTORY.

WE GET THE ROUGH  
DIRECT AND CUT  
OUR OWN  
GOODS.

No. 15 MAIDEN LANE,

→NEWYORK←

Rue Leopold Robert,  
CHAUX-DE-FONDS.



Boulevard Haussman, 30,  
PARIS.



# THE MIDDLETOWN PLATE COMP'Y,

Factories, MIDDLETOWN, CONN.

→ SALESROOMS →

13 JOHN ST., NEW YORK.

120 SUTTER ST., SAN FRANCISCO.



No. 1051, Tea Set, Slop Bowl and Cream,  
 Gold Lined, - - - \$68.00  
 Waiter, 24 inch, to match, - 50.00  
 " Urn, - - - - 36.00

No. 1051, Butter Dish, - - - \$9.50  
 " Syrup Cup and Plate, - 9.00  
 " Spoon Holder, Gold Lined, - 8.00

Offer to the Trade a **LARGER** Assortment than ever, for Fall of 1883, of Elegant New Designs in Electro-Plate, finished in Plain Burnished Surface, (with Elegant Borders), Satin, Hammered, Fancy Gilt, New Satin, Etc., Etc.

**A LARGE LINE OF GOODS IN RUSSIAN GOLD.**



“THE BEST”

# THE DUEBER

## GOLD WATCH CASES.



£ 91907.



591897.



591906.

*Quality Guaranteed as per following U. S. Registered Trade Marks:*



Trade Mark for 14-K. Gold Cases.



Trade Mark for 18-K. Gold Cases.



Trade Mark for 10-K. Gold Cases.

We use but Three Qualities of Gold—18-K., 14-K., and 10-K ;—use no Trade Mark or Stamp but our own; and invite inspection of Finish and Workmanship in every particular.

# The Dueber Watch Case Mfg. Co.

•CHICAGO,•

•CINCINNATI,•

•NEW YORK,•

4 Tribune Building.

P. O. Box 1334.

20 Bryant Building.



# THE BEST THE DUEBER COIN SILVER WATCH CASES

WITH

Solid Soldered Edges and Joint Bearings Throughout.

For Twenty Years, as to-day, the Leading Watch Case in the American Market.

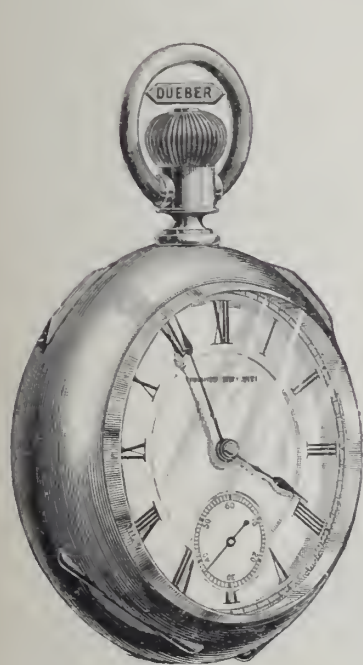

381842—Full Bassine Style.



Pat. July 6th, 1880. No. 229,681.

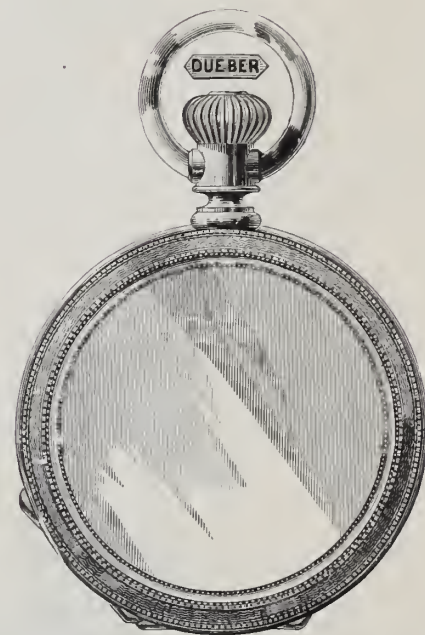

381888—Bourbon Style, with Gold Crown.

Their Equal in Construction, Finish or Intrinsic Value has never been Produced.

THE DUEBER WATCH CASE MFG. CO.

4 Tribune Building, Chicago.

Box 1334, Cincinnati, Ohio.

20 Bryant Building, New York.



# THE "PRINCESS" RING.



DESIGN  
PATENTED  
No. 1647  
14 K. fine.

## THE "PRINCESS"

Ring, now so well and favorably known to the Trade, is a RAISED INITIAL GLOVE RING, and the design is protected by LETTERS PATENT.

These goods are stamped

"PATENTED APRIL 3, '83."

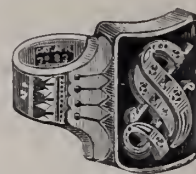

No. 1634  
14 K. fine.



14 K. FINE  
No. 1757

Any firm or person Making, Buying, Selling or having in their possession a Ring of this description, unless

STAMPED AS ABOVE, will be prosecuted.



14 K. FINE  
1780

A Raised Initial on a Flat Surface is NOT a Glove Ring, nor is it technically known or regarded as such by the Trade.



No. 1828  
14 K. fine.

A Raised Initial on a Curved Stone IS a Glove Ring, and is the "Princess" Ring, on which there is a Design Patent.

A Ring  
FOR THE  
HOLIDAYS



No. 2032

The Quality of Gold contained in the "Princess" Ring is

GUARANTEED AS STAMPED, and the workmanship and finish is unsurpassed.



No. 2125

An  
Appropriate  
Birthday  
Present.



No. 2028

## THE "PRINCESS"

Raised Diamond Initial Glove Ring has achieved a great popularity in the Trade, and is universally acknowledged to be the BEST SELLING Initial RING made.



PATENTED  
1853

FOR SALE BY THE WHOLESALE JEWELERS OF THE UNITED STATES.



**STERN & STERN,**

MANUFACTURERS,

JOBBER,

AND IMPORTERS OF

# JEWELRY, WATCHES & DIAMONDS,

## NO. 6 MAIDEN LANE, N. Y.

*We offer this season one of the Largest, Most Complete and Varied Stock of*

# JEWELRY,

*mounted in 14 k. and 10 k. Gold, and the Best Grade of Roll Plate Goods made, comprising the Newest and Most Desirable Designs.*

RINGS, BRACELETS, CHAINS, LOCKETS, CHARMS,  
SETS, EAR RINGS, LACE PINS, BUTTONS, STUDS,  
GOLD AND SILVER THIMBLES, Etc., Etc.

# WATCHES.

*We are Sole Agents for the Celebrated "Manhattan" and "Lady Washington" Movements, fitting American Cases,*

AND THE CELEBRATED

## S. S. MELVILLE WATCHES,

*universally acknowledged by our Southern Trade to be the Best Swiss Watch for the money made. Cased in 2 and 3 oz. Silver Cases, Key and Stem Wind*

AND

Jobbers in all the Leading American Movements and Cases.

# DIAMONDS.

*In this Department our Stock is UNUSUALLY LARGE and COMPLETE, consisting of Rich and Elegant Designs in Rings, Lace Pins and Ear Rings, as well as Loose Stones.*

Goods Sent on Approval, and Prompt Attention Given to Orders and Repairs.

**STERN & STERN,**

NO. 6 MAIDEN LANE.



# JOSEPH FAHYS & CO.,

MANUFACTURERS OF

## WATCH CASES,

38 Maiden Lane, NEW YORK.

78 MONROE STREET, CHICAGO.



654321



654322



654323



654324



654326



654325

Electrotypes of any of the above cuts, for advertising purposes, will be furnished the Trade, free of charge, upon application.



THE  
 BROOKLYN WATCH CASE CO.  
 EAGLE CASE.



In order to meet an imperative and growing demand in the Trade for a reliable grade of Low Karat Cases, this Company, seven years ago, was induced to place upon the market their since Celebrated **EAGLE CASES**, which are made of full 8-k. gold in all their parts, joints and bearings, the backs and caps free from solder, saving that which holds the joints. Since their introduction, these cases have achieved a wide spread reputation for the reliable and standard quality maintained in their manufacture. It has been demonstrated that the wearing qualities of the **EAGLE CASES** are unexcelled by any 12-k. case in the market, while their color is permanent and the appearance equal to that of the best cases made of this grade. The 8-k. **EAGLE CASES** will stand the severest acid test and will not tarnish when exposed in the show case or worn in the pocket.

All these goods are Stamped in the Cap with the Trade Mark of the Company,

B. W. C. Co.

and are guaranteed to be of the uniform standard designated.

A LARGE AND WELL ASSORTED STOCK OF 18-K., 14-K. AND EAGLE CASES IN THE LATEST AND MOST ARTISTIC DESIGNS, KEPT CONSTANTLY ON HAND.

For Sale by all the Principal Jobbers.



# DAVID F. CONOVER & CO.

(SUCCESSORS TO WM. B. WARNE & Co.)

Manufacturers and Wholesale Dealers in

## WATCHES and JEWELRY.

Wholesale Agents For

### Rogers & Brother's Flat and Hollow Ware



### Celluloid Eye-Glasses.

And Sole Agents for the

Patent Railroad Train Watch Chains, Nickel.

WHOLESALE AGENTS FOR

T. A. WILLSON & CO.'S Optical Goods.

Would invite attention to the following new grades of Steel Spectacles lately introduced in the market.

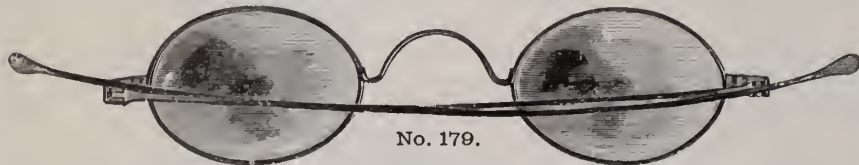

No. 179.

They are Steel, Full Tempered. Parts Interchangeable. Joints so constructed that wear is compensated for. Temple will not work loose and fall down as in old style joints. Nose-piece on No. 155 reinforced where it joins eye, giving extra strength with neatness.

PRIZE MEDALS AT ALL EXHIBITIONS WHERE EXHIBITED.

Patented July 31, 1877.

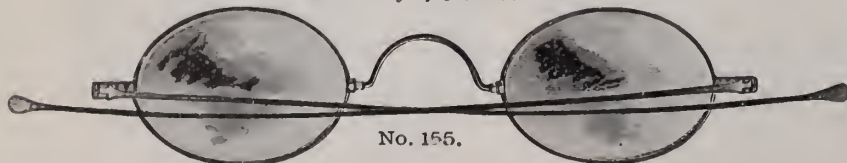

No. 155.

American Watch Wholesale Salesroom:

Southeast Cor. Chestnut and Seventh Sts., First Floor,

**PHILADELPHIA.**

DAVID F. CONOVER,  
C. FRANK WILLIAMS  
B. EDGAR RIGTER.

### A SPECTACLE TEMPLE

THAT WILL

**NOT WEAR LOOSE.**

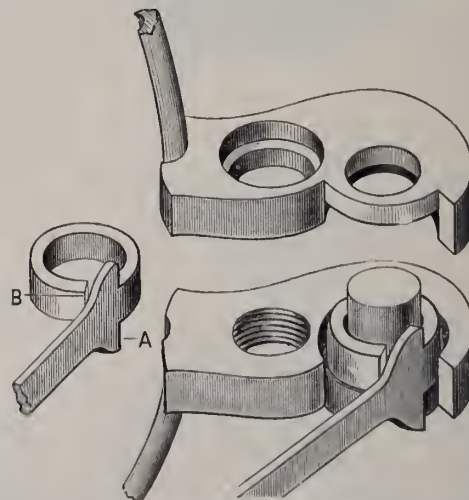

Patented May 13th, 1879. Re-issued June 8th, 1880.

- A.—Stop for Temple, preventing Strain on Joint.
- B.—Compensating eye, for taking up wear of joint. The eye of Temple is smaller than Stubb Steel Joint Pin on which it works, and is left open at B, exerting a Spring Tension on Pin.



## SHAKSPEARE—NEW VERSION.

*Oberon.* \* \* \* \* "And be thou here again, ere the leviathan  
Can swim a league."

*Puck.* "I'll put a girdle round about the earth in forty minutes,"  
*Following THE AMERICAN LEVER SLEEVE BUTTON,*  
*Which always leads!*

THE AMERICAN LEVER



BEST IN THE WORLD



TRADE MARK.

TO THE RETAIL TRADE.

Please ask your Jobber for the goods bearing the *FAMOUS HORSE-SHOE AND CLOVER TRADE-MARK*, and if he should decline to furnish them, kindly write to "*THE MANUFACTURERS OF THE AMERICAN LEVER BUTTONS, PROVIDENCE, R. I.*," who will send the address of Jobbing Houses from whom these *Celebrated Goods* can be purchased.



# Derby Silver Co.'s Celebrated Wares,

Original and Novel Designs for the Fall Season of 1883.

SALESROOMS:

25 MAIDEN LANE,  
170 STATE STREET,

New York.

Chicago.



Main Factories at BIRMINGHAM, CONN.

Where all Communications should be Addressed.

CANADIAN BRANCH FACTORY:

No. 31 Adelaide Street East, Toronto, Ont.



On or about September 1st shall open our New Salesroom,

No. 3 UNION SQUARE, NEW YORK.



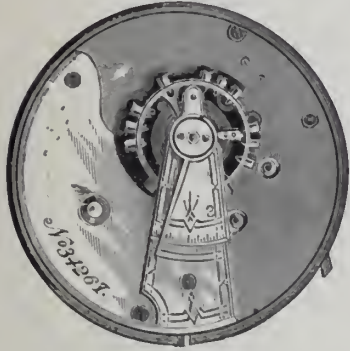
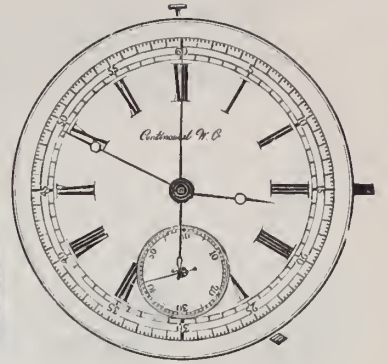
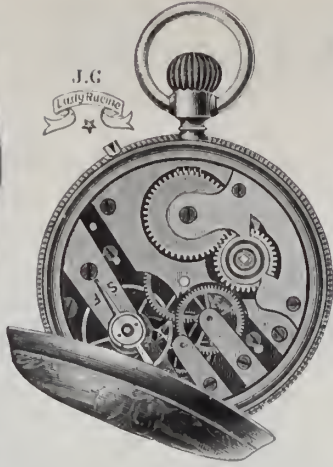

# CONTINENTAL WATCH CO. MOVEMENTS

6, 8, 10, 16 & 18 Sizes.



Fitting Waltham and Elgin Cases, and are the Most Reliable Movements in the market.

For Sale by all the Leading Jobbers in the Country.



Would call the attention of the Trade to our Eureka, Lady Racine, Railroad Regulator and Continental Watches, in Silver and Nickel Cases in all sizes.

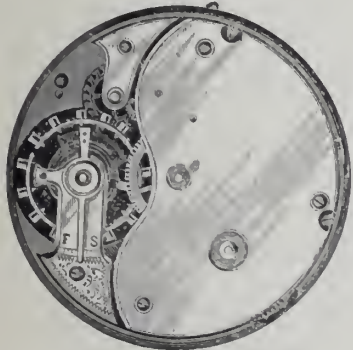
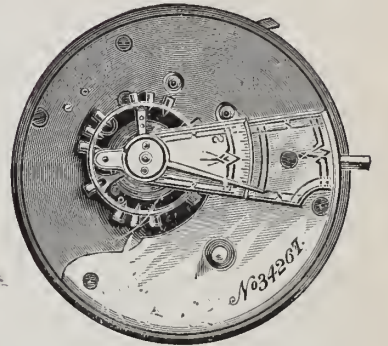

## JULIEN GALLET & CO.,

No. 1 MAIDEN LANE, NEW YORK.

SOLE AGENCY FOR THE CELEBRATED JAMES NARDIN WATCHES.

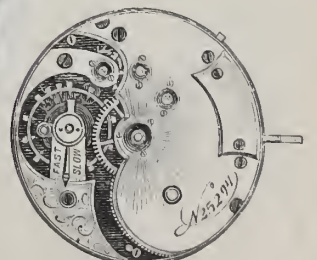
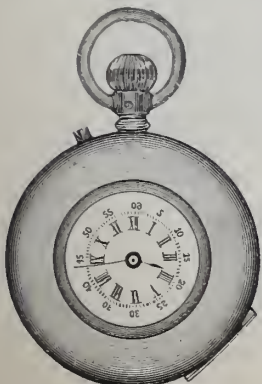
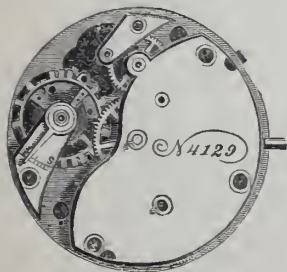
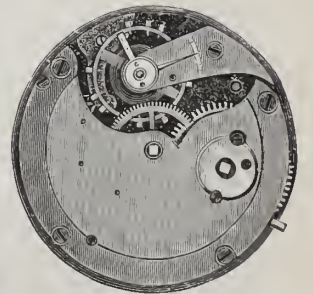
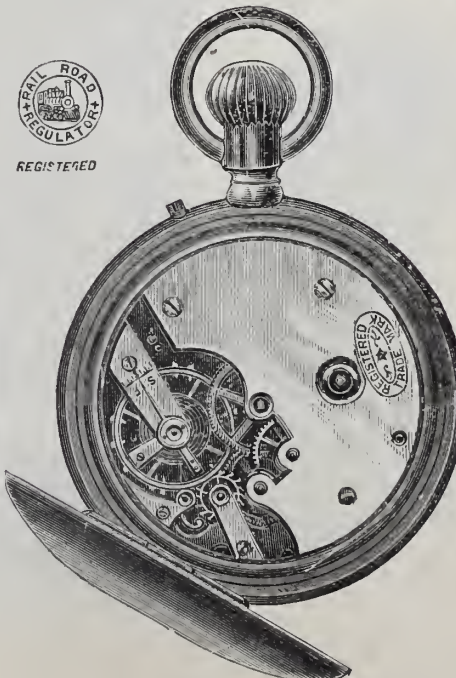
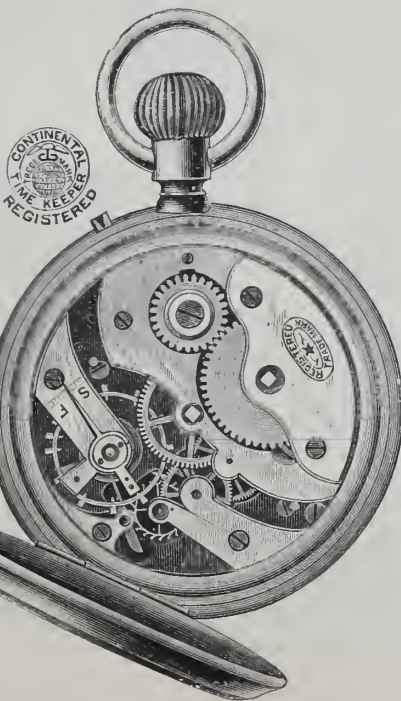
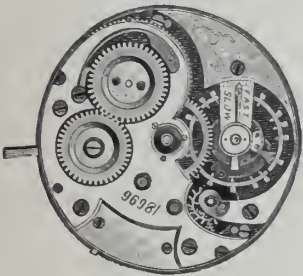
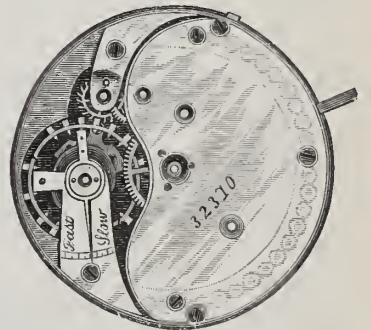



# SIMPSON, HALL, MILLER & CO.,

36 E. 14TH. ST., UNION SQUARE, N. Y.      FACTORIES, WALLINGFORD, CONN.

EXTENSIVE MANUFACTURERS OF

## Highest Quality of Artistic and Useful Silver Electro-plated Hollow-Ware.

BRANCH FACTORY, MONTREAL, CANADA.

AGENCIES: Philadelphia, Baltimore, Cincinnati, Chicago, San Francisco, Australia, Etc.

Excelling by no manufacturers in the United States in facilities for the production of Fine Goods. Spoons and Forks sold by Simpson, Hall, Miller & Co., Wallingford, Conn., bearing my individual name, to authenticate the quality, are all made in their Factories, of Finest Nickel Silver, under my personal supervision, and by my ideas of Style, Pattern and Finish, and control of quality.

The patterns are made exclusively by them and patented, and are the Highest Quality Goods in market.



My individual name, Wallingford, Conn., is a positive guarantee of the quality of the goods, and in buying them the Trade do so upon my personal guarantee of quality.

WM. ROGERS, PERSONALLY,

Since May, 1878, with SIMPSON, HALL, MILLER & Co., Wallingford, Conn.



# MERIDEN BRITANNIA CO.,

MANUFACTURERS OF

## ELECTRO GOLD AND SILVER PLATED WARE.

SALESROOMS:

46 East 14th Street, Union Square, N. Y.  
Canada Branch, Hamilton, Ont.

And at the Manufactory, Meriden, Conn.

145 State Street, Chicago.  
134 Sutter Street, San Francisco.

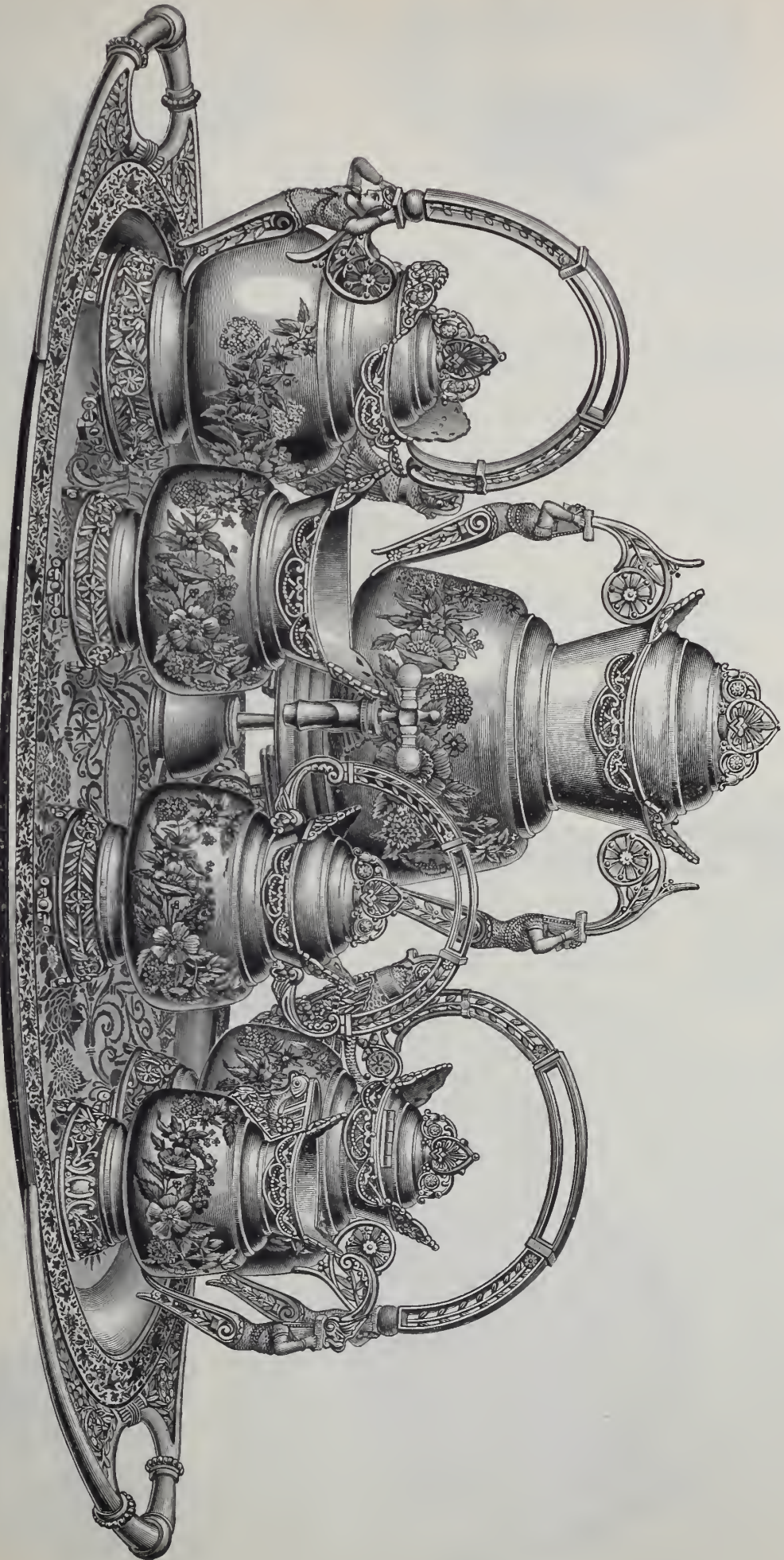

No. 1953. TEA SET.



# THE VERY LATEST!



Closed.



Open.



Closed.

PATENT APPLIED FOR.

MADE ONLY IN 14 KARAT.

*The above Cuts represent my new*

## Combination Vinaigrette Ring,

MADE IN A LARGE VARIETY OF NOVEL DESIGNS.

This Ring enables the wearer to dispense with the Scent Bottle.

Just the thing for HOLIDAY and BIRTHDAY PRESENTS.

Must be seen to be appreciated.

Bound to be a UNIVERSAL FAVORITE.

Please apply for Samples on Selection, as my travelers do not carry stock.

MANUFACTURED AND SOLD BY

ADOLPH GOLDSMITH, 38 Maiden Lane.

N. B.—This Patent is applicable to almost every design, and any special pattern will be made to order upon request.

# ADOLPH GOLDSMITH,

SOLE AGENT FOR THE

## RELIANCE WATCH COMPANY,

38 MAIDEN LANE,

NEW YORK.

FULL LINE OF

Gold and Plated Jewelry.

EVERY DESCRIPTION OF

SWISS WATCHES

A SPECIALTY.



"RELIANCE,"  
18 Size, to Fit Waltham Cases.



"RELIANCE,"  
Nickel Stem Winder in all Sizes.



"RELIANCE,"  
Ladies' 8 Size, to Fit Waltham Cases.



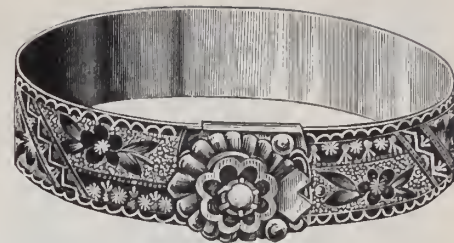
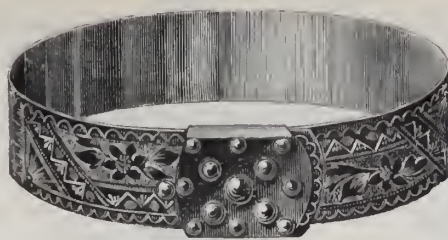

**J. M. CHANDLER & CO.,  
MANUFACTURING JEWELERS.**

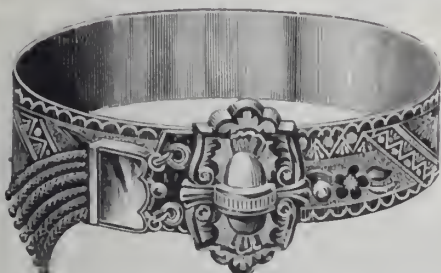

We especially call the attention of the Trade to our new Patent Band Bracelet Catch. The design of the Catch is to make a Band Bracelet adjustable to any size without the slightest difficulty—leaving the band clean and smooth, and make a secure fastening. These goods are pronounced by all who have seen them to be the *Ne Plus Ultra* of all Band Bracelets. The goods must be seen to be appreciated. We will send Selection Package of these goods to the Regular Trade.

**J. M. CHANDLER & CO.**

Manufactured at our own Factory, 111 Broad Street, Providence, R. I.

Office and Salesroom, 185 Superior Street, Cleveland, Ohio.

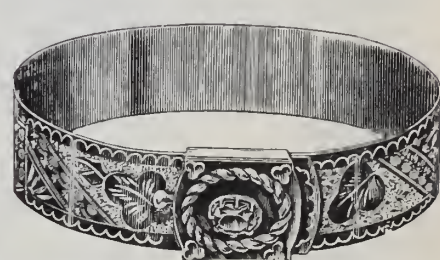
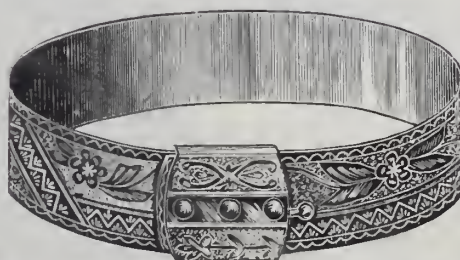

**TXB**  
TRADE MARK

OUR RINGS ARE ALL STAMPED

**TI4KB**  
TRADE MARK

WITH OUR TRADE MARKS

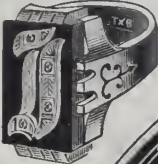

NO. 223 DI  
PAT. APR. 10 83



NO. 195



NO. 174-IN



NO. 304



PAT. AP. ID  
1883  
NO 2231

**TRAITEL BROTHERS**  
**SOLID GOLD**  
**RING-MAKERS**

MAKERS OF HANDSOMEST, COMPLETE, LINE OF INITIAL, STANDARD QUALITIES OF GOLD. OUR INITIALS ON ONYX, NOT SOFT SOLDERED, THROUGH OUR RAISED LETTERS, VARIOUS COLORS, OF GOLD NOS. 297 298 315 RINGS INITIALS WITH OR WITH

MOST ORIGINAL, & COMPLETE, LINE OF INITIAL, & OTHER RINGS, IN STANDARD QUALITIES OF GOLD. OUR INITIALS ON ONYX, ARE RIVITED, ON THE STONE, BOX OF RING. [WITHOUT DIAMONDS] SHOW - RED. GREEN. & WHITE. NOS. 297 298 315 RINGS ARE ALL GOLD. NO ONYX. OUT DIAMONDS.



PAT. APR. 10 83. NO 226 DI



NO. 299



NO 297



NO. 315 PAT APPLIED FOR



NO. 300



NO 298

299 195 ONYX ENCRUSTED WITH DIAMONDS. . . . . 226 DI. 223 DI.  
 RAISED LETTER ON ONYX SET WITH DIAMONDS. . . . . 223 I. 174-IN. 300  
 RAISED LETTER ON ONYX WITHOUT DIAMONDS. . . . . 304 RAISED LETTER  
 ON ONYX SET WITH DIAMONDS IN CUVETTE SHAPED STONE.

OUR GOODS ARE TO BE HAD OF ALL JOBBERS

**TRAITEL BROS.**  
NO. 40 MAIDEN LANE NEW YORK



OFFICE 16 MADISON AVE.

**A. PINOVER & CO**  
 MANUFACTURERS  
 OF SEAL RINGS & DIAMOND MOUNTINGS. A FULL LINE OF DIAMOND MOUNTED GOODS. CONSTANTLY ON HAND. WE CALL SPECIAL ATTENTION TO OUR RAISED INITIAL GLOVE RINGS

# CHARLES GLATZ,

Cor. Nassau & Liberty Sts., Bryant Building, N. Y. 100, 102 & 104 State Street, Chicago.

MANUFACTURER OF

## WATCH CASES.

NOTICE.—Our Eight Karat Case is to-day Superior to any made in the market, as it is made in greater variety of design, and stands acid test as well as the best made. Also, we claim superiority as we do not have to sacrifice or alter the color of our gold to make it acid proof, so it still stands at the head of any case made.



GOLD. COMMON [C.S.] SENSE.

TRADE MARK



SILVER. WARRANTED COIN.

TRADE MARK

FOR THE  
JOBGING TRADE ONLY.



# SIMONS, BRO. & CO.

MANUFACTURERS.



CHAIN.



Fine Jewelry.

ILLUSTRATED CATALOGUE

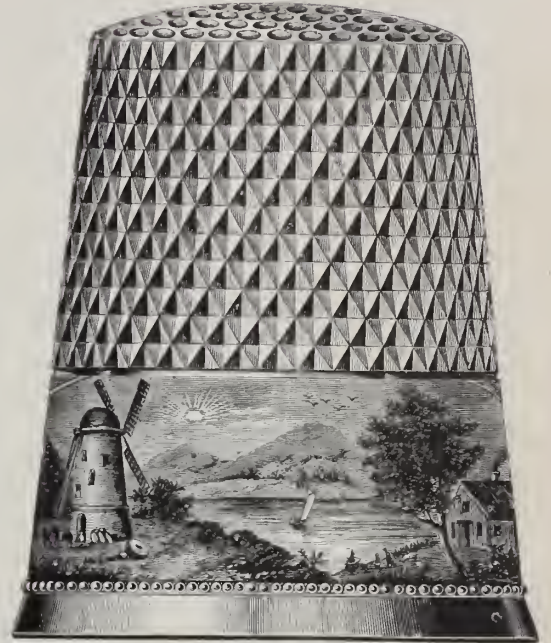

611 and 613 SANSON STREET, PHILADELPHIA, OR NEAREST JOBBER.

ESTABLISHED 1833.  
(50 YEARS.)

❖ E. IRA RICHARDS & CO. ❖

❖ EXCLUSIVELY MANUFACTURERS. ❖

## FINE ROLLED PLATED JEWELRY,

The Largest and Choicest Stock in the Country.

Factories, NORTH ATTLEBORO, MASS. Salesrooms, 200 BROADWAY, NEW YORK.

**HASKELL & MUEGGE, Agents, 206 Kearney St., San Francisco, Cal.**

Goods Sent on Selection to Responsible Parties.

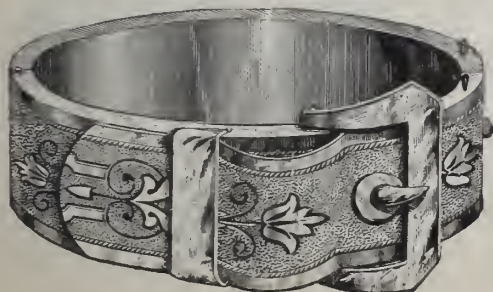

*Examples of Medium Quality Bands, made in all the Widths, Sizes, etc., and acknowledged to be the Cheapest for Quality and Finish in the market.*

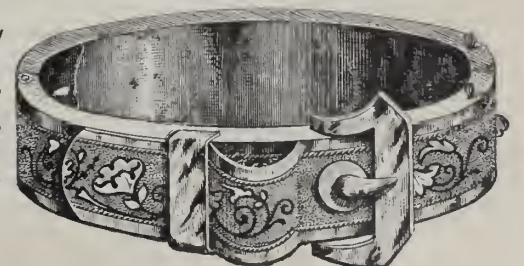



WATCHES



TRIUMPH-ROSKOPF WATCH.



JEWELRY



ESTABLISHED 1847.

J. T. SCOTT & CO.

7 Maiden Lane, New York.

Would respectfully invite the attention of Buyers to our

LARGE AND COMPREHENSIVE STOCK,

which is now more attractive than ever before. Buyers visiting the city will find it to their interest to give us a call.

Orders committed to our care will receive prompt and careful attention.

DIAMONDS



ROSKOPF WATCH.



CHAINS, &c.





Manufactory, 47, 49 & 51 Franklin Street, Newark, N. J.

# MILLER BROS.,

No. 7 Maiden Lane,

NEW YORK.

## IMPORTERS OF DIAMONDS

— AND —

MANUFACTURERS OF FINE JEWELRY.



OPEN.

We would call the attention of the Trade to our Newly Patented TURN OVER CAP SLEEVE BUTTON. The mechanical device by which the cap is turned is by a spring working in the pillar, which makes a much stronger and more durable cap than any other in the market.



CLOSED.

INITIAL GOODS A SPECIALTY.

# CROSS & BEQUELIN,

21 MAIDEN LANE, N. Y.

P. O. BOX No. 531.

MANUFACTURERS OF THE CENTENNIAL

## CHRONOGRAPH

THE BEST AND CHEAPEST HORSE TIMER

AND THE

Most Accurate Time Keeper in the World for the Money.

IN GOLD AND SILVER CASES.

CHEAP AND RELIABLE.

See Cut.



WHOLESALE DEALERS IN ALL GRADES OF

AMERICAN AND SWISS WATCHES, JEWELRY, MATERIALS, ETC.

SOLE AGENTS IN NEW YORK FOR THE SALE OF THE ENGLE ENGRAVING MACHINE.



# WM. SMITH & CO.,

MANUFACTURERS OF

## GOLD and SILVER Chains & Jewelry,

Also a Large Line of SILVER RINGS.

OFFICE :

**No. 25 Maiden Lane, New York.**

MANUFACTORY—No 61 PECK STREET, PROVIDENCE, R. I.

# W. & S. BLACKINTON,

MANUFACTURERS OF

ONLY

## FINE ROLLED PLATE CHAINS,

Necklaces, Polished and Roman, of Latest Gold Designs. Also a Complete Line of Gents' and Ladies' Locketts and Pendants.

In consequence of the first-class reputation our goods have obtained, unscrupulous dealers have been selling goods of an inferior quality, represented as our manufacture. In order to protect ourselves, as well as dealers, all goods of our manufacture will hereafter bear this

TRADE MARK. **W&S B** ★ TRADE MARK.

*These Goods are for sale by all Wholesale Dealers.*

# WM. J. SUTTIE,

MANUFACTURER AND JOBBER OF

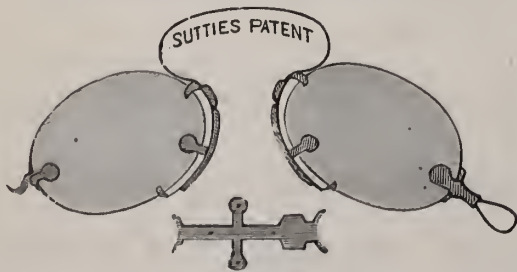

## Eye-Glasses and Spectacles,

In GOLD, SILVER, STEEL and SHELL,

No. 39 Maiden Lane, New York.

**CYLINDRICAL AND PRISMATIC GLASSES.**

REPAIRING A SPECIALTY,

# Webster's Silver Solution,

PREPARED BY

**E. G. WEBSTER & BROTHER,**

(Established 1859.)

Manufacturers of Quadruple

## Electro Silver Plated Ware

14 MAIDEN LANE, N. Y.,

Expressly for Cleaning Silver and Silver Plated Ware.

Jewelers will find this a valuable adjunct for cleaning their stock, and a reliable article to recommend to their customers.

Guaranteed entirely free from Cyanide, Acid, Grit, or anything detrimental to the Finest Wares.

Packed in Boxes containing 2 Doz. Bottles.

Price, \$1.25 per Doz., NET.



# CHESTER MANCHESTER & CO.,

MANUFACTURERS OF

## Gold & Silver Chains,

No. 13 HANOVER STREET,

PROVIDENCE, R. I.

Waltham, Elgin, Illinois, Hampden, E. Howard & Co. and Special Movements.

**392 WASHINGTON ST., BOSTON.**

P. O. Box 5259.

**D. C. PERCIVAL & CO.,** WHOLESALE DEALERS.

Watches, Jewelry,  
Gold Chains, Gold,  
Filled and Silver Cases,  
Spectacles, Eye - Glasses,  
Gold Head Canes, and Rogers &  
Bro.'s Flat Ware.

Price List of Movements and Cases  
Sent on Receipt of Business Card.



# LOUIS A. SCHERR & CO.

Importers and Wholesale Dealers in

## Watches, Jewelry,

WATCH MATERIALS, TOOLS, GLASSES, &c.

Spectacles, Silk Guards, &c.

Wholesale Agents for American Watches.

**No. 726 CHESTNUT STREET  
PHILADELPHIA.**

AGENTS FOR THE WHITCOMB LATHE  
AGENTS FOR W. F. NYE'S WATCH AND CLOCK OILS.

## HAUG & LUTHY,

MANUFACTURERS OF

### FINE DIAMOND MOUNTINGS, &c.,

130 FULTON STREET,

Cor. Nassau St., NEW YORK.

N. B.—All Diamond Mountings of our Man-  
ufacture have a Patented

✦SELF-CLOSING ✦ SAFETY ✦ CATCH✦

### Abbott's Stem Winding Devices

Are for sale and are applied to watches by  
all reputable jobbers, and by the manufac-  
turer,

## HENRY ABBOTT,

7 MAIDEN LANE, NEW YORK.

FACTORY, JOHN STREET.

ALSO MANUFACTURER OF

### Fine Enamel Watch Dials.

# YALE CLOCK CO.

NEW HAVEN, CONN., U. S. A.

## NOVELTIES IN CLOCKS.

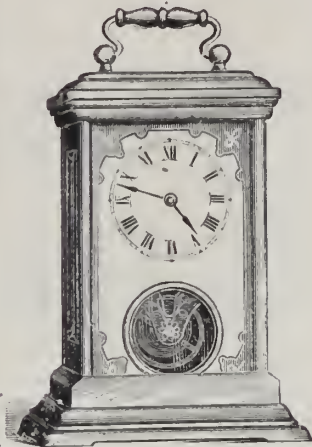

A. I. HALL & SON,

General Agents,

52 Maiden Lane,

New York.

528 & 530 Market Street,

SAN FRANCISCO,

CAL.

## JOHN W. STEELE,

MANUFACTURER OF

### FINE GOLD JEWELRY,

—AND—

BRAINERD'S

PATENT

### LOCKETS

Patented June 17, 1874.



No. 9 Maiden Lane, NEW YORK.

Agents for the Lancaster, Pa., Watches.

## A. FRIEDENTHAL & CO.

MANUFACTURING JEWELERS,

AND IMPORTERS OF WATCHES.

43 Maiden Lane, New York.

MATERIALS and OPTICAL GOODS.



# COLBY & JOHNSON,

Manufacturers and Jobbers,  
17 MAIDEN LANE, NEW YORK.

WATCH CASES,  
FINE JEWELRY,  
AMERICAN WATCHES.

SOLE MANUFACTURERS OF  
**CELLULOID WATCH CASES,**

MOUNTED IN  
GOLD, SILVER OR NICKEL.

## PEARCE & HOAGLAND,

MANUFACTURERS OF

Gold Pens, Pencils, Pen Holders, Tooth Picks,  
OF EVERY DESCRIPTION.



CLOSED

SOLE MANUFACTURERS OF THE

**QUILL RESERVE TOOTH PICK,**

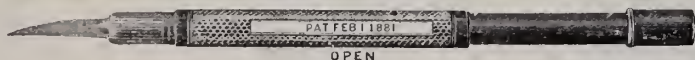

OPEN



CLOSED

The Holder of this Case is made in various styles in Gold Plate, Celluloid, Ivory, etc., while the Pick is of ordinary Goose Quill, and can be easily replaced by a new one, at any time, from the Reserve in the end of the Holder, and is the only Pick that will not injure the Teeth.

FOR SALE BY ALL JOBBERS.

Office and Factory, 29 Point Street, Providence, R. I.

ESTABLISHED 1853.

## WELCH & MILLER,

**JEWELRY  
Case Manufacturers,**

Of Morocco, Velvet, Russia, Brocade and Plush.

SHOW CASE TRAYS OF ALL DESCRIPTIONS.

LOCK RING TRAYS FOR DIAMOND RINGS.

Agents for Jewelers' Cotton and Twine.

All Goods of our Own Manufacture, and a Large Stock  
Always on Hand.

**169 BROADWAY, NEW YORK.**

## SUSSFELD, LORSCH & NORDLINGER,

IMPORTERS OF

# Optical & Mathematical Instruments,

Watchmakers' Tools, Materials, Etc.

SPECIALTIES:

**BARDOU & SONS'** Universal Opera Glasses. U. S. Army and Navy Glasses.  
Rifle Range Telescopes, Etc., Etc.

**LA REINE** Opera and Marine Glasses.

**CROWN** Spectacles and Eye-Glasses.

**PARADIS MAINSPRINGS.**

**PARAGON TOOLS.**

**13 MAIDEN LANE, NEW YORK.**

16 Rue D'Enghien, PARIS.

FRANK O. LODWICK.

CHAS. A. NOLTING.

## LODWICK & NOLTING, WHOLESALE JEWELERS,



JOBBERS OF

Gold, Silver & Nickel

WATCHES,

Gold and Roll Plate

JEWELRY

MOVEMENTS

AND

Watch Cases,

SPECTACLES,

Clocks and Silverware.

Positively will all Orders. Inquiries and Repairs receive immediate and reliable attention.

CINCINNATI.

ESTABLISHED 1850.

## JOHN T. MAURAN,

MANUFACTURER OF

FINE ROLLED PLATE GOODS

15 MAIDEN LANE, NEW YORK.

SPECIALTIES FOR THE FALL.

FULL LINE OF

STONE LACE PINS IN RUBY AND SAPPHIRE DOUBLET,  
GARNETS AND FOILED WHITE STONES,

Jet Lace Pins, Sets and Ear Knobs, Solid Gold White Stone Knobs.

ALSO

Full Line of Coral and Wire Sets, Lace Pins, Knobs, &c.

These Goods, which are so well and favorably known to the Trade, bear this

TRADE MARK

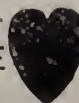

as well as the same being stamped on the cards.



**HELLER & BARDEL**

MANUFACTURERS OF



**JEWELRY,**

13 John St., New York.

*A Full Line of DIAMONDS, Mounted and Unmounted, Always on hand, which we will send for Selection to Responsible Houses.*

All Goods Ordered on Selection or for Stock are Insured while in the Hands of the Express Companies.

R. WALLACE & SONS M'FG Co.,

MANUFACTURERS OF



**SILVERWARE,**

GUARANTEED  $\frac{925}{1000}$  FINE.

WALLINGFORD, CONN.

**JAMES W. TODD,**

SUCCESSOR TO GEO. W. PLATT,

→\* Wholesale Dealer in \*←

WATCHES & JEWELRY,

GOLD AND SILVER SPECTACLES

And Eye-Glasses,

No. 6 LIBERTY PLACE,  
NEW YORK.

LEROY C. FAIRCHILD & CO.

MAKERS OF

GOLD PENS, PEN & PENCIL CASES,

No. 14 MAIDEN LANE,

LEROY C. FAIRCHILD,  
G. HARRY ALLEN.

NEW YORK.

WOOD & HUGHES,

STERLING

**SILVERWARE MANUFACTURERS,**

New York Agents for the Derby Silver Co.'s

**Fine Quadruple Plated Ware,**

**No. 16 John Street, N. Y.**

206 Kearney Street, San Francisco, Cal.

HASKELL & MUEGGE, Agents.

J. B. & S. M. KNOWLES,

MANUFACTURERS OF

**Sterling Silver Ware,**

No. 20 MAIDEN LANE,

NEW YORK.

FACTORY, PROVIDENCE, R. I.



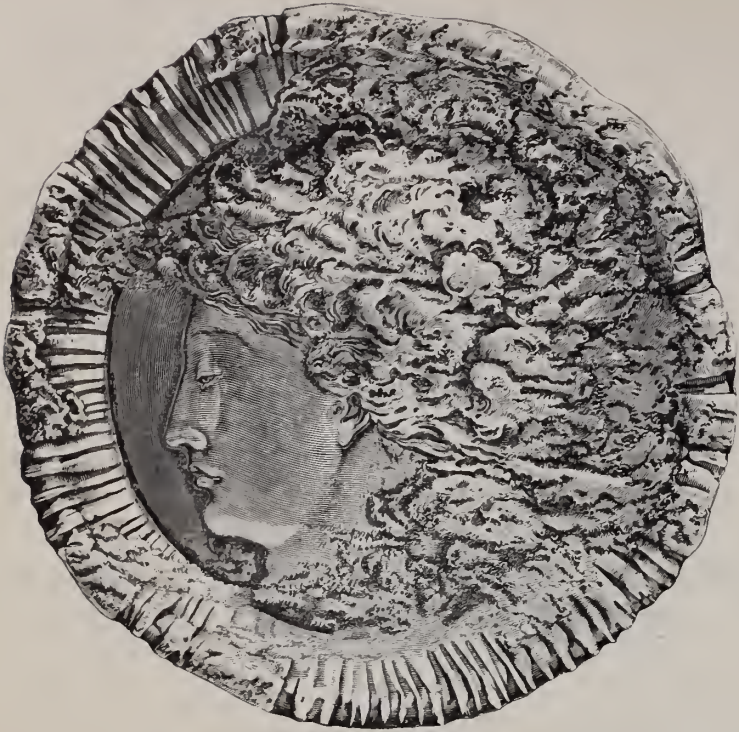

## THE GORHAM M'F'G CO., (Silversmiths,)

have in preparation their Catalogue for Autumn, 1883, which it is expected will be ready for distribution in October. It is the intention of the Company to make the present issue superior even to the one of 1882. While it is impracticable to illustrate a complete line of their productions, the plan adopted last year will be extended, thus showing a much greater number of illustrations.

Price Lists will be made, but to avoid the liability of getting into hands detrimental to the interests of the Trade, copies will be sent (to Dealers only) upon application.

The Catalogues, without Price Lists, will be forwarded to all reputable dealers throughout the United States and the Canadas.

Saleerooms of the Gorham Manufacturing Company:

NEW YORK,  
37 Union Square.

CHICAGO,  
170 State Street.

SAN FRANCISCO,  
120 Sutter Street.

Manufactory at Providence, R. I.



Alfred N. Smith & Co.,

**DIAMONDS,**

33 Abchurch Lane, Viadrinet,  
London.

125 State Street,  
Chicago.

182 Broadway,  
New York.

Autumn, 1883.

We would respectfully direct the attention of the Trade to our Fall Importations of Diamonds, comprising, in addition to important parcels of regular and speculative goods, the finest line of Cold White Single Gems and Important Pairs to be found in this market.

Alfred N. Smith & Co.

182 Broadway, N. Y.

October 1<sup>st</sup>, 1883.



**THE**  
**NEW HAVEN CLOCK CO.**  
**MANUFACTURERS, IMPORTERS, DEALERS,**

**FACTORIES:**  
**NEW HAVEN, CONN.**

**WESTERN OFFICES AND SALESROOMS:**  
**31 Washington St., Chicago, Ill., 134 Sutter St., San Francisco, Cal.**

**GENERAL OFFICE AND SALESROOMS:**  
**16 & 18 PARK PLACE, New York.**

**EUROPEAN OFFICE AND SALESROOMS:**  
**Victoria St., Liverpool, Eng.**

We beg to call special attention to our line of Fall Importations of Marble, Gilt and Alabaster, Antique Brass and Porcelain Placques, Clocks, Bronzes and Novelties for the Holiday Trade. Also, New and Novel Designs for the Fall Season of 1883, in Bamboo, Walnut, Ash, Porcelain, Nickel, Brass, and Plush Cases.

No. 124, GILT AND ALABASTER.

MARBLE.

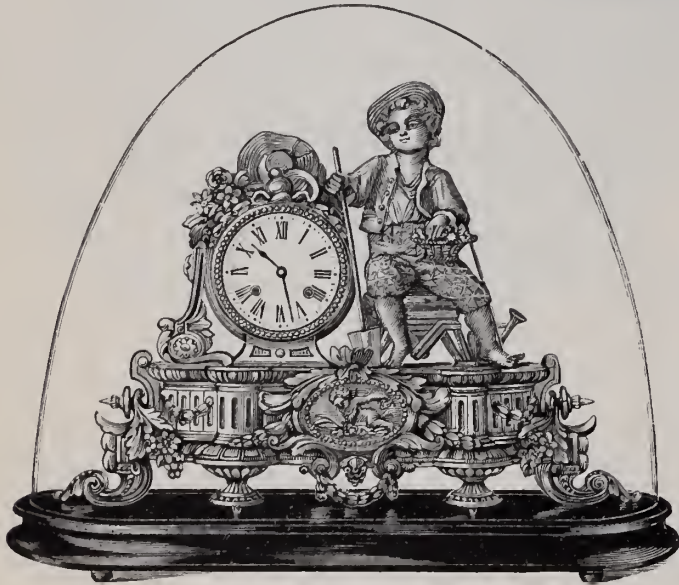

15 DAY, 1/2 HOUR STRIKE.  
 Height, with Glass Shade, 15 in. Width, with Glass Shade, 19 in.

LARK.—Porcelain and Plush Cases.

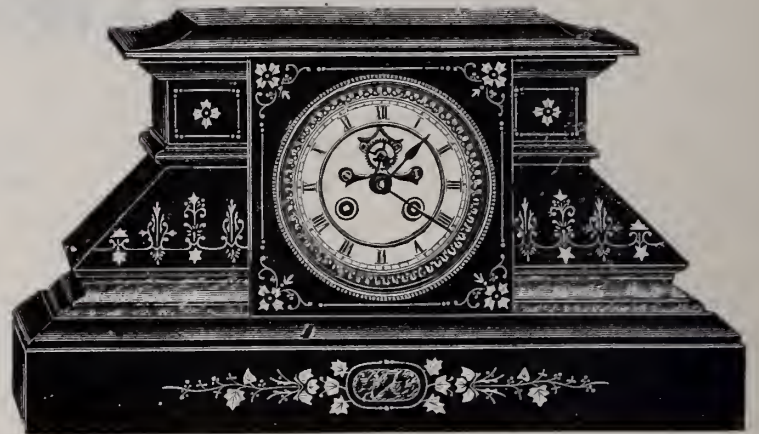

15 DAY STRIKE. CATHEDRAL GONG.  
 Height, 8 1/2 inches. Base, 15 inches. Dial, 4 inches.

ANTIQUE BRASS, No. 2.—Visible Escapement, Porcelain Dial.

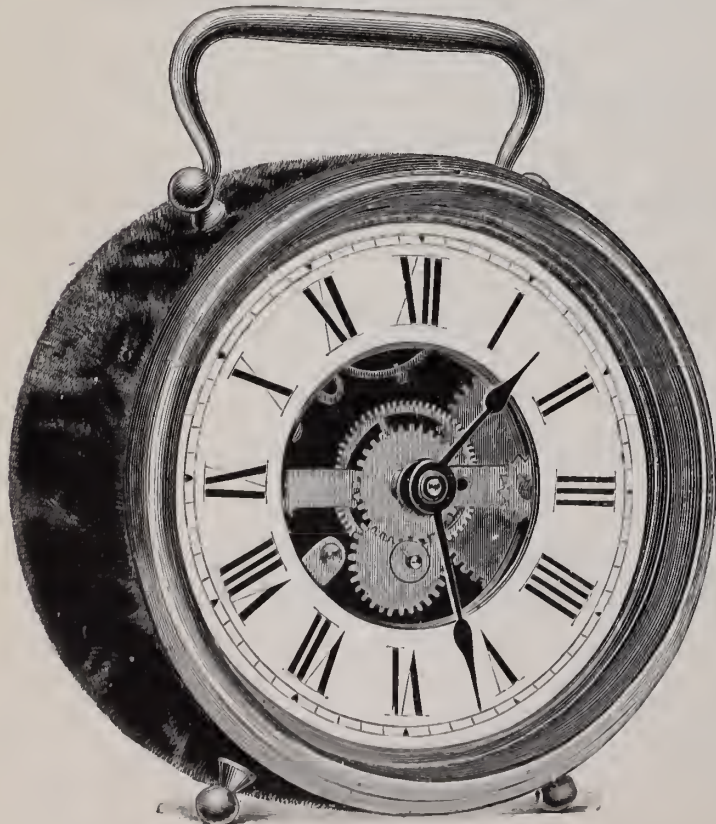

1 Day Lever Time. Nickel Plate Movement.  
 A Reliable Timekeeper.

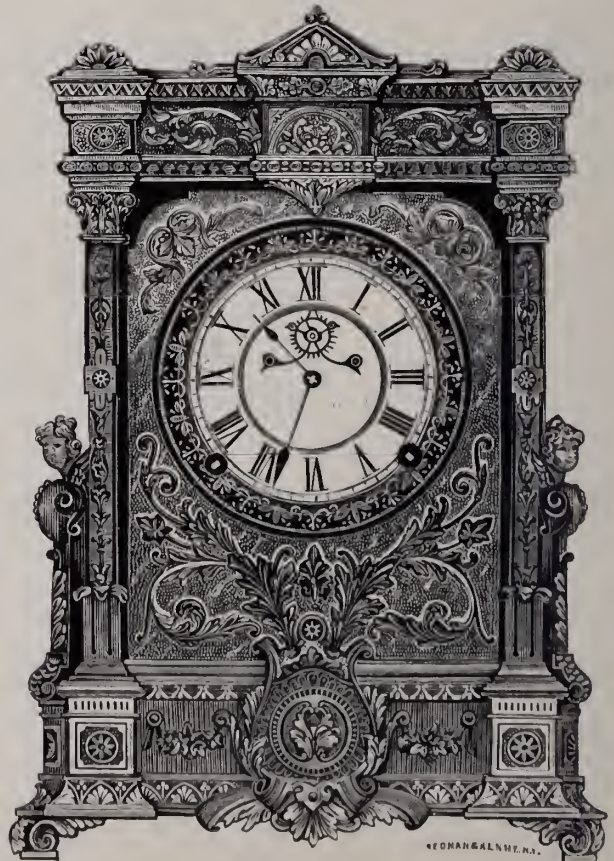

8 DAY, 1/2 HOUR STRIKE, CATHEDRAL GONG.  
 Height, 13 1/2 inches. Dial, 4 inches. Also in Plain Porcelain Dial.

**CATALOGUES AND PRICE LISTS FURNISHED THE TRADE UPON APPLICATION.**





CARTER, SLOAN & CO.,  
MANUFACTURERS OF ALL KINDS OF

GOLD JEWELRY,

No. 15 MAIDEN LANE,  
NEW YORK.

A. CARTER, JR.  
A. K. SLOAN,

C. E. HASTINGS,  
G. R. HOWE.

BALDWIN, SEXTON & PETERSON,

IMPORTERS OF

DIAMONDS and all PRECIOUS STONES,

MANUFACTURERS OF

DIAMOND AND RICH JEWELRY.

Cutters and Polishers of

DIAMONDS

692 & 694 BROADWAY, NEW YORK.

120 SUTTER ST., SAN FRANCISCO, CAL.

*J. G. Chatellier,*  
*Manufacturing Jeweler,*

*692 & 694 Broadway,*

*New York.*



Whiting Manufacturing Co.

SILVERSMITHS,

BROADWAY & FOURTH ST., N. Y.

ESTABLISHED 1837.

TAYLOR & BROTHER,

Old House READ, TAYLOR & CO.,

Importers of Diamonds and Pearls,

—)AND(—

MANUFACTURERS OF DIAMOND JEWELRY,

21 Holborn Viaduct, 676 Broadway,

LONDON.

NEW YORK.

ESTABLISHED 1813.

THOMAS G. BROWN & SONS,  
Newark, N. J., & 5 Bond Street, New York.

MANUFACTURERS OF

ARTISTIC JEWELRY  
FOR PRESENTATION,

Including Prizes for ROWING, RIFLE SHOOTING, ARCHERY and  
all ATHLETIC SPORTS.

COLLEGE SOCIETY PINS AND CLASS RINGS, ALSO BADGES FOR MILITARY  
AND CIVIC BODIES IN ALL METALS.

Employing able Designers, and having all work, both in Designing and Manu-  
facturing, done in our own factory, we can submit, for the inspection of those  
interested, entirely original designs, appropriate in style, and not to be else-  
where.

Estimates and Designs will be sent to Reputable Dealers when desired.



# REED & BARTON,

MANUFACTURERS OF

## Fine Table Ware

## AND FANCY GOODS

IN GOLD AND SILVER PLATE,



Are now offering to the Trade a great number of New Patterns. In addition to the

PEARL, HAMMERED, SNOW FLAKE, CHASED AND ENGRAVED DECORATIONS, are many other NEW AND ARTISTIC DESIGNS OF ORNAMENTATION,—

Figures, Fruits and Flowers in Full and Bas Relief,

AND

Appliqué Finished in Oxidized Silver and in Varied Shades of Gold.

**FACTORIES:**

Taunton, Mass.

**SALESROOMS:**

686 Broadway, N. Y.



ESTABLISHED 1834.

G. & S. OWEN & CO.,

—MAKERS OF—

FINE ROMAN JEWELRY,

—BOX and GLASS PINS,

—AND—

Black Onyx and Pearl Goods,  
OF EVERY DESCRIPTION.

All Goods sold by us are exclusively of our own manufacture and are warranted 14 K. Fine, and stamped as such when possible.

No. 3 Maiden Lane, New York.

W. H. SHEAFER & CO.,

MAKERS OF

BRACELETS,

BANGLES,

LACE PINS,

SCARF PINS, ETC.

No. 15 JOHN STREET,  
NEW YORK.

RIPLEY HOWLAND M'F'G CO.,

MAKERS OF

FINE JEWELRY,

SPECIALTIES:

DIAMOND MOUNTINGS, with Platinum Tips.  
ENGRAVED RINGS, STONE RINGS,

OFFICE, 17 MAIDEN LANE,  
NEW YORK.

FACTORY, 383 WASHINGTON ST.,  
BOSTON, MASS.



GOLD

SAXTON, SMITH & CO.,

Manufacturers of

SOLE AGENTS

FOR THE

NEW PATENTED CHAIN BAR,

Containing a Detachable Pencil.

FACTORY:  
183 EDDY ST.,  
PROVIDENCE, R. I.

OFFICE:  
14 JOHN ST.,  
NEW YORK.

CHAIN

A. J. HEDGES & CO.,

MANUFACTURING

JEWELERS,

No. 6 MAIDEN LANE,

NEW YORK.

Factory, No. 90 MECHANIC ST.,  
NEWARK, N. J.

A. W. FABER'S  
Gold Pens,

—PEN AND PENCIL CASES.—

EBERHARD FABER, MANUFACTURER,  
718 & 720 BROADWAY,  
NEW YORK.



# FOWLER BROS.,

MANUFACTURERS OF

## JET & ONYX JEWELRY.

Offer a large and varied stock of desirable goods of original designs, especially manufactured for the coming Fall Trade.

These goods are elegant in design, beautifully finished, and must be seen to be appreciated.



PATENTED MARCH 27th. 1893.

Are Carried by all the Leading Jobbing Houses  
Throughout the Country.

# MOORE & HORTON,

No. 11 Maiden Lane,  
NEW YORK.

# JEWELERS.

### SPECIALTIES:

Stone Cameo, Onyx, Amethyst, Topaz  
and Pearl Rings.

Studs, Collar and Sleeve Buttons.

Also our fac-simile of Fine African Diamonds,  
with Foile Back, Mounted in Rings, Studs,  
Pins, Ear Rings, Scarf Pins, Lace Pins, &c.

JOHN F. SAUNDERS,  
Of the late firm of Buckenham, Cole & Saunders.

CHAUNCEY IVES.

# SAUNDERS & IVES,

IMPORTERS OF

## DIAMONDS, PEARLS, And Other Precious Stones.

Manufacturers of Diamond Mountings.  
No. 26 MAIDEN LANE, NEW YORK.

A Large Stock of FINE DIAMONDS, Mounted and  
Unmounted, kept constantly on hand.

Goods sent on approval to any part of the country on receipt of  
satisfactory reference. All our goods ARE IN-  
SURED by us while in transit.

# DORRANCE, EDGE & CO.,

Makers of the Celebrated

## Woven Fabric Gold Chain,

And Patentees of the

### Embossed Inlaid Jewelry.

The Latest and Most Effective Styles of Decoration  
Introduced.

15 JOHN ST., NEW YORK.  
FACTORY, 46 GREENE ST., NEWARK, N. J.

# G. W. PRATT & Co.,

Manufacturers and Dealers in

## Watches and Jewelry

OF EVERY DESCRIPTION.

ELGIN AND ILLINOIS MOVEMENTS  
IN ALL GRADES.

Gold, Silver and Ladd Patent Cases.

No. 14 JOHN STREET, NEW YORK.

# C. ROSSWOG & SON,

MANUFACTURERS OF

Rich Jewelry and Diamond Goods,

NOS. 5 & 7 MAIDEN LANE,

NEW YORK.



CHURCHILL, LEWIS & CO.,  
 Manufacturing Jewelers,  
 692 BROADWAY, NEW YORK.

S. W. HALE & CO.,  
 SUCCESSORS TO HALE & MULFORD,  
 MANUFACTURERS OF  
**FINE JEWELRY**

692 BROADWAY, N. Y.  
 SETH W. HALE. WILLIAM A. LEE. WILLIS H. HOWES.

TRADE MARK  
 GEO. W. SHIEBLER,  
 MANUFACTURER OF  
 Sterling Silverware,  
 HANDSOME NOVELTIES  
 CONSTANTLY ON HAND.  
 8 LIBERTY PLACE, NEW YORK.

JAMES F. ANGELL,  
 MANUFACTURING JEWELER,  
 AND WHOLESALE DEALER IN  
**SOLID GOLD,**  
 AND  
 ROLLED PLATED JEWELRY,  
 176 BROADWAY, N. Y.

SMITH & KNAPP,  
 WHOLESALE DEALERS IN  
 AMERICAN AND SWISS WATCHES,  
**DIAMONDS,**  
 Gold & Plated Jewelry & Gold Chain,  
**No. 182 BROADWAY,**  
 COR. OF JOHN STREET, NEW YORK.

E. STITES' SONS.  
**BRACELETS**  
 14 JOHN STREET,  
 NEW YORK.  
 FACTORY, NEWARK, N. J.



HODENPYL, TUNISON & CO.,  
MANUFACTURERS OF  
**FINE GOLD JEWELRY**  
OF ALL DESCRIPTIONS IN  
**Roman and Enamel.**

ALSO THE  
PATENT SPRING DIAMOND COVERS IN ALL STYLES.

OFFICE, 170 BROADWAY.  
Factory, 95 & 97 Cliff St., NEW YORK.

**GEO. O. STREET & SONS,**

ESTABLISHED 1837.

OFFICE AND FACTORY,  
15 JOHN STREET, NEW YORK.

*Fine Intaglio and Platina and Gold  
Locketts, Seals, Ladies' Gent's and Chil-  
dren's Rings in Great Variety. Stone But-  
tons, Lace Pins, Scarf Pins, Etc.*

STRICTLY FIRST-CLASS GOODS OF OUR OWN MAKE.

**DAY & CLARK,**

No. 10 MAIDEN LANE, NEW YORK.

*Fine Roman Goods,*

IN VERMICELLA AND HAMMERED ORNAMENTATION.

BANGLES, DIAMOND BALL COVERS, LACE PINS  
AND EAR DROPS. BEAD NECKLACES.  
EAR HOOPS, SCARF PINS.

Send for Selection Package.

FACTORY, NEWARK, N. J.

**G. B. BARRETT & CO.,**

IMPORTERS AND WHOLESALE DEALERS IN

**Watches, Diamonds, Jewelry,**  
Clocks, Bronzes, Silver and Plated Ware,  
Watch Materials, Etc.

A Full and Complete Line of all goods handled  
by the Trade, constantly on hand. Lowest  
Prices Guaranteed.

WHOLESALE EXCLUSIVELY.

238 & 240 Liberty St., PITTSBURGH, PA.

ESTABLISHED 1837.

**VICTOR BISHOP & CO.,**

IMPORTERS OF

**DIAMONDS,**

RUBIES, SAPPHIRES,

EMERALDS AND PEARLS.

ENAMEL PAINTINGS, ROMAN PEARLS,

Copper, Platinum and Iridium.

**33 MAIDEN LANE, NEW YORK.**

House in Paris, 66 Boulevard de Sebastopol.

**JOHN A. RILEY & CO.,**

9 BOND STREET, N. Y.

SOLE MANUFACTURERS OF THE POPULAR

→ PATENT SPRING BRACELETS ←

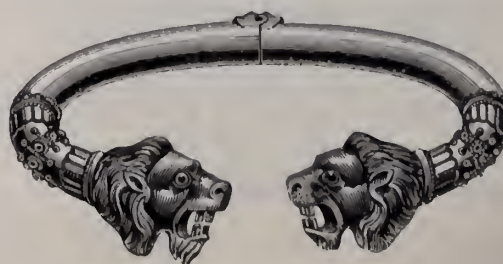

Also Lace Pins, Ear Rings, Scarf Pins, Etc.



CHAS. F. TERHUNE & CO.,  
 Manufacturing Jewelers,  
 Swiss & American Watches,  
 194 Broadway  
 NEW YORK.

Sets, Drops, Lace Pins, Bracelets, Neck Chains,  
 Vest Chains, Locket Rings, a Perfect Joint when Closed.  
 Raised Initial in Diamonds.  
 Charms, Rings, Etc.



Our stock of Plated Jewelry and Rolled Plate Chains represent fully the best and newest designs of all the leading manufacturers. Goods sent on selection on receipt of business card and satisfactory New York references.

HESS & SCHLIESSER,  
 25 MAIDEN LANE,  
 NEW YORK.

IMPORTERS.

SPECIALTIES:  
 DIAMONDS.  
 NOVELTIES IN FINE JEWELRY.  
 Blue and Black ENAMELED LOCKETS.  
 Charms, Garnet and Silver Filigree Goods.

LEVY, DREYFUS & CO.,  
 Importers and Manufacturers,  
 11 MAIDEN LANE, N. Y.

OFFER A LARGE ASSORTMENT OF

**Fine Bisque Figures,**  
 Especially Selected for the requirements of the Jewelry Trade.

Alluminium, all Pearl Opera Glasses,  
 Six or Twelve Lenses, and a Large Variety of other Glasses of Standard Makers.

**GOLD SPECTACLES AND EYE-GLASSES IN GREAT VARIETY.**  
 Monogram Albums containing 35 Series of Alphabets, Price, \$5.00; also Monogram Albums, 3\*and 4 Letter Combinations, Price, \$10.00.

**COX & SEDGWICK,**  
 26 JOHN STREET, N. Y.,  
**Makers of Patent Black Onyx Bracelets**  
 Also Black Onyx Faceted Bead Bracelets,  
 AT THE LOWEST PRICES.

COLORED AND Turquoise  
 Lace Pins, Ear Rings, Locketts, Bracelets, Sleeve Buttons, Scarf Pins,



**ONYX**  
 Lace Pins, Ear Rings, Medallions, Necklaces, Chatelaines Sleeve Buttons Ladies & Gents Vest and Guard Chain.

Black Onyx Pins, Ear Rings and Locketts for 1, 3 and 5 Diamonds.  
 GOODS SENT ON APPROVAL TO RESPONSIBLE FIRMS.

**W. F. NYE,**  
**Watch and Clock Oil,**  
 New Bedford, Mass.



These Oils have been before the Trade for the last twelve years and are generally acknowledged by Watchmakers throughout the country to be the best and most reliable Watch and Clock Oils made.

FOR SALE BY THE  
 Jobbing Trade Generally.

**JOHN M. GODDARD,**  
 Manufacturing Jeweler,  
 3 MAIDEN LANE, NEW YORK.

BRACELETS,  
 BANGLES,  
 SEAL RINGS,  
 DIAMOND RINGS,  
 STONE Locketts,  
 Roman Locketts,  
 Engraved Locketts,  
 CHAINS, Etc.,  
 Etc., Etc., in  
 ALL QUALITIES

**JOBGING DEPARTMENT.**  
 Jewelry Repaired, Colored or Matched Promptly.  
 Designs & Estimates Furnished for Ordered Work.



MANUFACTURERS  
OF  
Everything in  
**BLACK ONYX JEWELRY**  
PLAIN, and {Ornamented with  
                  { Pearls and  
                  { Diamonds.

Our manufacturing facilities have been for the past ten years devoted exclusively to the production of fine Black Onyx Jewelry. We carry in stock the largest variety of articles made in our specialty, well made, finely finished, uniformly 14 karats, at medium and low prices.

**WOGLOM & MILLER,**  
Office & Factory, 32 & 34 JOHN STREET,  
NEW YORK.

**W. M. GREENE & CO.**  
GOLDSMITHS  
MANUFACTURERS OF

RICH SETS IN TAPER WIRE CORAL

Factory 95 PINE ST. Providence, R. I.  
Stone Cameo  
Amethyst  
Coral Cameo  
Engraved  
Enamel  
Brooches  
Sleeve Buttons  
Stud Buttons  
Ear & C. Drops  
Crosses  
New York Office 192 BROADWAY.

WM. C. GREENE. B. W. GREENE. GEO. D. BRIGGS.

**KETCHAM & McDOUGALL,**  
Bryant Building, (55 Liberty St.) New York.  
MANUFACTURERS OF  
**COLD AND SILVER THIMBLES.**



**THE AUTOMATIC EYE-GLASS HOLDER,**  
It Reels Up Cord Itself.  
A—Shows position of Glasses with cord Reeled up.



ESTABLISHED 1859.

**STURDY BROS. & CO.**  
MANUFACTURERS OF  
**Fine Rolled Plate Jewelry,**  
GRADUATED WIRE CORAL GOODS,  
STERLING SILVER JEWELRY.

Bangles, Sleeve Buttons, Cuff Buttons, Baby Pins, Sets in Stone, Cameo, Enamel, Chased, and Polished, Drops and Knobs, Bar Pins, Children's Sets, Locketts, Studs, Charms, Etc.

Only Who'sale Dealers' Trade Solicited. ATTLEBORO, MASS.

Flexible Bracelets,  
Diamond Mountings,  
Strung Pearl Work,  
Repairing,

Flexible Braided  
Bracelets,  
White Stone Goods,  
Strung Pearl Repa'ng

**Thos. M. Guilbert & Co.,**  
SUCCESSORS TO CARROW, DUBOSQ & Co.  
908 Chestnut Street, Philadelphia, Pa.

TRADE MARK

The ORIGINAL GOLD CROWN  
**FILLED RINGS.**

For the past thirteen years we have manufactured as a specialty, the well known "CROWN GOLD FILLED RING," with the high standing of which the trade is already perfectly familiar. In consequence of the above fact, and in justice to ourselves, we feel it a duty to make the announcement to the trade that there are now being offered in the market several other makes of filled rings, each of which has a CROWN in some way connected with its STAMP.

We Manufacture for the Jobbing Trade Only.  
**McCALL & NEWMAN,**  
625 Arch Street, Philadelphia

**B. A. BALLOU & CO.,**  
61 Peck St., Providence, R. I.  
MANUFACTURERS OF  
**GOLD JEWELRY.**



We call special attention to our PATENT FASTENING FOR EAR RINGS, which is free from the objections raised to ordinary ear wire or screw fastenings. They present a very neat and attractive appearance, are perfectly secure, and much more convenient than ordinary ear wires which always annoy the wearer by catching the hair, veil, or lace about the neck. These Goods are for Sale by all Wholesale Dealers.

Gold Studs, Small Chains for Eye-Glasses, Bracelets, Etc.  
a Specialty.

**McCarty & Hurlburt,**  
WHOLESALE DEALERS IN  
WALTHAM, ELGIN & ILLINOIS  
**WATCHES.**  
MANUFACTURERS OF  
Jewelry, Gold Spectacles, Silver Thimbles, &c  
**131 North Second St.,**  
PHILADELPHIA, Pa.



**CLOCKS**

ESTABLISHED 1853.



AMERICAN  
AND  
FRENCH CLOCKS  
AND  
BRONZES.

**B. J. COOKE'S SONS,**

137 N. 3d Street, PHILADELPHIA.  
Catalogues and Price Lists furnished to the Trade only, on application.

**BOOZ & CO.,**

MANUFACTURERS OF

FINE GOLD

Watch Cases



AND

PLAIN GOLD

RINGS.

Jobbers in American Movements.

**DIAMONDS.**

108 South Eighth St., (2d Story) Philadelphia.

Samples of our goods sent on approval when satisfactory reference is furnished.  
Old Gold and Silver Bought or Exchanged.

PARTICULAR ATTENTION PAID TO REPAIRING.

**BOSTON WATCH CASE COMPANY**

WATCH CASE MANUFACTURERS,

Nos. 1, 3 and 5 Province Court, Boston, Mass.,

ENTRANCE COR. PROVINCE STREET.

Especial Attention given to Watch Case Repairing, Springing, Re-engine Turning, Engraving, Polishing, &c.

Particular Attention given to Orders by Express.

WE OFFER THE LARGEST VARIETY OF ORIGINAL DESIGNS IN WATCH CASES EVER PRESENTED TO THE TRADE.

**CHAS. S. PLATT,**

Successor to George W. Platt,

GOLD AND SILVER

Refiner, Assayer and Sweep Smelter,

No. 4 LIBERTY PLACE,

Refinery, 67 and 69 Thomas St., NEW YORK.

Platers' and Electro-Platers' Silver Platinum and Aluminum.



KING JAMES,  
MARQUIS, } RINGS.  
GLOVE, }

Quality Guaranteed.  
Prices Close.

BARNET BROS. & POWELL,  
—Manufacturers,—

Newark, N. J., & 15 JOHN ST., NEW YORK.

**TRIER BROS.,**

**IMPORTERS,**

15 MAIDEN LANE, NEW YORK.

**SPECIALTIES:**

*Bohemian Garnet, Whitby Jet, Steel and Amber Jewelry, Opera, Marine and Field Glasses, Telescopes, Pearl Card Cases, Silk Guards, Etc.*

Also a Complete Line of

GOLD AND GOLD PLATED JEWELRY.

ESTABLISHED 1850.

TRADE



MARK

**PETER L. KRIDER,**

MANUFACTURER OF

**STERLING SILVERWARE**

Medal and Diploma Awarded. &c. Striking Society Medals in Gold, Silver or Bronze a Specialty.

Artisan Hall, 618 Chestnut St., Philadelphia.

**William T. Smith,**  
ASSAYER, REFINER AND SWEEP SMELTER.

ESTABLISHED IN 1855.

Cor. Blackstone & Hawkins Sts

PROVIDENCE, R. I.

BOSTON, Mar. 15, 1883.

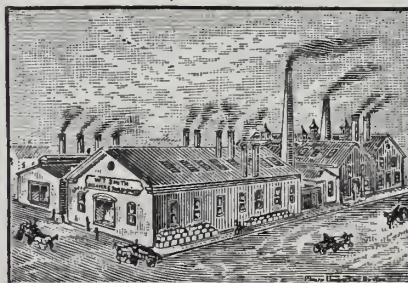

To whom it may Concern :

Mr. Wm. T. Smith, of Providence, R. I., has done refining for us for years, as well as his father before him, and we take pleasure in saying we have never received anything but satisfaction in our dealings with him.

RIPLEY HOWLAND MFG. CO., R. Crosby, Treasurer.



JEWELRY AND WATCHES.

ROGERS' SILVERWARE.

MATERIALS AND TOOLS.

S. F. MYERS & CO.,  
Manufacturers and Jobbers,  
179 BROADWAY, NEW YORK.

ILLUSTRATED CATALOGUE FOR THE TRADE.

**W. E. WHITE & CO.,**  
Manufacturing Jewelers.

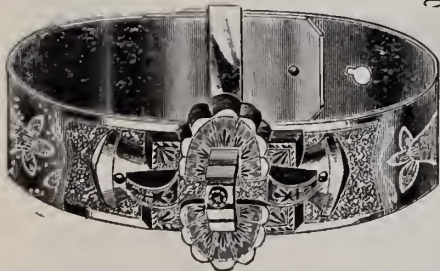

**FINE  
ROLLED PLATE  
GOODS.**

Bracelets---Engraved, Enamelled, Flat Band and Buckle.

Ladies' Goods---Lace Pins, Drops, Crosses, Sets, Collar Buttons, &c.

FOR SALE BY JOBBERS ONLY.

New York Office, 26 MAIDEN LANE, Corner Nassau Street.

Factory 54 Page St., Providence, R. I.

Represented by S. A. BALDWIN.

**ALEX. MILNE,**  
Manufacturer of Stem-Winding Watch Crowns



**ALSO GOLD AND SILVER THIMBLES.**



19 Ward Street, NEWARK, N. J.

**JAMES J. FISHER,**  
DEALER IN

**WATCHMAKERS' and JEWELERS' MATERIALS,**

Files, Tools, Silk Guards, Watch Glasses, Spectacles, Rolled Plate, Fire Gilt, Nickel and Silver Chains, Charms, &c.

No. 697 BROADWAY,  
Corner Fourth Street, NEW YORK.

All kinds of Job Work for the Trade Promptly attended to.

The "Acme" French Clock Movement Support.  
(Pat. Nov. 1st, 1881.)

This Support is adapted to the holding in position of any French Clock Movement while regulating or adjusting, and will be found very desirable on account of its simplicity of action and the small space it occupies. To be had of any material jobbing house, or sent, post paid, to any address, on receipt of 85 cents.



*Henry Fera,*  
Importer of Rough & Polished Diamonds,  
DIAMOND CUTTING AND POLISHING WORKS:  
21, 23, 25 Loijersgracht. 4 & 6 JOHN ST.,  
Amsterdam, Holland. New York.



Diamonds repaired and matched by some of the finest workmen in the world.  
Diamond Bort and Powder always on hand.

**G. W. SCHUMANN,**

No. 24 JOHN STREET,  
NEW YORK.

*Sole Licensee in the United States for the manufacture of*

**TRENOR'S DIFFERENTIAL DIAL,**

*by which the time in two cities can be recorded at once.*

The Dial can be applied to any Watch.

GEO. W. DUBOIS.

F. N. NAUMAN.

**GEO. W. DUBOIS & CO.,**

IMPORTERS OF

**Watches & Optical Goods.**

ALL STYLES AND QUALITIES OF

SPECTACLES AND EYE-GLASSES.

**LONGINES' WATCHES AND MOVEMENTS.**

The Watches in Gold, Silver and Nickel Cases of New and Handsome Patterns. The Movements fit 18 size Waltham Stem Winding Hunting Cases.

36 MAIDEN LANE, NEW YORK.

Orders by Mail Receive Prompt Attention.

R. & K.'S PATENT GAS FURNACES FOR MELTING, PLATING,  
ENAMELING, ANNEALING, &c., &c.

**Reichhelm & Koester,**

Importers and Manufacturers of

Jewelers' Tools, Files, Materials, &c.,

**Manufacturers of**  
Bristle Brushes of all kinds,  
Cotton and Wool Buffs,  
Felt Polishing Wheels,  
Walrus Leather Polishing  
Wheels,  
Jewelers' Satin Finish and  
Scratch Brushes,  
Brass & Steel Wire Brushes  
Jewelers' Standard Saw  
Frames,  
Plain & Fancy Draw Plates,  
Improved Jewelers' Ingots,  
R. & K.'s Jewelers' Combi-  
nation Gas Burners.

**Importers of**  
French, English & German  
Tools and Files,  
Piercing Saws,  
Renard & Vantier Gravers,  
Steel and Brass Wires,  
Vienna and Ruby Draw  
Plates,  
Alloying Copper Wire,  
Felt, Walrus Leather,  
Vienna Lime, Tripoli,  
&c., &c., &c.

**80 Nassau St.**

NEW YORK.



# STUART & SHEPARD, IMPORTERS,

No. 2 Maiden Lane, New York.

## FRENCH MARBLE CLOCKS OF ARTISTIC DESIGNS.

BRONZES, BRASS AND FANCY GOODS,

SILVER JEWELRY (Bright Cut),

MUSICAL BOXES of the Celebrated Manufacturer

**B. A. BREMOND,**

All Variety and Sizes from 4 to 30 Airs. Wholesale Dealers in

**AMERICAN WALTHAM WATCHES.**

**H. H. HEINRICH & CO.,**

12 JOHN ST., NEW YORK,

Manufacturers of the

**PATENT SELF-ADJUSTING BALANCE**

FOR EXTREME HIGH AND LOW TEMPERATURE.

Marine Chronometers  
AND  
Zimmerman Watches  
are provided with  
this Balance.

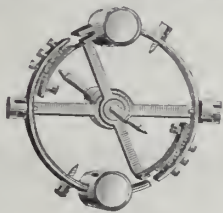

Tried by three  
Observatories with  
the best results.

We are also agents for the Celebrated K. Zimmerman Watch, which we can recommend to the Trade. Send for Circular containing information in regard to the Patent Balance Zimmerman Watches and Marine Chronometers.

**C. F. A. HINRICHS,**

Importer of and Dealer in

**Fancy Goods, Glassware, China, Toys, Games,**

CLOCKS, BRONZES, &c.,

Brass Goods, Faience, China and Glass Metal-Mounted Lamps,

C. A. KLEEMANN'S PATENT ST. GERMAIN STUDENT LAMPS.

Goods suitable for Jewelers and Holiday Trade.

AGENCIES: LONDON, ENGLAND; LIMOGES, FRANCE; HAIDA, BOHEMIA.

Nos. 29, 31 and 33 PARK PLACE,

N. W. Corner Church St.,  
Opposite Elevated R. R. Station.

NEW YORK.

**BLANCARD & OBERLANDER,**

MANUFACTURERS OF

**Settings and Galleries,**

IN THE LATEST STYLE.

**BALL WIRE**, Solid and Hollow, in 14 and 10 karat, also single **Hollow Balls** without joint, of all sizes, in Silver and 14 karat alloy and upwards. Made in any thickness of Gold to order.

Platinum, Platinum-Lined and Fancy Settings a Specialty.

PLATINUM SCRAPS EXCHANGED OR PURCHASED.

36 & 38 JOHN STREET, N. Y.

PLEASE SEND FOR SAMPLE CARD.

Patented November 18, 1873.

**MORRISON'S**

**GOLD AND SILVER SOLUTIONS**

For Electro-Plating Without a Battery.

Invaluable for Watchmakers and Jewelers. So simple that any one can use them.

Price, Gold Solution, \$3.00

Silver Solution, \$1.50

MANUFACTURED BY

**ARTHUR B. MORRISON, Portland, Maine.**

FOR SALE BY

Sussfeld, Lorsch & Co., New York; Henry Ginnel, New York; Cross & Beguelin, New York; Kearney & Swartzchild, Chicago, Ill.; Louis A. Scherr & Co., Philadelphia, Pa.; Duhme & Co., Cincinnati, O.; Harwood Bros., A. Paul & Co., Palmer, Bachelder & Co., Boston, Mass., and material dealers generally.

*BEWARE OF BASE IMITATIONS put up by unprincipled persons. None are genuine without the Trade Mark which consists of the letters A. B. M. in monogram and fac simile of Medal awarded by U. S. Centennial Commission.*



**CHARLES VAGT & CO.,**

60 &amp; 62 MURRAY STREET, (cor. College Place,) NEW YORK.

⇒\*IMPORTERS OF\*←

Vases, Biscuit Statuettes, Plaques, Paintings,  
Hispaniola and Hungarian Ware, Fine Potteries,Dresden Porcelain, Vienna Ivory Ware,  
Fine China Fancy Articles decorated with Roses, Apple Blossom and Cactus.

⇒\*SPECIALLY ADAPTED FOR THE JEWELRY TRADE.\*←

**L. A. CUPPIA,**

Manufacturing Jeweler,

19 Union Square, N. Y.

**SILVER CANE HEADS,**

A Large and Comprehensive Assortment of New and Original Designs.

AND IMPORTER OF

 **SILVER FILIGREE JEWELRY** 

Embracing a Large and Varied Assortment of Popular Designs.

**SILVER JEWELRY.**

SILVER BRACELETS A SPECIALTY.

SELECTION PACKAGES SENT ON APPROVAL.

Established 1828.

**JACOB BENNETT & SON,**

Diamond Setters and Manufacturing Jewelers,

No. 923 CHESTNUT STREET, PHILADELPHIA.

WE MANUFACTURE AND MAKE A SPECIALTY OF  
EVERY DESCRIPTION OF**DIAMOND MOUNTINGS,**

SUPERIOR IN DESIGN AND WORKMANSHIP.



Dealers in

**DIAMONDS**

And all kinds of Precious Stones.

Of which we keep a Large Assortment Constantly on Hand.

Masonic Marks Society and School Badges, Made to Order Only. Designs and Estimates Furnished.  
PARTICULAR ATTENTION GIVEN TO ALL KINDS OF JOBBING.**JAMES H. HART,**

4 MAIDEN LANE,

NEW YORK.

**IMPORTER AND JOBBER.***Diamonds, Watches, French Clocks and Bronzes. Faience, Porcelain and Royal Worcester Ware. Opera Glasses, Silk Guards, Etc.***AMERICAN-WALTHAM WATCHES.**have just received a very large line of **WHITBY JET GOODS**, comprising all the Novelties, at very low prices.

GOODS SENT ON SELECTION TO RESPONSIBLE HOUSES.





181



193



PATENT APPLIED FOR  
193



214



218



219

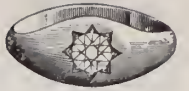

812



THE ABOVE CUTS ARE THREE DIFFERENT  
SHAPES IN THE SAME WEIGHT OF PLAIN  
RINGS. TO BE USED IN ORDERING.

# J. B. BOWDEN & Co.,

## MANUFACTURERS OF SOLID RINGS OF EVERY DESCRIPTION.

No. 1 MAIDEN LANE, cor. Broadway, NEW YORK.

# WILLIAM H. BALL, MANUFACTURING JEWELER,

(Bracelets and Bangles a Specialty,)

No. 9 JOHN ST., N. Y.

San Francisco Office, 120 Sutter Street.

Factory, Newark, N. J.

GOODS SENT ON SELECTION TO RESPONSIBLE PARTIES.

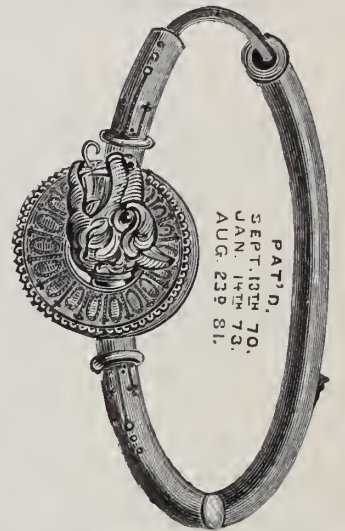

# THEUERNER & CHURCH, MANUFACTURERS OF FINE RINGS,

No. 9 MAIDEN LANE,

NEW YORK.

FACTORY, COR. MULBERRY & DURAND STS., NEWARK, N. J.

LEON JEANNE.

PAUL JEANNE

## JEANNE BROTHERS

MANUFACTURERS OF

# DIAMOND MOUNTINGS,

## AND RICH JEWELRY.

No. 1 MAIDEN LANE, NEW YORK

Designs Furnished and Estimates Given.

JEANNE BROS PAT. DIAMOND SETTINGS.

A PLATINUM SETTING WITH A GOLD SURFACE OUTSIDE

IN THIS WAY THE REFLECTION OF GOLD THROUGH THE DIAMOND IS ENTIRELY AVOIDED.

PAT. AUG. 15TH 1882



# A NEW PIN TONGUE VISE

FOR JEWELERS and DEALERS  in JEWELERS' SUPPLIES.

*This New Device for securely holding Pin Tongues while being fitted, will commend itself to every Practical Workman.*

*The joint of the tongue is placed in one of the graduated grooves and firmly secured by tightening the screw, enabling the workman to either file the joint to any required thickness, brooch the hole, shorten the pin or correct such defects as he may desire with ease and dispatch.*

*These tools are made of Hardened Steel, Nickel Plated, and is a useful and handy tool.*

Price, \$1.25. For Sale to the Trade by

**HENRY GINNEL & CO., Wholesale Agents,**  
**31 Maiden Lane, NEW YORK.**

## F. W. GESSWEIN,

No. 39 JOHN STREET,

NEW YORK.

### MANUFACTURER OF

MACHINERY AND TOOLS FOR

*Jewelers, Watch, Clock, Chronometer,  
 Watch Case and Fine Instrument  
 Makers. Wire and Bristle  
 Brushes. Polishing Im-  
 plements.*

### IMPORTER OF

TOOLS, FILES AND SUPPLIES FOR

*Jewelers, Silversmiths, Engravers, Watch  
 and Watch Case Manufacturers,  
 Clock and Chronometer Makers,  
 Platers, Polishers, Machin-  
 ists, Dentists, etc., etc.*

MANUFACTURER OF HAND CUT FILES.

Factory, PATERSON FILE WORKS, PATERSON, N. J.

—† ESTABLISHED 1874. †—

## JOSEPH P. WATHIER,

Successor to JOSEPH P. WATHIER & BRO.,

178 WEST MADISON ST., CHICAGO, ILL.

WHOLESALE JEWELER & WATCHMAKER & JEWELER FOR THE TRADE,

Changing of Key Winding Movements into Stem Winding and Hand Setting,

AND MAKING STEM WINDING PARTS A SPECIALTY.

*All Work Intrusted to me will receive PROMPT ATTENTION, and Satisfaction Warranted, at Prices Always the Lowest.*

## EDWIN A. THRALL,

1 MAIDEN LANE,

NEW YORK.

—° JOBBER IN °—

**American Watches, Diamonds, Fine Jewelry, Chains, Etc.**

Respectfully calls the attention of Cash Buyers to his stock of American **WALTHAM WATCHES**, embracing all grades and styles. Every Watch before being sent out is carefully examined and timed by competent workmen. This precaution will be appreciated by practical men. To Buyers visiting New York, I shall be pleased to show my stock and method of timing. Correspondence solicited from regular dealers. I sell only for Cash and give all discounts allowed. Special Styles of Cases, made to my order, always on hand. Agent for the New Mascot Bracelet, Patented. Repairing and Adjusting Watches and Chronometers for the Trade a Specialty.



MAKER OF FINE

Jewelry.



394D.  
Patented.

SEND FOR REDUCED PRICES

# INITIAL RINGS.



DEALERS WISHING TO ADVERTISE CAN BE FURNISHED

WITH ELECTROTYPES OF DESIGNS,

WITHOUT CHARGE,

BY ADDRESSING THIS HOUSE.

HENRY C. HASKELL,

12

JOHN STREET,

NEW YORK.

Goods sent on approval upon receipt  
of Satisfactory References.

## A. J. WARNER & CO., WHOLESALE JEWELERS,

309 Nicollet Avenue, Minneapolis, Minn.

We carry a Large and Elegant Stock of Jewelry, Watches, Cases, Etc., Etc.

North-western Agents of the WATERBURY CLOCK CO., and carry a Complete  
Line of their Goods.

OUR TRADE IS EXCLUSIVELY WITH THE JEWELERS.

## O. A. GAGER,

Successor to CHAS. FIELD HAVILAND & CO.,

IMPORTER OF

# Porcelain and Ornamental Ceramics,

29 BARCLAY STREET.

A Fine Line of FANCY POTTERY of all grades, specially adapted for Jewelers.

PARIAN, BISQUE, TERRE COTTA, FAIENCE, PORCELAIN, ETC.

VASES, PLAQUES, STATUETTES, BUSTS, ETC., ETC.

## M. FOX & CO.,

Practical Lapidaries and Importers of

# DIAMONDS.

Rubies, Sapphires and Fancy Gems.

PEARLS, TURQUOISE, INTAGLIOS, ONYX, AMETHYST, ETC.

No. 1 MAIDEN LANE, NEW YORK.



**N. H. WHITE,**  
 JOBBER IN  
**AMERICAN-WALTHAM WATCHES,**  
 EXCLUSIVELY.

Waltham make of gold and silver cases a Specialty. Ladd, Boss, and the Patent Screw Bezel Filled Cases to fit Waltham movements only  
 No. 11 MAIDEN LANE, NEW YORK.

I not only advertise that I have the Waltham Goods, but **have constantly on hand** the Largest Stock carried by any jobber in the trade. Gold Cases of all Weights and Styles. Memorandum Packages with pleasure to dealers furnishing satisfactory reference.

**COMPLETE PRICE LIST TO THE TRADE.**

**HERMAN TROST & CO.,**  
**IMPORTERS,**

50, 52, 54 MURRAY STREET, NEW YORK.

**PARIS:**

130 Rue du Faubourg St. Denis.

**YOKOHAMA.**

**LIMOGES:**

38 Avenue du Crucifix.

*Fine China Ware, Vases, Figures, &c., Biscuit Statuettes, &c., Sevres, Dresden and Worcester Porcelain, Vienna Fancy Goods. Very Fine Collection of PAINTINGS and PLAQUES on China and Faience. JAPANESE and CHINESE GOODS. Capo di Monte China Articles, Vases, Tankards, &c. Specialty of Fine China Articles, suitable for Jewelry Stores.*

The Largest Assortment in the United States at Lowest Prices.

ESTABLISHED 1859.

**RINGS AND DIAMOND JEWELRY.**  
**BRYANT & BENTLEY,**  
 12 MAIDEN LANE, Up-Stairs, NEW YORK.

AMONG OUR STAPLE PATTERNS ARE



595.



610.



607.



611.



616.



630.

No. 595, Turquoise or Square Garnets with 3 Diamonds, 2 Pearls and 1 Diamond, or 3 Pearls. No. 610, All combinations of Doublets and whole Pearls and Diamonds, or all Diamonds. No. 607, All combinations of Doublets and whole Pearls and Diamonds, or all Diamonds, or 3 Pearls. No. 611, Emerald, Sapphire or Ruby Doublets, with 2 whole Pearls, or 2 Diamond Brilliants. No. 616, Pearls or Diamond. No. 630, 2 Garnets with 2 whole Pearls or 2 Diamond Brilliants.

We also continue to make a full line of our well known 16 K. HARD SOLDER RINGS. Goods sent on approval to responsible parties.

**C. ROGERS & BROS.,**  
 MERIDEN, WESTMINSTER, CONN.

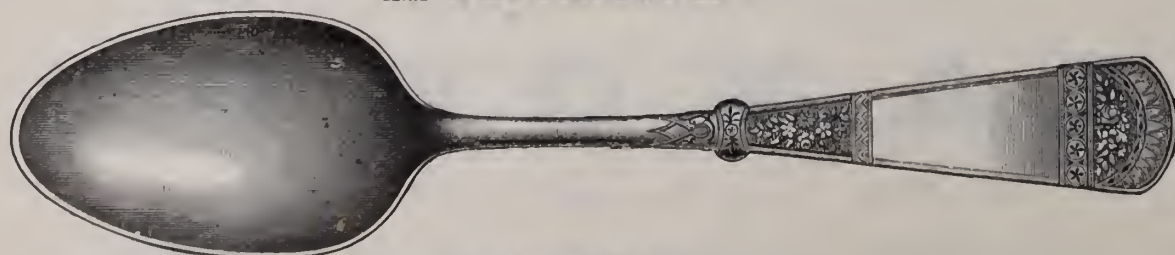

**PATENTED.**

We Guarantee all goods bearing our stamp to be made of 18 per cent. Nickel Silver, and plated equal to the very best in market.



# WM. S. HEDGES & CO.,

IMPORTERS OF



COPYRIGHT SECURED. Entered according to Act of Congress in the year 1880, by WM. S. HEDGES & Co., in the Office of the Librarian of Congress, at Washington.

170 BROADWAY,

**Corner Maiden Lane, New York.**

---

**CHOICE BRILLIANTS IN SINGLE STONES AND MATCHED PAIRS A SPECIALTY.**

---

**Fresh invoices of Goods in all Grades constantly arriving. Also choice parcels of exceptionally Fine Gems ESPECIALLY Selected for critical purchasers. A full line of Mounted Goods, Artistically Designed.**

GOODS SENT ON APPROVAL.



THE CELEBRATED  
**PATENT DUST PROOF**  
 SCREW BEZEL



MANUFACTURED BY

**THE AMERICAN WATCH CO.,**

OF

**WALTHAM, MASS.,**

Are now made in the following styles:



No. 303.

No. 301. Regular Weight (about 3 oz.), with Patent Screw Bezel and Cap.

This case has been favorably known to the Trade for the past four years, and is regarded as the STANDARD for this style of goods.



No. 302. Extra Weight (about 4 oz.), with Patent Screw Bezel and Cap.

This case is now offered to the Trade with the view of supplying the demand for a heavier and larger case than our Standard, No. 301.



No. 303. Regular Weight (about 3 oz.), with Patent Screw Bezel and Cap, and INLAID DECORATION of 14 karat Gold, pressed into the Silver, flush with the surface, preventing all wear on the decoration.

**ROBBINS & APPLETON,**

**GENERAL AGENTS,**

NEW YORK.

CHICAGO.

BOSTON.

LONDON, ENG.

SYDNEY, N. S. W., AUSTRALIA.



8 AND 14 SIZE  
**Waltham Movements**

— IN —

“CRESCENT” GOLD FILLED CASES,

**Also 18 Size Gold Filled Cases**

**IN HUNTING, OPEN FACE AND PATENT DUST PROOF SCREW BEZEL.**



The above Cases are Manufactured by the

CHICAGO WATCH CASE CO.,

and we take pleasure in recommending them to the Trade generally as the Best Gold Filled Cases made.

Special Net Price List of the above, and all goods manufactured by The American Watch Co., will be forwarded to Dealers only. Applicants must inclose BUSINESS CARD.

**ROBBINS & APPLETON,**

GENERAL AGENTS,

New York,

Chicago,

Boston,

London, England,

Sydney, N. S. W., Australia.





*Randel, Barmore & Billings,*

*Importers of*

*Diamonds*

*and Manufacturers of*

*Diamond Jewelry.*

*58 Nassau Street,  
8 29 Maiden Lane,  
New York.*

*1 St. Andrews Street,  
Holborn Circus,  
London, E. C.*



A SPECIALTY.  
PATENT CATCH BRACELETS.



PAT. SEPT. 30 1882.

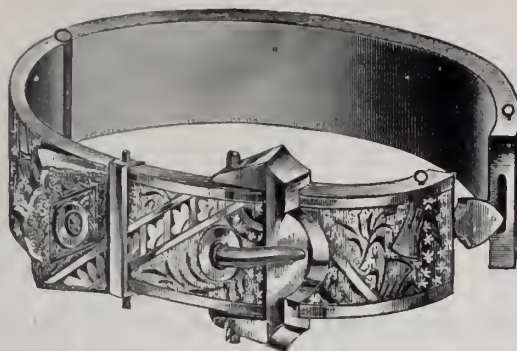

The most Convenient and Complete Catch ever invented. Not liable to get out of Order. Very Durable.

C. I. RICHARDS, BROWN & CO.,

MANUFACTURERS OF

Gold and Plated Jewelry,

202 BROADWAY,

Factory, Providence, R. I.

NEW YORK.

We now offer to the Trade a Fine Assortment of Rolled Plate Jewelry, Patent Catch Bracelets in First and Second Quality, Enameled, Chased and Roman, with and without Buckle and Fancy Ornaments. Bangles and Flat Bands in great variety. Our Patent Lever and Separable Buttons and Studs, Ladies' and Gent's Collar Buttons, Charms, Lockets, Lace and Scarf Pins, Sets, Chains, etc., etc.

ALSO A FULL LINE OF BRILLIANT JEWELRY IN GOLD.

Goods Sent on Approval upon Application with Satisfactory Reference.



R. HENRICH,

"SELF-SIZING RING,"

(PATENTED MARCH 20th, 1883.)

NEW PATTERNS FOR FALL TRADE.



FOR SALE BY ALL JOBBERS.

SEAL AND STONE RINGS IN ALL VARIETIES.

35 Maiden Lane, NEW YORK.

ESTABLISHED 1849.

KOCH & DREYFUS,

WHOLESALE DEALERS IN

WATCHES, JEWELRY, CLOCKS, DIAMONDS, SPECTACLES, ETC.

ALSO JEWELERS' AND WATCHMAKERS' TOOLS AND MATERIALS AT MANUFACTURERS' PRICES.

18 CHARTRES ST., NEW ORLEANS.

BRANCH OFFICE, 20 MAIDEN LANE, N. Y.

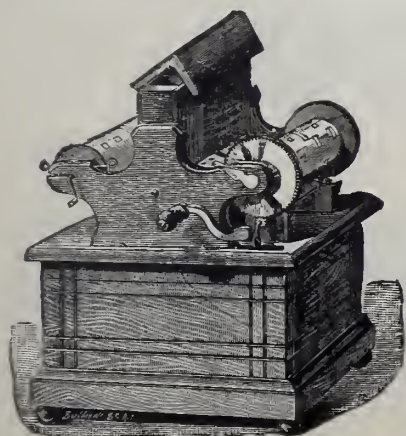

Reed Pipe Clariona, \$8.

CLARIONAS. AUREPHONAS.  
ATTRACTIVE AND SALABLE STOCK.

Both Instruments of Superior Tone, Beautiful in Finish, thoroughly Durable and Salable.

We make a Specialty of the Sale of Mechanical Musical Instruments, and keep the Largest Variety in the world. Send for Catalogue and Discounts to

WM. BLASIUS, 923 & 925 Chestnut St., Philadelphia, Pa.  
Gen'l Agent.



Aurephone, \$10.

17 Full Sized Reeds. Durability Guaranteed. All Music on Spools, at 4c. a Foot.



# SINNOCK & SHERRILL,



No. 2234.  
Doublet and Pearl.



No. 2047  
14 K. fine.  
Garnet and Pearl.



No. 2156  
14 K. fine.  
Class Rings.



No. 1195  
14 K. fine.  
Turquoise and Pearl.



No. 1909  
14 K. fine.  
Sapphire and Diamond.

MANUFACTURERS OF  
Ladies Fancy Stone Rings in Great Variety.

Factory, Newark, N. J.

All 14 K. Goods Guaranteed to Assay  $\frac{584}{1000}$  Fine.



ALSO  
DIAMOND INITIAL RINGS.

Office, 3 Maiden Lane, New York.

All 14 K. Goods Guaranteed to Assay  $\frac{584}{1000}$  Fine.

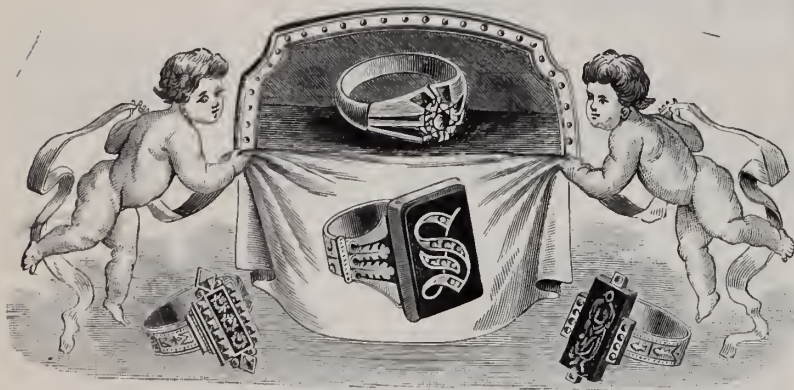

SPECIALTY.—Solid Gold Rings of  
Every Description, Scarf Pins,  
Studs, Etc.

## L. SAUTER,

1 MAIDEN LANE, Cor. Broadway, NEW YORK.

MANUFACTURER OF

Fine and Diamond Jewelry,

HAIR JEWELRY and DEVICE WORK.

JOBGING FOR THE TRADE.



## HEEREN BROS. & CO.,

MANUFACTURING AND WHOLESALE JEWELERS.

IMPORTERS AND JOBBERS OF

WATCHES, CLOCKS, JEWELRY, OPTICAL GOODS,

Silver Plated Ware, Watchmakers' & Jewelers' Tools, Materials & Supplies.

42 FIFTH AVE., PITTSBURG, PA.

## J. KITTEL & CO.,

IMPORTERS OF



# ROYAL WORCESTER

AND OTHER FINE POTTERY AND GLASS,

28 Barclay Street,

New York.





In conformity to the desires of our  
Customers for new styles of Goods, we  
are prepared to display many

❖SPECIALTIES,❖

together with a Full Line of Staple  
Productions for the

❖FALL TRADE.❖

We solicit your custom.

CARTER, SLOAN & CO.,

**No. 15 MAIDEN LANE,**

P. O. Box 90.

NEW YORK.





# WHEELER, PARSONS & HAYES,

NO. 2 MAIDEN LANE, NEW YORK.

Manufacturers of  
**WATCH CASES,**  
 GOLD CHAINS and GOLD JEWELRY.  
 Importers of  
**SWISS WATCHES,**  
 And Wholesale Dealers in  
**GOLD AND SILVER CASES,**  
**AMERICAN WATCHES,**  
 AND  
**CHRONOGRAPHS.**

**DIAMONDS,**  
 GOLD JEWELRY,  
 GOLD CHAINS,  
 PLATED CHAINS,  
 AND  
 PLATED JEWELRY.

A Full Stock of  
**WALTHAM,**  
**ELGIN,**  
**HAMPDEN,**  
**ILLINOIS**  
 AND  
**E. HOWARD & CO.**  
**MOVEMENTS.**

**CHATELAINE WATCHES,**  
 Gold, Silver and Nickel,  
 In Elegant Designs.

Our Stock of Gold Cases is of our own manufacture, and is Full and Complete in every detail. We are constantly adding to our *REGULAR STYLES* Novelties in Fancy Engraved and Raised Ornamentation Work, both in Fine and Lower Grades.

In our "Eagle" quality we have introduced many *NEW DESIGNS*, making a more Attractive Assortment than ever before presented.

We are also adding to our general stock of JEWELRY Choice and Desirable Patterns, which for Beauty of Design, Quality and Price must attract the attention of buyers. The entire stock of goods displayed by us this season is unusually large and complete, and to which we invite the attention of the Trade.

*Our Price List of Movements and Cases will be forwarded to Dealers upon Application.*

The A. W. Co., have ceased making the Lady Riverside Movements. We have secured the *entire* remaining stock and are prepared to fill all orders for the same.

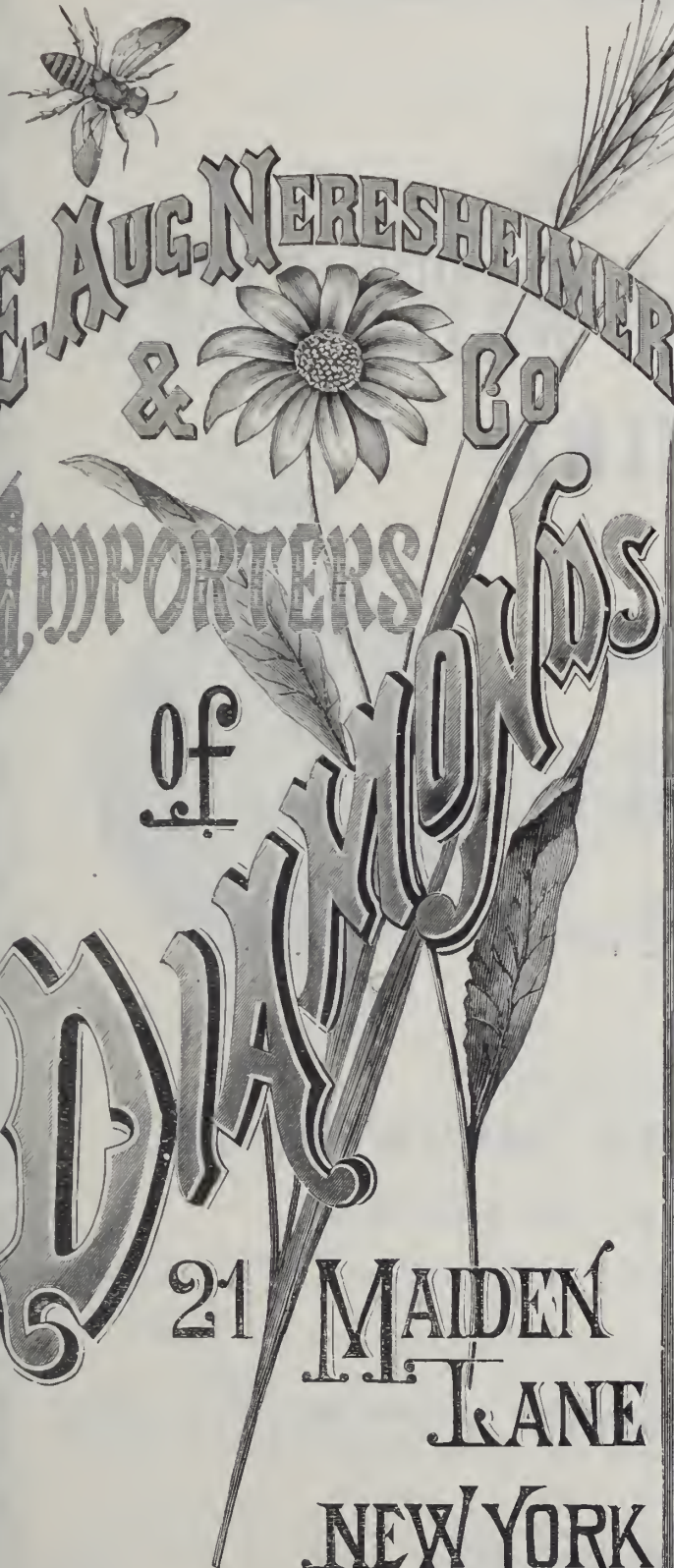

A decorative arrangement of a bee at the top left, a daisy flower in the center, and a stalk of grain at the top right, all intertwined with the text.

**E. AUG. NERESHEIMER**  
**& Co**  
**IMPORTERS**  
**of**  
**DIAMONDS**  
**21 MAIDEN**  
**LANE**  
**NEW YORK**

NO 66 SARPHATI STRAAT  
AMSTERDAM HOLL.

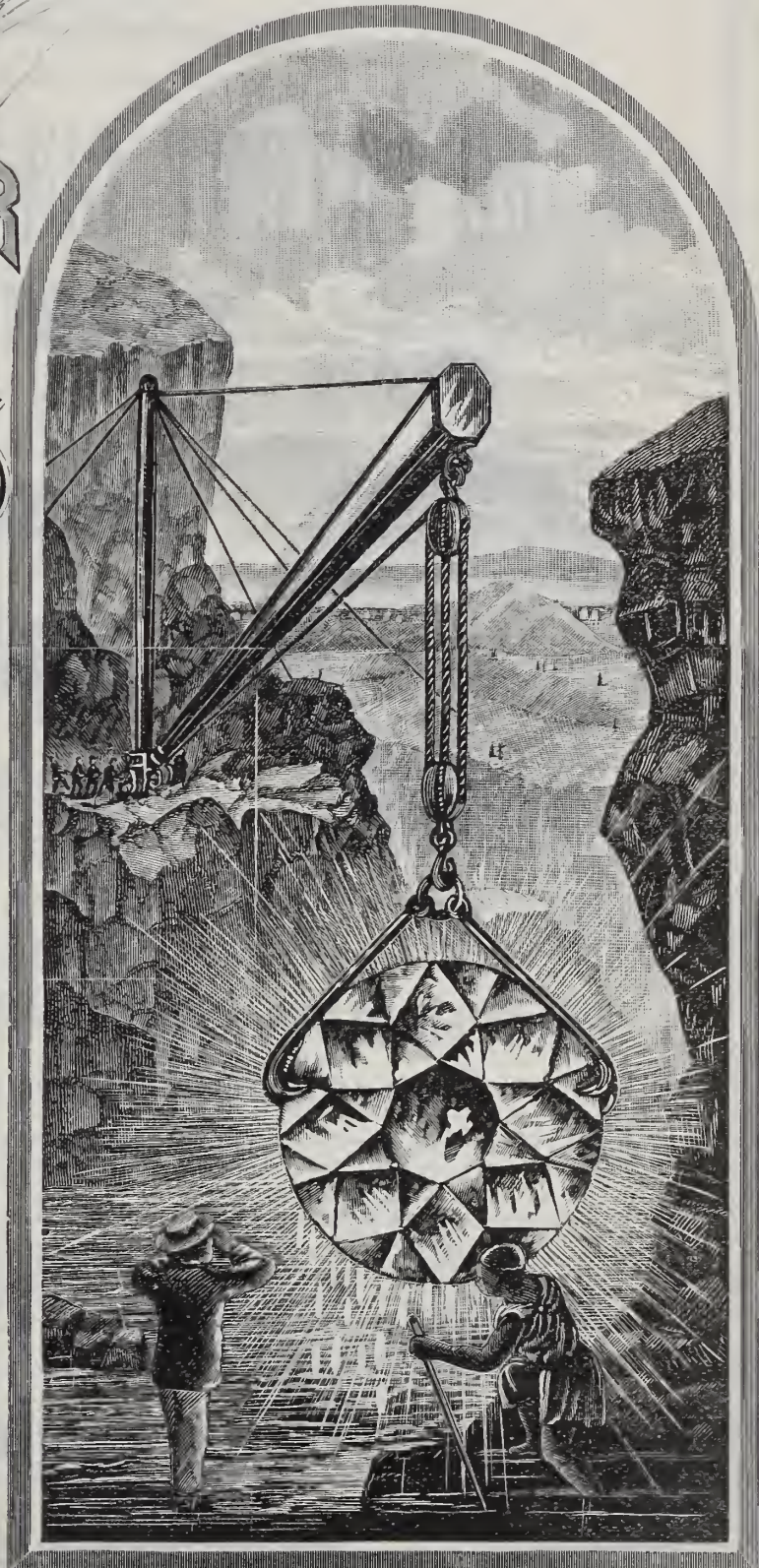



# Ladd Watch Case Company,

(ORGANIZED 1883.)

SUCCESSORS TO J. A. BROWN & CO.

(ESTABLISHED 1858.)

MANUFACTURERS OF THE

## LADD PATENT GOLD WATCH CASES.

### EXAMINE

THE

### NEW MODEL

### WARRANTY

### Ladd Case.



Design No. 615.



Design No. 799.

*Which is universally pronounced on sight to be the Most Elegant and the Best Article in this line yet brought out.*

### IT HAS ALL THE LATE IMPROVEMENTS

Including Solid Gold Bows and Solid Gold Linings,  
AND FOR WORKMANSHIP, STYLE AND FINISH IT IS UNEQUALED.

Its Shape is such as to admit of the most elaborate ornamentation, or any intermediate style down to the plainest, without loss of effectiveness, in accordance with the taste of the purchaser.

The **GOLD** in all of the **LADD CASES**, in the **COVERS** and **CENTER RIM** and **PEN-DANT**, is plump 14 Kt. fine, **POLISHED** to its natural color, a most **ESSENTIAL FEATURE** in the **WEAR** of a **WATCH CASE**.

For Sale by the Leading Wholesale Jobbing Trade.



# A Line of Novelties Suitable for Fall and Holiday Trade.

ARTISTIC POTTERY

BAWO &  
PLAQUES.

ITALIAN  
MARBLE

DOTTER,

FAIENCE.

MANUFACTURERS  
AND  
IMPORTERS.

BISQUE.

The Best Workshops of Europe

HAVE THIS SEASON

Been carefully searched to give us an assortment of Rich and Desirable Novelties unequalled by any Importing House in America.

Jewelers and others desiring a line of **FINE GOODS** to sell at a moderate price will find with us the following lines in great variety:

Articles to retail at from \$5.00 to \$40.00 a Specialty.

**VASES.**—Hungarian, French, China, Faience and Paris Barbotine.

**Choice Line of Royal Worcester Goods.**

**PLAQUES** of all values from Paris, Dresden, Vienna, Hungary, &c.

**CARLSBAD FLOWER WARE.**

**ITALIAN MARBLE.**—Groups, Figures, Busts, &c., hand carved and nice.

**BISQUE.**—Groups, Figures, Busts, &c., all prices, and a nice assortment of small articles.

**PARIAN WARE** in large variety.

**DRESDEN CHINA and AUGUSTUS REX** Vases, Cups and Saucers, Plates, Figures, &c., &c.

**LAVA GOODS.**—Figures, Animals, Smoke Sets, &c.

**BLUE FLEMISH WARE**, for Use and Ornament.

**CLOUD GOLD WARE**, with Raised Heron Decorations.

**FOR WEDDING AND BIRTHDAY GIFTS.**—Dresden, Old Vienna, Sevres, Limoges and other Novelties in Satin Lined Cases.

**FRENCH CHINA DECORATED WARE.**—An immense variety, entirely from our own works at Limoges. Gift Cups and Saucers, Tea, Chamber, Dinner, Breakfast, Ice Cream, Fruit, Game, Fish, Tom and Jerry, Tete-a-Tete Sets, Fruit Plates, Cuspadores, Jardinieres, &c.; Articles for Practical Use.

**MISCELLANEOUS.**—Wax and Bisque Dolls, Bohemian Glass Ware in great variety. Table Glass Ware, Cut and Engraved, Italian Figures, Wedgewood Ware, Minton Ware, &c.

Be sure and see our stock before you place your orders. Mail orders will receive particular attention. Name the articles wanted and prices you wish to pay, and we guarantee satisfaction in every instance.

NEW YORK WAREHOUSES AND OFFICE,  
30 & 32 Barclay Street.

P. O. BOX, 1872.

LIMOGES, FRANCE.  
RUE RICHER, PARIS.  
STEINSCHONAN, BOHEMIA.



# J. W. Wilson & Sons

have the finest and largest stock of  
French Clocks

both in Gilt and Marble cases,  
ever shown in the United States.

They offer a Cathedral  
Gong, Marble-cased Clock for  
\$1197 net.

This is not a cheap movement  
gotten up "regardless of cost," but  
is a reliable and well finished  
article. Salesrooms and office,  
31 Maiden Lane, New York.



Falkenau Oppenheimer & Co.  
Importers of  
Diamonds



40 Maiden Lane N. Y.

Post Office Box 3314.



ADOLF J. GRINBERG  
HENRY GOODMAN

LEOPOLD GOODMAN  
WM. L. POLLACK.

**GRINBERG, GOODMAN & POLLACK,**

MANUFACTURERS OF  
**FINE JEWELRY**  
AND  
**IMPORTERS OF DIAMONDS,**

**PARIS**  
44, rue de Lafayette

*No. 32 Maiden Lane,*  
**NEW YORK.**

DIAMOND MOUNTINGS A SPECIALTY.

Goods Sent on Approval upon Application.

Value need not be put upon Packages sent by us, as we carry an  
OPEN INSURANCE POLICY.





**F. KROEBER,**  
**IMPORTER,**

**No. 14 Corlandt Street,**

**NEW YORK.**

LARGE ASSORTMENT OF  
FRENCH MARBLE CLOCKS,  
GILT CLOCKS,  
GILT AND ALABASTER CLOCKS.

*GILT and PORCELAIN CLOCKS, and NOVELTIES FROM PARIS for the Fall Season, 1883,  
at Low Prices.*

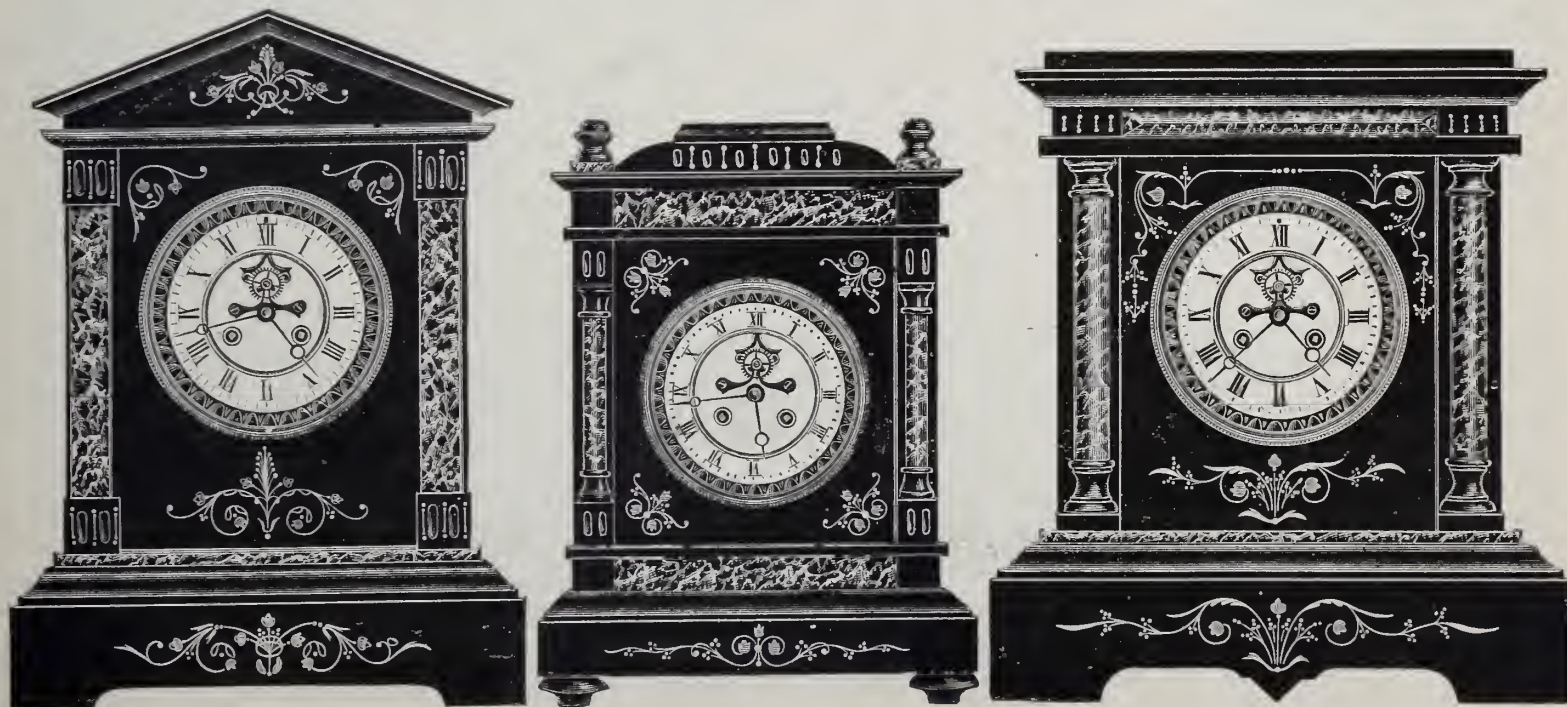

*Marble Clocks with Cathedral Gongs, at \$13.75 and upwards.*



The Third Annual Report of the Astronomer of Yale College Observatory awards the **Celebrated VACHERON & CONSTANTIN Geneva Watches** the highest average ever recorded at this Observatory. Below is given a copy of Report of Movements subjected to the severest Observatory tests during 1883:

**TABLE No. 1.**—WATCH MOVEMENTS OBSERVED FOR 42 DAYS, IN FIVE POSITIONS, AND IN THE OVEN AND REFRIGERATOR, AND WHICH RECEIVED CLASS I. CERTIFICATES.

| Rank. | Maker's Number. | Name engraved on the face of the watch. | Escapement.  | Spring.      | Mean daily |            | Variation for 1° Fahr. | Diff. bet. Pendant up and Dial up. | Diff. Pend't up and Pend't right. | Diff. Pend't up and Pend't left. | Diff. Dial up and Dial down. | Diff. bet. extremes of rate. | Mark compared for. |           |              | Total. |
|-------|-----------------|-----------------------------------------|--------------|--------------|------------|------------|------------------------|------------------------------------|-----------------------------------|----------------------------------|------------------------------|------------------------------|--------------------|-----------|--------------|--------|
|       |                 |                                         |              |              | rate.      | variation. |                        |                                    |                                   |                                  |                              |                              | Daily variation    | Position. | Temperature. |        |
| 1     | 2               | 3                                       | 4            | 5            | 6          | 7          | 8                      | 9                                  | 10                                | 11                               | 12                           | 13                           | 14                 | 15        | 16           | 17     |
| 1     | 263137          | Vacheron & Constantin,                  | Anchor.      | Breguet.     | -0.38      | 0.40       | +0.06                  | -1.94                              | -0.49                             | +1.36                            | +1.40                        | 4.5                          | 32                 | 37        | 16           | 85     |
| 2     | 999995          | American Watch Co.                      | Anchor.      | Breguet.     | -0.87      | 0.44       | +0.01                  | +1.96                              | -0.27                             | +4.63                            | +2.32                        | 5.7                          | 31                 | 33        | 19           | 83     |
| 3     | 1436            | Johnson.                                | Chronometer. | Cylindrical. | +0.74      | 0.36       | +0.07                  | +5.56                              | +1.52                             | +4.01                            | -1.44                        | 8.9                          | 33                 | 33        | 15           | 81     |
| 4     | 263136          | Vacheron & Constantin,                  | Anchor.      | Breguet.     | +4.36      | 0.65       | -0.05                  | -0.04                              | +2.53                             | +4.33                            | +0.02                        | 7.0                          | 27                 | 33        | 17           | 77     |
| 5     | 1583692         | American Watch Co.                      | Anchor.      | Flat.        | -2.19      | 0.40       | -0.05                  | +5.76                              | -2.22                             | -0.25                            | -13.55                       | 14.7                         | 32                 | 27        | 17           | 76     |
| 6     | 871104          | American Watch Co.                      | Anchor.      | Breguet.     | -4.35      | 0.62       | +0.13                  | -2.48                              | +2.16                             | -0.06                            | +3.47                        | 7.3                          | 28                 | 35        | 11           | 74     |
| 7     | 13533           | J. Jurgensen.                           | Anchor.      | Breguet.     | +2.18      | 0.81       | +0.08                  | +0.70                              | -4.20                             | +2.40                            | +0.80                        | 8.1                          | 24                 | 33        | 15           | 72     |
| 8     | 6049            | Schoof.                                 | Lever.*      | Breguet.     | -0.06      | 0.63       | -0.19                  | +0.95                              | +3.96                             | -4.71                            | -3.34                        | 11.0                         | 27                 | 29        | 7            | 63     |

\*Resilient attachment.

The Highest Distinction awarded the *Vacheron & Constantin* Watch in competition with other distinguished makers of Watches, as shown in the above table is sufficiently eloquent to speak for itself, considering the two movements mentioned above are known as our *No. 9 Grade*, or *Medium Quality*. The different grades made by Vacheron & Constantin are as follows:

|           | BALANCE.     | ESCAPEMENT.                                       | LEVER.       | HAIR SPRING. | JEWELS.                                             | CENTER JEWEL.                               | FINISHING.       | ADJUSTING.                                                 | SPECIAL SIGNS.                                           | Waltham Size. | Elgin Size. | Elgin Size. | Arabic, Roman and Gothic Dials. |
|-----------|--------------|---------------------------------------------------|--------------|--------------|-----------------------------------------------------|---------------------------------------------|------------------|------------------------------------------------------------|----------------------------------------------------------|---------------|-------------|-------------|---------------------------------|
| No. I.    | Compensated. | Straight line double roller exposed Ruby Pallets. | Contrepoids. | Breguet.     | Full Jeweled, best ruby.                            | Set center Jewel.                           | Highly finished. | Accurately adjusted to isochronism, cold, heat & position. | None.                                                    | 14 & 18       | 16          |             |                                 |
| No. II.   | "            | "                                                 | Polished.    | "            | "                                                   | Center Jewel.                               | "                | "                                                          | "                                                        | "             | "           |             |                                 |
| No. VIII. | "            | "                                                 | Plain.       | "            | Full Jeweled, ruby.                                 | "                                           | Fine finish.     | "                                                          | "                                                        | "             | "           | 6           |                                 |
| No. IX.   | "            | "                                                 | "            | "            | Ruby Jeweled, no end stone at the escapement wheel. | "                                           | "                | "                                                          | The center bridge has a cut opposite to the crown wheel. | "             | "           | "           |                                 |
| No. X.    | "            | "                                                 | "            | Flat.        | "                                                   | Without center Jewel, or with center Jewel. | "                | "                                                          | "                                                        | "             | "           | "           |                                 |

The Movements are interchangeable in all their parts. All those qualities are manufactured to fit Waltham and Elgin cases, both Open Face and Hunting. The ladies' watches are not manufactured in No. I, and only the 6 size fits the Elgin cases. The 12, 13 and 14 lines are Swiss sizes and case on blocks but are generally cased abroad. No. I is a watch of the highest grade of precision. No. II, VIII and IX give nearly the same results, but are not adjusted so close, all those three grades have nevertheless the same limits of running. No. X has an ordinary fine adjusting.

All parts of Movements or Materials are always in stock and can be supplied entirely finished. Also any desired information cheerfully given as well as copies of a large number of letters and testimonials from dealers who use and have the Vacheron & Constantin Watches and Movements constantly in their stocks. Prices furnished to the Trade on application to

**CHAS. LEO ABBY,**

*Sole Agent for United States and Canada,*



ESTABLISHED IN 1841.

# Wm. RICHARDSON & Co.

Manufacturers of  
**Gold Jewelry and Chains.**

23 MAIDEN LANE NEW YORK.

SAN FRANCISCO, 206 KEARNEY ST. HASKELL & MUEGGE AGT'S.



## MATHEY BROS. & MATHEZ,

NO. 16 MAIDEN LANE.

IMPORTERS OF ALL GRADES OF

Plain and Complicated Watches and Movements

SOLE AGENTS FOR THE WELL-KNOWN

# H. L. MATILE

Fine Watches of Astronomical Precision.



REPEATERS.



CHRONOGRAPHS.

In order to facilitate the handling of our Stem-Winding Movements, we have adopted a standard of sizes to fit American Cases. Of these we have a complete line from the medium grade to the highest class goods of fine adjustment and precision. As all our Movements, complicated and plain, are perfectly uniform in quality according to their respective grades, we can furnish material for any parts that may be required, with the positive assurance of accurate interchangeability.

An Extensive Line of all Grades of

# CHRONOGRAPHS, SPLIT SECONDS AND REPEATERS.

WATCHES DEMAGNETIZED.





WILHELM & GRAEF,  
 IMPORTERS OF

**Ceramic Specialties**

FOR FINE JEWELRY TRADE.

After a six months' personal search we are now prepared to offer choice selections from 1883 Exhibitions of Rome, Amsterdam and Zurich, and Novelties from England, France, Germany, Austria and Italy. Fine Figures and Cabinet Pieces from Worcester, Derby, Copeland, Mintons, Royal Dresden, Vienna and Ginori manufactories. Unequaled collection of Porcelain Paintings and Fine Plates. Antique and Modern Rich Enameled Glass. Own Designs and Models of Rich Decorated Duplex Lamps.

**INSPECTION AND COMPARISON SOLICITED.**

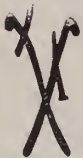

Broadway and 26th Street,  
**NEW YORK CITY.**



*Cutting Works,*  
 57-61 Rapenburgerstraat.  
 Amsterdam.

*House in*  
 Paris,  
 44 Rue Laffitte.

*L. B. Citroen & Co.,*

**DIAMONDS**

*21 John Street,*

*L. B. Citroen, Paris.*  
*Gustave Kuhn, N. Y.*

*New York.*



# THE CLIMAX REVERSIBLE WATCH CASES.

MANUFACTURED BY THE

Northwestern Watch Case Co.

MANUFACTURED BY THE

Northwestern Watch Case Co.



CHANGED FROM AN OPEN FACE TO A HUNTING CASE AT WILL.

MADE TO FIT THE 18 SIZE STEM WIND AMERICAN MOVEMENTS.

Patented April 3d, 1883, No. 275,251.

ABSOLUTELY DUST PROOF. A PERFECT WATCH CASE.

**A MARVEL OF INGENUOUS MECHANISM.**

—\*Descriptive Circulars Furnished Upon Application.\*—

# STANDARD WATCH CO.

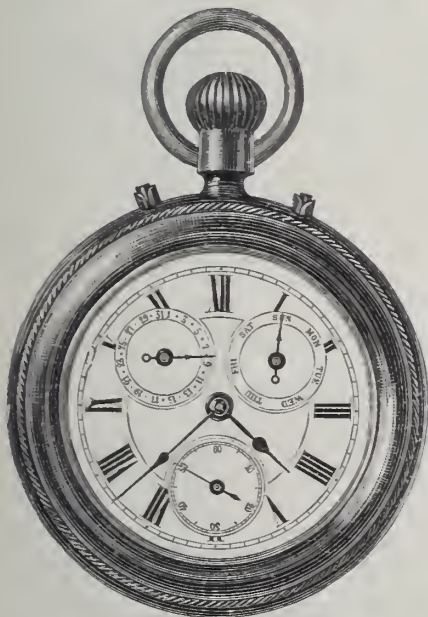

STANDARD CALENDAR

**"STANDARD CALENDAR."**

20 Line, Open Face, in Nickel and Silver, showing the date and day of the week, Full Jeweled, Finished Movement. The Latest Novelty offered.



**"STANDARD."**

18 Size, Low Price Movement, will fit Waltham and Elgin Cases.

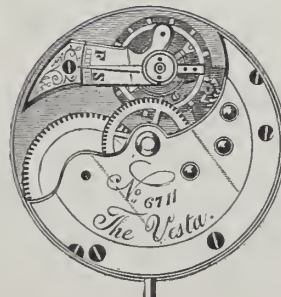

**"VESTA."**

8 Size, Low Price Movement, fits Elgin Cases.



**"STANDARD."**

8 Size, Full Jeweled, Ladies. Fits Waltham Cases.

REGISTERED.



**"STANDARD."**

Nickel, 17, 19 and 20 Line. Lever, Full Jeweled.

**Max Freund & Co., Sole Agents, 8 Maiden Lane, N. Y.**



ESTABLISHED 1844.

**DENNISON MFG CO.,**

BOSTON, NEW YORK, PHILADELPHIA, CHICAGO, CINCINNATI AND ST. LOUIS.

**JEWELERS' FINDINGS.**

**PAPER JEWELRY BOXES IN ALL STYLES AND QUALITIES. IMITATION MOROCCO BOXES, SATIN LINED. TAGS, JEWELERS' CARDS, PINK AND WHITE COTTON, &c., &c.**

**MOROCCO CASES.**

Manufacturing in our own Shops Every Description of Morocco, Plush and Velvet Jewelry and Silverware Cases in large quantities, we are enabled to sell lower than other goods of equal quality can be offered, and we carry in all our Stores FULL Stock of our whole line.

Catalogue on Application.

**BAKER, PRATT & CO.,**

IMPORTERS OF JEWELERS' FANCY GOODS,

MANUFACTURERS OF FINE LEATHER WARES,

No. 19 BOND STREET, NEW YORK.

Our success during the past season in manufacturing a Special Line of FINE LEATHER GOODS, has encouraged us to make greater efforts to present this season designs particularly for the Jewelry Trade. Our line embraces all known leathers, such as Seal, Alligator, Calf, Russia, Morocco, and our two ORIGINAL SPECIALTIES in leather,

**"ANTIQUÉ" AND "HAMMERED."**

The collection consists of all articles of personal belongings in leather, such as Promenade Bags, Card, Letter and Bank Bill Cases, Pocket and Betting Books, Coin Purses, Note Blocks, Dressing Cases, etc. Our line is now being handled by many leading jewelers.

(WRITE TO US FOR PARTICULARS.)





FRANK S. KENNEDY,

Manufacturer and Wholesale Dealer in

# JEWELRY

OF EVERY DESCRIPTION.



13 Maiden Lane,  
NEW YORK.

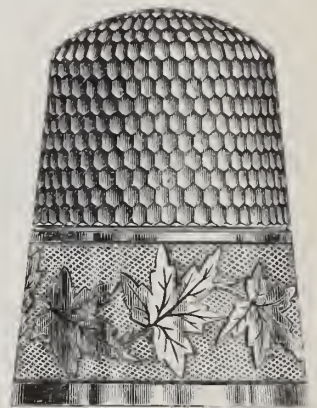

13 Maiden Lane,  
NEW YORK.

*In addition to my stock of Jewelry, which is complete in all lines of Gold, Silver and Roll Plate, I am now making a Full Assortment of*

## THIMBLES,

*in Solid Silver, 10 karat and 14 karat Gold. These Thimbles are Superior in Finish to any now in the market, and are as near perfection as long practical experience can make them. Will send Samples if desired.*

*The Assortments of Jewelry I send on Memorandum for Special and Stock Orders have an increasingly high reputation.*

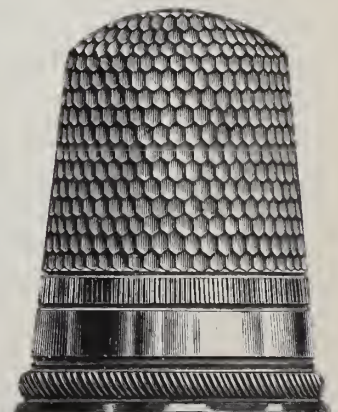



**T H E**  
**E. HOWARD WATCH AND CLOCK CO.,**

—MANUFACTURERS OF—

**Fine Stem-Winding Watches,**

FINE REGULATORS, OFFICE CLOCKS, TOWER CLOCKS,

**And Electric Watch Clocks.**



**LADIES'**  
6 Size.

**STEM-WINDING**  
AND



**GENT'S**  
16 Size.

**Stem-Setting**  
Movements.



**GENT'S**  
18 Size.

**114 TREMONT ST., BOSTON.**

**29 MAIDEN LANE, New York.**

J. W. J. PIERSON, Agent.



**WILLEMIN WATCH CASE CO.,**

109 Sands Street, Brooklyn, N. Y.



Our Engine Turned (Jurgensen Cases), a Specialty with us, have achieved a high reputation in the Trade, and are, without any exception, the Best and Cleanest Cut Engine Turned Cases in the market.

We ask you to compare these Cases with those of any other manufacture, as they are so made that they will stand the closest criticism. We also invite especial attention to our Raised Gold Ornamentation Work, Escalloped, Enameled and other styles of decoration.

—♦—

**New York Office, 14 & 16 Maiden Lane.**



# KREMENTZ & CO.,

MANUFACTURERS OF

GOLD, PEARL AND DIAMOND JEWELRY,

Nos. 182 and 184 BROADWAY,

Corner of John Street,

NEW YORK.

(Elevator Entrance on John Street.)

NOVELTIES IN SILVER JEWELRY.

FACTORY, NEWARK, N. J.

---

## J. EUGENE ROBERT,

IMPORTER OF

MOVEMENTS & WATCHES,

**No. 30 Maiden Lane, New York.**

Ladies' and Gent's Stem Winding Movements, Fitting American Cases,  
all fully warranted.

Ladies' Small Sized Watches in Fancy Gold Cases of every Variety and  
Style of Decoration.

—: SOLE AGENT FOR :—

**LOUIS AUDEMARS**

Superior Watches. Plain and Complicated Stem Winders of every style, man-  
ufactured with the Latest Improvements.

**CHRONOGRAPHS WITH OR WITHOUT SPLIT SECONDS.**



# GEO. H. RICHARDS, JR.,

383 Washington Street, Boston, Mass., U. S. A.,

## JOBBER

# AMERICAN MOVEMENTS & CASES

A SPECIALTY.

WE GUARANTEE TO HAVE **ALL GRADES** IN STOCK.

### MOVEMENTS.

WALTHAM.    SPRINGFIELD, ILLS.    HAMPDEN.    ELGIN.    HOWARD.

### CASES.

❖GOLD❖

WALTHAM.  
DUEBER.  
BROOKLYN.  
G. H. R., Jr.

❖FILLED❖

"BOSS."  
CROWN.  
LADD.

❖SILVER❖

WALTHAM.  
DUEBER.  
FAHYS.  
KEYSTONE.

## Watches, Jewelry and Silver Plated Ware.

ROGERS & BRO.'S FLAT WARE.

HOLLOW AND FLAT WARE SOLD AT MANUFACTURERS' DISCOUNTS.

Our Stock is positively the Largest, Finest and Best Assorted of any Jobbing House in the Country. All Orders Promptly Executed.

SOLE AGENT FOR

## GOOLD'S PATENT REGULATOR,

FOR SALE BY ALL JOBBERS AND MATERIAL DEALERS.

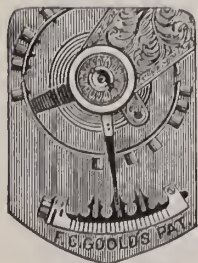

For 18 Size Movements, K. W. & S. W.



For 18 Size Movements, K. W. & S. W.

THE REGULATOR WILL BE IN THE MARKET JULY 1st, Price, \$1.25.

GEO. H. RICHARDS, Jr., 383 Washington Street, Boston, Mass.



# AIKIN, LAMBERT & CO.

23 MAIDEN LANE, NEW YORK,

MANUFACTURERS, IMPORTERS, JOBBERS.

## →: JEWELRY. :←

A Large Assortment of all Leading Styles in GOLD, SILVER and ROLL PLATE, including

|                   |                        |
|-------------------|------------------------|
| <i>Diamonds,</i>  | <i>Bullions,</i>       |
| <i>Bracelets,</i> | <i>Studs,</i>          |
| <i>Rings,</i>     | <i>Lace Pins,</i>      |
| <i>Chains,</i>    | <i>Drops and Sets,</i> |
| <i>Charms,</i>    | <i>Scarf Pins,</i>     |
| <i>Locketts,</i>  | <i>Emblems,</i>        |
|                   | <i>Thimbles, Etc.</i>  |

## →: WATCHES. :←

PAUL BRETON

Fine Movements, In Gold Cases.

AGASSIZ AND LONGINES

Stem Winding Movements, Fitting American Cases.

CHRONOGRAPHS, in Silver and Gold Cases.

Reliable Swiss Silver and Nickel Stem Winders.

ALL LEADING AMERICAN MOVEMENTS AND CASES.

## GOLD PENS,

HOLDERS, PENCILS, TOOTH PICKS.



“NOVELTIES” IN PENCIL CHARMS.

Show Case and Fancy Tray Assortments, in New and Tasty Designs for Jewelers, A SPECIALTY.

Catalogues and Price Lists sent to Dealers when request is accompanied by Business Card.



Branches: } 113 EAST MADISON STREET, CHICAGO, ILLS.  
 } 41 WEST FOURTH STREET, CINCINNATI, O.

Factories: } 14, 16 & 18 MAIDEN LANE, N. Y.  
 } 12 VESEY AND 6 BARCLAY ST., N. Y.

→: Novelties Continually Being Introduced. :←

SELECTION PACKAGES SENT.

JAMES C. AIKIN. }  
 H. A. LAMBERT. }

PROMPT ATTENTION TO ORDERS AND REPAIRS.

{ J. B. SHEA.  
 { D. F. FOLEY.





99



1162



93



28



94



0027



0045



1336



1810

THE



1741



1016



1094

# ACME LEVER BUTTON



0001



OPEN.



OPEN.



OPEN.



0025



43



CLOSED.



CLOSED.



CLOSED.



1091



323



VENI + VICI.

Always was, is now, ever shall be  
THE MOST CONVENIENT,  
STRONG, RELIABLE and PERFECT SLEEVE BUTTON MADE

It Overcomes  
ALL TROUBLE WITH STIFF CUFFS.

ASK YOUR JEWELER FOR THE  
ACME LEVER SLEEVE AND COLLAR BUTTON,  
AND TAKE NO OTHER.

For Sale by all Jobbers of Jewelry.



1420



1166



1369



1316

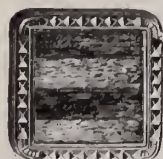

319

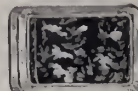

1269



50



58



1585



046



321



57



1515



1338



1235



1340



315



1235



02

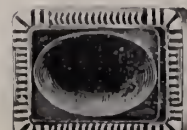

1182



634



NEW YORK :

No. 676 Broadway.

LONDON :

21 Holborn Viaduct.

ESTABLISHED 1847.

OLD HOUSE, READ, TAYLOR & Co.

**TAYLOR & BROTHER,**  
IMPORTERS OF

*French Marble Clocks and Bronzes,*

AND NOVELTIES IN

French, Vienna, English and other Fancy Goods.

We invite the attention of the Trade to our Latest Importations, personally selected by one of our firm now in Europe.

See also our advertisement of

Diamonds, &c.

Watches, etc.

Sole Agents

Jaques Le Coultre

**RAZORS.**



OPPENHEIMER BROS. & VEITH,  
 WATCHES,  
 DIAMONDS,  
 JEWELRY.

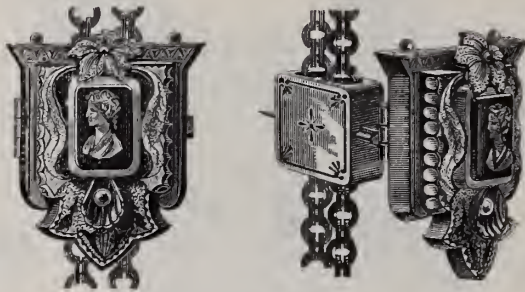

*We are the Manufacturers and Patentees of the Combination Slide, Pendant and Locket, and the Combination Necklace, Lace Pin and Pendant.*



*We can furnish quite a variety of Styles, and are prepared to fill all Orders at once.*

35 MAIDEN LANE, NEW YORK.



# A NEW DEPARTURE.

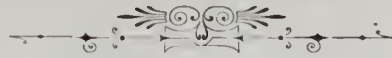

## 14 KARAT GOLD CHAIN, SILVER LINED,

— MADE BY —

### A NEW PROCESS.

Guaranteed to wear as well as the best 14 karat Gold Chain made.  
Every Chain warranted to assay one-third ( $\frac{1}{3}$ ) its entire weight in gold.  
Each Chain stamped with registered trade mark:



*Showing the Relative Thickness*  
OF THE GOLD AND SILVER.



*Showing the Relative Thickness*  
OF THE GOLD AND SILVER.

Money refunded if test is unsatisfactory.

## KOSSUTH MARX & CO.,

Proprietors and Manufacturers,

39 Maiden Lane, New York.

In introducing our new Chain we aim to supply a want which we believe the Trade can place before the public in a legitimate manner without deception, and no detriment to the standard of the most scrupulous dealer.

We offer these goods strictly upon their merits, and give but a few reasons why they can take the place of the older styles of manufacture, viz.:

- 1st.—*In the make up there is no base metal, excepting such as is necessary in standard 14 karat.*
- 2d.—*It makes a larger and more showy appearance for its corresponding weight than the old standard.*
- 3d.—*The cost is materially reduced, bringing it within reach of a greater number who desire a good article.*
- 4th.—*It is a well known fact that the principal cause of wear in chain is the friction produced by its own weight, consequently, being light weight to the extent of a large percentage, their better wear is assured.*

By a strict adherence to quality we hope to create a popular demand for a meritorious article.

Send for selection package, as our travelers do not carry any in stock.

KOSSUTH MARX & CO.



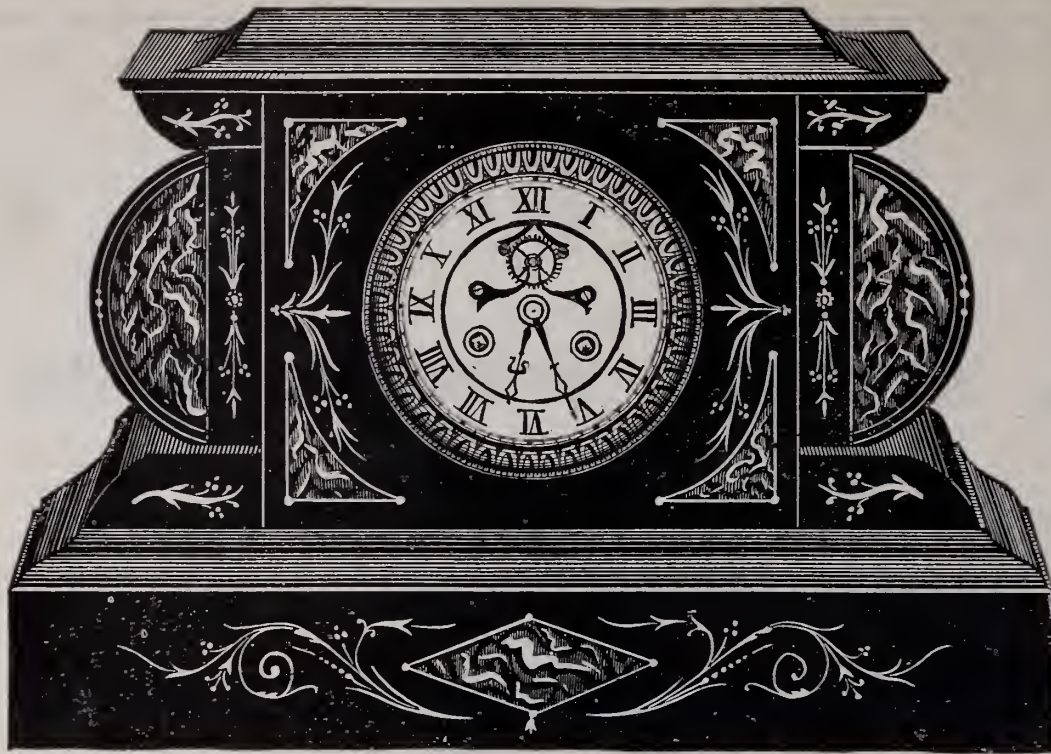

# LE BOUTILLIER & CO.,

**Importers and Jobbers.**

31 & 33 West 23d Street, (Second Loft) NEW YORK.

Half a Block from Sixth Avenue Elevated Station.

## **FRENCH MARBLE CLOCKS,**

Of this Summer's Importation, at VERY CLOSE PRICES.





# ENGLISH CHIME CLOCKS,

Striking and Chiming on 5 Gongs and 8 Bells.

**Royal Worcester Porcelains,**

**French Marble Clocks,**

**Brass Umbrella Stands,**

**Vienna Fancies and other Novelties.**

We are offering the balance of our

IMITATION and REAL BRONZES,

LEATHER and VELVET GLOVE and HDKF. BOXES.

PORTEMONNAIES, FANS, PEDESTALS,

DRESSING CASES, HAND MIRRORS,

JEWEL BOXES, IVORY and PEARL CARD CASES,

PLAQUES, TERRA COTTA, Etc., Etc

at very Low Prices by the single article or in JOB LOTS to large buyers.

This is an opportunity seldom offered, as no reasonable offer will be refused.

---

## LE BOUTILLIER & CO.,

**IMPORTERS AND JOBBERS,**

**Nos. 31 and 33 WEST 23d STREET, Second Loft,**

Half a Block from 6th Avenue Elevated Station.

**ELEVATOR DIRECT TO OUR SHOW ROOMS.**



# KOSSUTH MARX & CO.,

39 Maiden Lane, New York.

IMPORTERS OF

## DIAMONDS,

AND MANUFACTURERS OF

## DIAMOND JEWELRY.

Our Stock of JEWELRY is complete in every detail, together with many NOVELTIES for the Fall and Holiday Season.

**GOLD RINGS,**

**GOLD CHAINS,**

**GOLD CASES.**

## AMERICAN WATCHES.

We are now carrying a complete line of the celebrated

**E. HOWARD WATCH AND CLOCK CO.'S MOVEMENTS, Cased and Uncased,**

— ALSO —

The Springfield, Ills., Co.'s Movements.



# JAMES W. TUFTS,

MANUFACTURER OF

## FINE SILVER PLATED WARE.

FACTORIES,  
BOSTON, MASS.

33 to 51 BOWKER STREET, and  
49 & 51 CHARDON STREET.

In Design, Material, Plating and Finish  
I guarantee my goods equal to the best  
made.

I am now preparing an  
**ILLUSTRATED CATALOGUE,**  
which will be furnished free to customers.



Butter Dish. No. 2007.



No. 1273.



No. 1290.



Cake Basket. No. 2719.



Vase. No. 1032.

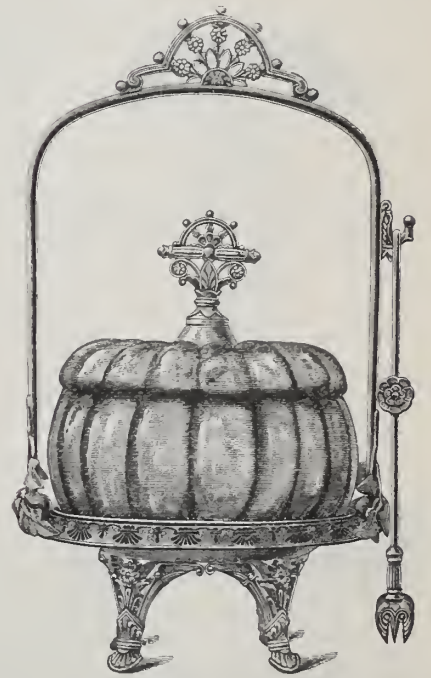

No. 2371. Pickel, with Craquelle Glass.

OFFICE AND WAREROOMS:

**33 Bowker Street, Boston, Mass., and 70 Park Place, New York,**

Where a Full Line of Samples can be seen. I invite all Dealers when in Boston or New York to inspect these goods, and will guarantee every article sold to be equal in finish to the sample.



ESTABLISHED 1854.

# HENRY MAY,

19 John Street,

New York.

## IMPORTER OF WATCHES AND DIAMONDS,

Wholesale Dealer in American Movements and Cases, and Manufacturer of Jewelry.

A Full Line of Gold, Swiss and Nickel Watches, Domestic Movements, Gold, Patent, Silver and Nickel Cases, 10 and 14 K. Jewelry, and Best Rolled Plate Jewelry, constantly on hand and Quality warranted.

**SPECIALTIES:**

The C. Melville Watch, and Brighton Movements, of which I am Sole Manufacturer, are well and favorably known to the Trade.

**BEWARE OF IMITATIONS.**

Each Watch and Movement is accompanied with a Fac-Simile of this Certificate :

NEW YORK,



19 JOHN ST.

THIS IS TO CERTIFY that Watch Movement No. ...., bearing the above Trade-Mark, has been manufactured by me, and is warranted a good Timekeeper.

**HENRY MAY.**

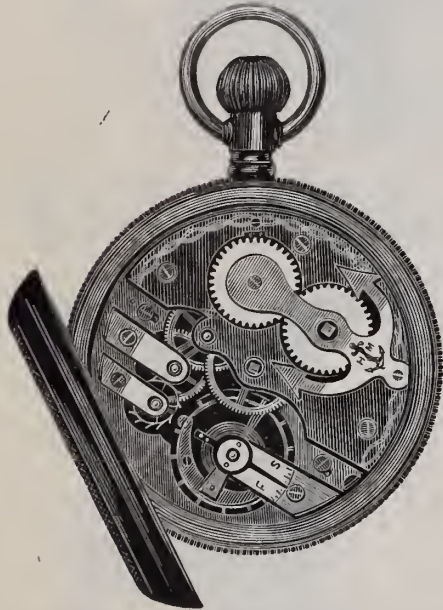

# THE WINDSOR SLEEVE LINK.

PATENTED MARCH 13, 1883.

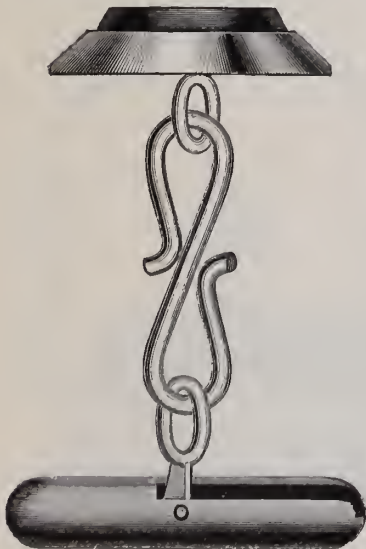

This Cut represents the Button with the Eye properly adjusted in the center of the Bar.

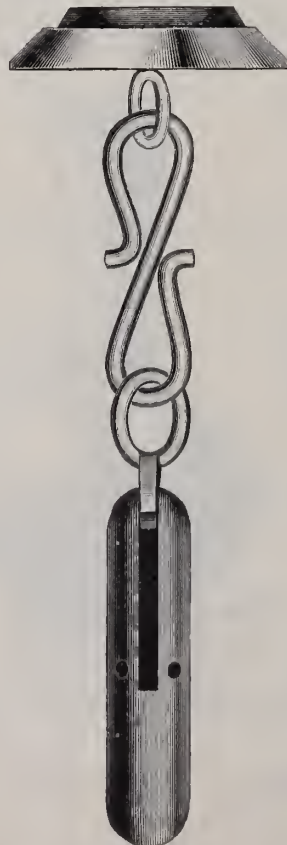

OPENED.

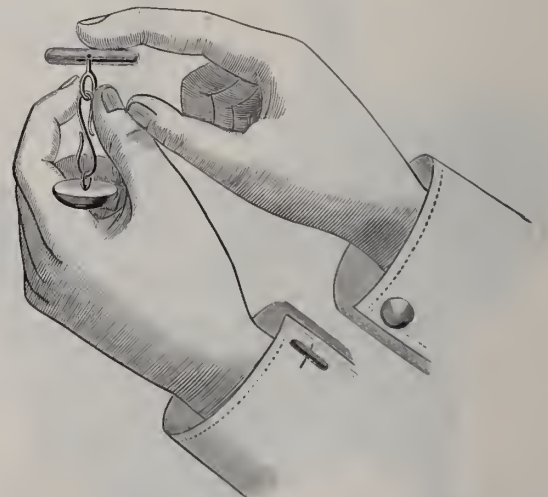

This Cut represents the proper manner of detaching the Eye and sliding the same to the end of the Bar.

**SOLD BY ALL LEADING JOBBERS.**



# MARTINS & TISSOT,

MANUFACTURERS OF

## GOLD WATCH CASES,

15 MAIDEN LANE, N. Y.

*We respectfully invite the attention of the Trade to our new alloy in 8 Kt. Cases.*

*It has been generally conceded that our Cases excelled in color, and as we still retain the same and have succeeded in making our new alloy **ACID PROOF**, we now claim superiority over all Cases of that grade manufactured, combining as we do, Good Construction, Neatness of Design, Superior Color, in fact, all the requirements necessary to a Good Case.*

A LARGE STOCK CONSTANTLY ON HAND.

ALSO 14 KARAT CASES IN LARGE VARIETY.

JOBGING TRADE SOLD ONLY.



# KAHN, HANOVER & CO.,

IMPORTERS AND MANUFACTURERS OF

## OPTICAL

METEOROLOGICAL,

ENGINEERING,

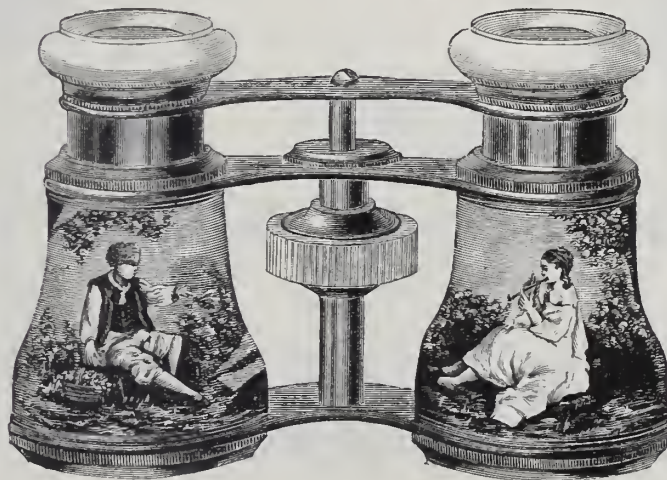

MATHEMATICAL,

ELECTRICAL,

## INSTRUMENTS,

32 MAIDEN LANE, NEW YORK.

We are the *only* Importers dealing *exclusively* in Optical, Meteorological, Engineering, Mathematical, Electrical and other Scientific Instruments. We keep the best selected Stock of Specialties in this line, and are constantly advised of all important Scientific Improvements, which enables us to present to our patrons the best results and latest achievements in the reach of science.

Our New Descriptive Catalogue and Price List of 210 pages, with over 400 Illustrations, forwarded to the Trade on application.





# IMPROVED CROWN FILLED CASE.

→ THE BEST FOR THE LEAST MONEY. ←

The Gold contained in the Crown Cases which are now being turned out under our supervision is fully equal to that of any Filled Case on the market.

This fact can be attested to the satisfaction of any dealer who will go to the trouble of having one of these Cases assayed with one of corresponding size and style of any other make.

The United States Mint at Philadelphia will make a complete assay for the sum of one dollar each, and we will return a New Case to the dealer in place of the one of our make destroyed, upon receipt of the Assay Certificates and the gold contained in the Crown Case assayed.

SOLID GOLD JOINTS,  
SOLID GOLD PLUGS,  
GOLD THE NATURAL COLOR,  
ABSOLUTELY NO GILDING.



IMPROVED FILLED.  
Louis XIV.



IMPROVED FILLED.  
Raised Gold Ornamentation.

**SOLD ONLY BY THE JOBBING TRADE.**

H. MUHR'S SONS, PHILADELPHIA,

NEW YORK OFFICE, 14 & 16 Maiden Lane.

CHICAGO OFFICE, 101 & 103 State Street.



308

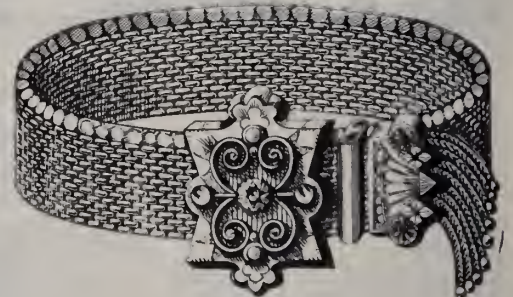

306

ELLISON & VESTER'S  
PATENT BAND AND BANGLE FINE ROLLED PLATE

BRACELETS.

FOR SALE BY EVERY JOBBER.

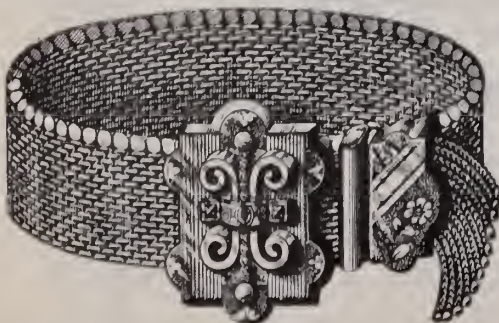

304



310 1/2



# JACOT & SON, 49 MAIDEN LANE, NEW YORK.

IMPORTERS, AND SOLE AGENTS FOR  
MERMOD FRÈRES, St. Croix, Switzerland,

MANUFACTURERS OF

## MUSICAL BOXES AND WATCHES.

ESTABLISHED IN 1840.

MEDALS RECEIVED AT THE EXPOSITIONS OF



PARIS,  
VIENNA,  
BERNE.

LONDON,  
ZURICH,  
CHAUX-DE-FONDS.

We have now a very large stock of Musical Boxes of all descriptions, such as the Mandoline, Sublime-Harmonie, Guitar-Tremolo, Aeolian-Harp. Musical Boxes with several cylinders, also with bells, drums and castanets. Musical Novelties, Toy Musical Boxes, etc., at the Lowest Prices. Price List sent on application. **WHOLESALE ONLY.**

## STANDARD DUST-PROOF WATCH KEYS.

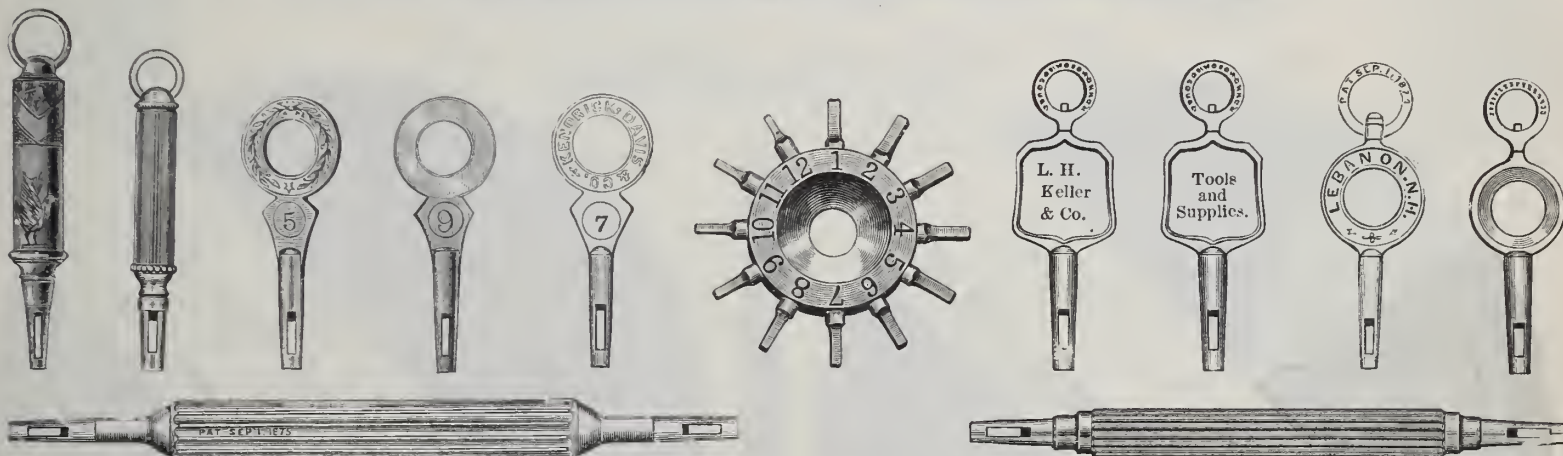

FOR SALE BY



THE TRADE.

# KENDRICK & DAVIS,

Sole Owners and Manufacturers, Lebanon, N. H.

ILLUSTRATED CATALOGUE and PRICE LIST SENT ON APPLICATION.



LOUIS KAHN.

MOSES KAHN.

SAMUEL H. LEVY.

I. W. FRIEDMAN.

# L. & M. KAHN,

IMPORTERS OF

## Watches, Diamonds & Precious Stones,

10 MAIDEN LANE, NEW YORK.

11 Corrairie, Geneva, Switzerland.

17 Rue de Chateaudun, Paris.

### WATCHES,

*Stem and Key-Winding, from the Lowest Priced Nickel and Silver to the Finest Gold and Complicated.*

A Full Assortment of these Goods always in Stock.

### DIAMONDS,

*Loose and Mounted, in all Sizes and Qualities.*

*Gold, Silver, Nickel and Celluloid Chatelaines in Great Variety.*



Send for Illustrated Catalogue.

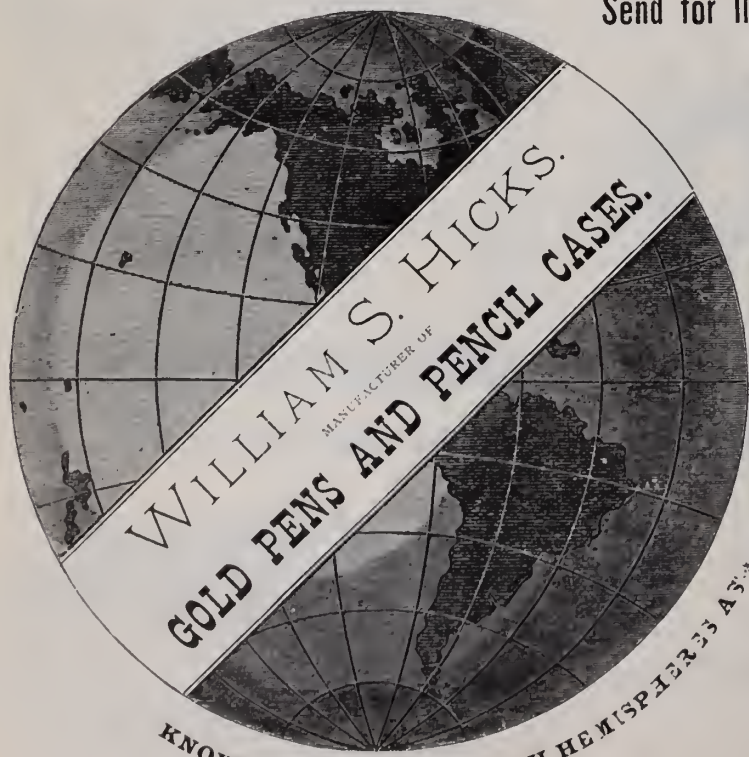

KNOWN AND SOLD IN BOTH HEMISPHERES

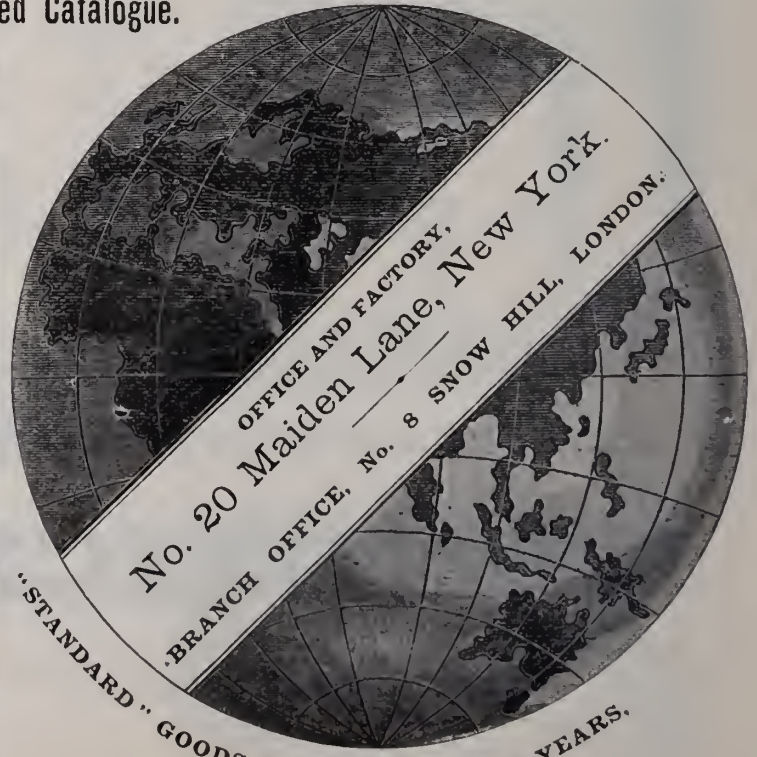

"STANDARD" GOODS FOR OVER THIRTY YEARS.

ESTABLISHED 1848.



**"The Waterbury." The New "Series B,"**

**With FULL DIAL and SOLID PLATES.**

In this new SOLID PLATE movement the position of the regulator has been changed; it will be found projecting beyond the plate, immediately under the bezel. The FULL DIAL enables the position of the hands to be readily seen.

The danger of injuring the Hair Spring in regulating is obviated in this new movement.

SERIES A.—Open Dial, Skeleton Plates, - - \$48.00 per doz.  
 SERIES B.—Full Dial, Solid Plates, - - - 48 00 "

**Discount to the Trade.**

We can supply either Pattern as ordered.

**WATERBURY WATCH CO.,**  
 WATERBURY, CONN.

**NEW YORK OFFICE, 52 MAIDEN LANE.**

GEO. MERRITT, GENERAL SELLING AGENT,

To whom all Orders and Correspondence as to Prices and Terms should be addressed.

**FOR SALE BY DEALERS GENERALLY.**



NEW SERIES B.  
 Solid Plates and Full Dial.



NEW SERIES B.  
 Bezel Off,  
 Showing Index Plate and Regulator.

**STERN BROS. & CO.,**

No. 30 Maiden Lane, New York,

**Importers of Diamonds,**

**MANUFACTURERS OF FINE JEWELRY.**

Jobbers in American Movements of all grades, Gold & Silver Cases, Gold & Plated Chains.

THE FOLLOWING ARE OUR **SPECIALTIES:**

*SEAL and STONE RINGS. GENT'S LOCKETS. The most complete and largest line of GOLD INITIAL RINGS and LOCKETS made in the United States. The celebrated DOUBLE CROWN Plain Filled Rings, which are universally acknowledged the MOST RELIABLE in the market. Made in seven different widths.*



No. 00

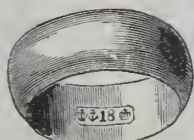

No. 0



No. 1



No. 2



No. 3



No. 3 1/4



No. 4

**EVERY RING IS WARRANTED TO GIVE SATISFACTION.**

Goods sent on selection to Dealers upon application with satisfactory reference.



Design Patented.

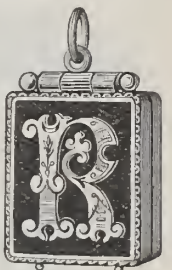



# CLEMENS HELLEBUSH,

## MANUFACTURER, IMPORTER AND WHOLESALE JEWELER,

### Dealer in everything required by the Jewelry Trade.

**DIAMONDS.**—Dealers will find in my stock an assortment of Diamonds unequalled in the West, embracing a choice variety of loose and mounted Stones in all qualities.

**WATCH CASES.**—In Gold and Silver, of all makers, to fit American Movements.

**WATCH MOVEMENTS.**—Include always a full stock of Waltham, Springfield, Hampden and Howard, together with a large assortment of fine and low-priced Swiss Watches.

**SILVER PLATED WARE.**—I have an unusually fine assortment of the choicest patterns of Flat and Hollow Ware of the best known manufacturers.

**SOLID GOLD AND ROLLED PLATE JEWELRY.**—This department is replete with Staple Goods and Novelties.

**FRENCH CLOCKS.**—Of our own importation, including all grades, with prices exceedingly low.

**AMERICAN CLOCKS.**—I am the General Agent in Cincinnati for the celebrated Seth Thomas Clocks, a full line of which will always be found in stock.

**TOOLS AND MATERIALS.**—In this department will be found everything required by Watch Makers.

Illustrated Catalogues sent to Dealers only upon Application.

## CLEMENS HELLEBUSH,

77 West 4th Street,

CINCINNATI, O.



Established  
1841.



## JOHN HOLLAND,

19 and 21 WEST 4th STREET,

CINCINNATI, OHIO.

Manufacturer of All Styles of Best Quality

### GOLD PENS, PENCIL CASES, FINE PEN HOLDERS, GOLD TOOTH PICKS, &c.

A Large Variety of New Designs in Staples and Novelties.



Received the Award "For Great Elasticity and General Excellence of Gold Pens," at Phila. Ex., '76.

Catalogues mailed free. Handsome show cases loaned for display of goods.



# THE JEWELERS' SECURITY ALLIANCE.

*What is being done for their Better Protection from Burglars.*

## "THE CHARLESTON BURGLARY."

"Burglars attacked the safe of Thomas & Bro., at Charleston, S. C., in February last and \$30,000 worth of Diamonds, Watches, etc. were extracted. Determined to prevent a recurrence of such a loss, they ordered the Marvin Safe Co., of New York, to construct and forward one of their best Safes, of a style specially designed for the protection of Jewelers. It was shipped a few days ago and is pronounced a model of excellence by all who examined it."—*N. Y. World*, Aug. 6, 1883.

BRIDGEPORT, CONN.

MARVIN SAFE CO., New York :

July 19th, 1883.

Enclosed find Check in payment of Safe. I am *very much pleased* with the Safe and now feel as if I had a Safe that will stand for a long time. Every one admires the fine appearance of the burglar work, and I am highly delighted with it and think my \$750 well invested.

Yours truly,

E. W. BUTTON.

# JOHN BLISS & CO.,

Standard Marine

CHRONOMETERS AND TRANSITS

FOR WATCHMAKERS' USE.



Standard Marine Chronometer,  
FOR KEEPING CORRECT TIME.

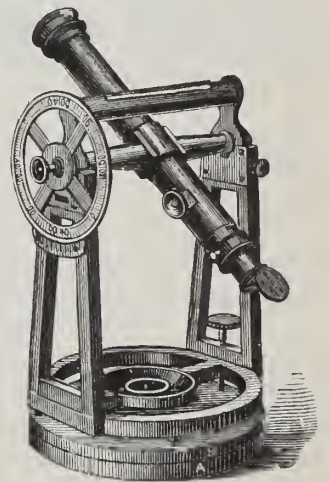

No. 10.

128 FRONT STREET,

Near Wall Street,

NEW YORK.

**NOTICE.**—*These Transits are readily set in position without the aid of strictly correct time as a basis for that purpose. Printed instructions, easily understood, accompany each Instrument, and no calculations are required preliminary to setting in position.*

SEND FOR ILLUSTRATED CIRCULAR WITH PRICES.



LERROY W. FAIRCHILD,  
GOLD PENS.



NOVELTIES IN  
CHARM  
PENCILS,

TOOTH-PICKS.  
Whistles, etc.

SALESROOM,  
18 JOHN ST., NEW YORK.

Offers a large and unique assortment of Novelties in Charm Pencils, Whistles, Tooth Picks, Cigarette Holders, Cigar Perforators and similar goods, which, for Novelty and Originality of Design, has never been surpassed. My New Illustrated Catalogue and Price List combined will be forwarded to dealers upon application.

LERROY W. FAIRCHILD.





GILES, BRO. & CO.  
 Wholesale,  
 Importing and  
 Manufacturing  
 → JEWELERS, ←  
 101 and 103 STATE STREET,  
 CHICAGO, ILLS.

Complete Illustrated Catalogue Furnished the  
 Trade upon Application.

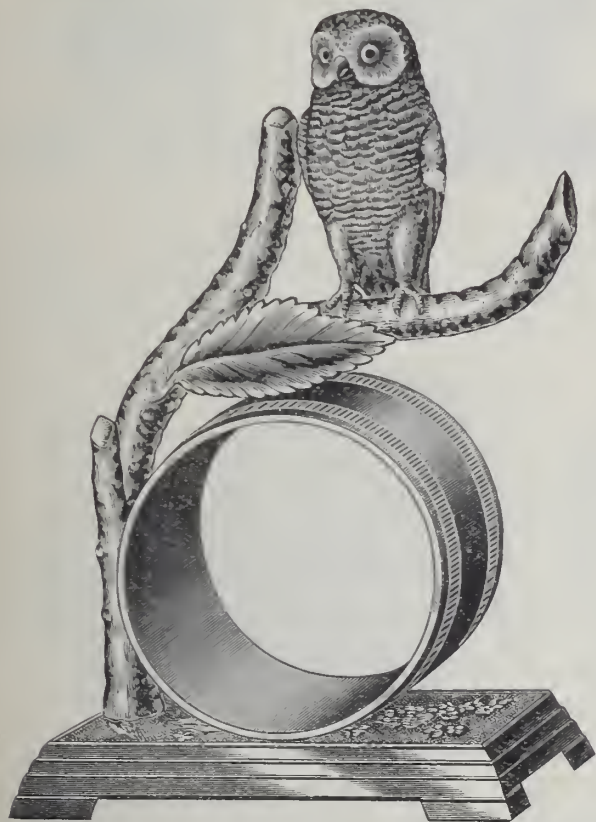

**T H E**

# Hartford Silver Plate Co.

MANUFACTURERS OF

## Fine Electro Plated Ware

**New Illustrated Catalogue now Ready,**

Which will be sent to Dealers on application.

**Manufactory and Salesroom at Hartford, Conn.**

14th VOLUME.

# THE JEWELERS' CIRCULAR AND HOROLOGICAL REVIEW,

THE RECOGNIZED ORGAN OF THE JEWELRY TRADE.

Subscription, to all parts of the United States and Canadas, \$2.00.

Subscription, to all parts of Europe, - - - \$3.00.

*The XV. VOLUME of THE JEWELERS' CIRCULAR will begin with the FEBRUARY, 1884, number.*



# DON'T BUY A LAW SUIT!



On account of the increasing popularity of KING'S COMBINATION SPECTACLES, certain parties are manufacturing an IMITATION, consisting of a Steel Framed Spectacle with a Nickel or White Metal Nose Piece.

King's Combination are a FINER QUALITY of Spectacles, with COIN SILVER NOSE PIECE, on which is stamped "KING'S PAT."

The IMITATIONS are a PLAIN and DIRECT INFRINGEMENT of my patent, and any person buying or selling them make themselves liable for damages, and WILL BE PROSECUTED to the extent of the law. The GENUINE can be bought only of the Patentee. An agent wanted in every town in the country. Address

Dr. JULIUS KING, Wholesale Optician, CLEVELAND, OHIO.

## S. KOHN & CO.,

43 MAIDEN LANE,

NEW YORK.

Manufacturers of  
Fine Morocco, Plush and  
Velvet Boxes.



Trays and Silverware  
Boxes of all Description  
Made to Order.

A Full Line of Boxes Constantly on Hand, and Samples sent on Selection.

ORDERS FROM THE JOBBING TRADE RESPECTFULLY SOLICITED.

### THE SELF-LOCKING TAG.

Patented May 29, 1883.

FOR ALL KINDS OF JEWELRY.

To introduce  
vention, I will  
by mail to any  
receipt of \$1.00.  
will convince

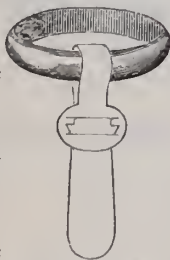

When attached.

this Novel In-  
send five gross  
address on re-  
A trial order  
you that this is

The BEST TAG now in Use!

### J. WIESBAUER,

MANUFACTURER OF

### Jewelers' Findings,

Morocco, Plush and Velvet Cases, Trays,  
Paper Boxes, Wood Mailing Boxes, Etc.,

OFFICE: 414 Main St. FACTORY: Cor. Oak & Clinton,  
BUFFALO.

JOBBING TRADE SOLICITED.

PATENTED JAN. 23, 1883.

What Every Jeweler Needs.



Will Keep Cards Clean.

The above useful device contains over 1200 of the various size Cards and 1000 Tags.

PRICE, \$4.50.

## THE HOPKINS LATHES.



These Lathes are Unsurpassed in Quality and Workmanship.

In Special Features of Practical Value, peculiarly adapted to Watch Repairing, they excel all others. The attachments are made interchangeable in all the sizes.

The only absolute substitute for wax, in Watch Repairing,

is found in our New and Improved Pivoting Chuck, represented in the above sectional view.

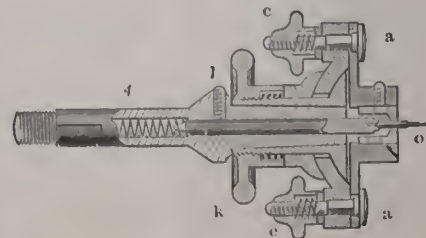

### HOPKINS WATCH TOOL CO.,

WALTHAM, MASS.

Send for full Descriptive Catalogue.



# F. P. LOCKLIN & BRO.,



MANUFACTURERS OF  
**GOLD & SILVER**  
**HEADED**  
**CANES**  
 — AND —  
**BRACELETS.**

**142 FULTON STREET,**  
 NEW YORK CITY.

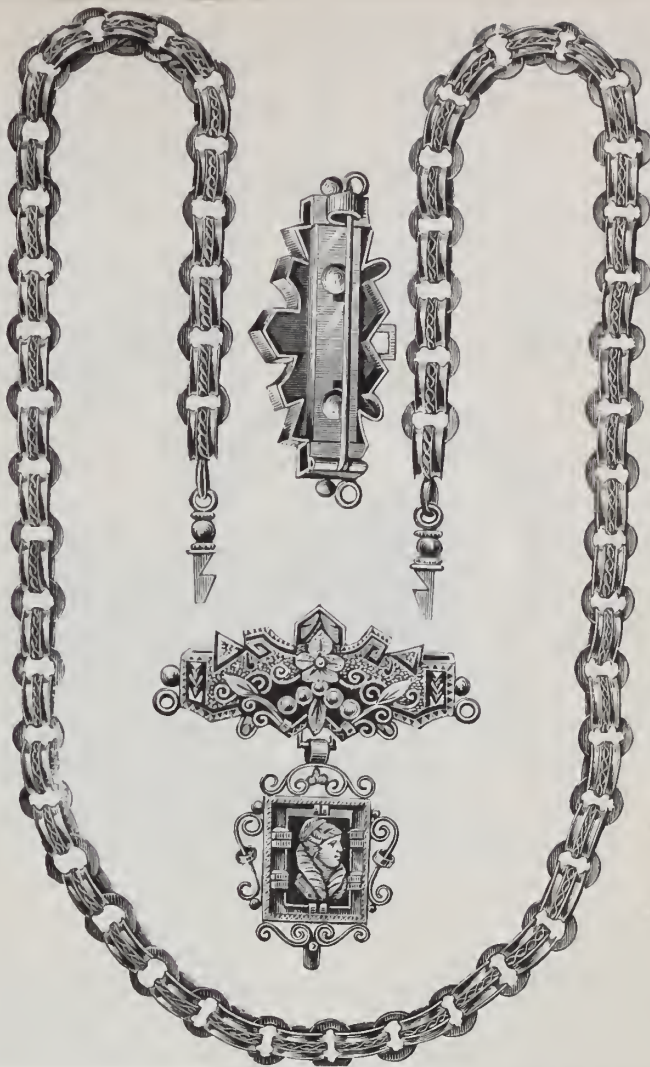

**L. F. CAHN, 12 Maiden Lane,**  
 Manufacturer of all kinds of Gold Chains, Chain Bracelets, also a full line of Seal and Fancy Rings, and Patentee of Cahn's Patent Chain Snap. These goods are made in 10 and 14 karat gold, and can be obtained through any Jobber in the U. S., or direct from me. A large stock of Gold Chains constantly on hand.  
 Goods sent on approval to responsible houses.

**KEY**  
 Patented Jan. 25,  
 1881.

**TAG**  
 Patented Jan. 25,  
 1881.

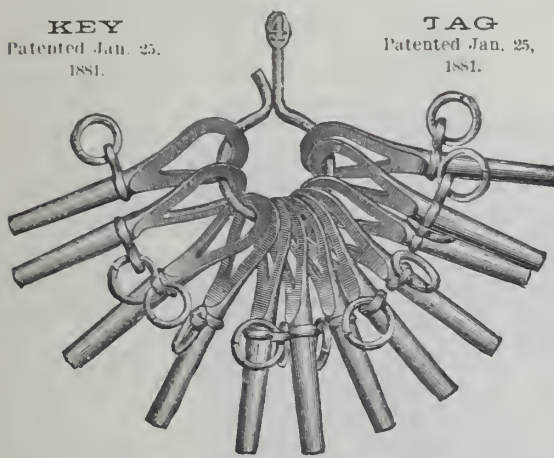

**A. N. CLARK**  
 PLAINVILLE,  
 CONN.,

Manufacturer of

Watch Case Springs, Watchmakers' & Jewelers' Bench Tools,  
**CROSBY'S JEWELING TOOLS, &c.**

**STOP IMPORTING KEYS!**

For Low Price Key Use the

**New Style Loop Key.**

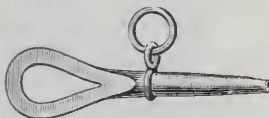

A plain Steel Key of good appearance, and excellent quality. It will not wear the pocket. It has a swivel, and is much better made than the imported plain steel or iron keys.

**PRICE PER GROSS, FINE NICKEL FINISH, \$2.25**  
 Postage, 10 Cents Per Gross Additional.

This Key is good and cheap enough to become universal. Send business card for illustrated price list. Enclose three cent stamp for sample key.

SOLD BY JOBBERS IN WATCH MATERIALS AND NOTIONS.

**A. N. CLARK, Plainville, Conn.**

## The Burbank Manufacturing Company

Manufacturers of **GOLD & SILVER**

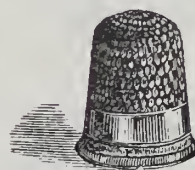

**GOLD**  
**SILVER,**  
**STEEL,**  
**RUBBER,**  
 And **SHELL,**

## Thimbles,



**EYE GLASS**  
 Self Adjusting.

## SPECTACLES AND EYE-GLASSES

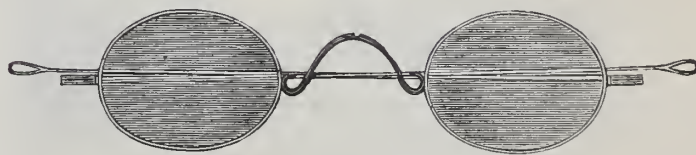

OF ALL DESCRIPTIONS.

## SOLID GOLD RINGS

**Office, 14 MAIDEN LANE, NEW YORK.**

Manufactory, Springfield, Mass.



# HUTCHISON & HUESTIS,

❖ SOLID ❖ GOLD ❖

## RING MAKERS



QUALITY GUARANTEED.

FOR JOBBERS ONLY.

No. 185 EDDY STREET,  
PROVIDENCE, R. I.

New York Office, . . . 196 Broadway.



### J. F. FRADLEY & CO.,

Manufacturers of Fine

### Gold and Silver Headed Canes

AND SPECIALTIES.

### 23 JOHN STREET, NEW YORK.

Designs furnished for Presentation Canes. Illustrated Catalogues sent upon application.

Special Inducements to the Jobbing Trade.

# WM. M. FISHER & CO.

Sole Manufacturers of the

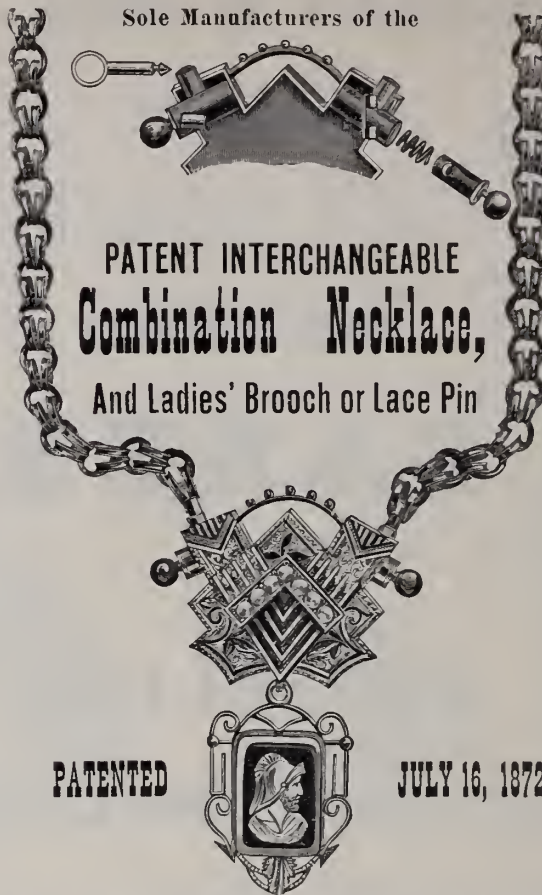

### PATENT INTERCHANGEABLE Combination Necklace,

And Ladies' Brooch or Lace Pin

PATENTED

JULY 16, 1872

GOLD  
AND  
SILVER  
CHAINS.

Gold Chain  
TRIMMINGS.

Complete  
Assortment of

14-k.

## Ribbon Fobs.

FOR SALE BY THE LEADING JOBBERS

## S. C. JACKSON, 180 BROADWAY, N. Y.



IMPROVED STYLES OF  
**FINE CASES,**  
(Also a Medium Quality on Hand)  
For Jewelry, Watches, Silverware, Etc.  
Specialty of Fine Rosewood, &c. Trays.  
P. Inlugs and Novelties from China, Japan, etc.



# AMERICAN WATCH TOOL CO.,

WALTHAM, MASS.

MANUFACTURE THE

## WHITCOMB LATHE,

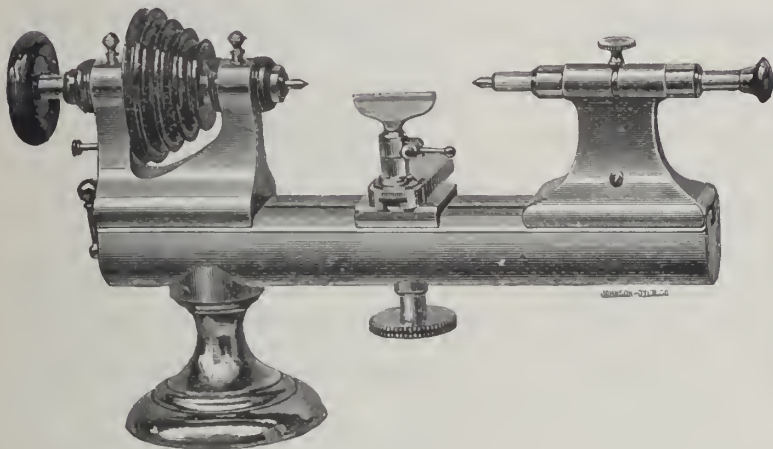

AND THE

## "Webster" Foot Wheel,

We guarantee it to be a worthy companion to the Whitcomb Lathe.

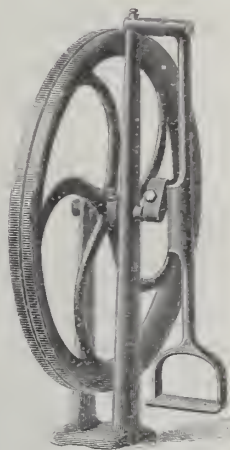

It is **not** a cheap made wheel but **First-class** in every respect.

### PRICES:

|                                                       |         |
|-------------------------------------------------------|---------|
| 30 lb. Wheel, for No. 1 Lathe, 20 inches in diameter, | \$12.00 |
| 40 " " " 1½ " 20¾ " "                                 | 13.00   |
| 50 " " " 2 " 21½ " "                                  | 14.00   |

DESCRIPTION.—The wheel runs on a hard steel arbor. It is clamped to the arbor by a set screw against a split bushing. This does not bend the arbor as is the case where the set screw is against the arbor. On the crank pin is a friction roll, having a hardened steel bushing, which runs on a hard steel pin. The swinging treadle is the **easiest** motion, and effects the body **less** than the foot treadle.

SEND FOR NEW CATALOGUE.

Our No. 1½ Lathes are Fast Superseding all other Sizes.

Soft Lathes have Hard Mouths, Hard Wire Chucks and Hard Tail Stock Spindles.

# R. & L. FRIEDLANDER,

IMPORTERS OF  
WATCHMAKERS' AND JEWELERS' SUPPLIES,

Optical Goods, Spectacles, Eye-Glasses, Marine Glasses, Silk Guards, Watch Keys, Etc., Etc.

Principal Salesrooms, 65 & 67 Nassau St.

Branch, 264 Bowery.

Factory, 50 Bond St.

NEW YORK CITY.



### Prices of Curved Watch Signs,

|                 |                   |
|-----------------|-------------------|
| 9 Inch, \$ 4.30 | —12 Inch, \$ 5.35 |
| 14 " 6.45       | —16 " 7.50        |
| 18 " 8.55       | —20 " 10.35       |
| 22 " 11.80      | —24 " 14.30       |
| 26 " 16.45      | —30 " 20.00       |
| 33 " 23.55,     |                   |

Boxing and Packing Extra.



|              | Painted Panels. | Eye Panels. |
|--------------|-----------------|-------------|
| 12 Inch..... | \$1.60          | \$1.95      |
| 18 " .....   | 1.95            | 2.50        |
| 24 " .....   | 3.20            | 3.95        |
| 30 " .....   | 4.65            | 5.35        |
| 36 " .....   | 5.35            | 6.45        |
| 42 " .....   | 7.85            | 9.65        |
| 48 " .....   | 9.80            | 12.00       |

Boxing and Packing Extra.

ADDRESS COMMUNICATIONS TO 65 & 67 NASSAU STREET.  
SEND FOR CATALOGUES.

## Birch's Patent Self-Adjusting Watch Keys.

FOR SALE BY THE TRADE GENERALLY.



2.—POCKET KEY.  
(Brass.)



3.—POCKET KEY.  
(Nickel Plated.)



4.—POCKET KEY.  
(Nickel Plated, Hexagon Shell.)



5.—POCKET KEY.  
(Heavy Rolled Gold Plate Mountings.)



6.—CELLULOID MOUNTED KEY.  
(With Heavy Rolled Gold Plate Tips.)



35.—POCKET KEY.  
CELLULOID MOUNTINGS.  
(Imitation Malachite, with Extra Heavy Rolled Gold Plate Tips. 18. K.)



7.—BENCH KEY. (Brass Handle.)



8.—SHORT WOOD HANDLE KEY.  
(Nickel Plated, for Bench or Pocket Use.)



9.—LONG WOOD HANDLE BENCH KEY. (Nickel Plated.)

Made in 37 Styles. Circulars on Application.

J. S. BIRCH & CO., 38 Dey Street, N. Y.



**E. J. BOYCE,**

(Formerly Boyce &amp; Walnwright,)

MANUFACTURING JEWELER

SOLID GOLD RINGS A SPECIALTY.

My BAND RING Specialties, for PRICE, QUALITY and FINISH, are not equaled by any in the Trade,

383 WASHINGTON ST.,  
BOSTON, MASS.**NEW ENGLAND MOROCCO CASE CO.,**

MANUFACTURERS OF

JEWELRY and SILVERWARE

**CASES,**

OF EVERY DESCRIPTION.

NO. 220 CHAPEL STREET

NEW HAVEN, CONN.

Solid Gold Rings a Specialty.

**WM. H. ELY,**SOLID GOLD RINGS,  
MANUFACTURER.Viz., Plain, Chased, Engraved, Enameled,  
Engine Turned, Shield and Scale. All  
qualities guaranteed. Orders  
Promptly Executed.

58 Nassau Street, New York.

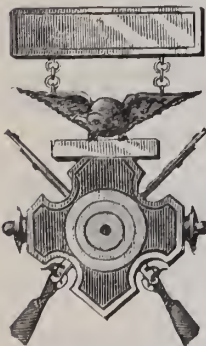
**C. B. WILKINSON,**  
Manufacturing Jeweler,

8 JOHN ST., N. Y.

Medals, Badges and  
Masonic Jewelry  
A SPECIALTY.Designs furnished free  
upon application.**H. WUNDOEHL,**

GOLD &amp; SILVER REFINER,

Assayer and Sweep Smelter,

21 JOHN ST.,

Bet. Broadway & Nassau St., **NEW YORK.**The highest price paid for Gold, Silver and Platinum.  
*Fine Gold, Silver and Copper always on hand.***JACOB STRAUSS,  
WATCHES & JEWELRY**

AT WHOLESALE.

REMOVED FROM

18 TO 25 JOHN STREET, N. Y.

Rings and Rolled Plated Chains  
A SPECIALTY.

New York Morocco Case Co.

CASES FOR

Jewelry, Silverware & Watches  
OF EVERY DESCRIPTION.Boxes and Trays for Jewelry Travelers,  
TRUNKS FITTED UP WITH TRAYS.Show Cases and Window Fittings  
a Specialty.

No. 69 NASSAU STREET, NEW YORK.

**FINE WOOD PHOTO-ENGRAVING**  
SEND COPY FOR ESTIMATE. IT WILL PAY YOU. CROSSCUP & WEST. 702 CHESTNUT ST. PHILADELPHIA**J. J. COHN,**

IMPORTER OF

WHITBY JET,

MANUFACTURER OF

Gold &amp; Rolled Plate Jewelry,

Bracelets, Charms &amp; Locketts a Specialty.

12 MAIDEN LANE, N. Y.

Goods Sent on Selection if Satisfactory References are Given.

**WM. SCHWENCKE.**

Manufacturing &amp; Jobbing Jeweler.

43 MAIDEN LANE, N. Y.

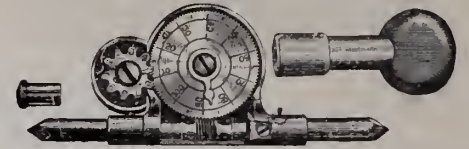
Gives particular attention to the  
Repairing and Jobbing Department  
of the Jewelry Business. Prompt  
Attention, Moderate Prices and First-  
Class Workmanship Guaranteed to  
all. Country Orders Promptly attended to.CHURCH'S PATENT IMPROVED  
DOUBLE SPEED INDICATOR  
*Either Right or Left.***MONTGOMERY & CO.,**

Importers of Stubs' Files, Tools &amp; Steel,

GROBET SWISS FILES. CHESTERMAN'S TAPES, RULES, &amp;c.

Horse Shoe Magnets. Hubert's French Emery Paper.

WM. SMITH &amp; SONS' CELEBRATED MUSIC WIRE.

105 Fulton Street, N. Y.

The Finest Line of High-Class English  
Watches in the U. S.**GEO. E. WILKINS,**  
SYRACUSE, N. Y.

Agent for the Celebrated Watches of

Chas. Frodsham &amp; Co., London,

W. G. Schoof, London,

Karl Zimmerman, Liverpool.

Timing and Adjusting done for the Trade.

Correspondence Solicited from the Trade.

**HIBBARD G. GILL,**

GOLD AND SILVER

Watch Case Manufacturer,

Dealer in Watches,

American Watch Movements Always on Hand.

618 Chestnut Street,

Fifth Floor.

PHILADELPHIA.

**HENRY TROEMNER,**  
710 Market Street,

PHILADELPHIA.

Manufacturer of Fine Gold Scales,

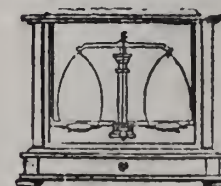

DIAMOND SCALES,

Bullion Balances and  
Weights, in use at all the  
U. S. Mints and Assay  
Offices.

PRICED CATALOGUE ON APPLICATION.

**JNO. F. LUTHER,**

MANUFACTURER OF

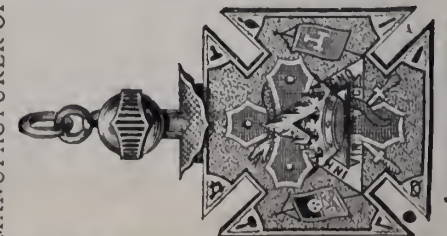

Masonic Jewelry.

79 Nassau Street, N. Y.

Illustrated Catalogue sent on application.



ADOPTED AND IN USE BY  
**RANDEL, BAREMORE & BILLINGS,**  
 88 Nassau Street, N. Y.

THE TRADE SUPPLIED  
 Descriptive Circulars Furnished  
 on Application to  
**George W. Washburn, Patentee,**  
 58 Nassau St.,  
 NEW YORK.

**SAFETY**  
**EAR FASTENING,**  
*Pat. May 10, '81—Oct. 11, '81.* 

**Jointed**  
**EAR WIRE**  
 AND  
**BAR BETWEEN CRAMPS**  
**OF SETTINGS.**  
*Patented March 1, 1881.* 

**TELESCOPIC**  
**SAFETY PIN CATCH,**   
*Pat. Sep. 20, '81 Jan. 10, '82.*

**A. BANTLE,**

Gold, Silver and Platinum

→ **Electro-Plating** ←

FINE WORK A SPECIALTY.

130 Fulton Street,

89 Nassau Street,

ROOM 36,

→ **NEW YORK** ←

**WATCH CASE POLISHING.**

**J. R. WOOD & SON,**

MANUFACTURERS OF



**Solid Gold Rings**

AND

**Diamond, Stone and Children's Rings,**

14 John Street, N. Y.

No Goods Stamped Different from Quality.

**W. W. OLIVER,**

Manufacturer of Hand and Power

**Rolling Mills,**

For Jewelers and Silversmiths.

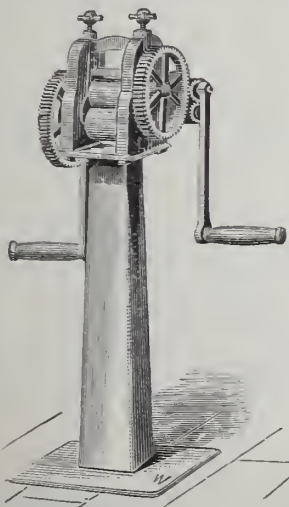

The "Little Giant" Ring Bender

Hollow Spindle Lathes, Punching and Drop Presses, Polishing Heads, Dies, Metal Laps, Etc.

39 Clinton St., Buffalo, N. Y.

Illustrated Price List mailed free upon application.

❖ **WM. DOWNEY,** ❖

Successor to Downey & Smith,

**Manufacturing Jeweler,**

24 John Street, N. Y.

Fine Stone Locket, Seals and Rings, Flexible  
 Bracelets, Rich Diamond Mountings, etc.

**WM. RAWLINGS, JR.,**

Manufacturing Jeweler,

FACTORY:

913 Arch Street, Phila.

FINE GOLD RINGS A SPECIALTY.

Goods sent on approval to any part of the  
 country upon receipt of satisfactory reference.



**HENRY LEFORT,**  
**Stem-Winding Watch Crown Manufacturer,**

Crowns and Pushers in gold, all sizes, quality and color,  
 made to order. Silver crowns and pushers always on hand.

60 Arlington Street,

Corner William Street,

**NEWARK, N. J.**

**Diamond Broker.**

R. J. Herbert, 26 Maiden Lane,

New York City,

Solicits Commissions,

Buying, Selling, Matching.

Prompt Attention.

References.

**EXCELSIOR'S**

Practical Treatise

ON THE

**BALANCE SPRING**

Including Making and Fitting Hair Springs,  
 Regulating, etc.

Also containing the Adjustment of Watches  
 and Chronometers for Isochronism, Posi-  
 tions, Heat and Cold and Rate.

PRICE, \$3.50.

**D. H. HOPKINSON,**

42 Nassau Street, New York.

**H. WASELL,**

**RUBBER STAMPS,**  
**BRASS STAMPS,**  
 Brushes, Inks, &c.

Stencil Plates,

**STEEL STAMPS.**

Burning Brands,

**SEALS & PRESSES,**

No. 7 North William St.

First house South of East River Bridge, N. Y.

**FINE STEEL STAMPS A SPECIALTY.**

**P. JANDORF & BRO.,**

**Watches and Jewelry,**

196 BROADWAY,

Bet. John & Fulton Sts., **NEW YORK.**

**We Publish No Price Lists.**

**C. KNAPP,**

Manufacturer of

**Superior Band**  
 and Children's

**Stone & Fancy**

**RINGS**

And Enameled Goods,

41 Maiden Lane,

**NEW YORK.**



**WILLIAM ERNST MOUTOUX,**

Leading Artist in Hair of the World

AND MANUFACTURER OF

**GOLD AND HAIR JEWELRY,**

OFFICE AND FACTORY,

81 Nassau St., Rooms 1 & 2,

BRANCH,

18 Lawrence St. West of 126th,  
 Near Ninth Ave., **NEW YORK.**

My New Catalogue of 1700 New Designs of Monuments  
 with Weeping Willows, Wreaths, Bouquets, Crosses, Churches,  
 Sceneries, Portraits, Pet Animals, Engravings of the Most  
 Difficult Description, Etc. Wholesale prices for Hair Chain  
 Braids in Assorted Colors, by the gross or dozen at half  
 book prices. Devices made at half of book prices if necessary.  
 15-5 per cent. cash discount on the prices of the old book.

❖ ESTABLISHED 1873 ❖

**CHAS. P. HEROLD**

MANUFACTURER JEWELER

**DIAMONDS**

916 CHESTNUT STREET UP STAIRS

**PHILADELPHIA**



CELLULOID SPECTACLE,

What is Novelty in Optics.

Made in Shell and Amber Shades.

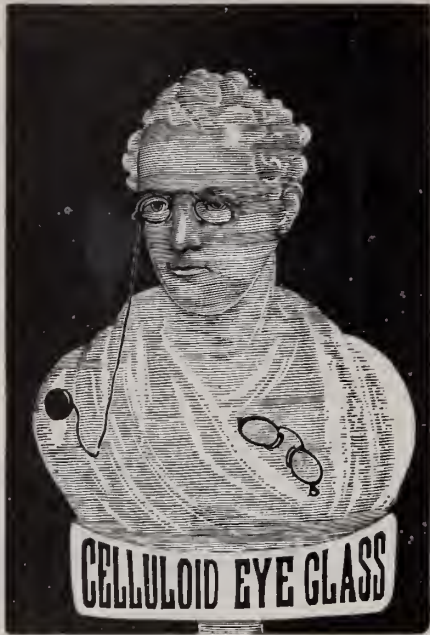

Please note a reduction of 50 cents per dozen on 286, 288, 276, 278, 300 and 366 Celluloid Eye-Glasses, No. 7 Catalogue.

The above cut represents a fine bust of Lord Byron, about twenty-five inches high, which will be furnished to parties purchasing 6 dozen Celluloid Eye-Glasses or Spectacles. It is securely packed, ready for shipment, and will make a very handsome ornament for the show window.

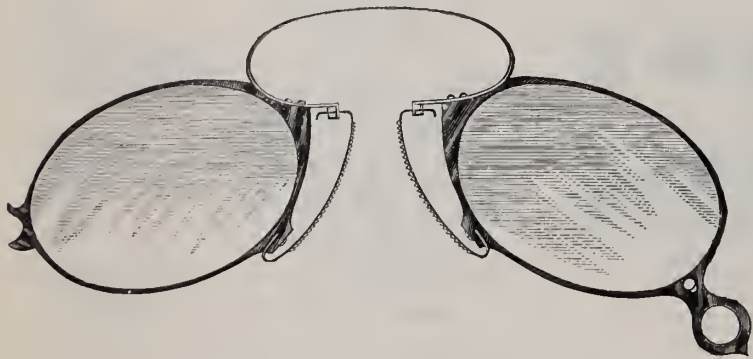

The above cut represents No. 366 Eye-Glass with Adjustable Nose Pieces, which we make in

Gold, Nickel, Celluloid, Rubber, Steel and Frameless.

This style of Eye-Glass is very popular. We make many NEW and EXCLUSIVE Styles that give a Dealer handling our goods an immense advantage over those who sell the ordinary line of goods in the market.

Special Goods, with Trade Mark, made for Dealers to Order.

Great Variety! Novel Styles! Attractive Goods!

While many houses have complained of DULL TRADE THIS FALL, we have been increasing our force.

ACTIONS SPEAK PLAINER THAN WORDS.

Spencer Optical Manufacturing Co.,

13 MAIDEN LANE, NEW YORK.

Established 1853.

L. H. KELLER & CO.

Successors to G. A. HUGUENIN,

IMPORTERS OF

WATCHMAKERS' and JEWELERS'

TOOLS AND MATERIALS.

GENERAL AGENTS FOR

The Philadelphia Watch Company,

— AND —

American Watch Tool Co.,

MANUFACTURERS OF

THE WHITCOMB LATHE.

SOLE AGENTS IN THE UNITED STATES FOR THE SALE OF

LUTZ'S

CELEBRATED ROLL HARDENED HAIR SPRINGS,  
MOEBIUS OIL

For Chronometers, Watches, Clocks, Telegraph Instruments and all other delicate machinery. Made from Pure Refined Neatsfoot Oil, and Warranted to Excel anything in the market as a Lubricator. SAMPLES GRATIS.

OUR OWN GRADUATED

AND JURGENSEN RECOILING MAINSPRINGS, pronounced by all experts Superior to all. Sold in Separate Strengths or Force.

Extra Fine Pinions cut from Solid Steel Wire. Gauged Hole Jewels of First-class Workmanship. A Full Line of Materials, for the PATEK, PHILIPPE & CO. GENEVA WATCHES, and all other Celebrated Makers.

THE BOLEY LATHES AND TOOLS,

Celebrated for their Practical, Substantial and Workmanlike Construction, Superior Design and Finish.

Our aim is to furnish nothing but First-class Serviceable Goods, especially manufactured for the Consumer, and not solely for the Market, like the cheap trash advertised in highly illustrated catalogues with which the country is flooded.

TREATISE ON MODERN HOROLOGY IN THEORY AND PRACTICE. By M. CLAUDIUS SAUNIER, Ex-Director of the School of Horology at Macon, France; Knight of the Legion of Honor, etc.; Hon. Sec. to the Paris Society of Horologists. Translated from the French by JULIEN TRIPPLIN, Besançon Watch Manufacturer, and EDWARD RIGG, M. A., Assayer in the Royal Mint, London.

This Work comprises 832 large octavo pages, with 78 wood cuts and 21 colored double-page copper-plate engravings. Bound in half calf, with an appropriate and handsome ornament in gold on front cover.

Price, \$15.00.

THE WATCHMAKER'S HAND BOOK. By the same author and translators. Intended as a companion to the Treatise. Bound in cloth.

PRICE, \$4.00.

64 Nassau Street,

NEAR MAIDEN LANE,

NEW YORK.

L. H. KELLER,  
EDWARD HUNZIKER,  
F. J. BOESSE.

We do not publish Price Lists.



## SPECIAL NOTICES.

**WANTED**—Situation as traveler for a manufacturing jewelry house. Address F. L., care Jewelers' Circular.

**WANTED**—A Moseley slide rest step head for No. 1 lathe, must be in order. Address Cash, care Jewelers' Circular.

**FOR SALE**—Moseley lathe No. 1, with extra chucks. Giving up bench work reason for selling. Address M., care Jewelers' Circular.

**WANTED**—A situation. Satisfactory reference and 4 years' experience in jewelry and clock repairing. Age 18 years. Address Jos. Jansen, Augusta, Ga.

**WANTED**—A good watchmaker. Will pay from \$12 to \$15 a week if party suits. Steady work to a competent workman. Address C. B. Morse, Evansville, Wis.

**WANTED**—A situation by a first-class letter engraver. One able to design monograms and fancy work. Address Will. G. Taylor, Box 554, Birmingham, Conn.

**WANTED**—A situation as engraver and designer, or as salesman. Thoroughly competent. Good reference. Address Engraver and Salesman, care Jewelers' Circular.

**SITUATION** wanted by a young man of 20 with 4 1/2 years' experience at the bench. Can repair clocks, jewelry and the lighter watch work. Address C. S., care Jewelers' Circular.

**WANTED**—A good watchmaker to go to Hot Springs, Ark. One who can engrave preferred. Permanent situation and fair salary to the right man. Address Box 157, Hot Springs, Ark.

**WANTED** to purchase, a few dozen of Elgin No. 6 and No. 10 movements. 75 cents premium on each movement paid over retailers' prices. Address S. A., care Jewelers' Circular.

**FIRST-CLASS** watchmaker and engraver would like to take charge of a stock of jewelry, fancy or optical goods for a share in the profits. Address R., care Jewelers' Circular. Best of reference given.

**WANTED**—A situation by a young man who understands the jobbing trade thoroughly and wishes to finish his trade in watch work with a competent workman. Jeweler, Box 1122, Poképsie, N. Y.

**WANTED**—A first-class watchmaker and engraver, one that is prompt and reliable; good wages and steady employment to the proper person; references required. Address F. P. Loomis, Ottumwa, Iowa.

**JEWELRY STORE FOR SALE**—In thriving western city of 7,000 inhabitants. Leading store. Good reasons for selling. Will sell stock, fixtures and tools, or without tools. Address Y., care Jewelers' Circular.

**MOSELEY & CO.**, Elgin, Ill., manufacturers of the "Moseley" Lathe, with full line of fixtures and attachments. Designed especially for the watchmaker and repairer. Combining accuracy, durability, convenience and style.

**YOUNG MAN** of four years' experience at watchmaking and jewelry repairing would like to finish his trade under a good workman. Can speak German and English. Good references given. Address Box 294, Vicksburg, Miss.

**WANTED**—Situation by a thorough workman of 17 years' experience on fine watches. Has fine set of tools. And is also a fair engraver and salesman, sober, steady and good references. Address Workman, care Jewelers' Circular.

**A PERSON** thoroughly posted about watches and jewelry, and acquainted with trade in New York and vicinity, would make arrangements now to sell goods to his trade next year for house making or handling a desirable line. Smith, 217 E. 40th street, New York City.

**WANTED**—A situation by a young man who has had five years' experience in watch repairing. Can repair French clocks, am a fair engraver in script and old English, and can do all ordinary hard soldering. Would prefer south or west. Address "Graver," care Jewelers' Circular.

**SEND FOR** "How to Repair Musical Boxes," published by us, and containing complete practical instructions for the repairing of musical boxes, with illustrations; also illustrated catalogue of material. Price, 25 cents. 2 and 5 cent postage stamps accepted. Jacot & Son, 49 Maiden Lane, N. Y.

**GEORGE E. WILKINS**, manufacturer and importer of cutters for watchmakers' use, stem-winding cutters of all the different forms, rounding up cutters of the finest quality, also ratchet cutters. A large stock of second hand and new marine chronometers. No. 21 South Salina street, Syracuse, N. Y.

**TWO WATCHMAKERS**.—Boswell's watch labels will enable you to tell at a glance what repairing you have done to a watch and when you did it. You can also have your name and address thereon. They are handsome in design and very low in price. Send for circular to F. C. Boswell, Clearspring, Maryland.

**JEWELRY BUSINESS**, without competition, for sale, in a town of about 50 business places. Established 18 years. Watch work and jobbing amounts to about \$1,000 per year. Price, for stock and fixtures, \$1,500 cash. Apply or address Cross & Bequelin, 21 Maiden Lane, N. Y., or M. B. W. Wheeler, Westport, Conn.

**WANTED**—Back numbers of "The Jewelers' Circular," as follows: The entire volumes of 1869, 1870, 1871 and 1872. May, August and January of 1873. February, March, April, May, July and September, 1874, and November, 1875. Parties having any of these copies address, stating price, K. M. C., care Jewelers' Circular.

**JEWELRY** store for sale in town of 2,000 inhabitants and improving fast, stock, tools, etc. full outfit, or will sell from \$500 to any amount the purchaser wants, have no opposition, repairing trade pays from \$150 to \$200 per month; reasons for selling, going to large town; must sell at once. Address M. E. Gelfert, Norborne, Mo.

**WANTED**—A competent salesman, engraver and jeweler, or watchmaker and engraver. Must be a good salesman. Permanent position by the year. Will pay from \$100 to \$150. None but reliable and experienced men need apply. Prefer a man who has been in business for himself. Address E. Hertzberg, San Antonio, Texas.

**SITUATION** wanted by a young watchmaker with four years' experience at the bench. Is a good jobber, engraver, has nice look, is a fair workman, and can furnish best of references. Party must furnish transportation, but will be made satisfactory to them. South or west preferred. Can come immediately. Address, stating salary, F. B. Rowe, Amherst, Mass.

**WANTED**—In N. Y. City or vicinity, situation by an experienced watchmaker. Can do all kinds of watch repairing and hard soldering. Is capable of taking charge of store and purchasing goods. Have first-class tools and references. Or would accept a situation as traveling salesman with a good jewelry jobbing house. Address C., care Station D, Jersey City, N. J.

**\$50 REWARD**.—Stolen by burglars the night of August 16, '83, gold watch, hunting case, Elgin movement No. 532725, with the initials of P. G. B. on the outside case, which can readily be scratched off. The above reward will be paid for the recovery of the property and arrest of the thieves. Address P. G. Barrett, Olyphant, Pa., or to Chief of Police Delacey, Scranton, Pa.

**JEWELRY STORE FOR SALE**—The stock, fixtures, lease, etc. of the leading jeweler in a live manufacturing western city for sale. The present owner desires to retire on account of poor health. Sum required for the purchase from \$8,000 to \$12,000. Positive proof given of a very profitable and increasing business for over 15 years. For information, address Robert M. Wilcox, care Rogers, Smith & Co., Meriden, Conn.

**WANTED**—Situation by a first-class, energetic, industrious salesman, who is an extra hand for keeping stock in neat, clean, shabby shape. Has always been connected with first-class stores and has managed large business, buying, selling, correspondence, etc., for himself over 20 years' experience. Does watch, clock, jewelry repairing and engraving nicely. Best reference furnished. Address Box 747, La Salle, La Salle County, Illinois.

**FOR SALE**—The business of the late John Chamberlin, of Greensboro, North Carolina. This prosperous, first-class jewelry and watch establishment, to a man with a proper knowledge of the business, is an extraordinary good chance. It is well-established and thoroughly known in all the adjacent manufacturing villages in the neighborhood, and bears an enviable reputation, especially in its repairing department. It is now and has been for years returning a handsome income. The subscriber wishes to sell it without delay. In the meantime the stock will be kept complete and every endeavor will be made to keep it up to the high standard of its former owner. Climate very healthy. For further particulars address Sarah Chamberlin, Administratrix, Greensboro, N. C.

## BUYERS' DIRECTORY.

## NEW YORK.

## Assayers and Sweep Smelters.

**Wundoehl, H.**—Gold and Silver Refiner, Assayer and Sweep Smelter. 21 John Street, N. Y.

## Badges and Medals.

**Stockwell & Newman**—19 John Street. Manufacturers of Badges, Medals and Presentation Pieces in Gold and Silver. Also Jewelry and Mounters of Diamonds. Designs supplied.

**Wilkinson, C. B.**—Manufacturing Jeweler, 8 John Street, N. Y. Medals, Badges and Masonic Jewelry a Specialty. Designs furnished free upon application.

## Band Rings.

**Knapp, Charles**, 41 Maiden Lane, N. Y. Specialty: Superior Band Rings, also Ring Shanks & Heads for Seal and Diamond Rings.

## Black Onyx Jewelry.

**Cox & Sedgwick**—Manufacturers of Black Onyx Jewelry, No. 26 John St. New York.

**Lawson, Samuel**—No. 18 John Street. Manufacturer of Black Onyx Jewelry. Coral repaired for the trade. Goods sent on approval to responsible dealers.

**Woglom & Miller**—Manufacturers of (exclusively) Black Onyx Jewelry, 32 & 34 John St., N. Y.

## Blue Enameled Locketts.

**Bissinger, Philip & Co.**—Importers of Diamonds, Pearls and Precious Stones. Agent for the Bohemian Garnet Goods. Blue Enameled Locketts. 22 John St., N. Y.

**Hess & Schliesser**—Importers of Diamonds, Fine Jewelry and Novelties in French Goods. Specialties: Gold and Blue Enameled Locketts, Charms and Crosses. 25 Maiden Lane.

## Bohemian Garnet Jewelry.

**Bissinger, Philip & Co.**—Importers of Diamonds, Pearls and Precious Stones. Sole Agent for the Bohemian Garnet Jewelry. Blue Enameled Locketts. 22 John St.

## Boxes, Wood Mailing and Nested.

**Main Manufacturing Co.**—Successors to Swift Mfg Co., makers of Wood Mailing and Nested Boxes for Mailing and Express purposes. J. Spencer Taylor, Agent, 18 Courtland St., N. Y.

**Wiesbauer, J.**—Manufacturer of the Sliding Cover Wood Mailing Boxes. All Sizes Made to Order. Buffalo, N. Y.

## Clock Companies.

**Ansonia Clock Co.**—Manufacturers of every description of Clocks. 11 to 21 Cliff street, New York.

**Kroeber, F.**—Manufacturer and Dealer in American and French Clocks, No. 8 Cortlandt Street.

**New Haven Clock Co.**—16 and 18 Park Place, N. Y.

**Seth Thomas Clock Co.**—20 Murray Street, N. Y.

**Waterbury Clock Co.**—M. Bailey, Treasurer, Manufs and Jobbers, No. 4 Cortlandt St., N. Y., and No. 197 State Street, Chicago.

**Wm. L. Gilbert Clock Co.**—No. 6 Murray Street, Manufacturers of Clocks. Factories, Winsted, Conn.

**Yale Clock Co.**—Manufacturers of Novelties in Clocks, 52 Maiden Lane, N. Y.

## Corals and Coral Jewelry.

**Cuppia, L. A.**—Importer of Coral and Silver Filigree Jewelry, 19 Union Square, N. Y.

## Cameo Cutters, Etc.

**Feiter, Theodore**—Cameo and Intaglio Engraver. Patentee of the Cameo-Intaglio. No. 2 Bond Street, near Broadway, Room 4 New York.

## Charms &amp; Gold Watch Keys.

**Rupp & Held**,—Manufacturing Jewelers, Charms and Gold Watch Keys, with French and English Ratchets, a specialty. 15 John St., N. Y.

## Crucibles.

**Berge, J. & H.**—Established 1850, Manufacturers and Importers of Sand Crucibles, Covers, Chemical Porcelain, Glassware, and Jewelers' and Assayers' Supplies, 95 John Street, N. Y.

**Berge, J. & Son.**—Importers of Sand Crucibles and Covers, Jewelers' Tools and Materials. Manufacturers of Berge's Improved Assay and Enamel Furnace, Assay and Enamel Muffles, &c. 32 and 34 John Street, N. Y.

## Cutlery.

**Harrison Bros. & Howson**,—Manufacturers of Fine Ivory and Pearl Table and Pocket Cutlery, Carvers in Cases; Nutpicks, Nutcracks and goods suitable for the jewelry trade. 126 Chambers Street. W. C. Burkinshaw, Sole Agent.

## Diamond Brokers.

**Anderson, Otis**—Diamond Merchant and Broker, always ready to pay cash for bargains in Diamonds and Precious Stones, 4 & 6 John Street, N. Y.

**Bernhardt, Richard**—Diamond Broker and Importer, 65 Nassau Street (Room 6), N. Y. Paris, 20, rue des Petites-écuries.

**Friend S. & Son**—Brokers and dealers in Diamonds 33 John Street, cor. Nassau St. New York.

**Herbert, R. J.**—Diamond Broker and Dealer. 26 Maiden Lane.

## Diamond Importers.

**Bissinger, Philip & Co.**—Importers of Diamonds, Pearls and Precious Stones. Agent for the Bohemian Garnet Goods. Blue Enameled Locketts. No. 22 John St., N. Y.



**Bruhl, D & M.**—Established in 1848. 14 Maiden Lane, N. Y.; 111 Broad Street, Providence, R. I.; 14 Rue Bleue, Paris.

**Brunswick, S. & Co.**—Importers of Diamonds. 17 Maiden Lane, New York. Paris, Rue Lafayette. Amsterdam, Damsstraat.

**Citroen, L. B., & Co.**—Diamonds. 21 John St., N. Y. Cutting Works, 57 & 61 Rapenburgerstraat, Amsterdam. House in Paris, 44 Rue Laffitte.

**Engelmann, M. & Co.**—Importers of Diamonds, Pearls and Precious Stones. Specialties in Fine Colored Stones. 192 Broadway and 1 and 3 John Street, N. Y. Paris, 1 Boulevard St. Denis.

**Faulkenau, Oppenheimer & Co.**—Manufacturers. Diamonds and Diamond Jewelry. 40 Maiden Lane, N. Y.

**Fera, Henry**—Importer of Diamonds, and Manufacturer of Fine Diamond Jewelry. 4 & 6 John Street, New York. Amsterdam, Holland, 23 Loojersgracht.

**Fox, M. & Co.**—Importers of Diamonds, Rubies, Sapphires and Fancy Gems. No. 1 Maiden Lane, New York.

**Hedges, Wm. S. & Co.**—Importers of Diamonds, No. 170 Broadway, corner Maiden Lane.

**Kuhn, Doerflinger, & Co.**—Manufacturing Jewelers and Importers of Diamonds, 18 John street, New York.

**Leberthon, L. M.**—Importer of Diamonds and Manufacturer of Fine Jewelry. 14 John Street, N. Y.

**Neresheimer, E. Aug. & Co.**—Importer of Diamonds. No. 21 Maiden Lane, New York.

**Randef, Baremore & Billings**—Importers of Diamonds, corner Maiden Lane and Nassau St.

**Saril, S.**—Importer of Diamonds, 182 Broadway, N. Y. Branch of Vve. H. A. Marchand & Frères, 47 Rue Le Peletier, Paris.

**Saunders & Ives.**—Importers of Diamonds and other Precious Stones. No. 26 Maiden Lane.

**Smith, Alfred H. & Co.**—Importers of Diamonds, No. 182 Broadway.

**Taylor & Brother.**—Importers of Diamonds and Diamond Jewelry. 676 Broadway.

**Wickham, D. H. & Co.**—Importer of Diamonds. No. 31 Holborn Viaduct, London, 24 Maiden Lane, New York.

**Wolff, G. A.**—Importer of Diamonds, Rubies, Sapphires, Pearls, and other Precious Stones, 65 Maiden Lane, New York. 12 Rue de Chateaudun, Paris.

#### Diamond Jewelry.

**Bornemann, Louis.**—Importer of Diamonds and Manufacturer of Rich Diamond Jewelry, 19 John Street, New York.

**Chalumeau, D.**—Diamond Jeweler and Manufacturer of Mountings. Novelties and Artistic Jewelry. No. 3 Maiden Lane, New York.

**Goldsmith & Co.**—Manufacturers of Diamond Mountings and Diamond Jewelry, 3 Maiden Lane, New York.

**Hartje, G. & F.**—Manufacturers of Diamond and Fine Jewelry, 39 Union Square, N. Y.

**Haug & Luthy.**—Manufacturers of Fine Diamond Mountings, etc. No. 130 Fulton St., N. Y.

**Heller & Bardel.**—Manufacturers of Diamond and Pearl Jewelry, and Dealers in Diamonds, Pearls, &c. 13 John Street.

**Jeanne Brothers.**—Manufacturers of Diamond Mountings & Rich Jewelry. 1 Maiden Lane.

**Lacroix & Verpillier.**—Manufacturers of Fine Gold Jewelry. Diamonds a specialty. 173 Broadway, N. Y.

**Rosswog, C. & Son.**—Manufacturers of Rich Diamond Goods. Nos. 5 and 7 Maiden Lane, N. Y.

**Scheer, William.**—Diamond Jeweler and Manufacturer of Mountings, Novelties in Artistic Jewelry, 859 Broadway, near 17th St., N. Y.

**Schilling & Nissen.**—Dealers in Diamonds and Diamond Jewelry. No. 51 Nassau Street, New York, near Maiden Lane.

**Voelker, C. T.**—Manufacturer of 18-k. Diamond Mountings, Diamond Jewelry and Roller Chain Bracelets. 189 Broadway, New York.

**Waterman & Lehmann.**—Manufacturing Jewelers and Dealers in Diamonds. Diamond Work, and Fine fancy Rings a specialty, any piece of single work made to order. 37 Maiden Lane, N. Y.

#### Diamond and Pearl Setter, &c.

**Danziger, H.**—Diamond and Pearl Setter, 116 Nassau Street, (Second Floor,) Room 6, N. Y.

#### Diamond Cutters.

**Levy, Herman.**—Importer, Cutter and Polisher of Diamonds. 105 Fulton Street, New York.

#### Dials, &c.

**Farnsworth, C. E. & Co.**—Successors to Jno. T. Gold, Manufacturers and Jobbers in Fine Watch Dials. 81 Nassau St., N. Y.

**New York Dial Co.**—Manufacturers of Fine Watch Dials. Henry Abbott, Agent, No. 7 Maiden Lane, N. Y.

#### Enameled Clock Dials and Figures.

**Caeser Bros.**—Manufacturers of Enameled Clock Dials, also letters and numbers for signs. 230 and 232 East 25th Street, New York.

#### Enamelers, Etc.

**Nutt, J. D.**—Enameler on Gold, Silver, and Copper. Linen finished Buttons and Studs. Enameling in colors. 32 and 34 John Street, New York.

**Orr, J. O.**—Enameler on Fine Jewelry. Enameled in Colors. Linen Finished Buttons and Studs. Band Bracelets. No. 75 Nassau Street, N. Y.

**Orr, William N.**—Enameler on Fine Jewelry. Masonic Jewels and Badges a specialty. Linen Finished Work. 79 Nassau Street, Room 18, New York.

#### Electroplaters, &c.

**Jeandheur, F. & Son.**—Gold and Silver Electro Platers & Fire Gilders, coloring Etruscan and Gold Jewelry a specialty. 125 Fulton St.

#### Engravers—Stone Seal, Etc.

**Fackner, Edward.**—Carver, Engraver and Chaser on Jewelry and Pencil Cases, lettering, &c., 19 John Street.

**Holland & Gosling.**—Stone Seal Engravers. Precious Stones inlaid and encrusted with Diamonds. No. 176 Broadway, New York, (fifth floor per elevator). Cameos cut and repaired.

**Knapp, Chas.** Engraver, Die Sinker & Stamper for Jewelry purposes. Ring Shanks & superior Band rings, 41 Maiden Lane, N. Y.

**Park, Wm.**—The Stone Seal Engraver. Arms, Crests, Monograms, etc., engraved on precious stones, 26 John Street, New York.

**Weston, James F.**—Stone Seal Engraver and inluster of Precious Stones. Coats of Arms, Masonic, Odd Fellows, and other devices engraved. 32 John Street.

#### Fancy Goods, Clocks, Bronzes, Etc.

**Baker, Pratt & Co.**—Importers and Dealers in Jewelers' Fancy Goods. 19 Bond Street, N. Y.

**Bawo & Dotter.**—Importers and Manufacturers. Potteries, Faïences, Bisque Figures, French Clocks, Fancy Goods, etc. 30 & 32 Barclay Street, N. Y.

**Hart, James H.**—Importer of French Clocks, Bronzes, Faïences and Porcelain Ware, and Dealer in Diamonds, Watches, Jewelry and Silver Plated Wares. 4 Maiden Lane, N. Y.

**Le Boutillier & Co.**—Importers of Fancy Goods, Clocks, Bronzes, &c., 3 Union Square.

**Straus, L. & Sons.**—Importers of Potteries, Faïences, Bisque Figures, and Rich Fancy Goods especially adapted for the Jewelry Trade. 40, 42 and 44 Warren Street, New York.

**Taylor & Bro.**—Importers of French Clocks, Bronzes, etc. 676 Broadway, N. Y.

**Trost, Herman & Co.**—Importers of Potteries, Faïences, Plaques, Bisque Figures, Fancy Goods, etc. 48, 50, 52 and 54 Murray St., N. Y.

**Vagt, Chas. & Co.**—Importers of Vases, Plaques, Paintings, French Faïences, etc., 60 & 62 Murray Street, N. Y.

**Wilson's Sons, Jno.**—Importers of French Clocks, Bronzes, Fancy Goods and Jewelers' Holiday Goods, 31 Maiden Lane, N. Y.

**Young, J. M. & Co.**—Importers of Fine Parian, Lava, and Bisque Statuary, Bohemian, German and English Fancy Goods, 37 & 39 Murray St., New York.

#### Gold and Silver Cane Heads.

**Simons, Bro. & Co.**—Manufacturers of Gold Headed Canes. 611 and 613 Sansom street, Philadelphia.

#### Gold and Silver Plating, Etc.

**Bantle, A.**—Gold, Silver and Electro-Plating, 130 Fulton and 89 Nassau Streets, cor. Fulton Street, (Room 36,) N. Y. Watch Case Polishing.

#### Gold Chains, Etc.

**Beck, J. & Son,** Manufacturers of Fine Gold Chains and Chain Bracelets, 10 Liberty Place, near Maiden Lane, N. Y.

**Carter, Sloan & Co.**—Manufacturers of Fine Gold Chain, 15 Maiden Lane, New York.

**Dorrance, Edge & Co.**—Manufacturers of the Celebrated Woven Fabric Gold Chain, No. 15 John Street.

**Kaufmann Bros.**—Manufacturers of Gold Chains, and Chain Bracelets, 26 John Street; Factory, 331 and 333 Bowery, N. Y.

**Kohn, Alois & Co.**—Manufacturers of Gold Chains. 9 Maiden Lane, N. Y.

**Nordt, Charles.**—Successor to Nordt & Schlag, manufacturer of Gold Chains and Chain Bracelets. Jobbing and Refilling Old Chains promptly attended to. No. 17 Maiden Lane, N. Y.

**Saxton, Smith & Co.**—Manufacturers of Fine Gold Chain, No. 14 John Street, N. Y.

**Schlag, Chas.**—Late Nordt & Schlag, Manufacturer of Gold Chains, Chain Bracelets, and Fine Jewelry, 177 Broadway, N. Y.

**Smith, W. & Co.**—Manufacturers of Gold and Silver Chains, Jewelry, etc. No. 25 Maiden Lane, N. Y.

#### Gold Pens, Etc.

**Aikin, Lambert & Co.**—Manufacturers of Choice Gold Pens, Cases, Holders, Toothpicks, etc., 23 Maiden Lane, N. Y.

**Faber, Eberhard.**—Manufacturer of 16-karat Gold Pens and Pencil Cases, Nos. 718 and 720 Broadway, N. Y.

**Fairchild, Leroy W.**—Manufacturer of Gold Pens, Pencil Cases, Tooth Picks and Novelties in Charms. No. 18 John St., N. Y.

**Gerow, Joseph U.**—Manufacturer of Pencil and Pen Cases for the Jobbing Trade only. No. 44 State Street, (near South Ferry,) Brooklyn, N. Y.

**Johnson, E. S. & Co.**—Manufacturers of Gold Pens, Pen Holders and Pencils, Cor. Maiden Lane and Nassau Street, New York.

**Ray Manufacturing Co.**—Gold Pens Manufactured and Stamped for the Trade. Also Pencil and Pen Cases, Tooth-picks, etc. Office, Sales-rooms and Factories, 94 and 96 Nassau street, 129, 131 and 133 Fulton street.

**Smith, H. M. & Co.**—Manufacturers of Gold Pens and Holders, Tooth Picks, Pencils, etc. Sole Manufacturers of Sprague's Patent Gold Fountain Pen. Importers of Nickel and Silver Watches. 173 Broadway, New York.

#### Gold Rings.

**Barnet Bros. & Powell.**—Manufacturers of Stone and Seal Rings, 15 John Street, New York. Factory, Newark, N. J.

**Bowden, J. B. & Co.**—Manufacturing Jeweler.—Solid Gold Rings a specialty, 1 Maiden Lane.

**Cable, Geo. W.**—Manufacturing Jeweler. Plain and Band Rings a Specialty. No. 104 Fulton Street, N. Y.

**Ely, W. H.**—Manufacturer of Solid Gold Rings of every description. No. 58 Nassau Street.

**Henrich, R.**—No. 35 Maiden Lane, Manufacturer of Gold Rings; also Patentee and Manufacturer of the Celebrated Self-Sizing Ring.

**Hutchison & Huestis.**—Makers of Solid Gold Rings. Quality guaranteed. For the Jobbing Trade only. 196 Broadway, N. Y.



**Kroll, H.**—Manufacturing Jeweler. 78 Nassau Street, New York. Specialty: Solid Gold Stone Rings. All kinds of Fine Jewelry made to order, also Repairing for the Trade.

**Ostby & Barton**—Manufacturers of Plain and Engraved Solid Gold Band Rings. Office, 176 Broadway, N. Y. Factory, 80 Clifford Street, Providence, R. I.

**Peckham, Wm. H.**—Manufacturers of Solid Gold Seamless Rings, and Fancy Embossed Rings, Patent Spectacles, Jewelry, etc. No. 4 Liberty Place N. Y.

**Radler, K.**—Manufacturing Jeweler. Gold Rings and Locketts a specialty. No. 39 Maiden Lane, New York.

**Sauter, L.**—No. 1 Maiden Lane, New York, Manufacturer of Stone Rings of every description, as Diamond, Cameo, Onyx Turquoise, etc., Scarf Pins, Scarf Rings, Studs and Buttons.

**Shafer & Douglass.**—Manufacturers of all kinds of Seal, Stone, Turquoise, and fancy rings. No. 7 Maiden Lane, N. Y.

**Sinnock & Sherrill.**—Manufacturers of Stone Rings. No. 3 Maiden Lane, N. Y.

**Thuerner & Church**—Manufacturers of Fine Gold Rings. No. 9 Maiden Lane, N. Y.

#### Hair Jewelry.

**Moutoux, Wm. E. & Co.**—Manufacturers of Fine Hair Mountings in Gold. Grand catalogues for the trade. 81 Nassau St., Rooms 1 and 2. Finest work and lowest prices

**Sauter, L.**—Manufacturer of Fine Gold and Hair Jewelry and Device Work. Pattern Book sent on application. No. 1 Maiden Lane, N. Y.

**Schwencke O.**—Manufacturer of Fine Hair Jewelry Orders from the country promptly attended to. No. 43 Maiden Lane.

#### Jewelry Cases, Fancy Boxes, Etc.

**American Morocco Case Co.**—7 and 9 Bond St., N. Y., make a specialty of Rich Jewelry and Silverware Cases for the fine Retail Trade. Also Improved Trays for Watches, Rings, etc.

**Bleyle, A.**—Manufacturer of Jewelry and Silverware Boxes, Jewelers' Traveling Cases, etc. Trays for Show Cases and Trunks, Ladies' and Gent's Jewel, Glove and Handkerchief Boxes, &c., &c., 80 Nassau street, N. Y.

**Braun, Chr. E.**—Manufacturer of Fine Jewelry Boxes and Trays for Show Cases and Trunks. No. 62 Chatham Street, New York. Trays for Show Cases and Trunks a Specialty.

**Bricka, C. A.**—Manufacturer of Morocco Cases for Cutlery, Silverware, Jewelry, etc. Sample Cards and Rolls. Cases in Rosewood, Black Walnut, etc. 52 Nassau Street, New York.

**Dennison Mfg Co.**—Manufacturers of Morocco, Plush and Velvet Jewelry and Silverware cases. New York, Boston, Philadelphia, Chicago, Cincinnati and St. Louis.

**Ettlinger, L. & Sons.**—Manufacturers of Fine Cases for Jewelry, Watches and Silverware. Trays for Travelers and Show Cases. Cases to Order a Specialty. No. 80 Nassau St., N. Y.

**Haensler, Chas. C.**—Manufacturer of Fine Morocco Cases for Jewelry and Silverware. Toilet Boxes, etc. Trays for Show Cases and Windows. 14 John Street, New York.

**Jackson, S. C.**, 180 Broadway, N. Y., Manufacturer of Fine Cases for Jewelry, Silverware, &c.

**Kohn, Solomon & Co.**—Manufacturers of Fine Morocco Cases for Jewelry, Watches, etc. 43 Maiden Lane, New York.

**Lauten, Edw. A. & Co.**—No. 4 Great Jones St., Manufacturers of Fine Velvet, Brocade, Plush and Morocco Boxes, Patent Ring, Ear Ring and Gent's Scarf Pin Trays, Patent Watch and Bracelet Blocks, Window Decorations, etc.

**Loehr & Koerner**—Manufacturers of Morocco, Velvet, Satin, Jewelry, Watches and Silverware Cases, Jewel, Work Boxes, etc., Fancy Trays and Store Fittings to order. 96 Liberty St.

**Metropolitan Fancy Box and Leather Goods Manufactory**—Makers of Plush, Velvet, Satin and Leather Cases for Watches, Jewelry, Silverware, etc. 75 and 77 Nassau Street, N. Y.

**New England Morocco Case Co.**—Makers of Jewelry and Silverware Cases of every description. 220 Chapel Street, New Haven, Conn.

**New York Morocco Case Co.**—Cases for Jewelry, Watches, Silverware. Boxes and Trays for Jewelers' Travelers. Show Cases and Window Fittings. No. 69 Nassau Street, New York.

**Schien, Charles E.**—Manufacturer of Cases for Jewelry and Silverware, No. 85 Nassau St., N. Y. Show Case Trays, etc., at short notice.

**Schwarz, N.**—Manufacturer of fine Cases for Jewelry and Silverware, 866 Broadway, near 17th street, N. Y.

**Steinle, E.**—Manufacturer of Cases for Jewelry of all kinds. Also Cases for Mathematical and Surgical Instruments and for Trays for Travelers' Trunks, etc. 66 Nassau Street, N. Y.

**Welch & Miller**—169 Broadway. Manufacturers of fine Morocco, Velvet, Russia, Brocade and Plush Jewelry Cases. Trays of every description; Jeweler's Cotton and Twine; Telescope Sample Cases with Flexible Trays. 169 Broadway, N. Y.

**Wiggers & Froelick**—No. 60 Nassau street—Manufacturers of Cases for Jewelry, &c., of every description. Trays for Show-cases, Stands for Show-windows, etc.

#### Jewelers' Findings.

**Dennison Mfg Co.**—Paper Jewelry Boxes, cards, tags, pink and white cotton, etc. etc. New York, Boston, Chicago, Cincinnati, Philadelphia, St. Louis.

**Ettlinger, L. & Sons.**—Manufacturers of Jewelers' Paper Boxes and Findings. Morocco Paper, Satin or Plush Lined Wooden Corner Stops Jewelry and Silverware Boxes. 80 Nassau Street, New York.

**Valfer, S. & Co.**—Manufacturers and Dealers in Jewelers' Boxes, Tags, Cards, Paper and Findings. Trays a specialty. Office and Salesroom, 66 Nassau street, New York.

#### Jewelry Manufacturers.

**Aikin, Lambert & Co.**—Manufacturers General stock of Reliable Jewelry, 23 Maiden Lane.

**Alling, Isaac A. & Co.**—Manufacturers of Fine Gold Jewelry. Sets, Lace Pins, Ear Rings, Studs, Collar Buttons and Scarf Pins. Specialties: Wire Bracelets, Bangles, American Lever Sleeve Buttons. Bryant Building, Nassau and Liberty Streets, N. Y. Factory, Newark, N. J.

**Baldwin, Sexton & Peterson**—Makers of Fine Jewelry and Importers of Diamonds, etc., corner Broadway and Fourth Street.

**Ball, W. H.**—Manufacturer of Gold Jewelry. Bracelets and Bangles of all kinds a specialty. 9 John Street, N. Y.

**Barthman, Straat & Co.**—Manufacturers of Fine Jewelry. Roman Goods, Rings, Diamonds. No. 43 Maiden Lane.

**Brown, Thos. G. & Sons**—Man'rs of Rich Jewelry Necklaces, Locketts, Bracelets, Sleeve Buttons, etc., 5 Bond Street, N. Y.

**Bryant & Bentley**—Manufacturing Jewelers. Rings a specialty. 12 Maiden Lane

**Carter, Sloan & Co.**—Manufacturing Jewelers, 15 Maiden Lane, New York.

**Champanois & Co.**—No. 5 Maiden Lane, manufacturers of Engraved and Enameled Gold goods, in Sets, Ear Knobs, Bracelets, Studs, Lace and Shawl Pins, Jet cluster and Onyx goods, also "Best Lever" Sleeve Buttons.

**Chatellier, Joseph F.**—Manufacturing Jeweler, No. 604 Broadway, N. Y.

**Churchill, Lewis & Co.**—Manufacturers of Fine Jewelry. 692 Broadway, cor. Fourth St., N. Y.

**Cook, Groeschel & Co.**—Manufacturers of Fine Jewelry and Locketts, 191 Broadway (over Mercantile Bank,) N. Y.

**Cottle S. Co.**—Manufacturers of Fine Jewelry. Waltham Building, 5 Bond Street, N. Y.

**Cox & Sedgwick**—Manufacturers of fine Onyx and Colored Jewelry. 26 John St., New York

**Day & Clark**—Manufacturers of Fine Jewelry, Lace Pins, Ear Rings, Studs, Locketts, &c., 10 Maiden Lane, New York.

**Geoffroy, Arthur R. & Co.**—Manufacturing Jewelers. Novelties in Diamond Goods. No. 23 Maiden Lane, N. Y.

**Greene Wm. C. & Co.**—Goldsmiths; Manufacturers of Rich Sets in Taper Wire Coral. Office, 192 Broadway.

**Hale, S. W. & Co.**—Manufacturers Rich Jewelry, Whiting Building, Broadway and 4th Street.

**Hartmann, P.**—Manufacturer & Importer of Fine Gold, Diamond, and Filigree Silver Jewelry, No. 36 Maiden Lane. P. O. Box 2,454.

**Hedges, A. J. & Co.**—Manufacturing Jewelers, 6 Maiden Lane.

**Henderson & Winter**—Jewelers, No. 15 Maiden Lane, New York. Specialties—Stone, Cameo, Onyx, Amethyst, Topaz, Pearl and Turquoise Rings.

**Hunt & Owen.**—Manufacturing Jewelers. Office 3 Maiden Lane.

**Kremetz & Co.**—Manufacturing Jewelers, No. 182 Broadway. N. Y.

**Kuhn, Doerflinger & Co.**—Manufacturers of Enamelled and Roman Band Bracelets, also Fine Locketts Pendants and Lace Pins. 18 John street.

**Miller Bros.**—Manufacturers of Fine Jewelry, Locketts, Sleeve Buttons, Studs, &c., 7 Maiden Lane, N. Y.

**Moore & Horton.**—11 Maiden Lane, Manufacturing Jewelers, Rings, Studs, Collars and Sleeve Buttons, Pins, Ear-rings, &c.

**Muhr's, H., Sons.**—Manufacturing Jewelers. Solid Gold and Filled Rings a specialty. Also Manufacturers of the celebrated Crown Filled Watch Case. 16 Maiden Lane, N. Y.

**Owen, G. & S. & Co.**—Manufacturing Jewelers. Office, No. 3 Maiden Lane.

**Richardson, Enos & Co.**—Manufacturers of Fine Gold Jewelry, Gold Chains, Locketts, Crosses and Necklaces. Colored and Etruscan Work. No. 23 Maiden Lane, New York.

**Richardson, J. W. & Co.**—Manufacturers of Jewelry. Masonic and other Emblems. 196 Broadway, N. Y. Manufactory, Providence, R. I.

**Riley, J. A. & Co.**—Manufacturing Jewelers. Etruscan Gold and Roman Bracelets, Lace Pins, Ear Rings, Scarf Pins, Brooch Pins, etc. Nos. 7 and 9 Bond Street, N. Y.

**Ripley, Howland & Co.**—Manufacturers of Fine Jewelry and Platinum Tipped Diamond Settings. No. 17 Maiden Lane, N. Y.

**Sauter, L.**—Manufacturer of Fine Jewelry, Solid Stone Rings and Studs a specialty. Jobbing for the trade. 1 Maiden Lane, New York.

**Schwencke, Wm.**—Manufacturing and Jobbing Jeweler. Repairing a specialty. Orders promptly attended to. No. 43 Maiden Lane, N. Y.

**Sexton & Cole**—Manufacturing Jewelers, Colored Gold and Onyx Goods a specialty. No. 30 Maiden Lane.

**Shafer & Douglas,** Manufacturing Jewelers—Roman Goods, Lace Pins, Cameo Sets, etc., Stone Rings, etc. No. 7 Maiden Lane, N. Y.

**Sheafer, W. H. & Co.**—Manufacturing Jewelers, Specialty Bangles and Bracelets, 15 John St., N. Y.

**Stites' Sons, E.**—Manufacturers of Fine Jewelry. No. 14 John Street, N. Y.

**Street, Geo. O. & Sons.**—Established 1837. Makers of Fine Jewelry, strictly first-class goods of our own make. No. 15 John Street, New York.

**Thoma, Ernest**—Manufacturer of Fine Jewelry, Sleeve Buttons, Rings, Ear-rings, &c. No. 173 Broadway, N. Y. Factory, Hackensack, N. J.

**Ward, Thos. M.**—Manufacturer of Fine Jewelry, Diamond Mountings a specialty. No. 25 John Street, N. Y.

**Wienhold, Joseph**—Manufacturer of Fine Jewelry Diamond Mountings a specialty. 24 John St.

**Woglom & Miller**—Manufacturers of Black Onyx Goods exclusively. 32 & 34 John Street, N. Y.

#### Jewelry—Rolled Plate.

**Frick, John & Co.**—Fine Rolled Plate Jewelry of all kinds. Repairing of every description. 21 and 23 Maiden Lane, N. Y.

**Mauran, J. T.**—Manufacturer of Fine Rolled Plate Jewelry, No. 15 Maiden Lane, N. Y.

**Richards, E. Ira & Co.**—Manufacturers of Fine Rolled Plate Jewelry, No. 200 Broadway, N. Y.

**Weil, Leopold & Co.**—Manufacturers of Rolled Plate Jewelry of every description, 35 Maiden Lane, N. Y.

#### Jewelers' Tools, etc.

**Fisher, James J.**—Dealer in Watchmakers' and Jewelers' Materials, Files, Tools, Silk Guards, Spectacles, etc., 697 Broadway, N. Y.



**Friedenthal, A. & Co.**—Importers and jobbers of Watchmakers' and Jewelers' Tools, Materials, etc. 43 Maiden Lane, N. Y.

**Friedlander, R. & L.**—Importers of Watchmakers' Tools and Materials. 65 & 67 Nassau Street. Branch Office, 264 Bowery.

**Kurtz, F. P.**—Manufacturer of Jewelers Machinery, Tools, Rolling Mills, Presses, Polishing Lathes, &c. 97 Cliff St., N. Y.

**Levy, Dreyfus & Co.**—Importers and Jobbers of Watchmakers' and Jewelers tools and materials of every description. 11 Maiden Lane, N. Y.

**Montgomery & Co.**—Importers of and Dealers in Manufacturing Jewelers' Tools and Materials of every description, 105 Fulton street, New York.

**Reichhelm & Koester.**—Importers of Jewelers' Tools, Files, etc. Manufacturers of Brushes and Buffing wheels; also Patent Gas Furnaces for Melting, Plating, Enamelling, Annealing, etc. 80 Nassau St., N. Y.

#### Lapidaries.

**Fox, M. & Co.**—Practical Lapidaries, No. 1 Maiden Lane, New York.

**Graham & Co.**—Practical Lapidaries, Cutters and Polishers of all kinds of Precious Stones. Miners' Relics Cut, Polished and Mounted. Miniature, Locket and Clock Glasses. 80 Nassau St., N. Y.

**Kordmann & Michel.**—Lapidaries. Dealers in Precious Stones. Cutting and Polishing Rubies, Sapphires and other Gems a specialty. Drilling done promptly. 59 Nassau St., N. Y.

**Korn, Ph.**—Lapidary. Importer of Precious and Imitation Stones, No. 63 Nassau street, between Maiden Lane and John street, New York.

#### Masonic Jewelry.

**Luther, John F.**—79 Nassau Street. Manufacturer of Fine Presentation Jewels for all Societies. Knights Templars, Crosses, Badges, &c.

**Popper, H.**—Manufacturer of Medals and Badges for Military, G. A. R., Shooting, Masonic, Odd Fellows, Knights of Pythias, etc. 91 Essex St., New York.

**Wilkinson, C. B.**—Manufacturing Jeweler, 8 John St., N. Y. Medals, Badges and Masonic Jewelry, a specialty. Designs furnished free upon application.

#### Optical Goods.

**Friedlander, R. & L.**—65 and 67 Nassau Street. Dealers in Optical Goods.

#### Opticians.

**Burbank Man'g Co.**—Manufacturers of Spectacles and Eye Glasses of all descriptions, in gold, silver, etc., 14 Maiden Lane, N. Y.

**DuBois, Geo. W. & Co.**—Importers of Watches and Optical Goods. 36 Maiden Lane, N. Y.

**Kahn, Hanover & Co.**—Importers of Spectacles, Eye-Glasses and Optical Goods generally, and Scientific Instruments of every description. 32 Maiden Lane, New York.

**Levy, Dreyfus & Co.**—Importers of Spectacles and Eye Glasses and Optical Instruments of every description, No. 11 Maiden Lane, N. Y.

**Lorsch, Albert**—Manufacturer of the Patent Accommodating Spectacles and Eye Glasses in Gold, Silver and Steel, and other Optical Goods, 37 Maiden Lane, N. Y.

**Spencer Optical Manufacturing Co.**—Gold, Silver, Steel, Nickel and Plated Spectacles; Gold, Celluloid, Steel, Nickel and Rubber Eye Glass and Opera Glasses. 13 Maiden Lane, N. Y.

#### Paper Boxes.

**Waterbury Paper and Box Co.**, 27 to 35 Canal St., Waterbury, Conn., Manufacture Jewelers' and Silversmiths' Fine Paper Boxes. Quality guaranteed to be equal to the best made.

#### Precious Stones, &c.

**Bishop, Victor & Co.**—33 Maiden Lane, Importers of Precious Stones, Cameos, &c. Also Manufacturers of Coral Jewelry.

**Bissinger, Philip & Co.**—Importer of Diamonds, Pearls and Precious Stones. Agent for the Bohemian Garnet Goods. Blue Enameled Locket. No. 22 John St., N. Y.

**Breidenbach, R. A.**—Importer of Black Onyx, Cameos, Turquoise, Pearls, Sardonyx, Amethysts, Topaz, Garnets, Opals, Rubies, Sapphires, Cat's Eyes, Hematites, Brilliants, Doublets, etc. 85 Nassau St., N. Y.

**Daue, Wm. & Co.**—Importer of Precious and Imitation Stones. No. 202 Broadway New York.

**Fox, M. & Co.**—Importers of Diamonds and other Precious Stones, No. 1 Maiden Lane, N. Y.

**Gruet, Jules.**—Importer of all Grades of Real and Imitation Stones. 14 John St., N. Y.

**Guntzburger Bros.**—Manufacturers and importers of Precious Stones—Amethysts, Topaz, Cameos, Garnets, Imitation Diamonds, &c. No. 9 Maiden Lane.

**Hahn & Co.**—Importers of Precious Stones. Cameos, Onyx, Pearls, Intaglios, Amethysts, Garnets, etc. 64 Nassau Street, New York.

**Kahn, L. & M.**—Importers of precious and imitation stones. 10 Maiden Lane, N. Y.

**Kipling, E. E.**—Importer of Precious and Imitation Stones. Manufacturer of the Patent Foil Solid Metal Back Rhine Stone Brilliant. No. 6 Maiden Lane, N. Y.

**Kipling, R. A.**—Precious and Imitation Stones, No. 24 Maiden Lane, N. Y. Manufacturer Cameos, Agates, Onyx, Etc., Oberstein, Germany. Commission Merchant, 49 Rue De L'Echiquier, Paris.

**Tannenbaum, L. & Co.**—Importers of Diamonds and Precious Stones. Steam Lapidary Works. Oriental Stones Cut and Polished a specialty. 65 Nassau St., N. Y.

#### Silverware.

**Gorham Manufacturing Co.**—Union Square.

**Knowles, J. B. & S. M.**—Manufacturers of Sterling Silverware, 20 Maiden Lane, N. Y. Factory, Providence, R. I.

**Shiebler, Geo. W.**—Manufacturer of Sterling Silverware. No. 8 Liberty Place, near Maiden Lane, N. Y.

**Whiting Manufacturing Co.**—Makers of Sterling Silver Ware. Broadway cor, 4th Street, N. Y.

**Wood & Hughes.**—Manufacturers of Fine Silverware. 16 John Street, N. Y.

#### Silver Filigree Jewelry.

**Cuppia, L. A.**—Manufacturer of Solid Silver Novelties, and Importer of Silver Filigree, 19 Union Square.

**Francesconi, Guido**—Silver Filigree Jewelry, 196 Broadway, Room 7, New York.

**Hartmann, P.**—Manufacturer of Silver Filigree Jewelry. 36 Maiden Lane, N. Y.

#### Silver Plated Ware.

**Hartford Silver Plate Co.**—Manufacturers of Fine Electro-Plated Ware. Factory and Salesroom, 28 High Street, Hartford, Conn.

**Holmes, Booth & Haydens**—Manufacturers of Silver-Plated Ware. 47 Chambers Street.

**Manhattan Silver Plate Co.**—Manufacturers of Silver Plated Ware. Showrooms, 23 John St. Factory, 301 to 305 East 22d St., cor. 2d Ave. Address all communications to Factory.

**Middletown Plate Co.**—Manufacturers of Superior Electro-Plate. Factories, Middletown, Conn., salesroom, 13 John Street.

**Rogers & Bro.**—Manufacturers of the finest quality of Electro-Plated Ware. 690 Broadway.

**Rogers, Smith & Co.**—Manufacturers of Fine Electro Plated Ware. No. 46 E. 14th St., N. Y.

**Simpson, Hall, Miller & Co.**—Manufacturers of fine Silver-Plated Ware. No. 36 E. 14th Street.

**Schade, Henry.**—Manufacturer of White Metal and Plated Ware. Nos. 56 & 58 Ainslie Street, Brooklyn, E. D., N. Y. Price list and catalogue furnished on application.

**Webster, E. G. & Bro.**—Manufacturers of Fine Silver-Plated Ware. Office and warerooms, 14 Maiden Lane, N. Y.

#### Show Cases, Etc.

**Smith, B. & W. B.**—Manufacturers of Patent Improved Dust Proof Show Cases, with Perpendicular Sliding Doors, No. 220 W. 29th St., N. Y.

#### Spectacle Case Manufacturers.

**Bertine P. D.**—Manufacturer of Spectacle and Eye-Glass Cases. 139 William Street, near Fulton St., New York.

**Koenen, A. & Bro.**—Manufacturers of Leather Spectacle and Eye-Glass Cases. 81 Nassau St., N. Y.

#### Stem Winding Attachments.

**Abbott, Henry** Maker of Stem Winding Attachments, No. 7 Maiden Lane, N. Y.

#### Thermometers, Etc.

**Tagliabue, Giuseppe.**—Manufacturer of Thermometers, Barometers and Hydrometers. Patentee and sole manufacturer of the U. S. Standard Hydrometer. 302 Pearl Street, near Beekman.

#### Thimble Manufacturers.

**Barker Manuf'g Co.**—Makers of Patent Graduated Thimbles, Stiffened Gold, Filled Gold and Rolled Gold, 36 Maiden Lane, N. Y. A. Lyons, Ag't. Factory, 129 Eddy St., Providence, R. I.

**Burbank Manuf'g Co.**—Manufacturers of Gold and Silver Thimbles, 14 Maiden Lane, N. Y.

**Ketcham & McDougall.**—Improved Gold and Silver Thimbles, Bryant Building, N. Y.

**Simons Bro. & Co.**—Manufacturers of Gold and Silver Thimbles, 611 and 613 Sansom Street, Philadelphia.

**Woglom & Miller.**—Sole Agents for the "Prime" Thimbles in Gold and Silver, manufactured by Ezra C. Prime. 34 John Street, N. Y.

#### Watch Companies.

**American Watch Co.**—Robbins & Appleton, No. 5 Bond Street, N. Y.

**The E. Howard Watch and Clock Co.**—Cor. Maiden Lane and Nassau Street, N. Y.

**Waterbury Watch Co.**—Manufacturers of the Waterbury Watch. Factory, Waterbury. Office, 52 Maiden Lane, N. Y.

#### Watch and Chronometer Jeweler.

**Queen, James.**—Watch and Chronometer Jeweler and Pallet Maker, 78 Nassau Street, room 8. Pivots inserted in Pinions, Balance, Staffs, etc.

**Wennstrom, John.** Watch, Chronometer and Clock Jeweling, Jewel Gauges, Ruby and Sapphire Draw Plates; Diamond Charged Polishing Stones for Jewel Settings; Pivots inserted in Pinions. 2 Dutch Street, N. Y.

#### Watch Importers, Etc.

**Abry, Chas. Leo**—Importer and Manufacturer of Swiss Watches of all grades. 63 Nassau Street.

**Aikin, Lambert & Co.**—Importers of Watches. Sole Agents for Paul Breton & Chas. Latour, Geneva. A general line of reliable Swiss Watches, Watch Cases, etc. 23 Maiden Lane, N. Y.

**Bartens & Rice**—20 John Street. Importers of Watches and sole agents in the United States for the celebrated Nicole, Nielsen & Co. Watches.

**Cross & Beguelin.**—Importers of Watches, Watch Tools and Materials, dealers in American Watches, No. 21 Maiden Lane, N. Y.

**Droz, Henry E.**—Importer of Watches, and Watch Case Manufacturer. Agent for the "E. Perregaux" Watch, and jobber in American Watches No. 92 Fulton Street, N. Y.

**Freund Max & Co.**—Importers of Watches, Jewelry and Precious Stones, 8 Maiden Lane, N. Y.

**Gagnebin, Chas.**—Importer of all kinds of Swiss, and Dealer in American Watches. 4 Maiden Lane, N. Y. Agent for Ulysse Breting's Fine Chronometers, Chronographs, Anchors, &c.

**Gallet, Julien.**—Importer of Watches. No. 1 Maiden Lane.

**Ginnel, Henry**—Importer of Watches, Tools and Materials, 31 Maiden Lane, N. Y. P.O. Box, 2967

**Hyde's Sons, John E.**—Wholesale Commission Agents, only for Jules Jurgensen, of Copenhagen; Jules Monard, of Geneva; and for other makers of all qualities of Watches, 22 Maiden Lane.

**Keller, L. H. & Co.**—Successors to G. A. Huguenin, Importers of Fine Watch and French Clock Materials, No. 64 Nassau Street, N. Y.

**Mathey Bros. & Mathez.**—Importers of Fine Watches and Sole Agents for the H. L. Matile's Watches. No. 16 Maiden Lane.

**Robert, J. Eugene**—No. 30 Maiden Lane, New York. Agent for Louis Audemar's celebrated watches.

**Schwob, Adolphe**—Manufacturer and Importer of Watches, 11 Maiden Lane, N. Y.

**Strasburger, Louis & Co.**—Importers and Makers of Watches of every description, 15 Maiden Lane.



**Watch Cases.**

- Dueber Watch Case Mfg Co.**—Manufacturers of Gold and Silver Watch Cases. Bryant Building, N. Y. Factory, Newport, Ky.
- Duhme & Co.**—Manufacturers of Gold and Silver Watch Cases, Carlisle Block, Fourth and Walnut Streets, Cincinnati.
- Fahys, Joseph**—Manufacturer of Watch Cases and Dealer in American Movements, 38 Maiden Lane.
- Glatz, Chas.**—Manufacturer of Silver Watch Cases. Bryant Building, cor. Nassau and Liberty Sts.
- Keller & Untermeyer.**—Manufacturers of Watch Cases with Raised Gold Ornaments. 9 Maiden Lane, N. Y.
- Ladd Watch Case Co.**—Manufacturers of the Ladd Patent Stiffened Gold Watch Cases, etc., 11 Maiden Lane, N. Y. Factory, 58 Eddy Street, Providence, R. I.
- Willemin Watch Case Co.**—Makers of Gold Watch Cases. Raised Gold Ornamentation and Jurgensen style of Engine Turning. 109 Sands Street, Brooklyn, N. Y. 16 Maiden Lane, N. Y.

**Watch and Chronometer Repairers.**

- Cerf, B.**—Practical Watchmaker and Repairer, No. 10 John Street, N. Y. Repairing and adjusting of Fine Watches done for the trade. All kinds of escape and stem-winding wheels cut to order.
- Heinrich, H. H. & Co.**—Sole Manufacturers of H. H. Heinrich's Patent Auxiliary Balance, and Adjusters and Repairers of Fine Watches and Chronometers. 12 John Street, N. Y.
- Lesperance, Theo.**—Watchmaker and Wheel Cutter. Also Stoning Nickel Movements. No. 1 Maiden Lane, New York. With Julien Gallet.
- Ludeman, W. H.**—Chronometer and Watch Maker. Repairing of every description for the trade, 75 and 77 Nassau Street.

**Watch Case Repairers.**

- Feinier, Joseph A.**—Watch Case Maker and General Repairer. Specialty in fine Gold and Silver Cases. Jobbing promptly attended to. Nos. 4 and 6 John St., N. Y.
- Tarbox, Hiram**—Watch Case Repairing, Springing, Polishing and Engine Turning. 1874 North Fourth Avenue, bet. 176th and 177th Sts., N. Y. Express Packages should be sent to 92 Fulton Street.

**Watch Glasses, Shades, Etc.**

- Brown, Edwin H.**—No. 85 Nassau Street, Imported and Own Manufacture Watch Glasses, Flat, Flat Concave, Concave, Convex and fine Geneva's. Fine fitting solicited.

**Watches, Diamonds and Jewelry.**

- Alford, C. G. & Co.**—Manufacturers. General line fine and Reliable Goods. Specialties in Onyx Goods and Chain. 200 Broadway, New York.
- Cohn, J. J.**—Importer and Manufacturer of Whitby Jet, Rubber and Pearl goods. Gold and Rolled-plate Jewelry, etc. 12 Maiden Lane, New York.
- Durfey & Reynolds**—Successors to Durfey & Shiebler, Watches, Diamonds, Jewelry. No. 9 John Street, (up-stairs) New York.
- Friedman, Saml.**—Wholesale Dealer in Watches and Jewelry, 42 Maiden Lane, N. Y.
- Goddard, John M.**—Manufacturing Jeweler,—Seal Rings and Fine Locketts a specialty, No. 3 Maiden Lane, N. Y.
- Greason J. R. & Co.**—Successors to Arthur, Rumrill & Co., 182 Broadway. Manufacturers of Fine Jewelry and Gold Chains, also Diamond Mountings.
- Haskell, H. C.**—Manufacturing Jeweler. Seal Rings a specialty. Special attention to Jobbing of every description. 12 John street.
- Herzog, Louis & Co.**—Importers of Watches, Dealers in Diamonds and Jewelry, 52 Maiden Lane, N. Y.
- Hirsch Bros.**—Dealers in Watches and Diamonds and Manufacturers of Jewelry, No. 23 Maiden Lane, N. Y.

**Jandorf, P. & Bro.**—Importers of Watches and Jewelry, 196 Broadway.

**Kennedy, Frank S.**—Manufacturer and Wholesale Dealer in Jewelry and Gold and Silver Thimbles, No. 13 Maiden Lane, New York.

**Lissauer & Sondheim**—Wholesale Jewelers and Jobbers in American Watches, No. 12 Maiden Lane, N. Y.

**Marx, Kossuth & Co.**—Importers of Watches and Dealers in Jewelry. 39 Maiden Lane, N. Y.

**Mayer, B.**—Manufacturer of Fine Jewelry, and Dealer in Watches, 71 Nassau street, cor. John street, New York.

**Myers, S. F. & Co.**—Manufacturing and Wholesale Jewelers—all grades. Importers of Watches. Illustrated Catalogue to the trade. 179 Broadway, N. Y.

**Oppenheimer Bros. & Veith**—Dealers in Watches and Diamonds, and Manufacturing Jewelers, No. 35 Maiden Lane.

**Scott, J. T. & Co.**—Importers of Watches, and Manufacturers of Jewelry, and Jobbers of all Grades of American Watches, 11 Maiden Lane.

**Smith & Knapp**—Wholesale Dealers in American and Swiss Watches, Diamonds, Gold and Plated Jewelry and Gold Chain. 182 Broadway, N. Y.

**Steele, J. W.**—Successor to Brainerd, Steele & Co., Manufacturer of Fine Jewelry and Brainerd's Patent Locketts. No. 9 Maiden Lane, N. Y.

**Stern Brothers & Co.**—Importers of Swiss Watches and wholesale dealers in American Watches, &c., 39 Maiden Lane.

**Stern & Stern**—Dealers in Watches, Jewelry and Diamonds. No. 6 Maiden Lane, N. Y.

**Stites, D. H. & Son**—Manufacturers of Fine Jewelry, Rolled Plated Goods and Chains, Parisian Diamond Rings, Studs and Earrings a specialty. 41 Maiden Lane, N. Y.

**Strauss, Jacob.**—Full Line of Gold and Plated Jewelry, and Importer of Watches. 18 John Street, New York.

**Terhune, Charles F.**—Manufacturing Jeweler, 194 Broadway, N. Y.

**Thrall, E. A.**—Wholesale Dealer in Watches and Jewelry. No. 1 Maiden Lane, N. Y.

**Trier Bros.**—Importers of Gamet, Whitby Jet and Amber Jewelry, Silk Guards, Opera, Field and Marine Glasses, Pearl Card Cases. Also a full line of Gold and Plated Jewelry. 15 Maiden Lane, N. Y.

**Wheeler, Parsons & Hays.**—Manufacturers of Fine Jewelry, Watch Cases, Gold Chains, &c. and Dealer in American and Swiss Watches, No. 2 Maiden Lane, N. Y.

**White, N. H.**—Jobber in American-Waltham Watches and Chronographs. Waltham make of 10-k., 14-k. and 18-k. Gold and Sterling Silver Cases; Filled Gold Cases. 11 Maiden Lane.

**Watch Tools, etc.**

**Keller, L. H. & Co.**—Importers of Watchmakers' and Jewelers' Tools, Materials, etc. 64 Nassau Street, N. Y.

**Zimmern, Henry**—Importer of Watch Materials, Tools, and Optical Goods, No. 8 Maiden Lane, (first floor.) Sole Agent for A. Hugenin & Gravier, Mainsprings, New York.

**PHILADELPHIA**

**Booz & Co.**—Manufacturers of Gold and Silver Watch Cases and Jewelry, 108 South 8th St., Philadelphia.

**Bennett, Jacob & Son**—Diamond Setters and Manufacturing Jewelers, 925 Chestnut St.

**Conover David F. & Co.**—American Watches, Wholesale Salesroom, Southeast corner 7th and Chestnut Streets, Philadelphia.

**Guilbert, Thos. M., & Co.**—Manufacturing Jewelers. Flexible Bracelets and Strung Pearl Repairing. 908 Chestnut St., Philadelphia.

**Herold, Chas P.**—Successor to Hildebrandt, Herold & Co., Manufacturing Jeweler and Diamond Setter. Diamonds. 916 Chestnut Street.

**Krieder, Peter L.**—Manufacturer of Sterling Silver Ware. 618 Chestnut Street, Philadelphia.

**McCarty & Hurlburt**—Manufacturers of Gold Spectacles, Silver Thimbles and Plain Rings. Wholesale dealers in American Watches, Jewelry, etc. 131 North Second Street.

**Morgan & Headly.**—Manufacturing Jewelers, Cameo Sets, Gold Sets, Roman Locketts, Rings, Coral Sets and a general line of rich goods. Corner 10th and Chestnut Streets, Philadelphia.

**Muhr's, H., Sons.**—Manufacturing Jewelers. Solid Gold and Filled Rings a specialty. 633 and 635 Chestnut Street, Philadelphia. 1½ Maiden Lane, New York.

**Scherr, L. A. & Co.**—Wholesale Dealers in Watches Silver-Plated Ware, Spectacles, Fancy Goods, Watch Materials, etc. 726 Chestnut Street.

**Sheafer, W. H. & Co.**—Manufacturing Jewelers. Specialty: Band Bracelets. Factory, 612 and 614 Chestnut street, Philadelphia. Office, 15 John street, New York.

**Simons, Brother & Co.**—Manufacturers of Fine Jewelry, Canes, Thimbles, Chains. 611 and 613 Sansom Street.

**Vansant, John T. & Co.**—611 and 613 Sansom Street, Artisan Hall, Manufacturers and Wholesale Dealers in English Sterling Silverware. Specialties: Tea Sets, Knives, Forks, Spoons, Cups and Napkin Rings.

**CHICAGO.**

**American Watch Company**,—of Waltham, Mass. No. 102 State Street, Chicago.

**Clapp & Davies**—Wholesale Jewelers, 63 and 65 Washington Street. Catalogue and price list issued to watchmakers and jewelers.

**Dennison Manufacturing Co.**—Manufacturers of Jewelers' Paper Boxes, Morocco Cases, Tags, Cards, Pink and White Cotton, Tissue Papers, Sealing Wax, &c., &c., 102 Madison St., Chicago. Boston, New York, St. Louis, and Philadelphia.

**Excelsior Sign Co.**—Manufacturers of (Grout's Excelsior) Iron Watch and Spectacle Signs. 124 Fifth Avenue, Chicago, Ills.

**Gilbert, Wm. L., Clock Co.**—Manufacturers of Clocks, Regulators, and Time Pieces, and Clock Material of every description, 54 and 56 Madison Street, Chicago.

**Giles, Bro. & Co.**—Manufacturers and Jobbers in Watches, all classes of Jewelry, Materials, Clocks, Silver Ware. &c. Illustrated catalogues furnished to dealers on application. 101 & 103 State St.

**Stein & Ellbogen**—Wholesale Dealers in Watches and Jewelry, 127 State Street, Chicago, Ill. Specialty, repairing for the trade.

**Wathier, Joseph P.**—Watchmakers and Jewelers for the trade, and Wholesale Dealers in Watch Materials, Tools, etc. 178 West Madison Street, Chicago, Ill. Send for price list.

**Wendell, Charles & Son**—Wholesale Watches, Jewelry, etc. 170 State street, Chicago.

**NEWARK.**

**Baker & Co.**—Gold, Silver and Platinum Refiners, Assayers and Sweep Smelters. 408 New Jersey Railroad Avenue, cor. Murray St., Newark, N. J.

**Diefenthaler Bros. & O'Donnell**—Manufacturers of Fine Jewelry, Lace Pins, Ear Rings and Patent Spring Bangles a Specialty. 36 Crawford Street, Newark, N. J.

**Felger, F. & F.**—Manufacturing Jewelers. Specialties:—Roman Band Bracelets, Lace Pins, Scarf Pins, Ball and Fancy Ear Rings. No. 477 Washington Street, Newark, N. J.

**Fiedler, Herrman**—Successor to Kunze & Fiedler, Engraver, Die Sinker and Press Tool Maker, 363 Market Street, Opposite Pennsylvania R. R. Depot, Newark, N. J.



**Glorieux, W. L.**—Assayer, Refiner and Sweep Smelter. 13 and 15 Franklin Street, Newark, N. J.

**Hopper & Valentine**—Manufacturers of Fine Jewelry, No. 8 Maple Place, Rear 44 Green St., Newark, N. J.

**Huger & Heitlinger.**—Manufacturers to the Jobbing Trade only. Makers of Roman Stone, Engraved and Enameled Locketts, also Sets, Lace Pins and Ear Rings. Rear 477 Washington St.

**Krippendorf, C. & Schuller, F.**—Machinists and Jewelers' Tool Makers. 19 Greene Street, Newark, N. J. Rolls, Dies, Cutters, and Draw-plates of every Description made and repaired.

**Lefort, Henry.**—Stem-winding Watch Crown Manufacturer. 60 Arlington Street.

**Lelong, L. & Bro.**—Gold and Silver Refiners Assayers and Sweep Smelters, Southwest corner of Halsey and Marshall Streets, Newark, N. J.

**Miller & Beam.**—Manufacturers of Enameled Sets, Ear Rings, Lace Pins, etc. Guard Slides and Pendants a Specialty. 21 and 23 Green Street.

**Milne, Alex.**—Manufacturer of Stem-winding Watch Crowns. 19 Ward Street.

**Plumb & Marcus**—Manufacturers of Traveling and Marine Clocks, Electric Appliances. 289 Washington St., Newark, N. J.

**Pollock, T. H.**—Manufacturer of Jewelers' and Silversmiths' Wheel Brushes, Buffs, etc. No. 36 Crawford Street, Newark, N. J.

**Regad, E. D.**—Lapidary. Specialty—Sardonyx, Black Onyx and Agates. 14 Oliver St., Newark.

**PROVIDENCE**

**Hutchison & Huestis**—Makers of Solid Gold Rings. Quality guaranteed. For the Jobbing Trade only. 185 Eddy Street, Providence, R. I.

**Lederer, S. & B.**—Manufacturers of Fire Gilt, Nickel, Electro and Silver Plated Chains, Necklaces, Charms, etc. Opera, Matinee and Guard Chains. 66 to 72 Stewart St., Providence, R. I.

**Pearce & Hoagland.**—Manufacturers of Gold Pens, Holders, Pencils, Tooth Picks, etc. Also the Quill Reserve Tooth Pick. 29 Point Street, Providence, R. I.

**Presbrey & Tuttle**—Manufacturers of a large variety of Fine Bracelet and Eye-Glass Chain in Gold Plate and Silver, Spring Rings, Holders, Hooks, Snaps, etc. 35 Point St., Providence, R. I.

**Seery Mfg. Co.**—Manufacturers of Fire Gilt, Nickel and Electro Plated Chains, Vest, Neck, Opera and Guard. 33 Beverly St., Providence, R. I.

**Smith, Wm. T.**—Assayer, Refiner and Sweep Smelter. Established 1855. Blackstone and Hawkins Streets, Providence, R. I.

**Taylor, Geo. H. & Co.**—Watchmakers and Wholesale Dealers in Watches, Clocks, Watch and Clock Material, Tools, Spectacles, Eye Glasses, &c. Particular attention given to trade work. 136 Westminster Street (Room 1), Providence, R. I.

**PAWTUCKET.**

**Draper, J. O. & Co.**—Manufacturers of Jewelers' Fig Soap, adapted for Washing Jewelry, Scratch Brushing and Drawing Wire. Pawtucket, R. I.

**Fuller, Geo. H. & Son**—Jewelers' Findings, Gold, Silver, Gold Plated and Fire Gilt. Pin Stems, Joints, Catches, Split Rings, Chain Hooks and Swivels, Ear Wires, Chain Bars, etc. 99 Exchange Street, Pawtucket, R. I.

**Thayer, Ellis & Son**—Brush Manufacturers, and Wholesale Dealers in all kinds of Brushes. Sole manufacturers of Ellis Thayer's Patent Polishing Wheels. Manufacturing Jewelers' and Machine Brushes a Specialty. 80 North Main Street, Pawtucket, R. I.

**Thayer, P. E. & Co.**—Manufacturers of Brushes. Jewelry and Machine Brushes a Specialty. All kinds of Wire Scratch Brushes on hand. Orders by mail or otherwise promptly attended to. 34 East Avenue, Pawtucket, R. I.

**CINCINNATI.**

**Hellebush, Clemens**—Manufacturer, Importer and Wholesale Dealer in everything required by the Jewelry Trade. 77 W. Fourth St., Cincinnati, O.

**Lodwick & Nolting**—Wholesale Jewelers, S. W. cor. 4th & Walnut Streets, Cincinnati.

**BALTIMORE.**

**Gruebel & Kesmodel**—Manufacturers of Fine Diamond Etruscan, Enameled, Plain and Rhine Stone Jewelry to order. Repairing a specialty. Orders by Mail solicited. 212 & 214 W. Baltimore St., Balto., Md.

**BOSTON.**

**Boston Watch Case Co.**, makers of Watch Cases. Especial attention given to Repairing. 1, 3 & 5 Province Court, Boston, Mass.

**Boyce, E. J.**—Manufacturer of Solid Gold Jewelry. Rings a Specialty. 383 Washington St., Boston, Mass.

**Smith, Wm. A.**—Importer of Diamonds and Precious Stones. Diamonds mounted and unmounted and Diamond Mountings. 383 Washington St., Boston, Mass.

**BUFFALO.**

**King & Eisele**—Manufacturers of Solid Gold Jewelry, and Agents for American and Foreign Watches; also Jobbers in Roll Plate Jewelry. Office and Salesrooms, 283 Main St. Factory, 2, 4, 6 and 8 Swan St.

**Oliver, W. W.**—Manufacturer of Hand and Power Rolling Mills for Jewelers and Silversmiths, 39 Clinton Street, Buffalo, N. Y.

**CLEVELAND.**

**Chandler, J. M. & Co.**—Manufacturers of the Patent Embossed Bracelet and Jobbers in all kinds of Clocks, Watches, Jewelry, Tools, Materials, etc. 185 Superior St., Cleveland, O.

**NORTH ATTLEBORO.**

**Whiting, F. M. & Co.**—Manufacturers of Sterling Silver Ware and Jewelry, North Attleboro, Mass.

**LANCASTER.**

**Bowman & Musser**—Jobbers in Watches, Clocks, Chains, Fine Tools and Materials. 20 East Chestnut Street, Lancaster, Pa.

**PITTSBURGH.**

**Barrett, G. B. & Co.**—Importers and Wholesale Dealers in Watches, Diamonds, Jewelry, Clocks, Bronzes, Silver and Plated Ware, Watch Materials, &c., 238 & 240 Liberty St.

**Goddard, Hill & Co.**—Wholesale Dealers in American Watches, Jewelry, Silverware, Clocks, Materials, &c., 43 Fifth Avenue, Pittsburgh, Pa.

**SPRINGFIELD.**

**Bullock, O. W.**—Springfield, Mass. Manufacturer of Fine Nickel Plated Watch and Jeweling Tools, Keys, and Light Metallic Goods.

**CANADA.**

**Ellis, P. W. & Co.**, No. 31 King street, East Toronto, Ontario, Manufacturing Jewelers, Watchmakers, importers and Jobbers of Watchmakers, and Jewelers' Tools, Materials, General Supplies and American Jewelry. Correspondence solicited with manufacturers of Novelties or specialties in American Tools and Jewelry.

**POSITIVELY NO GOODS RETAILED.**

**BOWMAN & MUSSER,**

SUCCESSORS TO

**E. F. BOWMAN,**

JOBBERS IN

**Watches, Clocks, Chains,**

Fine Tools and Materials,

**20 E. CHESTNUT STREET,**

Cop. P. R. R. Passenger Depot,

**LANCASTER, PA.**

Selection Packages sent to Regular Jewelers on Request.

**BARNES' No. 4 LATHE,**  
For the Heavier Work of Jewelers.

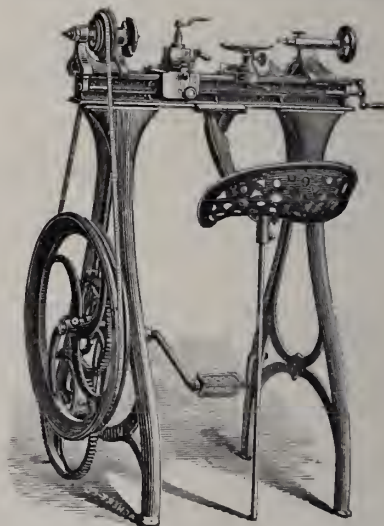

Barnes' Patent Foot and Steam Power Machinery. Complete outfits for Actual Workshop Business. Lathes for wood or metal. Circular Saws, Scroll Saws, Formers, Mortisers, Tenoners, etc., etc. Machines on trial if desired. Descriptive Catalogue and Price List Free.

**W. F. & JOHN BARNES,**  
2088 Main Street, ROCKFORD, ILL.



**SOLID GOLD**

AND

**STONE INLAID**

**Cigar Cutter,**

Pat'd Oct. 5, 1880.

**J. WIENHOLD,**  
Manufacturer of FINE JEWELRY.  
DIAMOND MOUNTINGS A SPECIALTY.  
24 John St., N. Y. City.





CROSSCUP & WEST PHILA

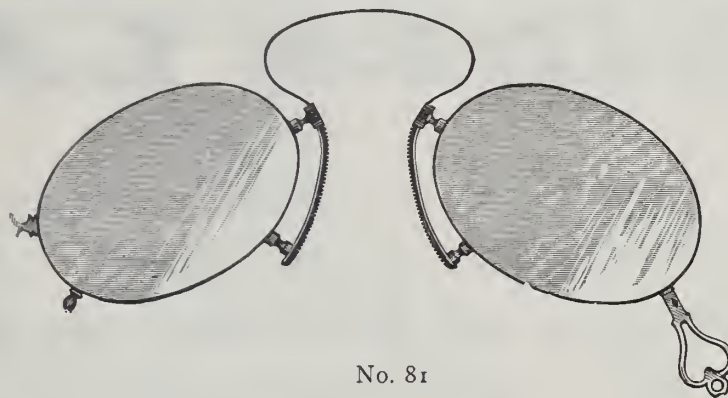

No. 81



# MORGAN & HEADLY,

MANUFACTURERS OF GOLD, SILVER AND STEEL

## Spectacles & Eye-Glasses.

### OUR TRADE GROWS APACE.

*We are constantly improving our patterns and machinery and educating our employees, thereby advancing the standard of our business.*

*The coming season will prove us to be still going ahead in our Special Line. With more extensive stock and facilities, and everything advanced except prices, which are uniformly low, we invite a continuance of your patronage.*



**WATCH CASES.**  
**SOLID GOLD,**  
**FILLED GOLD,**  
**COIN SILVER,**  
**NICKEL.**

**WATCH MOVEMENTS.**  
**ELGIN,**  
**SPRINGFIELD,**  
**WALTHAM,**  
**TROY.**

**DIAMOND JEWELRY.**

UNIQUE PATTERNS  
 OF  
**Rings, Lace Pins, Ear Rings,**  
 Studs, Collar Buttons,  
 Etc.

Goods sent on Selection  
 To Responsible Jewelers.

ESTABLISHED 1866.

# LISSAUER & SONDHEIM



MANUFACTURERS, IMPORTERS, JOBBERS,

**12 MAIDEN LANE,**

(P. O. Box 2516.)

**NEW YORK.**

REPRESENTED ON THE ROAD BY

**Mr. A. Krailsheimer, Mr. M. Lissauer, Mr. M. Daniel,**  
**Mr. D. H. Lowman, Mr. G. Silberberg, Mr. I. Smith.**  
**Mr. E. M. Bracher.**

**SPECIALTIES:**

A COMPLETE LINE OF  
**"DUEBER" WATCH CASES**

In Gold, Silver and Rolled Plate, and

**"L. & S." 14 Kt. Ladies' Cases,**

With Raised Gold Ornamentation.

OUR NEW PRICE LIST IS NOW READY

AND WILL BE SENT UPON APPLICATION, TO THE TRADE ONLY.

**Solid Gold Jewelry.**  
**RINGS,**  
**LOCKETS,**  
**BRACELETS,**  
**BUTTONS, ETC.**

**Rolled Plate Jewelry.**  
**CHAINS,**  
**CHARMS,**  
**BANGLES,**  
**NECKLACES, ETC.**



# WATERBURY CLOCK CO.,

MANUFACTURERS OF

## CLOCKS,

NOVELTIES AND MATERIALS.

No. 10 CORTLANDT ST., N. Y.

— AND —

No. 63 WASHINGTON ST., CHICAGO.

Factories, WATERBURY, CONN.

M. BAILEY, Treasurer.

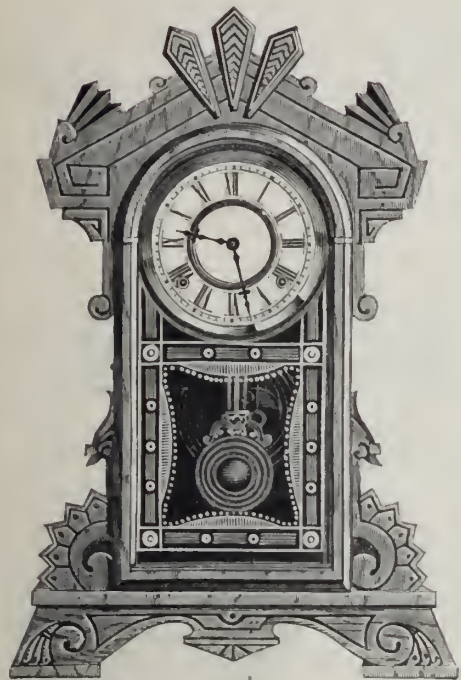

SEAFORD.

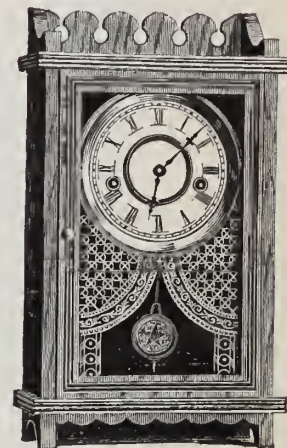

RACER

# THE ANSONIA CLOCK CO.

HANGING CLOCKS

— AND —

## MANTEL CLOCKS

OF EVERY DESCRIPTION.

A Large and Complete Stock of

|                  |                        |                    |
|------------------|------------------------|--------------------|
| Tower<br>Clocks  | } HANGING AND STANDING | } Street<br>Clocks |
|                  |                        |                    |
| } AT LOW PRICES. |                        |                    |



CHICAGO,  
64 Washington St.

NEW YORK,  
11 to 19 Cliff St.

LONDON,  
128 Minories.





“AMPHION.”—Walnut.

Cut Glass Mirror Panels in Side and Base. Improved Equalizing, Adjustable, Slow Strike Movement. Eight Day Strike on Gong only. Height, 25 inches. 6 inch Dial.

# W. L. Gilbert Clock Co.

GEORGE B. OWEN, General Manager.

Salesrooms:

No. 6 Murray St., N. Y.  
54 & 56 Madison St., Chicago.

Factories:

WINSTED,  
Conn.

MANUFACTURERS OF

## Walnut, Veneered and Other Clocks.

IMPORTERS OF

## Marble and Cuckoo Clocks.

*Catalogue and Price List Furnished upon application.*

ESTABLISHED 1829.

# E. N. WELCH MANUFACTURING CO.

AND

## WELCH, SPRING & CO.,

6 Warren Street,

New York, U. S. A.

W. H. ATWATER, Agent.

MANUFACTURERS OF

## SUPERIOR AMERICAN CLOCKS & REGULATORS.

IMPORTERS OF

### FINE FRENCH CLOCKS.

CHICAGO,

SAN FRANCISCO.

CHINA AND JAPAN.

LONDON,

GLASGOW.

Factories, FORESTVILLE, CONN., U. S. A.





# NOW!



ORDER WHATEVER

## PLATED WARE

YOU NEED FOR THE HOLIDAYS.

Late Buyers always suffer the disappointment and delay inevitable to the rush of business, broken stocks, uncertainties of railroads, etc. incident to December.

# ROGERS & BROTHER,

**690 BROADWAY, NEW YORK.**

# NICHOLAS MULLER'S SONS,

**117 CHAMBERS STREET, NEW YORK.**

MANUFACTURERS OF

## Fine Clocks and Ornamental Bronzes.



New Regulating Attachment (Patented).

BRASS AND BRONZE

Fancy Goods

—FOR THE—

JEWELRY TRADE.



"ROYAL," Embroidered Satin and Bronze.



SOLE AGENTS FOR THE  
 JAMES PICARD,  
 CHARLES LODTMAN  
AND  
 ULYSSE HUMBERT  
 WATCHES.

MANUFACTURERS OF  
 MINUTE, FIVE MINUTE and  
 QUARTER HOUR REPEATERS,  
 with and without  
 CHRONOGRAPH ATTACHMENTS.

LOUIS STRASBURGER & CO.

DIRECT IMPORTERS OF

WATCHES AND DIAMONDS,

WE MAKE EVERY KIND  
 OF WATCH IN  
 OUR OWN  
 FACTORY.

WE KEEP ALL  
 KINDS OF GOLD  
 AND SILVER AMERICAN  
 CASES AND MOVEMENTS.

WE GET THE ROUGH  
 DIRECT AND CUT  
 OUR OWN  
 GOODS.

No. 15 MAIDEN LANE,

→NEW-YORK←

Rue Leopold Robert,  
 CHAUX-DE-FONDS.



Boulevard Haussman, 30,  
 PARIS.

MANUFACTURERS OF  
 Split 1-4 Second CHRONOGRAPHS,  
 Split 1-3 Second CHRONOGRAPHS,  
 SINGLE CHRONOGRAPHS,  
 Open Face and Hunting  
 SILVER AND GOLD CASES.

SOLE AGENTS FOR THE  
 Celebrated Brands of Nickel Watches  
 "RAILWAY,"  
 "SUN,"  
 "ALASKA,"  
 and Manufacturers of all grades of  
 8 and 18 Size Movements



# THE MIDDLETOWN PLATE COMP'Y,

Factories, MIDDLETOWN, CONN.

→ SALESROOMS ←

13 JOHN ST., NEW YORK.

120 SUTTER ST., SAN FRANCISCO.



No. 1051, Tea Set, Slop Bowl and Cream,  
 Gold Lined, - - - \$68.00  
 Waiter, 24 inch, to match, - 50.00  
 " Urn, - - - - 36.00

No. 1051, Butter Dish, - - - \$9.50  
 " Syrup Cup and Plate, - 9.00  
 " Spoon Holder, Gold Lined, - 8.00

Offer to the Trade a **LARGER** Assortment than ever, for Fall of 1883, of Elegant New Designs in Electro-Plate, finished in Plain Burnished Surface, (with Elegant Borders), Satin, Hammered, Fancy Gilt, New Satin, Etc., Etc.

**A LARGE LINE OF GOODS IN RUSSIAN GOLD.**



“THE BEST”

# THE DUEBER

## GOLD WATCH CASES.



DESIGNS FOR CHURCH PRESENTATION PURPOSES.

*Quality Guaranteed as per following U. S. Registered Trade Marks:*



Trade Mark for 14-K. Gold Cases.



Trade Mark for 18-K. Gold Cases.



Trade Mark for 10-K. Gold Cases.

We use but Three Qualities of Gold—18-K., 14-K., and 10-K.;—use no Trade Mark or Stamp but our own; and invite inspection of Finish and Workmanship in every particular.

# The Dueber Watch Case Mfg. Co.

•CHICAGO,•

4 Tribune Building.

•CINCINNATI,•

P. O. Box 1334.

•NEW YORK,•

20 Bryant Building



# THE BEST THE DUEBER COIN SILVER WATCH CASES

WITH

Solid Soldered Edges and Joint Bearings Throughout.

For Twenty Years, as to-day, the Leading Watch Case in the American Market.

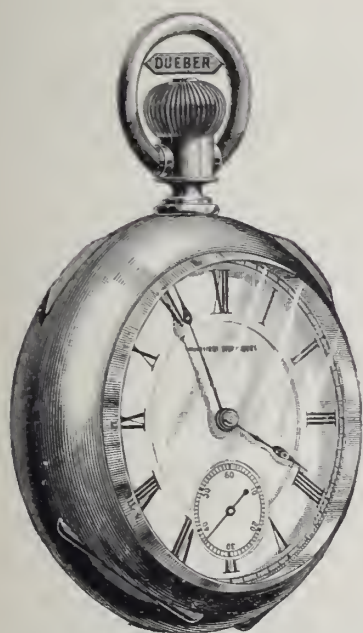

381842—Full Bassine Style.



Pat. July 6th, 1880. No. 229,681.

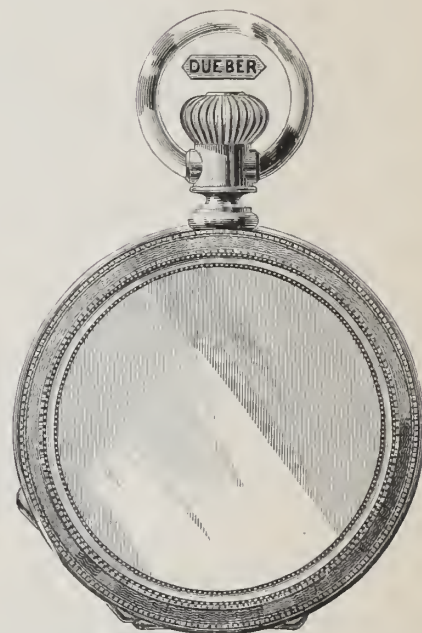

381888—Bourbon Style, with Gold Crown.

Their Equal in Construction, Finish or Intrinsic Value has never been Produced.

THE DUEBER WATCH CASE MFG. CO.

4 Tribune Building, Chicago.

Box 1334, Cincinnati, Ohio.

20 Bryant Building, New York.



# LERROY W. FAIRCHILD, MANUFACTURER OF

18 JOHN ST.,  
N. Y.

GOLD PENS.

PEN AND PENCIL  
CASES.

CHARM PENCILS.

TOOTH PICKS.

WHISTLES.

MATCH BOXES.

CIGARETTE HOLDERS.

CIGAR PERFORATORS.  
ETC., ETC.

Gold Pens and Ornamental Charms of every description, made from Original Designs and of Standard Quality.

Would invite the attention of buyers to a large and comprehensive assortment of novelties in this line never before presented to the Trade.

The unique and graceful conception of sedate styles and the wide range of odd and fantastic conceits presented in these goods render them exceedingly desirable for Holiday Presents and Presentation Purposes, while the unapproachable excellence of the workmanship and finish which characterize all goods made in my establishment, cannot fail to satisfy the most fastidious and critical taste.

Especial attention is directed to my New Illustrated Catalogue of Designs, containing many objects of artistic merit and designed especially for the Jewelry Trade.

Dealers carrying but a limited stock of these goods can present this Catalogue to their customers, and selection made therefrom without fear of exposing the dealer's profit.

Copies of the Catalogue will be forwarded to legitimate dealers only upon application.

LERROY W. FAIRCHILD,

18 JOHN ST., N. Y.



**STERN & STERN,**

MANUFACTURERS,

JOBBER,

AND IMPORTERS OF

# JEWELRY, WATCHES & DIAMONDS,

## No. 6 MAIDEN LANE, N. Y.

*We offer this season one of the Largest, Most Complete and Varied Stock of*

# JEWELRY,

*mounted in 14 k. and 10 k. Gold, and the Best Grade of Roll Plate Goods made, comprising the Newest and Most Desirable Designs.*

RINGS,  
SETS,BRACELETS,  
EAR RINGS,CHAINS,  
LACE PINS,LOCKETS,  
BUTTONS,CHARMS,  
STUDS,

GOLD AND SILVER THIMBLES, Etc., Etc.

# WATCHES.

*We are Sole Agents for the Celebrated "Manhattan" and "Lady Washington" Movements, fitting American Cases,*

AND THE CELEBRATED

## S. S. MELVILLE WATCHES,

*universally acknowledged by our Southern Trade to be the Best Swiss Watch for the money made. Cased in 2 and 3 oz. Silver Cases, Key and Stem Wind.*

AND

## Jobbers in all the Leading American Movements and Cases.

# DIAMONDS.

*In this Department our Stock is UNUSUALLY LARGE and COMPLETE, consisting of Rich and Elegant Designs in Rings, Lace Pins and Ear Rings, as well as Loose Stones.*

Goods Sent on Approval, and Prompt Attention Given to Orders and Repairs.

**STERN & STERN,**

No. 6 MAIDEN LANE.



# JOSEPH FAHYS & CO.,

MANUFACTURERS OF

## WATCH CASES,

38 Maiden Lane,

NEW YORK.

78 MONROE STREET, CHICAGO.



654321



654322



654323



654324



654326



654325

Electrotypes of any of the above cuts, for advertising purposes, will be furnished the Trade, free of charge, upon application.



THE  
 BROOKLYN WATCH CASE CO.  
  
 EAGLE CASE.



In order to meet an imperative and growing demand in the Trade for a reliable grade of Low Karat Cases, this Company, seven years ago, was induced to place upon the market their since Celebrated **EAGLE CASES**, which are made of full 8-k. gold in all their parts, joints and bearings, the backs and caps free from solder, saving that which holds the joints. Since their introduction, these cases have achieved a wide spread reputation for the reliable and standard quality maintained in their manufacture. It has been demonstrated that the wearing qualities of the **EAGLE CASES** are unexcelled by any 12-k. case in the market, while their color is permanent and the appearance equal to that of the best cases made of this grade. The 8-k. **EAGLE CASES** will stand the severest acid test and will not tarnish when exposed in the show case or worn in the pocket.

All these goods are Stamped in the Cap with the Trade Mark of the Company,

B. W. C. Co.

and are guaranteed to be of the uniform standard designated.

A LARGE AND WELL ASSORTED STOCK OF 18-K., 14-K. AND EAGLE CASES IN THE LATEST AND MOST ARTISTIC DESIGNS, KEPT CONSTANTLY ON HAND.

For Sale by all the Principal Jobbers.



# DAVID F. CONOVER & CO.

(SUCCESSORS TO WM. B. WARNE & Co.)

Manufacturers and Wholesale Dealers in

## WATCHES and JEWELRY.

Wholesale Agents For

### Rogers & Brother's Flat and Hollow Ware



### Celluloid Eye-Glasses.

And Sole Agents for the

#### Patent Railroad Train Watch Chains, Nickel.

WHOLESALE AGENTS FOR

#### T. A. WILLSON & CO.'S Optical Goods.

Would invite attention to the following new grades of Steel Spectacles lately introduced in the market.

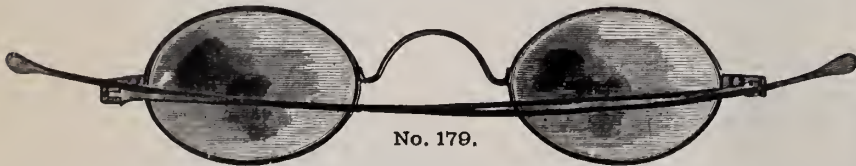

No. 179.

They are Steel, Full Tempered. Parts interchangeable. Joints so constructed that wear is compensated for. Temple will not work loose and fall down as in old style joints. Nose-piece on No. 155 reinforced where it joins eye, giving extra strength with neatness.

**PRIZE MEDALS AT ALL EXHIBITIONS WHERE EXHIBITED.**

Patented July 31, 1877.

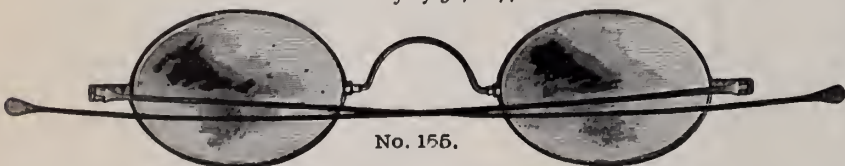

No. 155.

### A SPECTACLE TEMPLE

THAT WILL

#### NOT WEAR LOOSE.

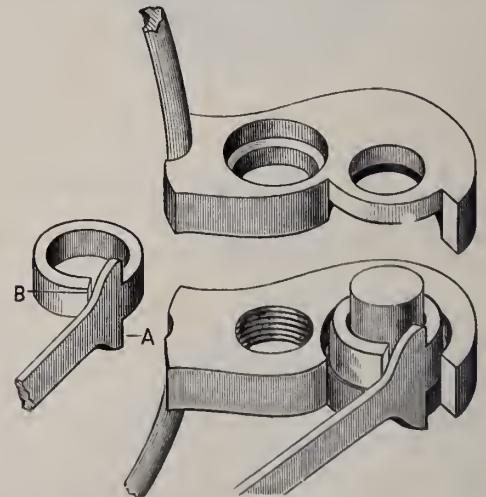

Patented May 13th, 1879. Re-issued June 8th, 1880.

- A.—Stop for Temple, preventing Strain on Joint.
- B.—Compensating eye, for taking up wear of joint. The eye of Temple is smaller than Stubb Steel Joint Pin on which it works, and is left open at B, exerting a Spring Tension on Pin.

American Watch Wholesale Salesroom:  
Southeast Cor. Chestnut and Seventh Sts., First Floor,

### PHILADELPHIA.

DAVID F. CONOVER,  
C. FRANK WILLIAMS  
B. EDGAR RIGHTER.



## SHAKSPEARE—NEW VERSION.

*Oberon.* \* \* \* \* "And be thou here again, ere the leviathan  
Can swim a league."

*Puck.* "I'll put a girdle round about the earth in forty minutes,"  
*Following THE AMERICAN LEVER SLEEVE BUTTON,*  
*Which always leads!*

THE AMERICAN LEVER



BEST IN THE WORLD



TO THE RETAIL TRADE.

Please ask your Jobber for the goods bearing the *FAMOUS HORSE-SHOE AND CLOVER TRADE-MARK*, and if he should decline to furnish them, kindly write to "*THE MANUFACTURERS OF THE AMERICAN LEVER BUTTONS, PROVIDENCE, R. I.*," who will send the address of Jobbing Houses from whom these *Celebrated Goods* can be purchased.



# Derby Silver Co.'s Celebrated Wares,

Original and Novel Designs for the Fall Season of 1883.

SALESROOMS:

25 MAIDEN LANE,

170 STATE STREET,

New York.

Chicago.

---

Having just opened our new Shop with a choice assortment of fine Silver-ware, consisting of all the latest novelties of the best and most pleasing designs, we respectfully solicit your inspection.

Main Factories at BIRMINGHAM, CONN.

Where all Communications should be Addressed.

CANADIAN BRANCH FACTORY:

No. 31 Adelaide Street East, Toronto, Ont.



No. 3 UNION SQUARE, NEW YORK.



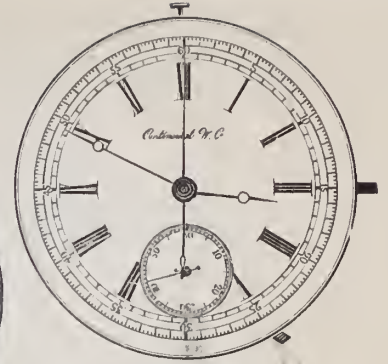
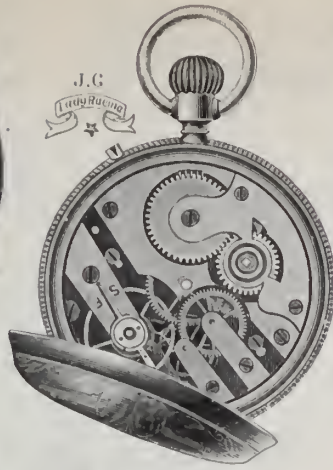

# CONTINENTAL WATCH CO. MOVEMENTS,

6, 8, 10, 16 & 18 Sizes.

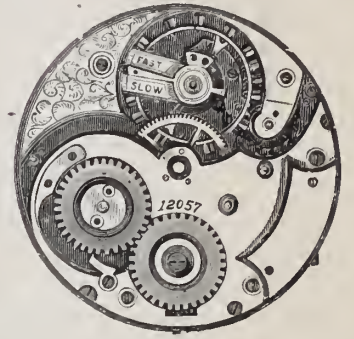

Fitting Waltham and Elgin Cases, and are the Most Reliable Movements in the market.

For Sale by all the Leading Jobbers in the Country.



Would call the attention of the Trade to our Eureka, Lady Racine, Railroad Regulator and Continental Watches, in Silver and Nickel Cases in all sizes.

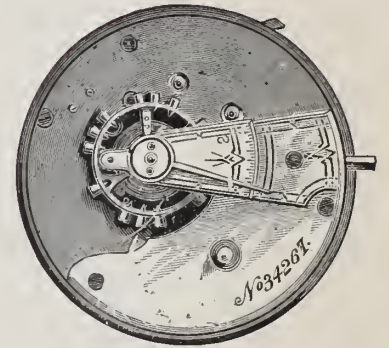

## JULIEN GALLET & CO.,

No. 1 MAIDEN LANE, NEW YORK.

SOLE AGENCY FOR THE CELEBRATED JAMES NARDIN WATCHES.

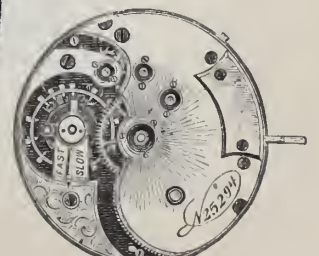
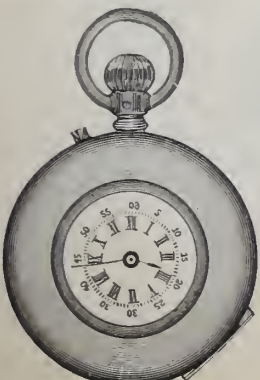
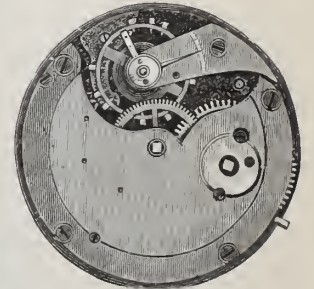
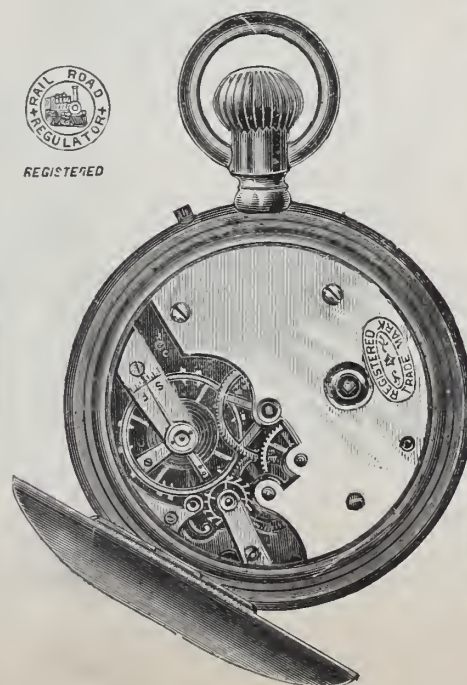
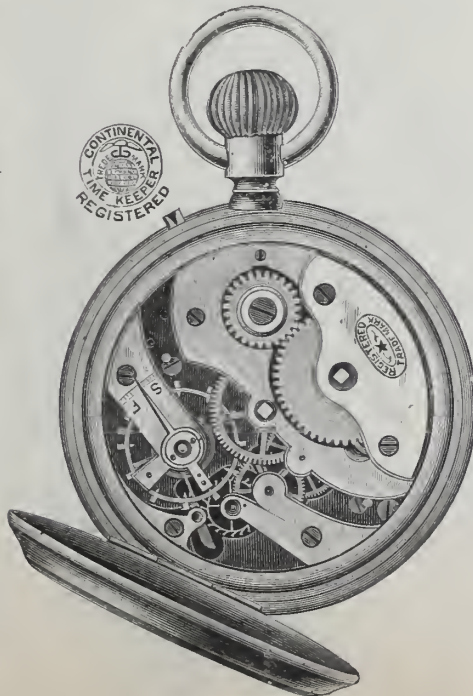
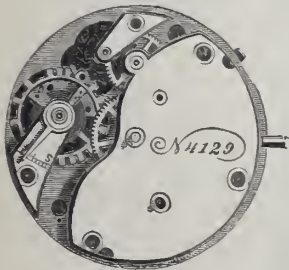
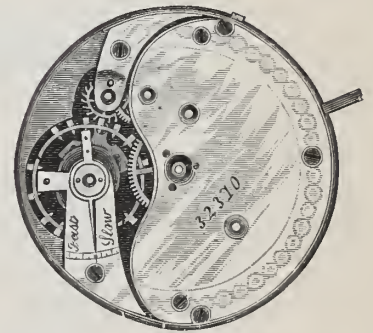
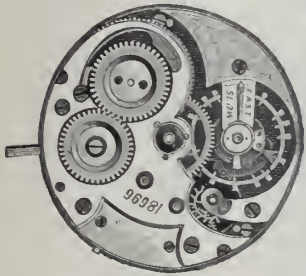



# SIMPSON, HALL, MILLER & CO.,

36 E. 14TH ST., UNION SQUARE, N. Y.

FACTORIES, WALLINGFORD, CONN.

## Manufacturers of HIGHEST QUALITY OF SILVER PLATED WARE.

Spoons and Forks sold by Simpson, Hall, Miller & Co., Wallingford, Conn., bearing my individual name, to authenticate the quality, are all made in their Factories, of Finest Nickel Silver, under my personal supervision, and by my ideas of Style, Pattern and Finish, and control of quality.

The patterns are made exclusively by them and patented, and are the Highest Quality Goods in market.

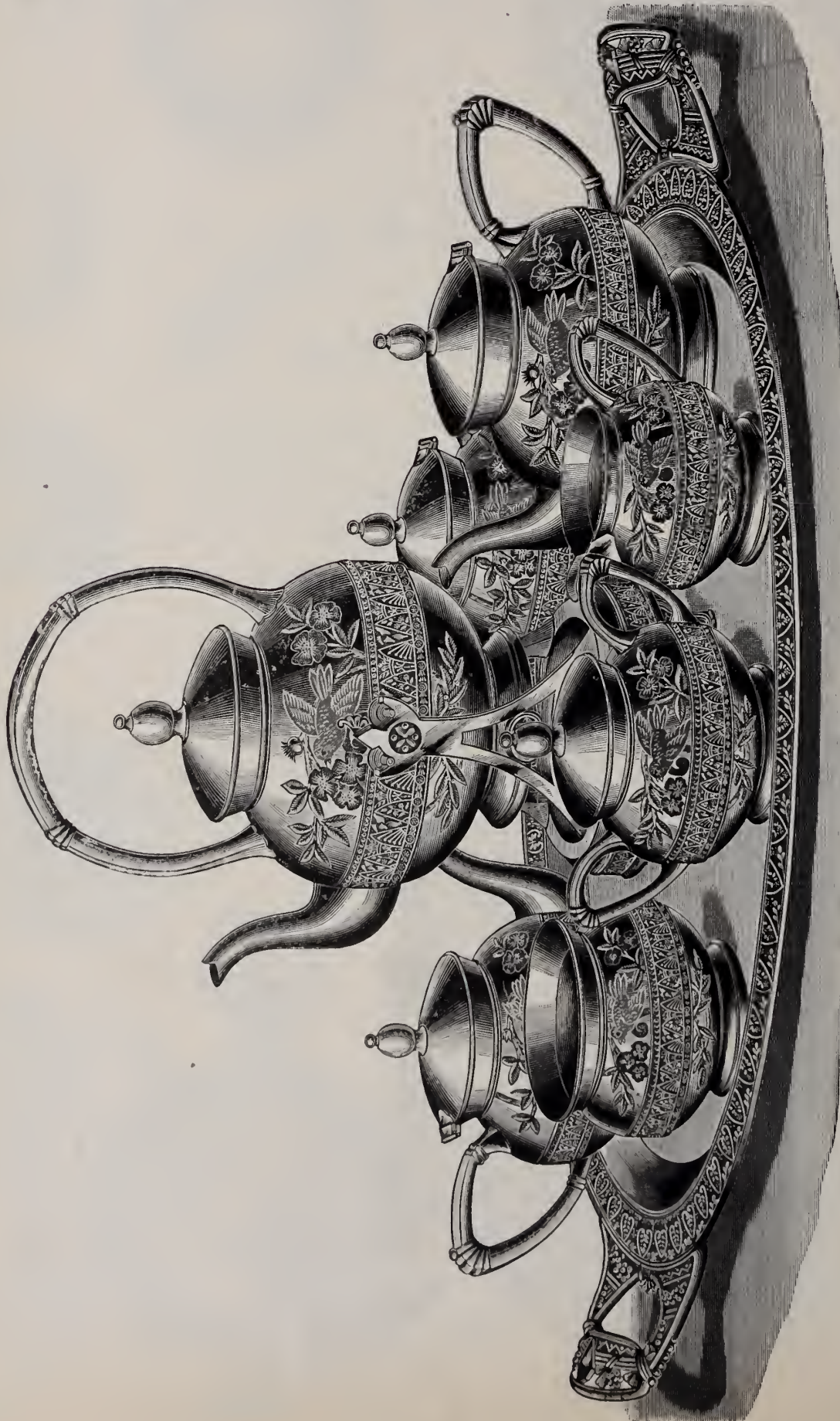

My individual name, Wallingford, Conn., is a positive guarantee of the quality of the goods, and in buying them the Trade do so upon my personal guarantee of quality.

**WM. ROGERS, PERSONALLY.**

Since May, 1878, with SIMPSON, HALL, MILLER & Co., Wallingford, Conn.



# MERIDEN BRITANNIA CO.,

MAKERS OF

## ELECTRO GOLD AND SILVER PLATED WARE.

SALESROOMS:

46 East 14th Street, Union Square, N. Y.

Canada Branch, Hamilton, Ont.

145 State Street, Chicago.

134 Sutter Street, San Francisco.

And at the Manufactory, Meriden, Conn.



No. 218. ICE PITCHER SET.



‡ **AGASSIZ** ‡

# MOVEMENTS.

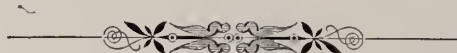

**CAUTION.**



I WOULD respectfully *caution* the Trade against a *spurious* movement made with intent to deceive, and in imitation of Watches and Movements made in my establishment.

The Movements made by me and bearing my Trade Mark



have achieved a high reputation in the Trade, which fact has induced certain unscrupulous parties to counterfeit them. I would, therefore, with a view to protecting the interest of Dealers in the United States, caution them against these spurious and greatly inferior goods, and state that all Movements made in my establishment have my Registered Trade Mark as above engraved upon the Plate under the Dial, and none other are genuine.

“AGASSIZ.”

*Switzerland, October, 1883.*



# KELLER & UNTERMAYER,

Makers of Artistic Watch Cases, would respectfully call the attention of the Trade to their Select Display of Watch Cases, made in every style of Artistic Decoration, from New and Original Designs (Patented).

These goods have achieved a high reputation and are especially appropriate for Holiday Offerings and Presentation Purposes.

As the Originators of Raised Gold Decorative Work, an especial feature with us, our facilities of manufacture are unequalled for the production of Genuine Works of Art in this style of ornamentation.

In addition to the several illustrated designs which recently appeared in "The Jewelers' Circular," we have introduced many New and Beautiful Styles that cannot fail to please the most fastidious and critical buyers.

In the production of these Cases, the same care and attention is exercised in regard to workmanship and finish as is maintained in the Standard of Quality, Excellence in Detail and Artistic Effect.

The popularity of our Cases has induced imitators to offer a class of inferior goods that intelligent dealers cannot fail to recognize at a glance.

Keller & Untermeyer,

No. 9 Maiden Lane, N. Y.



OFFICE 18 MADISON AVE.

**A. PINOVER & CO**  
 MANUFACTURERS  
 OF SEAL RINGS & DIAMOND MOUNTINGS. A FULL LINE OF DIAMOND MOUNTED GOODS CONSTANTLY ON HAND. WE CALL SPECIAL ATTENTION TO OUR RAISED INITIAL GLOVE RINGS

**THE INCRUSTED GOLD RING IS THE ONLY GLOVE RING.**



247



248

THE INCRUSTED RING of our manufacture is a 24 KARAT Gold letter imbedded in a Curved Stone WITH or WITHOUT DIAMONDS, and is sold by us at the same price as the raised initial rings of any other manufacturer.



246

**WHAT A GLOVE RING IS.**

An Incrustated Letter on a Curved Stone is THE ONLY RING that can be technically called a GLOVE RING.

**WHAT IS NOT A GLOVE RING.**

A Raised Initial on EITHER a CURVED or FLAT Surface IS NOT a GLOVE RING.



249

An incrustated ring will permit the glove to set flat upon the finger, while any raised letter will have a tendency to tear the glove; if not, to at least make the finger look awkward by making the glove bulge, and is, therefore, not a glove ring.

**FOR SALE BY EVERY JOBBER OF JEWELRY IN THE UNITED STATES.**

Manufactured by A. PINOVER & CO.



# THE VERY LATEST!



Closed.



Open.



Closed.

PATENT APPLIED FOR.

MADE ONLY IN 14 KARAT.

*The above Cuts represent my new*

## Combination Vinaigrette Ring,

MADE IN A LARGE VARIETY OF NOVEL DESIGNS.

This Ring enables the wearer to dispense with the Scent Bottle.

Just the thing for HOLIDAY and BIRTHDAY PRESENTS.

Must be seen to be appreciated.

Bound to be a UNIVERSAL FAVORITE.

Please apply for Samples on Selection, as my travelers do not carry stock.

MANUFACTURED AND SOLD BY

ADOLPH GOLDSMITH, 38 Maiden Lane.

N. B.—This Patent is applicable to almost every design, and any special pattern will be made to order upon request.

# ADOLPH GOLDSMITH,

SOLE AGENT FOR THE

## RELIANCE WATCH COMPANY,

38 MAIDEN LANE,

NEW YORK.

FULL LINE OF

Gold and Plated Jewelry.

EVERY DESCRIPTION OF

SWISS WATCHES

A SPECIALTY.

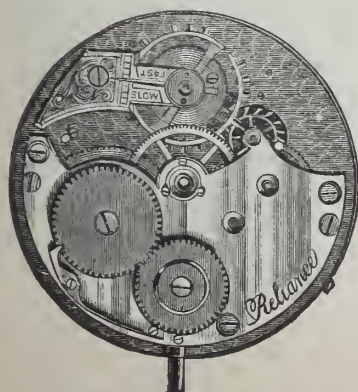

"RELIANCE,"  
18 Size, to Fit Waltham Cases.



"RELIANCE,"  
Nickel Stem Winder in all Sizes.



"RELIANCE,"  
Ladies' 8 Size, to Fit Waltham Cases.





# ROGERS, SMITH & CO.,

MANUFACTURERS OF

## ELECTRO GOLD

AND

## SILVER PLATED WARE.

SALESROOMS :

46 EAST 14TH STREET, UNION SQUARE, N. Y.

FOR THE TRADE ONLY.

FACTORY, - - MERIDEN, CONN.

# STANDARD WATCH CO.



STANDARD CALENDAR

### "STANDARD CALENDAR."

20 Line, Open Face, in Nickel and Silver, showing the date and day of the week, Full Jeweled, Finished Movement. The Latest Novelty offered.



### "STANDARD."

18 Size, Low Price Movement, will fit Waltham and Elgin Cases.

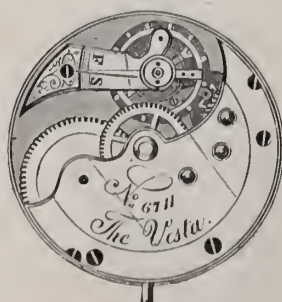

### "VESTA."

8 Size, Low Price Movement, fits Elgin Cases.



### "STANDARD."

8 Size, Full Jeweled, Ladies. Fits Waltham Cases.

REGISTERED.



### "STANDARD."

Nickel, 17, 19 and 20 Line. Lever, Full Jeweled.

Max Freund & Co., Sole Agents, 8 Maiden Lane, N. Y.





A Gold Medal was awarded DUHME & CO. by the 11th Cincinnati Industrial Exposition (1883) for GOLD and SILVER WATCH CASES, of their own manufacture.

INTERIOR VIEW OF DUHME & CO.'S WATCH CASE FACTORY, CINCINNATI.







**FREUND & OPPENHEIMER,**  
**MANUFACTURING JEWELERS**

**25 Maiden Lane,**  
**New York.**









Fac-Simile of Ring Finished.  
Patented Aug. 28, 1883.



To meet the demand for an Encrusted Initial Ring, we have introduced the

**PATENT GRAIN INITIAL RING**

in 10 k. gold (guaranteed), with one diamond, encrusted in various colors. Being confident of a large sale of these rings, we shall keep in stock a complete assortment of initials and sizes, which will enable us to ship all orders on the day we receive them.

Respectfully yours,  
**FREUND & OPPENHEIMER,**  
 25 Maiden Lane, N. Y.

Price Lists Sent on Application.



# CHARLES GLATZ,

Cor. Nassau & Liberty Sts., Bryant Building, N. Y. 100, 102 & 104 State Street, Chicago.

MANUFACTURER OF

## WATCH CASES.



**GOLD.**  
COMMON [C.S.] SENSE.

TRADE  MARK

NOTICE.—Our Eight Karat Case is to-day Superior to any made in the market, as it is made in greater variety of design, and stands acid test as well as the best made. Also, we claim superiority as we do not have to sacrifice or alter the color of our gold to make it acid proof, so it still stands at the head of any case made.



**SILVER.**  
WARRANTED COIN.

TRADE  MARK

**FOR THE  
JOBGING TRADE ONLY.**

# SIMONS, BRO. & CO.

MANUFACTURERS.



TRADE  MARK

CHAIN.



Fine Jewelry.

ILLUSTRATED CATALOGUE



611 and 613 SANSOM STREET, PHILADELPHIA, OR NEAREST JOBBER.



OFFICE OF VAN MOPPES & MARX, 37 MAIDEN LANE,

New York, October 1st, 1883.

We beg leave to inform you that the partnership heretofore existing under the firm name of VAN MOPPES & MARX, is this day dissolved by mutual consent.

Respectfully yours,

D. L. VAN MOPPES,  
N. MARX.

**D. L. VAN MOPPES,**  
**DIAMONDS**

P. O. Box 3492.

37 MAIDEN LANE, NEW YORK.

PRINCIPAL OFFICE, PARIS, 10<sup>BIS</sup> RUE DE CHATEAUDUN.  
CUTTING ESTABLISHMENT, 16 PLANTAGE MIDDENLAAN, AMSTERDAM.

Dear Sir:

I beg leave to inform you that I have this day established myself under the firm name of

**D. L. VAN MOPPES,**

and shall continue the business which was established under the firm name of Van Moppes & Marx. I shall always keep on hand a complete assortment of desirable goods. Having my own Lapidary in Amsterdam, I am manufacturer of all my goods, and with this advantage the Trade will see the advisability of purchasing from me direct. Thanking you for your kind patronage you have hitherto shown me, I solicit continuance of same and the preference of your orders. Respectfully yours,

D. L. VAN MOPPES.



ESTABLISHED 1833.

(30 YEARS.)



**E. IRA RICHARDS & CO.**

200 BROADWAY,

NEW YORK.

Exclusively Manufacturers of FINE ROLLED PLATED JEWELRY.

THE LARGEST AND CHOICEST STOCK IN THE COUNTRY.



Examples of Medium Quality Bands made in all the widths, sizes, etc., and acknowledged to be the cheapest for quality and finish in the market.



**ESTABLISHED 1847.**

---

**J. T. SCOTT & CO.**



WILL OCCUPY

**4 MAIDEN LANE, N. Y.,**

**ABOUT FEBRUARY 1st,**

Where, with largely increased facilities, they will present additional attractions in all their lines at prices that will interest purchasers.





Manufactory, 47, 49 & 51 Franklin Street, Newark, N. J.

# MILLER BROS.,

No. 7 Maiden Lane,

NEW YORK.

## IMPORTERS OF DIAMONDS

— AND —

### MANUFACTURERS OF FINE JEWELRY.



OPEN.

We would call the attention of the Trade to our Newly Patented TURN OVER CAP SLEEVE BUTTON. The mechanical device by which the cap is turned is by a spring working in the pillar, which makes a much stronger and more durable cap than any other in the market.



CLOSED.

**INITIAL GOODS A SPECIALTY.**

# CROSS & BEQUELIN,

21 MAIDEN LANE, N. Y.

P. O. BOX No. 531.

Manufacturers of the **CENTENNIAL WATCH**, **CENTENNIAL CHRONOGRAPH** and **CENTENNIAL CALENDAR** (Reliable Timekeepers,) the Best Watches for the money made.

DEALERS IN AMERICAN WATCHES, WATCH MATERIALS, ETC.



CENTENNIAL.



CENTENNIAL CHRONOGRAPH.

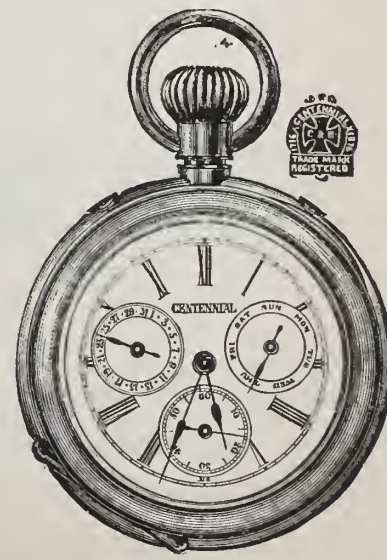

CENTENNIAL CALENDAR.



**WM. SMITH & CO.,**

MANUFACTURERS OF

**GOLD and SILVER  
Chains & Jewelry,**

Also a Large Line of SILVER RINGS.

OFFICE :

**No. 25 Maiden Lane, New York.**

MANUFACTORY—No 61 PECK STREET, PROVIDENCE, R. I.

**W. & S. BLACKINTON,**

MANUFACTURERS OF

ONLY

**FINE ROLLED PLATE CHAINS,**

Necklaces, Polished and Roman, of Latest Gold Designs. Also a Complete Line of Gents' and Ladies' Locketts and Pendants.

In consequence of the first-class reputation our goods have obtained, unscrupulous dealers have been selling goods of an inferior quality, represented as our manufacture. In order to protect ourselves, as well as dealers, all goods of our manufacture will hereafter bear this

TRADE MARK. **W&S.B** ★ TRADE MARK.*These Goods are for sale by all Wholesale Dealers.***WM. J. SUTTIE,**

MANUFACTURER AND JOBBER OF

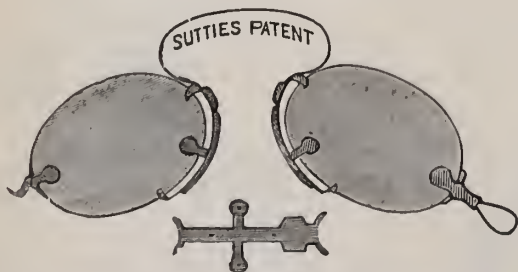
**Eye-Glasses and Spectacles,**

In GOLD, SILVER, STEEL and SHELL,

**No. 39 Maiden Lane, New York.****CYLINDRICAL AND PRISMATIC GLASSES.***REPAIRING A SPECIALTY,***Webster's Silver Solution,**

PREPARED BY

**E. G. WEBSTER & BROTHER,**

(Established 1859.)

Manufacturers of Quadruple

**Electro Silver Plated Ware**

14 MAIDEN LANE, N. Y.,

Expressly for Cleaning Silver and Silver Plated Ware.

Jewelers will find this a valuable adjunct for cleaning their stock, and a reliable article to recommend to their customers.

Guaranteed entirely free from Cyanide, Acid, Grit, or anything detrimental to the Finest Wares.

Packed in Boxes containing 2 Doz. Bottles.

Price, \$1.25 per Doz., NET.

**CHESTER MANCHESTER & CO.,**

MANUFACTURERS OF

**Gold ♦ and ♦ Silver ♦ Chains,**

No. 13 HANOVER STREET,

PROVIDENCE, R. I.

Waltham, Elgin, Illinois, Hampden, E. Howard &amp; Co. and Special Movements.

**392 WASHINGTON ST.,  
BOSTON.**

P. O. Box 5259.

 Watches, Jewelry,  
Gold Chains, Gold,  
Filled and Silver Cases,  
Spectacles, Eye - Glasses,  
Gold Head Canes, and Rogers &  
Bro.'s Flat Ware.

Price List of Movements and Cases

Sent on Receipt of Business Card.

**D. C. PERCIVAL & CO.,** WHOLESALE DEALERS.



# LOUIS A. SCHERR & CO.

Importers and Wholesale Dealers in

## Watches, Jewelry,

WATCH MATERIALS, TOOLS, GLASSES, &c.

Spectacles, Silk Guards, &c.

Wholesale Agents for American Watches.

**No. 726 CHESTNUT STREET  
PHILADELPHIA.**

AGENTS FOR THE WHITCOMB LATHE

AGENTS FOR W. F. NYE'S WATCH AND CLOCK OILS.

# HAUG & LUTHY,

MANUFACTURERS OF

## FINE DIAMOND MOUNTINGS, ETC.,

130 FULTON STREET,

Cor. Nassau St., NEW YORK.

N. B.—All Diamond Mountings of our Man-  
ufacture have a Patented

❖SELF-CLOSING ❖ SAFETY ❖ CATCH❖

## Abbott's Stem Winding Devices

*Are for sale and are applied to watches by  
all reputable jobbers, and by the manufac-  
turer,*

### HENRY ABBOTT,

7 MAIDEN LANE, NEW YORK.

FACTORY, JOHN STREET.

ALSO MANUFACTURER OF

## Fine Enamel Watch Dials.

# YALE CLOCK CO.

NEW HAVEN, CONN., U. S. A.

## NOVELTIES IN CLOCKS.

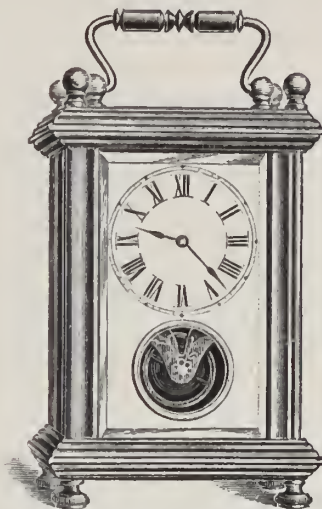

A. I. HALL & SON,

General Agents,

52 Maiden Lane,  
New York.

528 & 530 Market Street,

SAN FRANCISCO,  
CAL.

# JOHN W. STEELE,

MANUFACTURER OF

FINE GOLD JEWELRY,

—AND—

BRAINERD'S

PATENT

## LOCKETS

Patented June 17, 1874.



No. 9 Maiden Lane, NEW YORK.

Agents for the Lancaster, Pa., Watches.

# A. FRIEDENTHAL & CO.

MANUFACTURING JEWELERS,

AND IMPORTERS OF WATCHES.

43 Maiden Lane, New York.

MATERIALS and OPTICAL GOODS.



# COLBY & JOHNSON,

Manufacturers and Jobbers,  
17 MAIDEN LANE, NEW YORK.

WATCH CASES,  
FINE JEWELRY,  
AMERICAN WATCHES.

SOLE MANUFACTURERS OF  
**CELLULOID WATCH CASES,**  
MOUNTED IN  
GOLD, SILVER OR NICKEL.

## PEARCE & HOAGLAND,

MANUFACTURERS OF

Gold Pens, Pencils, Pen Holders, Tooth Picks,  
OF EVERY DESCRIPTION.



CLOSED

SOLE MANUFACTURERS OF THE

**QUILL RESERVE TOOTH PICK,**



OPEN



CLOSED

The Holder of this Case is made in various styles in Gold Plate, Celluloid, Ivory, etc., while the Pick is of ordinary Goose Quill, and can be easily replaced by a new one, at any time, from the Reserve in the end of the Holder, and is the only Pick that will not injure the Teeth.

FOR SALE BY ALL JOBBERS.

Office and Factory, 29 Point Street, Providence, R. I.

ESTABLISHED 1853.

## WELCH & MILLER,

**JEWELRY  
Case Manufacturers,**

Of Morocco, Velvet, Russia, Brocade and Plush.

SHOW CASE TRAYS OF ALL DESCRIPTIONS.

LOCK RING TRAYS FOR DIAMOND RINGS.

Agents for Jewelers' Cotton and Twine.

All Goods of our Own Manufacture, and a Large Stock  
Always on Hand.

**169 BROADWAY, NEW YORK.**

## SUSSFELD, LORSCH & NORDLINGER,

IMPORTERS OF

# Optical & Mathematical Instruments,

Watchmakers' Tools, Materials, Etc.

SPECIALTIES:

**BARDOU & SONS'** Universal Opera Glasses U. S. Army and Navy Glasses.  
Rifle Range Telescopes, Etc., Etc.

**LA REINE** Opera and Marine Glasses.

**CROWN** Spectacles and Eye-Glasses.

**PARADIS MAINSPRINGS.**

**PARAGON TOOLS.**

13 MAIDEN LANE, NEW YORK.

16 Rue D'Enghien, PARIS.

FRANK O. LODWICK.

CHAS. A. NOLTING.

## LODWICK & NOLTING, WHOLESALE JEWELERS,



JOBBERS OF

Gold, Silver & Nickel

WATCHES,

Gold and Roll Plate

JEWELRY

MOVEMENTS

AND

Watch Cases,

SPECTACLES,

Clocks and Silverware.

Positively will all Orders, Inquiries and Repairs receive immediate and reliable attention.

CINCINNATI.

ESTABLISHED 1850.

## JOHN T. MAURAN,

MANUFACTURER OF

FINE ROLLED PLATE GOODS

15 MAIDEN LANE, NEW YORK.

SPECIALTIES FOR THE FALL.

FULL LINE OF

STONE LACE PINS IN RUBY AND SAPPHIRE DOUBLETS,  
GARNETS AND FOILED WHITE STONES,

Jet Lace Pins, Sets and Ear Knobs, Solid Gold White Stone Knobs.

ALSO

Full Line of Coral and Wire Sets, Lace Pins, Knobs, &c.

These Goods, which are so well and favorably known to the Trade, bear this

TRADE MARK

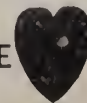

as well as the same being stamped on the cards.



**HELLER & BARDEL**

MANUFACTURERS OF



**JEWELRY,**

13 John St., New York.

*A Full Line of DIAMONDS, Mounted and Unmounted, Always on hand, which we will send for Selection to Responsible Houses.*

All Goods Ordered on Selection or for Stock are Insured while in the Hands of the Express Companies.

R. WALLACE & SONS M'FG Co.,

MANUFACTURERS OF

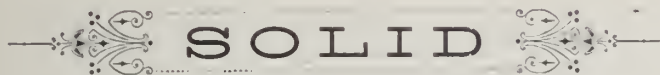

**SILVERWARE,**

GUARANTEED  $\frac{925}{1000}$  FINE.

WALLINGFORD, CONN.

**USE GOLD STOCK PLATED CHAINS**

With Swivels Stamped

**"R. F. S. & CO."**

Every Chain Guaranteed by the Makers.

R. F. SIMMONS & CO.

ATTLEBORO FALLS, MASS.

Sold ONLY through Wholesale Houses.

LEROY C. FAIRCHILD & CO.

MAKERS OF

GOLD PENS, PEN & PENCIL CASES,

No. 14 MAIDEN LANE,

LEROY C. FAIRCHILD,  
G. HARRY ALLEN.

NEW YORK.

WOOD & HUGHES,  
STERLING

**SILVERWARE MANUFACTURERS,**

New York Agents for the Derby Silver Co.'s

**Fine Quadruple Plated Ware,**

**No. 16 John Street, N. Y.**

206 Kearney Street, San Francisco, Cal.

HASKELL & MUEGGE, Agents.

J. B. & S. M. KNOWLES,

MANUFACTURERS OF

**Sterling Silver Ware,**

No. 20 MAIDEN LANE,

**NEW YORK.**

FACTORY, PROVIDENCE, R. I.





# GORHAM M'F'G CO., (Silversmiths,)

NEW YORK,  
37 Union Square.

CHICAGO,  
170 State Street.

SAN FRANCISCO,  
120 Sutter Street.



The "Medici,"

*Design Copyrighted  
1883.*

The Gorham Company present to the Trade for the present season new patterns in Sterling Silver Spoons and Forks,

## THE "MEDICI." THE "CLUNY." THE "HIZEN."

The Illustration here given of the "Medici" is of the handle of the Soup Ladle, showing to the best advantage the characteristics of the pattern. The central figure of the design varies in each of the pieces, while the outline of each is the same, preserving the harmony as a whole and telling the story of the Italian Court. Whether in Merit of Design or Skill in Execution, it marks a decided advance step.

The "Cluny" is of Floral Design, in bold relief as if cast and chased; it is, consequently, a pattern of heavy weight. It is now completed as far as applies to dozen work, the remaining pieces being in process.

Notwithstanding the enhanced cost of the preparation of the "Medici" and "Cluny," the price to the Trade will be the same per ounce as for our other standard patterns.

The "Hizen" is adapted for Fancy Pieces; the handles are cast, Japanesque in design, the decoration of the bowls are hand chased, and parcel gilding is introduced to good effect.



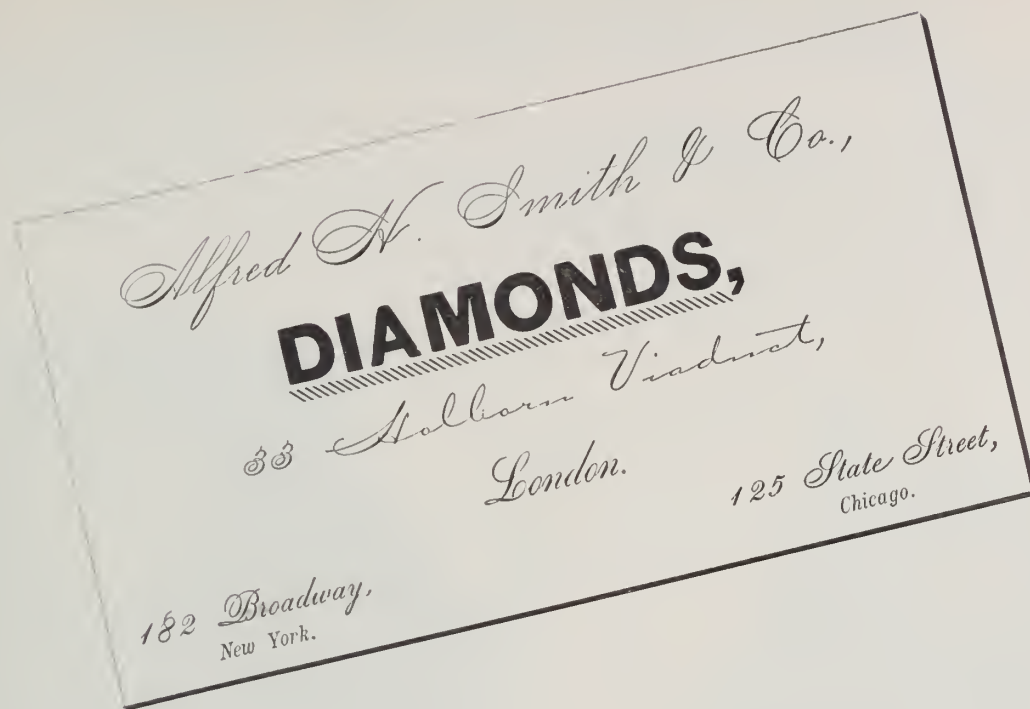

## Autumn, 1883.

We would respectfully direct the attention of the Trade to our Fall Importations of Diamonds, comprising, in addition to important parcels of regular and speculative goods, the finest line of Cold White Single Gems and Important Pairs to be found in this market.

Alfred H. Smith & Co.

182 Broadway, N. Y.

October 1<sup>st</sup>, 1883.



**THE**  
**NEW HAVEN CLOCK CO.**  
**MANUFACTURERS, IMPORTERS, DEALERS,**

**FACTORIES:**  
**NEW HAVEN, CONN.**

**WESTERN OFFICES AND SALESROOMS:**  
**31 Washington St., Chicago, Ill., 134 Sutter St., San Francisco, Cal.**

**GENERAL OFFICE AND SALESROOMS:**  
**16 & 18 PARK PLACE, New York.**

**EUROPEAN OFFICE AND SALESROOMS:**  
**Victoria St., Liverpool, Eng.**

We beg to call special attention to our line of Fall Importations of Marble, Gilt and Alabaster, Antique Brass and Porcelain Placques, Clocks, Bronzes and Novelties for the Holiday Trade. Also, New and Novel Designs for the Fall Season of 1883, in Bamboo, Walnut, Ash, Porcelain, Nickel, Brass, and Plush Cases.

No. 124, GILT AND ALABASTER.

MARBLE.

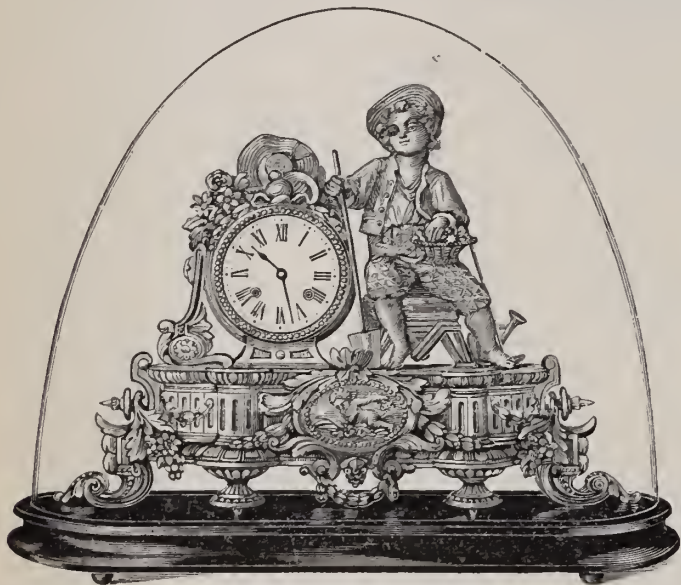

15 DAY,  $\frac{1}{2}$  HOUR STRIKE.  
 Height, with Glass Shade, 15 in. Width, with Glass Shade, 13 in.

LARK.—Porcelain and Plush Cases.



15 DAY STRIKE. CATHEDRAL GONG.  
 Height,  $8\frac{1}{2}$  inches. Base, 15 inches. Dial, 4 inches.

ANTIQUÉ BRASS, No. 2.—Visible Escapement,  
 Porcelain Dial.

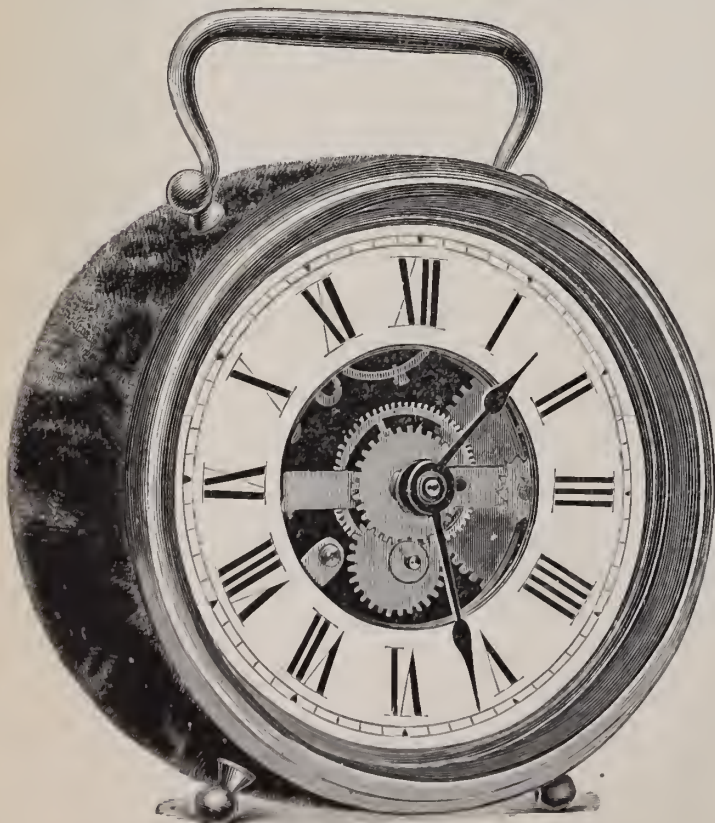

1 Day Lever Time. Nickel Plate Movement.  
 A Reliable Timekeeper.

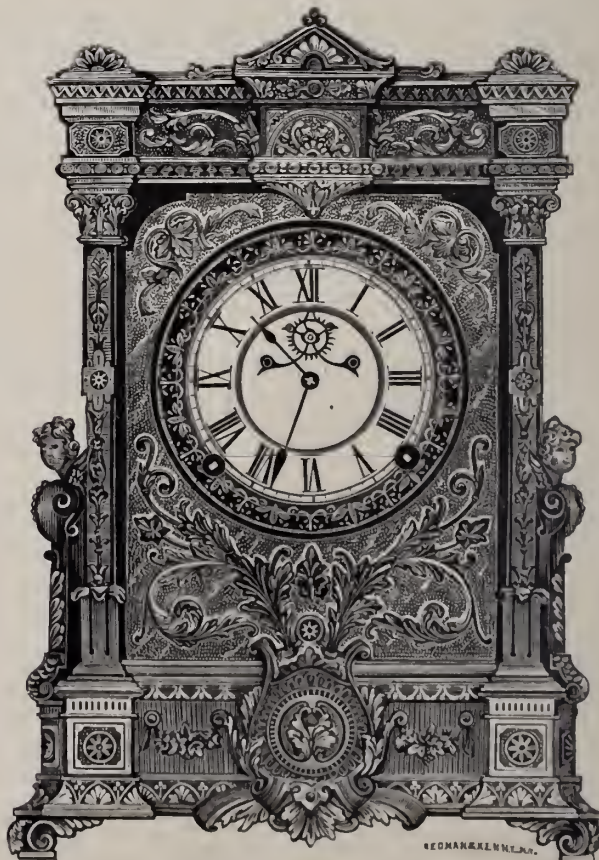

8 DAY,  $\frac{1}{2}$  HOUR STRIKE, CATHEDRAL GONG.  
 Height,  $13\frac{1}{2}$  inches. Dial, 4 inches. Also in Plain Porcelain Dial.

**CATALOGUES AND PRICE LISTS FURNISHED THE TRADE UPON APPLICATION.**





CARTER, SLOAN & CO.,  
MANUFACTURERS OF ALL KINDS OF

GOLD JEWELRY,

No. 15 MAIDEN LANE,  
NEW YORK.

A. CARTER, JR.  
A. K. SLOAN,

C. E. HASTINGS,  
G. R. HOWE.

BALDWIN, SEXTON & PETERSON,

IMPORTERS OF

DIAMONDS and all PRECIOUS STONES,

MANUFACTURERS OF

DIAMOND AND RICH JEWELRY.

Cutters and Polishers of

DIAMONDS

692 & 694 BROADWAY, NEW YORK.

120 SUTTER ST., SAN FRANCISCO, CAL.

*J. F. Chatellier,*  
*Manufacturing Jeweler,*

*692 & 694 Broadway,*

*New York.*

TRADE



MARK

STERLING.

Whiting Manufacturing Co.

SILVERSMITHS,

BROADWAY & FOURTH ST., N. Y.

ESTABLISHED 1837.

TAYLOR & BROTHER,

Old House READ, TAYLOR & CO.,

Importers of Diamonds and Pearls,

—)AND(—

MANUFACTURERS OF DIAMOND JEWELRY,

21 Holborn Viaduct, 676 Broadway,

LONDON.

NEW YORK.

ESTABLISHED 1813.

THOMAS G. BROWN & SONS,  
Newark, N. J., & 5 Bond Street, New York.

MANUFACTURERS OF

ARTISTIC JEWELRY  
FOR PRESENTATION,

Including Prizes for ROWING, RIFLE SHOOTING, ARCHERY and  
all ATHLETIC SPORTS.

COLLEGE SOCIETY PINS AND CLASS RINGS, ALSO BADGES FOR MILITARY  
AND CIVIC BODIES IN ALL METALS.

Employing able Designers, and having all work, both in Designing and Manu-  
facturing, done in our own factory, we can submit, for the inspection of those  
interested, entirely original designs, appropriate in style, and not to be seen else-  
where.

Estimates and Designs will be sent to Reputable Dealers when desired.



ESTABLISHED 1834.

G. & S. OWEN & CO.,  
 —MAKERS OF—  
 FINE ROMAN JEWELRY, &—  
 —BOX and GLASS PINS,  
 —AND—  
 Black Onyx and Pearl Goods,  
 OF EVERY DESCRIPTION.

All Goods sold by us are exclusively of our own manufacture and are warranted 14 K. Fine, and stamped as such when possible.

No. 3 Maiden Lane, New York.

W. H. SHEAFER & CO.,

MAKERS OF  
 BRACELETS,  
 BANGLES,  
 LACE PINS,  
 SCARF PINS, ETC.

No. 15 JOHN STREET,  
 NEW YORK.

RIPLEY HOWLAND M'F'G CO.,

MAKERS OF

**FINE JEWELRY,**

SPECIALTIES:

DIAMOND MOUNTINGS, with Platinum Tips.  
 ENGRAVED RINGS, STONE RINGS,  
 OFFICE, 17 MAIDEN LANE,  
 NEW YORK.

FACTORY, 383 WASHINGTON ST.,  
 BOSTON, MASS.

SAXTON, SMITH & CO.,  
 Manufacturers of

**GOLD CHAIN**

SOLE AGENTS  
 FOR THE  
 NEW PATENTED CHAIN BAR,  
 Containing a Detachable Pencil.

FACTORY:  
 183 EDDY ST.,  
 PROVIDENCE, R. I.

OFFICE:  
 14 JOHN ST.,  
 NEW YORK.

A. J. HEDGES & CO.,

MANUFACTURING

**JEWELERS,**

No. 6 MAIDEN LANE,  
 NEW YORK.

Factory, No. 90 MECHANIC ST.,  
 NEWARK, N. J.

**A. W. FABER'S**  
**Gold Pens,**

→ PEN AND PENCIL CASES. ←

EBERHARD FABER, MANUFACTURER,  
 718 & 720 BROADWAY,  
 NEW YORK.



# FOWLER BROS.,

MANUFACTURERS OF

## JET & ONYX JEWELRY.

Offer a large and varied stock of desirable goods of original designs, especially manufactured for the coming Fall Trade. These goods are elegant in design, beautifully finished, and must be seen to be appreciated.



PATENTED MARCH 27th. 1893.

Are Carried by all the Leading Jobbing Houses  
Throughout the Country.

# MOORE & HORTON,

No. 11 Maiden Lane,  
NEW YORK.

# JEWELERS'

### SPECIALTIES:

Stone Cameo, Onyx, Amethyst, Topaz  
and Pearl Rings.

Studs, Collar and Sleeve Buttons.

Also our fac-simile of Fine African Diamonds,  
with Foile Back, Mounted in Rings, Studs,  
Pins, Ear Rings, Scarf Pins, Lace Pins, &c.

JOHN F. SAUNDERS,  
Of the late firm of Buckenham, Cole & Saunders.

CHAUNCEY IVES.

## SAUNDERS & IVES,

IMPORTERS OF

# DIAMONDS, PEARLS,

And Other Precious Stones.

Manufacturers of Diamond Mountings.

### No. 26 MAIDEN LANE, NEW YORK.

A Large Stock of FINE DIAMONDS, Mounted and  
Unmounted, kept constantly on hand.

Goods sent on approval to any part of the country on receipt of  
satisfactory reference. All our goods ARE IN-  
SURED by us while in transit.

# DORRANCE, EDGE & CO.,

Makers of the Celebrated

## Woven Fabric Gold Chain,

And Patentees of the

### Embossed Inlaid Jewelry.

The Latest and Most Effective Styles of Decoration  
Introduced.

15 JOHN ST., NEW YORK.  
FACTORY, 46 GREENE ST., NEWARK, N. J.

# G. W. PRATT & Co.,

Manufacturers and Dealers in

## Watches and Jewelry

OF EVERY DESCRIPTION.

ELGIN AND ILLINOIS MOVEMENTS  
IN ALL GRADES.

Gold, Silver and Ladd Patent Cases.

No. 14 JOHN STREET, NEW YORK.

# C. ROSSWOG & SON,

MANUFACTURERS OF

Rich Jewelry and Diamond Goods,

Nos. 5 & 7 MAIDEN LANE,

NEW YORK.



CHURCHILL, LEWIS & CO.,  
 Manufacturing Jewelers,  
 692 BROADWAY, NEW YORK.

S. W. HALE & CO.,  
 SUCCESSORS TO HALE & MULFORD,  
 MANUFACTURERS OF  
**FINE JEWELRY**



692 BROADWAY, N. Y.  
 SETH W. HALE. WILLIAM A. LEE. WILLIS H. HOWES.



GEO. W. SHIEBLER,  
 MANUFACTURER OF  
 Sterling Silverware,  
 HANDSOME NOVELTIES  
 CONSTANTLY ON HAND.  
 8 LIBERTY PLACE, NEW YORK.

JOHN A. RILEY & CO.,  
 9 BOND STREET, N. Y.  
 SOLE MANUFACTURERS OF THE POPULAR  
 PATENT SPRING BRACELETS

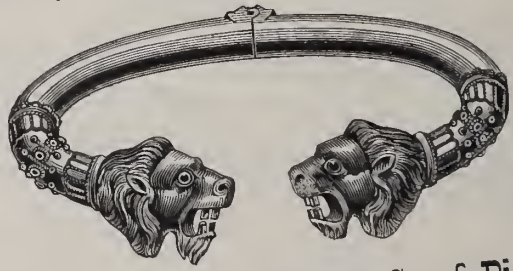

Also Lace Pins, Ear Rings, Scarf Pins, Etc.

SMITH & KNAPP,  
 WHOLESALE DEALERS IN

AMERICAN AND SWISS WATCHES,  
**DIAMONDS.**

Gold & Plated Jewelry & Gold Chain,  
**No. 182 BROADWAY,**  
 COR. OF JOHN STREET, NEW YORK.

E. STITES' SONS.

**BRACELETS**

14 JOHN STREET,  
 NEW YORK.  
 FACTORY, NEWARK, N. J.



HODENPYL, TUNISON & CO.,  
 MANUFACTURERS OF  
**FINE GOLD JEWELRY**  
 OF ALL DESCRIPTIONS IN  
**Roman and Enamel.**

ALSO THE  
**PATENT SPRING DIAMOND COVERS IN ALL STYLES.**

OFFICE, 170 BROADWAY.

Factory, 95 & 97 Cliff St., **NEW YORK.**

**GEO. O. STREET & SONS,**

ESTABLISHED 1837.

OFFICE AND FACTORY,

15 JOHN STREET, NEW YORK.

*Fine Intaglio and Platina and Gold  
 Lockets, Seals, Ladies' Gent's and Chil-  
 dren's Rings in Great Variety. Stone But-  
 tons, Lace Pins, Scarf Pins, Etc.*

STRICTLY FIRST-CLASS GOODS OF OUR OWN MAKE.

**DAY & CLARK,**

No. 10 MAIDEN LANE, NEW YORK.

*Fine Roman Goods,*

IN VERMICELLA AND HAMMERED ORNAMENTATION.

BANGLES, DIAMOND BALL COVERS, LACE PINS  
 AND EAR DROPS. BEAD NECKLACES,  
 EAR HOOPS, SCARF PINS.

Send for Selection Package.

FACTORY, NEWARK, N. J.

**G. B. BARRETT & CO.,**

IMPORTERS AND WHOLESALE DEALERS IN

**Watches, Diamonds, Jewelry,**

Clocks, Bronzes, Silver and Plated Ware,

Watch Materials, Etc.

A Full and Complete Line of all goods handled  
 by the Trade, constantly on hand. Lowest  
 Prices Guaranteed.

WHOLESALE EXCLUSIVELY.

238 & 240 Liberty St., **PITTSBURGH, PA.**

ESTABLISHED 1837.

**VICTOR BISHOP & CO.,**

IMPORTERS OF

**DIAMONDS,**

RUBIES, SAPPHIRES,

EMERALDS AND PEARLS.

ENAMEL PAINTINGS, ROMAN PEARLS,

Copper, Platinum and Iridium.

**33 MAIDEN LANE, NEW YORK.**

House in Paris, 66 Boulevard de Sebastopol.

**G. W. SCHUMANN,**

No. 24 JOHN STREET,

NEW YORK.

*Sole Licensee in the United States for the  
 manufacture of*

**TRENOR'S DIFFERENTIAL DIAL,**

*by which the time in two cities can be re-  
 corded at once.*

The Dial can be applied to any Watch.



# A. S. HERZOG & CO.,

MANUFACTURING JEWELERS.

Rings and Lockets a Specialty.



Jobbers in American Watches.

38 MAIDEN LANE, NEW YORK.

LEVY, DREYFUS & CO.,

Importers and Manufacturers,

11 MAIDEN LANE, N. Y.

OFFER A LARGE ASSORTMENT OF

## Fine Bisque Figures,

Especially Selected for the requirements of the Jewelry Trade.

Alluminium, all Pearl Opera Glasses,

Six or Twelve Lenses, and a Large Variety of other Glasses of Standard Makers.

## GOLD SPECTACLES AND EYE-GLASSES IN GREAT VARIETY.

Monogram Albums containing 35 Series of Alphabets, Price, \$5.00; also Monogram Albums, 3 and 4 Letter Combinations, Price, \$10.00.

# W. F. NYE,

## Watch and Clock Oil,

New Bedford, Mass.



These Oils have been before the Trade for the last twelve years and are generally acknowledged by Watchmakers throughout the country to be the best and most reliable Watch and Clock Oils made.



FOR SALE BY THE Jobbing Trade Generally.

HESS & SCHLIESSER,

25 MAIDEN LANE,

NEW YORK.

IMPORTERS.

SPECIALTIES:

DIAMONDS.

NOVELTIES IN FINE JEWELRY.

Blue and Black ENAMELED LOCKETS.

Charms, Garnet and Silver Filigree Goods.

## COX & SEDGWICK,

26 JOHN STREET, N. Y.,

## Makers of Patent Black Onyx Bracelets

Also Black Onyx Faceted Bead Bracelets,

AT THE LOWEST PRICES.

COLORED AND

Turquoise

Lace Pins, Ear Rings, Lockets, Bracelets, Sleeve

Buttons, Scarf Pins,

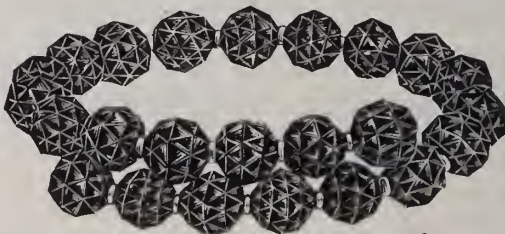

ONYX

Lace Pins, Ear Rings, Medallions, Necklaces, Chatelaines, Sleeve Buttons, Ladies & Gents Vest and Guard Chain.

Black Onyx Pins, Ear Rings and Lockets for 1, 3 and 5 Diamonds.

GOODS SENT ON APPROVAL TO RESPONSIBLE FIRMS.

## JOHN M. GODDARD,

Manufacturing Jeweler,

3 MAIDEN LANE, NEW YORK.

BRACELETS, BANGLES, SEAL RINGS, DIAMOND RINGS, STONE Lockets, Roman Lockets, Engraved Lockets, CHAINS, Etc., in Etc., Etc., in ALL QUALITIES

## JOBGING DEPARTMENT.

Jewelry Repaired, Colored or Matched Promptly.

Designs & Estimates Furnished for Ordered Work.



MANUFACTURERS OF Everything in **BLACK ONYX JEWELRY** PLAIN, and {Ornamented with Pearls and Diamonds.

Our manufacturing facilities have been for the past ten years devoted exclusively to the production of fine Black Onyx Jewelry. We carry in stock the largest variety of articles made in our specialty, well made, finely finished, uniformly 14 karats, at medium and low prices.

**WOGLOM & MILLER,**  
Office & Factory, 32 & 34 JOHN STREET,  
NEW YORK.

**W. C. GREENE & CO.**  
GOLDSMITHS  
MANUFACTURERS OF

RICH SETS IN TAPER WIRE CORAL

Factory 95 PINE ST. Providence, R. I.

Stone Amethyst Coral Cameo Engraved & Brooches Sleeve Buttons Studs & Crosses EAR DROPS & New York Office 192 BROADWAY

WM. C. GREENE. B. W. GREENE. GEO. D. BRIGGS.

**KETCHAM & McDOUGALL,**  
Bryant Building, (55 Liberty St.) New York.  
MANUFACTURERS OF **GOLD AND SILVER THIMBLES.**



**THE AUTOMATIC EYE-GLASS HOLDER,**  
It Reels Up Cord Itself.  
A—Shows position of Glasses with cord Reeled up.

ESTABLISHED 1859.

**STURDY BROS. & CO.**  
MANUFACTURERS OF

**Fine Rolled Plate Jewelry**  
GRADUATED WIRE CORAL GOODS,  
STERLING SILVER JEWELRY

Bangles, Sleeve Buttons, Cuff Buttons, Baby Pins, Sets in Stone, Cameo, Enamel, Chased, and Polished, Drops and Knobs, Bar Pins, Children's Sets, Lockets, Studs, Charms, Etc.

Only Wholesale Dealers' Trade Solicited. **ATTLEBORO, MASS**

Flexible Bracelets,  
Diamond Mountings,  
Strung Pearl Work,  
Repairing,

Flexible Braided  
Bracelets,  
White Stone Goods,  
Strung Pearl Repa'ng

**Thos. M. Guilbert & Co.,**  
SUCCESSORS TO CARROW, DUBOSQ & Co.  
908 Chestnut Street, Philadelphia, Pa.

TRADE MARK

**The ORIGINAL GOLD CROWN FILLED RINGS.**

For the past thirteen years we have manufactured as a specialty, the well known "CROWN GOLD FILLED RING," with the high standing of which the trade is already perfectly familiar. In consequence of the above fact, and in justice to ourselves, we feel it a duty to make the announcement to the trade that there are now being offered in the market several other makes of filled rings, each of which has a CROWN in some way connected with its STAMP.

We Manufacture for the Jobbing Trade Only.

**McCALL & NEWMAN,**  
625 Arch Street, Philadelphia

**B. A. BALLOU & CO.,**  
61 Peck St., Providence, R. I.  
MANUFACTURERS OF **GOLD JEWELRY.**

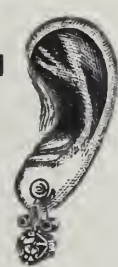

We call special attention to our PATENT FASTENING FOR EAR RINGS, which is free from the objections raised to ordinary ear wire or screw fastenings. They present a very neat and attractive appearance, are perfectly secure, and much more convenient than ordinary ear wires which always annoy the wearer by catching the hair, veil, or lace about the neck. These Goods are for Sale by all Wholesale Dealers.

Gold Studs, Small Chains for Eye-Glasses, Bracelets, Etc.  
a Specialty.

**McCarty & Hurlburt,**  
WHOLESALE DEALERS IN  
WALTHAM, ELGIN & ILLINOIS  
**WATCHES.**  
MANUFACTURERS OF  
Jewelry, Gold Spectacles, Silver Thimbles, &  
**131 North Second St.,**  
PHILADELPHIA, Pa



CLOCKS

ESTABLISHED 1853.



AMERICAN  
AND  
FRENCH CLOCKS  
AND  
BRONZES.

**B. J. COOKE'S SONS,**  
137 N. 3d Street, PHILADELPHIA.  
Catalogues and Price Lists furnished to the Trade only, on application.

**BOOZ & CO.,**

MANUFACTURERS OF  
FINE GOLD



AND  
PLAIN GOLD

Watch Cases RINGS.

Jobbers in American Movements.

**DIAMONDS.**

108 South Eighth St., (2d Story) Philadelphia.

Samples of our goods sent on approval when satisfactory reference is furnished.  
Old Gold and Silver Bought or Exchanged.

PARTICULAR ATTENTION PAID TO REPAIRING.

**BOSTON WATCH CASE COMPANY**

WATCH CASE MANUFACTURERS,

Nos. 1, 3 and 5 Province Court, Boston, Mass.,

ENTRANCE COR. PROVINCE STREET.

Special Attention given to Watch Case Repairing, Springing, Re-engine Turning, Engraving, Polishing, &c.

Particular Attention given to Orders by Express.

WE OFFER THE LARGEST VARIETY OF ORIGINAL DESIGNS IN WATCH CASES EVER PRESENTED TO THE TRADE.

**CHAS. S. PLATT,**

Successor to George W. Platt,

GOLD AND SILVER

Refiner, Assayer and Sweep Smelter,

No. 4 LIBERTY PLACE,

Refinery, 67 and 69 Thomas St., NEW YORK.

Platers' and Electro-Platers' Silver Platinum and Aluminum.



KING JAMES,  
MARQUIS, } RINGS.  
GLOVE, }

Quality Guaranteed.  
Prices Close.

BARNET BROS. & POWELL,  
—Manufacturers,—  
Newark, N. J., & 15 JOHN ST., NEW YORK.

**TRIER BROS.,**  
**IMPORTERS,**

15 MAIDEN LANE, NEW YORK.

**SPECIALTIES:**

Bohemian Garnet, Whitby Jet, Steel and Amber Jewelry, Opera, Marine and Field Glasses, Telescopes, Pearl Card Cases, Silk Guards, Etc.

Also a Complete Line of

GOLD AND GOLD PLATED JEWELRY.

ESTABLISHED 1850.

TRADE



MARK

**PETER L. KRIDER,**

MANUFACTURER OF

**STERLING SILVERWARE**

Medal and Diploma Awarded. &c. Striking Society Medals in Gold, Silver or Bronze a Specialty.

Artisan Hall, 618 Chestnut St., Philadelphia.

ESTABLISHED 1866.



**ARNOLD & WEBSTER,**

MANUFACTURERS OF



≡ SOLID GOLD ≡

ENGRAVED BAND RINGS

FOR THE JOBBING TRADE.

29 Point Street, Providence, R. I.



NEW YORK OFFICE,

No. 196 BROADWAY.





**W. E. WHITE & CO.,**  
Manufacturing Jewelers.

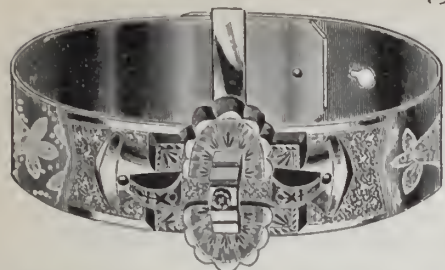

**FINE  
ROLLED PLATE  
GOODS.**

Bracelets---Engraved, Enamelled, Flat Band and Buckle.

Ladies' Goods---Lace Pins, Drops, Crosses, Sets, Collar Buttons, &c.

FOR SALE BY JOBBERS ONLY.

New York Office, 26 MAIDEN LANE, Corner Nassau Street.

Factory 54 Page St., Providence, R. I.

Represented by S. A. BALDWIN.

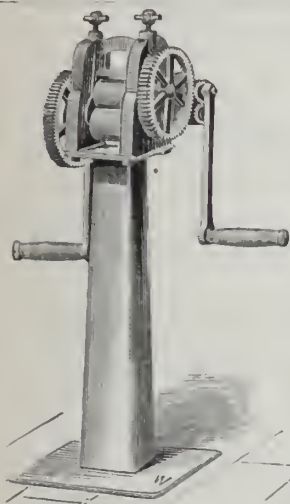

**W. W. OLIVER,**

Manufacturer of Hand and Power

**Rolling Mills,**

For Jewelers and Silversmiths.

The "Little Giant" Ring Bender

Hollow Spindle Lathes, Punching and Drop Presses, Polishing Heads, Dies, Metal Laps, Etc.

39 Clinton St., Buffalo, N. Y.

Illustrated Price List mailed free upon application.

**ALEX. MILNE,**

Manufacturer of Stem-Winding Watch Crowns



ALSO GOLD AND SILVER THIMBLES.



19 Ward Street, NEWARK, N. J.

**JAMES J. FISHER,**

DEALER IN

**WATCHMAKERS' and JEWELERS' MATERIALS,**

Files, Tools, Silk Guards, Watch Glasses, Spectacles, Rolled Plate, Fire Gilt, Nickel and Silver Chains, Charms, &c.

No. 697 BROADWAY,

Corner Fourth Street, NEW YORK.

All kinds of Job Work for the Trade Promptly attended to.

The "Acme" French Clock Movement Support.  
(Pat. Nov. 1st, 1881.)

This Support is adapted to the holding in position of any French Clock Movement while regulating or adjusting, and will be found very desirable on account of its simplicity of action and the small space it occupies. To be had of any material jobbing house, or sent, post paid, to any address, on receipt of 85 cents.



*Henry Fera,*

Importer of Rough & Polished Diamonds,

DIAMOND CUTTING AND POLISHING WORKS:

21, 23, 25 Looijersgracht,

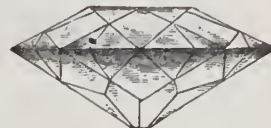

4 & 6 JOHN ST.,

Amsterdam, Holland.

New York.

Diamonds repaired and matched by some of the finest workmen in the world.

Diamond Bort and Powder always on hand.

ESTABLISHED 1828.

**JACOB BENNETT & SON,**

MANUFACTURERS OF FINE

**DIAMOND MOUNTINGS,**

No. 925 CHESTNUT STREET, PHILADELPHIA.

— FINE REPAIRING. —

GEO. W. DUBOIS.

F. N. NAUMAN.

**GEO. W. DUBOIS & CO.,**

IMPORTERS OF

**Watches & Optical Goods.**

ALL STYLES AND QUALITIES OF

SPECTACLES AND EYE-GLASSES.

**LONGINES' WATCHES AND MOVEMENTS.**

The Watches in Gold, Silver and Nickel Cases of New and Handsome Patterns. The Movements fit 18 size Waltham Stem Winding Hunting Cases.

36 MAIDEN LANE, NEW YORK.

Orders by Mail Receive Prompt Attention.

R. & K.'S PATENT GAS FURNACES FOR MELTING, PLATING, ENAMELING, ANNEALING, &c., &c.

**Reichhelm & Koester,**

Importers and Manufacturers of

Jewelers' Tools, Files, Materials, &c.,

Manufacturers of  
Bristle Brushes of all kinds,  
Cotton and Wool Buifs,  
Felt Polishing Wheels,  
Walrus Leather Polishing  
Wheels,  
Jewelers' Satin Finish and  
Scratch Brushes,  
Brass & Steel Wire Brushes  
Jewelers' Standard Saw  
Frames,  
Plain & Fancy Draw Plates,  
Improved Jewelers' Ingots,  
R. & K.'s Jewelers' Combi-  
nation Gas Burners.

**80 Nassau St.**

NEW YORK.

Importers of

French, English & German  
Tools and Files,  
Piercing Saws,  
Renard & Vautier Gravers,  
Steel and Brass Wires,  
Vienna and Ruby Draw  
Plates,  
Alloying Copper Wire,  
Felt, Walrus Leather,  
Vienna Lime, Tripoli,  
&c., &c., &c.



**ROTARY MEASURING INSTRUMENT,**

American Manufacture, for or straight line by running face. The distance is shown inches and fractions the feet. It is in Nickel Holiday Present, and a elers, Opticians, and Fancy only instrument with which line. Sent by mail on re- be had of Jewelers, Opti- Dealers.



Full Size.

measuring any object, curved the instrument over the sur- on the dial, the long hand of an inch, the short hand Silver Case. It is a Useful Desirable Article for Jew- Goods Dealers. It is the you can measure a curved ceipt of price, \$2.00; or can cians, and Fancy Goods

Wholesale and Retail by

**R. MERRILL'S SONS,**  
Importers and Manufacturers of NAUTICAL INSTRUMENTS,  
179 WATER STREET, NEW YORK.

**"SOMETHING NEW."**

FOR SALE BY ALL JOBBERS OF TOOLS AND MATERIALS.

**"LITTLE'S"**

Patent Second Hand Holder & Ruby Pin Setter Combined



Nickel Plated. Each, 50 Cents.

**C. W. LITTLE, Wholesale Jeweler,**  
408 Lawrence Street, Denver, Col.,

Patentee of the Celebrated Rolled Gold Post Office Department Vest Chain, Charm and Key.

**H. H. HEINRICH & CO.,**

12 JOHN ST., NEW YORK,

Manufacturers of the

**PATENT SELF-ADJUSTING BALANCE**

FOR EXTREME HIGH AND LOW TEMPERATURE.

Marine Chronometers  
AND  
Zimmerman Watches  
are provided with  
this Balance.

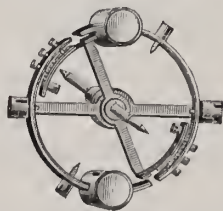

Tried by three  
Observatories with  
the best results.

We are also agents for the Celebrated K. Zimmerman Watch, which we can recommend to the Trade. Send for Circular containing information in regard to the Patent Balance Zimmerman Watches and Marine Chronometers.

**C. F. A. HINRICHS,**

Importer of and Dealer in

**Fancy Goods, Glassware, China, Toys, Games,**

CLOCKS, BRONZES, &c.,

Brass Goods, Falence, China and Glass Metal-Mounted Lamps,

C. A. KLEEMANN'S PATENT ST. GERMAIN STUDENT LAMPS.

Goods suitable for Jewelers and Holiday Trade.

AGENCIES: LONDON, ENGLAND; LIMOGES, FRANCE; HAIDA, BOHEMIA.

Nos. 29, 31 and 33 PARK PLACE,

N. W. Corner Church St.,  
Opposite Elevated R. R. Station, }

NEW YORK.

**PFORZHEIMER, KELLER & CO.,**

MANUFACTURERS OF

**FINE JEWELRY,**

AND DEALERS IN

**Diamonds, American and Swiss Watches,**

No. 24 JOHN STREET,

I. PFORZHEIMER, }  
D. KELLER. }

**NEW YORK.**

{ I. B. ETTINGER,  
{ H. J. FINK.

**BLANCARD & OBERLANDER,**

MANUFACTURERS OF

**Settings and Galleries,**

IN THE LATEST STYLE.

**BALL WIRE**, Solid and Hollow, in 14 and 10 karat, also single **Hollow Balls** without joint, of all sizes, in Silver and 14 karat alloy and upwards. Made in any thickness of Gold to order.

Platinum, Platinum-Lined and Fancy Settings a Specialty.

PLATINUM SCRAPS EXCHANGED OR PURCHASED.

36 & 38 JOHN STREET, N. Y.

PLEASE SEND FOR SAMPLE CARD.

**FINE WATCH AND CLOCK**

**W O I L**



MANUFACTURED BY

**GEO. B. WHEELER,**

NEW BEDFORD, MASS.

Patented November 18, 1873.

**MORRISON'S**

**GOLD AND SILVER SOLUTIONS**

For Electro-Plating Without a Battery.

Invaluable for Watchmakers and Jewelers. So simple that any one can use them.

Price, Gold Solution, \$3.00

Silver Solution, \$1.50

MANUFACTURED BY

ARTHUR B. MORRISON, Portland, Maine.

FOR SALE BY

Sussfeld, Lorsch & Co., New York; Henry Ginnel, New York; Cross & Beguelin, New York; Kearney & Swartchild, Chicago, Ill.; Louis A. Scherr & Co., Philadelphia, Pa.; Duhme & Co., Cincinnati, O.; Harwood Bros., A. Paul & Co., Palmer, Bachelder & Co., Boston, Mass., and material dealers generally.

BEWARE OF BASE IMITATIONS put up by unprincipled persons. None are genuine without the Trade Mark which consists of the letters A. B. M. in monogram and fac simile of Medal awarded by U. S. Centennial Commission.





181



193

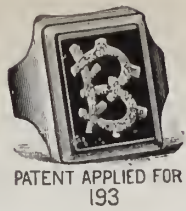

PATENT APPLIED FOR  
193



214



218



219

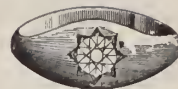

812



THE ABOVE CUTS ARE THREE DIFFERENT  
SHAPES IN THE SAME WEIGHT OF PLAIN  
RINGS. TO BE USED IN ORDERING.

### J. B. BOWDEN & Co.,

MANUFACTURERS OF SOLID RINGS  
OF EVERY DESCRIPTION.

No. 1 MAIDEN LANE, cor. Broadway, NEW YORK.

## WILLIAM H. BALL, MANUFACTURING JEWELER,

(Bracelets and Bangles a Specialty)

No. 9 JOHN ST., N. Y.

San Francisco Office, 120 Sutter Street.

Factory, Newark, N. J.

GOODS SENT ON SELECTION TO RESPONSIBLE PARTIES.



# THEUERNER & CHURCH, MANUFACTURERS OF FINE RINGS,

No. 9 MAIDEN LANE,

NEW YORK.

FACTORY, COR. MULBERRY & DURAND STS., NEWARK, N. J.

LEON JEANNE.

PAUL JEANNE

## JEANNE BROTHERS

MANUFACTURERS OF

# DIAMOND MOUNTINGS,

## AND RICH JEWELRY.

No. 1 MAIDEN LANE, NEW YORK

Designs Furnished and Estimates Given.

**JEANNE BROS PAT. DIAMOND SETTINGS.**

A PLATINUM SETTING WITH A GOLD SURFACE OUTSIDE

IN THIS WAY THE REFLECTION OF COLD THROUGH THE DIAMOND IS ENTIRELY AVOIDED.

PAT. AUG. 15TH 1882



# STEPHEN PELL,

IMPORTER OF

**FRENCH MARBLE CLOCKS,** with Finest Cathedral Gongs.

Alabaster and Gilt Clocks and Side Ornaments. Bronzes, Beautiful Bisque Figures and Decorated China Vases. Fancy Gilt Goods, Dressing Cases. Leather and Plush Glove, Handkerchief, Jewel and Odor Cases. Bridal and Party Fans, Opera Glasses, and a Large Variety of Novelties from Paris.

**21 JOHN STREET,**

**NEW YORK.**

ESTABLISHED 1837.

## SINNOCK & SHERRILL,



No. 2234.  
Doublet and Pearl.



No. 2047  
14 K. fine.  
Garnet and Pearl.



No. 2156  
14 K. fine.  
Class Rings.

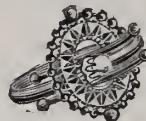

No. 1195  
14 K. fine.  
Turquoise and Pearl.



No. 1909  
14 K. fine.  
Sapphire and Diamond.

MANUFACTURERS OF

Ladies Fancy Stone Rings in Great Variety.

Factory, Newark, N. J.

All 14 K. Goods Guaranteed to Assay  $\frac{584}{1000}$  Fine.

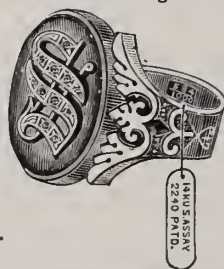

ALSO

DIAMOND INITIAL RINGS.

Office, 3 Maiden Lane, New York.

All 14 K. Goods Guaranteed to Assay  $\frac{584}{1000}$  Fine.

## WULFF, WORMS & Co.,

Wholesale Art Rooms,

43 PARK PLACE,

NEW YORK.

A LARGE DISPLAY OF

Royal Worcester, Bisques and other Ceramics,

Antique Brass, Old Iron and Bronze Goods,

Rich French Clocks.

PARIS OFFICE, 8<sup>BIS</sup> RUE MARTEL.

## CHARLES VAGT & CO.,

60 & 62 MURRAY STREET, (cor. College Place,) NEW YORK.

IMPORTERS OF

Vases, Biscuit Statuettes, Plaques, Paintings, Hispaniola and Hungarian Ware, Fine Potteries,

Dresden Porcelain, Vienna Ivory Ware,

Fine China Fancy Articles decorated with Roses, Apple Blossom and Cactus.

SPECIALY ADAPTED FOR THE JEWELRY TRADE.



**A NEW PIN TONGUE VISE**FOR JEWELERS and DEALERS  in JEWELERS' SUPPLIES.

*This New Device for securely holding Pin Tongues while being fitted, will commend itself to every Practical Workman.*

*The joint of the tongue is placed in one of the graduated grooves and firmly secured by tightening the screw, enabling the workman to either file the joint to any required thickness, brooch the hole, shorten the pin or correct such defects as he may desire with ease and dispatch.*

*These tools are made of Hardened Steel, Nickel Plated, and is a useful and handy tool.*

Price, \$1.25. For Sale to the Trade by

**HENRY GINNEL & CO., Wholesale Agents,  
31 Maiden Lane, NEW YORK.**

**F. W. GESSWEIN,**

No. 39 JOHN STREET,

NEW YORK.

MANUFACTURER OF

MACHINERY AND TOOLS FOR

*Jewelers, Watch, Clock, Chronometer,  
Watch Case and Fine Instrument  
Makers. Wire and Bristle  
Brushes. Polishing Im-  
plements.*

MANUFACTURER OF HAND CUT FILES.

IMPORTER OF

TOOLS, FILES AND SUPPLIES FOR

*Jewelers, Silversmiths, Engravers, Watch  
and Watch Case Manufacturers,  
Clock and Chronometer Makers,  
Platers, Polishers, Machin-  
ists, Dentists, etc., etc.*

Factory, PATERSON FILE WORKS, PATERSON, N. J.

—♦ ESTABLISHED 1874. ♦—

**JOSEPH P. WATHIER,**

Successor to JOSEPH P. WATHIER & BRO.,

178 WEST MADISON ST., CHICAGO, ILL.

**WHOLESALE JEWELER & WATCHMAKER & JEWELER FOR THE TRADE,**

Changing of Key Winding Movements into Stem Winding and Hand Setting,

AND MAKING STEM WINDING PARTS A SPECIALTY.

*All Work Intrusted to me will receive PROMPT ATTENTION, and Satisfaction Warranted, at Prices Always the Lowest.*

**EDWIN A. THRALL,**

1 MAIDEN LANE,

NEW YORK.

—◦ JOBBER IN ◦—

**American Watches, Diamonds, Fine Jewelry, Chains, Etc.**

Respectfully calls the attention of Cash Buyers to his stock of American **WALTHAM WATCHES**, embracing all grades and styles. Every Watch before being sent out is carefully examined and timed by competent workmen. This precaution will be appreciated by practical men. To Buyers visiting New York, I shall be pleased to show my stock and method of timing. Correspondence solicited from regular dealers. I sell only for Cash and give all discounts allowed. Special Styles of Cases, made to my order, always on hand. Agent for the New Mascot Bracelet, Patented. Repairing and Adjusting Watches and Chronometers for the Trade a Specialty.



MAKER OF FINE

Jewelry.

HENRY C. HASKELL,

12

JOHN STREET,

NEW YORK.

Goods sent on approval upon receipt of Satisfactory References.



394D. Patented.



797. Patented.

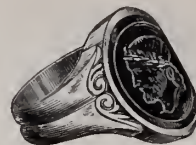

798. Patented.



799. Patented.

INITIAL RINGS

AT REDUCED PRICES.

FINE LINE CAMEO AND INTAGLIO IN SARD TIGER STONES, ETC.,

MADE FOR HOLIDAY TRADE.

ALSO DIAMONDS, RUBIES, EMERALDS, ETC.

A. J. WARNER & CO.,

WHOLESALE JEWELERS,

309 Nicollet Avenue, Minneapolis, Minn.

We carry a Large and Elegant Stock of Jewelry, Watches, Cases, Etc., Etc.

North-western Agents of the WATERBURY CLOCK CO., and carry a Complete Line of their Goods.

OUR TRADE IS EXCLUSIVELY WITH THE JEWELERS.

O. A. GAGER,

Successor to CHAS. FIELD HAVILAND & CO.,

IMPORTER OF

Porcelain and Ornamental Ceramics,

29 BARCLAY STREET.

A Fine Line of FANCY POTTERY of all grades, specially adapted for Jewelers.

PARIAN, BISQUE, TERRE COTTA, FAIENCE, PORCELAIN, ETC.

VASES, PLAQUES, STATUETTES, BUSTS, ETC., ETC.

M. FOX & CO.,

Practical Lapidaries and Importers of

DIAMONDS.

Rubies, Sapphires and Fancy Gems.

PEARLS, TURQUOISE, INTAGLIOS, ONYX, AMETHYST, ETC.

No. 1 MAIDEN LANE, NEW YORK.



TRADE MARK.

ESTABLISHED 1810.

TRADE MARK.

VACHERON &  
CONSTANTIN

VACHERON &  
CONSTANTIN

**WATCH MANUFACTORY**  
— OF —  
**VACHERON & CONSTANTIN,**  
— GENEVA. —

The Third Annual Report (June, 1883) of the Astronomer of the YALE COLLEGE OBSERVATORY awards the VACHERON & CONSTANTIN Watches the *Highest Average ever Recorded at that Observatory.*

**LADIES' AND GENT'S STEM WINDING MOVEMENTS FITTING AMERICAN CASES.**

Prices Furnished to the Trade on Application.

**CHAS. LEO ABRY,**  
SOLE AGENT FOR UNITED STATES AND CANADA,  
P. O. Box 611. NEW YORK. 63 NASSAU STREET.

**HERMAN TROST & CO.,**  
**IMPORTERS,**

30, 32, 34 MURRAY STREET, NEW YORK.

**PARIS:**

**YOKOHAMA.**

**LIMOGES:**

130 Rue du Faubourg St. Denis.

38 Avenue du Crucifix.

*Fine China Ware, Vases, Figures, &c., Biscuit Statuettes, &c., Serres, Dresden and Worcester Porcelain, Vienna Fancy Goods. Very Fine Collection of PAINTINGS and PLAQUES on China and Faience. JAPANESE and CHINESE GOODS. Capo di Monte China Articles, Vases, Tankards, &c. Specialty of Fine China Articles, suitable for Jewelry Stores.*

The Largest Assortment in the United States at Lowest Prices.

ESTABLISHED 1859.

**RINGS AND DIAMOND JEWELRY.**  
**BRYANT & BENTLEY,**

12 MAIDEN LANE,

Up-Stairs,

NEW YORK.

AMONG OUR STAPLE PATTERNS ARE



595.



610.



607.



611.



616.



630.

No. 595, Turquoise or Square Garnets with 3 Diamonds, 2 Pearls and 1 Diamond, or 3 Pearls. No. 610, All combinations of Doublets and whole Pearls and Diamonds, or all Diamonds, No. 607, All combinations of Doublets and whole Pearls and Diamonds, or all Diamonds, or 3 Pearls. No. 611, Emerald, Sapphire or Ruby Doublets, with 2 whole Pearls, or 2 Diamond Brilliants. No. 616, Pearls or Diamond. No. 630, 2 Garnets with 2 whole Pearls or 2 Diamond Brilliants.

We also continue to make a full line of our well known 16 K. HARD SOLDER RINGS. Goods sent on approval to responsible parties.

**N. H. WHITE,**

JOBBER IN

**AMERICAN-WALTHAM WATCHES,**  
**EXCLUSIVELY.**

Waltham make of gold and silver cases a Specialty. Ladd, Boss, and the Patent Screw Bezel Filled Cases to fit Waltham movements only

No. 11 MAIDEN LANE, NEW YORK.

I not only advertise that I have the Waltham Goods, but **have constantly on hand** the Largest Stock carried by any jobber in the trade. Gold Cases of all Weights and Styles. Memorandum Packages with pleasure to dealers furnishing satisfactory reference

COMPLETE PRICE LIST TO THE TRADE.



A SPECIALTY.  
PATENT CATCH BRACELETS.



PAT. SEPT. 30 1882.

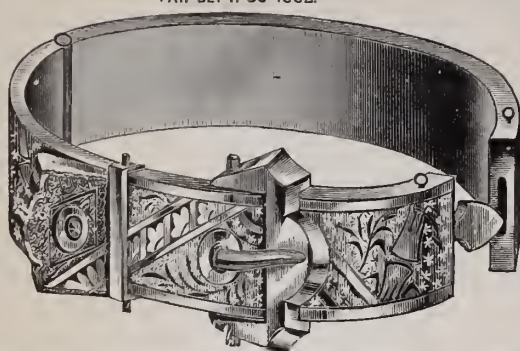

The most Convenient and Complete Catch ever invented. Not liable to get out of Order. Very Durable.

**C. I. RICHARDS, BROWN & CO.,**  
MANUFACTURERS OF  
**Gold and Plated Jewelry,**  
202 BROADWAY,  
NEW YORK.  
Factory, Providence, R. I.

We now offer to the Trade a Fine Assortment of Rolled Plate Jewelry, Patent Catch Bracelets in First and Second Quality, Enameled, Chased and Roman, with and without Buckle and Fancy Ornaments. Bangles and Flat Bands in great variety. Our Patent Lever and Separable Buttons and Studs, Ladies' and Gent's Collar Buttons, Charms, Lockets, Lace and Scarf Pins, Sets, Chains, etc., etc.

ALSO A FULL LINE OF BRILLIANT JEWELRY IN GOLD.  
*Goods Sent on Approval upon Application with Satisfactory Reference.*



**R. HENRICH,**  
"SELF-SIZING RING,"



(PATENTED MARCH 20th, 1883.)

NEW PATTERNS FOR FALL TRADE.

FOR SALE BY ALL JOBBERS.

SEAL AND STONE RINGS IN ALL VARIETIES.

35 Maiden Lane, NEW YORK.

ESTABLISHED 1849.

**KOCH & DREYFUS,**

WHOLESALE DEALERS IN

**WATCHES, JEWELRY, CLOCKS, DIAMONDS, SPECTACLES, ETC.**

ALSO JEWELERS' AND WATCHMAKERS' TOOLS AND MATERIALS AT MANUFACTURERS' PRICES.

18 CHARTRES ST., NEW ORLEANS.

BRANCH OFFICE, 20 MAIDEN LANE, N. Y.

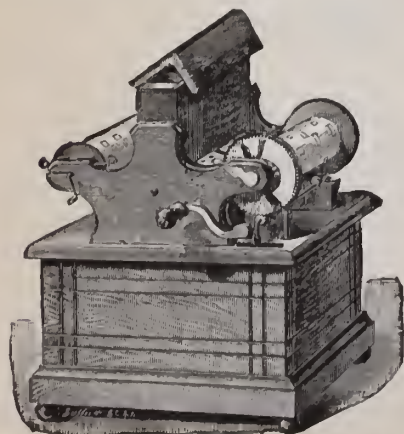

Reed Pipe Clariona, \$8.

**CLARIONAS. AUREPHONAS.**  
ATTRACTIVE AND SALABLE **STOCK.**

Both Instruments of Superior Tone, Beautiful in Finish, thoroughly Durable and Salable.

We make a Specialty of the Sale of Mechanical Musical Instruments, and keep the Largest Variety in the world. Send for Catalogue and Discounts to

**WM. BLASIUS,** 923 & 925 Chestnut St.,  
Gen'l Agent. Philadelphia, Pa.



Aurephone, \$10.

17 Full Sized Reeds. Durability Guaranteed. All Music on Spools, at 4c. a Foot.



# T. B. HAGSTOZ & CO.,

Successors to **MORGAN & HEADLY,**

MUTUAL LIFE INSURANCE BUILDING, TENTH & CHESTNUT STS., PHILADELPHIA.

The only house in Philadelphia making a Specialty of

**Diamonds,  
Diamond Jewelry  
and Mountings.**

Also, Gold, Silver and Steel Spectacles and Eye-Glasses.

*Goods Sent on Approval upon Application and Satisfactory Reference.*

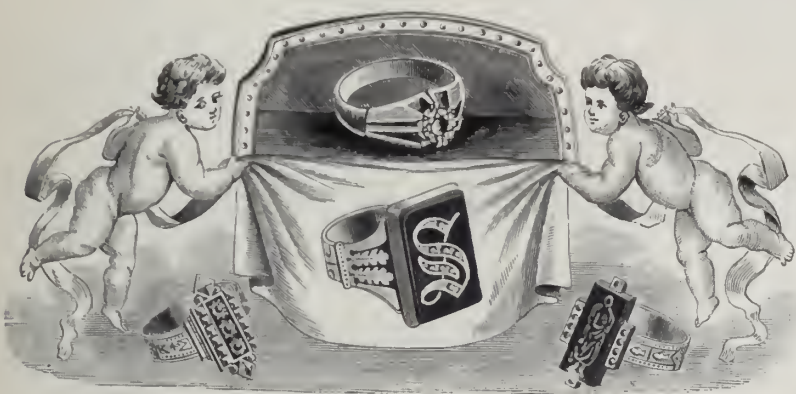

SPECIALTY.—Solid Gold Rings of  
Every Description, Scarf Pins,  
Studs, Etc.

## L. SAUTER,

1 MAIDEN LANE, Cor. Broadway, NEW YORK.

MANUFACTURER OF

Fine and Diamond Jewelry,

HAIR JEWELRY and DEVICE WORK.

JOBGING FOR THE TRADE.



## HEEREN BROS. & CO.,

MANUFACTURING AND WHOLESALE JEWELERS.

IMPORTERS AND JOBBERS OF

WATCHES, CLOCKS, JEWELRY, OPTICAL GOODS,

Silver Plated Ware, Watchmakers' & Jewelers' Tools, Materials & Supplies.

42 FIFTH AVE., PITTSBURG, PA.

# J. KITTEL & CO.,

IMPORTERS OF

# ROYAL WORCESTER

AND OTHER FINE POTTERY AND GLASS,

28 Barclay Street,

New York.



IMPORTERS OF  
**SWISS WATCHES,**  
 OPTICAL GOODS, Etc.  
 JOBBERS OF ALL  
 AMERICAN  
 WATCH MOVEMENTS,  
 Gold, Silver and Filled Cases  
 CLOCKS, SILVER PLATED WARE,  
 FINDINGS, ETC.



SPECIALTIES.  
 THE "CENTURY" WATCH,  
 S. Wind, Nickel, Ancre.  
 THE "CENTURY WATCH CO."  
 MOVEMENTS  
 Fit all American Cases.  
 THE 1 DAY  
 TIME ALARM WATCH,  
 19 Line, O. F. Nickel Case, with  
 Fine Stem Wind Movement.  
 The "CENTURY LEVER" Cuff Button.  
 The "S. F. M. & Co." Rolled  
 Gold Chain, &c., &c.

179 Broadway, Near Maiden Lane, New York.

Our Pocket Price List, or our Large Illustrated Catalogue, MAILED TO DEALERS FREE.

**A. BERNHARD & CO.,**

No. 2 Maiden Lane,

NEW YORK.

MANUFACTURERS OF

## Diamond Jewelry and Diamond Mountings.

*We have in press and will issue early in November, a Catalogue containing our Designs of Diamond Mountings for Manufacturers' Use, which will be the most complete work of the kind ever issued in this country or Europe. It will be sent to Manufacturers and Dealers upon application, Free of Charge.*

# STUART & SHEPARD, IMPORTERS,

No. 2 Maiden Lane, New York.

## FRENCH MARBLE CLOCKS OF ARTISTIC DESIGNS.

BRONZES, BRASS AND FANCY GOODS.

SILVER JEWELRY (Bright Cut),

MUSICAL BOXES of the Celebrated Manufacturer

**B. A. BREMOND,**

All Variety and Sizes from 4 to 30 Airs. Wholesale Dealers in

**AMERICAN WALTHAM WATCHES.**



# WHEELER, PARSONS & HAYES,

No. 2 MAIDEN LANE, NEW YORK.

Manufacturers of  
WATCH CASES,  
GOLD CHAINS and GOLD JEWELRY.

Importers of  
SWISS WATCHES,  
And Wholesale Dealers in  
GOLD AND SILVER CASES,  
AMERICAN WATCHES,  
AND  
CHRONOGRAPHS.

**DIAMONDS,**  
GOLD JEWELRY,  
GOLD CHAINS,  
PLATED CHAINS,  
AND  
PLATED JEWELRY.

A Full Stock of  
WALTHAM,  
HAMPDEN,  
ILLINOIS,  
ELGIN,  
AND  
E. HOWARD & CO.  
MOVEMENTS.  
CHATELAINE WATCHES,  
Gold, Silver and Nickel,  
In Elegant Designs.

*We invite attention to our present carefully selected stock of*  
**DIAMOND JEWELRY.**

*in Rings, Ear Rings, Lace Pins, Studs, &c., at exceptionally low prices.*

*Our entire stock of*  
**WATCHES AND JEWELRY.**  
*is composed of new goods throughout, both in novelties and staple designs. The excellence and completeness of our assortment offers unusual advantages to buyers.*

The American Watch Co., of Waltham, have ceased making the Lady Riverside Movements. We have secured the *entire* remaining stock and are prepared to fill all orders for the same.



# CARTER, SLOAN & CO.,

15 MAIDEN LANE,

NEW YORK.



CARTER, SLOAN & CO.'S MANUFACTORY, NEWARK, N. J.

HAVE NOW ON DISPLAY COMPLETE LINES  
OF GOODS IN EVERY DEPARTMENT.

The attention of Buyers especially invited to the Variety  
and Prices.





**E. AUG. NERESHEIMER**  
**& Co**  
**IMPORTERS**  
**of**  
**DIA MONDS**  
**21 MAIDEN**  
**LANE**  
**NEW YORK**

NO 66 SARPHATI STRAAT  
AMSTERDAM HOLL.

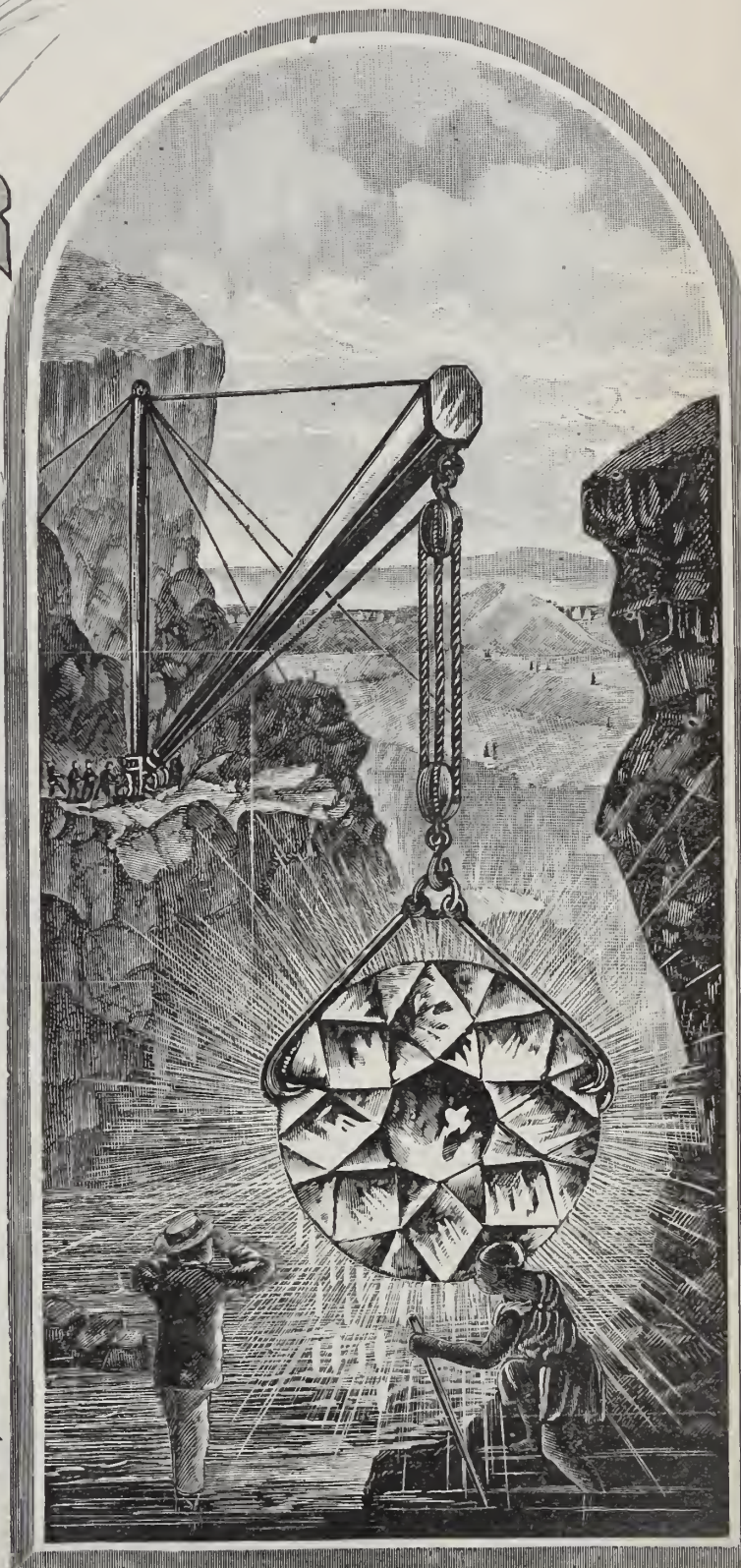



# Ladd Watch Case Company,

(ORGANIZED 1883.)

SUCCESSORS TO J. A. BROWN & CO.

(ESTABLISHED 1858.)

MANUFACTURERS OF THE

## LADD PATENT GOLD WATCH CASES.

### EXAMINE

THE

### NEW MODEL

### WOMEN

### Ladd Case.



Design No. 752.



Design No. 738.

*Which is universally pronounced on sight to be the Most Elegant and the Best Article in this line yet brought out.*

### IT HAS ALL THE LATE IMPROVEMENTS

Including Solid Gold Bows and Solid Gold Linings,

AND FOR WORKMANSHIP, STYLE AND FINISH IT IS UNEQUALED.

Its Shape is such as to admit of the most elaborate ornamentation, or any intermediate style down to the plainest, without loss of effectiveness, in accordance with the taste of the purchaser.

The **GOLD** in all of the **LADD CASES**, in the **COVERS** and **CENTER RIM** and **PENDANT**, is plump 14 Kt. fine, **POLISHED** to its natural color, a most **ESSENTIAL FEATURE** in the **WEAR** of a **WATCH CASE**.

For Sale by the Leading Wholesale Jobbing Trade.



A Line of Novelties Suitable for Fall and Holiday Trade.

ARTISTIC POTTERY

BAWDO &  
PLAQUES.

ITALIAN  
MARBLE

DOTTER,

FAIENCE.

MANUFACTURERS  
AND  
IMPORTERS.

BISQUE.

The Best Workshops of Europe

HAVE THIS SEASON

Been carefully searched to give us an assortment of Rich and Desirable Novelties unequalled by any Importing House in America.

Jewelers and others desiring a line of FINE GOODS to sell at a moderate price will find with us the following lines in great variety:

Articles to retail at from \$5.00 to \$40.00 a Specialty.

**VASES.**—Hungarian, French, China, Faience and Paris Barbotine.

Choice Line of Royal Worcester Goods.

**PLAQUES** of all values from Paris, Dresden, Vienna, Hungary, &c.

**CARLSBAD FLOWER WARE.**

**ITALIAN MARBLE.**—Groups, Figures, Busts, &c., hand carved and nice.

**BISQUE.**—Groups, Figures, Busts, &c., all prices, and a nice assortment of small articles.

**PARIAN WARE** in large variety.

**DRESDEN CHINA** and **AUGUSTUS REX** Vases, Cups and Saucers, Plates, Figures, &c., &c.

**LAVA GOODS.**—Figures, Animals, Smoke Sets, &c.

**BLUE FLEMISH WARE,** for Use and Ornament.

**CLOUD GOLD WARE,** with Raised Heron Decorations.

**FOR WEDDING AND BIRTHDAY GIFTS.**—Dresden, Old Vienna, Sevres, Limoges and other Novelties in Satin Lined Cases.

**FRENCH CHINA DECORATED WARE.**—An immense variety, entirely from our own works at Limoges. Gift Cups and Saucers, Tea, Chamber, Dinner, Breakfast, Ice Cream, Fruit, Game, Fish, Tom and Jerry, Tete-a-Tete Sets, Fruit Plates, Cuspadores, Jardinières, &c.; Articles for Practical Use.

**MISCELLANEOUS.**—Wax and Bisque Dolls, Bohemian Glass Ware in great variety. Table Glass Ware, Cut and Engraved, Italian Figures, Wedgewood Ware, Minton Ware, &c.

Be sure and see our stock before you place your orders. Mail orders will receive particular attention. Name the articles wanted and prices you wish to pay, and we guarantee satisfaction in every instance.

NEW YORK WAREHOUSES AND OFFICE,  
30 & 32 Barclay Street,  
P. O. BOX, 1872.

LIMOGES, FRANCE.  
RUE RICHER, PARIS.  
STEINSCHONAN, BOHEMIA.



J. W. Wilson & Sons

have the finest and largest stock of  
French Clocks  
both in Gilt and Marble cases,  
ever shown in the United States.

They offer a Cathedral  
Gong, Marble-cased Clock for  
\$1197 net.

This is not a cheap movement  
gotten up "regardless of cost," but  
is a reliable and well finished  
article. Salesrooms and office,  
31 Maiden Lane, New York.



Falkenau Oppenheimer & Co.  
Importers of  
Diamonds



40 Maiden Lane N. Y.

Post Office Box 3314.



ADOLF J. GRINBERG  
HENRY GOODMAN

LEOPOLD GOODMAN.  
WM. L. POLLACK.

**GRINBERG, GOODMAN & POLLACK,**

MANUFACTURERS OF  
**FINE JEWELRY**

AND  
**IMPORTERS OF DIAMONDS,**

PARIS  
44, rue de Lafayette

*No. 32 Maiden Lane,*  
**NEW YORK.**

DIAMOND MOUNTINGS A SPECIALTY.

Goods Sent on Approval upon Application.

Value need not be put upon Packages sent by us, as we carry an  
OPEN INSURANCE POLICY.



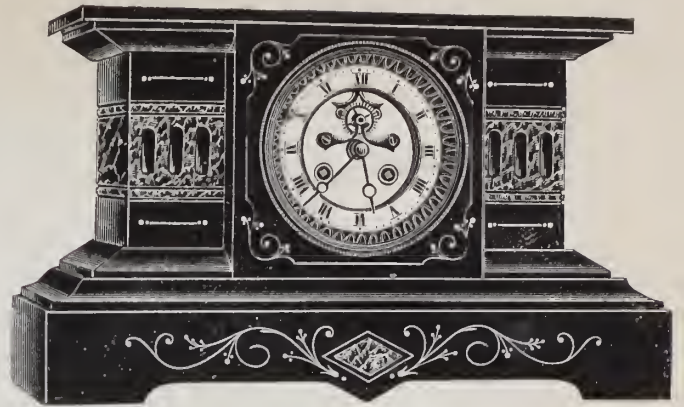
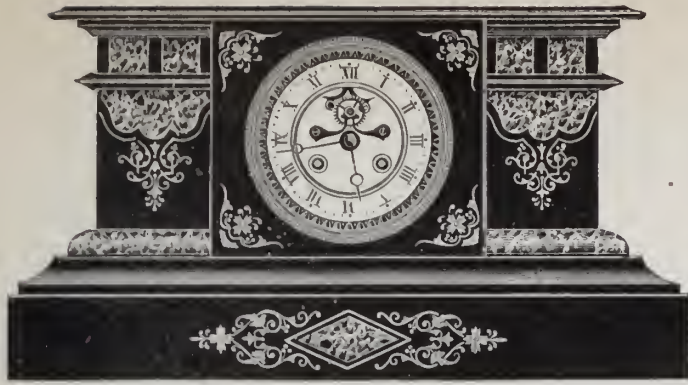

**F. KROEBER,**  
**IMPORTER,**

No. 14 Cortlandt Street,

NEW YORK.

LARGE ASSORTMENT OF  
FRENCH MARBLE CLOCKS,  
GILT CLOCKS,  
GILT AND ALABASTER CLOCKS.

*GILT and PORCELAIN CLOCKS, and NOVELTIES FROM PARIS for the Fall Season, 1883,  
at Low Prices.*

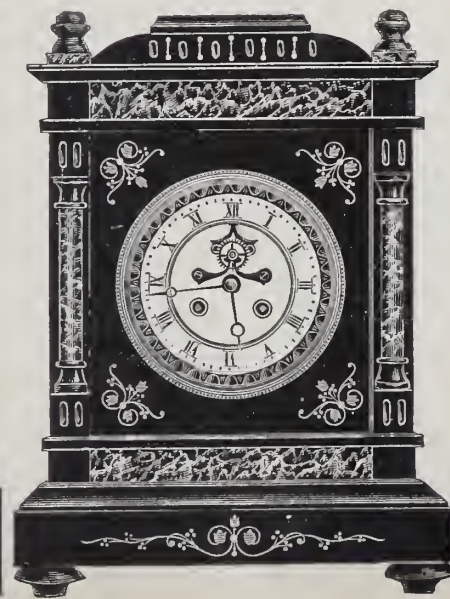

*Marble Clocks with Cathedral Gongs, at \$13.75 and upwards.*



# SMITH & KNAPP,

182 Broadway, New York,

Offer to the Trade a large assortment of goods for the Holidays.

Waltham Complete Watches,

in 8, 14 & 16 Size, 10 K., 14 K. & 18 K.

Waltham, Elgin, Hampden, Illinois & E. Howard Movements,

GOLD, SILVER & FILLED CASES

in Entirely New Designs of Engraved and Ornamented work.

Diamonds, Gold Chain, Gold and Plated Jewelry

in the latest and most approved designs of this Season's Manufacture.

ALL OUR GOODS ARE NEW,

and we have no accumulation of old stock to work off.

We fill orders correctly and promptly and will send approval packages to all parts of the country.



ESTABLISHED IN 1841.

# EROS RICHARDSON & CO.

Manufacturers of  
**Gold Jewelry & Chains.**

23 MAIDEN LANE NEW YORK.

SAN FRANCISCO, 206 KEARNEY ST. HASKELL & MUEGGE AGT'S.



## THE CLIMAX REVERSIBLE WATCH CASES.

MANUFACTURED BY THE

Northwestern Watch Case Co.

CHANGED FROM AN OPEN FACE TO A HUNTING CASE AT WILL.



Patented April 3d, 1883, No. 275,251.

MANUFACTURED BY THE

Northwestern Watch Case Co.

MADE TO FIT THE 18 SIZE STEM WIND AMERICAN MOVEMENTS.

ABSOLUTELY DUST PROOF. A PERFECT WATCH CASE.

**A MARVEL OF INGENUOUS MECHANISM.**

—Descriptive Circulars Furnished Upon Application.—



# MATHEY BROS. & MATHEZ,

## NO. 16 MAIDEN LANE.

IMPORTERS OF ALL GRADES OF

Plain and Complicated Watches and Movements

SOLE AGENTS FOR THE WELL-KNOWN

# H. L. MATILE



REPEATERS.



CHRONOGRAPHIS.

Fine Watches of Astronomical Precision.

In order to facilitate the handling of our Stem-Winding Movements, we have adopted a standard of sizes to fit American Cases. Of these we have a complete line from the medium grade to the highest class goods of fine adjustment and precision. As all our Movements, complicated and plain, are perfectly uniform in quality according to their respective grades, we can furnish material for any parts that may be required, with the positive assurance of accurate interchangeability.

An Extensive Line of all Grades of

# CHRONOGRAPHS,

# SPLIT SECONDS AND REPEATERS.

WATCHES DEMAGNETIZED.







WILHELM & GRAEF,



IMPORTERS OF

**Ceramic Specialties**

FOR FINE JEWELRY TRADE.

After a six months' personal search we are now prepared to offer choice selections from 1883 Exhibitions of Rome, Amsterdam and Zurich, and Novelties from England, France, Germany, Austria and Italy. Fine Figures and Cabinet Pieces from Worcester, Derby, Copeland, Mintons, Royal Dresden, Vienna and Ginori manufactories. Unequaled collection of Porcelain Paintings and Fine Plates. Antique and Modern Rich Enameled Glass. Own Designs and Models of Rich Decorated Duplex Lamps.

**INSPECTION AND COMPARISON SOLICITED.**



Broadway and 26th Street,  
NEW YORK CITY.



Cutting Works,  
57-61 Rapenburgerstraat,  
Amsterdam.

House in  
Paris,  
44 Rue Laffitte.

*L. B. Citroen & Co.,*

**DIAMONDS**

*21 John Street,*

L. B. Citroen, Paris.  
Gustave Kuhn, N. Y.

*New York.*



ESTABLISHED 1844.

**DENNISON MFG CO.,**

BOSTON, NEW YORK, PHILADELPHIA, CHICAGO, CINCINNATI AND ST. LOUIS.

**JEWELERS' FINDINGS.**

**PAPER JEWELRY BOXES IN ALL STYLES AND QUALITIES. IMITATION MOROCCO BOXES, SATIN LINED. TAGS, JEWELERS' CARDS, PINK AND WHITE COTTON, &c., &c.**

**MOROCCO CASES.**

Manufacturing in our own Shops Every Description of Morocco, Plush and Velvet Jewelry and Silverware Cases in large quantities, we are enabled to sell lower than other goods of equal quality can be offered, and we carry in all our Stores FULL Stock of our whole line.

Catalogue on Application.

**BAKER, PRATT & CO.,**

IMPORTERS OF JEWELERS' FANCY GOODS,

MANUFACTURERS OF FINE LEATHER WARES,

No. 19 BOND STREET, NEW YORK.

Our success during the past season in manufacturing a Special Line of FINE LEATHER GOODS has encouraged us to make greater efforts to present this season designs particularly for the Jewelry Trade. Our line embraces all known leathers, such as Seal, Alligator, Calf, Russia, Morocco, and our two ORIGINAL SPECIALTIES in leather,

“ANTIQUE” AND “HAMMERED.”

The collection consists of all articles of personal belongings in leather, such as Promenade Bags, Card, Letter and Bank Bill Cases, Pocket and Betting Books, Coin Purses, Note Blocks, Dressing Cases, etc. Our line is now being handled by many leading jewelers.

(WRITE TO US FOR PARTICULARS.)



**JEWELERS' FANCY GOODS.**

*If you want Novelties, come and see them, you will make your expenses off one sale. It is useless to write for catalogue or price list (except of the regular Folding Mirrors), as our Stock is essentially Novelties, many of them not duplicated anywhere. We do not care to carry listable goods, as when listed they are no longer novelties and get in everybody's hands.*

**HALL NICOLL & GRANBERY,**

LATE SCHUYLER, HARTLEY &amp; GRAHAM,

20 &amp; 22 JOHN STREET, NEW YORK CITY.

**BRADLEY & HUBBARD MFG. CO.,**

21 BARCLAY STREET, NEW YORK.

FACTORIES,

Meriden, Conn.

ARTISTIC AND ORNAMENTAL BRONZES

IN LARGE VARIETY.

**FINE CLOCKS, ETC.****BRASS GOODS,**

Consisting of Candlesticks, Candelabras, Card Tables, New Patterns  
Sconces, Stand and Hanging Mirrors, Plaques, Easels,  
Smokers' Sets, Inkstands, Etc.

A SPECIAL LINE OF FINE HAMMERED METAL LAMPS,

*In Real Bronze and of Rich Designs, Specially adapted for the Jewelry Trade.*

Inspection of Goods Invited at our Salesrooms.



THE

**E. HOWARD WATCH AND CLOCK CO.,**

—MANUFACTURERS OF—

**Fine Stem-Winding Watches,**FINE REGULATORS, OFFICE CLOCKS, TOWER CLOCKS,  
And Electric Watch Clocks.LADIES'  
6 Size.STEM-WINDING  
ANDGENT'S  
16 Size.Stem-Setting  
Movements.GENT'S  
18 Size.**114 TREMONT ST., BOSTON.****29 MAIDEN LANE, New York.**

J. W. J. PIERSON, Agent.

**WILLEMIN WATCH CASE CO.,**

109 Sands Street, Brooklyn, N. Y.



Our Engine Turned (Jurgensen Cases), a Specialty with us, have achieved a high reputation in the Trade, and are, without any exception, the Best and Cleanest Cut Engine Turned Cases in the market.

We ask you to compare these Cases with those of any other manufacture, as they are so made that they will stand the closest criticism. We also invite especial attention to our Raised Gold Ornamentation Work, Escalloped, Enameled and other styles of decoration.



New York Office, 14 & 16 Maiden Lane.



# KREMENTZ & CO.,

MANUFACTURERS OF

GOLD, PEARL AND DIAMOND JEWELRY,

Nos. 182 and 184 BROADWAY,

Corner of John Street,

NEW YORK.

(Elevator Entrance on John Street.)

NOVELTIES IN SILVER JEWELRY.

FACTORY, NEWARK, N. J.

---

## J. EUGENE ROBERT,

IMPORTER OF

MOVEMENTS & WATCHES,

**No. 30 Maiden Lane, New York.**

Ladies' and Gent's Stem Winding Movements, Fitting American Cases,  
all fully warranted.

**Ladies' Small Sized** Watches in Fancy Gold Cases of every Variety and  
Style of Decoration.

—: SOLE AGENT FOR :—

**LOUIS AUDEMARS**

Superior Watches. Plain and Complicated Stem Winders of every style, man-  
ufactured with the Latest Improvements.

**CHRONOGRAPHS** WITH OR WITHOUT **SPLIT SECONDS,**

Various Grades Minute Repeaters.



# GEO. H. RICHARDS, JR.,

383 Washington Street, Boston, Mass., U. S. A.,

## JOBBER

# AMERICAN MOVEMENTS & CASES

A SPECIALTY.

WE GUARANTEE TO HAVE **ALL GRADES** IN STOCK.

### MOVEMENTS.

WALTHAM. SPRINGFIELD, ILLS. HAMPDEN. ELGIN. HOWARD.

### CASES.

❖GOLD❖

WALTHAM.  
DUEBER.  
BROOKLYN.  
G. H. R., Jr.

➤FILLED❖

"BOSS."  
CROWN.  
LADD.

❖SILVER❖

WALTHAM.  
DUEBER.  
FAHYS.  
KEYSTONE.

## Watches, Jewelry and Silver Plated Ware.

ROGERS & BRO.'S FLAT WARE.

HOLLOW AND FLAT WARE SOLD AT MANUFACTURERS' DISCOUNTS.

Our Stock is positively the Largest, Finest and Best Assorted of any Jobbing House in the Country. All Orders Promptly Executed.

SOLE AGENT FOR

## GOOLD'S PATENT REGULATOR,

FOR SALE BY ALL JOBBERS AND MATERIAL DEALERS.

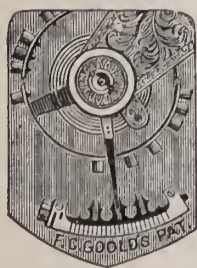

For 18 Size  
Movements,  
K. W. & S. W.



For 18 Size  
Movements,  
K. W. & S. W.

THE REGULATOR WILL BE IN THE MARKET JULY 1st, Price, \$1.50.

GEO. H. RICHARDS, Jr., 383 Washington Street, Boston, Mass.



# AIKIN, LAMBERT & CO.

23 MAIDEN LANE, NEW YORK,

MANUFACTURERS, IMPORTERS, JOBBERS.

## ❖ JEWELRY. ❖

A Large Assortment of all Leading Styles in GOLD, SILVER and ROLL PLATE, including

|                   |                        |
|-------------------|------------------------|
| <i>Diamonds,</i>  | <i>Buttons,</i>        |
| <i>Bracelets,</i> | <i>Studs,</i>          |
| <i>Rings,</i>     | <i>Lace Pins,</i>      |
| <i>Chains,</i>    | <i>Drops and Sets,</i> |
| <i>Charms,</i>    | <i>Scarf Pins,</i>     |
| <i>Locketts,</i>  | <i>Emblems,</i>        |
|                   | <i>Thimbles, Etc.</i>  |

## ❖ WATCHES. ❖

PAUL BRETON

Fine Movements, In Gold Cases.

AGASSIZ AND LONGINES

Stem Winding Movements, Fitting American Cases.

CHRONOGRAPHS, in Silver and Gold Cases.

Reliable Swiss Silver and Nickel Stem Winders.

ALL LEADING AMERICAN MOVEMENTS AND CASES.

## GOLD PENS,

HOLDERS, PENCILS, TOOTH PICKS.

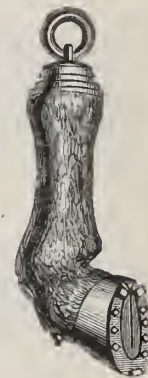

“NOVELTIES” IN PENCIL CHARMS.

Show Case and Fancy Tray Assortments, in New and Tasty Designs for Jewelers, A SPECIALTY.

Catalogues and Price Lists sent to Dealers when request is accompanied by Business Card.



Branches: } 113 EAST MADISON STREET, CHICAGO, ILLS.  
 } 41 WEST FOURTH STREET, CINCINNATI, O.

Factories: } 14, 16 & 18 MAIDEN LANE, N. Y.  
 } 12 VESEY AND 6 BARCLAY ST., N. Y.

❖ Novelties Continually Being Introduced. ❖

SELECTION PACKAGES SENT.

JAMES C. AIKIN. }  
 H. A. LAMBERT. }

PROMPT ATTENTION TO ORDERS AND REPAIRS.

{ J. B. SHEA.  
 { D. F. FOLEY.





99



1162



93



28



94



0027



0045



1336



1840

THE

# ACME LEVER BUTTON



1741



1016



1094



0001



OPEN.



OPEN.



OPEN.



43



CLOSED.



CLOSED.



CLOSED.



323



0025



1091



043



1420

Always was, is now, ever shall be  
**THE MOST CONVENIENT,  
STRONG, RELIABLE and PERFECT SLEEVE BUTTON MADE**

**It Overcomes  
ALL TROUBLE WITH STIFF CUFFS.**

ASK YOUR JEWELER FOR THE  
**ACME LEVER SLEEVE AND COLLAR BUTTON,  
AND TAKE NO OTHER.**

**For Sale by all Jobbers of Jewelry.**



1369



1196

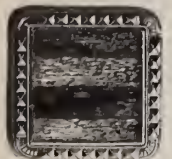

319



1316



50



58



1585



046



321



57



1545

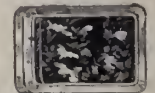

1269

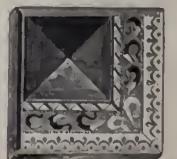

1338



1235



1349



315



1238



02

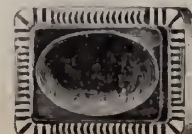

1182



634



NEW YORK:

No. 676 Broadway.

LONDON:

21 Holborn Viaduct.

ESTABLISHED 1837.

OLD HOUSE, READ, TAYLOR & CO.

**TAYLOR & BROTHER,**

IMPORTERS OF

*French Marble Clocks and Bronzes,*

AND NOVELTIES IN

*French, Vienna, English and other Fancy Goods.*

We invite the attention of the Trade to our Latest Importations, which are now arriving in great variety.

See also our advertisement of

Diamonds, &

Watches, etc.

Sole Agents

Jaques Le Coultre

**RAZORS.**



OPPENHEIMER BROS. & VEITH,  
WATCHES,  
DIAMONDS,  
JEWELRY.

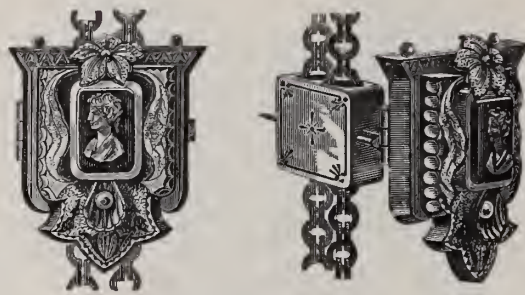

*We are the Manufacturers and Patentees of the Combination Slide, Pendant and Locket, and the Combination Necklace, Lace Pin and Pendant.*



*We can furnish quite a variety of Styles, and are prepared to fill all Orders at once.*

35 MAIDEN LANE, NEW YORK.



# FOLDING TRIPLICATE MIRRORS.



We are carrying a large stock of choice patterns and new designs which cannot be found elsewhere, as we control our own Styles.



Our Fall Catalogue of

## **FRENCH MARBLE CLOCKS**

is now ready, and will be sent on application. We do not put cheap movements in the Clocks, but a Fine Quality made ESPECIALLY for us. Every Movement Guaranteed.

LE BOUTILLIER & CO.,

**Importers and Jobbers.**

31 & 33 West 23d Street, (Second Loft,) NEW YORK.

Half a Block from Sixth Avenue Elevated Station.



THE CELEBRATED  
W. B. & CO.  
WATCH GLASSES,

Universally acknowl-  
edged by competent  
judges to be the BEST  
WATCH GLASSES made.  
OVER ONE HUNDRED AND  
TWENTY-FIVE THOUSAND GROSS  
of these Watch Glasses sold yearly.

The W. B. & Co. Watch Glasses  
excel all others by reason of the Strict  
Uniformity of Temper, Accurately Gradu-  
ated Sizes and Uniform Proportion of Thickness, essential requirements  
not to be found in glasses of inferior make.

A cheaper grade of glasses, in every respect as good as those of other  
makes, excepting the W. B. & Co., are imported by us to order at 90  
cents per gross, NET, in lots not less than 100 gross, and flat mi-concave  
glasses at \$1.20 net, in lots not less than 50 gross, and all other styles of  
glasses in proportion.

ALBERT BERGER & CO.,  
47 MAIDEN LANE, NEW YORK.

ALBERT BERGER & CO.,

MANUFACTURERS OF THE

W. B. & CO.  
WATCH GLASSES.

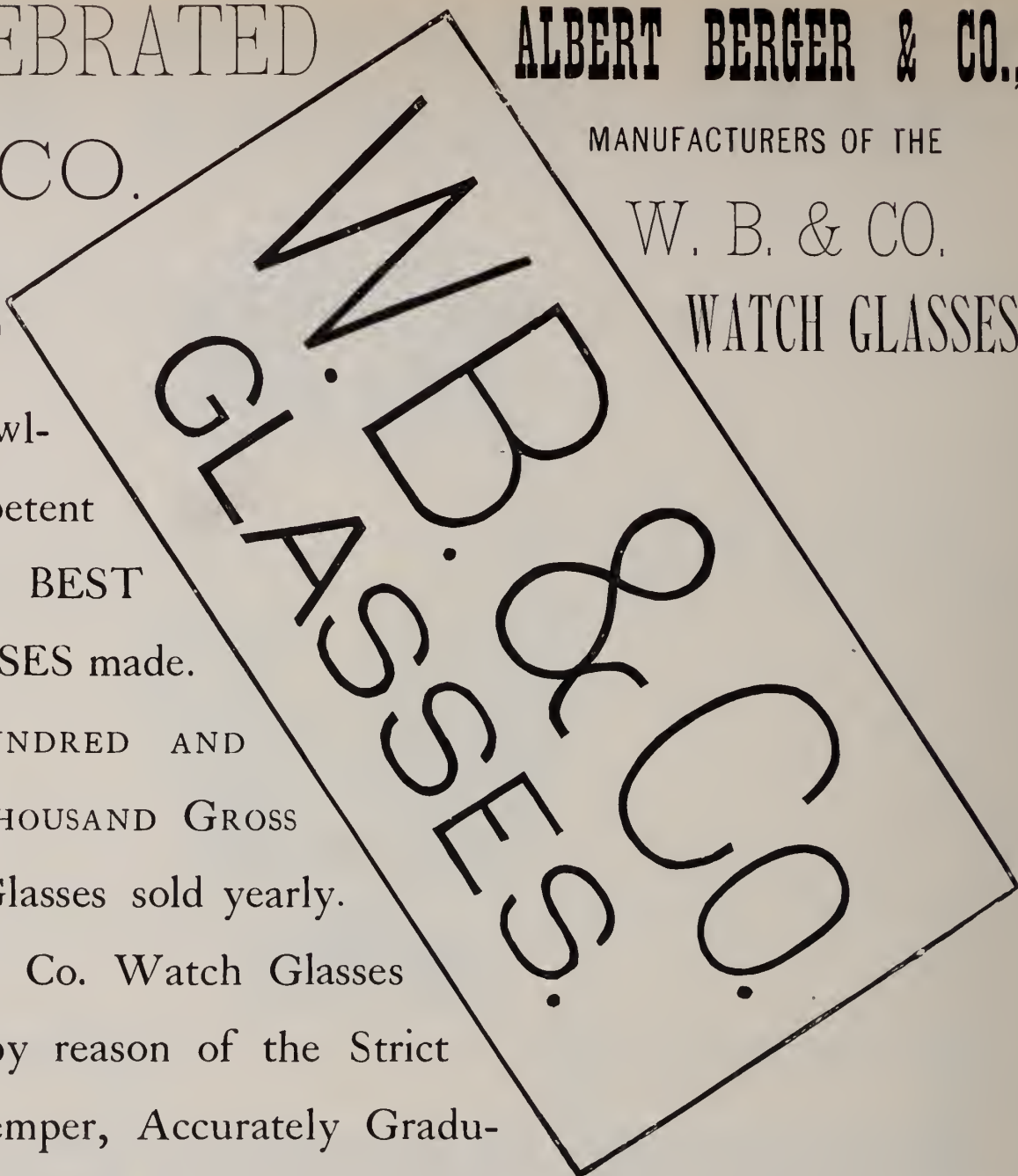



# A NEW DEPARTURE.



## 14 KARAT GOLD CHAIN, SILVER LINED,

— MADE BY —

### A NEW PROCESS.

Guaranteed to wear as well as the best 14 karat Gold Chain made.  
Every Chain warranted to assay one-third ( $\frac{1}{3}$ ) its entire weight in gold.  
Each Chain stamped with registered trade mark:



*Showing the Relative Thickness  
OF THE GOLD AND SILVER.*



*Showing the Relative Thickness  
OF THE GOLD AND SILVER.*

Money refunded if test is unsatisfactory.

### **KOSSUTH MARX & CO.,**

Proprietors and Manufacturers,

39 Maiden Lane, New York.

In introducing our new Chain we aim to supply a want which we believe the Trade can place before the public in a legitimate manner without deception, and no detriment to the standard of the most scrupulous dealer.

We offer these goods strictly upon their merits, and give but a few reasons why they can take the place of the older styles of manufacture, viz.:

- 1st.—In the make up there is no base metal, excepting such as is necessary in standard 14 karat.*
- 2d.—It makes a larger and more showy appearance for its corresponding weight than the old standard.*
- 3d.—The cost is materially reduced, bringing it within reach of a greater number who desire a good article.*
- 4th.—It is a well known fact that the principal cause of wear in chain is the friction produced by its own weight consequently, being light weight to the extent of a large percentage, their better wear is assured.*

By a strict adherence to quality we hope to create a popular demand for a meritorious article.

Send for selection package, as our travelers do not carry any in stock.

KOSSUTH MARX & Co.



**JAMES W. TUFTS,**  
 ·Manufacturer· of·  
**Fine Plated Ware.**



**FACTORIES:**

**33 to 51 Bowker Street, and 49 & 51 Chardon Street,  
 BOSTON.**

OFFICE & SALESROOM, 33 BOWKER ST., BOSTON.

BRANCH, 70 PARK PLACE, NEW YORK CITY.

Where a Full Line of Samples can be seen. I invite all Dealers, when in Boston or New York, to inspect these goods, and will guarantee every article sold to be equal in finish to the sample.

—\*—

IN DESIGN, MATERIAL, PLATING AND FINISH I GUARANTEE MY GOODS TO BE EQUAL TO THE BEST MADE.

I am now preparing an ILLUSTRATED CATALOGUE, which will be furnished free to customers.



# REST FENNER SMITH & CO.,

MANUFACTURERS AND IMPORTERS OF

## WALKING STICKS,

701 BROADWAY,

FACTORY,  
GREAT JONES STREET.

New York.



SALES DEPARTMENT, REST FENNER SMITH & CO.

The attention of the Trade is cordially invited to the complete and varied stock of WALKING STICKS now exhibited. The salesroom is the largest and most elegant for the display of Walking Sticks in the world. The departments contain all that is required for every class of trade dealing in Walking Sticks. Gold Headed Walking Sticks in new and original designs.

Silver Mounted goods in all grades and of unique designs. Imported Novelties personally selected in Europe by our Mr. Spencer Smith. Largest manufactory of Walking Sticks in this country, and goods sold at prices that command the attention of the closest buyers.



# MARTINS & TISSOT,

MANUFACTURERS OF

## GOLD WATCH CASES,

15 MAIDEN LANE, N. Y.

*We respectfully invite the attention of the Trade to our new alloy in 8 Kt. Cases.*

*It has been generally conceded that our Cases excelled in color, and as we still retain the same and have succeeded in making our new alloy **ACID PROOF**, we now claim superiority over all Cases of that grade manufactured, combining as we do, Good Construction, Neatness of Design, Superior Color, in fact, all the requirements necessary to a Good Case.*

A LARGE STOCK CONSTANTLY ON HAND.

ALSO 14 KARAT CASES IN LARGE VARIETY.

JOBGING TRADE SOLD ONLY.



# KAHN, HANOVER & CO.,

IMPORTERS AND MANUFACTURERS OF

## OPTICAL

METEOROLOGICAL,

ENGINEERING,

MATHEMATICAL,

ELECTRICAL,

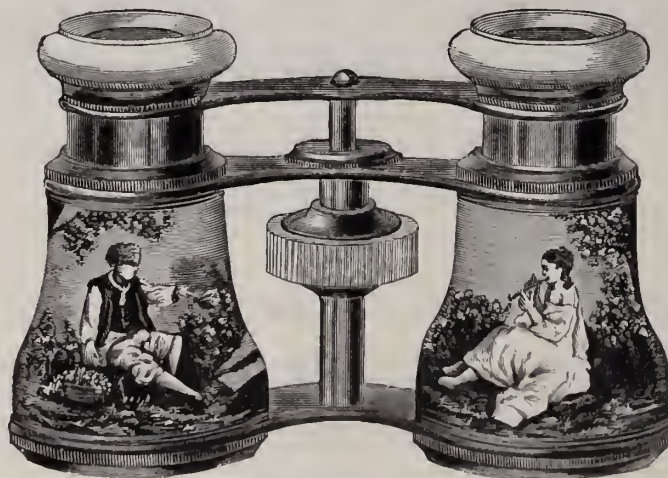

## INSTRUMENTS,

32 MAIDEN LANE, NEW YORK.

We are the *only* Importers dealing *exclusively* in Optical, Meteorological, Engineering, Mathematical, Electrical and other Scientific Instruments. We keep the best selected Stock of Specialties in this line, and are constantly advised of all important Scientific Improvements, which enables us to present to our patrons the best results and latest achievements in the reach of science.

Our New Descriptive Catalogue and Price List of 210 pages, with over 400 Illustrations, forwarded to the Trade on application.







13 Maiden Lane,  
NEW YORK.



FRANK S. KENNEDY,  
Manufacturer and Wholesale Dealer in  
**JEWELRY**  
OF EVERY DESCRIPTION.



13 Maiden Lane,  
NEW YORK.

*In addition to my stock of Jewelry, which is complete in all lines of Gold, Silver and Roll Plate, I am now making a Full Assortment of*

**THIMBLES,**

*in Solid Silver, 10 karat and 14 karat Gold. These Thimbles are Superior in Finish to any now in the market, and are as near perfection as long practical experience can make them. Will send Samples if desired.*

*The Assortments of Jewelry I send on Memorandum for Special and Stock Orders have an increasingly high reputation.*

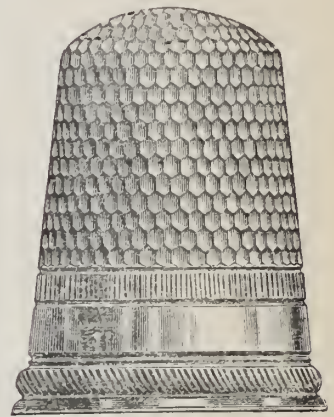

308

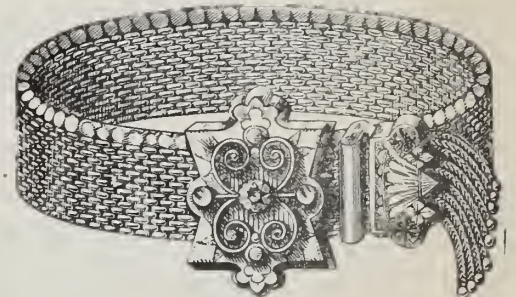

306

**ELLISON & VESTER'S**  
PATENT BAND AND BANGLE FINE ROLLED PLATE

**BRACELETS.**

FOR SALE BY EVERY JOBBER.

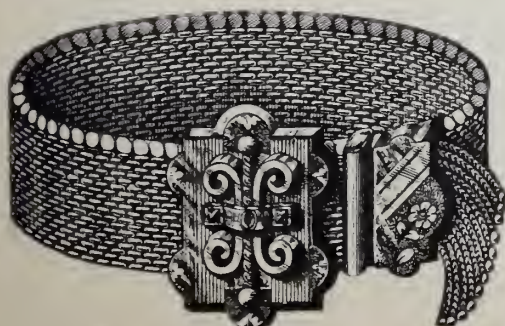

304



310½



# JACOT & SON,

IMPORTERS OF

## MUSICAL BOXES,

49 MAIDEN LANE, NEW YORK.

Round and Square Crank Toy Music Boxes, small, 2, 3, 4, 6 and 8 tune and small Mandolines in all styles of cases.

Large Size Musical Boxes from 4 to 15 inch cylinders and playing from 4 to 12 tunes.

Musical Boxes with Bells, Bells and Drum, Bells, Drum and Castanettes.

Mandolines, Piccoloes, Guitare-Mandolines, Sublime Harmonies and many other styles of all sizes.

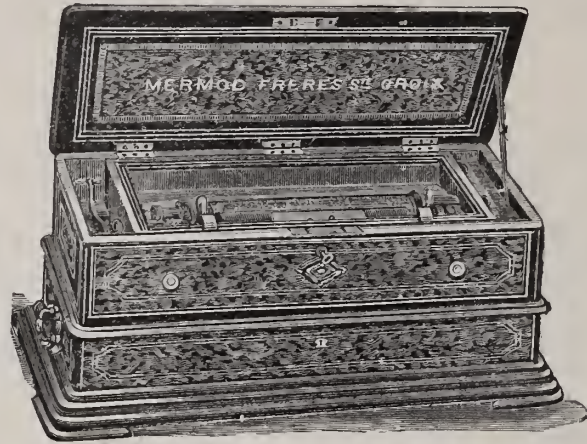

Musical Boxes with several cylinders, double and quadruple Main Springs, and Richly Inlaid Cases.

These Boxes are of superior quality and with airs appropriate to each style.

PRICE LIST SENT ON APPLICATION.

Send for "How to Repair Musical Boxes," with Price List of Material. No Watchmaker should be without it.

## STANDARD DUST-PROOF WATCH KEYS.

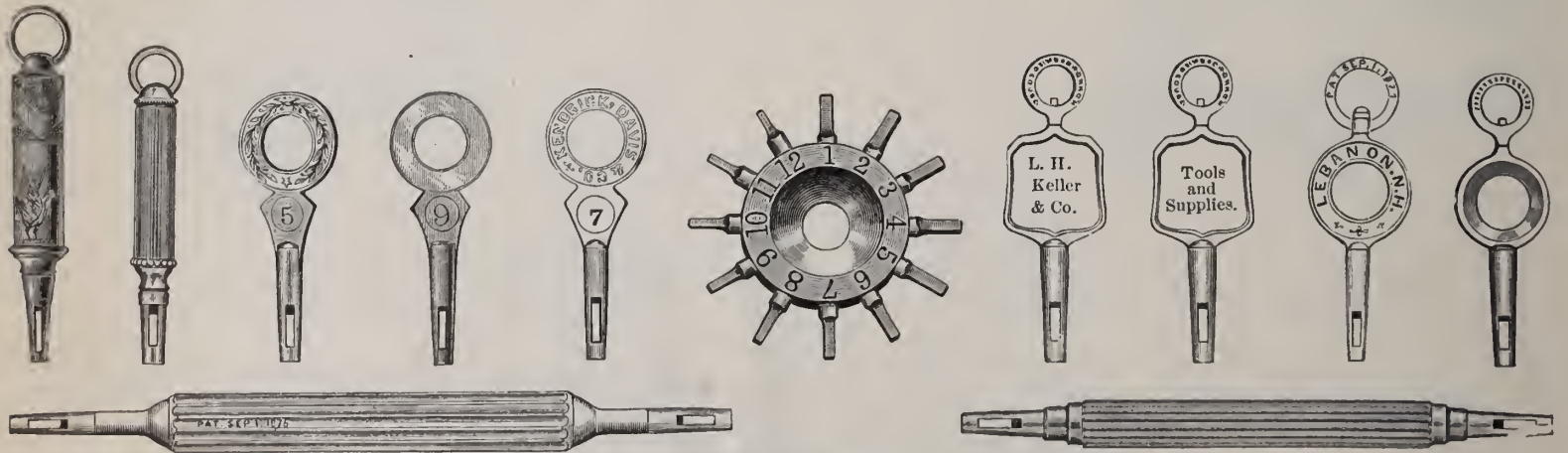

FOR SALE BY



THE TRADE.

## KENDRICK & DAVIS,

Sole Owners and Manufacturers, Lebanon, N. H.

ILLUSTRATED CATALOGUE and PRICE LIST SENT ON APPLICATION.



LOUIS KAHN.

MOSES KAHN.

SAMUEL H. LEVY.

I. W. FRIEDMAN.

# L. & M. KAHN,

IMPORTERS OF

## Watches, Diamonds & Precious Stones,

10 MAIDEN LANE, NEW YORK.

11 Corrairie, Geneva, Switzerland.

17 Rue de Chateaudun, Paris.

### WATCHES,

*Stem and Key-Winding, from the Lowest Priced Nickel and Silver to the Finest Gold and Complicated.*

A Full Assortment of these Goods always in Stock.

### DIAMONDS,

*Loose and Mounted, in all Sizes and Qualities.*

*Gold, Silver, Nickel and Celluloid Chatelaines in Great Variety.*



Send for Illustrated Catalogue.

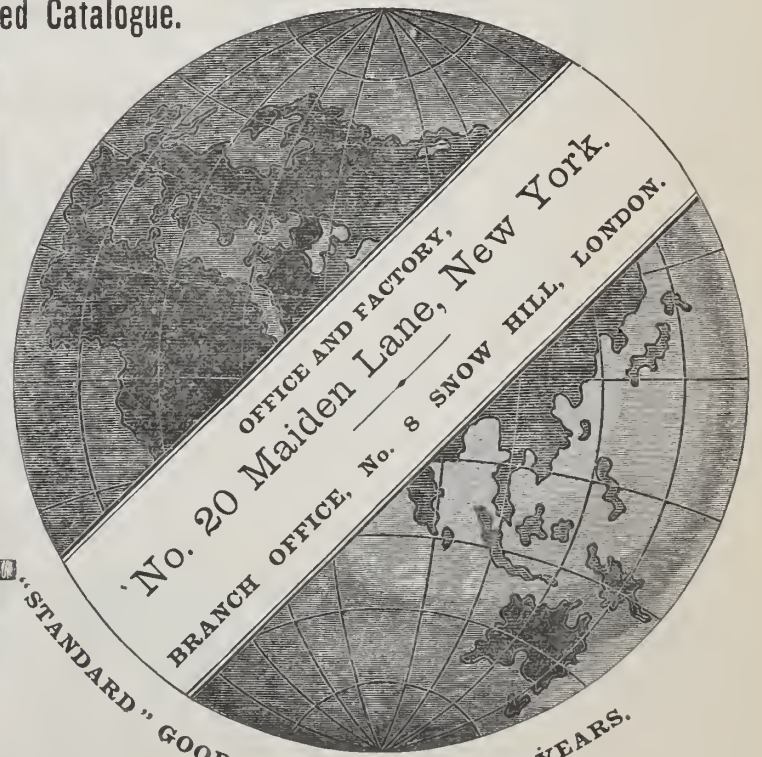
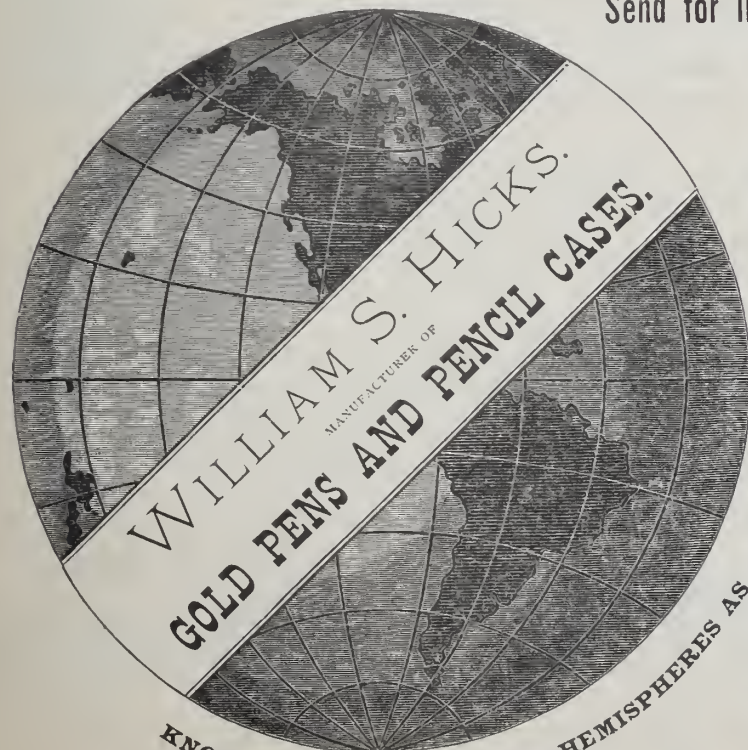

ESTABLISHED 1848.



**"The Waterbury." The New "Series B,"**

**With FULL DIAL and SOLID PLATES.**

In this new SOLID PLATE movement the position of the regulator has been changed; it will be found projecting beyond the plate, immediately under the bezel. The FULL DIAL enables the position of the hands to be readily seen.

The danger of injuring the Hair Spring in regulating is obviated in this new movement.

SERIES A.—Open Dial, Skeleton Plates, - \$48.00 per doz.  
 SERIES B.—Full Dial, Solid Plates, - - - 48.00 "

**Discount to the Trade.**

We can supply either Pattern as ordered.

**WATERBURY WATCH CO.,**  
 WATERBURY, CONN.



NEW SERIES B.  
 Solid Plates and Full Dial.



NEW SERIES B.  
 Bezel Off,  
 Showing Index Plate and Regulator.

**NEW YORK OFFICE, 52 MAIDEN LANE.**

GEO. MERRITT, GENERAL SELLING AGENT,

To whom all Orders and Correspondence as to Prices and Terms should be addressed.

**FOR SALE BY DEALERS GENERALLY.**

**STERN BROS. & CO.,**

No. 30 Maiden Lane, New York,

**Importers of Diamonds,**

**MANUFACTURERS OF FINE JEWELRY.**

Jobbers in American Movements of all grades, Gold & Silver Cases, Gold & Plated Chains.

THE FOLLOWING ARE OUR **SPECIALTIES:**

*SEAL and STONE RINGS. GENT'S LOCKETS. The most complete and largest line of GOLD INITIAL RINGS and LOCKETS made in the United States. The celebrated DOUBLE CROWN Plain Filled Rings, which are universally acknowledged the MOST RELIABLE in the market. Made in seven different widths.*



No. 00



No. 0



No. 1



No. 2



No. 3



No. 3 1/4



No. 4

**EVERY RING IS WARRANTED TO GIVE SATISFACTION.**

Goods sent on selection to Dealers upon application with satisfactory reference.



**CLEMENS HELLEBUSH,**

MANUFACTURER, IMPORTER AND WHOLESALE JEWELER,

Dealer in everything required by the Jewelry Trade.

**DIAMONDS.**—Dealers will find in my stock an assortment of Diamonds unequalled in the West, embracing a choice variety of loose and mounted Stones in all qualities.

**WATCH CASES.**—In Gold and Silver, of all makers, to fit American Movements.

**WATCH MOVEMENTS.**—Include always a full stock of Waltham, Springfield, Hampden and Howard, together with a large assortment of fine and low-priced Swiss Watches.

**SILVER PLATED WARE.**—I have an unusually fine assortment of the choicest patterns of Flat and Hollow Ware of the best known manufacturers.

**SOLID GOLD AND ROLLED PLATE JEWELRY.**—This department is replete with Staple Goods and Novelties.

**FRENCH CLOCKS.**—Of our own importation, including all grades, with prices exceedingly low.

**AMERICAN CLOCKS.**—I am the General Agent in Cincinnati for the celebrated Seth Thomas Clocks, a full line of which will always be found in stock.

**TOOLS AND MATERIALS.**—In this department will be found everything required by Watch Makers.

Illustrated Catalogues sent to Dealers only upon Application.

**CLEMENS HELLEBUSH,**

77 West 4th Street,

CINCINNATI, O.

## “GLYPTIC CAPITALS.”

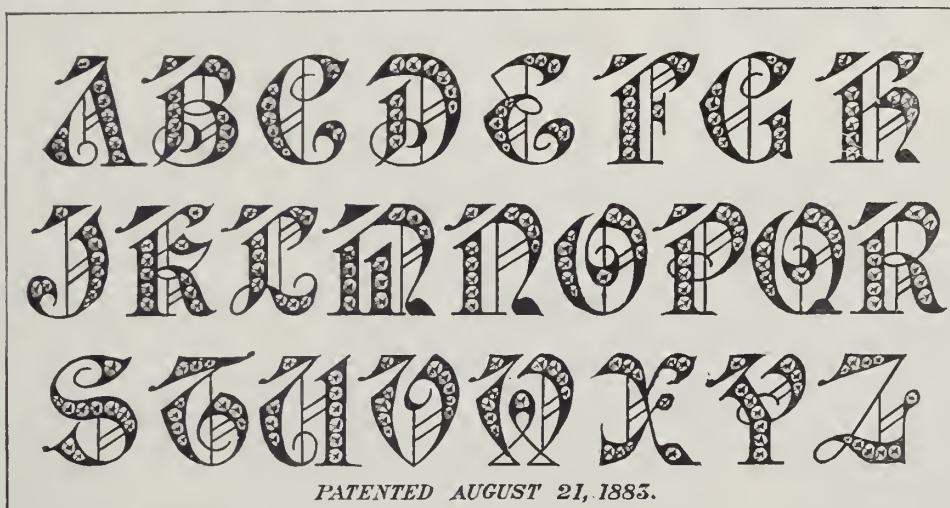

A New and Original Alphabet introduced in Incrusted Initial

**RINGS AND LOCKETS**

this season by

H. MUHR'S SONS,

NEW YORK OFFICE,  
NO. 14 MAIDEN LANE.224 SOUTH FIFTH ST.,  
PHILADELPHIA, PA.

CHICAGO OFFICE, No. 101 STATE STREET.



**JOHN BLISS & CO.,**

Standard Marine Chronometer,  
FOR KEEPING CORRECT TIME.

Standard Marine

CHRONOMETERS AND TRANSITS

FOR WATCHMAKERS' USE.

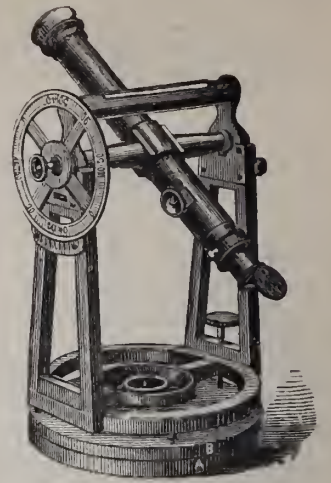

No. 10.

128 FRONT STREET,

Near Wall Street,

NEW YORK.

**NOTICE.**—*These Transits are readily set in position without the aid of strictly correct time as a basis for that purpose. Printed instructions, easily understood, accompany each Instrument, and no calculations are required preliminary to setting in position.*

SEND FOR ILLUSTRATED CIRCULAR WITH PRICES.

PATENT IMPROVEMENT IN  
**COUNTER + SHOW + CASES,**  
WITH PERPENDICULAR SLIDING DOORS. DUST PROOF.

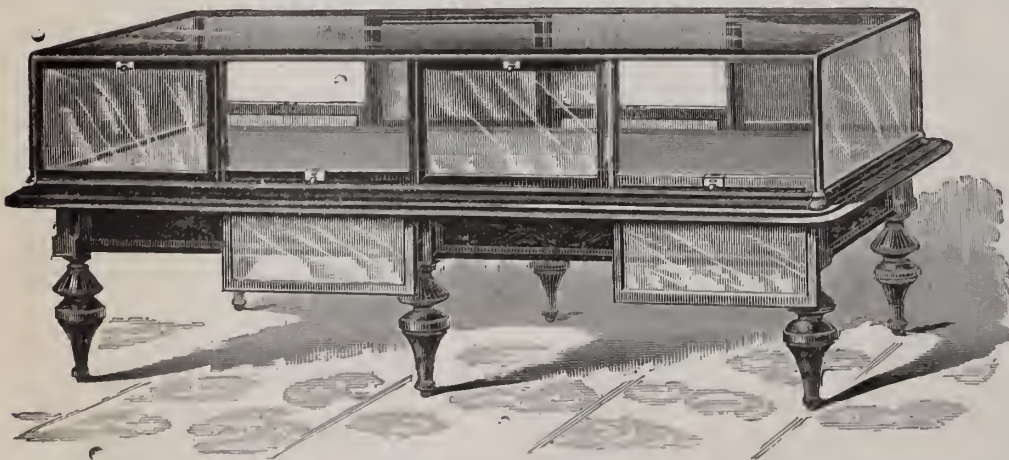

The Advantage and Convenience of these Show Cases will be apparent to everyone.

The doors are more conveniently opened and closed, less liable to get out of repair or broken, articles are more easily reached in wide cases, mirrors are more safe, it dispenses with hinges, economizes room, excludes dust, and is air tight when closed.

Drawings furnished and estimates given for fitting stores in cabinet work complete.

Letters Patent having been granted us for the construction of these doors, we shall prosecute all parties using Cases which infringe on our Patents.

REFERENCES:—Gorham Mfg Co., Rogers & Bro., Mitchell Vance & Co.,  
Meriden Britannia Co., M. S. Smith & Co., Detroit, Mich.  
D. Valentine, Syracuse, N. Y.

**B. & W. B. SMITH,**  
220 West 29th Street, New York.

M. Anderson, No. 57 State Street, Chicago, has the exclusive right to manufacture and sell our Improved Cases for the States of Wisconsin, Illinois, Missouri, Mississippi, Arkansas, and all States West of same.

CATALOGUE OF STYLES SENT ON APPLICATION,



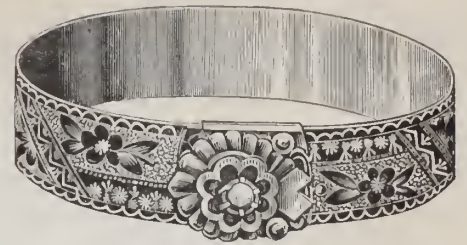
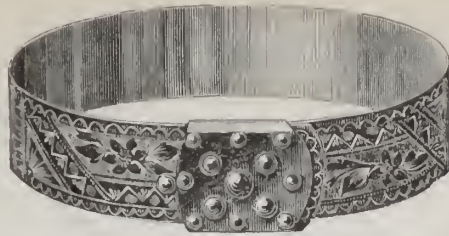
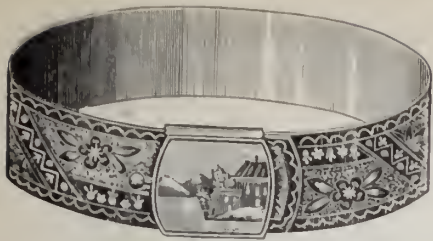

**J. M. CHANDLER & CO.,  
MANUFACTURING JEWELERS.**

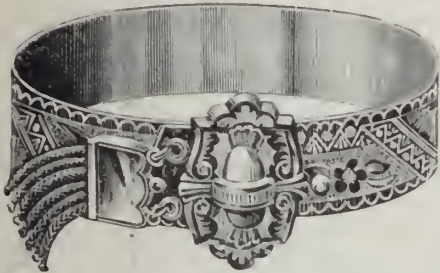

We especially call the attention of the Trade to our new Patent Band Bracelet Catch. The design of the Catch is to make a Band Bracelet adjustable to any size without the slightest difficulty—leaving the band clean and smooth, and make a secure fastening. These goods are pronounced by all who have seen them to be the *Ne Plus Ultra* of all Band Bracelets. The goods must be seen to be appreciated. We will send Selection Package of these goods to the Regular Trade.

**J. M. CHANDLER & CO.**

Manufactured at our own Factory, 111 Broad Street, Providence, R. I.

Office and Salesroom, 185 Superior Street, Cleveland, Ohio.

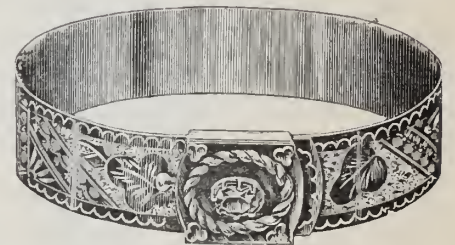

**IMPROVED CROWN FILLED CASE.**

→ **THE BEST FOR THE LEAST MONEY.** ←

The Gold contained in the Crown Cases which are now being turned out under our supervision is **fully equal to that of any Filled Case on the market.**

This fact can be attested to the satisfaction of any dealer who will go to the trouble of having one of these Cases assayed with one of corresponding size and style of **any other make.**

The United States Mint at Philadelphia will make a complete assay for the sum of one dollar each, and we will return a New Case to the dealer in place of the one of our make destroyed, upon receipt of the Assay Certificates and the gold contained in the Crown Case assayed.

**SOLID GOLD JOINTS,  
SOLID GOLD PLUGS,  
GOLD THE NATURAL COLOR,  
ABSOLUTELY NO GILDING.**



IMPROVED FILLED.  
Louis XIV.



IMPROVED FILLED.  
Raised Gold Ornamentation.

**SOLD ONLY BY THE JOBBING TRADE.**

**H. MUHR'S SONS, PHILADELPHIA,**  
NEW YORK OFFICE, 14 & 16 Maiden Lane. CHICAGO OFFICE, 101 & 103 State Street.





GILES, BRO. & CO.

Wholesale,  
Importing and  
Manufacturing

→ JEWELERS, ←

101 and 103 STATE STREET,

CHICAGO, ILLS.

Complete Illustrated Catalogue Furnished the  
Trade upon Application.

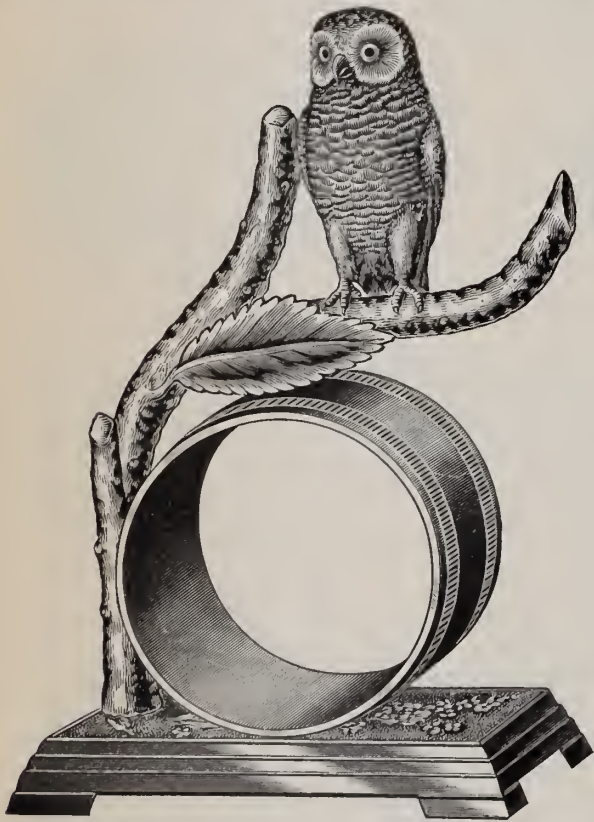

THE

# Hartford Silver Plate Co.

MANUFACTURERS OF

# Fine Electro Plated Ware

**New Illustrated Catalogue now Ready,**

Which will be sent to Dealers on application.

Manufactory and Salesroom at Hartford, Conn.

**L. A. CUPPIA,**

Manufacturing Jeweler,

19 Union Square, N. Y.

**SILVER CANE HEADS,**

A Large and Comprehensive Assortment of New and Original Designs.

AND IMPORTER OF

→ **SILVER FILIGREE JEWELRY** ←

Embracing a Large and Varied Assortment of Popular Designs.

**SILVER JEWELRY.**

SILVER BRACELETS A SPECIALTY.

SELECTION PACKAGES SENT ON APPROVAL.



# THE HOPKINS LATHE.



These Lathes are **Unsurpassed in Quality and Workmanship.**

In **Special Features of Practical Value**, peculiarly adapted to Watch Repairing, they excel all others. The attachments are made **interchangeable** in all the sizes.

The only absolute substitute for wax, in Watch Repairing,

is found in our **New and Improved Pivoting Chuck**, represented in the above sectional view.

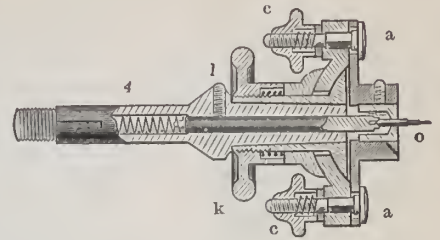

**HOPKINS WATCH TOOL CO.,**

**WALTHAM, MASS.**

Send for full Descriptive Catalogue.

## S. KOHN & CO.,

43 MAIDEN LANE,

NEW YORK.

Manufacturers of  
Fine Morocco, Plush and  
Velvet Boxes.



Trays and Silverware  
Boxes of all Description  
Made to Order.

*A Full Line of Boxes Constantly on Hand, and Samples sent on Selection.*

ORDERS FROM THE JOBBING TRADE RESPECTFULLY SOLICITED.

# R. & L. FRIEDLANDER,

65 & 67 NASSAU STREET.

BRANCH SALESROOMS, 264 BOWERY. } . . . . . NEW YORK CITY.  
FACTORY, 50 BOND STREET.

**IMPORTERS OF**

Watch Materials, Tools, Optical Goods, Silk Guards, Watch Keys, White Metal Chains,  
Rolled Plated and Fire Gilt Chains, Charms, Lockets, Etc., Etc., Etc.



Silver Bangles.

Plain Gold Bangles.

### PRICE OF SOLID GOLD BANGLES.

|                                      |                         |
|--------------------------------------|-------------------------|
| No. 5, \$3.50 per doz.               | No. 13, \$1.75 per doz. |
| " 6, 1.75 "                          | " 15, 3.50 "            |
| " 7, 1.75 "                          | " 24, 1.25 "            |
| " 8, 3.50 "                          | " 25, 1.25 "            |
| " 9, 1.75 "                          | " 26, 2.50 "            |
| " 11, 3.50 "                         | " 27, 2.50 "            |
| No. 28, \$2.50 per doz.              |                         |
| Silver Dimes, Engraved, - - - \$3.00 |                         |
| " " Plain, - - - 1.25                |                         |



# F. P. LOCKLIN & BRO.,

MANUFACTURERS OF

## GOLD & SILVER

### HEADED

## CANES

— AND —

## BRACELETS.



**142 FULTON STREET,**

NEW YORK CITY.

## Swiss Automatic Clock Pictures,

Representing Various Pastoral Scenes and Landscapes with Animated Domestic Animals, Etc.

**A Most Desirable and Attractive Picture for a JEWELRY STORE WINDOW.**



This cut represents the **Automatic Clock Picture** without the frame. They are framed in Ornamental Gilt Frames, and finished in various oil colors, resembling in appearance an oil painting. By winding the mechanical part the figures all move and the clock keeps correct time.

Size 21x25, \$21.60.      Size 15x18, \$15.00.      Net Cash.

**L. & M. KAHN,**

SOLE IMPORTERS,

No. 10 MAIDEN LANE, NEW YORK.

**KEY**  
Patented Jan. 25,  
1881.

**TAG**  
Patented Jan. 25,  
1881.

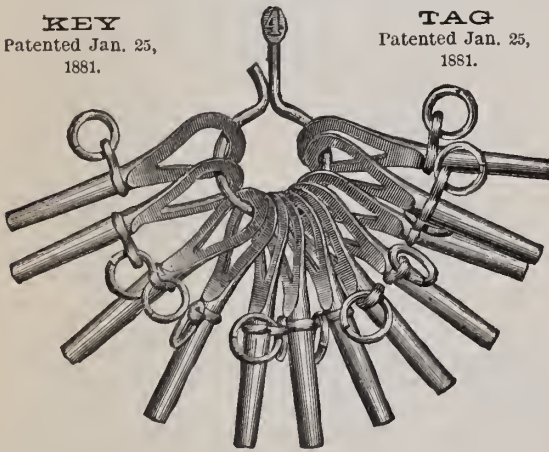

## A. N. CLARK

PLAINVILLE,  
CONN.,

Manufacturer of

**Watch Case Springs, Watchmakers' & Jewelers' Bench Tools,  
CROSBY'S JEWELING TOOLS, &c.**

**STOP IMPORTING KEYS!**

For Low Price Key Use the

**New Style Loop Key.**



A plain Steel Key of good appearance, and excellent quality. It will not wear the pocket. It has a swivel, and is much better made than the imported plain steel or iron keys.

**PRICE PER GROSS, FINE NICKEL FINISH, \$2.25**  
Postage, 10 Cents Per Gross Additional.

This Key is good and cheap enough to become universal. Send business card for illustrated price list. Enclose three cent stamp for sample key.

SOLD BY JOBBERS IN WATCH MATERIALS AND NOTIONS.

**A. N. CLARK, Plainville, Conn.**

## The Burbank Manufacturing Company

Manufacturers of GOLD & SILVER

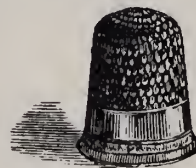

GOLD  
SILVER,  
STEEL,  
RUBBER,  
And SHELL,

## Thimbles,



EYE GLASS  
Self Adjusting.

## SPECTACLES AND EYE-GLASSES



OF ALL DESCRIPTIONS.

## SOLID GOLD RINGS

**Office, 14 MAIDEN LANE, NEW YORK.**

Manufactory, Springfield, Mass.



# T. L. MAXWELL & BRO.,



MANUFACTURERS OF  
**GOLD AND SILVER HEADED**  
**CANES**  
 IN GREAT VARIETY.  
 42 CORTLANDT ST.,  
 NEW YORK.

Special Attention given to the Jobbing Trade.

PRICE LIST SENT ON APPLICATION.

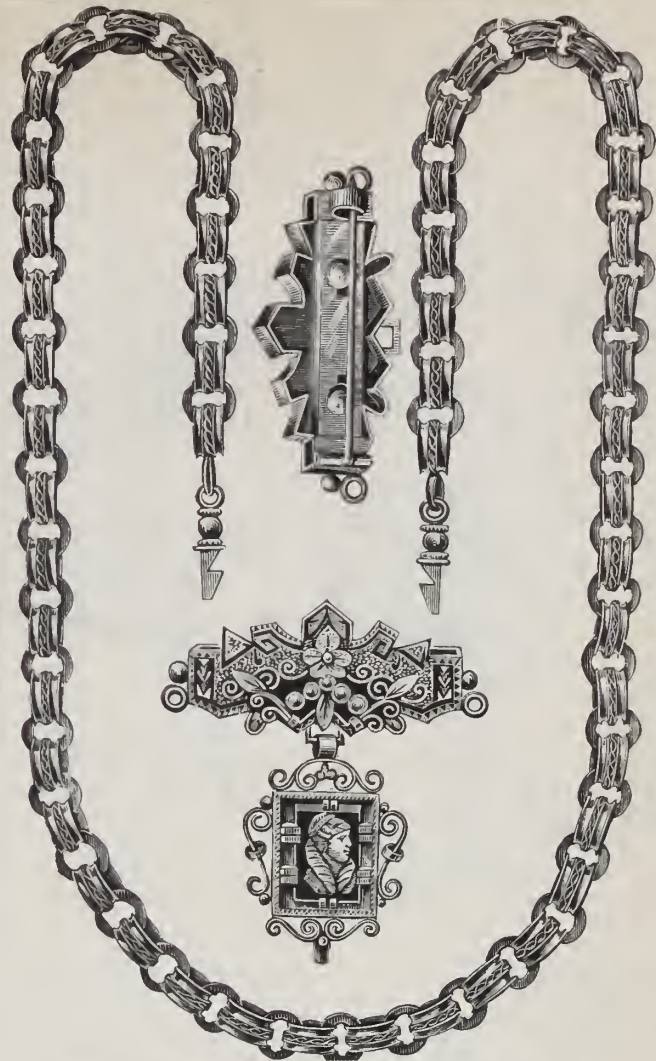

**L. F. CAHN, 12 Maiden Lane,**  
 Manufacturer of all kinds of Gold Chains, Chain Bracelets; also a full line of Seal and Fancy Rings, and Patent of Cahn's Patent Chain Snap. These goods are made in 10 and 14 karat gold, and can be obtained through any Jobber in the U. S., or direct from me. A large stock of Gold Chains constantly on hand. Goods sent on approval to responsible houses.

Vol. XV.

ESTABLISHED 1869.

Vol. XV.

THE

## JEWELERS' CIRCULAR

AND HOROLOGICAL REVIEW.

The XV VOLUME will begin with the February Issue of 1884, and will surpass all others in interest.

\$2.00 per Annum to all parts of the United States and Canada,  
 and all Foreign Subscriptions \$3.00.

D. H. HOPKINSON,

42 Nassau Street,

NEW YORK.

### Birch's Patent Self-Adjusting Watch Keys.

FOR SALE BY THE TRADE GENERALLY.



2.-POCKET KEY.  
(Brass.)



3.-POCKET KEY.  
(Nickel Plated.)



4.-POCKET KEY.  
(Nickel Plated, Hexagon Shell.)



5.-POCKET KEY.  
(Heavy Rolled Gold Plate Mountings.)



6.-CELLULOID MOUNTED KEY.  
(With Heavy Rolled Gold Plate Tips.)



35.-POCKET KEY.  
CELLULOID MOUNTINGS.  
(Imitation Malachite, with Extra Heavy Rolled Gold Plate Tips. 18. K.)



7.-BENCH KEY. (Brass Handle.)



8.-SHORT WOOD HANDLE KEY.  
(Nickel Plated, for Bench or Pocket Use.)



9.-LONG WOOD HANDLE BENCH KEY. (Nickel Plated.)

Made in 37 Styles. Circulars on Application.

J. S. BIRCH & CO., 38 Dey Street, N. Y.



# HUTCHISON & HUESTIS,

❖ SOLID ❖ GOLD ❖

## RING MAKERS



QUALITY GUARANTEED.

FOR JOBBERS ONLY.

No. 185 EDDY STREET,  
PROVIDENCE, R. I.

New York Office, . . . 196 Broadway.



**J. F. FRADLEY & CO.,**

Manufacturers of Fine

Gold and Silver Headed Canes

AND SPECIALTIES.

**23 JOHN STREET, NEW YORK.**

Designs furnished for Presentation Canes. Illustrated Catalogues sent upon application.

Special Inducements to the Jobbing Trade.

# WM. M. FISHER & CO.

Sole Manufacturers of the

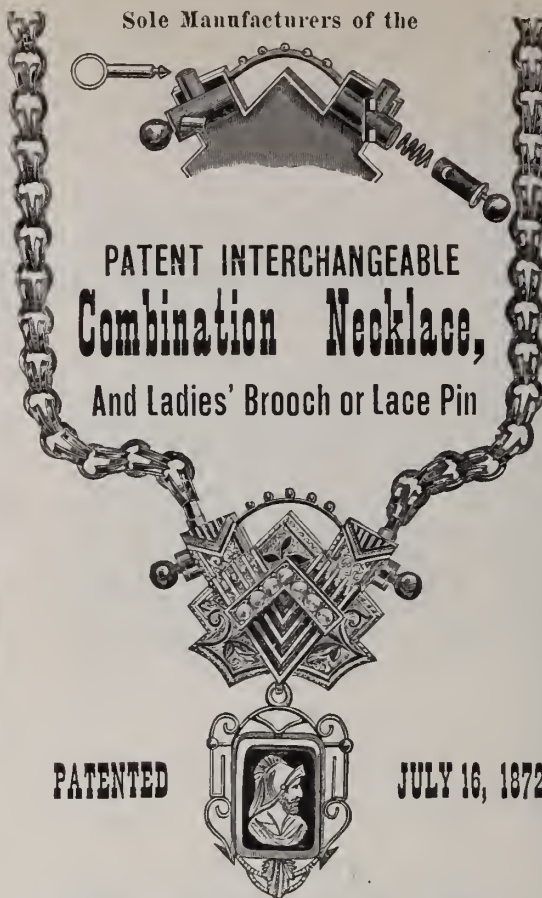

PATENT INTERCHANGEABLE  
**Combination Necklace,**  
And Ladies' Brooch or Lace Pin

PATENTED

JULY 16, 1872

GOLD  
AND

SILVER  
CHAINS.

Gold Chain  
TRIMMINGS.

Complete  
Assortment of

14-k.

**Ribbon Fobs.**

FOR SALE BY THE LEADING JOBBERS

**S. C. JACKSON,**  
180 BROADWAY, N. Y.



IMPROVED STYLES OF  
**FINE CASES,**  
(Also a Medium Quality on Hand)  
For Jewelry, Watches, Silverware, Etc.  
Specialty of Fine Rosewood, &c. Trays.  
Paintings and Novelties from China, Japan, etc.



# AMERICAN WATCH TOOL CO.,

WALTHAM, MASS.

MANUFACTURE THE

## WHITCOMB LATHE,

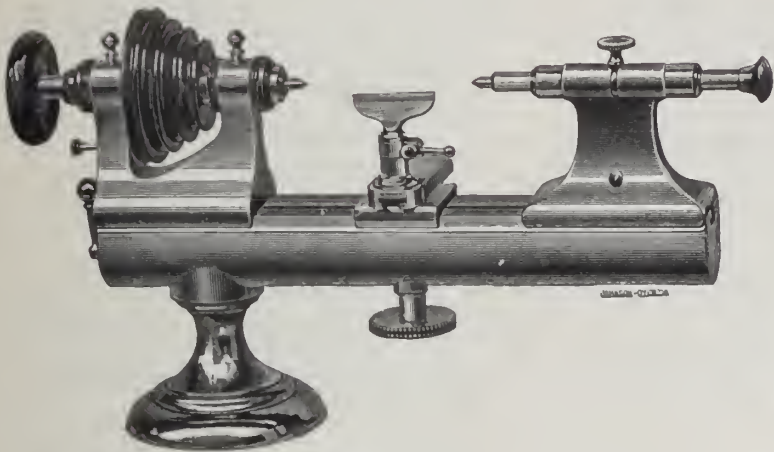

AND THE

## "Webster" Foot Wheel,

We guarantee it to be a worthy companion to the Whitcomb Lathe.

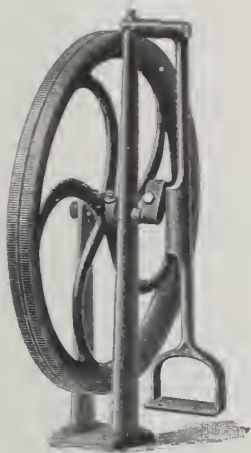

It is **not** a cheap made wheel but **First-class** in every respect.

### PRICES:

|                                                       |         |
|-------------------------------------------------------|---------|
| 30 lb. Wheel, for No. 1 Lathe, 20 inches in diameter, | \$12 00 |
| 40 " " " 1½ " 20¼ " "                                 | 13.00   |
| 50 " " " 2 " 21½ " "                                  | 14.00   |

DESCRIPTION.—The wheel runs on a hard steel arbor. It is clamped to the arbor by a set screw against a split bushing. This does not bend the arbor as is the case where the set screw is against the arbor. On the crank pin is a friction roll, having a hardened steel bushing, which runs on a hard steel pin. The swinging treadle is the **easiest** motion, and effects the body **less** than the foot treadle.

SEND FOR NEW CATALOGUE.

Our No. 1½ Lathes are Fast Superseding all other Sizes.

Soft Lathes have Hard Mouths, Hard Wire Chucks and Hard Tail Stock Spindles.

ESTABLISHED 1854.

## FINE HAIR JEWELRY AND DEVICE WORK

Manufactured by CHAS. THEO. MENGE,

Nos. 32 and 34 John Street,

New York.

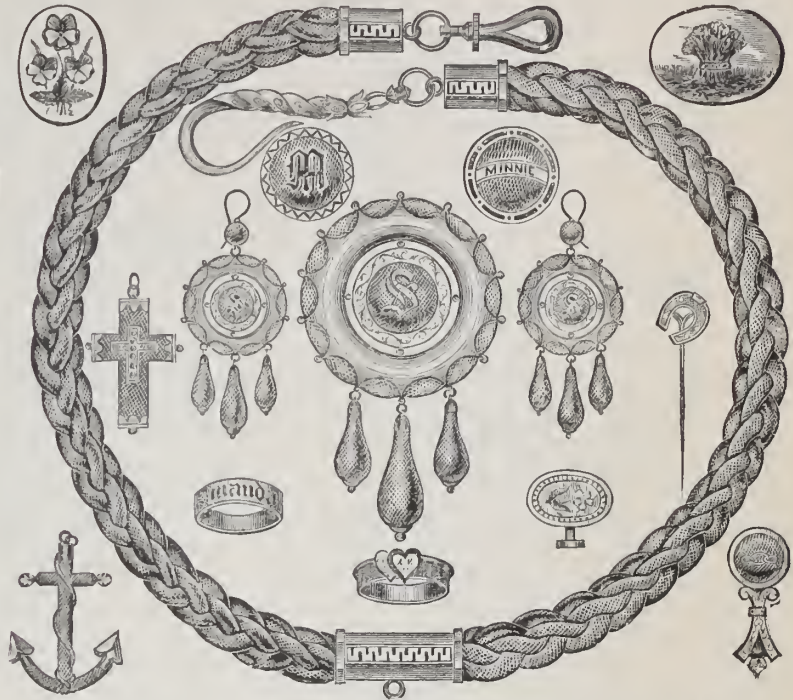

The attention of the Trade is invited to the above designs of **Hair Jewelry and Device Work**, which are a few of the many designs contained in my Pattern Book. I will send a large Pattern Book and Price List, containing all the latest designs on receipt of fifty cents, which will be refunded on first order. I also fill orders taken from any other book upon advice of name and number of design. All orders will receive prompt attention, and repairing of Fine Jewelry in all its branches. A large assortment of 14 k. Mountings always in stock. Satisfaction warranted as to quality and workmanship.

ESTABLISHED 1867.

## F. JEANDHEUR, Jr.,

125 FULTON STREET, N. Y.

## Gold and Silver Electro-Plating.

Mr. Jeandheur begs to notify the Trade that he has made more improvements with his new process of Electro-Plating Watches, Jewelry, Etc. By having introduced an Electro-Plating Machine instead of using the old method of Plating with Chemical Battery, he is able to plate with a far greater depth of gold than before, and for wear it is equal to rolled plate. The Trade can rely on this statement, as a trial will abundantly prove, and his well-earned reputation amongst the leading houses in the Trade will be sustained.

P. S.—He also begs to notify the Trade that he has no connection with any other house or person using his name, for the purpose of soliciting work.

PRICE LISTS SENT UPON APPLICATION.



**E. J. BOYCE,**

(Formerly Boyce &amp; Walnwright.)

→ **MANUFACTURING + JEWELER** ←*SOLID GOLD RINGS A SPECIALTY.*My **BAND RING** Specialties, for **PRICE, QUALITY** and **FINISH**, are not equaled by any in the Trade,**383 WASHINGTON ST.,  
BOSTON, MASS.****NEW ENGLAND MOROCCO CASE CO.,****MANUFACTURERS OF****JEWELRY and SILVERWARE****CASES,****OF EVERY DESCRIPTION.****NO. 220 CHAPEL STREET****NEW HAVEN, CONN.**

Solid Gold Rings a Specialty.

**WM. H. ELY,****SOLID GOLD RINGS,  
MANUFACTURER.**

Viz., Plain, Chased, Engraved, Enameled, Engine Turned, Shield and Scale. All qualities guaranteed. Orders Promptly Executed.

**58 Nassau Street, New York.****C. B. WILKINSON,**  
Manufacturing + Jeweler,**8 JOHN ST., N. Y.**Medals, Badges and  
Masonic Jewelry  
**A SPECIALTY.**Designs furnished free  
upon application.**H. WUNDOEHL,****GOLD & SILVER REFINER,**

Assayer and Sweep Smelter,

**21 JOHN ST.,**Bet. Broadway & Nassau St., **NEW YORK.**The highest price paid for Gold, Silver and Platinum.  
*Fine Gold, Silver and Copper always on hand.***JACOB STRAUSS,  
WATCHES & JEWELRY****AT WHOLESALE.**

REMOVED FROM

**18 TO 25 JOHN STREET, N. Y.****Rings and Rolled Plated Chains  
A SPECIALTY.****EXCELSIOR'S****Practical Treatise**

ON THE

**BALANCE SPRING**Including Making and Fitting Hair Springs,  
Regulating, etc.Also containing the Adjustment of Watches  
and Chronometers for Isochronism, Posi-  
tions, Heat and Cold and Rate.

PRICE, \$3.50.

**D. H. HOPKINSON,**

42 Nassau Street, New York.

**FINE WOOD PHOTO-ENGRAVING**  
SEND COPY FOR  
ESTIMATE.  
IT WILL PAY YOU  
**CROSSCUP & WEST.**  
702 CHESTNUT PHILADELPHIA**J. J. COHN,**

IMPORTER OF

→ **WHITBY JET,** ←

MANUFACTURER OF

**Gold & Rolled Plate Jewelry,**

Bracelets, Charms &amp; Locketts a Specialty.

**12 MAIDEN LANE, N. Y.**Goods Sent on Selection if Satisfactory References are  
Given.**WM. SCHWENCKE.****Manufacturing & Jobbing Jeweler,****43 MAIDEN LANE, N. Y.**Gives particular attention to the  
Repairing and Jobbing Department  
of the Jewelry Business. Prompt  
Attention, Moderate Prices and First-  
Class Workmanship Guaranteed to  
all. Country Orders Promptly attended to.**CHURCH'S PATENT IMPROVED  
DOUBLE SPEED INDICATOR**  
*Either Right or Left.***MONTGOMERY & CO.,***Importers of Stubs' Files, Tools & Steel,*

GROBET SWISS FILES. CHESTERMAN'S TAPES, EULES, &amp;c.

Horse Shoe Magnets. Hubert's French Emery Paper.

**WM. SMITH & SONS' CELEBRATED MUSIC WIRE.****105 Fulton Street, N. Y.****The Finest Line of High-Class English  
Watches in the U. S.****GEO. E. WILKINS,****SYRACUSE, N. Y.**

Agent for the Celebrated Watches of

**Chas. Frodsham & Co., London,****W. G. Schoof, London,****Karl Zimmerman, Liverpool.****Timing and Adjusting done for the Trade.****Correspondence Solicited from the Trade.****HIBBARD G. GILL,****GOLD AND SILVER****Watch Case Manufacturer,**

Dealer in Watches,

American Watch Movements Always on Hand.

**618 Chestnut Street,**

Fifth Floor.

PHILADELPHIA.

**HENRY TROEMNER,****710 Market Street,****PHILADELPHIA.**

Manufacturer of Fine Gold Scales,

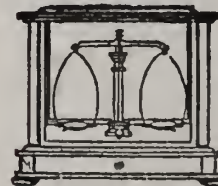
**DIAMOND SCALES,**Bullion Balances and  
Weights, in use at all the  
U. S. Mints and Assay  
Offices.

PRICED CATALOGUE ON APPLICATION.

**JNO. F. LUTHER,**

MANUFACTURER OF



Masonic Jewelry.

**79 Nassau Street, N. Y.**

Illustrated Catalogue sent on application.



ADOPTED AND IN USE BY  
**RANDEL, BAREMORE & BILLINGS,**  
 58 Nassau Street, N. Y.

THE TRADE SUPPLIED  
 Descriptive Circulars Furnished  
 on Application to  
**George W. Washburn, Patentee,**  
 58 Nassau St.,  
 NEW YORK.

**SAFETY**  
**EAR FASTENING,**  
*Pat. May 10, '81—Oct. 11, '81.*



**Jointed**  
**EAR WIRE**  
 AND  
**BAR BETWEEN CRAMPS**  
**OF SETTINGS.**  
*Patented March 1, 1881.*



**TELESCOPIC**  
**SAFETY PIN CATCH,**  
*Pat. Sep. 20, '81—Jan. 10, '82.*



**A. BANTLE,**

Gold, Silver and Platinum

Electro-Plating

FINE WORK A SPECIALTY.

130 Fulton Street,

89 Nassau Street,

ROOM 36,

NEW YORK.

WATCH CASE POLISHING.

**J. R. WOOD & SON,**

MANUFACTURERS OF



Solid Gold Rings

AND

Diamond, Stone and Children's Rings,

14 John Street, N. Y.

No Goods Stamped Different from Quality.

**Office of American Watch Co.**

R. E. ROBBINS, Treasurer.

WALTHAM, MASS., Apr. 20, 1883.

Mr. Chas. A. Winship, 200 Kinzie Street,  
 Chicago: Dear Sir—The skins you left with us  
 when here, are as good as any we ever had. As  
 soon as we are in need of more we will send you  
 an order. Yours Respectfully,

AMERICAN WATCH CO.,

H. BOND.

**ELK SKINS**

FOR

Polishing Watch Cases, Jewelry, Etc.  
 Samples and Prices sent on application.

CHAS. A. WINSHIP,

200 KINZIE STREET,

CHICAGO, ILL.

**DANGERFIELD'S**  
**IGNITING MATCH CASE**



**PAT 1879, '80 & '81**

**MATCH CASE OPEN**

T. S. and Foreign Pat.

**60 DAYS OFFER.**  
 No Gentleman or  
 Lady should ever be without  
 this celebrated MATCH CASE.  
 It is the ACME OF PERFEC-  
 TION. The fortunate possessor  
 has only to push the slide quick-  
 ly when a match presents it-  
 self lighted. Your clothes,  
 walls and furniture need no  
 longer be injured or defaced; no  
 vexations and dangers are overcome.  
 By Mail on receipt of price, Sold  
 Nickel Silver, 50 cents each;  
 Three, \$1.00; Six, \$1.65. A liberal discount  
 on larger quantities. Delivered free to any part of the  
 world (Duties and Express paid). Address F. S. DANGER-  
 FIELD, Sole Proprietor, Auburn, N. Y., U. S. A.

**John F. Stratton & Co.,**

No. 49 Maiden Lane, NEW YORK.

Importers and Wholesale Dealers in

**Violin Strings**

And all kinds of Musical Merchandise.

ALSO

Music Boxes, Musical Novelties, Ladies' Musical Work Boxes, Clove Boxes, Etc.

SEND FOR DESCRIPTIVE CATALOGUE.

**CLOCK MATERIAL FOR SALE.**—To close the business.—Alarm Dials, per doz., 20 c., Alarms, each, 25 c., Balls, 1 day, with screws, per doz., 25 c., Balls, 8 day, with screws, per doz., 35 c., Bells, wire, per doz., 35 c., Bells, iron, per doz., 10 c., Clicks and Rivets, per 100, 50 c., Click Springs, per 100, 20 c., Hands, assorted, per 100 prs., 65 c., Second Hands, per doz., 10 c., Hand Pins, per 100, 5 c., Hand Washers, per 100, 5 c., Keys, brass, per doz., 25 c., Keys, Iron, per doz., 15 c., Pendulum Rods, per 100, 75 c., Springs, 1 day, per 100, \$6.00, Springs, 8 day, per 100, \$12.00, Springs (a little rusty), 1 day, 3 day, 8 day, 6 c., Verges, assorted, per doz., 15 c. Terms Cash. Address B. W. Bowen, successor to U. S. Clock Co., Austin, Cook Co., Ills.



**HENRY LEFORT,**

Stem-Winding Watch Crown Manufacturer,

Crowns and Pushers in gold, all sizes, quality and color, made to order. Silver crowns and pushers always on hand.

60 Arlington Street,

Corner William Street,

NEWARK, N. J.

**Diamond Broker.**

R. J. Herbert, 26 Maiden Lane,

New York City,

Solicits Commissions,  
 Buying, Selling, Matching.

Prompt Attention.

References.



**BURGESS'**

Patent Portable Mechanical

**BLOW-PIPE,**

Supersedes the Forge, Bellows and Mouth Blow-pipe, by saving time, labor, and breath, giving the gentlest flame or hottest blast without exertion.

PRICE, - - \$10.00.

J. ELLIOTT SHAW,  
 154 South 4th Street, Philadelphia.

**H. WASELL,**

RUBBER STAMPS,

BRASS STAMPS,

Brushes, Inks, &c.

Stencil Plates,

Burning Brands,

SEALS & PRESSES,

No. 7 North William St.

First house South of East River Bridge, N. Y.

FINE STEEL STAMPS A SPECIALTY.

**P. JANDORF & BRO.,**

Watches and Jewelry,

196 BROADWAY,

Bet. John & Fulton Sts., NEW YORK.

We Publish No Price Lists.

**C. KNAPP,**

Manufacturer of

Superior Band and Children's

Stone & Fancy

**RINGS**

And Enameled Goods,

41 Maiden Lane,

NEW YORK.



**The American Improved Saw Frame,**

Patented Sept. 4th, 1883,

AND SUPERIOR IN EVERY RESPECT TO THE GERMAN.

It is made of the best steel (not case hardened as are the imported) and are constructed in such a way as to preclude the possibility of the saw slipping or the screws giving out; nor is it necessary for the workman to use pliers to tighten them. The opening and closing of the jaws are regulated by the screws.

This invention is highly spoken of by practical workmen, and is superseding all other styles of saw frames. Orders addressed to

F. W. GESSWEIN,

39 John Street,

NEW YORK.

ESTABLISHED 1873

**CHAS. P. HEROLD**

MANUFACTURER JEWELER

**DIAMONDS**

916 CHESTNUT STREET UP STAIRS

PHILADELPHIA



# Spencer Optical Manuf'g Co.

## NEW STYLES

FOR

## Fall & Holiday Trade.

NEW AND  
Novel Ideas.

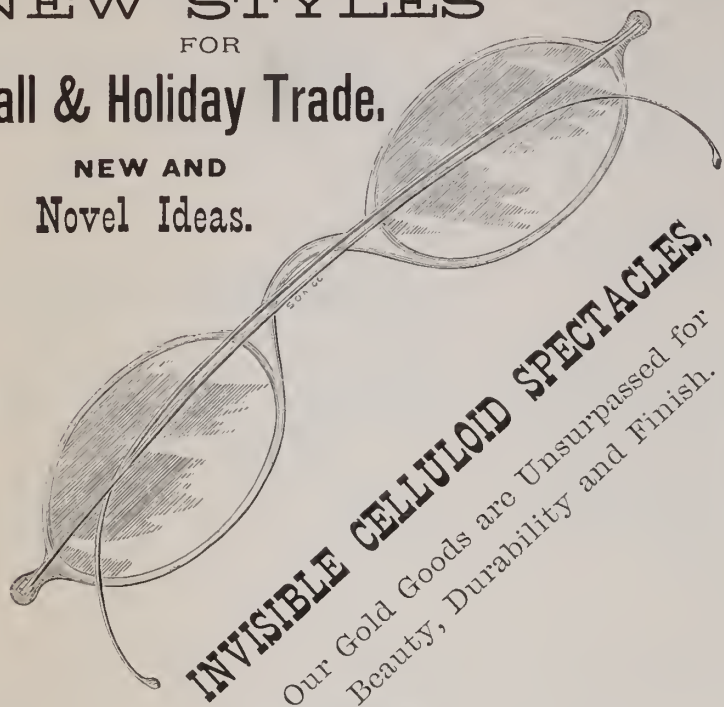

**INVISIBLE CELLULOID SPECTACLES,**  
Our Gold Goods are Unsurpassed for  
Beauty, Durability and Finish.

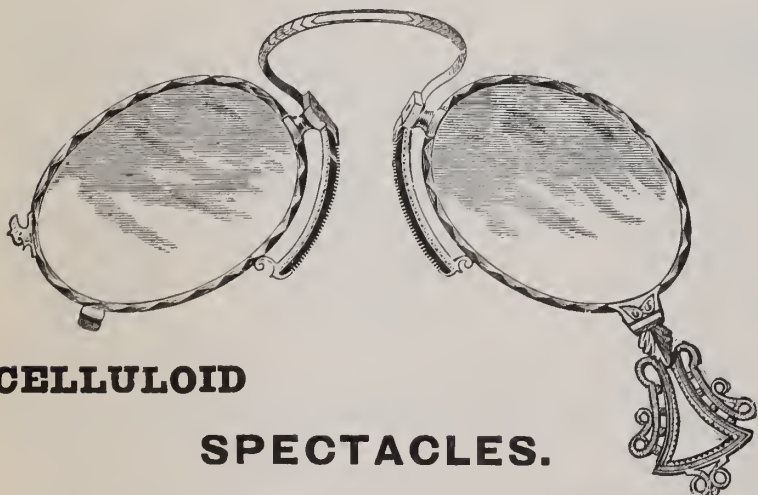

**CELLULOID**

**SPECTACLES.**

*The very latest improvement, made in Shell and Amber Color; it has substantial advantages over all others, being strong, light and not subject to rust.* THE

## CELLULOID EYE-GLASS

*has made its own reputation and is universally popular wherever introduced.*

**BEWARE OF IMITATIONS.**

*We make a specialty in special goods for the Fine Retail Trade, which gives customers handling our goods immense advantage over all others.*

**QUALITY OF GOLD GUARANTEED.**

We are importing large Invoices of Opera, Field and Marine Glasses in Staple and Novel Designs.

# Spencer Optical Manufacturing Co.,

13 MAIDEN LANE, NEW YORK.

Established 1853.

# L. H. KELLER & CO.

Successors to G. A. HUGUENIN,

IMPORTERS OF

WATCHMAKERS' and JEWELERS'

## TOOLS AND MATERIALS.

GENERAL AGENTS FOR

The Philadelphia Watch Company,

— AND —

American Watch Tool Co.,

MANUFACTURERS OF

## THE WHITCOMB LATHE.

SOLE AGENTS IN THE UNITED STATES FOR THE SALE OF

**LUTZ'S**

## CELEBRATED ROLL HARDENED HAIR SPRINGS, MOEBIUS OIL

For Chronometers, Watches, Clocks, Telegraph Instruments and all other delicate machinery. Made from Pure Refined Neatsfoot Oil, and Warranted to Excel anything in the market as a Lubricator. **SAMPLES GRATIS.**

**OUR OWN GRADUATED**

AND JURGENSEN RECOILING MAINSPRINGS, pronounced by all experts Superior to all. Sold in Separate Strengths or Force.

Extra Fine Pinions cut from Solid Steel Wire. Gauged Hole Jewels of First-class Workmanship. A Full Line of Materials, for the PATEK, PHILIPPE & CO. GENEVA WATCHES, and all other Celebrated Makers.

## THE BOLEY LATHES AND TOOLS,

Celebrated for their Practical, Substantial and Workmanlike Construction, Superior Design and Finish.

*Our aim is to furnish nothing but First-class Serviceable Goods, especially manufactured for the Consumer, and not solely for the Market, like the cheap trash advertised in highly illustrated catalogues with which the country is flooded.*

**TREATISE ON MODERN HOROLOGY IN THEORY AND PRACTICE.** By M. CLAUDIUS SAUNIER, Ex-Director of the School of Horology at Macon, France; Knight of the Legion of Honor, etc.; Hon. Sec. to the Paris Society of Horologists. Translated from the French by JULIEN TRIPPLIN, Besançon Watch Manufacturer, and EDWARD RIGG, M. A., Assayer in the Royal Mint, London.

This Work comprises 832 large octavo pages, with 78 wood cuts and 21 colored double-page copper-plate engravings. Bound in half calf, with an appropriate and handsome ornament in gold on front cover.

**Price, \$15.00.**

**THE WATCHMAKER'S HAND BOOK.** By the same author and translators. Intended as a companion to the Treatise. Bound in cloth.

**PRICE, \$4.00.**

## 64 Nassau Street,

NEAR MAIDEN LANE,

## NEW YORK.

L. H. KELLER,  
EDWARD HUNZIKER, }  
F. J. BOESSE.

We do not publish Price Lists.



**SPECIAL NOTICES.**

**Notices under this heading, not to exceed Six Lines, \$1.00 each insertion.**

**THE JEWELRY STORE** cor. Main and Market streets, Johnstown, N. Y., for sale. Address J. Y. Harling, Johnstown, N. Y.

**A GOOD WATCHMAKER** is open to an engagement. Long experience on fine watches. Address C., care Jewelers' Circular.

**WANTED IMMEDIATELY**—A reliable watchmaker and engraver. One who can come well recommended. Good wages to the right man. J. Kopelowich & Co., Johnstown, N. Y.

**WANTED**—A watchmaker. Must give good references as to honesty, etc. State age, experience and salary wanted. A permanent situation. Address Chas. S. Stiff, Little Rock, Ark.

**FOR SALE**—Two engine turning tools, one straight line and one turning lathe with oval ring, both in perfect running order. Address L'Epitapier, Watchmaker, 170 State street, Room 24, Chicago, Ills.

**A SITUATION** by a young man in the jewelry business to complete his trade. Has been in the business about 3 years. Best reference given. Address C. B. Abercrombie, Lock Box 54, Aledo, Mercer Co., Illinois.

**WANTED**—Situation by the 1st of November by a young man with no bad habits, 25 years of age, 2 years' experience at the trade. Those who can give good wages and a steady job please address Help, this office.

**WANTED IMMEDIATELY**—A young man to do jewelry jobbing and clock work. A good situation to the right man. Will have benefit of first-class instructions on watches. Address Geo. W. Ludwig, Chambersburg, Pa.

**WANTED**—On or about the 1st of May, a watchmaker and engraver. One who can come well recommended. A permanent situation to the right man. Address Albert G. Spingler, P. O. Box 551, Newport, R. I., stating wages.

**MOSELEY & CO.**, Elgin, Ill., manufacturers of the "Moseley" Lathe, with full line of fixtures and attachments. Designed especially for the watchmaker and repairer. Combining accuracy, durability, convenience and style.

**WANTED**—By a young man with four and a half years' experience at the trade, a situation with good watchmaker to improve. Can speak German and English and furnish good references. Address Box 294, Vicksburg, Miss.

**FOR SALE**—Price \$30, cost \$75, one combination jeweling and universal lathe. Also one lathe for jeweler's heavy work, with bed 3 foot long, has slide and T-rests, etc., price \$40, cost \$65. Address F. M. Herron, Indianapolis, Ind.

**SITUATION WANTED** by a watchmaker qualified to do finest of work. Can also engrave. Fifteen years' experience. Excellent line of tools. A permanent and strictly first-class situation only is desired. Address J. J. Curtis, care Jewelers' Circular.

**ADOPTED** BY THE Hampden Watch Company, Hubbard's Hair Spring Collet Remover. Every watchmaker and repairer must have one. Price, 25 cts. For sale by all leading material dealers and the inventor, F. A. Hubbard, Brattleboro, Vt., U. S. A.

**WANTED**—Situation by an unmarried man 30 years of age. Three years' experience. Is familiar with watch, clock and jewelry repairing. Has a good set of tools, including a Moseley lathe. Good reference from present employer. Address F. W., Lock Box 27, Dundee, N. Y.

**FOR SALE**—A well-established jewelry business in a town of 3,000 inhabitants situated in a good, rich farming country. Stock and fixtures about \$3,000; would be reduced to any amount. No competition. Good reasons for selling. Address F. C. McKinney, Nevada, Wyandot Co., Ohio.

**SEND FOR** "How to Repair Musical Boxes," published by us, and containing complete practical instructions for the repairing of musical boxes, with illustrations; also illustrated catalogue of material. Price, 25 cents. 2 and 5 cent postage stamps accepted. Jacot & Son, 49 Maiden Lane, N. Y.

**WANTED**—An active, reliable young man, a good workman, to take charge of a branch store in one of the best towns in the slate regions of Pennsylvania. To a suitable party an interest will be given in the business. One who can speak German preferred. Address E. S., care Jewelers' Circular.

**GEORGE E. WILKINS**, manufacturer and importer of cutters for watchmakers' use, stem-winding cutters of all the different forms, rounding up cutters of the finest quality, also ratchet cutters. A large stock of second hand and new marine chronometers. No. 21 South Salina street, Syracuse, N. Y.

**JEWELRY BUSINESS**, without competition, for sale, in a town of about 50 business places. Established 18 years. Watch work and jobbing amounts to about \$1,000 per year. Price, for stock and fixtures, \$1,500 cash. Apply or address Cross & Beguelin, 21 Maiden Lane, N. Y., or M. B. W. Wheeler, Westport, Conn.

**ELECTRO GILDER**, plater, nickeler, etc., thoroughly competent, gilds like colored gold. Solid durable red gilding, regilding colored gold work, fine art gilding. Specialty, jewelry and steel work. Long experience in Europe and America. First-class references. Will be open for re-engagement shortly. Address "Electro," care Jewelers' Circular.

**WANTED**—Situation as salesman by a man of fourteen years' experience in the retail watch and jewelry business. Is a practical workman, a good salesman and understands the manufacturing of watches and jewelry thoroughly. Has a knowledge of tools and materials. Satisfactory references furnished. Address Salesman, care C. E. Allen & Co., Lancaster, N. H.

**WANTED**—Back numbers of "The Jewelers' Circular," as follows: The entire volumes of 1869 and 1872. February, March, April and May, 1870. August, September, October, November, December and January, 1871. August, 1873. January, March, April, May and September, 1874, and November, 1875. Parties having any of these copies address, stating price, K. M. C., care Jewelers' Circular.

**JEWELRY STORE FOR SALE**—An old-established jewelry business in a city of 20,000 inhabitants in central Pennsylvania doing a profitable business. Present owner desires to go south to a warmer climate. Stock, cases and fixtures mainly new and in good condition. The purchaser can buy all or a part of the stock, or the fixtures and lease only. Address Mainspring, care Jewelers' Circular.

**TO THE TRADE**—I make a specialty of supplying the Trade with stones for jobbing purposes. Parties having jewelry out of which the stones have been lost, sending their orders by mail or express, will have them promptly attended to. A large stock of cameos, pearls, turquoise, garnets, amethysts, doublets, foil backs, white and colored imitation stones on hand. All kinds of setting done for the Trade. W. Archibald, 73 Nassau street, New York.

**FOR SALE**—The stock, fixtures, tools, etc., valued about \$5,000, of the late O. L. Ballard, is the leading jewelry store in a town of 5,000 inhabitants. Business established 25 years. Very little competition and no first-class workman in town. The business has been carried on successfully since death of deceased and will be continued by estate until a sale is made. Prefer to sell at once. In case parties desiring to purchase wish the stock reduced, the estate will continue until after the holidays. Address Estate of O. L. Ballard, Box 431, Malone, Franklin Co., N. Y.

**FOR SALE**—A well-established jewelry business in Norfolk, Va. This is in every respect a first-class business. Sales are large and repairing for two or three workmen, good prices. It is in the finest building and best location in the city. Norfolk and surroundings has a population of at least 50,000 inhabitants, and is to-day the most flourishing city in the south. Can show as good results from amount of capital required (about \$10,000) as any jewelry business in this country. Ill health and change of business a necessity. Address H. M. Gordon, 206 Main street, Norfolk, Va.

**SITUATION WANTED** by a skilled Swiss watchmaker, jeweler and engraver who has held a prominent position in an American watch factory, thoroughly familiar with making and repairing all sorts of timepieces, especially accustomed to the finer grades of watches, chronometers and repeaters and complicated movements. Would prefer a wholesale house or a first-class retail establishment, or even buy an interest in a substantial watch and jewelry business and at the same time work at the bench. Has all necessary tools. Will furnish references as to character and ability. Address O. P. B., care Jewelers' Circular.

**BUYERS' DIRECTORY.****NEW YORK.****Assayers and Sweep Smelters.**

**Wundoehl, H.**—Gold and Silver Refiner, Assayer and Sweep Smelter. 21 John Street, N. Y.

**Badges and Medals.**

**Stockwell & Newman**—19 John Street. Manufacturers of Badges, Medals and Presentation Pieces in Gold and Silver. Also Jewelry and Mounters of Diamonds. Designs supplied.

**Wilkinson, C. B.**—Manufacturing Jeweler, 8 John Street, N. Y. Medals, Badges and Masonic Jewelry a Specialty. Designs furnished free upon application.

**Band Rings.**

**Knapp, Charles**, 41 Maiden Lane, N. Y. Specialty: Superior Band Rings, also Ring Shanks & Heads for Seal and Diamond Rings.

**Black Onyx Jewelry.**

**Cox & Sedgwick**—Manufacturers of Black Onyx Jewelry, No. 26 John St. New York.

**Lawson, Samuel**—No. 18 John Street. Manufacturer of Black Onyx Jewelry. Coral repaired for the trade. Goods sent on approval to responsible dealers.

**Woglom & Miller**—Manufacturers of (exclusively) Black Onyx Jewelry, 32 & 34 John St., N. Y.

**Blue Enameled Locketts.**

**Bissinger, Philip & Co.**—Importers of Diamonds, Pearls and Precious Stones. Agent for the Bohemian Garnet Goods. Blue Enameled Locketts. 22 John St., N. Y.

**Hess & Schliesser**—Importers of Diamonds, Fine Jewelry and Novelties in French Goods. Specialties: Gold and Blue Enameled Locketts, Charms and Crosses. 25 Maiden Lane.

**Bohemian Garnet Jewelry.**

**Bissinger, Philip & Co.**—Importers of Diamonds, Pearls and Precious Stones. Sole Agent for the Bohemian Garnet Jewelry. Blue Enameled Locketts. 22 John St.

**Boxes, Wood Mailing and Nested.**

**Maine Manufacturing Co.**—Successors to Swift M'g Co., makers of Wood Mailing and Nested Boxes for Mailing and Express purposes. J. Spencer Taylor, Agent, 18 Courtlandt St., N. Y.

**Wiesbauer, J.**—Manufacturer of the Sliding Cover Wood Mailing Boxes. All Sizes Made to Order. Buffalo, N. Y.

**Clock Companies.**

**Ansonia Clock Co.**—Manufacturers of every description of Clocks. 11 to 21 Cliff street, New York.

**Kroeber, F.**—Manufacturer and Dealer in American and French Clocks, No. 14 Cortlandt Street.

**New Haven Clock Co.**—16 and 18 Park Place, N. Y.

**Seth Thomas Clock Co.**—20 Murray Street, N. Y.

**Waterbury Clock Co.**—M. Bailey, Treasurer, Manufs and Jobbers, No. 4 Cortlandt St., N. Y., and No. 197 State Street, Chicago.

**Wm. L. Gilbert Clock Co.**—No. 6 Murray Street, Manufacturers of Clocks. Factories, Winsted, Conn.

**Yale Clock Co.**—Manufacturers of Novelties in Clocks, 52 Maiden Lane, N. Y.

**Corals and Coral Jewelry.**

**Cuppia, L. A.**—Importer of Coral and Silver Filigree Jewelry, 19 Union Square, N. Y.

**Cameo Cutters, Etc.**

**Peiter, Theodore**—Cameo and Intaglio Engraver. Patentee of the Cameo-Intaglio. No. 2 Bond Street, near Broadway, Room 4 New York.

**Charms & Gold Watch Keys.**

**Rupp & Held**—Manufacturing Jewelers, Charms and Gold Watch Keys, with French and English Ratchets, a specialty. 15 John St., N. Y.

**Crucibles.**

**Berge, J. & H.**—Established 1850, Manufacturers and Importers of Sand Crucibles, Covers, Chemical Porcelain, Glassware, and Jewelers' and Assayers' Supplies, 95 John Street, N. Y.

**Berge, J. & Son**—Importers of Sand Crucibles and Covers, Jewelers' Tools and Materials. Manufacturers of Berge's Improved Assay and Enamel Furnace, Assay and Enamel Muffles, &c. 32 and 34 John Street, N. Y.

**Cutlery.**

**Harrison Bros. & Howson**—Manufacturers of Fine Ivory and Pearl Table and Pocket Cutlery, Carvers in Cases; Nutpicks, Nutcracks and goods suitable for the jewelry trade. 126 Chambers Street. W. C. Burkinshaw, Sole Agent.

**Diamond Brokers.**

**Anderson, Otis**—Diamond Merchant and Broker, always ready to pay cash for bargains in Diamonds and Precious Stones, 4 & 6 John Street, N. Y.

**Bernhardt, Richard**—Diamond Broker and Importer, 65 Nassau Street (Room 6), N. Y. Paris, 20, rue des Petites-Écuries.

**Friend S. & Son**—Brokers and dealers in Diamonds 33 John Street, cor. Nassau St. New York.

**Herbert, R. J.**—Diamond Broker and Dealer. 26 Maiden Lane.

**Diamond Importers.**

**Bissinger, Philip & Co.**—Importers of Diamonds, Pearls and Precious Stones. Agent for the Bohemian Garnet Goods. Blue Enameled Locketts. No. 22 John St., N. Y.



**Bruhl, D. & M.**—Established in 1848. 14 Maiden Lane, N. Y.; 111 Broad Street, Providence, R. I.; 14 Rue Bleue, Paris.

**Brunswick, S. & Co.**—Importers of Diamonds. 17 Maiden Lane, New York. Paris, Rue Lafayette. Amsterdam, Damsstraat.

**Citroen, L. B., & Co.**—Diamonds. 21 John St., N. Y. Cutting Works, 57 & 61 Rapenburgerstraat, Amsterdam. House in Paris, 44 Rue Laffitte.

**Engelmann, M. & Co.**—Importers of Diamonds, Pearls and Precious Stones. Specialties in Fine Colored Stones. 192 Broadway and 1 and 3 John Street, N. Y. Paris, 1 Boulevard St. Denis.

**Faulkenau, Oppenheimer & Co.**—Manufacturers. Diamonds and Diamond Jewelry. 40 Maiden Lane, N. Y.

**Fera, Henry**—Importer of Diamonds, and Manufacturer of Fine Diamond Jewelry. 4 & 6 John Street, New York. Amsterdam, Holland, 23 Loojersgracht.

**Fox, M. & Co.**—Importers of Diamonds, Rubies, Sapphires and Fancy Gems. No. 1 Maiden Lane, New York.

**Hedges, Wm. S. & Co.**—Importers of Diamonds, No. 170 Broadway, corner Maiden Lane.

**Kuhn, Doerflinger, & Co.**—Manufacturing Jewelers and Importers of Diamonds, 18 John Street, New York.

**Leberthon, L. M.**—Importer of Diamonds and Manufacturer of Fine Jewelry. 14 John Street, N. Y.

**Neresheimer, E. Aug. & Co.**—Importer of Diamonds. No. 21 Maiden Lane, New York.

**Randel, Baremore & Billings**—Importers of Diamonds, corner Maiden Lane and Nassau St.

**Saril, S.**—Importer of Diamonds, 182 Broadway, N. Y. Branch of Vve. H. A. Marchand & Frères, 47 Rue Le Peletier, Paris.

**Saunders & Ives.**—Importers of Diamonds and other Precious Stones. No. 26 Maiden Lane.

**Smith, Alfred H. & Co.**—Importers of Diamonds, No. 182 Broadway.

**Taylor & Brother.**—Importers of Diamonds and Diamond Jewelry. 676 Broadway.

**Wickham, D. H. & Co.**—Importer of Diamonds. No. 31 Holborn Viaduct, London, 24 Maiden Lane, New York.

**Wolff, G. A.**—Importer of Diamonds, Rubies, Sapphires, Pearls, and other Precious Stones, 65 Maiden Lane, New York. 12 Rue de Chateaudun, Paris.

#### Diamond Jewelry.

**Bornemann, Louis.**—Importer of Diamonds and Manufacturer of Rich Diamond Jewelry, 19 John Street, New York.

**Chalumeau, D.**—Diamond Jeweler and Manufacturer of Mountings. Novelties and Artistic Jewelry. No. 3 Maiden Lane, New York.

**Goldsmith, Ingomar & Co.**—Manufacturers of Diamond Mountings and Diamond Jewelry, 61 Nassau Street, New York.

**Hartje, G. & F.**—Manufacturers of Diamond and Fine Jewelry, 39 Union Square, N. Y.

**Haug & Luthy**—Manufacturers of Fine Diamond Mountings, etc. No. 130 Fulton St., N. Y.

**Heller & Bardel.**—Manufacturers of Diamond and Pearl Jewelry, and Dealers in Diamonds, Pearls, &c. 13 John Street.

**Jeanne Brothers.**—Manufacturers of Diamond Mountings & Rich Jewelry. 1 Maiden Lane.

**Lacroix & Verpillier.**—Manufacturers of Fine Gold Jewelry. Diamonds a specialty. 173 Broadway, N. Y.

**Rosswog, C. & Son**—Manufacturers of Rich Diamond Goods. Nos. 5 and 7 Maiden Lane, N. Y.

**Scheer, William**—Diamond Jeweler and Manufacturer of Mountings, Novelties in Artistic Jewelry, 859 Broadway, near 17th St., N. Y.

**Schilling & Nissen**—Dealers in Diamonds and Diamond Jewelry. No. 51 Nassau Street, New York, near Maiden Lane.

**Voelker, C. T.**—Manufacturer of 18-k. Diamond Mountings, Diamond Jewelry and Roller Chain Bracelets. 189 Broadway, New York.

**Waterman & Lehmann.**—Manufacturing Jewelers and Dealers in Diamonds. Diamond Work, and Fine fancy Rings a specialty, any piece of single work made to order. 37 Maiden Lane, N. Y.

#### Diamond and Pearl Setter, &c.

**Danziger, H.**—Diamond and Pearl Setter, 116 Nassau Street, (Second Floor,) Room 6, N. Y.

#### Diamond Cutters.

**Levy, Herman.**—Importer, Cutter and Polisher of Diamonds. 105 Fulton Street, New York.

#### Dials, &c.

**Farnsworth, C. E. & Co.**—Successors to Jno. T. Gold, Manufacturers and Jobbers in Fine Watch Dials. 81 Nassau St., N. Y.

**New York Dial Co.**—Manufacturers of Fine Watch Dials. Henry Abbott, Agent, No. 7 Maiden Lane, N. Y.

#### Enameled Clock Dials and Figures.

**Caeser Bros.**—Manufacturers of Enameled Clock Dials, also letters and numbers for signs. 230 and 232 East 25th Street, New York.

#### Enamelers, Etc.

**Nutt, J. D.**—Enameler on Gold, Silver, and Copper. Linen finished Buttons and Studs. Enameling in colors. 32 and 34 John Street, New York.

**Orr, J. C.**—Enameler on Fine Jewelry. Enameled in Colors. Linen Finished Buttons and Studs. Band Bracelets. No. 75 Nassau Street, N. Y.

**Orr, William N.**—Enameler on Fine Jewelry. Masonic Jewels and Badges a specialty. Linen Finished Work. 79 Nassau Street, Room 18, New York.

#### Electroplaters, &c.

**Jeandheur, F. & Son,**—Gold and Silver Electro Platers & Fire Gilders, coloring Etruscan and Gold Jewelry a specialty. 125 Fulton St.

#### Engravers—Stone Seal, Etc.

**Fackner, Edward**—Carver, Engraver and Chaser on Jewelry and Pencil Cases, lettering, &c., 19 John Street.

**Holland & Gosling**—Stone Seal Engravers. Precious Stones inlaid and encrusted with Diamonds. No. 176 Broadway, New York, (fifth floor per elevator). Cameos cut and repaired.

**Knapp, Chas.** Engraver, Die Sinker & Stamper for Jewelry purposes. Ring Shanks & superior Band rings, 41 Maiden Lane, N. Y.

**Park, Wm.**—The Stone Seal Engraver. Arms, Crests, Monograms, etc., engraved on precious stones, 26 John Street, New York.

**Weston, James F.**—Stone Seal Engraver and in-cruster of Precious Stones. Coats of Arms, Masonic, Odd Fellows, and other devices engraved. 32 John Street.

#### Fancy Goods, Clocks, Bronzes, Etc.

**Baker, Pratt & Co.**—Importers and Dealers in Jewelers' Fancy Goods. 19 Bond Street, N. Y.

**Bawo & Dotter.**—Importers and Manufacturers. Potteries, Faïences, Bisque Figures, French Clocks, Fancy Goods, etc. 30 & 32 Barclay Street, N. Y.

**Hinrichs, C. F. A.**—Importer of Fancy Goods, Glassware, China, Clocks, Bronzes, etc. 31 Park Place.

**Le Boutillier & Co.**—Importers of Fancy Goods, Clocks, Bronzes, &c., 3 Union Square.

**Straus, L. & Sons**—Importers of Potteries, Faïences, Bisque Figures, and Rich Fancy Goods especially adapted for the Jewelry Trade. 40, 42 and 44 Warren Street, New York.

**Taylor & Bro.**—Importers of French Clocks, Bronzes, etc. 676 Broadway, N. Y.

**Trost, Herman & Co.**—Importers of Potteries, Faïences, Plaques, Bisque Figures, Fancy Goods, etc. 48, 50, 52 and 54 Murray St., N. Y.

**Vagt, Chas. & Co.**—Importers of Vases, Plaques, Paintings, French Faïences, etc., 60 & 62 Murray Street, N. Y.

**Wilson's Sons, Jno.**—Importers of French Clocks, Bronzes, Fancy Goods and Jewelers' Holiday Goods, 31 Maiden Lane, N. Y.

**Young, J. M. & Co.**—Importers of Fine Parian, Lava, and Bisque Statuary, Bohemian, German and English Fancy Goods, 37 & 39 Murray St., New York.

#### Gold and Silver Cane Heads.

**Simons, Bro. & Co.**—Manufacturers of Gold Headed Canes. 611 and 613 Sansom street, Philadelphia.

#### Gold and Silver Plating, Etc.

**Bantle, A.**—Gold, Silver and Electro-Plating, 130 Fulton and 89 Nassau Streets, cor. Fulton Street, (Room 36,) N. Y. Watch Case Polishing.

#### Gold Chains, Etc.

**Beck, J. & Son,** Manufacturers of Fine Gold Chains and Chain Bracelets, 10 Liberty Place, near Maiden Lane, N. Y.

**Carter, Sloan & Co.**—Manufacturers of Fine Gold Chain, 15 Maiden Lane, New York.

**Dorrance, Edge & Co.**—Manufacturers of the Celebrated Woven Fabric Gold Chain, No. 15 John Street.

**Kaufmann Bros.**—Manufacturers of Gold Chains, and Chain Bracelets, 26 John Street; Factory, 331 and 333 Bowery, N. Y.

**Kohn, Alois & Co.**—Manufacturers of Gold Chains. 9 Maiden Lane, N. Y.

**Nordt, Charles.**—Successor to Nordt & Schlag, manufacturer of Gold Chains and Chain Bracelets. Jobbing and Refilling Old Chains promptly attended to. No. 17 Maiden Lane, N. Y.

**Saxton, Smith & Co.**—Manufacturers of Fine Gold Chain, No. 14 John Street, N. Y.

**Schlag, Chas.**—Late Nordt & Schlag, Manufacturer of Gold Chains, Chain Bracelets, and Fine Jewelry, 177 Broadway, N. Y.

**Smith, W. & Co.**—Manufacturers of Gold and Silver Chains, Jewelry, etc. No. 25 Maiden Lane, N. Y.

#### Gold Pens, Etc.

**Aikin, Lambert & Co.**—Manufacturers of Choice Gold Pens, Cases, Holders, Toothpicks, etc., 23 Maiden Lane, N. Y.

**Faber, Eberhard,**—Manufacturer of 16-karat Gold Pens and Pencil Cases, Nos. 718 and 720 Broadway, N. Y.

**Fairchild, Leroy W.**—Manufacturer of Gold Pens, Pencil Cases, Tooth Picks and Novelties in Charms. No. 18 John St., N. Y.

**Gerow, Joseph U.**—Manufacturer of Pencil and Pen Cases for the Jobbing Trade only. No. 44 State Street, (near South Ferry,) Brooklyn, N. Y.

**Johnson, E. S. & Co.**—Manufacturers of Gold Pens, Pen Holders and Pencils. Cor. Maiden Lane and Nassau Street, New York.

**Ray Manufacturing Co.**—Gold Pens Manufactured and Stamped for the Trade. Also Pencil and Pen Cases, Tooth-picks, etc. Office, Sales-rooms and Factories, 94 and 96 Nassau street, 129, 131 and 133 Fulton street.

**Smith, H. M. & Co.**—Manufacturers of Gold Pens and Holders, Tooth Picks, Pencils, etc. Sole Manufacturers of Sprague's Patent Gold Fountain Pen. Importers of Nickel and Silver Watches. 173 Broadway, New York.

#### Gold Rings.

**Barnet Bros. & Powell**—Manufacturers of Stone and Seal Rings, 15 John Street, New York. Factory, Newark, N. J.

**Bowden, J. B. & Co.**—Manufacturing Jeweler.—Solid Gold Rings a specialty, 1 Maiden Lane.

**Cable, Geo. W.**—Manufacturing Jeweler. Plain and Band Rings a Specialty. No. 104 Fulton Street, N. Y.

**Ely, W. H.**—Manufacturer of Solid Gold Rings of every description. No. 58 Nassau Street.

**Henrich, R.**—No. 35 Maiden Lane, Manufacturer of Gold Rings; also Patentee and Manufacturer of the Celebrated Self-Sizing Ring.

**Hutchison & Huestis**—Makers of Solid Gold Rings. Quality guaranteed. For the Jobbing Trade only. 196 Broadway, N. Y.



**Kroll, H.**—Manufacturing Jeweler. 78 Nassau Street, New York. Specialty: Solid Gold Stone Rings. All kinds of Fine Jewelry made to order, also Repairing for the Trade.

**Ostby & Barton**—Manufacturers of Plain and Engraved Solid Gold Band Rings. Office, 176 Broadway, N. Y. Factory, 80 Clifford Street, Providence, R. I.

**Peckham, Wm. H.**—Manufacturers of Solid Gold Seamless Rings, and Fancy Embossed Rings, Patent Spectacles, Jewelry, etc. No. 4 Liberty Place N. Y.

**Radler, K.**—Manufacturing Jeweler. Gold Rings and Locketts a specialty. No. 39 Maiden Lane, New York.

**Sauter, L.**—No. 1 Maiden Lane, New York, Manufacturer of Stone Rings of every description, as Diamond, Cameo, Onyx Turquoise, etc., Scarf Pins, Scarf Rings, Studs and Buttons.

**Shafer & Douglass.**—Manufacturers of all kinds of Seal, Stone, Turquoise, and fancy rings. No. 7 Maiden Lane, N. Y.

**Sinnock & Sherrill.**—Manufacturers of Stone Rings. No. 3 Maiden Lane, N. Y.

**Thuerner & Church**—Manufacturers of Fine Gold Rings. No. 9 Maiden Lane, N. Y.

**Wood, J. R.**—Gold Ring Manufacturer of 14 John Street, has assumed his son into partnership. The firm will now be J. R. Wood & Son.

#### Hair Jewelry.

**Moutoux, Wm. E. & Co.**—Manufacturers of Fine Hair Mountings in Gold. Grand catalogues for the trade. 81 Nassau St., Rooms 1 and 2. Finest work and lowest prices.

**Sauter, L.**—Manufacturer of Fine Gold and Hair Jewelry and Device Work. Pattern Book sent on application. No. 1 Maiden Lane, N. Y.

**Schwencke O.**—Manufacturer of Fine Hair Jewelry Orders from the country promptly attended to. No. 43 Maiden Lane.

#### Jewelry Cases, Fancy Boxes, Etc.

**American Morocco Case Co.**—7 and 9 Bond St., N. Y., make a specialty of Rich Jewelry and Silverware Cases for the fine Retail Trade. Also Improved Trays for Watches, Rings, etc.

**Bleyle, A.**—Manufacturer of Jewelry and Silverware Boxes, Jewelers' Traveling Cases, etc. Trays for Show Cases and Trunks, Ladies' and Gent's Jewel, Glove and Handkerchief Boxes, &c., &c., 80 Nassau street, N. Y.

**Braun, Chr. E.**—Manufacturer of Fine Jewelry Boxes and Trays for Show Cases and Trunks. No. 62 Chatham Street, New York. Trays for Show Cases and Trunks a Specialty.

**Bricka, C. A.**—Manufacturer of Morocco Cases for Cutlery, Silverware, Jewelry, etc. Sample Cards and Rolls. Cases in Rosewood, Black Walnut, etc. 52 Nassau Street, New York.

**Dennison Mfg Co.**—Manufacturers of Morocco, Plush and Velvet Jewelry and Silverware cases. New York, Boston, Philadelphia, Chicago, Cincinnati and St. Louis.

**Ettlinger, L. & Sons.**—Manufacturers of Fine Cases for Jewelry, Watches and Silverware. Trays for Travelers and Show Cases. Cases to Order a Specialty. No. 80 Nassau St., N. Y.

**Haensler, Chas. C.**—Manufacturer of Fine Morocco Cases for Jewelry and Silverware. Toilet Boxes, etc. Trays for Show Cases and Windows. 14 John Street, New York.

**Jackson, S. C.**, 180 Broadway, N. Y., Manufacturer of Fine Cases for Jewelry, Silverware, &c.

**Kohn, Solomon & Co.**—Manufacturers of Fine Morocco Cases for Jewelry, Watches, etc. 43 Maiden Lane, New York.

**Lauten, Edw. A. & Co.**—No. 4 Great Jones St., Manufacturers of Fine Velvet, Brocade, Plush and Morocco Boxes, Patent Ring, Ear Ring and Gent's Scarf Pin Trays, Patent Watch and Bracelet Blocks, Window Decorations, etc.

**Loehr & Koerner**—Manufacturers of Morocco, Velvet, Satin, Jewelry, Watches and Silverware Cases, Jewel, Work Boxes, etc., Fancy Trays and Store Fittings to order. 96 Liberty St.

**Metropolitan Fancy Box and Leather Goods Manufactory**—Makers of Plush, Velvet, Satin and Leather Cases for Watches, Jewelry, Silverware, etc. 75 and 77 Nassau Street, N. Y.

**New England Morocco Case Co.**—Makers of Jewelry and Silverware Cases of every description. 220 Chapel Street, New Haven, Conn.

**New York Morocco Case Co.**—Cases for Jewelry, Watches, Silverware. Boxes and Trays for Jewelers' Travelers. Show Cases and Window Fittings. No. 69 Nassau Street, New York.

**Schien, Charles E.**—Manufacturer of Cases for Jewelry and Silverware, No. 85 Nassau St., N. Y. Show Case Trays, etc., at short notice.

**Schwarz, N.**—Manufacturer of fine Cases for Jewelry and Silverware, 866 Broadway, near 17th street, N. Y.

**Steinle, E.**—Manufacturer of Cases for Jewelry of all kinds. Also Cases for Mathematical and Surgical Instruments and for Trays for Travelers' Trunks, etc. 66 Nassau Street, N. Y.

**Welch & Miller**—169 Broadway. Manufacturers of fine Morocco, Velvet, Russia, Brocade and Plush Jewelry Cases. Trays of every description; Jeweler's Cotton and Twine.

**Wiggers & Froelick**—No. 60 Nassau street—Manufacturers of Cases for Jewelry, &c., of every description. Trays for Show-cases, Stands for Show-windows, etc.

#### Jewelers' Findings.

**Dennison Mfg Co.**—Paper Jewelry Boxes, cards, tags, pink and white cotton, etc. etc. New York, Boston, Chicago, Cincinnati, Philadelphia, St. Louis.

**Ettlinger, L. & Sons.**—Manufacturers of Jewelers' Paper Boxes and Findings. Morocco Paper, Satin or Plush Lined Wooden Corner Stops Jewelry and Silverware Boxes. 80 Nassau Street, New York.

**Vaffer, S. & Co.**—Manufacturers and Dealers in Jewelers' Boxes, Tags, Cards, Paper and Findings. Trays a specialty. Office and Salesroom, 66 Nassau street, New York.

#### Jewelry Manufacturers.

**Aikin, Lambert & Co.**—Manufacturers General stock of Reliable Jewelry, 23 Maiden Lane.

**Alling, Isaac A. & Co.**—Manufacturers of Fine Gold Jewelry. Sets, Lace Pins, Ear Rings, Studs, Collar Buttons and Scarf Pins. Specialties: Wire Bracelets, Bangles, American Lever Sleeve Buttons. Bryant Building, Nassau and Liberty Streets, N. Y. Factory, Newark, N. J.

**Baldwin, Sexton & Peterson**—Makers of Fine Jewelry and Importers of Diamonds, etc., corner Broadway and Fourth Street.

**Ball, W. H.**—Manufacturer of Gold Jewelry. Bracelets and Bangles of all kinds a specialty. 9 John Street, N. Y.

**Barthman, Straat & Co.**—Manufacturers of Fine Jewelry. Roman Goods, Rings, Diamonds. No. 43 Maiden Lane.

**Brown, Thos. G. & Sons**—Man'rs of Rich Jewelry Necklaces, Locketts, Bracelets, Sleeve Buttons, etc., 5 Bond Street, N. Y.

**Bryant & Bentley**—Manufacturing Jewelers. Rings a specialty. 12 Maiden Lane

**Carter, Sloan & Co.**—Manufacturing Jewelers, 15 Maiden Lane, New York.

**Champanois & Co.**—No. 5 Maiden Lane, manufacturers of Engraved and Enameled Gold goods, in Sets, Ear Knobs, Bracelets, Studs, Lace and Shawl Pins, Jet cluster and Onyx goods, also "Best Lever" Sleeve Buttons.

**Chatellier, Joseph F.**—Manufacturing Jeweler, No. 694 Broadway, N. Y.

**Churchill, Lewis & Co.**—Manufacturers of Fine Jewelry. 692 Broadway, cor. Fourth St., N. Y.

**Cook, Groeschel & Co.**—Manufacturers of Fine Jewelry and Locketts, 191 Broadway (over Mercantile Bank,) N. Y.

**Cottle S. Co.**—Manufacturers of Fine Jewelry. Waltham Building, 5 Bond Street, N. Y.

**Cox & Sedgwick**—Manufacturers of fine Onyx and Colored Jewelry. 26 John St., New York

**Day & Clark**—Manufacturers of Fine Jewelry, Lace Pins, Ear Rings, Studs, Locketts, &c., 10 Maiden Lane, New York.

**Geoffroy, Arthur R. & Co.**—Manufacturing Jewelers. Novelties in Diamond Goods. No. 23 Maiden Lane, N. Y.

**Greene Wm. C. & Co.**—Goldsmiths; Manufacturers of Rich Sets in Taper Wire Coral. Office, 192 Broadway.

**Hale, S. W. & Co.**—Manufacturers Rich Jewelry, Whiting Building, Broadway and 4th Street.

**Hartmann, P.**—Manufacturer & Importer of Fine Gold, Diamond, and Filigree Silver Jewelry, No. 36 Maiden Lane. P. O. Box 2,454.

**Hedges, A. J. & Co.**—Manufacturing Jewelers, 6 Maiden Lane.

**Henderson & Winter**—Jewelers, No. 15 Maiden Lane, New York. Specialties—Stone, Cameo, Onyx, Amethyst, Topaz, Pearl and Turquoise Rings.

**Hunt & Owen.**—Manufacturing Jewelers. Office 3 Maiden Lane.

**Kremetz & Co.**—Manufacturing Jewelers, No. 182 Broadway, N. Y.

**Kuhn, Doerflinger & Co.**—Manufacturers of Enameled and Roman Band Bracelets, also Fine Locketts Pendants and Lace Pins. 18 John street.

**Miller Bros.**—Manufacturers of Fine Jewelry, Locketts, Sleeve Buttons, Studs, &c., 7 Maiden Lane, N. Y.

**Moore & Horton.**—11 Maiden Lane, Manufacturing Jewelers, Rings, Studs, Collars and Sleeve Buttons, Pins, Ear-rings, &c.

**Muhr's, H., Sons.**—Manufacturing Jewelers. Solid Gold and Filled Rings a specialty. Also Manufacturers of the celebrated Crown Filled Watch Case. 16 Maiden Lane, N. Y.

**Owen, G. & S. & Co.**—Manufacturing Jewelers. Office, No. 3 Maiden Lane.

**Richardson, Enos & Co.**—Manufacturers of Fine Gold Jewelry, Gold Chains, Locketts, Crosses and Necklaces. Colored and Etruscan Work. No. 23 Maiden Lane, New York.

**Richardson, J. W. & Co.**—Manufacturers of Jewelry. Masonic and other Emblems. 196 Broadway, N. Y. Manufactory, Providence, R. I.

**Riley, J. A. & Co.**—Manufacturing Jewelers Etruscan Gold and Roman Bracelets, Lace Pins, Ear Rings, Scarf Pins, Brooch Pins, etc. Nos. 7 and 9 Bond Street, N. Y.

**Ripley, Howland & Co.**—Manufacturers of Fine Jewelry and Platinum Tipped Diamond Settings. No. 17 Maiden Lane, N. Y.

**Sauter, L.**—Manufacturer of Fine Jewelry, Solid Stone Rings and Studs a specialty. Jobbing for the trade. 1 Maiden Lane, New York.

**Schwencke, Wm.**—Manufacturing and Jobbing Jeweler. Repairing a specialty. Orders promptly attended to. No. 43 Maiden Lane, N. Y.

**Sexton & Cole**—Manufacturing Jewelers, Colored Gold and Onyx Goods a specialty. No. 30 Maiden Lane.

**Shafer & Douglas,** Manufacturing Jewelers—Roman Goods, Lace Pins, Cameo Sets, etc., Stone Rings, etc. No. 7 Maiden Lane, N. Y.

**Sheafer, W. H. & Co.**—Manufacturing Jewelers, Specialty Bangles and Bracelets, 15 John St., N. Y.

**Stites' Sons, E.**—Manufacturers of Fine Jewelry. No. 14 John Street, N. Y.

**Street, Geo. O. & Sons.**—Established 1837. Makers of Fine Jewelry, strictly first-class goods of our own make. No. 15 John Street, New York.

**Thoma, Ernest**—Manufacturer of Fine Jewelry, Sleeve Buttons, Rings, Ear-rings, &c. No. 173 Broadway, N. Y. Factory, Hackensack, N. I.

**Ward, Thos. M.**—Manufacturer of Fine Jewelry, Diamond Mountings a specialty. No. 25 John Street, N. Y.

**Wienhold, Joseph**—Manufacturer of Fine Jewelry Diamond Mountings a specialty. 24 John St.

**Woglom & Miller**—Manufacturers of Black Onyx Goods exclusively. 32 & 34 John Street, N. Y.

#### Jewelry—Rolled Plate.

**Frick, John & Co.**—Fine Rolled Plate Jewelry of all kinds. Repairing of every description. 21 and 23 Maiden Lane, N. Y.

**Mauran, J. T.**—Manufacturer of Fine Rolled Plate Jewelry, No. 15 Maiden Lane, N. Y.

**Richards, E. Ira & Co.**—Manufacturers of Fine Rolled Plate Jewelry, No. 200 Broadway, N. Y.

#### Jewelers' Tools, etc.

**Fisher, James J.**—Dealer in Watchmakers' and Jewelers' Materials, Files, Tools, Silk Guards, Spectacles, etc. 697 Broadway, N. Y.



**Friedenthal, A. & Co.**—Importers and jobbers of Watchmakers' and Jewelers' Tools, Materials, etc. 43 Maiden Lane, N. Y.

**Friedlander, R. & L.**—Importers of Watchmakers' Tools and Materials. 65 & 67 Nassau Street. Branch Office, 264 Bowery.

**Kurtz, F. P.**—Manufacturer of Jewelers Machinery, Tools, Rolling Mills, Presses, Polishing Lathes, &c. 97 Cliff St., N. Y.

**Levy, Dreyfus & Co.**—Importers and Jobbers of Watchmakers' and Jewelers' tools and materials of every description. 11 Maiden Lane, N. Y.

**Montgomery & Co.**—Importers of and Dealers in Manufacturing Jewelers' Tools and Materials of every description, 105 Fulton street, New York.

**Reichhelm & Koester.**—Importers of Jewelers' Tools, Files, etc. Manufacturers of Brushes and Buffing wheels; also Patent Gas Furnaces for Melting, Plating, Enamelling, Annealing, etc. 80 Nassau St., N. Y.

#### Lapidaries.

**Fox, M. & Co.**—Practical Lapidaries, No. 1 Maiden Lane, New York.

**Graham & Co.**—Practical Lapidaries, Cutters and Polishers of all kinds of Precious Stones. Miners' Relics Cut, Polished and Mounted. Miniature, Locket and Clock Glasses. 80 Nassau St., N. Y.

**Kordmann & Michel.**—Lapidaries. Dealers in Precious Stones. Cutting and Polishing Rubies, Sapphires and other Gems a specialty. Drilling done promptly. 59 Nassau St., N. Y.

**Korn, Ph.**—Lapidary. Importer of Precious and Imitation Stones, No. 63 Nassau street, between Maiden Lane and John street, New York.

#### Masonic Jewelry.

**Luther, John F.**—79 Nassau Street. Manufacturer of Fine Presentation Jewels for all Societies. Knights Templars, Crosses, Badges, &c.

**Popper, H.**—Manufacturer of Medals and Badges for Military, G. A. R., Shooting, Masonic, Odd Fellows, Knights of Pythias, etc. 91 Essex St., New York.

**Wilkinson, C. B.**—Manufacturing Jeweler, 8 John St., N. Y. Medals, Badges and Masonic Jewelry, a specialty. Designs furnished free upon application.

#### Optical Goods.

**Friedlander, R. & L.**—65 and 67 Nassau Street. Dealers in Optical Goods.

#### Opticians.

**Burbank Manuf'g Co.**—Manufacturers of Spectacles and Eye Glasses of all descriptions, in gold, silver, etc., 14 Maiden Lane, N. Y.

**DuBois, Geo. W. & Co.**—Importers of Watches and Optical Goods. 36 Maiden Lane, N. Y.

**Kahn, Hanover & Co.**—Importers of Spectacles, Eye-Glasses and Optical Goods generally, and Scientific Instruments of every description. 32 Maiden Lane, New York.

**Levy, Dreyfus & Co.**—Importers of Spectacles and Eye Glasses and Optical Instruments of every description, No. 11 Maiden Lane, N. Y.

**Lorsch, Albert**—Manufacturer of the Patent Accommodating Spectacles and Eye Glasses in Gold, Silver and Steel, and other Optical Goods, 37 Maiden Lane, N. Y.

**Spencer Optical Manufacturing Co.**—Gold, Silver, Steel, Nickel and Plated Spectacles; Gold, Celluloid, Steel, Nickel and Rubber Eye Glass and Opera Glasses. 13 Maiden Lane, N. Y.

#### Paper Boxes.

**Waterbury Paper and Box Co.**, 27 to 35 Canal St., Waterbury, Conn., Manufacture Jewelers' and Silversmiths' Fine Paper Boxes. Quality guaranteed to be equal to the best made.

#### Precious Stones, &c.

**Bishop, Victor & Co.**—33 Maiden Lane, Importers of Precious Stones, Cameos, &c. Also Manufacturers of Coral Jewelry.

**Bissinger, Philip & Co.**—Importer of Diamonds, Pearls and Precious Stones. Agent for the Bohemian Garnet Goods. Blue Enamelled Lockets. No. 22 John St., N. Y.

**Breidenbach, R. A.**—Importer of Black Onyx, Cameos, Turquoise, Pearls, Sardonyx, Amethysts, Topaz, Garnets, Opals, Rubies, Sapphires, Cat's Eyes, Hematites, Brilliants, Doublets, etc. 85 Nassau St., N. Y.

**Daue, Wm. & Co.**—Importer of Precious and Imitation Stones. No. 202 Broadway New York.

**Fox, M. & Co.**—Importers of Diamonds and other Precious Stones, No. 1 Maiden Lane, N. Y.

**Gruet, Jules.**—Importer of all Grades of Real and Imitation Stones. 14 John St., N. Y.

**Guntzburger Bros.**—Manufacturers and importers of Precious Stones—Amethysts, Topaz, Cameos, Garnets, Imitation Diamonds, &c. No. 9 Maiden Lane.

**Hahn & Co.**—Importers of Precious Stones. Cameos, Onyx, Pearls, Intaglios, Amethysts, Garnets, etc. 64 Nassau Street, New York.

**Kahn, L. & M.**—Importers of precious and imitation stones. 10 Maiden Lane, N. Y.

**Kipling, E. E.**—Importer of Precious and Imitation Stones. Manufacturer of the Patent Foil Solid Metal Back Rhine Stone Brilliant. No. 6 Maiden Lane, N. Y.

**Kipling, R. A.**—Precious and Imitation Stones, No. 24 Maiden Lane, N. Y. Manufacturer Cameos, Agates, Onyx, Etc. Oberstein, Germany. Commission Merchant, 79 Rue De L'Echiquier, Paris.

**Tannenbaum, L. & Co.**—Importers of Diamonds and Precious Stones. Steam Lapidary Works. Oriental Stones Cut and Polished a specialty. 65 Nassau St., N. Y.

#### Silverware.

**Gorham Manufacturing Co.**—Union Square.

**Knowles, J. P. & S. M.**—Manufacturers of Sterling Silverware, 20 Maiden Lane, N. Y. Factory, Providence, R. I.

**Shiebler, Geo. W.**—Manufacturer of Sterling Silverware. No. 8 Liberty Place, near Maiden Lane, N. Y.

**Whiting Manufacturing Co.**—Makers of Sterling Silver Ware. Broadway cor. 4th Street, N. Y.

**Wood & Hughes.**—Manufacturers of Fine Silverware. 16 John Street, N. Y.

#### Silver Filigree Jewelry.

**Cuppia, L. A.**—Manufacturer of Solid Silver Novelties, and Importer of Silver Filigree, 19 Union Square.

**Francesconi, Guido**—Importer of Silver Filigree Jewelry, 196 Broadway, New York.

**Hartmann, P.**—Manufacturer of Silver Filigree Jewelry. 36 Maiden Lane, N. Y.

#### Silver Plated Ware.

**Hartford Silver Plate Co.**—Manufacturers of Fine Electro-Plated Ware. Factory and Salesroom, 28 High Street, Hartford, Conn.

**Holmes, Booth & Haydens**—Manufacturers of Silver-Plated Ware. 47 Chambers Street.

**Manhattan Silver Plate Co.**—Manufacturers of Silver Plated Ware. Showrooms, 23 John St. Factory, 301 to 305 East 22d St., cor. 2d Ave. Address all communications to Factory.

**Middletown Plate Co.**—Manufacturers of Superior Electro-Plate. Factories, Middletown, Conn., salesroom, 13 John Street.

**Rogers & Bro**—Manufacturers of the finest quality of Electro-Plated Ware. 690 Broadway.

**Rogers, Smith & Co.**—Manufacturers of Fine Electro Plated Ware. No. 46 E. 14th St., N. Y.

**Simpson, Hall, Miller & Co.**—Manufacturers of fine Silver-Plated Ware. No. 36 E. 14th Street.

**Schade, Henry.**—Manufacturer of White Metal and Plated Ware. Nos. 56 & 58 Ainslie Street, Brooklyn, E. D., N. Y. Price list and catalogue furnished on application.

**Webster, E. G. & Bro.**—Manufacturers of Fine Silver-Plated Ware. Office and warehouses, 14 Maiden Lane, N. Y.

#### Show Cases, Etc.

**Smith, B. & W. B.**—Manufacturers of Patent Improved Dust Proof Show Cases, with Perpendicular Sliding Doors, No. 220 W. 29th St., N. Y.

#### Spectacle Case Manufacturers.

**Bertine, P. D.**—Manufacturer of Spectacle and Eye-Glass Cases. 139 William Street, near Fulton St., New York.

**Koenen, A. & Bro.**—Manufacturers of Leather Spectacle and Eye-Glass Cases. 81 Nassau St., N. Y.

#### Stem Winding Attachments.

**Abbott, Henry** Maker of Stem Winding Attachments, No. 7 Maiden Lane, N. Y.

#### Thermometers, Etc.

**Tagliabue, Giuseppe.**—manufacturer of Thermometers, Barometers and Hydrometers. Patentee and sole manufacturer of the U. S. Standard Hydrometer. 302 Pearl Street, near Beekman.

#### Thimble Manufacturers.

**Barker Manuf'g Co.**—Makers of Patent Graduated Thimbles, Stiffened Gold, Filled Gold and Rolled Gold, 36 Maiden Lane, N. Y. A. Lyons, Ag't. Factory, 129 Eddy St., Providence, R. I.

**Burbank Manuf'g Co.**—Manufacturers of Gold and Silver Thimbles, 14 Maiden Lane, N. Y.

**Ketcham & McDougall.**—Improved Gold and Silver Thimbles, Bryant Building, N. Y.

**Simons Bro. & Co.**—Manufacturers of Gold and Silver Thimbles. 611 and 613 Sansom Street, Philadelphia.

**Woglom & Miller.**—Sole Agents for the "Prime" Thimbles in Gold and Silver, manufactured by Ezra C. Prime. 34 John Street, N. Y.

#### Watch Companies.

**American Watch Co.**—Robbins & Appleton, No. 5 Bond Street, N. Y.

**The E. Howard Watch and Clock Co.**—Cor. Maiden Lane and Nassau Street, N. Y.

**Waterbury Watch Co.**—Manufacturers of the Waterbury Watch. Factory, Waterbury. Office, 52 Maiden Lane, N. Y.

#### Watch and Chronometer Jeweler.

**Queen, James.**—Watch and Chronometer Jeweler and Pallet Maker, 78 Nassau Street, room 8. Pivots inserted in Pinions, Balance, Staffs, etc.

**Wennstrom, John.**—Watch, Chronometer and Clock Jeweling, Jewel Gauges, Ruby and Sapphire Draw Plates; Diamond Charged Polishing Stones for Jewel Settings; Pivots inserted in Pinions. 2 Dutch Street, N. Y.

#### Watch Importers, Etc.

**Abry, Chas. Leo**—Importer and Manufacturer of Swiss Watches of all grades. 63 Nassau Street.

**Aikin, Lambert & Co.**—Importers of Watches. Sole Agents for Paul Breton & Chas. Latour, Geneva. A general line of reliable Swiss Watches, Watch Cases, etc. 23 Maiden Lane, N. Y.

**Bartens & Rice**—20 John Street, Importers of Watches and sole agents in the United States for the celebrated Nicole, Nielsen & Co. Watches.

**Cross & Beguelin.**—Importers of Watches, Watch Tools and Materials, dealers in American Watches, No. 21 Maiden Lane, N. Y.

**Droz, Henry E.**—Importer of Watches, and Watch Case Manufacturer. Agent for the "E. Perregaux" Watch, and jobber in American Watches No. 92 Fulton Street, N. Y.

**Freund Max & Co.**—Importers of Watches, Jewelry and Precious Stones, 8 Maiden Lane, N. Y.

**Gagnebin, Chas.**—Importer of all kinds of Swiss, and Dealer in American Watches. 4 Maiden Lane, N. Y. Agent for Ulysse Breting's Fine Chronometers, Chronographs, Anchors, &c.

**Gallet, Julien.**—Importer of Watches. No. 1 Maiden Lane.

**Ginnel, Henry**—Importer of Watches, Tools and Materials, 31 Maiden Lane, N. Y. P.O. Box, 2967

**Hyde's Sons, John E.**—Wholesale Commission Agents, only for Jules Jurgensen, of Copenhagen; Jules Monard, of Geneva; and for other makers of all qualities of Watches, 22 Maiden Lane.

**Keller, L. H. & Co.**—Successors to G. A. Huguenin, Importers of Fine Watch and French Clock Materials, No. 64 Nassau Street, N. Y.

**Mathey Bros. & Mathez.**—Importers of Fine Watches and Sole Agents for the **H. L. Matthe's** Watches. No. 16 Maiden Lane.

**Robert, J. Eugene**—No. 30 Maiden Lane, New York. Agent for Louis Audemar's celebrated watches.

**Schwob, Adolphe**—Manufacturer and Importer of Watches, 11 Maiden Lane, N. Y.

**Strasburger, Louis & Co.**—importers and Makers of Watches of every description, 15 Maiden Lane.



**Watch Cases.**

- Dueber Watch Case Mfg Co.**—Manufacturers of Gold and Silver Watch Cases. Bryant Building, N. Y. Factory, Newport, Ky.
- Duhme & Co.**—Manufacturers of Gold and Silver Watch Cases. Carlisle Block, Fourth and Walnut Streets, Cincinnati.
- Fahys, Joseph**—Manufacturer of Watch Cases and Dealer in American Movements, 38 Maiden Lane.
- Glatz, Chas.**—Manufacturer of Silver Watch Cases. Bryant Building, cor. Nassau and Liberty Sts.
- Keller & Untermeyer.**—Manufacturers of Watch Cases with Raised Gold Ornaments. 9 Maiden Lane, N. Y.
- Ladd Watch Case Co.**—Manufacturers of the Ladd Patent Stiffened Gold Watch Cases, etc., 11 Maiden Lane, N. Y. Factory, 58 Eddy Street, Providence, R. I.
- Willemin Watch Case Co.**—Makers of Gold Watch Cases. Raised Gold Ornamentation and Jurgensen style of Engine Turning. 109 Sands Street, Brooklyn, N. Y. 16 Maiden Lane, N. Y.

**Watch and Chronometer Repairers.**

- Cerf, B.**—Practical Watchmaker and Repairer, No. 10 John Street, N. Y. Repairing and adjusting of Fine Watches done for the trade. All kinds of escape and stem-winding wheels cut to order.
- Goepf, Frederick A.**—Practical Watchmaker. Repairing of every description for the trade. 25 Maiden Lane, N. Y. In office of H. Garland, Engraver.
- Heinrich, H. H. & Co.**—Sole Manufacturers of H. H. Heinrich's Patent Auxiliary Balance, and Adjusters and Repairers of Fine Watches and Chronometers. 12 John Street, N. Y.
- Lesperance, Theo.**—Watchmaker and Wheel Cutter. Also Stoning Nickel Movements. No. 1 Maiden Lane, New York. With Julien Gallet.
- Ludeman, W. H.**—Chronometer and Watch Maker. Repairing of every description for the trade, 75 and 77 Nassau Street.

**Watch Case Repairers.**

- Feinier, Joseph A.**—Watch Case Maker and General Repairer. Specialty in fine Gold and Silver Cases. Jobbing promptly attended to. Nos. 4 and 6 John St., N. Y.
- Tarbox, Hiram**—Watch Case Repairing, Springing, Polishing and Engine Turning. 1874 North Fourth Avenue, bet. 176th and 177th Sts., N. Y. Express Packages should be sent to 92 Fulton Street.

**Watch Glasses, Shades, Etc.**

- Brown, Edwin H.**—No. 85 Nassau Street, Imported and Own Manufacture Watch Glasses, Flat, Flat Concave, Concave, Convex and fine Genevas. Fine fitting solicited.

**Watches, Diamonds and Jewelry.**

- Alford, C. G. & Co.**—Manufacturers. General line fine and Reliable Goods. Specialties in Onyx Goods and Chain. 200 Broadway, New York.
- Ohn, J. J.**—Importer and Manufacturer of Whitby Jet, Rubber and Pearl goods. Gold and Rolled-plate Jewelry, etc. 12 Maiden Lane, New York.
- Durfey & Reynolds**—Successors to Durfey & Shiebler, Watches, Diamonds, Jewelry. No. 9 John Street, (up-stairs) New York.
- Friedman, Saml.**—Wholesale Dealer in Watches and Jewelry, 42 Maiden Lane, N. Y.
- Goddard, John M.**—Manufacturing Jeweler, Seal Rings and Fine Locketts a specialty, No. 3 Maiden Lane, N. Y.
- Greason J. R. & Co.**—Successors to Arthur, Rumrill & Co., 182 Broadway. Manufacturers of Fine Jewelry and Gold Chains, also Diamond Mountings.
- Haskell, H. C.**—Manufacturing Jeweler. Seal Rings a specialty. Special attention to Jobbing of every description. 12 John street.
- Herzog, Louis & Co.**—Importers of Watches, Dealers in Diamonds and Jewelry, 52 Maiden Lane, N. Y.

**Hirsch Bros.**—Dealers in Watches and Diamonds and Manufacturers of Jewelry, No. 23 Maiden Lane, N. Y.

**Jandorf, P. & Bro.**—Importers of Watches and Jewelry, 196 Broadway.

**Kennedy, Frank S.**—Manufacturer and Wholesale Dealer in Jewelry and Gold and Silver Thimbles. No. 13 Maiden Lane, New York.

**Lissauer & Sondheim**—Wholesale Jewelers and Jobbers in American Watches, No. 12 Maiden Lane, N. Y.

**Marx, Kossuth & Co.**—Importers of Watches and Dealers in Jewelry. 39 Maiden Lane, N. Y.

**Mayer, B.**—Manufacturer of Fine Jewelry, and Dealer in Watches, 71 Nassau street, cor. John street, New York.

**Myers, S. F. & Co.**—Manufacturing and Wholesale Jewelers—all grades. Importers of Watches. Illustrated Catalogue to the trade. 179 Broadway, N. Y.

**Oppenheimer Bros. & Veith.**—Dealers in Watches and Diamonds, and Manufacturing Jewelers, No. 35 Maiden Lane.

**Scott, J. T. & Co.**—Importers of Watches, and Manufacturers of Jewelry, and Jobbers of all Grades of American Watches, 11 Maiden Lane.

**Smith & Knapp**—Wholesale Dealers in American and Swiss Watches, Diamonds, Gold and Plated Jewelry and Gold Chain. 182 Broadway, N. Y.

**Steele, J. W.**—Successor to Brainerd, Steele & Co., Manufacturer of Fine Jewelry and Brainerd's Patent Locketts. No. 9 Maiden Lane, N. Y.

**Stern Brothers & Co.**—Importers of Swiss Watches and wholesale dealers in American Watches, &c., 39 Maiden Lane.

**Stern & Stern**—Dealers in Watches, Jewelry and Diamonds. No. 6 Maiden Lane, N. Y.

**Stites, D. H. & Son**—Manufacturers of Fine Jewelry, Rolled Plated Goods and Chains, Parisian Diamond Rings, Studs and Earrings a specialty. 41 Maiden Lane, N. Y.

**Strauss, Jacob.**—Full Line of Gold and Plated Jewelry, and Importer of Watches. 18 John Street, New York.

**Thrall, E. A.**—Wholesale Dealer in Watches and Jewelry. No. 1 Maiden Lane, N. Y.

**Trier Bros.**—Importers of Garnet, Whitby Jet and Amber Jewelry, Silk Guards, Opera, Field and Marine Glasses, Pearl Card Cases. Also a full line of Gold and Plated Jewelry. 15 Maiden Lane, N. Y.

**Wheeler, Parsons & Hays.**—Manufacturers of Fine Jewelry, Watch Cases, Gold Chains, &c. and Dealer in American and Swiss Watches, No. 2 Maiden Lane, N. Y.

**White, N. H.**—Jobber in American-Waltham Watches and Chronographs. Waltham make of 10-k., 14-k. and 18-k. Gold and Sterling Silver Cases; Filled Gold Cases. 11 Maiden Lane.

**Watch Tools, etc.**

**Keller, L. H. & Co.**—Importers of Watchmakers' and Jewelers' Tools, Materials, etc. 64 Nassau Street, N. Y.

**Zimmern, Henry**—Importer of Watch Materials, Tools, and Optical Goods, No. 8 Maiden Lane, (first floor.) Sole Agent for A. Hugenin & Gravier. Mainsprings, New York.

**PHILADELPHIA**

**Booz & Co.**—Manufacturers of Gold and Silver Watch Cases and Jewelry, 108 South 8th St., Philadelphia.

**Bennett, Jacob & Son.**—Diamond Setters and Manufacturing Jewelers, 925 Chestnut St.

**Conover David F. & Co.**—American Watches, Wholesale Salesroom, Southeast corner 7th and Chestnut Streets, Philadelphia.

**Guilbert, Thos. M., & Co.**—Manufacturing Jewelers. Flexible Bracelets and Strung Pearl Repairing. 908 Chestnut St., Philadelphia.

**Herold, Chas P.**—Successor to Hildebrandt, Herold & Co., Manufacturing Jeweler and Diamond Setter. Diamonds. 916 Chestnut Street.

**Krieder, Peter L.**—Manufacturer of Sterling Silver Ware. 618 Chestnut Street, Philadelphia.

**McCarty & Hurlburt**—Manufacturers of Gold Spectacles, Silver Thimbles and Plain Rings. Wholesale dealers in American Watches, Jewelry, etc. 131 North Second Street.

**Morgan & Headly.**—Manufacturing Jewelers, Cameo Sets, Gold Sets, Roman Locketts, Rings, Coral Sets and a general line of rich goods. Corner 10th and Chestnut Streets, Philadelphia.

**Muhr's, H., Sons.**—Manufacturing Jewelers. Solid Gold and Filled Rings a specialty. 633 and 635 Chestnut Street, Philadelphia. 1½ Maiden Lane, New York.

**Scherr, L. A. & Co.**—Wholesale Dealers in Watches Silver-Plated Ware, Spectacles, Fancy Goods, Watch Materials, etc. 726 Chestnut Street.

**Sheaffer, W. H. & Co.**—Manufacturing Jewelers. Specialty: Band Bracelets. Factory, 612 and 614 Chestnut street, Philadelphia. Office, 15 John street, New York.

**Simons, Brother & Co.**—Manufacturers of Fine Jewelry, Cans, Thimbles, Chains. 611 and 613 Sansom Street.

**Vansant, John T. & Co.**—611 and 613 Sansom Street, Artisan Hall, Manufacturers and Wholesale Dealers in English Sterling Silverware. Specialties: Tea Sets, Knives, Forks, Spoons, Cups and Napkin Rings.

**CHICAGO.**

**American Watch Company,**—of Waltham, Mass. No. 102 State Street, Chicago.

**Clapp & Davies**—Wholesale Jewelers, 63 and 65 Washington Street. Catalogue and price list issued to watchmakers and jewelers.

**Dennison Manufacturing Co**—Manufacturers of Jewelers' Paper Boxes, Morocco Cases, Tags, Cards, Pink and White Cotton, Tissue Papers, Sealing Wax, &c., &c., 102 Madison St., Chicago. Boston, New York, St. Louis, and Philadelphia.

**Excelsior Sign Co.**—Manufacturers of (Grout's Excelsior) Iron Watch and Spectacle Signs. 124 Fifth Avenue, Chicago, Ills.

**Gilbert, Wm. L., Clock Co.**—Manufacturers of Clocks, Regulators, and Time Pieces, and Clock Material of every description, 54 and 56 Madison Street, Chicago.

**Giles, Bro. & Co.**—Manufacturers and Jobbers in Watches, all classes of Jewelry, Materials, Clocks, Silver Ware, &c. Illustrated catalogues furnished to dealers on application. 101 & 103 State St.

**Stein & Ellbogen**—Wholesale Dealers in Watches and Jewelry. 127 State Street, Chicago, Ill. Specialty, repairing for the trade.

**Wathier, Joseph P.**—Watchmakers and Jewelers for the trade, and Wholesale Dealers in Watch Materials, Tools, etc. 178 West Madison Street, Chicago, Ill. Send for price list.

**Wendell, Charles & Son**—Wholesale Watches, Jewelry, etc. 170 State street, Chicago.

**NEWARK.**

**Baker & Co.**—Gold, Silver and Platinum Refiners, Assayers and Sweep Smelters. 408 New Jersey Railroad Avenue, cor. Murray St., Newark, N. J.

**Diefenthaler Bros. & O'Donnell**—Manufacturers of Fine Jewelry, Lace Pins, Ear Rings and Patent Spring Bangles a Specialty. 36 Crawford Street, Newark, N. J.

**Felger, F. & F.**—Manufacturing Jewelers. Specialties:—Roman Band Bracelets, Lace Pins, Scarf Pins, Ball and Fancy Ear Rings. No. 477 Washington Street, Newark, N. J.

**Fiedler, Herrman**—Successor to Kunze & Fiedler, Engraver, Die Sinker and Press Tool Maker, 363 Market Street, Opposite Pennsylvania R. R. Depot, Newark, N. J.



**Glorieux, W. L.**—Assayer, Refiner and Sweep Smelter. 13 and 15 Franklin Street, Newark, N. J.

**Hopper & Valentine**—Manufacturers of Fine Jewelry, No. 8 Maple Place, Rear 44 Green St., Newark, N. J.

**Huger & Heitlinger**—Manufacturers to the Jobbing Trade only. Makers of Roman Stone, Engraved and Enameled Locketts, also Sets, Lace Pins and Ear Rings. Rear 477 Washington St.

**Krippendorf, C. & Schuller, F.**—Machinists and Jewelers' Tool Makers. 19 Greene Street, Newark, N. J. Rolls, Dies, Cutters, and Draw-plates of every Description made and repaired.

**Lefort, Henry**—Stem-winding Watch Crown Manufacturer. 60 Arlington Street.

**Lelong, L. & Bro.**—Gold and Silver Refiners Assayers and Sweep Smelters, Southwest corner of Halsey and Marshall Streets, Newark, N. J.

**Miller & Beam**—Manufacturers of Enameled Sets, Ear Rings, Lace Pins, etc. Guard Slides and Pendants a Specialty. 21 and 23 Green Street.

**Milne, Alex.**—Manufacturer of Stem-winding Watch Crowns. 19 Ward Street.

**Plumb & Marcus**—Manufacturers of Traveling and Marine Clocks, Electric Appliances. 289 Washington St., Newark, N. J.

**Pollock, T. H.**—Manufacturer of Jewelers' and Silversmiths' Wheel Brushes, Buffs, etc. No. 36 Crawford Street, Newark, N. J.

**Regad, E. D.**—Lapidary. Specialty—Sardonyx, Black Onyx and Agates. 14 Oliver St., Newark.

### PROVIDENCE

**Arnold & Webster**—Manufacturers of Solid Gold Engraved Band Rings for the Jobbing Trade. 29 Point Street, Providence, R. I.

**Capron & Co.**—Manufacturers of Jewelry. Engraved Box Bracelets, Bangle Wire Bracelets, Original Lever Collar and Cuff Button. No. 407 Pine Street, Providence, R. I.

**Coombs & Tuttle**—Manufacturers of a large variety of Fine Bracelet and Eye-Glass Chain in Gold Plate and Silver, Spring Rings, Holders, Hooks, Snaps, etc. 35 Point St., Providence, R. I.

**Hamilton, William & Co.**—Manufacturers of Fine Rolled Plated Chains and Patent Band Bracelets. 116 Pine St., Providence, R. I.

**Hough, W. S., Jr., & Co.**—Manufacturers of the Hough, Jr., Rolled Plate Locketts, Charms and Pendants. For sale by all first-class Jobbers or Wholesale Jewelers in the United States and Canadas.

**Hutchison & Huestis**—Makers of Solid Gold Rings. Quality guaranteed. For the Jobbing Trade only. 185 Eddy Street, Providence, R. I.

**Pearce & Hoagland**—Manufacturers of Gold Pens, Holders, Pencils, Tooth Picks, etc. Also the Quill Reserve Tooth Pick. 29 Point Street, Providence, R. I.

**Seary Mfg. Co.**—Manufacturers of Fire Gilt, Nickel and Electro Plated Chains, Vest, Neck, Opera and Guard. 33 Beverly St., Providence, R. I.

**Taylor, Geo. H. & Co.**—Watchmakers and Wholesale Dealers in Watches, Clocks, Watch and Clock Material, Tools, Spectacles, Eye Glasses, &c. Particular attention given to trade work. 136 Westminster Street (Room 1), Providence, R. I.

### PAWTUCKET.

**Draper, J. O. & Co.**—Manufacturers of Jewelers' Fig Soap, adapted for Washing Jewelry, Scratch Brushing and Drawing Wire. Pawtucket, R. I.

**Fuller, Geo. H. & Son**—Jewelers' Findings, Gold, Silver, Gold Plated and Fire Gilt. Pin Stems, Joints, Catches, Split Rings, Chain Hooks and Swivels, Ear Wires, Chain Bars, etc. 99 Exchange Street, Pawtucket, R. I.

**Thayer, Ellis & Son**—Brush Manufacturers, and Wholesale Dealers in all kinds of Brushes. Sole manufacturers of Ellis Thayer's Patent Polishing Wheels. Manufacturing Jewelers' and Machine Brushes a Specialty. 80 North Main Street, Pawtucket, R. I.

### CINCINNATI.

**Hellebush, Clemens**—Manufacturer, Importer and Wholesale Dealer in everything required by the Jewelry Trade. 77 W. Fourth St., Cincinnati, O.

**Lodwick & Nolting**—Wholesale Jewelers, S. W. cor. 4th & Walnut Streets, Cincinnati.

### BALTIMORE.

**Gruebel & Kesmodel**—Manufacturers of Fine Diamond Etruscan, Enameled, Plain and Rhine Stone Jewelry to order. Repairing a specialty. Orders by Mail solicited. 212 & 214 W. Baltimore St., Balto., Md.

### BOSTON.

**Boston Watch Case Co.**, makers of Watch Cases. Especial attention given to Repairing. 1, 3 & 5 Province Court, Boston, Mass.

**Boyce, E. J.**—Manufacturer of Solid Gold Jewelry. Rings a Specialty. 383 Washington St., Boston, Mass.

**Smith, Wm. A.**—Importer of Diamonds and Precious Stones. Diamonds mounted and unmounted and Diamond Mountings. 383 Washington St., Boston, Mass.

**Weber, H. & Co.**—Wholesale Jewelers, Importers and Jobbers of Fine Watch Materials, Jewelers' Findings, Tools, etc., Optical Goods and Silk Guards. Agents for Whitcomb, Standard and Stark's Lathes. 424 Washington St., Boston, Mass.

### BUFFALO.

**King & Eisele**—Manufacturers of Solid Gold Jewelry, and Agents for American and Foreign Watches; also Jobbers in Roll Plate Jewelry. Office and Salesrooms, 283 Main St. Factory, 2, 4, 6 and 8 Swan St.

**Oliver, W. W.**—Manufacturer of Hand and Power Rolling Mills for Jewelers and Silversmiths, 39 Clinton Street, Buffalo, N. Y.

### CLEVELAND.

**Chandler, J. M. & Co.**—Manufacturers of the Patent Embossed Bracelet and Jobbers in all kinds of Clocks, Watches, Jewelry, Tools, Materials, etc. 185 Superior St., Cleveland, O.

### LANCASTER.

**Bowman & Musser**—Jobbers in Watches, Clocks, Chains, Fine Tools and Materials. 20 East Chestnut Street, Lancaster, Pa.

### PITTSBURGH.

**Barrett, G. B. & Co.**—Importers and Wholesale Dealers in Watches, Diamonds, Jewelry, Clocks, Bronzes, Silver and Plated Ware, Watch Materials, &c., 238 & 240 Liberty St.

**Goddard, Hill & Co.**—Wholesale Dealers in American Watches, Jewelry, Silverware, Clocks, Materials, &c., 43 Fifth Avenue, Pittsburgh, Pa.

### CANADA.

**Ellis, P. W. & Co.**, No. 31 King street, East Toronto, Ontario, Manufacturing Jewelers, Watchmakers, importers and Jobbers of Watchmakers, and Jewelers' Tools, Materials, General Supplies and American Jewelry. Correspondence solicited with manufacturers of Novelties or specialties in American Tools and Jewelry.

**POSITIVELY NO GOODS RETAILED.**

**BOWMAN & MUSSER,**

SUCCESSORS TO

**E. F. BOWMAN,**

JOBBERS IN

**Watches, Clocks, Chains,**

Fine Tools and Materials,

**20 E. CHESTNUT STREET,**

Cop. P. R. R. Passenger Depot,

**LANCASTER, PA.**

Selection Packages sent to Regular Jewelers on Request.

**BARNES'**  
**No. 4 LATHE,**  
For the Heavier Work of Jewelers.

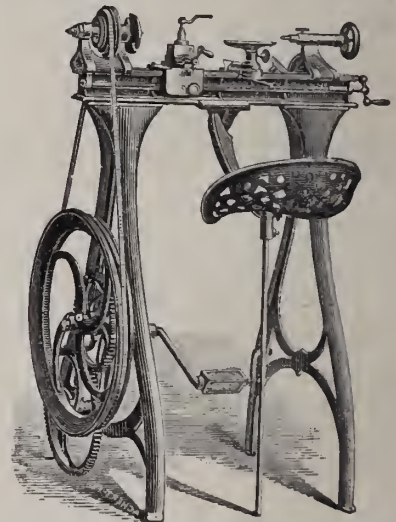

Barnes' Patent Foot and Steam Power Machinery. Complete outfits for Actual Workshop Business. Lathes for wood or metal. Circular Saws, Scroll Saws, Formers, Mortisers, Tenoners, etc., etc. Machines on trial if desired. Descriptive Catalogue and Price List Free.

**W. F. & JOHN BARNES,**  
2088 Main Street, ROCKFORD, ILL.

**SOLID GOLD**  
AND  
**STONE INLAID**  
**Cigar Cutter,**  
Pat'd Oct. 5, 1880.



**J. WIENHOLD,**  
Manufacturer of FINE JEWELRY.  
**DIAMOND MOUNTINGS A SPECIALTY.**  
24 John St., N. Y. City.



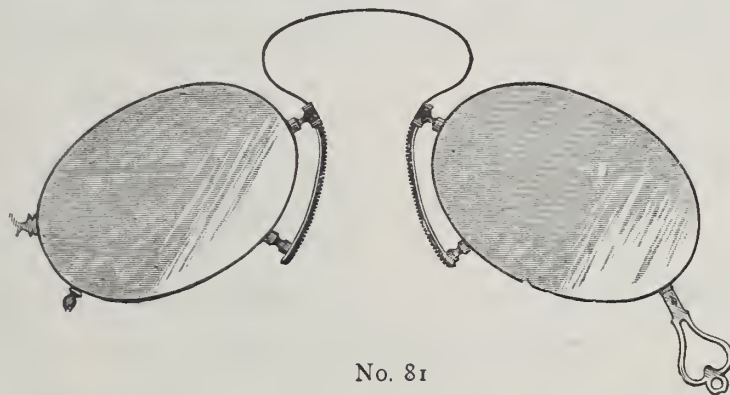

No. 81

# MORGAN & HEADLY,

MANUFACTURERS OF GOLD, SILVER AND STEEL

## Spectacles & Eye-Glasses.

### OUR TRADE GROWS APACE.

*We are constantly improving our patterns and machinery and educating our employes, thereby advancing the standard of our business.*

*The coming season will prove us to be still going ahead in our Special Line. With more extensive stock and facilities, and everything advanced except prices, which are uniformly low, we invite a continuance of your patronage.*



# C. T. SLOAN & CO.,

BUILDERS OF

## WATCH AND CLOCK MACHINERY,

289, 291 AND 293 WASHINGTON ST.,

**NEWARK, N. J.,**

*Would respectfully announce to parties interested that they are prepared to build the entire equipment necessary for the Manufacture of Watches on the American System.*

*We have a large, complete and extensive plant, with improved machinery, constructed on established Scientific Principles, with especial reference to odd and intricate work, consisting in part of:*

**Automatic Staff Pivot Lathes,**

“ **Pinion Cutting Engines,**

“ **Wheel Cutting Engines,**

“ **Leaf Polisher,**

**Wig-wag or Staff Polisher,**

**Epicycloid Machine,**

**Pinion Cutter Making Machine,**

**Escapement Wheel Cutting Engine,**

**Sapphire Cutter Grinding Machine,**

**Pallet Sawing Machine,**

**Pallet Stone Sawing Machine,**

**Slab Grinding Machine,**

**Jewel Making Lathes,**

**Jeweling Lathes,**

**Fly Cutter Grinder,**

*and a large plant of other machinery necessary to a complete establishment for building Watch, Clock and Mechanical Machinery.*

*We have extensive experience in the construction of Compound Dies, Train Wheels and Flat Steel Work, and guarantee to produce satisfactory work at the lowest possible prices consistent with first-class workmanship.*

*Our No. 5, or Machinist Bench Lathe, has a number of NEW and IMPORTANT FEATURES, which renders it the best Lathe for small work ever made.*

*We are now building a large Wheel and Pinion Cutting Engine with a capacity to cut Brass Wheel Bevel or Spur 5 inches in diameter, and Steel Pinion 1 inch in diameter.*



# WATERBURY CLOCK CO.,

MANUFACTURERS OF

## CLOCKS,

Novelties & Materials,

No. 10 CORTLANDT ST., N. Y.

— AND —

No. 63 WASHINGTON ST., CHICAGO.

Factories, **WATERBURY, CONN.**

M. BAILEY, Treasurer.

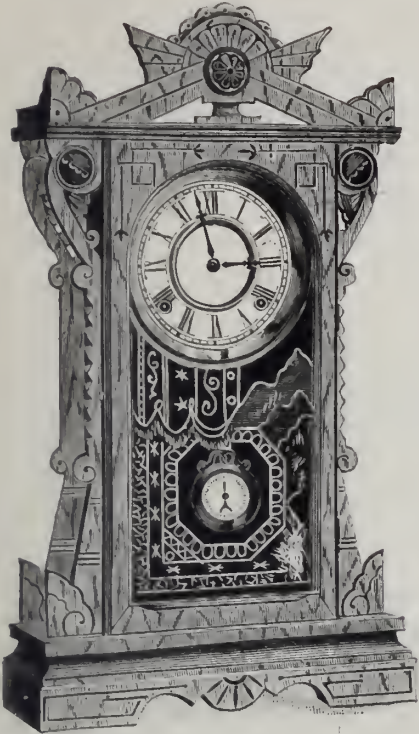

VENTNOR.—Walnut.

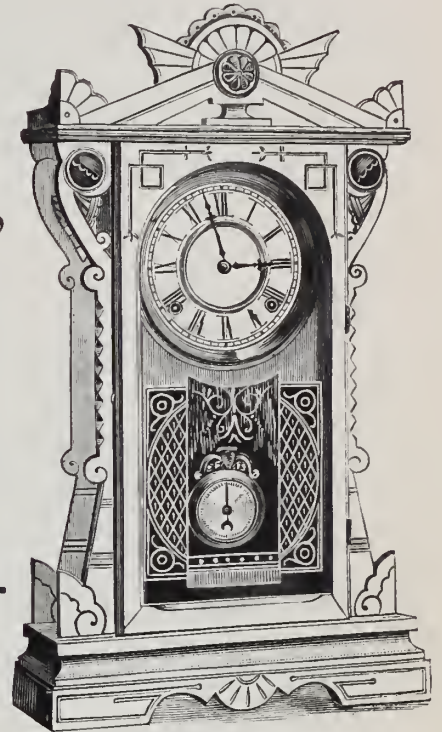

VENTNOR.—Ash.

# THE ANSONIA CLOCK CO.

HANGING CLOCKS

— AND —

## MANTEL CLOCKS

OF EVERY DESCRIPTION.



A Large and Complete Stock of

|                 |                                      |                    |
|-----------------|--------------------------------------|--------------------|
| Tower<br>Clocks | } HANGING AND STANDING<br>REGULATORS | } Street<br>Clocks |
|                 |                                      |                    |

CHICAGO,  
64 Washington St.

NEW YORK,  
11 to 19 Cliff St.

LONDON,  
128 Minories.





"AMPHION."—Walnut.

Cut Glass Mirror Panels in Side and Base. Improved Equalizing, Adjustable, Slow Strike Movement. Eight Day Strike on Gong only. Height, 25 inches. 6 inch Dial.

# W. L. Gilbert Clock Co.

GEORGE B. OWEN, General Manager.

Salesrooms:

No. 6 Murray St., N. Y.  
54 & 56 Madison St., Chicago.

Factories:

WINSTED,  
Conn.

MANUFACTURERS OF

## Walnut, Veneered and Other Clocks.

IMPORTERS OF

## Marble and Cuckoo Clocks.

*Catalogue and Price List Furnished upon application.*

# E. N. WELCH MANUFACTURING CO.

AND

## WELCH, SPRING & CO.,

6 WARREN ST., NEW YORK.

W. H. ATWATER, Agent.

SEMBRICH.



MANUFACTURERS OF

## SUPERIOR AMERICAN CLOCKS.

Factories, Forestville, Conn.

Established 1829.

**BLACK WALNUT.**  
Height, 39 Inches. Dial, 6 Inches.  
8-Day Cathedral Gong.



 **N O W !** 

ORDER WHATEVER

**PLATED WARE**

YOU NEED FOR THE HOLIDAYS.

Late Buyers always suffer the disappointment and delay inevitable to the rush of business, broken stocks, uncertainties of railroads, etc. incident to December.

**ROGERS & BROTHER,**  
**690 BROADWAY, NEW YORK.**



ESTABLISHED 1833.  
(50 YEARS.)



**E. IRA RICHARDS & CO.**  
200 BROADWAY, NEW YORK.  
Exclusively Manufacturers of FINE ROLLED PLATED JEWELRY.  
THE LARGEST AND CHOICEST STOCK IN THE COUNTRY.



Examples of Medium Quality Bands made in all the widths, sizes, etc., and acknowledged to be the cheapest for quality and finish in the market.



SOLE AGENTS FOR THE  
 JAMES PICARD,  
 CHARLES LODTMAN  
AND  
 ULYSSE HUMBERT  
 WATCHES.

MANUFACTURERS OF  
 MINUTE, FIVE MINUTE and  
 QUARTER HOUR REPEATERS,  
 with and without  
 CHRONOGRAPH ATTACHMENTS.

LOUIS STRASBURGER & CO.

DIRECT IMPORTERS OF

WATCHES AND DIAMONDS,

WE MAKE EVERY KIND  
 OF WATCH IN  
 OUR OWN  
 FACTORY.

WE KEEP ALL  
 KINDS OF GOLD  
 AND SILVER AMERICAN  
 CASES AND MOVEMENTS.

WE GET THE ROUGH  
 DIRECT AND CUT  
 OUR OWN  
 GOODS.

No. 15 MAIDEN LANE,

→NEW YORK←

Rue Leopold Robert,  
 CHAUX-DE-FONDS.



Boulevard Haussman, 30,  
 PARIS.

MANUFACTURERS OF  
 Split 1-4 Second CHRONOGRAPHS,  
 Split 1-5 Second CHRONOGRAPHS,  
 SINGLE CHRONOGRAPHS,  
 Open Face and Hunting  
 SILVER AND GOLD CASES.

SOLE AGENTS FOR THE  
 Celebrated Brands of Nickel Watches  
 "RAILWAY,"  
 "SUN,"  
 "ALASKA,"  
 and Manufacturers of all grades of  
 8 and 18 Size Movements.



## SHAKSPEARE—NEW VERSION.

*Oberon.* \* \* \* \* "And be thou here again, ere the leviathan  
Can swim a league."

*Puck.* "I'll put a girdle round about the earth in forty minutes,"  
*Following THE AMERICAN LEVER SLEEVE BUTTON,*  
*Which always leads!*



TO THE RETAIL TRADE.

Please ask your Jobber for the goods bearing the *FAMOUS HORSE-SHOE AND CLOVER TRADE-MARK*, and if he should decline to furnish them, kindly write to "*THE MANUFACTURERS OF THE AMERICAN LEVER BUTTONS, PROVIDENCE, R. I.*" who will send the address of Jobbing Houses from whom these *Celebrated Goods* can be purchased.



“THE BEST”  
**THE DUEBER**  
 GOLD WATCH CASES.  
**THE PERFECTION OF WATCH CASE MAKING.**



731318.



731317.

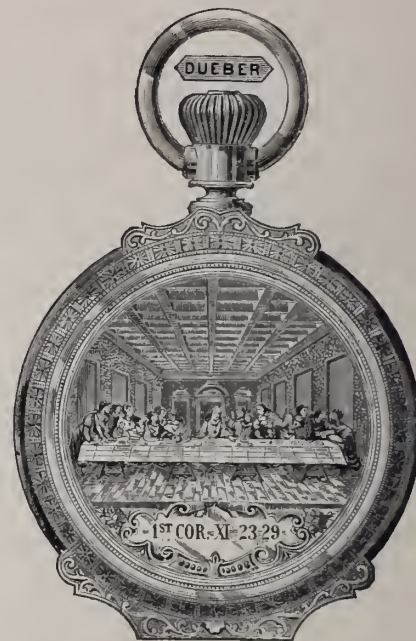

731319.



591907.



591897.



591906.

**THE MOST ELABORATE OF ARTISTIC ENGRAVING.**

The Dueber Watch Case Mfg. Co.

❖CHICAGO,❖

4 Tribune Building.

❖CINCINNATI,❖

P. O. Box 1334.

❖NEW YORK,❖

20 Bryant Building.



THE BEST.

THE DUEBER

COIN



WATCH



TRADE

MARK.

SILVER



CASES

747986.

With Solid Soldered Edges and Joint Bearings Throughout.

For Twenty Years, as to-day, the Leading Watch Case in the American Market.

THE CHEAPEST.

THE NEWPORT

COIN



WATCH

TRADE

MARK.

SILVER



CASES

685370.

With Albata Cap and Silver Joints.

Their Equal in Construction, Finish or Intrinsic Value has never been Produced.

THE PARALYZER.

THE "DUEBER COIN"

COIN



WATCH

TRADE

MARK.

SILVER



CASE

790613.

Struck Up Seamless Style, with Silver Cap, Gold Joints and Joint Bearings.

This Case is intended to Turn Over, Fold Over, Sweage Hammer, and Keep Down all Competiton.



# LERROY W. FAIRCHILD, MANUFACTURER OF

18 JOHN ST.,  
N. Y.

GOLD PENS.

PEN AND PENCIL  
CASES.

CHARM PENCILS.

TOOTH PICKS.

WHISTLES.

MATCH BOXES.

CIGARETTE HOLDERS.

CIGAR PERFORATORS.  
ETC., ETC.

Gold Pens and Ornamental Charms of every description, made from Original Designs and of Standard Quality.

Would invite the attention of buyers to a large and comprehensive assortment of novelties in this line never before presented to the Trade.

The unique and graceful conception of sedate styles and the wide range of odd and fantastic conceits presented in these goods render them exceedingly desirable for Holiday Presents and Presentation Purposes, while the unapproachable excellence of the workmanship and finish which characterize all goods made in my establishment, cannot fail to satisfy the most fastidious and critical taste.

Especial attention is directed to my New Illustrated Catalogue of Designs, containing many objects of artistic merit and designed especially for the Jewelry Trade.

Dealers carrying but a limited stock of these goods can present this Catalogue to their customers, and selection made therefrom without fear of exposing the dealer's profit.

Copies of the Catalogue will be forwarded to legitimate dealers only upon application.

LERROY W. FAIRCHILD,

18 JOHN ST., N. Y.







# STUART & SHEPARD, IMPORTERS,

No. 2 Maiden Lane, New York.

## FRENCH MARBLE CLOCKS OF ARTISTIC DESIGNS.

BRONZES, BRASS AND FANCY GOODS.

SILVER JEWELRY (Bright Cut),

MUSICAL BOXES of the Celebrated Manufacturer

**B. A. BREMOND,**

All Variety and Sizes from 4 to 30 Airs. Wholesale Dealers in

**AMERICAN WALTHAM WATCHES.**

## Diamond Cutting and Polishing.

### Repairing for the Trade

Rough Jewels Finished; Nicks and Scratches taken out. Many stones can be increased in value by being put in shape.

#### Diamond Dust for Watchmakers' Use.

By cutting our own Diamonds, we have unequalled facilities for putting up Diamond Dust in any grade of fineness, and absolutely pure.

#### DIAMOND TOOLS.

|                                                           |        |
|-----------------------------------------------------------|--------|
| Diamond Counter-sink, . . . . .                           | \$1 00 |
| Brushes, charged ready for use, . . . . .                 | 75     |
| Diamond File, charged on one side and one edge, . . . . . | 3 50   |
| Diamond Lap, 1 inch, . . . . .                            | 3 00   |
| “ “ 1¼ “ . . . . .                                        | 4 00   |
| “ “ 1½ “ . . . . .                                        | 5 00   |

These are all charged with the best quality diamond dust, and any grade of fineness desired.

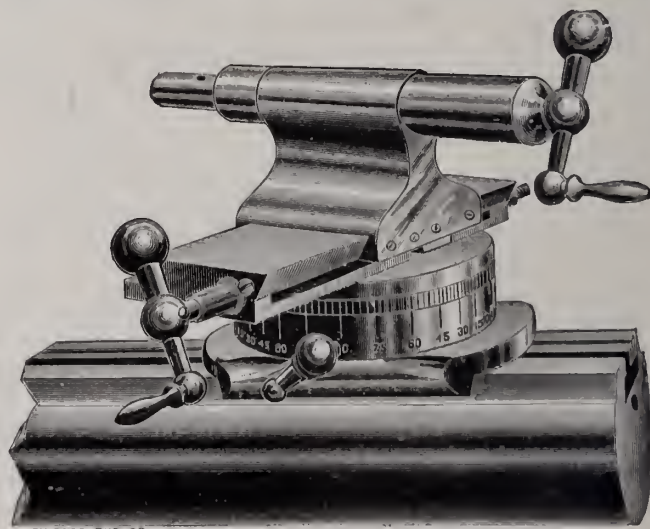

**UNIVERSAL TAIL STOCK.**

(PATENT APPLIED FOR)

We call the attention of the Trade to the most desirable tool or appendage to the watchmaker's lathe yet invented. It takes the place of a Slide Rest and Tail Stock (screw), also does away with the necessity of a Jeweling tool. It can be used for counter sinking, drilling, freeing, in fact, takes the place of a Universal Lathe. The tool is adjustable, just the tool for altering Key wind watches to Stem wind. The base is marked off in degrees, so that no mistake can be made. We also manufacture a rounding up tool, wheel cutter, and grinding fixture to go with the same, the whole making a complete outfit, so that the most intricate work can be accomplished by any ordinary workman.

**GILES, BRO. & CO.,**

State and Washington Streets,

CHICAGO, ILLS.



**STERN & STERN,**

**JOBBERS**

WATCHES,

**IMPORTERS**

DIAMONDS,

**MANUFACTURERS OF**

JEWELRY.

SPECIAL ATTRACTIONS FOR THE HOLIDAY TRADE.

Goods Sent on Approval. Prompt Attention Given to Orders.

NO. 6 MAIDEN LANE, N. Y.



# DAVID F. CONOVER & CO.

(SUCCESSORS TO WM. B. WARNE & Co.)

Manufacturers and Wholesale Dealers in

## WATCHES and JEWELRY.

Wholesale Agents For

### Rogers & Brother's Flat and Hollow Ware



### Celluloid Eye-Glasses.

And Sole Agents for the

Patent Railroad Train Watch Chains, Nickel.

WHOLESALE AGENTS FOR

T. A. WILLSON & CO.'S Optical Goods.

Would invite attention to the following new grades of Steel Spectacles lately introduced in the market.

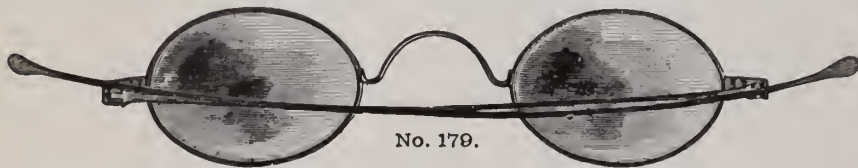

They are Steel, Full Tempered. Parts Interchangeable. Joints so constructed that wear is compensated for. Temple will not work loose and fall down as in old style joints. Nose-piece on No. 155 reinforced where it joins eye, giving extra strength with neatness.

PRIZE MEDALS AT ALL EXHIBITIONS WHERE EXHIBITED.

Patented July 31, 1877.

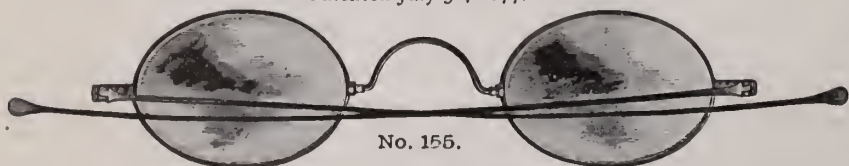

American Watch Wholesale Salesroom:

Southeast Cor. Chestnut and Seventh Sts., First Floor,

**PHILADELPHIA.**

DAVID F. CONOVER,  
C. FRANK WILLIAMS,  
B. EDGAR RIGHTER.

### A SPECTACLE TEMPLE THAT WILL NOT WEAR LOOSE.

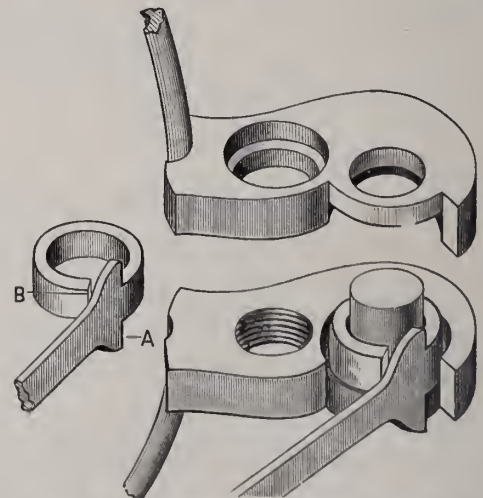

Patented May 13th, 1879. Re-issued June 8th, 1880.

- A.—Stop for Temple, preventing Strain on Joint.
- B.—Compensating eye, for taking up wear of joint. The eye of Temple is smaller than Stubb Steel Joint Pin on which it works, and is left open at B, exerting a Spring Tension on Pin.



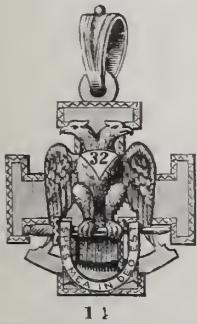
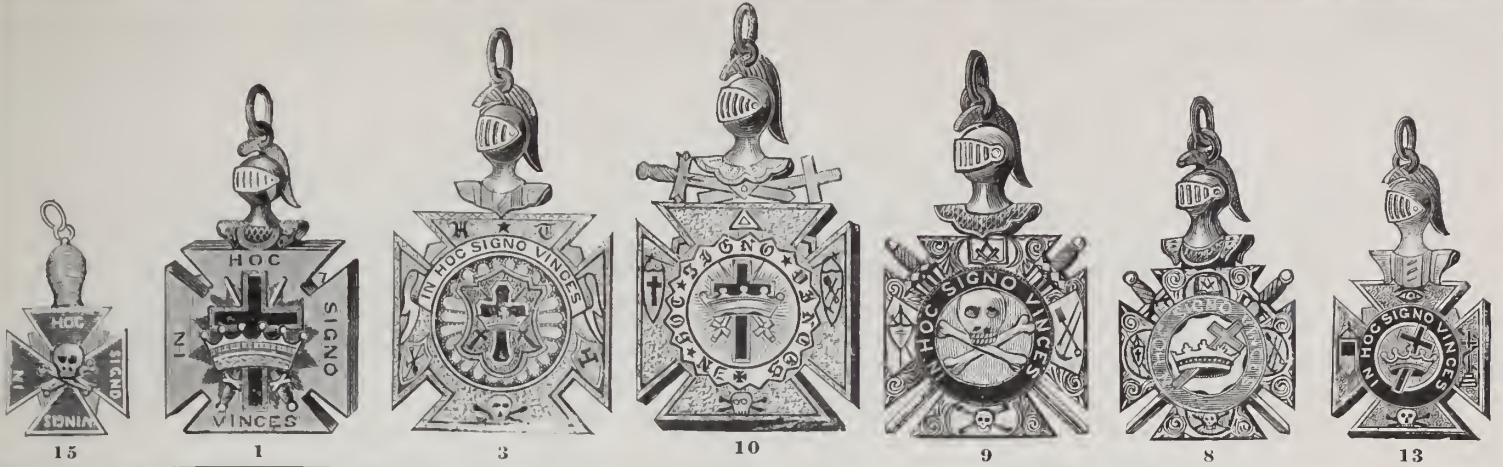

# WIDE AWAKE!

## A. & J. PLAUT, Wholesale Jewelers,

13 EMERY ARCADE,

CINCINNATI, OHIO.

JOBBERS OF

ELGIN, WALTHAM, SPRINGFIELD AND E. HOWARD & CO.'S MOVEMENTS.

DUEBER, BOSS, FAHYS AND WALTHAM CASES.

Meriden Silver Plate Co.'s Hollow Ware.

Rogers & Bro.'s Flat Ware.

Swiss Watches in Gold, Silver and Nickel.

Anson's Clocks.

### Diamonds,

MOUNTED AND UNMOUNTED, WALTHAM CHRONOGRAPHS, HORSE TIMERS,  
OPTICAL GOODS.

CHOICE SELECTIONS SENT ON APPLICATION.

We always have the Latest Novelties in Jewelry as soon as they appear. We make a Specialty of the Best Goods Manufactured, buy exclusively for cash and are able to give Bottom Prices.

We issue no Illustrated Catalogue. They are a detriment instead of a benefit to the legitimate Jewelry Trade. Our customers are without exception opposed to them. They are issued ostensibly for the Retail Jeweler, but invariably find their way into the dry goods merchants' and grocers' hands. Of course the party issuing them pleads **ignorance and innocence**, and can't account for the manner in which they get into their possession, and expects the Retail Jewelers to swallow their "taffy."

In these days of **sharp competition** illustrated catalogues are quite useless to the Retail Jeweler, for some of the following reasons:

1. A great many goods illustrated, owing to the length of time it takes to prepare, print and issue them, are, at the time they leave the publisher's hands, already **supplanted by later and handsomer designs and styles**. Therefore they never illustrate the latest designs.
2. **The Prices quoted**, whether on catalogue or on separate printed lists, **are not the lowest**, and any responsible Jeweler can buy for from ten to twenty per cent. less.
3. As illustrations do not show the quality or finish of the goods, Jewelers prefer to select from stock, and any of them will testify to being enabled to see quite a sufficient number of stocks.
4. Illustrated catalogues represent a large expenditure of time, labor and money, which **buyers invariably pay for** in the enhanced price of goods bought through that medium.

We refer to and quote the opening lines of a passage in a dissertation on the utility of catalogues, by a neighbor and competitor. "**Catalogues are good when not issued, etc.**" This is a sentiment all the Trade will subscribe to. If Jobbers are deluded into preparing and printing them, they ought, when finished, at least sell them by the pound to rag dealers, but **never to issue** them, if they wish to maintain their standing with the Trade.

## A. & J. PLAUT,

13 EMERY ARCADE,

CINCINNATI, O.





# JOSEPH FAHYS & CO.,

MANUFACTURERS OF

## WATCH CASES,

38 Maiden Lane,

NEW YORK.

78 MONROE STREET, CHICAGO.



654321



654322



654323



654324



654326



654325

Electrotypes of any of the above cuts, for advertising purposes, will be furnished the Trade, free of charge, upon application.



THE  
 BROOKLYN WATCH CASE CO.  
 EAGLE CASE.



In order to meet an imperative and growing demand in the Trade for a reliable grade of Low Karat Cases, this Company, seven years ago, was induced to place upon the market their since Celebrated **EAGLE CASES**, which are made of full 8-k. gold in all their parts, joints and bearings, the backs and caps free from solder, saving that which holds the joints. Since their introduction, these cases have achieved a wide spread reputation for the reliable and standard quality maintained in their manufacture. It has been demonstrated that the wearing qualities of the **EAGLE CASES** are unexcelled by any 12-k. case in the market, while their color is permanent and the appearance equal to that of the best cases made of this grade. The 8-k. **EAGLE CASES** will stand the severest acid test and will not tarnish when exposed in the show case or worn in the pocket.

All these goods are Stamped in the Cap with the Trade Mark of the Company,

B. W. C. Co.

and are guaranteed to be of the uniform standard designated.

A LARGE AND WELL ASSORTED STOCK OF 18-K., 14-K. AND EAGLE CASES IN THE LATEST AND MOST ARTISTIC DESIGNS, KEPT CONSTANTLY ON HAND.

For Sale by all the Principal Jobbers.



# Derby Silver Co.'s Celebrated Wares, Finest Quadruple Silver Plated Ware.

FACTORIES:

BIRMINGHAM, CONN.  
TORONTO, ONTARIO.

SALESROOMS:

3 UNION SQUARE and 25 MAIDEN LANE, N. Y.  
170 STATE STREET, CHICAGO.  
513 MARKET STREET, SAN FRANCISCO.  
31 ADELAIDE STREET, EAST, TORONTO.

Address all Communications to Birmingham, Conn.



No. 1123. SUGAR.  
Hammered, Chased, Gold Lined,  
\$7.50.



No. 4802. NUT BOWL.  
Gold Inlaid, \$20.00.



No. 1123. CREAM.  
Hammered, Chased, Gold Lined,  
\$7.75.



No. 62. CUP.  
Chased, Niello, Gold Lined, \$4.00.

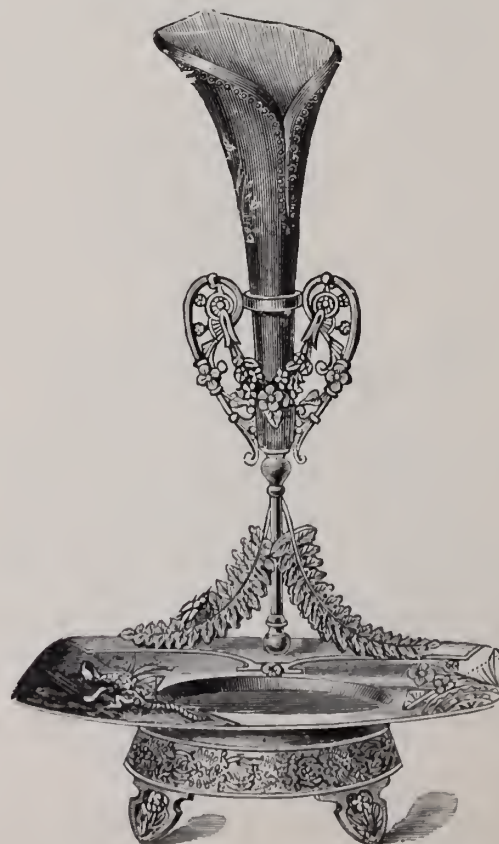

No. 3523. CARD RECEIVER.  
Chased, Niello and Gold, \$10.50.



No. 67. CUP.  
Chased, Gilt, \$4.25.



OFFICE 16 MADISON AVE.

**A. PINOVER & CO**  
 MANUFACTURERS  
 OF SEAL RINGS & DIAMOND MOUNTINGS. A FULL LINE OF DIAMOND MOUNTED GOODS CONSTANTLY ON HAND. WE CALL SPECIAL ATTENTION TO OUR RAISED INITIAL GLOVE RINGS

THE INCRUSTED GOLD RING IS THE ONLY GLOVE RING.



247



248

THE INCRUSTED RING of our manufacture is a 24 KARAT Gold letter imbedded in a Curved Stone WITH or WITHOUT DIAMONDS, and is sold by us at the same price as the raised initial rings of any other manufacturer.



246

WHAT A GLOVE RING IS.

An Incrustated Letter on a Curved Stone is THE ONLY RING that can be technically called a GLOVE RING.

WHAT IS NOT A GLOVE RING.

A Raised Initial on EITHER a CURVED or FLAT Surface IS NOT a GLOVE RING.

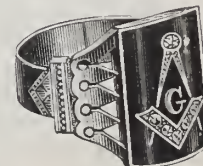

249

An incrustated ring will permit the glove to set flat upon the finger, while any raised letter will have a tendency to tear the glove; if not, to at least make the finger look awkward by making the glove bulge, and is, therefore, not a glove ring.

FOR SALE BY EVERY JOBBER OF JEWELRY IN THE UNITED STATES.

Manufactured by A. PINOVER & CO.



# SIMPSON, HALL, MILLER & CO.,

36 E. 14TH ST., UNION SQUARE, N. Y.

FACTORIES, WALLINGFORD, CONN.

Manufacturers of HIGHEST QUALITY OF SILVER PLATED WARE.

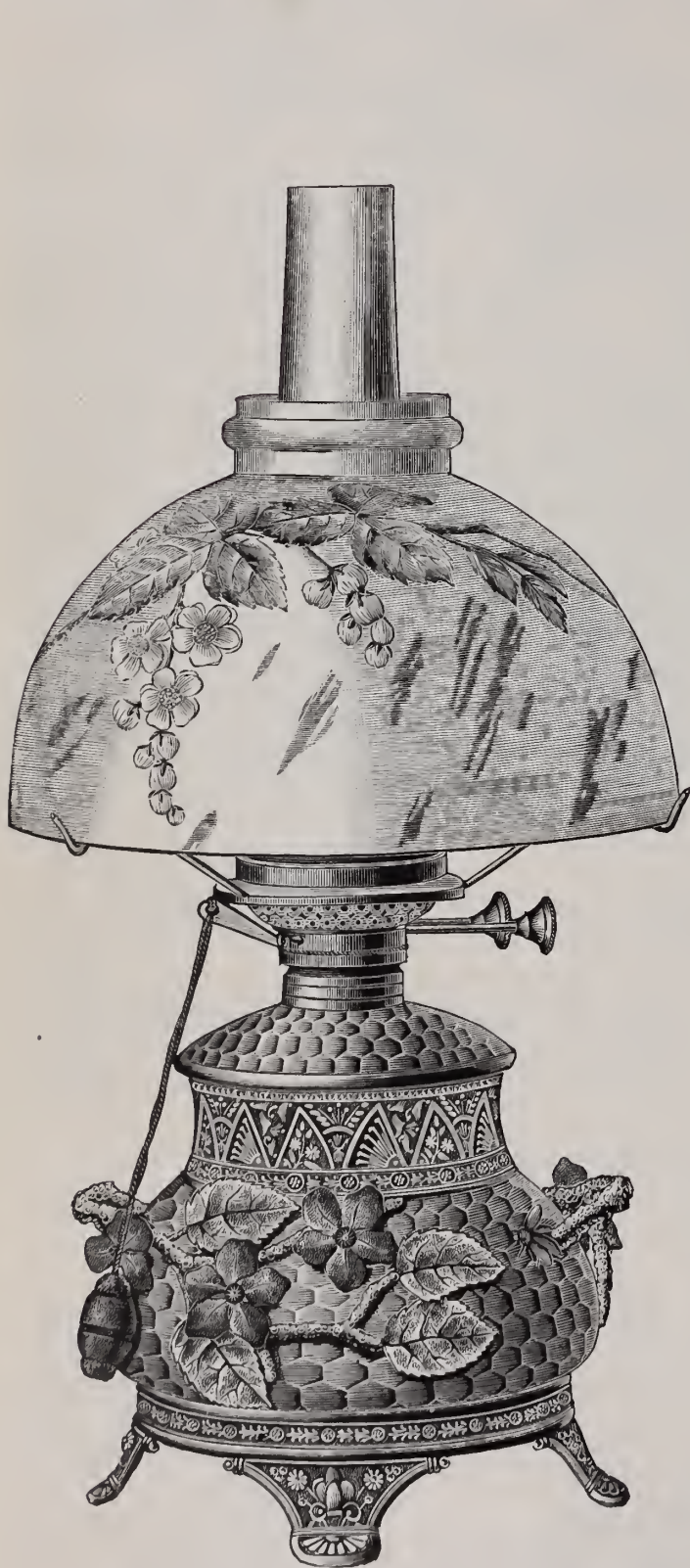

Spoons and Forks sold by Simpson, Hall, Miller & Co., Wallingford, Conn., bearing my individual name, to authenticate the quality, are all made in their Factories, of Finest Nickel Silver, under my personal supervision, and by my ideas of Style, Pattern and Finish, and control of quality.

The patterns are made exclusively by them and patented, and are the Highest Quality Goods in market.

My individual name, Wallingford, Conn., is a positive guarantee of the quality of the goods, and in buying them the Trade do so upon my personal guarantee of quality.

WM. ROGERS, PERSONALLY,

Since May, 1878, with SIMPSON, HALL, MILLER & Co., Wallingford, Conn.





**INCRUSTED STONES A SPECIALTY.**

*All kinds of Monogram Work and Initial Lettering executed in different colors of gold and set with diamonds.*

*On account of having made a specialty of Incrustation Work, and having facilities in this branch, superior to those of any house in the trade, I can ensure prompt completion and delivery of orders, and reasonable prices for first-class work.*

— ALL MY WORK IS GUARANTEED. —



**CHARLES F. WOOD,**

169 BROADWAY, NEW YORK.

Established 1854.

**HENRY MAY,**

19 JOHN ST., NEW YORK.

**Manufacturing Jeweler,**

Jobber in all Domestic Movements and Cases,  
And Sole Maker of the Charles Melville Watch  
and Brighton Watch Co.'s Movements,  
of which the cuts are *fac similes*.

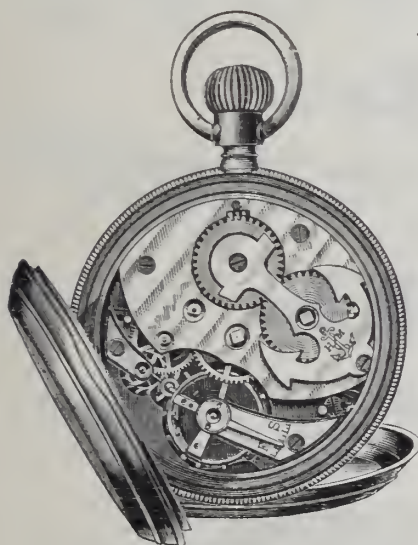

Trade Mark.

All Watches and Movements, bearing above names, *without* my Trade Mark on Movement, or unaccompanied by following Certificate are Imitations.

**BEWARE OF THEM!!!**

This is to Certify, that Watch Movement No.....bearing the above Trade Mark, has been manufactured by me, and is warranted a good Timekeeper.

HENRY MAY.

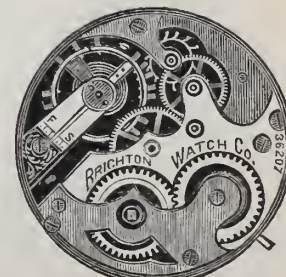
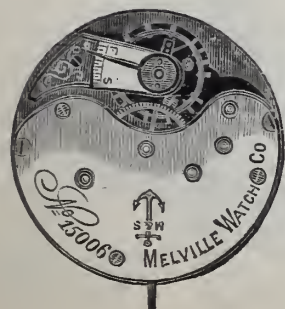



ESTABLISHED 1847.

WATCHES



TRIUMPH-ROSKOPF WATCH.



JEWELRY

**J. T. SCOTT & CO.,**

7 MAIDEN LANE, N. Y.

IMPORTERS OF  
**WATCHES.**

MANUFACTURERS OF  
**JEWELRY.**

JOBBERS IN

**All American Movements, Gold & Silver Cases, Jewelry, Chains, Diamonds, Etc.**

Our Stock of Holiday Goods is much larger and more comprehensive than ever before, and contains all the Novelties of the Trade.

All orders committed to our care will receive prompt and careful attention. Jobbing done on our premises under our personal supervision.

Would call especial attention to our Triumph-Roskopf and Roskopf Watches, Cased in Nickel Open Face Cases, in 18 and 20 Lines, and the best watch in the market for the money. We have just received our Triumph-Roskopf Movement made to fit the Elgin stem wind cases, and is a very superior cheap movement.

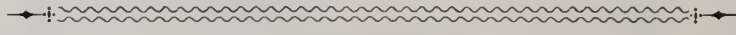

**REMOVAL.**

On or about February 1st we will remove to the large and spacious rooms (ground floor)

**No. 4 MAIDEN LANE.**

Our constantly increasing trade compels us to seek larger and more commodious quarters.

We cordially invite our customers to make their headquarters with us while in New York, and will have, for their convenience, a private office specially fitted up for them to attend to correspondence, etc. Thanking you for past favors, we remain, very respectfully,

**J. T. SCOTT & CO.**

DIAMONDS



ROSKOPF WATCH.



CHAINS, &c.





Manufactory, 47, 49 & 51 Franklin Street, Newark, N. J.

# MILLER BROS.,

## No. 7 Maiden Lane,

## NEW YORK.

# IMPORTERS OF DIAMONDS

— AND —

## MANUFACTURERS OF FINE JEWELRY.



OPEN.

We would call the attention of the Trade to our Newly Patented TURN OVER CAP SLEEVE BUTTON. The mechanical device by which the cap is turned is by a spring working in the pillar, which makes a much stronger and more durable cap than any other in the market.



CLOSED.

### INITIAL GOODS A SPECIALTY.

# CROSS & BEQUELIN,

## 21 MAIDEN LANE, N. Y.

P. O. BOX No. 531.

Manufacturers of the **CENTENNIAL WATCH**, **CENTENNIAL CHRONOGRAPH** and **CENTENNIAL CALENDAR** (Reliable Timekeepers.)

the **Best Watches for the money made.**

**DEALERS IN AMERICAN WATCHES, WATCH MATERIALS, ETC.**



CENTENNIAL.



CENTENNIAL CHRONOGRAPH.



CENTENNIAL CALENDAR.



# WM. SMITH & CO.,

MANUFACTURERS OF

## GOLD and SILVER Chains & Jewelry,

Also a Large Line of SILVER RINGS.

OFFICE :

**No. 25 Maiden Lane, New York.**

MANUFACTORY—No 61 PECK STREET, PROVIDENCE, R. I.

# W. & S. BLACKINTON,

MANUFACTURERS OF

ONLY

## FINE ROLLED PLATE CHAINS,

Necklaces, Polished and Roman, of Latest Gold Designs. Also a Complete Line of Gents' and Ladies' Locketts and Pendants.

In consequence of the first-class reputation our goods have obtained, unscrupulous dealers have been selling goods of an inferior quality, represented as our manufacture. In order to protect ourselves, as well as dealers, all goods of our manufacture will hereafter bear this

TRADE MARK. **W&S.B** ★ TRADE MARK.

*These Goods are for sale by all Wholesale Dealers.*

# WM. J. SUTTIE,

MANUFACTURER AND JOBBER OF

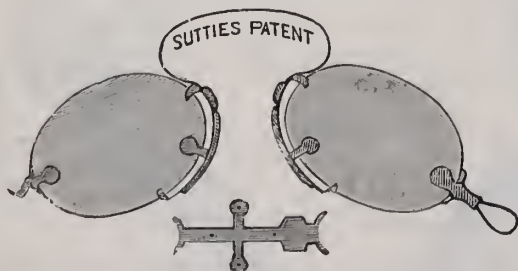

## Eye-Glasses and Spectacles,

In GOLD, SILVER, STEEL and SHELL.

**No. 39 Maiden Lane, New York.**

**CYLINDRICAL AND PRISMATIC GLASSES.**

*REPAIRING A SPECIALTY,*

# Webster's Silver Solution,

PREPARED BY

**E. G. WEBSTER & BROTHER,**

(Established 1859.)

Manufacturers of Quadruple

**Electro Silver Plated Ware**

14 MAIDEN LANE, N. Y.,

Expressly for Cleaning Silver and Silver Plated Ware.

Jewelers will find this a valuable adjunct for cleaning their stock, and a reliable article to recommend to their customers.

Guaranteed entirely free from Cyanide, Acid, Grit, or anything detrimental to the Finest Wares.

Packed in Boxes containing 2 Doz. Bottles.

Price. \$1.25 per Doz., NET.



# CHESTER MANCHESTER & CO.,

MANUFACTURERS OF

## Gold & Silver Chains,

No. 13 HANOVER STREET,

PROVIDENCE, R. I.

# THE YALE CLOCK CO.

Manufacturers of

## Fine American Clocks

In Great Variety of Styles & Finish.

EXCLUSIVE OWNERS OF  
F. A. Lane's Patents.

Originators of the Celebrated  
YALE GEM CLOCK.

Over 100,000 already in use.

Office and Factory:  
**NEW HAVEN, CONN.**

CATALOGUES and PRICE LISTS  
Mailed on Application.

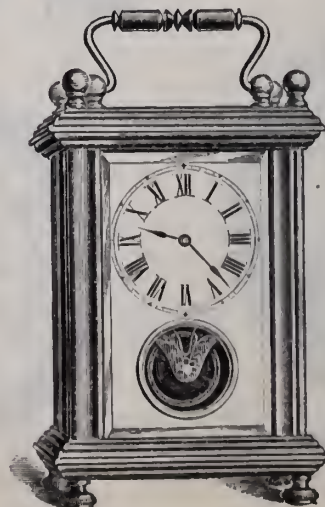



# LOUIS A. SCHERR & CO.

Importers and Wholesale Dealers in

## Watches, Jewelry,

WATCH MATERIALS, TOOLS, GLASSES, &c.

Spectacles, Silk Guards, &c.

Wholesale Agents for American Watches.

**No. 726 CHESTNUT STREET  
PHILADELPHIA.**

AGENTS FOR THE WHITCOMB LATHE  
AGENTS FOR W. F. NYE'S WATCH AND CLOCK OILS.

# HAUG & LUTHY,

MANUFACTURERS OF

## FINE DIAMOND MOUNTINGS, ETC.,

130 FULTON STREET,

Cor. Nassau St., NEW YORK.

N. B.—All Diamond Mountings of our Man-  
ufacture have a Patented

✦SELF-CLOSING ✦ SAFETY ✦ CATCH✦

## Abbott's Stem Winding Devices

*Are for sale and are applied to watches by  
all reputable jobbers, and by the manufac-  
turer,*

### HENRY ABBOTT,

7 MAIDEN LANE, NEW YORK.

FACTORY, JOHN STREET.

ALSO MANUFACTURER OF

### Fine Enamel Watch Dials.

# HODGE, SLEMMONS & CO.

WHOLESALE DEALERS IN

American & Swiss Watches,

DIAMONDS,

Gold and Plated Jewelry and Gold Chains,

CLOCK MATERIALS, ETC.,

**77 FIFTH AVE., PITTSBURG, PA.**

# JOHN W. STEELE,

MANUFACTURER OF

## FINE GOLD JEWELRY,

—AND—

BRAINERD'S

PATENT

## LOCKETS

Patented June 17, 1874.



No. 9 Maiden Lane, NEW YORK.

Agents for the Lancaster, Pa., Watches.

## A. FRIEDENTHAL & CO.

MANUFACTURING JEWELERS,

AND IMPORTERS OF WATCHES.

43 Maiden Lane, New York.

MATERIALS and OPTICAL GOODS.



# COLBY & JOHNSON,

Manufacturers and Jobbers,  
17 MAIDEN LANE, NEW YORK.

WATCH CASES,  
FINE JEWELRY,  
AMERICAN WATCHES.

SOLE MANUFACTURERS OF  
**CELLULOID WATCH CASES,**  
MOUNTED IN  
GOLD, SILVER OR NICKEL.

## PEARCE & HOAGLAND,

MANUFACTURERS OF  
Gold Pens, Pencils, Pen Holders, Tooth Picks,  
OF EVERY DESCRIPTION.



SOLE MANUFACTURERS OF THE  
**QUILL RESERVE TOOTH PICK,**

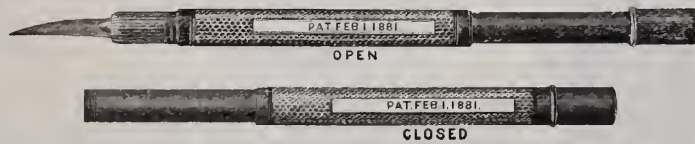

The Holder of this Case is made in various styles in Gold Plate, Celluloid, Ivory, etc., while the Pick is of ordinary Goose Quill, and can be easily replaced by a new one, at any time, from the Reserve in the end of the Holder, and is the only Pick that will not injure the Teeth.

FOR SALE BY ALL JOBBERS.

Office and Factory, 29 Point Street, Providence, R. I.

ESTABLISHED 1853.

## WELCH & MILLER,

**JEWELRY  
Case Manufacturers,**

Of Morocco, Velvet, Russia, Brocade and Plush.

SHOW CASE TRAYS OF ALL DESCRIPTIONS.

LOCK RING TRAYS FOR DIAMOND RINGS.

Agents for Jewelers' Cotton and Twine.

All Goods of our Own Manufacture, and a Large Stock  
Always on Hand.

**169 BROADWAY, NEW YORK.**

## SUSSFELD, LORSCH & NORDLINGER,

IMPORTERS OF

# Optical & Mathematical Instruments,

Watchmakers' Tools, Materials, Etc.

SPECIALTIES:

**BARDOU & SONS'** Universal Opera Glasses. U. S. Army and Navy Glasses.  
Rifle Range Telescopes, Etc., Etc.

**LA REINE** Opera and Marine Glasses.

**CROWN** Spectacles and Eye-Glasses.

**PARADIS MAINSPRINGS.**

**PARAGON TOOLS.**

13 MAIDEN LANE, NEW YORK.

16 Rue D'Enghien, PARIS.

FRANK O. LODWICK.

CHAS. A. NOLTING.

## LODWICK & NOLTING, WHOLESALE JEWELERS,



JOBBERS OF  
Gold, Silver & Nickel  
WATCHES,  
Gold and Roll Plate  
JEWELRY  
MOVEMENTS  
AND  
Watch Cases,  
SPECTACLES,  
Clocks and Silverware.  
Positively will all Orders, In-  
quiries and Repairs receive im-  
mediate and reliable attention.  
CINCINNATI.

ESTABLISHED 1850.

## JOHN T. MAURAN,

MANUFACTURER OF

→ FINE ROLLED PLATE GOODS ←

15 MAIDEN LANE, NEW YORK.

SPECIALTIES FOR THE FALL.

FULL LINE OF

STONE LACE PINS IN RUBY AND SAPPHIRE DOUBLETS,  
GARNETS AND FOILED WHITE STONES,

Jet Lace Pins, Sets and Ear Knobs, Solid Gold White Stone Knobs.

ALSO

Full Line of Coral and Wire Sets, Lace Pins, Knobs, &c.

These Goods, which are so well and favorably known to the Trade, bear this

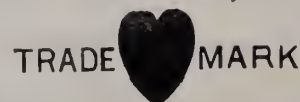

as well as the same being stamped on the cards.



**HELLER & BARDEL**

MANUFACTURERS OF



13 John St., New York.

*A Full Line of DIAMONDS, Mounted and Unmounted, Always on hand, which we will send for Selection to Responsible Houses.*

All Goods Ordered on Selection or for Stock are Insured while in the Hands of the Express Companies.

R. WALLACE & SONS M'FG Co.,

MANUFACTURERS OF



**SILVERWARE,**

GUARANTEED  $\frac{925}{1000}$  FINE.

WALLINGFORD, CONN.

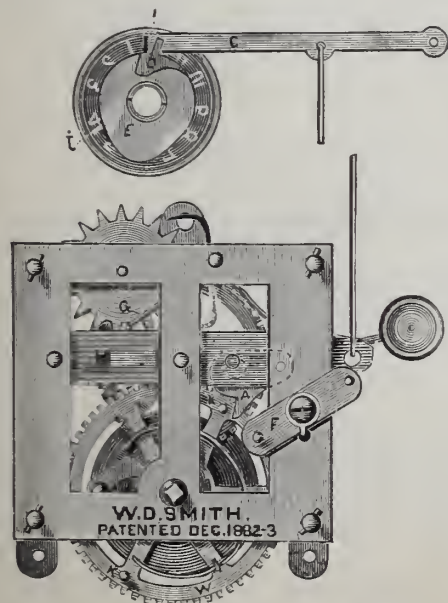

**W. D. SMITH'S**  
Patent Eight-Day  
Alarm Apparatus,  
Designed to be Attached to  
Eight-Day Clocks.

Simple in Construction, easily attached, and durable. Endorsed by the Trade generally. Send for Circular giving full description and particulars.

**W. D. SMITH & CO.,** Manufacturers & Cen'l Ag'ts,  
867 PENN AVE., PITTSBURGH, PA.

LEROY C. FAIRCHILD & CO.

MAKERS OF

GOLD PENS, PEN & PENCIL CASES,

No. 14 MAIDEN LANE,

LEROY C. FAIRCHILD,  
G. HARRY ALLEN.

NEW YORK.

**WOOD & HUGHES,**  
STERLING

**SILVERWARE MANUFACTURERS,**

New York Agents for the Derby Silver Co.'s

**Fine Quadruple Plated Ware,**

**No. 16 John Street, N. Y.**

206 Kearney Street, San Francisco, Cal.

**HASKELL & MUEGGE,** Agents.

**J. B. & S. M. KNOWLES,**

MANUFACTURERS OF

**Sterling Silver Ware,**

No. 20 MAIDEN LANE,

**NEW YORK.**

**FACTORY, PROVIDENCE, R. I.**





# GORHAM M'F'G CO., (Silversmiths,)

NEW YORK,  
37 Union Square.

CHICAGO,  
170 State Street.

SAN FRANCISCO,  
120 Sutter Street.



The "Medici,"

*Design Copyrighted  
1883.*

The Gorham Company present to the Trade for the present season new patterns in Sterling Silver Spoons and Forks,

## THE "MEDICI." THE "CLUNY." THE "HIZEN."

The Illustration here given of the "Medici" is of the handle of the Soup Ladle, showing to the best advantage the characteristics of the pattern. The central figure of the design varies in each of the pieces, while the outline of each is the same, preserving the harmony as a whole and telling the story of the Italian Court. Whether in Merit of Design or Skill in Execution, it marks a decided advance step.

The "Cluny" is of Floral Design, in bold relief as if cast and chased; it is, consequently, a pattern of heavy weight. It is now completed as far as applies to dozen work, the remaining pieces being in process.

Notwithstanding the enhanced cost of the preparation of the "Medici" and "Cluny," the price to the Trade will be the same per ounce as for our other standard patterns.

The "Hizen" is adapted for Fancy Pieces; the handles are cast, Japanesque in design, the decoration of the bowls are hand chased, and parcel gilding is introduced to good effect.



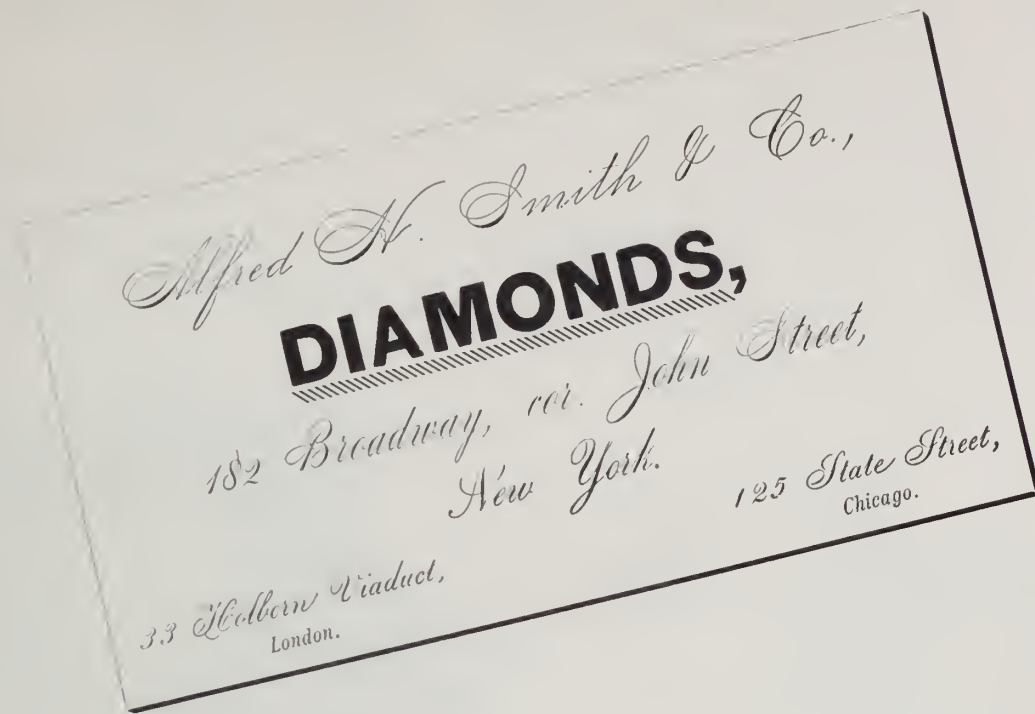

❖: HOLIDAY ANNOUNCEMENT. ❖:

We shall be pleased to forward to dealers "on memorandum" during December, any goods

MOUNTED OR UNSET

for which they may have SPECIAL CALLS, and we shall give to such orders extreme care and great promptness, asking in return as early a report as possible.

To avoid, however, misapprehension and possible disappointment, we beg to state that we cannot "CONSIGN" goods to form a stock from which to sell during the holiday trade.

Soliciting your orders, we remain, yours respectfully,

Alfred H. Smith & Co.

182 Broadway, N. Y.

December 1<sup>st</sup>, 1883.



**THE**  
**NEW HAVEN CLOCK CO.**  
**MANUFACTURERS, IMPORTERS, DEALERS,**

**FACTORIES:**  
**NEW HAVEN, CONN.**

**WESTERN OFFICES AND SALESROOMS:**  
**31 Washington St., Chicago, Ill., 134 Sutter St., San Francisco, Cal.**

**GENERAL OFFICE AND SALESROOMS:**  
**16 & 18 PARK PLACE, New York.**

**EUROPEAN OFFICE AND SALESROOMS:**  
**Victoria St., Liverpool, Eng.**

We beg to call special attention to our line of Fall Importations of Marble, Gilt and Alabaster, Antique Brass and Porcelain Placques, Clocks, Bronzes and Novelties for the Holiday Trade. Also, New and Novel Designs for the Fall Season of 1883, in Bamboo, Walnut, Ash, Porcelain, Nickel, Brass, and Plush Cases.

No. 124, GILT AND ALABASTER.

MARBLE.



15 DAY, 1/2 HOUR STRIKE.  
 Height, with Glass Shade, 15 in. Width, with Glass Shade, 19 in.

LARK.—Porcelain and Plush Cases.

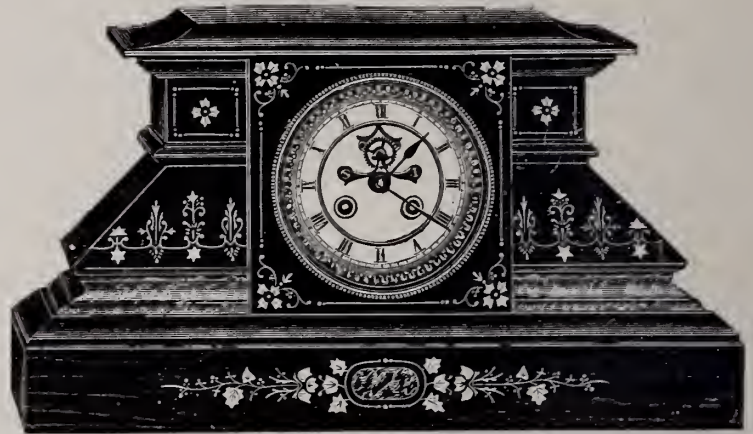

15 DAY STRIKE. CATHEDRAL GONG.  
 Height, 8 1/2 inches. Base, 15 inches. Dial, 4 inches.

ANTIQUE BRASS, No. 2.—Visible Escapement,  
 Porcelain Dial.



1 Day Lever Time. Nickel Plate Movement.  
 A Reliable Timekeeper.



8 DAY, 1/2 HOUR STRIKE, CATHEDRAL GONG.  
 Height, 13 1/2 inches. Dial, 4 inches. Also in Plain Porcelain Dial.

**CATALOGUES AND PRICE LISTS FURNISHED THE TRADE UPON APPLICATION.**





CARTER, SLOAN & CO.,  
MANUFACTURERS OF ALL KINDS OF

GOLD JEWELRY,

No. 15 MAIDEN LANE,  
NEW YORK.

A. CARTER, JR.  
A. K. SLOAN,

C. E. HASTINGS,  
G. R. HOWE.

BALDWIN, SEXTON & PETERSON,

IMPORTERS OF

DIAMONDS and all PRECIOUS STONES,

MANUFACTURERS OF

DIAMOND AND RICH JEWELRY.

Cutters and Polishers of

DIAMONDS

692 & 694 BROADWAY, NEW YORK.

120 SUTTER ST., SAN FRANCISCO, CAL.

*J. F. Chatellier,*  
*Manufacturing Jeweler,*

*692 & 694 Broadway,*

*New York.*

TRADE



MARK

STERLING.

Whiting Manufacturing Co.

SILVERSMITHS,

BROADWAY & FOURTH ST., N. Y.

ESTABLISHED 1837.

TAYLOR & BROTHER,

Old House READ, TAYLOR & CO.,

Importers of Diamonds and Pearls,

AND

MANUFACTURERS OF DIAMOND JEWELRY,

21 Holborn Viaduct, 676 Broadway,

LONDON.

NEW YORK.

ESTABLISHED 1813.

THOMAS G. BROWN & SONS,  
Newark, N. J., & 5 Bond Street, New York.

MANUFACTURERS OF

ARTISTIC JEWELRY  
FOR PRESENTATION,

Including Prizes for ROWING, RIFLE SHOOTING, ARCHERY and  
all ATHLETIC SPORTS.

COLLEGE SOCIETY PINS AND CLASS RINGS, ALSO BADGES FOR MILITARY  
AND CIVIC BODIES IN ALL METALS.

Employing able Designers, and having all work, both in Designing and Manu-  
facturing, done in our own factory, we can submit, for the inspection of those  
interested, entirely original designs, appropriate in style, and not to be seen else-  
where.

Estimates and Designs will be sent to Reputable Dealers when desired.



# REED & BARTON,

MANUFACTURERS OF FINE

# TABLE WARE AND FANCY GOODS

IN GOLD AND SILVER PLATE.

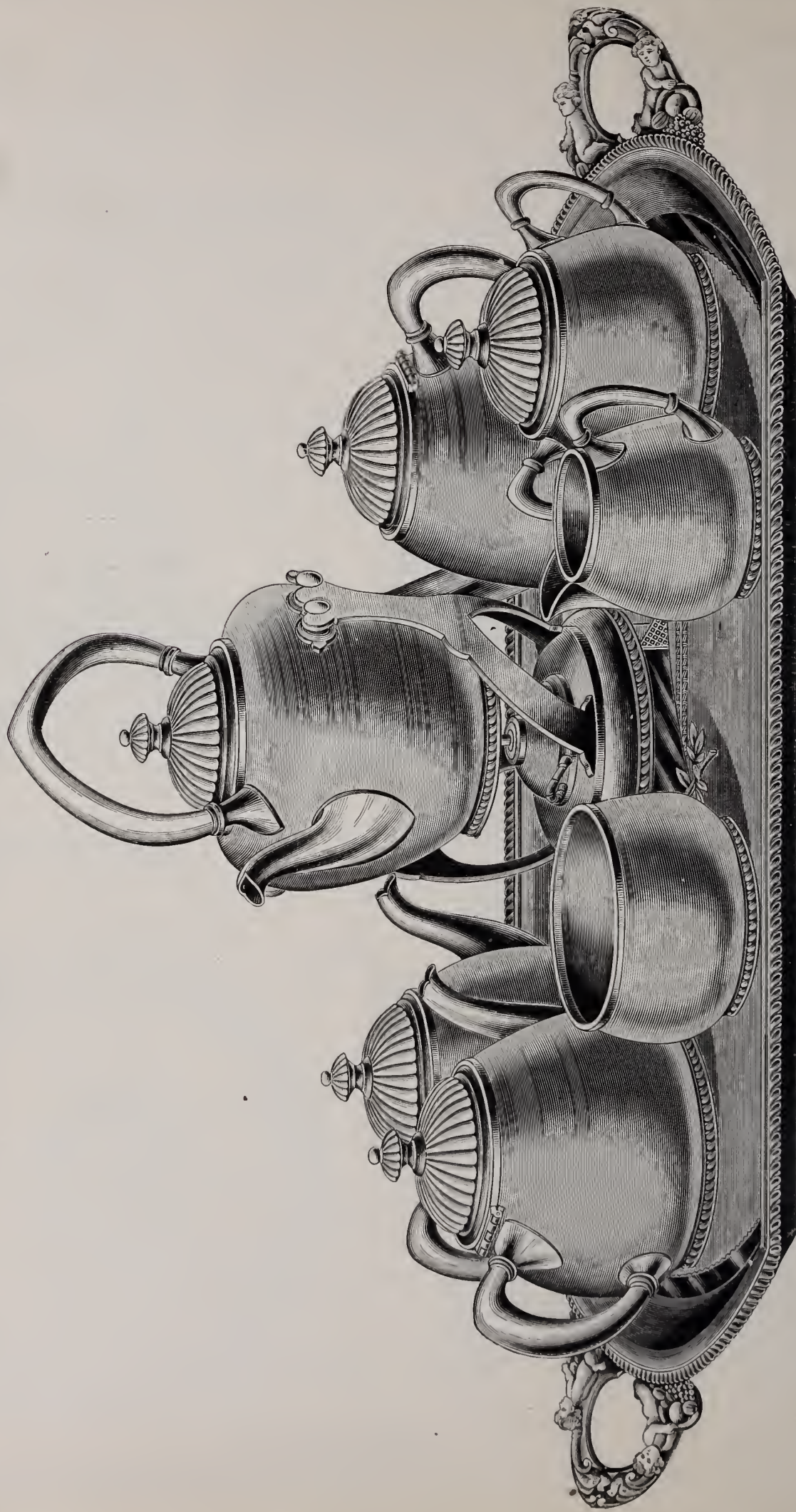

Are now offering to the Trade a great number of New Patterns. In addition to the Pearl, Hammered, Snow Flake, Chased and Engraved Decorations are many other New and Artistic Designs of Ornamentation,—Figures, Fruits and Flowers in Full and Bas Relief, and Appliqué Finished in Oxidized Silver and in Varied Shades of Gold.

**Factories, TAUNTON, MASS.**

**Salesrooms, 686 BROADWAY, N. Y.**



ESTABLISHED 1834.

G. & S. OWEN & CO.,

—MAKERS OF—

FINE ROMAN JEWELRY, &c—

—&c— BOX and GLASS PINS,

—AND—

Black Onyx and Pearl Goods,  
OF EVERY DESCRIPTION.

All Goods sold by us are exclusively of our own manufacture and are warranted 14 K. Fine, and stamped as such when possible.

No. 3 Maiden Lane, New York.

W. H. SHEAFER & Co.,

MAKERS OF

BRACELETS,

BANGLES,

LACE PINS,

SCARF PINS, ETC.

No. 15 JOHN STREET,  
NEW YORK.

RIPLEY HOWLAND M'F'G CO.,

MAKERS OF

**FINE JEWELRY,**

SPECIALTIES:

DIAMOND MOUNTINGS. with Platinum Tips.  
ENGRAVED RINGS, STONE RINGS,

OFFICE, 17 MAIDEN LANE,  
NEW YORK.

FACTORY, 383 WASHINGTON ST.,  
BOSTON, MASS.



**GOLD CHAIN**

SAXTON, SMITH & CO.,

Manufacturers of

SOLE AGENTS

FOR THE

NEW PATENTED CHAIN BAR,

Containing a Detachable Pencil.

FACTORY:  
183 EDDY ST.,  
PROVIDENCE, R. I.

OFFICE:  
14 JOHN ST.,  
NEW YORK.

A. J. HEDGES & CO.,

MANUFACTURING

**JEWELERS,**

No. 6 MAIDEN LANE,

NEW YORK.

Factory, No. 90 MECHANIC ST.,  
NEWARK, N. J.

**A. W. FABER'S**  
**Gold Pens,**

→ PEN AND PENCIL CASES. ←

EBERHARD FABER, MANUFACTURER,  
718 & 720 BROADWAY,  
NEW YORK.



**FOWLER BROS.,**  
MANUFACTURERS OF

**JET & ONYX JEWELRY.**

Offer a large and varied stock of desirable goods of original designs, especially manufactured for the coming Fall Trade.

These goods are elegant in design, beautifully finished, and must be seen to be appreciated.

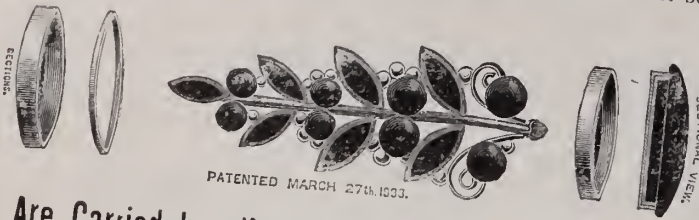

Are Carried by all the Leading Jobbing Houses  
Throughout the Country.

**MOORE & HORTON,**

No. 11 Maiden Lane,

NEW YORK.

**JEWELERS.**

SPECIALTIES:

Stone Cameo, Onyx, Amethyst, Topaz and Pearl Rings.

Studs, Collar and Sleeve Buttons.

Also our fac-simile of Fine African Diamonds, with Foile Back, Mounted in Rings, Studs, Pins, Ear Rings, Scarf Pins, Lace Pins, &c.

JOHN F. SAUNDERS,  
Of the late firm of Buckenham, Cole & Saunders.

CHAUNCEY IVES.

**SAUNDERS & IVES,**  
IMPORTERS OF

**DIAMONDS, PEARLS,**  
And Other Precious Stones.

Manufacturers of Diamond Mountings.  
**No. 26 MAIDEN LANE, NEW YORK.**

A Large Stock of FINE DIAMONDS, Mounted and Unmounted, kept constantly on hand.

Goods sent on approval to any part of the country on receipt of satisfactory reference. All our goods ARE INSURED by us while in transit.

**DORRANCE, EDGE & CO.,**

Makers of the Celebrated

**Woven Fabric Gold Chain,**

And Patentees of the

**Embossed Inlaid Jewelry.**

The Latest and Most Effective Styles of Decoration Introduced.

**15 JOHN ST., NEW YORK.**

FACTORY, 46 GREENE ST., NEWARK, N. J.

**G. W. PRATT & Co.,**

Manufacturers and Dealers in

**Watches and Jewelry**

OF EVERY DESCRIPTION.

ELGIN AND ILLINOIS MOVEMENTS  
IN ALL GRADES.

Gold, Silver and Ladd Patent Cases.  
**No. 14 JOHN STREET, NEW YORK.**

**C. ROSSWOG & SON,**  
MANUFACTURERS OF

Rich Jewelry and Diamond Goods,

NOS. 5 & 7 MAIDEN LANE,

—NEW YORK.—



**CHURCHILL, LEWIS & CO.,**  
*Manufacturing Jewelers,*  
 692 BROADWAY, NEW YORK.

— S. W. HALE & CO., —  
 SUCCESSORS TO HALE & MULFORD,  
 MANUFACTURERS OF  
**FINE JEWELRY**

692 BROADWAY, N. Y.  
 SETH W. HALE. WILLIAM A. LEE. WILLIS H. HOWES.

**GEO. W. SHIEBLER,**  
 MANUFACTURER OF  
*Sterling Silverware,*  
 HANDSOME NOVELTIES  
 CONSTANTLY ON HAND.  
 8 LIBERTY PLACE, NEW YORK.

**JOHN A. RILEY & CO.,**  
 9 BOND STREET, N. Y.  
 SOLE MANUFACTURERS OF THE POPULAR  
 — PATENT — SPRING — BRACELETS —

Also Lace Pins, Ear Rings, Scarf Pins, Etc.

**SMITH & KNAPP,**  
 WHOLESALE DEALERS IN  
 AMERICAN AND SWISS WATCHES,  
**DIAMONDS,**  
 Gold & Plated Jewelry & Gold Chain,  
**No. 182 BROADWAY,**  
 COR. OF JOHN STREET, NEW YORK.

**E. STITES' SONS.**

**BRACELETS**

14 JOHN STREET,  
 NEW YORK.  
 FACTORY, NEWARK, N. J.



**A. S. HERZOG & CO.,**  
MANUFACTURING JEWELERS.  
Rings and Locketts a Specialty.

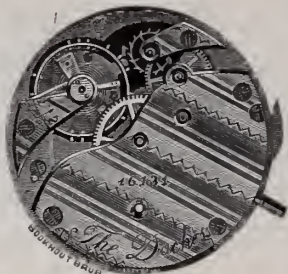

Jobbers in American Watches.

38 MAIDEN LANE, NEW YORK.

**DAY & CLARK,**

No. 10 MAIDEN LANE, NEW YORK.

*Fine Roman Goods,*

IN VERMICELLA AND HAMMERED ORNAMENTATION.

BANGLES, DIAMOND BALL COVERS, LACE PINS  
AND EAR DROPS. BEAD NECKLACES,  
EAR HOOPS, SCARF PINS.

Send for Selection Package.

FACTORY, NEWARK, N. J.

**COX & SEDGWICK,**

26 JOHN STREET, N. Y.,

**Makers of Patent Black Onyx Bracelets**

Also Black Onyx Faceted Bead Bracelets,  
AT THE LOWEST PRICES.

**COLORED**  
AND  
**Turquoise**  
Lace Pins,  
Ear Rings,  
Locketts,  
Bracelets,  
Sleeve  
Buttons,  
Scarf Pins,

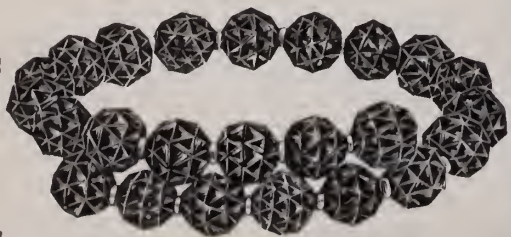

**ONYX**  
Lace Pins,  
Ear Rings,  
Medallions,  
Necklaces,  
Chatelaines  
Sleeve Buttons  
Ladies & Gents  
Vest and  
Guard Chain.

Black Onyx Pins, Ear Rings and Locketts for 1, 3 and 5 Diamonds.

GOODS SENT ON APPROVAL TO RESPONSIBLE FIRMS.

**HESS & SCHLISSER,**

25 MAIDEN LANE,

NEW YORK.

**IMPORTERS.**

SPECIALTIES:

**DIAMONDS.**

NOVELTIES IN FINE JEWELRY.

Blue and Black ENAMELED LOCKETS.

Charms, Garnet and Silver Filigree Goods.

**G. B. BARRETT & CO.,**

IMPORTERS AND WHOLESALE DEALERS IN

**Watches, Diamonds, Jewelry,**  
Clocks, Bronzes, Silver and Plated Ware,  
Watch Materials, Etc.

A Full and Complete Line of all goods handled  
by the Trade, constantly on hand. Lowest  
Prices Guaranteed.

WHOLESALE EXCLUSIVELY.

238 & 240 Liberty St., PITTSBURGH, PA.

**W. F. NYE,**

**Watch and Clock Oil,**

New Bedford, Mass.



These Oils have been  
before the Trade for the  
last twelve years and are  
generally acknowledged by  
Watchmakers throughout  
the country to be the best  
and most reliable Watch  
and Clock Oils made.



FOR SALE BY THE  
Jobbing Trade Generally.



MANUFACTURERS OF Everything in

# BLACK ONYX JEWELRY

PLAIN, and {Ornamented with Pearls and Diamonds.

Our manufacturing facilities have been for the past ten years devoted exclusively to the production of fine Black Onyx Jewelry. We carry in stock the largest variety of articles made in our specialty, well made, finely finished, uniformly 14 karats, at medium and low prices.

**WUOLM & MILLER,**  
Office & Factory, 32 & 34 JOHN STREET,  
NEW YORK.



**W.M. GREENE & Co.**  
GOLDSMITHS.

MANUFACTURERS of

RICH SETS IN TAPER WIRE CORAL

Factory 95 PINE ST. Providence, R. I.

Stone-Cameo Engraved Coral Cameo Enamel Brooches Sleeve Buttons Studs & Crosses EAR DROPS & C. New York Office 192 BROADWAY.

WM. C. GREENE. B. W. GREENE. GEO. D. BRIGGS.

**KETCHAM & McDOUGALL,**  
Bryant Building, (55 Liberty St.) New York.  
MANUFACTURERS OF  
**COLD AND SILVER THIMBLES.**



**THE AUTOMATIC EYE-GLASS HOLDER,**  
It Reels Up Cord Itself.  
A—Shows position of Glasses with cord Reeled up.



ESTABLISHED 1859.

**STURDY BROS. & CO.**  
MANUFACTURERS OF

## Fine Rolled Plate Jewelry,

GRADUATED WIRE CORAL GOODS,  
STERLING SILVER JEWELRY.

Bangles, Sleeve Buttons, Cuff Buttons, Baby Pins, Sets in Stone, Cameo, Enamel, Chased, and Polished. Drops and Knobs, Bar Pins, Children's Sets, Locketts, Studs, Charms, Etc.

Only Wholesale Dealers' Trade Solicited. **ATTLEBORO, MASS.**

Flexible Bracelets,  
Diamond Mountings,  
Strung Pearl Work,  
Repairing,

Flexible Braided  
Bracelets,  
White Stone Goods,  
Strung Pearl Repa'ng

**Thos. M. Guilbert & Co.,**

SUCCESSORS TO CARROW, DUBOSQ & Co.

908 Chestnut Street, Philadelphia, Pa.



**B. A. BALLOU & CO.,**

61 Peck St., Providence, R. I.  
MANUFACTURERS OF

# GOLD JEWELRY.



We call special attention to our **PATENT FASTENING FOR EAR RINGS**, which is free from the objections raised to ordinary ear wire or screw fastenings. They present a very neat and attractive appearance, are perfectly secure, and much more convenient than ordinary ear wires which always annoy the wearer by catching the hair, veil, or lace about the neck. These Goods are for Sale by all Wholesale Dealers.

Gold Studs, Small Chains for Eye-Glasses, Bracelets, Etc.  
a Specialty.

TRADE MARK



The ORIGINAL GOLD CROWN  
**FILLED RINGS.**

For the past thirteen years we have manufactured as a specialty, the well known "CROWN GOLD FILLED RING," with the high standing of which the trade is already perfectly familiar. In consequence of the above fact, and in justice to ourselves, we feel it a duty to make the announcement to the trade that there are now being offered in the market several other makes of filled rings, each of which has a CROWN in some way connected with its STAMP.

We Manufacture for the Jobbing Trade Only.

**McCALL & NEWMAN,**  
625 Arch Street, Philadelphia

**McCarty & Hurlburt,**  
WHOLESALE DEALERS IN

## WALTHAM, ELGIN & ILLINOIS WATCHES.

MANUFACTURERS OF

Jewelry, Gold Spectacles, Silver Thimbles, &  
**131 North Second St.,**  
PHILADELPHIA, Pa.



C  
L  
O  
C  
K  
S

ESTABLISHED 1853.



AMERICAN

AND

FRENCH CLOCKS

AND

BRONZES.

**B. J. COOKE'S SONS,**137 N. 3d Street, PHILADELPHIA.  
Catalogues and Price Lists furnished to the Trade only, on application.

ESTABLISHED 1869.

## THE JEWELERS' CIRCULAR AND HOROLOGICAL REVIEW

The recognized Organ of the Trade, and the Exclusive Official Paper of the Jewelers' League, will enter upon the 15th Year of its Publication with the issue of the FEBRUARY NUMBER.

Subscription, \$2.00 per annum to all parts of the United States and Canada. Foreign Subscription, \$3.00.

D. H. HOPKINSON,  
*Editor and Proprietor,*  
42 Nassau St., N. Y.

### → BOSTON ← WATCH ← CASE ← COMPANY →

WATCH CASE MANUFACTURERS,

Nos. 1, 3 and 5 Province Court, Boston, Mass.,

ENTRANCE COR. PROVINCE STREET.

*Especial Attention given to Watch Case Repairing, Springing, Re-engine Turning, Engraving, Polishing, &c.*

**Particular Attention given to Orders by Express.**

WE OFFER THE LARGEST VARIETY OF ORIGINAL DESIGNS IN WATCH CASES EVER PRESENTED TO THE TRADE.

## CHAS. S. PLATT,

Successor to George W. Platt,

GOLD AND SILVER

Refiner, Assayer and Sweep Smelter,

No. 4 LIBERTY PLACE,

Refinery, 67 and 69 Thomas St., NEW YORK.

Platers' and Electro-Platers' Silver Platinum and Aluminum.



KING JAMES, }  
MARQUIS, } RINGS.  
GLOVE, }

Quality Guaranteed.  
Prices Close.

BARNET BROS. &amp; POWELL,

—Manufacturers,—

Newark, N. J., &amp; 15 JOHN ST., NEW YORK.

### EXCELSIOR'S

## PRACTICAL TREATISE ON THE Balance ← Spring,

INCLUDING MAKING AND FITTING HAIR SPRINGS,  
REGULATING, ETC.

Also containing the Adjustment of Watches and Chronometers for Isochronism, Positions, Heat and Cold and Rate.

Price, \$3.50.

D. H. HOPKINSON,  
42 Nassau St., New York.

ESTABLISHED 1850.

TRADE



MARK

PETER L. KRIDER,

MANUFACTURER OF

## STERLING SILVERWARE

Medal and Diploma Awarded, &c. Striking Society  
Medals in Gold, Silver or Bronze a Specialty.

Artisan Hall, 618 Chestnut St., Philadelphia.

ESTABLISHED 1866.



ARNOLD &amp; WEBSTER,

MANUFACTURERS OF

→ SOLID GOLD ←



## ENGRAVED BAND RINGS

FOR THE JOBBING TRADE.

29 Point Street, Providence, R. I.

NEW YORK OFFICE,

No. 196 BROADWAY.





**W. E. WHITE & CO.,**  
Manufacturing Jewelers.

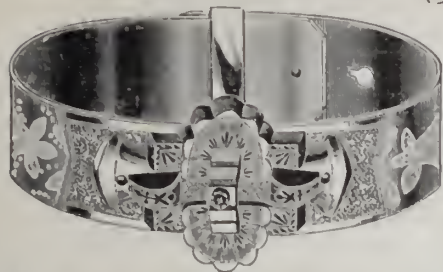

**FINE  
ROLLED PLATE  
GOODS.**

Bracelets---Engraved, Enamelled, Flat Band and Buckle.  
*Ladies' Goods---Lace Pins, Drops, Crosses, Sets, Collar Buttons, &c.*  
**FOR SALE BY JOBBERS ONLY.**  
New York Office, 26 MALDEN LANE, Corner Nassau Street.  
Factory 54 Page St., Providence, R. I. Represented by S. A. BALDWIN.

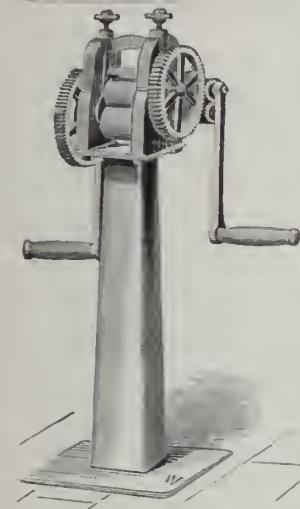

**W. W. OLIVER,**

Manufacturer of Hand and Power

**Rolling Mills,**

For Jewelers and Silversmiths.

The "Little Giant" Ring Bender

Hollow Spindle Lathes, Punching and Drop Presses, Polishing Heads, Dies, Metal Laps, Etc.

39 Clinton St., Buffalo, N. Y.

Illustrated Price List mailed free upon application.

**ALEX. MILNE,**  
Manufacturer of Stem-Winding Watch Crowns



**ALSO GOLD AND SILVER THIMBLES.**



19 Ward Street, NEWARK, N. J.

**JAMES J. FISHER,**

DEALER IN

**WATCHMAKERS' and JEWELERS' MATERIALS,**

Files, Tools, Silk Guards, Watch Glasses, Spectacles, Rolled Plate, Fire Gilt, Nickel and Silver Chains, Charms, &c.

No. 697 BROADWAY,

Corner Fourth Street, NEW YORK.

All kinds of Job Work for the Trade Promptly attended to.

The "Acme" French Clock Movement Support.  
(Pat. Nov. 1st, 1881.)

This Support is adapted to the holding in position of any French Clock Movement while regulating or adjusting, and will be found very desirable on account of its simplicity of action and the small space it occupies. To be had of any material jobbing house, or sent, post paid, to any address, on receipt of 85 cents.



*Henry Fera,*

*Importer of Rough & Polished Diamonds,*

DIAMOND CUTTING AND POLISHING WORKS:

21, 23, 25 Looijersgracht,

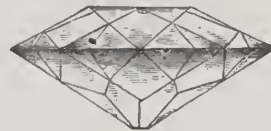

4 & 6 JOHN ST.,

Amsterdam, Holland.

New York.

Diamonds repaired and matched by some of the finest workmen in the world.

Diamond Bort and Powder always on hand.

ESTABLISHED 1828.

**JACOB BENNETT & SON,**

MANUFACTURERS OF FINE

**DIAMOND MOUNTINGS,**

No. 925 CHESTNUT STREET, PHILADELPHIA.

— FINE REPAIRING. —

*D. VALENTINE,*

DIRECT IMPORTER OF THE CELEBRATED

**GENEVA WATCHES**

Manufactured by Patek, Philippe & Co. and J. J. Badollet & Co.,

In all sizes from 12 to 19 Line, Open Face or Hunting, with or without Cases. Also a Full Assortment of REPEATERS, CHRONOGRAPHS AND CHRONOGRAPH AND REPEATING COMBINED.

692 BROADWAY, NEW YORK.

R. & K.'S PATENT GAS FURNACES FOR MELTING, PLATING, ENAMELING, ANNEALING, &c., &c.

**Reichhelm & Koester,**

Importers and Manufacturers of

Jewelers' Tools, Files, Materials, &c.,

Manufacturers of  
Bristle Brushes of all kinds,  
Cotton and Wool Buffs,  
Felt Polishing Wheels,  
Walrus Leather Polishing  
Wheels,  
Jewelers' Satin Finish and  
Scratch Brushes,  
Brass & Steel Wire Brushes  
Jewelers' Standard Saw  
Frames,  
Plain & Fancy Draw Plates,  
Improved Jewelers' Ingots,  
R. & K.'s Jewelers' Combi-  
nation Gas Burners.

**80 Nassau St.**

NEW YORK.

Importers of  
French, English & German  
Tools and Files,  
Piercing Saws,  
Renard & Vautier Gravers,  
Steel and Brass Wires,  
Vienna and Ruby Draw  
Plates,  
Alloying Copper Wire,  
Felt, Walrus Leather,  
Vienna Lime, Tripoli,  
&c., &c., &c.



**ROTARY MEASURING INSTRUMENT,**

American Manufacture, for or straight line by running face. The distance is shown inches and fractions the feet. It is in Nickel Holiday Present, and a elers, Opticians, and Fancy only instrument with which line. Sent by mail on re- be had of Jewelers, Opti- Dealers.

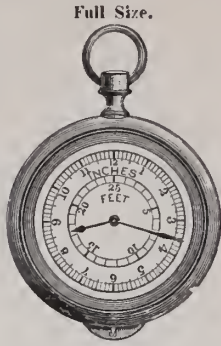

Full Size.

measuring any object, curved the instrument over the sur- on the dial, the long hand of an inch, the short hand Desirable Article for Jew- Goods Dealers. It is the you can measure a curved ceipt of price, \$2.00; or can cians, and Fancy Goods

Wholesale and Retail by

**R. MERRILL'S SONS,**

Importers and Manufacturers of NAUTICAL INSTRUMENTS,  
179 WATER STREET, NEW YORK.

**BOOZ & CO.,**

MANUFACTURERS OF

FINE GOLD

Watch Cases



AND

PLAIN GOLD

RINGS.

Jobbers in American Movements.

**DIAMONDS.**

108 South Eighth St., (2d Story) Philadelphia.

Samples of our goods sent on approval when satisfactory reference is furnished. Old Gold and Silver Bought or Exchanged.

PARTICULAR ATTENTION PAID TO REPAIRING

**H. H. HEINRICH & CO.,**

12 JOHN ST., NEW YORK,

Manufacturers of the

**PATENT SELF-ADJUSTING BALANCE**

FOR EXTREME HIGH AND LOW TEMPERATURE.

Marine Chronometers  
AND  
Zimmerman Watches  
are provided with  
this Balance.

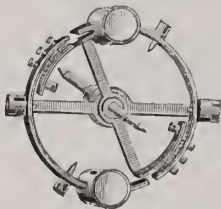

Tried by three  
Observatories with  
the best results.

We are also agents for the Celebrated K. Zimmerman Watch, which we can recommend to the Trade. Send for Circular containing information in regard to the Patent Balance Zimmerman Watches and Marine Chronometers.

**C. F. A. HINRICHS,**

Importer of and Dealer in

Fancy Goods, Glassware, China, Toys, Games,

CLOCKS, BRONZES, &c.,

Brass Goods, Falence, China and Glass Metal-Mounted Lamps,

C. A. KLEEMANN'S PATENT ST. GERMAIN STUDENT LAMPS.

Goods suitable for Jewelers and Holiday Trade.

AGENCIES: LONDON, ENGLAND; LIMOGES, FRANCE; HAIDA, BOHEMIA.

Nos. 29, 31 and 33 PARK PLACE,

N. W. Corner Church St., }  
Opposite Elevated R. R. Station. }

NEW YORK.

**PFORZHEIMER, KELLER & CO.,**

MANUFACTURERS OF

**FINE JEWELRY,**

AND DEALERS IN

Diamonds, American and Swiss Watches,

No. 24 JOHN STREET,

I PFORZHEIMER, }  
D. KELLER. }

**NEW YORK.**

{ I. B. ETTINGER,  
{ H. J. FINK.

**CHAS. W. SCHUMANN,**

24 JOHN STREET, NEW YORK.

IMPORTER OF

Fine Diamonds, Watches, &c.

Sole Agent in U. S. for the celebrated "A. LANGE" DRESDEN WATCH. Also Sole Licensee in U. S. for

**TRENOR'S DIFFERENTIAL DIAL,**  
SPECIALLY USEFUL FOR TRAVELERS.

The Movable Rims around the Main Dial are set from the side similar to the band-setting of stem winding watches. Set the difference of time desired to figure X11, as shown on cut, and the hands will indicate that difference all around the dial, viz.: hands of Main Dial 9.14, Differential, 10.19, being one hour five minutes difference as set at figure X11.

Can be Applied to any Watch.

READY MADE DIALS ON HAND FOR AMERICAN WATCHES.

**FINE WATCH AND CLOCK**

**OIL,**



MANUFACTURED BY

**GEO. B. WHEELER,**

NEW BEDFORD, MASS.

Patented November 18, 1873.

**MORRISON'S**

**GOLD AND SILVER SOLUTIONS**

For Electro-Plating Without a Battery.

Invaluable for Watchmakers and Jewelers. So simple that any one can use them.

Price, Gold Solution, \$3.00

Silver Solution, \$1.50

MANUFACTURED BY

**ARTHUR B. MORRISON, Portland, Maine.**

FOR SALE BY

Sussfeld, Lorsch & Co., New York; Henry Gimmel, New York; Cross & Beguelin, New York; Kearney & Swarthchild, Chicago, Ill.; Louis A. Scherr & Co., Philadelphia, Pa.; Duhme & Co., Cincinnati, O.; Harwood Bros., A. Paul & Co., Palmer, Bachelder & Co., Boston, Mass., and material dealers generally.

BEWARE OF BASE IMITATIONS put up by unprincipled persons. None are genuine without the Trade Mark which consists of the letters A. B. M. in monogram and fac simile of Medal awarded by U. S. Centennial Commission.





181



193



PATENT APPLIED FOR  
193



214

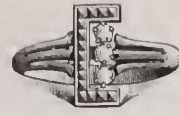

218



219



812



THE ABOVE CUTS ARE THREE DIFFERENT SHAPES IN THE SAME WEIGHT OF PLAIN RINGS, TO BE USED IN ORDERING.

**J. B. BOWDEN & Co.,**  
MANUFACTURERS OF SOLID RINGS  
OF EVERY DESCRIPTION.

No. 1 MAIDEN LANE, cor. Broadway, NEW YORK.

**WILLIAM H. BALL,**  
**MANUFACTURING JEWELER,**

(Bracelets and Bangles a Specialty)

No. 9 JOHN ST., N. Y.

San Francisco Office, 120 Sutter Street.

Factory, Newark, N. J.

GOODS SENT ON SELECTION TO RESPONSIBLE PARTIES.



**THEUERER & CHURCH,**  
MANUFACTURERS OF FINE RINGS,

No. 9 MAIDEN LANE,

NEW YORK.

FACTORY, COR. MULBERRY & DURAND STS., NEWARK, N. J.

LEON JEANNE.

PAUL JEANNE

**JEANNE BROTHERS**

MANUFACTURERS OF

**DIAMOND MOUNTINGS,**

**AND RICH JEWELRY.**

No. 1 MAIDEN LANE, NEW YORK

Designs Furnished and Estimates Given.

**JEANNE BROS PAT. DIAMOND SETTINGS.**

A PLATINUM SETTING WITH A GOLD SURFACE OUTSIDE

IN THIS WAY THE REFLECTION OF GOLD THROUGH THE DIAMOND IS ENTIRELY AVOIDED.

PAT. AUG. 15TH 1882



IMPORTERS OF  
**SWISS WATCHES,**  
 OPTICAL GOODS, Etc.  
 JOBBERS OF ALL  
 AMERICAN  
 WATCH MOVEMENTS,  
 Gold, Silver and Filled Cases  
 CLOCKS, SILVER PLATED WARE,  
 FINDINGS, ETC.



SPECIALTIES.  
 THE "CENTURY" WATCH,  
 S. Wind, Nickel, Ancre.  
 THE "CENTURY WATCH CO."  
 MOVEMENTS  
 Fit all American Cases.  
 THE 1 DAY  
 TIME ALARM WATCH,  
 19 Line, O. F. Nickel Case, with  
 Fine Stem Wind Movement.  
 The "CENTURY LEVER" Cuff Button.  
 The "S. F. M. & Co." Rolled  
 Gold Chain, &c., &c.

179 Broadway, Near Maiden Lane, New York.

Our Pocket Price List, or our Large Illustrated Catalogue, MAILED TO DEALERS FREE.

**SINNOCK & SHERRILL,**



No. 2234.  
 Doublet and Pearl.



No. 2047  
 14 K. fine.  
 Garnet and Pearl.



No. 2156  
 14 K. fine.  
 Clasp Rings.



No. 1195  
 14 K. fine.  
 Turquoise and Pearl.



No. 1909  
 14 K. fine.  
 Sapphire and Diamond.

MANUFACTURERS OF

Ladies Fancy Stone Rings in Great Variety.

Factory, Newark, N. J.

All 14 K. Goods Guaranteed to Assay  $\frac{584}{1000}$  Fine.



ALSO

DIAMOND INITIAL RINGS.

Office, 3 Maiden Lane, New York.

All 14 K. Goods Guaranteed to Assay  $\frac{584}{1000}$  Fine.

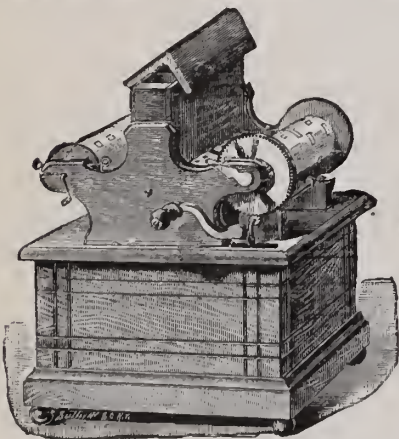

Reed Pipe Clariona, \$8.

**CLARIONAS. AUREPHONAS.**  
**ATTRACTIVE AND SALABLE STOCK.**

Both Instruments of Superior Tone, Beautiful in Finish, thoroughly Durable and Salable.

We make a Specialty of the Sale of **Mechanical Musical Instruments**, and keep the Largest Variety in the world. Send for Catalogue and Discounts to

**WM. BLASIUS,** 923 & 925 Chestnut St.,  
 Gen'l Agent. Philadelphia, Pa.



Aurephone, \$10.

17 Full Sized Reeds. Durability Guaranteed. All Music on Spools, at 4c. a Foot.

**CHARLES VAGT & CO.,**

60 & 62 MURRAY STREET, (cor. College Place,) NEW YORK.

IMPORTERS OF

Vases, Biscuit Statuettes, Plaques, Paintings,  
 Hispaniola and Hungarian Ware, Fine Potteries,

Dresden Porcelain, Vienna Ivory Ware,

Fine China Fancy Articles decorated with Roses, Apple Blossom and Cactus.

SPECIALLY ADAPTED FOR THE JEWELRY TRADE.



(ESTABLISHED 1839.)

**HENRY GINNEL & CO.,**  
**31 MAIDEN LANE, NEW YORK.**

**Jobbers in all Grades of AMERICAN MOVEMENTS and CASES.**

IMPORTERS OF SWISS WATCHES, JEWELERS' TOOLS AND MATERIALS OF THE LATEST MANUFACTURE.

MANUFACTURERS and SOLE IMPORTERS of the

**PIONEER WATCHES,**

In Silver and Nickel Cases, Hunting and Open Face, 16, 18 and 20 line. Made also with **Chronograph** and **Calendar** Attachments. These Watches are fully warranted, and since their introduction in 1876 have proved always reliable, and have the reputation of being the best Watch ever offered for the money.

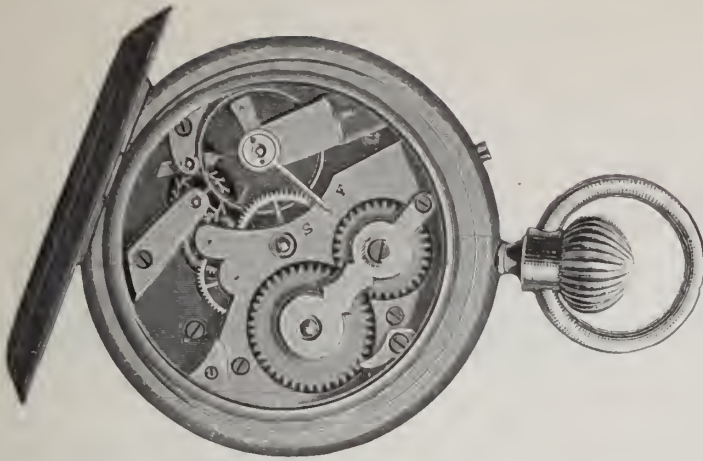

**F. W. GESSWEIN,**

NO. 39 JOHN STREET,

NEW YORK.

MANUFACTURER OF

MACHINERY AND TOOLS FOR

*Jewelers, Watch, Clock, Chronometer,  
 Watch Case and Fine Instrument  
 Makers. Wire and Bristle  
 Brushes. Polishing Im-  
 plements.*

IMPORTER OF

TOOLS, FILES AND SUPPLIES FOR

*Jewelers, Silversmiths, Engravers, Watch  
 and Watch Case Manufacturers,  
 Clock and Chronometer Makers,  
 Platers, Polishers, Machin-  
 -ists, Dentists, etc., etc.*

MANUFACTURER OF HAND CUT FILES.

Factory, PATERSON FILE WORKS, PATERSON, N. J.

→† ESTABLISHED 1874. †←

**JOSEPH P. WATHIER,**

Successor to JOSEPH P. WATHIER & BRO.,

178 WEST MADISON ST, CHICAGO, ILL.

**WHOLESALE JEWELER & WATCHMAKER & JEWELER FOR THE TRADE,**

Changing of Key Winding Movements into Stem Winding and Hand Setting,

AND MAKING STEM WINDING PARTS A SPECIALTY.

*All Work Intrusted to me will receive PROMPT ATTENTION, and Satisfaction Warranted, at Prices Always the Lowest.*

**EDWIN A. THRALL,**

1 MAIDEN LANE,

NEW YORK.

—◦ JOBBER IN ◦—

**American Watches, Diamonds, Fine Jewelry, Chains, Etc.**

Respectfully calls the attention of Cash Buyers to his stock of American **WALTHAM WATCHES**, embracing all grades and styles. Every Watch before being sent out is carefully examined and timed by competent workmen. This precaution will be appreciated by practical men. To Buyers visiting New York, I shall be pleased to show my stock and method of timing. Correspondence solicited from regular dealers. I sell only for Cash and give all discounts allowed. Special Styles of Cases, made to my order, always on hand. Agent for the New Mascot Bracelet, Patented. Repairing and Adjusting Watches and Chronometers for the Trade a Specialty.



MAKER OF FINE

Jewelry.

HENRY C. HASKELL,

12

JOHN STREET,  
NEW YORK.

Goods sent on approval upon receipt  
of Satisfactory References.



394D.  
Patented.

FOR HOLIDAY TRADE.

DIAMOND, EMERALD, RUBY RINGS AT

LOWEST PRICES.



1067.



2109.



1070.



1071.

FINE LINE CAMEO AND INTAGLIO IN SARD TIGER STONES, ETC.

A. J. WARNER & CO.,

WHOLESALE JEWELERS,

309 Nicollet Avenue, Minneapolis, Minn.

We carry a Large and Elegant Stock of Jewelry, Watches, Cases, Etc., Etc.

North-western Agents of the WATERBURY CLOCK CO., and carry a Complete Line of their Goods.

OUR TRADE IS EXCLUSIVELY WITH THE JEWELERS.

O. A. GAGER,

Successor to CHAS. FIELD HAVILAND & CO.,

IMPORTER OF

Porcelain and Ornamental Ceramics,

29 BARCLAY STREET.

A Fine Line of FANCY POTTERY of all grades, specially adapted for Jewelers.

PARIAN, BISQUE, TERRE COTTA, FAIENCE, PORCELAIN, ETC.

VASES, PLAQUES, STATUETTES, BUSTS, ETC., ETC.

M. FOX & CO.,

Practical Lapidaries and Importers of

DIAMONDS.

Rubies, Sapphires and Fancy Gems.

PEARLS, TURQUOISE, INTAGLIOS, ONYX, AMETHYST, ETC.

No. 1 MAIDEN LANE, NEW YORK.



TRADE MARK.

ESTABLISHED 1810.

TRADE MARK.

VACHERON &  
CONSTANTIN

**WATCH MANUFACTORY**  
— OF —  
**VACHERON & CONSTANTIN,**  
— GENEVA. —

VACHERON &  
CONSTANTIN

The Third Annual Report (June, 1883) of the Astronomer of the YALE COLLEGE OBSERVATORY awards the VACHERON & CONSTANTIN Watches the *Highest Average ever Recorded at that Observatory.*

**LADIES' AND GENT'S STEM WINDING MOVEMENTS FITTING AMERICAN CASES.**

Prices Furnished to the Trade on Application.

**CHAS. LEO ABRY,**  
SOLE AGENT FOR UNITED STATES AND CANADA,  
P. O. Box 611. NEW YORK. 63 NASSAU STREET.

**HERMAN TROST & CO.,**  
**IMPORTERS,**

30, 32, 34 MURRAY STREET, NEW YORK.

**PARIS:**

**YOKOHAMA.**

**LIMOGES:**

130 Rue du Faubourg St. Denis.

38 Avenue du Crucifix.

*Fine China Ware, Vases, Figures, &c., Biscuit Statuettes, &c., Sevres, Dresden and Worcester Porcelain, Vienna Fancy Goods. Very Fine Collection of PAINTINGS and PLAQUES on China and Faience. JAPANESE and CHINESE GOODS. Capo di Monte China Articles, Vases, Tankards, &c. Specialty of Fine China Articles, suitable for Jewelry Stores.*

The Largest Assortment in the United States at Lowest Prices.

ESTABLISHED 1859.

**RINGS AND DIAMOND JEWELRY.**  
**BRYANT & BENTLEY,**  
12 MAIDEN LANE, Up-Stairs, NEW YORK.

AMONG OUR STAPLE PATTERNS ARE



595.



610.



607.



611.



616.



630.

No. 595, Turquoise or Square Garnets with 3 Diamonds, 2 Pearls and 1 Diamond, or 3 Pearls. No. 610, All combinations of Doublets and whole Pearls and Diamonds, or all Diamonds.  
No. 607, All combinations of Doublets and whole Pearls and Diamonds, or all Diamonds, or 3 Pearls. No. 611, Emerald, Sapphire or Ruby Doublets, with 2 whole Pearls, or 2 Diamond  
Brilliants. No. 616, Pearls or Diamond. No. 630, 2 Garnets with 2 whole Pearls or 2 Diamond Brilliants.

We also continue to make a full line of our well known 16 K. HARD SOLDER RINGS.

Goods sent on approval to responsible parties.

**N. H. WHITE,**

JOBBER IN

**AMERICAN-WALTHAM WATCHES,**  
**EXCLUSIVELY.**

Waltham make of gold and silver cases a Specialty. Ladd, Boss, and the Patent Screw Bezel Filled Cases to fit Waltham movements only

No. 11 MAIDEN LANE, NEW YORK.

I not only advertise that I have the Waltham Goods, but **have constantly on hand** the Largest Stock carried by any jobber in the trade. Gold Cases of all Weights and Styles. Memorandum Packages with pleasure to dealers furnishing satisfactory reference

COMPLETE PRICE LIST TO THE TRADE.



A SPECIALTY.  
PATENT CATCH BRACELETS.



The most Convenient and Complete Catch ever invented. Not liable to get out of Order. Very Durable.

**C. I. RICHARDS, BROWN & CO.,**  
MANUFACTURERS OF  
**Gold and Plated Jewelry,**  
202 BROADWAY,  
Factory, Providence, R. I. NEW YORK.

We now offer to the Trade a Fine Assortment of Rolled Plate Jewelry, Patent Catch Bracelets in First and Second Quality, Enameled, Chased and Roman, with and without Buckle and Fancy Ornaments. Bangles and Flat Bands in great variety. Our Patent Lever and Separable Buttons and Studs, Ladies' and Gent's Collar Buttons, Charms, Lockets, Lace and Scarf Pins, Sets, Chains, etc., etc.

ALSO A FULL LINE OF BRILLIANT JEWELRY IN GOLD.  
*Goods Sent on Approval upon Application with Satisfactory Reference.*



**R. HENRICH,**  
"SELF-SIZING RING,"



(PATENTED MARCH 20th, 1883.)

NEW PATTERNS FOR FALL TRADE.

FOR SALE BY ALL JOBBERS.

SEAL AND STONE RINGS IN ALL VARIETIES.

35 Maiden Lane, NEW YORK.

ESTABLISHED 1849.

**KOCH & DREYFUS,**

WHOLESALE DEALERS IN

**WATCHES, JEWELRY, CLOCKS, DIAMONDS, SPECTACLES, ETC.**

ALSO JEWELERS' AND WATCHMAKERS' TOOLS AND MATERIALS AT MANUFACTURERS' PRICES.

18 CHARTRES ST., NEW ORLEANS.

BRANCH OFFICE, 20 MAIDEN LANE, N. Y.

**A. BERNHARD & CO.,**

No. 2 Maiden Lane, NEW YORK.

MANUFACTURERS OF

**Diamond Jewelry and Diamond Mountings.**

*We have issued a Catalogue containing our Designs of Diamond Mountings for Manufacturers' Use, which is the most complete work of the kind ever issued in this country or Europe.*

*It will be sent to Manufacturers and Dealers upon application, Free of Charge.*



# WM. S. HEDGES & CO.,

IMPORTERS OF

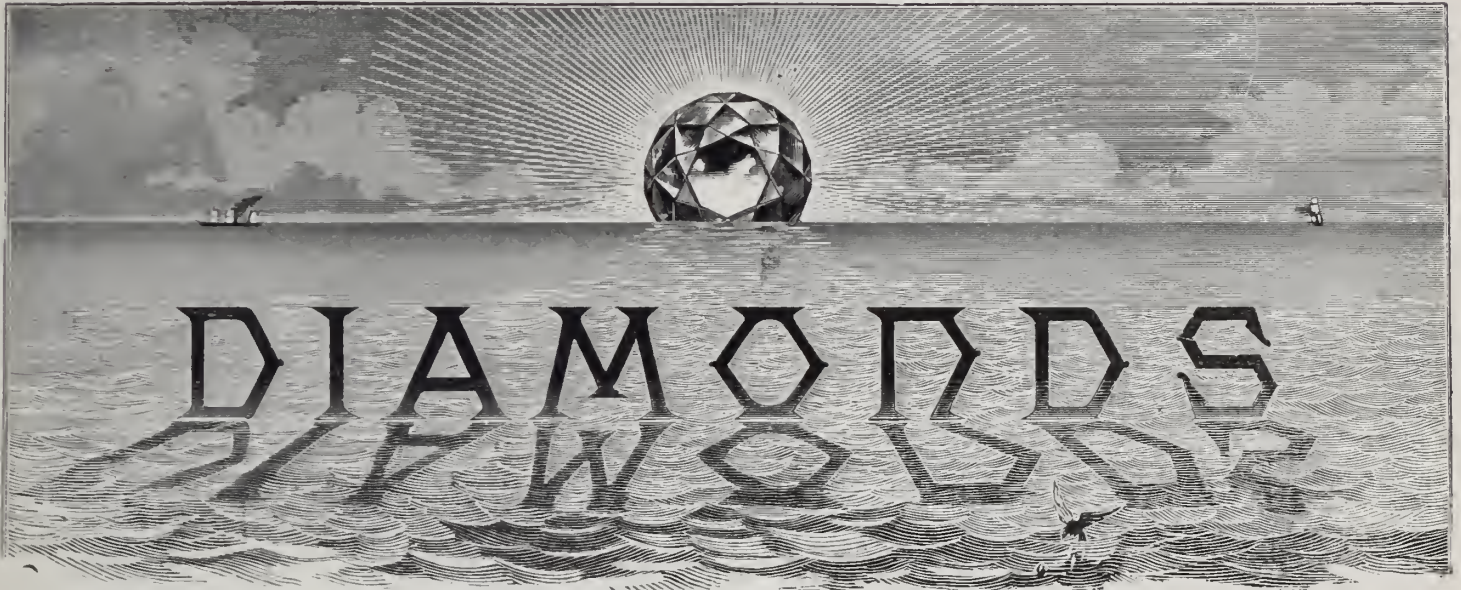

COPYRIGHT SECURED. Entered according to Act of Congress in the year 1880, by WM. S. HEDGES & Co., in the Office of the Librarian of Congress, at Washington.

170 BROADWAY,

**Corner Maiden Lane, New York.**

---

**CHOICE BRILLIANTS IN SINGLE STONES AND MATCHED PAIRS A SPECIALTY.**

---

**☞ Fresh invoices of Goods in all Grades constantly arriving. Also choice parcels of exceptionally Fine Gems ESPECIALLY Selected for critical purchasers. A full line of Mounted Goods, Artistically Designed.**

**GOODS SENT ON APPROVAL.**



# NEW GOODS.

We have now ready an accurate and reliable

## CHRONOGRAPH

Gilt Movement, in Filled Gold Hunting Case.

The Cheapest Chronograph Watch for the money made.

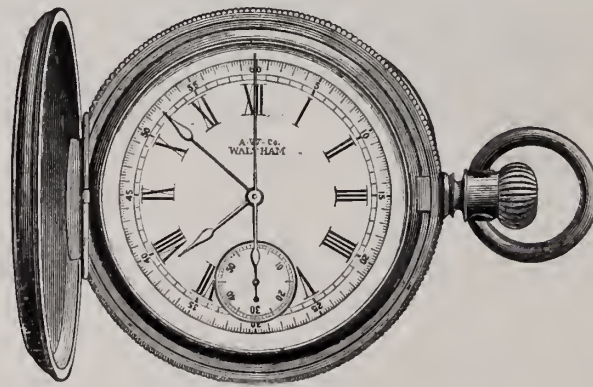

These Filled Gold Cases are made by the Chicago Watch Case Company, and for Style, Quality, Workmanship and Finish are not surpassed by any other Filled Goods in the market.

## ROBBINS & APPLETON,

**GENERAL AGENTS,**

NEW YORK.

CHICAGO.

BOSTON.

LONDON, ENG.

SYDNEY, N. S. W., AUSTRALIA.



# ANNOUNCEMENT!



We would respectfully direct the attention of the Trade to our Open Face Stem Winding Watches (Gentlemen's Size), cased in our improved 10 K. Gold Cases, the wearing surface of which is made of 14 K. Gold and the unexposed and non-wearing part of 8 Karat Gold, the whole assaying 10 Karat and presenting the appearance of a solid 14 Karat Case, and fully equal in Workmanship and Finish.

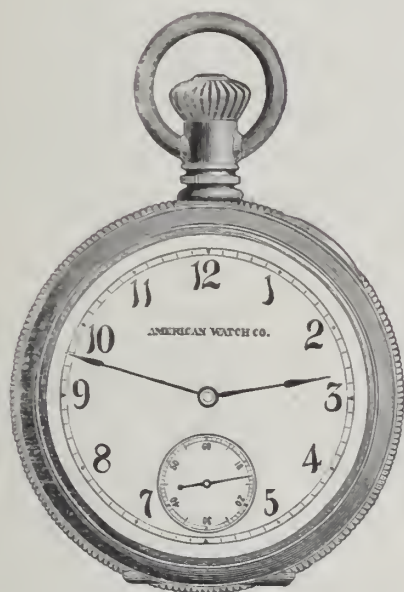

141.



142.

These Cases weigh about 32 dwts. and are spread to  $2\frac{1}{8}$  inches in diameter.

The Movement (Hillside Gilt) 7 or 11 Jewels, Expansion Balance, with Roman (142) or Arabic (141) Dials, making a very neat and desirable Watch at a comparatively low price.

These are offered to the Trade by Jobbers generally.

**ROBBINS & APPLETON,**  
**GENERAL AGENTS,**

NEW YORK.

CHICAGO.

BOSTON.

LONDON, ENG.

SYDNEY, N. S. W., AUSTRALIA.





*Randel, Baremore & Billings,*

*Importers of*

*Diamonds*

*and Manufacturers of*

*Diamond Jewelry.*

*58 Nassau Street,  
8 29 Maiden Lane,  
New York.*

*1 St. Andrews Street,  
Holborn Circus,  
London, E. C.*



# T. B. HAGSTOZ & CO.,

Successors to **MORGAN & HEADLY,**

MUTUAL LIFE INSURANCE BUILDING, TENTH & CHESTNUT STS., PHILADELPHIA.

The only house in Philadelphia making a Specialty of

**Diamonds,  
Diamond Jewelry  
and Mountings.**

Also, Gold, Silver and Steel Spectacles and Eye-Glasses.

*Goods Sent on Approval upon Application and Satisfactory Reference.*

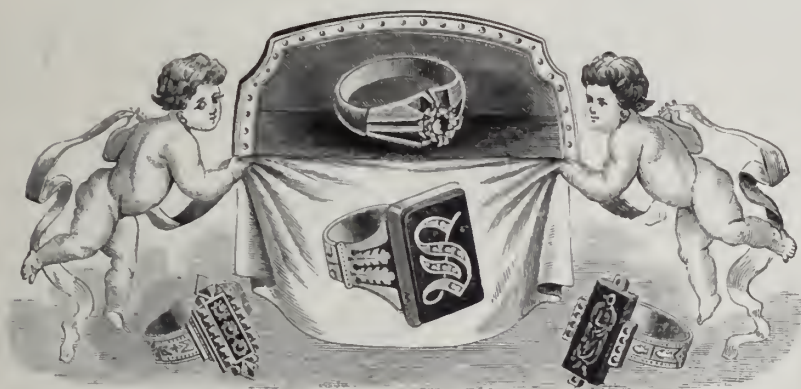

SPECIALTY.—Solid Gold Rings of Every Description, Scarf Pins, Studs, Etc.

## L. SAUTER,

1 MAIDEN LANE, Cor. Broadway, NEW YORK.

MANUFACTURER OF

Fine and Diamond Jewelry,

HAIR JEWELRY and DEVICE WORK.

JOBGING FOR THE TRADE.



## HEEREN BROS. & CO., MANUFACTURING AND WHOLESALE JEWELERS.

IMPORTERS AND JOBBERS OF

WATCHES, CLOCKS, JEWELRY, OPTICAL GOODS,

Silver Plated Ware, Watchmakers' & Jewelers' Tools, Materials & Supplies.

42 FIFTH AVE., PITTSBURG, PA.

## BRYANT & BENTLEY

*Always have something new in Finger Rings, and spend lots of time and good money getting up new and salable patterns.*

*This Cut is not one of this year's styles, but as it was popular in the year B. C. 300, so it may possibly be THE thing soon again.*

*Till that time comes, we have original and taking RINGS which JEWELERS whom we cannot otherwise reach, should see by sending for SELECTION PACKAGE.*



BRYANT & BENTLEY, 12 MAIDEN LANE, N. Y.



# FOX, BRO. & CO.,

THE ONLY EXCLUSIVE  
DIAMOND House in the West.

FOX, BRO. & CO.,

CINCINNATI, OHIO.

Manufacturers of the Largest Assortment and Newest Designs of Diamond Mountings.

# D. C. PERCIVAL & CO.

WHOLESALE DEALERS

-IN-

|                                                                                  |                                                                                  |                                                                       |
|----------------------------------------------------------------------------------|----------------------------------------------------------------------------------|-----------------------------------------------------------------------|
| WALTHAM, ELCIN,<br>ILLINOIS, HAMPDEN,<br>E. HOWARD & CO.<br>& SPECIAL MOVEMENTS. | WATCHES, JEWELRY,<br>GOLD CHAINS, GOLD,<br>FILLED & SILVER CASES,<br>SPECTACLES, | EYE-GLASSES,<br>GOLD HEAD CANES,<br>AND ROGERS &<br>BRO.'S FLAT WARE. |
|----------------------------------------------------------------------------------|----------------------------------------------------------------------------------|-----------------------------------------------------------------------|

392 WASHINGTON STREET.

**BOSTON.**

PRICE LIST of MOVEMENTS and CASES  
SENT ON RECEIPT OF BUSINESS CARD.

Established

POST OFFICE BOX,  
5259.

1864.

# HOPKINS WATCH TOOL CO., WALTHAM, MASS.,

MANUFACTURERS OF

HOPKINS' PATENT LATHES, CHUCKS, JEWELING TOOLS, ETC.,

And Sole Agents for the Celebrated

*HOPKINS' PATENT FOOT WHEELS*, by all odds the Best Working Foot  
Wheels in use, and *the only Foot Wheel with Swing Treadle*, in which the  
backward and forward movements of the Treadle or Stirrup are equalized.  
These Wheels are now made either for fastening to the floor, or to the end, or  
the under side of work bench.

SEND FOR CATALOGUE.

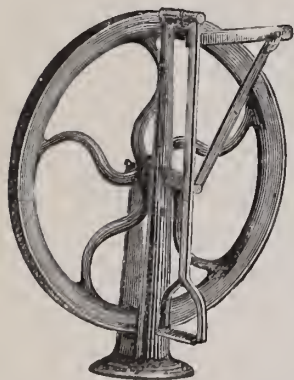

# J. KITTEL & CO.,

IMPORTERS OF

# ROYAL WORCESTER

AND OTHER FINE POTTERY AND GLASS,

28 Barclay Street,

New York.



# WHEELER, PARSONS & HAYES,

No. 2 MAIDEN LANE, NEW YORK.

Manufacturers of  
WATCH CASES,  
GOLD CHAINS and GOLD JEWELRY.

Importers of  
SWISS WATCHES,  
And Wholesale Dealers in  
GOLD AND SILVER CASES,  
AMERICAN WATCHES,  
AND  
CHRONOGRAPHS.

**DIAMONDS,**  
GOLD JEWELRY,  
GOLD CHAINS,  
PLATED CHAINS,  
AND  
PLATED JEWELRY.

A Full Stock of  
WALTHAM,

HAMPDEN,

ILLINOIS,

ELGIN,

AND

E. HOWARD & CO.

MOVEMENTS.

CHATELAINE WATCHES,

Gold, Silver and Nickel,

In Elegant Designs.

*We invite attention to our present carefully selected stock of*  
**DIAMOND JEWELRY.**

*in Rings, Ear Rings, Lace Pins, Studs, &c., at exceptionally low prices*

*Our entire stock of*

**WATCHES AND JEWELRY.**

*is composed of new goods throughout, both in novelties and staple designs. The excellence and completeness of our assortment offers unusual advantages to buyers*

The American Watch Co., of Waltham, have ceased making the Lady Riverside Movements. We have secured the entire remaining stock and are now closing them out at special rates, either with or without cases.



**SPECIAL ATTRACTIONS FOR  
THE HOLIDAYS.**

---

**A LARGE AND VARIED AS-  
SORTMENT OF ALL STYLES OF  
JEWELRY AT PRICES THAT  
WILL ATTRACT BUYERS.**

---

**CARTER, SLOAN & CO.,  
15 MAIDEN LANE,  
P. O. BOX 90. NEW YORK.**



E. AUG. NERESHEIMER  
& Co

IMPORTERS  
of

**DIA MONDS**

21 MAIDEN  
LANE  
NEW YORK

NO 66 SARPHATI STRAAT  
AMSTERDAM HOLL.





# Ladd Watch Case Company,

(ORGANIZED 1883.)

SUCCESSORS TO J. A. BROWN & CO.

(ESTABLISHED 1858.)

MANUFACTURERS OF THE

## LADD PATENT GOLD WATCH CASES.

### EXAMINE

THE

### NEW MODEL

### WOMEN

### Ladd Case.



Design No. 757.



Design No. 789.

*Which is universally pronounced on sight to be the Most Elegant and the Best Article in this line yet brought out.*

### IT HAS ALL THE LATE IMPROVEMENTS

Including Solid Gold Bows and Solid Gold Linings,

AND FOR WORKMANSHIP, STYLE AND FINISH IT IS UNEQUALED.

Its Shape is such as to admit of the most elaborate ornamentation, or any intermediate style down to the plainest, without loss of effectiveness, in accordance with the taste of the purchaser.

The **GOLD** in all of the **LADD CASES**, in the **COVERS** and **CENTER RIM** and **PENDANT**, is plump 14 Kt. fine, **POLISHED** to its natural color, a most **ESSENTIAL FEATURE** in the **WEAR** of a **WATCH CASE**.

For Sale by the Leading Wholesale Jobbing Trade. :



Falkenau Oppenheimer & Co.  
Importers of Diamonds



40 Maiden Lane N. Y.

Post Office Box 3314.



ADOLF J. GRINBERG  
HENRY GOODMAN

LEOPOLD GOODMAN  
WM. L. POLLACK.

**GRINBERG, GOODMAN & POLLACK,**

MANUFACTURERS OF

**FINE JEWELRY**

AND

**IMPORTERS OF DIAMONDS,**

PARIS  
44, rue de Lafayette

*No. 32 Maiden Lane,*

**NEW YORK.**

DIAMOND MOUNTINGS A SPECIALTY.

Goods Sent on Approval upon Application.

Value need not be put upon Packages sent by us, as we carry an  
OPEN INSURANCE POLICY.



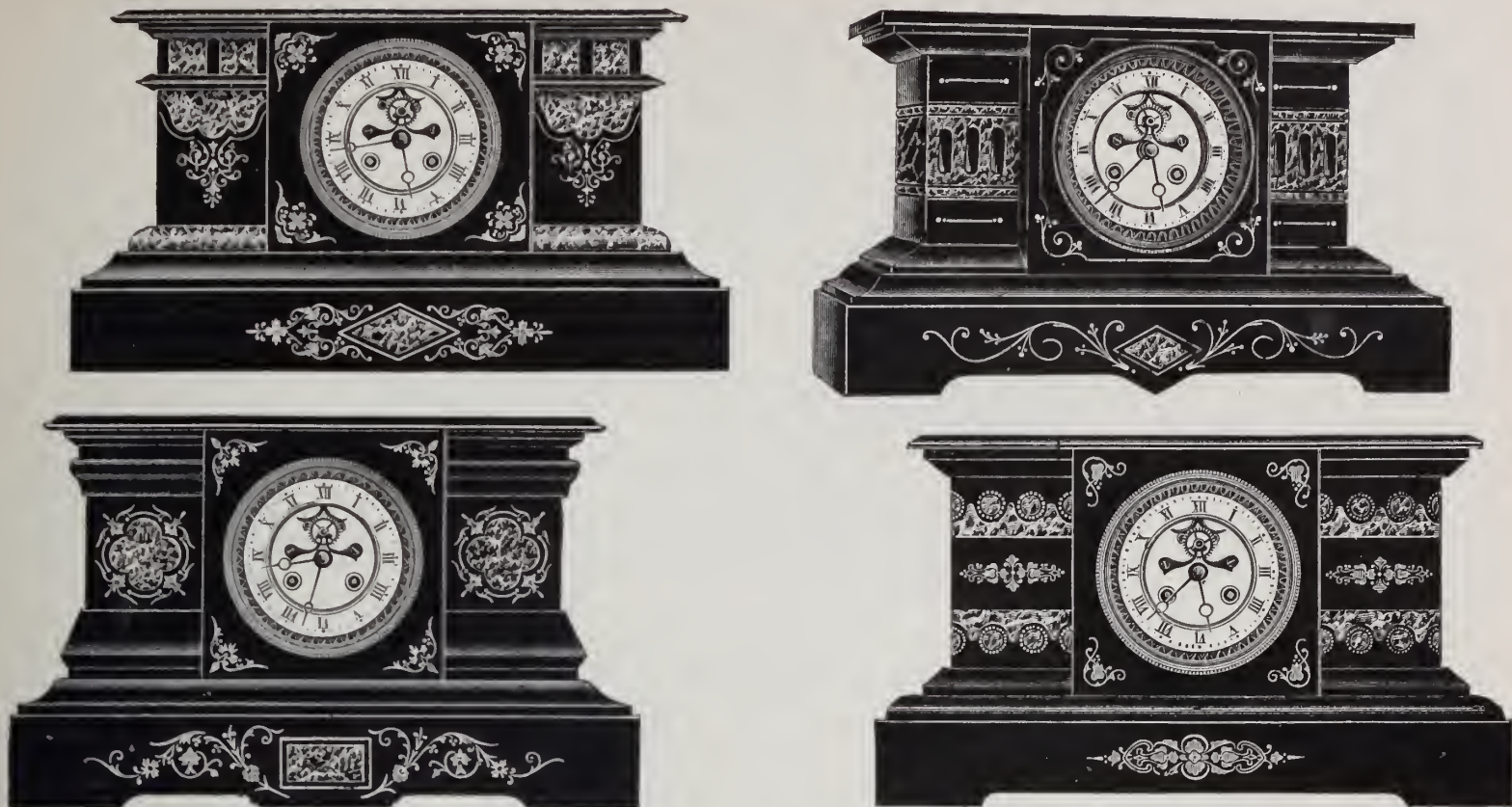

**F. KROEBER,**  
**IMPORTER,**

No. 14 Cortlandt Street,

NEW YORK.

LARGE ASSORTMENT OF  
FRENCH MARBLE CLOCKS,  
GILT CLOCKS,  
GILT AND ALABASTER CLOCKS.

*GILT and PORCELAIN CLOCKS, and NOVELTIES FROM PARIS for the Fall Season, 1883,  
at Low Prices.*



*Marble Clocks with Cathedral Gongs, at \$13.75 and upwards.*



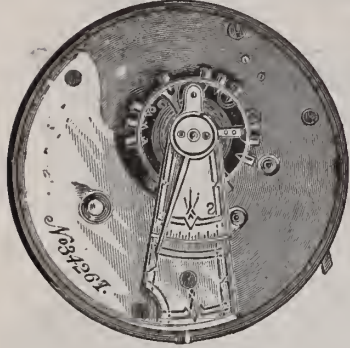

# CONTINENTAL WATCH CO. MOVEMENTS,

6, 8, 10, 16 & 18 Sizes.

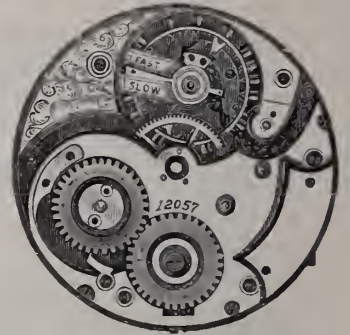

Fitting Waltham and Elgin Cases, and are the Most Reliable Movements in the market.

For Sale by all the Leading Jobbers in the Country.

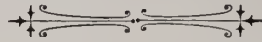

Would call the attention of the Trade to our Eureka, Lady Racine, Railroad Regulator and Continental Watches, in Silver and Nickel Cases in all sizes.



## JULIEN GALLET & CO.,

No. 1 MAIDEN LANE, NEW YORK.

SOLE AGENCY FOR THE CELEBRATED JAMES NARDIN WATCHES.

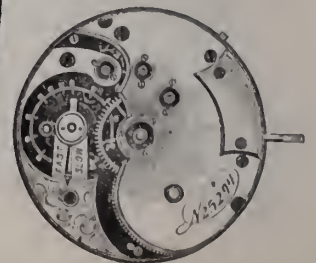
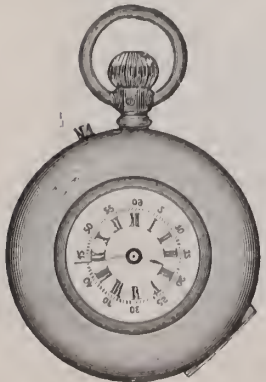
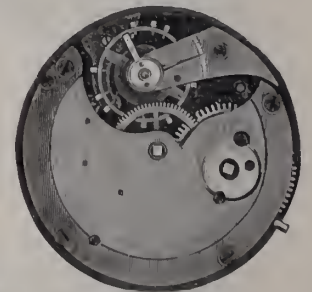
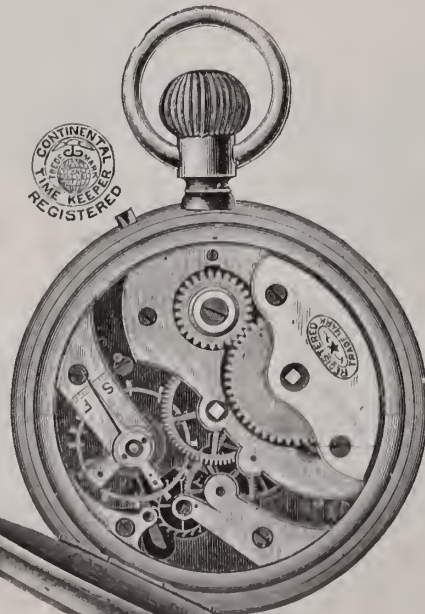
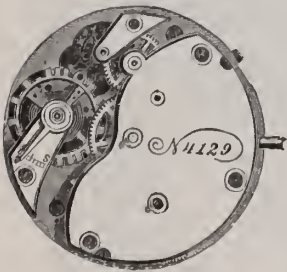
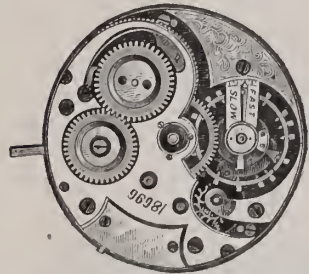
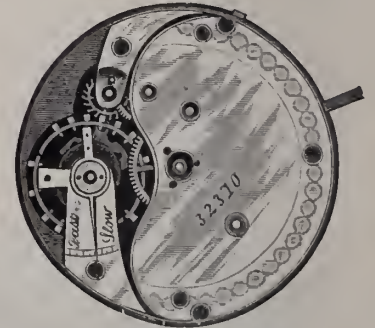



# MERIDEN BRITANNIA CO. MERIDEN CONN.

AND  
1847 ROGERS BROS. A1 & XII.  
ELECTRO GOLD & SILVER PLATED WARE





AGASSIZ

MOVEMENTS.

CAUTION.

I WOULD respectfully *caution* the Trade against a *spurious* movement made with intent to deceive, and in imitation of Watches and Movements made in my establishment.

The Movements made by me and bearing my Trade Mark



have achieved a high reputation in the Trade, which fact has induced certain unscrupulous parties to counterfeit them. I would, therefore, with a view to protecting the interest of Dealers in the United States, caution them against these spurious and greatly inferior goods, and state that all Movements made in my establishment have my Registered Trade Mark as above engraved upon the Plate under the Dial, and none other are genuine.

“AGASSIZ.”

Switzerland, October, 1883.





WILHELM & GRAEF,



IMPORTERS OF

**Ceramic Specialties**

FOR FINE JEWELRY TRADE.

After a six months' personal search we are now prepared to offer choice selections from 1883 Exhibitions of Rome, Amsterdam and Zurich, and Novelties from England, France, Germany, Austria and Italy. Fine Figures and Cabinet Pieces from Worcester, Derby, Copeland, Mintons, Royal Dresden, Vienna and Ginori manufactories. Unequaled collection of Porcelain Paintings and Fine Plates. Antique and Modern Rich Enameled Glass. Own Designs and Models of Rich Decorated Duplex Lamps.

**INSPECTION AND COMPARISON SOLICITED.**



Broadway and 26th Street,  
NEW YORK CITY.



*Morgan & Heady,*

*Manufacturing Opticians*

*Office and Factory:*

*11<sup>th</sup> & Mifflin Streets,*

*Philadelphia*



# SIMONS, BRO. & CO.

MANUFACTURERS.



CHAIN.



Fine Jewelry.

ILLUSTRATED CATALOGUE



611 and 613 SANSOM STREET, PHILADELPHIA, OR NEAREST JOBBER.

# STANDARD WATCH CO.

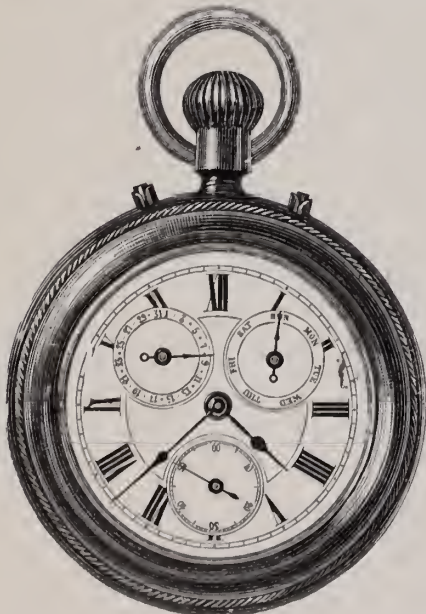

STANDARD CALENDAR

"STANDARD CALENDAR."

20 Line, Open Face, in Nickel and Silver, showing the date and day of the week, Full Jeweled, Finished Movement. The Latest Novelty offered.



"STANDARD."

18 Size, Low Price Movement, will fit Waltham and Elgin Cases.



"VESTA."

8 Size, Low Price Movement, fits Elgin Cases.



"STANDARD."

8 Size, Full Jeweled, Ladies, Fits Waltham Cases.

REGISTERED.



"STANDARD."

Nickel, 17, 19 and 20 Line. Lever, Full Jeweled.

Max Freund & Co., Sole Agents, 8 Maiden Lane, N. Y.



ESTABLISHED IN 1841.

# EROS RICHARDSON & CO.

Manufacturers of  
**Gold Jewelry & Chains.**

23 MAIDEN LANE NEW YORK.

SAN FRANCISCO, 206 KEARNEY ST. HASKELL & MUEGGE AGT'S.



## THE CLIMAX REVERSIBLE WATCH CASE,

MANUFACTURED BY THE

**Northwestern Watch Case Company, of Rockford, Illinois.**

Patented April 3d, 1883, No. 275,251.



Made in 4 oz. to fit all American Stem Wind Movements, also in 3 oz. to fit 16 Size Elgin.

**SOLD BY ALL WHOLESALE JEWELERS.**



# MATHEY BROS. & MATHEZ,

NO. 16 MAIDEN LANE.

IMPORTERS OF ALL GRADES OF

Plain and Complicated Watches and Movements

SOLE AGENTS FOR THE WELL-KNOWN

## H. L. MATILE

Fine Watches of Astronomical Precision.



REPEATERS.



CHRONOGRAPHS.

In order to facilitate the handling of our Stem-Winding Movements, we have adopted a standard of sizes to fit American Cases. Of these we have a complete line from the medium grade to the highest class goods of fine adjustment and precision. As all our Movements, complicated and plain, are perfectly uniform in quality according to their respective grades, we can furnish material for any parts that may be required, with the positive assurance of accurate interchangeability.

An Extensive Line of all Grades of

# CHRONOGRAPHS, SPLIT SECONDS AND REPEATERS.

WATCHES DEMAGNETIZED.





ESTABLISHED 1844.

# DENNISON MFG CO.,

BOSTON, NEW YORK, PHILADELPHIA, CHICAGO, CINCINNATI AND ST. LOUIS.

## JEWELERS' FINDINGS.

**PAPER JEWELRY BOXES IN ALL STYLES AND QUALITIES. IMITATION MOROCCO BOXES, SATIN LINED. TAGS, JEWELERS' CARDS, PINK AND WHITE COTTON, &c., &c.**

### MOROCCO CASES.

Manufacturing in our own Shops Every Description of Morocco, Plush and Velvet Jewelry and Silverware Cases in large quantities, we are enabled to sell lower than other goods of equal quality can be offered, and we carry in all our Stores FULL Stock of our whole line.

Catalogue on Application.

# D. L. VAN MOPPES, 37 MAIDEN LANE, N. Y.

CUTTING ESTABLISHMENT,  
AMSTERDAM, 16 Plantage Middenlaan.

PRINCIPAL OFFICE,  
PARIS, 10<sup>BIS</sup> Rue Chateaudun.

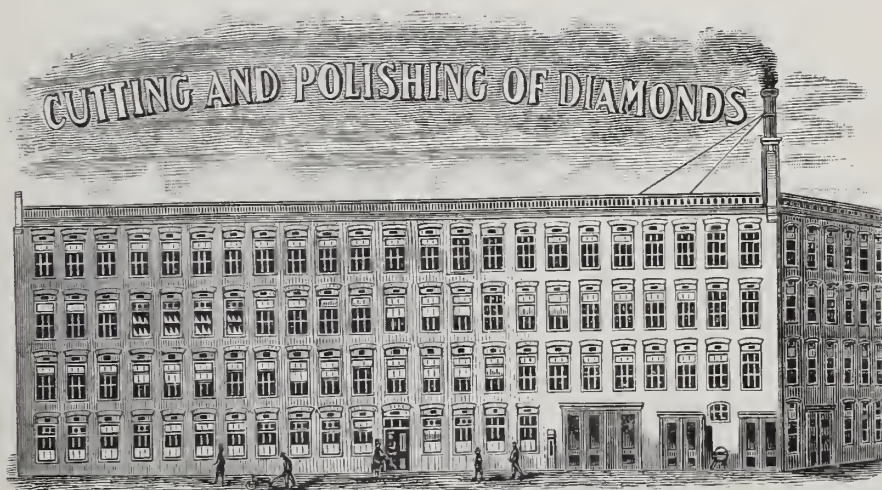

DIAMONDS.

DIAMONDS.

Cutting Establishment of D. L. Van Moppes, AMSTERDAM.

Constantly on hand, Bort and Diamond Dust for Lapidary and other purposes.



**T H E**

**E. HOWARD WATCH AND CLOCK CO.,**

—MANUFACTURERS OF—

**Fine Stem-Winding Watches,**

FINE REGULATORS, OFFICE CLOCKS, TOWER CLOCKS,

**And Electric Watch Clocks.**



LADIES'  
6 Size.

**STEM-WINDING  
AND**



GENT'S  
16 Size.

**Stem-Setting  
Movements.**



GENT'S  
18 Size.

**114 TREMONT ST., BOSTON.**

**29 MAIDEN LANE, New York,**

J. W. J. PIERSON, Agent.

**BRADLEY & HUBBARD MFG. CO.,**

21 BARCLAY STREET, NEW YORK.

FACTORIES,

Meriden, Conn.

ARTISTIC AND ORNAMENTAL BRONZES

IN LARGE VARIETY.

**FINE CLOCKS, ETC.**

**BRASS GOODS,**

Consisting of Candlesticks, Candelabras, Card Tables, New Patterns Scones, Stand and Hanging Mirrors, Placques, Easels, Smokers' Sets, Inkstands, Etc.

**A Special Line of Fine Hammered Metal Lamps**

*In Real Bronze and of Rich Designs, Specially adapted for the Jewelry Trade.*

Inspection of Goods Invited at our Salesrooms.





# KREMENTZ & CO.,

MANUFACTURERS OF

GOLD, PEARL AND DIAMOND JEWELRY,

Nos. 182 and 184 BROADWAY,

Corner of John Street,

NEW YORK.

(Elevator Entrance on John Street.)

NOVELTIES IN SILVER JEWELRY.

FACTORY, NEWARK, N. J.

---

## J. EUGENE ROBERT,

IMPORTER OF

MOVEMENTS & WATCHES,

**No. 30 Maiden Lane, New York.**

Ladies' and Gent's Stem Winding Movements, Fitting American Cases,  
all fully warranted.

**Ladies' Small Sized** Watches in Fancy Gold Cases of every Variety and  
Style of Decoration.

—: SOLE AGENT FOR :—

**LOUIS AUDEMARS**

Superior Watches. Plain and Complicated Stem Winders of every style, man-  
ufactured with the Latest Improvements.

**CHRONOGRAPHS** WITH OR WITHOUT **SPLIT SECONDS.**

Various Grades Minute Repeaters.



# GEO. H. RICHARDS, JR.,

383 Washington Street, Boston, Mass., U. S. A.,

## JOBBER

# AMERICAN MOVEMENTS & CASES

A SPECIALTY.

WE GUARANTEE TO HAVE **ALL GRADES** IN STOCK.

### MOVEMENTS.

WALTHAM.    SPRINGFIELD, ILLS.    HAMPDEN.    ELGIN.    HOWARD.

### CASES.

❖GOLD❖

WALTHAM.  
DUEBER.  
BROOKLYN.  
G. H. R., Jr.

→FILLED←

"BOSS."  
CROWN.  
LADD.

❖SILVER❖

WALTHAM.  
DUEBER.  
FAHYS.  
KEYSTONE.

## Watches, Jewelry and Silver Plated Ware.

ROGERS & BRO.'S FLAT WARE.

HOLLOW AND FLAT WARE SOLD AT MANUFACTURERS' DISCOUNTS.

Our Stock is positively the Largest, Finest and Best Assorted of any Jobbing House in the Country. All Orders Promptly Executed.

SOLE AGENT FOR

## GOOLD'S PATENT REGULATOR,

FOR SALE BY ALL JOBBERS AND MATERIAL DEALERS.

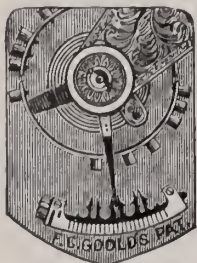

For 18 Size Movements, K. W. & S. W.



For 18 Size Movements, K. W. & S. W.

THE REGULATOR WILL BE IN THE MARKET JULY 1st, Price, \$1.50.

GEO. H. RICHARDS, Jr., 383 Washington Street, Boston, Mass.



# AIKIN, LAMBERT & CO.

23 MAIDEN LANE, NEW YORK,

MANUFACTURERS, IMPORTERS, JOBBERS.

## →: JEWELRY. :←

A Large Assortment of all Leading Styles in GOLD, SILVER and ROLL PLATE, including

|                   |                        |
|-------------------|------------------------|
| <i>Diamonds,</i>  | <i>Buttons,</i>        |
| <i>Bracelets,</i> | <i>Studs,</i>          |
| <i>Rings,</i>     | <i>Lace Pins,</i>      |
| <i>Chains,</i>    | <i>Drops and Sets,</i> |
| <i>Charms,</i>    | <i>Scarf Pins,</i>     |
| <i>Locketts,</i>  | <i>Emblems,</i>        |
|                   | <i>Thimbles, Etc.</i>  |

## →: WATCHES. :←

PAUL BRETON

Fine Movements, In Gold Cases.

AGASSIZ AND LONGINES

Stem Winding Movements, Fitting American Cases.

CHRONOGRAPHS, in Silver and Gold Cases.

Reliable Swiss Silver and Nickel Stem Winders.

ALL LEADING AMERICAN MOVEMENTS AND CASES.

## GOLD PENS,

HOLDERS, PENCILS, TOOTH PICKS.



“NOVELTIES” IN PENCIL CHARMS.

Show Case and Fancy Tray Assortments, in New and Tasty Designs for Jewelers, A SPECIALTY.

Catalogues and Price Lists sent to Dealers when request is accompanied by Business Card.



Branches: } 113 EAST MADISON STREET, CHICAGO, ILLS.  
 } 41 WEST FOURTH STREET, CINCINNATI, O.

Factories: } 14, 16 & 18 MAIDEN LANE, N. Y.  
 } 12 VESEY AND 6 BARCLAY ST., N. Y.

→: Novelties Continually Being Introduced. :←

SELECTION PACKAGES SENT.

JAMES C. AIKIN, }  
 H. A. LAMBERT, }

PROMPT ATTENTION TO ORDERS AND REPAIRS.

{ J. B. SHEA.  
 { D. F. FOLEY.



# Beauty, Simplicity, Lightness and Strength!

## The Patent Eureka INTERCHANGEABLE SPECTACLE AND EYE-GLASS.

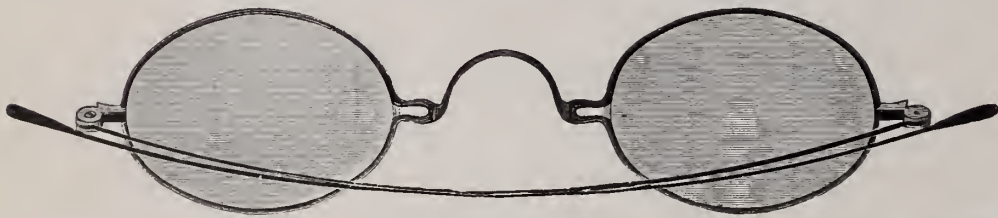

MANUFACTURED IN

**GOLD, SILVER, GERMAN SILVER and STEEL.**

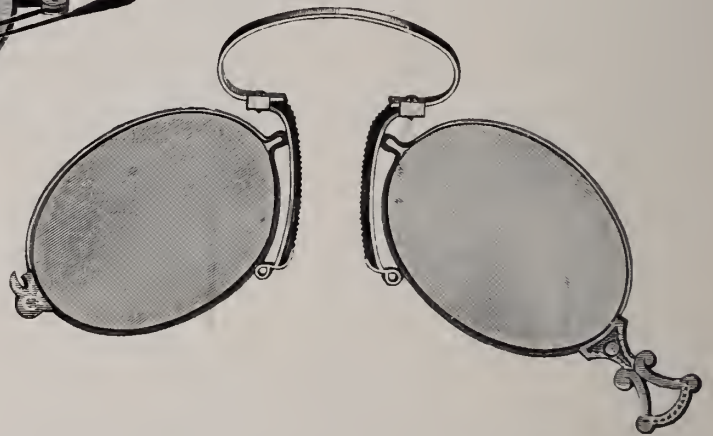

Completely INTERCHANGEABLE in all its parts.

*These Spectacles are absolutely interchangeable, and duplicate parts may be selected at hazard with a positive certainty of accurate adjustment.*

*The loops of the eye-frames can be enlarged or contracted at will, according to the requirements of the case, so that lenses of various sizes may be made to fit tightly in the same frame, thus securing an Interchange of Lenses.*

*The joints or end pieces are made of a slender solid piece of metal from one-quarter to one-half the usual size, and are so constructed that the Temples can be easily detached from one frame and freely adjusted to any other, thereby securing the Interchange of Temples.*

*Should the Temples become loose through wear, they may be easily tightened by the aid of a screw driver.*

**The Simplicity and Solidity of Construction, Lightness of Weight and Interchangeable Quality,**

*render them exceedingly Desirable Goods for Dealers to handle, and certainly the most satisfactory to the general wearer, while the price cannot fail to attract the attention of Dealers.*

A FULL AND COMPLETE ASSORTMENT OF THESE GOODS

CAN BE HAD OF THE JOBBING TRADE GENERALLY.



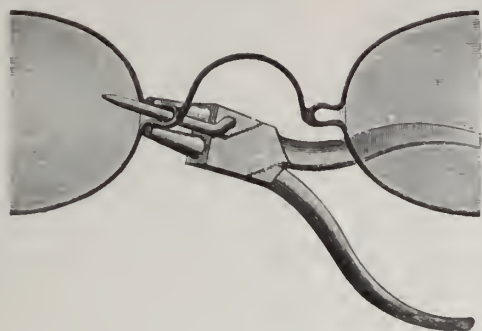

**To Close Loop or put Lense in Frame,**

Insert a Pin or other Instrument in LOOP NEAREST THE NOSE, rest and press gradually with a small pleyer on LOOP NEAREST THE GLASS.

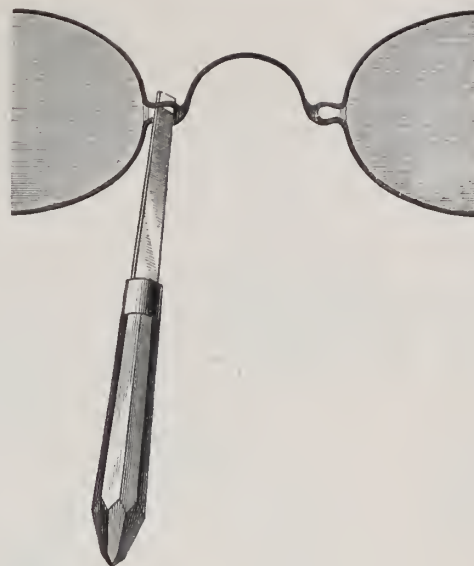

**To Open Loop or Take Out Lense,**

Insert a small screw driver in LOOP NEAREST THE GLASS, work it GENTLY from ONE SIDE to the OTHER till the Loop EXPANDS sufficiently.

*The following are a few expressions of opinion from Dealers and their Customers :*

**18 Chartres Street,**

NEW ORLEANS, La., Sept. 3d 1883.

We have had fair success with your Eureka Spectacles and Eye-Glasses, and our customers are well pleased with style and quality of goods. The sale of these goods will be much increased whenever you increase the line. We have faith in the goods and do not hesitate to recommend them. KOCH & DREYFUS.

**43 Maiden Lane,**

NEW YORK, Aug. 17th, 1883.

We consider your Eureka Spectacles to bear the same relation to the ordinary Spectacles as the American Watches do to the imported ones. As in the latter so in the former, the practicability of interchanging parts and ease of repairing them are truly American features, and your Spectacles are bound to supersede all others as soon as their merits become known. Were it not for the high prices heretofore asked, they would already have done so. If, however, as you state, you are enabled to sell them as cheaply as any similarly finished goods, we see no limit for their general adoption in place of all others. A. FRIEDENTHAL & CO.

**13 Emery Arcade,**

CINCINNATI, Sept. 1st, 1883.

We think they possess greater strength than those adjusted with screws, and have a greater advantage in the easy, quick and perfect adjustment of the Lenses. A. & J. PLAUT.

**56 St. Charles Street,**

NEW ORLEANS, La., Sept. 1st, 1883.

We find your Eureka Frames far superior to any others we have yet handled. They not only sell better to our retail trade, but to the wholesale also. HOUSAH & ANSELL.

FAIRFIELD, Iowa, Sept. 4th, 1883.

Your Patent Interchangeable Spectacles are the ones that take the lead. Please send us one dozen Patent Silver Frames. C. S. CLARKE & SON.

DENVER, Col., Sept. 1st, 1883.

I find your Eureka Spectacles and Eye-Glasses very convenient to sell and they give good satisfaction all around. I have been using them for two years. Please send me one-half dozen each 10 and 14 kt. Spectacles and Eye-Glasses, two dozen Steel Spectacles and one dozen Steel Eye-Glasses. JAS. P. TRYNER.

**8 Pine Street,**

CINCINNATI, Sept. 2d, 1883.

The Eureka Interchangeable Spectacles give great satisfaction and are vastly superior to the ordinary make of Spectacles. Please send me five dozen Patent Steel Frames, two dozen Patent Silver, eight pair 10 kt. Patent Frames and nine dozen Lenses. S. SAMUELS.

**68 Bowery,**

NEW YORK CITY, Aug. 31st, 1883.

I have found your Eureka Interchangeable Spectacles and Eye-Glasses so very convenient that I use them exclusively at present. F. SCHNEIDER.

GREEN COVE SPRINGS, Fla., Oct. 5th, 1883.

Have used your Eureka Interchangeable Spectacles and Eye-Glasses since they were first manufactured. They fill a long felt want, are durable and the Lenses so easily exchanged that they are a great convenience to both dealer and wearer, and if once given a trial no others will be used, as hundreds of my patrons testify. E. H. BEMIS.

NASHUA, Iowa, Sept. 11th, 18 3.

The Eureka Interchangeable Spectacles and Eye-Glasses are a great convenience, and they are most assuredly a long step in advance of the ordinary make. Please send your new list when you issue it. M. L. WOODBRIDGE.

**17 Rutgers Place,**

NEW YORK CITY, Aug. 23d, 1883.

Your Eureka Spectacles and Eye-Glasses have given great satisfaction to my customers and myself, they work to perfection. I conscientiously recommend them to all spectacle wearers and dealers as being superior to any article of the kind ever invented. J. M. DUBRIN.

OLNEY, Ills., Sept. 7th, 1883.

I have handled your Eureka Interchangeable Spectacles and Eye-Glasses since they were first introduced. I consider them the greatest invention in the spectacle line. R. G. FOWLER.

OWENSBORO, Sept. 3d, 18-3.

Your Eureka Interchangeable Spectacles and Eye-Glasses have supplied a long felt want. I cheerfully recommend them to all dealers as the best thing out. They are easily fitted and a great deal of time and trouble is saved by using them. J. H. BISHOP.

FORT SMITH, Ark., Sept. 15th, 1883.

We heartily recommend the Eureka Spectacles and Eye-Glasses to all dealers, as none have given such universal satisfaction as they have. MAYER & CO.

**34 Broad Street,**

SELMA, Ala., Sept. 10th, 1883.

The Eureka Interchangeable Spectacles have given perfect satisfaction, and the convenience and ease of interchanging lenses is very great. J. A. CLANCY, Ag't.

GAINESVILLE, Pa., Sept. 9th, 1883.

Your Eureka Interchangeable Spectacles and Eye-Glasses have given me entire satisfaction and I find them very convenient. J. N. LODEN.

**Frank Leslie's Publishing House,**

NEW YORK CITY, Oct. 26th, 1883.

I have worn a pair of Eureka Spectacles a considerable time, and they have given me entire satisfaction. They have kept their shape, the Lenses have never fallen out and the Frame sets firmly on the face. D. E. HERVEY.

**243 Broadway,**

NEW YORK CITY, Oct. 19th, 1883.

I have been wearing a pair of Eureka Spectacles for more than six months and they have given me great satisfaction. Notwithstanding the extreme lightness of the Frame, they have proved to be very strong, in spite of considerable rough usage to which they have been submitted; the Glasses are perfectly firm in the Frame. PHILIP MALONE.

**Supreme Court,**

NEW YORK CITY, Oct. 7th, 1883.

I am wearing a pair of Eureka Spectacles some time, they have given me the greatest satisfaction. They have kept their shape perfectly and the Lenses have never fallen out. EDWARD J. KNIGHT, Lib'n Sup. Court.

**399 Grand Street,**

WILLIAMSBURGII, N. Y., Sept. 27th, 1883.

I am still wearing a pair of Eureka Eye-Glasses, and am well pleased with them. They retain their shape better than any I have ever used, and I have no trouble with the glasses being loose. JAMES J. McENTEE.



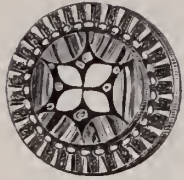

99



1162



93



28



94



0027



0045



1336

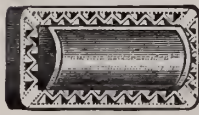

1840

THE

# ACME LEVER BUTTON



1741



1016



1094



0001



OPEN.



OPEN.



OPEN.



43



CLOSED.



CLOSED.



CLOSED.



0025



1091



043



323

Always was, is now, ever shall be  
**THE MOST CONVENIENT,  
STRONG, RELIABLE and PERFECT SLEEVE BUTTON MADE**



1420

**It Overcomes**

**ALL TROUBLE WITH STIFF CUFFS.**



1196



1369

ASK YOUR JEWELER FOR THE  
ACME LEVER SLEEVE AND COLLAR BUTTON,  
AND TAKE NO OTHER.



1316



319

**For Sale by all Jobbers of Jewelry.**

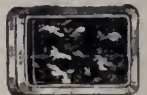

1269



50



58



1585



046



321



57



1545



1338



1235



1340



315



1238



02

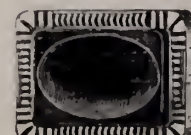

1182



634



SAN FRANCISCO:

206 Kearney St.

LONDON:

21 Holborn Viaduct.

**No. 676 BROADWAY,**

→\*NEW YORK.\*←

ESTABLISHED 1837.

OLD HOUSE, READ, TAYLOR & CO.

**TAYLOR & BROTHER,**  
IMPORTERS OF

*French Marble Clocks and Bronzes,*

AND NOVELTIES IN

*French, Vienna, English and other Fancy Goods.*

We invite the attention of the Trade to our Latest Importations, which are now arriving in great variety.

See also our advertisement of

Diamonds, ↩

↩ Watches, etc.

Sole Agents

Jaques Le Coultre

**RAZORS.**



OPPENHEIMER BROS. & VEITH,  
 WATCHES,  
 DIAMONDS,  
 JEWELRY.

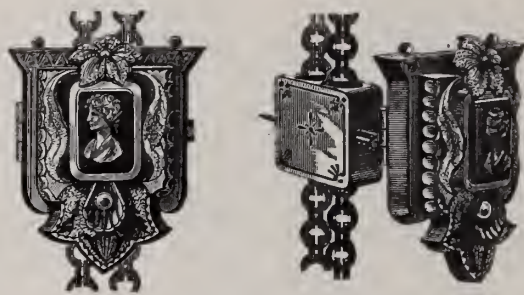

*We are the Manufacturers and Patentees of the Combination Slide, Pendant and Locket, and the Combination Necklace, Lace Pin and Pendant.*



*We can furnish quite a variety of Styles, and are prepared to fill all Orders at once.*

35 MAIDEN LANE, NEW YORK.



# HELIOLA.

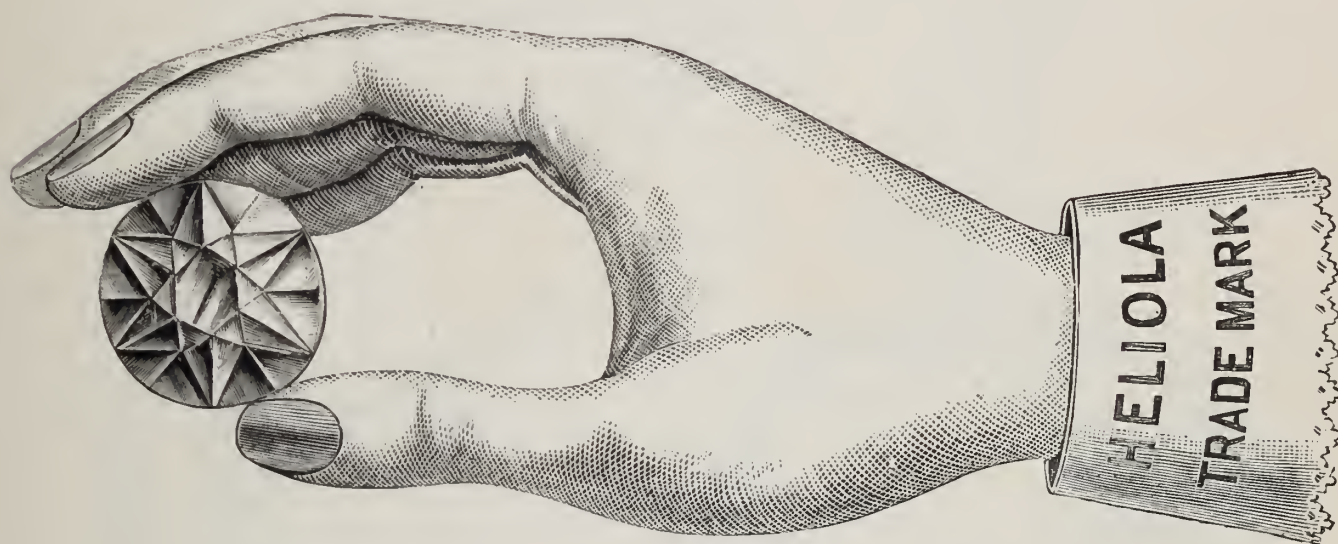

L. & M. KAHN,  
IMPORTERS OF PRECIOUS STONES,

10 MAIDEN LANE, N. Y.

42 WEYBOSSET ST.,  
PROVIDENCE, R. I.

17 RUE CHATEAUDUN,  
PARIS.

LOUIS KAHN.

MOSES KAHN.

M. D. ROTHSCHILD.



# IMPORTANT TO MANUFACTURERS, JOBBER AND RETAILERS.

*To the Trade:*

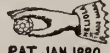
The undersigned are now ready to supply Manufacturers of Jewelry with their celebrated "HELIOLA" or Tipped Foil Brilliants. This tip foiling is covered by U. S. Letters Patent, and we caution the Trade that any Tipped Foil Stones other than those sold by us and bearing our trade mark  are infringements.

Respectfully,

L. & M. KAHN, 10 Maiden Lane, N. Y.

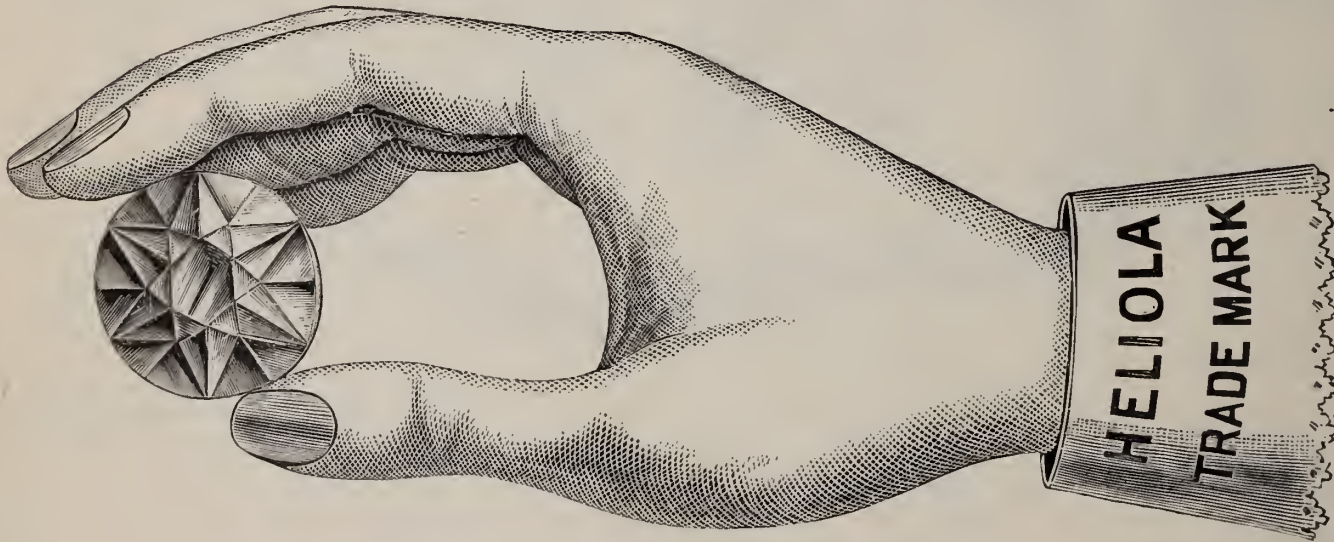

## HELIOLA



Foil Invisible when mounted in any kind of setting.

THE MOST PERFECT IMITATION DIAMONDS EVER OFFERED FOR SALE.

WHITE, HANDSOME, DURABLE and BRILLIANT!

EVERY HELIOLA IS WARRANTED TO KEEP ITS COLOR AND STAND ALL WASHING AND CLEANSING.

Ask your Manufacturer or Jobber for  
**THE "HELIOLA."**

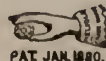
Every Paper Stamped with our Trade Mark, 





QUALITY  
Guaranteed.

HUTCHISON & HUESTIS,  
MAKERS OF

**SOLID GOLD RINGS,**

FOR  
Jobbing Trade  
ONLY.

FACTORY,  
No. 185 Eddy Street,  
PROVIDENCE, R. I.

NEW YORK OFFICE,

• No. 196 Broadway. •



# A NEW DEPARTURE.



## 14 KARAT GOLD CHAIN, SILVER LINED.

— MADE BY —

### A NEW PROCESS.

Guaranteed to wear as well as the best 14 karat Gold Chain made.  
Every Chain warranted to assay one-third ( $\frac{1}{3}$ ) its entire weight in gold.  
Each Chain stamped with registered trade mark:



*Showing the Relative Thickness  
OF THE GOLD AND SILVER.*



*Showing the Relative Thickness  
OF THE GOLD AND SILVER.*

Money refunded if test is unsatisfactory.

### KOSSUTH MARX & CO.,

Proprietors and Manufacturers,

39 Maiden Lane, New York.

In introducing our new Chain we aim to supply a want which we believe the Trade can place before the public in a legitimate manner without deception, and no detriment to the standard of the most scrupulous dealer.

We offer these goods strictly upon their merits, and give but a few reasons why they can take the place of the older styles of manufacture, viz.:

- 1st.—*In the make up there is no base metal, excepting such as is necessary in standard 14 karat.*
- 2d.—*It makes a larger and more showy appearance for its corresponding weight than the old standard.*
- 3d.—*The cost is materially reduced, bringing it within reach of a greater number who desire a good article.*
- 4th.—*It is a well known fact that the principal cause of wear in chain is the friction produced by its own weight, consequently, being light weight to the extent of a large percentage, their better wear is assured.*

By a strict adherence to quality we hope to create a popular demand for a meritorious article.

Send for selection package, as our travelers do not carry any in stock.

KOSSUTH MARX & CO.



LOUIS KAHN.

MOSES KAHN.

SAMUEL H. LEVY.

I. W. FRIEDMAN

# L. & M. KAHN,

IMPORTERS OF

## Watches, Diamonds & Precious Stones,

10 MAIDEN LANE, NEW YORK.

11 Corrairie, Geneva, Switzerland.

17 Rue de Chateaudun, Paris.

### WATCHES,

*Stem and Key-Winding, from the Lowest Priced Nickel and Silver to the Finest Gold and Complicated.*

A Full Assortment of these Goods always in Stock.

### DIAMONDS,

*Loose and Mounted, in all Sizes and Qualities.*

*Gold, Silver, Nickel and Celluloid Chatelaines in Great Variety.*



**FREUND & OPPENHEIMER,**  
MANUFACTURING



Fac-Simile of Ring Finished. Patented Aug. 28, 1883.

JEWELERS



25 Maiden Lane,

New York.

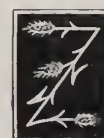

To meet the demand for an Encrusted Initial Ring, we have introduced the

### PATENT GRAIN INITIAL RING

in 10 k. gold (guaranteed), with one diamond, encrusted in various colors. Being confident of a large sale of these rings, we shall keep in stock a complete assortment of initials and sizes, which will enable us to ship all orders on the day we receive them.

Respectfully yours,

**FREUND & OPPENHEIMER,**

25 Maiden Lane, N. Y.

Price Lists Sent on Application.



# MARTINS & TISSOT,

MANUFACTURERS OF

## GOLD WATCH CASES,

15 MAIDEN LANE, N. Y.

*We respectfully invite the attention of the Trade to our new alloy in 8 Kt. Cases.*

*It has been generally conceded that our Cases excelled in color, and as we still retain the same and have succeeded in making our new alloy **ACID PROOF**, we now claim superiority over all Cases of that grade manufactured, combining as we do, Good Construction, Neatness of Design, Superior Color, in fact, all the requirements necessary to a Good Case.*

A LARGE STOCK CONSTANTLY ON HAND.

ALSO 14 KARAT CASES IN LARGE VARIETY.

JOBGING TRADE SOLD ONLY.



## AN IMPORTANT AND SPECIAL NOTICE!!

We have just published an Illustrated and Descriptive Manual of Optical, Meteorological, Mathematical and Engineering Instruments, including Electrical Apparatus, comprising 210 pages, with upward of 400 illustrations, which is not merely intended for the sale of merchandise, but also as a standard book of reference, of special interest to every Jeweler and Optician, and call attention to several original and novel ideas therein embodied, as follows:—

- 1st.—The marked absence of RETAIL PRICES allows the dealer to show the volume to his customer, not binding him to a fixed charge, thus leaving the question of profit entirely to the dealer, yet placing both parties in possession of the desired information regarding any article inquired for.
- 2d.—The Systematic Classification, Elaborate Illustration and Thorough Explanation of the various articles frequently recall to mind and facilitate the sale of Instruments which may not be in such general demand as to warrant their being kept in stock.
- 3d.—NET WHOLESALE PRICES are preferably quoted in a separate list, thereby placing the reader in prompt possession of the actual cost, as also avoiding the annoyance and inconvenience of calculating upon a basis of the so generally adopted though arbitrary discounts.
- 4th.—The Price List is intentionally *affixed* to obviate its being mislaid. It may, however, be conveniently removed to suit the purposes of the dealer.

COPIES OF THE ABOVE WILL BE FORWARDED TO THE TRADE, GRATIS, ON APPLICATION.

KAHN, HANOVER & CO.,

Importers and Manufacturers of Scientific Instruments,

32 MAIDEN LANE, NEW YORK,



FRANK S. KENNEDY,  
 Manufacturer and Wholesale Dealer in  
**JEWELRY**  
 OF EVERY DESCRIPTION.



13 Maiden Lane,  
 NEW YORK.



13 Maiden Lane,  
 NEW YORK.



*In addition to my stock of Jewelry, which is complete in all lines of Gold, Silver and Roll Plate, I am now making a Full Assortment of*

**THIMBLES,**

*in Solid Silver, 10 karat and 14 karat Gold. These Thimbles are Superior in Finish to any now in the market, and are as near perfection as long practical experience can make them. Will send Samples if desired.*

*The Assortments of Jewelry I send on Memorandum for Special and Stock Orders have an increasingly high reputation.*



No. 234. Gold Edge, Tassel, Landscape Engraved, Patent Lever Catch.

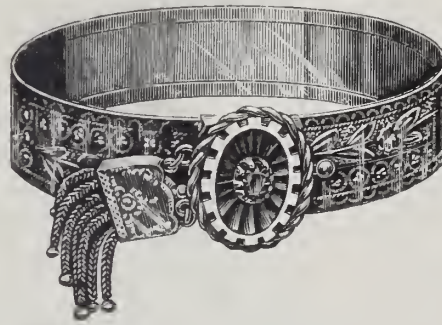

No. 92. Gold Edge, Garnet, Twist Border, Gold Front, Patent Lever Catch.

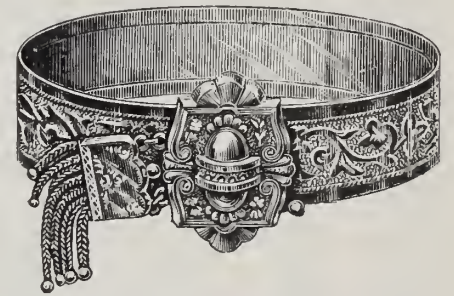

No. 113. Gold Edge, Tassel, Chased Top, Engraved Band, Patent Lever Catch.

**THE CONQUEROR.**

Our latest success, an Adjustable Band Bracelet with a Gold Edge, made from a single piece of 14 Karat Rolled Gold Plate, folded in such a manner as to completely cover the raw edge. These Bracelets are a marvel of mechanism, and have puzzled the best mechanics of this country to tell how it is done. The bands have the appearance of being turned on the inside while the fact is the joints are on the outside. Will some Jeweler tell how this is done? We will send these goods to the legitimate Jeweler only.

SEND FOR PRICES.

**J. M. CHANDLER & CO.,**

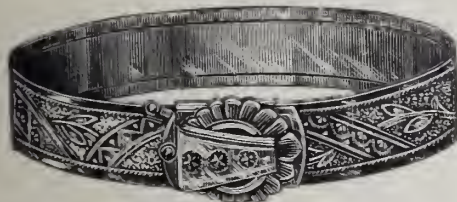

No. 227. Gold Edge, Garnet, Chased Top, Engraved Band, Patent Lever Catch.

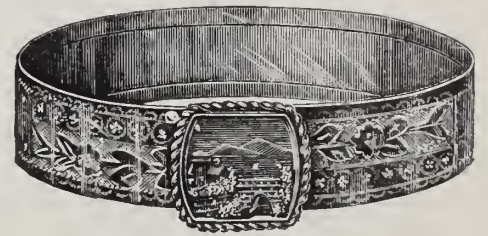

No. 232. Gold Edge, Landscape, Wire Border, Engraved, Patent Lever Catch.

Factory, 111 Broad Street, Providence, R. I.

185 Superior Street, Cleveland, O.



No. 231. Gold Edge, Landscape, Burnished Border, Engraved Band, Patent Lever Catch.

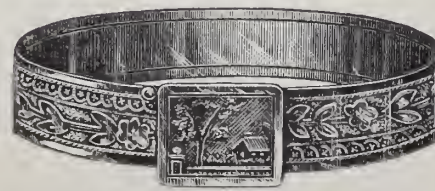

No. 230. Gold Edge, Landscape, Burnished Border, Engraved, Patent Lever Catch.

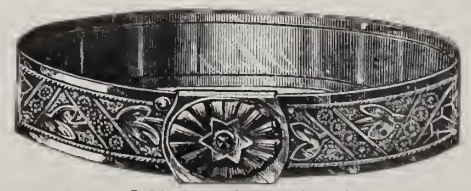

No. 225. Gold Edge, Garnet, Gold Front, Star Engraved, Patent Lever Catch.



# JACOT, JUILLERAT & CO.,

IMPORTERS OF

## MUSICAL BOXES,

49 MAIDEN LANE, NEW YORK.

Round and Square Crank Toy Music Boxes, small, 2, 3, 4, 6 and 8 tune and small Mandolines in all styles of cases.

Large Size Musical Boxes from 4 to 15 inch cylinders and playing from 4 to 12 tunes.

Musical Boxes with Bells, Bells and Drum, Bells, Drum and Castanettes.

Mandolines, Piccoloes, Guitare-Mandolines, Sublime Harmonies and many other styles of all sizes.



Musical Boxes with several cylinders, double and quadruple Main Springs, and Richly Inlaid Cases.

These Boxes are of superior quality and with airs appropriate to each style.

PRICE LIST SENT ON APPLICATION.

Send for "How to Repair Musical Boxes," with Price List of Material, Price 25 Cts. No Watchmaker should be without it.

## STANDARD DUST-PROOF WATCH KEYS.

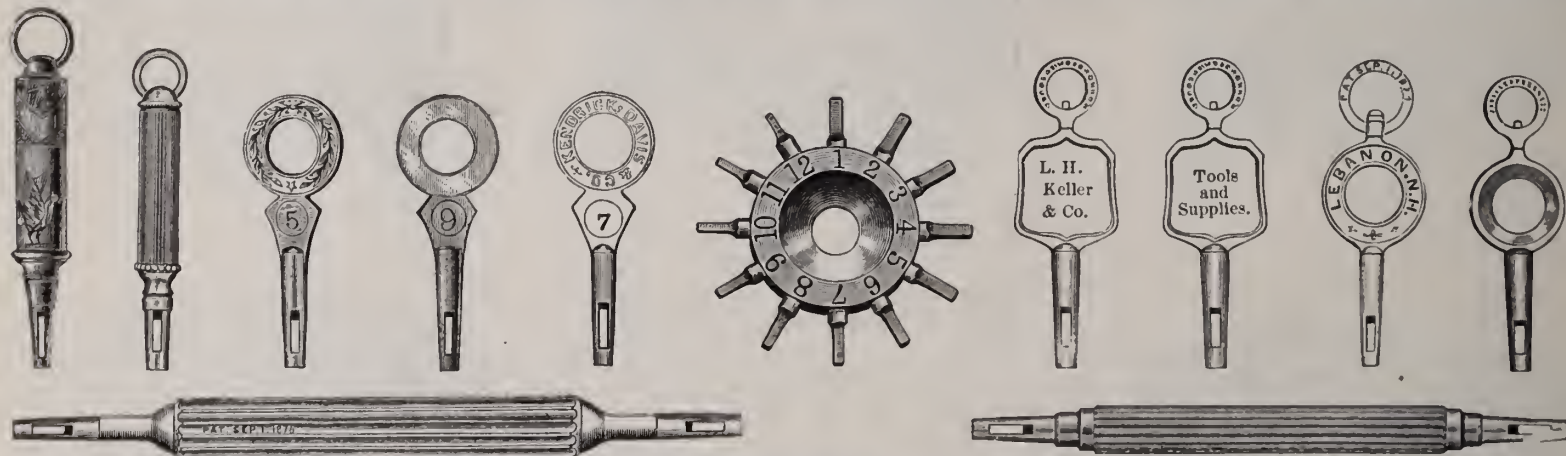

FOR SALE BY



THE TRADE.

## KENDRICK & DAVIS,

Sole Owners and Manufacturers, Lebanon, N. H.

ILLUSTRATED CATALOGUE and PRICE LIST SENT ON APPLICATION.



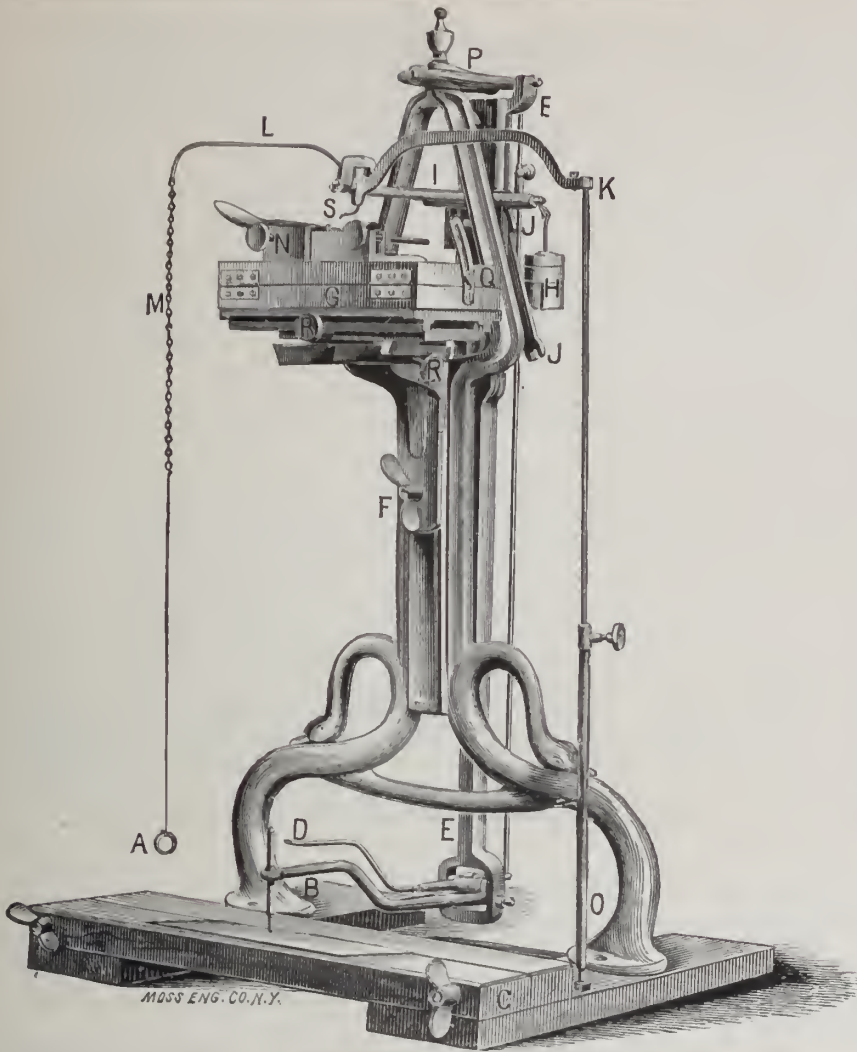

S. D. ENGLE ENGRAVING MACHINE CO.,

Sole Manufacturers of the

**ENGLE ENGRAVING MACHINE,**

HAZLETON, LUZERNE COUNTY, PA.,

Would Respectfully call the attention of Jewelers throughout the United States to this New Invention.

*Patented by S. D. Engle, September 6th, 1881.*

Do not confound this machine with any heretofore put in market. You will see by the cut that it is an entirely different arrangement.

It is very simple to operate.  
It is easily kept under perfect control.  
It meets all the requirements of the trade.

We claim that it eclipses all similar machines.

This machine has a compound slide rest under the chocking table, to move the work in any direction, also a radial link to set the table at any angle, for sloping work, like the base of castors, &c. We also furnish a chuck with the machine, for holding all small articles, and one for holding large work such as tea sets.

This machine does beautiful shading in script, and the tracer is just as much under the control of the operator as a writing pen. You can shade letters where and as you wish without danger of spoiling the work, as the cutter is under perfect control. The cutter is not made out of a piece of a graver, but out of the best sub steel, for this special purpose, and engraves as well inside of rings as outside.

It is nicely designed, occupies only 18 by 21 inches, and weighs about 80 lbs. They are finished in black and nicely ornamented. All bearings have steel cones to take up all lost motion, and will last for generations, and all sliding surfaces are planed to fit nicely. Our tracing type is not made out of thin sheet zinc, cut at random, but is cast in steel moulds an eighth of an inch thick out of a composition for the purpose. The tracing lines on the type are sunk deep so the tracer cannot slip out, and all down strokes are free and do not cross the up strokes, as there is a stop on either side of the down strokes, and all letters match together like one piece, change them as you wish.

Price is \$85, complete, with Full Sets of Old English and Script Type.

We shall be glad to correspond with any party who has use for a machine of this kind, and give them full particulars.

“GLYPTIC CAPITALS.”

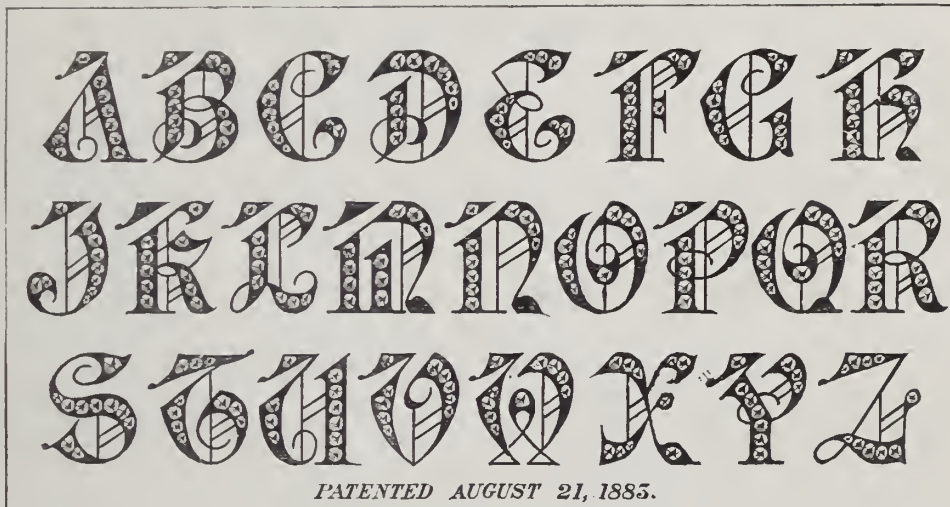

A New and Original Alphabet introduced in Incrustated Initial

**RINGS AND LOCKETS**

this season by

**H. MUHR'S SONS,**

NEW YORK OFFICE,  
NO. 14 MAIDEN LANE.

224 SOUTH FIFTH ST.,  
PHILADELPHIA, PA.

CHICAGO OFFICE, No. 101 STATE STREET.



"The Waterbury."

**THE NEW "SERIES C,"**

**With FULL DIAL and SOLID PLATES.**



NEW SERIES C.  
Solid Plates and Full Dial.

With each series we have greatly improved the quality of the Watch, and are fully satisfied that "Series C" will be admitted by Dealers generally to be a decided step in advance.

The past three years' experience has enabled us to make the decided improvement so well known and acknowledged by those who have handled the Waterbury since its first introduction.

The "Series A" had open dial and skeleton plates. Our judgment in making the change in "Series B" to full dial and solid plates has received the unanimous verdict of approval, and we have retained them in "Series C."

The metal of the cases of "Series C" will be of Nickel Silver, which always wears white and clean.

Having found the Satin Lined Spring Box admirably adapted for safe transportation of Watches, we shall pack "Series C" in same box.

Material in any desired quantity can be had of New York office only.

**ONE THOUSAND WATCHES MANUFACTURED EVERY WORKING DAY.**

SERIES C.—Full Dial, Solid Plates, - - - \$48.00 per dozen.

**Discount to the Trade.**

Orders for less than one dozen are referred to the nearest Jobber. **We do not fill them.**

**Waterbury Watch Co., Waterbury, Conn.**

**NEW YORK OFFICE, 52 MAIDEN LANE.**

GEO. MERRITT, GENERAL SELLING AGENT,

To whom all Orders and Correspondence as to Prices and Terms should be addressed.

**FOR SALE BY DEALERS GENERALLY.**

**STERN BROS. & CO.,**

**No. 30 Maiden Lane, New York,**

**Importers of Diamonds,**

**MANUFACTURERS OF FINE JEWELRY.**

**Jobbers in American Movements of all grades, Gold & Silver Cases, Gold & Plated Chains.**

THE FOLLOWING ARE OUR **SPECIALTIES:**

*SEAL and STONE RINGS. GENT'S LOCKETS. The most complete and largest line of GOLD INITIAL RINGS and LOCKETS made in the United States. The celebrated DOUBLE CROWN Plain Filled Rings, which are universally acknowledged the MOST RELIABLE in the market. Made in seven different widths.*



No. 00



No. 0



No. 1



No. 2



No. 3



No. 3 1/2



No. 4

**EVERY RING IS WARRANTED TO GIVE SATISFACTION.**

Goods sent on selection to Dealers upon application with satisfactory reference.



# CLEMENS HELLEBUSH,

MANUFACTURER, IMPORTER AND WHOLESALE JEWELER,

Dealer in everything required by the Jewelry Trade.

**DIAMONDS.**—Dealers will find in my stock an assortment of Diamonds unequalled in the West, embracing a choice variety of loose and mounted Stones, in all qualities.

**WATCH CASES.**—In Gold and Silver, of all makers, to fit American Movements.

**WATCH MOVEMENTS.**—Include always a full stock of Waltham, Springfield, Hampden and Howard, together with a large assortment of fine and low-priced Swiss Watches.

**SILVER PLATED WARE.**—I have an unusually fine assortment of the choicest patterns of Flat and Hollow Ware of the best known manufacturers.

**SOLID GOLD AND ROLLED PLATE JEWELRY.**—This department is replete with Staple Goods and Novelties.

**FRENCH CLOCKS.**—Of our own importation, including all grades, with prices exceedingly low.

**AMERICAN CLOCKS.**—I am the General Agent in Cincinnati for the celebrated Seth Thomas Clocks, a full line of which will always be found in stock.

**TOOLS AND MATERIALS.**—In this department will be found everything required by Watch Makers.

Illustrated Catalogues sent to Dealers only upon Application.

## CLEMENS HELLEBUSH,

77 West 4th Street,

CINCINNATI, O.

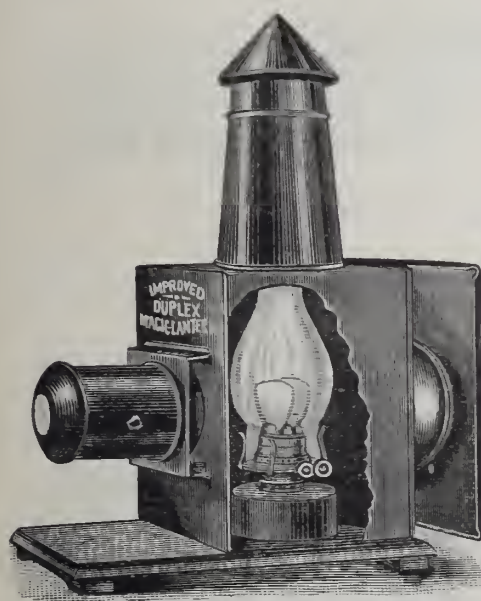

This Cut represents our **New Improved Duplex Magic Lantern**, specially adapted for Parlor and School-house Entertainments.

In using the Duplex Burner we obtain a far superior light to that which any single wick burner will produce, and dispense with the enormous cost and danger of gases, which had to be used until now, to obtain a perfect picture with the ordinary parlor lantern.

The high power and finish of the condensing lens, which is  $3\frac{1}{2}$  inches in diameter, permits the use of fine photographic and painted views, and will reproduce them in every detail from 8 feet diameter upwards.

The picture carrier,  $3\frac{3}{8}$  inches wide, will hold any of the standard sizes of views.

CIRCULARS SENT ON APPLICATION.

## JOHN SCHEIDIG & CO.,

IMPORTERS AND MANUFACTURERS OF

OPTICAL GOODS,

MAGIC LANTERNS AND MATHEMATICAL INSTRUMENTS,

No. 43 MAIDEN LANE,

NEW YORK.





GILES, BRO. & CO.  
 Wholesale,  
 Importing and  
 Manufacturing  
 → JEWELERS, ←  
 101 and 103 STATE STREET,  
 CHICAGO, ILLS.

Complete Illustrated Catalogue Furnished the  
 Trade upon Application.

THE

# Hartford Silver Plate Co.

OF HARTFORD, CONN.,

MANUFACTURERS OF

# Fine Electro Plated Ware.

New Illustrated Catalogue now Ready,

Which will be sent to Dealers on application.

Elegant New Salesroom just opened at the Factory, where Dealers  
 are invited to call or send their orders.



No. 0254. SYRUP CUP.

L. A. CUPPIA,

Manufacturing Jeweler,

19 Union Square, N. Y.

SILVER CANE HEADS,

A Large and Comprehensive Assortment of New and Original Designs.

AND IMPORTER OF

→ SILVER FILIGREE JEWELRY ←

Embracing a Large and Varied Assortment of Popular Designs.

SILVER JEWELRY.

SILVER BRACELETS A SPECIALTY.

SELECTION PACKAGES SENT ON APPROVAL



# R. & L. FRIEDLANDER,

65 & 67 NASSAU STREET.

BRANCH SALESROOMS, 264 BOWERY. } . . . . . NEW YORK CITY.  
 FACTORY, 50 BOND STREET.

IMPORTERS OF

Watch Materials, Tools, Optical Goods, Silk Guards, Watch Keys, White Metal Chains,

Rolled Plated and Fine Gilt Chains, Charms, Locketts, Etc., Etc., Etc.



**PRICE OF SOLID GOLD BANGLES.**

|                                      |                         |
|--------------------------------------|-------------------------|
| No. 5, \$3.50 per doz.               | No. 13, \$1.75 per doz. |
| " 6, 1.75 "                          | " 13, 3.50 "            |
| " 7, 1.75 "                          | " 24, 1.25 "            |
| " 8, 3.50 "                          | " 25, 1.25 "            |
| " 9, 1.75 "                          | " 26, 2.50 "            |
| " 11, 3.50 "                         | " 27, 2.50 "            |
| No. 28, \$2.50 per doz.              |                         |
| Silver Dimes, Engraved, - - - \$3.00 |                         |
| " " Plain, - - - 1.25                |                         |

Silver Bangles.

Plain Gold Bangles.

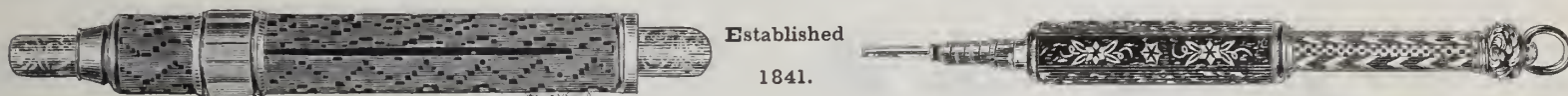

Established  
1841.

## JOHN HOLLAND,

19 and 21 WEST 4th STREET,

CINCINNATI, OHIO.

Manufacturer of All Styles of Best Quality

**GOLD PENS, PENCIL CASES, FINE PEN HOLDERS, GOLD TOOTH PICKS, &c.**

A Large Variety of New Designs in Staples and Novelties.



Received the Award "For Great Elasticity and General Excellence of Gold Pens," at Phila. Ex., '76.

Catalogues mailed free. Handsome show cases loaned for display of goods.



LEVY, DREYFUS & CO.,  
 Importers and Manufacturers,  
 11 MAIDEN LANE, N. Y.

OFFER A LARGE ASSORTMENT OF

**Fine Bisque Figures,**

Especially Selected for the requirements of the Jewelry Trade.

**Alluminium, all Pearl Opera Glasses,**

Six or Twelve Lenses, and a Large Variety of other Glasses of Standard Makers.

**GOLD SPECTACLES AND EYE-GLASSES IN GREAT VARIETY.**

Monogram Albums containing 35 Series of Alphabets, Price, \$5.00; also Monogram Albums, 3 and 4 Letter Combinations, Price, \$10.00.

**WM. M. FISHER & CO.**

Sole Manufacturers of the



**PATENT INTERCHANGEABLE  
 Combination Necklace,**

And Ladies' Brooch or Lace Pin

**PATENTED**

**JULY 16, 1872**

**GOLD  
 AND  
 SILVER  
 CHAINS.**

—:—  
 Gold Chain  
**TRIMMINGS.**

—:—  
 Complete  
 Assortment of

**14-k.  
 Ribbon Fobs.**

**FOR SALE BY THE LEADING JOBBERS**

**F. P. LOCKLIN & BRO.,**

MANUFACTURERS OF

**GOLD & SILVER**

**HEADED**

**CANES**

— AND —

**BRACELETS.**



**142 FULTON STREET,**

**NEW YORK CITY.**

**T. L. MAXWELL & BRO.,**

MANUFACTURERS OF

**GOLD AND SILVER HEADED**

**CANES**

IN GREAT VARIETY,

42 CORTLANDT ST.,

**NEW YORK.**



Special Attention given to the Jobbing Trade.

PRICE LIST SENT ON APPLICATION.



# THE ATTENTION OF THE TRADE

IS CALLED TO THE MERITS OF THE

## FISHER, POTTER & FISHER LATHE,

IN COMBINATION WITH POTTER'S PATENT LATHE ATTACHMENT.

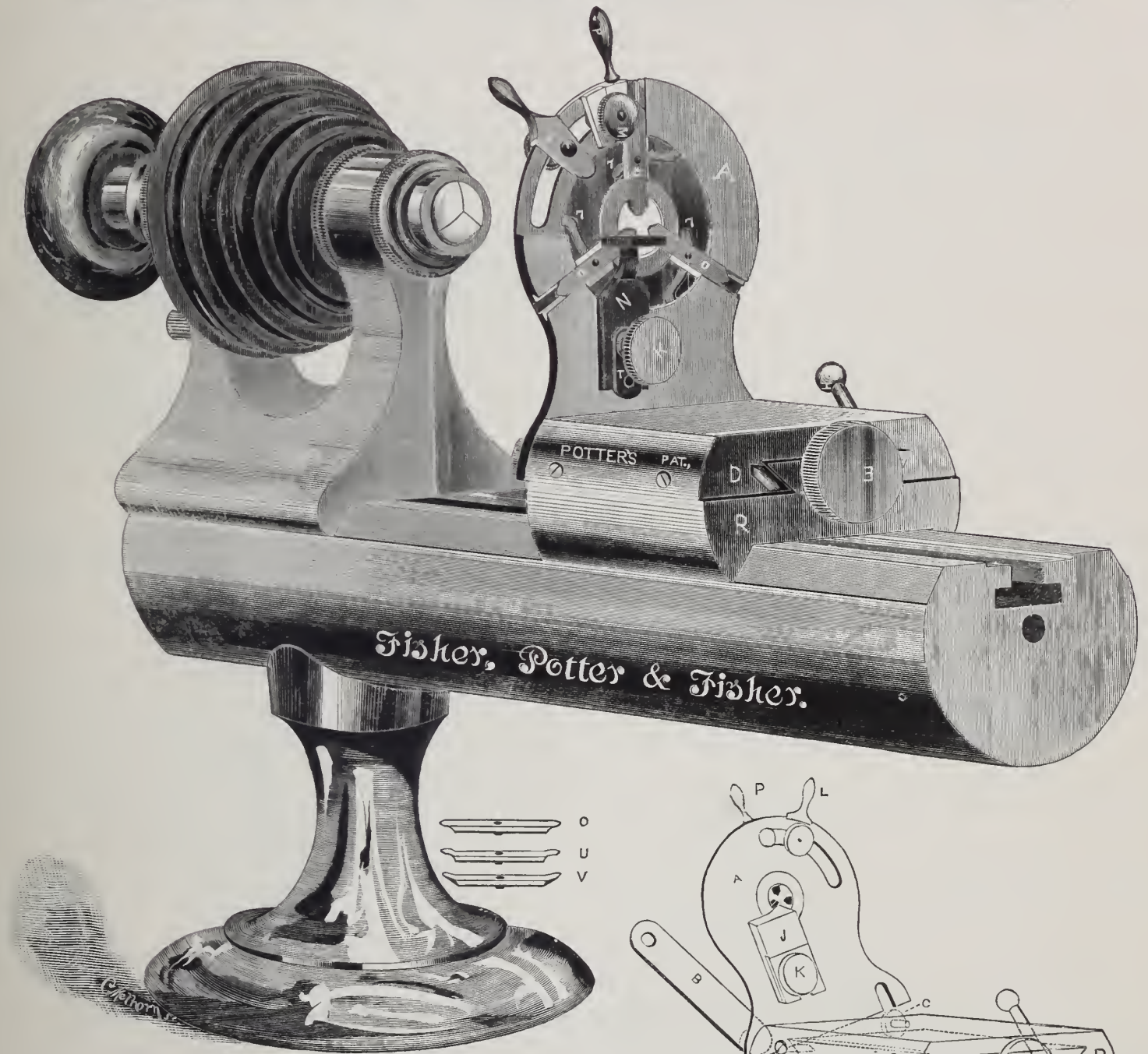

Competent mechanics of the Trade pronounce it the most perfect operating Lathe that ingenuity and mechanical skill has yet produced. It instantly and accurately centers both ends of the work. It completely dispenses with the use of cementing all regular Staff and Pinion Work to a chuck. A full line of the latest Improved Attachments are manufactured for the above Lathe. This Lathe and Attachments are manufactured by special machinery under the supervision of competent mechanics of repute and long experience. Its beauty is unexcelled; its reliability is attested by a certificate of guarantee. Potter's Patent Lathe Attachment can be fitted to any Split Chuck American Lathe.

**Descriptive Catalogues Furnished on Application.**

**FISHER, POTTER & FISHER WATCH TOOL CO.,**

P. O. Box 9999.

WALTHAM, MASS.

Sole Proprietors of Potter's Patent Lathe Attachment in America, England, France and Germany.



ESTABLISHED 1869.

---

THE  
JEWELERS' CIRCULAR

AND

HOROLOGICAL REVIEW.

THE RECOGNIZED ORGAN OF THE TRADE.

---

Enters upon the 15th year of its publication with the issue of the February number.

---

Subscription to all parts of the United States and Canada, \$2.00.

Foreign Countries, \$3.00.

---

D. H. HOPKINSON,

42 NASSAU STREET,

NEW YORK.



# AMERICAN WATCH TOOL CO.,

WALTHAM, MASS.

MANUFACTURE THE

## WHITCOMB LATHE,

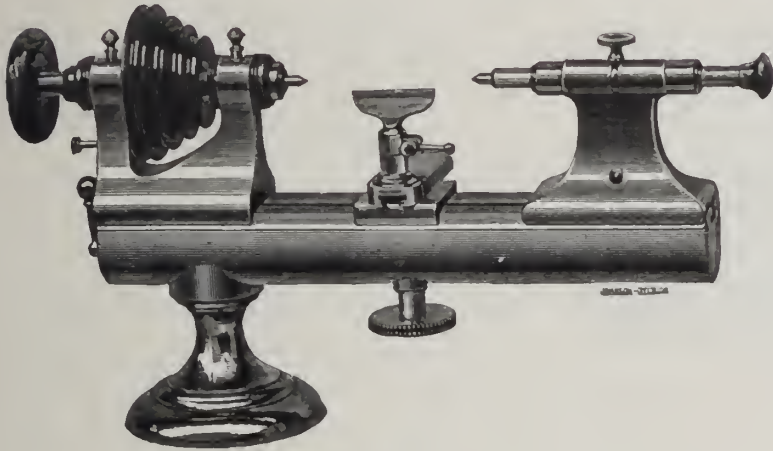

AND THE

## "Webster" Foot Wheel,

We guarantee it to be a worthy companion to the Whitcomb Lathe.

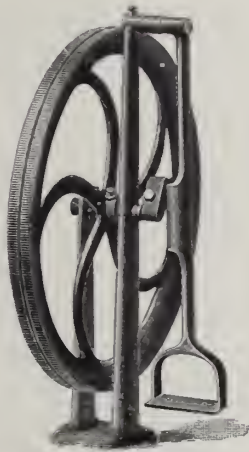

It is **not** a cheap made wheel but **First-class** in every respect.

### PRICES:

|                                                       |       |         |
|-------------------------------------------------------|-------|---------|
| 30 lb. Wheel, for No. 1 Lathe, 20 inches in diameter, | - - - | \$12.00 |
| 40 " " " 1½ " 20¼ " "                                 | - - - | 13.00   |
| 50 " " " 2 " 21½ " "                                  | - - - | 14.00   |

DESCRIPTION.—The wheel runs on a hard steel arbor. It is clamped to the arbor by a set screw against a split bushing. This does not bend the arbor as is the case where the set screw is against the arbor. On the crank pin is a friction roll, having a hardened steel bushing, which runs on a hard steel pin. The swinging treadle is the **easiest** motion, and effects the body **less** than the foot treadle.

SEND FOR NEW CATALOGUE.

Our No. 1½ Lathes are Fast Superseding all other Sizes.

Soft Lathes have Hard Mouths, Hard Wire Chucks and Hard Tail Stock Spindles,

GEO. W. DUBOIS.

F. N. NAUMAN.

## GEO. W. DUBOIS & CO.,

IMPORTERS OF

## Watches & Optical Goods.

ALL STYLES AND QUALITIES OF

SPECTACLES AND EYE-GLASSES.

### Longines' Watches and Movements,

The Watches in Gold, Silver and Nickel Cases of New and Handsome Patterns. The Movements fit 18 size Waltham Stem Winding Hunting Cases.

36 Maiden Lane, New York.

ORDERS BY MAIL RECEIVE

ATTENTION.

## Elgin & Waltham 18 Size Movement

### DISPLAY CASES.

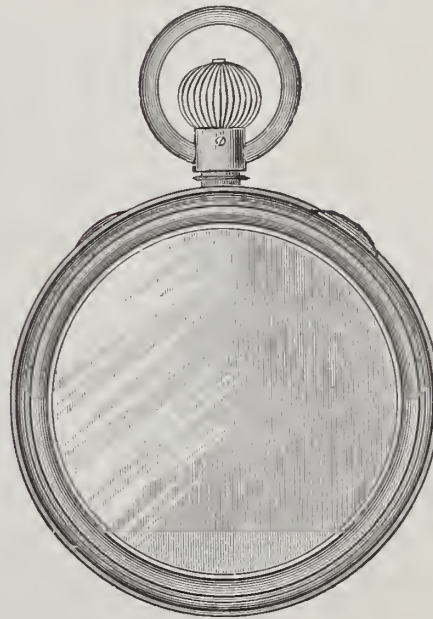

Each Case Suitable for Key and Stem Winders.

Thick Glass

FRONT AND BACK.

Nickel, dozen, \$12.00

Gilt, " 16.50

## LEVY, DREYFUS & CO.,

Sole Manufacturers' Agents,

11 MAIDEN LANE,

NEW YORK.



**E. J. BOYCE,**

(Formerly Boyce & Wainwright.)

MANUFACTURING JEWELER

SOLID GOLD RINGS A SPECIALTY.

My BAND RING Specialties, for PRICE, QUALITY and FINISH, are not equaled by any in the Trade,

383 WASHINGTON ST.,  
BOSTON, MASS.

**NEW ENGLAND MOROCCO CASE CO.,**

MANUFACTURERS OF

JEWELRY and SILVERWARE

**CASES,**

OF EVERY DESCRIPTION.

NO. 220 CHAPEL STREET

NEW HAVEN, CONN.

Solid Gold Rings a Specialty.

**WM. H. ELY,**

SOLID GOLD RINGS,  
MANUFACTURER.

Viz., Plain, Chased, Engraved, Enameled, Engine Turned, Shield and Scale. All qualities guaranteed. Orders Promptly Executed.

58 Nassau Street, New York.

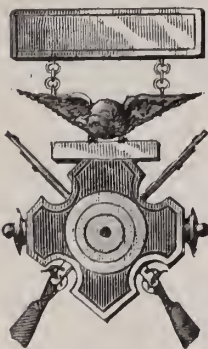

**C. B. WILKINSON,**

Manufacturing Jeweler,

8 JOHN ST., N. Y.

Medals, Badges and Masonic Jewelry  
A SPECIALTY.

Designs furnished free upon application.

**H. WUNDOEHL,**  
GOLD & SILVER REFINER,

Assayer and Sweep Smelter,

21 JOHN ST.,

bet. Broadway & Nassau St., **NEW YORK.**

The highest price paid for Gold, Silver and Platinum.  
*Fine Gold, Silver and Copper always on hand.*

**JACOB STRAUSS,**  
**WATCHES & JEWELRY**

AT WHOLESALE.

REMOVED FROM

18 TO 25 JOHN STREET, N. Y.

Rings and Rolled Plated Chains  
A SPECIALTY.



**J. J. COHN,**

IMPORTER OF

WHITBY JET,

MANUFACTURER OF

Gold & Rolled Plate Jewelry,

Bracelets, Charms & Locketts a Specialty.

12 MAIDEN LANE, N. Y.

Goods Sent on Selection if Satisfactory References are Given.

**WM. SCHWENCKE,**

Manufacturing & Jobbing Jeweler.

43 MAIDEN LANE, N. Y.

Gives particular attention to the Repairing and Jobbing Department of the Jewelry Business. Prompt Attention, Moderate Prices and First-Class Workmanship Guaranteed to all. Country Orders Promptly attended to.

**CHURCH'S PATENT IMPROVED  
DOUBLE SPEED INDICATOR**  
*Either Right or Left.*



**MONTGOMERY & CO.,**

Importers of Stubs' Files, Tools & Steel,

GROBET SWISS FILES. CHESTERMAN'S TAPES, RULES, &c.

Horse Shoe Magnets. Hubert's French Emery Paper.

WM. SMITH & SONS' CELEBRATED MUSIC WIRE.

105 Fulton Street, N. Y.

The Finest Line of High-Class English  
Watches in the U. S.

**GEO. E. WILKINS,**  
SYRACUSE, N. Y.

Agent for the Celebrated Watches of

Chas. Frodsham & Co., London,

W. G. Schoof, London,

Karl Zimmerman, Liverpool.

Timing and Adjusting done for the Trade.

Correspondence Solicited from the Trade.

**HIBBARD G. GILL,**

GOLD AND SILVER

Watch Case Manufacturer,

Dealer in Watches,

American Watch Movements Always on Hand.

618 Chestnut Street,

Fifth Floor.

PHILADELPHIA.

**HENRY TROEMNER,**  
710 Market Street,

PHILADELPHIA.

Manufacturer of Fine Gold Scales,

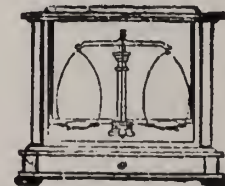

DIAMOND SCALES,

Bullion Balances and Weights, in use at all the U. S. Mints and Assay Offices.

PRICED CATALOGUE ON APPLICATION.

**JNO. F. LUTHER,**

MANUFACTURER OF

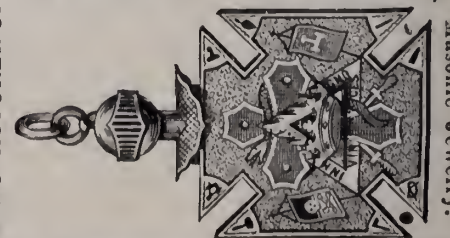

Masonic Jewelry.

79 Nassau Street, N. Y.

Illustrated Catalogue sent on application.



ADOPTED AND IN USE BY  
**RANDEL, BAREMORE & BILLINGS,**  
 88 Nassau Street, N. Y.

THE TRADE SUPPLIED  
 Descriptive Circulars Furnished  
 on Application to  
**George W. Washburn, Patentee,**  
 88 Nassau St.,  
 NEW YORK.

**SAFETY**  
**EAR FASTENING,**   
*Pat. May 10, '81—Oct. 11, '81.*

**Jointed**  
**EAR WIRE**  
 AND  
**BAR BETWEEN CRAMPS**  
 OF SETTINGS.  
*Patented March 1, 1881.* 

**TELESCOPIC**  
**SAFETY PIN CATCH,**   
*Pat. Sep. 20, '81—Jan. 10, '82.*

**A. BANTLE,**

Gold, Silver and Platinum  
 Electro-Plating  
 FINE WORK A SPECIALTY.  
 130 Fulton Street,  
 89 Nassau Street,  
 ROOM 36, **NEW YORK.**

WATCH CASE POLISHING.

**J. R. WOOD & SON,**  
 MANUFACTURERS OF



**Solid Gold Rings**  
 AND

**Diamond, Stone and Children's Rings,**  
 14 John Street, N. Y.

No Goods Stamped Different from Quality.

**Diamond Broker.**

**R. J. Herbert, 26 Maiden Lane,**  
 New York City,  
 Solicits Commissions,  
 Buying, Selling, Matching.

Prompt Attention.

References.



**60 DAYS OFFER.**  
 No Gentleman or  
 Lady should ever be without  
 this celebrated MATCH CASE  
 It is the ACME OF PERFECTION.  
 The fortunate possessor  
 has only to push the slide quickly  
 when a match presents itself  
 self lighted. Your clothes,  
 walls and furniture need no  
 longer be injured or defaced; many  
 vexations and dangers are overcome.  
 By Mail on receipt of price, **Solid**  
**Nickel Silver, 50 cents each;**  
**Three, \$1.00; Six, \$1.65.** A liberal discount  
 on larger quantities. Delivered free to any part of  
 the world (Duties and Express paid). Address **F. S. DANGER-**  
**FIELD, Sole Proprietor, Auburn, N. Y., U. S. A.**

**John F. Stratton & Co.,**  
 No. 49 Maiden Lane, NEW YORK.  
 Importers and Wholesale Dealers in  
**Violin Strings**  
 And all kinds of Musical Merchandise.  
 ALSO  
 Music Boxes, Musical Novelties, Ladies'  
 Musical Work Boxes, Glove Boxes, Etc.  
 SEND FOR DESCRIPTIVE CATALOGUE.

**P. JANDORF & BRO.,**  
**Watches and Jewelry,**  
 196 BROADWAY,  
 Bet. John & Fulton Sts., NEW YORK.

We Publish No Price Lists.

Mansard English Geneve Louis XV.  
  
**HENRY LEFORT,**  
 Stem-Winding Watch Crown Manufacturer,  
 Crowns and Pushers in gold, all sizes, quality and color,  
 made to order. Silver crowns and pushers always on hand.  
 60 Arlington Street,  
 Corner William Street,  
**NEWARK, N. J.**



**Pennsylvania Engraving Co.**  
 PHOTO ENGRAVERS  
 113 SOUTH 7TH STREET  
 PHOENIX, ARIZONA

ESTABLISHED 1873  
**CHAS. P. HEROLD**  
 MANUFACTURER JEWELER  
**DIAMONDS**  
 916 CHESTNUT STREET UP STAIRS  
**PHILADELPHIA**

**H. WASELL,**  
**RUBBER STAMPS,**  
**BRASS STAMPS,**  
 Brushes, Inks, &c.  
 Stencil Plates,  
 Burning Brands,  
 SEALS & PRESSES,  
 No. 7 North William St.  
 First house South of East River Bridge, N. Y.  
**FINE STEEL STAMPS A SPECIALTY.**

**C. KNAPP,**  
 Manufacturer of  
**Superior Band**  
 and Children's  
**Stone & Fancy**  
**RINGS**  
 And Enameled Goods,  
 41 Maiden Lane,  
**NEW YORK.**



**WILLIAM ERNST MOUTOUX,**  
 Leading Artist in Hair of the World  
 AND MANUFACTURER OF  
**GOLD AND HAIR JEWELRY,**  
 OFFICE AND FACTORY,  
 81 Nassau St., Rooms 1 & 2,  
 BRANCH,  
 18 Lawrence St. West of 126th,  
 Near Ninth Ave., NEW YORK.  
 My New Catalogue of 1700 New Designs of Monuments  
 with Weeping Willows, Wreaths, Bouquets, Crosses, Churches,  
 Sceneries, Portraits, Pet Animals, Engravings of the Most  
 Difficult Description, Etc. Wholesale prices for Hair Chain  
 Braids in Assorted Colors, by the gross or dozen at half of  
 book prices. Devices made at half of book prices if necessary.  
 15-5 per cent. cash discount on the prices of the old book.

**Office of American Watch Co.**  
 R. E. ROBBINS, Treasurer.  
 WALTHAM, MASS., Apr. 20, 1883.  
 Mr. Chas. A. Winship, 200 Kinzie Street,  
 Chicago: Dear Sir—The skins you left with us  
 when here, are as good as any we ever had. As  
 soon as we are in need of more we will send you  
 an order. Yours Respectfully,  
**AMERICAN WATCH CO.,**  
 H. BOND.  
**ELK SKINS**  
 FOR  
 Polishing Watch Cases, Jewelry, Etc.  
 Samples and Prices sent on application.  
**CHAS. A. WINSHIP,**  
 200 KINZIE STREET, CHICAGO, ILL.

**BURGESS'**  
 Patent Portable Mechanical  
**BLOW-PIPE,**  
 Supersedes the Forge, Bellows  
 and Mouth Blow-pipe, by sav-  
 ing time, labor, and breath,  
 giving the gentlest flame or hot-  
 test blast without exertion.  
 PRICE, - - \$10.00.  
**J. ELLIOTT SHAW,**  
 154 South 4th Street, Philadelphia.





# Spencer Optical Manuf'g Co.

NEW STYLES

FOR

Fall & Holiday Trade.

NEW AND  
Novel Ideas.

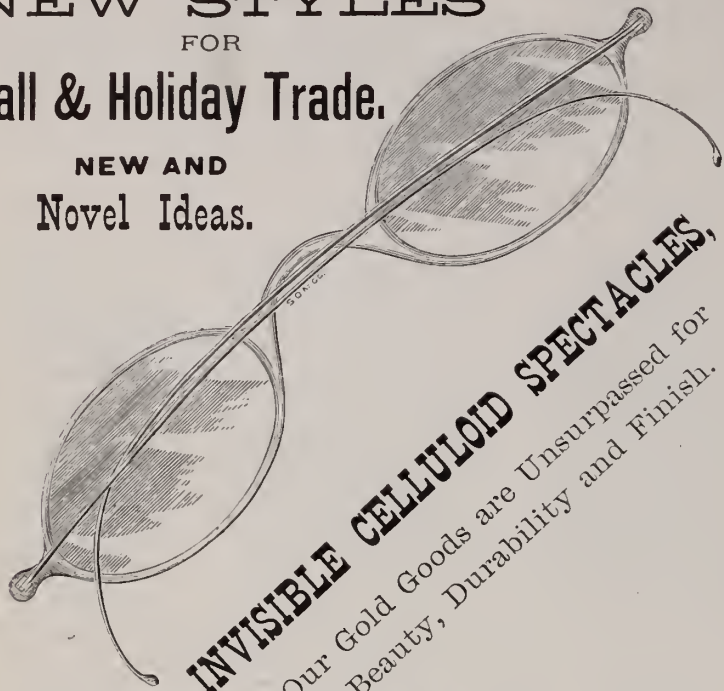

**INVISIBLE CELLULOID SPECTACLES,**  
Our Gold Goods are Unsurpassed for  
Beauty, Durability and Finish.



**CELLULOID**

**SPECTACLES.**

The very latest improvement, made in Shell and Amber Color; it has substantial advantages over all others, being strong, light and not subject to rust.

## THE CELLULOID EYE-GLASS

has made its own reputation and is universally popular wherever introduced.

**BEWARE OF IMITATIONS.**

We make a specialty in special goods for the Fine Retail Trade, which gives customers handling our goods immense advantage over all others.

**QUALITY OF GOLD GUARANTEED.**

We are importing large Invoices of Opera, Field and Marine Glasses in Staple and Novel Designs.

# Spencer Optical Manufacturing Co.,

13 MAIDEN LANE, NEW YORK.

Established 1853.

# L. H. KELLER & CO.

Successors to G. A. HUGUENIN,

IMPORTERS OF

WATCHMAKERS' and JEWELERS'

## TOOLS AND MATERIALS.

GENERAL AGENTS FOR

The Philadelphia Watch Company,

— AND —

American Watch Tool Co.,

MANUFACTURERS OF

### THE WHITCOMB LATHE.

SOLE AGENTS IN THE UNITED STATES FOR THE SALE OF

**LUTZ'S**

## CELEBRATED ROLL HARDENED HAIR SPRINGS,

## MOEBIUS OIL

For Chronometers, Watches, Clocks, Telegraph Instruments and all other delicate machinery. Made from Pure Refined Neatsfoot Oil, and Warranted to Excel anything in the market as a Lubricator. **SAMPLES GRATIS.**

**OUR OWN GRADUATED**

AND JURGENSEN RECOILING MAINSPRINGS, pronounced by all experts Superior to all. Sold in Separate Strengths or Force.

Extra Fine Pinions cut from Solid Steel Wire. Gauged Hole Jewels of First-class Workmanship. A Full Line of Materials, for the PATEK, PHILIPPE & CO. GENEVA WATCHES, and all other Celebrated Makers.

### THE BOLEY LATHES AND TOOLS,

Celebrated for their Practical, Substantial and Workmanlike Construction, Superior Design and Finish.

*Our aim is to furnish nothing but First-class Serviceable Goods, especially manufactured for the Consumer, and not solely for the Market, like the cheap trash advertised in highly illustrated catalogues with which the country is flooded.*

**TREATISE ON MODERN HOROLOGY IN THEORY AND PRACTICE.** By M. CLAUDIUS SAUNIER, Ex-Director of the School of Horology at Macon, France; Knight of the Legion of Honor, etc.; Hon. Sec. to the Paris Society of Horologists. Translated from the French by JULIEN TRIPPLIN, Besançon Watch Manufacturer, and EDWARD RIGG, M. A., Assayer in the Royal Mint, London.

This Work comprises 832 large octavo pages, with 78 wood cuts and 21 colored double-page copper-plate engravings. Bound in half calf, with an appropriate and handsome ornament in gold on front cover.

**Price, \$15.00.**

**THE WATCHMAKER'S HAND BOOK.** By the same author and translators. Intended as a companion to the Treatise. Bound in cloth.

**PRICE, \$4.00.**

## 64 Nassau Street,

NEAR MAIDEN LANE,

## NEW YORK.

L. H. KELLER,  
EDWARD HUNZIKER,  
F. J. BOESSE.

We do not publish Price Lists.



**SPECIAL NOTICES.**

**Notices under this Heading, not to exceed Six Lines, \$1.00 each insertion.**

Advertisers having letters addressed in care of this office, must inclose postage for answers forwarded.

**WANTED**—A few Elgin movements No. 7, No. 6, No. 94. \$1.00 premium over the net retail price. Address D. H., care Jewelers' Circular.

**SITUATION** wanted by a watchmaker of 8 years' experience. Good set tools. References given. Address L. A. Davenport, Davenport, N. Y.

**WANTED**—To buy a new or good second-hand marine chronometer for jewelers' use. Must be cheap for cash. Frank K. Smith, Wooster, Ohio.

**THE FINE TOOLS** of the late Dexter Newton are offered for sale at a reasonable price, also a lot of other tools. E. L. White, Huntington, Ind.

**WANTED**—A young man with two or three years' experience at the bench to finish his trade under a good workman. Address F. Mongin, Oswego, N. Y.

**WANTED**—Two Grandfather clocks. Must be in good condition. Brass dials preferred. State full particulars, maker's name and lowest price. G. R. A., care Jewelers' Circular.

**A PERSON** acquainted with trade in New York and vicinity would introduce article of merit in jewelry, watch or kindred line next year. Smith, 217 East 40th street, New York.

**FOR SALE**—New rounding-up tool. Red brass mountings late pattern, with 24 cutters finest quality. Will be sold cheap for cash. Address Rounding-up Tool, care Jewelers' Circular.

**WANTED**—A situation by a competent watchmaker accustomed to all kinds of watch work. Can furnish satisfactory references. J. W. Reed, 13 E. Park street, E. Newark, N. J.

**TRAVELER WANTED** by wholesale jewelry house. Knowledge of German and previous experience on the road indispensable. Address, with full particulars, L. & S., Box 2516, P. O., N. Y.

**SITUATION** wanted by a first-class watchmaker. 10 years' experience. Do not engrave. Own tools, American lathe, etc. Competent, sober and reliable. Address G. D., care Jewelers' Circular.

**WANTED**—A situation by a young man to work on watches with an experienced workman; has served 3½ years at bench. Reference from present employer. W. S. Banks, Greenwich, Conn.

**FOR SALE**—One Levy, Dreyfus & Co.'s Imperial optometer. Rosewood case, new and perfect. Contains all the eye lenses used in specs. The best inst. in use, \$6, cost \$10. Geo. M. Marekres, Sharon, Conn.

**MOSELEY & CO.**, Elgin, Ill., manufacturers of the "Moseley" Lathe, with full line of fixtures and attachments. Designed especially for the watchmaker and repairer. Combining accuracy, durability, convenience and style.

**WANTED**—Situation by the 1st of January, by a young man of good habits, nineteen years of age, two years' experience at the trade. Those who can give fair wages and a steady job please address "Watchmaker," care Jewelers' Circular.

**WANTED AT ONCE**—A first-class watchmaker who can also act as salesman, must have good references, sober habits and strictly honest. Will pay good wages and will give permanent situation. Address Rockford, care Jewelers' Circular.

**SITUATION** wanted by a practical watchmaker and jeweler. 14 years' experience at the bench. Has had charge of store in last place 3½ years. Best references. Only a good and permanent situation desired. Address E. Zimmerman, 518 Grand street, New York.

**WANTED**—An active partner with from \$3,000 to \$10,000 capital, to purchase a one-third or one-half interest in an established manufacturing jewelry business. Factory in complete running order and a large trade acquaintance. Address W. G., Newark, N. J., P. O.

**SITUATION** wanted by a young man who has had 10 years' experience in the business. Can repair watches, clocks and jewelry, can furnish first-class references. Would prefer situation as salesman in some leading house. Address C. W. P., care Jewelers' Circular.

**WANTED**—To buy for cash. In a thriving town or city in New England or Middle States, the stock and fixtures of a well-established jewelry store with business enough for two men. All communications strictly confidential. Address E. R. W., care Jewelers' Circular.

**\$100 WILL BUY** a large fire-proof safe that cost \$1,000. 76 drawers suitable for jewelry or pawn-broking business. H. Mulligan, 33 and 35 S. Eighth street, Philadelphia, Pa. Good-will and fixtures for sale. One of the best locations in the city. Possession in January, 1884.

**FOR SALE**—The leading jewelry store in a good Iowa town of 7,500. Stock, etc. is worth \$6,000, but will reduce to suit customer. Plenty of work for two men. A good chance for a young man, as this will be sold at a bargain. Good reasons for selling. Address Lock Box 1026, Oskaioosa, Iowa.

**GEORGE E. WILKINS**, manufacturer and importer of cutters for watchmakers' use, stem-winding cutters of all the different forms, rounding up cutters of the finest quality, also ratchet cutters. A large stock of second hand and new marine chronometers. No. 21 South Salina street, Syracuse, N. Y.

**WANTED**—By the 1st of January, a situation at the bench and as salesman with an experienced workman, to finish the trade. Those who can use a steady young man of 20 and two years' experience in the trade, with no bad habits, will please address, stating salary you are willing to pay, help, this office.

**WANTED**—As a partner, a watchmaker who can invest about \$2,000 in a safe jewelry business. Established 1865. Sales last year \$12,000. Have kept a watchmaker seven years. Want to do business for cash is the reason for wanting a partner. Can give and shall expect the best of references. Address W. & F., care Jewelers' Circular.

**INFORMATION WANTED**—Enameled Hunting Case Key Winder, Ladies Swiss Gold Watch, Detached Lever Escapement, Full Ruby Jeweled, Compensated Balance, No. 42161. Was taken to some jeweler in this city about Aug. 1st, to have dents taken from lids, by Wm. A. Miller. Information leading to recovery of this watch will be thankfully received. Address K., care Jewelers' Circular.

**FOR SALE**—The jewelry and variety store of the oldest jeweler in the town of Ebensburg, Pa. Population 1,500. Situated on the top of the Allegheny mountains. The climate very healthy. Store is located the best in town. Plate glass front, lit with gas, dwelling under same roof. Will sell building, or lease to party purchasing stock. One other jeweler in town. Plenty of repairing for two shops. Address Box 81, Ebensburg, Cambria Co., Pa.

**TO THE TRADE**—I make a specialty of supplying the Trade with stones for jobbing purposes. Parties having jewelry out of which the stones have been lost, sending their orders by mail or express, will have them promptly attended to. A large stock of canoes, pearls, turquoise, garnets, amethysts, doublets, foil backs, white and colored imitation stones on hand. All kinds of setting done for the Trade. W. Archibald, 73 Nassau street, New York.

**FOR SALE**—Rare opportunity. A first-class jewelry store in one of the best towns in Illinois of 7,000 inhabitants. County seat, three railroads, college and large manufacturing. Doing a good business and will bear investigation. Bench work from \$100 to \$150 per month. Good clean stock. Reason for selling, poor health. If not sold before January 1st will sell tools and fixtures without stock. For particulars address A. J. Green, Monmouth, Ills.

**FOR SALE**—A jewelry store (brick building) with dwelling, in a thriving town of 2,000 inhabitants, with railroad through center of town, in western part of Ohio. Good business. Established about 18 years ago. Good farming country. Stock reduced. Sum required for the purchase, for building, stock and fixtures, from \$4,000 to \$6,000. Will take part cash and balance in easy payments on good security. Good reason for selling. For information address Henry Weber, Wauseon, Fulton Co., Ohio.

**BUYERS' DIRECTORY.****NEW YORK.****Assayers and Sweep Smelters.**

**Wundoehl, H.**—Gold and Silver Refiner, Assayer and Sweep Smelter. 21 John Street, N. Y.

**Badges and Medals.**

**Stockwell & Newman**—19 John Street. Manufacturers of Badges, Medals and Presentation Pieces in Gold and Silver. Also Jewelry and Mounters of Diamonds. Designs supplied.

**Wilkinson, C. B.**—Manufacturing Jeweler, 8 John Street, N. Y. Medals, Badges and Masonic Jewelry a Specialty. Designs furnished free upon application.

**Band Rings.**

**Knapp, Charles**, 41 Maiden Lane, N. Y. Specialty: Superior Band Rings, also Ring Shanks & Heads for Seal and Diamond Rings.

**Black Onyx Jewelry.**

**Cox & Sedgwick**—Manufacturers of Black Onyx Jewelry, No. 26 John St. New York.

**Lawson, Samuel**—No. 18 John Street. Manufacturer of Black Onyx Jewelry. Coral repaired for the trade. Goods sent on approval to responsible dealers.

**Woglom & Miller**—Manufacturers of (exclusively) Black Onyx Jewelry, 32 & 34 John St., N. Y.

**Blue Enameled Lockets.**

**Bissinger, Philip & Co.**—Importers of Diamonds, Pearls and Precious Stones. Agent for the Bohemian Garnet Goods. Blue Enameled Lockets. 22 John St., N. Y.

**Hess & Schliesser**—Importers of Diamonds, Fine Jewelry and Novelties in French Goods. Specialties: Gold and Blue Enameled Lockets, Charms and Crosses. 25 Maiden Lane.

**Bohemian Garnet Jewelry.**

**Bissinger, Philip & Co.**—Importers of Diamonds, Pearls and Precious Stones. Sole Agent for the Bohemian Garnet Jewelry. Blue Enameled Lockets. 22 John St.

**Boxes, Wood Mailing and Nested.**

**Maine Manufacturing Co.**—Successors to Swift Mfg Co., makers of Wood Mailing and Nested Boxes for Mailing and Express purposes. J. Spencer Taylor, Agent, 18 Courtlandt St., N. Y.

**Wiesbauer, J.**—Manufacturer of the Sliding Cover Wood Mailing Boxes. All Sizes Made to Order. Buffalo, N. Y.

**Clock Companies.**

**Ansonia Clock Co.**—Manufacturers of every description of Clocks. 11 to 21 Cliff street, New York.

**Kroeber, F.**—Manufacturer and Dealer in American and French Clocks, No. 14 Cortlandt Street.

**New Haven Clock Co.**—16 and 18 Park Place, N. Y.

**Seth Thomas Clock Co.**—20 Murray Street, N. Y.

**Waterbury Clock Co.**—M. Bailey, Treasurer, Manufs and Jobbers, No. 4 Cortland St., N. Y., and No. 197 State Street, Chicago.

**Wm. L. Gilbert Clock Co.**—No. 6 Murray Street, Manufacturers of Clocks. Factories, Winsted, Conn.

**Yale Clock Co.**—Manufacturers of Novelties in Clocks, 52 Maiden Lane, N. Y.

**Corals and Coral Jewelry.**

**Cuppia, L. A.**—Importer of Coral and Silver Filigree Jewelry, 19 Union Square, N. Y.

**Cameo Cutters, Etc.**

**Peiter, Theodore**—Cameo and Intaglio Engraver. Patentee of the Cameo-Intaglio. No. 2 Bond Street, near Broadway, Room 4 New York.

**Charms & Gold Watch Keys.**

**Rupp & Held**—Manufacturing Jewelers, Charms and Gold Watch Keys, with French and English Ratchets, a specialty. 15 John St., N. Y.

**Crucibles.**

**Berge, J. & H.**—Established 1850, Manufacturers and Importers of Sand Crucibles, Covers, Chemical Porcelain, Glassware, and Jewelers' and Assayers' Supplies, 95 John Street, N. Y.

**Cutlery.**

**Harrison Bros. & Howson**—Manufacturers of Fine Ivory and Pearl Table and Pocket Cutlery, Carvers in Cases; Nutpicks, Nutcracks and goods suitable for the jewelry trade. 126 Chambers Street. W. C. Burkinshaw, Sole Agent.

**Diamond Brokers.**

**Anderson, Otis**—Diamond Merchant and Broker, always ready to pay cash for bargains in Diamonds and Precious Stones, 4 & 6 John Street, N. Y.

**Bernhardt, Richard**—Diamond Broker and Importer, 65 Nassau Street (Room 6), N. Y. Paris, 20, rue des Petites-Écuries.

**Friend S. & Son**—Brokers and dealers in Diamonds 33 John Street, cor. Nassau St. New York.

**Herbert, R. J.**—Diamond Broker and Dealer. 26 Maiden Lane.

**Diamond Importers.**

**Bernhard, A. & Co.**—Importers of Diamonds and Manufacturers of First-class Diamond Jewelry, Diamond Settings for Manufacturing Jewelers. Catalogue of Designs for the Trade free of charge. No. 2 Maiden Lane, New York.

**Bissinger, Philip & Co.**—Importers of Diamonds, Pearls and Precious Stones. Agent for the Bohemian Garnet Goods. Blue Enameled Lockets. No. 22 John St., N. Y.



**Bruhl, D. & M.**—Established in 1848. 14 Maiden Lane, N. Y.; 111 Broad Street, Providence, R. I.; 14 Rue Bleue, Paris.

**Brunswick, S. & Co.**—Importers of Diamonds. 17 Maiden Lane, New York. Paris, Rue Lafayette. Amsterdam, Damsstraat.

**Citroen, L. B., & Co.**—Diamonds. 21 John St., N. Y. Cutting Works, 57 & 61 Rapenburgerstraat, Amsterdam. House in Paris, 44 Rue Laffitte.

**Engelmann, M. & Co.**—Importers of Diamonds, Pearls and Precious Stones. Specialties in Fine Colored Stones. 192 Broadway and 1 and 3 John Street, N. Y. Paris, 1 Boulevard St. Denis.

**Faulkenau, Oppenheimer & Co.**—Manufacturers. Diamonds and Diamond Jewelry. 40 Maiden Lane, N. Y.

**Fera, Henry**—Importer of Diamonds, and Manufacturer of Fine Diamond Jewelry. 4 & 6 John Street, New York. Amsterdam, Holland, 23 Loojersgracht.

**Fox, M. & Co.**—Importers of Diamonds, Rubies, Sapphires and Fancy Gems. No. 1 Maiden Lane, New York.

**Hedges, Wm. S. & Co.**—Importers of Diamonds, No. 170 Broadway, corner Maiden Lane.

**Kuhn, Doerflinger, & Co.**—Manufacturing Jewelers and Importers of Diamonds, 18 John street, New York.

**Leberthon, L. M.**—Importer of Diamonds and Manufacturer of Fine Jewelry. 14 John Street, N. Y.

**Neresheimer, E. Aug. & Co.**—Importer of Diamonds. No. 21 Maiden Lane, New York.

**Randel, Baremore & Billings**—Importers of Diamonds, corner Maiden Lane and Nassau St.

**Saril, S.**—Importer of Diamonds, 182 Broadway, N. Y. Branch of Vve. H. A. Marchand & Frères, 47 Rue Le Peletier, Paris.

**Saunders & Ives.**—Importers of Diamonds and other Precious Stones. No. 26 Maiden Lane.

**Smith, Alfred H. & Co.**—Importers of Diamonds, No. 182 Broadway.

**Taylor & Brother.**—Importers of Diamonds and Diamond Jewelry. 676 Broadway.

**Wickham, D. H. & Co.**—Importer of Diamonds. No. 31 Holborn Viaduct, London, 24 Maiden Lane, New York.

**Wolff, G. A.**—Importer of Diamonds, Rubies, Sapphires, Pearls, and other Precious Stones, 65 Maiden Lane, New York. 12 Rue de Chateaudun, Paris.

#### Diamond Jewelry.

**Bornemann, Louis.**—Importer of Diamonds and Manufacturer of Rich Diamond Jewelry, 19 John Street, New York.

**Chalumeau, D.**—Diamond Jeweler and Manufacturer of Mountings. Novelties and Artistic Jewelry. No. 3 Maiden Lane, New York.

**Goldsmith, Ingomar & Co.**—Manufacturers of Diamond Mountings and Diamond Jewelry, 61 Nassau Street, New York.

**Hartje, G. & F.**—Manufacturers of Diamond and Fine Jewelry, 39 Union Square, N. Y.

**Haug & Luthy.**—Manufacturers of Fine Diamond Mountings, etc. No. 130 Fulton St., N. Y.

**Heller & Bardel.**—Manufacturers of Diamond and Pearl Jewelry, and Dealers in Diamonds, Pearls, &c. 13 John Street.

**Jeanne Brothers.**—Manufacturers of Diamond Mountings & Rich Jewelry. 1 Maiden Lane.

**Lacroix & Verpillier.**—Manufacturers of Fine Gold Jewelry. Diamonds a specialty. 173 Broadway, N. Y.

**Rosswog, C. & Son.**—Manufacturers of Rich Diamond Goods. Nos. 5 and 7 Maiden Lane, N. Y.

**Scheer, William.**—Diamond Jeweler and Manufacturer of Mountings, Novelties in Artistic Jewelry, 859 Broadway, near 17th St., N. Y.

**Schilling & Nissen.**—Dealers in Diamonds and Diamond Jewelry. No. 51 Nassau Street, New York, near Maiden Lane.

**Voelker, C. T.**—Manufacturer of 18-k. Diamond Mountings, Diamond Jewelry and Roller Chain Bracelets. 189 Broadway, New York.

**Waterman & Lehmann.**—Manufacturing Jewelers and Dealers in Diamonds. Diamond Work, and Fine fancy Rings a specialty, any piece of single work made to order. 37 Maiden Lane, N. Y.

#### Diamond and Pearl Setter, &c.

**Danziger, H.**—Diamond and Pearl Setter, 116 Nassau Street, (Second Floor,) Room 6, N. Y.

#### Diamond Cutters.

**Levy, Herman.**—Importer, Cutter and Polisher of Diamonds. 105 Fulton Street, New York.

#### Dials, &c.

**Farnsworth, C. E. & Co.**—Successors to Jno. T. Gold, Manufacturers and Jobbers in Fine Watch Dials. 81 Nassau St., N. Y.

**New York Dial Co.**—Manufacturers of Fine Watch Dials. Henry Abbott, Agent, No. 7 Maiden Lane, N. Y.

#### Enameled Clock Dials and Figures.

**Caeser Bros.**—Manufacturers of Enameled Clock Dials, also letters and numbers for signs. 230 and 232 East 25th Street, New York.

#### Enamelers, Etc.

**Nutt, J. D.**—Enameler on Gold, Silver, and Copper. Linen finished Buttons and Studs. Enameling in colors. 32 and 34 John Street, New York.

**Orr, J. C.**—Enameler on Fine Jewelry. Enameled in Colors. Linen Finished Buttons and Studs. Band Bracelets. No. 75 Nassau Street, N. Y.

**Orr, William N.**—Enameler on Fine Jewelry. Masonic Jewels and Badges a specialty. Linen Finished Work. 79 Nassau Street, Room 18, New York.

#### Electroplaters, &c.

**Jeandheur, F. & Son.**—Gold and Silver Electro Platers & Fire Gilders, coloring Etruscan and Gold Jewelry a specialty. 125 Fulton St.

#### Engravers—Stone Seal, Etc.

**Fackner, Edward.**—Carver, Engraver and Chaser on Jewelry and Pencil Cases, lettering, &c., 19 John Street.

**Holland & Gosling.**—Stone Seal Engravers. Precious Stones inlaid and encrusted with Diamonds. No. 176 Broadway, New York, (fifth floor per elevator). Cameos cut and repaired.

**Knapp, Chas.** Engraver, Die Sinker & Stamper for Jewelry purposes. Ring Shanks & superior Band rings, 41 Maiden Lane, N. Y.

**Park, Wm.**—The Stone Seal Engraver. Arms, Crests, Monograms, etc., engraved on precious stones, 26 John Street, New York.

**Weston, James F.**—Stone Seal Engraver and inlaid of Precious Stones. Coats of Arms, Masonic, Odd Fellows, and other devices engraved. 32 John Street.

#### Fancy Goods, Clocks, Bronzes, Etc.

**Bawo & Dotter.**—Importers and Manufacturers. Potteries, Faïences, Bisque Figures, French Clocks, Fancy Goods, etc. 30 & 32 Barclay Street, N. Y.

**Hinrichs, C. F. A.**—Importer of Fancy Goods, Glassware, China, Clocks, Bronzes, etc. 31 Park Place.

**Le Boutillier & Co.**—Importers of Fancy Goods, Clocks, Bronzes, &c., 3 Union Square.

**Straus, L. & Sons.**—Importers of Potteries, Faïences, Bisque Figures, and Rich Fancy Goods especially adapted for the Jewelry Trade. 40, 42 and 44 Warren Street, New York.

**Taylor & Bro.**—Importers of French Clocks, Bronzes, etc. 676 Broadway, N. Y.

**Trost, Herman & Co.**—Importers of Potteries, Faïences, Plaques, Bisque Figures, Fancy Goods, etc. 48, 50, 52 and 54 Murray St., N. Y.

**Vagt, Chas. & Co.**—Importers of Vases, Plaques, Paintings, French Faïences, etc., 60 & 62 Murray Street, N. Y.

**Young, J. M. & Co.**—Importers of Fine Parian, Lava, and Bisque Statuary, Bohemian, German and English Fancy Goods, 37 & 39 Murray St., New York.

#### Gold and Silver Cane Heads.

**Simons, Bro. & Co.**—Manufacturers of Gold Headed Canes. 611 and 613 Sansom street, Philadelphia.

#### Gold and Silver Plating, Etc.

**Bantle, A.**—Gold, Silver and Electro-Plating, 130 Fulton and 89 Nassau Streets, cor. Fulton Street, (Room 36,) N. Y. Watch Case Polishing.

#### Gold Chains, Etc.

**Beck, J. & Son,** Manufacturers of Fine Gold Chains and Chain Bracelets, 10 Liberty Place, near Maiden Lane, N. Y.

**Carter, Sloan & Co.**—Manufacturers of Fine Gold Chain, 15 Maiden Lane, New York.

**Dorrance, Edge & Co.**—Manufacturers of the Celebrated Woven Fabric Gold Chain, No. 15 John Street.

**Kaufmann Bros.**—Manufacturers of Gold Chains, and Chain Bracelets, 26 John Street; Factory, 331 and 333 Bowery, N. Y.

**Kohn, Alois & Co.**—Manufacturers of Gold Chains. 9 Maiden Lane, N. Y.

**Nordt, Charles.**—Successor to Nordt & Schlag, manufacturer of Gold Chains and Chain Bracelets. Jobbing and Refilling Old Chains promptly attended to. No. 17 Maiden Lane, N. Y.

**Saxton, Smith & Co.**—Manufacturers of Fine Gold Chain, No. 14 John Street, N. Y.

**Schlag, Chas.**—Late Nordt & Schlag, Manufacturer of Gold Chains, Chain Bracelets, and Fine Jewelry, 177 Broadway, N. Y.

**Smith, W. & Co.**—Manufacturers of Gold and Silver Chains, Jewelry, etc. No. 25 Maiden Lane, N. Y.

#### Gold Pens, Etc.

**Aikin, Lambert & Co.**—Manufacturers of Choice Gold Pens, Cases, Holders, Toothpicks, etc., 23 Maiden Lane, N. Y.

**Faber, Eberhard.**—Manufacturer of 16-karat Gold Pens and Pencil Cases, Nos. 718 and 720 Broadway, N. Y.

**Fairchild, Leroy W.**—Manufacturer of Gold Pens, Pencil Cases, Tooth Picks and Novelties in Charms. No. 18 John St., N. Y.

**Gerow, Joseph U.**—Manufacturer of Pencil and Pen Cases for the Jobbing Trade only. No. 44 State Street, (near South Ferry,) Brooklyn, N. Y.

**Johnson, E. S. & Co.**—Manufacturers of Gold Pens, Pen Holders and Pencils. Cor. Maiden Lane and Nassau Street, New York.

**Ray Manufacturing Co.**—Gold Pens Manufactured and Stamped for the Trade. Also Pencil and Pen Cases, Tooth-picks, etc. Office, Sales-rooms and Factories, 94 and 96 Nassau street, 129, 131 and 133 Fulton street.

**Smith, H. M. & Co.**—Manufacturers of Gold Pens and Holders, Tooth Picks, Pencils, etc. Sole Manufacturers of Sprague's Patent Gold Fountain Pen. Importers of Nickel and Silver Watches. 173 Broadway, New York.

#### Gold Rings.

**Barnet Bros. & Powell.**—Manufacturers of Stone and Seal Rings, 15 John Street, New York. Factory, Newark, N. J.

**Bowden, J. B. & Co.**—Manufacturing Jeweler.—Solid Gold Rings a specialty, 1 Maiden Lane.

**Cable, Geo. W.**—Manufacturing Jeweler. Plain and Band Rings a Specialty. No. 104 Fulton Street, N. Y.

**Ely, W. H.**—Manufacturer of Solid Gold Rings of every description. No. 58 Nassau Street.

**Henrich, R.**—No. 35 Maiden Lane, Manufacturer of Gold Rings; also Patentee and Manufacturer of the Celebrated Self-Sizing Ring.

**Hutchison & Huestis.**—Makers of Solid Gold Rings. Quality guaranteed. For the Jobbing Trade only. 196 Broadway, N. Y.



**Kroll, H.**—Manufacturing Jeweler. 78 Nassau Street, New York. Specialty: Solid Gold Stone Rings. All kinds of Fine Jewelry made to order, also Repairing for the Trade.

**Ostby & Barton**—Manufacturers of Plain and Engraved Solid Gold Band Rings. Office, 176 Broadway, N. Y. Factory, 80 Clifford Street, Providence, R. I.

**Peckham, Wm. H.**—Manufacturers of Solid Gold Seamless Rings, and Fancy Embossed Rings, Patent Spectacles, Jewelry, etc. No. 4 Liberty Place N. Y.

**Radler, K.**—Manufacturing Jeweler. Gold Rings and Lockets a specialty. No. 39 Maiden Lane, New York.

**Sauter, L.**—No. 1 Maiden Lane, New York, Manufacturer of Stone Rings of every description, as Diamond, Cameo, Onyx Turquoise, etc., Scarf Pins, Scarf Rings, Studs and Buttons.

**Shafer & Douglass.**—Manufacturers of all kinds of Seal, Stone, Turquoise, and fancy rings. No. 7 Maiden Lane, N. Y.

**Sincock & Sherrill.**—Manufacturers of Stone Rings. No. 3 Maiden Lane, N. Y.

**Thuerner & Church**—Manufacturers of Fine Gold Rings. No. 9 Maiden Lane, N. Y.

**Wood, J. R.**—Gold Ring Manufacturer of 14 John Street, has assumed his son into partnership. The firm will now be J. R. Wood & Son.

#### Hair Jewelry.

**Moutoux, Wm. E. & Co.**—Manufacturers of Fine Hair Mountings in Gold. Grand catalogues for the trade. 81 Nassau St., Rooms 1 and 2. Finest work and lowest prices

**Sauter, L.**—Manufacturer of Fine Gold and Hair Jewelry and Device Work. Pattern Book sent on application. No. 1 Maiden Lane, N. Y.

**Schwencke O.**—Manufacturer of Fine Hair Jewelry Orders from the country promptly attended to. No. 43 Maiden Lane.

#### Jewelry Cases, Fancy Boxes, Etc.

**American Morocco Case Co.**—7 and 9 Bond St., N. Y., make a specialty of Rich Jewelry and Silverware Cases for the fine Retail Trade. Also Improved Trays for Watches, Rings, etc.

**Bleyle, A.**—Manufacturer of Jewelry and Silverware Boxes, Jewelers' Traveling Cases, etc. Trays for Show Cases and Trunks, Ladies' and Gent's Jewel, Glove and Handkerchief Boxes, &c., &c., 80 Nassau street, N. Y.

**Braun, Chr. E.**—Manufacturer of Fine Jewelry Boxes and Trays for Show Cases and Trunks. No. 62 Chatham Street, New York. Trays for Show Cases and Trunks a Specialty.

**Bricka, C. A.**—Manufacturer of Morocco Cases for Cutlery, Silverware, Jewelry, etc. Sample Cards and Rolls. Cases in Rosewood, Black Walnut, etc. 52 Nassau Street, New York.

**Dennison Mfg Co.**—Manufacturers of Morocco, Plush and Velvet Jewelry and Silverware cases. New York, Boston, Philadelphia, Chicago, Cincinnati and St. Louis.

**Ettlinger, L. & Sons.**—Manufacturers of Fine Cases for Jewelry, Watches and Silverware. Trays for Travelers and Show Cases. Cases to Order a Specialty. No. 80 Nassau St., N. Y.

**Haensler, Chas. C.**—Manufacturer of Fine Morocco Cases for Jewelry and Silverware. Toilet Boxes, etc. Trays for Show Cases and Windows. 14 John Street, New York.

**Jackson, S. C.**, 180 Broadway, N. Y., Manufacturer of Fine Cases for Jewelry, Silverware, &c.

**Kohn, Solomon & Co.**—Manufacturers of Fine Morocco Cases for Jewelry, Watches, etc. 43 Maiden Lane, New York.

**Lauten, Edw. A. & Co.**—No. 4 Great Jones St., Manufacturers of Fine Velvet, Brocade, Plush and Morocco Boxes, Patent Ring, Ear Ring and Gent's Scarf Pin Trays, Patent Watch and Bracelet Blocks, Window Decorations, etc.

**Loehr & Koerner**—Manufacturers of Morocco, Velvet, Satin, Jewelry, Watches and Silverware Cases, Jewel, Work Boxes, etc., Fancy Trays and Store Fittings to order. 96 Liberty St.

**Metropolitan Fancy Box and Leather Goods Manufactory**—Makers of Plush, Velvet, Satin and Leather Cases for Watches, Jewelry, Silverware, etc. 75 and 77 Nassau Street, N. Y.

**New England Morocco Case Co.**—Makers of Jewelry and Silverware Cases of every description. 220 Chapel Street, New Haven, Conn.

**New York Morocco Case Co.**—Cases for Jewelry, Watches, Silverware. Boxes and Trays for Jewelers' Travelers. Show Cases and Window Fittings. No. 69 Nassau Street, New York.

**Schien, Charles E.**—Manufacturer of Cases for Jewelry and Silverware, No. 85 Nassau St., N. Y. Show Case Trays, etc., at short notice.

**Schwarz, N.**—Manufacturer of fine Cases for Jewelry and Silverware, 866 Broadway, near 17th street, N. Y.

**Steinle, E.**—Manufacturer of Cases for Jewelry of all kinds. Also Cases for Mathematical and Surgical Instruments and for Trays for Travelers' Trunks, etc. 66 Nassau Street, N. Y.

**Welch & Miller**—169 Broadway. Manufacturers of fine Morocco, Velvet, Russia, Brocade and Plush Jewelry Cases. Trays of every description; Jeweler's Cotton and Twine.

**Wiggers & Froelick**—No. 60 Nassau street—Manufacturers of Cases for Jewelry, &c., of every description. Trays for Show-cases, Stands for Show-windows, etc.

#### Jewelers' Findings.

**Dennison Mfg Co.**—Paper Jewelry Boxes, cards, tags, pink and white cotton, etc. New York, Boston, Chicago, Cincinnati, Philadelphia, St. Louis.

**Ettlinger, L. & Sons.**—Manufacturers of Jewelers' Paper Boxes and Findings. Morocco Paper, Satin or Plush Lined Wooden Corner Stops Jewelry and Silverware Boxes. 80 Nassau Street, New York.

**Valfer, S. & Co.**—Manufacturers and Dealers in Jewelers' Boxes, Tags, Cards, Paper and Findings. Trays a specialty. Office and Salesroom, 66 Nassau street, New York.

#### Jewelry Manufacturers.

**Aikin, Lambert & Co.**—Manufacturers General stock of Reliable Jewelry, 23 Maiden Lane.

**Alling, Isaac A. & Co.**—Manufacturers of Fine Gold Jewelry. Sets, Lace Pins, Ear Rings, Studs, Collar Buttons and Scarf Pins. Specialties: Wire Bracelets, Bangles, American Lever Sleeve Buttons. Bryant Building, Nassau and Liberty Streets, N. Y. Factory, Newark, N. J.

**Ball, W. H.**—Manufacturer of Gold Jewelry. Bracelets and Bangles of all kinds a specialty. 9 John Street, N. Y.

**Barthman, Straat & Co.**—Manufacturers of Fine Jewelry. Roman Goods, Rings, Diamonds. No. 43 Maiden Lane.

**Bissinger, Philip & Co.**—Importers of Diamonds, Pearls and Precious Stones. Sole Agents for the Bohemian Garnet Jewelry, Blue Enameled Lockets. 22 John St., N. Y.

**Brown, Thos. G. & Sons**—Man'rs of Rich Jewelry Necklaces, Lockets, Bracelets, Sleeve Buttons, etc., 5 Bond Street, N. Y.

**Bryant & Bentley**—Manufacturing Jewelers. Rings a specialty. 12 Maiden Lane

**Carter, Sloan & Co.**—Manufacturing Jewelers, 15 Maiden Lane, New York.

**Champanois & Co.**—No. 5 Maiden Lane, manufacturers of Engraved and Enameled Gold goods, in Sets, Ear Knobs, Bracelets, Studs, Lace and Shawl Pins, Jet cluster and Onyx goods, also "Best Lever" Sleeve Buttons.

**Chatellier, Joseph F.**—Manufacturing Jeweler, No. 694 Broadway, N. Y.

**Churchill, Lewis & Co.**—Manufacturers of Fine Jewelry. 692 Broadway, cor. Fourth St., N. Y.

**Cook, Groeschel & Co.**—Manufacturers of Fine Jewelry and Lockets, 191 Broadway (over Mercantile Bank,) N. Y.

**Cottle S. Co.**—Manufacturers of Fine Jewelry. Waltham Building, 5 Bond Street, N. Y.

**Cox & Sedgwick**—Manufacturers of fine Onyx and Colored Jewelry. 26 John St., New York

**Day & Clark**—Manufacturers of Fine Jewelry, Lace Pins, Ear Rings, Studs, Lockets, &c., 10 Maiden Lane, New York.

**Geoffroy, Arthur R. & Co.**—Manufacturing Jewelers. Novelties in Diamond Goods. No. 23 Maiden Lane, N. Y.

**Greene Wm. C. & Co.**—Goldsmiths; Manufacturers of Rich Sets in Taper Wire Coral. Office, 192 Broadway.

**Hale, S. W. & Co.**—Manufacturers Rich Jewelry, Whiting Building, Broadway and 4th Street.

**Hartmann, P.**—Manufacturer & Importer of Fine Gold, Diamond, and Filigree Silver Jewelry, No. 36 Maiden Lane. P. O. Box 2,454.

**Hedges, A. J. & Co.**—Manufacturing Jewelers, 6 Maiden Lane.

**Henderson & Winter**—Jewelers, No. 15 Maiden Lane, New York. Specialties—Stone, Cameo, Onyx, Amethyst, Topaz, Pearl and Turquoise Rings.

**Hunt & Owen.**—Manufacturing Jewelers. Office 3 Maiden Lane.

**Kremetz & Co.**—Manufacturing Jewelers, No. 182 Broadway, N. Y.

**Kuhn, Doerflinger & Co.**—Manufacturers of Enamelled and Roman Band Bracelets, also Fine Lockets Pendants and Lace Pins. 18 John street.

**Miller Bros.**—Manufacturers of Fine Jewelry, Lockets, Sleeve Buttons, Studs, &c., 7 Maiden Lane, N. Y.

**Moore & Horton.**—11 Maiden Lane, Manufacturing Jewelers, Rings, Studs, Collars and Sleeve Buttons, Pins, Ear-rings, &c.

**Muhr's, H., Sons.**—Manufacturing Jewelers. Solid Gold and Filled Rings a specialty. Also Manufacturers of the celebrated Crown Filled Watch Case. 16 Maiden Lane, N. Y.

**Owen, G. & S. & Co.**—Manufacturing Jewelers. Office, No. 3 Maiden Lane.

**Richardson, Enos & Co.**—Manufacturers of Fine Gold Jewelry, Gold Chains, Lockets, Crosses and Necklaces. Colored and Etruscan Work. No. 23 Maiden Lane, New York.

**Richardson, J. W. & Co.**—Manufacturers of Jewelry. Masonic and other Emblems. 196 Broadway, N. Y. Manufactory, Providence, R. I.

**Riley, J. A. & Co.**—Manufacturing Jewelers Etruscan Gold and Roman Bracelets, Lace Pins, Ear Rings, Scarf Pins, Brooch Pins, etc. Nos. 7 and 9 Bond Street, N. Y.

**Ripley, Howland & Co.**—Manufacturers of Fine Jewelry and Platinum Tipped Diamond Settings. No. 17 Maiden Lane, N. Y.

**Sauter, L.**—Manufacturer of Fine Jewelry, Solid Stone Rings and Studs a specialty. Jobbing for the trade. 1 Maiden Lane, New York.

**Schwencke, Wm.**—Manufacturing and Jobbing Jeweler. Repairing a specialty. Orders promptly attended to. No. 43 Maiden Lane, N. Y.

**Sexton & Cole**—Manufacturing Jewelers, Colored Gold and Onyx Goods a specialty. No. 30 Maiden Lane.

**Shafer & Douglas,** Manufacturing Jewelers—Roman Goods, Lace Pins, Cameo Sets, etc., Stone Rings, etc. No. 7 Maiden Lane, N. Y.

**Sheafer, W. H. & Co.**—Manufacturing Jewelers, Specialty Bangles and Bracelets, 15 John St., N. Y.

**Stites' Sons, E.**—Manufacturers of Fine Jewelry. No. 14 John Street, N. Y.

**Street, Geo. O. & Sons.**—Established 1837. Makers of Fine Jewelry, strictly first-class goods of our own make. No. 15 John Street, New York.

**Thoma, Ernest**—Manufacturer of Fine Jewelry, Sleeve Buttons, Rings, Ear-rings, &c. No. 173 Broadway, N. Y. Factory, Hackensack, N. J.

**Ward, Thos. M.**—Manufacturer of Fine Jewelry, Diamond Mountings a specialty. No. 25 John Street, N. Y.

**Wienhold, Joseph**—Manufacturer of Fine Jewelry Diamond Mountings a specialty. 24 John St.

**Woglom & Miller**—Manufacturers of Black Onyx Goods exclusively. 32 & 34 John Street, N. Y.

#### Jewelry—Rolled Plate.

**Frick, John & Co.**—Fine Rolled Plate Jewelry of all kinds. Repairing of every description. 21 and 23 Maiden Lane, N. Y.

**Mauran, J. T.**—Manufacturer of Fine Rolled Plate Jewelry, No. 15 Maiden Lane, N. Y.

**Richards, E. Ira & Co.**—Manufacturers of Fine Rolled Plate Jewelry, No. 200 Broadway, N. Y.

#### Jewelers' Tools, etc.

**Fisher, James J.**—Dealer in Watchmakers' and Jewelers' Materials, Files, Tools, Silk Guards Spectacles, etc. 697 Broadway, N. Y.



**Friedenthal, A. & Co.**—Importers and jobbers of Watchmakers' and Jewelers' Tools, Materials, etc. 43 Maiden Lane, N. Y.

**Friedlander, R. & L.**—Importers of Watchmakers' Tools and Materials. 65 & 67 Nassau Street. Branch Office, 264 Bowery.

**Kurtz, F. P.**—Manufacturer of Jewelers Machinery, Tools, Rolling Mills, Presses, Polishing Lathes, &c. 97 Cliff St., N. Y.

**Levy, Dreyfus & Co.**—Importers and Jobbers of Watchmakers' and Jewelers' tools and materials of every description. 11 Maiden Lane, N. Y.

**Montgomery & Co.**—Importers of and Dealers in Manufacturing Jewelers' Tools and Materials of every description, 105 Fulton street, New York.

**Reichhelm & Koester.**—Importers of Jewelers' Tools, Files, etc. Manufacturers of Brushes and Buffing wheels; also Patent Gas Furnaces for Melting, Plating, Enamelling, Annealing, etc. 80 Nassau St., N. Y.

#### Lapidaries.

**Fox, M. & Co.**—Practical Lapidaries, No. 1 Maiden Lane, New York.

**Graham & Co.**—Practical Lapidaries, Cutters and Polishers of all kinds of Precious Stones. Miners' Relics Cut, Polished and Mounted. Miniature, Locket and Clock Glasses. 80 Nassau St., N. Y.

**Kordmann & Michel.**—Lapidaries. Dealers in Precious Stones. Cutting and Polishing Rubies, Sapphires and other Gems a specialty. Drilling done promptly. 59 Nassau St., N. Y.

**Korn, Ph.**—Lapidary. Importer of Precious and Imitation Stones, No. 63 Nassau street, between Maiden Lane and John street, New York.

#### Masonic Jewelry.

**Luther, John F.**—79 Nassau Street. Manufacturer of Fine Presentation Jewels for all Societies. Knights Templars, Crosses, Badges, &c.

**Popper, H.**—Manufacturer of Medals and Badges for Military, G. A. R., Shooting, Masonic, Odd Fellows, Knights of Pythias, etc. 91 Essex St., New York.

**Wilkinson, C. B.**—Manufacturing Jeweler, 8 John St., N. Y. Medals, Badges and Masonic Jewelry, a specialty. Designs furnished free upon application.

#### Optical Goods.

**Friedlander, R. & L.**—65 and 67 Nassau Street. Dealers in Optical Goods.

#### Opticians.

**Burbank Manf'g Co.**—Manufacturers of Spectacles and Eye Glasses of all descriptions, in gold, silver, etc., 14 Maiden Lane, N. Y.

**DuBois, Geo. W. & Co.**—Importers of Watches and Optical Goods. 36 Maiden Lane, N. Y.

**Kahn, Hanover & Co.**—Importers of Spectacles, Eye-Glasses and Optical Goods generally, and Scientific Instruments of every description. 32 Maiden Lane, New York.

**Levy, Dreyfus & Co.**—Importers of Spectacles and Eye Glasses and Optical Instruments of every description, No. 11 Maiden Lane, N. Y.

**Lorsch, Albert**—Manufacturer of the Patent Accommodating Spectacles and Eye Glasses in Gold, Silver and Steel, and other Optical Goods, 37 Maiden Lane, N. Y.

**Spencer Optical Manufacturing Co.**—Gold, Silver, Steel, Nickel and Plated Spectacles; Gold, Celluloid, Steel, Nickel and Rubber Eye Glass and Opera Glasses. 13 Maiden Lane, N. Y.

#### Paper Boxes.

**Waterbury Paper and Box Co.**, 27 to 35 Canal St., Waterbury, Conn., Manufacture Jewelers' and Silversmiths' Fine Paper Boxes. Quality guaranteed to be equal to the best made.

#### Precious Stones, &c.

**Bishop, Victor & Co.**—33 Maiden Lane, Importers of Precious Stones, Cameos, &c. Also Manufacturers of Coral Jewelry.

**Bissinger, Philip & Co.**—Importer of Diamonds, Pearls and Precious Stones. Agent for the Bohemian Garnet Goods. Blue Enamelled Locketts. No. 22 John St., N. Y.

**Breidenbach, R. A.**—Importer of Black Onyx, Cameos, Turquoise, Pearls, Sardonyx, Amethysts, Topaz, Garnets, Opals, Rubies, Sapphires, Cat's Eyes, Hematites, Brilliants, Doublets, etc. 85 Nassau St., N. Y.

**Daue, Wm. & Co.**—Importer of Precious and Imitation Stones. No. 202 Broadway New York.

**Fox, M. & Co.**—Importers of Diamonds and other Precious Stones, No. 1 Maiden Lane, N. Y.

**Gruet, Jules.**—Importer of all Grades of Real and Imitation Stones. 14 John St., N. Y.

**Guntzburger Bros.**—Manufacturers and importers of Precious Stones—Amethysts, Topaz, Cameos, Garnets, Imitation Diamonds, &c. No. 9 Maiden Lane.

**Hahn & Co.**—Importers of Precious Stones, Cameos, Onyx, Pearls, Intaglios, Amethysts, Garnets, etc. 64 Nassau Street, New York.

**Kahn, L. & M.**—Importers of precious and imitation stones. 10 Maiden Lane, N. Y.

**Kipling, E. E.**—Importer of Precious and Imitation Stones. Manufacturer of the Patent Foil Solid Metal Back Rhine Stone Brilliant. No. 6 Maiden Lane, N. Y.

**Kipling, R. A.**—Precious and Imitation Stones, No. 24 Maiden Lane, N. Y. Manufacturer Cameos, Agates, Onyx, Etc., Oberstein, Germany. Commission Merchant, 49 Rue De L'Echiquier, Paris.

**Tannenbaum, L. & Co.**—Importers of Diamonds and Precious Stones. Steam Lapidary Works. Oriental Stones Cut and Polished a specialty. 65 Nassau St., N. Y.

#### Silverware.

**Gorham Manufacturing Co.**—Union Square.

**Knowles, J. P. & S. M.**—Manufacturers of Sterling Silverware, 20 Maiden Lane, N. Y. Factory, Providence, R. I.

**Shiebler, Geo. W.**—Manufacturer of Sterling Silverware. No. 8 Liberty Place, near Maiden Lane, N. Y.

**Whiting Manufacturing Co.**—Makers of Sterling Silver Ware. Broadway cor, 4th Street, N. Y.

**Wood & Hughes.**—Manufacturers of Fine Silverware. 16 John Street, N. Y.

#### Silver Filigree Jewelry.

**Cuppia, L. A.**—Manufacturer of Solid Silver Novelties, and Importer of Silver Filigree, 19 Union Square.

**Francesconi, Guido**—Importer of Silver Filigree Jewelry, 196 Broadway, New York.

**Hartmann, P.**—Manufacturer of Silver Filigree Jewelry. 36 Maiden Lane, N. Y.

#### Silver Plated Ware.

**Hartford Silver Plate Co.**—Manufacturers of Fine Electro-Plated Ware. Factory and Salesroom, 28 High Street, Hartford, Conn.

**Holmes, Booth & Haydens**—Manufacturers of Silver-Plated Ware. 47 Chambers Street.

**Manhattan Silver Plate Co.**—Manufacturers of Silver Plated Ware. Showrooms, 23 John St. Factory, 301 to 305 East 22d St., cor. 2d Ave. Address all communications to Factory.

**Middletown Plate Co.**—Manufacturers of Superior Electro-Plated Ware. Factories, Middletown, Conn., salesroom, 13 John Street.

**Rogers & Bro**—Manufacturers of the finest quality of Electro-Plated Ware. 690 Broadway.

**Rogers, Smith & Co.**—Manufacturers of Fine Electro Plated Ware. No. 46 E. 14th St., N. Y.

**Simpson, Hall, Miller & Co.**—Manufacturers of fine Silver-Plated Ware. No. 36 E. 14th Street.

**Schade, Henry.**—Manufacturer of White Metal and Plated Ware. Nos. 56 & 58 Ainslie Street, Brooklyn, E. D., N. Y. Price list and catalogue furnished on application.

**Webster, E. G. & Bro.**—Manufacturers of Fine Silver-Plated Ware. Office and warerooms, 14 Maiden Lane, N. Y.

#### Show Cases, Etc.

**Smith, B. & W. B.**—Manufacturers of Patent Improved Dust Proof Show Cases, with Perpendicular Sliding Doors, No. 220 W. 29th St., N. Y.

#### Spectacle Case Manufacturers.

**Bertine, P. D.**—Manufacturer of Spectacle and Eye-Glass Cases. 139 William Street, near Fulton St., New York.

**Koenen, A. & Bro.**—Manufacturers of Leather Spectacle and Eye-Glass Cases. 81 Nassau St., N. Y.

#### Stem Winding Attachments.

**Abbott, Henry** Maker of Stem Winding Attachments, No. 7 Maiden Lane, N. Y.

#### Thermometers, Etc.

**Tagliabue, Giuseppe.**—manufacturer of Thermometers, Barometers and Hydrometers. Patentee and sole manufacturer of the U. S. Standard Hydrometer. 302 Pearl Street, near Beekman.

#### Thimble Manufacturers.

**Barker Manuf'g Co.**—Makers of Patent Graduated Thimbles, Stiffened Gold, Filled Gold and Rolled Gold, 36 Maiden Lane, N. Y. A. Lyons, Agt. Factory, 129 Eddy St., Providence, R. I.

**Burbank Manuf'g Co.**—Manufacturers of Gold and Silver Thimbles, 14 Maiden Lane, N. Y.

**Ketcham & McDougall.**—Improved Gold and Silver Thimbles, Bryant Building, N. Y.

**Simons Bro. & Co.**—Manufacturers of Gold and Silver Thimbles, 611 and 613 Sansom Street, Philadelphia.

**Woglom & Miller.**—Sole Agents for the "Prime" Thimbles in Gold and Silver, manufactured by Ezra C. Prime. 34 John Street, N. Y.

#### Watch Companies.

**American Watch Co.**—Robbins & Appleton, No. 5 Bond Street, N. Y.

**The E. Howard Watch and Clock Co.**—Cor. Maiden Lane and Nassau Street, N. Y.

**Waterbury Watch Co.**—Manufacturers of the Waterbury Watch. Factory, Waterbury. Office, 52 Maiden Lane, N. Y.

#### Watch and Chronometer Jeweler.

**Queen, James.**—Watch and Chronometer Jeweler and Pallet Maker, 78 Nassau Street, room 8. Pivots inserted in Pinions, Balance, Staffs, etc.

**Robert, Lewis H.**—Practical Chronometer and Watch Jeweler, and Adjuster of all kinds of Escapements. 71 Nassau Street (Room No. 3). All kinds of Pallet and Hole Jewels for Chronometer Watches and Compasses done in the best manner.

**Wennstrom, John.**—Watch, Chronometer and Clock Jeweling, Jewel Gauges, Ruby and Sapphire Draw Plates; Diamond Charged Polishing Stones for Jewel Settings; Pivots inserted in Pinions. 2 Dutch Street, N. Y.

#### Watch Importers, Etc.

**Abry, Chas. Leo**—Importer and Manufacturer of Swiss Watches of all grades. 63 Nassau Street.

**Aikin, Lambert & Co.**—Importers of Watches. Sole Agents for Paul Breton & Chas. Latour, Geneva. A general line of reliable Swiss Watches, Watch Cases, etc. 23 Maiden Lane, N. Y.

**Bartens & Rice**—20 John Street, Importers of Watches and sole agents in the United States for the celebrated Nicole, Nielsen & Co. Watches.

**Cross & Beguelin.**—Importers of Watches, Watch Tools and Materials, dealers in American Watches, No. 21 Maiden Lane, N. Y.

**Droz, Henry E.**—Importer of Watches, and Watch Case Manufacturer. Agent for the "E. Perregaux" Watch, and jobber in American Watches No. 92 Fulton Street, N. Y.

**Freund Max & Co.**—Importers of Watches, Jewelry and Precious Stones, 8 Maiden Lane, N. Y.

**Gagnebin, Chas.**—Importer of all kinds of Swiss, and Dealer in American Watches. 4 Maiden Lane, N. Y. Agent for Ulysse Breting's Fine Chronometers, Chronographs, Anchors, &c.

**Gallet, Julien.**—Importer of Watches. No. 1 Maiden Lane.

**Ginnel, Henry**—Importer of Watches, Tools and Materials, 31 Maiden Lane, N. Y. P.O. Box, 2967

**Hyde's Sons, John E.**—Wholesale Commission Agents, only for Jules Jurgensen, of Copenhagen; Jules Monard, of Geneva; and for other makers of all qualities of Watches, 22 Maiden Lane.

**Keller, L. H. & Co.**—Successors to G. A. Huguenin, Importers of Fine Watch and French Clock Materials, No. 64 Nassau Street, N. Y.

**Mathey Bros. & Mathez.**—Importers of Fine Watches and Sole Agents for the H. L. Matile's Watches. No. 16 Maiden Lane.

**Robert, J. Eugene**—No. 30 Maiden Lane, New York. Agent for Louis Audemar's celebrated watches.



**Schwob, Adolphe**—Manufacturer and Importer of Watches, 11 Maiden Lane, N. Y.

**Strasburger, Louis & Co.**—Importers and Makers of Watches of every description, 15 Maiden Lane.

#### Watch Cases.

**Dueber Watch Case Mfg Co.**—Manufacturers of Gold and Silver Watch Cases. Bryant Building, N. Y. Factory, Newport, Ky.

**Duhme & Co.**—Manufacturers of Gold and Silver Watch Cases. Carlisle Block, Fourth and Walnut Streets, Cincinnati.

**Fahys, Joseph**—Manufacturer of Watch Cases and Dealer in American Movements, 38 Maiden Lane.

**Glatz, Chas.**—Manufacturer of Silver Watch Cases. Bryant Building, cor. Nassau and Liberty Sts.

**Keller & Untermeyer.**—Manufacturers of Watch Cases with Raised Gold Ornaments. 9 Maiden Lane, N. Y.

**Ladd Watch Case Co.**—Manufacturers of the Ladd Patent Stiffened Gold Watch Cases, etc., 11 Maiden Lane, N. Y. Factory, 58 Eddy Street, Providence, R. I.

**Willemin Watch Case Co.**—Makers of Gold Watch Cases. Raised Gold Ornamentation and Jurgensen style of Engine Turning. 109 Sands Street, Brooklyn, N. Y. 16 Maiden Lane, N. Y.

#### Watch and Chronometer Repairers.

**Cerf, B.**—Practical Watchmaker and Repairer, No. 10 John Street, N. Y. Repairing and adjusting of fine Watches done for the trade. All kinds of escape and stem-winding wheels cut to order.

**Goepf, Frederick A.**—Practical Watchmaker. Repairing of every description for the Trade. 25 Maiden Lane, N. Y. In office of H. Garland, Engraver.

**Heinrich, H. H. & Co.**—Sole Manufacturers of H. H. Heinrich's Patent Auxiliary Balance, and Adjusters and Repairers of Fine Watches and Chronometers. 12 John Street, N. Y.

**La Croix, J. H.**—(Late with Benedict's Time,) Watch and Clock Maker, 21 John Street, N. Y. Clocks of every description Repaired for the Trade.

**Lesperance, Theo.**—Watchmaker and Wheel Cutter. Also Stoning Nickel Movements. No. 1 Maiden Lane, New York. With Julien Gallet.

**Ludeman, W. H.**—Chronometer and Watch Maker. Repairing of every description for the trade, 75 and 77 Nassau Street.

#### Watch Case Repairers.

**Feinier, Joseph A.**—Watch Case Maker and General Repairer. Specialty in fine Gold and Silver Cases. Jobbing promptly attended to. Nos. 4 and 6 John St., N. Y.

**Tarbox, Hiram**—Watch Case Repairing, Springing, Polishing and Engine Turning. 1874 North Fourth Avenue, bet. 176th and 177th Sts., N. Y. Express Packages should be sent to 92 Fulton Street.

#### Watch Glasses, Shades, Etc.

**Brown, Edwin H.**—No. 85 Nassau Street, Imported and Own Manufacture Watch Glasses, Flat, Flat Concave, Concave, Convex and fine Genevas. Fine fitting solicited.

#### Watches, Diamonds and Jewelry.

**Alford, C. G. & Co.**—Manufacturers. General line fine and Reliable Goods. Specialties in Onyx Goods and Chain. 200 Broadway, New York.

**Cohn, J. J.**—Importer and Manufacturer of Whitby Jet, Rubber and Pearl goods. Gold and Rolled-plate Jewelry, etc. 12 Maiden Lane, New York.

**Durfey & Reynolds**—Successors to Durfey & Shiebler, Watches, Diamonds, Jewelry. No. 9 John Street, (up-stairs) New York.

**Friedman, Saml.**—Wholesale Dealer in Watches and Jewelry, 42 Maiden Lane, N. Y.

**Goddard, John M.**—Manufacturing Jeweler.—Seal Rings and Fine Lockets a specialty, No. 3 Maiden Lane, N. Y.

**Greason J. R. & Co.**—Successors to Arthur, Rumrill & Co., 182 Broadway. Manufacturers of Fine Jewelry and Gold Chains, also Diamond Mountings.

**Haskell, H. C.**—Manufacturing Jeweler. Seal Rings a specialty. Special attention to Jobbing of every description. 12 John street.

**Herzog, Louis & Co.**—Importers of Watches, Dealers in Diamonds and Jewelry, 52 Maiden Lane, N. Y.

**Hirsch Bros.**—Dealers in Watches and Diamonds and Manufacturers of Jewelry, No. 23 Maiden Lane, N. Y.

**Jandorf, P. & Bro.**—Importers of Watches and Jewelry, 196 Broadway.

**Kennedy, Frank S.**—Manufacturer and Wholesale Dealer in Jewelry and Gold and Silver Thimbles. No. 13 Maiden Lane, New York.

**Lissauer & Sondheim**—Wholesale Jewelers and Jobbers in American Watches, No. 12 Maiden Lane, N. Y.

**Marx, Kossuth & Co.**—Importers of Watches and Dealers in Jewelry. 39 Maiden Lane, N. Y.

**Mayer, B.**—Manufacturer of Fine Jewelry, and Dealer in Watches, 71 Nassau street, cor. John street, New York.

**Myers, S. F. & Co.**—Manufacturing and Wholesale Jewelers—all grades. Importers of Watches. Illustrated Catalogue to the trade. 179 Broadway, N. Y.

**Oppenheimer Bros. & Veith.**—Dealers in Watches and Diamonds, and Manufacturing Jewelers, No. 35 Maiden Lane.

**Scott, J. T. & Co.**—Importers of Watches, and Manufacturers of Jewelry, and Jobbers of all Grades of American Watches, 11 Maiden Lane.

**Smith & Krapp**—Wholesale Dealers in American and Swiss Watches, Diamonds, Gold and Plated Jewelry and Gold Chain. 182 Broadway, N. Y.

**Steele, J. W.**—Successor to Brainerd, Steele & Co., Manufacturer of Fine Jewelry and Brainerd's Patent Lockets. No. 9 Maiden Lane, N. Y.

**Stern Brothers & Co.**—Importers of Swiss Watches and wholesale dealers in American Watches, &c., 39 Maiden Lane.

**Stern & Stern**—Dealers in Watches, Jewelry and Diamonds. No. 6 Maiden Lane, N. Y.

**Stites, D. H. & Son**—Manufacturers of Fine Jewelry, Rolled Plated Goods and Chains, Parisian Diamond Rings, Studs and Earrings a specialty. 41 Maiden Lane, N. Y.

**Strauss, Jacob.**—Full Line of Gold and Plated Jewelry, and Importer of Watches. 18 John Street, New York.

**Thrall, E. A.**—Wholesale Dealer in Watches and Jewelry. No. 1 Maiden Lane, N. Y.

**Trier Bros.**—Importers of Garnet, Whitby Jet and Amber Jewelry, Silk Guards, Opera, Field and Marine Glasses, Pearl Card Cases. Also a full line of Gold and Plated Jewelry. 15 Maiden Lane, N. Y.

**Wheeler, Parsons & Hays.**—Manufacturers of Fine Jewelry, Watch Cases, Gold Chains, &c. and Dealer in American and Swiss Watches, No. 2 Maiden Lane, N. Y.

**White, N. H.**—Jobber in American-Waltham Watches and Chronographs. Waltham make of 10-k., 14-k. and 18-k. Gold and Sterling Silver Cases; Filled Gold Cases. 11 Maiden Lane.

#### Watch Tools, etc.

**Keller, L. H. & Co.**—Importers of Watchmakers' and Jewelers' Tools, Materials, etc. 64 Nassau Street, N. Y.

**Zimmern, Henry**—Importer of Watch Materials, Tools, and Optical Goods, No. 8 Maiden Lane, (first floor.) Sole Agent for A. Hugenin & Gravier. Mainsprings, New York.

### PHILADELPHIA

**Bennett, Jacob & Son.**—Diamond Setters and Manufacturing Jewelers, 925 Chestnut St.

**Bernard & Co.**—Manufacturers of Fine Roman and Etruscan Jewelry. Designs of every description made to order, 123 & 125 South Eleventh Street, Philadelphia.

**Booz & Co.**—Manufacturers of Gold and Silver Watch Cases and Jewelry, 108 South 8th St., Philadelphia.

**Conover David F. & Co.**—American Watches, Wholesale Salesroom, Southeast corner 7th and Chestnut Streets, Philadelphia.

**Guilbert, Thos. M., & Co.**—Manufacturing Jewelers. Flexible Bracelets and Strung Pearl Repairing. 908 Chestnut St., Philadelphia.

**Herold, Chas P.**—Successor to Hildebrandt, Herold & Co., Manufacturing Jeweler and Diamond Setter. Diamonds. 916 Chestnut Street.

**Krieder, Peter L.**—Manufacturer of Sterling Silver Ware. 618 Chestnut Street, Philadelphia.

**McCarty & Hurlburt**—Manufacturers of Gold Spectacles, Silver Thimbles and Plain Rings. Wholesale dealers in American Watches, Jewelry, etc. 131 North Second Street.

**Morgan & Headly.**—Manufacturing Jewelers, Cameo Sets, Gold Sets, Roman Lockets, Rings, Coral Sets and a general line of rich goods. Corner 10th and Chestnut Streets, Philadelphia.

**Muhr's, H., Sons.**—Manufacturing Jewelers. Solid Gold and Filled Rings a specialty. 633 and 635 Chestnut Street, Philadelphia. 1½ Maiden Lane, New York.

**Peters, Reese S.**—Manufacturer of Patent Rolled Plate or Filled Watch Cases, Dealer in American Movements, 308 Chestnut Street, Philadelphia.

**Rosenthal, G. F. C.**—Manufacturing Jeweler and Diamond Setter. Engraving and Designing of Monograms a specialty. No. 917 Sansom Street.

**Scherr, L. A. & Co.**—Wholesale Dealers in Watches Silver-Plated Ware, Spectacles, Fancy Goods, Watch Materials, etc. 726 Chestnut Street.

**Sheafer, W. H. & Co.**—Manufacturing Jewelers. Specialty: Band Bracelets. Factory, 612 and 614 Chestnut street, Philadelphia. Office, 15 John street, New York.

**Simons, Brother & Co.**—Manufacturers of Fine Jewelry, Canes, Thimbles, Chains. 611 and 613 Sansom Street.

### CHICAGO.

**American Watch Company.**—of Waltham, Mass. No. 102 State Street, Chicago.

**Clapp & Davies**—Wholesale Jewelers, 63 and 65 Washington Street. Catalogue and price list issued to watchmakers and jewelers.

**Dennison Manufacturing Co.**—Manufacturers of Jewelers' Paper Boxes, Morocco Cases, Tags, Cards, Pink and White Cotton, Tissue Papers, Sealing Wax, &c., &c., 102 Madison St., Chicago. Boston, New York, St. Louis, and Philadelphia.

**Excelsior Sign Co.**—Manufacturers of (Grout's Excelsior) Iron Watch and Spectacle Signs. 124 Fifth Avenue, Chicago, Ills.

**Gilbert, Wm. L., Clock Co.**—Manufacturers of Clocks, Regulators, and Time Pieces, and Clock Material of every description, 54 and 56 Madison Street, Chicago.

**Giles, Bro. & Co.**—Manufacturers and Jobbers in Watches, all classes of Jewelry, Materials, Clocks, Silver Ware, &c. Illustrated catalogues furnished to dealers on application. 101 & 103 State St.

**Stein & Ellbogen**—Wholesale Dealers in Watches and Jewelry, 127 State Street, Chicago, Ill. Specialty, repairing for the trade.

**Wathier, Joseph P.**—Watchmakers and Jewelers for the trade, and Wholesale Dealers in Watch Materials, Tools, etc. 178 West Madison Street, Chicago, Ill. Send for price list.

**Wendell, Charles & Son**—Wholesale Watches, Jewelry, etc. 170 State street, Chicago.

### NEWARK.

**Baker & Co.**—Gold, Silver and Platinum Refiners, Assayers and Sweep Smelters. 408 New Jersey Railroad Avenue, cor. Murray St., Newark, N. J.

**Diefenthaler Bros. & O'Donnell**—Manufacturers of Fine Jewelry, Lace Pins, Ear Rings and Patent Spring Bangles a Specialty. 36 Crawford Street, Newark, N. J.

**Felger, F. & F.**—Manufacturing Jewelers. Specialties:—Roman Band Bracelets, Lace Pins, Scarf Pins, Ball and Fancy Ear Rings. No. 477 Washington Street, Newark, N. J.



**Fiedler, Herrman**—Successor to Kunze & Fiedler, Engraver, Die Sinker and Press Tool Maker, 363 Market Street, Opposite Pennsylvania R. R. Depot, Newark, N. J.

**Glorieux, W. L.**—Assayer, Refiner and Sweep Smelter. 13 and 15 Franklin Street, Newark, N. J.

**Hopper & Valentine**—Manufacturers of Fine Jewelry, No. 8 Maple Place, Rear 44 Green St., Newark, N. J.

**Huger & Heitlinger**—Manufacturers to the Jobbing Trade only. Makers of Roman Stone, Engraved and Enameled Locketts, also Sets, Lace Pins and Ear Rings. Rear 477 Washington St.

**Krippendorf, C. & Schuller, F.**—Machinists and Jewelers' Tool Makers. 19 Greene Street, Newark, N. J. Rolls, Dies, Cutters, and Draw-plates of every Description made and repaired.

**Lefort, Henry**.—Stem-winding Watch Crown Manufacturer. 60 Arlington Street.

**Lelong, L. & Bro.**—Gold and Silver Refiners Assayers and Sweep Smelters, Southwest corner of Halsey and Marshall Streets, Newark, N. J.

**Miller & Beam**.—Manufacturers of Enameled Sets, Ear Rings, Lace Pins, etc. Guard Slides and Pendants a Specialty. 21 and 23 Green Street.

**Milne, Alex.**—Manufacturer of Stem-winding Watch Crowns. 19 Ward Street.

**Plumb & Marcus**—Manufacturers of Traveling and Marine Clocks, Electric Appliances. 289 Washington St., Newark, N. J.

**Pollock, T. H.**—Manufacturer of Jewelers' and Silversmiths' Wheel Brushes, Buffs, etc. No. 36 Crawford Street, Newark, N. J.

**Regad, E. D.**—Lapidary. Specialty—Sardonyx, Black Onyx and Agates. 14 Oliver St., Newark.

### PROVIDENCE

**Arnold & Webster**—Manufacturers of Solid Gold Engraved Band Rings for the Jobbing Trade. 29 Point Street, Providence, R. I.

**Capron & Co.**—Manufacturers of Jewelry. Engraved Box Bracelets, Bangle Wire Bracelets, Original Lever Collar and Cuff Button. No. 407 Pine Street, Providence, R. I.

**Coombs & Tuttle**—Manufacturers of a large variety of Fine Bracelet and Eye-Glass Chain in Gold Plate and Silver, Spring Rings, Holders, Hooks, Snaps, etc. 35 Point St., Providence, R. I.

**Hamilton, William & Co.**—Manufacturers of Fine Rolled Plated Chains and Patent Band Bracelets. 116 Pine St., Providence, R. I.

**Hough, W. S., Jr., & Co.**—Manufacturers of the Hough, Jr., Rolled Plate Locketts, Charms and Pendants. For sale by all first-class Jobbers or Wholesale Jewelers in the United States and Canadas.

**Hutchison & Huestis**—Makers of Solid Gold Rings. Quality guaranteed. For the Jobbing Trade only. 185 Eddy Street, Providence, R. I.

**Pearce & Hoagland**—Manufacturers of Gold Pens, Holders, Pencils, Tooth Picks, etc. Also the Quill Reserve Tooth Pick. 29 Point Street, Providence, R. I.

**Taylor, Geo. H. & Co.**—Watchmakers and Wholesale Dealers in Watches, Clocks, Watch and Clock Material, Tools, Spectacles, Eye Glasses, &c. Particular attention given to trade work. 136 Westminster Street (Room 1), Providence, R. I.

### PAWTUCKET.

**Draper, J. O. & Co.**—Manufacturers of Jewelers' Fig Soap, adapted for Washing Jewelry, Scratch Brushing and Drawing Wire. Pawtucket, R. I.

**Fuller, Geo. H. & Son**—Jewelers' Findings, Gold, Silver, Gold Plated and Fire Gilt. Pin Stems, Joints, Catches, Split Rings, Chain Hooks and Swivels, Ear Wires, Chain Bars, etc. 99 Exchange Street, Pawtucket, R. I.

### CINCINNATI.

**Hellebush, Clemens**—Manufacturer, Importer and Wholesale Dealer in everything required by the Jewelry Trade. 77 W. Fourth St., Cincinnati, O.

**Lodwick & Nolting**—Wholesale Jewelers, S. W. cor. 4th & Walnut Streets, Cincinnati.

### BALTIMORE.

**Gruebel & Kesmodel**—Manufacturers of Fine Diamond Etruscan, Enameled, Plain and Rhine Stone Jewelry to order. Repairing a specialty. Orders by Mail solicited. 212 & 214 W. Baltimore St., Balto., Md.

### BOSTON.

**Boston Watch Case Co.**, makers of Watch Cases. Especial attention given to Repairing. 1, 3 & 5 Province Court, Boston, Mass.

**Boyce, E. J.**—Manufacturer of Solid Gold Jewelry. Rings a Specialty. 383 Washington St., Boston, Mass.

**Smith, Wm. A.**—Importer of Diamonds and Precious Stones. Diamonds mounted and unmounted and Diamond Mountings. 383 Washington St., Boston, Mass.

**Weber, H. & Co.**—Wholesale Jewelers, Importers and Jobbers of Fine Watch Materials, Jewelers' Findings, Tools, etc., Optical Goods and Silk Guards. Agents for Whitcomb, Standard and Stark's Lathes. 424 Washington St., Boston, Mass.

### BUFFALO.

**King & Eisele**—Manufacturers of Solid Gold Jewelry, and Agents for American and Foreign Watches; also Jobbers in Roll Plate Jewelry. Office and Salesrooms, 283 Main St. Factory, 2, 4, 6 and 8 Swan St.

**Oliver, W. W.**—Manufacturer of Hand and Power Rolling Mills for Jewelers and Silversmiths, 39 Clinton Street, Buffalo, N. Y.

### CLEVELAND.

**Chandler, J. M. & Co.**—Manufacturers of the Patent Embossed Bracelet and Jobbers in all kinds of Clocks, Watches, Jewelry, Tools, Materials, etc. 185 Superior St., Cleveland, O.

### LANCASTER.

**Bowman & Musser**—Jobbers in Watches, Clocks, Chains, Fine Tools and Materials. 20 East Chestnut Street, Lancaster, Pa.

### PITTSBURGH.

**Barrett, G. B. & Co.**—Importers and Wholesale Dealers in Watches, Diamonds, Jewelry, Clocks, Bronzes, Silver and Plated Ware, Watch Materials, &c., 238 & 240 Liberty St.

**Goddard, Hill & Co.**—Wholesale Dealers in American Watches, Jewelry, Silverware, Clocks, Materials, &c., 43 Fifth Avenue, Pittsburgh, Pa.

**Hodge, Slemmons & Co.**—Wholesale Dealers in American and Swiss Watches, Diamonds, Gold and Plated Jewelry, Clock Material, etc. No. 77 Fifth Ave., Pittsburgh.

### CANADA.

**Ellis, P. W. & Co.**, No. 31 King street, East Toronto, Ontario, Manufacturing Jewelers, Watchmakers, importers and Jobbers of Watchmakers, and Jewelers' Tools, Materials, General Supplies and American Jewelry. Correspondence solicited with manufacturers of Novelties or specialties in American Tools and Jewelry.

**POSITIVELY NO GOODS RETAILED.**

**BOWMAN & MUSSER,**

SUCCESSORS TO

**E. F. BOWMAN,**

JOBBERS IN

**Watches, Clocks, Chains,**

Fine Tools and Materials,

**20 E. CHESTNUT STREET,**

Opp. P. R. R. Passenger Depot,

**LANCASTER, PA.**

Selection Packages sent to Regular Jewelers on Request.

**BARNES' No. 4 LATHE,**  
For the Heavier Work of Jewelers.

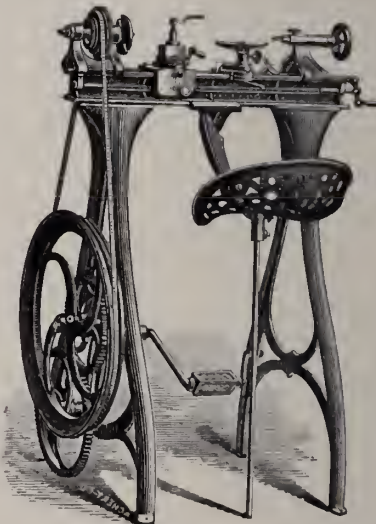

Barnes' Patent Foot and Steam Power Machinery. Complete outfits for Actual Workshop Business. Lathes for wood or metal. Circular Saws, Scroll Saws, Formers, Mortisers, Tenoners, etc., etc. Machines on trial if desired. Descriptive Catalogue and Price List Free.

**W. F. & JOHN BARNES,**  
2088 Main Street, ROCKFORD, ILL.



**STONE INLAID Cigar Cutter,**

Pat'd Oct. 5, 1880.

**J. WIENHOLD,**  
Manufacturer of FINE JEWELRY.  
DIAMOND MOUNTINGS A SPECIALTY.  
24 John St., N. Y. City.



# MILLER BROS.,

7 MAIDEN LANE,

NEW YORK.

SETS,  
EAR RINGS,  
LACE PINS,  
FINGER RINGS,  
CHATELAINES.



STUDS,  
SLEEVE BUTTONS,  
COLLAR BUTTONS,  
SCARF PINS,  
LOCKETS, ETC.

MOUNTED IN NEW AND ELEGANT DESIGNS WITH  
**DIAMONDS, RUBIES, PEARLS, &C.**  
OF OUR OWN IMPORTATION.

VACHERON & CONSTANTIN,  
GENEVA, SWITZERLAND.

THE SPECIAL LOW PRICED MOVEMENT CALLED THE

## HORSE SHOE,

BEARING THE FOLLOWING TRADE MARK:



IS NOW READY.

This Movement has some of the principal qualities of our other grades.

PRICES FURNISHED ONLY TO THE TRADE, BY

**CHAS. LEO ABRY,**

SOLE AGENT FOR UNITED STATES AND CANADA.

P. O. B. 611.

**NEW YORK.**

63 Nassau St.



# AMERICAN WATCH COMPANY.

## Twelve and Twenty-four Hour Division Dials.

Recognizing the importance of having Watches that will conform to the new system of indicating time adopted by many railroads of counting the hours from one to twenty-four consecutively, instead of from one to twelve, we are now prepared to furnish dials as indicated by the accompanying cut, marking

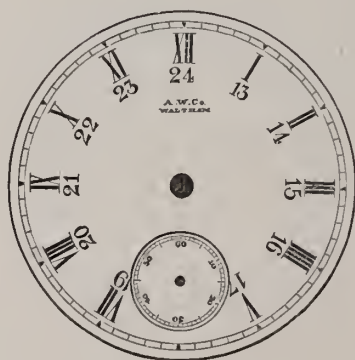

either twelve or twenty-four hours, without occasioning confusion in either system.

These Dials can be substituted by any ordinarily intelligent workman for those now in use. In order to afford dealers every facility for obtaining these Dials, they have been placed in the hands of Jobbers, who will be able to supply all demands.

ROBBINS & APPLETON,

NEW YORK.

CHICAGO.

BOSTON.

LONDON, ENG.

SYDNEY, N. S. W., AUSTRALIA.



# WATERBURY CLOCK CO.,

MANUFACTURERS OF

## CLOCKS,

### Novelties & Materials,

No. 10 CORTLANDT ST., N. Y.

— AND —

No. 63 WASHINGTON ST., CHICAGO.

Factories, **WATERBURY, CONN.**

M. BAILEY, Treasurer.

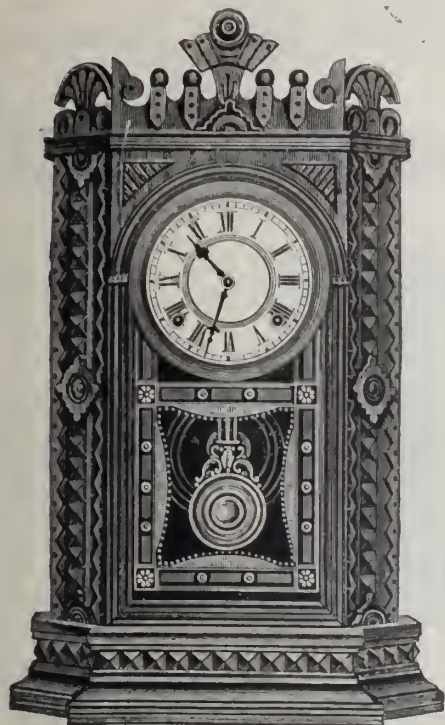

GRANVILLE.—Walnut.

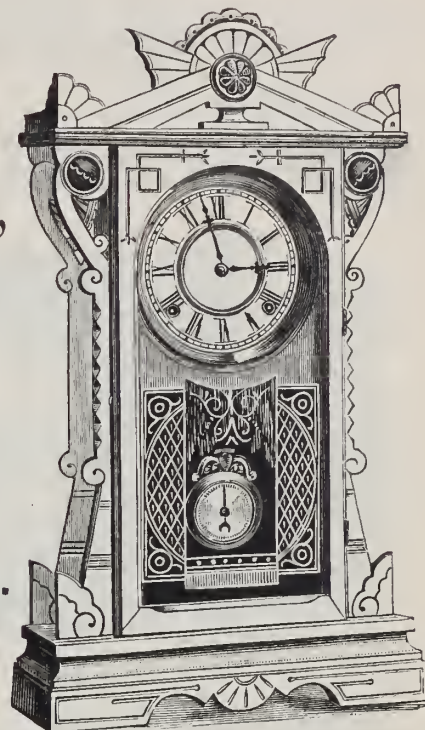

VENTNOR.—Ash.

# THE ANSONIA CLOCK CO.

## HANGING CLOCKS

— AND —

## MANTEL CLOCKS

OF EVERY DESCRIPTION.

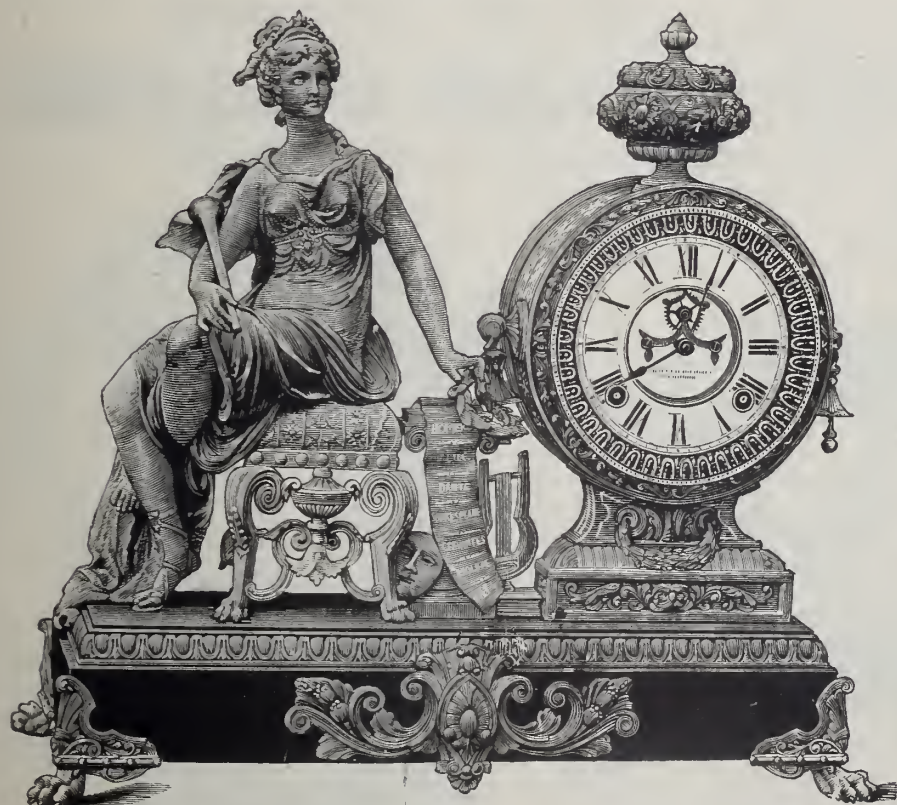

A Large and Complete Stock of

|                  |                        |                    |
|------------------|------------------------|--------------------|
| Tower<br>Clocks  | } HANGING AND STANDING | } Street<br>Clocks |
|                  |                        |                    |
| } AT LOW PRICES. |                        |                    |

AT LOW PRICES.

**CHICAGO,**  
64 Washington St.

**NEW YORK,**  
11 to 19 Cliff St.

**LONDON,**  
128 Minories.



# W. L. GILBERT CLOCK CO.

GEORGE B. OWEN, General Manager.

SALESROOMS:

6 Murray Street, New York.

54 & 56 Madison Street, Chicago.

Factories, WINSTED, CONN.

## MANUFACTURERS OF WALNUT, VENEERED AND OTHER CLOCKS.

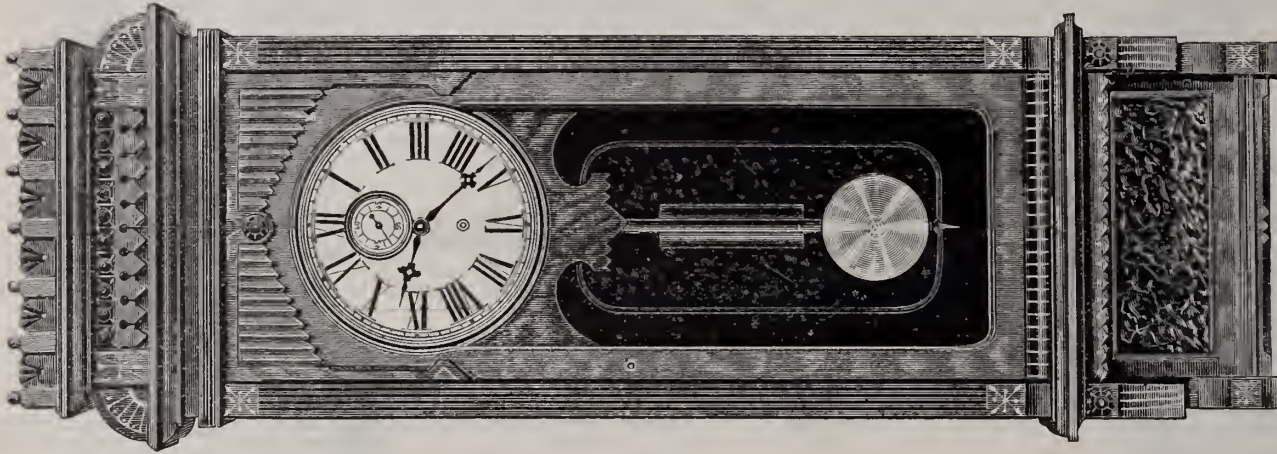

REGULATOR No. 10.

WALNUT CASE.

Eight Day Time, Weight.

Dead Beat Escapement. Glass Sides.

Height, 53 inches. 10 inch Dial.

### Importers of Marble and Cuckoo Clocks.

Catalogue and Price List Furnished upon Application.

# E. N. WELCH MANUFACTURING CO. AND WELCH, SPRING & CO.,

6 WARREN ST., NEW YORK.

W. H. Atwater, Agent.

MANUFACTURERS OF

## SUPERIOR AMERICAN CLOCKS

Factories, FORESTVILLE, CONN. ESTABLISHED 1829.

NILSSON.

### THE JEWEL.

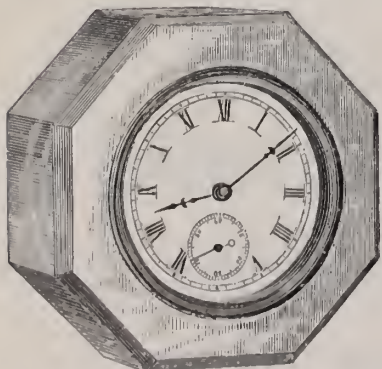

HEIGHT, 3 1/4 INCHES.



DIAL, 2 1/2 INCHES.

ONE DAY - LEVER - TIME.  
PORCELAIN DIAL.

This CLOCK has a fine SOLID STEEL PINION MOVEMENT. The Case is SOLID CUT GLASS, and can be furnished in "Crystal" (White), Amber, Emerald and Sapphire, and with or without SILK PLUSH or LEATHER TRAVELING CASES.

NILSSON.—POLISHED BLACK WALNUT,  
With "Patti" Movement.



Height, 22 inches.  
8 Day Cathedral Gong.  
Dial, 6 inches.



# ROGERS & BROTHER

Manufacturers of

## ELECTRO SILVER

# PLATED GOODS,

No. 690 BROADWAY,

WORKS:  
WATERBURY, CONN.

**NEW YORK.**

## GROUT'S EXCELSIOR IRON SIGNS FOR JEWELERS.

LOUIS 14th WATCH SIGN. MADE OF THE BEST IRON.



EVERY ONE WARRANTED.

EVERY ONE WARRANTED.

Finished with the best XX Gold Leaf.  
SIZES AND PRICES.

|                 |                  |
|-----------------|------------------|
| 12 Inch, \$6.00 | 26 Inch, \$16.00 |
| 14 " 7.50       | 28 " 18.50       |
| 16 " 9.50       | 30 " 19.50       |
| 18 " 10.50      | 36 " 28.00       |
| 22 " 11.75      | 48 " 36.00       |
| 24 " 13.50      |                  |

BOXING EXTRA.

### GROUT'S EXCELSIOR Gold Ring Sign

Made of the BEST METAL and gilded with the Best XX GOLD LEAF, and WARRANTED to stand in any Climate.

Light and Handsome



WARRANTED.

SIZES AND PRICES.

|                |         |
|----------------|---------|
| 18 Inches..... | \$12.50 |
| 24 " .....     | 16.50   |
| 36 " .....     | 27.50   |

MANUFACTURED ONLY BY THE

**EXCELSIOR SIGN CO.,**  
CHICAGO.

Combined Watch Spec Octagon and SIGN.

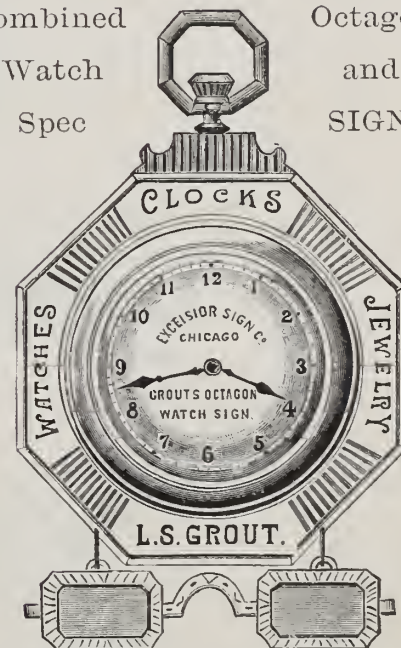

This Watch is made of the Best Iron, has SWELL Metal DIALS; the Spec is also of Iron, and both finished with the Best XX GOLD LEAF and WARRANTED.

This COMBINATION makes a very handsome, light and durable Sign. Made only by the EXCELSIOR SIGN CO., Chicago.

ASK YOUR JOBBERS FOR THESE SIGNS.



SOLE AGENTS FOR THE  
 JAMES PICARD,  
 CHARLES LODTMAN  
 AND  
 ULYSSE HUMBERT  
 WATCHES.

MANUFACTURERS OF  
 MINUTE, FIVE MINUTE and  
 QUARTER HOUR REPEATERS,  
 with and without  
 CHRONOGRAPH ATTACHMENTS.

LOUIS STRASBURGER & CO.

DIRECT IMPORTERS OF

WATCHES AND DIAMONDS,

WE MAKE EVERY KIND  
 OF WATCH IN  
 OUR OWN  
 FACTORY.

WE KEEP ALL  
 KINDS OF GOLD  
 AND SILVER AMERICAN  
 CASES AND MOVEMENTS.

WE GET THE ROUGH  
 DIRECT AND CUT  
 OUR OWN  
 GOODS.

No. 15 MAIDEN LANE,

⇒NEW YORK.←

Rue Leopold Robert,

CEAUX-DE-FONDS.



Boulevard Haussman, 30,

PARIS.

MANUFACTURERS OF  
 Split 1-4 Second CHRONOGRAPHS,  
 Split 1-5 Second CHRONOGRAPHS,  
 SINGLE CHRONOGRAPHS,  
 Open Face and Hunting  
 SILVER AND GOLD CASES.

SOLE AGENTS FOR THE  
 Celebrated Brands of Nickel Watches  
 "RAILWAY,"  
 "SUN,"  
 "ALASKA,"  
 and Manufacturers of all grades of  
 8 and 18 Size Movements.



# SHAKSPEARE—NEW VERSION.

*Oberon.* \* \* \* \* "And be thou here again, ere the leviathan  
Can swim a league."

*Puck.* "I'll put a girdle round about the earth in forty minutes,"  
*Following THE AMERICAN LEVER SLEEVE BUTTON,*  
*Which always leads!*

## THE AMERICAN LEVER



## BEST IN THE WORLD

TO THE RETAIL TRADE.

Please ask your Jobber for the goods bearing the *FAMOUS HORSE-SHOE AND CLOVER TRADE-MARK*, and if he should decline to furnish them, kindly write to "*THE MANUFACTURERS OF THE AMERICAN LEVER BUTTONS, PROVIDENCE, R. I.*," who will send the address of Jobbing Houses from whom these *Celebrated Goods* can be purchased.



“THE BEST”  
**THE DUEBER**  
 GOLD WATCH CASES.

**THE PERFECTION OF WATCH CASE MAKING.**



731318.



731317.

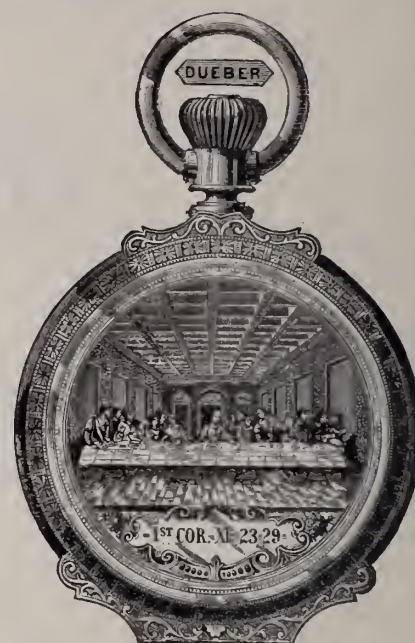

731319.



591907.



591897.



591906.

**THE MOST ELABORATE OF ARTISTIC ENGRAVING.**

The Dueber Watch Case Mfg. Co.

•CHICAGO,•

4 Tribune Building.

•CINCINNATI,•

P. O. Box 1334.

•NEW YORK,•

20 Bryant Building.



THE BEST.

THE DUEBER

COIN

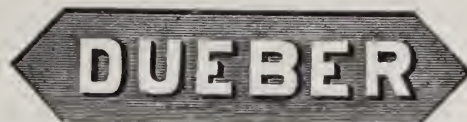

WATCH

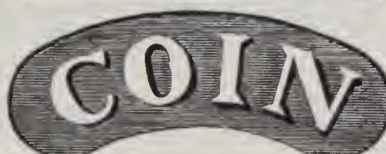

TRADE

MARK.

SILVER



CASES

747986.

With Solid Soldered Edges and Joint Bearings Throughout.

For Twenty Years, as to-day, the Leading Watch Case in the American Market.

THE CHEAPEST.

THE NEWPORT

COIN



WATCH

TRADE

MARK.

SILVER



CASES

685370.

With Albata Cap and Silver Joints.

Their Equal in Construction, Finish or Intrinsic Value has never been Produced.

THE PARALYZER.

THE "DUEBER COIN"

COIN



WATCH

TRADE

MARK.

SILVER

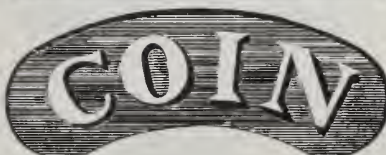

CASE

790613.

Struck Up Seamless Style, with Silver Cap, Gold Joints and Joint Bearings.

This Case is intended to Turn Over, Fold Over, Sweage, Hammer, and Keep Down all Competiton.





99



1162



93



28



94



0027



0045



1336



1840

THE

# ACME LEVER BUTTON



1741



1016



1094



0091



OPEN.



OPEN.



OPEN.



0025



43



CLOSED.



CLOSED.



CLOSED.



1091



323

VENI + VICI.

Always was, is now, ever shall be  
**THE MOST CONVENIENT,  
STRONG, RELIABLE and PERFECT SLEEVE BUTTON MADE**

**It Overcomes  
ALL TROUBLE WITH STIFF CUFFS.**

ASK YOUR JEWELER FOR THE  
ACME LEVER SLEEVE AND COLLAR BUTTON,  
AND TAKE NO OTHER.

**For Sale by all Jobbers of Jewelry.**



1420



1369



319



50



58



1585



046



321



57



1545



1269



1338



1235



1340



315



1238



02

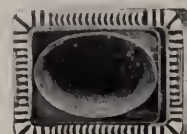

1182



634



# A NEW DEPARTURE.



## 14 KARAT GOLD CHAIN, SILVER LINED,

— MADE BY —

### A NEW PROCESS.

Guaranteed to wear as well as the best 14 karat Gold Chain made.  
Every Chain warranted to assay one-third ( $\frac{1}{3}$ ) its entire weight in gold.  
Each Chain stamped with registered trade mark:



*Showing the Relative Thickness*  
OF THE GOLD AND SILVER.



*Showing the Relative Thickness*  
OF THE GOLD AND SILVER.

Money refunded if test is unsatisfactory.

## KOSSUTH MARX & CO.,

Proprietors and Manufacturers,

39 Maiden Lane, New York.

In introducing our new Chain we aim to supply a want which we believe the Trade can place before the public in a legitimate manner without deception, and no detriment to the standard of the most scrupulous dealer.

We offer these goods strictly upon their merits, and give but a few reasons why they can take the place of the older styles of manufacture, viz.:

- 1st.—*In the make up there is no base metal, excepting such as is necessary in standard 14 karat.*
- 2d.—*It makes a larger and more showy appearance for its corresponding weight than the old standard.*
- 3d.—*The cost is materially reduced, bringing it within reach of a greater number who desire a good article.*
- 4th.—*It is a well known fact that the principal cause of wear in chain is the friction produced by its own weight, consequently, being light weight to the extent of a large percentage, their better wear is assured.*

By a strict adherence to quality we hope to create a popular demand for a meritorious article.

Send for selection package, as our travelers do not carry any in stock.

KOSSUTH MARX & Co.



# DAVID F. CONOVER & CO.

(SUCCESSORS TO WM. B. WARNE & Co.)

Manufacturers and Wholesale Dealers in

## WATCHES and JEWELRY.

Wholesale Agents For

### Rogers & Brother's Flat and Hollow Ware



### Celluloid Eye-Glasses.

And Sole Agents for the

Patent Railroad Train Watch Chains, Nickel.

WHOLESALE AGENTS FOR

T. A. WILLSON & CO.'S Optical Goods.

Would invite attention to the following new grades of Steel Spectacles lately introduced in the market.

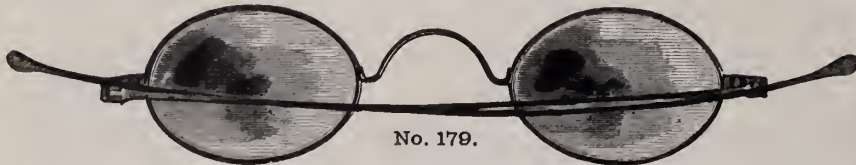

No. 179.

They are Steel, Full Tempered. Parts Interchangeable. Joints so constructed that wear is compensated for. Temple will not work loose and fall down as in old style joints. Nose-piece on No. 155 reinforced where it joins eye, giving extra strength with neatness.

PRIZE MEDALS AT ALL EXHIBITIONS WHERE EXHIBITED.

Patented July 31, 1877.

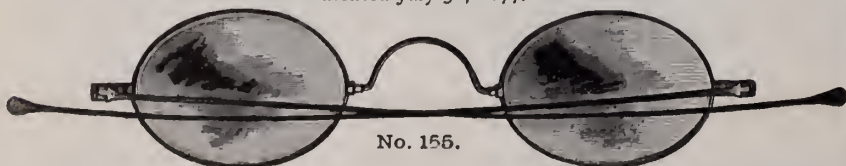

No. 155.

American Watch Wholesale Salesroom:

Southeast Cor. Chestnut and Seventh Sts., First Floor,

DAVID F. CONOVER,  
C. FRANK WILLIAMS,  
B. EDGAR RIGHTER.

**PHILADELPHIA.**

### A SPECTACLE TEMPLE

THAT WILL

**NOT WEAR LOOSE.**

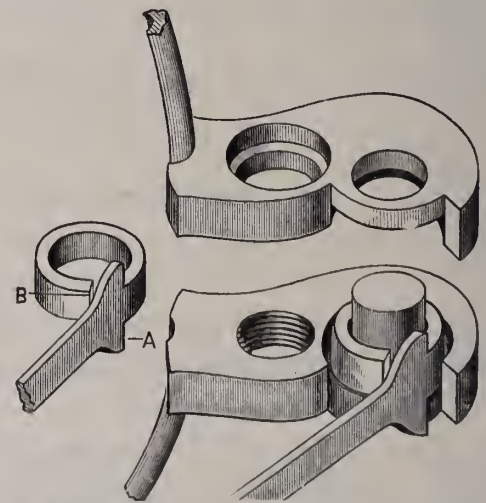

Patented May 13th, 1879. Re-issued June 8th, 1880.

- A.—Stop for Temple, preventing Strain on Joint.
- B.—Compensating eye, for taking up wear of joint. The eye of Temple is smaller than Stubb Steel Joint Pin on which it works, and is left open at B, exerting a Spring Tension on Pin.



# THE MIDDLETOWN PLATE COMP'Y,

Factories, MIDDLETOWN, CONN.

→SALESROOMS←

13 JOHN ST., NEW YORK.

120 SUTTER ST., SAN FRANCISCO.



No. 1051, Tea Set, Slop Bowl and Cream.  
 Gold Lined, - - - \$68.00  
 Waiter, 24 inch, to match, - 50.00  
 " Urn, - - - - 36.00

No. 1051, Butter Dish, - - \$9.50  
 " Syrup Cup and Plate, - 9.00  
 " Spoon Holder, Gold Lined, - 8.00

Offer to the Trade a **LARGER** Assortment than ever of Elegant New Designs in Electro-Plate, finished in Plain Burnished Surface, (with Elegant Borders), Satin, Hammered, Fancy Gilt, New Satin, Etc., Etc.

**A LARGE LINE OF GOODS IN RUSSIAN GOLD.**



# FAHYS' IMPROVED NO. 1 SILVER WATCH CASES.



All Cases made in our establishment are stamped with the above "Trade Mark" and are WARRANTED.

They are made in a great variety of styles, and distinguished by Superior WORKMANSHIP and UNIFORM FINISH throughout all their parts, and GUARANTEED as STAMPED.

A large and constantly changing stock of CASES, embracing the newest designs and every variety of decoration, suitable for the requirements of all dealers.

✦FOR SALE BY ALL THE PRINCIPAL JOBBERS.✦

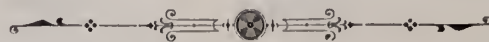

✦JOSEPH FAHYS & CO.✦

38 Maiden Lane, NEW YORK.



THE  
 BROOKLYN WATCH CASE CO.  
 EAGLE CASE.



In order to meet an imperative and growing demand in the Trade for a reliable grade of Low Karat Cases, this Company, seven years ago, was induced to place upon the market their since Celebrated **EAGLE CASES**, which are made of full 8-k. gold in all their parts, joints and bearings, the backs and caps free from solder, saving that which holds the joints. Since their introduction, these cases have achieved a wide spread reputation for the reliable and standard quality maintained in their manufacture. It has been demonstrated that the wearing qualities of the **EAGLE CASES** are unexcelled by any 12-k. case in the market, while their color is permanent and the appearance equal to that of the best cases made of this grade. The 8-k. **EAGLE CASES** will stand the severest acid test and will not tarnish when exposed in the show case or worn in the pocket.

All these goods are Stamped in the Cap with the Trade Mark of the Company,

B. W. C. Co.

and are guaranteed to be of the uniform standard designated.

A LARGE AND WELL ASSORTED STOCK OF 18-K., 14-K. AND EAGLE CASES IN THE LATEST AND MOST ARTISTIC DESIGNS, KEPT CONSTANTLY ON HAND.

For Sale by all the Principal Jobbers.



# OPPENHEIMER BROS. & VEITH,

35 MAIDEN LANE, **NEW YORK.**

Importers of

**DIAMONDS.**

Manufacturers of

**Gold Chains,  
Rings,  
And Jewelry.**

Dealers in

**HOWARD,**

**ELGIN,**

**SPRINGFIELD**

**AND**

**LANCASTER**

**Movements.**

**DUEBER**

**GOLD AND SILVER CASES.**

**LADD'S**

**STIFFENED GOLD CASES.**

**PLATED**

**CHAINS**

**AND**

**JEWELRY.**



*We are the Manufacturers and Patentees of the Combination Slide, Pendant and Locket, and the Combination Necklace, Lace Pin and Pendant.*

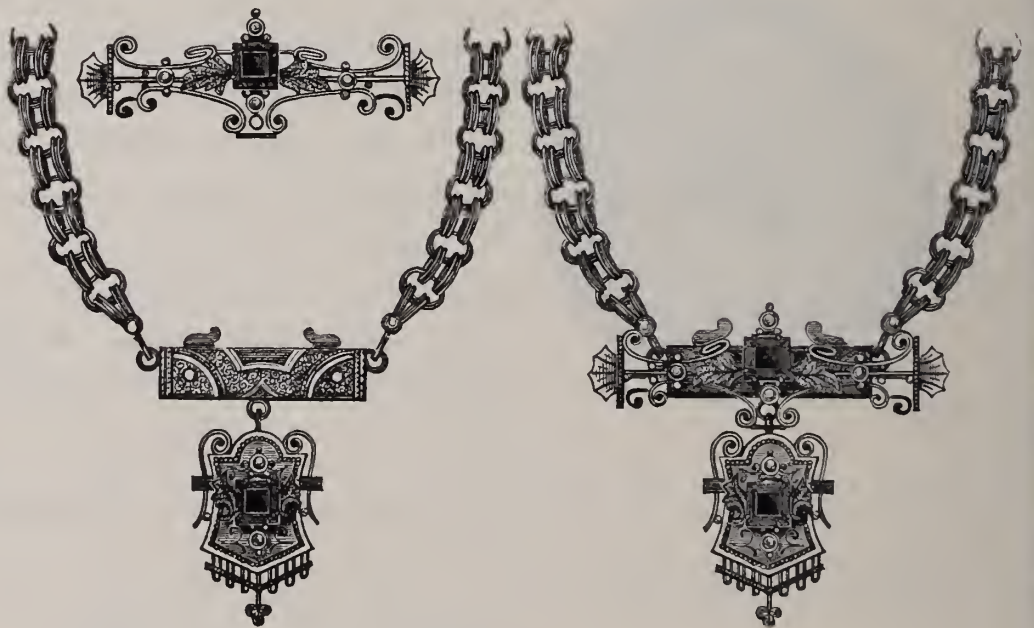

*We can furnish quite a variety of Styles, and are prepared to fill all Orders at once.*

L. S.—A large line of Diamonds, mounted in Ear Rings, Lace Pins, Rings, Studs, Scarf Pins, etc., constantly on hand, and sent on approval upon application. Value need not be stated on Packages, as we carry an Open Insurance Policy.

**OPPENHEIMER BROS. & VEITH.**



# IMPROVED SECURITY.



Fire and Burglar-Proof Safes, as now constructed by the leading manufacturers of the United States, are better finished, afford better protection, and are proportionately cheaper than those made elsewhere in the world. That the degree of perfection reached is largely due to the enterprise of the makers themselves cannot be denied. Nothing serves to elevate the standard of quality in manufactured products so much as a spirit of legitimate rivalry.

In this connection we do not refer to that class of makers who aim to supply the demand for the cheapest safe, for the inevitable tendency in that direction must be to sacrifice all those features so essential in one that is thoroughly reliable. To nothing, perhaps, does the old adage, "The best is the cheapest," apply with so much force as to the purchase of a safe. The value of the article remains in question, as a rule, until demonstrated by either fire or burglars. If it is then proven to be without merit, it is at a time too late to correct the mistake. Our own experience (and it extends over a period of FORTY-FIVE YEARS) is, that the encouragement received by manufacturers to improve their production and enhance its intrinsic worth comes from that class of buyers who discriminate with reference to economy as against parsimony.

Radical changes, having for their object the improvement of a system or method of construction, cannot be made without a considerable outlay of money, sufficient oftentimes to deter the manufacturer from consummating them. Our unrivalled facilities, complete manufacturing plant and ample capital have enabled us to ignore the barrier to progress that is presented by the item of first cost.

Our catalogue of 1880 presented a full line of safes, containing many valuable devices not found in other makes. We could not at that time see how or where advantageous improvements could be effected; notwithstanding, we have, in less than THREE YEARS, completely revolutionized our system of building fire-proof safes by the adoption of MARVIN'S

"Tongue and Groove Improvement,"

"Projecting Hinge Flange,"

"Forged Angle Frame with Sliding Back Plate,"

"Recessed Door with Book-Case Protector,"

"Outside Hinges," Etc.

All of which are covered by Letters Patent No. 263,930, dated September 5th, 1882, and are owned and in use by this company *exclusively*. These improvements have for their purpose a protection *not heretofore obtained*.

When it is remembered that our former system enabled us to construct a safe unsurpassed by those of any other make, and that we have voluntarily surrendered that system for the adoption of this later one, it will be believed that our aim is to produce only the highest grade of security extant. The reputation of the "MARVIN" Safe has been thoroughly established, and that it stands high, if not the highest, can be verified by a reference to our list of customers. It should be remembered that the most prosperous and wealthiest corporations, firms and individuals congregate in large cities, and they constitute a class that buy, as a rule, the *best* Safe. It will be found that the greater bulk of this trade favor the "MARVIN," and not only are there a larger number of "MARVIN'S" Safes in use in the city of New York, but the proportion is constantly increasing.

**MARVIN SAFE COMPANY,**

265 Broadway, New York,



# AIKIN, LAMBERT & CO.

23 MAIDEN LANE, NEW YORK,

MANUFACTURERS, IMPORTERS, JOBBERS.

## ❖ JEWELRY. ❖

A Large Assortment of all Leading Styles in GOLD, SILVER  
and ROLL PLATE, including

|                   |                        |
|-------------------|------------------------|
| <i>Diamonds,</i>  | <i>Buttons,</i>        |
| <i>Bracelets,</i> | <i>Studs,</i>          |
| <i>Rings,</i>     | <i>Lace Pins,</i>      |
| <i>Chains,</i>    | <i>Drops and Sets,</i> |
| <i>Charms,</i>    | <i>Scarf Pins,</i>     |
| <i>Lockets,</i>   | <i>Emblems,</i>        |
|                   | <i>Thimbles, Etc.</i>  |

## ❖ WATCHES. ❖

PAUL BRETON

Fine Movements, In Gold Cases.

AGASSIZ AND LONGINES

Stem Winding Movements, Fitting American Cases.

CHRONOGRAPHS, in Silver and Gold Cases.

Reliable Swiss Silver and Nickel Stem Winders.

ALL LEADING AMERICAN MOVEMENTS AND CASES.



# GOLD PENS, HOLDERS, PENCILS, TOOTH PICKS.



“NOVELTIES” IN PENCIL CHARMS.

Show Case and Fancy Tray Assortments, in New and Tasty Designs for Jewelers,  
A SPECIALTY.

Catalogues and Price Lists sent to Dealers when request is accompanied by Business Card.



Branches: } 113 EAST MADISON STREET, CHICAGO, ILLS.  
              } 41 WEST FOURTH STREET, CINCINNATI, O.

Factories: } 14, 16 & 18 MAIDEN LANE, N. Y.  
              } 12 VESEY AND 6 BARCLAY ST., N. Y.

❖ Novelties Continually Being Introduced. ❖

SELECTION PACKAGES SENT.

JAMES C. AIKIN. }  
H. A. LAMBERT. }

PROMPT ATTENTION TO ORDERS AND REPAIRS.

{ J. E. SHEA.  
D. F. FOLEY.



# SIMPSON, HALL, MILLER & CO.,

WALLINGFORD, CONN.

MANUFACTURERS OF

## ARTISTIC & USEFUL HOLLOW WARE,

❖ ELECTRO PLATED UPON FINE HARD WHITE METAL. ❖



Spoons, Forks, etc., plated upon the Finest Nickel Silver in **Extra Double, Triple, and Sectional Plates.** Full lines of over **Forty Staple and Fancy Pieces** in each Pattern in Geneva, St. James, Countess, Windsor, Oval Thread, etc. Made under the supervision, and quality guaranteed and controlled by Wm. Rogers, formerly of Hartford and Meriden. (Wm. Rogers, Sr., died 1873).

WM. ROGERS, Wallingford, Conn.

No connection with any concern in Waterbury, Meriden or Hartford using name of Rogers in any form.

Store and Stock of Goods for Delivery in N. Y. and Vicinity,

**No. 36 East Fourteenth Street, Union Square.**

Philadelphia, 506 Commerce St.—San Francisco, Cal., 530 Market St.

Montreal, Canada.—Baltimore, 6 German St.

**JOBBERS IN CINCINNATI, CHICAGO, ST. LOUIS, Etc.**

# STERN BROS. & CO.,

No. 30 Maiden Lane, New York,

Importers of **Diamonds,**

MANUFACTURERS OF FINE JEWELRY.

Jobbers in American Movements of all grades, Gold & Silver Cases, Gold & Plated Chains.

THE FOLLOWING ARE OUR **SPECIALTIES:**

*SEAL and STONE RINGS. GENT'S LOCKETS. The most complete and largest line of GOLD INITIAL RINGS and LOCKETS made in the United States. The celebrated DOUBLE CROWN Plain Filled Rings, which are universally acknowledged the MOST RELIABLE in the market. Made in seven different widths.*



No. 00



No. 0

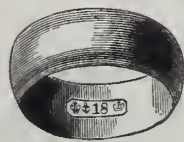

No. 1



No. 2



No. 3



No. 3 1/2



No. 4

**EVERY RING IS WARRANTED TO GIVE SATISFACTION.**

Goods sent on selection to Dealers upon application with satisfactory reference.



ESTABLISHED 1847.

**J. T. SCOTT & CO.,**IMPORTERS OF  
**WATCHES.**MANUFACTURERS OF  
**JEWELRY.**

AND JOBBERS IN

**AMERICAN MOVEMENTS, GOLD AND SILVER CASES, DIAMONDS, ETC.****WILL REMOVE,**

Early in February, to their new store,

**No. 4 MAIDEN LANE,**

Where, with greatly increased facilities, we shall be better enabled to present a large and more varied stock of goods, and provide better conveniences for the especial accommodation of buyers.

**D. L. VAN MOPPES,**  
**37 MAIDEN LANE, N. Y.**CUTTING ESTABLISHMENT,  
AMSTERDAM, 16 Plantage Middenlaan.PRINCIPAL OFFICE,  
PARIS, 10<sup>BIS</sup> Rue Chateaudun.

DIAMONDS.



DIAMONDS.

Cutting Establishment of D. L. Van Moppes, AMSTERDAM.

Constantly on hand, Bort and Diamond Dust for Lapidary and other purposes.





Manufactory, 47, 49 & 51 Franklin Street, Newark, N. J.

# MILLER BROS.,

No. 7 Maiden Lane,

NEW YORK.

## IMPORTERS OF DIAMONDS

— AND —

### MANUFACTURERS OF FINE JEWELRY.



OPEN.

We would call the attention of the Trade to our Newly Patented TURN OVER CAP SLEEVE BUTTON. The mechanical device by which the cap is turned is by a spring working in the pillar, which makes a much stronger and more durable cap than any other in the market.



CLOSED.

**INITIAL GOODS A SPECIALTY.**

# CROSS & BEQUELIN,

21 MAIDEN LANE, N. Y.

P. O. BOX No. 531.

**Manufacturers of the CENTENNIAL WATCH, CENTENNIAL CHRONOGRAPH and CENTENNIAL CALENDAR (Reliable Timekeepers,) the Best Watches for the money made.**

**DEALERS IN AMERICAN WATCHES, WATCH MATERIALS, ETC.**



CENTENNIAL.



CENTENNIAL CHRONOGRAPH.

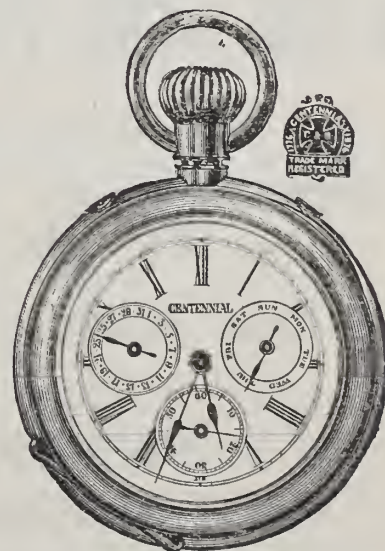

CENTENNIAL CALENDAR.



# WM. SMITH & CO.,

MANUFACTURERS OF

## GOLD and SILVER Chains & Jewelry,

Also a Large Line of SILVER RINGS.

OFFICE :

**No. 25 Maiden Lane, New York.**

MANUFACTORY—No 61 PECK STREET, PROVIDENCE, R. I.

# W. & S. BLACKINTON,

MANUFACTURERS OF

ONLY

## FINE ROLLED PLATE CHAINS,

Necklaces, Polished and Roman, of Latest Gold Designs. Also a Complete Line of Gents' and Ladies' Locketts and Pendants.

In consequence of the first-class reputation our goods have obtained, unscrupulous dealers have been selling goods of an inferior quality, represented as our manufacture. In order to protect ourselves, as well as dealers, all goods of our manufacture will hereafter bear this

TRADE MARK. **W&S B** ★ TRADE MARK.

*These Goods are for sale by all Wholesale Dealers.*

# USE GOLD STOCK PLATED CHAINS

With Swivels Stamped

## "R. F. S. & CO."

Every Chain Guaranteed by the Makers.

**R. F. SIMMONS & CO.**

**ATTLEBORO FALLS, MASS.**

Sold **ONLY** through Wholesale Houses.

# Webster's Silver Solution,

PREPARED BY

**E. G. WEBSTER & BROTHER,**

(Established 1859.)

Manufacturers of Quadruple  
**Electro Silver Plated Ware**

14 MAIDEN LANE, N. Y.,

Expressly for Cleaning Silver and Silver  
Plated Ware.

Jewelers will find this a valuable adjunct for  
cleaning their stock, and a reliable article to  
recommend to their customers.

Guaranteed entirely free from Cyanide, Acid,  
Grit, or anything detrimental to the Finest  
Wares.

Packed in Boxes containing 2 Doz. Bottles.

Price, \$1.25 per Doz., NET.



# CHESTER MANCHESTER & CO.,

MANUFACTURERS OF

## Gold and Silver Chains,

No. 13 HANOVER STREET,

PROVIDENCE, R. I.

# W. F. NYE, Watch and Clock Oil,

New Bedford, Mass.

These Oils have been  
before the Trade for the  
last twelve years and are  
generally acknowledged by  
Watchmakers throughout  
the country to be the best  
and most reliable Watch  
and Clock Oils made.

FOR SALE BY THE  
Jobbing Trade Generally.





# LOUIS A. SCHERR & CO.

Importers and Wholesale Dealers in

## Watches, Jewelry,

WATCH MATERIALS, TOOLS, GLASSES, &c.

Spectacles, Silk Guards, &c.

Wholesale Agents for American Watches.

**No. 726 CHESTNUT STREET  
PHILADELPHIA.**

AGENTS FOR THE WHITCOMB LATHE

AGENTS FOR W. F. NYE'S WATCH AND CLOCK OILS.

# HODGE, SLEMMONS & CO.

WHOLESALE DEALERS IN

American & Swiss Watches,

**DIAMONDS,**

Gold and Plated Jewelry and Gold Chains,

CLOCK MATERIALS, ETC.,

**77 FIFTH AVE., PITTSBURG, PA.**

# JOHN W. STEELE,

MANUFACTURER OF

**FINE GOLD JEWELRY,**

—AND—

BRAINERD'S

PATENT

**LOCKETS**

Patented June 17, 1874.



No. 9 Maiden Lane, NEW YORK.

Agents for the Lancaster, Pa., Watches.

## A. FRIEDENTHAL & CO.

MANUFACTURING JEWELERS,

AND IMPORTERS OF WATCHES.

43 Maiden Lane, New York.

MATERIALS and OPTICAL GOODS.

THE

## Yale Clock

COMPANY,

New Haven, Conn.

Manufacturers of

## CLOCKS

Our New 24 Hour  
Clock is quite Attract-  
ive.

Send for Illustrated  
Catalogue.

JUST OUT.

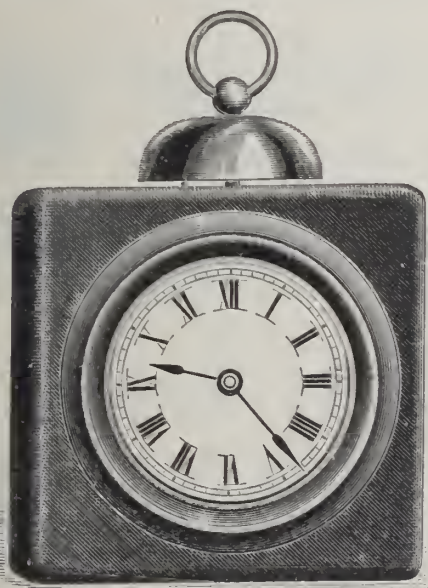

BEAUTY, ALARM.

## Abbott's Stem Winding Devices

Are for sale and are applied to watches by  
all reputable jobbers, and by the manufac-  
turer,

## HENRY ABBOTT,

7 MAIDEN LANE, NEW YORK.

FACTORY, JOHN STREET.

ALSO MANUFACTURER OF

**Fine Enamel Watch Dials.**



# COLBY & JOHNSON,

Manufacturers and Jobbers,  
17 MAIDEN LANE, NEW YORK.

WATCH CASES,  
FINE JEWELRY,  
AMERICAN WATCHES.

SOLE MANUFACTURERS OF  
**CELLULOID WATCH CASES,**  
MOUNTED IN  
GOLD, SILVER OR NICKEL.

## COX & SEDGWICK,

26 JOHN STREET, N. Y.,

### Makers of Patent Black Onyx Bracelets

Also Black Onyx Faceted Bead Bracelets,  
AT THE LOWEST PRICES.

COLORED  
AND  
Turquoise  
Lace Pins,  
Ear Rings,  
Lockets,  
Bracelets,  
Sleeve  
Buttons,  
Scarf Pins,

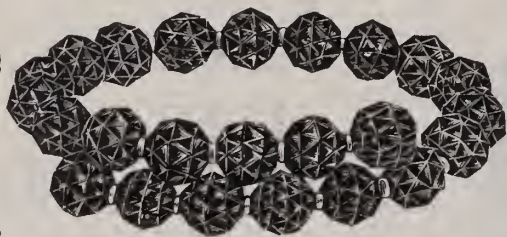

**ONYX**  
Lace Pins,  
Ear Rings,  
Medallions,  
Necklaces,  
Chatelaines  
Sleeve Buttons  
Ladies & Gents  
Vest and  
Guard Chain.

Black Onyx Pins, Ear Rings and Lockets for 1, 3 and 5 Diamonds.

☞ GOODS SENT ON APPROVAL TO RESPONSIBLE FIRMS. ☜

ESTABLISHED 1838.

## WELCH & MILLER,

**JEWELRY**  
**Case Manufacturers,**

Of Morocco, Velvet, Russia, Brocade and Plush.

SHOW CASE TRAYS OF ALL DESCRIPTIONS.

LOCK RING TRAYS FOR DIAMOND RINGS.

Agents for Jewelers' Cotton and Twine.

All Goods of our Own Manufacture, and a Large Stock  
Always on Hand.

**169 BROADWAY, NEW YORK.**

## SUSSFELD, LORSCH & NORDLINGER,

IMPORTERS OF

### Optical & Mathematical Instruments,

Watchmakers' Tools, Materials, Etc.

SPECIALTIES:

**BARDOU & SONS'** Universal Opera Glasses. U. S. Army and Navy Glasses.  
Rifle Range Telescopes, Etc., Etc.

**LA REINE** Opera and Marine Glasses.

**CROWN** Spectacles and Eye-Glasses.

**PARADIS MAINSPRINGS.**

**PARAGON TOOLS.**

13 MAIDEN LANE, NEW YORK.

16 Rue D'Enghien, PARIS.

ESTABLISHED 1842.



## JOHN HOLLAND,

MANUFACTURER OF



### GOLD PENS

PEARL, IVORY,  
AND WOOD PEN HOLDERS,

GOLD, SILVER & RUBBER PENCIL CASES.

19 WEST FOURTH STREET,

CINCINNATI.

ESTABLISHED 1850.

## JOHN T. MAURAN,

MANUFACTURER OF

☛ FINE ROLLED PLATE GOODS ☛

15 MAIDEN LANE, NEW YORK.

SPECIALTIES FOR THE FALL.

FULL LINE OF

STONE LACE PINS IN RUBY AND SAPPHIRE DOUBLETS,  
GARNETS AND FOILED WHITE STONES,

Jet Lace Pins, Sets and Ear Knobs, Solid Gold White Stone Knobs.

ALSO

Full Line of Coral and Wire Sets, Lace Pins, Knobs, &c.

These Goods, which are so well and favorably known to the Trade, bear this

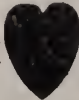
TRADE  MARK

as well as the same being stamped on the cards.



# HELLER & BARDEL

MANUFACTURERS OF



## JEWELRY,

13 John St., New York.

*A Full Line of DIAMONDS, Mounted and Unmounted, Always on hand, which we will send for Selection to Responsible Houses.*

All Goods Ordered on Selection or for Stock are Insured while in the Hands of the Express Companies.

# R. WALLACE & SONS M'FG Co.,

MANUFACTURERS OF

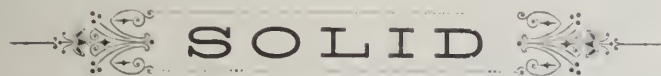

# SILVERWARE,

GUARANTEED  $\frac{92.5}{1000}$  FINE.

WALLINGFORD, CONN.

LEROY C. FAIRCHILD & CO.

MAKERS OF

GOLD PENS, PEN & PENCIL CASES,

No. 14 MAIDEN LANE,

LEROY C. FAIRCHILD.  
G. HARRY ALLEN.

NEW YORK.

# WOOD & HUGHES,

STERLING

# SILVERWARE MANUFACTURERS,

New York Agents for the Derby Silver Co.'s

**Fine Quadruple Plated Ware,**

**No. 16 John Street, N. Y.**

206 Kearney Street, San Francisco, Cal.

**HASKELL & MUEGGE, Agents.**

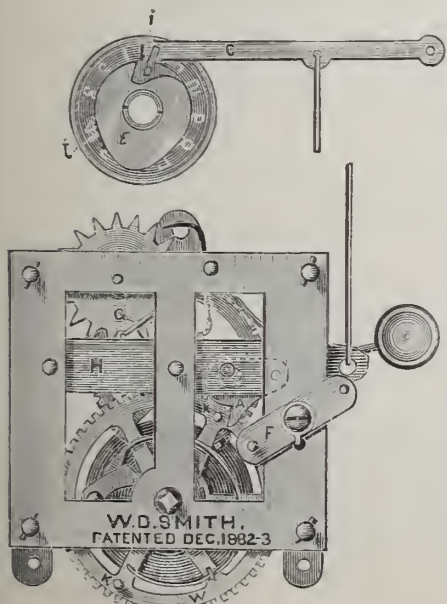

**W. D. SMITH'S**  
**Patent Eight-Day**

**Alarm Apparatus,**

Designed to be Attached to  
**Eight-Day Clocks.**

Simple in Construction,  
easily attached, and durable.  
Endorsed by the Trade  
generally. Send for Circular  
giving full description and  
particulars.

**W. D. SMITH & CO., Manufacturers & Gen'l Ag'ts,**  
867 PENN AVE., PITTSBURGH, PA.

# J. B. & S. M. KNOWLES,

MANUFACTURERS OF

# Sterling Silver Ware,

No. 20 MAIDEN LANE,

**NEW YORK.**

**FACTORY, PROVIDENCE, R. I.**



# GORHAM M'F'G CO., (Silversmiths,)

NEW YORK,  
37 Union Square.

CHICAGO,  
170 State Street.

SAN FRANCISCO,  
120 Sutter Street.

Factory, Providence, R. I.

We would announce to the Trade that, as our present store fixtures are not suitable in shape for our new store, and to save interruption of our business during the time of removal, we have decided to furnish with new fixtures throughout, and consequently offer our present fixtures for sale at the rate of 50 per cent. of their cost, viz.:—

|                                                                                                                                                                                                                                                                      |            |
|----------------------------------------------------------------------------------------------------------------------------------------------------------------------------------------------------------------------------------------------------------------------|------------|
| 2 Black Walnut, Sliding Sash, Plate Glass, Wall Cases, with French Walnut Veneers, made by B. & W. B. Smith, and in use only a few years; 24 ft. 9 in. long. Cost us to build \$1,100 each. For sale at \$600 each,                                                  | \$1,200 00 |
| 1 Black Walnut, Sliding Sash, Plate Glass, Wall Case, with French Walnut Veneers, built by B. & W. B. Smith. Duplicate of the above in every way; 32 ft. long. Cost \$1,500. For sale at                                                                             | 750 00     |
| 1 Black Walnut, Sliding Sash, Wall Case. Same as the above in every way; 16 ft. long. Cost \$850. For sale at                                                                                                                                                        | 450 00     |
| 2 Black Walnut and Bird's-Eye Maple, Sliding Sash, Wall Cases. Maple being Stained to Match the Black Walnut Cases. Built by Potter, Dennison & Co., of Providence. Cost \$800. For Sale at \$400.                                                                   | 800 00     |
| 1 Black Walnut and Maple Swing Door, Plate Glass. Sash goes within 12 inches of the floor, and one of Howard & Co.'s Clocks in the center. A very fine Wall Case. Cost \$1,500. For sale at                                                                          | 750 00     |
| 1 Very fine Black Walnut, French Veneer, Office, for High Desk, with Rounded Corners. For sale with desk complete. Cost \$750. For sale at                                                                                                                           | 375 00     |
| 11 Rosewood Counter Cases and Tables 10 ft. in length. One Plate Glass Top and One Plate Glass Front. Made with Smith's Patent Sliding Doors, and Black Walnut Tables, complete with Drawers, built by B. & W. B. Smith. Cost \$265 each. For sale at \$132.50 each. | 1,457 50   |
| 5 Rosewood Counter Cases and Tables, same as above but with Hinged Doors. Cost \$265 each. For sale at \$110 each.                                                                                                                                                   | 550 00     |

All the above Cases were built for our own use, and we can say that they are the best class of work of this kind that has ever been built. We also offer:—

|                                                                                                                                   |            |
|-----------------------------------------------------------------------------------------------------------------------------------|------------|
| 1 Ebonized Cabinet, Wall Case, 19 ft. 2 in. long, with Sliding Wood Doors and Drawers. Cost to build \$400. For sale at           | 150 00     |
| 1 Pine Case, Painted, with Plate Glass, Swing Doors, 29 ft. 8 in. in length. For sale at                                          | 100 00     |
| 1 Pine Case, Painted, Swing Doors, Crystal Glass, with Cupboards underneath and Closet at one end, 49 ft. 3 in. long. For sale at | 300 00     |
| 1 Duplicate of above, 42 ft. 8 in. in length. For sale at                                                                         | 250 00     |
| 1 Cherry Table. For sale at                                                                                                       | 40 00      |
| Total,                                                                                                                            | \$7,172 50 |

To be sold in whole or in part, and will be delivered May 1st, 1884, at 37 Union Square, in their present condition. Terms, Net Cash. Any dealer wishing to purchase cases of this class will find this offer an unusual bargain, as the cases can be taken down and removed, and fitted into any place desired. Inspection Invited. Cases will be shown to anyone calling at our store.

GORHAM M'F'G CO.



LONDON, 33 HOLBORN VIADUCT. CHICAGO, 125 STATE STREET.

ALFRED H. SMITH & CO.

IMPORTERS OF

**DIAMONDS.**

182

BROADWAY,

COR. JOHN ST.

NEW YORK.

P. MEEDER ENG. N. Y.

The advertisement is a highly decorative, vertically oriented rectangular frame. At the top, two curved banners contain the addresses: 'LONDON, 33 HOLBORN VIADUCT.' on the left and 'CHICAGO, 125 STATE STREET.' on the right. Below these, the name 'ALFRED H. SMITH & CO.' is written in a large, bold, serif font, following the curve of a decorative arch. Underneath the name is a smaller banner that reads 'IMPORTERS OF'. The central focus is a large, stylized diamond shape, with the word 'DIAMONDS.' written across it in a very bold, black, sans-serif font. Inside the diamond, at its base, is a small circular emblem containing the number '182'. Below the diamond is another banner with the word 'BROADWAY,'. Underneath that is a smaller banner with 'COR. JOHN ST.' and a final banner at the bottom with 'NEW YORK.' The entire design is framed by intricate, symmetrical scrollwork and floral patterns. At the very bottom center, in small capital letters, is the text 'P. MEEDER ENG. N. Y.'



THE

# NEW HAVEN CLOCK CO.

## MANUFACTURERS, IMPORTERS, DEALERS,

FACTORIES:

NEW HAVEN, CONN.

WESTERN OFFICES AND SALESROOMS:

31 Washington St., Chicago, Ill., 134 Sutter St., San Francisco, Cal.

GENERAL OFFICE AND SALESROOMS:

16 & 18 PARK PLACE, New York.

EUROPEAN OFFICE AND SALESROOMS:

Victoria St., Liverpool, Eng.

We beg to call special attention to our line of Fall Importations of Marble, Gilt and Alabaster, Antique Brass and Porcelain Placques, Clocks, Bronzes and Novelties for the Holiday Trade. Also, New and Novel Designs for the Fall Season of 1883, in Bamboo, Walnut, Ash, Porcelain, Nickel, Brass, and Plush Cases.

No. 124, GILT AND ALABASTER.

MARBLE.

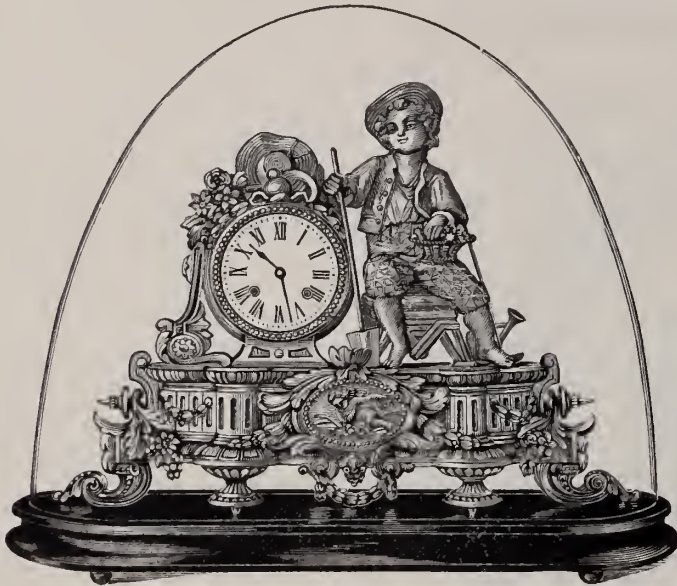

15 DAY, 1/2 HOUR STRIKE.  
Height, with Glass Shade, 15 in. Width, with Glass Shade, 19 in.

LARK.—Porcelain and Plush Cases.

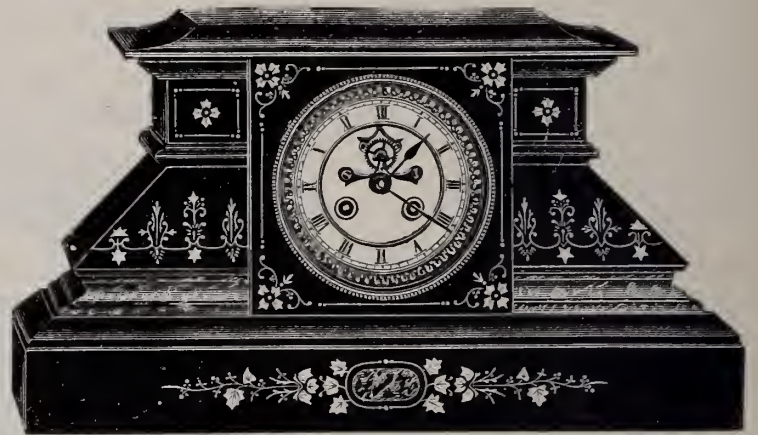

15 DAY STRIKE. CATHEDRAL GONG.  
Height, 8 1/2 inches. Base, 15 inches. Dial, 4 inches.

ANTIQUÉ BRASS, No. 2.—Visible Escapement, Porcelain Dial.



1 Day Lever Time. Nickel Plate Movement.  
A Reliable Timekeeper.



8 DAY, 1/2 HOUR STRIKE, CATHEDRAL GONG.  
Height, 13 1/2 inches. Dial, 4 inches. Also in Plain Porcelain Dial.

CATALOGUES AND PRICE LISTS FURNISHED THE TRADE UPON APPLICATION.





CARTER, SLOAN & CO.,  
MANUFACTURERS OF ALL KINDS OF

GOLD JEWELRY,

No. 15 MAIDEN LANE,  
NEW YORK.

A. CARTER, JR.  
A. K. SLOAN,

C. E. HASTINGS,  
G. R. HOWE.

S. W. HALE & CO.,

SUCCESSORS TO HALE & MULFORD,  
MANUFACTURERS OF

FINE JEWELRY

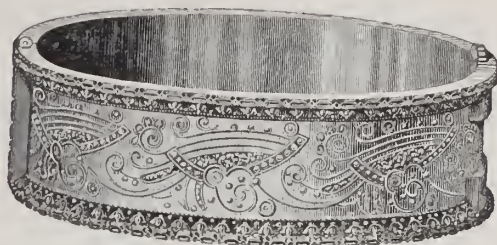

692 BROADWAY, N. Y.

SETH W. HALE. WILLIAM A. LEE. WILLIS H. HOWES.

*J. F. Chatellier,*  
*Manufacturing Jeweler,*

*692 & 694 Broadway,*

*New York.*



TRADE

MARK

STERLING.

Whiting Manufacturing Co.

SILVERSMITHS,

BROADWAY & FOURTH ST., N. Y.

ESTABLISHED 1887.

TAYLOR & BROTHER,

Old House READ, TAYLOR & CO.,

Importers of Diamonds and Pearls,

—:—)AND(:—

MANUFACTURERS OF DIAMOND JEWELRY,

21 Holborn Viaduct, 676 Broadway,

LONDON.

NEW YORK.

ESTABLISHED 1818.

THOMAS G. BROWN & SONS,  
Newark, N. J., & 5 Bond Street, New York.  
MANUFACTURERS OF

ARTISTIC JEWELRY  
FOR PRESENTATION,

Including Prizes for ROWING, RIFLE SHOOTING, ARCHERY and  
all ATHLETIC SPORTS.

COLLEGE SOCIETY PINS AND CLASS RINGS, ALSO BADGES FOR MILITARY  
AND CIVIC BODIES IN ALL METALS.

Employing able Designers, and having all work, both in Designing and Manu-  
facturing, done in our own factory, we can submit, for the inspection of those  
interested, entirely original designs, appropriate in style, and not to be seen else-  
where.

Estimates and Designs will be sent to Reputable Dealers when desired.



ESTABLISHED 1834.

G. & S. OWEN & CO.,

—MAKERS OF—

FINE ROMAN JEWELRY,

—BOX and GLASS PINS,

—AND—

Black Onyx and Pearl Goods,  
OF EVERY DESCRIPTION.

All Goods sold by us are exclusively of our own manufacture and are warranted 14 K. Fine, and stamped as such when possible.

No. 3 Maiden Lane, New York.

W. H. SHEAFER & CO.,

MAKERS OF

BRACELETS,

BANGLES,

LACE PINS,

SCARF PINS, ETC.

No. 15 JOHN STREET,

NEW YORK.

RIPLEY HOWLAND M'F'G CO.,

MAKERS OF

**FINE JEWELRY,**

SPECIALTIES:

DIAMOND MOUNTINGS, with Platinum Tips.  
ENGRAVED RINGS, STONE RINGS,

OFFICE, 17 MAIDEN LANE,  
NEW YORK.

FACTORY, 383 WASHINGTON ST.,  
BOSTON, MASS.

**GOLD**

SAXTON, SMITH & CO.,

Manufacturers of



SOLE AGENTS

FOR THE

NEW PATENTED CHAIN BAR,

Containing a Detachable Pencil.

FACTORY:  
183 EDDY ST.,  
PROVIDENCE, R. I.

OFFICE:  
14 JOHN ST.,  
NEW YORK.

**CHAIN**

A. J. HEDGES & CO.,

MANUFACTURING

**JEWELERS,**

No. 6 MAIDEN LANE,

NEW YORK.

Factory, No. 90 MECHANIC ST.,  
NEWARK, N. J.

HESS & SCHLISSER,

25 Maiden Lane,

NEW YORK.

**IMPORTERS.**

SPECIALTIES:

DIAMONDS.

NOVELTIES IN FINE JEWELRY.

Blue and Black ENAMELED LOCKETS.

Charms, Garnet and Silver Filigree Goods.



**FOWLER BROS.,**  
MANUFACTURERS OF

**JET & ONYX JEWELRY.**

Offer a large and varied stock of desirable goods of original designs, especially manufactured for the coming Fall Trade. These goods are elegant in design, beautifully finished, and must be seen to be appreciated.



PATENTED MARCH 27th 1893.

Are Carried by all the Leading Jobbing Houses  
Throughout the Country.

**MOORE & HORTON,**

No. 11 Maiden Lane,  
NEW YORK.

**JEWELERS.**

SPECIALTIES:

Stone Cameo, Onyx, Amethyst, Topaz  
and Pearl Rings.

Studs, Collar and Sleeve Buttons.

Also our fac-simile of Fine African Diamonds,  
with Foile Back, Mounted in Rings, Studs,  
Pins, Ear Rings, Scarf Pins, Lace Pins, &c.

JOHN F. SAUNDERS,  
Of the late firm of Buckenham, Cole & Saunders.

CHAUNCEY IVES.

**SAUNDERS & IVES,**  
IMPORTERS OF

**DIAMONDS, PEARLS,**  
And Other Precious Stones.

Manufacturers of Diamond Mountings.  
No. 26 MAIDEN LANE, NEW YORK.

A Large Stock of FINE DIAMONDS, Mounted and  
Unmounted, kept constantly on hand.

Goods sent on approval to any part of the country on receipt of  
satisfactory reference. All our goods ARE IN-  
SURED by us while in transit.

**DORRANCE, EDGE & CO.,**

Makers of the Celebrated

**Woven Fabric Gold Chain,**

And Patentees of the

**Embossed Inlaid Jewelry.**

The Latest and Most Effective Styles of Decoration  
Introduced.

15 JOHN ST., NEW YORK.

FACTORY, 46 GREENE ST., NEWARK, N. J.

**G. W. PRATT & Co.,**

Manufacturers and Dealers in

**Watches and Jewelry**

OF EVERY DESCRIPTION.

ELGIN AND ILLINOIS MOVEMENTS  
IN ALL GRADES.

Gold, Silver and Ladd Patent Cases.

No. 14 JOHN STREET, NEW YORK.

**C. ROSSWOG & SON,**  
MANUFACTURERS OF

Rich Jewelry and Diamond Goods,

NOS. 5 & 7 MAIDEN LANE,

—NEW YORK.—



**DAY & CLARK,**  
No. 10 MAIDEN LANE, NEW YORK.

*Fine Roman Goods,*

IN VERMICELLA AND HAMMERED ORNAMENTATION.

BANGLES, DIAMOND BALL COVERS, LACE PINS  
AND EAR DROPS. BEAD NECKLACES,  
EAR HOOPS, SCARF PINS.

Send for Selection Package.

FACTORY, NEWARK, N. J.

ESTABLISHED 1833.

**E. IRA RICHARDS & CO.,**  
MANUFACTURERS (Exclusively) OF  
**Fine Rolled Plated Jewelry.**

The Largest and Choicest Stock in the Country.

SPECIALTY FOR THE COMING SPRING,  
Band and Bangle Bracelets and Extra Quality Rolled Plated Chains.

These Vest Chains are produced to meet the demand for a  
**ROLLED PLATED CHAIN**  
that will wear for years. Each Chain bears the initial letters of our firm

No. 200 BROADWAY, NEW YORK.  
2d STORY, FRONT.

GOODS SENT ON SELECTION TO RESPONSIBLE PARTIES.

**JULIEN GALLET & CO.,**  
IMPORTERS OF

**WATCHES**

OF EVERY GRADE,

No. 1 MAIDEN LANE,

NEW YORK.

**JOHN A. RILEY & CO.,**  
9 BOND STREET, N. Y.

SOLE MANUFACTURERS OF THE POPULAR  
**PATENT SPRING BRACELETS**

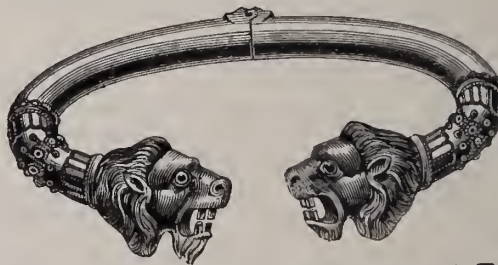

Also Lace Pins, Ear Rings, Scarf Pins, Etc.

**SMITH & KNAPP,**

WHOLESALE DEALERS IN

AMERICAN AND SWISS WATCHES,

**DIAMONDS.**

Gold & Plated Jewelry & Gold Chain,

**No. 182 BROADWAY,**

COR. OF JOHN STREET,

NEW YORK.

**E. STITES' SONS.**

**BRACELETS**

14 JOHN STREET,  
NEW YORK.

FACTORY, NEWARK, N. J.



MANUFACTURERS OF Everything in

# BLACK ONYX JEWELRY

PLAIN, and {Ornamented with Pearls and Diamonds.

Our manufacturing facilities have been for the past ten years devoted exclusively to the production of fine Black Onyx Jewelry. We carry in stock the largest variety of articles made in our specialty, well made, finely finished, uniformly 14 karats, at medium and low prices.

**WOGLOM & MILLER,**  
Office & Factory, 32 & 34 JOHN STREET,  
NEW YORK.



**W.M. GREENE & Co.**  
GOLDSMITHS

MANUFACTURERS of

RICH SETS IN TAPER WIRE CORAL

Factory 95 PINE ST. Providence, R. I.

Stone Cameo  
Amethyst  
Coral Cameo  
Engraved  
Enamel Sets  
Sleeve Buttons  
Stud Buttons  
Ear Drops  
&c. New York Office 192 BROADWAY.

WM. C. GREENE. B. W. GREENE. GEO. D. BRIGGS.



**KETCHAM & McDOUGALL,**  
Bryant Building, (55 Liberty St.) New York.  
MANUFACTURERS OF  
**GOLD AND SILVER THIMBLES.**





**THE AUTOMATIC EYE-GLASS HOLDER,**  
It Reels Up Cord Itself.  
A—Shows position of Glasses with cord Reeled up.

Patented November 18, 1873.

# MORRISON'S

## GOLD AND SILVER SOLUTIONS

For Electro-Plating Without a Battery.

Invaluable for Watchmakers and Jewelers. So simple that any one can use them.  
Price, Gold Solution, \$3.00 Silver Solution, \$1.50

MANUFACTURED BY  
**ARTHUR B. MORRISON, Portland, Maine.**

FOR SALE BY  
Sussfeld, Lorsch & Co., New York; Henry Ginnel, New York; Cross & Beguelin, New York; Kearney & Swartzchild, Chicago, Ill.; Louis A. Scherr & Co., Philadelphia, Pa.; Duhme & Co., Cincinnati, O.; Harwood Bros., A. Paul & Co., Palmer, Bachelder & Co., Boston, Mass., and material dealers generally.

BEWARE OF BASE IMITATIONS put up by unprincipled persons. None are genuine without the Trade Mark which consists of the letters A. B. M. in monogram and fac simile of Medal awarded by U. S. Centennial Commission.

# BOOZ & CO.,

MANUFACTURERS OF FINE GOLD AND PLAIN GOLD



Watch Cases RINGS.

Jobbers in American Movements.

**DIAMONDS.**

108 South Eighth St., (2d Story) Philadelphia.

Samples of our goods sent on approval when satisfactory reference is furnished. Old Gold and Silver Bought or Exchanged.

PARTICULAR ATTENTION PAID TO REPAIRING.



TRADE MARK

# The ORIGINAL GOLD CROWN FILLED RINGS.

For the past thirteen years we have manufactured as a specialty, the well known "CROWN GOLD FILLED RING," with the high standing of which the trade is already perfectly familiar. In consequence of the above fact, and in justice to ourselves, we feel it a duty to make the announcement to the trade that there are now being offered in the market several other makes of filled rings, each of which has a CROWN in some way connected with its STAMP.

We Manufacture for the Jobbing Trade Only.

**McGALL & NEWMAN,**  
625 Arch Street, Philadelphia



# B. A. BALLOU & CO.,

61 Peck St., Providence, R. I.

MANUFACTURERS OF

# GOLD JEWELRY.



We call special attention to our PATENT FASTENING FOR EAR RINGS, which is free from the objections raised to ordinary ear wire or screw fastenings. They present a very neat and attractive appearance, are perfectly secure, and much more convenient than ordinary ear wires which always annoy the wearer by catching the hair, veil, or lace about the neck. These Goods are for Sale by all Wholesale Dealers.

Gold Studs, Small Chains for Eye-Glasses, Bracelets, Etc.  
a Specialty.

# ALEX. MILNE,

Manufacturer of Stem-Winding Watch Crowns





ALSO GOLD AND SILVER THIMBLES.





19 Ward Street, NEWARK, N. J.



CLOCKS

ESTABLISHED 1853.



AMERICAN  
AND  
FRENCH CLOCKS  
AND  
BRONZES.

**B. J. COOKE'S SONS,**

137 N. 3d Street, PHILADELPHIA.  
Catalogues and Price Lists furnished to the Trade only, on application.

**W. E. WHITE & CO.,**  
Manufacturing Jewelers.



Finely Ornamented and Soldered Edge Chain Bracelets, in  $\frac{3}{8}$ ,  $\frac{1}{2}$ ,  $\frac{5}{8}$ ,  $\frac{3}{4}$  inch widths; also Thin Bands in a Large Variety of Plain, Chased, Buckle and Ornamented Patterns of the Celebrated

**W. E. W. & CO.**  
Stamp; also Lace Pins, Drops, Collar Buttons, Crosses, etc.  
For Sale by Jobbers Only.

FACTORY:  
54 Page St., Providence, R. I.  
N. Y. OFFICE:  
No. 26 Maiden Lane.  
Represented by S. A. BALDWIN

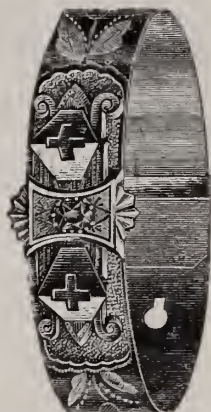

**BOSTON WATCH CASE COMPANY**

WATCH CASE MANUFACTURERS,

Nos. 1, 3 and 5 Province Court, Boston, Mass.,

ENTRANCE COR. PROVINCE STREET.

Especial Attention given to Watch Case Repairing, Springing, Re-engine Turning, Engraving, Polishing, &c.

Particular Attention given to Orders by Express.

WE OFFER THE LARGEST VARIETY OF ORIGINAL DESIGNS IN WATCH CASES EVER PRESENTED TO THE TRADE.

**JAMES J. FISHER,**

DEALER IN

**WATCHMAKERS' and JEWELERS' MATERIALS,**

Files, Tools, Silk Guards, Watch Glasses, Spectacles, Rolled Plate, Fire Gilt, Nickel and Silver Chains, Charms, &c.

No. 697 BROADWAY,  
Corner Fourth Street, NEW YORK.

All kinds of Job Work for the Trade Promptly attended to.

The "Acme" French Clock Movement Support.

(Pat. Nov. 1st, 1881.)

This Support is adapted to the holding in position of any French Clock Movement while regulating or adjusting, and will be found very desirable on account of its simplicity of action and the small space it occupies. To be had of any material jobbing house, or sent, post paid, to any address, on receipt of 85 cents.



KING JAMES,  
MARQUIS, } RINGS.  
GLOVE, }

Quality Guaranteed.  
Prices Close.

BARNET BROS. & POWELL,  
—Manufacturers,—

Newark, N. J., & 15 JOHN ST., NEW YORK.

**PFORZHEIMER, KELLER & CO.,**

MANUFACTURERS OF

**FINE JEWELRY,**

AND DEALERS IN

Diamonds, American and Swiss Watches,

No. 24 JOHN STREET,

I PFORZHEIMER,  
D. KELLER.

**NEW YORK.**

I. B. ETINGER,  
H. J. FINK.

ESTABLISHED 1830.

TRADE



MARK

**PETER L. KRIDER,**

MANUFACTURER OF

**STERLING SILVERWARE**

Medal and Diploma Awarded. &c. Striking Society Medals in Gold, Silver or Bronze a Specialty.

Artisan Hall, 618 Chestnut St., Philadelphia.

ESTABLISHED 1866.



**ARNOLD & WEBSTER,**

MANUFACTURERS OF

**SOLID GOLD**



**ENGRAVED BAND RINGS**

FOR THE JOBBING TRADE.



29 Point Street, Providence, R. I.

NEW YORK OFFICE,

No. 196 BROADWAY.







**CHAS. W. SCHUMANN,**  
24 JOHN STREET, NEW YORK.  
IMPORTER OF

Fine Diamonds, Watches, &c.

Sole Agent in U. S. for the celebrated "A. LANGE" DRESDEN WATCH. Also Sole Licensee in U. S. for

**TRENOR'S DIFFERENTIAL DIAL,**  
SPECIALLY USEFUL FOR TRAVELERS.

The Movable Rims around the Main Dial are set from the side similar to the hand-setting of stem winding watches. Set the difference of time desired to figure XII, as shown on cut, and the hands will indicate that difference all around the dial, viz.: hands of Main Dial 9.14, Differential, 10.19, being one hour five minutes difference as set at figure XII.

Can be Applied to any Watch.

READY MADE DIALS ON HAND FOR AMERICAN WATCHES.

**ROTARY MEASURING INSTRUMENT,**

American Manufacture, for or straight line by running face. The distance is shown shows inches and fractions the feet. It is in Nickel Holiday Present, and a elers, Opticians, and Fancy only instrument with which line. Sent by mail on re- be had of Jewelers, Opti- Dealers.



Full Size.

measuring any object, curved the instrument over the sur- on the dial, the long hand of an inch, the short hand Silver Case. It is a Useful Desirable Article for Jew- Goods Dealers. It is the you can measure a curved ceipt of price, \$2.00; or can cians, and Fancy Goods

Wholesale and Retail by

**R. MERRILL'S SONS,**  
Importers and Manufacturers of NAUTICAL INSTRUMENTS,  
179 WATER STREET, NEW YORK.

**FINE WATCH AND CLOCK**

**OIL,**



MANUFACTURED BY

**GEO. B. WHEELER,**  
NEW BEDFORD, MASS.

**C. F. A. HINRICHS,**

Importer of and Dealer in

**Fancy Goods, Glassware, China, Toys, Games,**  
CLOCKS, BRONZES, &c.,

Brass Goods, Faience, China and Glass Metal-Mounted Lamps,

C. A. KLEEMANN'S PATENT ST. GERMAIN STUDENT LAMPS.

Goods suitable for Jewelers.

AGENCIES: LONDON, ENGLAND; LIMOGES, FRANCE; HAIDA, BOHEMIA.

Nos. 29, 31 and 33 PARK PLACE,

N. W. Corner Church St., }  
Opposite Elevated R. R. Station. }

NEW YORK.

*Henry Fera,*

Importer of Rough & Polished Diamonds,

DIAMOND CUTTING AND POLISHING WORKS:

21, 23, 25 Looijersgracht,

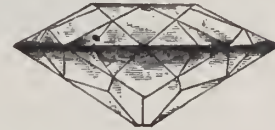

4 & 6 JOHN ST.,

Amsterdam, Holland.

New York.

Diamonds repaired and matched by some of the finest workmen in the world.

Diamond Bort and Powder always on hand.

ESTABLISHED 1828.

**JACOB BENNETT & SON,**

MANUFACTURERS OF FINE

**DIAMOND MOUNTINGS,**

No. 925 CHESTNUT STREET, PHILADELPHIA.

— FINE REPAIRING. —

*D. VALENTINE,*

DIRECT IMPORTER OF THE CELEBRATED

**GENEVA WATCHES**

Manufactured by Patek, Philippe & Co. and J. J. Badollet & Co.,

In all sizes from 12 to 19 Line, Open Face or Hunting, with or without Cases. Also a Full Assortment of REPEATERS, CHRONOGRAPHS AND CHRONOGRAPH AND REPEATING COMBINED.

692 BROADWAY, NEW YORK.

R. & K.'S PATENT GAS FURNACES FOR MELTING, PLATING, ENAMELING, ANNEALING, &c., &c.

**Reichhelm & Koester,**

Importers and Manufacturers of

Jewelers' Tools, Files, Materials, &c.,

Manufacturers of  
Bristle Brushes of all kinds,  
Cotton and Wool Buffs,  
Felt Polishing Wheels,  
Walrus Leather Polishing  
Wheels,  
Jewelers' Satin Finish and  
Scratch Brushes,  
Brass & Steel Wire Brushes  
Jewelers' Standard Saw  
Frames,  
Plain & Fancy Draw Plates,  
Improved Jewelers' Ingots,  
R. & K.'s Jewelers' Combi-  
nation Gas Burners.

Importers of  
French, English & German  
Tools and Files,  
Piercing Saws,  
Renard & Vautier Gravers,  
Steel and Brass Wires,  
Vienna and Ruby Draw  
Plates,  
Alloying Copper Wire,  
Felt, Walrus Leather,  
Vienna Lime, Tripoli,  
&c., &c., &c.

**80 Nassau St.**

NEW YORK.





181



193

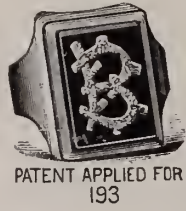

PATENT APPLIED FOR  
193

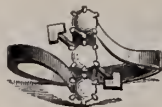

214



218



219



812



THE ABOVE CUTS ARE THREE DIFFERENT  
SHAPES IN THE SAME WEIGHT OF PLAIN  
RINGS. TO BE USED IN ORDERING.

**J. B. BOWDEN & Co.,**

MANUFACTURERS OF SOLID RINGS

OF EVERY DESCRIPTION.

No. 1 MAIDEN LANE, cor. Broadway, NEW YORK.

**WILLIAM H. BALL,  
MANUFACTURING JEWELER,**

(Bracelets and Bangles a Specialty.)

No. 9 JOHN ST., N. Y.

San Francisco Office, 120 Sutter Street.

Factory, Newark, N. J.

GOODS SENT ON SELECTION TO RESPONSIBLE PARTIES.



**THEUERNER & CHURCH,  
MANUFACTURERS OF FINE RINGS,**

No. 9 MAIDEN LANE,

FACTORY, COR. MULBERRY & DURAND STS., NEWARK, N. J.

NEW YORK.

LEON JEANNE.

PAUL JEANNE

**JEANNE BROTHERS**

MANUFACTURERS OF

**DIAMOND MOUNTINGS,**

**AND RICH JEWELRY.**

No. 1 MAIDEN LANE, NEW YORK

Designs Furnished and Estimates Given.

**JEANNE BROS PAT. DIAMOND  
SETTINGS.**

A PLATINUM SETTING WITH A GOLD SURFACE  
OUTSIDE

IN THIS WAY THE REFLECTION OF GOLD  
THROUGH THE DIAMOND IS ENTIRELY  
AVOIDED.

PAT'D AUG. 15<sup>TH</sup> 1882



IMPORTERS OF  
**SWISS WATCHES,**  
 OPTICAL GOODS, Etc.  
 JOBBERS OF ALL  
 AMERICAN  
 WATCH MOVEMENTS,  
 Gold, Silver and Filled Cases  
 CLOCKS, SILVER PLATED WARE,  
 FINDINGS, Etc.



SPECIALTIES.  
 THE "CENTURY" WATCH;  
 S. Wind, Nickel, Ancre.  
 THE "CENTURY WATCH CO."  
 MOVEMENTS  
 Fit all American Cases.  
 THE 1 DAY  
 TIME ALARM WATCH,  
 19 Line, O. F. Nickel Case, with  
 Fine Stem Wind Movement.  
 The "CENTURY LEVER" Cuff Button.  
 The "S. F. M. & Co." Rolled  
 Gold Chain, &c., &c.

179 Broadway, Near Maiden Lane, New York.

Our Pocket Price List, or our Large Illustrated Catalogue, MAILED TO DEALERS FREE.

**SINNOCK & SHERRILL,**



No. 2234.  
 Doublet and Pearl.



No. 2047  
 14 K. fine.  
 Garnet and Pearl.



No. 2156  
 14 K. fine.  
 Class Rings.

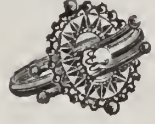

No. 1195  
 14 K. fine.  
 Turquoise and Pearl.



No. 1939  
 14 K. fine.  
 Sapphire and Diamond.

MANUFACTURERS OF  
 Ladies Fancy Stone Rings in Great Variety.

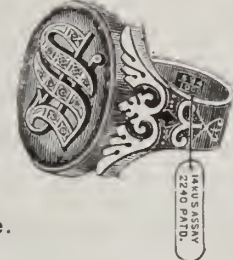

ALSO  
 DIAMOND INITIAL RINGS.

Factory, Newark, N. J.

Office, 3 Maiden Lane, New York.

All 14 K. Goods Guaranteed to Assay  $\frac{584}{1000}$  Fine.

All 14 K. Goods Guaranteed to Assay  $\frac{584}{1000}$  Fine.



ESTABLISHED 1810.



WATCH MANUFACTORY  
 — OF —  
**VACHERON & CONSTANTIN,**  
 — GENEVA. —

The Third Annual Report (June, 1883) of the Astronomer of the YALE COLLEGE OBSERVATORY awards the VACHERON & CONSTANTIN Watches the *Highest Average ever Recorded at that Observatory.*

LADIES' AND GENT'S STEM WINDING MOVEMENTS FITTING AMERICAN CASES.

Prices Furnished to the Trade on Application.

CHAS. LEO ABRY,  
 SOLE AGENT FOR UNITED STATES AND CANADA,  
 P. O. Box 611. NEW YORK. 63 NASSAU STREET.

**EDWIN A. THRALL,**

1 MAIDEN LANE, NEW YORK.

— JOBBER IN —

American Watches, Diamonds, Fine Jewelry, Chains, Etc.

Respectfully calls the attention of Cash Buyers to his stock of American **WALTHAM WATCHES**, embracing all grades and styles. Every Watch before being sent out is carefully examined and timed by competent workmen. This precaution will be appreciated by practical men. To Buyers visiting New York, I shall be pleased to show my stock and method of timing. Correspondence solicited from regular dealers. I sell only for Cash and give all discounts allowed. Special Styles of Cases, made to my order, always on hand. Agent for the New Mascot Bracelet, Patented. Repairing and Adjusting Watches and Chronometers for the Trade a Specialty.



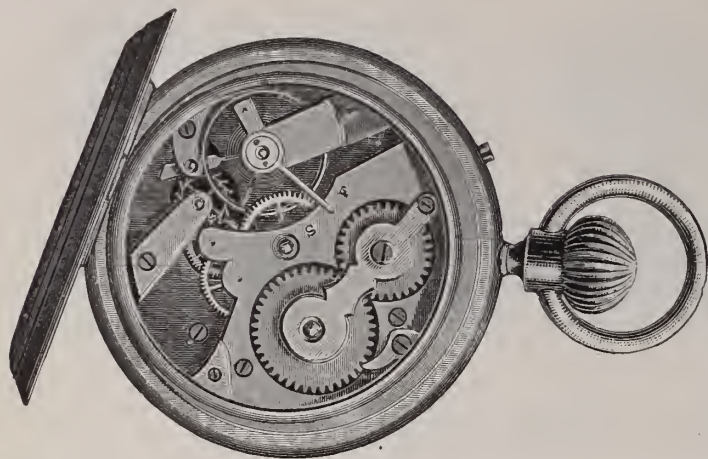

(ESTABLISHED 1839.)

**HENRY GINNEL & CO.,**  
**31 MAIDEN LANE, NEW YORK.**

Jobbers in all Grades of **AMERICAN MOVEMENTS** and **CASES.**

IMPORTERS OF SWISS WATCHES, JEWELERS' TOOLS AND MATERIALS OF THE LATEST MANUFACTURE.

MANUFACTURERS and **SOLE IMPORTERS** of the  
**PIONEER WATCHES,**

In Silver and Nickel Cases, Hunting and Open Face, 16, 18 and 20 line. Made also with **Chronograph** and **Calendar** Attachments. These Watches are fully warranted, and since their introduction in 1876 have proved always reliable, and have the reputation of being the best Watch ever offered for the money.

**A. J. WARNER & CO.,**  
**WHOLESALE JEWELERS,**

309 Nicollet Avenue, Minneapolis, Minn.

*We carry a Large and Elegant Stock of Jewelry, Watches, Cases, Etc., Etc.*

North-western Agents of the **WATERBURY CLOCK CO.**, and carry a Complete Line of their Goods.

**OUR TRADE IS EXCLUSIVELY WITH THE JEWELERS.**

**N. H. WHITE,**  
 JOBBER IN  
**AMERICAN-WALTHAM WATCHES,**  
**EXCLUSIVELY.**

Waltham make of gold and silver cases a Specialty. Ladd, Boss, and the Patent Screw Bezel Filled Cases to fit Waltham movements only  
 No. 11 MAIDEN LANE, NEW YORK.

I not only advertise that I have the Waltham Goods, but **have constantly on hand** the Largest Stock carried by any jobber in the trade. Gold Cases of all Weights and Styles. Memorandum Packages with pleasure to dealers furnishing satisfactory reference

**COMPLETE PRICE LIST TO THE TRADE.**

→ † **M. FOX & CO.,** † ←

*Practical Lapidaries and Importers of*

**DIAMONDS.**

Rubies, Sapphires and Fancy Gems.

→ † PEARLS, † † TURQUOISE, † † INTAGLIOS, † † ONYX, † † AMETHYST, † † ETC. † ←

No. 1 MAIDEN LANE. NEW YORK.





A SPECIALTY.  
PATENT CATCH BRACELETS.



PAT. SEPT. 30 1882.

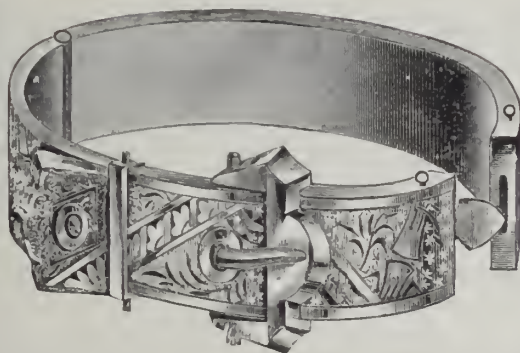

The most Convenient and Complete Catch ever invented. Not liable to get out of Order. Very Durable.

**C. I. RICHARDS, BROWN & CO.,**  
MANUFACTURERS OF  
**Gold and Plated Jewelry,**  
202 BROADWAY,  
Factory, Providence, R. I. NEW YORK.

We now offer to the Trade a Fine Assortment of Rolled Plate Jewelry, Patent Catch Bracelets in First and Second Quality, Enameled, Chased and Roman, with and without Buckle and Fancy Ornaments. Bangles and Flat Bands in great variety. Our Patent Lever and Separable Buttons and Studs, Ladies' and Gent's Collar Buttons, Charms, Lockets, Lace and Scarf Pins, Sets, Chains, etc., etc.

ALSO A FULL LINE OF BRILLIANT JEWELRY IN GOLD.  
*Goods Sent on Approval upon Application with Satisfactory Reference.*

ESTABLISHED 1859.

**RINGS AND DIAMOND JEWELRY.**  
**BRYANT & BENTLEY,**  
12 MAIDEN LANE, Up-Stairs, NEW YORK.

AMONG OUR STAPLE PATTERNS ARE



595.



610.



607.



611.



616.



630.

No. 595, Turquoise or Square Garnets with 3 Diamonds, 2 Pearls and 1 Diamond, or 3 Pearls. No. 610, All combinations of Doublets and whole Pearls and Diamonds, or all Diamonds. No. 607, All combinations of Doublets and whole Pearls and Diamonds, or all Diamonds, or 3 Pearls. No. 611, Emerald, Sapphire or Ruby Doublets, with 2 whole Pearls, or 2 Diamond Brilliants. No. 616, Pearls or Diamond. No. 630, 2 Garnets with 2 whole Pearls or 2 Diamond Brilliants.

We also continue to make a full line of our well known 16 K. HARD SOLDER RINGS.

Goods sent on approval to responsible parties.

**A. BERNHARD & CO.,**  
No. 2 Maiden Lane, NEW YORK.  
MANUFACTURERS OF  
**Diamond Jewelry and Diamond Mountings.**

*We have issued a Catalogue containing our Designs of Diamond Mountings for Manufacturers' Use, which is the most complete work of the kind ever issued in this country or Europe. It will be sent to Manufacturers and Dealers upon application, Free of Charge.*



**T. B. HAGSTOZ & CO.,**Successors to **MORGAN & HEADLY,**

MUTUAL LIFE INSURANCE BUILDING, TENTH &amp; CHESTNUT STS., PHILADELPHIA.

The only house in Philadelphia making a Specialty of

**Diamonds,****Diamond Jewelry****and Mountings.**

Also, Gold, Silver and Steel Spectacles and Eye-Glasses.

*Goods Sent on Approval upon Application and Satisfactory Reference.*

ESTABLISHED 1849.

**KOCH & DREYFUS,**

WHOLESALE DEALERS IN

**WATCHES, JEWELRY, CLOCKS, DIAMONDS, SPECTACLES, ETC.**

ALSO JEWELERS' AND WATCHMAKERS' TOOLS AND MATERIALS AT MANUFACTURERS' PRICES.

**18 CHARTRES ST., NEW ORLEANS.****BRANCH OFFICE, 20 MAIDEN LANE, N. Y.****HEEREN BROS. & CO.,**

MANUFACTURING AND WHOLESALE JEWELERS.

IMPORTERS AND JOBBERS OF

WATCHES, CLOCKS, JEWELRY, OPTICAL GOODS,

Silver Plated Ware, Watchmakers' &amp; Jewelers' Tools, Materials &amp; Supplies.

42 FIFTH AVE., PITTSBURG, PA.

**L. A. CUPPIA,**

Manufacturing Jeweler, 19 Union Square, N. Y.

**SILVER CANE HEADS,**

A Large and Comprehensive Assortment of New and Original Designs.

AND IMPORTER OF

**SILVER FILIGREE JEWELRY**

Embracing a Large and Varied Assortment of Popular Designs.

**SILVER JEWELRY.**

SILVER BRACELETS A SPECIALTY.

SELECTION PACKAGES SENT ON APPROVAL.



# WM. S. HEDGES & CO.,

IMPORTERS OF



COPYRIGHT SECURED. Entered according to Act of Congress in the year 1880, by Wm. S. HEDGES & Co., in the Office of the Librarian of Congress, at Washington.

170 BROADWAY,

Corner Maiden Lane, New York.

---

CHOICE BRILLIANTS IN SINGLE STONES AND MATCHED PAIRS A SPECIALTY.

---

 Fresh invoices of Goods in all Grades constantly arriving. Also choice parcels of exceptionally Fine Gems ESPECIALLY Selected for critical purchasers. A full line of Mounted Goods, Artistically Designed.

GOODS SENT ON APPROVAL.



# ANNOUNCEMENT!

We beg to announce to the Trade that we have secured from the United States Patent Office Letters Patent for an improvement in Watch Cases. This invention consists of a compound plate for Watch Cases, made of two plates, one of gold of low standard, the other of gold of higher standard, rolled together, the relative thickness of the two plates being so adjusted with relation to their relative fineness that the compound plate shall equal gold of a predetermined standard.

**FOR EXAMPLE:—The Outer Plate of 14-k. gold and the Inner Plate of 8-k. gold, so distributed as to equal 10-k. Gold.**

*By this construction we are enabled to make Watch Cases having all the advantages of the different qualities of the gold, and they are so disposed as to produce the greatest benefits. The outer layer being of a high grade admits of a fine finish, and is least liable to become tarnished or oxidized by handling or exposure. The inner layer of the lower grade adds strength and stiffness to the case.*

~~~~~  
Infringers on the above Patent will be Prosecuted to the Full Extent of the Law.
 ~~~~~

The superior merits of our 10 Karat cases, manufactured under the above patent, will prove apparent to every intelligent dealer for its exterior richness and its intrinsic value.

## ROBBINS & APPLETON,

**GENERAL AGENTS,**

NEW YORK.

CHICAGO.

BOSTON.

LONDON, ENG.

SYDNEY, N. S. W., AUSTRALIA.





These

INLAID DECORATIONS

in 14 Karat Gold can now be had in

Patent Dust Proof Screw Bezel

**SILVER + CASES.**

ROBBINS & APPLETON,

GENERAL AGENTS,

NEW YORK.

CHICAGO.

BOSTON.

LONDON, ENG.

SYDNEY, N. S. W., AUS.

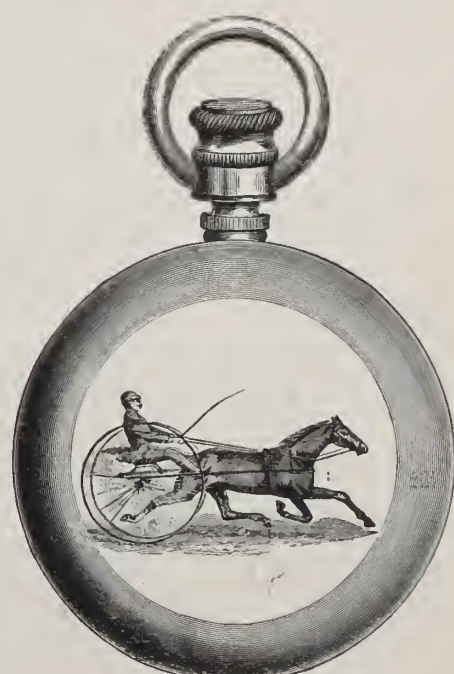
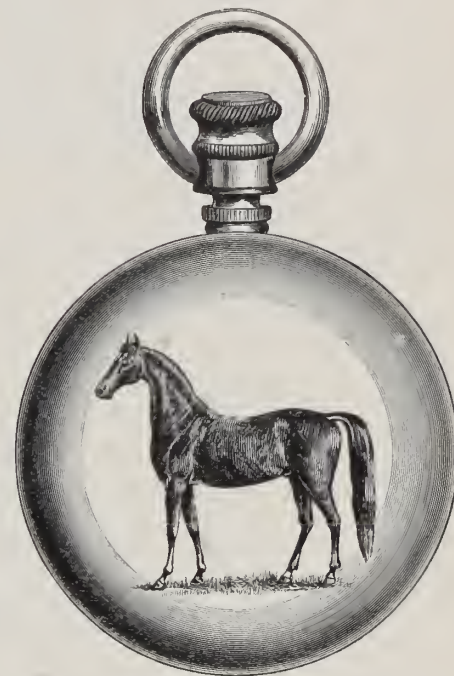





*Randel, Barmore & Billings,*

*Importers of*

*Diamonds*

*and Manufacturers of*

*Diamond Jewelry.*

*58 Nassau Street,  
8 29 Maiden Lane,  
New York.*

*1 St. Andrews Street,  
Holborn Circus,  
London, E. C.*



MAKER OF FINE

Jewelry.

HENRY C. HASKELL,

12

JOHN STREET,  
NEW YORK.

Goods sent on approval upon receipt  
of Satisfactory References.



394D.  
Patented.

FOR 1884.

DIAMOND, EMERALD, RUBY RINGS AT

LOWEST PRICES.



1067.



2109.



1070.



1071.

FINE LINE CAMEO AND INTAGLIO IN SARD TIGER STONES, ETC.

# D. C. PERCIVAL & CO.

## WHOLESALE DEALERS

-IN-

WALTHAM, ELGIN, WATCHES, JEWELRY, EYE-GLASSES,  
ILLINOIS, HAMPDEN, COLD CHAINS, GOLD, GOLD HEAD CANES,  
E. HOWARD & CO. FILLED & SILVER CASES, AND ROGERS &  
& SPECIAL MOVEMENTS. SPECTACLES, BRO.'S FLAT WARE.

392 WASHINGTON STREET.

BOSTON.

POST OFFICE BOX,  
5259.

PRICE LIST of MOVEMENTS and CASES  
SENT ON RECEIPT OF BUSINESS CARD.

Established

1864.

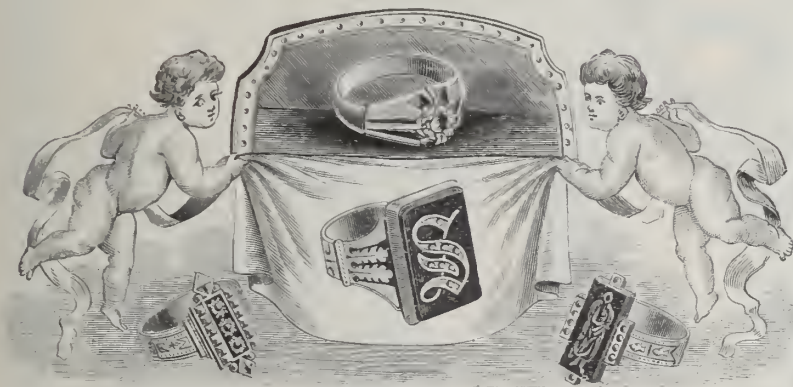

SPECIALTY.—Solid Gold Rings of  
Every Description, Scarf Pins,  
Studs, Etc.

L. SAUTER,

1 MAIDEN LANE, Cor. Broadway, NEW YORK.

MANUFACTURER OF

Fine and Diamond Jewelry,

HAIR JEWELRY and DEVICE WORK.

JOBGING FOR THE TRADE.

# HOPKINS WATCH TOOL CO.,

## WALTHAM, MASS.,

MANUFACTURERS OF

HOPKINS' PATENT LATHES, CHUCKS, JEWELING TOOLS, ETC.,

And Sole Agents for the Celebrated

HOPKINS' PATENT FOOT WHEELS, by all odds the Best Working Foot  
Wheels in use, and the only Foot Wheel with Swing Treadle, in which the  
backward and forward movements of the Treadle or Stirrup are equalized.  
These Wheels are now made either for fastening to the floor, or to the end, or  
the under side of work bench.

SEND FOR CATALOGUE.

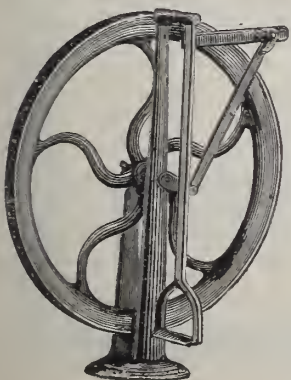





QUALITY  
Guaranteed.

HUTCHISON & HUESTIS,  
MAKERS OF  
**SOLID GOLD RINGS,**

FOR  
Jobbing Trade  
ONLY.

FACTORY,

No. 185 Eddy Street,

PROVIDENCE, R. I.

NEW YORK OFFICE,

No. 196 Broadway.



E. AUG. NERESHEIMER  
& Co

IMPORTERS  
of

**DIA MONDS**

21 MAIDEN  
LANE  
NEW YORK

NO 66 SARPHATI STRAAT  
AMSTERDAM HOLL.

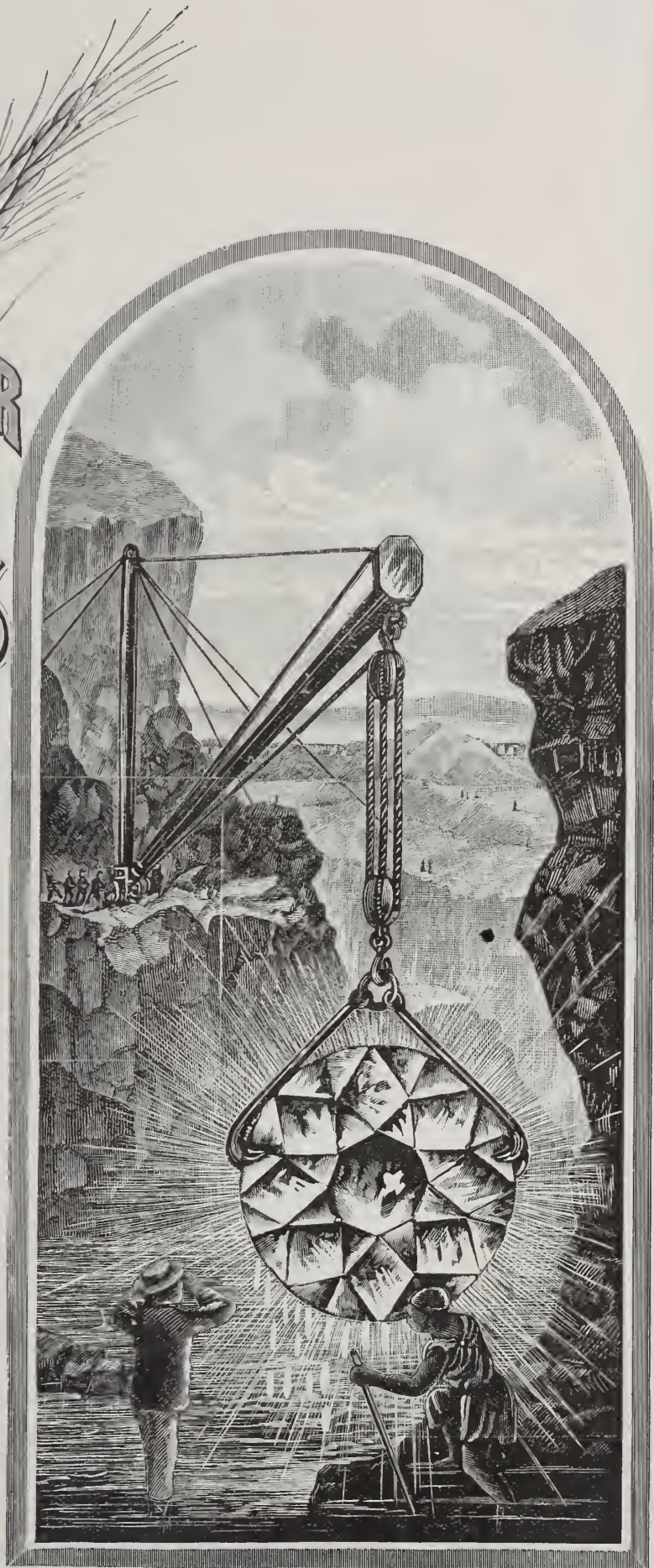



# Ladd Watch Case Company,

(ORGANIZED 1883.)

SUCCESSORS TO J. A. BROWN & CO.

(ESTABLISHED 1858.)

MANUFACTURERS OF THE

## LADD PATENT GOLD WATCH CASES.

### EXAMINE

THE

### NEW MODEL

### LADD

### Case.



Design No. 750.



Design No. 661.

*Which is universally pronounced on sight to be the Most Elegant and the Best Article in this line yet brought out.*

**IT HAS ALL THE LATE IMPROVEMENTS**

Including Solid Gold Bows and Solid Gold Linings,

**AND FOR WORKMANSHIP, STYLE AND FINISH IT IS UNEQUALED.**

Its Shape is such as to admit of the most elaborate ornamentation, or any intermediate style down to the plainest, without loss of effectiveness, in accordance with the taste of the purchaser.

The **GOLD** in all of the **LADD CASES**, in the **COVERS** and **CENTER RIM** and **PENDANT**, is plump 14 Kt. fine, **POLISHED** to its natural color, a most **ESSENTIAL FEATURE** in the **WEAR** of a **WATCH CASE**.

For Sale by the Leading Wholesale Jobbing Trade.



Falkenau Oppenheimer & Co.  
Importers of  
Diamonds



40 Maiden Lane N. Y.

Post Office Box 3314.



‡ **AGASSIZ** ‡

# MOVEMENTS.

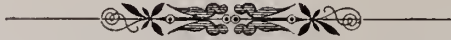

**CAUTION.**



I WOULD respectfully *caution* the Trade against a *spurious* movement made with intent to deceive, and in imitation of Watches and Movements made in my establishment.

The Movements made by me and bearing my Trade Mark



have achieved a high reputation in the Trade, which fact has induced certain unscrupulous parties to counterfeit them. I would, therefore, with a view to protecting the interest of Dealers in the United States, caution them against these spurious and greatly inferior goods, and state that all Movements made in my establishment have my Registered Trade Mark as above engraved upon the Plate under the Dial, and none other are genuine.

“AGASSIZ.”

Switzerland, October, 1883.



# R. HENRICH,

SEAL AND STONE RINGS IN ALL VARIETIES,

No. 35 Maiden Lane, New York.



OPEN.

"ACME"

Patent Ring.



CLOSED.

The Latest Novelty in Rings.

This ring is one in which the stone is interchangeable, and especially adapted to

**INITIAL RINGS.**

Made with and without the SELF-SIZING ATTACHMENT.



Self-Sizing Ring.

Pat. March 20, '83.



This ring has proved to be thoroughly practical and desirable, and has met with complete success.

With increased facilities I am prepared to manufacture in larger quantities this season.

New and Attractive Styles for Spring.

**FOR SALE BY ALL JOBBERS.**

LOUIS KAHN.

MOSES KAHN.

SAMUEL H. LEVY.

I. W. FRIEDMAN

## L. & M. KAHN,

IMPORTERS OF

# Watches, Diamonds & Precious Stones

10 MAIDEN LANE, NEW YORK.

11 Corrairie, Geneva, Switzerland.

17 Rue de Chateaudun, Paris.

### WATCHES,

*Stem and Key-Winding, from the Lowest Priced Nickel and Silver to the Finest Gold and Complicated.*

A Full Assortment of these Goods always in Stock.

### DIAMONDS,

*Loose and Mounted, in all Sizes and Qualities.*

*Gold, Silver, Nickel and Celluloid Chatelaines in Great Variety.*



# Diamond \* Cutting \* and \* Polishing.

## REPAIRING FOR THE TRADE.

Rough Jewels Finished; Nicks and Scratches taken out. Many stones can be increased in value by being put in shape.

## Diamond Dust for Watchmakers' Use.

By cutting our own Diamonds we have unequaled facilities for putting up Diamond Dust in any grade of fineness, and absolutely pure.

### DIAMOND TOOLS.

|                                                           |        |
|-----------------------------------------------------------|--------|
| Diamond Counter-sink, . . . . .                           | \$1 00 |
| Brushes, charged ready for use, . . . . .                 | 75     |
| Diamond File, charged on one side and one edge, . . . . . | 3 50   |
| Diamond Lap, 1 inch, . . . . .                            | 3 00   |
| "    "    1 1/4 " . . . . .                               | 4 00   |
| "    "    1 1/2 " . . . . .                               | 5 00   |

These are all charged with the best quality diamond dust, and any grade of fineness desired.

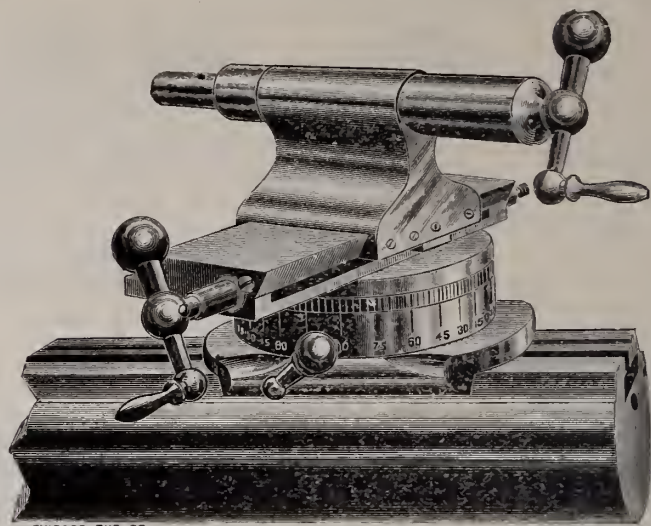

**UNIVERSAL TAIL STOCK.**  
(PATENT APPLIED FOR.)

# GILES, BRO. & CO.,

State and Washington Streets,

CHICAGO, ILLINOIS.

## Ἡλιολα.

Helios in Greek means the sun—and termination ola means little or diminutive—so that the arbitrary word or trade mark Heliola means little sun. This title best describes a stone which has created a complete revolution in the imitation diamond business.

Many manufacturers of fine goods have, during the past three years, made a specialty of imitating the most costly and beautiful diamond jewelry, and mounting fine paste stones and the so-called foiled brilliants in solid gold and fine rolled plate. The fine paste stones answer the purpose of imitation diamonds very well until they become dirty on the lower surface or culet, and then the fire is gone from the stone and it is worthless. The foiled brilliant preserves its fire and beauty, and, until the advent of the Heliola, held the foremost place for imitation diamond jewelry.

To see the foil is an easy matter, as everybody knows, therefore the illusion is dissipated, and instead of possessing an imitation of a diamond the owner finds, to his sorrow, that his mock diamond is easily detected by everybody.

The Heliolas are foiled in a durable manner, so that the jewelry in which they are set can at all times be cleaned without first removing the stones. In fact the great desideratum has at length been attained—diamond jewelry can now be so closely imitated that even experts will have the greatest difficulty in selecting the real from the unreal when set in the ordinary open cramp jewelry.

These stones are sold in jewelry by all first-class manufacturers and jobbers, and are all stamped on the cards with the trade



None genuine or guaranteed without the trade mark.

The Trade is cautioned against infringements, which, although foiled on the tip, will come off at a touch, or will not stand the least handling or cleansing.

ESTABLISHED 1813.

# SETH THOMAS CLOCK COMPANY,

## THOMASTON, CONN.

No. 20 MURRAY STREET, NEW YORK.

161 State Street, Chicago.

132 Sutter Street, San Francisco.

7 Cripplegate Buildings, Wood Street, London, E. C.

*We have in stock some Joker Alarm Clocks showing 24 hours upon one dial at the same price as regular Jokers, and we have prepared some 12 inch dials which can be readily placed upon our Drop Octagon Times and World Times, and have made to order two or three Regulators both with the 24 hours in one circle and in two circles.*

DESCRIPTIVE CIRCULARS MAILED ON APPLICATION.



# **CLEMENS HELLEBUSH,**

## **MANUFACTURER, IMPORTER AND WHOLESALE JEWELER,**

### **Dealer in everything required by the Jewelry Trade.**

---

**DIAMONDS.**—Dealers will find in my stock an assortment of Diamonds unequalled in the West, embracing a choice variety of loose and mounted Stones in all qualities.

**WATCH CASES.**—In Gold and Silver, of all makers, to fit American Movements.

**WATCH MOVEMENTS.**—Include always a full stock of Waltham, Springfield, Hampden and Howard, together with a large assortment of fine and low-priced Swiss Watches.

**SILVER PLATED WARE.**—I have an unusually fine assortment of the choicest patterns of Flat and Hollow Ware of the best known manufacturers.

**SOLID GOLD AND ROLLED PLATE JEWELRY.**—This department is replete with Staple Goods and Novelties.

**FRENCH CLOCKS.**—Of our own importation, including all grades, with prices exceedingly low.

**AMERICAN CLOCKS.**—I am the General Agent in Cincinnati for the celebrated Seth Thomas Clocks, a full line of which will always be found in stock.

**TOOLS AND MATERIALS.**—In this department will be found everything required by Watch Makers.

Illustrated Catalogues sent to Dealers only upon Application.

# **CLEMENS HELLEBUSH,**

**77 West 4th Street, CINCINNATI, O.**

---

MORGAN & HEADLY,  
MANUFACTURING OPTICIANS  
OFFICE AND FACTORY:  
11TH AND MIFFLIN STREETS,  
PHILADELPHIA.



# THE CLIMAX REVERSIBLE WATCH CASE,

MANUFACTURED BY THE  
Northwestern Watch Case Company, of Rockford, Illinois.

Patented April 3d. 1883. No. 275,251.



Made in  $\frac{1}{4}$  oz. to fit all American Stem Wind Movements, also in 3 oz. to fit 16 Size Elgin.

**SOLD BY ALL WHOLESALE JEWELERS.**

VACHERON & CONSTANTIN.  
GENEVA, SWITZERLAND.

THE SPECIAL LOW PRICED MOVEMENT CALLED THE

## HORSE SHOE,

BEARING THE FOLLOWING TRADE MARK:



IS NOW READY.

This Movement has some of the principal qualities of our other grades.

PRICES FURNISHED ONLY TO THE TRADE, BY

**CHAS. LEO ABRY.**

SOLE AGENT FOR UNITED STATES AND CANADA.

10 B. 611

NEW YORK.

63 Nassau St.





ROGERS, SMITH & CO.,  
ELECTRO GOLD  
AND  
SILVER PLATED WARE.

SALESROOMS:  
46 EAST 14th STREET, UNION SQUARE, N. Y.  
FOR THE TRADE ONLY.

FACTORY, . . . MERIDEN, CONN.

**STANDARD WATCH CO.**



STANDARD CALENDAR

**"STANDARD CALENDAR."**

20 Line, Open Face, in Nickel and Silver, showing the date and day of the week, Full Jeweled, Finished Movement. The Latest Novelty offered.



**"STANDARD."**

18 Size, Low Price Movement, will fit Waltham and Elgin Cases.

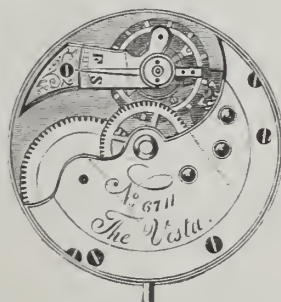

**"VESTA."**

8 Size, Low Price Movement, fits Elgin Cases.



**"STANDARD."**

8 Size, Full Jeweled, Ladies. Fits Waltham Cases.

REGISTERED.



**"STANDARD."**

Nickel, 17, 19 and 20 Line. Lever, Full Jeweled.

**Max Freund & Co., Sole Agents, 8 Maiden Lane, N. Y.**



# MATHEY BROS. & MATHEZ,

## NO. 16 MAIDEN LANE.

IMPORTERS OF ALL GRADES OF

Plain and Complicated Watches and Movements

SOLE AGENTS FOR THE WELL-KNOWN

# H. L. MATILE



REPEATERS.

Fine Watches of Astronomical Precision.



CHRONOGRAPHS.

In order to facilitate the handling of our Stem-Winding Movements, we have adopted a standard of sizes to fit American Cases. Of these we have a complete line from the medium grade to the highest class goods of fine adjustment and precision. As all our Movements, complicated and plain, are perfectly uniform in quality according to their respective grades, we can furnish material for any parts that may be required, with the positive assurance of accurate interchangeability.

An Extensive Line of all Grades of

# CHRONOGRAPHS,

## SPLIT SECONDS AND REPEATERS.

WATCHES DEMAGNETIZED.

**C. G. ALFORD & CO.** ESTABLISHED 1868

DIAMONDS. Manufacturing Jewelers

J. P. G. THORNBURY. 200 BROADWAY. NEW YORK.



ESTABLISHED 1844.

# DENNISON MFG CO.,

BOSTON, NEW YORK, PHILADELPHIA, CHICAGO, CINCINNATI AND ST. LOUIS.

## JEWELERS' FINDINGS.

**PAPER JEWELRY BOXES IN ALL STYLES AND QUALITIES. IMITATION MOROCCO BOXES, SATIN LINED. TAGS, JEWELERS' CARDS, PINK AND WHITE COTTON, &c., &c.**

## MOROCCO CASES.

Manufacturing in our own Shops Every Description of Morocco, Plush and Velvet Jewelry and Silverware Cases in large quantities, we are enabled to sell lower than other goods of equal quality can be offered, and we carry in all our Stores FULL Stock of our whole line.

Catalogue on Application.

## THE DERBY SILVER CO., Birmingham, Conn.

Finest Silver Plated Ware.



New York Salesrooms, 3 Union Square and 25 Maiden Lane.  
CHICAGO, 170 State Street.  
SAN FRANCISCO, 513 Market St. TORONTO, 31 Adelaide St., East.



**T H E**

# **E. HOWARD WATCH AND CLOCK CO.,**

—MANUFACTURERS OF—

## **Fine Stem-Winding Watches,**

**FINE REGULATORS, OFFICE CLOCKS, TOWER CLOCKS,  
And Electric Watch Clocks.**



**LADIES'**  
6 Size.

**STEM-WINDING  
AND**



**GENT'S**  
16 Size.

**Stem-Setting  
Movements.**



**GENT'S**  
18 Size.

**114 TREMONT ST., BOSTON.**

**29 MAIDEN LANE, New York.**

**J. W. J. PIERSON, Agent.**

# **SIMONS, BRO. & CO.**

**MANUFACTURERS.**



**CHAIN.**



**Fine Jewelry.**

**ILLUSTRATED CATALOGUE**



**611 and 613 SANSON STREET, PHILADELPHIA, OR NEAREST JOBBER.**



# KREMENTZ & CO.,

MANUFACTURERS OF

GOLD, PEARL AND DIAMOND JEWELRY,

Nos. 182 and 184 BROADWAY,

Corner of John Street,

NEW YORK.

(Elevator Entrance on John Street.)

NOVELTIES IN SILVER JEWELRY.

FACTORY, NEWARK, N. J.

---

## J. EUGENE ROBERT,

IMPORTER OF

MOVEMENTS & WATCHES,

**No. 30 Maiden Lane, New York.**

Ladies' and Gent's Stem Winding Movements, Fitting American Cases,  
all fully warranted.

**Ladies' Small Sized** Watches in Fancy Gold Cases of every Variety and  
Style of Decoration.

—: SOLE AGENT FOR —

**LOUIS AUDEMARS**

Superior Watches. Plain and Complicated Stem Winders of every style, man-  
ufactured with the Latest Improvements.

**CHRONOGRAPHS** WITH OR WITHOUT **SPLIT SECONDS.**

Various Grades Minute Repeaters.



**THE ATTENTION OF THE TRADE**  
**IS CALLED TO THE MERITS OF THE**  
**FISHER, POTTER & FISHER LATHE,**  
**IN COMBINATION WITH POTTER'S PATENT LATHE ATTACHMENT.**

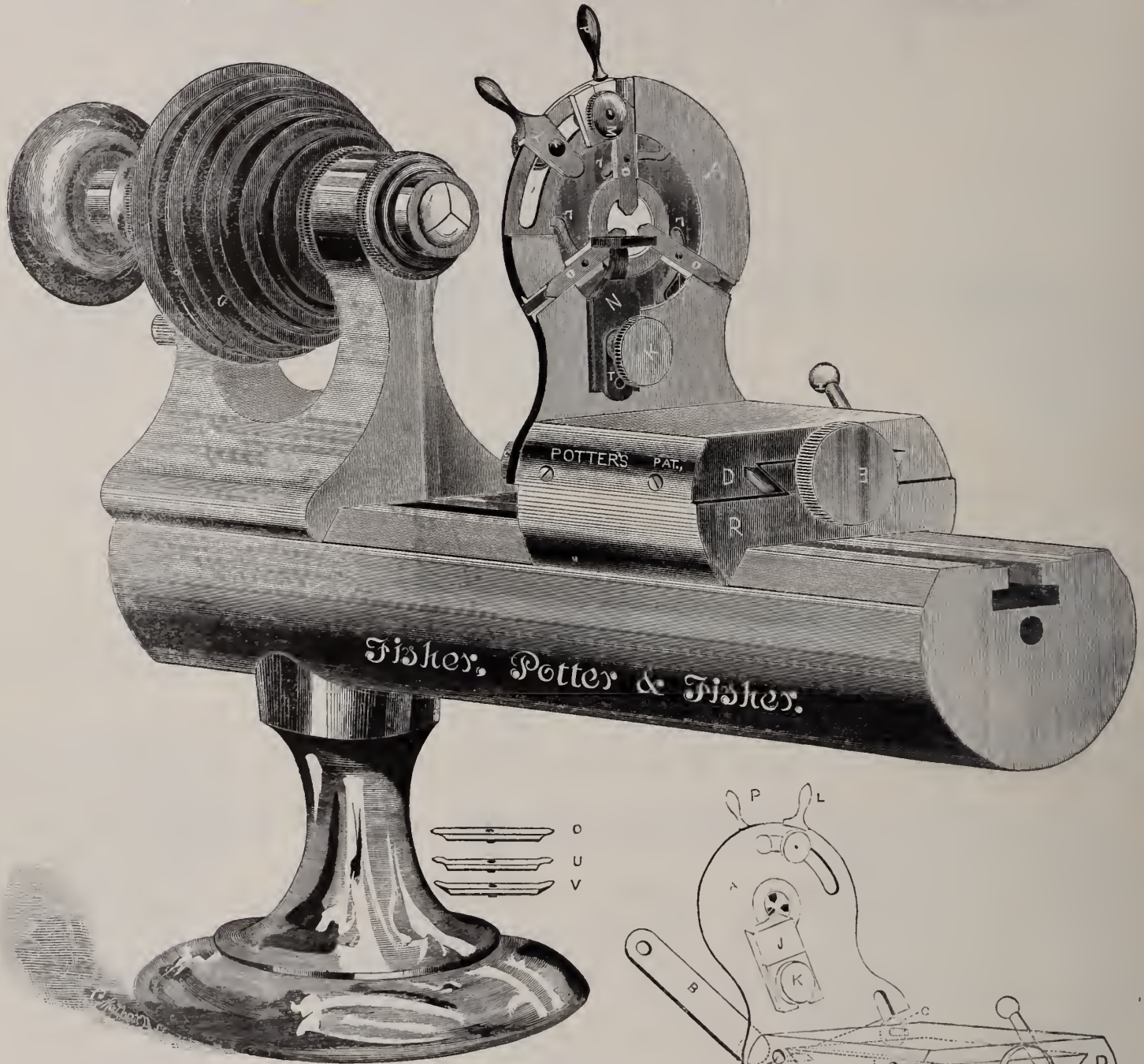

Competent mechanics of the Trade pronounce it the most perfect operating Lathe that ingenuity and mechanical skill has yet produced. It instantly and accurately centers both ends of the work. It completely dispenses with the use of cementing all regular Staff and Pinion Work to a chuck.

A full line of the latest Improved Attachments are manufactured for the above Lathe. This Lathe and Attachments are manufactured by special machinery under the supervision of competent mechanics of repute and long experience. Its beauty is unexcelled; its reliability is attested by a certificate of guarantee.

Potter's Patent Lathe Attachment can be fitted to any Split Chuck American Lathe.

**Descriptive Catalogues Furnished on Application.**

**FISHER, POTTER & FISHER WATCH TOOL CO.,**

P. O. Box 9999.

WALTHAM, MASS.

Sole Proprietors of Potter's Patent Lathe Attachment in America, England, France and Germany.



# R. & L. FRIEDLANDER,

65 & 67 NASSAU STREET.

BRANCH SALESROOMS, 264 BOWERY. } . . . . . NEW YORK CITY.  
FACTORY, 50 BOND STREET.

IMPORTERS OF

Watch Materials, Tools, Optical Goods, Silk Guards, Watch Keys, White Metal Chains,

Rolled Plated and Fire Gilt Chains, Charms, Locketts, Etc., Etc., Etc.



**PRICE OF SOLID GOLD BANGLES.**

|                                        |                         |
|----------------------------------------|-------------------------|
| No. 3, \$3.50 per doz.                 | No. 13, \$1.75 per doz. |
| " 6, 1.75 "                            | " 13, 3.50 "            |
| " 7, 1.75 "                            | " 24, 1.25 "            |
| " 8, 3.50 "                            | " 25, 1.25 "            |
| " 9, 1.75 "                            | " 26, 2.50 "            |
| " 11, 3.50 "                           | " 27, 2.50 "            |
| No. 28, \$2.50 per doz.                |                         |
| Silver Dimes, Engraved, - - - - \$3.00 |                         |
| " " Plain, - - - - 1.25                |                         |

SEND FOR CATALOGUE.

Silver Bangles.

Plain Gold Bangles.

## JOHN BLISS & CO.,

Standard Marine

CHRONOMETERS AND TRANSITS

FOR WATCHMAKERS' USE.

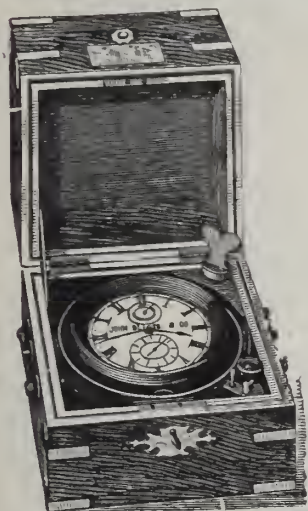

Standard Marine Chronometer,  
FOR KEEPING CORRECT TIME.

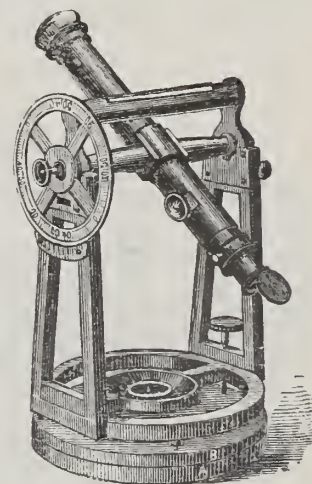

No. 10.

128 FRONT STREET,

Near Wall Street,

NEW YORK.

NOTICE.—These Transits are readily set in position without the aid of strictly correct time as a basis for that purpose. Printed instructions, easily understood, accompany each Instrument, and no calculations are required preliminary to setting in position.

SEND FOR ILLUSTRATED CIRCULAR WITH PRICES.



**IMPROVED CROWN FILLED CASE.**

→ **THE BEST FOR THE LEAST MONEY.** ←

The Gold contained in the Crown Cases which are now being turned out under our supervision is **fully equal to that of any Filled Case on the market.**

This fact can be attested to the satisfaction of any dealer who will go to the trouble of having one of these Cases assayed with one of corresponding size and style of **any other make.**

The United States Mint at Philadelphia will make a complete assay for the sum of one dollar each, and we will return a New Case to the dealer in place of the one of our make destroyed, upon receipt of the Assay Certificates and the gold contained in the Crown Case assayed.

**SOLID GOLD JOINTS,  
SOLID GOLD PLUGS,  
GOLD THE NATURAL COLOR,  
ABSOLUTELY NO GILDING.**



IMPROVED FILLED.  
Louis XIV.



IMPROVED FILLED.  
Raised Gold Ornamentation.

**SOLD ONLY BY THE JOBBING TRADE.**

H. MUHR'S SONS, PHILADELPHIA,  
NEW YORK OFFICE, 14 & 16 Maiden Lane. CHICAGO OFFICE, 101 & 103 State Street.

**PATENT IMPROVEMENT IN  
COUNTER + SHOW + CASES,  
WITH PERPENDICULAR SLIDING DOORS. DUST PROOF.**

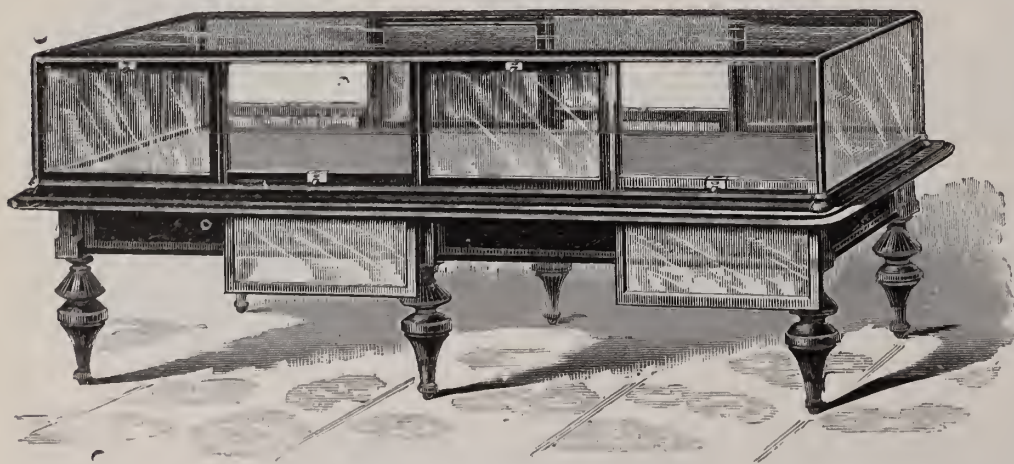

**The Advantage and Convenience of these Show Cases will be apparent to everyone.**

The doors are more conveniently opened and closed, less liable to get out of repair or broken, articles are more easily reached in wide cases, mirrors are more safe, it dispenses with hinges, economizes room, excludes dust, and is air tight when closed.

Drawings furnished and estimates given for fitting stores in cabinet work complete.

Letters Patent having been granted us for the construction of these doors, we shall prosecute all parties using Cases which infringe on our Patents.

REFERENCES:—Gorham Mfg Co., Rogers & Bro., Mitchell Vance & Co.,  
Meriden Britannia Co., M. S. Smith & Co., Detroit, Mich.  
D. Valentine, Syracuse, N. Y.

**B. & W. B. SMITH,  
220 West 29th Street, New York.**

M. Anderson, No. 57 State Street, Chicago, has the exclusive right to manufacture and sell our Improved Cases for the States of Wisconsin, Illinois, Missouri, Mississippi, Arkansas, and all States West of same.

CATALOGUE OF STYLES SENT ON APPLICATION.



S. D. ENGLE ENGRAVING MACHINE CO.,

Sole Manufacturers of the

**ENGLE ENGRAVING MACHINE,**

HAZLETON, LUZERNE COUNTY, PA.,

Would Respectfully call the attention of Jewelers throughout the United States to this New Invention.

Patented by S. D. Engle, September 6th, 1881.

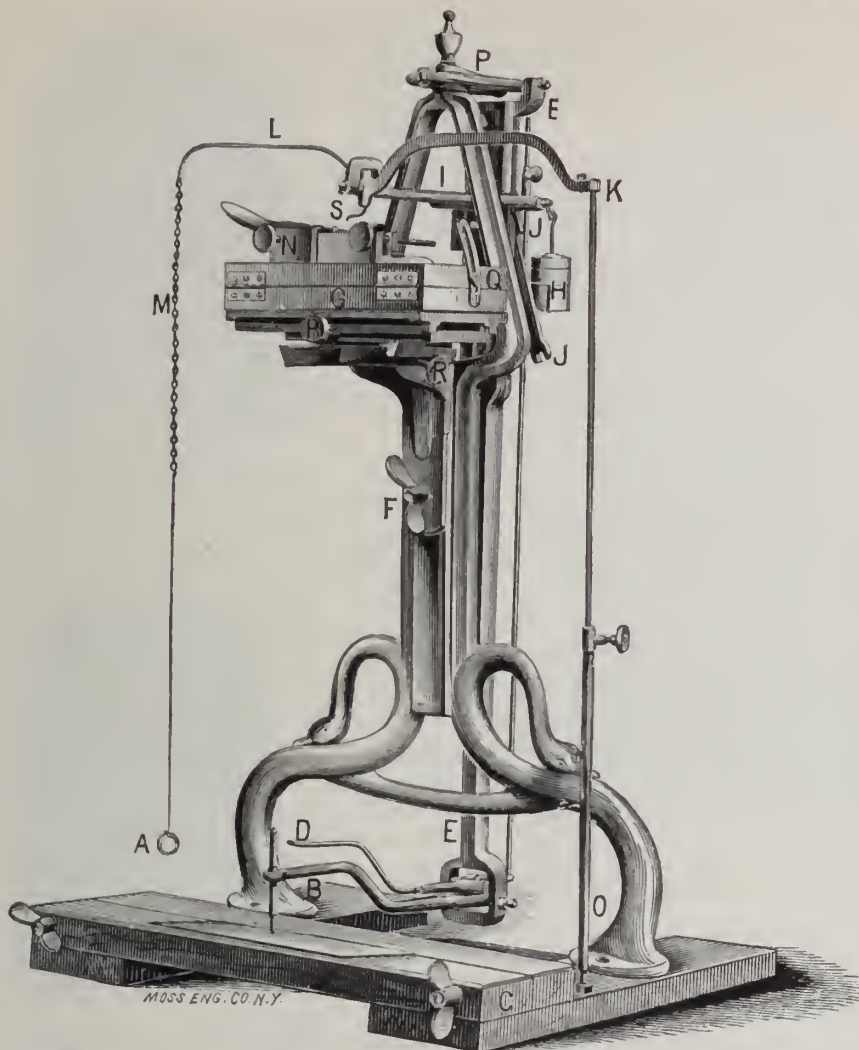

Do not confound this machine with any heretofore put in market. You will see by the cut that it is an entirely different arrangement.

It is very simple to operate.

It is easily kept under perfect control.

It meets all the requirements of the trade.

We claim that it eclipses all similar machines.

This machine has a compound slide rest under the chocking table, to move the work in any direction, also a radial link to set the table at any angle, for sloping work, like the base of castors, &c. We also furnish a chuck with the machine, for holding all small articles, and one for holding large work such as tea sets.

This machine does beautiful shading in script, and the tracer is just as much under the control of the operator as a writing pen. You can shade letters where and as you wish without danger of spoiling the work, as the cutter is under perfect control. The cutter is not made out of a piece of a graver, but out of the best s b steel, for this special purpose, and engraves as well inside of rings as outside.

It is nicely designed, occupies only 18 by 21 inches, and weighs about 80 lbs. They are finished in black and nicely ornamented. All bearings have steel cones to take up all lost motion, and will last for generations, and all sliding surfaces are planed to fit nicely. Our tracing type is not made out of thin sheet zinc, cut at random, but is cast in steel moulds an eighth of an inch thick out of a composition for the purpose. The tracing lines on the type are sunk deep so the tracer cannot slip out, and all down strokes are free and do not cross the up strokes, as there is a stop on either side of the down strokes, and all letters match together like one piece, change them as you wish.

Price is \$85, complete, with Full Sets of Old English and Script Type.

We shall be glad to correspond with any party who has use for a machine of this kind, and give them full particulars.

“The Waterbury.”

**THE NEW “SERIES C,”**

With FULL DIAL and SOLID PLATES.



NEW SERIES C.

Solid Plates and Full Dial.

With each series we have greatly improved the quality of the Watch, and are fully satisfied that “Series C” will be admitted by Dealers generally to be a decided step in advance.

The past three years’ experience has enabled us to make the decided improvement so well known and acknowledged by those who have handled the Waterbury since its first introduction.

The “Series A” had open dial and skeleton plates. Our judgment in making the change in “Series B” to full dial and solid plates has received the unanimous verdict of approval, and we have retained them in “Series C.”

The metal of the cases of “Series C” will be of Nickel Silver, which always wears white and clean.

Having found the Satin Lined Spring Box admirably adapted for safe transportation of Watches, we shall pack “Series C” in same box.

Material in any desired quantity can be had of New York office only.

**ONE THOUSAND WATCHES MANUFACTURED EVERY WORKING DAY.**

SERIES C.—Full Dial, Solid Plates, - - - \$48 00 per dozen.

**Discount to the Trade.**

Orders for less than one dozen are referred to the nearest Jobber. **We do not fill them.**

**Waterbury Watch Co., Waterbury, Conn.**

**NEW YORK OFFICE, 52 MAIDEN LANE.**

GEO. MERRITT, GENERAL SELLING AGENT,

To whom all Orders and Correspondence as to Prices and Terms should be addressed.

**FOR SALE BY DEALERS GENERALLY.**



# FRANK S. KENNEDY,

Manufacturer and Wholesale Dealer in

# JEWELRY

OF EVERY DESCRIPTION.

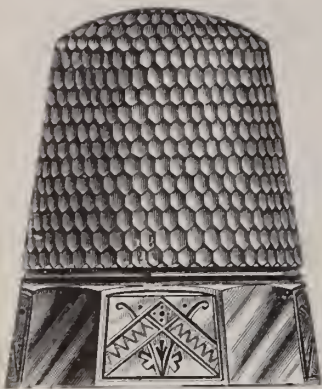

13 Maiden Lane,  
NEW YORK.



13 Maiden Lane,  
NEW YORK.

*In addition to my stock of Jewelry, which is complete in all lines of Gold, Silver and Roll Plate, I am now making a Full Assortment of*

## THIMBLES,

*in Solid Silver, 10 karat and 14 karat Gold. These Thimbles are Superior in Finish to any now in the market, and are as near perfection as long practical experience can make them. Will send Samples if desired.*

*The Assortments of Jewelry I send on Memorandum for Special and Stock Orders have an increasingly high reputation.*

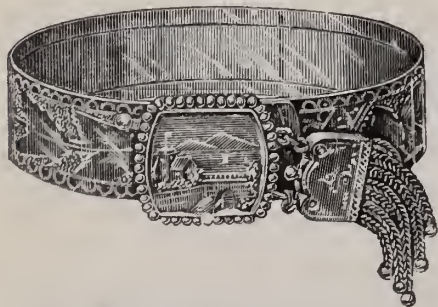
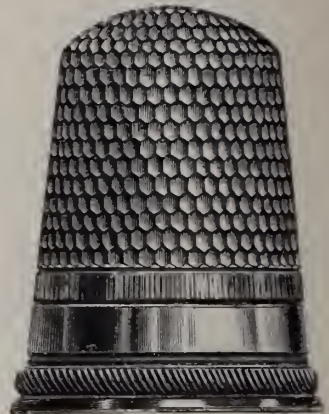
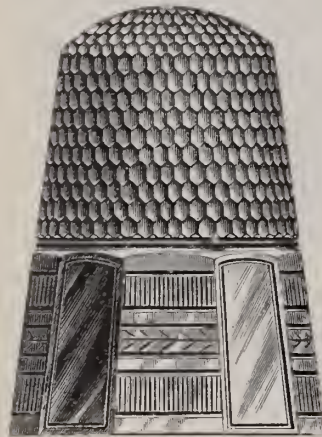

No. 231. Gold Edge, Tassel, Landscape Engraved, Patent Lever Catch.

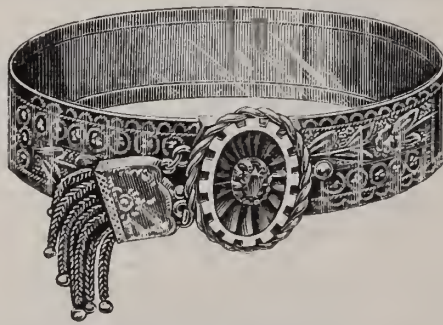

No. 92. Gold Edge, Garnet, Twist Border, Gold Front, Patent Lever Catch.

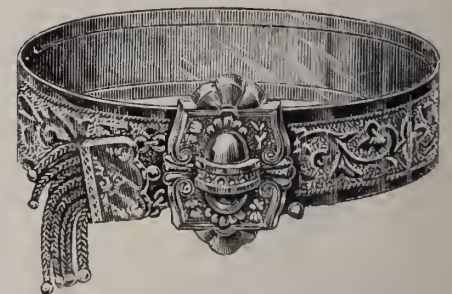

No. 113. Gold Edge, Tassel, Chased Top, Engraved Band, Patent Lever Catch.

## THE CONQUEROR.

Our latest success, an Adjustable Band Bracelet with a Gold Edge, made from a single piece of 14 Karat Rolled Gold Plate, folded in such a manner as to completely cover the raw edge. These Bracelets are a marvel of mechanism, and have puzzled the best mechanics of this country to tell how it is done. The bands have the appearance of being turned on the inside while the fact is the joints are on the outside. Will some Jeweler tell how this is done? We will send these goods to the legitimate Jeweler only.

SEND FOR PRICES.

**J. M. CHANDLER & CO.,**

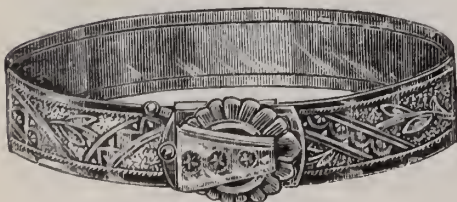

No. 227. Gold Edge, Garnet, Chased Top, Engraved Band, Patent Lever Catch.



No. 232. Gold Edge, Landscape, Wire Border, Engraved, Patent Lever Catch.

Factory, 111 Broad Street, Providence, R. I.

185 Superior Street, Cleveland, O.



No. 231. Gold Edge, Landscape, Burnished Border, Engraved Band, Patent Lever Catch.



No. 230. Gold Edge, Landscape, Burnished Border, Engraved, Patent Lever Catch.

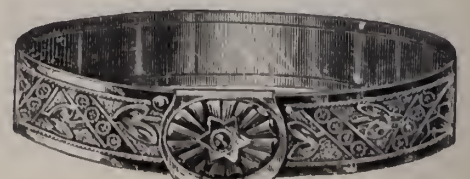

No. 225. Gold Edge, Garnet, Gold Front, Star Engraved, Patent Lever Catch.



# JACOT, JUIILLERAT & CO.,

IMPORTERS OF

## MUSICAL BOXES,

49 MAIDEN LANE, NEW YORK.

Round and Square Crank Toy Music Boxes, small, 2, 3, 4, 6 and 8 tune and small Mandolines in all styles of cases.  
 Large Size Musical Boxes from 4 to 15 inch cylinders and playing from 4 to 12 tunes.  
 Musical Boxes with Bells, Bells and Drum, Bells, Drum and Castanettes.  
 Mandolines, Piccoloes, Guitare-Mandolines, Subline Harmonies and many other styles of all sizes.



Musical Boxes with several cylinders, double and quadruple Main Springs, and Richly Inlaid Cases.

These Boxes are of superior quality and with airs appropriate to each style.

PRICE LIST SENT ON APPLICATION.

*Send for "How to Repair Musical Boxes," with Price List of Material, Price 25 Cts. No Watchmaker should be without it.*

## STANDARD DUST-PROOF WATCH KEYS.

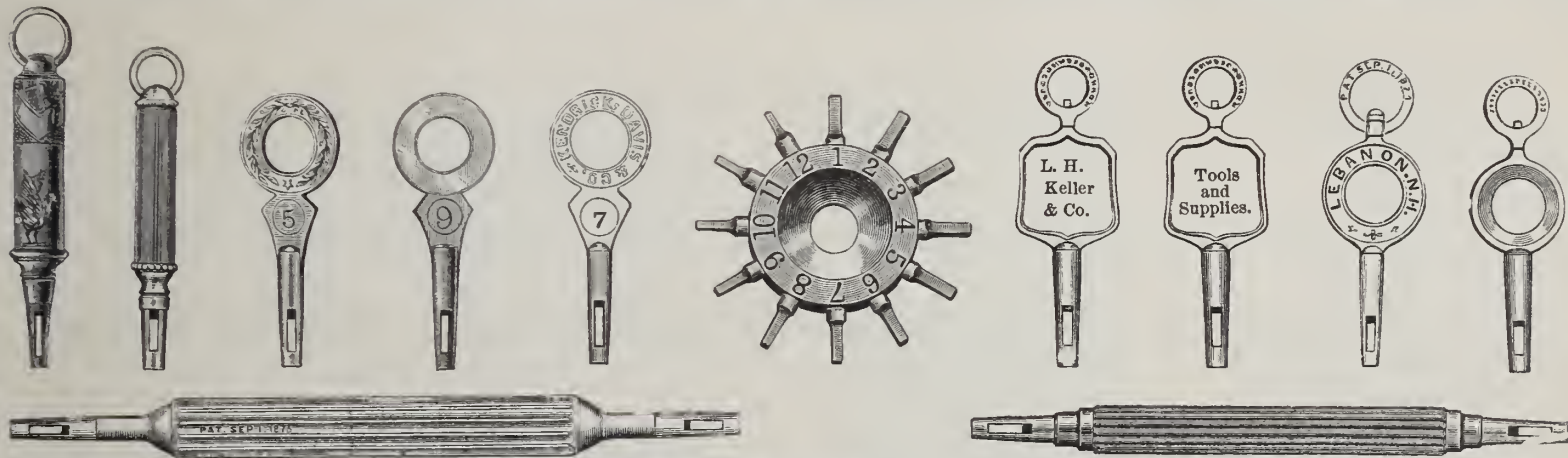

FOR SALE BY



THE TRADE.

## KENDRICK & DAVIS,

Sole Owners and Manufacturers, Lebanon, N. H.

ILLUSTRATED CATALOGUE and PRICE LIST SENT ON APPLICATION.



CLOCKS,  
CLOCKS,  
CLOCKS.



LE BOUTILLIER & CO.,

**Importers and Jobbers,**

31 & 33 West 23d Street, (Second Loft,) NEW YORK.

Half a Block from Sixth Avenue Elevated Station.



We wish to inform our friends again that we have given up the Retail Business and are directing our exclusive attention to the

**JOBGING TRADE.**

Being under merely nominal expenses as to Rent, etc., we are able to offer goods at **EXTREMELY CLOSE PRICES**, and would solicit a call from buyers before closing contracts elsewhere.

**Novelties will be on Exhibition about February 6th, 1884.**



# Swiss Automatic Clock Pictures,

Representing Various Pastoral Scenes and Landscapes with Animated Domestic Animals, Etc.

A Most Desirable and Attractive Picture for a JEWELRY STORE WINDOW.



This cut represents the **Automatic Clock Picture** without the frame. They are framed in Ornamental Gilt Frames, and finished in various oil colors, resembling in appearance an oil painting. By winding the mechanical part the figures all move and the clock keeps correct time.

Size 21x25, \$21.60.      Size 15x18, \$15.00.      Net Cash.

**L. & M. KAHN,**  
SOLE IMPORTERS,  
No. 10 MAIDEN LANE, NEW YORK.

ESTABLISHED 1867.

## F. JEANDHEUR, Jr.,

125 FULTON STREET, N. Y.

### Gold and Silver Electro-Plating,

Mr. Jeandheur begs to notify the Trade that he has made more improvements with his new process of Electro-Plating Watches, Jewelry, Etc. By having introduced an Electro-Plating Machine instead of using the old method of Plating with Chemical Battery, he is able to plate with a far greater depth of gold than before, and for wear it is equal to rolled plate. The Trade can rely on this statement, as a trial will abundantly prove, and his well-earned reputation amongst the leading houses in the Trade will be sustained.

P. S.—He also begs to notify the Trade that he has no connection with any other house or person using his name, for the purpose of soliciting work.

PRICE LISTS SENT UPON APPLICATION.

LEVY, DREYFUS & CO.,  
Importers and Manufacturers,  
11 MAIDEN LANE, N. Y.

OFFER A LARGE ASSORTMENT OF

## Fine Bisque Figures,

Especially Selected for the requirements of the Jewelry Trade.

## Alluminium, all Pearl Opera Glasses,

Six or Twelve Lenses, and a Large Variety of other Glasses of Standard Makers.

## GOLD SPECTACLES AND EYE-GLASSES IN GREAT VARIETY.

Monogram Albums containing 35 Series of Alphabets, Price, \$5.00; also Monogram Albums, 3 and 4 Letter Combinations, Price, \$10.00.

## Birch's Patent Self-Adjusting Watch Keys.

FOR SALE BY THE TRADE GENERALLY.



2.—POCKET KEY.  
(Brass.)



3.—POCKET KEY.  
(Nickel Plated.)



4.—POCKET KEY.  
(Nickel Plated, Hexagon Shell.)



5.—POCKET KEY.  
(Heavy Rolled Gold Plate Mountings.)



6.—CELLULOID MOUNTED KEY.  
(With Heavy Rolled Gold Plate Tips.)



35.—POCKET KEY, CELLULOID MOUNTINGS.  
(Imitation Malachite, with Extra Heavy Rolled Gold Plate Tips. 18. K.)



7.—BENCH KEY. (Brass Handle.)



8.—SHORT WOOD HANDLE KEY.  
(Nickel Plated, for Bench or Pocket Use.)



9.—LONG WOOD HANDLE BENCH KEY. (Nickel Plated.)

Made in 37 Styles.      Circulars on Application.

J. S. BIRCH & CO., 38 Dey Street, N. Y.



ESTABLISHED 1854.

# FINE HAIR JEWELRY AND DEVICE WORK

## Manufactured by CHAS. THEO. MENGE,

Nos. 32 and 34 John Street,

New York.

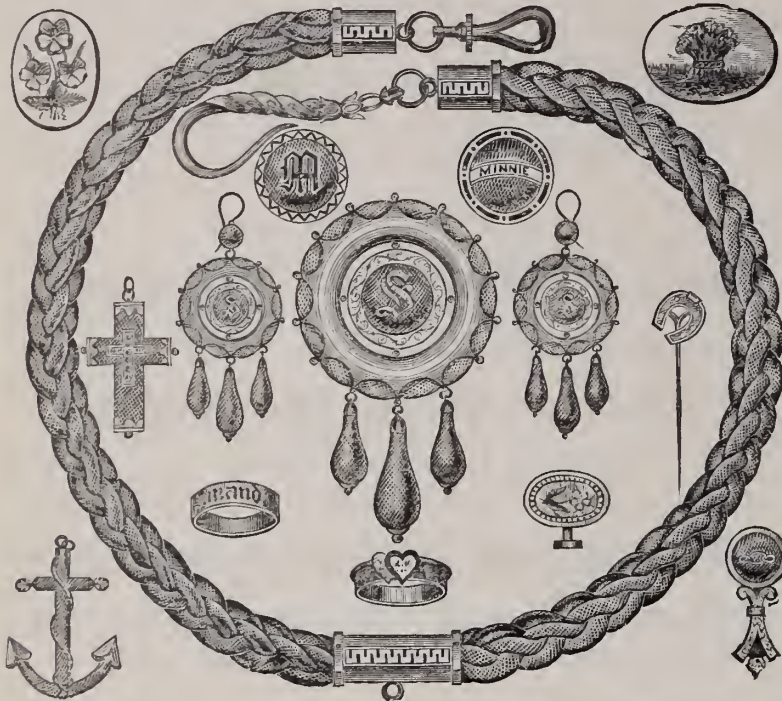

The attention of the Trade is invited to the above designs of **Hair Jewelry and Device Work**, which are a few of the many designs contained in my Pattern Book. I will send a large Pattern Book and Price List, containing all the latest designs on receipt of fifty cents, which will be refunded on first order. I also fill orders taken from any other book upon advice of name and number of design. All orders will receive prompt attention, and repairing of Fine Jewelry in all its branches. A large assortment of 14 k. Mountings always in stock. Satisfaction warranted as to quality and workmanship.

**KEY**  
Patented Jan. 25,  
1881.

**TAG**  
Patented Jan. 25,  
1881.

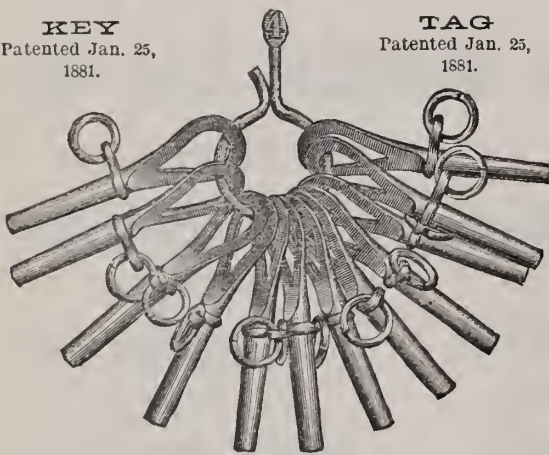

# A. N. CLARK

PLAINVILLE,  
CONN.,

Manufacturer of

### Watch Case Springs, Watchmakers' & Jewelers' Bench Tools, CROSBY'S JEWELING TOOLS, &c.

**STOP IMPORTING KEYS!**

For Low Price Key Use the

## New Style Loop Key.



A plain Steel Key of good appearance, and excellent quality. It will not wear the pocket. It has a swivel, and is much better made than the imported plain steel or iron keys.

**PRICE PER CROSS, FINE NICKEL FINISH, \$2.25**  
Postage, 10 Cents Per Gross Additional.

This Key is good and cheap enough to become universal. Send business card for illustrated price list. Enclose three cent stamp for sample key.

SOLD BY JOBBERS IN WATCH MATERIALS AND NOTIONS.

**A. N. CLARK, Plainville, Conn.**

# W. M. FISHER & CO.

Sole Manufacturers of the



## PATENT INTERCHANGEABLE Combination Necklace,

And Ladies' Brooch or Lace Pin

PATENTED

JULY 16, 1872

GOLD  
AND  
SILVER  
CHAINS.

Gold Chain  
TRIMMINGS.

Complete  
Assortment of  
14-k.

## Ribbon Fobs.

**FOR SALE BY THE LEADING JOBBERS**

# The Burbank Manufacturing Company

Manufacturers of GOLD & SILVER

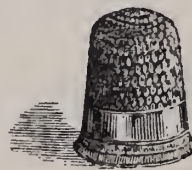

GOLD  
SILVER,  
STEEL,  
RUBBER,  
And SHELL,

## Thimbles,



EYE GLASS  
Self Adjusting.

## SPECTACLES AND EYE-GLASSES



OF ALL DESCRIPTIONS.

## SOLID GOLD RINGS

Office, 14 MAIDEN LANE. NEW YORK.

Manufactory, Springfield, Mass.



# AMERICAN WATCH TOOL CO.,

WALTHAM, MASS.

MANUFACTURE THE

## WHITCOMB LATHE,

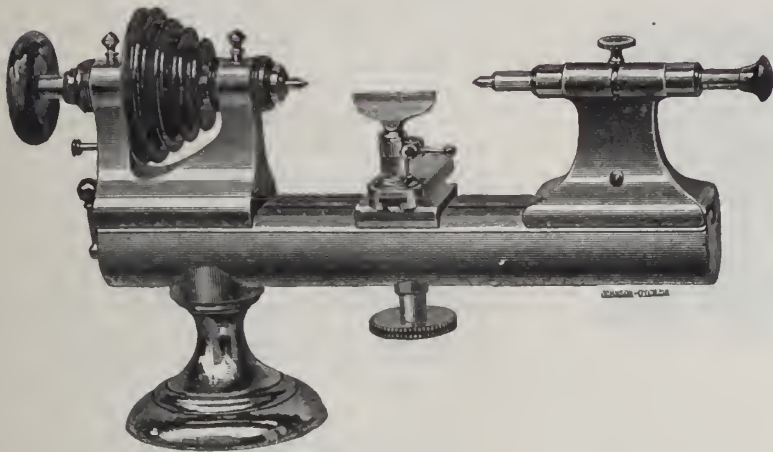

AND THE

## "Webster" Foot Wheel,

We guarantee it to be a worthy companion to the Whitcomb Lathe.

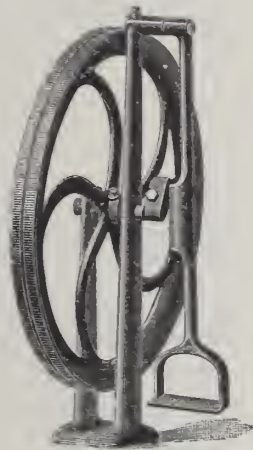

It is **not** a cheap made wheel but **First-class** in every respect.

### PRICES.

|                                                       |         |         |
|-------------------------------------------------------|---------|---------|
| 30 lb. Wheel, for No. 1 Lathe, 20 inches in diameter, | - - - - | \$12.00 |
| 40 " " " 1½ " 20¾ " "                                 | - - - - | 13.00   |
| 50 " " " 2 " 21½ " "                                  | - - - - | 14.00   |

DESCRIPTION.—The wheel runs on a hard steel arbor. It is clamped to the arbor by a set screw against a split bushing. This does not bend the arbor as is the case where the set screw is against the arbor. On the crank pin is a friction roll, having a hardened steel bushing, which runs on a hard steel pin. The swinging treadle is the **easiest** motion, and effects the body **less** than the foot treadle.

SEND FOR NEW CATALOGUE.

Our No. 1½ Lathes are Fast Superseding all other Sizes.

Soft Lathes have Hard Mouths, Hard Wire Chucks and Hard Tail Stock Spindles.

# Elgin & Waltham 18 Size Movement DISPLAY CASES.



Each Case Suitable for  
**Key and Stem Winders.**

Thick Glass  
FRONT AND BACK.

Nickel, dozen, \$12.00

Gilt, " 16.50

## LEVY, DREYFUS & CO.,

Sole Manufacturers' Agents,

11 MAIDEN LANE,

NEW YORK.

# T. L. MAXWELL & BRO.,

MANUFACTURERS OF

GOLD AND SILVER HEADED

## CANES

IN GREAT VARIETY,

42 CORTLANDT ST.,

NEW YORK.



Special Attention given to the Jobbing Trade.

PRICE LIST SENT ON APPLICATION.



**E. J. BOYCE,**

(Formerly Boyce & Walnwright,)

→ **MANUFACTURING JEWELER** ←

*SOLID GOLD RINGS A SPECIALTY.*

My **BAND RING** Specialties, for **PRICE, QUALITY** and **FINISH**, are not equaled by any in the Trade,

**383 WASHINGTON ST.,**  
**BOSTON, MASS.**

**NEW ENGLAND MOROCCO CASE CO.,**

**MANUFACTURERS OF**

**JEWELRY and SILVERWARE**

**CASES,**

**OF EVERY DESCRIPTION.**

**NO. 220 CHAPEL STREET**  
**NEW HAVEN, CONN.**

Solid Gold Rings a Specialty.

**WM. H. ELY,**

**SOLID GOLD RINGS,**  
MANUFACTURER.

Viz., Plain, Chased, Engraved, Enameled, Engine Turned, Shield and Scale. All qualities guaranteed. Orders Promptly Executed.

**58 Nassau Street, New York.**



**C. B. WILKINSON,**  
Manufacturing Jeweler,

**8 JOHN ST., N. Y.**

Medals, Badges and Masonic Jewelry  
**A SPECIALTY.**

Designs furnished free upon application.

**H. WUNDOEHL,**  
**GOLD & SILVER REFINER,**

Assayer and Sweep Smelter,

**21 JOHN ST.,**

bet. Broadway & Nassau St., **NEW YORK.**

The highest price paid for Gold, Silver and Platinum.  
*Fine Gold, Silver and Copper always on hand.*

**JACOB STRAUSS,**  
**WATCHES & JEWELRY**

**AT WHOLESALE.**

REMOVED FROM

**18 TO 25 JOHN STREET, N. Y.**

Rings and Rolled Plated Chains  
**A SPECIALTY.**



**FINE WOOD PHOTO-ENGRAVING**  
SEND COPY FOR ESTIMATE. IT WILL PAY YOU!  
CROSSCUP & WEST.  
702 CHESTNUT ST. PHILADELPHIA

**J. J. COHN,**

IMPORTER OF

→ **WHITBY JET** ←

MANUFACTURER OF

**Gold & Rolled Plate Jewelry,**

Bracelets, Charms & Lockets a Specialty.

**12 MAIDEN LANE, N. Y.**

Goods Sent on Selection if Satisfactory References are Given.

**WM. SCHWENCKE,**

Manufacturing & Jobbing Jeweler,

**43 MAIDEN LANE, N. Y.**

Gives particular attention to the Repairing and Jobbing Department of the Jewelry Business. Prompt Attention, Moderate Prices and First-Class Workmanship Guaranteed to all. Country Orders Promptly attended to.

**CHURCH'S PATENT IMPROVED DOUBLE SPEED INDICATOR**  
*Either Right or Left.*

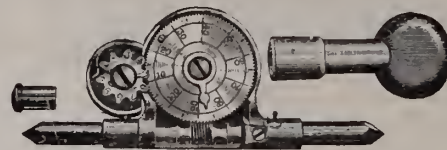

**MONTGOMERY & CO.,**

Importers of *Stubs' Files, Tools & Steel,*

GROBET SWISS FILES, CHESTERMAN'S TAPES, RULES, &c.

Horse Shoe Magnets. Hubert's French Emery Paper.

**WM. SMITH & SONS' CELEBRATED MUSIC WIRE.**

**105 Fulton Street, N. Y.**

The Finest Line of High-Class English Watches in the U. S.

**GEO. E. WILKINS,**  
**SYRACUSE, N. Y.**

Agent for the Celebrated Watches of

Chas. Frodsham & Co., London,

W. G. Schoof, London,

Karl Zimmerman, Liverpool.

Timing and Adjusting done for the Trade.

Correspondence Solicited from the Trade.

**HIBBARD G. GILL,**  
GOLD AND SILVER

**Watch Case Manufacturer,**

Dealer in Watches,

American Watch Movements Always on Hand.

**618 Chestnut Street,**

Fifth Floor.

PHILADELPHIA.

**HENRY TROEMNER,**  
**710 Market Street,**  
**PHILADELPHIA.**

Manufacturer of Fine Gold Scales,

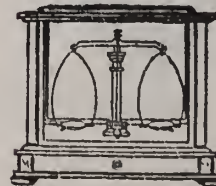

DIAMOND SCALES,

→ Bullion Balances and Weights, in use at all the U. S. Mints and Assay Offices.

PRICED CATALOGUE ON APPLICATION.

**JNO. F. LUTHER,**

MANUFACTURER OF

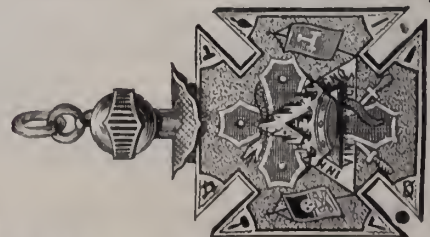

Masonic Jewelry.

**79 Nassau Street, N. Y.**

Illustrated Catalogue sent on application.



ADOPTED AND IN USE BY  
**RANDEL, BAREMORE & BILLINGS,**  
 88 Nassau Street, N. Y.

THE TRADE SUPPLIED.  
 Descriptive Circulars Furnished  
 on Application to  
**George W. Washburn, Patentee,**  
 88 Nassau St.,  
 NEW YORK.

**SAFETY**  
**EAR FASTENING,**   
*Pat. May 10, '81—Oct. 11, '81.*

**Jointed**  
**EAR WIRE**   
 AND  
**BAR BETWEEN CRAMPS**  
**OF SETTINGS.**  
*Patented March 1, 1881.*

**TELESCOPIC**  
**SAFETY PIN CATCH,**   
*Pat. Sep. 20, '81—Jan. 10, '82.*

**A. BANTLE,**  
 Gold, Silver and Platinum  
 ✦ Electro-Plating ✦  
 FINE WORK A SPECIALTY.  
 130 Fulton Street,  
 89 Nassau Street,  
 ROOM 36, **NEW YORK.**

WATCH CASE POLISHING.

**J. R. WOOD & SON,**  
 MANUFACTURERS OF

 **Solid Gold Rings**  
 AND  
**Diamond, Stone and Children's Rings,**  
 14 John Street, N. Y.

No Goods Stamped Different from Quality.

**REUBEN HAINES,**  
**ANALYTICAL CHEMIST,**  
 No. 738 SANSOM ST.,  
 PHILADELPHIA.

Laboratory for Assay and Analysis of  
 GOLD AND SILVER ORES. LEAD, COPPER,  
 ZINC, IRON, STEEL, COAL,  
 WATER ANALYSIS.

 **BURGESS'**  
 Patent Portable Mechanical  
**BLOW-PIPE,**  
 Supersedes the Forge, Bellows  
 and Mouth Blow-pipe, by sav-  
 ing time, labor, and breath,  
 giving the gentlest flame or hot-  
 test blast without exertion.

PRICE, - - \$10.00.  
**J. ELLIOTT SHAW,**  
 154 South 4th Street, Philadelphia.

**John F. Stratton & Co.,**  
 No. 49 Maiden Lane, NEW YORK.  
 Importers and Wholesale Dealers in

**Violin Strings**  
 And all kinds of Musical Merchandise.

ALSO  
**Music Boxes, Musical Novelties, Ladies' Musical Work Boxes, Glove Boxes, Etc.**

SEND FOR DESCRIPTIVE CATALOGUE.

**P. JANDORF & BRO.,**  
**Matches and Jewelry,**  
 196 BROADWAY,  
 Bet. John & Fulton Sts., NEW YORK.

We Publish No Price Lists.

**Watchmakers' Slide Rests**  
 A SPECIALTY.

 **TWO STYLES,**  
**PRICE,**  
**\$10.00 & \$16.00.**

Warranted as good as the best. Sent C. O. D. on approval.  
 Write for Illustrated Circular to the Manufacturer

**R. H. FRAZEE,**  
**TOLEDO, IOWA.**

**Pennsylvania Engraving Co.**  
 112 SOUTH 7TH STREET  
 PHOT. ENGRAVE. PHOTO & WOOD.

ESTABLISHED 1873

**CHAS. P. HEROLD**  
 MANUFACTURER JEWELER  
**DIAMONDS**  
 916 CHESTNUT STREET UP STAIRS  
 PHILADELPHIA

**H. WASELL,**  
**RUBBER STAMPS,**  
**BRASS STAMPS,**  
 Brushes, Inks, &c.  
 Stencil Plates, 

**STEEL STAMPS.**  
 Burning Brands,  
 SEALS & PRESSES,  
 No. 7 North William St.  
 First house South of East River Bridge, N. Y.

FINE STEEL STAMPS A SPECIALTY.

**C. KNAPP,**  
 Manufacturer of  
**Superior Band**  
 and Children's  
**Stone & Fancy RINGS**   
 And Enameled Goods,  
 41 Maiden Lane,  
**NEW YORK.**   

**WILLIAM ERNST MOUTOUX,**  
 Leading Artist in Hair of the World  
 AND MANUFACTURER OF  
**GOLD AND HAIR JEWELRY,**  
 OFFICE AND FACTORY,  
 81 Nassau St., Rooms 1 & 2,  
 BRANCH,  
 18 Lawrence St. West of 126th,  
 Near Ninth Ave., NEW YORK.

My New Catalogue of 1700 New Designs of Monuments with Weeping Willows, Wreaths, Bouquets, Crosses, Churches, Sceneries, Portraits, Pet Animals, Engravings of the Most Difficult Description, Etc. Wholesale prices for Hair Chain Braids in Assorted Colors, by the gross or dozen at half of book prices. Devices made at half of book prices if necessary. 15-5 per cent. cash discount on the prices of the old book.

GEO. W. DUBOIS. F. N. NAUMAN.

**GEO. W. DUBOIS & CO.,**  
 IMPORTERS OF  
**Watches & Optical Goods.**

ALL STYLES AND QUALITIES OF  
**SPECTACLES AND EYE-GLASSES.**

**Longines' Watches and Movements,**

The Watches in Gold, Silver and Nickel Cases of New and Handsome Patterns. The Movements fit 18 size Waltham Stem Winding Hunting Cases.

36 Maiden Lane, New York.

ORDERS BY MAIL RECEIVE PROMPT ATTENTION.



# Spencer Optical Manuf'g Co.

Are now making many

**NEW**

AND

Desirable Styles

FOR THE

Early Spring

Trade

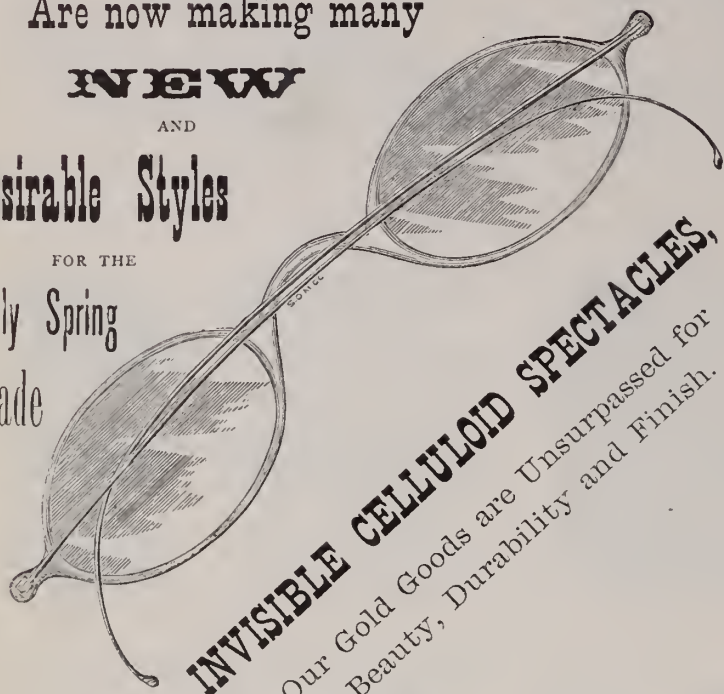

**INVISIBLE CELLULOID SPECTACLES,**  
Our Gold Goods are Unsurpassed for  
Beauty, Durability and Finish.



**CELLULOID**

**SPECTACLES.**

The very latest improvement, made in Shell and Amber Color; it has substantial advantages over all others, being strong, light and not subject to rust. THE

**CELLULOID EYE-GLASS**

has made its own reputation and is universally popular wherever introduced.

**BEWARE OF IMITATIONS.**

We make a **SPECIALTY** in **SPECIAL GOODS** for the **FINE RETAIL TRADE**, which gives customers handling our goods **IMMENSE ADVANTAGE** over all others.

**QUALITY OF GOLD GUARANTEED.**

We are importing large Invoices of Opera, Field and Marine Glasses in Staple and Novel Designs.

**Spencer Optical Manufacturing Co.,**

13 MAIDEN LANE, NEW YORK.

Established 1853.

**L. H. KELLER & CO.**

Successors to G. A. HUGUENIN,

IMPORTERS OF

WATCHMAKERS' and JEWELERS'

**TOOLS AND MATERIALS.**

GENERAL AGENTS FOR

The Philadelphia Watch Company,

— AND —

American Watch Tool Co.,

MANUFACTURERS OF

**THE WHITCOMB LATHE.**

SOLE AGENTS IN THE UNITED STATES FOR THE SALE OF

**LUTZ'S**

**CELEBRATED ROLL HARDENED HAIR SPRINGS,  
MOEBIUS OIL**

For Chronometers, Watches, Clocks, Telegraph Instruments and all other delicate machinery. Made from Pure Refined Neatsfoot Oil, and Warranted to Excel anything in the market as a Lubricator. **SAMPLES GRATIS.**

**OUR OWN GRADUATED**

AND JURGENSEN RECOILING MAINSPRINGS, pronounced by all experts Superior to all. Sold in Separate Strengths or Force.

Extra Fine Pinions cut from Solid Steel Wire. Gauged Hole Jewels of First-class Workmanship. A Full Line of Materials, for the PATEK, PHILIPPE & CO. GENEVA WATCHES, and all other Celebrated Makers.

**THE BOLEY LATHES AND TOOLS,**

Celebrated for their Practical, Substantial and Workmanlike Construction, Superior Design and Finish.

*Our aim is to furnish nothing but First-class Serviceable Goods, especially manufactured for the Consumer, and not solely for the Market, like the cheap trash advertised in highly illustrated catalogues with which the country is flooded.*

**TREATISE ON MODERN HOROLOGY IN THEORY AND PRACTICE.** By M. CLAUDIUS SAUNIER, Ex-Director of the School of Horology at Macon, France; Knight of the Legion of Honor, etc.; Hon. Sec. to the Paris Society of Horologists. Translated from the French by JULIEN TRIPPLIN, Besançon Watch Manufacturer, and EDWARD RIGG, M. A., Assayer in the Royal Mint, London.

This Work comprises 832 large octavo pages, with 78 wood cuts and 21 colored double-page copper-plate engravings. Bound in half calf, with an appropriate and handsome ornament in gold on front cover.

**Price, \$15.00.**

**THE WATCHMAKER'S HAND BOOK.** By the same author and translators. Intended as a companion to the Treatise. Bound in cloth.

**PRICE, \$4.00.**

**64 Nassau Street,**

NEAR MAIDEN LANE,

**NEW YORK.**

L. H. KELLER,  
EDWARD HUNZIKER,  
F. J. BOESSE.

We do not publish Price Lists.



**SPECIAL NOTICES.**

**Notices under this Heading, not to exceed Six Lines, \$1.00 each insertion.**

Advertisers having letters addressed in care of this office, must inclose postage for answers forwarded.

**FOR SALE**—A fine chronometer, made by the John Gowans. Enquire of Thos. M. Ward, 25 John St.

**WANTED**—A few Elgin movements No. 7, No. 6 No. 94. \$1.00 premium over the net retail price. Address D. H., care Jewelers' Circular.

**A WATCHMAKER**, fully competent, wishes to change his present location. Has had long experience on fine work. Address Hair Spring, Jewelers' Circular.

**WATCHES OR JEWELRY**—City salesman would introduce fine of goods to trade. Well acquainted in New York city and neighboring cities. Smith, 217 East 40th street.

**WANTED**—Two Grandfather clocks. Must be in good condition. Brass dials preferred. State full particulars, maker's name and lowest price. G. R. A., care Jewelers' Circular.

**WANTED**—By a young man, a position in the diamond or jewelry trade or first-class jewelry store. 8 years' experience in diamonds and diamond setting. Address Gardner, care Jewelers' Circular.

**WANTED**—Situation; am competent to take charge of watch work for city trade and act as salesman if necessary, or would travel. Age 31; American; no engraver. Address "Rox," care Jewelers' Circular.

**WANTED**—A fully competent and trustworthy person to take entire charge of the optical goods department in a large jobbing and importing house in Chicago. Address J. G. & Co., Box 845, P. O., New York.

**FOR SALE**—An old and well-established jewelry store in a large and thriving city in the state of Connecticut. Only moderate capital required. Inquire of Oppenheimer Bros. & Veith, 35 Maiden Lane, New York.

**WANTED**—On or about the 1st of May, a watchmaker and engraver. One who can come well recommended. A permanent situation to the right man. Address Albert G. Spangler, P. O. Box 551, Newport, R. I., stating wages.

**MOSELEY & CO.**, Elgin, Ill., manufacturers of the "Moseley" Lathe, with full line of fixtures and attachments. Designed especially for the watchmaker and repairer. Combining accuracy, durability, convenience and style.

**WANTED**—A man who thoroughly understands buying and selling to jobbers, watches, jewelry, silverware, optical goods and material; large salary to the right man. Address, with reference in full confidence, second floor, 70 N. Second St., Philadelphia, Pa.

**FOR SALE**—A newly fitted up shop, small stock. Rent low and centrally located. A good man can easily make \$100 per month or more, \$1,000 cash. I wish to travel South for a few years. Direct to W. W. Wiklison, watchmaker, 168 Union St., Nashville, Tenn.

**FOR SALE**—The leading jewelry store in a good Iowa town of 7,500. Stock, etc. is worth \$6,000, but will reduce to suit customer. Plenty of work for two men. A good chance for a young man, as this will be sold at a bargain. Good reasons for selling. Address Lock Box 1026, Oskaloosa, Iowa.

**GEORGE E. WILKINS**, manufacturer and importer of cutters for watchmakers' use, stem-winding cutters of all the different forms, rounding up cutters of the finest quality, also ratchet cutters. A large stock of second hand and new marine chronometers. No. 21 South Salina street, Syracuse, N. Y.

**FOR SALE**—The stock of a jewelry store in a manufacturing town of 6,000 inhabitants. 3 rolling mills, 3 glass houses, 3 foundries, 2 agricultural works, 1 blast furnace, rake factory, cooper shop, 2 planing mills. No other jeweler in town. Capital required, \$2,500 to \$3,000. Ill health the cause of selling. Address or apply to P. J. Manson, Martin's Ferry, Belmont Co., Ohio.

**WANTED**—Permanent situation as watchmaker and salesman, by an energetic, reliable man of 27 years. 7 years' experience at the bench and as general salesman; thoroughly understands French clocks and jewelry repairing; has had experience in first-class stores; best of references given. Address stating compensation, C. B. Raymond, 60 Spring street, Springfield, Mass.

**WANTED**—An experienced salesman in the spectacle department of our business. Must have a good knowledge of the principles of optical science, so far as relates to spectacle lenses; also must understand how to fit and adjust spectacle and eye-glass frames accurately to face and the nose of wearer. Address, with reference and other information about self, to James W. Queen & Co., Opticians, Philadelphia.

**FOR SALE**—The jewelry and variety store of the oldest jeweler in the town of Ebensburg, Pa. Population 1,500. Situated on the top of the Allegheny mountains. The climate very healthy. Store is located the best in town. Plate glass front, lit with gas, dwelling under same roof. Will sell building, or lease to party purchasing stock. One other jeweler in town. Plenty of repairing for two shops. Address Box 51, Ebensburg, Cambria Co., Pa.

**TO THE TRADE**.—I make a specialty of supplying the Trade with stones for jobbing purposes. Parties having jewelry out of which the stones have been lost, sending their orders by mail or express, will have them promptly attended to. A large stock of cameos, pearls, turquoise, garnets, amethysts, doublets, foil backs, white and colored imitation stones on hand. All kinds of setting done for the Trade. W. Archibald, 73 Nassau street, New York.

**FOR SALE**—Rare opportunity. A first-class jewelry store in one of the best towns in Illinois of 7,000 inhabitants. County seat, three railroads, college and large manufacturing. Doing a good business and will bear investigation. Bench work from \$100 to \$150 per month. Good clean stock. Reason for selling, poor health. If not sold before January 1st will sell tools and fixtures without stock. For particulars address A. J. Green, Monmouth, Ills.

**BUYERS' DIRECTORY.****NEW YORK.****Assayers and Sweep Smelters.**

**Wundoehl, H.**—Gold and Silver Refiner, Assayer and Sweep Smelter. 21 John Street, N. Y.

**Badges and Medals.**

**Stockwell & Newman**—19 John Street. Manufacturers of Badges, Medals and Presentation Pieces in Gold and Silver. Also Jewelry and Mounters of Diamonds. Designs supplied.

**Wilkinson, C. B.**—Manufacturing Jeweler, 8 John Street, N. Y. Medals, Badges and Masonic Jewelry a Specialty. Designs furnished free upon application.

**Band Rings.**

**Knapp, Charles**, 41 Maiden Lane, N. Y. Specialty: Superior Band Rings, also Ring Shanks & Heads for Seal and Diamond Rings.

**Black Onyx Jewelry.**

**Cox & Sedgwick**—Manufacturers of Black Onyx Jewelry, No. 26 John St. New York.

**Lawson, Samuel**—No. 18 John Street. Manufacturer of Black Onyx Jewelry. Coral repaired for the trade. Goods sent on approval to responsible dealers.

**Woglom & Miller**—Manufacturers of (exclusively) Black Onyx Jewelry, 32 & 34 John St., N. Y.

**Blue Enameled Lockets.**

**Bissinger, Philip & Co.**—Importers of Diamonds, Pearls and Precious Stones. Agent for the Bohemian Garnet Goods. Blue Enameled Lockets, 22 John St., N. Y.

**Hess & Schliesser**—Importers of Diamonds, Fine Jewelry and Novelties in French Goods. Specialties: Gold and Blue Enameled Lockets, Charms and Crosses. 25 Maiden Lane.

**Bohemian Garnet Jewelry.**

**Bissinger, Philip & Co.**—Importers of Diamonds, Pearls and Precious Stones. Sole Agent for the Bohemian Garnet Jewelry. Blue Enameled Lockets. 22 John St.

**Boxes, Wood Mailing and Nested.**

**Maine Manufacturing Co.**—Successors to Swift Mfg Co., makers of Wood Mailing and Nested Boxes for Mailing and Express purposes. J. Spencer Taylor, Agent, 18 Courtlandt St., N. Y.

**Wiesbauer, J.**—Manufacturer of the Sliding Cover Wood Mailing Boxes. All Sizes Made to Order. Buffalo, N. Y.

**Clock Companies.**

**Ansonia Clock Co.**—Manufacturers of every description of Clocks. 11 to 21 Cliff street, New York.

**Kroeber, F.**—Manufacturer and Dealer in American and French Clocks, No. 14 Cortlandt Street.

**New Haven Clock Co.**—16 and 18 Park Place, N. Y.

**Seth Thomas Clock Co.**—20 Murray Street, N. Y.

**Waterbury Clock Co.**—M. Bailey, Treasurer, Manufs and Jobbers, No. 4 Cortlandt St., N. Y., and No. 197 State Street, Chicago.

**Welch, E. N., Manufacturing Co.**—Manufacturers of American Clocks. No. 6 Warren St.

**Wm. L. Gilbert Clock Co.**—No. 6 Murray Street, Manufacturers of Clocks. Factories, Winsted, Conn.

**Yale Clock Co.**—Manufacturers of Novelties in Clocks, 52 Maiden Lane, N. Y.

**Corals and Coral Jewelry.**

**Cuppia, L. A.**—Importer of Coral and Silver Filigree Jewelry, 19 Union Square, N. Y.

**Cameo Cutters, Etc.**

**Peiter, Theodore**—Cameo and Intaglio Engraver. Patentee of the Cameo-Intaglio. No. 2 Bond Street, near Broadway, Room 4 New York.

**Charms & Gold Watch Keys.**

**Rupp & Held**,—Manufacturing Jewelers, Charms and Gold Watch Keys, with French and English Ratchets, a specialty. 15 John St., N. Y.

**Crucibles.**

**Berge, J. & H.**—Established 1850, Manufacturers and Importers of Sand Crucibles, Covers, Chemical Porcelain, Glassware, and Jewelers' and Assayers' Supplies, 95 John Street, N. Y.

**Cutlery.**

**Harrison Bros. & Howson**,—Manufacturers of Fine Ivory and Pearl Table and Pocket Cutlery, Carvers in Cases; Nutpicks, Nutcracks and goods suitable for the jewelry trade. 126 Chambers Street. W. C. Burkinshaw, Sole Agent.

**Diamond Brokers.**

**Anderson, Otis**—Diamond Merchant and Broker, always ready to pay cash for bargains in Diamonds and Precious Stones, 4 & 6 John Street, N. Y.

**Bernhardt, Richard**—Diamond Broker and Importer, 65 Nassau Street (Room 6), N. Y. Paris, 20, rue des Petites-Écuries.

**Friend S. & Son**—Brokers and dealers in Diamonds 33 John Street, cor. Nassau St. New York.

**Herbert, R. J.**—Diamond Broker and Dealer, 26 Maiden Lane.

**Diamond Importers.**

**Bernhard, A. & Co.**—Importers of Diamonds and Manufacturers of First-class Diamond Jewelry, Diamond Settings for Manufacturing Jewelers. Catalogue of Designs for the Trade free of charge. No. 2 Maiden Lane, New York.

**Bissinger, Philip & Co.**—Importers of Diamonds, Pearls and Precious Stones. Agent for the Bohemian Garnet Goods. Blue Enameled Lockets. No. 22 John St., N. Y.

**Bruhl, D. & M.**—Established in 1848. 14 Maiden Lane, N. Y.; 111 Broad Street, Providence, R. I.; 14 Rue Bleue, Paris.

**Brunswick, S. & Co.**—Importers of Diamonds. 17 Maiden Lane, New York. Paris, Rue Lafayette. Amsterdam, Damsstraat.

**Citroen, L. B. & Co.**—Diamonds. 21 John St., N. Y. Cutting Works, 57 & 61 Rapenburgerstraat, Amsterdam. House in Paris, 44 Rue Laffitte.

**Engelmann, M. & Co.**—Importers of Diamonds, Pearls and Precious Stones. Specialties in Fine Colored Stones. 192 Broadway and 1 and 3 John Street, N. Y. Paris, 1 Boulevard St. Denis.

**Faulkenau, Oppenheimer & Co.**—Manufacturers. Diamonds and Diamond Jewelry. 40 Maiden Lane, N. Y.

**Fera, Henry**—Importer of Diamonds, and Manufacturer of Fine Diamond Jewelry. 4 & 6 John Street, New York. Amsterdam, Holland, 23 Loojersgracht.

**Fox, M. & Co.**—Importers of Diamonds, Rubies, Sapphires and Fancy Gems. No. 1 Maiden Lane, New York.

**Hedges, Wm. S. & Co.**—Importers of Diamonds, No. 170 Broadway, corner Maiden Lane.

**Kuhn, Doerflinger, & Co.**—Manufacturing Jewelers and Importers of Diamonds, 18 John street, New York.



**Leberthon, L. M.**—Importer of Diamonds and Manufacturer of Fine Jewelry. 14 John Street, N. Y.

**Neresheimer, E. Aug. & Co.**—Importer of Diamonds. No. 21 Maiden Lane, New York.

**Randel, Baremore & Billings**—Importers of Diamonds, corner Maiden Lane and Nassau St.

**Saril, S.**—Importer of Diamonds, 182 Broadway, N. Y. Branch of Vve. H. A. Marchand & Frères, 47 Rue Le Peletier, Paris.

**Saunders & Ives.**—Importers of Diamonds and other Precious Stones. No. 26 Maiden Lane.

**Smith, Alfred H & Co.**—Importers of Diamonds, No. 182 Broadway.

**Taylor & Brother.**—Importers of Diamonds and Diamond Jewelry. 676 Broadway.

**Wickham, D. H. & Co.**—Importer of Diamonds. No. 31 Holborn Viaduct, London, 24 Maiden Lane, New York.

**Wolff, G. A.**—Importer of Diamonds, Rubies, Sapphires, Pearls, and other Precious Stones, 65 Maiden Lane, New York. 12 Rue de Chateaudun, Paris.

#### Diamond Jewelry.

**Bornemann, Louis.**—Importer of Diamonds and Manufacturer of Rich Diamond Jewelry, 19 John Street, New York.

**Chalumeau, D.**—Diamond Jeweler and Manufacturer of Mountings. Novelties and Artistic Jewelry. No. 3 Maiden Lane, New York.

**Goldsmith, Isomar & Co.**—Manufacturers of Diamond Mountings and Diamond Jewelry, 61 Nassau Street, New York.

**Hartje, G. & F.**—Manufacturers of Diamond and Fine Jewelry, 39 Union Square, N. Y.

**Haug & Luthy**—Manufacturers of Fine Diamond Mountings, etc. No. 130 Fulton St., N. Y.

**Heller & Bardel.**—Manufacturers of Diamond and Pearl Jewelry, and Dealers in Diamonds, Pearls, &c. 13 John Street.

**Jeanne Brothers.**—Manufacturers of Diamond Mountings & Rich Jewelry. 1 Maiden Lane.

**Lacroix & Verpillier.**—Manufacturers of Fine Gold Jewelry. Diamonds a specialty. 173 Broadway, N. Y.

**Rosswog, C. & Son.**—Manufacturers of Rich Diamond Goods. Nos. 5 and 7 Maiden Lane, N. Y.

**Scheer, William.**—Diamond Jeweler and Manufacturer of Mountings, Novelties in Artistic Jewelry, 859 Broadway, near 17th St., N. Y.

**Schilling & Nissen.**—Dealers in Diamonds and Diamond Jewelry. No. 51 Nassau Street, New York, near Maiden Lane.

**Voelker, C. T.**—Manufacturer of 18-k. Diamond Mountings, Diamond Jewelry and Roller Chain Bracelets. 189 Broadway, New York.

**Waterman & Lehmann.**—Manufacturing Jewelers and Dealers in Diamonds. Diamond Work, and Fine fancy Rings a specialty, any piece of single work made to order. 37 Maiden Lane, N. Y.

#### Diamond and Pearl Setter, &c.

**Danziger, H.**—Diamond and Pearl Setter, 116 Nassau Street, (Second Floor,) Room 6, N. Y.

#### Diamond Cutters.

**Levy, Herman.**—Importer, Cutter and Polisher of Diamonds. 105 Fulton Street, New York.

#### Dials, &c.

**Farnsworth, C. E. & Co.**—Successors to Jno. T. Gold, Manufacturers and Jobbers in Fine Watch Dials. 81 Nassau St., N. Y.

**New York Dial Co.**—Manufacturers of Fine Watch Dials. Henry Abbott, Agent, No. 7 Maiden Lane, N. Y.

#### Enameled Clock Dials and Figures.

**Caeser Bros.**—Manufacturers of Enameled Clock Dials, also letters and numbers for signs. 230 and 232 East 25th Street, New York.

#### Enamelers, Etc.

**Nutt, J. D.**—Enameler on Gold, Silver, and Copper. Linen finished Buttons and Studs. Enameling in colors. 32 and 34 John Street, New York.

**Orr, J. C.**—Enameler on Fine Jewelry. Enameled in Colors. Linen Finished Buttons and Studs. Band Bracelets. No. 75 Nassau Street, N. Y.

**Orr, William N.**—Enameler on Fine Jewelry. Masonic Jewels and Badges a specialty. Linen Finished Work. 79 Nassau Street, Room 18, New York.

#### Electroplaters, &c.

**Jeandheur, F. & Son.**—Gold and Silver Electro Platers & Fire Gilders, coloring Etruscan and Gold Jewelry a specialty. 125 Fulton St.

#### Engravers—Stone Seal, Etc.

**Fackner, Edward.**—Carver, Engraver and Chaser on Jewelry and Pencil Cases, lettering, &c., 19 John Street.

**Holland & Gosling.**—Stone Seal Engravers. Precious Stones inlaid and encrusted with Diamonds. No. 176 Broadway, New York, (fifth floor per elevator). Cameos cut and repaired.

**Knapp, Chas.**—Engraver, Die Sinker & Stamper for Jewelry purposes. Ring Shanks & superior Band rings, 41 Maiden Lane, N. Y.

**Park, Wm.**—The Stone Seal Engraver. Arms, Crests, Monograms, etc., engraved on precious stones. 26 John Street, New York.

**Weston, James F.**—Stone Seal Engraver and incruiter of Precious Stones. Coats of Arms, Masonic, Odd Fellows, and other devices engraved. 32 John Street.

#### Fancy Goods, Clocks, Bronzes, Etc.

**Hinrichs, C. F. A.**—Importer of Fancy Goods, Glassware, China, Clocks, Bronzes, etc. 31 Park Place.

**Le Boutillier & Co.**—Importers of Fancy Goods, Clocks, Bronzes, &c., 3 Union Square.

**Straus, L. & Sons.**—Importers of Potteries, Faïences, Bisque Figures and Rich Fancy Goods especially adapted for the Jewelry Trade. 40, 42 and 44 Warren Street, New York.

**Taylor & Bro.**—Importers of French Clocks, Bronzes, etc. 676 Broadway, N. Y.

**Young, J. M. & Co.**—Importers of Fine Parian, Lava, and Bisque Statuary, Bohemian, German and English Fancy Goods, 37 & 39 Murray St., New York.

#### Gold and Silver Cane Heads.

**Simons, Bro. & Co.**—Manufacturers of Gold Ilead Canes. 611 and 613 Sansom street, Philadelphia.

#### Gold and Silver Plating, Etc.

**Bantle, A.**—Gold, Silver and Electro-Plating, 130 Fulton and 89 Nassau Streets, cor. Fulton Street, (Room 36,) N. Y. Watch Case Polishing.

#### Gold Chains, Etc.

**Beck, J. & Son.**—Manufacturers of Fine Gold Chains and Chain Bracelets, 10 Liberty Place, near Maiden Lane, N. Y.

**Carter, Sloan & Co.**—Manufacturers of Fine Gold Chain, 15 Maiden Lane, New York.

**Dorrance, Edge & Co.**—Manufacturers of the Celebrated Woven Fabric Gold Chain, No. 15 John Street.

**Kaufmann Bros.**—Manufacturers of Gold Chains, and Chain Bracelets, 26 John Street; Factory, 331 and 333 Bowery, N. Y.

**Kohn, Alois & Co.**—Manufacturers of Gold Chains. 9 Maiden Lane, N. Y.

**Nordt, Charles.**—Successor to Nordt & Schlag, manufacturer of Gold Chains and Chain Bracelets. Jobbing and Refilling Old Chains promptly attended to. No. 17 Maiden Lane, N. Y.

**Saxton, Smith & Co.**—Manufacturers of Fine Gold Chain, No. 14 John Street, N. Y.

**Schlag, Chas.**—Late Nordt & Schlag, Manufacturer of Gold Chains, Chain Bracelets, and Fine Jewelry, 177 Broadway, N. Y.

**Smith, W. & Co.**—Manufacturers of Gold and Silver Chains, Jewelry, etc. No. 25 Maiden Lane, N. Y.

#### Gold Pens, Etc.

**Aikin, Lambert & Co.**—Manufacturers of Choice Gold Pens, Cases, Holders, Toothpicks, etc., 23 Maiden Lane, N. Y.

**Faber, Eberhard.**—Manufacturer of 16-karat Gold Pens and Pencil Cases, Nos. 718 and 720 Broadway, N. Y.

**Fairchild, Leroy W.**—Manufacturer of Gold Pens, Pencil Cases, Tooth Picks and Novelties in Charms. No. 18 John St., N. Y.

**Gerow, Joseph U.**—Manufacturer of Pencil and Pen Cases for the Jobbing Trade only. No. 44 State Street, (near South Ferry,) Brooklyn, N. Y.

**Johnson, E. S. & Co.**—Manufacturers of Gold Pens, Pen Holders and Pencils. Cor. Maiden Lane and Nassau Street, New York.

**Ray Manufacturing Co.**—Gold Pens Manufactured and Stamped for the Trade. Also Pencil and Pen Cases, Tooth-picks, etc. Office, Sales-rooms and Factories, 94 and 96 Nassau street, 129, 131 and 133 Fulton street.

**Smith, H. M. & Co.**—Manufacturers of Gold Pens and Holders, Tooth Picks, Pencils, etc. Sole Manufacturers of Sprague's Patent Gold Fountain Pen. Importers of Nickel and Silver Watches. 173 Broadway, New York.

#### Gold Rings.

**Barnet Bros. & Powell.**—Manufacturers of Stone and Seal Rings, 15 John Street, New York. Factory, Newark, N. J.

**Bowden, J. B. & Co.**—Manufacturing Jeweler.—Solid Gold Rings a specialty, 1 Maiden Lane.

**Cable, Geo. W.**—Manufacturing Jeweler. Plain and Band Rings a Specialty. No. 104 Fulton Street, N. Y.

**Ely, W. H.**—Manufacturer of Solid Gold Rings of every description. No. 58 Nassau Street.

**Henrich, R.**—No. 35 Maiden Lane, Manufacturer of Gold Rings; also Patentee and Manufacturer of the Celebrated Self-Sizing Ring.

**Hutchison & Huestis.**—Makers of Solid Gold Rings. Quality guaranteed. For the Jobbing Trade only. 196 Broadway, N. Y.

**Kroll, H.**—Manufacturing Jeweler. 78 Nassau Street, New York. Specialty: Solid Gold Stone Rings. All kinds of Fine Jewelry made to order, also Repairing for the Trade.

**Ostby & Barton.**—Manufacturers of Plain and Engraved Solid Gold Band Rings. Office, 176 Broadway, N. Y. Factory, 80 Clifford Street, Providence, R. I.

**Peckham, Wm. H.**—Manufacturers of Solid Gold Seamless Rings, and Fancy Embossed Rings, Patent Spectacles, Jewelry, etc. No. 4 Liberty Place N. Y.

**Radler, K.**—Manufacturing Jeweler. Gold Rings and Lockets a specialty. No. 39 Maiden Lane, New York.

**Sauter, L.**—No. 1 Maiden Lane, New York, Manufacturer of Stone Rings of every description, as Diamond, Camco, Onyx Turquoise, etc., Scarf Pins, Scarf Rings, Studs and Buttons.

**Shafer & Douglass.**—Manufacturers of all kinds of Seal, Stone, Turquoise, and fancy rings. No. 7 Maiden Lane, N. Y.

**Sinnock & Sherrill.**—Manufacturers of Stone Rings. No. 3 Maiden Lane, N. Y.

**Thuerner & Church.**—Manufacturers of Fine Gold Rings. No. 9 Maiden Lane, N. Y.

**Wood, J. R.**—Gold Ring Manufacturer of 14 John Street, has assumed his son into partnership. The firm will now be J. R. Wood & Son.



**Hair Jewelry.**

- Moutoux, Wm. E. & Co.**—Manufacturers of Fine Hair Mountings in Gold. Grand catalogues for the trade. 81 Nassau St., Rooms 1 and 2. Finest work and lowest prices
- Sauter, L.**—Manufacturer of Fine Gold and Hair Jewelry and Device Work. Pattern Book sent on application. No. 1 Maiden Lane, N. Y.

**Schwencke O.**—Manufacturer of Fine Hair Jewelry Orders from the country promptly attended to. No. 43 Maiden Lane.

**Jewelry Cases, Fancy Boxes, Etc.**

**American Morocco Case Co.**—7 and 9 Bond St., N. Y., make a specialty of Rich Jewelry and Silverware Cases for the fine Retail Trade. Also Improved Trays for Watches, Rings, etc.

**Blayle, A.**—Manufacturer of Jewelry and Silverware Boxes, Jewelers' Traveling Cases, etc. Trays for Show Cases and Trunks, Ladies' and Gent's Jewel, Glove and Handkerchief Boxes, &c., &c., 80 Nassau street, N. Y.

**Braun, Chr. E.**—Manufacturer of Fine Jewelry Boxes and Trays for Show Cases and Trunks. No. 62 Chatham Street, New York. Trays for Show Cases and Trunks a Specialty.

**Bricka, C. A.**—Manufacturer of Morocco Cases for Cutlery, Silverware, Jewelry, etc. Sample Cards and Rolls. Cases in Rosewood, Black Walnut, etc. 52 Nassau Street, New York.

**Dennison Mfg Co.**—Manufacturers of Morocco, Plush and Velvet Jewelry and Silverware cases. New York, Boston, Philadelphia, Chicago, Cincinnati and St. Louis.

**Ettlinger, L. & Sons.**—Manufacturers of Fine Cases for Jewelry, Watches and Silverware. Trays for Travelers and Show Cases. Cases to Order a Specialty. No. 80 Nassau St., N. Y.

**Haensler, Chas. C.**—Manufacturer of Fine Morocco Cases for Jewelry and Silverware. Toilet Boxes, etc. Trays for Show Cases and Windows. 14 John Street, New York.

**Jackson, S. C.**, 180 Broadway, N. Y., Manufacturer of Fine Cases for Jewelry, Silverware, &c.

**Kohn, Solomon & Co.**—Manufacturers of Fine Morocco Cases for Jewelry, Watches, etc. 43 Maiden Lane, New York.

**Lauten, Edw. A. & Co.**—No. 4 Great Jones St., Manufacturers of Fine Velvet, Brocade, Plush and Morocco Boxes, Patent Ring, Ear Ring and Gent's Scarf Pin Trays, Patent Watch and Bracelet Blocks, Window Decorations, etc.

**Loehr & Koerner**—Manufacturers of Morocco, Velvet, Satin, Jewelry, Watches and Silverware Cases, Jewel, Work Boxes, etc., Fancy Trays and Store Fittings to order. 96 Liberty St.

**Metropolitan Fancy Box and Leather Goods Manufactory**—Makers of Plush, Velvet, Satin and Leather Cases for Watches, Jewelry, Silverware, etc. 75 and 77 Nassau Street, N. Y.

**New England Morocco Case Co.**—Makers of Jewelry and Silverware Cases of every description. 220 Chapel Street, New Haven, Conn.

**New York Morocco Case Co.**—Cases for Jewelry, Watches, Silverware. Boxes and Trays for Jewelers' Travelers. Show Cases and Window Fittings. No. 69 Nassau Street, New York.

**Schien, Charles E.**—Manufacturer of Cases for Jewelry and Silverware, No. 85 Nassau St., N. Y. Show Case Trays, etc., at short notice.

**Schwarz, N.**—Manufacturer of fine Cases for Jewelry and Silverware, 866 Broadway, near 17th street, N. Y.

**Steinle, E.**—Manufacturer of Cases for Jewelry of all kinds. Also Cases for Mathematical and Surgical Instruments and for Trays for Travelers' Trunks, etc. 66 Nassau Street, N. Y.

**Welch & Miller**—169 Broadway. Manufacturers of fine Morocco, Velvet, Russia, Brocade and Plush Jewelry Cases. Trays of every description; Jeweler's Cotton and Twine.

**Wiggers & Froelick**—No. 60 Nassau street—Manufacturers of Cases for Jewelry, &c., of every description. Trays for Show-cases, Stands for Show-windows, etc.

**Jewelers' Findings.**

**Dennison Mfg Co.**—Paper Jewelry Boxes, cards, tags, pink and white cotton, etc. etc. New York, Boston, Chicago, Cincinnati, Philadelphia, St. Louis.

**Ettlinger, L. & Sons.**—Manufacturers of Jewelers' Paper Boxes and Findings. Morocco Paper, Satin or Plush Lined Wooden Corner Stops Jewelry and Silverware Boxes. 80 Nassau Street, New York.

**Valfer, S. & Co.**—Manufacturers and Dealers in Jewelers' Boxes, Tags, Cards, Paper and Findings. Trays a specialty. Office and Salesroom, 66 Nassau street, New York.

**Jewelry Manufacturers.**

**Aikin, Lambert & Co.**—Manufacturers General stock of Reliable Jewelry, 23 Maiden Lane.

**Alling, Isaac A. & Co.**—Manufacturers of Fine Gold Jewelry. Sets, Lace Pins, Ear Rings, Studs, Collar Buttons and Scarf Pins. Specialties: Wire Bracelets, Bangles, American Lever Sleeve Buttons. Bryant Building, Nassau and Liberty Streets, N. Y. Factory, Newark, N. J.

**Ball, W. H.**—Manufacturer of Gold Jewelry. Bracelets and Bangles of all kinds a specialty. 9 John Street, N. Y.

**Barthman, Straat & Co.**—Manufacturers of Fine Jewelry. Roman Goods, Rings, Diamonds. No. 43 Maiden Lane.

**Bissinger, Philip & Co.**—Importers of Diamonds, Pearls and Precious Stones. Sole Agents for the Bohemian Garnet Jewelry, Blue Enameled Lockets. 22 John St., N. Y.

**Brown, Thos. G. & Sons**—Manfrs of Rich Jewelry Necklaces, Locketts, Bracelets, Sleeve Buttons, etc., 5 Bond Street, N. Y.

**Bryant & Bentley**—Manufacturing Jewelers. Rings a specialty. 12 Maiden Lane

**Carter, Sloan & Co.**—Manufacturing Jewelers, 15 Maiden Lane, New York.

**Champerois & Co.**—No. 5 Maiden Lane, manufacturers of Engraved and Enameled Gold goods, in Sets, Ear Knobs, Bracelets, Studs, Lace and Shawl Pins, Jet cluster and Onyx goods, also "Best Lever" Sleeve Buttons.

**Chatellier, Joseph F.**—Manufacturing Jeweler, No. 694 Broadway, N. Y.

**Churchill, Lewis & Co.**—Manufacturers of Fine Jewelry. 692 Broadway, cor. Fourth St., N. Y.

**Cook, Groeschel & Co.**—Manufacturers of Fine Jewelry and Locketts, 191 Broadway (over Mercantile Bank,) N. Y.

**Cottle S. Co.**—Manufacturers of Fine Jewelry. Waltham Building, 5 Bond Street, N. Y.

**Cox & Sedgwick**—Manufacturers of fine Onyx and Colored Jewelry. 26 John St., New York

**Day & Clark**—Manufacturers of Fine Jewelry, Lace Pins, Ear Rings, Studs, Locketts, &c., 10 Maiden Lane, New York.

**Geoffroy, Arthur R. & Co.**—Manufacturing Jewelers. Novelties in Diamond Goods. No. 23 Maiden Lane, N. Y.

**Greene Wm. C. & Co.**—Goldsmiths; Manufacturers of Rich Sets in Taper Wire Coral. Office, 192 Broadway.

**Hale, S. W. & Co.**—Manufacturers Rich Jewelry, Whiting Building, Broadway and 4th Street.

**Hartmann, P.**—Manufacturer & Importer of Fine Gold, Diamond, and Filigree Silver Jewelry, No. 36 Maiden Lane. P. O. Box 2,454.

**Hedges, A. J. & Co.**—Manufacturing Jewelers, 6 Maiden Lane.

**Henderson & Winter**—Jewelers, No. 15 Maiden Lane, New York. Specialties—Stone, Cameo, Onyx, Amethyst, Topaz, Pearl and Turquoise Rings.

**Howard & Scherrieble**—Manufacturers of the American Lever Sleeve Button. 175 Broadway.

**Hunt & Owen.**—Manufacturing Jewelers. Office 3 Maiden Lane.

**Krementsz & Co.**—Manufacturing Jewelers. No. 182 Broadway, N. Y.

**Kuhn, Doerffinger & Co.**—Manufacturers of Enamelled and Roman Band Bracelets, also Fine Locketts Pendants and Lace Pins. 18 John street.

**Miller Bros.**—Manufacturers of Fine Jewelry, Locketts, Sleeve Buttons, Studs, &c., 7 Maiden Lane, N. Y.

**Moore & Horton.**—11 Maiden Lane, Manufacturing Jewelers, Rings, Studs, Collars and Sleeve Buttons, Pins, Ear-rings, &c.

**Muhr's, H., Sons.**—Manufacturing Jewelers. Solid Gold and Filled Rings a specialty. Also Manufacturers of the celebrated Crown Filled Watch Case. 16 Maiden Lane, N. Y.

**Owen, G. & S. & Co.**—Manufacturing Jewelers. Office, No. 3 Maiden Lane.

**Richardson, Enos & Co.**—Manufacturers of Fine Gold Jewelry, Gold Chains, Locketts, Crosses and Necklaces. Colored and Etruscan Work. No. 23 Maiden Lane, New York.

**Richardson, J. W. & Co.**—Manufacturers of Jewelry. Masonic and other Emblems. 196 Broadway, N. Y. Manufactory, Providence, R. I.

**Riley, J. A. & Co.**—Manufacturing Jewelers. Etruscan Gold and Roman-Bracelets, Lace Pins, Ear Rings, Scarf Pins, Brooch Pins, etc. Nos. 7 and 9 Bond Street, N. Y.

**Ripley, Howland & Co.**—Manufacturers of Fine Jewelry and Platinum Tipped Diamond Settings. No. 17 Maiden Lane, N. Y.

**Sauter, L.**—Manufacturer of Fine Jewelry, Solid Stone Rings and Studs a specialty. Jobbing for the trade. 1 Maiden Lane, New York.

**Schwencke, Wm.**—Manufacturing and Jobbing Jeweler. Repairing a specialty. Orders promptly attended to. No. 43 Maiden Lane, N. Y.

**Sexton & Cole**—Manufacturing Jewelers, Colored Gold and Onyx Goods a specialty. No. 30 Maiden Lane.

**Shafer & Douglas**, Manufacturing Jewelers—Roman Goods, Lace Pins, Cameo Sets, etc., Stone Rings, etc. No. 7 Maiden Lane, N. Y.

**Sheaffer, W. H. & Co.**—Manufacturing Jewelers, Specialty Bangles and Bracelets, 15 John St., N. Y.

**Stites' Sons, E.**—Manufacturers of Fine Jewelry. No. 14 John Street, N. Y.

**Street, Geo. O. & Sons.**—Established 1837. Makers of Fine Jewelry, strictly first-class goods of our own make. No. 15 John Street, New York.

**Thoma, Ernest**—Manufacturer of Fine Jewelry, Sleeve Buttons, Rings, Ear-rings, &c. No. 173 Broadway, N. Y. Factory, Hackensack, N. I.

**Ward, Thos. M.**—Manufacturer of Fine Jewelry, Diamond Mountings a specialty. No. 25 John Street, N. Y.

**Wienhold, Joseph**—Manufacturer of Fine Jewelry Diamond Mountings a specialty. 24 John St.

**Woglom & Miller**—Manufacturers of Black Onyx Goods exclusively. 32 & 34 John Street, N. Y.

**Jewelry—Rolled Plate.**

**Blackinton, W. & S.**—Manufacturers of the W. & S. B. Rolled Plated Chains. No. 11 Maiden Lane.

**Frick, John & Co.**—Fine Rolled Plate Jewelry of all kinds. Repairing of every description. 21 and 23 Maiden Lane, N. Y.

**Mauran, J. T.**—Manufacturer of Fine Rolled Plate Jewelry, No. 15 Maiden Lane, N. Y.

**Richards, E. Ira & Co.**—Manufacturers of Fine Rolled Plate Jewelry, No. 200 Broadway, N. Y.

**Jewelers' Tools, etc.**

**Fisher, James J.**—Dealer in Watchmakers' and Jewelers' Materials, Files, Tools, Silk Guards Spectacles, etc. 607 Broadway, N. Y.

**Friedenthal, A. & Co.**—Importers and jobbers of Watchmakers' and Jewelers' Tools, Materials, etc. 43 Maiden Lane, N. Y.

**Friedlander, R. & L.**—Importers of Watchmakers' Tools and Materials. 65 & 67 Nassau Street. Branch Office, 264 Bowery.

**Kurtz, F. P.**—Manufacturer of Jewelers Machinery, Tools, Rolling Mills, Presses, Polishing Lathes, &c. 97 Cliff St., N. Y.



**Levy, Dreyfus & Co.**—Importers and Jobbers of Watchmakers' and Jewelers tools and materials of every description. 11 Maiden Lane, N. Y.

**Montgomery & Co.**—Importers of and Dealers in Manufacturing Jewelers' Tools and Materials of every description, 105 Fulton street, New York.

**Reichhelm & Koester.**—Importers of Jewelers' Tools, Files, etc. Manufacturers of Brushes and Buffing wheels; also Patent Gas Furnaces for Melting, Plating, Enamelling, Annealing, etc. 80 Nassau St., N. Y.

#### Lapidaries.

**Fox, M. & Co.**—Practical Lapidaries, No. 1 Maiden Lane, New York.

**Graham & Co.**—Practical Lapidaries, Cutters and Polishers of all kinds of Precious Stones. Miners' Relics Cut, Polished and Mounted. Miniature, Locket and Clock Glasses. 80 Nassau St., N. Y.

**Kordmann & Michel.**—Lapidaries. Dealers in Precious Stones. Cutting and Polishing Rubies, Sapphires and other Gems a specialty. Drilling done promptly. 59 Nassau St., N. Y.

**Korn, Ph.**—Lapidary. Importer of Precious and Imitation Stones, No. 63 Nassau street, between Maiden Lane and John street, New York.

#### Masonic Jewelry.

**Luther, John F.**—79 Nassau Street. Manufacturer of Fine Presentation Jewels for all Societies. Knights Templars, Crosses, Badges, &c.

**Popper, H.**—Manufacturer of Medals and Badges for Military, G. A. R., Shooting, Masonic, Odd Fellows, Knights of Pythias, etc. 91 Essex St., New York.

**Wilkinson, C. B.**—Manufacturing Jeweler, 8 John St., N. Y. Medals, Badges and Masonic Jewelry, a specialty. Designs furnished free upon application.

#### Optical Goods.

**Friedlander, R. & L.**—65 and 67 Nassau Street. Dealers in Optical Goods.

#### Opticians.

**Burbank Manf'g Co.**—Manufacturers of Spectacles and Eye Glasses of all descriptions, in gold, silver, etc., 14 Maiden Lane, N. Y.

**DuBois, Geo. W. & Co.**—Importers of Watches and Optical Goods. 36 Maiden Lane, N. Y.

**Kahn, Hanover & Co.**—Importers of Spectacles, Eye-Glasses and Optical Goods generally, and Scientific Instruments of every description. 32 Maiden Lane, New York.

**Levy, Dreyfus & Co.**—Importers of Spectacles and Eye Glasses and Optical Instruments of every description, No. 11 Maiden Lane, N. Y.

**Lorsch, Albert**—Manufacturer of the Patent Accommodating Spectacles and Eye Glasses in Gold, Silver and Steel, and other Optical Goods, 37 Maiden Lane, N. Y.

**Spencer Optical Manufacturing Co.**—Gold, Silver, Steel, Nickel and Plated Spectacles; Gold, Celluloid, Steel, Nickel and Rubber Eye-Glasses and Opera Glasses. 13 Maiden Lane, N. Y.

#### Paper Boxes.

**Waterbury Paper and Box Co.**, 27 to 35 Canal St., Waterbury, Conn., Manufacture Jewelers' and Silversmiths' Fine Paper Boxes. Quality guaranteed to be equal to the best made.

#### Precious Stones, &c.

**Bishop, Victor & Co.**—33 Maiden Lane, Importers of Precious Stones, Cameos, &c. Also Manufacturers of Coral Jewelry.

**Bissinger, Philip & Co.**—Importer of Diamonds, Pearls and Precious Stones. Agent for the Bohemian Garnet Goods. Blue Enamelled Locketts. No. 22 John St., N. Y.

**Breidenbach, R. A.**—Importer of Black Onyx, Cameos, Turquoise, Pearls, Sardonyx, Amethysts, Topaz, Garnets, Opals, Rubies, Sapphires, Cat's Eyes, Hematites, Brilliants, Doublets, etc. 85 Nassau St., N. Y.

**Daue, Wm. & Co.**—Importer of Precious and Imitation Stones. No. 202 Broadway New York.

**Fox, M. & Co.**—Importers of Diamonds and other Precious Stones, No. 1 Maiden Lane, N. Y.

**Gruet, Jules.**—Importer of all Grades of Real and Imitation Stones. 14 John St., N. Y.

**Guntzburger Bros.**—Manufacturers and importers of Precious Stones—Amethysts, Topaz, Cameos, Garnets, Imitation Diamonds, &c. No. 9 Maiden Lane.

**Hahn & Co.**—Importers of Precious Stones. Cameos, Onyx, Pearls, Intaglios, Amethysts, Garnets, etc. 64 Nassau Street, New York.

**Kahn, L. & M.**—Importers of precious and imitation stones. 10 Maiden Lane, N. Y.

**Kipling, E. E.**—Importer of Precious and Imitation Stones. Manufacturer of the Patent Foil Solid Metal Back Rhine Stone Brilliant. No. 6 Maiden Lane, N. Y.

**Kipling, R. A.**—Precious and Imitation Stones, No. 24 Maiden Lane, N. Y. Manufacturer Cameos, Agates, Onyx, Etc., Oberstein, Germany. Commission Merchant, 49 Rue De L'Echiquier, Paris.

**Tannenbaum, L. & Co.**—Importers of Diamonds and Precious Stones. Steam Lapidary Works. Oriental Stones Cut and Polished a specialty. 65 Nassau St., N. Y.

#### Safes.

**Butler, W. H.**—Fire and Burglar Proof Safes, 291 Broadway, N. Y.

#### Silverware.

**Gorham Manufacturing Co.**—Union Square.

**Knowles, J. P. & S. M.**—Manufacturers of Sterling Silverware, 20 Maiden Lane, N. Y. Factory, Providence, R. I.

**Shiebler, Geo. W.**—Manufacturer of Sterling Silverware. No. 8 Liberty Place, near Maiden Lane, N. Y.

**Whiting Manufacturing Co.**—Makers of Sterling Silver Ware. Broadway cor. 4th Street, N. Y.

**Wood & Hughes.**—Manufacturers of Fine Silverware. 16 John Street, N. Y.

#### Silver Filigree Jewelry.

**Cuppia, L. A.**—Manufacturer of Solid Silver Novelties, and Importer of Silver Filigree, 19 Union Square.

**Francesconi, Guido**—Importer of Silver Filigree Jewelry, 196 Broadway, New York.

**Hartmann, P.**—Manufacturer of Silver Filigree Jewelry. 36 Maiden Lane, N. Y.

#### Silver Plated Ware.

**Hartford Silver Plate Co.**—Manufacturers of Fine Electro-Plated Ware. Factory and Salesroom, 28 High Street, Hartford, Conn.

**Holmes, Booth & Haydens**—Manufacturers of Silver-Plated Ware. 47 Chambers Street.

**Manhattan Silver Plate Co.**—Manufacturers of Silver Plated Ware. Showrooms, 23 John St. Factory, 301 to 305 East 22d St., cor. 2d Ave. Address all communications to Factory.

**Middletown Plate Co.**—Manufacturers of Superior Electro-Plate. Factories, Middletown, Conn., salesroom, 13 John Street.

**Rogers & Bro.**—Manufacturers of the finest quality of Electro-Plated Ware. 690 Broadway.

**Rogers, Smith & Co.**—Manufacturers of Fine Electro Plated Ware. No. 46 E. 14th St., N. Y.

**Simpson, Hall, Miller & Co.**—Manufacturers of fine Silver-Plated Ware. No. 36 E. 14th Street.

**Schade, Henry.**—Manufacturer of White Metal and Plated Ware. Nos. 56 & 58 Ainslie Street, Brooklyn, E. D., N. Y. Price list and catalogue furnished on application.

**The Derby Silver Co.**—Manufacturers of Finest Quadruple Silver Plated Ware, Birmingham, Conn. New York office, 25 Maiden Lane.

**Webster, E. G. & Bro.**—Manufacturers of Fine Silver-Plated Ware. Office and warerooms, 14 Maiden Lane, N. Y.

#### Show Cases, Etc.

**Smith, B. & W. B.**—Manufacturers of Patent Improved Dust Proof Show Cases, with Perpendicular Sliding Doors, No. 220 W. 29th St., N. Y.

#### Spectacle Case Manufacturers.

**Bertine, P. D.**—Manufacturer of Spectacle and Eye-Glass Cases. 139 William Street, near Fulton St., New York.

**Koenen, A. & Bro.**—Manufacturers of Leather Spectacle and Eye-Glass Cases. 81 Nassau St., N. Y.

#### Stem Winding Attachments.

**Abbott, Henry** Maker of Stem Winding Attachments, No. 7 Maiden Lane, N. Y.

#### Thermometers, Etc.

**Tagliabue, Giuseppe.**—manufacturer of Thermometers, Barometers and Hydrometers. Patentee and sole manufacturer of the U. S. Standard Hydrometer. 302 Pearl Street, near Beekman.

#### Thimble Manufacturers.

**Barker Manuf'g Co.**—Makers of Patent Graduated Thimbles, Stiffened Gold, Filled Gold and Rolled Gold, 36 Maiden Lane, N. Y. A. Lyons, Ag't. Factory, 129 Eddy St., Providence, R. I.

**Burbank Manuf'g Co.**—Manufacturers of Gold and Silver Thimbles, 14 Maiden Lane, N. Y.

**Ketcham & McDougall.**—Improved Gold and Silver Thimbles, Bryant Building, N. Y.

**Simons Bro. & Co.**—Manufacturers of Gold and Silver Thimbles. 611 and 613 Sansom Street, Philadelphia.

**Woglom & Miller.**—Sole Agents for the "Prime" Thimbles in Gold and Silver, manufactured by Ezra C. Prime. 34 John Street, N. Y.

#### Watch Companies.

**American Watch Co.**—Robbins & Appleton, No. 5 Bond Street, N. Y.

**The E. Howard Watch and Clock Co.**—Cor. Maiden Lane and Nassau Street, N. Y.

**Waterbury Watch Co.**—Manufacturers of the Waterbury Watch. Factory, Waterbury. Office, 52 Maiden Lane, N. Y.

#### Watch and Chronometer Jeweler.

**Queen, James.**—Watch and Chronometer Jeweler and Pallet Maker, 78 Nassau Street, room 8. Pivots inserted in Pinions, Balance, Staffs, etc.

**Robert, Henry L.**—Practical Chronometer and Watch Jeweler, and Adjuster of all kinds of Escapements. 71 Nassau Street (Room No. 3). All kinds of Pallet and Hole Jewels for Chronometer Watches and Compasses done in the best manner.

**Wennstrom, John.**—Watch, Chronometer and Clock Jeweling, Jewel Gauges, Ruby and Sapphire Draw Plates; Diamond Charged Polishing Stones for Jewel Settings; Pivots inserted in Pinions. 2 Dutch Street, N. Y.

#### Watch Importers, Etc.

**Abry, Chas. Leo**—Importer and Manufacturer of Swiss Watches of all grades. 63 Nassau Street.

**Aikin, Lambert & Co.**—Importers of Watches. Sole Agents for Paul Breton & Chas. Latour, Geneva. A general line of reliable Swiss Watches, Watch Cases, etc. 23 Maiden Lane, N. Y.

**Bartens & Rice**—20 John Street, Importers of Watches and sole agents in the United States for the celebrated Nicole, Nielsen & Co. Watches.

**Cross & Beguelin.**—Importers of Watches, Watch Tools and Materials, dealers in American Watches, No. 21 Maiden Lane, N. Y.

**Droz, Henry E.**—Importer of Watches, and Watch Case Manufacturer. Agent for the "E. Perregaux" Watch, and jobber in American Watches No. 92 Fulton Street, N. Y.

**Freund Max & Co.**—Importers of Watches, Jewelry and Precious Stones, 8 Maiden Lane, N. Y.

**Gagnebin, Chas.**—Importer of all kinds of Swiss, and Dealer in American Watches. 4 Maiden Lane, N. Y. Agent for Ulysse Breting's Fine Chronometers, Chronographs, Anchors, &c.

**Gallet, Julien.**—Importer of Watches. No. 1 Maiden Lane.

**Ginnel, Henry**—Importer of Watches, Tools and Materials, 31 Maiden Lane, N. Y. P. O. Box 2967

**Hyde's Sons, John E.**—Wholesale Commission Agents, only for Jules Jurgensen, of Copenhagen; Jules Monard, of Geneva; and for other makers of all qualities of Watches, 22 Maiden Lane.



**Keller, L. H. & Co.**—Successors to G. A. Huguenin, Importers of Fine Watch and French Clock Materials, No. 64 Nassau Street, N. Y.

**Mathey Bros. & Mathez.**—Importers of Fine Watches and Sole Agents for the **H. L. Matile's** Watches. No. 16 Maiden Lane.

**Robert, J. Eugene.**—No. 30 Maiden Lane, New York. Agent for Louis Audemar's celebrated watches.

**Schwob, Adolphe.**—Manufacturer and Importer of Watches, 11 Maiden Lane, N. Y.

**Strasburger, Louis & Co.**—Importers and Makers of Watches of every description, 15 Maiden Lane.

#### Watch Cases.

**Dueber Watch Case Mfg Co.**—Manufacturers of Gold and Silver Watch Cases. Bryant Building, N. Y. Factory, Newport, Ky.

**Duhme & Co.**—Manufacturers of Gold and Silver Watch Cases, Carlisle Block, Fourth and Walnut Streets, Cincinnati.

**Fahys, Joseph.**—Manufacturer of Watch Cases and Dealer in American Movements, 38 Maiden Lane.

**Glatz, Chas.**—Manufacturer of Silver Watch Cases. Bryant Building, cor. Nassau and Liberty Sts.

**Keller & Untermeyer.**—Manufacturers of Watch Cases with Raised Gold Ornaments. 9 Maiden Lane, N. Y.

**Ladd Watch Case Co.**—Manufacturers of the Ladd Patent Stiffened Gold Watch Cases, etc., 11 Maiden Lane, N. Y. Factory, 58 Eddy Street, Providence, R. I.

**The Brooklyn Watch Case Co.**—Manufacturers of the celebrated Eagle Case. 40 Maiden Lane.

**Willemin Watch Case Co.**—Makers of Gold Watch Cases. Raised Gold Ornamentation and Jurgensen style of Engine Turning. 109 Sands Street, Brooklyn, N. Y. 16 Maiden Lane, N. Y.

#### Watch and Chronometer Repairers.

**Cerf, B.**—Practical Watchmaker and Repairer, No. 10 John Street, N. Y. Repairing and adjusting of Fine Watches done for the trade. All kinds of escape and stem-winding wheels cut to order.

**Goepf, Frederick A.**—Practical Watchmaker. Repairing of every description for the Trade. 25 Maiden Lane, N. Y. In office of H. Garland, Engraver.

**Heinrich, H. H. & Co.**—Sole Manufacturers of H. H. Heinrich's Patent Auxiliary Balance, and Adjusters and Repairers of Fine Watches and Chronometers. 12 John Street, N. Y.

**La Croix, J. H.**—(Late with Benedict's Time.) Watch and Clock Maker, 21 John Street, N. Y. Clocks of every description Repaired for the Trade.

**Lesperance, Theo.**—Watchmaker and Wheel Cutter. Also Stoning Nickel Movements. No. 1 Maiden Lane, New York. With Julien Gallet.

**Ludeman, W. H.**—Chronometer and Watch Maker. Repairing of every description for the trade, 75 and 77 Nassau Street.

#### Watch Case Repairers.

**Feinier, Joseph A.**—Watch Case Maker and General Repairer. Specialty in fine Gold and Silver Cases. Jobbing promptly attended to. Nos. 4 and 6 John St., N. Y.

**Tarbox, Hiram.**—Watch Case Repairing, Springing, Polishing and Engine Turning. 1874 North Fourth Avenue, bet. 176th and 177th Sts., N. Y. Express Packages should be sent to 92 Fulton Street.

#### Watch Glasses, Shades, Etc.

**Brown, Edwin H.**—No. 85 Nassau Street, Imported and Own Manufacture Watch Glasses, Flat, Flat Concave, Concave, Convex and fine Geneva's. Fine fitting solicited.

#### Watches, Diamonds and Jewelry.

**Alford, C. G. & Co.**—Manufacturers. General line fine and Reliable Goods. Specialties in Onyx Goods and Chain. 200 Broadway, New York.

**Cohn, J. J.**—Importer and Manufacturer of Whitby Jet, Rubber and Pearl goods. Gold and Rolled-plate Jewelry, etc. 12 Maiden Lane, New York.

**Durfey & Reynolds.**—Successors to Durfey & Shiebler, Watches, Diamonds, Jewelry. No. 9 John Street, (up-stairs) New York.

**Friedman, Saml.**—Wholesale Dealer in Watches and Jewelry, 42 Maiden Lane, N. Y.

**Goddard, John M.**—Manufacturing Jeweler.—Seal Rings and Fine Locketts a specialty, No. 3 Maiden Lane, N. Y.

**Greason J. R. & Co.**—Successors to Arthur, Rumrill & Co., 182 Broadway. Manufacturers of Fine Jewelry and Gold Chains, also Diamond Mountings.

**Haskell, H. C.**—Manufacturing Jeweler. Seal Rings a specialty. Special attention to Jobbing of every description. 12 John street.

**Herzog, Louis & Co.**—Importers of Watches, Dealers in Diamonds and Jewelry, 52 Maiden Lane, N. Y.

**Hirsch Bros.**—Dealers in Watches and Diamonds and Manufacturers of Jewelry, No. 23 Maiden Lane, N. Y.

**Jandorf, P. & Bro.**—Importers of Watches and Jewelry, 196 Broadway.

**Kennedy, Frank S.**—Manufacturer and Wholesale Dealer in Jewelry and Gold and Silver Thimbles, No. 13 Maiden Lane, New York.

**Lissauer & Sondheim.**—Wholesale Jewelers and Jobbers in American Watches, No. 12 Maiden Lane, N. Y.

**Marx, Kossuth & Co.**—Importers of Watches and Dealers in Jewelry. 39 Maiden Lane, N. Y.

**Mayer, B.**—Manufacturer of Fine Jewelry, and Dealer in Watches, 71 Nassau street, cor. John street, New York.

**Myers, S. F. & Co.**—Manufacturing and Wholesale Jewelers—all grades. Importers of Watches. Illustrated Catalogue to the trade. 179 Broadway, N. Y.

**Oppenheimer Bros. & Veith.**—Dealers in Watches and Diamonds, and Manufacturing Jewelers, No. 35 Maiden Lane.

**Scott, J. T. & Co.**—Importers of Watches, and Manufacturers of Jewelry, and Jobbers of all Grades of American Watches, 11 Maiden Lane.

**Smith & Knapp.**—Wholesale Dealers in American and Swiss Watches, Diamonds, Gold and Plated Jewelry and Gold Chain. 182 Broadway, N. Y.

**Steele, J. W.**—Successor to Brainerd, Steele & Co., Manufacturer of Fine Jewelry and Brainerd's Patent Locketts. No. 9 Maiden Lane, N. Y.

**Stern Brothers & Co.**—Importers of Swiss Watches and wholesale dealers in American Watches, &c., 39 Maiden Lane.

**Stern & Stern.**—Dealers in Watches, Jewelry and Diamonds. No. 6 Maiden Lane, N. Y.

**Stites, D. H. & Son.**—Manufacturers of Fine Jewelry, Rolled Plated Goods and Chains, Parisian Diamond Rings, Studs and Earrings a specialty. 41 Maiden Lane, N. Y.

**Strauss, Jacob.**—Full Line of Gold and Plated Jewelry, and Importer of Watches. 18 John Street, New York.

**Thrall, E. A.**—Wholesale Dealer in Watches and Jewelry. No. 1 Maiden Lane, N. Y.

**Trier Bros.**—Importers of Garnet, Whitby Jet and Amber Jewelry, Silk Guards, Opera, Field and Marine Glasses, Pearl Card Cases. Also a full line of Gold and Plated Jewelry. 15 Maiden Lane, N. Y.

**Wheeler, Parsons & Hays.**—Manufacturers of Fine Jewelry, Watch Cases, Gold Chains, &c. and Dealer in American and Swiss Watches, No. 2 Maiden Lane, N. Y.

**White, N. H.**—Jobber in American-Waltham Watches and Chronographs. Waltham make of 10-k., 14-k. and 18-k. Gold and Sterling Silver Cases; Filled Gold Cases. 11 Maiden Lane.

#### Watch Tools, etc.

**Keller, L. H. & Co.**—Importers of Watchmakers' and Jewelers' Tools, Materials, etc. 64 Nassau Street, N. Y.

**Zimmern, Henry.**—Importer of Watch Materials, Tools, and Optical Goods, No. 8 Maiden Lane, (first floor.) Sole Agent for A. Hugenin & Gravier. Mainsprings, New York.

## PHILADELPHIA

**Bennett, Jacob & Son.**—Diamond Setters and Manufacturing Jewelers, 925 Chestnut St.

**Bernard & Co.**—Manufacturers of Fine Roman and Etruscan Jewelry. Designs of every description made to order, 123 & 125 South Eleventh Street, Philadelphia.

**Booz & Co.**—Manufacturers of Gold and Silver Watch Cases and Jewelry, 108 South 8th St., Philadelphia.

**Conover David F. & Co.**—American Watches, Wholesale Salesroom, Southeast corner 7th and Chestnut Streets, Philadelphia.

**Herold, Chas P.**—Successor to Hildebrandt, Herold & Co., Manufacturing Jeweler and Diamond Setter. Diamonds, 916 Chestnut Street.

**Krieder, Peter L.**—Manufacturer of Sterling Silver Ware. 618 Chestnut Street, Philadelphia.

**Morgan & Headly.**—Manufacturing Jewelers, Cameo Sets, Gold Sets, Roman Locketts, Rings, Coral Sets and a general line of rich goods. Corner 10th and Chestnut Streets, Philadelphia.

**Muhr's, H. Sons.**—Manufacturing Jewelers. Solid Gold and Filled Rings a specialty. 633 and 635 Chestnut Street, Philadelphia. 1½ Maiden Lane, New York.

**Peters, Reese S.**—Manufacturer of Patent Rolled Plate or Filled Watch Cases, Dealer in American Movements, 308 Chestnut Street, Philadelphia.

**Rosenthal, G. F. C.**—Manufacturing Jeweler and Diamond Setter. Engraving and Designing of Monograms a specialty. No. 917 Sansom Street.

**Scherr, L. A. & Co.**—Wholesale Dealers in Watches Silver-Plated Ware, Spectacles, Fancy Goods, Watch Materials, etc. 726 Chestnut Street.

**Sheafer, W. H. & Co.**—Manufacturing Jewelers. Specialty: Band Bracelets. Factory. 612 and 614 Chestnut street, Philadelphia. Office, 15 John street, New York.

**Simons, Brother & Co.**—Manufacturers of Fine Jewelry, Canes, Thimbles, Chains. 611 and 613 Sansom Street.

## CHICAGO.

**American Watch Company.**—of Waltham, Mass. No. 102 State Street, Chicago.

**Clapp & Davies.**—Wholesale Jewelers, 63 and 65 Washington Street. Catalogue and price list issued to watchmakers and jewelers.

**Dentison Manufacturing Co.**—Manufacturers of Jewelers' Paper Boxes, Morocco Cases, Tags, Cards, Pink and White Cotton, Tissue Papers, Sealing Wax, &c., &c., 102 Madison St., Chicago. Boston, New York, St. Louis, and Philadelphia.

**Excelsior Sign Co.**—Manufacturers of (Grout's Excelsior) Iron Watch and Spectacle Signs. 124 Fifth Avenue, Chicago, Ills.

**Gilbert, Wm. L., Clock Co.**—Manufacturers of Clocks, Regulators, and Time Pieces, and Clock Material of every description, 54 and 56 Madison Street, Chicago.

**Giles, Bro. & Co.**—Manufacturers and Jobbers in Watches, all classes of Jewelry, Materials, Clocks, Silver Ware, &c. Illustrated catalogues furnished to dealers on application. 101 & 103 State St.

**Stein & Ellbogen.**—Wholesale Dealers in Watches and Jewelry, 127 State Street, Chicago, Ill. Specialty, repairing for the trade.

**Wathier, Joseph P.**—Watchmakers and Jewelers for the trade, and Wholesale Dealers in Watch Materials, Tools, etc. 178 West Madison Street, Chicago, Ill. Send for price list.

**Wendell, Charles & Son.**—Wholesale Watches, Jewelry, etc. 170 State street, Chicago.

## NEWARK.

**Baker & Co.**—Gold, Silver and Platinum Refiners, Assayers and Sweep Smelters. 408 New Jersey Railroad Avenue, cor. Murray St., Newark, N. J.



**Diefenthaler Bros. & O'Donnell**—Manufacturers of Fine Jewelry, Lace Pins, Ear Rings and Patent Spring Bangles a Specialty. 36 Crawford Street, Newark, N. J.

**Felger, F. & F.**—Manufacturing Jewelers. Specialties:—Roman Band Bracelets, Lace Pins, Scarf Pins, Ball and Fancy Ear Rings. No. 477 Washington Street, Newark, N. J.

**Fiedler, Herrman**—Successor to Kunze & Fiedler, Engraver, Die Sinker and Press Tool Maker, 363 Market Street, Opposite Pennsylvania R. R. Depot, Newark, N. J.

**Glorieux, W. L.**—Assayer, Refiner and Sweep Smelter. 13 and 15 Franklin Street, Newark, N. J.

**Hopper & Wilson**—Manufacturers of Fine Jewelry, No. 8 Maple Place, Rear 44 Green St., Newark, N. J.

**Huger & Heitlinger**—Manufacturers to the Jobbing Trade only. Makers of Roman Stone, Engraved and Enameled Locketts, also Sets, Lace Pins and Ear Rings. Rear 477 Washington St.

**Krippendorf, C. & Schuller, F.**—Machinists and Jewelers' Tool Makers. 19 Greene Street, Newark, N. J. Rolls, Dies, Cutters, and Draw-plates of every Description made and repaired.

**Lelong, L. & Bro.**—Gold and Silver Refiners. Assayers and Sweep Smelters, Southwest corner of Halsey and Marshall Streets, Newark, N. J.

**Miller & Beam**—Manufacturers of Enameled Sets, Ear Rings, Lace Pins, etc. Guard Slides and Pendants a Specialty. 21 and 23 Green Street.

**Milne, Alex.**—Manufacturer of Stem-winding Watch Crowns. 19 Ward Street.

**Plumb & Marcus**—Manufacturers of Traveling and Marine Clocks, Electric Appliances. 289 Washington St., Newark, N. J.

**Regad, E. D.**—Lapidary. Specialty—Sardonyx, Black Onyx and Agates. 14 Oliver St., Newark.

### PROVIDENCE

**Arnold & Webster**—Manufacturers of Solid Gold Engraved Band Rings for the Jobbing Trade. 29 Point Street, Providence, R. I.

**Capron & Co.**—Manufacturers of Jewelry. Engraved Box Bracelets, Bangle Wire Bracelets, Original Lever Collar and Cuff Button. No. 407 Pine Street, Providence, R. I.

**Coombs & Tuttle**—Manufacturers of a large variety of Fine Bracelet and Eye-Glass Chain in Gold Plate and Silver, Spring Rings, Holders, Hooks, Snaps, etc. 35 Point St., Providence, R. I.

**Hamilton, William & Co.**—Manufacturers of Fine Rolled Plated Chains and Patent Band Bracelets. 116 Pine St., Providence, R. I.

**Hough, W. S., Jr., & Co.**—Manufacturers of the Hough, Jr., Rolled Plate Locketts, Charms and Pendants. For sale by all first-class Jobbers or Wholesale Jewelers in the United States and Canadas.

**Hutchison & Huestis**—Makers of Solid Gold Rings. Quality guaranteed. For the Jobbing Trade only. 185 Eddy Street, Providence, R. I.

**Irons, Chas. F.**—Manufacturer of Solid Gold Jewelry. Specialty, Emblems, Pins and Charms, Masonic, Odd Fellows, etc. 102 Friendship St.

**Pearce & Hoagland**—Manufacturers of Gold Pens, Holders, Pencils, Tooth Picks, etc. Also the Quill Reserve Tooth Pick. 29 Point Street, Providence, R. I.

**Taylor, Geo. H. & Co.**—Watchmakers and Wholesale Dealers in Watches, Clocks, Watch and Clock Material, Tools, Spectacles, Eye Glasses, &c. Particular attention given to trade work. 136 Westminster Street (Room 1), Providence, R. I.

### PAWTUCKET.

**Draper, J. O. & Co.**—Manufacturers of Jewelers' Fig Soap, adapted for Washing Jewelry, Scratch Brushing and Drawing Wire. Pawtucket, R. I.

**Fuller, Geo. H. & Son**—Jewelers' Findings, Gold, Silver, Gold Plated and Fire Gilt. Pin Stems, Joints, Catches, Split Rings, Chain Hooks and Swivels, Ear Wires, Chain Bars, etc. 99 Exchange Street, Pawtucket, R. I.

### CINCINNATI.

**Hellebush, Clemens**—Manufacturer, Importer and Wholesale Dealer in everything required by the Jewelry Trade. 77 W. Fourth St., Cincinnati, O.

**Holland, John**—Manufacturer of Gold Pens, Pencils and Pencil Cases, Gold Toothpicks, etc. Nos. 19 and 21 W. 4th St., Cincinnati, Ohio.

**Lodwick & Nolting**—Wholesale Jewelers, S. W. cor. 4th & Walnut Streets, Cincinnati.

### BALTIMORE.

**Gruebel & Kesmodel**—Manufacturers of Fine Diamond Etruscan, Enameled, Plain and Rhine Stone Jewelry to order. Repairing a specialty. Orders by Mail solicited. 212 & 214 W. Baltimore St., Balto., Md.

### BOSTON.

**Boston Watch Case Co.**, makers of Watch Cases. Especial attention given to Repairing. 1, 3 & 5 Province Court, Boston, Mass.

**Boyce, E. J.**—Manufacturer of Solid Gold Jewelry. Rings a Specialty. 383 Washington St., Boston, Mass.

**Smith, Wm. A.**—Importer of Diamonds and Precious Stones. Diamonds mounted and unmounted and Diamond Mountings. 383 Washington St., Boston, Mass.

**Weber, H. & Co.**—Wholesale Jewelers, Importers and Jobbers of Fine Watch Materials, Jewelers' Findings, Tools, etc., Optical Goods and Silk Guards. Agents for Whitcomb, Standard and Stark's Lathes. 424 Washington St., Boston, Mass.

### BUFFALO.

**King & Eisele**—Manufacturers of Solid Gold Jewelry, and Agents for American and Foreign Watches; also Jobbers in Roll Plate Jewelry. Office and Salesrooms, 283 Main St. Factory, 2, 4, 6 and 8 Swan St.

**Oliver, W. W.**—Manufacturer of Hand and Power Rolling Mills for Jewelers and Silversmiths, 39 Clinton Street, Buffalo, N. Y.

### CLEVELAND.

**Chandler, J. M. & Co.**—Manufacturers of the Patent Embossed Bracelet and Jobbers in all kinds of Clocks, Watches, Jewelry, Tools, Materials, etc. 185 Superior St., Cleveland, O.

### LANCASTER.

**Bowman & Musser**—Jobbers in Watches, Clocks, Chains, Fine Tools and Materials. 20 East Chestnut Street, Lancaster, Pa.

### PITTSBURGH.

**Barrett, G. B. & Co.**—Importers and Wholesale Dealers in Watches, Diamonds, Jewelry, Clocks, Bronzes, Silver and Plated Ware, Watch Materials, &c., 238 & 240 Liberty St.

**Goddard, Hill & Co.**—Wholesale Dealers in American Watches, Jewelry, Silverware, Clocks, Materials, &c., 43 Fifth Avenue, Pittsburgh, Pa.

**Hodge, Slemmons & Co.**—Wholesale Dealers in American and Swiss Watches, Diamonds, Gold and Plated Jewelry, Clock Material, etc. No. 77 Fifth Ave., Pittsburg.

### CANADA.

**Ellis, P. W. & Co.**, No. 31 King street, East Toronto, Ontario, Manufacturing Jewelers, Watchmakers, importers and Jobbers of Watchmakers, and Jewelers' Tools, Materials, General Supplies and American Jewelry. Correspondence solicited with manufacturers of Novelties or specialties in American Tools and Jewelry.

**POSITIVELY NO GOODS RETAILED.**

**BOWMAN & MUSSER,**

SUCCESSORS TO

**E. F. BOWMAN,**

JOBBERS IN

**Watches, Clocks, Chains,**

Fine Tools and Materials,

**20 E. CHESTNUT STREET,**

Cop. P. R. R. Passenger Depot,

**LANCASTER, PA.**

Selection Packages sent to Regular Jewelers on Request.

**BARNES'**  
**NO. 4 LATHE,**  
For the Heavier Work of Jewelers.

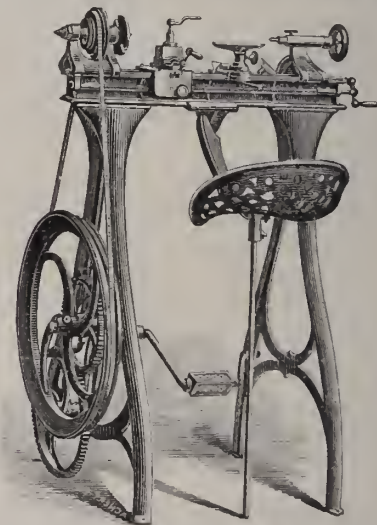

Barnes' Patent Foot and Steam Power Machinery. Complete outfits for Actual Workshop Business. Lathes for wood or metal. Circular Saws, Scroll Saws, Formers, Mortisers, Tenoners, etc., etc. Machines on trial if desired. Descriptive Catalogue and Price List Free.

**W. F. & JOHN BARNES,**  
2088 Main Street, ROCKFORD, ILL.



**SOLID GOLD**

AND

**STONE INLAID**

**Cigar Cutter,**

Pat'd Oct. 5, 1880.

**J. WIENHOLD,**

Manufacturer of FINE JEWELRY.

**DIAMOND MOUNTINGS A SPECIALTY.**

24 John St., N. Y. City.















