

Jewelry
Gem Cutting, and
Metalcraft

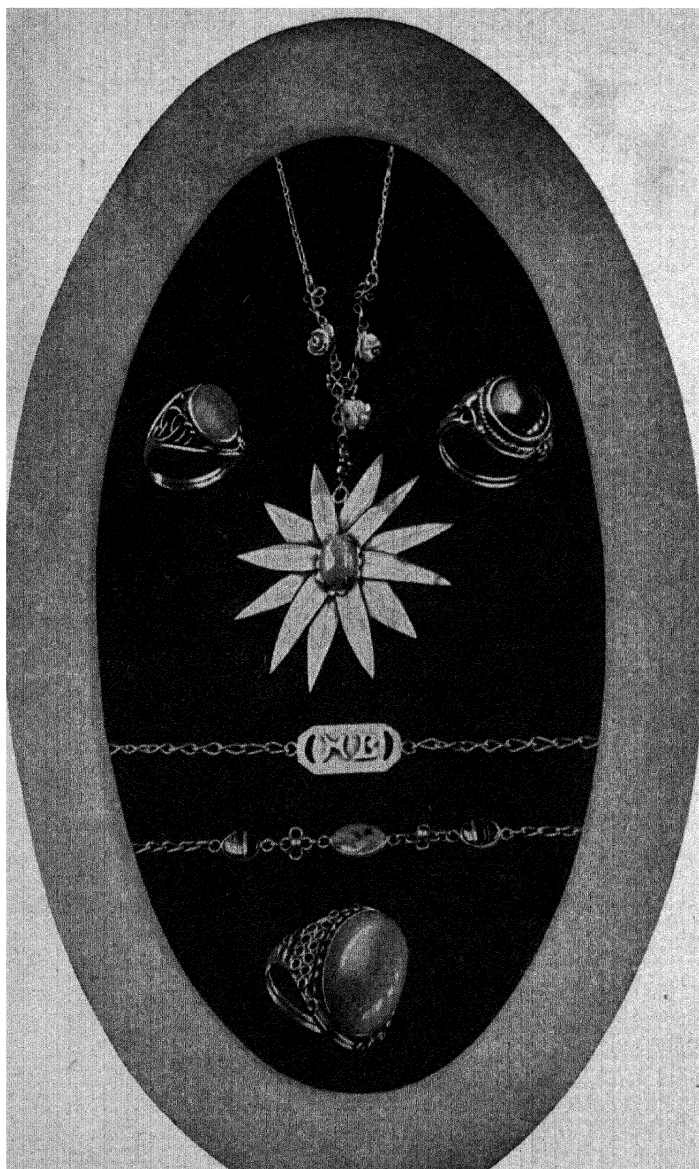

Jewelry Gem Cutting, and Metalcraft

REVISED EDITION

by

WILLIAM T. BAXTER, M.A.

Instructor, Art Metal and Jewelry, Woodrow Wilson High School,
Washington, D. C.; Coauthor of "Woodworking
Projects and Upholstery"

With a section on Identification of Gem Stones

By HENRY C. DAKE

Editor, The Mineralogist

SECOND EDITION

WHITTLESEY HOUSE
McGRAW-HILL BOOK COMPANY, INC
NEW YORK · LONDON

JEWELRY, GEM CUTTING, AND METALCRAFT

Copyright, 1938, 1942, by the McGraw-Hill Book Company, Inc

All rights reserved. This book, or parts thereof, may not be reproduced in any form without permission of the publishers.

TENTH PRINTING

The quality of the materials used in the manufacture of this book is governed by continued postwar shortages.

PUBLISHED BY WHITTLESEY HOUSE
A Division of the McGraw-Hill Book Company, Inc.

Printed in the United States of America by The Maple Press Co., York, Pa.

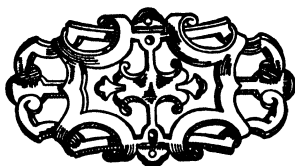

Preface to the Second Edition

SINCE the publication, in 1938, of the first edition of "Jewelry, Gem Cutting, and Metalcraft," there has been an ever growing interest in the fascinating hobby of gem cutting and mounting stones in hand-wrought jewelry. Gem cutting has in recent years been introduced into many schools in connection with jewelry making and art metalwork.

In this revised edition the section devoted to gem cutting has been increased by 48 pages, with 31 new illustrations. Additional information, with illustrations, is given on the making of diamond-charged disks used for sectioning gem material and on tube drilling. The use of abrasives in lapidary technique and of flat laps is fully discussed. In the jewelry section 23 new illustrations are used, which include 61 new pieces of handmade jewelry, bringing the total number of pieces of jewelry shown to 146.

Preface to the Second Edition

For suggestions and assistance given during the preparation of this second edition the author is grateful to Mr. John Grieger, Pasadena, Calif.; Mr. Vaden Covington, Redlands, Calif.; Mr. Edward Bush, a former student of the author, Bethesda, Md.; Wildberg Bros. Smelting and Refining Co., Los Angeles, Calif.; Mr. H. L. Monlux, Los Angeles, Calif.; Mr. Wilfred C. Eyles, Hayward, Calif.; Norton Company, Worcester, Mass.; The Carborundum Co., Niagara Falls, N. Y.; Vreeland Lapidary Mfg. Co., Portland, Ore.; and numerous friends and students.

WILLIAM T. BAXTER.

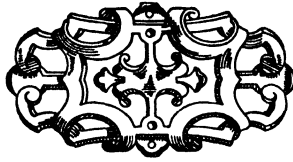

Preface to the First Edition

THIS book is written primarily for the student and home craftsman who is interested in metalcraft, jewelry making, and gem cutting. It is based upon methods used by the author in teaching high school students.

The photographs of the various objects illustrated are of student work, with the exception of those showing the work of Mr. Mardirosian, a professional of New York City.

Many of the pieces of jewelry shown are the work of beginners—boys and girls—who in many instances had been working at the art only a short time. Their work is used for illustrative purposes so that others interested in the work can see what high school students, amateurs, have accomplished.

Photographs of a number of the pieces of jewelry have appeared in the Home Workshop Department of the

Preface to the First Edition

Popular Science Monthly, illustrating articles on jewelry making.

A list of firms dealing in various kinds of equipment and supplies that are needed in the different types of work is given on pages 275 to 278 to help those who do not know where to secure their material.

The author is indebted to the following for making this book possible: students of art metal and jewelry classes of Woodrow Wilson High School, for the privilege of photographing their work; Mr. Joseph L. Kochka, Instructor of Commercial Subjects, Woodrow Wilson High School, for the use of photographic equipment; Dr. Henry C. Dake, editor of *The Mineralogist*, Portland, Ore., for the chapter on Identification of Gem Stones and Gem Minerals, and for assistance in preparing material on gem cutting; Wildberg Bros. Smelting and Refining Co., Los Angeles, Handy & Harman, New York City, and Thomas J. Dee & Co., Chicago, for technical information on gold and silver; and the Copper and Brass Research Association, New York City, for information on copper and brass.

Appreciation is also extended to the following for supplying photographs or material to be photographed: William Dixon, Inc., Newark, N. J.; Buffalo Dental Mfg. Co., Buffalo, N. Y.; N. Mardirosian, New York City; Gus Brockman, Portland, Ore.; Clinefelter and Larson, Oswego, Ore.; Bausch & Lomb Optical Co., Rochester, N. Y.; The Polarizing Instrument Co., New York City; and Ultra-Violet Products Co., Los Angeles.

WILLIAM T. BAXTER.

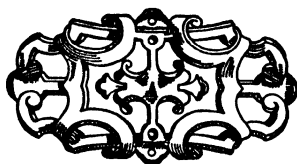

Contents

PREFACE TO THE SECOND EDITION	v
PREFACE TO THE FIRST EDITION	vii
FOREWORD	xi
<i>Part I—METALCRAFT</i>	1
Copper, Brass, Nickel silver, Monel metal, Pewter, Soft-soldering, Etching, Annealing, Pickling, Polishing, Coloring, Jewelers' saw frames and blades, Paper knives, Match box holder, Book ends, Letter holders, Desk calendar, Picture frame, Whisk broom holder, Tray making, Making a bowl, Tea bells, Wood and metal projects, Alphabets.	
<i>Part II—JEWELRY MAKING</i>	45
Tools and equipment, Silver soldering, Chain making, Ring making, Polishing, Oxidizing, Setting of stone, Sheet-silver rings, Rings from wire, Belt buckle ring, Bracelets, Bangle bracelets, Belt buckle bracelet, Necklaces and pendants, Scarf pins, Cuff links, Eardrops, Tie clips, Brooches and clips, Belt chains and watch fobs,	

Contents

Key chain, Indian jewelry, Discarded dental instruments, Use of investments, Ring casting in sand, Casting flat objects, Finishing cast rings, Gold and silver, Semiprecious stones.

Part III—THE ART OF GEM STONE CUTTING. . . . 145

Classes of work, Precious gem stones, Birthstones, Where to find material, Cutting material, Hardness of minerals, Abrasives, Grinding wheels, Cabochon cutting, Equipment for gem cutting, Four main operations, Sawing, Sawing outfits, Truing saw disks, Mud Sawing, Diamond-charged saws, Charging a diamond saw, Grinding, Sanding, Polishing, Dopping, Drilling, How to cut a sphere, Making a doublet, Horizontal laps, Ash trays, Facet cutting.

Part IV—IDENTIFICATION OF GEM STONES AND GEM MINERALS 241

Methods of testing gems, Physical properties, Color, Hardness, Specific gravity, Specific-gravity fluids, Examining for flaws and inclusions, Ultraviolet light, Luster, Chatoyancy, Asterism, Fracture, Cleavage, Optical methods, Reflection test, Use of the dichroscope, Polariscope, Refractometer, Polarizing microscope, Synthetic gems, Altered gems, Agate coloring, Qualities enhancing values in stones.

DEALERS 275

INDEX 281

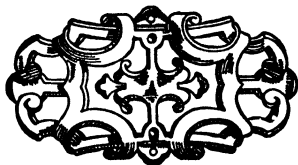

Foreword

THIS is a book written by a true craftsman about a craft of which he is fond; by a teacher concerning his own work—work in which he has experienced success. It is practical and useful because in it the author has written from the proved experience of his own hands. It is informing because he has put into it all the wealth of detail and background that should be in the possession of the worker in this art. By the directness of his style and through the great amount of illustrative material, he arouses the interest in “making things” that results in satisfaction to so many of us, and especially to young people.

We who have known the vast amount of preparatory work that has gone into the making of this book—the testing of processes, tools, and materials; the study of the qualities of gems, together with methods of cutting and polishing them; the laborious and painstaking although

Foreword

equally fascinating photography; and the descriptive and expository writing—now share vicariously the author's gratifying realization that the book is an accomplished fact. And it is not just another book; we believe with its author that it is unique and that it will be of inestimable service to teachers in shops and classrooms, to students, and to workers, young and old—wherever their workshops—who wish to engage in the hobby of art metalcraft and jewelry making or in more serious pursuits along the same line.

As head of the school which has served as a kind of testing laboratory and as a friend and close observer of the author and his work, I consider it a distinct compliment to be invited to write this foreword, and it affords me great pleasure to commend this volume with hearty sincerity to workers and readers.

NORMAN J. NELSON,
Principal, Woodrow Wilson High School

WASHINGTON, D. C.

Part I

METALCRAFT

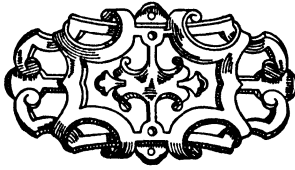

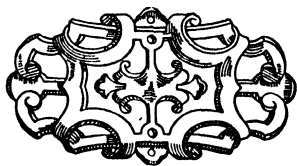

THERE are a number of metals and alloys that are suitable for the home craftsman or the student to use in making ornamental and useful projects. Copper is, however, used more than any other material.

COPPER

Copper was known to the Greeks as "Chalkos," and to the Romans as "aes Cyprum," later "Cuprum," the names being derived from the island of Cyprus in the Mediterranean which had a natural wealth of copper. Copper was one of the first metals of which mankind made use. When it was first produced is not definitely known, although many of the ancient peoples used it.

The prehistoric Egyptians knew how to hammer native copper into sheets, from which they made harpoons, chisels, and adzes. The Chaldeans as early as 4500 B.C.

Jewelry, Gem Cutting, and Metalcraft

were artisans with the metal. By 2750 B.C. the copper-smiths were able to hammer and form drainpipes of copper. During the Dark Ages the copper, brass, and bronze industries, which were well established in Roman times, passed into eclipse, although they were revived about A.D. 900.

When America was discovered, the art of working copper and brass was well understood. The first rolling mill in the United States was at Waterbury, Conn., 1802, and was used to roll sheets for the making of metal buttons, which were popular among civilians as well as military men. This mill was driven by horsepower. In 1808 a mill was built at Attleboro where water power took the place of horsepower. The copper used in these early mills was imported or obtained by the purchase and melting of copper articles which the colonists had brought over with them. With the development of copper mines in the Lake Superior district, an adequate supply of raw copper became available. Although the production of copper in the United States prior to 1850 was very small, the production since then has amounted to about half the world's output.

Copper is distinguished by its red color. It melts at 1981°F. and may be worked into many shapes. It is especially useful to the craftsman because it is tough and malleable and will take a good polish.

Copper is usually supplied in sheets 30 by 60 inches, 30 by 96 inches, or 36 by 96 inches, although smaller pieces may be secured from dealers. Its thickness may be measured by either of two gauges, the English Stubs

Metalcraft

gauge, used by plumbers and coppersmiths, or the American Brown and Sharpe gauge, used by silversmiths and art metalworkers. Copper is also designated by weight, in ounces per square foot. For example, a square foot of 20-gauge Brown and Sharpe copper weighs approximately 24 ounces and is known as 24-ounce copper; 18-gauge Brown and Sharpe weighs approximately 32 ounces to the square foot.

Copper sheets may be purchased either hot rolled or cold rolled. It is best to secure cold-rolled copper that has been annealed, because it is much smoother and works better.

BRASS

Brass, an alloy of copper and zinc, is one of the most useful alloys in industry. The copper content varies according to the intended use of the alloy. Brass is somewhat harder for the craftsman to work than copper, as it is less malleable and splits easily.

NICKEL SILVER

Nickel silver (German silver) is an alloy containing approximately 60 per cent copper and 20 per cent each of zinc and nickel. It is used extensively in industry as a base metal for silver plating.

MONEL METAL

Monel metal is a technically controlled alloy of two-thirds nickel and one-third copper. It originally was melted and refined from natural ore mined in Canada,

Jewelry, Gem Cutting, and Metalcraft

which consisted of 60 to 70 per cent nickel, $1\frac{1}{2}$ per cent iron, and the remainder copper.

Monel metal is silver white in color and takes a high polish. It can be used by the craftsman in making some forms of art metal projects and jewelry. Owing to its noncorrosive qualities, it is used extensively in marine construction. It is also used for making kitchen sinks, drainboards, and table tops.

PEWTER

Pewter is an alloy of tin and lead, usually about four parts tin to one part lead. It is very soft and can be readily hammered into shallow trays and plates. Articles made of pewter are usually plain, without decoration. Pewter should not be heated to anneal, owing to its low melting point. As it is soft, it should need no annealing.

SOFT-SOLDERING

Soft-soldering is the joining together of pieces of metal by means of another metal or alloy of lower melting point.

The most common type of soft solder consists of half lead and half tin, usually called half-and-half solder. It melts at a temperature of about 375°F. Soft solder may be purchased in bar, ribbon, or wire form. The wire and ribbon forms may be secured with a flux, either rosin, acid, or paste, inside the wire.

Several things are necessary in order to solder successfully.

1. The work to be soldered must be clean.

Metalcraft

2. The soldering copper, also known as soldering iron, must be of correct temperature, the faces tinned, and it must be large enough to heat the work properly.

3. A flux must be used to help clean the parts and to prevent the work from oxidizing when heat is applied.

4. Both solder and the spot where the solder is being applied must be heated to the melting point of the solder.

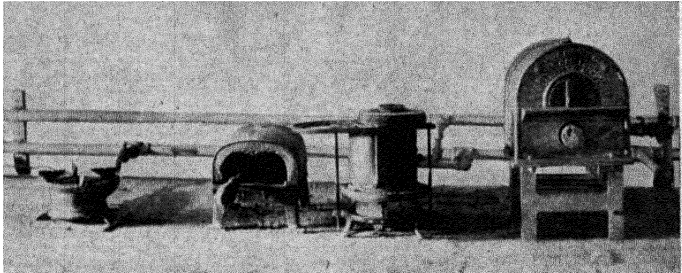

Fig. 1.—Furnaces mounted on brick-top table. Solid flame burner; soldering copper furnace; melting furnace; enameling furnace.

In preparing work to be soldered, make sure that it is clean. Scrape or file until bright, if any oxide is present.

Tinning Soldering Copper. Heat the soldering copper until it will melt the solder. File the faces and tin each. The tinning is done by placing some flux and solder on a piece of bright tin or copper and rubbing the hot soldering copper over the solder until the solder melts and coats (tins) the face of the copper.

Another method is to use rosin and solder on a brick. Make a depression in a brick and in the hole place some rosin and a few pieces of solder. The point of the hot cop-

Jewelry, Gem Cutting, and Metalcraft

per is placed on the solder and rosin and rubbed until the solder melts and coats the faces of the copper. Wipe the point clean with a cloth.

Either sal ammoniac or soldering salts, dissolved in water in a small jar, make a good solution in which to

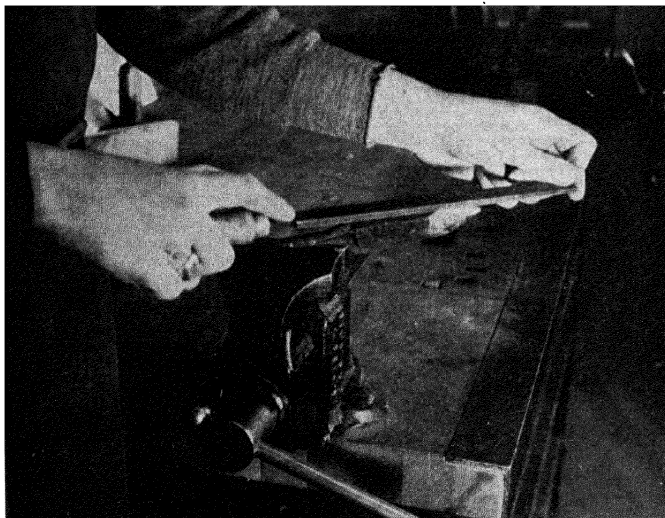

Fig. 2.—Filing a soldering copper.

clean the soldering copper. Dip the tip of the hot copper, after filing, in this solution and it will become bright and clean and will tin very easily. This solution will also clean a tinned copper that has become dirty through use, if the point is dipped, while hot, in the solution. Once a soldering copper has been tinned properly, it will seldom need retinning unless it is overheated.

Metalcraft

Fluxes. There are several different kinds of fluxes that may be used in soft-soldering.

For brass and copper use any of the following: Rosin, soldering paste, chloride of zinc, or soldering salts.

On galvanized iron and zinc use either raw muriatic acid, chloride of zinc, or soldering salts.

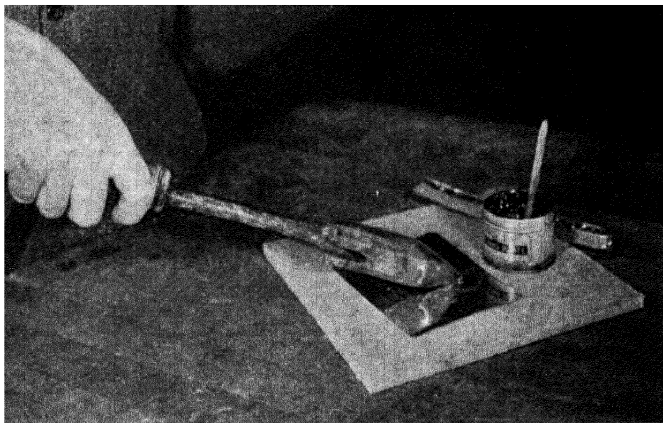

Fig. 3.—Tinning a soldering copper.

For black iron use chloride of zinc or soldering salts.

For soldering tin plate use rosin or soldering paste.

Soldering salts may be purchased in pound tins and a solution made by dissolving a small amount in water. Soldering paste may be purchased in small cans at almost any place solder is sold.

Chloride of zinc is prepared by adding small pieces of zinc to muriatic (hydrochloric) acid, which has been placed in a glass jar, until the acid quits reacting with

Jewelry, Gem Cutting, and Metalcraft

the zinc. This operation should be done out of doors. Add an equal amount of water to this solution before using.

Tinning the Work. After cleaning the piece to be soldered, rub some flux over the spot or seam and place a tinned face of the hot soldering copper on the work, and hold it there until the spot becomes hot. Melt a little solder on the work and rub the copper back and forth, so as to tin the spot. More solder may then be used. Solder will not stick properly unless the work is tinned.

Solder will not stick properly to cold metal. When the work gets hot enough to melt the solder, the solder will stick. A small soldering copper cannot be used to advantage on heavy work, as it cannot heat the work properly.

Electric soldering coppers may be purchased for use where electricity, but no gas, is available. They need not be quite so large as the other type, for in using them the heat is being continuously applied.

Sweating. Sometimes it is necessary to solder one object to another and not have any solder show around the edges. In this case apply a thin coat of solder to the underside of the smaller piece, filing evenly if necessary. Apply flux to the spot on the larger piece where the ornament is to be soldered and put the ornament in place. Wipe off all excess solder from the faces of the soldering copper and hold the copper on top of the ornament until the solder underneath melts and joins the two pieces. This type of soldering is known as sweating.

Metalcraft

Another method is to heat both pieces over a gas flame, or with a blowpipe, until the solder flows. In using the flame of the blowpipe, take care not to overheat the solder, for if heated too much it will not hold properly.

Small bits of solder may be picked up with the hot copper and transferred to the work being soldered, unless the solder is of the flux-cored type, in which case it is best to feed the solder to the work alongside the hot copper so as not to lose the flux.

Pewter Solder. Pewter, because of its low melting point, requires a special low melting solder. Flux for pewter is prepared by mixing a few drops of hydrochloric acid in an ounce of glycerine.

ETCHING

Etching requires few tools and is an easy means of ornamenting objects made from sheet copper, brass, or silver. The object is made and polished, after which the surface is thoroughly cleaned. The design to be etched on the object is drawn full size upon paper and is transferred to the surface of the project by using a piece of carbon paper.

The etched design is usually left raised, or higher than the surrounding metal, although it may be eaten into the metal. If the design is to be left raised, cover the design with a coat of asphaltum varnish, using an artist's brush to paint on the varnish. The lines in the design are left free of varnish. Be sure to cover with varnish the back of the project, as well as any other surfaces that are not to be eaten away. If the varnish is too thick, thin with tur-

Jewelry, Gem Cutting, and Metalcraft

pentine. The varnish should be allowed to dry several hours, preferably overnight, before placing the object in the etching solution.

Prepare the etching solution by mixing one part nitric acid with two parts water in a glass or earthen vessel,

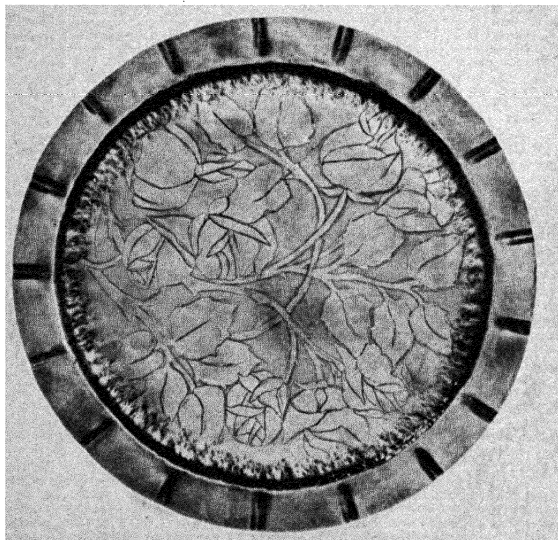

Fig. 4.—Etched copper tray.

adding the acid to the water. An old battery case makes an excellent container for the solution if small objects are to be etched. Place the object in the solution and watch closely for a few minutes. The acid should begin to eat away the metal almost immediately, the reaction forming tiny bubbles. If the reaction is too fast, the solution must

Metalcraft

be diluted with water, for the acid will eat under the edge of the asphaltum and possibly cause it to peel. A solution, especially after using, may cease to eat the metal, in which case add more acid, stirring thoroughly.

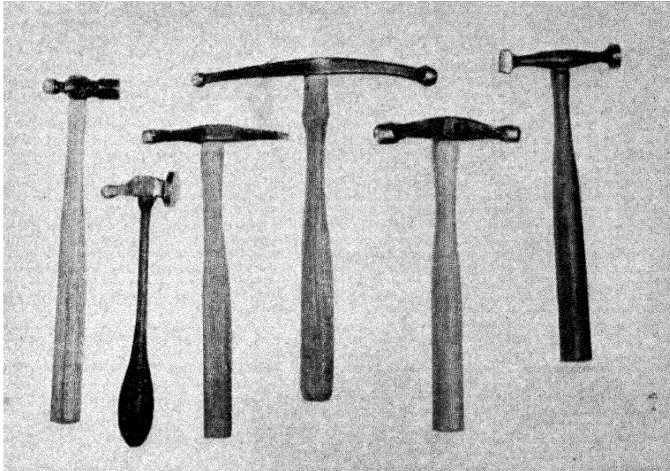

Fig. 5.—Hammers used in art metalwork. Ball peen, French chasing hammer, and raising and planishing hammers.

The length of time required for the etching process varies, depending upon the strength of the diluted acid and the depth of etching desired. It usually takes from 45 minutes to more than an hour. The object may be taken from the solution at intervals for inspection. After the solution has eaten to the desired depth, remove the object and wash with water. The asphaltum varnish is removed by rubbing with a cloth dampened with gasoline

Jewelry, Gem Cutting, and Metalcraft

or turpentine. In etching the inside of a tray, or bowl, the acid may be placed in the bowl.

ANNEALING

Copper and brass when subjected to hammer blows become hard and must be annealed (softened). Heat the metal over an open flame, or with a torch, until it is a dull red color. Copper, like silver, may be cooled by plunging into water without affecting the metal. Brass, however, should be cooled slowly. Frequent annealings are necessary to keep the metal soft.

PICKLING

When copper or brass is heated to soften, an oxide scale forms on the surface which must be removed. Mix 1 part sulphuric acid with 10 parts water, *adding the acid to the water*. Place the solution in a large stone jar and drop the metal into the solution, while the metal is warm. If the reaction is too slow, add more acid. Use copper or brass wire or copper tongs to remove the metal. Never use an iron object as the reaction of the iron in the acid will cause discoloring of the copper. On large pieces of work, to scour the metal with the pickle solution use a swab made by tying a cloth on a stick. Be careful not to get the solution on your clothing. After an article is pickled, it should be washed in water.

POLISHING

File marks and scratches are best removed by using fine emery cloth and steel wool, and then buffing the surface.

Metalcraft

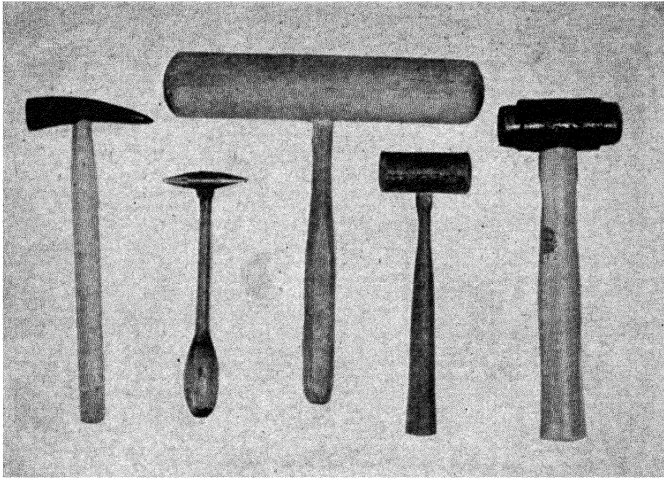

Fig. 6.—Horn mallet. Special-made spotting hammer. Bowl mallet made from wood. Rawhide mallet and rawhide end mallet.

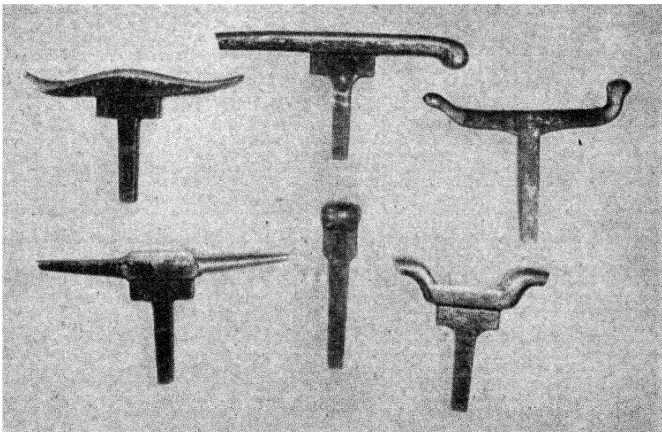

Fig. 7.—Metal stakes used in bending, forming, raising, and planishing.

Jewelry, Gem Cutting, and Metalcraft

The buffing is done on a felt or muslin buff attached to the shaft of a motor, or mounted upon a special arbor. powered with a motor, using a V belt. Tripoli in cake form is a good abrasive to use on the buff.

Hold the work so that the buffing is done on the lower part of the wheel, to keep from throwing the abrasive on you. Hold the work firmly, yet in such a manner that if the metal catches on the buff and is pulled from your hand your fingers will not be injured.

In buffing a flat piece of metal, use a piece of wood on the back side to keep the metal from bending. After the buffing is completed, remove the tripoli by washing with soap and water.

Jewelers' rouge in stick form is also an excellent abrasive. It is a finer grit abrasive than the tripoli and is used for buffing silver. Jewelers' rouge is, however, more expensive than the tripoli.

COLORING

A good solution for coloring copper is made by dissolving a lump of potassium sulphide (liver of sulphur) about the size of a walnut in a gallon of water. Best results are obtained by applying the solution while it is hot. Small objects may be placed in the solution and the solution heated. A brush or cloth may be used to apply it to large surfaces. The stronger the solution, the darker will be the color obtained.

When copper or brass is heated, different colors appear on the surface. The first colors disappear, but the dark red

Metalcraft

and purple will remain if the metal is not heated too hot and if the surface is covered with wax or lacquer.

Copper surfaces will, when exposed to the air, oxidize to a certain extent. The coloring caused by oxidation is preferred by many workers to the artificial coloring.

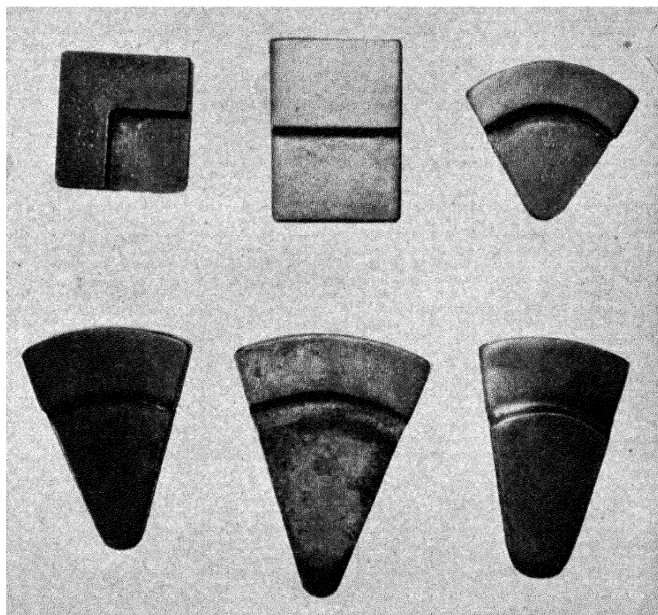

Fig. 8.—Metal plate- and tray-forming stakes.

Brass may be given a dark antique finish by applying butter of antimony to the surface and allowing it to dry. The object after being colored may be left as it comes from the solution, or it may be given light areas by rubbing the surface with a paste made of fine pumice and water.

Jewelry, Gem Cutting, and Metalcraft

Kitchen cleanser may be substituted for the pumice. Clear lacquer may be brushed or sprayed on the surface to protect it against further oxidation. Wax rubbed on while the metal is slightly warm is also used for preserving the color.

JEWELERS' SAW FRAMES AND BLADES

Jewelers' saw frames may be obtained in a number of depths. The narrow depth frame is excellent for small

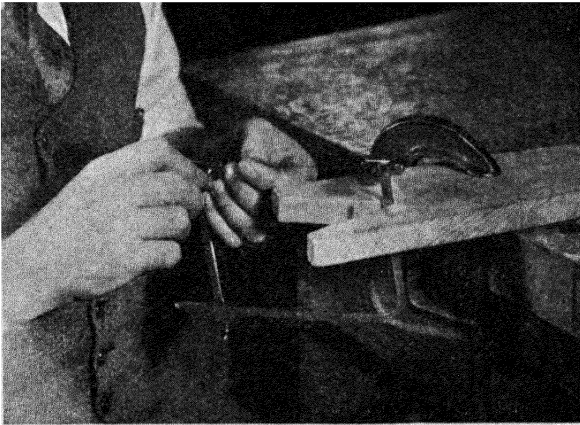

Fig. 9.—Inserting blade in jewelers' saw frame.

work, but if a frame that can be used for both small and large work is wanted, one with a depth of at least 4 or 5 inches is best.

Jewelers' saw blades are available in a number of sizes; the higher the number the coarser the blade. For most work the No. 0 and finer blades are used. For silver and

Metalcraft

thin copper and brass work the No. 3/0 and No. 4/0 blades are excellent.

The blade is inserted so that it will cut on the downward stroke of the saw, that is, the teeth point toward the handle of the saw. The saw blade will not cut unless it is held taut. To insure tautness, fasten one end of the

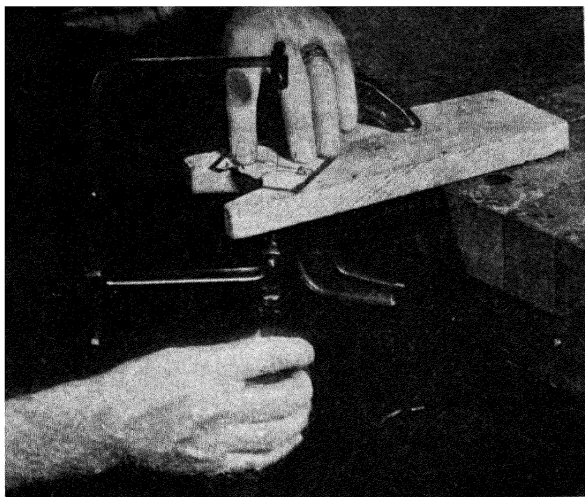

Fig. 10.—Using a jewelers' saw to cut ornament from sheet metal.

blade in the saw frame and force the other end of the saw frame in before fastening that end of the blade (Fig. 9). It is absolutely necessary that the blade be stretched tight.

Sawing is usually done over a notched board (Fig. 10). A V-shaped notch cut into a small board and the board clamped to a table top works well. Place the piece to be

Jewelry, Gem Cutting, and Metalcraft

sawed on the board over the notch. Use the fingers of the left hand to hold down the work. Grasp the handle of the saw in the right hand, holding it lightly, and with a little practice you will be able to follow outlines quite easily.

If designs are to be sawed into the metal, it is necessary first to drill small holes in the waste material. Then fasten the blade in one end of the frame, run it through the hole, and make it fast in the other end. Sawing is then done in the usual manner.

Very slight pressure is needed on the blade to make it cut into the metal. In order to make sharp turns do not apply any pressure on the blade but while continuing the up-and-down movement gradually turn the handle of the frame.

Paraffin or soap rubbed on the saw blade at frequent intervals will aid in the sawing and reduce the number of broken blades.

PAPER KNIVES

Paper knives and letter openers make excellent projects for the beginner who is learning to work copper and brass. They are usually made of 18-gauge Brown and Sharpe, or heavier material, and may be made in various widths and lengths.

First draw the pattern upon paper, and glue to the metal. Then saw the metal out, using the jewelers' saw. In designing the project bear in mind that the blade of a paper knife or letter opener is to be sharpened and that the handle should have no sharp projections that will be

Metalcraft

uncomfortable to the hand. Decoration is usually applied to the handle. Designs may be sawed through the metal, etched into the metal, or ornaments may be soft-soldered or riveted to the handle.

The edge of the blade should be sharpened by filing and then the entire project sanded with fine emery cloth and

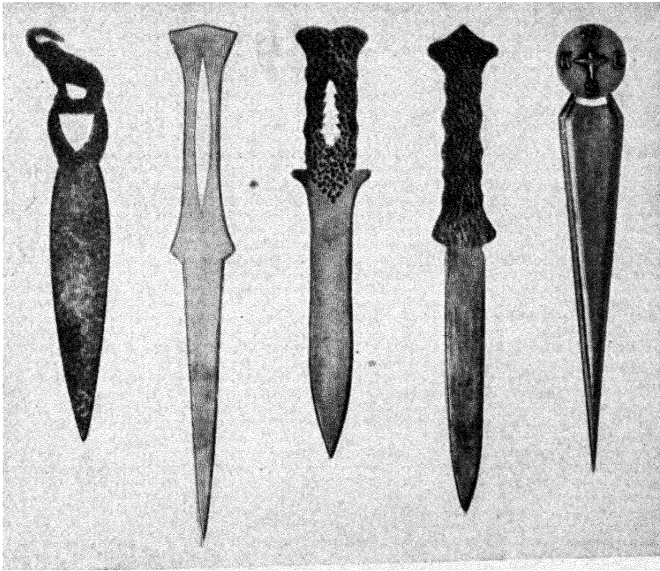

Fig. 11.—Paper knives made of copper and brass.

buffed. If desired, the entire project, or the handle only, may be hammered with a small ball peen hammer. Hold the project on an anvil or other smooth iron surface while hammering, but avoid hitting the face of the anvil with the hammer.

Jewelry, Gem Cutting, and Metalcraft

MATCH BOX HOLDERS

Another project for the beginner is the making of a match box holder from a piece of 20-gauge Brown and Sharpe copper $3\frac{3}{4}$ by $2\frac{1}{4}$ inches.

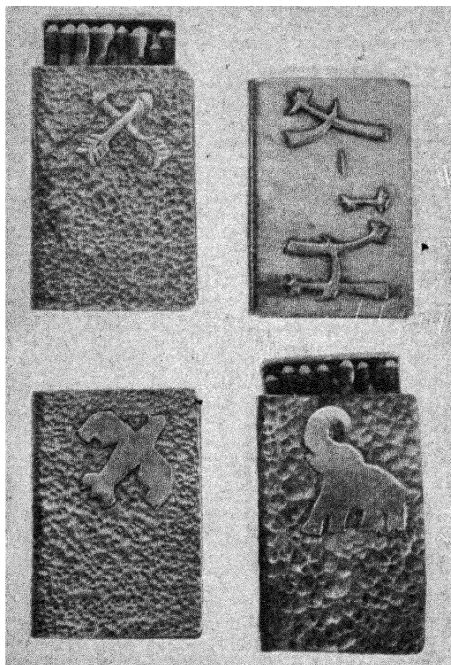

Fig. 12.—Match box holders.

The piece of metal, after being cut to size and the corners slightly rounded with a file, is smoothed and polished.

Figure 14 shows one method of bending the piece of copper to shape. The material is placed between two

Metalcraft

pieces of wood held in a vise at one end and with a clamp at the other. One piece of wood must be exactly $\frac{3}{4}$ inch thick. The metal is bent over and down the side of this piece of wood. It is important that the metal be placed between the two pieces so that the bend will be at a right angle to the edge of the metal. Use a try square to measure the angles, mark the lines with a pencil where the

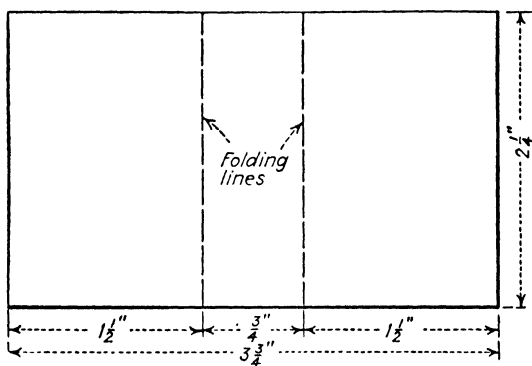

Fig. 13.—Pattern for making match box holder.

bends are to be made, and place a line even with the edge of the board when a bend is made.

The boxes may be ornamented in a number of ways. Initials and various designs may be sawed into the metal with a jewelers' saw before the metal is bent, or they may be etched into the metal. Indian symbols, initials, monograms, animals, and various other ornaments may be sawed from 18-gauge, or heavier, brass and soldered in place. One's ingenuity alone limits the various ornaments that may be applied. For instance, one student, in order

Jewelry, Gem Cutting, and Metalcraft

to have something individualistic, made a match box holder and ornamented it with a pipe, cut from 16-gauge brass. The design showed smoke curled from the bowl of the pipe in such a manner as to form the owner's initials.

Ornaments look better if the edges are rounded with a file and then buffed before they are soldered to the sur-

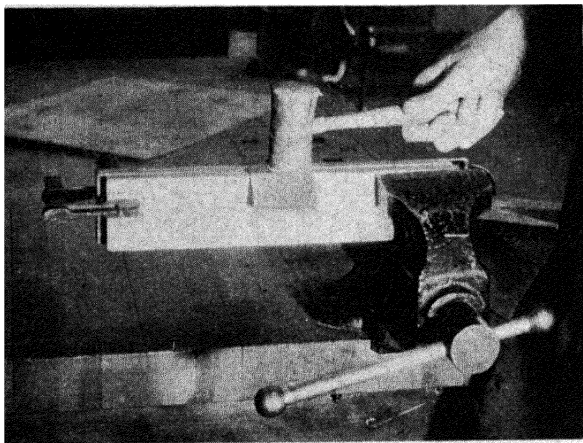

Fig. 14.—One method of bending a match box holder.

face. The ornaments are best soft-soldered in place by sweating. If any of the solder flows out from under the ornament onto the surface, remove it by careful scraping, and then buff the surface.

BOOK ENDS

Book ends may be made from heavy sheet copper or brass, or combinations of the two, and decorated in a number of ways.

Metalcraft

Figure 15 shows four book ends that were made by girl students, who used the jewelers' saw as the principal tool. Three of them are examples of pierced sawing, with the outer rims hammered after sawing. Instead of using a ball peen hammer to planish the rims, the ham-

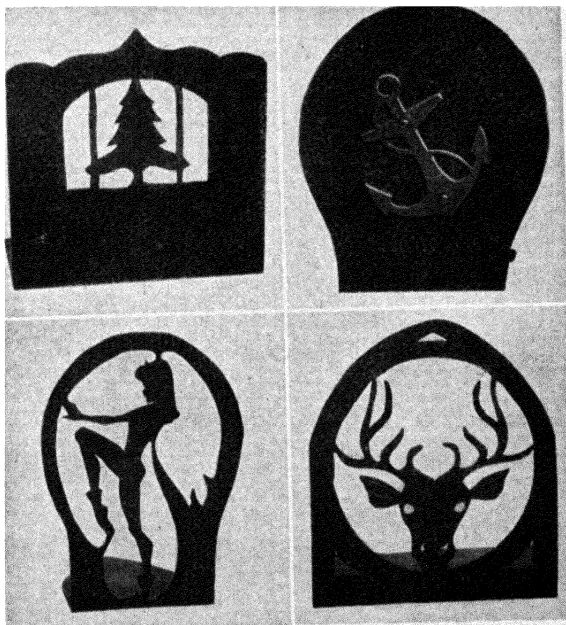

Fig. 15.—Book ends.

mered effect in such projects may be obtained by using one of the dapping dies (Fig. 16). A medium weight hammer is used to hit the punch which is held in position on the metal. The metal is placed over an anvil or other metal surface while hammering. By using the punch instead of

Jewelry, Gem Cutting, and Metalcraft

a ball peen hammer, the spots can be placed where desired without disturbing the edge of the rim.

To make the book end using the anchor for decoration, first cut out the book end to shape from sheet copper,

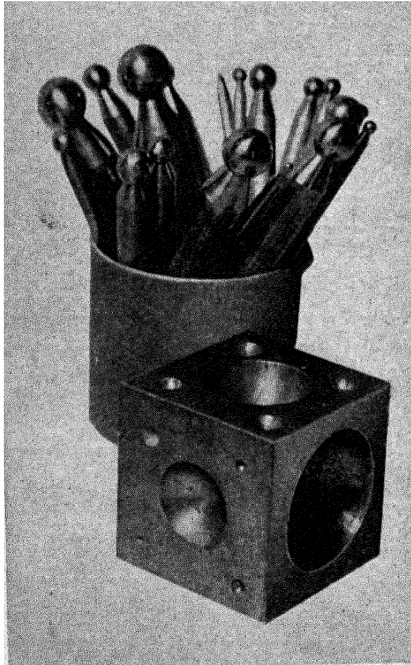

Fig. 16.—Dapping dies and punches.

planish with a ball peen hammer, and bend to shape. The anchor is made from heavy sheet brass. Draw the anchor design upon paper, paste on the metal, and then saw it out, after which file and buff the edges. Then rivet

Metalcraft

in place, using $\frac{1}{8}$ inch diameter, roundheaded copper rivets.

After the holes are drilled through the book end for the rivets, use a $\frac{3}{16}$ -inch drill to countersink them on the back side. Then insert the rivet and cut off so that it barely protrudes. Place the head of the rivet in a rivet set, the correct-sized hole of a dapping die (Fig. 16), or on a lead block, and upset the end of the rivet with a small ball peen hammer. If the rivet is not left too long, it will fill the countersunk hole, as the end is hammered, and the book end will be smooth on the inside.

A right-angled bend, in forming the base, may be obtained by clamping the metal to the edge of a table, using a piece of wood on top of the book end, and bending over the portion that forms the base by hammering with a wood or rawhide mallet. A sharper bend may then be made by hammering on the edge of an anvil, or other convenient piece of iron.

LETTER HOLDERS

Letter holders are made somewhat like book ends, except that they are usually made of thinner material, 20 gauge being ample in thickness.

They may be made in a number of sizes and decorated in various ways. The three shown in Fig. 17 make use of three methods of ornamenting. One shows a design cut from sheet brass and soft-soldered in place. Another is simply hammered with a ball peen hammer, after which the edges are fluted at intervals by beating the metal

Jewelry, Gem Cutting, and Metalcraft

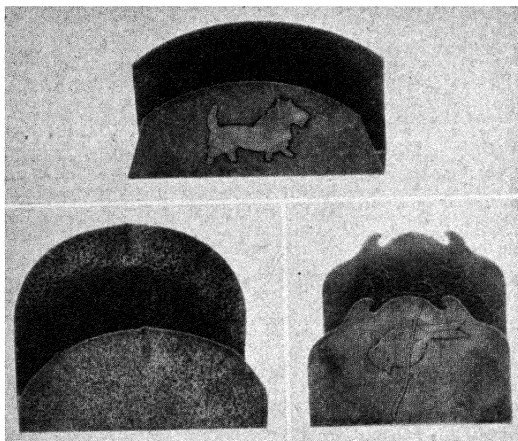

Fig. 17.—Letter holders.

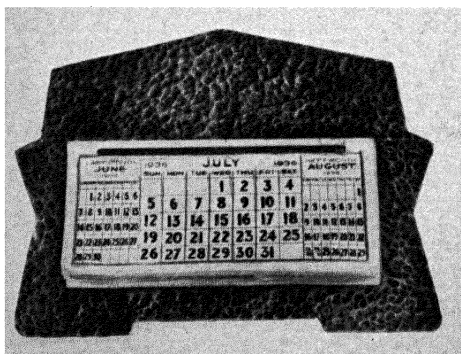

Fig. 18.—Desk calendar.

Metalcraft

down into a notched block. The third has an etched design. Designs may also be sawed into the metal.

The angles are bent in somewhat the same manner as the base of the book end, that is, over the edge of a table.

DESK CALENDAR

The desk calendar offers many possibilities of ornamentation, as any of the methods already described may be used. The calendar leaves are ordinarily obtained from a small calendar and are used as the central figure in the frame.

The calendar leaves may be held in place by drilling small holes through the metal and inserting split rivets of the type used in holding paper in folders, or by using a thin strip of metal, as shown in Fig. 18. Holes must necessarily be drilled through the metal at the correct places.

One end of a piece of copper strip is soft-soldered to the back of the calendar near the top, and is bent so that it will hold the stand at the desired angle.

PICTURE FRAME

Picture frames may be made in the same general way as a desk calendar, with a piece of metal soldered on the back to give the proper angle, or they may be made from one piece of metal, with one end bent at an angle to form the base, as shown in Fig. 19.

The opening for the picture or photograph is sawed out and channels are formed from thin metal and soft-soldered in place at the bottom and along the sides of the

Jewelry, Gem Cutting, and Metalcraft

opening to hold the glass and the picture. Designs may be sawed or etched into the metal, or it may be planished with a ball peen hammer.

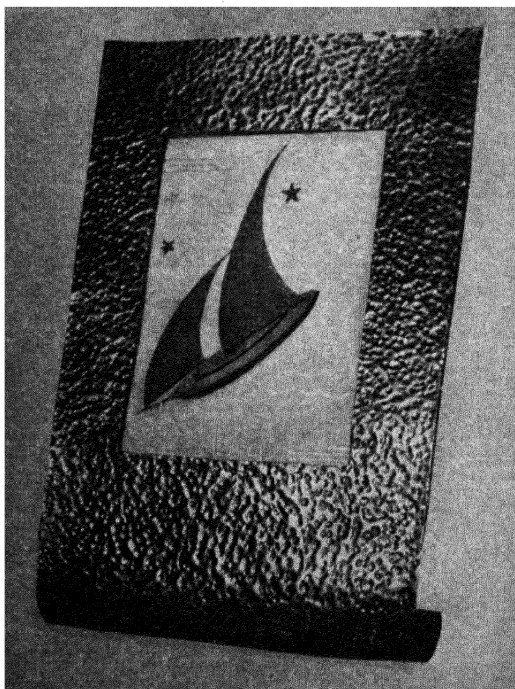

Fig. 19.—Picture frame.

WHISK BROOM HOLDER

The whisk broom holder consists of two pieces, the back and the band, or strap. The back may be made of either copper or wood. If made of wood, the band should be tacked in place using escutcheon pins; if made of copper,

Metalcraft

the band may be soldered, or riveted in place, using round-headed rivets.

It is necessary to have the whisk broom at hand before starting work, for the band must be shaped and bent so

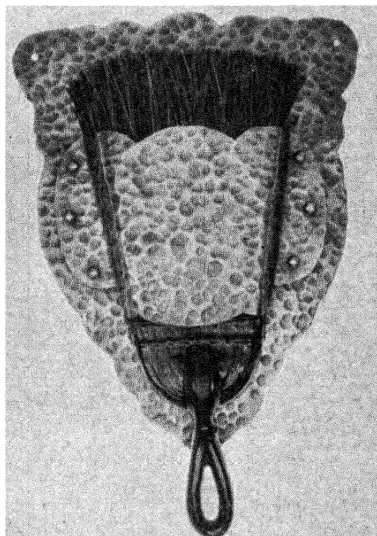

Fig. 20.—Whisk broom holder.

that the broom will not slip through it, yet will fit loosely enough so that it can be pulled out from the bottom.

TRAY MAKING

The making of a tray necessitates using more tools and somewhat different processes than those used in the making of the projects already described.

Jewelry, Gem Cutting, and Metalcraft

The depression forming the tray is usually made by beating down, that is, stretching, the metal with a hammer. Hold the metal on the edge of the end grain of a block of wood, or upon a specially cut wood block (Fig. 23), and beat down the metal, following the desired out-

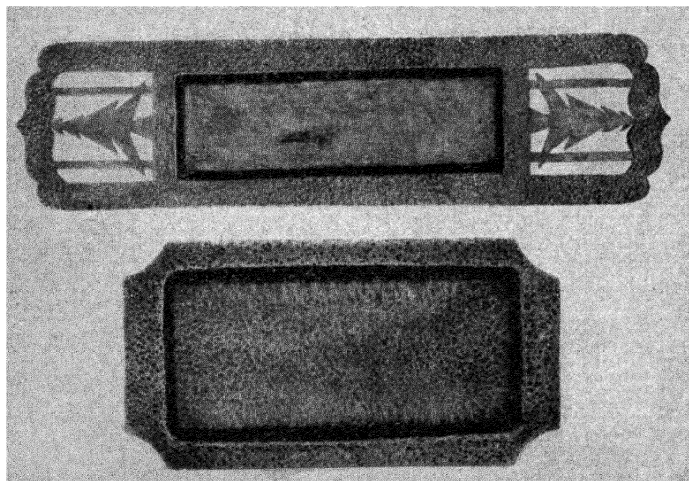

Fig. 21.—Pen trays.

line which has been previously drawn upon the metal. Strike the metal along the edge of the block, using a light stroke.

After going around the design once, place the metal face down on a table top or other piece of wood, and straighten out the wrinkles in the rim. Then proceed with the hammering on the block of wood.

Metalcraft

If the metal ceases to stretch after hammering, anneal by heating to a red heat, and proceed with the hammering. With light hammer blows and frequent annealing, the metal can be stretched to the desired depth.

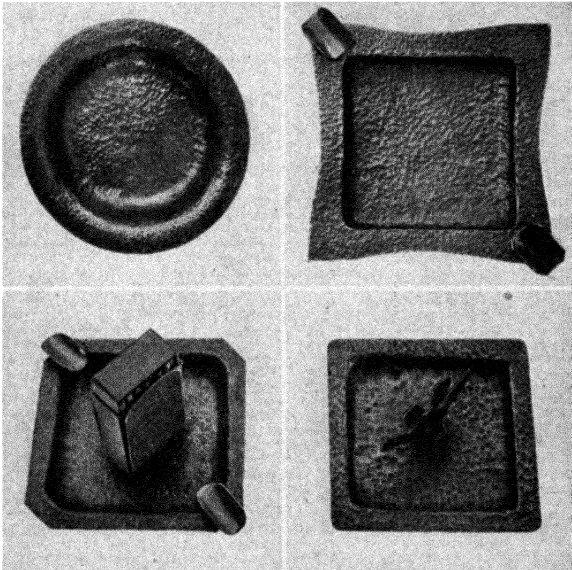

Fig. 22.—Ash trays.

In forming the tray the rim will pull in, as shown in Fig. 22. If this is uniform it may be left, if desired, or after the hammering is finished the edges may be cut straight with a pair of snips. Then file and buff them. If the edges are to be cut straight, extra width must be allowed in the beginning, so as not to make the rim too narrow.

Jewelry, Gem Cutting, and Metalcraft

Instead of using wood blocks to form the tray, metal plate and tray-forming stakes may be used. Or the tray may be formed on the wood block and finishing touches given on the metal stake.

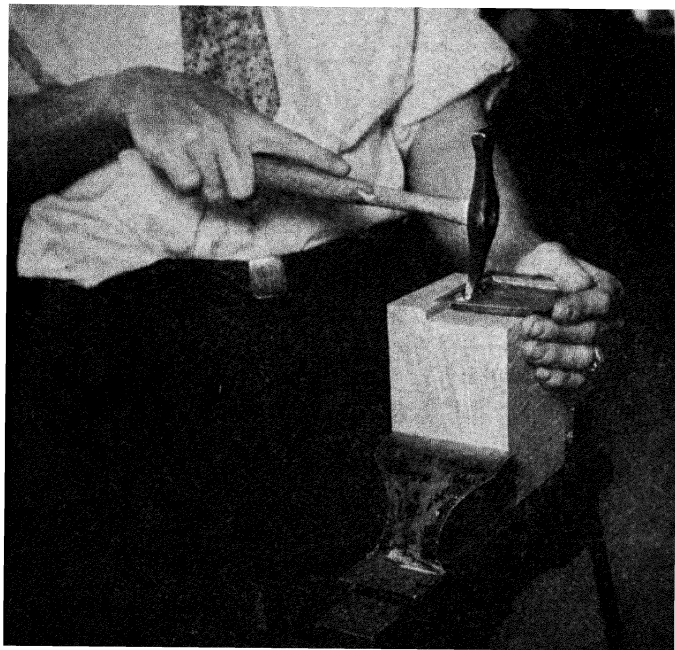

Fig. 23.—Raising a tray on end grain of block of wood.

The tabs, shown on the corners of two of the trays (Fig. 22), are cut from sheet material, shaped, and soft-soldered in place by sweating. The match box holder in the center of the tray was made the desired shape and

Metalcraft

soft-soldered in place. A piece of metal bent so that it will go inside the cover of a match box and soldered in place will force the box open. The match box holder is made from one piece of metal, bent into a U-shape.

MAKING A BOWL

The depression forming the bottom of the bowl is usually made first. It is made in the same manner as a tray.

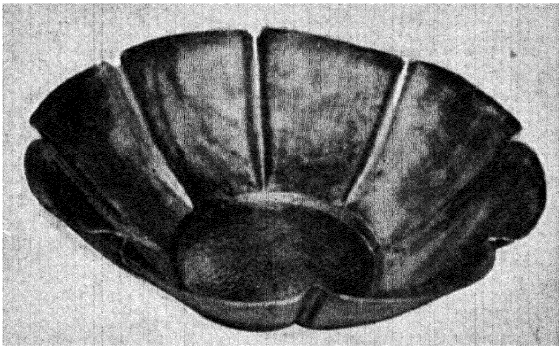

Fig. 24.—Fluted copper bowl.

If the bowl is to be very deep, it is best after beating down the bottom, to flute the sides at regular intervals in order to gain depth and help in the raising. Place the circular piece of metal over a notched block and hammer the metal down into the notch. This may be done with a wood mallet with the end shaped into a V, or else by placing a length of round rod over the notch and striking the rod with a hammer. Then place the metal over a stake and hammer out the flutes with a wood or a rawhide

Jewelry, Gem Cutting, and Metalcraft

mallet. If the bowl is not of the required depth after the hammering on the stake, the process may be repeated. All hammering on the bowl should be done in circles, concentric with the base.

Instead of fluting to gain depth, the metal may be hammered on a sandbag with a wood mallet which has

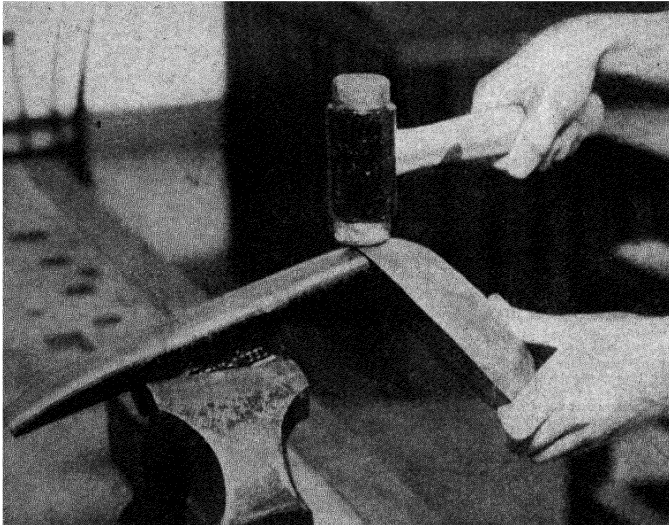

Fig. 25.—Shaping a bowl upon a metal stake.

been rounded on the ends. Sandbags may be purchased, or one may be made from heavy canvas. Partially fill the bag with sand. The hammering is done on the inside of the bowl, and the sand in the bag should be shifted around so that there is a depression underneath the metal that is being hammered.

Metalcraft

Shallow bowls may be raised without fluting by hammering on the sandbag, or upon a metal stake.

Another method that is quite satisfactory on small bowls is to hammer over a depression made in the end



Fig. 26.—Fluting a bowl.

grain of a piece of wood or in a block cut from a well-seasoned log.

After a bowl is raised to the desired shape and depth, the rim must be made the same height all around. This is done by first marking all around with a scribe and either filing or cutting off the uneven portion.

Jewelry, Gem Cutting, and Metalcraft

Instead of leaving the bowl plain, scallops may be cut at regular intervals and, if desired, the bowl may be fluted. Figure 26 shows a bowl being fluted. A piece of wood is cut the same approximate curvature as that of the bowl and a groove is cut and filed in the curve. The block of wood is then put in a vise, the bowl is placed over the

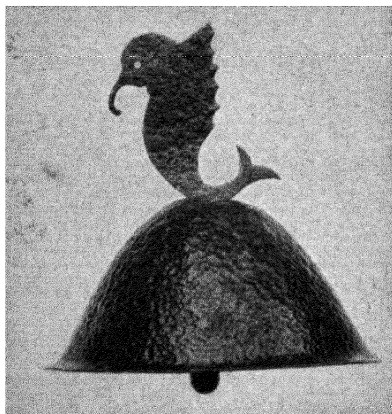

Fig. 27.—Tea bell raised from copper disk.

block, and a rod is placed on the metal and hit with a mallet. It generally takes two people to do the fluting, one to hold the bowl in place on the block, and the other to hold the rod and do the hammering.

The rim of the bowl, between the flutes, may be flared out by hammering with a mallet while the rim is held against a block of wood that has been cut or filed to the desired shape.

Metalcraft

TEA BELLS

Tea bells of various tones may be made of copper or brass by first raising the metal to the desired shape and then hammering with a ball peen hammer.

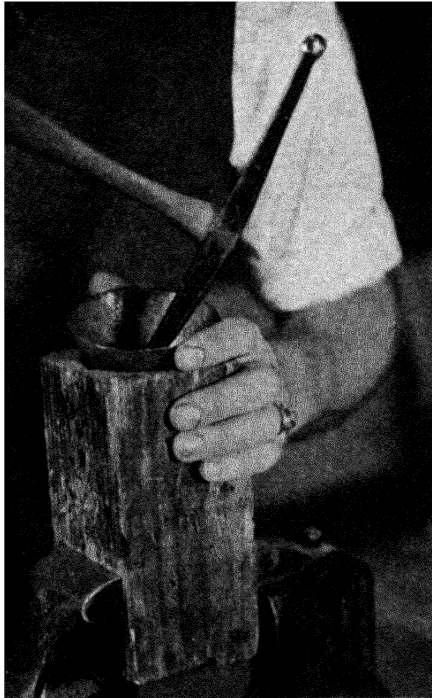

Fig. 28.—Raising a tea bell over hole in block of wood.

The bell shown in Fig. 27 was made of 20-gauge sheet copper cut into a $3\frac{1}{2}$ -inch disk. The handle was cut from brass.

Jewelry, Gem Cutting, and Metalcraft

The raising is done by hammering over a depression made in the end grain of a piece of wood or upon a sand-bag. Frequent annealing and light hammer blows allow the metal to stretch.

The handle should have a piece left at the bottom that protrudes, through a slot, into the bell. A hole is bored through this projection through which the clapper is

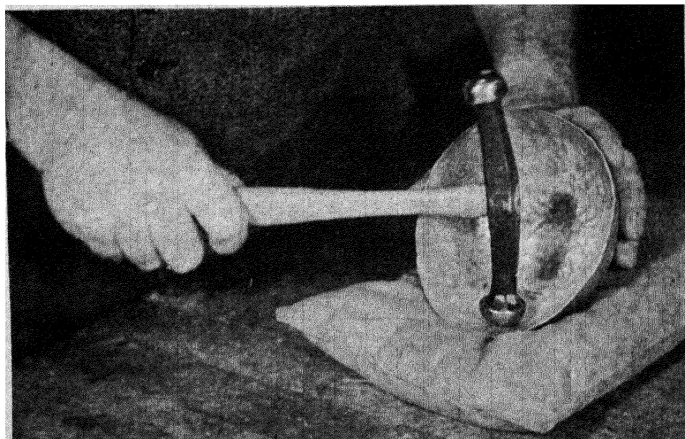

Fig. 29.—Raising a bowl upon a sandbag.

attached by means of a wire or chain. Make the piece on the handle that protrudes into the bell about $\frac{3}{8}$ inch wide and bore the hole in the center. Then saw a slit on each side of the hole to divide the piece into three divisions. In fastening the handle to the bell, bend one of the outer divisions one way, and the other the other way, leaving the portion with the hole protruding straight down-

Metalcraft

ward. Then soft-solder the two bent pieces to the bell, thus fastening the handle to the bell.

Bore a hole into the clapper, which is shaped from a piece of iron rod, and insert a small wire shaped like a cotter pin in the hole and soft-solder in place. Then connect the clapper to the handle with a chain made of copper wire.

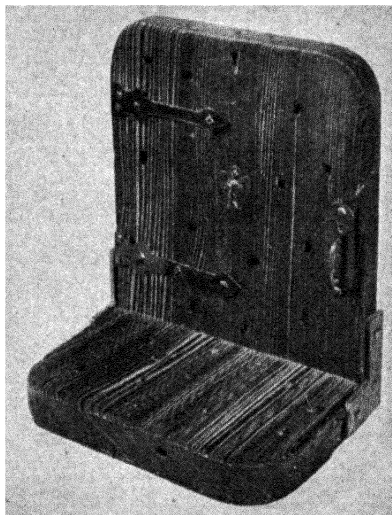

Fig. 30.—Book end made of wood and metal.

The bell should be hammered with a ball peen hammer upon a metal stake before the handle is soldered in place. If the bell has lost its tone after the handle is soldered, hammer again with a ball peen hammer.

Many different designs may be worked out for the handle.

Jewelry, Gem Cutting, and Metalcraft

WOOD AND METAL PROJECTS

Many interesting and worth-while objects may be worked out by combining wood and metal. The book end shown in Fig. 30 is an example. This book end was made of two pieces of cypress and was decorated with metal pieces shaped to resemble colonial door hardware.

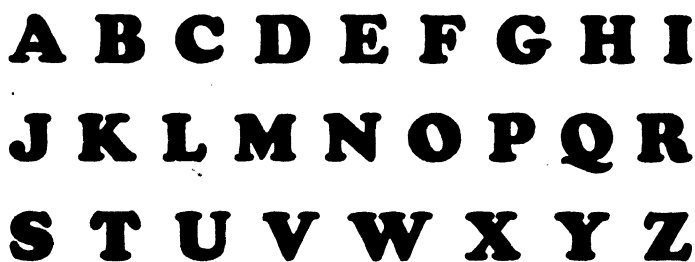

Fig. 31.—Franklin gothic.

The wood was treated by burning with a torch and then scrubbing with a stiff wire brush to bring out the grain. The worm-eaten effect was obtained by burning holes, at various angles, into the wood with a red-hot wire, after which the wood was again scrubbed with a stiff wire brush. The book end should be weighted with lead poured into a hole cut on the underside of the base. Felt is then glued on the base. Melt the lead in a ladle and test with a piece of paper before pouring into the hole in the base. When the lead browns but does not burn the paper, it is about the right temperature to pour.

Wax is applied to the wood for a finish.

Metalcraft

ALPHABETS

Frequently one desires to ornament with letters sawed from copper, brass, or silver. It is first necessary to draw the letter, paste it on the metal, and then saw it out.



Fig. 32.—Cheltenham bold italic.



Fig. 33.—Old English.

In designing the letter allow for irregularities in the sawing. In other words, make it a little larger and wider than necessary in order to allow for the filing. Letters, as

Jewelry, Gem Cutting, and Metalcraft

a rule, look better if they are made somewhat heavier than ordinary type letters. They also look better, in most instances, if the edges of the letters are rounded. The alphabets given in Figs. 31, 32, and 33 are three of the most frequently used. Many variations are possible, especially with the Old English letters.

Part II

JEWELRY MAKING

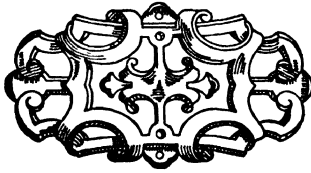

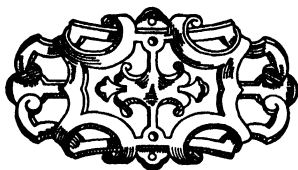

AFTER primitive man had satisfied his greatest need—food—his thoughts undoubtedly turned to ornaments, which were claws and tusks of wild animals hung about his body. They were worn for two reasons: first, to show his prowess as a hunter, and, second, because of a superstition that they would help him in combat against wild animals.

Ornaments for personal adornment were in use long before clothing was used. They were of the type that adorned the neck, ankles, arms, and fingers. As man began to wear clothing, other types of ornaments such as pins and brooches came into use. Among primitive people the men wore most of the ornaments, as is true today among uncivilized people.

A study of history down through the ages shows that as man became acquainted with new materials and their uses, he immediately used that knowledge in fashioning

Jewelry, Gem Cutting, and Metalcraft

his ornaments. The greatest advance was made in the Bronze Age, when man fashioned bronze into various forms of ornaments by hammering, riveting, and casting.

Much of the jewelry worn in ancient eras was cumbersome. At one period some of the finger rings worn weighed as much as half a pound each, and the finger band



Fig. 34.—Necklace made by Edward Bush, seventeen-year-old high-school student.

was so wide that the joint of the finger was covered. When rings with stone sets first made their appearance in Rome, it was the custom to wear them on every finger and to change them with the seasons.

TOOLS AND EQUIPMENT

The making of simple handmade jewelry does not require experience, nor does it require an expensive layout of tools and equipment.

Jewelry Making

Many of the tools needed for jewelry work are already at hand in almost any school or craftsman's shop. The essential tools are as follows:

Blowpipe. For hard-soldering a gas blowpipe or an alcohol, gasoline, or acetylene torch is needed. If gas is available, the blowpipe is preferable.

Soldering Block. Charcoal blocks are very good to place the work upon while it is being heated to hard-solder, as the charcoal glows and reflects the heat back onto the work. An asbestos block or a magnesium block with asbestos fiber is also good.

Pliers. An assortment of pliers for various types of work usually includes a flat-nosed plier with squared ends; a round-nosed plier, the jaws of which are wholly round and taper toward the tips; a half-round-nosed plier, one jaw of which is rounded and has a convex surface while the other is flat; a chain-nosed plier, the jaws of which have flat gripping surfaces that taper to narrow tips and the backs or outer surfaces of which are rounded. Most jewelry pliers are available in 4, 4½, and 5 inches lengths. End- or side-cutting nippers are almost indispensable in jewelry work.

Pliers with smooth gripping surfaces are ideal for jewelry work, because the serrations on most pliers, although ideal for gripping a surface, will mar silver and gold. If your pliers have serrations, grind the jaws smooth and polish the surfaces with an abrasive cloth or

Jewelry, Gem Cutting, and Metalcraft

an oilstone. It is much easier to prevent scratches on silver and gold than it is to remove the scratches after they have been made.

Saw Frame. A frame is essential for holding the jewelers' saw blades used in sawing out designs, ring blanks, etc. These frames are available in 3, 4, 5, 6, and 8 inches depths. For all-round jewelry work the 5-inches-depth frame is preferable.

Jewelers' Saw Blades. Jewelers' saw blades are 5 inches in length and are available in a number of sizes ranging from No. 8/0, the smallest, to No. 14, the largest. No. 0 or No. 2/0 blades are good for sawing 18- and 20-gauge silver. Smaller sized blades are used on thinner metal. See pages 18-20 for instructions on the use of a jewelers' saw.

Ring Mandrel. A ring mandrel (Fig. 35) is used in shaping and forming a ring blank. It is usually 12 or 14 inches

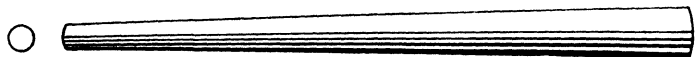

Fig. 35.—Ring mandrel. Used in shaping a ring blank.

in length, made of steel, circular in the cross section, and it tapers from 1 inch to $\frac{1}{2}$ inch. A ring mandrel can easily be made on a machinists' lathe. It may be purchased plain or graduated to the scale of U. S. standard ring sizes. The plain mandrel is available either hardened or not hardened. The graduated mandrel is hardened.

Jewelry Making

Ring Gauge. A ring gauge or ring stick (Fig. 36) is used for measuring the size of rings. It cannot be used to form a ring as, being hollow, it is usually made of thin material.

Another use of the ring gauge is the determination, by the use of the scale on the gauge, of the length of a

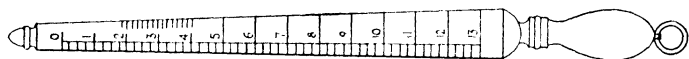

Fig. 36.—Ring stick. Used in finding the size of a ring.

ring blank before the blank is formed into a ring. Measure from the metal tip of the gauge to the desired ring size on the small scale. The scale is shown in Fig. 39.

Burnisher. Oval steel burnishers with wood handles (Fig. 37) are used for turning, or burnishing, the top

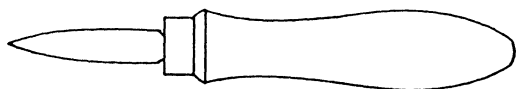

Fig. 37 - Burnisher.

edge of the bezel over the stone to hold the stone in place. A burnisher may have either a straight or a curved blade.

Ring Sizes. Ring sizes (Fig. 38) consist of a number of metal rings, each marked with a standard ring size, which are slipped on the finger to determine the size of the ring desired.

The finger size can also be determined by the use of the scale shown in Fig. 39. Cut a strip of paper that will

Jewelry, Gem Cutting, and Metalcraft

go just around the largest part of the finger and then measure this strip of paper on the scale to determine the ring size.

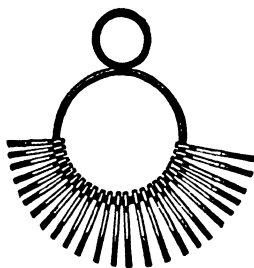

Fig. 38.—Ring sizes are used in measuring the finger to determine the size of ring.

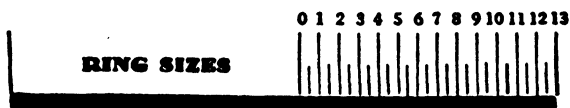

Fig. 39.—Actual size scale showing the length of blank required for various ring sizes.

Hammers and Mallets. Hammers that are useful in jewelry making include small ball peen hammers and the French chasing hammer. Small-sized wooden mallets are useful in many ways. Other mallets that are often found convenient are those that are made of rawhide or that have rawhide or fiber tips.

Files. Files are a necessity in jewelry making. An assortment should include at least one flat, one half-round smooth file of 5- or 6-inch length, and a number of needle files.

Jewelry Making

Needle files are approximately $5\frac{1}{2}$ inches in length, have a round handle, and are available in a number of shapes, such as round, half-round, flat, flat-tapered, square, knife, three-square, crossing, and slitting. The half-round, flat-tapered, knife, round, and square files are used more than any of the others. Needle files may be purchased singly or in a set that consists of a dozen assorted files.

Wire Gauge. The gauge size, thickness, of wire and sheet metal can be determined by using a wire and sheet-

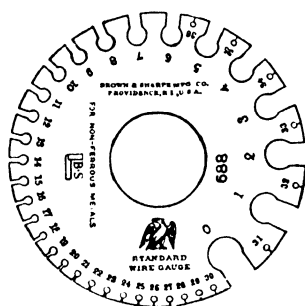

Fig. 40.—Wire and sheet-metal gauge. (Courtesy of Brown & Sharpe Manufacturing Company, Providence, R.I.)

metal gauge (Fig. 40). The gauge sizes are stamped on one side and their decimal equivalents on the reverse side. In gauging the size of wire, slip the wire into the slot, just as you do with sheet metal.

Drills. Twist drills, of the smaller sizes, are needed in making many pieces of jewelry. These drills may be pur-

Jewelry, Gem Cutting, and Metalcraft

chased in fractions of an inch, such as $\frac{3}{32}$ inch, or by number. Numbered drills run from 1 to 80.

No. by gauge	Decimals of 1 inch	No. by gauge	Decimals of 1 inch	No. by gauge	Decimals of 1 inch	No. by gauge	Decimals of 1 inch
1	0.2280	21	0.1590	41	0.0960	61	0.0390
2	0.2210	22	0.1570	42	0.0935	62	0.0380
3	0.2130	23	0.1540	43	0.0890	63	0.0370
4	0.2090	24	0.1520	44	0.0860	64	0.0360
5	0.2055	25	0.1495	45	0.0820	65	0.0350
6	0.2040	26	0.1470	46	0.0810	66	0.0330
7	0.2010	27	0.1440	47	0.0785	67	0.0320
8	0.1990	28	0.1405	48	0.0760	68	0.0310
9	0.1960	29	0.1360	49	0.0730	69	0.0292
10	0.1935	30	0.1285	50	0.0700	70	0.0280
11	0.1910	31	0.1200	51	0.0670	71	0.0260
12	0.1890	32	0.1160	52	0.0635	72	0.0250
13	0.1850	33	0.1130	53	0.0595	73	0.0240
14	0.1820	34	0.1110	54	0.0550	74	0.0225
15	0.1800	35	0.1100	55	0.0520	75	0.0210
16	0.1770	36	0.1065	56	0.0465	76	0.0200
17	0.1730	37	0.1040	57	0.0430	77	0.0180
18	0.1695	38	0.1015	58	0.0420	78	0.0160
19	0.1660	39	0.0995	59	0.0410	79	0.0145
20	0.1610	40	0.0980	60	0.0400	80	0.0135

Fig. 41.—Numbered drill sizes.

Before starting to drill a hole in a piece of metal, make a prick mark with a center punch.

Other Tools. Additional tools that are useful and often-times essential include tweezers, a pin or hand vise,

Jewelry Making

snips, a bench vise, dapping punches, chasing tools, engraving tools, draw plates, and draw tongs.

The silver jewelry shown in the accompanying illustrations was made by students, unless otherwise credited. A minimum number of tools were used. Some of the pieces were made at home by students using a few files, a hammer, a ring mandrel, and in some instances an alcohol blowtorch.

Although all the articles illustrated were made from sterling silver, gold could be used equally well. Gold is worked in almost the same manner as silver, except that gold solder must be used. Otherwise a white streak will appear on all joints.

SILVER SOLDERING

In jewelry making one must master the art of hard-soldering, known also as silver soldering, for it is by this means that joints are made.

Silver solder is an alloy of silver, copper, and zinc and melts at a high temperature, from 1300 to 1600°F. Because of the neat, strong joint it makes, silver soldering is used widely in commercial work of all kinds. Owing to its strength and resistance to vibration, the United States government makes mandatory the use of silver solder for fuel oil lines and many other connections in airplanes for government use.

Caution: Do not attempt to silver solder a joint if soft solder is present on the piece being soldered. Under the high temperature required for silver soldering, the

Jewelry, Gem Cutting, and Metalcraft

soft solder will react with the silver to cause serious damage, ruining the work.

Methods of Heating. Melting hard (silver) solder requires intense heat. The heat in commercial manufacturing plants is usually applied with oxyacetylene, oxygen and gas, or air and gas torches.

In school shops or the home workshop, where illuminating (artificial) gas is available and where most of the

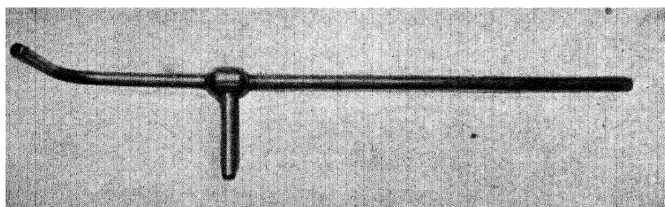

Fig. 42.—Blowpipe suitable for hard soldering where artificial gas is available.

soldering is on small pieces, such as rings and bracelets, the mouth blowpipe is excellent (Fig. 42). Unfortunately, however, this type of torch is not suitable for most natural gases, although it does work well with some.

This type of blowpipe is connected with a rubber tube to a gas outlet. The torch is lighted, the amount of gas flowing through the blowpipe is regulated, and then by blowing through the end of the blowpipe one obtains a high heat. Figure 49 shows the method of using the blowpipe. This type of torch may be used at home by connecting it to any convenient gas outlet or to the kitchen stove, after the removal of a burner which usually slips

Jewelry Making

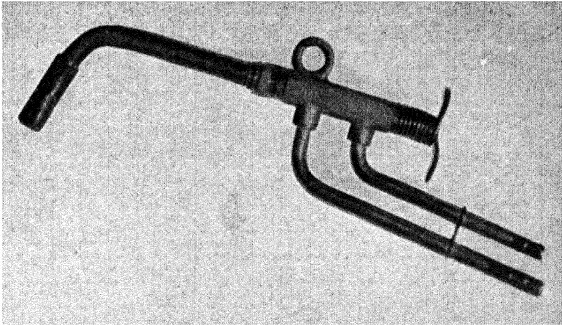

Fig. 43.—The Automaton torch which requires stream of air supplied by foot bellows or blower.

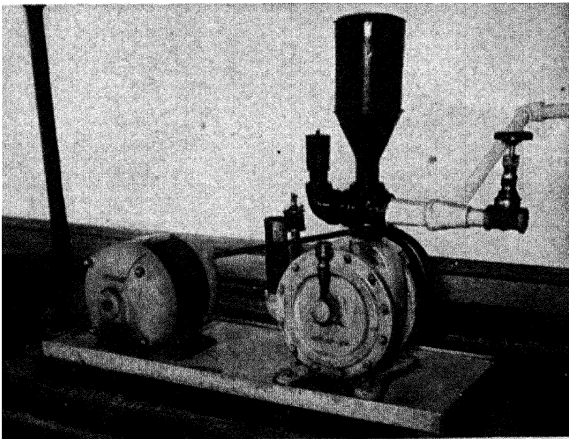

Fig. 44.—Rotary air blower.

Jewelry, Gem Cutting, and Metalcraft

over the gas stopcock. For this torch individual mouth-pieces are available.

In using a blowpipe of this type, the user must learn to blow and breathe at the same time, for a continuous stream of air through the blowpipe is necessary. This may

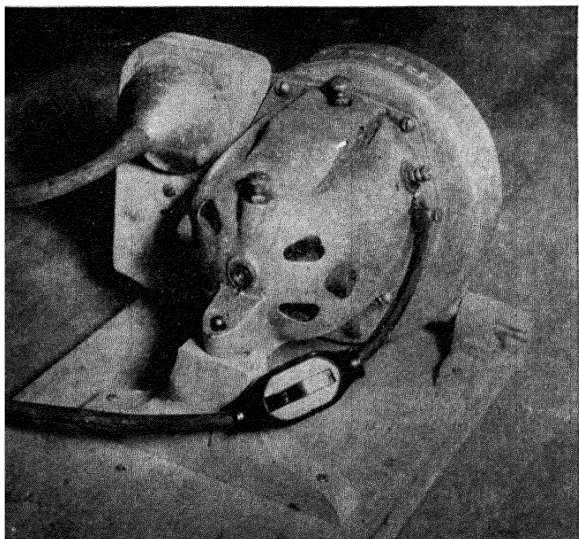

Fig. 45.—Blower made from vacuum-cleaner motor.

seem difficult to obtain at first, but by the use of the tongue as a valve to the throat it will, after a little practice, become quite easy. Stopping to breathe allows the metal to cool and often results in failure to solder the joint.

The Automaton, Hi-Heat, or a similar torch may be used if much soldering is to be done, especially on large

Jewelry Making

pieces. The air for such torches is supplied by a foot bellows or a blower. The size of the flame can be changed instantly by a slight movement of the fingers controlling the gas valve.

Instead of the foot bellows, a rotary air blower powered with an electric motor may be used. These blowers are

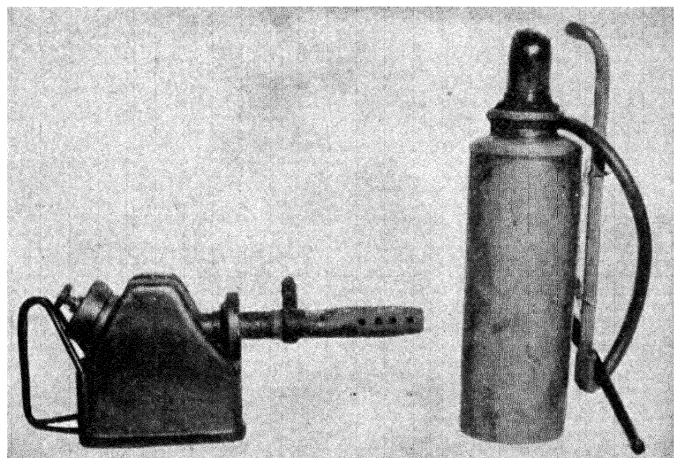

Fig. 46.—Alcohol torches suitable for hard-soldering where gas is not available.

available in various sizes. Many craftsmen improvise a blower from an old vacuum cleaner and motor or from a spray-gun outfit such as is used for painting. In a motor-driven blower the amount of air is regulated by installing a foot rheostat to regulate the speed of the motor.

If natural gas is to be used, be sure when you purchase your torch that it is of the type used with natural gas, for the torch made for illuminating (artificial) gas will not

Jewelry, Gem Cutting, and Metalcraft

work satisfactorily on most natural gases. The Automaton, as well as a number of other torches, is also made specially for natural gases, but must be so ordered. The Hi-Heat torch will operate with either natural or artificial gas.

Alcohol Blowtorch. Alcohol or small gasoline blowtorches may be used in silver soldering when gas is not available. Although not so convenient as the gas torches, they are quite effective. The automatic alcohol torches are very good for soldering large pieces.

The alcohol torch shown at the left in Fig. 46 is an automatic one that produces a high heat. The one at the right is used by blowing through the mouthpiece.

An alcohol lamp and the conventional type of blowpipe may be used in making rings and small jewelry, but such equipment is not suitable for heavy soldering, as it is difficult to produce enough heat with it.

Outfits for Camps. For camp work and shops where gas is not available, a gasoline gas generator may be installed. It is simple to operate, weighs only a few pounds, and produces a gas vapor that is excellent for soldering.

A rotary blower, or foot bellows, must be used to force air through the generator, and a special blowpipe designed for use with gasoline vapor is needed.

Acetylene torches, using acetylene gas stored in tanks under pressure, are excellent. With these a pressure regulator should be used.

Jewelry Making

Silver Solder. Silver solder is sold by the ounce (troy) in sheets, wire, strips, and granulated form. Two general types are available, "easy" and "hard" flowing. The easy flowing is preferable for most jewelry work as it melts at a lower temperature:

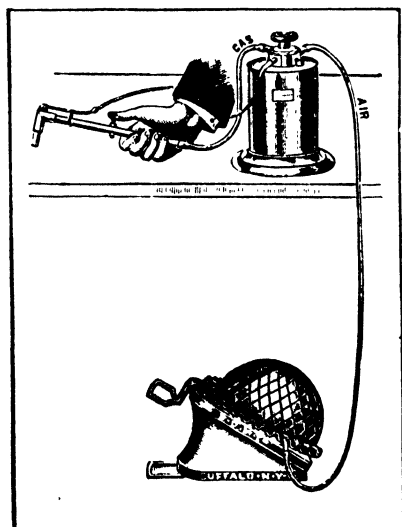

Fig. 47.—Gasoline generator complete with foot bellows and torch. (*Buffalo Dental Mfg. Co., Buffalo, N. Y.*)

Handy & Harman, Wildberg Bros., and Dee & Co., all make a number of silver solders, which have different fusing points. Each solder has a specific use. For general jewelry work Handy & Harman recommend their grade sold as "Easy," which has a melting point of 1325°F.; Wildberg Bros. recommend their No. 3, which melts at 1375°F.; and Dee & Co. recommend Dee's No. 3, which

Jewelry, Gem Cutting, and Metalcraft

melts at 1430°F. All three of these silver solders are silver white in color and a close match for sterling silver, as their silver content is high.

Although silver solder may be purchased in any desired thickness (Brown and Sharpe gauge) and then cut into pieces suitable for use, the author has found that 28 or 30 gauge in strips $\frac{1}{16}$ inch wide is excellent for student use. Being thin and narrow, it is easily cut into small pieces. Some of the supply houses dealing in jewelry findings handle silver solder that has been cut into small pieces. If your solder oxidizes through exposure to air, before you use it, rub it with fine steel wool until it is bright.

A very small piece of silver solder should be used in soldering a joint. Do not use a piece large enough to form a high place on the work for this must later be removed by filing, a process that in many instances is difficult. It is easier, if necessary, to add more solder than it is to remove excess solder. On some joints, such as sections where ornamentation is soldered to a ring, it is almost impossible to remove excess solder. Most beginners are likely to use too much solder.

Preparing the Joint. Any joint to be silver soldered must first be scraped clean or filed and then made to fit snug, for this type of solder will not bridge a gap. If there is any likelihood of the pieces moving while being soldered, bind them with thin black binding wire, which is sold by supply houses for this purpose. Do not use copper, brass,

Jewelry Making

silver, or any of the bright wires for binding purposes, as the solder will stick to them.

Whenever possible, solder without the use of binding wire, for sometimes the solder will flow alongside the

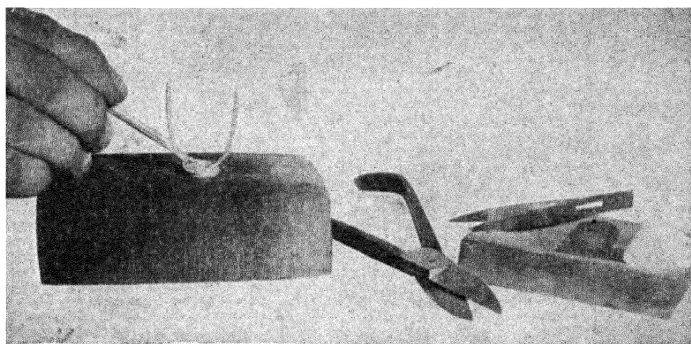

Fig. 48.—Applying solder to a ring shank-bezel joint.

wire and in some instances flow over it. When this happens, the ridge of solder must be removed by filing.

Fluxes. A flux must be used on the joint to prevent oxides from forming when the work is heated. Powdered borax or stick borax dissolved to a saturated solution in hot water is a good flux. Borum Junk, obtainable from supply houses, ground in water to the consistency of a thin paste is excellent and is used extensively. Liquid fluxes for hard-soldering are obtainable and work satisfactorily. Battern's Self Pickling Flux, a liquid flux, sold by William Dixon, Inc., is good. It can be applied with a medicine dropper. Handy Flux, in paste form, sold by

Jewelry, Gem Cutting, and Metalcraft

Handy & Harman in half-pound and larger jars, is excellent.

Apply the flux to the joint with a small artist's brush, being sure that the joint is thoroughly covered. Then dip



Fig. 49.—Student silver-soldering a ring, using mouth blowpipe and artificial gas.

the solder, which has been cut into small pieces, into the flux and apply to the joint with tweezers, brush, or toothpick.

Jewelry Making

Applying the Heat. With the work on a charcoal or asbestos block, apply heat gently until the water in the flux has evaporated. If heat is applied too strongly at first, the moisture in the flux will cause the flux to rise and thus to move the solder. Keep the flame in motion and

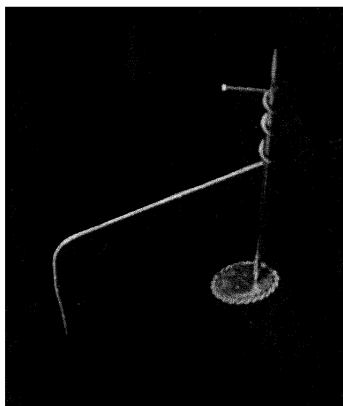

Fig. 50.—Method of holding scarf-pin stem in place on a charcoal block while it is being soldered.

off the joint as much as possible. When the joint shows a dull red, indicating that the temperature is around 1200°F., concentrate the heat upon the joint. The solder will flow when the parts to be joined reach the melting point of the solder.

Avoid using a small needlelike flame as this type of flame is very hot and is likely to melt the joint, especially on work on bezels and small wires. Very little air is required to produce the correct flame, especially if you are using artificial gas. If too much air is mixed with the

Jewelry, Gem Cutting, and Metalcraft

gas, it will cool the work. Practice and experience will show what type of flame is best, as well as the correct amount of air required.

On large pieces such as bracelets it is well not only to place the work upon a charcoal or asbestos block, but to use charcoal or asbestos at the back of and on each side of the work so as to reflect the heat. Soldering should not be done in a draft as the air current will cool the work.

In soldering a small piece to a large piece, apply more heat to the large piece, for the solder will flow and join the two pieces only when both pieces are of the correct temperature.

Balling of Solder. If the solder rolls into a ball when it melts and refuses to flow readily, it is probably because the solder or joint was not covered with flux or because the work was underheated. Keep the flame upon the work as much as possible, instead of upon the solder; otherwise the solder will melt, ball, and will not flow readily when the work reaches the melting point of the solder.

Pinholes in the finished joint may be caused by dirt, oil, or improper fluxing, or by too much or not enough heat.

Soldering Ornaments. Small ornaments, shot, twisted wire, leaves, and other decorations, can be soldered onto larger pieces easily by the use of silver solder filings, known also as granulated silver solder. The filings are mixed with powdered Borum Junk, one part of solder

Jewelry Making

being mixed with two parts of the powder. Using a pestle, crush the Borum Junk in a mortar and then sift it through a cloth. Mix a little at a time or, if a large amount is mixed, remove a small quantity and place it in a jar to be used while you are working.

Make sure, by pickling, that the ornament to be soldered in place is clean; then moisten the underside of the leaf or ornament and, holding it with tweezers, touch it to the filings-flux mixture. Put it in place and apply the heat, being careful to keep the flame off the ornament.

In soldering a small ornament, you will find that it will generally hold better if at the instant the solder melts the ornament is pressed against the surface with the tang end of an old file or a similar object.

Another method quite effective in soldering leaves to a ring or to other pieces of jewelry is first to put flux over the place on which the leaf is to be applied and then to glaze (melt) the flux. Next dip a small piece of the solder into a thick consistency of Borum Junk and water and place it on the underside of the leaf, usually in a hollow. Then apply the leaf to the object in the usual manner. When the work gets hot enough, the solder underneath the leaf will melt and flow onto both the leaf and the work.

Some craftsmen wet the tip of the tang end of a small discarded file, stick this into a mixture of silver solder filings and Borum Junk, and then touch the joint or piece to be soldered when it becomes red-hot. Borax must be applied to the joint before the heat is applied. This

Jewelry, Gem Cutting, and Metalcraft

method is sometimes used in chain making, especially for chains made of gold wire.

Large joints can sometimes be silver soldered by applying flux to the joint and heating to a point that will melt the solder. A thin strip or wire of solder is then dipped in the flux and touched to the joint. This method is used extensively in work on long seams and joints.

Protecting Soldered Joints. When more than one joint is to be soldered, coat previously made joints with borax. If there is danger of the joints opening, a solder of lower melting point may be used, or the soldered joints may be coated with a paste made of yellow ocher and water, whiting and water, or jewelers' rouge and water. After the soldering is completed, the ocher may be removed by soaking the work in water and scrubbing with an old toothbrush.

All the jewelry shown in the illustrations in this book was made with one grade of solder, and very little difficulty was encountered. Yellow ocher was used on some pieces by beginners. Advanced students, as a rule, depend upon borax flux to hold the pieces together and to protect previously soldered joints, seldom using either binding wire or yellow ocher if their use can be avoided. Cautious application of heat in evaporating the water from the flux, so as not to disturb the solder or the joint, is essential.

Pickling. Glazed borax, as well as oxides left on the article after the joint is soldered, may be removed in a pickling

Jewelry Making

bath prepared by adding 1 part sulphuric acid to about 15 parts water. *Add the acid to the water.*

The solution is more effective when used hot and should be heated in a copper pickling pan. When not in use, the liquid should be kept in a glass or earthen jar.

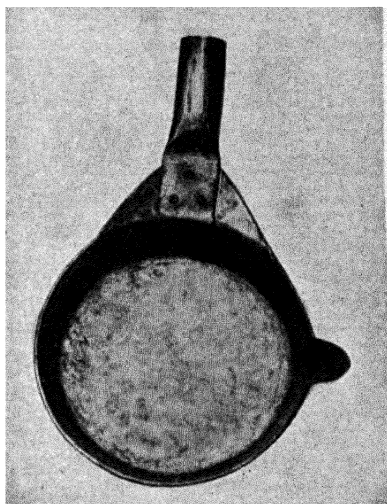

Fig. 51.—Copper pickling pan.

Remove all iron binding wire and place the soldered article in the heated pickle bath. Retrieve the work with copper or silver wire or copper tweezers. Never use an iron wire or object to retrieve the work as the reaction of the iron in the solution will discolor silver.

If it is inconvenient to heat the acid solution, the article to be cleaned may be heated and, while hot, dropped into the cold liquid.

Jewelry, Gem Cutting, and Metalcraft

Making Silver Solder. Small amounts of silver solder may be made by fusing small pieces of silver and brass on a charcoal or asbestos block, the proportions being about 4 parts silver to 1 part brass. If a melting furnace is available, a larger amount may be prepared. Place the silver in a crucible, put in a small amount of borax, and melt

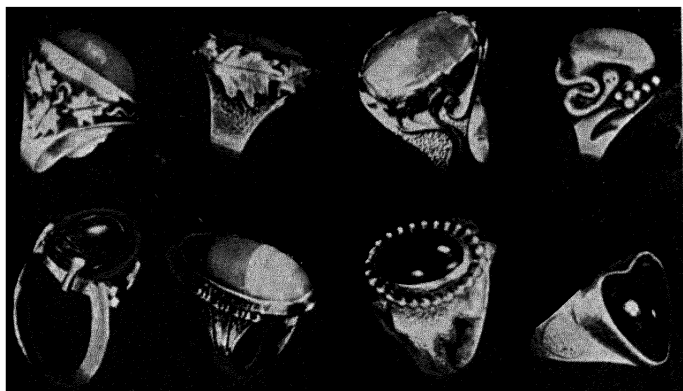

Fig. 52.—Sheet-silver rings using leaves, wire, and shot for decoration.

the silver. Then add the brass filings and stir. Pour the alloy from the crucible and when cold make into granulated form by filing with a coarse file or hammer or roll into the desired thickness.

Silver solder, however, is not expensive and is best bought ready-made.

Gold Solder. Gold solder is made of fine (pure) gold alloyed in varying degrees to melt at different temperatures for the different karat golds. Gold solder is used

Jewelry Making

in the same way as silver solder, with borax as a flux. Owing to the fact that different karat golds have different melting points, a special solder for each karat gold must be used. Gold solder must also match in color. For example: 10-karat white gold is soldered with 10-karat white-gold solder, and 14-karat yellow gold is soldered with 14-karat yellow-gold solder. Gold solder is sold by the pennyweight (dwt.).

CHAIN MAKING

Before attempting to silver solder a ring or other piece of jewelry, one should practice first upon copper, which is inexpensive and works much the same as silver. A useful beginning exercise in hard-soldering is the making of a chain.

Secure a short length of 18- or 20-gauge round copper wire and a large nail. Wrap two layers of paper around the nail. Then hold the nail and the end of the wire in a pair of pliers and tightly wrap the wire around the nail. Hold the nail in a flame to burn out the paper. Remove the coil of wire from the nail and saw or cut into links. File the links until the ends fit snugly. Solder a number of links into single units. Then connect two such soldered units with a third unit, making units of three. When two units of three links each have been made, join these with another link, thus making seven units. Repeat until the desired length is obtained. Links of various shape can be made on mandrels of the desired shape cut from thick copper or sheet metal, or the links may be twisted by using pliers.

Jewelry, Gem Cutting, and Metalcraft

RING MAKING

Finger-ring making, the most popular form of jewelry work for students, may be divided into eight operations: (1) designing, (2) bezel making, (3) shank making, (4) assembling shank and bezel, (5) ornamenting, (6) polishing, (7) oxidizing, and (8) setting the stone.

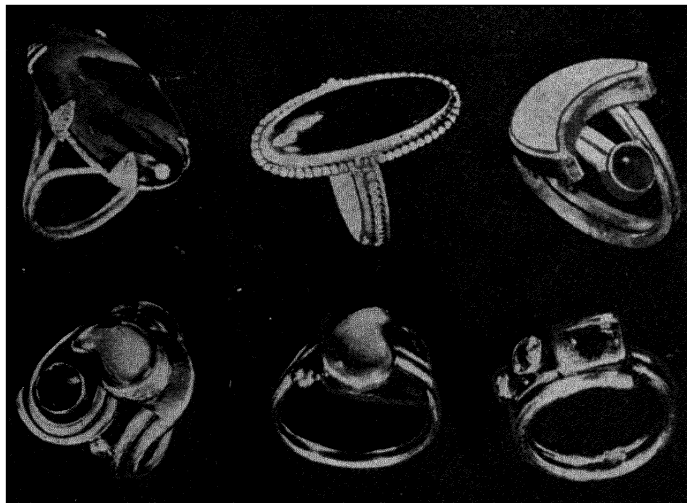

Fig. 53.—Wire shank rings.

Rings may be made from wire and sheet silver or from sheet silver only.

Designing. The designing of a ring must necessarily be based upon the ornament, or stone, that is to be used on the ring. Different kinds and shapes of stones require different mountings. Faceted and cabochon stones gener-

Jewelry Making

ally require different methods of ornamentation as well as of mounting. In designing a ring, one is limited only by his ability to execute his designs and by the material at hand.

Before starting work on the actual making of a ring, it is well to prepare a number of sketches of different types of

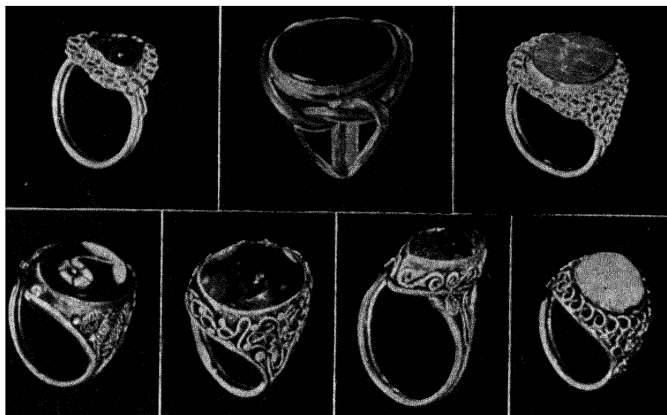

Fig. 54.—Rings ornamented with twisted wires and small balls of silver, termed "shot."

mountings with decoration or ornamentation for each and decide definitely which is to be used. Often it is advisable to make these sketches larger than the actual size of the ring.

Bezel Making. Although either sterling or fine silver may be used in making the bezel, it has been the experience of the author that fine silver is preferable for student work, as it is much softer and will bend to shape more

Jewelry, Gem Cutting, and Metalcraft

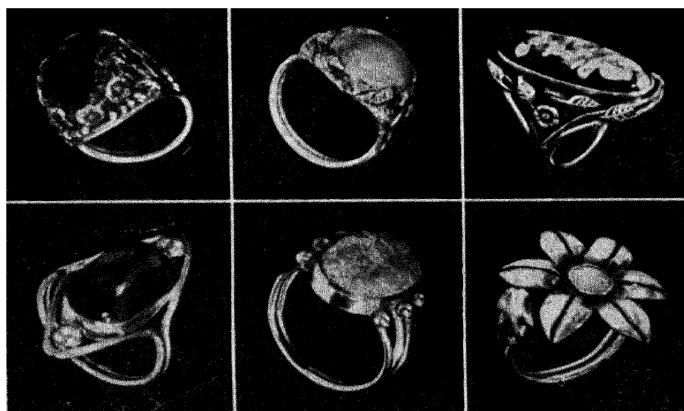

Fig. 55.—Rings using leaves and shot for decoration.

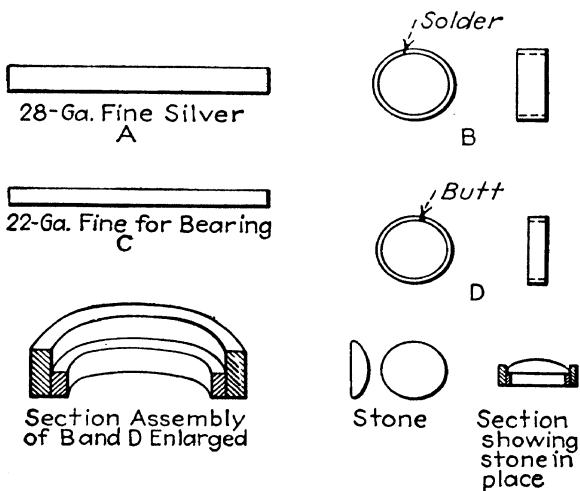

Fig. 56.—How the bezel is made.

Jewelry Making

readily. Regular bezel made of sterling may be purchased, but it is harder to work than that made of fine silver.

The bezel consists of two parts, an outer rim that is burnished over at the top to hold the stone in place and an inner part, or bearing, that supports the stone and keeps it from going on through the outer rim. The outer

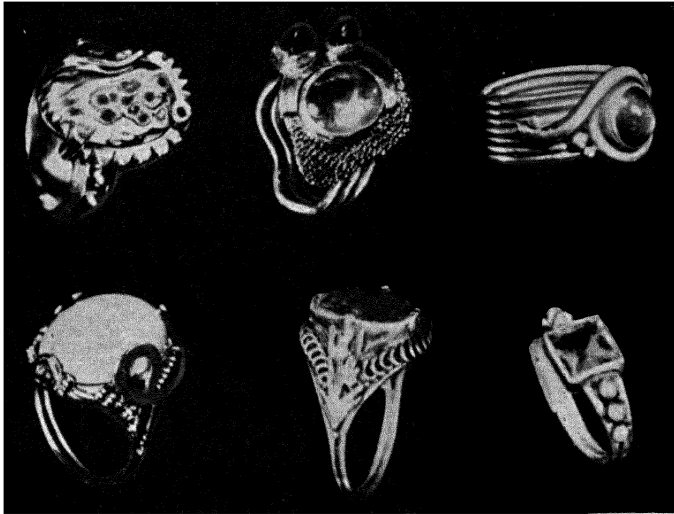

Fig. 57.—Rings.

rim is generally made of 26- or 28-gauge Brown and Sharpe fine silver. It is made to the exact shape of the stone, and the ends are silver soldered together. Fine silver may be purchased in widths suitable for bezel making, usually either $\frac{1}{8}$ or $\frac{3}{16}$ inch.

If the outer rim of the bezel, when made, is too small, it may be stretched by slipping it over a round mandrel and

Jewelry, Gem Cutting, and Metalcraft

hammering lightly. It may then be shaped to fit the stone. As the metal is quite soft and stretches easily, avoid heavy hammering.

The bearing may be made of small round sterling wire or of sterling or fine sheet silver cut into strips about $\frac{1}{16}$ inch wide. Fine silver $\frac{1}{16}$ inch wide may be purchased and then cut into the desired lengths. Although any of several gauges of silver may be used for the bearing, the 22-gauge Brown and Sharpe works satisfactorily. The bearing is made so that it fits exactly the inside of the outer rim. Do not solder together the ends of the bearing before inserting the bearing in the outer rim.

After the two parts are assembled, place them upon the soldering block and solder together.

Although fine silver has a melting point approximately 400°F. higher than that of the solder, it will quickly melt if too much heat is applied or if a pointed flame is used.

Shank Making. Shanks for rings may be made either from round wire or from sheet silver. Sterling silver is used for shanks, as the fine silver is too soft. If the shank is to be made from round wire, use 15- or 16-gauge Brown and Sharpe. Wire shanks may be made in either of two styles, as shown in Fig. 58. Secure two pieces of wire, about 3 inches in length, and anneal by heating to a dull red. Pickle and then bend the wires to shape. If desired, bind with binding wire to keep them from moving while they are being soldered. Use several small pieces of solder instead of one large piece.

Jewelry Making

After the wires have been soldered together, bend them to shape and solder to the bezel. The only difference in the two styles is that in type 1 the shank is made the size desired after it is soldered to the bezel, and in type 2 it must be sized before it is soldered to the bezel.

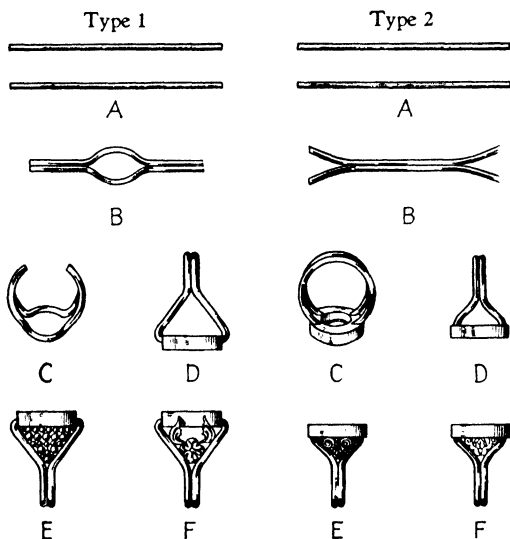

Fig. 58.—Steps in making rings from wire. A, 16-gauge round sterling wires. B, wires bent to fit bezel and soldered together. C and D, wires shaped and soldered to bezel. E and F, decoration applied to ring assembly.

Square or triangular wire may be used in making shanks. Shanks may also be made of sheet silver, 18- or 20-gauge Brown and Sharpe usually being used. In this case the bezel may be soldered upon a thin sheet of sterling and the shank soldered in place after being cut to shape and sized.

Jewelry, Gem Cutting, and Metalcraft

Assembling Shank and Bezel. After the shank and bezel have been made, it is necessary to solder them together. Place the bezel, inverted, upon the soldering block and put the shank in place.

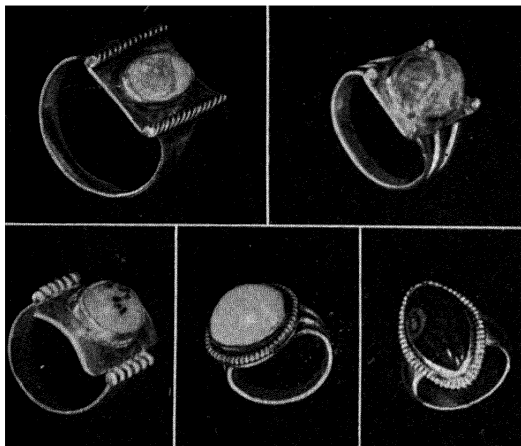

Fig. 59.—Rings made with sheet-silver shanks using twisted wire, shot, and beaded wire for ornamentation.

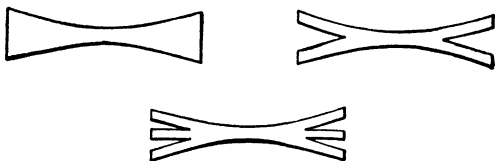

Fig. 60.—Shanks made from sheet silver.

If using a wire shank, type 1, the wires may be sprung apart just enough to insert the bezel, which usually will stay in place while being soldered. Both sides are soldered at the same time. If a wire shank, type 2, is used,

Jewelry Making

it must be made of correct size and the end of each wire filed so that it fits against the bottom of the bezel. All four joints may be soldered at the same time. No binding is necessary if the flame is cautiously applied so that the borax will not "rise" to disturb the assembly.

Shanks made from sheet silver are shaped, sized, and placed upon the bezel or upon a thin sheet of sterling to

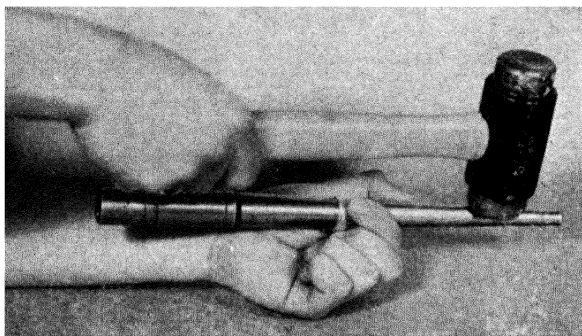

Fig. 61.—To remove a cabochon from a mounting, loosen the bezel around the stone with a penknife, place ring on mandrel, hold as shown, and strike end of mandrel a sharp blow.

which the bezel has been soldered, and both sides are soldered at the same time.

Ornamenting. The ornamentation that is to be applied to a ring depends to a large extent upon the kind and shape of stone, as well as upon the kind of mounting, that is being used. One's ingenuity is, however, a large factor, as many variations and adaptations are possible.

The ornamentation usually consists of the following or combinations of the following: bent and twisted wires,

Jewelry, Gem Cutting, and Metalcraft

shot, leaves, beaded wire, special designs cut from sheet silver, and saw piercing.

BENT AND TWISTED WIRES. Small wires, ranging in size from 20 to 30 gauge, may be twisted together and used for ornamentation. A good way to twist them is to tie the ends of two or more wires together, fasten on a hook, which is held in the chuck of the drill press, hold the free ends, and start the drill press. One can, however, twist them by hooking them onto any revolving arbor or by using a small hand drill.

The twist should be annealed before being used and then pickled. In annealing the twist, roll it into a coil about 2 inches in diameter and use a large flame of the torch with very little, if any, air.

Scrolls and various shapes may be made of the twists. The use of this type of decoration is shown in Fig. 54.

Instead of the wire being formed into scrolls, circles are sometimes made. If this type of decoration is to be used, the bezel is usually mounted upon a piece of 22-gauge sheet silver. The circles are made by wrapping the twisted wire around a small drill, usually a No. 55 or a No. 60. The coil is cut into links, which are soldered on the sheet silver. The drill is then used to bore out the metal. Small balls of silver, called shot, may be soldered onto the circles if desired.

Wire bent into many shapes or designs may be used to great advantage for decorating rings. Shot may also be used on this kind of decoration. If desired, the shot may be filed partly away to produce a flat effect. In using wire or any ornamentation that is applied to the bezel, do not

Jewelry Making

get it too near the top of the bezel, or difficulty will be encountered in setting the stone.

SHOT. Small balls of silver, or shot, may be made by melting scraps of silver upon a soldering block. If, however, several balls of the same size are desired, equal lengths of wire may be cut and a ball made from each length.

To cut wires of equal length, wrap a piece of wire around a nail or other suitable mandrel and then cut the coil into single units. Always use borax on the silver when melting to form the balls. The shot should be pickled before it is soldered onto the ring.

Shot may be soldered in clusters, used at regular intervals, or used to fill in spaces that otherwise would appear open.

LEAVES. You can shape leaves from sheet silver by first sawing to the desired shape, cutting in the veins with an engraving tool or other sharp instrument, and then doming or dapping. The dapping is usually done on the end grain of wood or upon a lead block, with dapping punches, which may be purchased or made from tool steel. A large nail, the end of which has been ground to the desired shape and then polished, is excellent for emergency use when dapping punches are not available.

Commercial stamped leaves of various shapes and sizes may be secured and used in ornamenting.

If leaves instead of the bezel are to be used to hold the stone in place, make the bezel in the usual manner but make it very low, so that when the leaves are soldered in place they will project above the bezel. Solder each leaf on

Jewelry, Gem Cutting, and Metalcraft



Fig. 62.—Leaf designs.

Jewelry Making

separately. After the ring has been cleaned, polished, and oxidized, the leaves are burnished over to hold the stone in place.

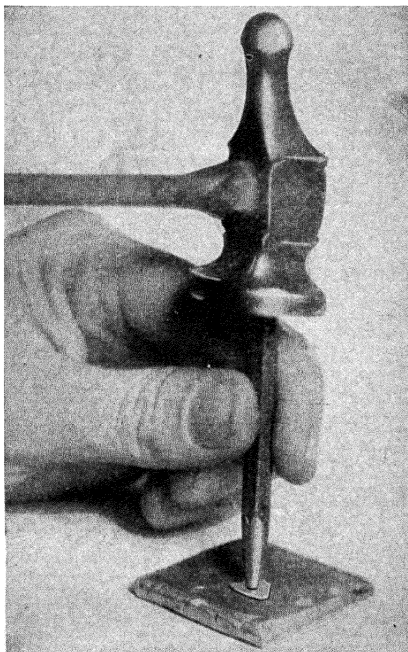

Fig. 63.—Making an ornament on the lead block.

BEADED WIRE. Beaded wire of various gauges may be secured from supply houses in any length desired, or it may be purchased by the ounce from a silver dealer. Beaded wire is available in round, half-round, and pearl bead. Often it is necessary to anneal beaded wire before bending it into shape.

Jewelry, Gem Cutting, and Metalcraft

TRIANGULAR WIRE. Low-dome triangular wire is useful in jewelry making in a number of ways. The smaller sizes







Weight per foot, ounces		Brown and Sharpe gauge
0.073		18
0.096		16
0.124		15
0.168		14
0.218		13
0.254		12

Fig. 64.—Round-bead wire. (Courtesy of Wildberg Bros. Smelting and Refining Co., Los Angeles.)

can be used in making ring shanks, as shown in the lower left ring in Fig. 52 and in the top center ring of Fig. 53, where two pieces of the wire were used and the V formed



Weight per foot, ounces		Brown and Sharpe gauge
0.090		14
0.128		12
0.277		9

Fig. 65.—Half round-bead wire. (Courtesy of Wildberg Bros. Smelting and Refining Co., Los Angeles.)

between the two was filled in with a beaded wire. Bracelets may also be made of the various sizes of triangular

Jewelry Making

wire, as shown in Fig. 81, where each of the bracelets shown at the left was made from two pieces of the smaller sized wire with bead or twisted wire for decoration.

SHEET-SILVER ORNAMENTS. Initials, monograms, Indian symbols, and many other designs may be sawed from sheet silver and soldered in place as ring decorations. The





Weight per foot, ounces		Brown and Sharpe gauge
0.060		18
0.095		16
0.148		14
0.265		12

Fig. 66.—Pearl bead wire. (Courtesy of Wildberg Bros. Smelting and Refining Co., Los Angeles.)

ring is usually made the correct size and the ends of the blank are soldered together before the ornaments are added.

If the ornament needs to be curved to fit the ring, this may be done by making an impression in a wood or lead block with a ring mandrel and a wood mallet. The ornament is then put in this impression and the mandrel placed on top of it and again hit with the mallet. Be sure that the ornament is face down in the impression; otherwise the curve will be wrong.

Jewelry, Gem Cutting, and Metalcraft

SAW PIERCING. Saw piercing is often used on rings made from sheet silver and must be done before the blank is bent to shape. The piercing is done with a fine jewelers' saw, as explained elsewhere.

Weight per
foot, ounces

Thousandths
of an inch

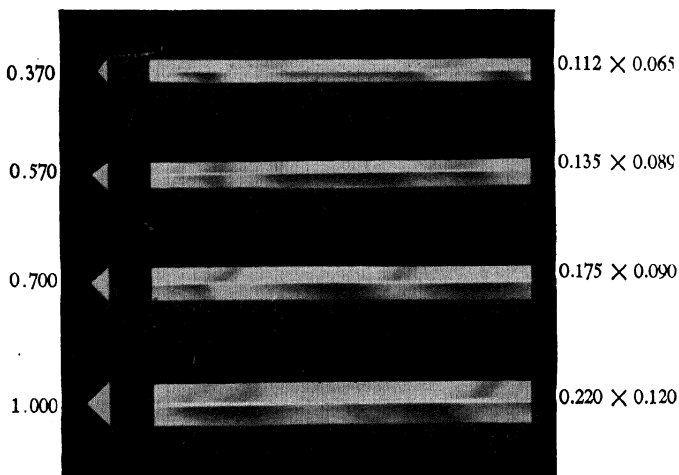

Fig. 67.—Low-dome triangular wire. (Courtesy of Wildberg Bros. Smelting and Refining Co., Los Angeles.)

POLISHING

After all silver soldering is completed, the ring must be cleaned in the pickling bath. Rough spots must be filed smooth, with jewelers' files, and the ring must be polished. The ring is polished with jewelers' rouge, used as an abrasive on a felt or muslin wheel, which is mounted upon a motor or arbor. Do not polish the ring upon a

Jewelry Making

wheel that is used for polishing brass or copper. After polishing on the buffer, wash the ring with soap and hot water to remove the rouge.

Small scratches and file marks that are in places from which it is impossible to get them out with the buffing wheel may be removed by using water-of-Ayr (Scotch) stone. Keep the stone wet while rubbing. A slate pencil will serve almost as well, and fine steel wool or crocus cloth will remove many scratches. Use it before buffing with rouge.

OXIDIZING

A silver ring when polished will appear very bright. It will gradually turn darker if left exposed to air, especially if any sulphur is present in the air. It may be readily darkened by dipping into a solution made by dissolving a lump of liver of sulphur in a small jar of water. Reaction is better if the solution is hot. Because of the objectional odor of the liver of sulphur, a commercial oxidizing solution may be preferred. This is usually applied with a small brush to the ring, while the ring is warm.

The oxidizing solution will discolor the entire ring. To remove part of the oxidization, a fine pumice powder, or a kitchen cleanser, mixed with water may be used. Rub it on with the fingers until the desired hue is obtained.

SETTING OF STONE

After the ring has been polished and oxidized, the stone is ready to be set. First taper the edge of the bezel with a file and then place the stone in the bezel.

Jewelry, Gem Cutting, and Metalcraft

Hold the ring in a ring clamp, and with a burnisher gradually turn the top edge of the bezel over onto the stone. This is best done by holding the burnisher in a

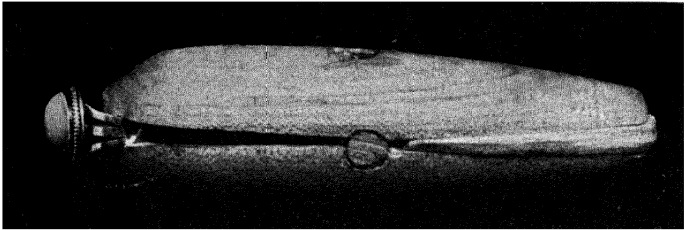

Fig. 68.—Ring clamp used for holding rings. Clamps like this are easily made.

position parallel to the base of the stone and going around the bezel, applying pressure, until the thin metal is turned in against the stone. The bezel may then be smoothed, if

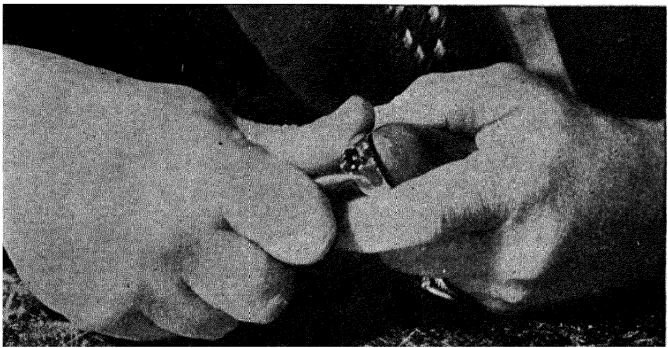

Fig. 69.—Setting a stone with a burnisher. The ring is held in a ring clamp.

necessary, with a jewelers' file. Polish with a hand buff, which is a piece of felt glued to a thin wood strip, using rouge as an abrasive.

Jewelry Making

The burnisher, or file, will not damage the majority of stones that are used, as the stones are harder than the file. Turquoise, variscite, malachite, opal, and a few others, however, being softer, can be damaged.

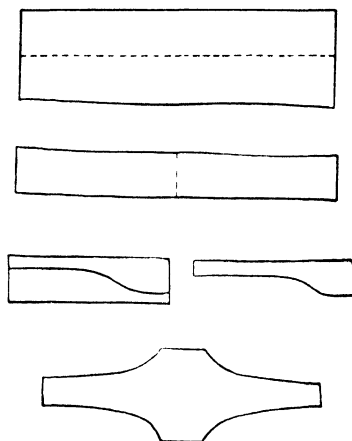

Fig. 70.—Making a paper pattern for a sheet-silver ring.

SHEET-SILVER RINGS

To make a ring from sheet silver, it is necessary first to make a paper pattern. If a stone is to be used, the width of the paper should be somewhat wider than the length of the stone. The length of the piece of paper is determined by the size of the ring. It is well to make a number of patterns and then to select the best. After the pattern for the ring blank has been selected, the design of the ring should be sketched on the pattern, especially if the decoration is to be saw pierced. One method of developing the paper pattern is shown in Fig. 70. Fold the paper

Jewelry, Gem Cutting, and Metalcraft

lengthwise, then crosswise. Draw the outline on the folded paper, cut it out with scissors, and unfold.

Make the paper pattern the correct length for the ring size desired by measuring on a ring stick or upon the full-size scale, as shown in Fig. 39. Add the thickness of the metal to the correct length to take care of filing and bending.

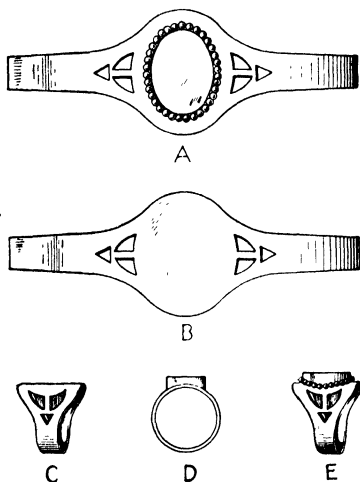

Fig. 71.—Steps in making a sheet-silver ring. A, paper pattern with design. B, blank sawed from sheet silver. C, blank sized and ends soldered together. D, bezel soldered in place. E, ornamentation soldered in place.

Glue the paper pattern to the sheet silver, 16, 18, or 20 gauge Brown and Sharpe, and, using a jewelers' saw, saw out the silver blank. If designs are to be sawed into the blank, drill small holes, insert the blade, and saw out the design. Fine saw blades (No. 3/0 or 4/0) are preferable, for they leave a smoother cut. Saw over a notched block

Jewelry Making

or a piece of wood fastened to a table top (Fig. 10). The blade cuts on the downward stroke. The method of applying tension to the blade as it is being inserted in the saw frame is shown in Fig. 9. Paraffin rubbed on the saw teeth aids in the sawing.

Ordinary glue will not adhere paper to metal satisfactorily. M.C. Glue, sold by Metal Crafts Supply Co., is excellent, and paper cement made from rubber is good.

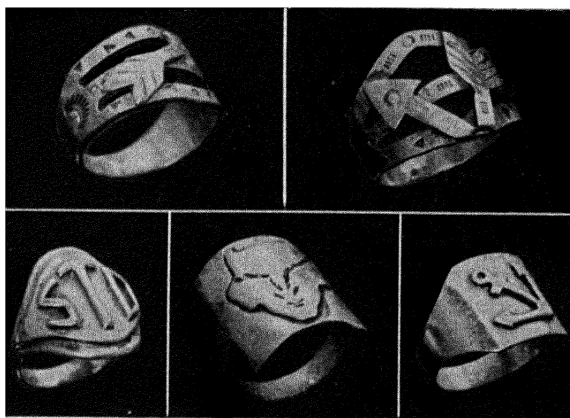

Fig. 72.—Rings made from sheet silver using simple designs.

After the blank is sawed out and pierced, if designs are to be sawed into the blank, bend it to shape around a ring mandrel, using a wood or rawhide mallet. Then size the blank and solder the ends together.

Next make the bezel. Wider strips of silver than those used in making bezels for wire rings must be used, as the bezel must be cut away on the underside to fit the curved surface of the ring. Bezel material $\frac{3}{16}$ inch and in some

Jewelry, Gem Cutting, and Metalcraft

case $\frac{1}{4}$ inch wide is used. The bearing or support is about $\frac{1}{16}$ inch less in width.

To file the bezel to fit the ring, wrap one thickness of abrasive cloth around a ring mandrel and cut out the metal on the underside of the bezel by drawing the bezel back

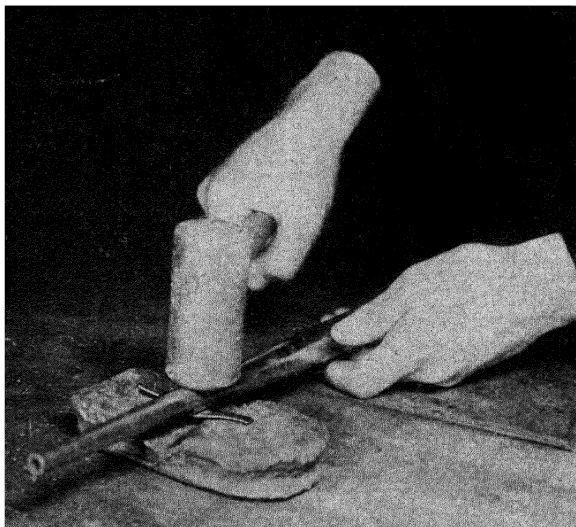

Fig. 73.—Use a mallet, ring mandrel, and lead or wood block to shape a sheet-silver ring blank.

and forth over the cloth. At some place along the mandrel is the exact curvature of the ring, and when this is found and the cutting done there, the bezel can be cut away to fit the ring exactly. In order to avoid a tapering cut, change the ends of the bezel frequently during filing. Avoid mashing the bezel out of shape while filing. If

Jewelry Making

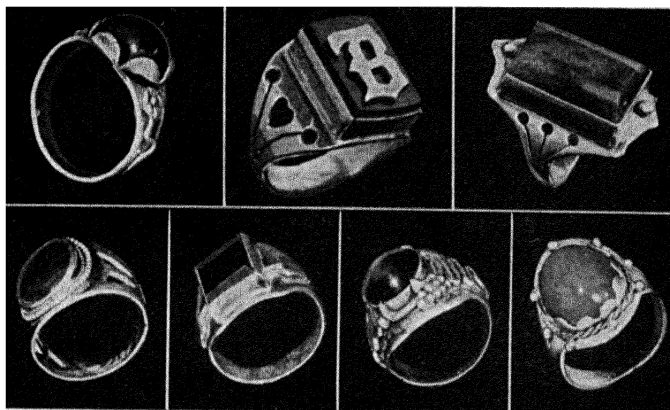

Fig. 74.—Sheet-silver rings with various kinds of ornamentation.

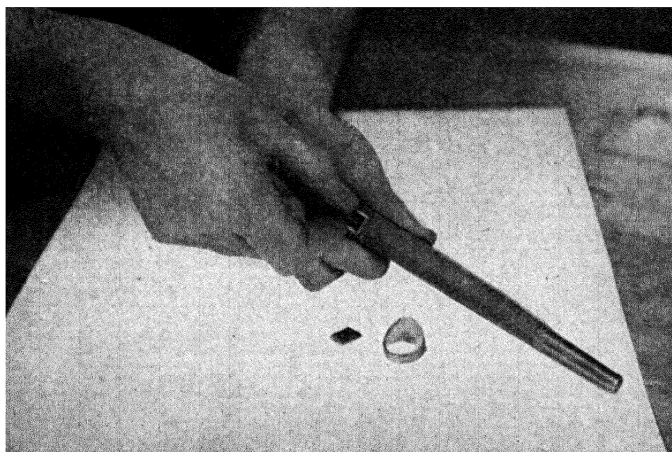

Fig. 75.—Filing a bezel to fit a sheet-silver ring on abrasive cloth wrapped around a ring mandrel.

Jewelry, Gem Cutting, and Metalcraft

desired, the stone may be kept in the bezel during the filing operation.

To solder the bezel to the ring, coat the joint in the ring with borax flux and place the ring so that the bezel will be on top. Hold the ring in position with small pieces of charcoal or asbestos blocks. Place the bezel in position and coat the inside of the bezel as well as the joint of the bezel with a borax flux. Place several pieces of solder on the ring, inside the bezel, and apply heat gently until all water is evaporated. Heat should then be applied upon the side of the ring, below the bezel, from a rather large flame, until the ring is red-hot, at which time the flame may be directed upon the top of the ring and bezel.

If ornaments are to be added, solder them in place and clean, polish, oxidize, and set the stone in the usual manner.

RINGS FROM WIRE

Rings that are inexpensive, costing only a few cents each to make, and that appeal to many students may be made from various sizes of round sterling wire.

The knot ring is very easy to make. Two 4-inch lengths of wire, usually 16 gauge or heavier, are used. Tie the knot in one piece of wire, but before drawing the knot tight insert the other piece of wire through the knot and tie the knot in this piece. Draw both knots tight and solder the wires together. Then size the ring and solder the ends together.

Snake rings, especially the double-headed kind, are much harder to make than knot rings. The difficulty

Jewelry Making

with the double-headed snake ring is to get the wire the correct length before bending to shape so that both heads will be visible when the finished ring is worn.

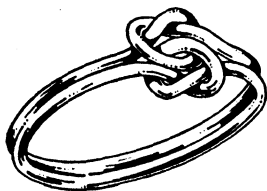

Fig. 76.—Knot ring made from round sterling wire.

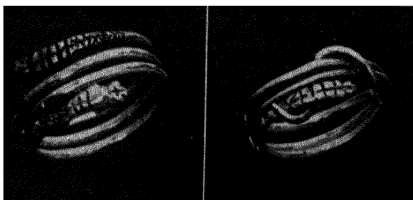

Fig. 77.—Snake rings made from round sterling wire.

BELT BUCKLE RING

Of the many rings already described and shown, the belt buckle ring is perhaps the most popular with high school students. Girls, instead of wearing it as a ring, often wear it as a neckerchief slide.

The belt buckle ring is a filing, bending, and fitting project and is excellent for beginners as it requires no soldering.

Jewelry, Gem Cutting, and Metalcraft

This ring is made by cutting the blank from 20-gauge sterling sheet and filing it to shape. If a piece of silver $4\frac{1}{4}$ inches wide is used and the blanks sawed out as

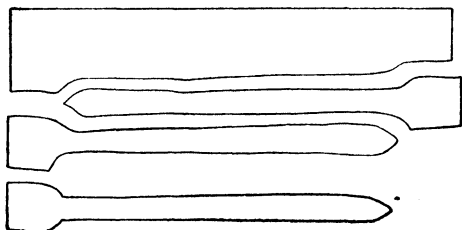
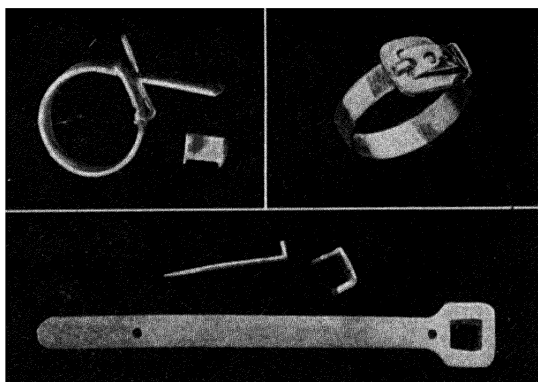

Fig. 78.—Belt buckle ring, showing method of assembling and how blanks are cut from a piece of sterling sheet.

illustrated, there will be no waste, and the cost of each blank will be very little. The width of the master blank used in marking out the blanks is $\frac{3}{16}$ inch for the narrow part and $\frac{3}{8}$ inch for the wide part, from which the buckle part is formed.

Jewelry Making

The buckle part can be filed to any of a number of desired shapes. In filing the square hole in the buckle after it has been drilled, make sure that it is the exact width of the narrow part of the blank. The tongue and the U-shaped strap are made from small pieces of sheet silver. The method of assembling is shown in Fig. 78.

If desired, three holes may be bored in the band instead of one, as shown in the finished ring.

In assembling, make sure that the tongue goes between the buckle and the band, with the bent portion extending into the hole. The U-shaped strap is bent to shape with flat-nosed pliers. The ends of the strap are bent over to hold the assembly in place. All rough edges are filed off, and the entire ring is then buffed and polished. If desired, all joints may be hard-soldered.

Monel or nickel-silver may be used instead of sterling but is much harder to work.

BRACELETS

Bracelets may be made in a number of designs by the use of wire, sheet silver, and gem stones and may be decorated in various ways.

Four bracelets are shown in Fig. 79, made by different means. The one at the top has a stone mounted in the center of a piece of sterling sheet. Small wires twisted and formed into various shapes are used for ornamentation around the stone and on the six small pieces of sheet silver. Shot was soldered between the coils of wire.

The coin bracelet, made of souvenir coins, is simple in design and quite popular. Six coins are generally used,

Jewelry, Gem Cutting, and Metalcraft

although five are sufficient. Small silver medals and commemorative pieces are sometimes substituted for the coins. Two of the pieces in the coin bracelet shown are not coins but are George Washington Bicentennial commemorative pieces. In selecting pieces for a bracelet of this type, choose those that have a high silver content. Coins from some countries have a low silver content and will, un-

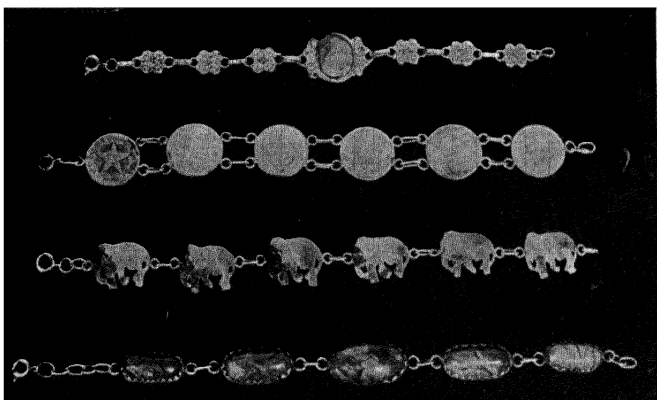

Fig. 79.—Bracelets.

fortunately, melt at about the same temperature as the silver solder, thus rendering them useless unless solder with a very low melting point is used. Coins that are unsuitable are generally yellow or brassy looking.

The elephant bracelet is very similar in construction to the coin bracelet, except that the elephants are handmade from 20-gauge sheet silver. The blanks are first sawed out and the edges filed. Body lines and features are then cut with an engraving tool. The figures are made lifelike by

Jewelry Making

being raised from the back. This is done by making a depression in a piece of lead or wood with a small ball peen hammer, placing the blank over the depression,



Fig. 80.—Bracelet made from three heart-shaped stones.

holding the small hammer on the metal, and hitting lightly with another hammer.

Many other designs may be worked into bracelets of this type. For instance, Indian symbols, such as thunder-birds, sun rays, arrowheads, and the Hopi horse, may be

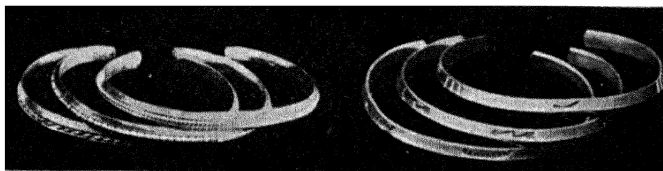

Fig. 81.—Bracelets made from triangular wire.

soldered upon sheet-silver blanks, cut into various shapes, and then linked together. If desired, a small turquoise may be set in each of the symbols.

Jewelry, Gem Cutting, and Metalcraft

Indian symbols may be suspended on chains, either handmade or commercial, to make charm bracelets. They are usually attached by soldering a small circle or loop to the top of the ornament and then connecting it with a link to the bracelet chain. Hearts, diamonds, spades, clubs, initials, monograms, crosses, and many other

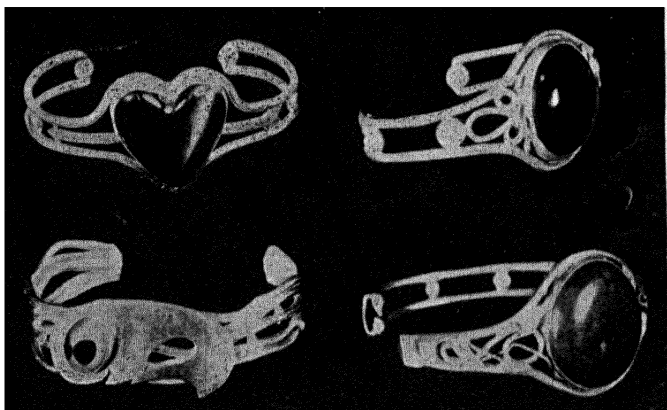

Fig. 82.—Bracelets.

symbols may be attached to a chain to make a charm bracelet of pleasing design.

The bracelet in Fig. 79 with five stones is only one of many designs that may be worked out where gem stones are featured. Three stones make a pleasing design if the central stone is larger than the other two, which are matched. With three stones some ornament is generally used in the bracelet between the large stone and each of the smaller stones. This ornament may be made of sheet silver or may be made of four small circles of 20-gauge

Jewelry Making

wire soldered together to form a "square," with a large shot soldered in the central opening.

The spring ring used to fasten the bracelet around the arm may be purchased from supply houses or jewelry stores. The ring is usually attached by opening the small loop with a pair of pliers, inserting the chain, and then

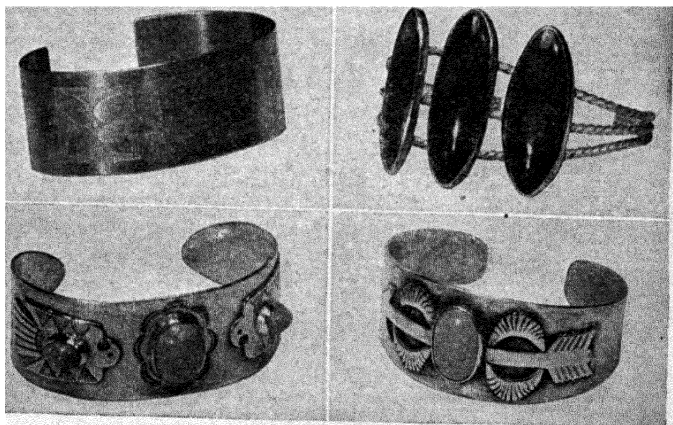

Fig. 83.—Bracelets.

closing the loop with the pliers. Do not solder, since the heat would ruin the spring in the catch. Do not place the spring ring in the pickling solution, as the acid may cause the spring to rust.

Four bracelets of the clamp-on style are shown in Fig. 83. Number 18-gauge sheet silver is ordinarily used for this type of bracelet, although the lighter weight 20 gauge is satisfactory. A piece of material of the desired width, about $5\frac{1}{2}$ inches long, is generally needed. Many different designs may be engraved, etched, stamped, or

Jewelry, Gem Cutting, and Metalcraft

soldered onto the band for ornamentation, or stones in combination with any of the above methods may be used.

Here again are many possibilities for the use of the Indian symbols. One of the bracelets in Fig. 83 uses three gem stones, amazonites, in connection with Indian symbols, thunderbirds, cut from sheet silver. Steel dies of Indian symbols were used for further decoration on

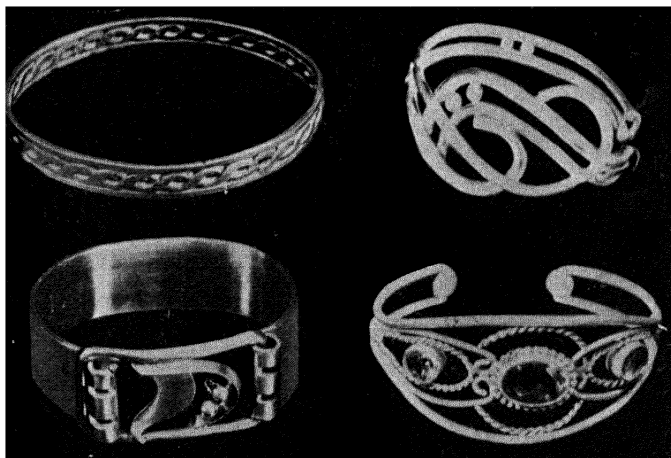

FIG. 84.—Bracelets.

this bracelet. The design of the thunderbird track was stamped alongside each stone set on the thunderbirds, and the symbol of the sun rays was stamped around the central stone. Symbols of the arrow and the sun rays were cut from sheet silver and used in ornamenting the bracelet where a turquoise was set in the center.

Other bracelets of this type using Indian symbols include narrow bands with the various symbols stamped

Jewelry Making

into the metal. Raised hogan designs are especially useful for ornamenting, as are those of the arrow, the sun rays, and the thunderbird track.

Various adaptations of the thunderbird may be sawed from sheet silver and soldered onto the bracelet as the central object of ornamentation.

BANGLE BRACELETS

Bangle bracelets, a popular project, are made from 12-gauge, or heavier, round sterling wire. For an arm of

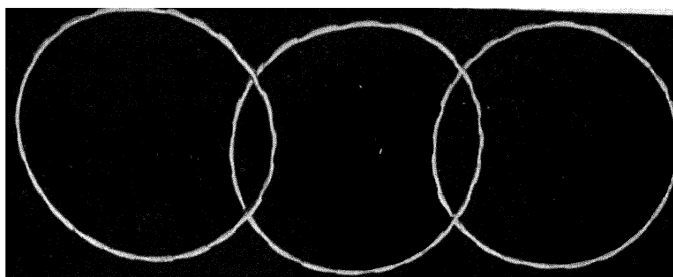

Fig. 85.—Bangle bracelets made from 12-gauge round sterling wire.

average size a piece $7\frac{3}{4}$ to $8\frac{1}{4}$ inches in length is sufficient for one band.

The ends of each piece are filed square, then soldered together. The bracelet is then placed over a round piece of iron and hammered with a wood or rawhide mallet to make it round. All hammering is done at one spot on the iron, and the bracelet is moved after each hammer blow. The iron does not have to be the size of the bracelet.

Jewelry, Gem Cutting, and Metalcraft

For decoration the band may be hammered with a small ball peen hammer, or flat indentations may be made at regular intervals.

Bangle bracelets may be made by twisting two or more wires. For a single twist use 20 inches of 12-gauge, or smaller, wire. Bend the wire at the middle, place the two ends in a vise, and, using a nail in the loop, twist the strands. If desired, run the twist through a rolling machine to flatten it. Use $8\frac{1}{4}$ inches of the twisted wire to make an average-sized bracelet.

The bangle bracelet shown at the upper left (Fig. 84), was made by twisting two wires, rolling the twist, and then soldering a wire on each side of the twist. If desired, the side wires may be pulled through a square drawplate. Flatten the sides of the twist with a flat file before soldering the wires together. Solder the wires together before bending. Use binding wire, and place a tiny piece of solder at each place at which the twist touches the outside wires.

BELT BUCKLE BRACELET

A bracelet that is popular with many high school girls is the belt buckle bracelet, which may be made of monel metal or of sterling. It is very similar to the belt buckle ring, except that it does not form a continuous circle.

The bracelet may be made in any desired width, although the width of the band is usually $\frac{1}{2}$ inch and that of the buckle part is 1 inch. If the bracelet is hammered with a ball peen hammer, a pleasing effect is obtained.

Jewelry Making

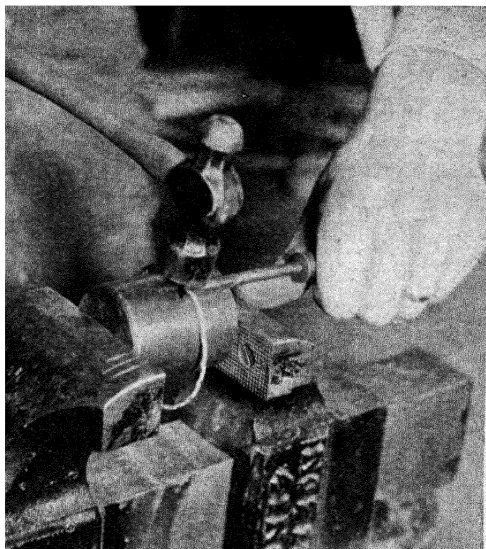

Fig. 86.—Decorating a bangle bracelet.

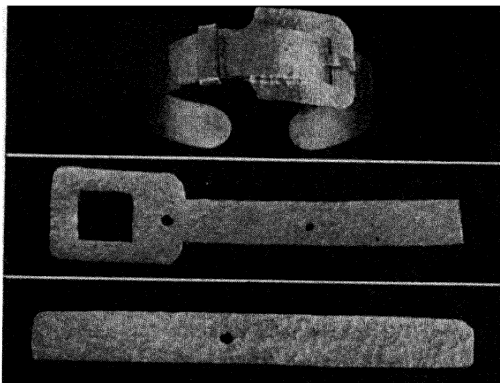

Fig. 87.—Belt buckle bracelet.

Jewelry, Gem Cutting, and Metalcraft

NECKLACES AND PENDANTS

The number of designs in which necklaces and pendants may be made is limited only by the material at hand and one's own ingenuity.



Fig. 88.—Pendants.

The necklace in Fig. 34 is made of garnets, both faceted and cabochon, ornamented with leaves and twisted wire. The heavy wire forming the outline of the heart was shaped and smaller wires carefully worked into the design so that they held the bezels of the four heart-shaped cabochons and the five faceted stones. The leaves were then soldered to the wires.

To form the chain of faceted stones linked together, first the required number of bezels were made, with rings soldered on at each end. The bezels were then connected with links. In work of this type no stone is set until all soldering is completed and the mountings cleaned, polished, and oxidized.

Jewelry Making

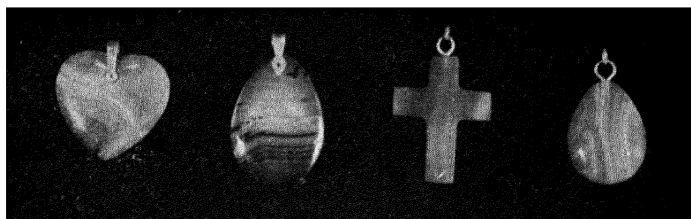

Fig. 89.—Drilled pendants are always popular.



Fig. 90.—Pendants.

Jewelry, Gem Cutting, and Metalcraft

Four different pendants are shown in Fig. 88. In No. 1 one oval and three round cabochons are used; No. 2 uses a

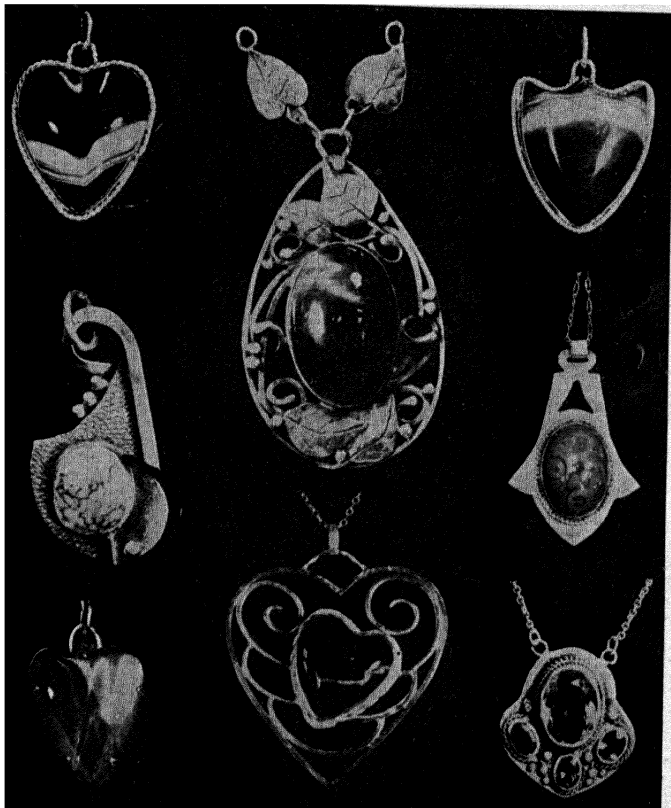

Fig. 91.—Pendants.

single stone, a moss agate ground into a heart shape, with the same curvature on both sides. No bearing is needed in setting a stone of this type. A narrow band of silver is

Jewelry Making

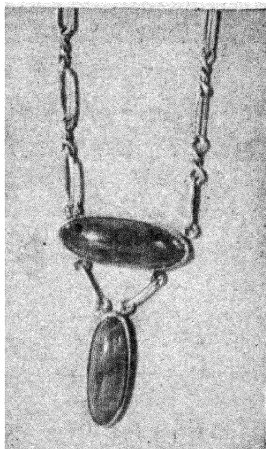

Fig. 92.—Pendant with handmade chain.

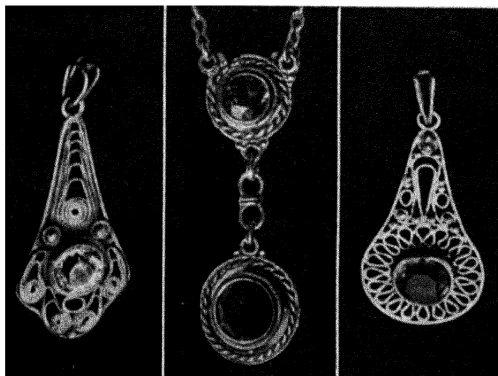

Fig. 93.—Pendants using twisted wire for decoration. (Courtesy of N. Mardirosian, New York City.)

Jewelry Making

shaped to fit the stone, a ring soldered in place, the stone inserted, and the edges of the silver burnished over against the stone.

Similar pendants may be made by using heart-shaped cabochons that are flat on one side (Fig. 91). Use the conventional-style bezel.

A large amethyst, surrounded by garnets and leaves, is used in No. 4, Fig. 88. After the bezel for the large stone had been made in the usual manner, a wire was soldered on the outside of the bezel. Another wire was shaped so that the small bezels might be soldered onto it and the wire on the outside of the bezel. The leaves and shot were then soldered in the spaces between the small bezels.

Twisted wires and shot were used in decorating the pendant using four amethysts mounted upon sheet silver, as shown at lower right in Fig. 91.

Many simple designs may be sawed from sheet silver, such as the cross in No. 3, Fig. 88. A circle is soldered in place to hold the link through which the chain is run. A number of Indian symbols, sometimes set with small turquoise, may be used for pendants.

A chain 18 or 20 inches long is generally used for necklaces and pendants. This may be purchased with the catch already attached, from dealers, or the chain may be purchased by the foot and cut to the right length and the spring ring attached. Instead of a spring ring, a fastener made from a short piece of wire may be used. A ring is usually soldered to the middle of the wire, and the chain attached to this ring. A large loop is needed on the other end of the chain, through which the wire, or bar, is

Jewelry Making

inserted. If desired, a ball may be soldered on each end of the bar.

SCARF PINS

The making of a scarf pin requires no processes other than those already explained. A scarf pin consists generally of two pieces, the mounting for the stone and the pin stem.

The method of holding a pin stem in place while soldering is shown in Fig. 50. Pin stems may be purchased with or without a twist in the stem.

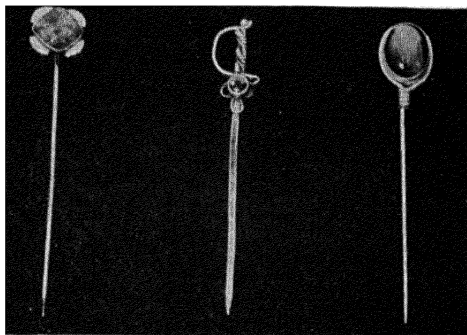

Fig. 94.—Scarf pins.

The effect obtained in the pin at No. 1, Fig. 94, is produced by mounting the bezel upon a piece of sheet silver that has been sawed to the desired shape.

The sword effect in No. 2 is obtained by soldering several pieces of wire and sheet silver together. The blade of the sword, which serves as the pin stem, was made of 20-gauge sheet silver. A small faceted stone is mounted on the hilt near the guard. The blade of the sword is made stiff by hammering.

Jewelry, Gem Cutting, and Metalcraft

In No. 3 a stone is mounted in a bezel in the usual manner. The pin stem is made of 17-gauge round sterling wire. One end of the wire goes around the bezel.

Pin stems for hard-soldering are usually straight. After the stem is soldered in place, it is bent to the desired shape with pliers. Pin stems, already bent, with patches riveted on, are obtainable for soft-soldering.

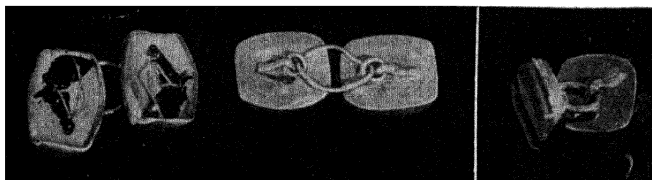

Fig. 95.—Cuff links.

CUFF LINKS

There are several methods of mounting gem stones for making cuff links. The method shown in Fig. 95 is quite satisfactory, however, for most stones.

The bezel is made and soldered onto a piece of sheet silver. A loop made of half-round wire, or round wire filed flat at points of contact, is made and soldered to each half of the cuff link. A link is then used to connect the halves.

EARDROPS

By the use of pierceless ear wires, many types of eardrops may be made with both faceted and cabochon stones. The eardrops shown in Fig. 96 were made of amethysts. The bezels for the large round stones were mounted upon

Jewelry Making

sheet silver and then soldered to the ear wires, after which the decoration was applied.

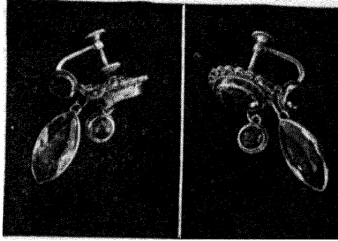

Fig. 96.—Eardrops.

The stones used in the eardrops in Fig. 97 were also mounted upon sheet silver. The decoration is shot of

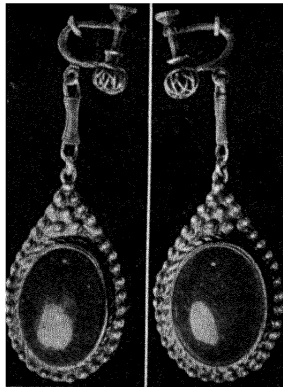

Fig. 97.—Eardrops. (Courtesy of N. Mardirosian, New York City.)

uniform size soldered to the sheet silver. The connecting link is made of wire.

Jewelry, Gem Cutting, and Metalcraft

TIE CLIPS

With sheet silver and wire, many types and designs of tie clips may be made, with and without stones for ornaments.

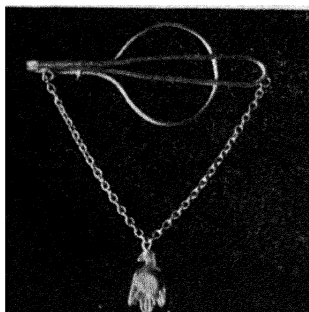

Fig. 98.—Tie clip

The wire clamp is made of 14-gauge round sterling wire. About 11 inches of wire is required. After all soldering and polishing have been completed, the wire, before it is folded over, is hammered stiff. Nickel silver tie clasps are available from dealers and can be adorned with handmade chains and ornamentation.

Spring tie clips may be secured and soft-soldered onto the underside of various ornaments.

BROOCHES AND CLIPS

Brooches and clips may be made of sheet silver and wire and ornamented by any of the methods described under ring making. Bezels for the gem stones are made in the same manner as those for rings.

Jewelry Making

The bezels for the three small turquoise used in the handmade flowers, Fig. 100, were made by twisting three strands of 30-gauge wire and then running the twist through a flat rolling mill. If no rolling mill is available, hammer lightly. No bearing or inner ring is required to support the stone. If the stone is not high enough, a small piece of sheet silver may be placed underneath it. The bezel, being made of twisted wire, has a pleasing effect when burnished over against the stone.

The brooch shown at lower center, Fig. 100, was made by mounting the bezels upon thin sheet silver and sawing out the portion inside the bezel. Twisted wire and shot were then used to fill in between the small bezels.

Catches, both plain and safety, as well as joints, are obtainable on patches, which can be tinned with soft solder. They are sweated into place. A much better, stronger joint may be made by obtaining catches and joints made for hard-soldering. The catch, or joint, is put in position, a piece of solder placed beside it, and the brooch heated until the solder flows, soldering the catch to the brooch.

Another method, preferred by many students, is to place a piece of solder covered with flux on the brooch at the spot where the catch or joint is to be attached and to heat the brooch until the solder melts. The base of the catch is then coated with flux and held upon the brooch, which is still hot, until the water has evaporated. The catch will usually stay in place when the brooch is again heated and the solder melted. Keep the flame off the

Jewelry, Gem Cutting, and Metalcraft

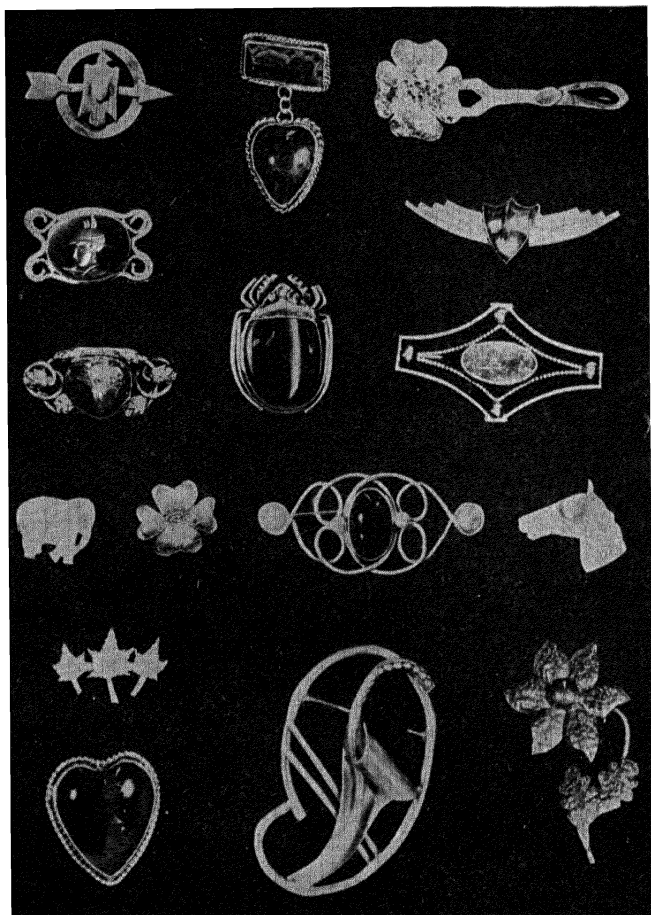

Fig. 99.—Pins made from sterling sheet and wire and inexpensive gem stones.

Jewelry Making

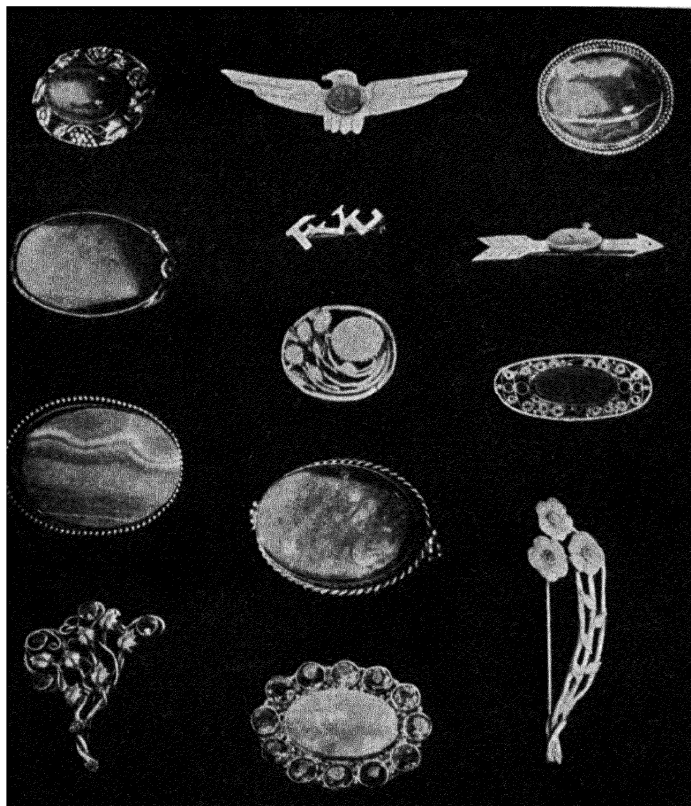

Fig. 100.—Brooches.

Jewelry, Gem Cutting, and Metalcraft

catch, for if the catch is heated too much, the solder is likely to flow onto it, rendering it useless.

Both joint and catch are usually soldered above the center of the brooch, so that the brooch will hang better. The joint is soldered on the right-hand side, in relation

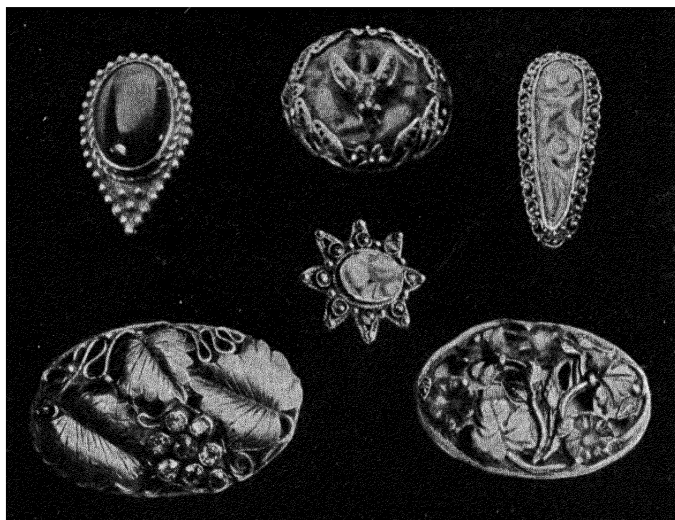

Fig. 101.—Brooches and clips. (Courtesy of N. Mardirosian, New York City.)

to the wearer. The catch is soldered on with the opening toward the bottom of the brooch.

The pin stem is riveted to the joint by the use of a small nickel wire, called rivet wire, which is available in assorted sizes. Silver wire will, however, serve the purpose. Pin stems with the rivet in place may be obtained although they require a special joint made for this type of pin stem.

Jewelry Making

The design of the top center brooch, Fig. 101, is unusual in the handling of both leaves and ornament. The leaves are of twisted wire coiled into shape. The ornament, a fly, in the center of the carved carnelian stone is of sterling, with the body made of a tigereye gem stone. The fly is mounted upon a silver tube, which extends through a hole drilled in the carnelian, and is burnished over on the underside to hold the ornament in place.

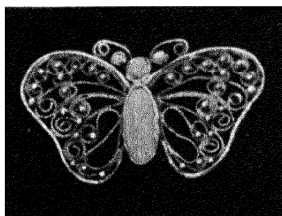

Fig. 102.—Costume ornament.

Clips may be made with a solid back of sheet silver or with the conventional-style bezel, which is open on the back. The spring clips used on the back of dress clips must be taken apart before being soldered into place, in order to protect the spring.

Various ornaments may be made that are to be sewed to the clothing, like the ornament shown in Fig. 102. Initials and monograms may also be cut out of sheet silver and attached to ladies' purses. Small wires, which are to be pushed through the material to which the initial is to be attached and bent over on the underside, are generally soldered to the back of the initial.

Jewelry, Gem Cutting, and Metalcraft

BELT CHAINS AND WATCH FOBS

Belt chains may be constructed by making the belt loop out of sterling sheet and attaching the chain and the swivel. The belt loop or slide is made of one piece of silver, bent to shape and the end soldered. One end ordinarily projects, through which a hole is drilled to attach the chain.

Watch fobs are usually a sawing project, to which initials, monograms, gem stones, or some other desired ornaments are soldered.

KEY CHAIN

The key chain shown in Fig. 103 is made of three parts: the "horseshoe," by means of which the key is slipped on the chain, the ornament, and the connecting chain.

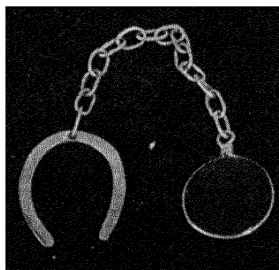

Fig. 103.—Key chain.

The horseshoe may be sawed from 18-gauge sheet silver. A hole is drilled in it, as shown, to attach the chain, which is usually about 2 inches in length. The ornament at the other end of the chain may be a gem stone,

Jewelry Making

souvenir coin, or any appropriate design, such as a monogram, soldered to a silver blank.

The stone used in the illustration is a bloodstone intaglio. An intaglio is a stone with a face or design cut into the stone. Many intaglios in both bloodstone and sard are ground with a groove in the edge. If such a stone is used, the bezel is a piece of 20-gauge wire slightly longer than the circumference, or girdle, of the stone. It is run through the chain link, and the ends are soldered together. It is then placed around the stone and the stone set by twisting the wire loop.

INDIAN JEWELRY

When one thinks of Indian jewelry today, he almost invariably thinks of the Navajo Indians of the Southwest, who long ago became artisans in the use of silver, decorating most of their jewelry with turquoise.

Mexican pesos were used for many years as the source of supply for silver by the Indians, but today silver alloyed to .900 fine, known as coin silver, is generally used.

The nomadic Indian, herding sheep over the barren areas and moving from place to place, had to make use of simple tools to fashion his silver. These usually consisted of a hammer and a piece of iron upon which to hammer. For heat he used charcoal and a hand bellows. In soldering he used silver dust and alum moistened with saliva.

Genuine Navajo dies were fashioned by each silver-smith from pieces of iron and, being soft, could not be used to stamp the imprints into the silver. Instead the

Jewelry, Gem Cutting, and Metalcraft

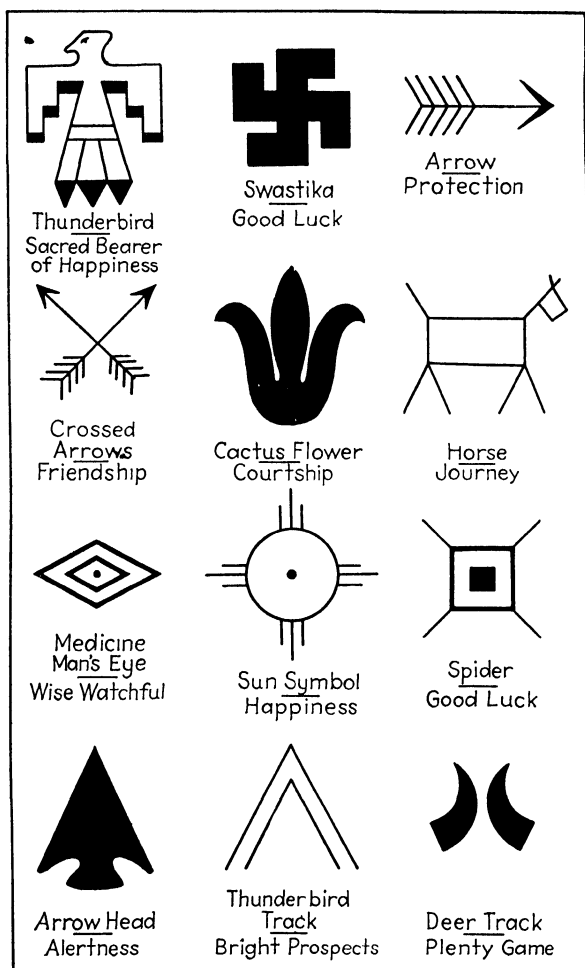

Fig. 104.—Indian symbols.

Jewelry Making

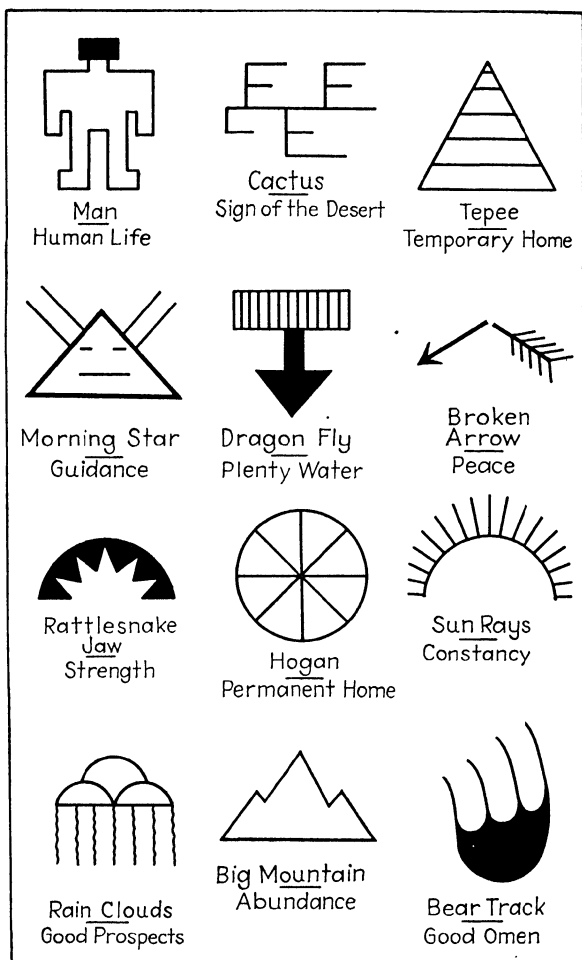

Fig. 104 (Continued).—Indian symbols.

Jewelry, Gem Cutting, and Metalcraft

dies were pressed into the silver while the silver was red-hot.

Turquoise, which from the dawn of civilization has always been held in high esteem, has long occupied an important place in the mythology and folklore of the Indians of the Southwest. Marvelous virtues have been attributed to it: "One who sees turquoise early in the morning will pass a fortunate day"; "The eye is strengthened by looking at a turquoise"; "The turquoise helps its owner to victory over his enemies, protects him against injury, and makes him liked by all men."

Much of the present-day Indian jewelry that is bought at trading posts and gift shops is made by Indians under the supervision of the white man. It is stamped out on presses, with an Indian operating the press, and taken to an Indian silversmith, who solders on the cups or bezels, which are often factory made. The Indian is allowed very little use of his own ingenuity.

Indian-type jewelry is quite popular with high school students. Many of the Indian symbols can be used in decorating handmade jewelry. They can be cut from sheet silver and soldered to rings, bracelets, and other pieces of jewelry.

Steel dies of Navajo design, to be used in stamping Indian designs into silver, may be purchased and used in ornamenting handmade jewelry.

DISCARDED DENTAL INSTRUMENTS

Many of the instruments and tools used by dentists are very useful in the fashioning of handmade jewelry by the

Jewelry Making

home craftsman. Dentists generally discard scalers, burnishers, excavators, enamel cleavers, and similar instruments, as they break or wear down through use or frequent sharpenings. A discarded instrument can be readily ground on a grinding wheel to a shape or point that will prove very useful in jewelry making.

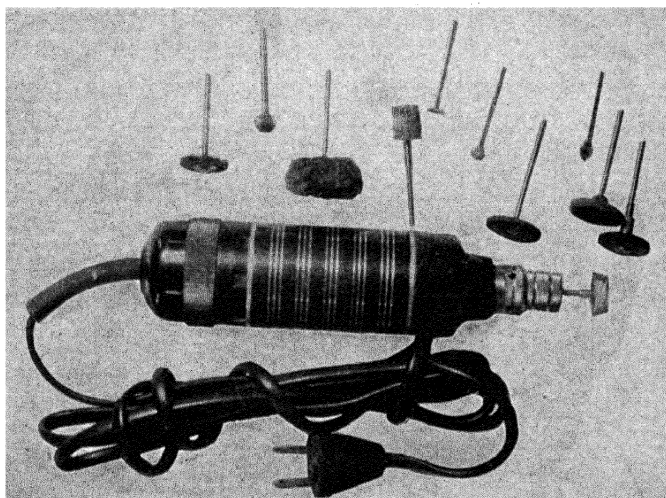

Fig. 105.—Hand motor tool and accessories.

Since dental instruments are generally made of the finest type of steel or one of the many chrome-steel alloys, even discarded instruments will give long and useful service in jewelry making. A broken scaler or chisel, for instance, can be sharpened to a point and will make a hand punch or scratch awl. Burnishing down of small

Jewelry, Gem Cutting, and Metalcraft

bezels can also be accomplished by many of the dental instruments.

The hand electric motor tool will serve admirably for holding small grinding wheels, mandrels, sandpaper disks, abrasive wheels, and polishing buffs.

After the assembling and soldering of a ring or ornament, there are generally rough spots that should be ground away prior to polishing, and this can be easily accomplished with the above equipment. The abrasive disks will be found more serviceable than files in many instances. Polishing can also be carried out with the small felt buffs about the size of a five-cent piece, with cake rouge used as an abrasive. Small muslin buffs about $1\frac{1}{4}$ inches in diameter can be made by sewing a number of pieces of muslin together and mounting these upon a small mandrel that fits the chucks already referred to. The claw type of rings are especially difficult to finish and polish by ordinary means but are a simple problem with the dental equipment.

USE OF INVESTMENTS

In soldering a large or complicated piece of work made of gold or silver, it is often desirable to protect portions of the work where soldering has already been done. The joints may be protected by yellow ochre, as previously described, or with the investments used by dentists. These materials are termed bridge investments and consist essentially of finely shredded asbestos and plaster of Paris. Work protected with them will not come un-

Jewelry Making

soldered through fusion during the soldering of the portions of the work left exposed.

Investments can be made easily at little expense by mixing 1 part of fine powdered or shredded fibrous asbestos with 2 parts of ordinary plaster of Paris. This material is mixed with water and handled like plaster of Paris. It will set in about 5 minutes and then can immediately be heated by the blowpipe, without cracking and with little shrinkage. Plaster of Paris alone would tend to fracture under high heat. In applying the investment to the part of the work to be protected during soldering, mix the investment material with water to a fairly thick mass and apply, leaving exposed the parts to be soldered. After the investment has set for 5 minutes, the excess can be trimmed off with a knife prior to heating and soldering. Do not leave a huge bulk of investment material attached to the work, as this will only absorb an excessive amount of heat. Only a thin layer of investment is needed to prevent any part of the work from "burning up." The large and complicated gold bridges made by dentists are assembled by the use of investments.

RING CASTING IN SAND

A flask, some fine casting sand, glycerine, parting sand or powder, a crucible, a melting furnace, and models are the requirements for casting rings and other objects in silver.

Making the Flask. Although the flask shown in the accompanying illustrations was made from two $1\frac{1}{2}$ -inch lengths of $3\frac{1}{2}$ -inch-inside-diameter brass tubing, other

Jewelry, Gem Cutting, and Metalcraft

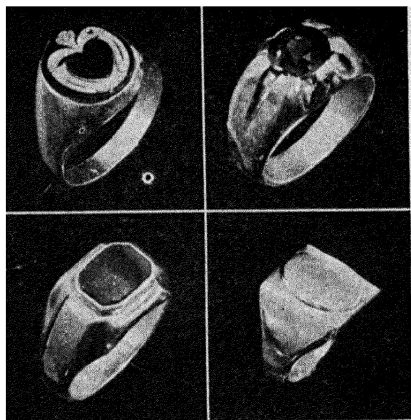

Fig. 106.—Rings cast from silver.

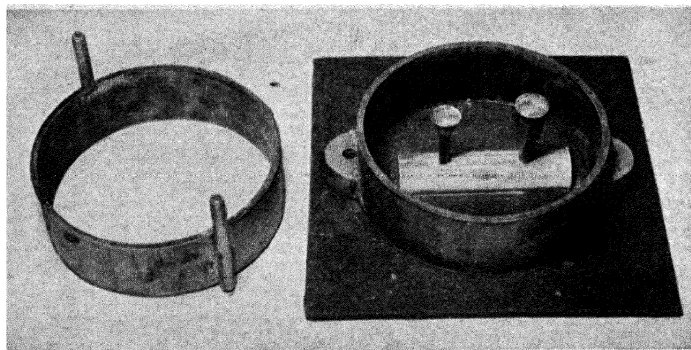

Fig. 107.—Drag ready to receive sand.

Jewelry Making

sizes of tubing or pipe or wood frames could be used equally well. First, cut off the tubing, or pipe, to the required lengths and file smooth. Then, using a piece of copper, steel, or brass rod, shape the two eyes, or ears, and soft-solder them to one of the pieces of tubing. Next bore a $\frac{3}{16}$ -inch hole in each ear, being sure that the hole

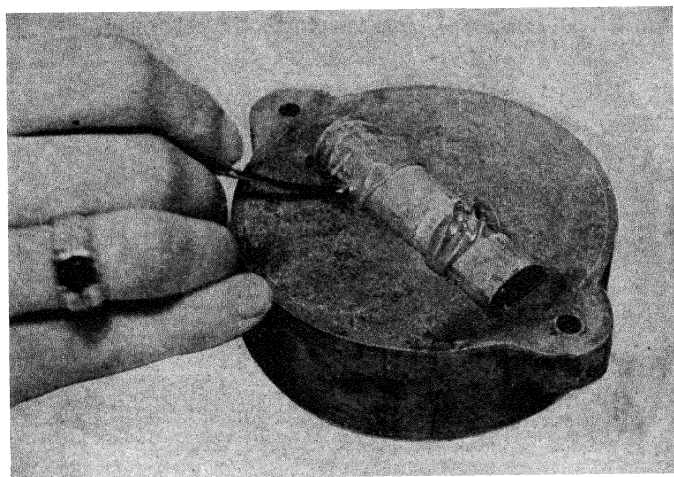

Fig. 108.—Repairing a mold.

just touches the piece of tubing. The half of the flask with the ears is known as the drag; the half with the pins is known as the cōpe.

Put the two pieces of tubing in a vise and insert short pieces of $\frac{3}{16}$ -inch rods through the holes in the ears and, after aligning, soft-solder them in place. If the rods fit too tightly in the holes, reduce their size with a file and

Jewelry, Gem Cutting, and Metalcraft

smooth with abrasive cloth. Flasks for ring casting may, however, be purchased ready for use.

Preparing the Sand. Fine casting sand is needed for silver casting. In preparing the sand for use, sift through a sieve made of screen wire. Then work in just enough

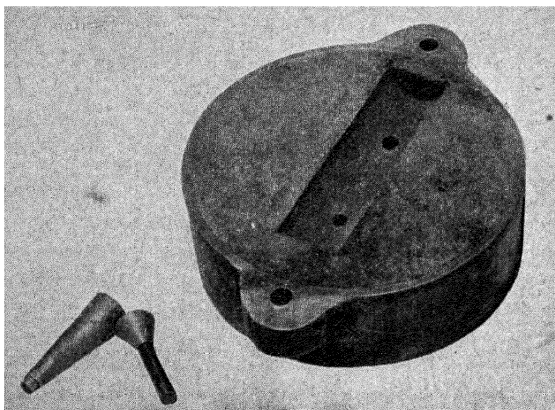

Fig. 109.—Mandrel and sprue pins removed.

glycerine to hold the sand together, mixing both thoroughly. After each use the sand should be sifted, and after repeated use, if the sand becomes dry, work in more glycerine. Satisfactory commercial sand for silver casting may be purchased, ready for use, in 5-pound cans.

Mandrels and Core Tube. Secure a 3-inch length of copper or brass tubing that has an inside diameter equal to the size of the ring to be cast. Then, on a lathe, turn a

Jewelry Making

wood dowel about 12 inches long, which will just slip inside the tubing.

Cut off two pieces of the dowel the exact length of the piece of tubing. Take one of these pieces and split it in half lengthwise, and mount it upon a 5- by 5-inch board, as shown in Fig. 107. Use the other short piece of dowel for the casting mandrel to hold the models, as shown in

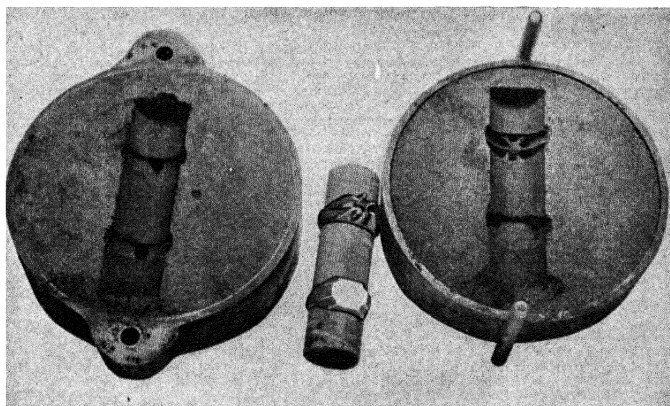

Fig. 110.—Mandrel and patterns removed.

Figs. 108 and 110. Use the long piece of dowel to push the sand core out of the small tubing. Different-sized mandrels and core tubing must be used for each size of ring.

Models. Before a ring can be cast, a model or pattern is necessary. It may be made of wood, soft solder, or plastic wood. If plastic wood is used, the models may be formed around the mandrel.

Jewelry, Gem Cutting, and Metalcraft

Maple or any other hard, close-grained wood is excellent for making ring models. Through a piece of the wood, bore a hole as nearly the size of the mandrel as possible and then file it out until it fits the mandrel snugly. Saw out the wood to approximately the shape and size of the finished model and finish with files and sandpaper. After the model is completed, give it and the mandrels a coat of lacquer or shellac and rub them down with steel wool until smooth.

In the making of models avoid undercutting, for the sand will not leave the pattern properly unless the pattern has a gentle slope from the bottom toward the top or, in the case of a ring, from the inside toward the outside.

Sprue Pins. Tapering plugs, called sprue pins, are needed to make holes in the sand through which the molten metal can reach the mold. These holes are known as sprue holes. After making the pins from either wood or metal, bore small holes in the half mandrel to hold them in an upright position, as shown in Fig. 107.

Preparing the Mold. In preparing for a cast, place the tapering plugs (sprue pins) in the half mandrel, dust both mandrel and plugs with the parting powder, and place the eye half of the flask, the drag, over the mandrel. Fill with sifted sand, packing lightly. Remove the pins, invert the flask, lift off the board, and you have what is shown in Fig. 109.

Place the model, or models if two rings are to be cast, on the round mandrel, dust with parting powder, and

Jewelry Making

place the mandrel in the sand, pressing it down firmly so that the model will make an imprint in the sand. If any sand is disturbed, it may be repacked with a small spatula.

Dust the sand, mandrel, and patterns with parting powder. Place the pin half of the flask in position and pack it with sifted sand. After this has been done, carefully pull the two halves of the flask apart and remove the mandrels and patterns, as shown in Fig. 110. If any sand falls into the mold, it should be carefully removed.

Making the Core. Using the piece of tubing with the inside diameter the same as that of the model, pack it

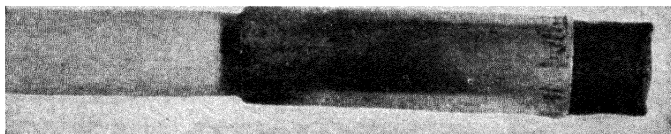

Fig. 111.—Removing the sand core from tubing.

with casting sand and push out with a dowel (Fig. 111). If it is correctly packed and if care is used in removing, the sand will come out in a cylinder, or core. Place this carefully in the pin half of the flask and put the eye half of the flask in position.

Melting the Silver. Place some silver in a graphite crucible and sprinkle a little powdered borax over the top of the silver. Place the crucible in the melting furnace, which is shown in Fig. 1. This type of furnace requires constant air pressure, which is usually supplied by a rotary air blower (Fig. 44).

Jewelry, Gem Cutting, and Metalcraft

After the silver has melted, remove the crucible with a pair of tongs and pour the molten metal into the holes left in the sand by the sprue pins. Allow the metal to cool for a few minutes and then pull the flask apart. If the cast is satisfactory, the ring, when cool, may be sawed from the tapering piece of silver formed in the sprue hole. It may then be finished by filing, sanding with abrasive cloth,

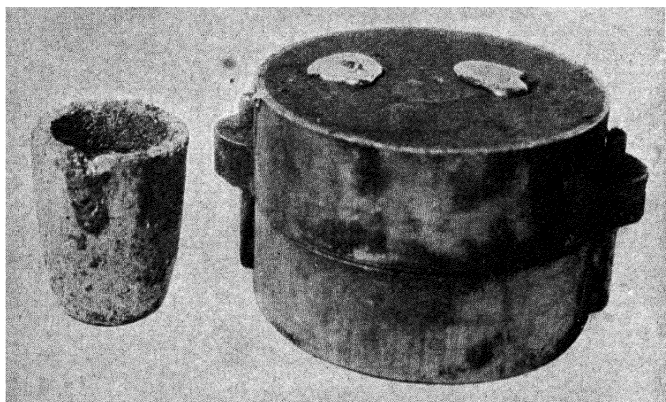

Fig. 112.—Crucible and flask after pouring.

and, finally, buffing. If for any reason the cast is unsatisfactory, the silver may be remelted.

Metal Models. If a large number of casts are to be made from a model, it is advisable to prepare a metal model from the wood model, as the wood model is likely to break. The metal model is also superior in that it can be made to more exacting dimensions and will make a much cleaner cast that needs much less filing.

Jewelry Making

To make the metal model, instead of pouring silver into the mold, pour molten brass. Then file and buff the brass model until it is smooth. As the cast-ring model will be a little smaller than the wood model, it will not fit the mandrel unless it is stretched or sawed through the shank. The sawing is preferable, for then the model will fit several sizes of mandrels.

The gap left between the sawed ends will not interfere with the casting. When the impression is made in the sand, this irregularity may be removed with a small spatula or by inserting a finished cast ring in the mold and gently pressing it into place.

CASTING FLAT OBJECTS

Small flat objects may be cast very easily. Make a pattern and then place the pattern and the eye half of the flask on a board. Pack with sand, holding the sprue pin in place. Remove the pin, invert the flask, lift off the board, but leave the pattern in place. Dust with parting powder and place the pin end of the flask in place and fill with sand. Invert the flask, separate the halves, and remove the pattern. Put the flask together again, and it is ready for pouring.

FINISHING CAST RINGS

Rings that are cast in sand may be set with stones of various kinds, or initials or emblems may be soldered or engraved upon the various types.

Several different styles of cast rings are shown in Fig. 106. Three of them are designed either for initials,

Jewelry, Gem Cutting, and Metalcraft

emblems, or stones; and one is designed for faceted stones. The bezel for the stone set on top of the ring was made of fine silver and soldered to the ring. After soldering a bezel to a cast ring, avoid sudden cooling of the ring, as it may warp. The carved agate is set flush with the top of the ring. This is accomplished by cutting out the metal and leaving a narrow rim, which is burnished over the stone and holds it in place.

The faceted stones are somewhat harder to set as the bearing must be cut on an angle. This may be done by filing, but a quicker, as well as an easier, way is to use a bearing burr. The method of cutting the bearing with a burr is shown in Fig. 113. The ring is held in a wood clamp. A hole is bored through the ring with a drill that is a little smaller than the stone. The burr is then inserted in the hand drill, and a seat or bearing is cut for the stone.

After the bearing is cut, the prongs are filed thin at the top, the stone set in place, and by using a burnisher the prongs are forced over the edge of the stone to hold it firmly. Bearing burrs may be purchased singly or in sets. A set of 30 different-sized burrs is shown in Fig. 114.

GOLD AND SILVER

Troy weight is used in weighing precious metals—gold, silver, and platinum.

TROY WEIGHT

24 grains = 1 pennyweight (dwt.)

20 pennyweight = 1 ounce (oz.)

12 ounces = 1 pound (lb.)

Jewelry Making

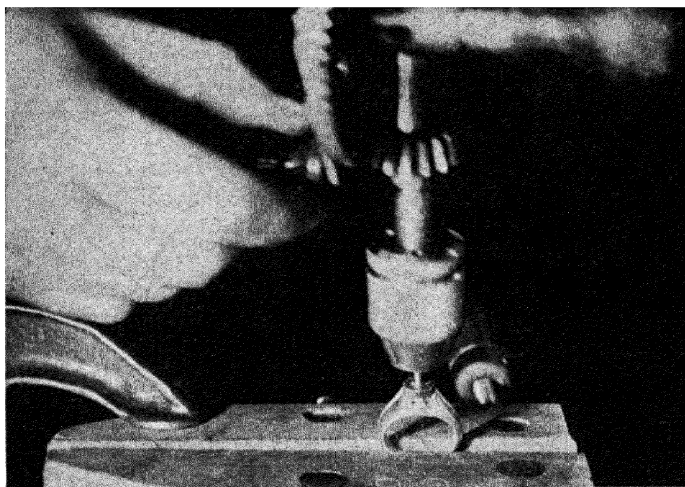

Fig. 113.—Cutting a bearing for a round faceted stone.

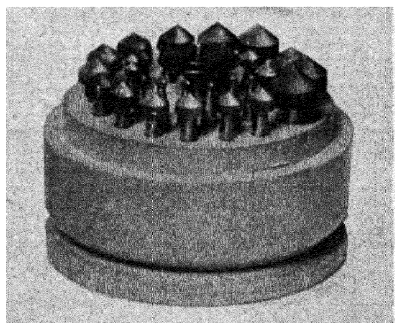

Fig. 114.—Bearing burrs.

Jewelry, Gem Cutting, and Metalcraft

The troy pound contains 5,760 grains; a pound avoirdupois weight contains 7,000 grains. The troy ounce is about 10 per cent heavier than the avoirdupois ounce. Gold is sold by the pennyweight; silver is sold by the ounce.

Fine Gold. Fine (pure) gold is known as 24-karat gold. It is very soft and is rarely used for jewelry purposes. The melting point of 24-karat gold is 1945°F.

Colored Golds. Fine gold is alloyed with silver, nickel, and zinc in varying degrees to produce different colors and to make it harder. If an article is stamped 18 karat, the fine gold in the article is $1\frac{8}{24}$ the total weight. Likewise, if it is stamped 10 karat, it is $1\frac{0}{24}$ fine gold by weight. (Various manufacturing laws allow a slight deviation to compensate for the solder used.)

The component metals used in various colored golds are as follows:

Yellow golds for general purposes: gold, silver, copper, small amount of zinc.

Yellow golds for enameling purposes: gold, silver, copper.

Green gold for general use: gold, silver, small amount of copper, small amount of zinc.

Green gold for enameling purposes: gold, silver, small amount of copper.

White gold for general use: gold, nickel, small amount of zinc.

Red gold for general use: gold, copper, small amount of silver.

Jewelry Making

Melting Points of Golds. The approximate melting points of various karat golds are as follows:

	Degrees Fahrenheit
10-karat gold	1480
14-karat gold	1550
18-karat yellow gold	1640
18-karat white gold	2015

All white golds melt at a higher temperature than yellow, red, or green golds because of the nickel that is added. Different 10-, 14-, and 18-karat golds vary as to melting points because of the variance of alloys that are generally used to obtain certain colors.

Gold Filled and Rolled Gold Plate. Gold filled is made by joining a layer of gold alloy to a base metal and then rolling or drawing to the required thickness.

Rolled gold plate is the same as gold filled, although usually of a lower quality.

Sterling Silver. "Sterling" is one of the best known and the most respected markings in use. Pure (fine) silver, like pure gold, is very soft. Sterling silver is made of 92½ per cent silver with 7½ per cent copper added to give stiffness and wearing qualities.

Coin Silver. Coin silver, the alloy used in making United States silver coins, consists of 90 per cent silver and 10 per cent copper.

Jewelry, Gem Cutting, and Metalcraft

Silver Melting Points. Fine silver melts at 1762°F., sterling from 1650 to 1675°F., and coin silver from 1675 to 1690°F.

How to Order Silver. In ordering silver be sure to specify the width, as well as the gauge (thickness), desired. Silver

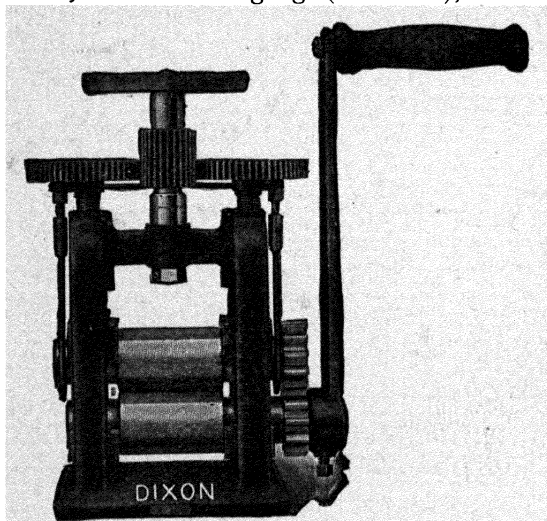

Fig. 115.—Hand rolling mill.

can be purchased in almost any width and gauge. Also specify whether sterling or fine silver is wanted.

The Brown and Sharpe gauge is used in measuring thickness of silver. It is advisable, unless a rolling mill is available with which to reduce the thickness, to keep several gauges of silver on hand. The author has found from experience in dealing with students that sheet silver kept in 18-, 20-, and 24-gauge thicknesses will meet the

Jewelry Making

requirements for most jewelry making, insofar as sterling silver is concerned.

Silver wire is sold by the ounce and costs more than sheet silver, owing to manufacturing costs. Many different sizes of wire are used in making jewelry, although

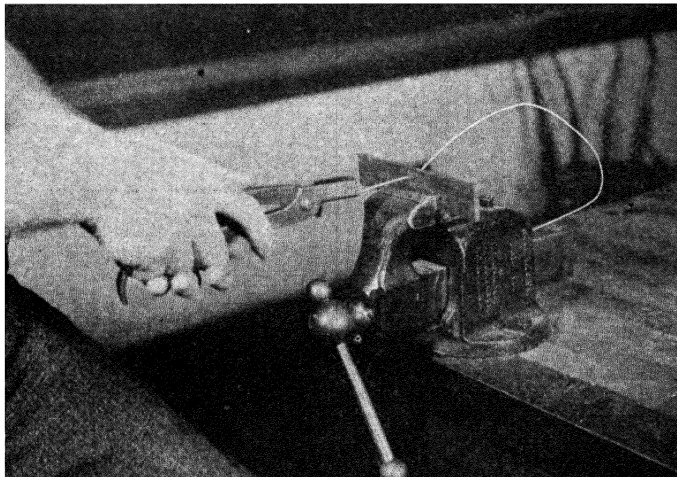

Fig. 116.—Reducing wire with a drawplate.

the 12, 15, 20, and 30 gauges, in round form, are the sizes used most.

Use of Drawplate. By the use of a drawplate, it is a simple matter to make any desired gauge by drawing, or reducing, wire of larger size. Drawplates may be purchased for drawing round, half-round, triangular, square, and rectangular wire.

Jewelry, Gem Cutting, and Metalcraft

WEIGHTS OF DIFFERENT GAUGE STERLING SILVER IN SHEET AND WIRE FORM

Brown and Sharpe gauge	Thickness, inches	Sheet, ounces per square inch	Wire (round), ounces per lineal foot
5	0.1819	0.9978	1 7110
6	0 1620	0.8886	1 3568
7	0.1443	0.7913	1.0760
8	0.1285	0.7047	0.8534
9	0.1144	0.6276	0 6768
10	0 1019	0.5588	0.5366
11	0.0907	0 4976	0 4256
12	0.0808	0.4431	0 3375
13	0.0720	0.3947	0 2677
14	0.0641	0.3514	0 2122
15	0.0571	0 3129	0 1683
16	0 0508	0 2786	0 1335
17	0 0453	0.2482	0 1058
18	0 0403	0 2210	0 0840
19	0.0359	0 1968	0 0666
20	0.0320	0.1753	0.0528
21	0.0285	0 1561	0 0419
22	0 0253	0 1390	0 0332
23	0.0226	0.1238	0 0263
24	0 0201	0 1102	0 0209
25	0.0179	0 0982	0 0166
26	0 0159	0 0874	0 0131
27	0 0142	0 0778	0 0104
28	0.0127	0.0693	0 0083
29	0.0113	0.0617	0.0065
30	0.0100	0.0550	0.0052

Sterling silver is 1.24 times heavier than brass. Sterling silver is 1.18 times heavier than copper. Fine silver is 1.01 times heavier than sterling silver. Ten-karat yellow gold is 1.13 times heavier than sterling silver. Fourteen-karat yellow gold is 1.27 times heavier than sterling silver. Eighteen-karat yellow gold is 1.46 times heavier than sterling silver. A circle is 0.7854 times as heavy as a square of same diameter.

Fig. 117.

Jewelry Making

Point on one end the wire to be reduced in size by filing or by hammering. Put the drawplate in a vise, the smaller side of the hole nearer you, with copper or other soft metal protecting it from the vise jaws. Insert the pointed end in the hole nearest its size.

Grip the wire with the drawing tongs and pull through the plate. Annealing is necessary after a few draws to keep the wire from breaking. No silver is lost in the reducing process, as the wire simply becomes longer as its size is reduced.

Fine Silver for Bezels. Fine silver, used for making bezels, may be purchased by the ounce in various widths and gauges. Either 26 or 28 gauge is a good thickness for bezel making. The widths of $\frac{1}{8}$ inch and $\frac{3}{16}$ inch are the two most used in bezel making, although the $\frac{1}{4}$ -inch width is sometimes used in making rings from sheet silver, where a higher bezel is needed. If desired, fine silver may be purchased in sheet form and cut into various widths as needed.

Cost per Square Inch. It is advisable, if dealing with students, to find out how much your sheet silver costs per square inch and how much the wire costs per inch or foot. Although you will buy it by the ounce, the student will not call for it in that manner. He will instead request a certain size of sheet or so many inches or feet of a certain gauge wire. By knowing the cost per square inch or lineal foot, you can eliminate much weighing and save time.

Jewelry, Gem Cutting, and Metalcraft

SEMI-PRECIOUS STONES

Semiprecious stones, both cabochon and faceted, suitable for use in handmade jewelry may be obtained from various dealers by those who do not care to cut and polish their own. Prices on stones vary, depending upon the quality, color, quantity bought, etc.

One of the best ways to buy stones is to arrange to have the dealer send an assortment of various stones "on consignment." Then you are permitted to look them over, select what you want, and return the remainder, paying only for what you have selected.



Fig. 118.—The metric scale, used in measuring many gem stones.

Often one is able to secure seconds, which are excellent for student work, especially for the beginner. These stones will appear as first-class stones in many instances, but they have slight defects, often color alone, imperceptible to the untrained eye.

Many of the dealers in gem-cutting material cut and polish a large number of stones, especially cabochons.

The karat, which is equal to $3\frac{1}{16}$ grains troy weight, is the unit of weight for weighing precious and some semiprecious stones. For convenience the karat is divided into 100 parts, each part of which is called a point. Thus a stone weighing 65 points would weigh 0.65 karat.

Part III

THE ART OF GEM
STONE-CUTTING

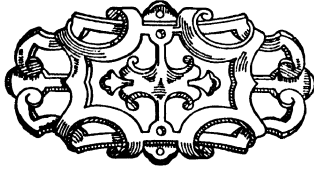

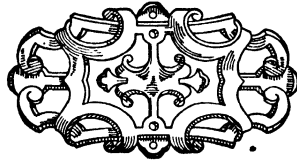

FROM time immemorial man has been fascinated by the gem minerals found in practically every part of the world. When prehistoric man first went afield, he was undoubtedly attracted by colorful gem minerals, polished by nature with the gravels of a river bed or the sands of the beach. Certainly he could not have resisted a gleaming red ruby or green turquoise among the unattractive pebbles of a gravel bar. Thus mineral and gem collecting is probably the oldest hobby known to man.

Archaeological investigations indicate that Neanderthal man, living in Europe some 12,000 years ago, worked crystal quartz into weapons and probably into objects of personal adornment. Fashioned fragments of his work have been found in his cave dwellings in France and elsewhere.

Jewelry, Gem Cutting, and Metalcraft

Our first record of the utilization of gem minerals as ornaments dates from about 5000 B.C., when turquoise and lapis were cut and polished and widely used by the early Pharaohs of Egypt. From that time on, as man became more skilled in the art of gem stone-cutting, the

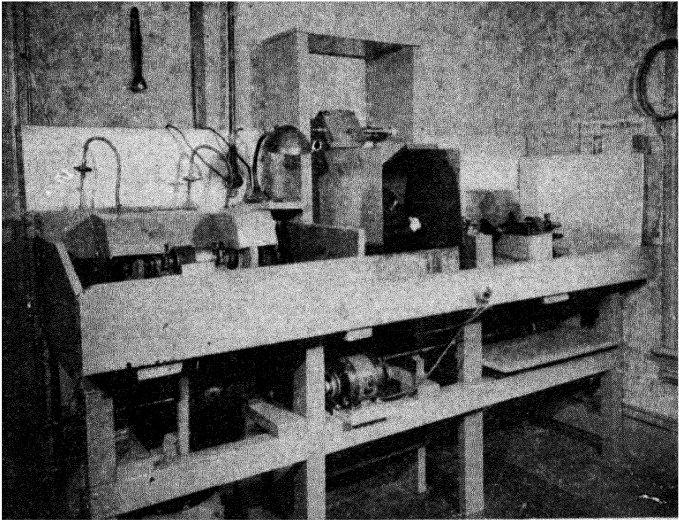

Fig. 119.—Typical unit installed as home gem cutting shop. Grinding wheels, with water connections shown at left, saws at right. Polishing buffs are mounted on a separate unit. (Shop and photograph courtesy of Gus Brockman, Portland, Ore.)

harder gem materials were brought into use. The cutting and polishing of the very hard gems, such as diamonds, sapphires, and rubies, however, have been relatively recent.

The early lapidary was handicapped by the lack of modern machinery and abrasives. The abrasive grits and

The Art of Gem Stone-cutting

polishing agents used by the early artisans were materials found in nature—emery, tripoli, pumice, rottenstone, and a number of others. Late in the nineteenth century the very hard artificial abrasives, such as silicon carbide and alumina, products of the electric furnace, were introduced into the lapidary industry, and since then these

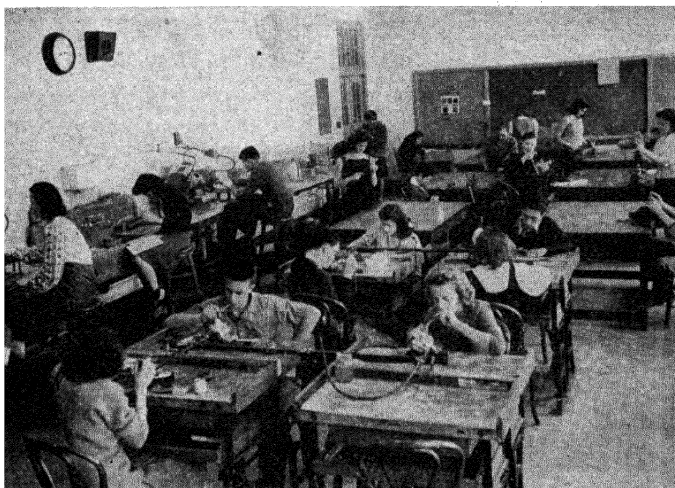

Fig. 120.—Students at work in Jewelry and Gem Cutting class of Woodrow Wilson High School, Washington, D.C.

materials have been manufactured into grits, grinding wheels, cutting disks, sanding cloths, and similar tools for the gem cutter.

In general, the lapidary industry has been rather slow to adopt modern grinding wheels and abrasives. This is partially due to the fact that textbooks published in the last century still detailed the technique of the art as car-

Jewelry, Gem Cutting, and Metalcraft

ried on prior to the introduction of more effective modern methods. Moreover, for centuries the technique of gem stone-cutting, particularly as applied to facet cutting, was carried on within families, all the members of which worked at the art in their homes. As a result, the secrets

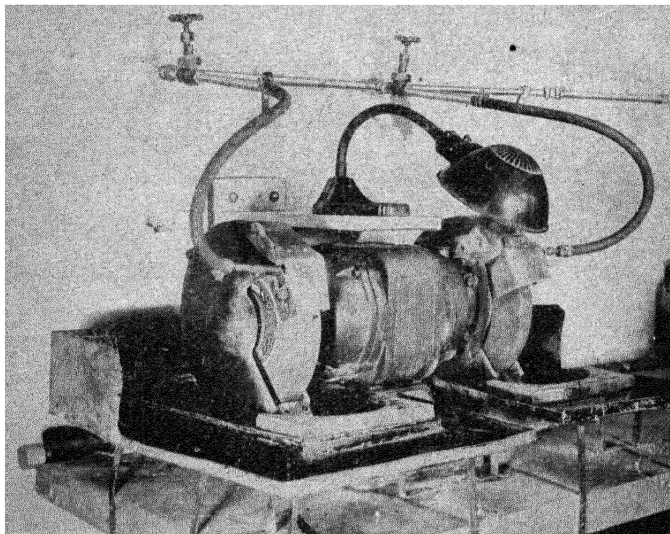

Fig. 121.—Bench grinder converted into a cabochon grinding outfit for school use.

of the art were closely confined to members of the guild and closely guarded. Until recently little modern lapidary technique had appeared in print. A search of the libraries will readily reveal the lack of information of this kind.

Within only the last ten years various individuals have conducted researches to learn the best methods of technique. The data given here are to some extent based

The Art of Gem Stone-cutting

on the work of others in addition to methods devised by the author.

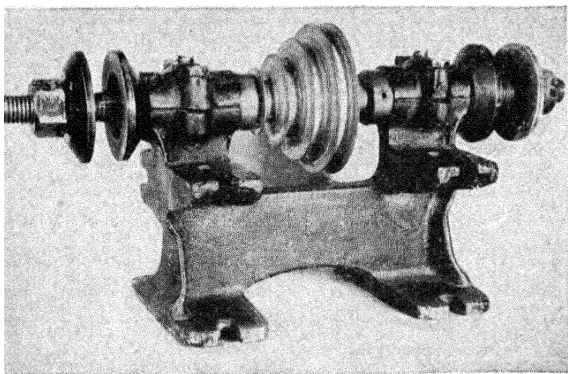

Fig. 122(A).—Four-step pulley grinding and polishing head.

Fig. 122(B).—Four-step pulley grinding and polishing head.

While it is altogether possible to reduce and polish gem stones by the use of antiquated abrasives and equipment, modern grinding wheels and manufactured abrasives will greatly speed and facilitate the procedure.

Jewelry, Gem Cutting, and Metalcraft

Although the technique given here is primarily for the amateur working in his own shop with limited equipment, the basic methods detailed are also suitable for commercial use, if the equipment described is added to speed up the work.

The home lapidary shop is often equipped with only one or two arbors, on which all work is carried on. This necessitates changing wheels and pulleys to secure the various speeds for the different operations and naturally slows up the work. The homemaker, not being interested in commercial production, will doubtless not find the lack of speed and efficiency a serious handicap.

CLASSES OF WORK

In general, the lapidary art is divided into two phases. The first is cabochon cutting, which includes curved- and flat-surface styles applied to the less precious stones. These are usually referred to as semiprecious and include agate, turquoise, jasper, opal, lapis, and numerous others. The second division, facet cutting, is confined mainly to the transparent gems having a hardness of 7 and greater. Diamond and zircon, for example, are always cut in facet styles to bring out the brilliance and play of colors and other features that enhance their beauty and value.

PRECIOUS GEM STONES

Five gem stones are generally recognized as belonging to the group of precious stones: namely, diamond, ruby, emerald, sapphire, and opal, although only the best

The Art of Gem Stone-cutting

quality of opal is actually of comparative value with the other members of this group. Pearls, although of organic origin, are usually considered among the precious group, because of their beauty and rarity in good quality.

BIRTHSTONES

Different months of the year have long been represented by certain gem stones. These stones are known as birthstones and are said to bring good luck to the wearer. The following stones have been officially adopted by the Precious Stone Dealers Association:

January	. Garnet
February	Amethyst
March Aquamarine or bloodstone
April Diamond
May Emerald
June	. Pearl or moonstone
July Ruby
August	. . . Peridot or sardonyx
September	. . . Sapphire
October Opal or tourmaline
November Topaz
December	. . . Turquoise or lapis

WHERE TO FIND MATERIAL

The home lapidary will doubtless confine his first efforts to cabochon cutting, and fortunately a great deal of rough material of this type is available at a reasonable cost. Further, semiprecious gem minerals are found in virtually every part of the country and can often be collected at no more cost than that of visiting the various localities. The beaches, especially those of the Pacific Coast states, yield

Jewelry, Gem Cutting, and Metalcraft

a great variety of material, mainly from waterworn pebbles cast up on the beach.

In the glacial drifts of the Midwest quantities of suitable material are available. Often a rock quarry or excavation within a large city will yield superb gem-cutting material. Similar rough material may also be found lying loose on the great deserts of the West. River gravels are often good areas where the treasure hunter may search. The great sapphire, ruby, and zircon mines of the world are often situated in ancient river-gravel deposits.

Most of the material the craftsman will use belongs to the quartz group. Detailed descriptions of the localities where this material is found, as well as of the materials, will be found in the book "Quartz Family Minerals" by Dake, Wilson, and Fleener (Whittlesey House). A complete description of gems is found in "Gems and Gem Materials" by Kraus and Slawson (Whittlesey House).

Gem material may be purchased in the rough by the pound from dealers. Many dealers also have pieces already sawed into sizes suitable for cabochons for those who want to grind and polish their own gem stones but who do not care to saw the rough material.

CUTTING MATERIAL

Material that cuts and polishes into beautiful cabochons includes agates and jaspers, found in many localities. Some of the materials that are popular with amateur lapidarists are:

The Art of Gem Stone-cutting

Montana Agates. Agates from Montana offer the lapidarist a variety. They are available in white with black moss spots or with black or red markings, which are sometimes in ribbons. Often scenic stones can be cut. This material is excellent for cabochons.

Beach Agates. Many of the beach agates, especially those of our northwest coast, when cut have an attractive pattern and make good gem stones.

Brazilian Banded Agates. This is one of the most popular agates as it comes in a wide variety of patterns and natural colors. It is excellent for rings and for the larger cabochons, such as hearts, pendants, and crosses.

Orbicular Jasper. Known also as California-poppy jasper, this material, which comes from near Gilroy, Calif., is available in a variety of markings, usually red and yellow.

Jasperized Arizona Wood. Selected scenic wood that is free from cracks works well into cabochons. By careful study of the sawed slabs, one can cut many unusual scenic stones. This type of stone is being used in much of the "Indian" jewelry of the Southwest.

Vesuvianite. This mineral is found in various shades of green, yellow, and brown. The green variety suitable for gem cutting is known as californite and is sometimes referred to as "California jade."

Jewelry, Gem Cutting, and Metalcraft

Tigereye. This chatoyant material, which comes from South Africa, saws easily and works into beautiful cabochons. It is available in yellow and red and in a yellow mixed with blue-green.

Rutilated Quartz. Most of the rutilated quartz, or sagenite, used for gem cutting comes from Brazil. It is a rock crystal that contains long fine needles of rutile. It is also known as Venus or Thetis hairstone.

Turquoise. Good-quality turquoise for gem cutting is hard to obtain, although it is sometimes available in small nodules. Much of the turquoise used in commercial jewelry is dyed.

Lapis Lazuli (Lazurite). Although too soft for use in men's rings, as its hardness is from 5 to $5\frac{1}{2}$, this blue-colored mineral is very popular for ladies' jewelry. Most of the material available for cutting comes from Chile.

Malachite. Although too soft for use in rings, this green mineral makes beautiful cabochons for brooches and pendants. Most of the material suitable for cutting comes from Siberia and Africa, though occasionally that found in Arizona is hard enough to cut.

HARDNESS OF MINERALS

The hardness of a mineral is usually given on Mohs' scale, where talc is the softest and the diamond the hardest. The scale is as follows:

The Art of Gem Stone-cutting

- | | |
|-------------|-------------|
| 1. Talc | 6. Feldspar |
| 2. Gypsum | 7. Quartz |
| 3. Calcite | 8. Topaz |
| 4. Fluorite | 9. Corundum |
| 5. Apatite | 10. Diamond |

Mohs' scale of hardness indicates the relative hardness only and does not tell how much harder one mineral is than another. Quartz, for instance, is not just 7 times as hard as talc; it is many times harder. The scale merely shows that quartz is harder than feldspar, that feldspar is harder than apatite, etc.

Minerals that can be scratched with a copper coin have a hardness of 3 or less. A knife blade has a hardness of $5\frac{1}{2}$, which is about the same as window glass; so any mineral that a good knife blade will not scratch must be over $5\frac{1}{2}$ in hardness.

A steel file has a hardness of from 6 to 7. This is well worth remembering in jewelry making. One can file a bezel in place with a cabochon cut from agate (quartz) without damaging the stone, for the stone is harder than the file. Stones cut from lapis lazuli, which has a hardness from 5 to $5\frac{1}{2}$, can be damaged with a file.

Rubies and sapphires are in the corundum group and have a hardness of 9.

ABRASIVES

Any hard, sharp material that will wear away a softer material when the two are rubbed together is known as an abrasive. There are two broad classifications of abrasive, natural and artificial.

Jewelry, Gem Cutting, and Metalcraft

Natural Abrasives. Flint, garnet, and emery are the best known natural abrasives and are today used primarily in the manufacture of coated abrasives.

Flint-coated paper, often referred to as just *sandpaper*, is the oldest type of coated abrasive. Garnet-coated abrasive paper and cloth are superior to flint in that the garnet is harder and tougher. Emery, a mixture of iron oxide and corundum, is used in coating both cloth and paper and finds its use primarily in metalworking. Before the discovery of artificial abrasives emery was used in making grinding wheels.

Natural abrasives are not used today in the grinding and polishing of gem stones to any appreciable extent, having been supplanted by the harder artificial abrasives.

Artificial Abrasives. There are three artificial abrasives, all of which are products of the electric furnace. They are silicon carbide, aluminum oxide, and boron carbide. Silicon carbide and boron carbide find wide use in the lapidary field. Boron carbide is available in grit size only. Silicon carbide and aluminum oxide are both made into grinding wheels, as well as being available in grit sizes.

SILICON CARBIDE. Silicon carbide was first made by Dr. Edward Goodrich Acheson, in a little shop at Monongahela City, Pa., in 1891. Dr. Acheson had just completed a number of experiments for Thomas A. Edison and conceived the idea of making an abrasive to replace emery, corundum, and other natural abrasives.

Putting a mixture of clay and coke into a small iron bowl, Dr. Acheson ran two wires from a generator to the

The Art of Gem Stone-cutting

bowl. He grounded one of the wires to the iron bowl, attached the other to a carbon rod, which he placed in the clay and coke mixture, and started the generator. After heating the mass for several hours, he allowed it to cool. Upon breaking open the mass, he found that he had something different. Tests proved that the material was extremely hard. Dr. Acheson took samples to New York City and prevailed upon gem cutters to give them a trial. He received a small order at 40 cents a karat—\$880 a pound.

Today silicon carbide is made in brick furnaces approximately 50 feet long, 10 feet wide, and 10 feet high. They have permanent ends and demountable sides. A charge of coke, pure glass sand, sawdust, and salt is placed in the furnace. When the furnace is half filled, a trench is made and filled with granulated coke to serve as a resistor. The furnace is then filled.

Electric current is passed through the core, and the mixture is heated to 4700°F. for 36 hours. The fused center of the mass, after cooling, is crushed, cleaned, and sized for use as an abrasive grit or made into grinding wheels.

Silicon carbide, both grit and wheels, is sold by manufacturers under several trade names. The Norton Company products are termed Crystolon, while those of the Carborundum Company are known as Carborundum.

ALUMINUM OXIDE. Aluminum oxide was first made in 1899 by Charles B. Jacobs. It is made from bauxite, a clay that contains aluminum. The bauxite is mixed with coke and iron filings, which are purifying agents, and put into

Jewelry, Gem Cutting, and Metalcraft

circular-arc-type furnaces. Two electrodes are placed in the mixture, and a current of 5,000 amperes heats the mixture to 3000°F.

Aluminum oxide, although harder than natural abrasives, is not so hard as silicon carbide. Its grains are not so sharp, but it is tougher. It finds wide use in the metal industry.

The Carborundum Company of America sells aluminum oxide products under the trade name of Aloxite. The Norton Company sells them under the trade name of Alundum, with the exception of alumina polishing powders, of which there are three, Levigated (fine), E111 (medium), and E67 (coarse).

BORON CARBIDE. Boron carbide, sold under the trade name of Norbide, is the hardest material made by man for commercial use, ranking next to the diamond in hardness. Developed by the Norton Company in 1934, it is made from coke and boric acid at a tremendously high temperature.

Boron carbide grit is now being used in work that previously was possible only by the use of diamond powder. It is especially useful to the lapidary for tube drilling and for the lapping of very hard gem stones. It is available only in grit.

Hardness of Abrasives. On Mohs' scale of hardness quartz is rated as 7, topaz 8, corundum 9, and diamond 10. The hardness of the various artificial abrasives has been shown by some scientists by the extension of Mohs' scale of hardness to 15. On this extended scale quartz is rated

The Art of Gem Stone-cutting

as 8, garnet 9, topaz 10, fused zirconia 11, aluminum oxide 12, silicon carbide 13, boron carbide 14, and diamond 15.

Grain, or Grit Size. After being crushed and cleaned, the various-sized grits must be separated, or graded. This is accomplished by sieving them through screens having a different number of meshes to the linear inch.

Grit that is classed as No. 100 grit has passed through a screen having 100 meshes to the linear inch. Grit finer than No. 240 is separated either by air flotation or sedimentation.

The size of the abrasive grain that is to be used depends largely upon the nature of the work and the finish desired. This is true whether the grains are to be made into wheels or used on laps or coated abrasives. Grits finer than No. 100 are used in the cutting of gem stones.

Standard sizes of silicon carbide grain, listed from coarse to fine, are as follows:

Screened sizes: 8, 10, 12, 14, 16, 20, 24, 30, 36, 46, 60, 70, 80, 90, 100, 120, 150, 180, 220, and 240.

Unclassified flours: *F*, *2F*, *3F*, *4F*, and *XF*.

Classified flours: 280, 320, 400, 500, and 600.

Aluminum oxide is made in the same grit sizes as silicon carbide.

Boron carbide is made in the following grit sizes: 8, 10, 12, 14, 16, 20, 24, 30, 36, 46, 54, 60, 70, 80, 90, 100, 120, 220, 240, 280, 320, 320*F*, 400, 500, 600, and 800.

Silicon carbide and aluminum oxide grain is packaged in 1-, 5-, 10-, 25-, and 50-pound cans and in kegs of 100 pounds and more.

Jewelry, Gem Cutting, and Metalcraft

Grinding Wheels. A grinding wheel has three physical characteristics, (1) the abrasive grains that do the cutting, (2) the bond that holds the grains together so that they may cut, and (3) the spacing of the abrasive grains in the wheel to provide clearance for the chips cut by the abrasive grains.

There are two abrasive grains used primarily in the manufacture of grinding wheels, aluminum oxide and silicon carbide. Wheels made from silicon carbide are used for cutting cabochons.

There are five general types of bonds used in making grinding wheels. They are (1) vitrified, (2) silicate, (3) rubber, (4) shellac, and (5) resinoid.

More than 75 per cent of the grinding wheels manufactured are made with a vitrified bond. Such wheels have great strength and porosity and are not affected by water, acid, or oils. Vitrified grinding wheels are used in gem cutting.

Ceramic materials—clay, feldspar, and flint—are used in making vitrified bonded wheels. The abrasive grains are mixed with the ceramic materials and molded to shape under high pressure. As very little water is used, the wheels are fired at once in a kiln. They are heated to 2400°F. for 4 or 5 days and then trued, bushed with lead, and submitted to speed tests, after which process they are ready for use.

The hardness, or grade, of a grinding wheel is determined by the amount of bond used in the making of the wheel. A hard wheel is made by increasing the amount of bond.

The Art of Gem Stone-cutting

Unfortunately, there is no uniform scale used in the grading of vitrified wheels made by the various manufacturers, although letters are used in designating the bond. The following are two different grading systems:

NORTON COMPANY				
Very soft	Soft	Medium	Hard	Very hard
E, F, G	H, I, J, K	L, M, N, O	P, Q, R, S	T, U, W, Z
THE CARBORUNDUM COMPANY				
Extra hard	Hard	Medium	Medium soft	Soft
E	F, G, H	I, J, K, L, M	N, O, P, R, S	T, U, V

Medium-grade bonded wheels are used for grinding cabochons. The Norton Company recommends *L* or *M* grade. Under the Carborundum grading system *J*, *K*, and *L* bonded wheels are used for this work. In general, use soft wheels for cutting hard material and hard wheels for cutting soft material. A wheel that is too hard will glaze; one that is too soft will show excessive wear.

The structure of a grinding wheel is determined by the spacing of the grain. The Norton Company recommends No. 8, which is a wide spacing. Its system of spacing is as follows: Close spacing: 0, 1, 2, 3; medium spacing: 4, 5, 6; wide spacing: 7, 8, 9, 10, 11, 12.

CABOCHON CUTTING

The cutting of cabochons—the stones most used by the student and craftsman—is a relatively simple process. It does not require long experience to produce beautifully polished stones suitable for many types of jewelry. A little experience and practice will enable the novice readily to fashion attractive gem stones from the softer

Jewelry, Gem Cutting, and Metalcraft

classes of gem minerals ordinarily used for cabochon styles.

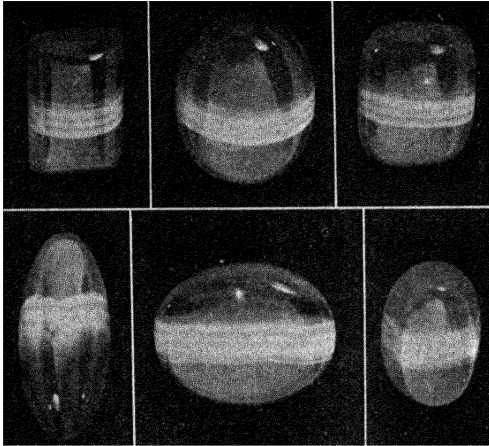

Fig. 123.—Cabochon gem stones cut from banded Brazilian agate.

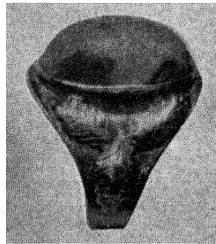

Fig. 124.—Cabochon ground from orbicular jasper.

So popular is the hobby of gem stone-cutting that individuals in all parts of the country are turning to this delightful and fascinating recreational activity. Many colleges and high schools have installed lapidary equip-

The Art of Gem Stone-cutting

ment for use in connection with jewelry work. Doubtless there are home lapidarists in your locality, or you may learn of them through following periodicals devoted to the hobby.

The cabochon mounted in the ring in Fig. 124 was the author's first attempt at cabochon cutting. He was assisted by a high school student, who later mounted the stone. The handmade leaves decorating the ring were the student's first attempt at leaf making. This semiprecious stone was ground and polished from a fragment of red orbicular jasper, found in California, without either author or student having previously seen lapidary equipment in operation.

EQUIPMENT FOR GEM CUTTING

Cabochons can be cut on either vertical or horizontal running silicon carbide wheels. The craftsman may build a unit using arbors (Fig. 122) upon which he can perform the various operations, or the outfit may be purchased ready to operate.

Horizontal running lap units are available in either kits, where the purchaser builds his own bench, or complete machines, such as the Covington Multi-Feature Lap Unit (Fig. 151), where grinding on silicon carbide wheels, sanding, and polishing are all done with various attachments. The multifeature lap unit can also be used for flat lapping and polishing of specimens and for sphere cutting. The lap units are popular in schools, as more than one student can lap at one time.

Jewelry, Gem Cutting, and Metalcraft

Bench grinders (Fig. 121), such as are found in most school shops, are ideal for converting into grinders for cutting cabochons, as they are fully protected by heavy cast-iron guards. The bench grinder using wheels 10 by 1 inch is ideal. The water used on the wheels does not enter the bearings as it is thrown out toward the periphery of the wheel. Drill a hole in the bottom of the cast-iron guard so that the water will drain out.

In a school shop separate arbors should be used for the grinding, sanding, and polishing, but the home lapidary may, if desired, use one arbor for all operations.

If funds are available, it is well to construct a sturdy bench and equip it with several $\frac{1}{4}$ -horsepower electric motors with grinding heads (arbors) for the different lapidary operations. Or, if desired, a line shaft may be installed and all units driven from the line shaft, which is usually powered with a single $\frac{1}{2}$ or $\frac{3}{4}$ -horsepower motor.

For those with limited means and space the following equipment will enable the lapidary to turn out satisfactory work:

- One $\frac{1}{4}$ -horsepower motor and grinding head (arbor), or a lap unit.
- One silicon carbide wheel, 1 inch thick, 6 to 12 inches in diameter, No. 100 or No. 120 grit.
- One silicon carbide wheel, 1 inch thick, 6 to 12 inches in diameter, No. 220 grit.
- Several sheets of silicon carbide sanding cloth, No. 220 grit.
- One hard, felt buff, preferably 6 or 8 inches in diameter, with a width of at least 1 inch.

The Art of Gem Stone-cutting

A supply of polishing powders.

A few sticks of dop cement.

A few pounds of No. 120 grit silicon carbide, for "mud" sawing, or a diamond-charged metal disk.

The sawing of gem-cutting material into blanks suitable for cutting cabochons causes beginners more trouble than any of the other operations. The beginner is in a hurry.



Fig. 125.—Carriage type sawing outfit. (Courtesy of W. C. Eyles, Bayfield, Colo.)

He is eager to see a finished stone and does not master the technique of sawing. The author recommends that beginners use small pieces or buy a few blanks from a dealer and grind and polish them before attempting the sawing. Get acquainted with the technique of grinding, sanding, and polishing. If you are not acquainted with the materials used in cabochon cutting, buy an assortment of blanks.

Jewelry, Gem Cutting, and Metalcraft

After you have mastered the grinding, sanding, and polishing, then turn to sawing, if you care to saw your own material.

Cabochon blanks that have been rough ground are known as "preforms" and are available from Warner & Grieger, who started this service for collectors and amateur gem cutters.

FOUR MAIN OPERATIONS

There are four distinct operations in the production of a cabochon gem. They are (1) sawing, (2) grinding, (3)

Mot. pulley size, inches	Pulley on machine: Size, inches												
	2	2¼	2½	2¾	3	3½	4	5	6	7	8	10	12
2	1725	1498	1325	1187	1075	905	781	614	505	425	371	295	245
2¼	1828	1725	1525	1360	1235	1040	897	684	577	490	426	327	282
2½	2120	1875	1725	1542	1402	1180	1019	794	655	556	483	372	319
2¾	2330	2120	1880	1725	1562	1317	1148	887	732	624	542	416	356
3	2550	2260	2040	1860	1725	1452	1252	980	807	685	596	458	392
3½	2990	2650	2380	2165	1985	1725	1489	1162	958	815	708	543	466
4	3800	3300	2920	2605	2360	2000	1725	1345	1100	940	820	650	540
5	4875	4230	3750	3350	3040	2560	2205	1725	1425	1210	1050	835	695
6	5900	5140	4550	4060	3700	3105	2680	2095	1725	1480	1250	1010	840
7	6950	6050	5340	4775	4350	3650	3160	2460	2025	1725	1500	1190	990
8	8000	6950	6150	5490	5000	4200	3600	2825	2320	1985	1725	1350	1135

Fig. 126.—Speed Table.

This table will enable one to select the proper pulleys for the approximate speeds listed. Motor pulley speeds are based on a motor speed of 1,725 r.p.m. (Courtesy of Delta Manufacturing Co., Milwaukee, Wis.)

sanding, and (4) polishing. Each of these operations is carried out at different speeds in commercial production, but for the student and home craftsman, the grinding and

The Art of Gem Stone-cutting

sanding can be carried out on a single arbor at the same speed. The same is true of sawing and polishing.

The use of a single arbor in this way simplifies the installation of equipment for the home or school shop.

SAWING

If the rough material is in large masses, sawing is generally resorted to in order to avoid the waste that would be involved in breaking up the specimen. Sawing is also used where a large flat surface upon a specimen is to be polished. However, if you are working with small pebbles or small fragments, you can start directly with the grinding wheels.

There are two general methods of sawing, in one the "mud" saw is used and in the other the diamond-charged saw. Both of these methods have their advantages and disadvantages, but more and more amateurs are turning to the use of the metal disk charged with diamond powder. The diamond saw is much faster and cleaner than the mud saw; however, satisfactory work can be done with either.

Sawing Outfits. Sawing is best done upon a machine designed and made for that purpose, although one can section an occasional small stone by improvising a saw with any available arbor.

Several carriage- and arm-type saws for use in diamond sawing have appeared on the market in recent years and have proved popular with craftsmen and in schools and laboratories where sectioning is done. These saws have

Jewelry, Gem Cutting, and Metalcraft

either a sliding carriage or arm. A vise, which can be moved laterally, mounted on the carriage makes it easy to cut slabs of uniform thickness. These saws use either

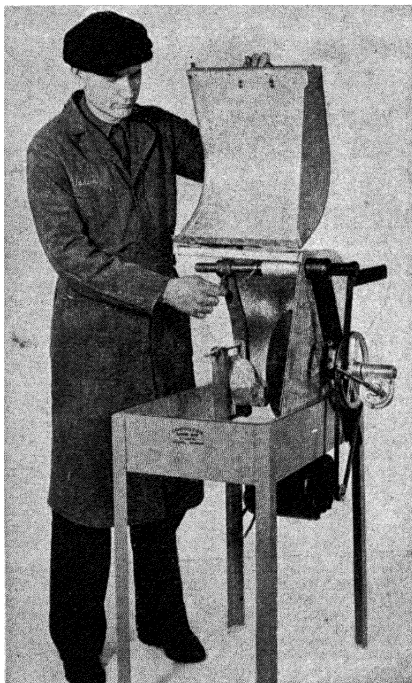

Fig. 127.—Power-feed sawing outfit. (Courtesy of Covington Lapidary Engineering Company, Redlands, Calif.)

spring or weights for tension in pulling the specimen into the blade.

Saws of this type are made by the Covington Lapidary Engineering Company, Wilfred C. Eyles, the Vreeland Lapidary Company, Klinefelter and Larson, and other

The Art of Gem Stone-cutting

firms catering to the craftsman's needs. The Covington firm also makes a power-feed diamond saw that is very popular, being the most recent improvement in the use of diamond blades for cutting gems and specimens. The

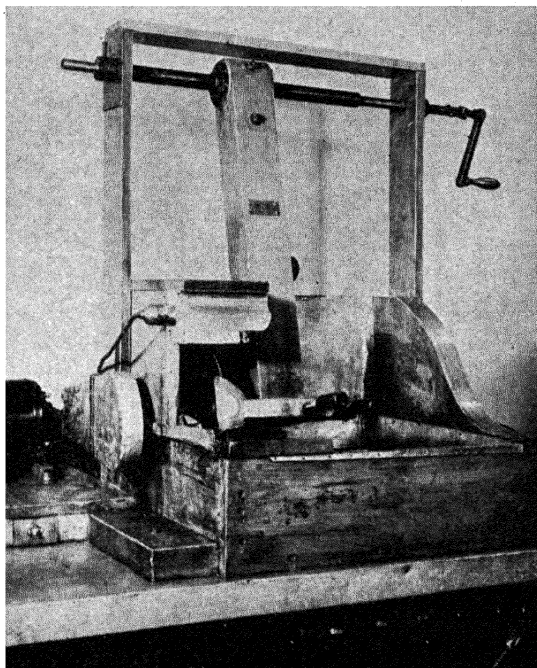

Fig. 128.—Swinging-arm sawing outfit built by students. Threaded pipe at top permits easy lateral movement of arm holding specimen.

power feed greatly increases the cutting life of the blade, as a smooth, steady pressure allows the blade to cut cleanly and to clear itself as it progresses. There is no shearing or breaking of specimen as the blade makes the

Jewelry, Gem Cutting, and Metalcraft

final cut. This type of saw is designed for a 12- or 14-inch blade and has a 5-inch cross-feed adjustment for slabbing. This type of saw is well suited to schools and beginners as it eliminates human errors.

Saw carriages and arbors for the blade are available from lapidary dealers for those who desire to build their own diamond-sawing outfit. A ball-bearing saw mandrel can be used in making a diamond-sawing outfit.

Saws designed to use the diamond blade cannot be used for grit, or "mud," sawing because the arbor bearings are too near the blade and the carriages are not covered to protect them from the grit. As the grit used in mud sawing wears down, it will work into any bearing that is near the blade because the mixture will run down the shaft if it does not splash into the bearing.

An arbor used in mud sawing should have the blade some distance from the nearest arbor bearing. A wood disk, several inches in diameter, forced on the shaft and fastened in place between the blade and arbor bearing will keep the grit from running down the shaft and entering the bearing.

A swinging arm is usually used to hold material being sliced by the grit method, for by its use the mechanism is removed from the field of the grit. The swinging-arm assembly is not hard to make. It consists of two lengths of iron pipe, one slipped inside the other and welded in place. The larger pipe is then threaded and flanges used to hold the movable arm. The swinging-arm saw shown in Fig. 128 was made by students in the author's classes and is equipped with a ball-bearing arbor. It is used exclu-

The Art of Gem Stone-cutting

sively in diamond sawing. This type of saw has long been in use by many craftsmen.

Material being sectioned on the swinging-arm type of saw can be held in place on the arm by being clamped

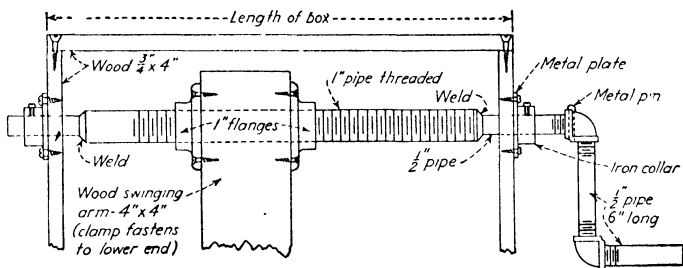

Fig. 129.—Detail drawing of pipe assembly used in making sawing outfit shown in Fig. 128.

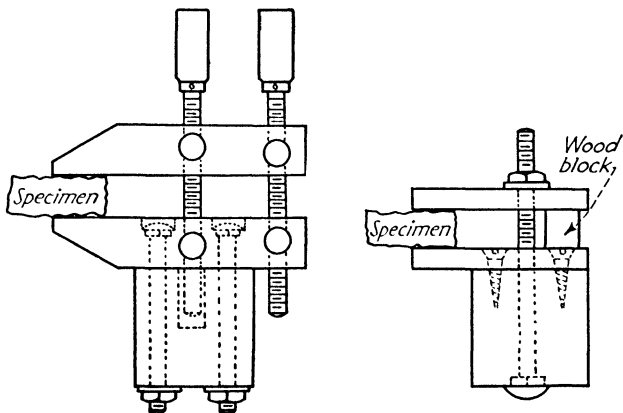

Fig. 130.—Two methods of holding a specimen while it is being sawed.

between boards, or a steel-spindle adjustable wood clamp can be bolted to the arm and used to hold the work. To start the operation reverse one of the spindles on the wood

Jewelry, Gem Cutting, and Metalcraft

clamp. This is easily done by removing the handles, which are held in place with metal pins, removing the spindles, exchanging positions with two of the metal screw plugs in the clamp, and replacing the spindles.

The specimen being sectioned is held against the blade by spring tension. By using two short lengths of sash

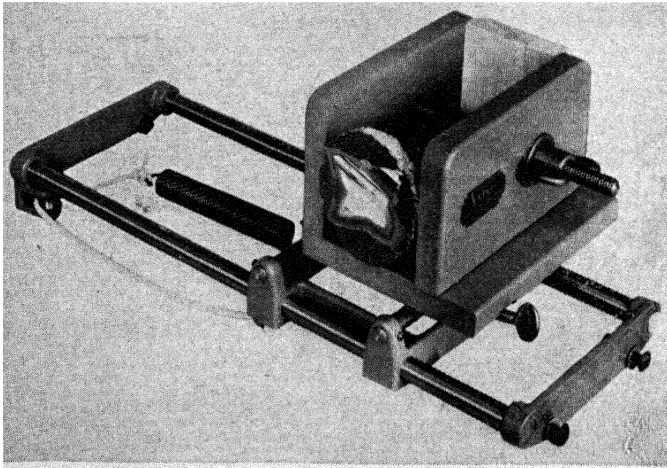

Fig. 131.—A saw carriage and vise with cross-feed adjustment may be used in building a sawing outfit. (Courtesy of Vreeland Lapidary Manufacturing Company, Portland, Ore.)

cord, a spring, and three small pulleys, one can easily control the tension from the front of the machine. Fasten the end of one cord to the lower end of the arm. Run this over a pulley and tie it onto the spring. Tie the second cord onto the other end of the spring and then use the other two pulleys to bring the cord to the front of machine. A metal ring fastened to the end of the cord may

The Art of Gem Stone-cutting

be hooked on various pins to give any desired pressure, or tension.

Truing Saw Disks. Circular metal blades used in cutting gem material into slabs and blanks suitable for cabochons will, through use, develop low spots. This is true of the disks used in both mud and diamond sawing. The mud

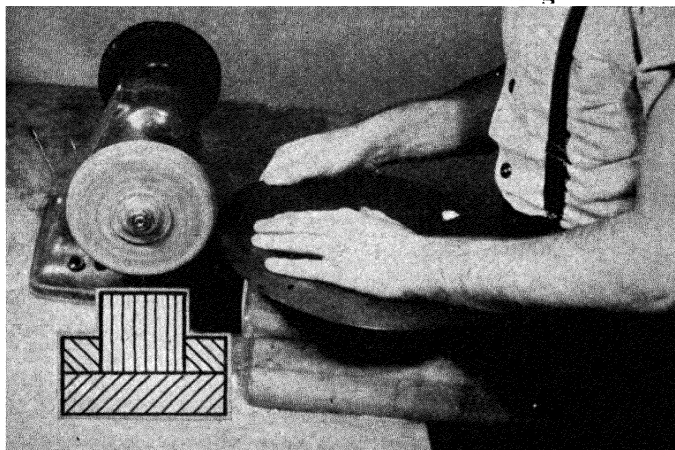

Fig. 132. ---Disks used for sawing can be trued on an abrasive wheel by means of a sliding block. A cross section of the blocks is shown in the inset.

disk, once bumpy, must be taken off and made true before it will continue cutting satisfactorily. The diamond-charged disk, when worn out, must be trued before it can be recharged.

A jig, as shown in use in Fig. 132, makes the truing of a disk a relatively simple job. The jig is made of four pieces of wood about 12 or 14 inches long, as shown in the inset

Jewelry, Gem Cutting, and Metalcraft

in the figure. The square block is 4 by 4 inches in the cross section; the bottom piece is about 6 inches wide and of such thickness that it will bring the top of the 4 by 4 to the center of the grinding wheel. The side pieces hold the 4 by 4 in place but allow it to slide.

Bolt the jig to the table. Bore a hole, the size of the arbor hole in the disk, in the top of the 4 by 4 and drop a machine bolt through the disk into the hole in the block. The blade should extend over the end of block about 1 inch.

Start the motor and as the grinding wheel rotates push the sliding block toward the wheel until the disk touches the wheel. Rotate the disk, making light cuts to avoid burning it. A wet sponge will help to prevent burning. With a little practice one can soon true a blade in a few minutes. If the block slides too easily, wet the blocks.

Mud Saws. The disk used in the mud saw is made of sheet metal. Armco or automobile-fender steels are satisfactory. The disks vary in diameter from about 8 up to 50 inches or more. The smaller disks are of 18- or 20-gauge metal and are operated at speeds of from 300 to 450 r.p.m. (revolutions per minute). Higher speeds tend to throw the mud mixture from the blade and thus slow the cutting.

The mud used as an abrasive is an aqueous mixture of No. 120 grit silicon carbide and water. A small amount of clay flour or similar substance is added to the mixture to give greater viscosity and therefore to make it adhere more firmly to the blade. The effectiveness of the mud saw

The Art of Gem Stone-cutting

depends upon the ability of the blade to carry the mixture to the point of cutting. The mud mixture is held in a metal reservoir below the saw, thus permitting the periphery of the saw to pass through the mixture. A water-soluble oil added to the mud-saw mixture stops rust and corrosion and does not impair the cutting solution.

Small pieces and slabs can be held against the saw, a flat table rest with a slot through which the saw runs being provided to steady the work and to hold it rigid. The grit may be fed to the revolving disk with a small varnish brush. This method, however, should be used only when one has an occasional slab or small piece to section, and for such work any available thin sheet metal, such as galvanized iron, can be used for the disk. Freehand sawing, however, is not practical, and some means should be devised to hold large pieces. Large pieces are generally held against the disk of the saw blade under proper pressure by a swinging mechanical arm clamp or some similar arrangement.

In general, a pressure equal to around 10 pounds is used for the specimen of average size. Larger ones require greater pressure and smaller ones less. This is a matter that can be adjusted by experiment.

In starting the cut, do not apply too much pressure. Permit the blade first to cut a slight slot and then increase the pressure. This procedure should also be observed in the use of the diamond-charged saw. One of the disadvantages of the mud saw is its slow cutting. This can be offset to some extent by adding about 10 per cent of Norbide No. 120 grit to the silicon carbide mixture.

Jewelry, Gem Cutting, and Metalcraft

As a rule, the mud saw will not develop bumpy spots if properly handled with respect to speed and tension of the pressure, as the saw will wear down evenly. Speeds too high or too low will tend to develop "flats." It is customary in sectioning large specimens to start, adjusting the saw properly, and then to proceed with other work. A large section of hard material, such as agate, may require several hours to complete, while the diamond saw would cut the same number of square inches in perhaps less than one-fourth of the time.

Diamond-charged Saws. Metal disks, charged on the edge with diamond powder and termed "diamond saws," are preferred by many amateur and most professional lapidaries. This tool cuts much faster and makes a cleaner and smoother cut than the mud saw, saving time later at lapping or sanding. It is also much cleaner to use.

An 8-inch saw, which is large enough for all ordinary purposes, may be purchased ready-made for from \$4.50 to \$5.50, the price depending usually upon the amount of diamond powder used in making the tool. Or the saw can be notched and charged with diamond powder. These circular disks are generally 18- or 20-gauge Armco automobile-fender steel. Some amateurs cut their own blades from sheet metal, but blades that run true and are ready for charging may be purchased in any size. These are accurately cut with the correct size of arbor hole and are free from wobble and uneven periphery. Some craftsmen use Stretcher Level steel, containing 4 to 6 per cent

The Art of Gem Stone-cutting

chromium, for making their saws. The chromium makes the disk harder.

When in operation, the diamond saw is lubricated by running the edge through a mixture of equal parts of kerosene and crankcase oil. The speed should be from 450 to 550 r.p.m. for a 10- or 12-inch saw. Both types of saw should be enclosed and shielded to prevent splashing of the mixture. Both saws should be run toward the work from above. In starting a cut with the diamond saw, use only slight pressure. Avoid dropping the saw against the sharp edge of a hard mineral, or the diamond may be suddenly torn from the metal. Many operators will ruin a few saws in learning the proper use of this very valuable tool. When properly charged and used, a diamond saw will generally section hundreds of square inches of such material as quartz or agate. On the other hand, careless charging or handling may greatly reduce its efficiency.

Skimping of diamond in making the charge will not help matters, for the efficiency of the saw is directly dependent upon the amount of diamond embedded on the edge. The saw does not lose its efficiency because the diamond "wears out." As long as the diamond is held in the metal, the saw will continue to function, but gradually, as the small particles of diamond are torn loose, the saw will slow down in cutting speed.

CHARGING A DIAMOND SAW. Various methods are used in charging the disk of a diamond saw. For quick work a small amount of diamond powder mixed into a thick paste with a small amount of vaseline can be hammered into the edge of the disk with a light hammer. This method is not

Jewelry, Gem Cutting, and Metalcraft

very effective, will cut only a small amount of material, and is wasteful of diamond.

The method used by the author in charging a diamond saw, which has proved quite satisfactory, is similar to that

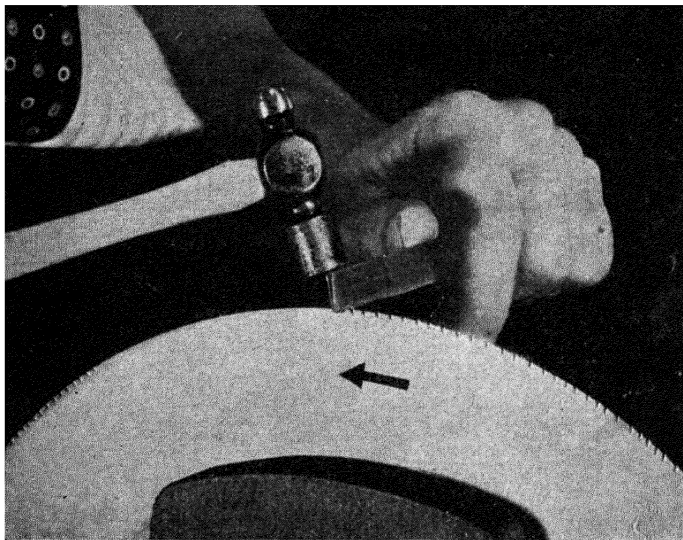

Fig. 133.—Cut nicks in the steel sawing disk with a hack-saw blade sharpened like a wood chisel using a lightweight hammer.

used by many other gem cutters. First place the disk on the arbor, making sure that it fits snugly. Ready-made disks will fit your arbor accurately and are true.

Make sure that the disk is running true by holding a sharp piece of quartz or agate or the end of a file ground to an edge on the rigid cutting-board rest. When the saw is revolved under power this test can be made. If the disk is

The Art of Gem Stone-cutting

not running true, remove it from the arbor and grind it true, as shown in Fig. 132.

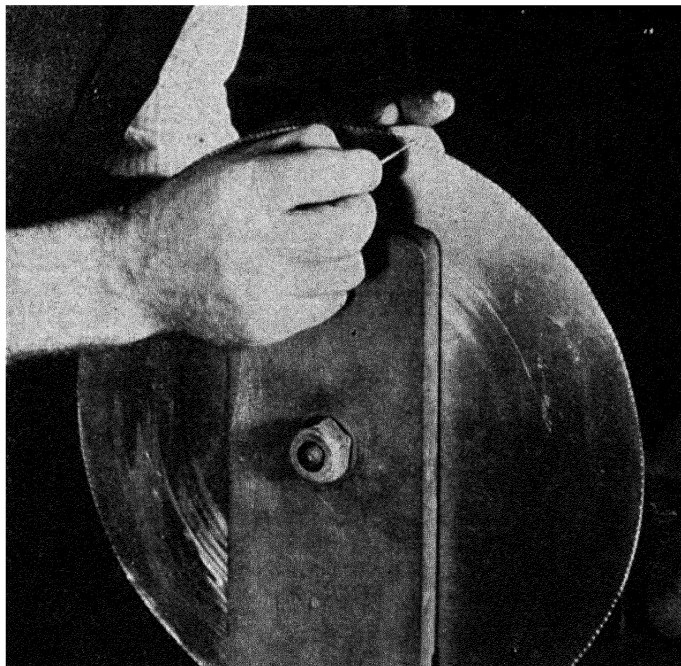

Fig. 134.—Work the diamond grit, mixed with vaseline, into the nicks cut into the blade, using a sharpened toothpick. A magnifying glass mounted above the blade is an aid in placing the diamond particles.

With a knife blade or an old hack-saw blade sharpened like a wood chisel and a small hammer, notch the periphery of the disk at regular intervals. Cut from 8 to 12 notches to the inch, making each notch about $\frac{3}{32}$ inch deep. Make the notches at a slight angle (Fig. 133), rather

Jewelry, Gem Cutting, and Metalcraft

than straight in toward the arbor hole. For an 8-inch disk a full karat of diamond should be used. Diamond bort used for this purpose can be purchased ready crushed. The

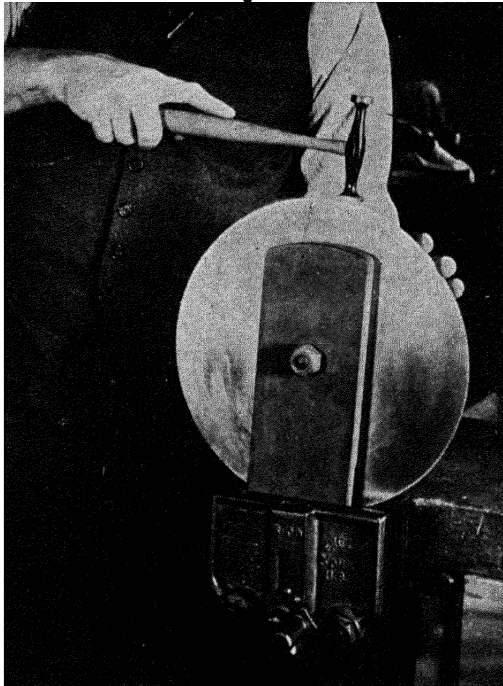

Fig. 135.—Close the nicks by hammering carefully with a lightweight hammer. This seals the diamond in the metal. Try to get the same amount of set on each side of the disk.

diamond powder is mixed with a bulk of vaseline about the size of a pea. With a toothpick the paste is applied to the notches and worked into the bottom of the notches. Use a lightweight hammer to close the notches by tapping

The Art of Gem Stone-cutting

lightly on the periphery of the blade, taking care to use approximately the same blow completely around the circumference. The hammering will embed the diamond in the notches and aid in giving the saw a set, so that it will cut its own clearance in the work. A case-hardened roller is then used to roll the edge of the saw, this being done with the saw operating under power. Rather heavy pressure can be used in the rolling. The case-hardened grooved roller used is ordinarily fitted into the handle of a Huntington grinding-wheel dresser.

If a roller is not available, be very careful with the hammering, so that, when completed, the periphery of the blade will be as smooth as possible. Start the saw cutting a smooth piece of quartz or agate, and it will soon wear smooth. Although not quite so good as a rolled saw, a saw that will section hundreds of square inches of agate can be made by careful hammering.

After a saw has been used, it will eventually lose its set and bind, or stick, in the cut. Remove it from the saw arbor and roll, or hammer carefully, giving it another set, and in most instances it will continue cutting. This is especially true if the proper amount of diamond was used in making the blade and if the nicks were cut deeply enough.

If the saw tends to wobble sideways, this can be corrected to some extent by "massaging" the side of the saw with a flat 2-inch width of hardwood, applied to the side when the saw is in motion. Start the operation near the arbor and work toward the periphery, using pressure in the proper direction. A little practice at this will soon

Jewelry, Gem Cutting, and Metalcraft

indicate the utility of this method. It is superior to attempting to hammer the disk true, for the latter is a difficult task for those not familiar with handling sheet metals.

In using the steel roller against the edge of the saw blade, note the formation of a slight set on each side. Every effort should be made to have this set uniform on both

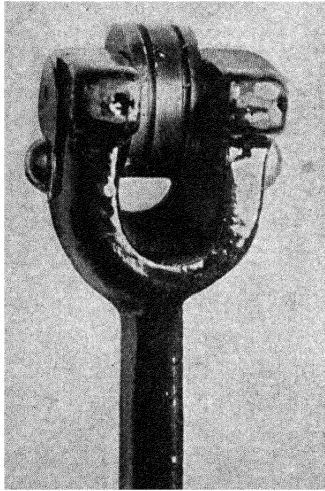

Fig. 136.—Diamond saw roller used in the making of a diamond-charged disk.

sides. A saw with a set on only one side will tend to travel sideways. Experience with the roller and the preliminary hammering will indicate the proper manner of setting the saw.

At the outset the diamond saw will not cut fast, as not much diamond may be actually exposed on the surface. Cut several small sections at the start until the tool cuts

The Art of Gem Stone-cutting

properly before proceeding to cut large sections. A flange is used to hold the saw on the arbor.

In the cutting of hollow geodes, especially those lined with quartz crystals, loose material may wedge into the cut and tear loose the diamond. As in the case of the mud saw, small sections not over 1 inch in diameter can be cut

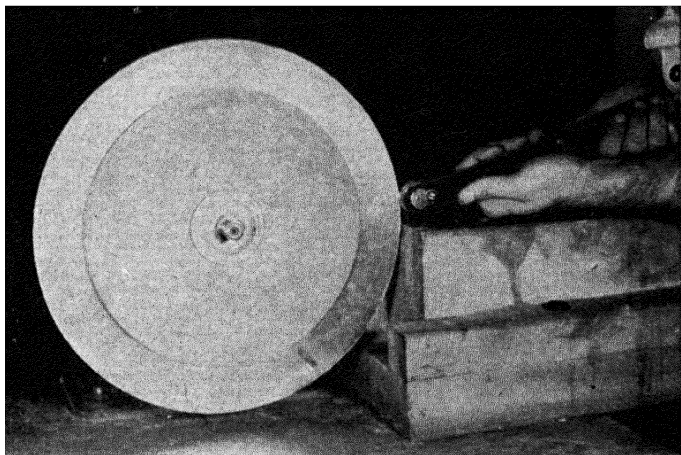

Fig. 137.—A diamond-charged disk is improved by rolling with a case-hardened grooved roller made for this purpose.

by hand on a steady and rigid rest. Larger sections should be clamped and pulled into the blade.

If your diamond saw fails to function properly or does not give long service, do not blame the tool but look into your technique of charging or using the blade. The experience of hundreds of gem stonecutters indicates that the diamond saw will give very satisfactory service at no great cost.

Jewelry, Gem Cutting, and Metalcraft

Pointers on Sawing. Do not use a diamond-charged disk on an arbor that has end play. Side play wears the set out of the blade.

Do not saw large specimens on a small saw and expect to get the maximum "mileage" out of your saw.

Be sure that the blade fits the arbor snugly and that there is no grit on the inside of the flanges.

Do not force the saw, or you will shorten the life of the blade.

Start a cut on as smooth and even a surface as possible. Often it is necessary to grind a smooth place on the specimen.

Allow the blade to cut a groove before applying tension or weight. Stop the machine and check the alignment of the blade and the groove it has cut. If necessary, move the specimen laterally, without removing it from the clamp, to align the cut with the saw blade. A blade that is cutting to the side will soon wear off the set.

Do not operate the saw too fast. A 10- or 12-inch blade should operate satisfactorily at a speed of from 450 to 600 r.p.m.

Watch the level of the lubricant—half kerosene and half motor oil—and do not let the saw run dry. The blade should dip down into the lubricant approximately $\frac{1}{2}$ inch.

If the blade heats while there is plenty of lubricant, the blade needs hammering or rolling to give it a set.

Never start a new blade or a hammered or rolled blade in an old cut. To do so will shear off the set in the blade.

Never start a cut until you are positive that the specimen is securely clamped. If the specimen slips, the blade is

The Art of Gem Stone-cutting

likely to be bent and thus damaged. Small kinks caused by the specimen slipping can often be hammered out by holding a hammer on one side of the blade and hammering the blade on the opposite side with a small hammer. The hammered portion must then be reset. A blade that has been bent and straightened is often good for small specimens but may bind in deep cuts.

Sometimes particles of diamond work out of the notches and become embedded in the side of the blade, causing it to bind in the cut. When this happens, back the saw out of the cut and remove the diamond particles by scraping with a knife blade.

As the blade nears the end of the cut, release most of the tension and allow the blade to cut until it is nearly through the specimen. Lift the specimen back from the blade and press the slab in toward the cut to snap it off. By carefully watching the beginning of the cut, the finishing of the cut, the clamping of the specimen, and the tension, most operators can greatly increase the life of their diamond saw blades.

Cutoff Saws. For sectioning purposes, the "cutoff" wheels made by the Norton Company and other manufacturers are used in some commercial establishments. These are thin disks of silicon carbide, available in various diameters.

These saws are well suited for many types of work, but the diamond-charged disk is better suited for sectioning material of quartz hardness. The author does not recommend their use to craftsmen or students, as few have

Jewelry, Gem Cutting, and Metalcraft

arbors sufficiently well guarded to protect the operator in case of breakage. •

Diamond-charged Bakelite Saws. The diamond-charged bakelite saws are without question the most efficient saws yet devised for the cutting of hard gem materials. The only disadvantage is their high cost. A small 3-inch disk, charged on the outer periphery with diamond powder, sells for about \$18, and the tool is too small for cutting large sections. This type of diamond saw is used by commercial gem cutters for sectioning valuable gem materials, such as sapphire and opal. The disks are thin and flexible and therefore waste little material in making a cut.

The bakelite diamond saw can be run at very high speeds. It can even be run dry and put to considerable abuse without damaging the disk. With a saw of this type, very hard gem minerals, such as sapphire, can be fed into the saw by hand. The tool will cut with approximately the same speed and ease as wood is cut by a high-speed steel saw. Moreover, since the bakelite diamond saw cuts so fast, little heat is generated by friction.

In 1941 the Norton Company introduced a metal-bonded diamond cutoff and slotting wheel that is superior to the wheels previously made. The diamond is actually embedded in solid metal, a special alloy that holds the tiny diamond particles securely and resists severe usage. Wheels with diamonds in the periphery are used extensively in the grinding and cutting of cemented carbides.

The cutoff wheels have diamond in the periphery to a depth of $\frac{1}{8}$ inch and are available in sizes from 4 to 8 inches.

The Art of Gem Stone-cutting

GRINDING

After the specimen has been cut to the desired shape, it is ready for the grinding wheels to shape the stone properly. Gems of different hardness require different grades of bond in the wheels. This, however, is not an important matter

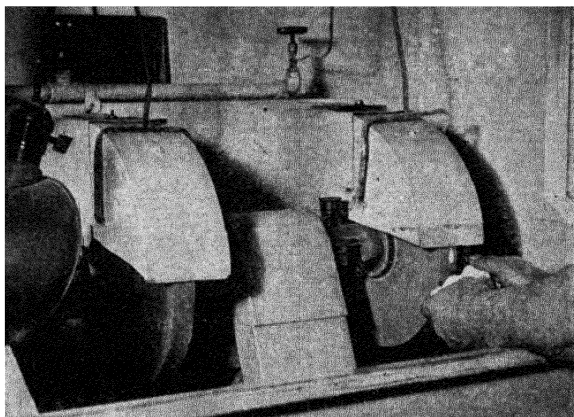

Fig. 138.— Grinding gem stone in *The Mineralogist* laboratory. No. 120 grit wheel on left, No. 220 grit wheel on the right. Note the water system, where water is sprayed on the sides of each wheel.

for the amateur since wheel wear is not a large factor in the home shop as it is in commercial shops.

Two grits of silicon carbide wheels will suffice for the home shop, namely, No. 120 and No. 220. All grinding wheels should be operated at surface speeds (S.F.M.) of 5,000 feet per minute. This means that a 6-inch wheel should revolve at about 3,000 r.p.m. and a 12-inch wheel at about 1,600 r.p.m.

Jewelry, Gem Cutting, and Metalcraft

Dealers in lapidary equipment handle properly bonded wheels for cutting cabochons. Silicon carbide grinding wheels are sold under various trade names, including Carborundum and Crystolon.

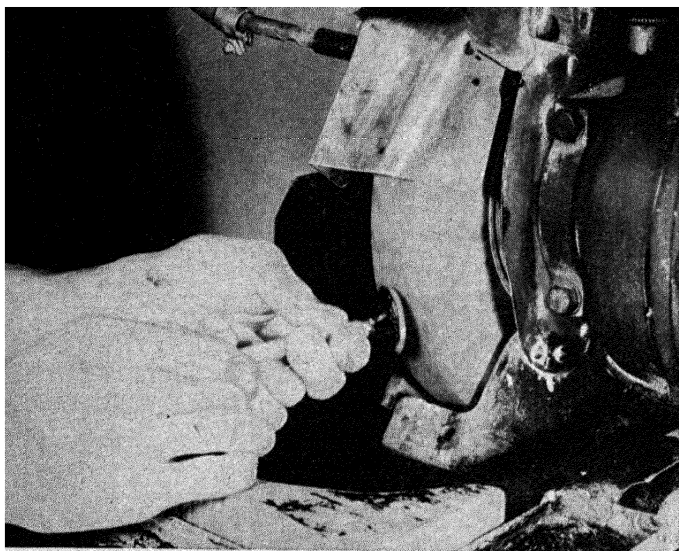

Fig. 139.—Grinding a cabochon that has been rough-ground and cemented to a dop stick. The dop stick facilitates movement of the stone.

Wheels 1 inch thick are generally used. These may be any size in diameter, from 6 to 12 inches, but the 10- and 12-inch wheels are more satisfactory and more economical than the smaller sizes.

If you are using a $\frac{1}{2}$ -inch-diameter arbor, do not use a wheel larger than 6 inches in diameter. Wheels 7 and 8 inches in diameter can be used safely on a $\frac{5}{8}$ -inch-diameter

The Art of Gem Stone-cutting

arbor; 10-inch wheels require arbors at least $\frac{3}{4}$ inch in diameter; and 12-inch wheels should not be operated on arbors less than 1 inch in diameter.

The grinding wheels should be kept wet with running water and well shielded to prevent splashing. Water may be sprayed on the sides of the wheels by the use of regular city water pressure, with valves controlling the amount of water. An air-pressure hose is useful in connecting the water pipeline to the small tubing used to direct the water on the wheels. Another method is to elevate a large pail to be used as a water reservoir, from which the water may be turned on the wheels. A 5- or 10-gallon milk can is an excellent container.

Provision must be made to take care of waste water. If this is run into a sink or drainpipe, make provisions to catch the sediment before the water is released. Run the water into a container that holds several gallons and make a connection near the top of this container to carry the waste water to the drain. Much of the sediment will remain in this improvised trap, instead of being carried into the drain. The container, or trap, must be cleaned out occasionally.

Small, compact grinding units (Fig. 140) can be constructed with watertight compartments made of galvanized iron or sheet copper. Two such compartments are needed, a right- and a left-hand unit. They should be provided with a drain and shielded to keep the water from splashing onto the bearings. Pour water into each compartment until it reaches a level just below the wheel.

Jewelry, Gem Cutting, and Metalcraft

When the wheel is rotating, the suction will lift the water onto the wheel.

Wheels should never be allowed to stand in water before being started, for the part that is in the water is heavier, and throws the wheel off balance. If it is started

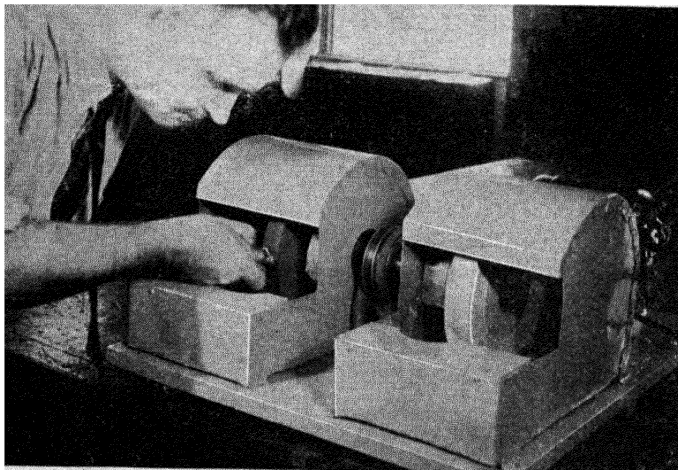

Fig. 140.—Grinding a cabochon on a small, compact gem-cutting outfit. Grinding wheel is at left and felt polishing buff is at right.

under such conditions, the wheel may explode, causing serious injury.

Always use a compressible washer between the flanges and a wheel. Before starting new wheels, inspect them carefully to see that they were not damaged in transit, and when starting the wheels stand to one side for a minute.

Grinding wheels may develop rough or high spots when in use, which make grinding difficult as well as increase

The Art of Gem Stone-cutting

the likelihood of chipping of the stone being ground. Vitrified silicon carbide wheels can be trued easily with a special type of silicon carbide stick, which is inexpensive and obtainable from supply houses. However, if the grinding wheels are used properly and are properly bonded for the work at hand, very little difficulty will be experienced with their getting out of true.

The ratio of the weight of the grinding wheel to the material being ground is very important. The ratio should

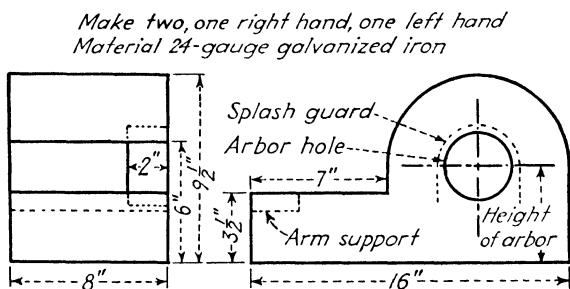

Fig. 141.—Detail drawing of the splash pans shown in Fig. 140. Dimensions may be changed to make pan fit your arbor.

be very large. Cabochons can be ground on a 6-inch grinding wheel without knocking the wheel out of round, but if you grind specimens weighing $\frac{1}{2}$ pound or more on the small wheels you are likely to have trouble.

This can be offset to some extent by placing a good heavy block in front of the wheel and using the same technique as though you were truing the wheel. The majority of wheel troubles are no doubt caused by grinding specimens too large for the wheels. When grinding large specimens, use larger (heavier) grinding wheels.

Jewelry, Gem Cutting, and Metalcraft

Plenty of water passing over the wheel will tend to keep the wheel surface flushed and clean for fast work. The water will also keep down frictional heat in the gem being ground, preventing it from cracking, and will avoid dust.

Cabochons are generally ground from small pieces of gem-cutting material or from blanks or slabs cut from larger pieces. Study the piece of material very carefully for unusual markings and cut the stone so as to show them to the best advantage.

Mark out the outline of the stone on the bottom side of the blank, using a pointed piece of aluminum wire or a strip of aluminum cut from a sheet. Marks made by aluminum will not wash or rub off easily. Outlines of stones may be drawn on cardboard and the cardboard cut out and used as a template, or finished cabochons may be used as outlines. If many cabochons are to be made the same size, a template may be sawed from sheet metal.

If the blank is thin, much of the waste material can be pinched off with a pair of blunt-nosed pinchers. It is necessary when using the pinchers to remove a very small portion at a time. One soon gets very adept at doing this and can thus save much wheel wear.

To shape a cabochon properly is a matter of experience and practice, although it is possible to cut some of the more difficult ones, such as a double-cabochon heart, on the first attempt. The author, in his experimenting, has found this true with exceptional students, though as a general rule it is best for beginners to stick to the conventional oval style.

The Art of Gem Stone-cutting

Most grinding is done by holding the work by hand against the wheel, using a steady rest for the arms. The preliminary rough grinding is done on the No. 100 grit wheel and the final grinding on the No. 200 grit wheel.

Keep the stone in motion as it is held against the wheel. All grinding should be done from the base of the stone toward the crown to avoid possible chipping at the edge. While most work is done on the periphery of the wheel, the sides are brought into use for obtaining flat surfaces.

Grasp the stone with the thumb and index finger of each hand, holding it tightly, yet not too rigidly. Allow the stone to rotate on the index finger of the left hand.

In grinding to the outline marked upon the blank, it is good practice to grind off the bottom edge first—in this case the top of the stone, as it is being held bottom upwards—and then grind off the waste around the outline. This will eliminate to a large extent any possible chipping on the crown side as it reduces the area of the stone that is in contact with the wheel.

After grinding the stone to the general outline desired, shape the crown side, always grinding from the edge toward the crown, or center, of the stone. When the blank has been shaped on the coarse grit wheel, take it to the fine grit wheel and shape further, removing many of the irregularities left by the rough-grinding.

Cement the stone to a dop stick 3 or 4 inches in length and further grind on the No. 220 grit wheel. With the aid of the dop it is possible to move the stone more quickly, giving it a brushing stroke and thus smoothing the stone.

Jewelry, Gem Cutting, and Metalcraft

Valuable and fragile gems should be cut entirely upon the fine grit wheel. Soft gems, such as opal, turquoise, malachite, and lapis, are generally cut on the finer grit wheel.

The sides of any cabochon-style gem stone should be slightly tapered to permit clamping in the bezel mounting. An improperly sloped stone will present difficulties in some styles of mounting. Never slope the edge to the very bottom of the stone, thus making a knife-edge, for such edges are easily broken when being mounted. Stones that are cut with a very high crown generally work loose in the bezels. Through experience in mounting gems one will soon gain an appreciation of the proper shape for the stone and the correct slope at the girdle (edge).

After the stone has been properly shaped to size and form and all dull-looking matrices and blemishes ground away, it is ready for the sanding operation. Hearts and crosses are ground and polished in the same manner as any other cabochon. If a horizontal lap is available, the stone can be roughed out on the grinding wheels and smoothed up on the lap plate. The lap plate is especially useful in making crosses. In the event that a lap plate is not available, a cross can best be sanded on a drum sander, as shown in Fig. 143, or upon a rubber-bonded silicon carbide wheel.

SANDING

The term *sanding* may be confusing, as no sand is used in this operation. Its purpose is to remove the deep scratches

The Art of Gem Stone-cutting

left by the grinding wheels and thus prepare the gem for the final glossy polish carried out on the felt buffs.

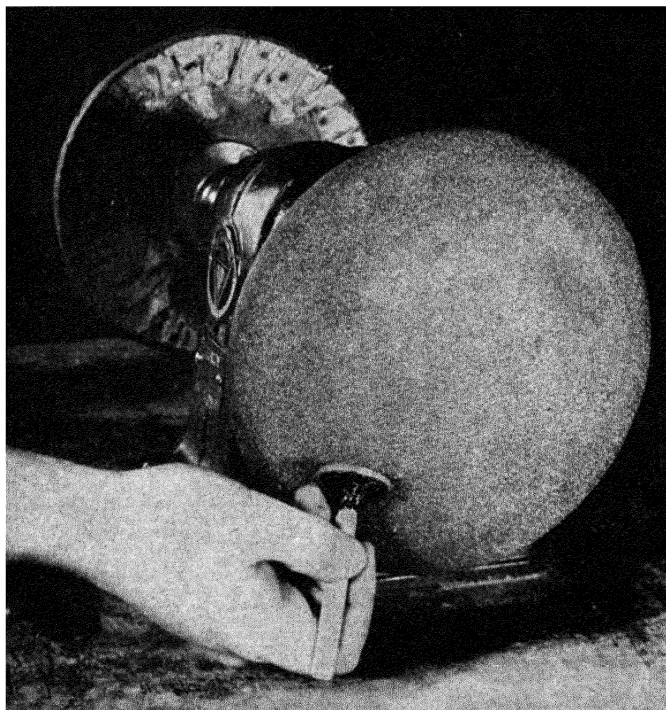

Fig. 142.—Sanding a cabochon on a vertical running wood disk covered with sponge rubber, canvas, and silicon carbide grit No. 220. The abrasive is held to the canvas with hot cabinetmaker's glue.

Sanding is carried out on two types of sanders, the horizontal or vertical running sander and the drum sander. All work with the horizontal or vertical type is done on the side of the disk and with the drum type, on the pe-

Jewelry, Gem Cutting, and Metalcraft

riphery of the wheel. Each type has its advantages. Vertical, horizontal, and drum sanders are available from dealers, or they can be made by the craftsman.

The vertical running sander consists of a disk of wood 8 inches or more in diameter and about $1\frac{3}{4}$ inches thick. This disk can be cut by any woodworker. The working surface should be slightly convex, with a rise of about $\frac{1}{4}$ inch in the center of the disk. The periphery should be slightly tapered in order to permit a metal hoop to be slipped over the edge to hold the cloth in position.

As an alternative to the metal hoop, a groove may be cut on the edge or periphery of the disk and the cloth held in position by being tied with a cord. The surface of the sander should be covered by a thickness of felt or sponge rubber to act as a soft base. A few thicknesses of old billiard-table felt will answer. The felt should be cemented in position.

If a metal hoop is used to hold the cloth in place, the joint should be brazed and filed smooth. The hoop may be made from thin band iron, or almost any convenient material that is thick enough.

The cloth used for sanding is coated with No. 220 grit silicon carbide. The cloth should be held rigid and smooth. Dampening the back of the cloth slightly with water prior to placing it in position will facilitate the elimination of wrinkles.

The vertical sanding disk can be attached to the arbor by threading a faceplate, about 3 inches in diameter, to fit the shaft and fastening the disk to the faceplate. Another method is to make your own faceplate by drilling several

The Art of Gem Stone-cutting

holes through a nut that fits your arbor and riveting the nut to a circular disk cut from heavy brass or sheet iron. Drill three or more holes in the metal plate and mount, with screws, to the sanding disk.

Many craftsmen mount their sanding disks on the arbor by using an inserted nut. Bore a hole the size of the arbor through the wood disk, and then on the work side of the disk countersink a nut that fits the arbor. Hold the nut in place with screws. Then cover the face of the disk with felt or rubber. Use a wood washer to keep the arbor from going too far into the disk.

If you have many persons, especially students, using the same sander, it may be advisable to make your own sanders, as follows: Secure an 8-inch wood disk that is at least $1\frac{1}{2}$ inches thick, mount a faceplate to the disk, and place it on the arbor.

True the disk with a chisel, making the work face slightly convex. Cut a circle, slightly larger than the disk, from a piece of sponge rubber—a kneeling pad is satisfactory—or felt and glue this to the disk. After the glue dries, trim the circle to the size of the disk. Cover the rubber, or felt, with canvas, tacking the canvas to the back side of the wood disk, at the same time keeping the canvas free from wrinkles.

Coat the canvas with No. 220 grit silicon carbide. Hide glue, also known as hot glue, is the best adhesive for holding the grit to the canvas. Cold, liquid, prepared glue does not work so satisfactorily as the hot glue, neither does casein or the synthetic resin glue.

Jewelry, Gem Cutting, and Metalcraft

Soak the glue overnight in water and then heat it, using a double boiler to keep it from overheating. Make the glue rather thin. Apply the glue to the canvas with a brush and immediately dust the canvas with No. 220 grit silicon carbide. If possible, warm the grit and the canvas before applying the glue to the canvas. A disk of this type must set overnight before being used. If you are using this type of sander, you will find it advisable to have several so that all may be recharged at the same time. Before recharging, wash off all glue and remaining grit with hot water, scrubbing with a stiff brush.

Sanding can be done very satisfactorily by mounting the wood disk upon a faceplate and mounting the assembly on the shaft of a $\frac{1}{4}$ -horsepower motor, using set screws to hold the faceplate on the motor shaft. Such faceplates are available at most stores handling equipment designed for the craftsman.

A new sanding cloth cuts much faster than an old one, but one that has been in use for some time is excellent for final sanding before the stone is put on the polishing buff. For this reason, two sanding disks are handy, one with a new cloth, and one with a well-worn cloth.

Instead of replacing a cloth, a new cutting surface may be added by coating the surface of an old cloth with silicon carbide grit. Coat the surface of the cloth with silicate of soda (ordinary water glass used for preserving eggs) and immediately dust on the proper grit. Shake off the excess grit and allow the silicate of soda to dry before using. Use the silicate of soda as obtained from the drug-store and keep the container tightly covered.

The Art of Gem Stone-cutting

A well-worn sanding cloth can also be renewed by applying a wet, stiff brush to the surface and brushing the unused abrasive in the center of the disk out toward the periphery. The disk is then allowed to dry before being used. This can sometimes be repeated several times and many stones sanded on a cloth that had apparently been worn out. This is true particularly of the type of sander that is mounted upon a faceplate and that has no projecting nut in the center.

A new cloth may cause scratches until it is broken in. A new, or a newly charged, cloth can be readily broken in by holding a piece of agate against it, using light pressure.

The drum-type sander, which is made of wood and is 7 inches or more in diameter, has in recent years proved very popular. Sanders of this type may be purchased, or made, in various widths, usually 2 or 3 inches. They are padded with felt and covered with No. 220 grit silicon carbide cloth, which is also available in various widths. The ends of the cloth strip are held in a slot by being wedged in or by the use of a tapered peg. Drum-type sanders may be covered with rubber or felt, then canvas, and lastly grit, which is cemented to the canvas with hot glue.

The drum-type sander is excellent for sanding specimens, as it is possible to sand large flat surfaces.

All types of sanders should have a speed of about 10 per cent less than that given for the grinding wheels. The sanders are run dry and need not be shielded.

In sanding cabochon-style gems it is best to mount the stones on dops to facilitate handling. The correct tech-

Jewelry, Gem Cutting, and Metalcraft

nique in using the sander is to brush the stone against the cloth, freely moving the dop. Scratches will thus be minimized. Avoid heating the stone, as this softens the cement holding the stone to the dop.

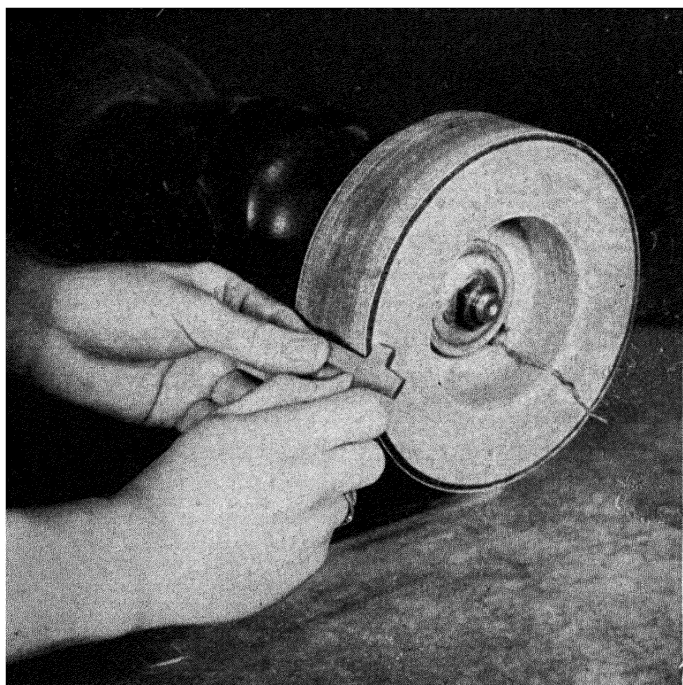

Fig. 143.—Drum-type sanders are ideal for many types of work, such as sanding crosses cut from agate.

Aluminum oxide and emery cloth are satisfactory for sanding the soft stones, although for stones of 7 or more in hardness silicon carbide cloth should be used.

The Art of Gem Stone-cutting

Time spent in sanding is time well spent, for if all the deep scratches are removed by sanding, considerable time will be saved at the polishing buffs. The sander removes the scratches much faster than the buffs. Proper sanding will give a near polish, or shine, to the stone, and only a short time will be needed to attain the final high glossy finish on the polishing buff.

For sanding the stone after it has been ground, instead of silicon carbide coated cloth silicon carbide grit is sometimes used. The grit is mixed with water and applied with a brush on a wood drum that has grooves cut on its periphery. Grooved lap plates are also used. Various-sized grooves are used for various-sized cabochons.

There is another method, which requires the use of a wood disk 10 or 12 inches in diameter and 2 inches thick, the inside of which is hollowed out to a depth of about $1\frac{1}{2}$ inches, a rim being left on the periphery. This disk, or internal grinder as it is sometimes called, is mounted upon the arbor, and silicon carbide mixed with water is applied to the inside of the grinder with a brush. As the grinder revolves, the stone, mounted upon a dop, is held against the wood, and the scratches are ground or lapped out.

This method of smoothing the stone after it has been ground is used by many craftsmen, who obtain excellent results. By the use of several drums, a different-sized grit being used in each drum, a cabochon can be given a semi-gloss finish, especially if the stone being cut is agate. The dry method of sanding has within recent years supplanted the wet method to a large extent. The chief objections to

Jewelry, Gem Cutting, and Metalcraft

the use of the wet method of sanding is that it is messy to use and that the drums through use become bumpy.

As the sanding is done without water, avoid overheating the stone, because it may crack. Water should not be used unless one uses waterproof sanding cloth where the

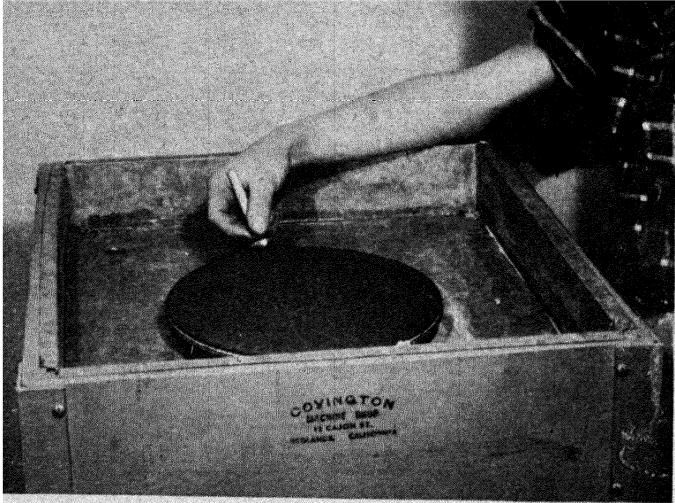

Fig. 144.—Sanding a cabochon on an abrasive-covered disk that screws to vertical spindle of a lap unit.

grit is held on the cloth with synthetic resin glue. This type of glue cannot be used by the craftsman in recharging sanding cloth as it cannot be washed off, and to recharge over the old glue usually gives a bumpy surface.

Sometimes a piece of sanding cloth can be used to best advantage by hand or wrapped around a specially shaped piece of wood.

The Art of Gem Stone-cutting

Rubber-bonded silicon carbide grit wheels of various grit sizes may be used to sand cabochons to a semi-polish after they have been sanded on the regular sander. These wheels are excellent for sanding irregularly shaped stones, such as hearts, crosses, etc. Some manufacturers make the rubber wheels with several grit sizes in the same wheel.

POLISHING

A gem stone with a high glossy finish will always be more attractive than one with a poorly polished surface. This is

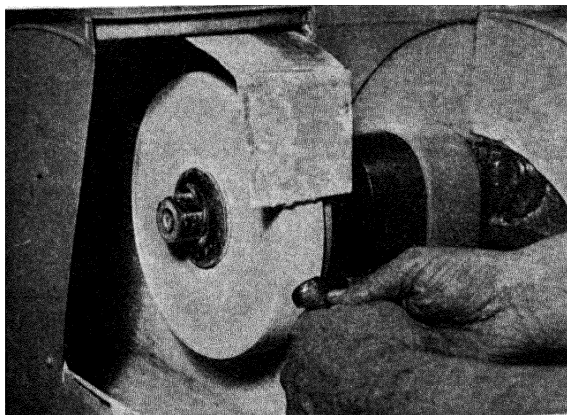

Fig. 145.—Polishing gem stone on felt buff wheel.

especially noted in "fire" opal, where the glossy finish appears to bring out additional colors and flame. Hence a good polish will greatly enhance the appearance of your work. If a gem stone is worth being worked, it certainly is worth being given a proper finish. The final polishing is

Jewelry, Gem Cutting, and Metalcraft

done on a revolving hard felt lap, either horizontal or vertical, or a muslin buff may be used:

For general use the hard felt is recommended. Wheels 6 or 8 inches in diameter and 1 inch thick are good for general use, the polishing being done on the periphery of the wheel. Larger wheels are available and will, of course,

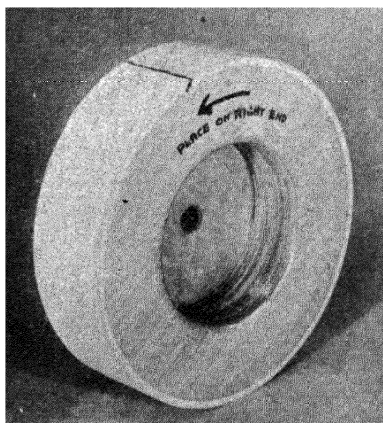

Fig. 146.—A strip of hard felt glued to a wood drum makes a good polishing buff. (Courtesy of Warner & Grieger, Pasadena, Calif.)

enable one to work larger specimens. Wheels less than 1 inch thick are generally backed with wood, and the polishing is done on the side of the wheel.

Special felt disks, $\frac{1}{4}$ inch thick, of various diameters can be used if they are cemented to flat or convex polishing laps. Many dealers stock felt and will cut it to any desired size.

A wood drum, similar to the drum sander, can be covered with a felt strip in the making of a polishing buff,

The Art of Gem Stone-cutting

Fig. 146. True the drum on the polishing arbor and cement or glue the felt in place with waterproof cement or glue. Taper the felt at the lap, being sure that the lap is in the right direction. Use tacks to hold the felt in place while the glue is drying. This type of polishing buff is used extensively, because of its low cost.

A muslin buff, of the type used for polishing jewelry and metal, is excellent for polishing gem stones. Many stones that do not seem to polish on the felt will soon take on a polish on the muslin buff. Many of the softer stones polish better on the muslin buff.

Ten-ounce canvas is better for polishing some types of material, as it has a lower polishing temperature than leather or wool felt.

Considerable pressure can be applied to the stone, but keep the buff wet. The stone is usually polished while still mounted on the stick used in the sanding operation.

The speed of a felt buff should be approximately 900 surface feet per minute, which is about 450 r.p.m. for an 8-inch wheel.

Many commercial lapidaries, as well as amateurs, use a leather buff. The leather buffs are of two types, one for flat surfaces and the other for cabochons. They are usually about 10 inches in diameter and are generally run at motor speed, 1,725 r.p.m.

A fine stream of water is necessary in using leather buffs. This can be obtained by hammering the end of a piece of copper tubing until the size of the opening allows the size of stream desired. The tubing is then connected to a water line or an elevated pail of water. Experi-

Jewelry, Gem Cutting, and Metalcraft

menting will determine the proper amount of water required on the leather buff. There should be a drag or pull on the gem as it is held against the buff.

The leather buff may be mounted directly on the shaft of a motor by using a small faceplate with set screws, or the faceplate may be threaded to fit a buffing or grinding arbor and then powered with a $\frac{1}{4}$ -horsepower motor.

In making a leather buff, obtain a wood disk about $1\frac{1}{2}$ inches in thickness and 10 inches in diameter. Mount the disk on the faceplate and true it up as the disk revolves. If it is to be used for flat surfaces, glue a piece of sponge rubber to the face of the wood disk and feather out the rubber so that the center is higher than the rim. Cut the leather to size, wet, and stretch over a form to dry. Then place it over the rubber and tack it to the rim.

For polishing cabochons, no rubber is used under the leather, but the wood disk is made concave, and the leather is stretched across the face of the plate and tacked to the rim. This allows the leather to give while being used, thus contacting a larger surface of the gem stone. If after long use the leather glazes, it should be scraped with a knife to renew it.

Many polishing agents are in use. These include tin oxide, tripoli, alumina flour, Waldru Final Finish Agent, Carborundum Company buffing powders, rouge, and numerous others. In general, the manufactured agents are most satisfactory, as they are uniform in grit and free from foreign material that may cause scratching. Special polishing powders are available for the polishing of jade, vesu-

The Art of Gem Stone-cutting

vianite, dumortierite, and rhodonite. Best results are obtained when the powders are used on a leather buff.

The polishing agent is mixed with water and applied with a brush. If different agents are used, a separate felt should be used with each.

Turquoise and variscite will, if much matrix is present, take a better polish if they receive their final polish on a muslin buff, with jewelers' rouge used as an abrasive.

Tigereye, which is popular with both students and craftsmen, is best polished at right angles to the fibers.

It is best to wash both stone and dop thoroughly after the sanding operation to remove any grit that may be adhering to the cement, thus keeping the grit off the buff.

Oxalic acid crystals added to the polishing mixture aid in the polishing of onyx and travertine. Dissolved in water, the oxalic acid will remove iron stains from many specimens.

A polishing buff should not be located near a sander, if equipment is set up permanently, and under no circumstances should it be left where grit will fall upon it.

A good low-cost polishing outfit can be made by using two pillow-block bearings, either ball, babbitt, or bronze bearing, a piece of $\frac{3}{4}$ -inch diameter shafting, 30 inches long, four collars, and two nuts. The motor can be placed in back of the unit or under the table.

Thread both ends of the shaft with right-hand threads if a left-hand die is not available and place two nuts on the left-hand side, using one nut as a lock nut, or drill a hole through the shaft and use a cotter pin.

Jewelry, Gem Cutting, and Metalcraft

The polishing outfit shown in Fig. 147 was made in this way. The polishing buffs are felt-covered wood drums. The splash pans are similar to the one shown in Fig. 141, except that they are larger and have hinged covers to protect the buffs when not in use.

With such a polishing outfit one can use one of the alumina polishing powders, levigated or E111, on one buff

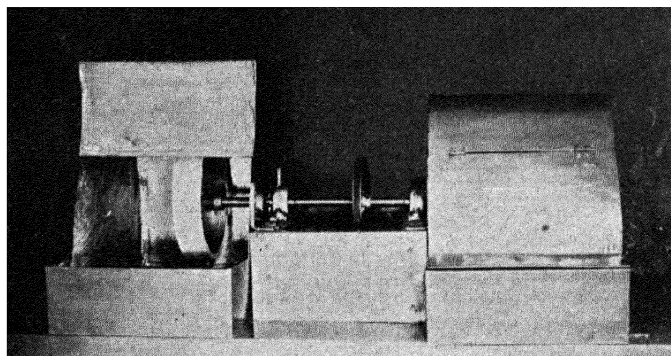

Fig. 147.—Polishing outfit made from pillow bearings, shafting, and collars. One buff is used with alumina powder and the other with the final polishing agent. Note the hinged covers that protect the buffs while not in use.

for polishing the stone after it has been sanded and then use the other buff with tin oxide, rouge, or other final finishing agent for the final buffing.

Often a stone has a slight crack or pit that cannot be ground out. During the polishing the agent becomes firmly packed in the flaw and cannot be very easily washed out. Do not try to pick out the polishing agent. Use black waterproof drawing ink and color the polishing agent.

The Art of Gem Stone-cutting

DOPPING

After the stone has been properly ground on the grinding wheels, it is advisable to "dop," that is, mount on a small round stick called a dop. This will facilitate handling during the operations of sanding and the final polishing. A small dowel 3 or 4 inches long makes a good dop. Dowel rods may be purchased from most lumber dealers in 3-foot lengths and then sawed into convenient lengths, the ends being sawed square. Small paintbrush handles also make suitable dops. For cabochon cutting wooden dops are generally used, but in facet cutting metal dops are best.

Dopping cement can be purchased from supply houses or made by melting together equal parts of sealing wax and flake shellac. Burgundy pitch mixed with sealing wax and clay flour makes a good cement. If your stones break off the dop very frequently, soften the cement by adding clay flour. If the cement is too soft, harden it by adding sealing wax or flake shellac. Sealing wax makes a very good dopping cement.

Warm the stone by placing it upon a piece of metal that has been warmed. The stone should be about as warm as can be held in the fingers. Stick one end of the dop into hot cement and coat it for about $\frac{3}{4}$ inch. Then pass the coated end of the dop through a flame and get the cement hot. Rub this hot cement over the base of the warm stone. Again heat the cement on the end of the dop; when it begins to melt, press the dop onto the base of the stone. With *damp* fingers mold the cement around the dop onto the stone, keeping it away from the edge.

Jewelry, Gem Cutting, and Metalcraft

After the stone is given its final polish, it is ready to be removed from the dop. This can be done with some cements by warming the stone and plunging it into cold water. The sudden chilling will cause the cement to break loose. Some cements on the market will not break loose when plunged into water. The stone is removed by warming and prying off with a knife blade. A sharp knife

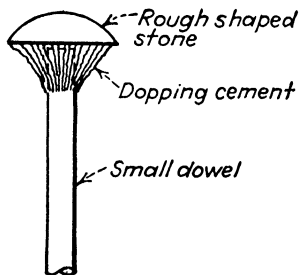

Fig. 148.—Cabochon cemented on dop stick.

may be used to scrape off any cement that remains on the base of the stone. A cloth dampened with alcohol, turpentine, or acetone will remove any particles left by the knife. Fine steel wool is good for removing particles of cement from the harder gem stones.

DRILLING

Many times one wishes to mount a cabochon as a pendant without using a bezel or to mount an initial or other ornament on top of the ring set. This may be done by drilling a hole through the stone. A small hollow metal tube and an abrasive provide a very satisfactory method of drilling. Any metal tubing, such as silver, brass, or

The Art of Gem Stone-cutting

gold-filled tubing, may be used. The tubing is generally used in short lengths of from 1 to 1½ inches.

Tubing for drilling stones can be very easily made from a narrow strip of tin plate or from metal cut from a tin can, by drawing the strip through a drawplate. Taper one end of the strip and pull it through the large hole of the drawplate. Continue pulling, reducing the size, until the desired size is obtained. Silver tubing can be made in the same manner.

Almost any drill press running at a speed of approximately 800 r.p.m. can be used. If the chuck on your drill press is not small enough to hold the small tubing, a special chuck fitted with a ½-inch straight arbor may be secured. These special chucks fit into most drill-press chucks and will hold small drills and tubing. They are obtainable at some five- and ten-cent stores. A chuck removed from a small hand drill will sometimes prove quite satisfactory.

Three-jaw drill chucks are likely to crush the small tubing unless extreme caution is used. This can be remedied by soft-soldering a wire inside the top end of the drilling tube. Special collet chucks, made especially to hold the small tubes used in drilling, are available from Warner & Grieger. They hold the tube firmly without crushing and fit any drill-press chuck.

Boron carbide, manufactured by the Norton Company and sold under the trade name of Norbide, is the cheapest and fastest abrasive for tube drilling. Diamond dust is faster, but its cost is at least 300 times that of Norbide.

Jewelry, Gem Cutting, and Metalcraft

Silicon carbide grit can be used, but it takes much longer to drill the hole.

Norbide is the hardest abrasive manufactured for commercial use, and, although it is expensive, costing \$1 an ounce in small quantities, the cost per hole drilled is very small. An all-purpose grit, for various-sized holes, is No. 280 grit. Finer grits take a much longer time.

Brass tubing $\frac{1}{16}$ inch in diameter is useful in drilling cabochons. This can be purchased from many hardware stores in 3-foot lengths. Cut off a piece about 1 inch long. Nick one end slightly with an old safety-razor blade or hack-saw blade ground to an edge and then upset the nicked end by tapping lightly. This will keep the tube free in the stone and will also keep the core from sticking in the tube.

Mount the stone to be drilled on a board, using hard dopping cement or sealing wax. Be sure to get the cement or wax under that portion of the stone where the hole is to be drilled, for this will give support to the stone as the final drilling is done.

Make a small ring from a narrow strip of thin sheet metal or use a piece of small tubing. Place this over the stone, centering the ring over the spot where the hole is to be drilled, and fasten the ring to the stone with sealing wax, making the joint watertight.

Place the board on the drill-press table, align the stone with the drilling tube, and clamp the board to the drill-press table.

Mix the abrasive with light machine oil and place the mixture inside the metal ring, or well. Start the drill press

The Art of Gem Stone-cutting

and bring the tube down upon the stone, using a very light pressure. Lift the tube every few seconds to allow new grit to run into the hole.

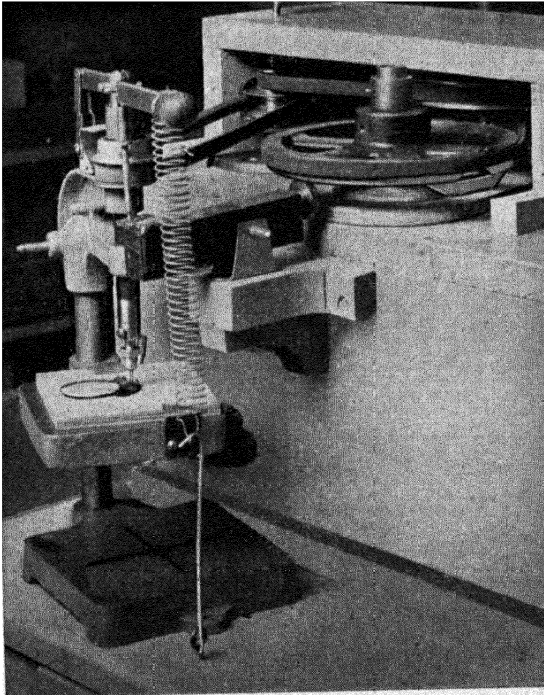

Fig. 149.—Small drill press used for tube drilling by H. L. Monlux, Los Angeles. Note spring tension and the cam arrangement to lift the tube. (Photograph by G. Haven Bishop, Los Angeles.)

Many craftsmen find that the stone chips on the underside. This is caused by too much pressure being applied on the tube. This can be remedied by using either a small

Jewelry, Gem Cutting, and Metalcraft

weight tied to the spindle handle or a coil spring to keep the tube down against the stone. In drilling, the procedure is reversed; the operator now has to raise the spindle instead of using a downward pressure. The light pressure from the weight or spring will allow the tube to cut through instead of breaking through.

If much drilling is to be done, you can mount a flat wheel, with a cam on the side, beside the drill press and by means of linkage and a rocker arm improvise a means of lifting the drill-press spindle (Fig. 149). The flat wheel should revolve very slowly so that the spindle is lifted every few seconds. Belt and pulleys or reduction gears can be used. The reducing pulleys can be driven from the small pulley of the drill press if press is equipped with a two- or three-step pulley. Two vertical shafts and one small and two large pulleys are needed. The large pulleys can be made of wood. Mount the cam to the underside of a large pulley. A ball-bearing roller-skate wheel fastened to end of wood rocker arm helps to reduce the friction. With such a drilling outfit you can do other work while the hole is being drilled.

Ornaments or initials may be mounted on drilled stones by soldering a short length of silver tubing to the ornament, letting the tube extend just through the stone, and burnishing on the underside.

If the silver tubing is too large to go into the hole, reduce the tubing by drawing it through a drawplate, in the same manner as wire is reduced. Silver solder a short length of wire into the end of the tube to avoid mashing the tube with the drawtongs, as it is pulled through the

The Art of Gem Stone-cutting

plate. If no drawplate is available, enlarge the hole in the stone by using a nail or brad, in the same way as the tube was used. Nails cannot be used satisfactorily in drilling a hole, as there is a dead center when the nail revolves.

Eye pins can be attached to stones, such as hearts, crosses, and teardrops, by drilling the hole into the stone and cementing the pin in place with pearl cement.

Many lapidary dealers stock drill tubes of rolled gold. They are especially good for those working in gold mountings, for part of the tube can be used to drill the hole and part then used to mount the bail, in the case of a heart pendant, to the stone.

HOW TO CUT A SPHERE

The grinding of a sphere is not a difficult task and can be accomplished on the grinding wheels, followed by grinding or lapping in a metal tube, or pipe, with various-sized grits. Many craftsmen cut spheres to add to their collections because they are odd and when accurately cut and given a high polish they have a high value, representing a quantity of work well done.

Select good material that is free from cracks and flaws. Some of the softer materials, such as onyx, are excellent for the first sphere. The first step is to saw out a cube. If a small sphere is being made, take the cube directly to the grinding wheel. If the cube is of any size, cut off the 12 cube edges, which leaves a regular rhombic dodecahedron.

Round off all sharp corners on the grinding wheel until the material resembles a sphere. It is possible, if one is adept at shaping cabochons, to grind a fairly accurate

Jewelry, Gem Cutting, and Metalcraft

sphere on the silicon carbide wheels. The author has had students grind spheres, doing the final grinding on a No. 220 grit wheel, that were so nearly perfect that it was almost unbelievable. For the final grinding be sure that



Fig. 150.—Lapping a sphere in a metal cutter mounted on a vertical spindle.

the wheel is perfectly true. If necessary, true the periphery of the wheel with a silicon carbide wheel truing brick.

Hold the spherical-shaped material with the thumb, index and forefinger of each hand. In the final stages of grinding hold the material in such a manner that when placed against the fine grit wheel it will tend to rotate. Guide the spinning sphere with the hands.

The Art of Gem Stone-cutting

The sphere is ready for the lapping in the tube or pipe, with the various-sized grits, when it is ground as nearly accurately as possible on the grinding wheels. Tubes of various sizes, made to fit your arbor, are available from lapidary-supply dealers.

If a machinists' lathe is available, you can make your own lapping tubes from pipe caps and short lengths of pipe threaded on one end. The piece of pipe should be about 3 inches in length. Center the pipe in the lathe chuck, screw the pipe cap onto the pipe, drill the correct-sized hole in the end of the cap, and thread it to fit your arbor. Bevel the inside of the top of the pipe. One can, by using one or more bushings, make a large-sized cap that will accommodate several different-sized pipes.

To keep the grit from going through onto the threads cement a cork into the bottom of the pipe. Dopping cement or sealing wax will do, or pitch may be used. Some craftsmen use half of a rubber ball of the proper size in the larger sized pipes, cementing it in place.

A piece of pipe, or tubing, can be mounted on a wood arbor and used in the drill press in making a small sphere, although this method is not so good as mounting the tube on a horizontal or vertical arbor. The ideal mounting is on a vertical shaft, such as a horizontal lap-unit shaft.

Use a tube that is smaller in diameter than the sphere being lapped. Only one tube is necessary, for, by holding the sphere in the hand, you can keep the work under better control. If two pipes are used, the sphere is at all times stationary in one of the pipes.

Jewelry, Gem Cutting, and Metalcraft

Hold the sphere in your hand, apply grit mixed with water to the sphere with a small paintbrush, and slowly turn it into the revolving tube. The grit tends to stick to the material as though held by electrostatic force.

Work the sphere through several grits, using Nos. 100, 220, 320, and 500. Wash both tube and sphere when going from one grit size to another.

Inspect the sphere frequently while lapping. If it shows frosty spots or pits, continue the lapping until they disappear. Do not try to take out the pits on the next-sized grit, for it will take much longer, and this technique often results in poorly finished work.

Final lapping with one of the final-lapping compounds, such as Warner & Grieger's Final Lapping Compound, will remove many of the fine scratches, leaving a semigloss surface, and result in a quicker and better polish on the buff. Polish with the felt or muslin buff using tin oxide, Waldru Final Finishing Agent, or one of the other polishing agents.

Students in the author's classes have cut and polished spheres that were accurate to within less than one-half of a thousandth of an inch.

MAKING A DOUBLET

Much of the remarkably beautiful black (fire) opal used in the jewelry trade is in the form of doublets. Doublets are not made with deceptive intent; they are usually sold as doublets. Frequently the "fire" in black Australian opal occurs in very thin layers and seams, and in many

The Art of Gem Stone-cutting

instances the only way to obtain a suitable gem for wear is by strengthening the back to obtain the added thickness necessary for mounting. The layer of "fire" opal on the matrix can be backed with common black "nonfire" opal, iridescent or common black obsidian, and similar materials.

The technique of making an opal doublet is quite simple. Grind down the face of the opal until the best fire is exposed, being careful not to grind away all the fire. Leave the surface flat and partly polished, being sure all deep scratches are removed. Cut a piece of obsidian with a similar flat surface, the piece of obsidian being about $\frac{1}{8}$ inch thick. Using doublet cement, cement the two pieces together and allow them to dry under weight.

When they are set, you have an irregular-shaped mass, obsidian (or common opal) on one side and the regular opal on the other. Take this to the grinding wheels and handle like ordinary opal, grinding off the excess backing of obsidian as well as the sides of the opal and obsidian. The thin layer of opal being backed with black obsidian makes a beautiful flashing gem stone.

Using the same procedure, doublets may be made of material other than opal.

Common colored opal (without fire) is found in many places in the United States. It is often suitable for gem cutting and is inexpensive as compared with the precious opal. Common opal is a gem stone that works and cuts readily and is quite popular with amateurs.

Purchasing fire opal in the rough is a matter of some speculation. Valuable gem stones are often cut from an

Jewelry, Gem Cutting, and Metalcraft

inexpensive rough specimen. A great deal of the cost of fire opal is in the cutting, handling, and waste.

HORIZONTAL LAPS

The polishing of flat surfaces can be done to best advantage on a horizontal lap plate made of cast iron or steel.

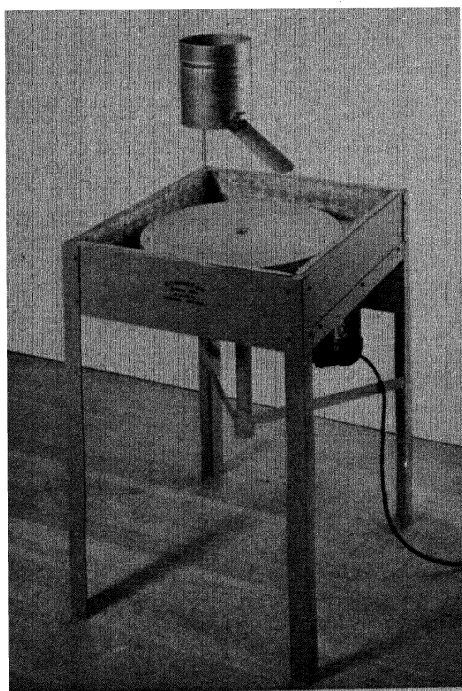

Fig. 151.—Multi-Feature Lap Unit. (Courtesy of Covington Lapidary Engineering Company, Redlands, Calif.)

Horizontal laps may be cast and machined to fit a vertical arbor. Lap kits consisting of a cast-iron plate, shaft, bear-

The Art of Gem Stone-cutting

ings, and splash pan are available for those who desire to build their own outfit.

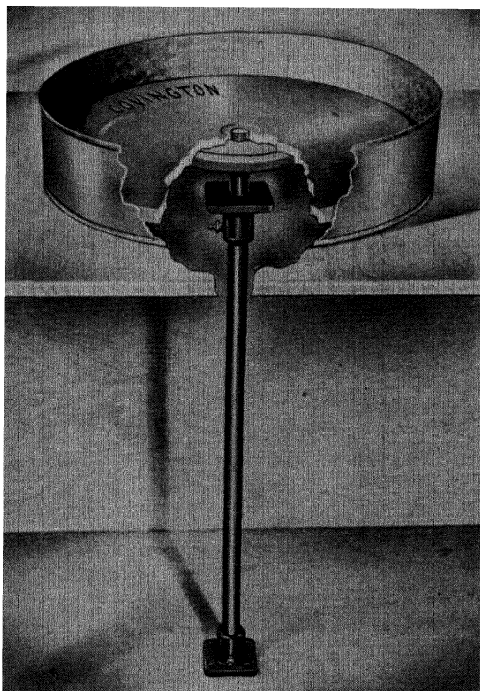

Fig. 152.—A lap kit consisting of plate, shafting, bearings, and splash pan is available for those desiring to build their own outfit. (Courtesy of Covington Lapidary Engineering Company, Redlands, Calif.)

With some of the modern lap units, such as the Covington Multi-Feature Lap Unit, one can through use of various attachments grind and polish cabochons; cut faceted gem stones, flap-lap specimens, and flat surfaces; sand, polish, and make book ends, spheres, and ash trays.

Jewelry, Gem Cutting, and Metalcraft

Cabochon cutting is done with silicon carbide grinding wheels that are mounted to steel plates that fit the arbor spindle (Fig. 154); upon the regular flat lap; or with the aid of a special grooved lap that is available from dealers.

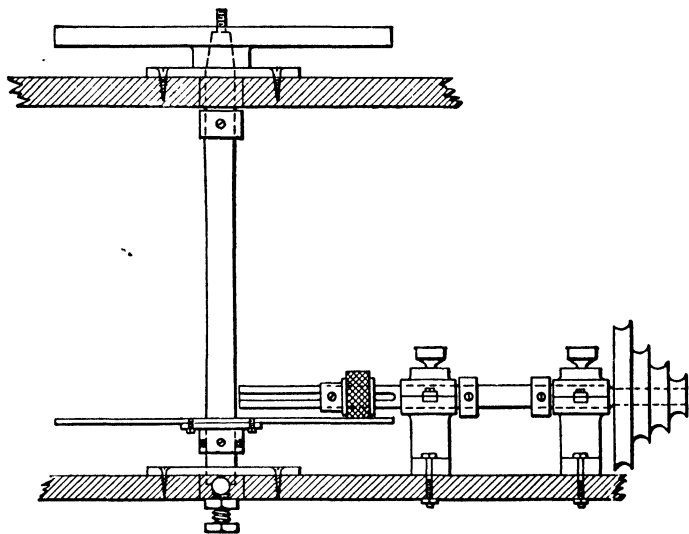

Fig. 153.—Horizontal running lap wheel showing details of construction. Note tapered shaft to permit easy removal of master lap. (Courtesy of Clinefelter Lapidary Supplies, Oswego, Ore.)

The cabochons can be cut more quickly upon the grinding wheel, although some cutters prefer the grooved laps.

Sanding and polishing are done with special plates that fit the arbor. These can be purchased, or made by the craftsman from wood in a manner similar to those discussed in the sections on sanding and polishing.

The Art of Gem Stone-cutting

The Multi-Feature Lap Unit has two speeds, 250 and 1,725 r.p.m. The low speed is for flat lapping, on the 16-inch lap plate, and for faceting, book-end, and ash-tray work. Grinding, sanding, polishing, and tube grinding of spheres are done on the high speed.

Another type of horizontal lap is the variable-speed assembly, shown in Fig. 153. Instead of using a cast-iron lap, a master lap is used with sheet-metal laps placed on top of the master lap. This makes easy the use of a separate lap for each size of grit. Instead of being threaded to fit the spindle, the master lap has a taper that fits the spindle. The sheet-metal laps are held in place by use of a stud that is inserted in the master lap, a wing nut being used to pull the sheet metal down against the master lap.

Contrary to popular belief and usage, a perfectly flat lap plate is the poorest type to use. A tapered lap is much better. When used with the coarser grits, Nos. 80 to 200, the flap lap offers no difficulty. However, when grit sizes No. 400 and finer are used, the lap tends to grab the specimen, and it is almost impossible to finish it.

The surfaces are in such close contact that the small-sized grit acts like a paste, and the specimen adheres to the lap-plate surface. The specimen is pulled out of the operator's hand and in many instances is broken. To overcome this many cutters use an increased volume of water, or lubricant, and in this way the grit is washed from the lap. On the flat laps the close contact of the specimen and the lap tends to wipe off the grit before it can do its work.

The majority of the lap plates in use today are of the flat type. It has been only within recent years that the

Jewelry, Gem Cutting, and Metalcraft

tapered lap has made its appearance, during which time it has proved popular and successful.

If the surface of the lap is machined with a slight taper, practically all specimen grabbing is eliminated, and



Fig. 154.—Grinding a cabochon on a plate-mounted silicon carbide wheel screwed to the vertical shaft of a lap unit.

the lapping can be done with a small amount of water. By the use of a tapered lap, specimens can be quickly and economically lapped. A 16-inch taper lap should have its center approximately $\frac{3}{32}$ inch higher than the periphery. As the center of a lap is practically stationary, it should

The Art of Gem Stone-cutting

be relieved to a depth of $\frac{1}{8}$ inch, making the cut about $1\frac{1}{2}$ inches in diameter.

A flat lap after it has been in use a short time will be ground away between the center and the rim, and the



Fig. 155.—Lapping a mineral specimen on a cast-iron lap using silicon carbide grit.

small grains will slide underneath the specimen. This tendency is not so pronounced on the tapered lap. Occasional large specimens lapped with coarse grit will, however, tend to true a lap plate.

If a large specimen is being lapped, it can be done much more easily on a tapered lap, as part of the specimen can

Jewelry, Gem Cutting, and Metalcraft

extend over the center of the lap and not be in contact with the lap. By rotation of the specimen a perfect surface is obtained.

In this discussion it is assumed that the lap is revolving counterclockwise and that the operator is seated directly at the 6-o'clock position. Hold the work with the right hand. Apply pressure to the back edge of the specimen, as this lifts up the front and allows the cutting grit to get underneath the specimen. Before placing the specimen on the lap, wet the lap to prevent grabbing.

The grit and water can best be applied to the lap with a paintbrush about 1 ½ inches wide. A metal can is best to keep the grit and water in, as glass containers are easily broken if a specimen gets away from the operator. Cans made from sheet copper are ideal because they will not rust.

If the lap plate becomes dry, apply a few drops of water with the brush. If the cutting action becomes too slow, apply some fresh grit with the brush. Two containers will be useful, one for grit and one for water. Apply grit and water with the left hand if possible. If inconvenient, hold the specimen temporarily with the left hand and apply the grit or water with the right hand.

Keep the specimen moving from the center to the periphery of the lap, and rotate. This changes the direction of approach of the grit and speeds the grinding. It also tends to prevent "dishing" of the lap plate. Lap until all saw marks, pits, bad spots, etc., are removed, applying grit and water as necessary.

The Art of Gem Stone-cutting

The length of time for making the first lap depends upon the condition of the specimen. A specimen cut with a diamond saw, which leaves a smooth cut, naturally takes less time. With a 16-inch lap, at 250 to 300 r.p.m., 1 minute per square inch, with a minimum time of 4 or 5 minutes, for any size of specimen should be sufficient lapping time.

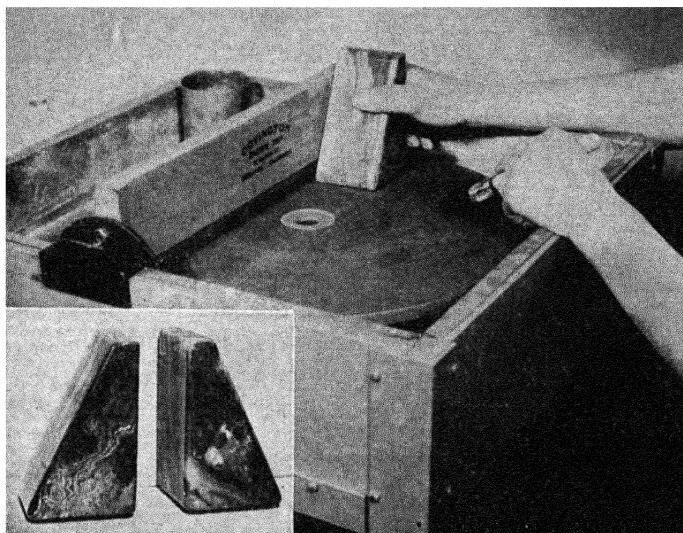

Fig. 156.—An adjustable guide aids in the lapping of book ends. Inset shows finished book ends.

The failure of the operator to understand just what is taking place on the lap plate is the cause of many poorly polished specimens. The following discussion may aid many cutters in finding out why they have poorly polished specimens.

Jewelry, Gem Cutting, and Metalcraft

Most cutters believe that the abrasive grains plane away a surface just as a metal planer cuts down a metal block. The grains are said to scratch the material and in this way to reduce the level. This is incorrect.

It is possible to lap a specimen with No. 80 grit silicon carbide and not have a scratch on the surface. The grains

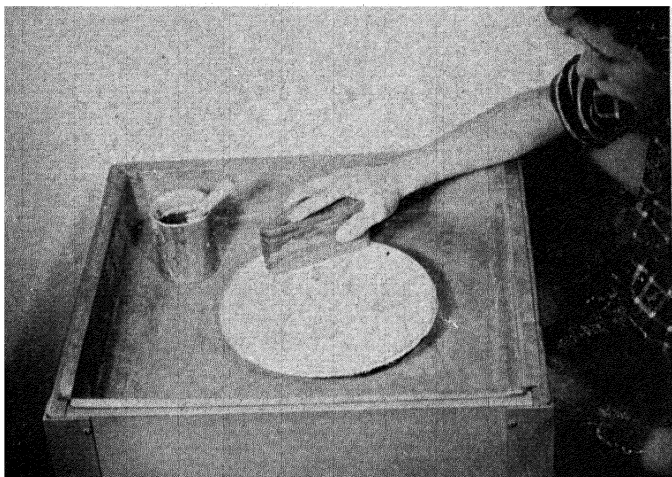

Fig. 157.—Polishing a book end on a horizontal running canvas-covered disk mounted on a lap unit spindle.

of abrasive roll beneath the specimen and dig out small craters or pits. If the specimen is next lapped with No. 220 grit, it must be lapped long enough to remove all the pits left in the previous lapping.

Here is where most polishers make their mistake. They are in a hurry and do not lap long enough. The result is that the surface, when polished, has a grainy appearance,

The Art of Gem Stone-cutting

or what is known in the optical trade as a "lemon peel" surface or "ice marks."

Another cause of "lemon peel" or "ice marks" in some types of materials is the generation of heat during the polishing. The heat causes minute chips to break off the surface. These chips are so small that they can hardly be seen without magnification. Leather for polishing buffs has a high friction-heat factor and if used should be kept wet at all times. Wool or felt buffs are better. Cotton and canvas are good for polishing, as they have a low heat factor, thus eliminating "ice marks" caused by heat.

After using No. 220 grit, use No. 400 grit. This time the surface must be lapped long enough to remove all pits left by the No. 220 grit. If grit finer than No. 400 is used, lap long enough to remove pits left in the previous lapping.

If each step is done properly, the specimen cannot help having a fine smooth gloss when polished. If the lapping in each stage was not properly done, the polished specimen will show white craters holding tin oxide.

The best way to check each stage is to lap the specimen the length of time needed, figuring 1 minute per square inch. Allow the specimen to dry and hold it in the light. If it has been lapped long enough, you will have an even texture. If it has not been lapped long enough, you will find spots that are frosty in contrast with the other areas.

Never say, "I'll take that out with the next-sized grit." That is the hard way. It is much easier to remove pits left from No. 80 grit with No. 220 grit than it is to remove them with No. 400 or No. 500 grit.

Jewelry, Gem Cutting, and Metalcraft

Do not leave scratches and pits to be taken out on the polishing buff. In some of the softer materials, such as malachite and onyx, it is almost impossible to lap the specimen so that it is free from scratches. These scratches can be "pulled" out on the polishing buff.



Fig. 158.—Cutting gem stones on large water-driven sandstone wheels at Idar, Germany, where the art has flourished for centuries with but few changes. (Illustration from *Gems and Gem Material*, Kraus and Slawson, McGraw-Hill Book Company, Inc.)

Scratches have a mysterious way of appearing. Most cutters blame the grits, but in most instances the scratches are caused by breaking or crumbling of the specimen edges.

Small pieces breaking off the edges will work under the specimen and cause a bad scratch. When you place the

The Art of Gem Stone-cutting

specimen on the lap and accidentally touch the front edge to the rotating lap, small pieces will crumble and scratch the material being lapped. Materials such as thunder eggs are especially bad because of the soft matrix. Material such as crystal quartz has such a strong cleavage that the slightest pressure on an edge will cause small cleavages to break off. Many cutters bevel all edges slightly to prevent chipping.

Another cause of scratches is embedded grains in the laps. Embedded grains cannot roll and will scratch, but if the grains are free to roll they will not scratch. Embedded grains can be removed by scraping the lap. Using an old safety-razor blade in a holder, hold it edgewise against the lap as the lap revolves.

As the grits used become finer, a lighter pressure must be used. A cushion of the abrasive mixture must at all times be between the lap and the specimen. If you have trouble with grit being thrown from the lap, use a lapping compound, such as Old Miser made by Covington. This holds the grit to the lap.

When changing from a coarse to a finer grit, wash specimen, lap, and splash pan free of all coarse grit to avoid contaminating the finer grit. Use a good scrubbing brush. Grit becomes embedded in cast-iron laps much more easily than it does in steel laps.

Oily and greasy specimens can be washed more easily by adding 2 teaspoonsful of trisodium phosphate to a pail of warm water. The trisodium phosphate emulsifies the oil and dirt, breaking them down into particles that can easily be washed off. A better cleansing solution can be

Jewelry, Gem Cutting, and Metalcraft

made by adding aerosol to the trisodium phosphate solution. Secure 1 ounce of aerosol OT 100 per cent and dissolve part of it in alcohol. Pour a very small amount of the

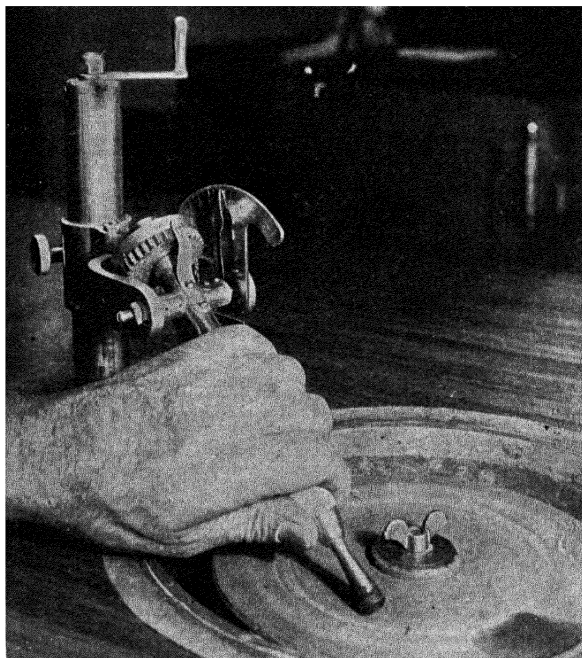

Fig. 159.—Mechanical device for holding gem stone for facet cutting. (Photograph from *The Mineralogist laboratory*.)

aerosol solution into the pail. Aerosol reduces surface tension, as it is the most powerful “wetting agent” made commercially. It is inexpensive and may be secured from drugstores. One part in 10,000 parts of water reduces the surface tension by half. Lapidary-supply houses handle

The Art of Gem Stone-cutting

cleansing powders, such as Miracle cleaner, by Warner & Grieger, which removes and emulsifies grease and oily liquids.

What grit sizes should be used in lapping? The harder the rock, the coarser must be the original lapping grit. For specimens that are about 2 inches by 2 inches and cut on a diamond saw, No. 220 grit is coarse enough for material of agate hardness.

Malachite should be started with No. 400 grit. It is so soft that even this fine grain will cut it down very fast. If too coarse a grain is used, the undercutting of softer layers will many times spoil the specimen.

If a specimen is about 3 by 4 inches in size and has been cut on a diamond saw, start with No. 120 grit. If a mud saw was used in cutting the material, use a coarser grit. Specimens 4 by 6 inches and larger are lapped first with No. 80 grit.

The most commonly used grit sizes are Nos. 80, 120, 220, 400, and final-lapping compounds.

A semifinal polish is obtained by using a final-lapping compound, such as Warner & Grieger's Final Lapping Compound, on a canvas buff, operating at motor speed. Mix the compound with water and apply with a brush to the canvas. By using a firm pressure and plenty of water and by constantly changing the direction of approach, a fair, but not high, polish is obtained. This is the technique used by optical firms in the polishing of fine quartz lenses and prisms.

Many cutters lap as fine as No. 400 grit, sand the specimen on a worn sanding cloth, using No. 320 grit, and

Jewelry, Gem Cutting, and Metalcraft

then polish. If No. 220 grit was used in the last lapping, sand the specimen on No. 220 grit cloth.

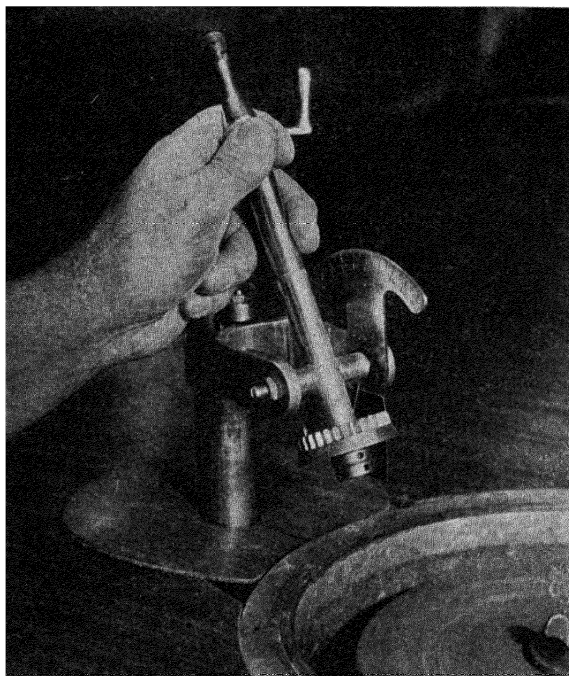

Fig. 160.—Facet-cutting device in raised position to enable examination of work, without disturbing position of facet being cut or polished. (*Photograph from The Mineralogist laboratory.*)

Polishing is done upon muslin, canvas, or felt buffs. Use tripoli or one of the alumina polishing powders and then use tin oxide, rouge, or another final-polishing agent for the final buffing. Use a separate polishing buff for each agent and keep the buff clean. Felt buffs can be scraped.

The Art of Gem Stone-cutting

If a canvas buff becomes contaminated with coarse grit, recover with wet 10-ounce canvas, using a waterproof glue, such as Cascamite, on the edges of the buff.

ASH TRAYS

Ash trays can be made from onyx or other suitable material by the use of special laps, such as the Covington Ash Tray Lapper (Fig. 161), which consists of a small grooved plate, a coring tool for removing the center, a ring for holding the grit, a convex cutter, and a handle.

Warm the grooved plate, cover it with sealing wax or dopping cement, and bed down the flat slab from which the tray is to be made firmly to the plate, being sure that the slab is centered. Center the grit-retaining ring on the slab and cement it in place, being sure that it is leakproof, so that the grit will not leak out.

Screw the plate and specimen on the vertical shaft of the lap unit. Attach the handle and center the coring tool. Apply No. 80 grit silicon carbide and water inside the ring, cut as deeply as you want the concave to be, and then break out the core left in the center of the specimen.

Install the ash-tray cutter and center and, using No. 80 grit silicon carbide, lap or grind out the slab to the required depth. Adjust the paddle, so that while the cutter is grinding the paddle will scrape the silicon carbide mixture from the retaining ring and return it to the cutter.

After you have ground the concave to size, use No. 120 grit and then No. 220 grit in the same way you did No. 80 grit.

Jewelry, Gem Cutting, and Metalcraft

Placing a different piece of canvas over the cutter for each operation, use No. 400 grit, then the final-lapping compound, and finish the tray with tin oxide or other final-polishing agent. Lap the edges of the tray on the lap plate, using a book-end guide to keep them square.

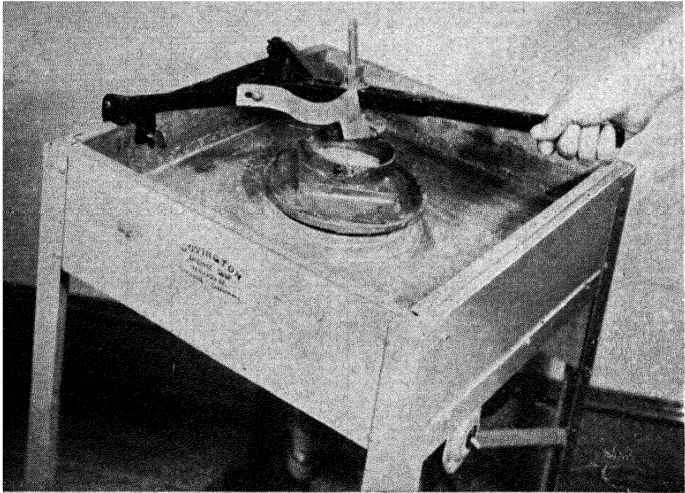

FIG. 161.—Grinding out an ash tray with an ash-tray lapper using silicon carbide grit.

FACET CUTTING

The art of facet cutting can be mastered by the amateur, and many are doing very fine work at this more complicated phase of gem stone-cutting. However, it is advisable first to master the technique of cabochon cutting and then to proceed to facet cutting. Saws, grinding wheels, and horizontal running laps used in cabochon cutting and specimen finishing will serve for use in facet cutting.

The Art of Gem Stone-cutting

Facet cutting involves placing numerous small flat surfaces on a gem. These facets must be spaced correctly, and the slope or angles of the various rows must all be correct for the material being worked. In some gems the angle or slope is greater or less than in others. Faceting heads may

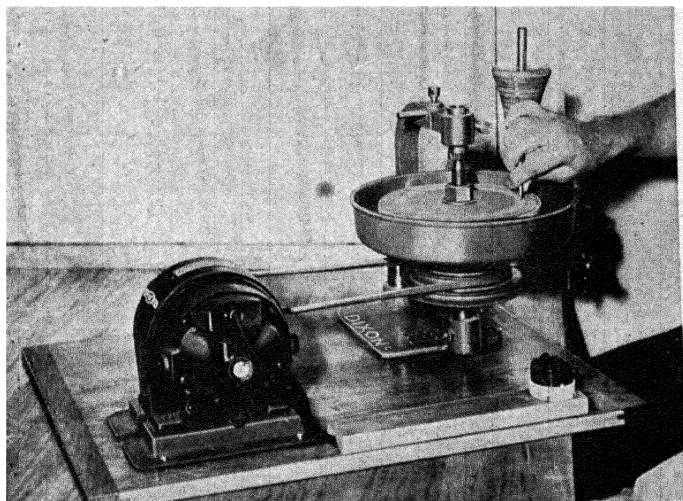

Fig. 162.—Cutting facets on a gem stone. The correct angle is obtained by holding end of dop in the jamb peg. (Photograph courtesy of Wm. Dixon, Inc., Newark, N. J.)

be purchased from lapidary dealers. They are usually made to order, as the demand is not sufficient to warrant their being carried in stock.

The correct angle is obtained by many lapidaries by putting the end of the dop in notches of a jamb peg, which is an upright at right angles to the lap. This is the

Jewelry, Gem Cutting, and Metalcraft

oldest method of cutting facets and is still practiced by most of the native gem cutters of the Orient. Facet-cutting devices, such as notched wheels and protractors, that eliminate guesswork are used by many gem cutters.

Small lapidary machines requiring a limited amount of space and designed to meet professional and amateur requirements for both cabochon and faceted work are available for those who do not care to assemble their own gem-cutting equipment.

Part IV

IDENTIFICATION OF
GEM STONES AND
GEM MINERALS

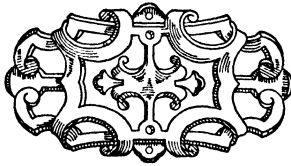

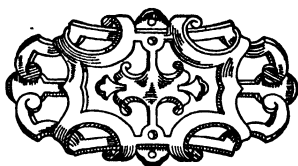

SOME 1,200 distinct mineral species are known to science and of these about 100 are commonly used as gem stones. Many of the opaque and translucent gems of the semiprecious class can be readily identified at a glance, while others present a more difficult problem.

Even with the aid of optical equipment definite determination of a gem is not always a simple matter. Experts often spend hours in the examination of a doubtful species before rendering their opinion. Moreover, it is well to bear in mind that some of the synthetic gems on the market are often very difficult to distinguish from the natural gems, this being especially true of the sapphire and spinel types, which are sold facet-cut style.

However, there are many simple tests of gem identification within the scope of the amateur. It is the purpose of this chapter to detail a few of the more elementary

Jewelry, Gem Cutting, and Metalcraft

methods. For more complete information the reader is referred to standard textbooks on optical mineralogy and similar technical works. Determinations involving the use of costly optical equipment are not given in detail here.

In studying a cut gem stone, remember that with very few exceptions every gem stone can be imitated in a form that will readily deceive the layman. It has often been said that the diamond and opal are the only gems of value that cannot be manufactured in a form that will pass easily for the genuine. This is very true of the opal, for the manufactured substitutes are palpable frauds to the eyes of everyone. White zircon, an inexpensive gem, very closely equals the diamond in play of colors, but the great difference in hardness serves to differentiate them immediately. In addition most diamonds present at least small areas of included black carbon, visible under magnifications ranging from low power up to 40 \times , or in some instances visible to the unaided eye. Carbon is not found in white zircon.

In recent years a great variety of gem imitations have appeared on the American market, most of this material originating in the foreign gem-cutting centers where labor is cheap. While many of these glass and similar imitations may be attractive in color and general appearance, they have no intrinsic value or interest comparable with that of a natural gem. To the connoisseur and student of gemmology, the fused and similar substitutes hold little fascination—no more than that of any other commercial glass.

Identification of Gem Stones and Gem Minerals

METHODS OF TESTING GEMS

There are two general methods by which a gem stone may be determined: first, a consideration of the physical properties, and, second from data gained by a study of the optical properties. Physical properties give a great deal of valuable information in most instances, but when a doubt arises, it is necessary to resort to a study of the optical properties. In general, it is not wise to use any *single test* as a sole guide in rendering a decision, although special methods are used in some instances. For example, in testing pearls an instrument known as the endoscope is used, or the X ray may be used to separate cultured pearls from noncultured.

PHYSICAL PROPERTIES

The physical properties of a gem or gem mineral include color, hardness, specific gravity, luster, cleavage, crystal form, and a number of others. When rough material is being tested, the problem is generally simplified because less concern is necessary for a possible slight damage to the specimen. Also the crystal form if present may offer a valuable clue for identification. Obviously, a cut stone which may prove valuable should be handled with care.

COLOR

Gem stones often depend upon their color for their beauty and charm, yet color alone is an unreliable guide in determining gem stones. Gem stones are known to occur in a wide range of colors and shade even in the same species.

Jewelry, Gem Cutting, and Metalcraft

For instance, we are most familiar with white diamond, yet this gem is found in black, yellow, brown, and more rarely pink and green shades. Moreover, some gems are subjected to heat-treatment to alter their native color; while some of the semiprecious gems, such as agate and turquoise, can be altered (colored) by various chemical means.

But the color of the gem should be given consideration, and lists of colors of gem stones can be found in standard textbooks on the subject. In some gems, such as amethyst and sapphire, the color may not be evenly distributed; it may be seen as patches and layers, with some areas more highly colored than others. This is frequently noted in amethyst, since large-sized crystals of amethyst with the color evenly distributed are seldom found. Hence, a large cut stone of amethyst showing even distribution of color should be viewed with suspicion and subjected to a close scrutiny before it is accepted as a natural gem. Purple-colored fused quartz resembles amethyst, at least in hardness, specific gravity, and color.

HARDNESS

Hardness is a reliable test where the suspected gems vary reasonably in range. However, where the several possibilities of identity are of similar hardness, then this test (by hand) becomes unreliable. It is quite simple to distinguish between two gems where the hardness of one is Mohs' 7 (quartz) and the other 9 (sapphire); but if the hardness of one is 7 and the other $7\frac{1}{4}$ or $7\frac{1}{2}$, distinguishing by this means is unreliable. Furthermore, gems of the

Identification of Gem Stones and Gem Minerals

same species will often vary slightly in hardness, especially on different crystal faces.

Mohs' scale of hardness, used in all standard textbooks on mineralogy and gemmology, fails to indicate properly the actual difference between the various gems. Sapphire is listed on Mohs' scale as 9 and diamond as 10, yet the hardness of the latter is actually at least *ten times* that of sapphire. The following table may serve to show the actual differences more accurately.

	Mohs' scale	Based on other methods	
Diamond	10	10,000	1,000
Sapphire	9	1,000	12
Topaz	8	450	2
Quartz	7	250	1
Opal	6	190	0.75

In testing the hardness of gems, care must be exercised to select a place on the stone where, if scratched, the mark will not show when mounted. A steel file or sharp fragments of gem minerals may be used and the test made on the girdle of the stone. A knife blade and glass are both approximately 5.5 in hardness, the steel file generally 6.5. Mounted hardness testing points are available from distributors. The slight dust of abrasion should not be confused with an actual scratch. When in doubt, examine the area with a magnifier.

When accuracy is required in measuring hardness, various instruments are used where the pressure of the scratching tool is under mechanical control and the actual

Jewelry, Gem Cutting, and Metalcraft

depth of the mark is determined. The gem cutter of experience can usually judge with reasonable accuracy the hardness of the material by the manner in which it is reduced and polished. All standard textbooks on mineralogy and gemmology list tables of hardness for reference purposes. Some gems vary in hardness, but usually not greatly, provided, of course, the material is pure.

SPECIFIC GRAVITY

The comparison of the weight of a substance with an equal bulk of water is termed its specific gravity, or gravity for short, water being taken as a standard of 1. Most of the gem minerals are nonmetallic in their composition and have gravities of less than 4, the usual range being from 2 to 4.

In one respect, it is unfortunate that gem stones should range so closely in gravity for this limits the use of this easy and simple method in making determination, unless very accurate balances are available. Further, the gravity of some gems will vary slightly in the same species, thus complicating matters even more. Obviously, the larger the bulk of the substance being tested, the less the factor of error, so that less accurate methods can be applied.

A good habit to acquire in handling loose gem stones is to heft them. If the stones are reasonably large, the practiced hand can gain a good approximate conception of the specific gravity. For example, in handling a zircon and an aquamarine of similar size, bulk for bulk, the zircon will be distinctly heavier since its gravity is nearly twice that of aquamarine. This method is, of course, applicable

Identification of Gem Stones and Gem Minerals

only to gems of fairly large size or large fragments of the uncut material.

There are two principal methods used for taking the specific gravity of a gem, one involving the use of accurate and sensitive balances, the other the use of liquids of known gravity.

If you have analytical balances at your disposal, you can make use of the pycnometer method, which is quite accurate.

The second method of determining specific gravity is to weigh the gem in air by suspending it from the beam of a balance with a fine thread or wire, then weigh it under water. The difference between the two weighings divided into the weight of the gem in air equals the specific gravity. Thus if a gem weighs 12 karats in air and 9 karats suspended under water, the difference is 3, and 12 divided by 3 gives 4, which is the gravity of the gem.

The larger the gem, the smaller will be the percentage of error by this method. A stone weighing 1 karat with error of 1 per cent in the weighings will give an error of about 0.15 in specific gravity. Hence accurate weighing is important in dealing with small stones or fragments.

SPECIFIC-GRAVITY FLUIDS

For quick work, simplicity, and low cost, the amateur will find specific-gravity fluids very convenient and accurate for use in making gem identifications. Various fluids can be used, but for general work the writer prefers the use of Thoulet's solution. This is made by saturating half an ounce of water with as much potassium iodide

Jewelry, Gem Cutting, and Metalcraft

and mercuric iodide (red) as the water will dissolve. The solution can be made by any druggist or you can prepare it yourself. In making this solution continue to add small portions of each solid to the water until no more will dissolve, taking several hours or longer to complete the saturation. Thoulet's solution, when fully saturated, will at room temperature have a specific gravity of 3.17. It should be kept in a small wide-mouthed glass-stoppered bottle. The stone or fragment to be tested is dropped in and removed with tweezers, as the solution is somewhat corrosive to the skin. Water readily removes the liquid which does no harm if permitted to remain on the fingers for only a short while.

With Thoulet's solution you can readily distinguish many gem stones from their imitations. For example, most of the "topaz" of commerce is citrine quartz, usually colored by heat-treatment to give it the lovely topaz shades of color. True topaz has a specific gravity of 3.4 (or slightly greater), while quartz has a specific gravity of not over 2.6. Thus by dropping the gem in the fluid and noting if it floats, an imitation topaz can be quickly discovered. By diluting this solution with water and using a small fragment of material with a known gravity as a guide, various liquids with lower gravity can be made.

Other "heavy liquids" can be made from various compounds. A saturated aqueous solution of cadmium borotungstate will give a solution with a gravity of 3.28. Thallium malonate formate (in water) will give a gravity of 4.38 and methylene iodide in benzol will give a gravity fluid of 3.32. These solutions are used widely in the field of

Identification of Gem Stones and Gem Minerals

mineralogy for separating mixtures of minerals, but some of them being dark in color have the disadvantage that it is difficult to locate a small gem stone in them.

Do not depend wholly upon this test with gravity fluids in every instance. Some of the glasses that are cut into imitation gem stones have a rather high specific gravity, and the hardness test is therefore a surer test for these, as all glass is relatively soft. Thus, in the test referred to above, if the stone sinks, do not assume it is necessarily topaz without first making additional check tests. In short, in testing any gem stone, do not rely solely upon one single result unless you are certain it is a conclusive one.

Any gem stone with a specific gravity less or greater than that of the fluid will either sink or float as the case may be, and thus the fluid serves as a means of making identifications by the process of elimination. All gravity fluids should be checked from time to time with a small fragment of known substance.

EXAMINING FOR FLAWS AND INCLUSIONS

Flaws, inclusions, and structural lines of some gem stones are quite characteristic and may be taken as criteria in making a determination. For instance, the fine feathers seen in practically all emeralds are characteristic, yet the cheap glass imitations sometimes used are manufactured with similar flaws; hence flaws alone should not be the sole guide. On the other hand, a stone alleged to be emerald and yet free of all feathers should be viewed with suspicion.

Jewelry, Gem Cutting, and Metalcraft

As an aid in detecting flaws and blemishes in a cut stone or fragment of rough material, the substance can be placed in a liquid with a refractive index (R.I. or n .) similar to that of the gem. Kerosene may be quite effective, and a small amount placed in a shallow white porcelain evaporating dish makes a convenient way to view the gem. Assuming the liquid selected has a refractive index very close to that of the stone or mineral, the fragment

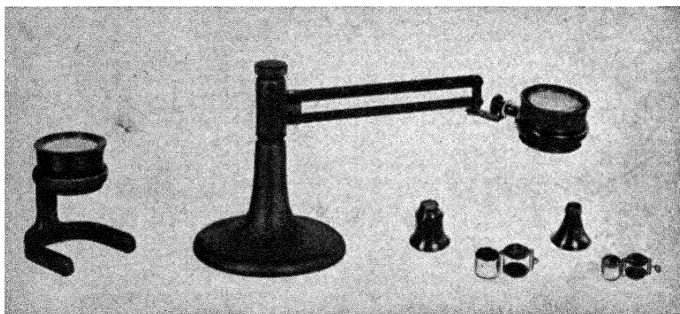

Fig. 163.—Hand lenses used in examining gem stones. (Photograph courtesy of Baush & Lomb Optical Co., Rochester, N. Y.)

will become almost invisible, especially if colorless or pale in color. Certain inclusions and flaws present will then stand out in glaring contrast.

Suggested fluids for this purpose include turpentine, oil of cedar, Canada balsam, glycerine, castor oil, and numerous others which are listed with their refractive indexes in textbooks on optical mineralogy.

If you have a microscope, the immersion fluids will also be valuable in determining the approximate refractive index of gem minerals by the use of the reaction known

Identification of Gem Stones and Gem Minerals

as the "Becke line." This test is widely used in the determination of all nonopaque substances, including minerals and gems. A very small amount of crushed fragments of the material is used and tested with various fluids of known refractive index. This method is fully within the

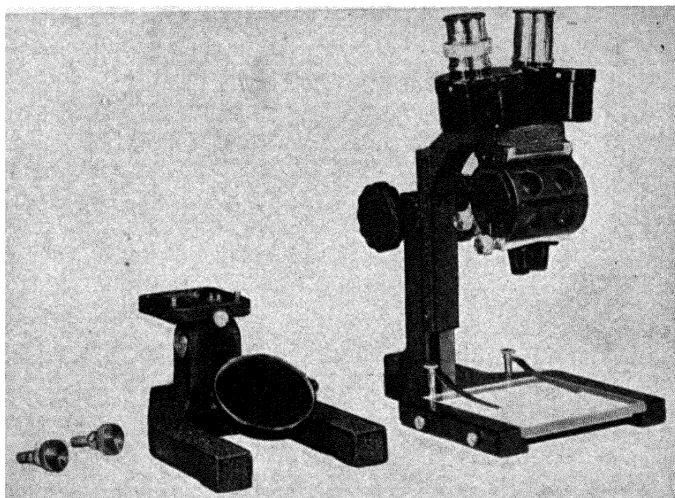

Fig. 164.—The binocular type microscope, useful in examining gem stones for structural lines, inclusions, flaws and other markings. (Photograph courtesy of Bausch & Lomb Optical Co., Rochester, N. Y.)

scope of the amateur and is described in detail in standard works. The method is not easily applicable to a large stone. Fragments crushed to a mesh of from 100 to 200 are best used.

As an aid in examining flaws, structural lines, inclusions, and other markings found in natural gems and the synthetic types, the binocular type (Greenough) micro-

Jewelry, Gem Cutting, and Metalcraft

scope is very useful. Generally low powers will suffice, ranging from 10 to 40 \times . The advantage of the binocular magnifier lies in being able to focus up and down and view the various internal as well as external parts of the gem. Carbon in diamonds and similar inclusions in other gem stones can be readily viewed by this instrument. Hand magnifiers and the jewelers' loupes are also useful and widely used.

ULTRAVIOLET LIGHT

Ultraviolet light, X rays, and cathode and gamma rays are used to some extent in the determination of gem stones, but their applications are limited. Under the X rays diamond and paste can be easily distinguished, as the glass will appear opaque when viewed on the fluorescent screen, while diamond will be rendered nearly invisible.

In the use of ultraviolet light, a short-wave ultraviolet light is desirable and the Braun Fluorolight, equipped with a Corex filter, No. 986, meets this requirement.

As a curiosity, it has been noted that a small percentage of diamonds will fluoresce a remarkably blue color when exposed to the searching invisible rays in a dark room. Why only a few diamonds should exhibit fluorescence under ultraviolet light is still a scientific mystery.

Synthetic rubies will fluoresce a very bright red color, as do the uncut boules. Many natural rubies fluoresce the same color; hence the test is unreliable. Certain zircons, especially those from Australia, fluoresce strongly, while gems from some other localities will fail to react. The writer has tested hundreds of zircons in this manner and

Identification of Gem Stones and Gem Minerals

is of the opinion that the test is valuable as a means of determining the locality where the gem was mined.

The use of ultraviolet light is finding wide application in the arts, industries, and science, and in all probability

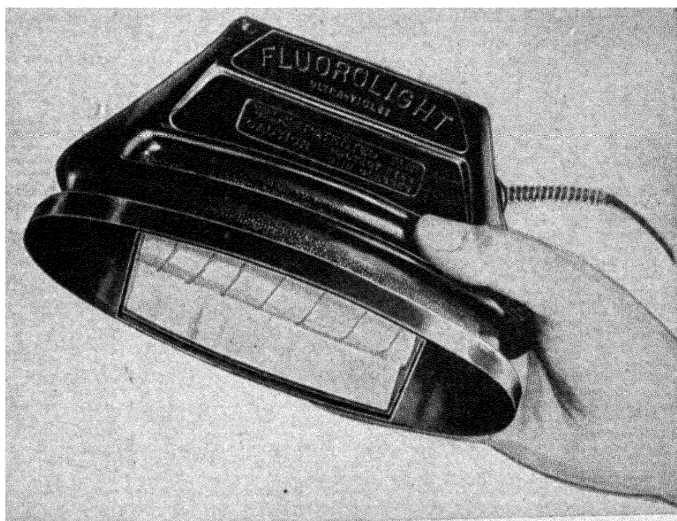

Fig. 165.—The Fluorolight, an ultraviolet light, used in identifying some minerals. (Photograph courtesy of Ultra-Violet Products Co., Los Angeles, Calif.)

wider uses will be found for it in the field of gem stones and minerals.

The ultraviolet light equipment used in testing gem stones is also useful for demonstrating the fluorescence of other minerals. Collections of gems and minerals which fluoresce are always of spectacular interest. Cabochons cut from the mineral wernerite will fluoresce a bright canary

Jewelry, Gem Cutting, and Metalcraft

yellow; kunzite will glow a delicate blue; the common opal and moss opal from Virgin Valley, Nevada, will instantly change to a brilliant green when exposed to the unseen light.

A long list of minerals and gems are known to fluoresce and startling effects can be had with them. The nearly black sphalerite found in Africa will change to a brilliant orange color, while a snow-white calcite from New Jersey may change to what appears in the dark room as a red-hot coal of fire.

In mines where there are fluorescent minerals excellent and valuable use is made of the ultraviolet light, as the ore can be followed merely by the aid of the color changes. Mine dumps can be prospected at night in search of minerals by the aid of a portable source of ultraviolet light.

A small inexpensive argon-gas-filled bulb, can be used as a source of ultraviolet light. This bulb can be used on any electrical outlet, and while it will not give the short-wave ultraviolet light, enough invisible light will be present to reveal many startling effects. Experimenting with an argon bulb in a dark room will reveal a great many common substances, in addition to minerals and gems, which will glow with weird colors.

The angstrom-unit range of the argon-filled bulb is around 3,900, while the Braun Fluorolight will give about 50 per cent of its light in the angstrom-unit range of around 2,400, and less than 7 per cent as visible light. For this reason, the lights of higher power have a much wider

Identification of Gem Stones and Gem Minerals

range of usefulness than the argon bulb, as substances that may fail entirely to react under the argon bulb will fluoresce powerfully and beautifully under the Braun type of lamp.

LUSTER, CHATOYANCY, ASTERISM, FRACTURE, CLEAVAGE

The luster of a gem is governed by the reflection of light from its surface and this quality is described variously as adamantine (diamond), metallic (marcasite and pyrite), greasy (jade), waxy (turquoise), pearly (pearl), and in other descriptive terms.

Chatoyancy is used in referring to the silky and changeable luster seen in a few of the gem stones. Moonstone shows this phenomenon.

A few gem stones when cut into steep-sided cabochons will show a four- or six-rayed star, termed asterism, characteristic of the more opaque forms of sapphire. Asterism is also met with in rose quartz and garnet and in rare instances in a few other gems (spinel and topaz).

Imitation stars are generally made of a base of rose quartz with a section of curved blue glass to act as a lens to magnify and bring out the asterism. Obviously, a doublet of this kind can be easily distinguished from a sapphire. The star in any asteriated gem can best be seen by viewing in a single light, as several sources of light bring out conflicting stars.

Fracture and cleavage are especially valuable in the identification of uncut gem material. Some crystals of gem

Jewelry, Gem Cutting, and Metalcraft

minerals, such as tourmaline and topaz, present typical cleavages. These crystals often show a flat surface on one or both ends of the crystal, this surface being at right angles to the principal optic axis (C axis) of the crystal. Familiarity with the various crystal forms will enable the gem stonecutter to recognize on sight most of the gem minerals when presented in the natural crystal form.

OPTICAL METHODS

Since all gem minerals except a few that occur in amorphous form crystallize in one of the six crystal systems, it would follow that those belonging in different systems will present variations in optical properties. These variations are very important and offer a highly useful means of determining a gem stone. To become expert or even quite proficient in testing gem stones, the gem cutter, jeweler, collector, or hobbyist should have a knowledge of crystallography. Familiarity with the optical properties of crystals (and gems) belonging to the various crystal systems will enable the individual to gain a much better understanding of the optical methods used by experts in determining gem stones. Hence a basic knowledge of crystallography is desirable.

It is not within the scope of this chapter to present the subject of crystallography, but suffice it to say that a great many individuals who handle gem stones in a commercial way are handicapped by a lack of knowledge of this subject. An understanding of crystallography, as it applies to gem stones, can be gained from any elementary textbook on the subject.

Identification of Gem Stones and Gem Minerals

REFLECTION TEST

By holding the cut gem in a beam of sunlight and casting the light passing through the stone on a white card, it can often be determined if the gem is of single or double refraction by noting if the reflections of the facets are separated or together. All gems crystallizing in the isometric (cubical) system are isotropic and give single refraction. Others are anisotropic and may show double refraction to a greater or lesser degree. Where the double refraction is feeble, it will not be possible to observe it by this simple method.

The diamond is isometric in crystallization, while the zircon gives strong double refraction; hence if you are proficient in using this test, you can generally distinguish between diamond and white zircon by this means. Likewise, red garnet shows only single refraction, while ruby shows a good double refraction. Further, all glass imitations show only single refraction, since they are amorphous substances lacking in any crystal form.

USE OF THE DICHROSCOPE

The inexpensive hand instrument known as the dichroscope is one of the most valuable instruments available for determining the optical properties of a gem stone which may give a helpful clue to its identity.

This little instrument consists essentially of a cut prism of calcite (Iceland spar) mounted in a short metal tube. Calcite gives a very strong double refraction and splits up the light entering at one end into two rays

Jewelry, Gem Cutting, and Metalcraft

which are seen as small squares at the eyepiece of the instrument.

Not all gems show the phenomenon of dichroism (and pleochroism). To be determined at all by the hand dichroscope the gem must be colored. The deeper the color the stronger will be the dichroism. All gems belonging to the isometric crystal system are negative under the dichroscope, as are all amorphous and noncrystalline substances such as glass. The outstanding exceptions

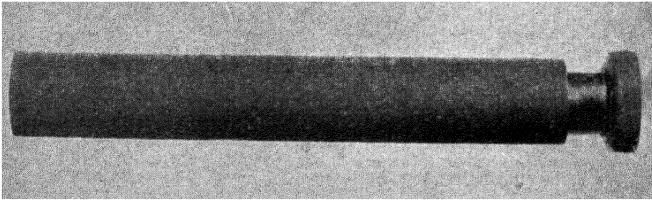

Fig. 166.—The dichroscope. A calcite prism mounted within the tube of the instrument gives separate views of the twin colors seen in some gems.

(unfortunately) to this rule are the fused synthetic types of sapphire and ruby. These carefully and skillfully manufactured substitutes are actually crystalline. Hence the dichroscope is unreliable in distinguishing between sapphire and ruby and their common commercial imitations.

In viewing a gem stone for possible dichroism, the stone and instrument are usually held toward the light and a search is made for twin colors which would appear, if present, on the two small squares seen in the instrument. Unmounted stones are the most convenient to examine or

Identification of Gem Stones and Gem Minerals

a small fragment if the material is in the rough state. The stone should be viewed from different angles, as dichroism is seen only when looking through certain portions of the stone at a particular relation to the various optic axes of the crystal. As the stone is viewed, the instrument is rotated in the fingers through 90 degrees; the different colored squares will appear and then disappear. In some instances, dichroism will be noted by viewing through the table of the specimen, and in others only through the girdle or at some other angle, depending on the manner in which the cutter oriented the material.

Some gem stones, such as sapphire, tourmaline, emerald, quartz, topaz, and others, show a strong or distinct dichroism in the colored varieties. Textbooks on gemology list tables of the various gems exhibiting this phenomenon, indicating the twin colors which will appear in the small squares.

By the aid of this simple instrument a great many valuable and helpful clues in making determinations can be obtained. Any gem stone alleged to be one of the gems known to show dichroism which fails to show it can, of course, be viewed with suspicion. By experimenting with known gem stones and fragments of minerals, you will soon become familiar with the use of this valuable instrument.

POLARISCOPE

Recently a new and quite inexpensive substance giving excellent polarization of light has appeared on the market in various optical instruments. This material known

Jewelry, Gem Cutting, and Metalcraft

under the trade name of Polaroid is being widely utilized in nonglare glasses and inexpensive adapters to convert an ordinary microscope into a polarizing instrument.

A polariscope made of two (1-inch) disks of Polaroid, mounted in a tube open at one side, with the disks separated by about 2 inches of space, makes a useful

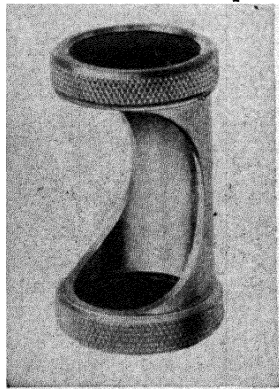

Fig. 167.—Field polariscope. Compact pocket size polariscope for viewing gem stones with polarized light. (Photograph courtesy of Polarizing Instrument Co., New York City.)

instrument for the examination of gem stones and fragments of minerals. The material being examined must, of course, be reasonably transparent to permit passage of light. Instruments of this kind can be made or purchased at a cost less than that of the calcite prism dichroscope, and the polariscope covers an even wider range of usefulness.

With a hand polariscope you can immediately determine if a substance is isotropic (glass or isometric system)

Identification of Gem Stones and Gem Minerals

or anisotropic. Thus any and all types of glass used in imitation gem stones can be readily detected. The top section (analyzer) of Polaroid mounted in the instrument is arranged to be rotated to enable viewing the object under crossed nicols. In short, the polariscope functions on the same principle as a polarizing microscope, except that there is no magnification as the former is not fitted with lenses. Experimenting with various substances will indicate a number of practical uses for the polariscope in gem determination.

REFRACTOMETER

The refractometer is an instrument designed to take a direct reading of the refractive index of a cut gem stone. This instrument is accurate and reliable, but its use is somewhat limited as stones with a very high refractive index, such as diamond, zircon, and garnet, are beyond its range. It is of medium price, costing less than the powerful microscopes and more than the smaller hand instruments.

POLARIZING MICROSCOPE

The polarizing microscope is an entirely different instrument from the ordinary microscope such as is used in biology and bacteriology. The former is equipped with two calcite (Nicol) prisms to enable the examination of substances by polarized light, while the ordinary microscope is primarily an instrument to give magnification only. Under polarized light the gems belonging to the different crystal systems will present specific phenomena, as will amorphous or noncrystalline substances, thus

Jewelry, Gem Cutting, and Metalcraft

enabling the operator to make a determination. Experts familiar with a polarizing microscope are generally able by using it to classify every nonopaque mineral known, including the gems.

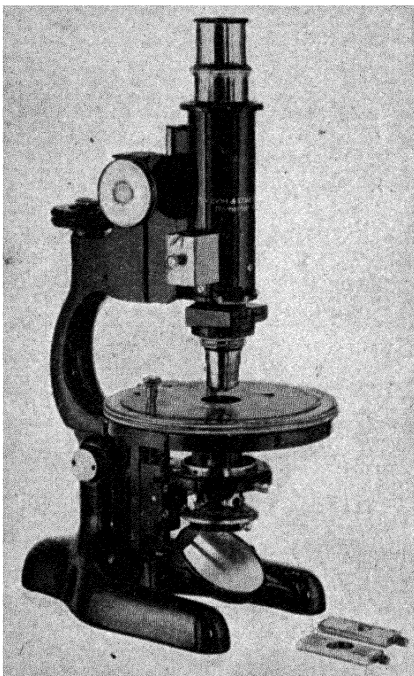
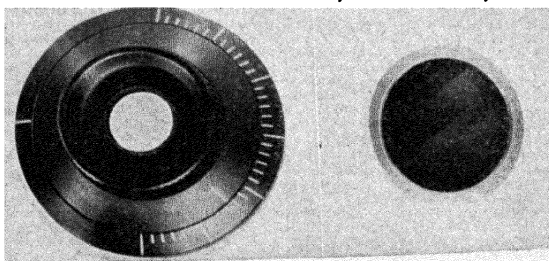

Fig. 168.—Polarizing microscope with analyzer in tube and rotating stage. Widely used for the determination of gem stones. (Photograph courtesy of Bausch & Lomb Optical Co., Rochester, N. Y.)

The use of the polarizing microscope is facilitated where the substance to be examined is available in fragments that can be crushed to a mesh of from 100 to 200

Identification of Gem Stones and Gem Minerals

fine. Since the instrument is also a microscope, it is obvious that difficulties would be experienced in attempting to examine a cut stone of large size. Crushed fragments are much easier to handle and orient. Aided by this instrument the operator can quickly determine the crystal system to which the gem mineral belongs and then if additional data are required, the index of refraction will serve to identify it definitely. In fact in



Analyzer

Polarizer

Fig. 169.—Polaroid analyzer and polarizer for converting ordinary microscope into a polarizing instrument. (Photograph courtesy of Polarizing Instrument Co., New York City.)

some instances this instrument fills a need that can be filled in no other way.

Through the recent introduction of Polaroid, the ordinary microscope can be easily converted into a polarizing instrument at a nominal cost. The regular polarizing microscope is fitted with a rotating stage to enable turning the substance and to permit the light to pass through in various directions. Ordinary microscopes have a stationary stage or a mechanical stage, neither of which permits rotation in a circle. This is a disadvantage, yet for some

Jewelry, Gem Cutting, and Metalcraft

purposes the revolving stage is not essential and many determinations can be made readily without its aid, or the specimen can be turned by hand. A special cross-hair eyepiece can be fitted to the ordinary microscope equipped with Polaroid and thus extend its usefulness.

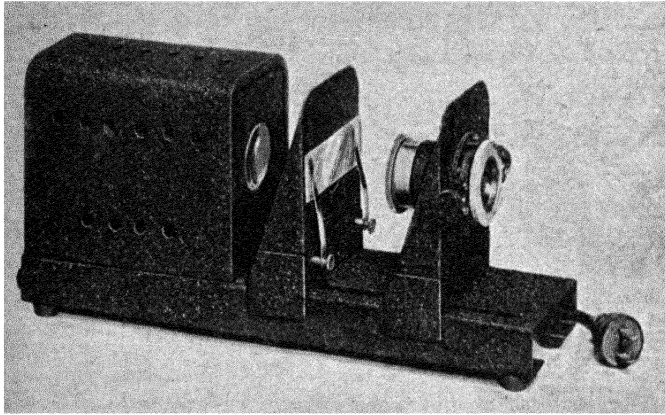

Fig. 170.—Projection lantern. Gem stones and any transparent fragments of gem minerals can be projected on screen with polarized light. Analyzer can be rotated to enable projection with crossed Nicols. (Photograph courtesy of Polarizing Instrument Co., New York City.)

The use of a polarizing microscope involves a working knowledge of crystallography and the optics of light. The reader desiring to take up this work is referred to textbooks on the subject.

SYNTHETIC GEMS, ALTERED GEMS

Of the better class of imitation gems, there are two main types of fused substances in common use. One is the sap-

Identification of Gem Stones and Gem Minerals

phire type, a fused aluminum oxide, made in the form of a round pear-shaped boule by permitting the powdered chemical to drop slowly into the intensely hot flame of a blowpipe. The other widely used substitute is the spinel type, of a different composition, but made in the same manner.

In the early years of the manufacture of synthetic sapphire and spinel the methods in use were relatively crude, with the result that air bubbles and similar defects were included during fusion. These were readily visible with an ordinary magnifying glass or even with the unaided eye. However, in recent years this manufacturing process has become so highly developed that the boule when cut into a gem stone may defy experts in making a certain diagnosis.

Synthetic ruby (sapphire), for instance, can be made into any shade of red color, with exactly the same chemical composition as the real article, the same hardness, specific gravity, refractive index, and even with a crystalline structure. Hence, in order to determine this substitute, it is often necessary to study the gem under high magnification and search for the curving lines of structure or minute air bubbles and similar fusion markings. Natural sapphire (ruby) is always hexagonal in structure, presenting straight and not curving lines.

So difficult is the determination of the synthetic sapphire and spinel, that these substitutes have been mixed with a lot of natural stones and sold as such without detection. Likewise, the unwary tourist visiting the native gem-cutting centers of Ceylon and Siam is often

Jewelry, Gem Cutting, and Metalcraft

sold a "ruby" manufactured in Germany or France, and thinks it is the real article. Since these synthetics can be readily manufactured in almost any color or shade, they are widely used as a substitute for gems not even remotely akin to sapphire or spinel.

Bakelite, one of the chief imitations of amber, has a higher specific gravity than amber and can be detected by a simple gravity test. Amber will float in strong salt water, while bakelite with its higher gravity will sink. A strand of suspected bakelite beads can be immersed in a vessel of strong salt water and if they sink they certainly are not amber. The cheaper pressed and molded types of true amber will, of course, have approximately the same specific gravity as the untreated fossil resin.

Heat-treatment is used to alter and often enhance the color and value of some gems. Virtually all the blue zircon stones on the market are inferior colored stones which have been subjected to heat-treatment. The white zircon is also frequently a heat-treated product.

The deeply colored "topaz" of commerce is a product of heat-treatment of smoky, pale, or inferior colored amethyst. The dark varieties are termed "Spanish topaz," and other names are applied to the other shades of color, including citrine *[[quartz]]* for the paler shades of yellow and brown. Most of this work of altering gems is carried on in foreign countries and the methods are looked upon as trade secrets, although some of them are generally known.

Turquoise occurring in pale colors can be dyed and the color enhanced. Substitutes for turquoise include the

Identification of Gem Stones and Gem Minerals

masses of pressed material which are made to resemble rounded and waterworn pebbles of turquoise.

AGATE COLORING

Agate coloring has been carried on in Germany for over a hundred years, where the modern methods of color altering were first developed. Agate is also heated in ovens, usually to bring out the deep colors of carnelian and sardonyx.

Various chemicals are used to dye agates. The black colors are produced by soaking the specimen in a sugar solution for a few weeks and then boiling it in sulphuric acid for several hours. The acid carbonizes the absorbed sugar to yield the black color.

Red colors can be had by soaking agate for several weeks in a strong solution of iron nitrate, after which the specimen is heated to a high temperature in an oven for several hours, starting with a gentle heat to prevent fracturing. Agate should be cooled gradually. Repeated applications of the above treatment may be required to attain the desired color.

The apple-green colors are produced by first soaking agate in a solution of nickel nitrate and then heating it in the manner already described. Green colors are obtained by first soaking agate in a saturated solution of potassium bichromate for several weeks, then placing in a similar solution of ammonium carbonate, followed by the oven treatment.

Various other colors can be had by first soaking agate in the proper chemical followed either by another chemical

Jewelry, Gem Cutting, and Metalcraft

or by heat-treatment to alter the absorbed substance to an oxide or similar insoluble form. The entire process of coloring agate is merely a matter of elementary chemistry and is no secret.

Although dyed agates may sometimes be desirable, they should be plainly marked as such when placed in museum collections or sold as gem stones. The manner in which agates assume the bands of color when placed in the dye pot is due to the fact that different layers vary in porosity; hence some layers will absorb a dye or chemical, while others lacking in porosity will take on little or no color. The coloring rarely penetrates very deeply into a thick specimen; hence if such stones are recut they generally show uncolored material. The crystalline quartz often seen in the central portion of slabs of dyed agate will also show colors which quartz never assumes in nature. Those familiar with agate can easily detect dyed specimens at a glance.

QUALITIES ENHANCING VALUES IN GEMS

In all gems there are certain inherent qualities which tend to increase their value, beauty, and general appearance. The diamond, for example, owes its value mainly to its hardness and brilliance, but it is not a rare gem compared with a stone such as benitoite, which is found in only one locality in the entire world, and then only sparingly. Yet the diamond has a greater value weight for weight.

The delicate color of some gems is taken into consideration in an appraisal of the value. Ruby, for example, is not

Identification of Gem Stones and Gem Minerals

a brilliant stone; its value is dependent mainly upon its rarity, hardness, and beauty of coloring. Stones of the softer class usually owe their value to color or similar factors.

Rarity of a gem also influences value. For instance, during the days of Queen Elizabeth of England, amethyst, the royal purple of the nobility, was obtained solely from the limited deposits of Siberia and karat for karat was in a class with diamond in value. Later the enormous deposits discovered in South America reduced the commercial value of amethyst to a point where now a choice amethyst can be purchased at a very reasonable cost. A study of these qualities in gems is of considerable interest and attention is called here to a few.

Diamond. Diamonds are graded either according to their lack of color or if distinctly colored according to the depth of color, which increases their value. A water-white stone, absolutely free from color, in other words, is very rare. This may not be perceptible to the untrained eye, but can be noted when several stones of large size are placed together for comparison. Diamonds showing a distinct green or pink color are classed as fancy stones and bring a substantial premium.

Size is also a factor in determining diamond values and those of numerous other gems. A diamond one karat in weight is worth considerably more than twice the value of a half-karat gem. Small diamonds, emeralds, rubies, amethysts, turquoise, and others are much more numerous than large choice examples.

Jewelry, Gem Cutting, and Metalcraft

Aquamarine. The best quality of aquamarine should present a definite bluish-green color and not a pale blue white.

Opal. A considerable amount of red showing in an opal increases its commercial value. Stones showing only green, orange, or purple, no matter how attractive, are generally worth less than the "fire" reds.

Experts familiar with opal can usually determine the origin of the specimen at a glance. For instance, the various localities in Australia yield characteristic gems. The Queensland opal is lively and with a strong basic yellow color. The White Cliffs gems are chalky white but full of good fire, while most of the Lightning Ridge material runs from gray to black in matrix. Stuarts Ridge opals are in a dense hard matrix, with a cream-colored background, and mainly green and red flashes of fire.

Turquoise. Although some admire the pleasing shades of green in turquoise, the blue colors are the most valuable, particularly the royal blue of a slight translucency. Turquoise should be free of matrix and flaws and should be of a uniform color, but such stones in large sizes are scarce.

Zircons. This gem is often marred by a slight cloudiness, perhaps not noted by the untrained eye, but stones free of this defect are decidedly more brilliant. Practically all the fine blue-green zircon of commerce has been subjected

Identification of Gem Stones and Gem Minerals

to heat-treatment, but this does not detract from its value since the treatment improves the appearance of the gem.

Garnet. This isotropic gem is often too dark in color; good translucent material is scarce in pieces large enough to cut a stone of substantial size. In the more opaque varieties of garnet the cutter should watch for possible asterism, as this enhances the value. In cutting for the star in garnet, the orientation of the crystal is not important, since it will come at a right angle to any of the three like crystal axes. In orienting sapphire for the star, the steep cabochon surface must be across the principal, or C, axis of the crystal.

Spinel. Rose-tinted shades of spinel are the most attractive and pleasing.

Jade. Jade (or jadeite) should be free of white and gray patches and, of course, the translucent Imperial jade (green) variety is costly when free of these patches. Jade is not at all a rare gem, being found in quantity in various colors including white, yellow, black, pink, gray, and mixed colors, but the high quality of Imperial jade is indeed rare and commands the market.

Lapis Lazuli. The best lapis lazuli is of a good deep-blue color and free of white and gray areas. This type of material is found principally in Russia. Pyrite of iron is often seen on the polished surface of a cut stone.

Jewelry, Gem Cutting, and Metalcraft

Amethyst. The deep-colored specimens of amethyst have a much greater value than those showing only a pale purple. Most of the amethyst of commerce comes to us from South America. The deposits of Siberia are said to be nearly exhausted. There is a distinct difference in the shade of color between the amethyst of South America and that of Siberia and the expert can detect this difference at a glance. Size and uniformity in the distribution of color are also factors affecting value.

Dealers

Gem-cutting Material and Gem Stones:

- Warner & Grieger, 405 Ninita Parkway, Pasadena 4, Calif.
Smith's Agate Shop, 228 S.W. Alder St., Portland 4, Ore.
Southern Oregon Mineral Exchange, 411 East Main St.,
Medford, Ore.
V. D. Hill, Rt. 7-F, Box 188, Salem, Ore.
Ward's Natural Science Establishment, P.O. Box 24, Beech-
wood Station, Rochester 9, N.Y.
Peter Zodac, Peekskill, N.Y.
Wilfred C. Eyles, Bayfield, Colo.
A. Joseph Alessi, 430 S. Highland Ave., Lombard, Ill.
Western Mineral Exchange, 320 Madison St., Seattle 4,
Wash.
Swenson's Agate Shop, 5114 S.E. 39th Ave., Portland, Ore.
The Gem Exchange, Lake Bluff, Ill.
Chas. E. Hill, 2205 N. 8th St., Phoenix, Ariz.
Death Valley Curly, Box 495, Goldfield, Nev.
John L. James, Tonopah, Nev.
N. Mardirosian, 87 Nassau St., New York 7, N.Y.

Lapidary Equipment and Supplies:

- Vreeland Manufacturing Co., 2020 S.W. Jefferson St., Port-
land 1, Ore.
Covington Lapidary Engineering Co., Redlands, Calif.
Lapidary Equipment Company, Inc., 2020 Westlake Ave.,
Seattle 1, Wash.
Warner & Grieger, 405 Ninita Parkway, Pasadena 4, Calif.
Clinefelter Lapidary Supplies, Oswego, Ore.
Wilfred C. Eyles, Bayfield, Colo.
B & I Manufacturing Co., 461 Washington St., Burlington,
Wis.

Jewelry, Gem Cutting, and Metalcraft

Highland Park Lapidary Supply Co., 1009 Mission St., South Pasadena, Calif.

The Gem Exchange, Lake Bluff, Ill.

William Dixon, Inc., 36 E. Kinney St., Newark, N.J.

Smith's Agate Shop, 228 S.W. Alder St., Portland 4, Ore.

Abrasives, Polishing Powders, Grinding Wheels:

Warner & Grieger, 405 Ninita Parkway, Pasadena 4, Calif.

Smith's Agate Shop, 228 S.W. Alder St., Portland 4, Ore.

William Dixon, Inc., 36 E. Kinney St., Newark, N.J.

Vreeland Manufacturing Co., 2020 S.W. Jefferson St., Portland 1, Ore.

Elcraft, 1637 Court Place, Denver 2, Colo.

The Gem Exchange, Lake Bluff, Ill.

Western Mineral Exchange, 320 Madison St., Seattle 4, Wash.

The Carborundum Co., Niagara Falls, N.Y.

Norton Company, Worcester, Mass.

Diamond Powder:

The Diamond Drill Carbon Co., 63 Park Row, New York 7, N.Y.

Arthur A. Crafts & Co., 532 Commonwealth Ave., Boston, Mass.; 30 W. Washington St., Chicago, Ill.; 7310 Woodward Ave., Detroit, Mich.

Standard Diamond Tool Corp., 64 W. 48th St., New York, N.Y.

Gold, Silver, and Solder:

Handy & Harman, 82 Fulton St., New York 7, N.Y.

Thomas J. Dee & Co., 55 E. Washington St., Chicago, Ill.

Dealers

Wildberg Bros. Smelting and Refining Co., 635 S. Hill St.,
Los Angeles, Calif.; 742 Market St., San Francisco,
Calif. (Also Findings.)

Metalcraft and Jewelry Equipment and Findings:

William Dixon, Inc., 36 E. Kinney St., Newark, N.J.
Metal Craft Supply Co., 10 Thomas St., Providence, R.I.
Craft Service, 337 University Ave., Rochester 7, N.Y.
Warner & Grieger, 405 Ninita Parkway, Pasadena 4, Calif.
Elcraft, 1637 Court Place, Denver 2, Colo.
American Handicrafts Company, Inc., 45 S. Harrison St.,
East Orange, N.J.; 915 S. Grand Ave., Los Angeles 15,
Calif.

Silver and Gold Leaves:

N. Mardirosian, 87 Nassau St., New York 7, N.Y.

Flexible Shaft Motor Tools:

Foredom Electric Company, 27 Park Place, New York 7, N.Y.

Hand-motor Tools:

The Chicago Wheel and Manufacturing Co., 1101 W. Mon-
roe St., Chicago 7, Ill.
The Dremel Manufacturing Co., Racine, Wis.

Indian-design Steel Dies:

William Dixon, Inc., 36 E. Kinney St., Newark, N.J.
Craft Service, 337 University Ave., Rochester 7, N.Y.
American Handicrafts Company, Inc., 45 S. Harrison St.,
East Orange, N.J.; 915 S. Grand Ave., Los Angeles
15, Calif.

Jewelry, Gem Cutting, and Metalcraft

Ring-casting Equipment:

William Dixon, Inc., 36 E. Kinney St., Newark, N.J.

Gem-testing Instruments:

Polarizing Instrument Co., 41 E. 42nd St., New York 17, N.Y.

Harry Ross, 68 W. Broadway, New York 7, N.Y.

Ultra-Violet Products Co., 6158 Santa Monica Blvd., Los Angeles 27, Calif.

Bausch & Lomb Optical Co., 195 Bausch St., Rochester, N.Y.

Magazines Devoted to Mineralogy and Gem Cutting

The Desert Magazine, 636 State St., El Centro, Calif.

The Mineralogist, 702 Couch Bldg., Portland, Ore.

Rocks and Minerals, Peekskill, N.Y.

Books of Interest

- Dake, Fleener, and Wilson: "Quartz Family Minerals," Whittlesey House (McGraw-Hill Book Company, Inc.), New York, 1938.
- Davidson: "Educational Metalcraft," Longmans, Green and Company, New York, 1932.
- English: "Getting Acquainted with Minerals," McGraw-Hill Book Company, Inc., New York, 1934.
- Howard: "Handbook for the Amateur Lapidary," Greenville, S.C., 1935.
- Kraus and Slawson: "Gems and Gem Materials," McGraw-Hill Book Company, Inc., New York, 1939.
- Kronquist: "Art Metal Work," Whittlesey House (McGraw-Hill Book Company, Inc.), New York, 1942.
- Kronquist: "Metalcraft and Jewelry," Manual Arts Press, Peoria, Ill., 1926.
- Pack: "Jewelry and Enameling," D. Van Nostrand Company, Inc., New York, 1941.
- Payne: "Art Metalwork," Manual Arts Press, Peoria, Ill., 1929.
- Rose: "Copper Work," Metal Crafts Publishing Co., Providence, R. I., 1931.
- Rose and Cirino: "Jewelry Making and Design," Metal Crafts Publishing Co., Providence, R. I., 1917.
- Whitlock: "The Story of the Gems," Lee Furman, Inc., Publisher, New York, 1936.
- Young: "The Art of Gem Cutting," Mineralogist Publishing Co., Portland, Ore., 1942.

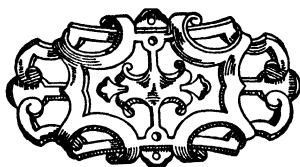

Index

A

Abrasives, artificial, 158
 grain size, 161
 natural, 158
Acetone, 212
Acetylene torches, 60
Acid, hydrochloric, 11
 muriatic, 9
 nitric, 12
 sulphuric, 14, 61
Aerosol, 234
Agates, beach, 155
 Brazilian, 155
 coloring, 269-270
 Montana, 155
Aloxite, 160
Aluminum oxide, 158-159
Alumina polishing powders, 210, 236
Alundum, 160
Amber, 268
Amethyst, 153, 246, 274

Ammonium carbonate, 269
Annealing, 14
Aquamarine, 153, 248, 272
Argon bulb, 256
Asbestos block, 49
Asphaltum varnish, 11
Asterism, 257

B

Bakelite, 268
Battern's flux, 63
Beaded wire, 83
Becke line, 253
Belt buckle ring, 95-96
Bezel making, 73-74
Birthstones, 153
Blow pipe, 49, 56-58
Blow torch, alcohol, 60
 gasoline, 60
Blower, rotary, 59
 vacuum cleaner, 59

Jewelry, Gem Cutting, and Metalcraft

Book ends, 24, 41
Borax, 63
Boron carbide, 158, 160, 213
Borum junk, 63
Bowl, making of, 35
Bracelets, 92-105
 bangle, 103
 belt buckle, 104
 coin, 98
 wire, 100, 102
Brass, 5
Brooches, 114-119
Buff, canvas, 207
 hand, 88
 leather, 207
 muslin, 207
 speed, 207
Buffing powders, 208
Burgundy pitch, 211
Burnisher, 51
Burrs, bearing, 136-137
Butter of antimony, 17

C

Cabochon, 152
 cutting, 163
 grinding, 189-196
 polishing, 205-210
 sanding, 196-205
Calcite, 157, 256, 259
Cadmium borotungstate, 250
Calendar, 29
Canada balsam, 252
Carborundum, 159, 190
Cast rings, 128
Casting sand, 130
Castor oil, 252

Catches, 115, 118
Cement, dropping, 211
 pearl, 217
Chains, belt, 120
 key, 120
 making, 71
Charcoal block, 49
Chatoyancy, 257
Chloride of zinc, 9
Clamp, ring, 88
Cleavage, 257
Clips, spring, 119
Cope, 129
Copper, 3
 coloring, 16
 melting point, 4
 soldering, 7, 10
 weight, 5
Core, 133
 tube, 130
Corex filter, 254
Corundum, 157
Crytolon, 159, 190
Cuff links, 112
Cutoff saws, 187

D

Dapping dies, 26
Dental instruments, 124
Diamond, 152, 153, 157, 247, 257, 271
Diamond-charged saw, bakelite, 188
 making, 179-185
 metal, 178
 pointers on using, 186
 roller, 184-185
Dichroscope, 259

Index

- Dies, dapping, 26
 Navajo, 102
Dopping gem stone, 211-212
Doublet, making, 220-222
Drag, 129
Drawplate, 141
Drilling gem stone, 212-217
Drills, 53
Drum sander, 197, 201-202
Dumortierite, 209
- E
- Eardrops, 112
Emerald, 152, 153, 251
Emery, 158
Endoscope, 245
Etching, 11
- F
- Facet cutting, 152, 238-240
Faceting head, 234, 236, 239
Feldspar, 157
Felt buff, 206
Files, jewelry, 52
Fine silver, 75
Flask, casting, 127
Flint, 158
Fluorite, 157
Fluorolight, 254
Fluting, 37
Flux, hard soldering, 63
 pewter, 11
 soft soldering, 5, 9
- G
- Garnet, 153, 158, 161, 273
Gas generator, 60
- Gauge, ring, 51
 wire, 53
Gem stone, dopping, 211, 212
 drilling, 212-217
 grinding, 189-196
Gem stones, precious, 152
Gem-cutting equipment, 165-168
Gem-cutting material, 154
Gems, physical properties, 245
 synthetic, 266-269
 testing, 245
"Gems and Gem Material," 154
Glycerine, 11, 127, 252
Gold, colored, 138
 fine, 138
 melting point, 139
 solder, 70
Gold filled, 139
Grain, troy, 136
Grinding gem stones, 189-196
Grinding wheels, 162-163
Gypsum, 157
- H
- Handy Flux, 63
Hard soldering, 55-71
Hardness, abrasives, 160-161
 minerals, 157
Horizontal lap, 227-237
Horizontal sander, 197-198
Hydrochloric acid, 9, 11
- I
- "Ice marks," 231
Iceland spar, 259
Indian jewelry, 121

Jewelry, Gem Cutting, and Metalcraft

Indian symbols, 122-123
Intaglio, 121
Internal grinder, 203
Investments, soldering, 126
Iron pyrite, 273

J

Jade, 208, 273
Jamb peg, 239
Jasper, orbicular, 155
Jasperized wood, 155
Jewelers' rouge, 16
Jewelers' saw blades, 18, 50
Jewelers' saw frames, 18
Jewelry, Indian, 121
 tools, 48-55
Joints, 115

K

Karat, gem-stone, 144
 gold, 138
Key chain, 120
Knot ring, 94
Kunzite, 256

L

Lap, felt, 206
 horizontal, 22-237
 kits, 222-223
Lapis lazuli, 153, 156, 273
Lapping compound, 233, 235
Leather buff, 207
Leaves, 81
"Lemon peel," 231
Letter holders, 27

Letter opener, 20
Liver of sulphur, 16, 87
Luster, 257

M

Magnesium block, 49
Malachite, 156, 235
Mandrel, ring, 50
Marcasite, 257
Match-box holder, 22
Melting point, coin silver, 139
 colored gold, 139
 copper, 4
 fine gold, 138
 fine silver, 139
Mercuric iodide, 250
Metal stakes, 34
Methylene iodide, 250
Miracle cleaner, 235
Mohs' scale, 247
Mold, casting, 132
Monel, 5
Mud saws, 176
Muriatic acid, 9

N

Navajo dies, 102
Necklaces, 106
Nickel nitrate, 269
Nickel silver, 5
Nitric acid, 12
Norbide, 214

O

Obsidian, 221
Ocher, yellow, 68, 126

Index

Opal, 152, 220, 247, 272
Orbicular jasper, 155
Ounce, avoirdupois, 138
 troy, 136
Oxalic acid, 209
Oxidizing, 87

P

Pan, pickling, 69
Paper knives 20
Paste, soldering, 9
Pearl bead wire, 85
Pearl cement, 217
Pearls, 245
Pencil, slate, 87
Pendants, 106-110
Pennyweight (dwt.), 136
Peridot, 153
Pesos, Mexican, 121
Pewter, 6
Pewter solder, 11
Pickling, 14, 68
Picture frame, 29
Pin, sprue, 132
 stems, 112
Pitch, burgundy, 211
Plaster of Paris, 126
Platinum, 136
Pleochroism, 260
Pliers, jewelers', 49
Polariscope, 261-263
Polarizing microscope, 264
Polaroid, 262
Polishing, copper, 14
 gem stones, 205-210
 jewelry, 86-87
Potassium bichromate, 269

Potassium iodide, 249
Potassium sulphide, 16
Pound, avoirdupois, 138
 troy, 136
Powder, diamond, 178, 181, 214
Precious gem stones, 152
Prism, calcite, 259
Pumice, 17
Pyrite, 257

Q

Quartz, 154, 157, 268
"Quartz Family Minerals," 154

R

Red gold, 138
Reflection test, 259
Refractive index, 252
Refractometer, 263
Rhodonite, 209
Ring, belt buckle, 95
 casting, 127-135
 clamp, 88
 designing, 72
 gauge, 51
 knot, 94
 making, 72
 mandrel, 50
 pattern, 89-90
 polishing, 86
 ornamentation, 79
 oxidizing, 87
 sheet silver, 74, 89
 sizes, 51, 52
 snake, 95
 stick, 51

Jewelry, Gem Cutting, and Metalcraft

Ring, wire, 72
Rolling mill, 140
Rosin, 7, 9
Rouge, jewelers', 16, 86, 208, 236
Ruby, 152, 267
Rutilated quartz, 156

S

Sand, casting, 127
Sandbag, 36
Sander, drum, 197, 201, 202
 horizontal, 197, 204
 vertical, 197
Sanding cabochon, 196-205
Sal ammoniac, 8
Sapphire, 152, 153, 157, 247
Sawing gem material, 169
Sawing outfits, 169-174
Saws, bakelite, 188
 cutoff, 187
 diamond, 178
 jewelers', 18, 50
 mud, 176
Scarf pins, 111
Scotch stone, 87
Sealing wax, 211
Shank making, 76-78
Sheet silver, ornaments, 85
 ring, 89
Shellac, flake, 211
Shot, 80, 81
Silicate of soda, 200
Silicon carbide, 158
Silver, bezel, 143
 coin, 121, 139
 fine, 75
 melting point, 140

Silver, solder, 61
 soldering, 55-68
 sterling, 139
Sizes, ring, 51, 52
Snake ring, 95
Solder, gold, 70
 pewter, 11
 silver, 61
 soft, 6
Soldering block, 49
Soldering paste, 9
Soldering salts, 8
Spanish topaz, 268
Specific gravity, 248
 fluids, 249-251
Sphalerite, 256
Sphere cutting, 217-220
Spinel, 273
Spring clips, 119
Sprue pins, 132
Stones, semiprecious, 144
Sulphuric acid, 14, 69
Synthetic gems, 266, 269

T

Talc, 157
Tea bell, 39
Thallium malonate formate, 250
Thoulet's solution, 249
Tie clips, 114
Tigereye, 156, 209
Tin oxide, 208, 236
Topaz, 153, 157, 161, 247, 268
Tourmaline, 153
Tray, ash, 33
 pen, 32
Tray making, 31

Index

- Triangular wire, 84
Tripoli, 16, 208, 236
Trisodium phosphate, 233
Truing saw disks 175
Tube, making, 213
Turquoise, 124, 153, 156, 209, 268,
272
- U
- Ultraviolet light, 254-257
- V
- Variscite, 209
Varnish, asphaltum, 11
Vertical sander, 197-200
Vesuvianite, 155, 209
- W
- Waldru Final Finish Agent, 208
Watch fobs, 120
Water glass, 200
- Wernerite, 255
Wheels, abrasive, 162-163
Whisk-broom holder, 30
Wire, beaded, 83
 gauge, 53
 rivet, 118
 triangular, 84
 twisted, 80
- X
- X ray, 245, 254
- Y
- Yellow gold, 138
Yellow ocher, 68, 126
- Z
- Zinc, 55, 123
Zinc chloride, 9
Zircon, 244, 248, 268, 272

