



PROGRAMMING LANGUAGE PRAGMATICS

THIRD EDITION

Michael L. Scott



In Praise of *Programming Language Pragmatics, Third Edition*

The ubiquity of computers in everyday life in the 21st century justifies the centrality of programming languages to computer science education. *Programming languages* is the area that connects the theoretical foundations of computer science, the source of problem-solving algorithms, to modern computer architectures on which the corresponding programs produce solutions. Given the speed with which computing technology advances in this post-Internet era, a computing textbook must present a structure for organizing information about a subject, not just the facts of the subject itself. In this book, Michael Scott broadly and comprehensively presents the key concepts of programming languages and their implementation, in a manner appropriate for computer science majors.

— From the Foreword by **Barbara Ryder**, Virginia Tech

Programming Language Pragmatics is an outstanding introduction to language design and implementation. It illustrates not only the theoretical underpinnings of the languages that we use, but also the ways in which they have been guided by the development of computer architecture, and the ways in which they continue to evolve to meet the challenge of exploiting multicore hardware.

— **Tim Harris**, Microsoft Research

Michael Scott has provided us with a book that is faithful to its title—*Programming Language Pragmatics*. In addition to coverage of traditional language topics, this text delves into the sometimes obscure, but always necessary, details of fielding programming artifacts. This new edition is current in its coverage of modern language fundamentals, and now includes new and updated material on modern run-time environments, including virtual machines. This book is an excellent introduction for anyone wishing to develop languages for real-world applications.

— **Perry Alexander**, Kansas University

Michael Scott has improved this new edition of *Programming Language Pragmatic* in big and small ways. Changes include the addition of even more insightful examples, the conversion of Pascal and MIPS examples to C and Intel 86, as well as a completely new chapter on run-time systems. The additional chapter provides a deeper appreciation of the design and implementation issues of modern languages.

— **Eileen Head**, Binghamton University

This new edition brings the gold standard of this dynamic field up to date while maintaining an excellent balance of the three critical qualities needed in a textbook: breadth, depth, and clarity.

— **Christopher Vickery**, Queens College of CUNY

Programming Language Pragmatics provides a comprehensive treatment of programming language theory and implementation. Michael Scott explains the concepts well and illustrates the practical implications with hundreds of examples from the most popular and influential programming languages. With the welcome addition of a chapter on run-time systems, the third edition includes new topics such as virtual machines, just-in-time compilation and symbolic debugging.

— **William Calhoun**, Bloomsburg University

This page intentionally left blank

Programming Language Pragmatics

THIRD EDITION

About the Author

Michael L. Scott is a professor and past chair of the Department of Computer Science at the University of Rochester. He received his Ph.D. in computer sciences in 1985 from the University of Wisconsin–Madison. His research interests lie at the intersection of programming languages, operating systems, and high-level computer architecture, with an emphasis on parallel and distributed computing. He is the designer of the Lynx distributed programming language and a co-designer of the Charlotte and Psyche parallel operating systems, the Bridge parallel file system, the Cashmere and InterWeave shared memory systems, and the RSTM suite of transactional memory implementations. His MCS mutual exclusion lock, co-designed with John Mellor-Crummey, is used in a variety of commercial and academic systems. Several other algorithms, designed with Maged Michael, Bill Scherer, and Doug Lea appear in the `java.util.concurrent` standard library. In 2006 he and Dr. Mellor-Crummey shared the ACM SIGACT/SIGOPS Edsger W. Dijkstra Prize in Distributed Computing.

Dr. Scott is a Fellow of the Association for Computing Machinery, a Senior Member of the Institute of Electrical and Electronics Engineers, and a member of the Union of Concerned Scientists and Computer Professionals for Social Responsibility. He has served on a wide variety of program committees and grant review panels, and has been a principal or co-investigator on grants from the NSF, ONR, DARPA, NASA, the Departments of Energy and Defense, the Ford Foundation, Digital Equipment Corporation (now HP), Sun Microsystems, IBM, Intel, and Microsoft. The author of more than 100 refereed publications, he served as General Chair of the 2003 ACM Symposium on Operating Systems Principles and as Program Chair of the 2007 ACM SIGPLAN Workshop on Transactional Computing and the 2008 ACM SIGPLAN Symposium on Principles and Practice of Parallel Programming. In 2001 he received the University of Rochester's Robert and Pamela Goergen Award for Distinguished Achievement and Artistry in Undergraduate Teaching.

Programming Language Pragmatics

THIRD EDITION

Michael L. Scott

*Department of Computer Science
University of Rochester*



ELSEVIER

AMSTERDAM • BOSTON • HEIDELBERG • LONDON
NEW YORK • OXFORD • PARIS • SAN DIEGO
SAN FRANCISCO • SINGAPORE • SYDNEY • TOKYO

Morgan Kaufmann Publishers is an imprint of Elsevier



MORGAN KAUFMANN PUBLISHERS

Morgan Kaufmann Publishers is an imprint of Elsevier
30 Corporate Drive, Suite 400
Burlington, MA 01803

This book is printed on acid-free paper. ∞

Copyright © 2009 by Elsevier Inc. All rights reserved.

Designations used by companies to distinguish their products are often claimed as trade-marks or registered trademarks. In all instances in which Morgan Kaufmann Publishers is aware of a claim, the product names appear in initial capital or all capital letters. Readers, however, should contact the appropriate companies for more complete information regarding trademarks and registration.

No part of this publication may be reproduced, stored in a retrieval system, or transmitted in any form or by any means, electronic, mechanical, photocopying, scanning, or otherwise, without prior written permission of the publisher.

Permissions may be sought directly from Elsevier's Science & Technology Rights Department in Oxford, UK: phone: (+44) 1865 843830, fax: (+44) 1865 853333, e-mail: permissions@elsevier.com. You may also complete your request on-line via the Elsevier homepage (<http://elsevier.com>), by selecting "Support & Contact" then "Copyright and Permission" and then "Obtaining Permissions."

Library of Congress Cataloging-in-Publication Data

Application submitted.

ISBN 13: 978-0-12-374514-9

Cover image: Copyright © 2008, Michael L. Scott.
Beaver Lake, near Lowville, NY, in the foothills of the Adirondacks

For all information on all Morgan Kaufmann publications,
visit our Website at www.books.elsevier.com

Printed in the United States
Transferred to Digital Printing in 2011

Working together to grow
libraries in developing countries

www.elsevier.com | www.bookaid.org | www.sabre.org

ELSEVIER

BOOK AID
International

Sabre Foundation

*To my parents,
Dorothy D. Scott and Peter Lee Scott,
who modeled for their children
the deepest commitment
to humanistic values.*

This page intentionally left blank

Contents

Foreword	xxi
Preface	xxiii
FOUNDATIONS	3
I Introduction	5
I.1 The Art of Language Design	7
I.2 The Programming Language Spectrum	10
I.3 Why Study Programming Languages?	14
I.4 Compilation and Interpretation	16
I.5 Programming Environments	24
I.6 An Overview of Compilation	25
I.6.1 Lexical and Syntax Analysis	27
I.6.2 Semantic Analysis and Intermediate Code Generation	29
I.6.3 Target Code Generation	33
I.6.4 Code Improvement	33
I.7 Summary and Concluding Remarks	35
I.8 Exercises	36
I.9 Explorations	37
I.10 Bibliographic Notes	39
2 Programming Language Syntax	41
2.1 Specifying Syntax: Regular Expressions and Context-Free Grammars	42
2.1.1 Tokens and Regular Expressions	43
2.1.2 Context-Free Grammars	46
2.1.3 Derivations and Parse Trees	48

2.2 Scanning		51
2.2.1 Generating a Finite Automaton		55
2.2.2 Scanner Code		60
2.2.3 Table-Driven Scanning		63
2.2.4 Lexical Errors		63
2.2.5 Pragmas		65
2.3 Parsing		67
2.3.1 Recursive Descent		70
2.3.2 Table-Driven Top-Down Parsing		76
2.3.3 Bottom-Up Parsing		87
2.3.4 Syntax Errors	© 1	99
2.4 Theoretical Foundations	© 13	100
2.4.1 Finite Automata	© 13	
2.4.2 Push-Down Automata	© 18	
2.4.3 Grammar and Language Classes	© 19	
2.5 Summary and Concluding Remarks		101
2.6 Exercises		102
2.7 Explorations		108
2.8 Bibliographic Notes		109
3 Names, Scopes, and Bindings		111
3.1 The Notion of Binding Time		112
3.2 Object Lifetime and Storage Management		114
3.2.1 Static Allocation		115
3.2.2 Stack-Based Allocation		117
3.2.3 Heap-Based Allocation		118
3.2.4 Garbage Collection		120
3.3 Scope Rules		121
3.3.1 Static Scoping		123
3.3.2 Nested Subroutines		124
3.3.3 Declaration Order		127
3.3.4 Modules		132
3.3.5 Module Types and Classes		136
3.3.6 Dynamic Scoping		139
3.4 Implementing Scope	© 29	143
3.4.1 Symbol Tables	© 29	
3.4.2 Association Lists and Central Reference Tables	© 33	
3.5 The Meaning of Names within a Scope		144
3.5.1 Aliases		144

3.5.2	Overloading		146
3.5.3	Polymorphism and Related Concepts		148
3.6	The Binding of Referencing Environments		151
3.6.1	Subroutine Closures		153
3.6.2	First-Class Values and Unlimited Extent		154
3.6.3	Object Closures		157
3.7	Macro Expansion		159
3.8	Separate Compilation	© 39	• 161
3.8.1	Separate Compilation in C	© 40	
3.8.2	Packages and Automatic Header Inference	© 42	
3.8.3	Module Hierarchies	© 43	
3.9	Summary and Concluding Remarks		162
3.10	Exercises		163
3.11	Explorations		171
3.12	Bibliographic Notes		172
4	Semantic Analysis		175
4.1	The Role of the Semantic Analyzer		176
4.2	Attribute Grammars		180
4.3	Evaluating Attributes		182
4.4	Action Routines		191
4.5	Space Management for Attributes	© 49	• 196
4.5.1	Bottom-Up Evaluation	© 49	
4.5.2	Top-Down Evaluation	© 54	
4.6	Decorating a Syntax Tree		197
4.7	Summary and Concluding Remarks		204
4.8	Exercises		205
4.9	Explorations		209
4.10	Bibliographic Notes		210
5	Target Machine Architecture	© 65	• 213
5.1	The Memory Hierarchy	© 66	
5.2	Data Representation	© 68	
5.2.1	Integer Arithmetic	© 69	
5.2.2	Floating-Point Arithmetic	© 72	

5.3 Instruction Set Architecture	© 75
5.3.1 Addressing Modes	© 75
5.3.2 Conditions and Branches	© 76
5.4 Architecture and Implementation	© 78
5.4.1 Microprogramming	© 79
5.4.2 Microprocessors	© 80
5.4.3 RISC	© 81
5.4.4 Multithreading and Multicore	© 82
5.4.5 Two Example Architectures: The x86 and MIPS	© 84
5.5 Compiling for Modern Processors	© 91
5.5.1 Keeping the Pipeline Full	© 91
5.5.2 Register Allocation	© 96
5.6 Summary and Concluding Remarks	© 101
5.7 Exercises	© 103
5.8 Explorations	© 107
5.9 Bibliographic Notes	© 109



CORE ISSUES IN LANGUAGE DESIGN

217

6 Control Flow	219
6.1 Expression Evaluation	220
6.1.1 Precedence and Associativity	222
6.1.2 Assignments	224
6.1.3 Initialization	233
6.1.4 Ordering within Expressions	235
6.1.5 Short-Circuit Evaluation	238
6.2 Structured and Unstructured Flow	241
6.2.1 Structured Alternatives to <code>goto</code>	242
6.2.2 Continuations	245
6.3 Sequencing	246
6.4 Selection	247
6.4.1 Short-Circuited Conditions	248
6.4.2 <code>Case/Switch</code> Statements	251
6.5 Iteration	256
6.5.1 Enumeration-Controlled Loops	256
6.5.2 Combination Loops	261

6.5.3 Iterators		262
6.5.4 Generators in Icon	© 111 ·	268
6.5.5 Logically Controlled Loops		268
6.6 Recursion		270
6.6.1 Iteration and Recursion		271
6.6.2 Applicative- and Normal-Order Evaluation		275
6.7 Nondeterminacy	© 115 ·	277
6.8 Summary and Concluding Remarks		278
6.9 Exercises		279
6.10 Explorations		285
6.11 Bibliographic Notes		287
7 Data Types		289
7.1 Type Systems		290
7.1.1 Type Checking		291
7.1.2 Polymorphism		291
7.1.3 The Meaning of “Type”		293
7.1.4 Classification of Types		294
7.1.5 Orthogonality		301
7.2 Type Checking		303
7.2.1 Type Equivalence		303
7.2.2 Type Compatibility		310
7.2.3 Type Inference		314
7.2.4 The ML Type System	© 125 ·	316
7.3 Records (Structures) and Variants (Unions)		317
7.3.1 Syntax and Operations		318
7.3.2 Memory Layout and Its Impact		319
7.3.3 With Statements	© 135 ·	323
7.3.4 Variant Records (Unions)	© 139 ·	324
7.4 Arrays		325
7.4.1 Syntax and Operations		326
7.4.2 Dimensions, Bounds, and Allocation		330
7.4.3 Memory Layout		335
7.5 Strings		342
7.6 Sets		344
7.7 Pointers and Recursive Types		345
7.7.1 Syntax and Operations		346

7.7.2 Dangling References	© 149	• 356
7.7.3 Garbage Collection		357
7.8 Lists		364
7.9 Files and Input/Output	© 153	• 367
7.9.1 Interactive I/O	© 153	
7.9.2 File-Based I/O	© 154	
7.9.3 Text I/O	© 156	
7.10 Equality Testing and Assignment		368
7.11 Summary and Concluding Remarks		371
7.12 Exercises		373
7.13 Explorations		379
7.14 Bibliographic Notes		380
8 Subroutines and Control Abstraction		383
8.1 Review of Stack Layout		384
8.2 Calling Sequences		386
8.2.1 Displays	© 169	• 389
8.2.2 Case Studies: C on the MIPS; Pascal on the x86	© 173	• 389
8.2.3 Register Windows	© 181	• 390
8.2.4 In-Line Expansion		391
8.3 Parameter Passing		393
8.3.1 Parameter Modes		394
8.3.2 Call-by-Name	© 185	• 402
8.3.3 Special-Purpose Parameters		403
8.3.4 Function Returns		408
8.4 Generic Subroutines and Modules		410
8.4.1 Implementation Options		412
8.4.2 Generic Parameter Constraints		414
8.4.3 Implicit Instantiation		416
8.4.4 Generics in C++, Java, and C#	© 189	• 417
8.5 Exception Handling		418
8.5.1 Defining Exceptions		421
8.5.2 Exception Propagation		423
8.5.3 Implementation of Exceptions		425
8.6 Coroutines		428
8.6.1 Stack Allocation		430
8.6.2 Transfer		432

8.6.3 Implementation of Iterators	© 201	• 433
8.6.4 Discrete Event Simulation	© 205	• 433
8.7 Events		434
8.7.1 Sequential Handlers		434
8.7.2 Thread-Based Handlers		436
8.8 Summary and Concluding Remarks		438
8.9 Exercises		439
8.10 Explorations		446
8.11 Bibliographic Notes		447
9 Data Abstraction and Object Orientation		449
9.1 Object-Oriented Programming		451
9.2 Encapsulation and Inheritance		460
9.2.1 Modules		460
9.2.2 Classes		463
9.2.3 Nesting (Inner Classes)		465
9.2.4 Type Extensions		466
9.2.5 Extending without Inheritance		468
9.3 Initialization and Finalization		469
9.3.1 Choosing a Constructor		470
9.3.2 References and Values		472
9.3.3 Execution Order		475
9.3.4 Garbage Collection		477
9.4 Dynamic Method Binding		478
9.4.1 Virtual and Nonvirtual Methods		480
9.4.2 Abstract Classes		482
9.4.3 Member Lookup		482
9.4.4 Polymorphism		486
9.4.5 Object Closures		489
9.5 Multiple Inheritance	© 215	• 491
9.5.1 Semantic Ambiguities	© 217	
9.5.2 Replicated Inheritance	© 220	
9.5.3 Shared Inheritance	© 222	
9.5.4 Mix-In Inheritance	© 223	
9.6 Object-Oriented Programming Revisited		492
9.6.1 The Object Model of Smalltalk	© 227	• 493
9.7 Summary and Concluding Remarks		494

9.8 Exercises	495
9.9 Explorations	498
9.10 Bibliographic Notes	499



ALTERNATIVE PROGRAMMING MODELS

503

10 Functional Languages		505
10.1 Historical Origins		506
10.2 Functional Programming Concepts		507
10.3 A Review/Overview of Scheme		509
10.3.1 Bindings		512
10.3.2 Lists and Numbers		513
10.3.3 Equality Testing and Searching		514
10.3.4 Control Flow and Assignment		515
10.3.5 Programs as Lists		517
10.3.6 Extended Example: DFA Simulation		519
10.4 Evaluation Order Revisited		521
10.4.1 Strictness and Lazy Evaluation		523
10.4.2 I/O: Streams and Monads		525
10.5 Higher-Order Functions		530
10.6 Theoretical Foundations	© 237	534
10.6.1 Lambda Calculus	© 239	
10.6.2 Control Flow	© 242	
10.6.3 Structures	© 244	
10.7 Functional Programming in Perspective		534
10.8 Summary and Concluding Remarks		537
10.9 Exercises		538
10.10 Explorations		542
10.11 Bibliographic Notes		543
11 Logic Languages		545
11.1 Logic Programming Concepts		546
11.2 Prolog		547
11.2.1 Resolution and Unification		549
11.2.2 Lists		550

11.2.3	Arithmetic	551
11.2.4	Search/Execution Order	552
11.2.5	Extended Example: Tic-Tac-Toe	554
11.2.6	Imperative Control Flow	557
11.2.7	Database Manipulation	561
11.3	Theoretical Foundations	© 253 • 566
11.3.1	Clausal Form	© 254
11.3.2	Limitations	© 255
11.3.3	Skolemization	© 257
11.4	Logic Programming in Perspective	566
11.4.1	Parts of Logic Not Covered	566
11.4.2	Execution Order	567
11.4.3	Negation and the “Closed World” Assumption	568
11.5	Summary and Concluding Remarks	570
11.6	Exercises	571
11.7	Explorations	573
11.8	Bibliographic Notes	573
12	Concurrency	575
12.1	Background and Motivation	576
12.1.1	The Case for Multithreaded Programs	579
12.1.2	Multiprocessor Architecture	581
12.2	Concurrent Programming Fundamentals	586
12.2.1	Communication and Synchronization	587
12.2.2	Languages and Libraries	588
12.2.3	Thread Creation Syntax	589
12.2.4	Implementation of Threads	598
12.3	Implementing Synchronization	603
12.3.1	Busy-Wait Synchronization	604
12.3.2	Nonblocking Algorithms	607
12.3.3	Memory Consistency Models	610
12.3.4	Scheduler Implementation	613
12.3.5	Semaphores	617
12.4	Language-Level Mechanisms	619
12.4.1	Monitors	619
12.4.2	Conditional Critical Regions	624
12.4.3	Synchronization in Java	626

12.4.4 Transactional Memory	629
12.4.5 Implicit Synchronization	633
12.5 Message Passing	Ⓒ 263 • 637
12.5.1 Naming Communication Partners	Ⓒ 263
12.5.2 Sending	Ⓒ 267
12.5.3 Receiving	Ⓒ 272
12.5.4 Remote Procedure Call	Ⓒ 278
12.6 Summary and Concluding Remarks	638
12.7 Exercises	640
12.8 Explorations	645
12.9 Bibliographic Notes	647
13 Scripting Languages	649
13.1 What Is a Scripting Language?	650
13.1.1 Common Characteristics	652
13.2 Problem Domains	655
13.2.1 Shell (Command) Languages	655
13.2.2 Text Processing and Report Generation	663
13.2.3 Mathematics and Statistics	667
13.2.4 “Glue” Languages and General-Purpose Scripting	668
13.2.5 Extension Languages	676
13.3 Scripting the World Wide Web	680
13.3.1 CGI Scripts	680
13.3.2 Embedded Server-Side Scripts	681
13.3.3 Client-Side Scripts	686
13.3.4 Java Applets	686
13.3.5 XSLT	Ⓒ 287 • 689
13.4 Innovative Features	691
13.4.1 Names and Scopes	691
13.4.2 String and Pattern Manipulation	696
13.4.3 Data Types	704
13.4.4 Object Orientation	710
13.5 Summary and Concluding Remarks	717
13.6 Exercises	718
13.7 Explorations	723
13.8 Bibliographic Notes	724

IV	A CLOSER LOOK AT IMPLEMENTATION	727
14	Building a Runnable Program	729
14.1	Back-End Compiler Structure	729
14.1.1	A Plausible Set of Phases	730
14.1.2	Phases and Passes	734
14.2	Intermediate Forms	© 303 • 734
14.2.1	Diana	© 303
14.2.2	The gcc IFs	© 306
14.2.3	Stack-Based Intermediate Forms	736
14.3	Code Generation	738
14.3.1	An Attribute Grammar Example	738
14.3.2	Register Allocation	741
14.4	Address Space Organization	744
14.5	Assembly	746
14.5.1	Emitting Instructions	748
14.5.2	Assigning Addresses to Names	749
14.6	Linking	750
14.6.1	Relocation and Name Resolution	751
14.6.2	Type Checking	751
14.7	Dynamic Linking	© 311 • 754
14.7.1	Position-Independent Code	© 312
14.7.2	Fully Dynamic (Lazy) Linking	© 313
14.8	Summary and Concluding Remarks	755
14.9	Exercises	756
14.10	Explorations	758
14.11	Bibliographic Notes	759
15	Run-time Program Management	761
15.1	Virtual Machines	764
15.1.1	The Java Virtual Machine	766
15.1.2	The Common Language Infrastructure	775
15.2	Late Binding of Machine Code	784
15.2.1	Just-in-Time and Dynamic Compilation	785
15.2.2	Binary Translation	791

15.2.3 Binary Rewriting	795
15.2.4 Mobile Code and Sandboxing	797
15.3 Inspection/Introspection	799
15.3.1 Reflection	799
15.3.2 Symbolic Debugging	806
15.3.3 Performance Analysis	809
15.4 Summary and Concluding Remarks	811
15.5 Exercises	812
15.6 Explorations	815
15.7 Bibliographic Notes	816
16 Code Improvement	321 · 817
16.1 Phases of Code Improvement	323
16.2 Peephole Optimization	325
16.3 Redundancy Elimination in Basic Blocks	328
16.3.1 A Running Example	328
16.3.2 Value Numbering	331
16.4 Global Redundancy and Data Flow Analysis	336
16.4.1 SSA Form and Global Value Numbering	336
16.4.2 Global Common Subexpression Elimination	339
16.5 Loop Improvement I	346
16.5.1 Loop Invariants	347
16.5.2 Induction Variables	348
16.6 Instruction Scheduling	351
16.7 Loop Improvement II	355
16.7.1 Loop Unrolling and Software Pipelining	355
16.7.2 Loop Reordering	359
16.8 Register Allocation	366
16.9 Summary and Concluding Remarks	370
16.10 Bibliographic Notes	377
A Programming Languages Mentioned	819
B Language Design and Language Implementation	831
C Numbered Examples	835
Bibliography	849
Index	867

Foreword

The ubiquity of computers in everyday life in the 21st century justifies the centrality of programming languages to computer science education. *Programming languages* is the area that connects the theoretical foundations of computer science, the source of problem-solving algorithms, to modern computer architectures on which the corresponding programs produce solutions. Given the speed with which computing technology advances in this post-Internet era, a computing textbook must present a structure for organizing information about a subject, not just the facts of the subject itself. In this book, Michael Scott broadly and comprehensively presents the key concepts of programming languages and their implementation, in a manner appropriate for computer science majors.

The key strength of Scott's book is that he holistically combines descriptions of language concepts with concrete explanations of how to realize them. The depth of these discussions, which have been updated in this third edition to reflect current research and practice, provide basic information as well as supplemental material for the reader interested in a specific topic. By eliding some topics selectively, the instructor can still create a coherent exploration of a subset of the subject matter. Moreover, Scott uses numerous examples from real languages to illustrate key points. For interested or motivated readers, additional in-depth and advanced discussions and exercises are available on the book's companion CD, enabling students with a range of interests and abilities to further explore on their own the fundamentals of programming languages and compilation.

I have taught a semester-long comparative programming languages course using Scott's book for the last several years. I emphasize to students that my goal is for them to learn how to learn a programming language, rather than to retain detailed specifics of any one programming language. The purpose of the course is to teach students an organizational framework for learning new languages throughout their careers, a certainty in the computer science field. To this end, I particularly like Scott's chapters on programming language paradigms (i.e., functional, logic, object-oriented, scripting), and my course material is organized in this manner. However, I also have included foundational topics such as memory organization, names and locations, scoping, types, and garbage collection—all of which benefit from being presented in a manner that links the language concept to its implementation details. Scott's explanations are to the point and intuitive, with clear illustrations and good examples. Often, discussions are independent of previously presented material, making it easier to pick and choose topics for

the syllabus. In addition, many supplemental teaching materials are provided on the Web.

Of key interest to me in this new edition are the new [Chapter 15](#) on run-time environments and virtual machines (VMs), and the major update of [Chapter 12](#) on concurrency. Given the current emphasis on virtualization, including a chapter on VMs, such as Java's JVM and CLI, facilitates student understanding of this important topic and explains how modern languages achieve portability over many platforms. The discussion of dynamic compilation and binary translation provides a contrast to the more traditional model of compilation presented earlier in the book. It is important that Scott includes this newer compilation technology so that a student can better understand what is needed to support the newer dynamic language features described. Further, the discussions of symbolic debugging and performance analysis demonstrate that programming language and compiler technology pervade the software development cycle.

Similarly, [Chapter 12](#) has been augmented with discussions of newer topics that have been the focus of recent research (e.g., memory consistency models, software transactional memory). A discussion of concurrency as a programming paradigm belongs in a programming languages course, not just in an operating systems course. In this context, language design choices easily can be compared and contrasted, and their required implementations considered. This blurring of the boundaries between language design, compilation, operating systems, and architecture characterizes current software development in practice. This reality is mirrored in this third edition of Scott's book.

Besides these major changes, this edition features updated examples (e.g., in X86 code, in C rather than Pascal) and enhanced discussions in the context of modern languages such as C#, Java 5, Python, and Eiffel. Presenting examples in several programming languages helps students understand that it is the underlying common concepts that are important, not their syntactic differences.

In summary, Michael Scott's book is an excellent treatment of programming languages and their implementation. This new third edition provides a good reference for students, to supplement materials presented in lectures. Several coherent tracks through the textbook allow construction of several "flavors" of courses that cover much, but not all of the material. The presentation is clear and comprehensive with language design and implementation discussed together and supporting one another.

Congratulations to Michael on a fine third edition of this wonderful book!

Barbara G. Ryder
J. Byron Maupin Professor of Engineering
Head, Department of Computer Science
Virginia Tech

Preface

A course in computer programming provides the typical student's first exposure to the field of computer science. Most students in such a course will have used computers all their lives, for email, games, web browsing, word processing, social networking, and a host of other tasks, but it is not until they write their first programs that they begin to appreciate how applications *work*. After gaining a certain level of facility as programmers (presumably with the help of a good course in data structures and algorithms), the natural next step is to wonder how *programming languages* work. This book provides an explanation. It aims, quite simply, to be the most comprehensive and accurate languages text available, in a style that is engaging and accessible to the typical undergraduate. This aim reflects my conviction that students will understand more, and enjoy the material more, if we explain what is really going on.

In the conventional “systems” curriculum, the material beyond data structures (and possibly computer organization) tends to be compartmentalized into a host of separate subjects, including programming languages, compiler construction, computer architecture, operating systems, networks, parallel and distributed computing, database management systems, and possibly software engineering, object-oriented design, graphics, or user interface systems. One problem with this compartmentalization is that the list of subjects keeps growing, but the number of semesters in a Bachelor's program does not. More important, perhaps, many of the most interesting discoveries in computer science occur at the boundaries *between* subjects. The RISC revolution, for example, forged an alliance between computer architecture and compiler construction that has endured for 25 years. More recently, renewed interest in virtual machines has blurred the boundaries between the operating system kernel, the compiler, and the language run-time system. Programs are now routinely embedded in web pages, spreadsheets, and user interfaces. And with the rise of multicore processors, concurrency issues that used to be an issue only for systems programmers have begun to impact everyday computing.

Increasingly, both educators and practitioners are recognizing the need to emphasize these sorts of interactions. Within higher education in particular there is a growing trend toward integration in the core curriculum. Rather than give the typical student an in-depth look at two or three narrow subjects, leaving holes in all the others, many schools have revised the programming languages and computer organization courses to cover a wider range of topics, with follow-on electives in various specializations. This trend is very much in keeping with the findings of the ACM/IEEE-CS *Computing Curricula 2001* task force, which emphasize the

growth of the field, the increasing need for breadth, the importance of flexibility in curricular design, and the overriding goal of graduating students who “have a system-level perspective, appreciate the interplay between theory and practice, are familiar with common themes, and can adapt over time as the field evolves” [CR01, Sec. 11.1, adapted].

The first two editions of *Programming Language Pragmatics* (PLP-1e and -2e) had the good fortune of riding this curricular trend. This third edition continues and strengthens the emphasis on integrated learning while retaining a central focus on programming language design.

At its core, PLP is a book about *how programming languages work*. Rather than enumerate the details of many different languages, it focuses on concepts that underlie all the languages the student is likely to encounter, illustrating those concepts with a variety of concrete examples, and exploring the tradeoffs that explain *why* different languages were designed in different ways. Similarly, rather than explain how to build a compiler or interpreter (a task few programmers will undertake in its entirety), PLP focuses on what a compiler does to an input program, and why. Language design and implementation are thus explored together, with an emphasis on the ways in which they interact.

Changes in the Third Edition

In comparison to the second edition, PLP-3e provides

1. A new chapter on virtual machines and run-time program management
2. A major revision of the chapter on concurrency
3. Numerous other reflections of recent changes in the field
4. Improvements inspired by instructor feedback or a fresh consideration of familiar topics

Item 1 in this list is perhaps the most visible change. It reflects the increasingly ubiquitous use of both managed code and scripting languages. [Chapter 15](#) begins with a general overview of virtual machines and then takes a detailed look at the two most widely used examples: the JVM and the CLI. The chapter also covers dynamic compilation, binary translation, reflection, debuggers, profilers, and other aspects of the increasingly sophisticated run-time machinery found in modern language systems.

Item 2 also reflects the evolving nature of the field. With the proliferation of multicore processors, concurrent languages have become increasingly important to mainstream programmers, and the field is very much in flux. Changes to [Chapter 12](#) (Concurrency) include new sections on nonblocking synchronization, memory consistency models, and software transactional memory, as well as increased coverage of OpenMP, Erlang, Java 5, and Parallel FX for .NET.

Other new material (Item 3) appears throughout the text. [Section 5.4.4](#) covers the multicore revolution from an architectural perspective. [Section 8.7](#) covers

event handling, in both sequential and concurrent languages. In [Section 14.2](#), coverage of gcc internals includes not only RTL, but also the newer GENERIC and Gimple intermediate forms. References have been updated throughout to accommodate such recent developments as Java 6, C++ '0X, C# 3.0, F#, Fortran 2003, Perl 6, and Scheme R6RS.

Finally, Item 4 encompasses improvements to almost every section of the text. Topics receiving particularly heavy updates include the running example of [Chapter 1](#) (moved from Pascal/MIPS to C/x86); bootstrapping ([Section 1.4](#)); scanning ([Section 2.2](#)); table-driven parsing ([Sections 2.3.2](#) and [2.3.3](#)); closures ([Sections 3.6.2](#), [3.6.3](#), [8.3.1](#), [8.4.4](#), [8.7.2](#), and [9.2.3](#)); macros ([Section 3.7](#)); evaluation order and strictness ([Sections 6.6.2](#) and [10.4](#)); decimal types ([Section 7.1.4](#)); array shape and allocation ([Section 7.4.2](#)); parameter passing ([Section 8.3](#)); inner (nested) classes ([Section 9.2.3](#)); monads ([Section 10.4.2](#)); and the Prolog examples of [Chapter 11](#) (now ISO conformant).

To accommodate new material, coverage of some topics has been condensed. Examples include modules ([Chapters 3](#) and [9](#)), loop control ([Chapter 6](#)), packed types ([Chapter 7](#)), the Smalltalk class hierarchy ([Chapter 9](#)), metacircular interpretation ([Chapter 10](#)), interconnection networks ([Chapter 12](#)), and thread creation syntax (also [Chapter 12](#)). Additional material has moved to the companion CD. This includes all of [Chapter 5](#) (Target Machine Architecture), unions ([Section 7.3.4](#)), dangling references ([Section 7.7.2](#)), message passing ([Section 12.5](#)), and XSLT ([Section 13.3.5](#)). Throughout the text, examples drawn from languages no longer in widespread use have been replaced with more recent equivalents wherever appropriate.

Overall, the printed text has grown by only some 30 pages, but there are nearly 100 new pages on the CD. There are also 14 more “Design & Implementations” sidebars, more than 70 new numbered examples, a comparable number of new “Check Your Understanding” questions, and more than 60 new end-of-chapter exercises and explorations. Considerable effort has been invested in creating a consistent and comprehensive index. As in earlier editions, Morgan Kaufmann has maintained its commitment to providing definitive texts at reasonable cost: PLP-3e is less expensive than competing alternatives, but larger and more comprehensive.

The PLP CD - See Note on page xxx

To minimize the physical size of the text, make way for new material, and allow students to focus on the fundamentals when browsing, approximately 350 pages of more advanced or peripheral material appears on the PLP CD. Each CD section is represented in the main text by a brief introduction to the subject and an “In More Depth” paragraph that summarizes the elided material.

Note that placement of material on the CD does *not* constitute a judgment about its technical importance. It simply reflects the fact that there is more material worth covering than will fit in a single volume or a single semester course. Since preferences and syllabi vary, most instructors will probably want to assign reading

from the CD, and most will refrain from assigning certain sections of the printed text. My intent has been to retain in print the material that is likely to be covered in the largest number of courses.

Also contained on the CD are compilable copies of all significant code fragments found in the text (in more than two dozen languages) and pointers to on-line resources.

Design & Implementation Sidebars

Like its predecessors, PLP-3e places heavy emphasis on the ways in which language design constrains implementation options, and the ways in which anticipated implementations have influenced language design. Many of these connections and interactions are highlighted in some 135 “Design & Implementations” sidebars. A more detailed introduction to these sidebars appears on page 9 ([Chapter 1](#)). A numbered list appears in [Appendix B](#).

Numbered and Titled Examples

Examples in PLP-3e are intimately woven into the flow of the presentation. To make it easier to find specific examples, to remember their content, and to refer to them in other contexts, a number and a title for each is displayed in a marginal note. There are nearly 1000 such examples across the main text and the CD. A detailed list appears in [Appendix C](#).

Exercise Plan

Review questions appear throughout the text at roughly 10-page intervals, at the ends of major sections. These are based directly on the preceding material, and have short, straightforward answers.

More detailed questions appear at the end of each chapter. These are divided into *Exercises* and *Explorations*. The former are generally more challenging than the per-section review questions, and should be suitable for homework or brief projects. The latter are more open-ended, requiring web or library research, substantial time commitment, or the development of subjective opinion. Solutions to many of the exercises (but not the explorations) are available to registered instructors from a password-protected web site: visit textbooks.elsevier.com/web/9780123745149.

How to Use the Book

Programming Language Pragmatics covers almost all of the material in the PL “knowledge units” of the *Computing Curricula 2001* report [CR01]. The book is an ideal fit for the CS 341 model course (Programming Language Design), and can also be used for CS 340 (Compiler Construction) or CS 343 (Programming

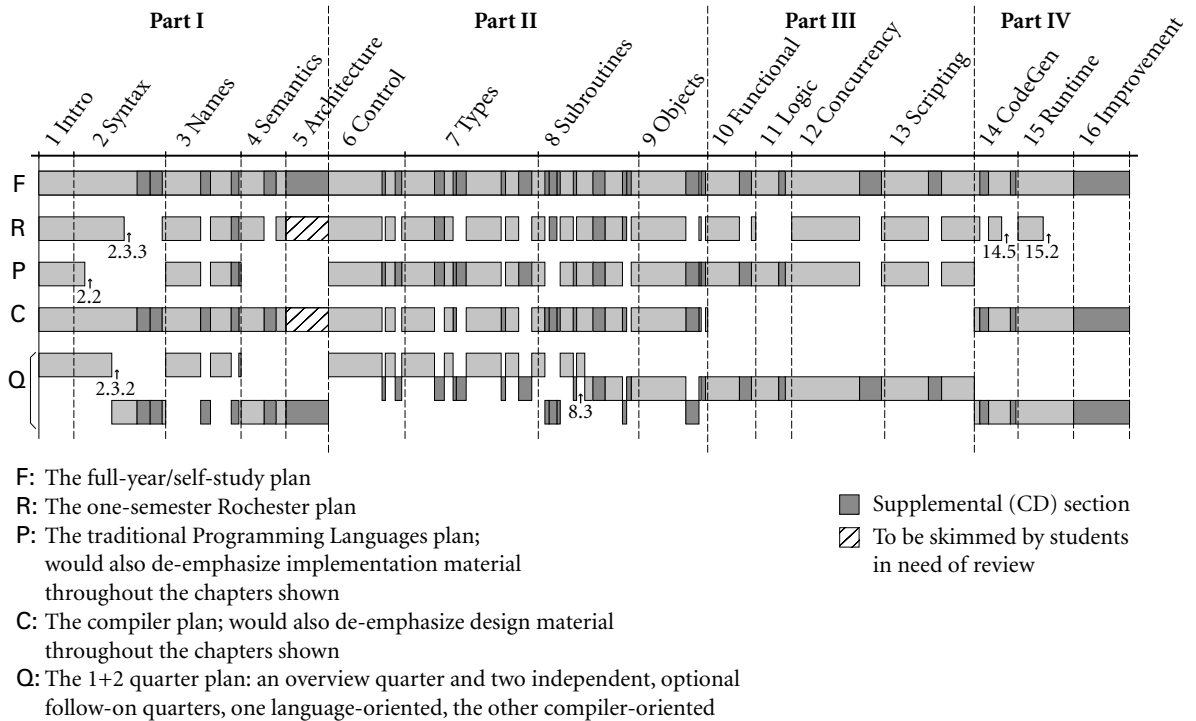

Figure 0.1 Paths through the text. Darker shaded regions indicate supplemental “In More Depth” sections on the PLP CD. Section numbers are shown for breaks that do not correspond to supplemental material.

Paradigms). It contains a significant fraction of the content of CS 344 (Functional Programming) and CS 346 (Scripting Languages). [Figure 0.1](#) illustrates several possible paths through the text.

For self-study, or for a full-year course (track F in [Figure 0.1](#)), I recommend working through the book from start to finish, turning to the PLP CD as each “In More Depth” section is encountered. The one-semester course at the University of Rochester (track R), for which the text was originally developed, also covers most of the book, but leaves out most of the CD sections, as well as bottom-up parsing (2.3.3) and the second halves of [Chapters 14](#) (Building a Runnable Program) and [15](#) (Run-time Program Management).

Some chapters (2, 4, 5, 14, 15, 16) have a heavier emphasis than others on implementation issues. These can be reordered to a certain extent with respect to the more design-oriented chapters. Many students will already be familiar with much of the material in [Chapter 5](#), most likely from a course on computer organization; hence the placement of the chapter on the PLP CD. Some students may also be familiar with some of the material in [Chapter 2](#), perhaps from a course on automata theory. Much of this chapter can then be read quickly as well, pausing

perhaps to dwell on such practical issues as recovery from syntax errors, or the ways in which a scanner differs from a classical finite automaton.

A traditional programming languages course (track P in [Figure 0.1](#)) might leave out all of scanning and parsing, plus all of [Chapter 4](#). It would also de-emphasize the more implementation-oriented material throughout. In place of these it could add such design-oriented CD sections as the ML type system (7.2.4), multiple inheritance (9.5), Smalltalk (9.6.1), lambda calculus (10.6), and predicate calculus (11.3).

PLP has also been used at some schools for an introductory compiler course (track C in [Figure 0.1](#)). The typical syllabus leaves out most of Part III ([Chapters 10 through 13](#)), and de-emphasizes the more design-oriented material throughout. In place of these it includes all of scanning and parsing, [Chapters 14 through 16](#), and a slightly different mix of other CD sections.

For a school on the quarter system, an appealing option is to offer an introductory one-quarter course and two optional follow-on courses (track Q in [Figure 0.1](#)). The introductory quarter might cover the main (non-CD) sections of [Chapters 1, 3, 6, and 7](#), plus the first halves of [Chapters 2 and 8](#). A language-oriented follow-on quarter might cover the rest of [Chapter 8](#), all of Part III, CD sections from [Chapters 6 through 8](#), and possibly supplemental material on formal semantics, type systems, or other related topics. A compiler-oriented follow-on quarter might cover the rest of [Chapter 2](#); [Chapters 4–5 and 14–16](#), CD sections from [Chapters 3 and 8–9](#), and possibly supplemental material on automatic code generation, aggressive code improvement, programming tools, and so on.

Whatever the path through the text, I assume that the typical reader has already acquired significant experience with at least one imperative language. Exactly which language it is shouldn't matter. Examples are drawn from a wide variety of languages, but always with enough comments and other discussion that readers without prior experience should be able to understand easily. Single-paragraph introductions to more than 50 different languages appear in [Appendix A](#). Algorithms, when needed, are presented in an informal pseudocode that should be self-explanatory. Real programming language code is set in "typewriter" font. Pseudocode is set in a sans-serif font.

Supplemental Materials

In addition to supplemental sections, the PLP CD contains a variety of other resources, including

- Links to language reference manuals and tutorials on the Web
- Links to open-source compilers and interpreters
- Complete source code for all nontrivial examples in the book
- A search engine for both the main text and the CD-only content

Additional resources are available on-line at textbooks.elsevier.com/web/9780123745149 (you may wish to check back from time to time). For instructors who have adopted the text, a password-protected page provides access to

- Editable PDF source for all the figures in the book
- Editable PowerPoint slides
- Solutions to most of the exercises
- Suggestions for larger projects

Acknowledgments for the Third Edition

In preparing the third edition I have been blessed with the generous assistance of a very large number of people. Many provided errata or other feedback on the second edition, among them Gerald Baumgartner, Manuel E. Bermudez, William Calhoun, Betty Cheng, Yi Dai, Eileen Head, Nathan Hoot, Peter Ketcham, Antonio Leitao, Jingke Li, Annie Liu, Dan Mullowney, Arthur Nunes-Harwitt, Zongyan Qiu, Beverly Sanders, David Sattari, Parag Tamhankar, Ray Toal, Robert van Engelen, Garrett Wollman, and Jingguo Yao. In several cases, good advice from the 2004 class test went unheeded in the second edition due to lack of time; I am glad to finally have the chance to incorporate it here. I also remain indebted to the many individuals acknowledged in the first and second editions, and to the reviewers, adopters, and readers who made those editions a success.

External reviewers for the third edition provided a wealth of useful suggestions; my thanks to Perry Alexander (University of Kansas), Hans Boehm (HP Labs), Stephen Edwards (Columbia University), Tim Harris (Microsoft Research), Eileen Head (Binghamton University), Doug Lea (SUNY Oswego), Jan-Willem Maessen (Sun Microsystems Laboratories), Maged Michael (IBM Research), Beverly Sanders (University of Florida), Christopher Vickery (Queens College, City University of New York), and Garrett Wollman (MIT). Hans, Doug, and Maged proofread parts of [Chapter 12](#) on very short notice; Tim and Jan were equally helpful with parts of [Chapter 10](#). Mike Spear helped vet the transactional memory implementation of [Figure 12.18](#). Xiao Zhang provided pointers for [Section 15.3.3](#). Problems that remain in all these sections are entirely my own.

In preparing the third edition, I have drawn on 20 years of experience teaching this material to upper-level undergraduates at the University of Rochester. I am grateful to all my students for their enthusiasm and feedback. My thanks as well to my colleagues and graduate students, and to the department's administrative, secretarial, and technical staff for providing such a supportive and productive work environment. Finally, my thanks to Barbara Ryder, whose forthright comments on the first edition helped set me on the path to the second; I am honored to have her as the author of the Foreword.

As they were on previous editions, the staff at Morgan Kaufmann have been a genuine pleasure to work with, on both a professional and a personal level. My thanks in particular to Nate McFadden, Senior Development Editor, who shepherded both this and the previous edition with unfailing patience, good humor, and a fine eye for detail; to Marilyn Rash, who managed the book's production; and to Denise Penrose, whose gracious stewardship, first as Editor and then as Publisher, have had a lasting impact.

Most important, I am indebted to my wife, Kelly, and our daughters, Erin and Shannon, for their patience and support through endless months of writing and revising. Computing is a fine profession, but family is what really matters.

Michael L. Scott
Rochester, NY
December 2008

PLP CD Content on a Companion Web Site

All content originally included on a CD is now available at this book's companion web site. Please visit the URL: <http://www.elsevierdirect.com/9780123745149> and click on "Companion Site"

This page intentionally left blank



Foundations

A central premise of *Programming Language Pragmatics* is that language design and implementation are intimately connected; it's hard to study one without the other.

The bulk of the text—[Parts II](#) and [III](#)—is organized around topics in language design, but with detailed coverage throughout of the many ways in which design decisions have been shaped by implementation concerns.

The first five chapters—[Part I](#)—set the stage by covering foundational material in both design and implementation. [Chapter 1](#) motivates the study of programming languages, introduces the major language families, and provides an overview of the compilation process. [Chapter 3](#) covers the high-level structure of programs, with an emphasis on *names*, the *binding* of names to objects, and the *scope rules* that govern which bindings are active at any given time. In the process it touches on storage management; subroutines, modules, and classes; polymorphism; and separate compilation.

[Chapters 2](#), [4](#), and [5](#) are more implementation oriented. They provide the background needed to understand the implementation issues mentioned in [Parts II](#) and [III](#). [Chapter 2](#) discusses the *syntax*, or textual structure, of programs. It introduces *regular expressions* and *context-free grammars*, which designers use to describe program syntax, together with the *scanning* and *parsing* algorithms that a compiler or interpreter uses to recognize that syntax. Given an understanding of syntax, [Chapter 4](#) explains how a compiler (or interpreter) determines the *semantics*, or meaning, of a program. The discussion is organized around the notion of *attribute grammars*, which serve to map a program onto something else that has meaning, such as mathematics or some other existing language. Finally, [Chapter 5](#) provides an overview of assembly-level computer architecture, focusing on the features of modern microprocessors most relevant to compilers. Programmers who understand these features have a better chance not only of understanding why the languages they use were designed the way they were, but also of using those languages as fully and effectively as possible.

This page intentionally left blank

Introduction

The first electronic computers were monstrous contraptions, filling several rooms, consuming as much electricity as a good-size factory, and costing millions of 1940s dollars (but with the computing power of a modern hand-held calculator). The programmers who used these machines believed that the computer's time was more valuable than theirs. They programmed in machine language. Machine language is the sequence of bits that directly controls a processor, causing it to add, compare, move data from one place to another, and so forth at appropriate times. Specifying programs at this level of detail is an enormously tedious task. The following program calculates the greatest common divisor (GCD) of two integers, using Euclid's algorithm. It is written in machine language, expressed here as hexadecimal (base 16) numbers, for the x86 (Pentium) instruction set.

EXAMPLE 1.1

GCD program in x86 machine language

```
55 89 e5 53 83 ec 04 83 e4 f0 e8 31 00 00 00 89 c3 e8 2a 00
00 00 39 c3 74 10 8d b6 00 00 00 00 39 c3 7e 13 29 c3 39 c3
75 f6 89 1c 24 e8 6e 00 00 00 8b 5d fc c9 c3 29 d8 eb eb 90
```

As people began to write larger programs, it quickly became apparent that a less error-prone notation was required. Assembly languages were invented to allow operations to be expressed with mnemonic abbreviations. Our GCD program looks like this in x86 assembly language:

EXAMPLE 1.2

GCD program in x86 assembler

```
    pushl   %ebp
    movl   %esp, %ebp
    pushl   %ebx
    subl   $4, %esp
    andl   $-16, %esp
    call   getint
    movl   %eax, %ebx
    call   getint
    cmpl   %eax, %ebx
    je     C
A:    cmpl   %eax, %ebx
    jle   D
    subl   %eax, %ebx
    B:    cmpl   %eax, %ebx
    jne   A
    C:    movl   %ebx, (%esp)
    call   putint
    movl   -4(%ebp), %ebx
    leave
    ret
    D:    subl   %ebx, %eax
    jmp   B
```

Assembly languages were originally designed with a one-to-one correspondence between mnemonics and machine language instructions, as shown in this example.¹ Translating from mnemonics to machine language became the job of a systems program known as an *assembler*. Assemblers were eventually augmented with elaborate “macro expansion” facilities to permit programmers to define parameterized abbreviations for common sequences of instructions. The correspondence between assembly language and machine language remained obvious and explicit, however. Programming continued to be a machine-centered enterprise: each different kind of computer had to be programmed in its own assembly language, and programmers thought in terms of the instructions that the machine would actually execute.

As computers evolved, and as competing designs developed, it became increasingly frustrating to have to rewrite programs for every new machine. It also became increasingly difficult for human beings to keep track of the wealth of detail in large assembly language programs. People began to wish for a machine-independent language, particularly one in which numerical computations (the most common type of program in those days) could be expressed in something more closely resembling mathematical formulae. These wishes led in the mid-1950s to the development of the original dialect of Fortran, the first arguably high-level programming language. Other high-level languages soon followed, notably Lisp and Algol.

Translating from a high-level language to assembly or machine language is the job of a systems program known as a *compiler*.² Compilers are substantially more complicated than assemblers because the one-to-one correspondence between source and target operations no longer exists when the source is a high-level language. Fortran was slow to catch on at first, because human programmers, with some effort, could almost always write assembly language programs that would run faster than what a compiler could produce. Over time, however, the performance gap has narrowed, and eventually reversed. Increases in hardware complexity (due to pipelining, multiple functional units, etc.) and continuing improvements in compiler technology have led to a situation in which a state-of-the-art compiler will usually generate better code than a human being will. Even in cases in which human beings can do better, increases in computer speed and program size have made it increasingly important to economize on programmer effort, not only in the original construction of programs, but in subsequent program *maintenance*—enhancement and correction. Labor costs now heavily outweigh the cost of computing hardware.

-
- 1 The 22 lines of assembly code in the example are encoded in varying numbers of bytes in machine language. The three `cmp` (compare) instructions, for example, all happen to have the same register operands, and are encoded in the two-byte sequence (`39 c3`). The four `mov` (move) instructions have different operands and lengths, and begin with `89` or `8b`. The chosen syntax is that of the GNU `gcc` compiler suite, in which results overwrite the last operand, not the first.
 - 2 High-level languages may also be *interpreted* directly, without the translation step. We will return to this option in [Section 1.4](#). It is the principal way in which scripting languages like Python and JavaScript are implemented.

1.1 The Art of Language Design

Today there are thousands of high-level programming languages, and new ones continue to emerge. Human beings use assembly language only for special-purpose applications. In a typical undergraduate class, it is not uncommon to find users of scores of different languages. Why are there so many? There are several possible answers:

Evolution. Computer science is a young discipline; we're constantly finding better ways to do things. The late 1960s and early 1970s saw a revolution in "structured programming," in which the goto-based control flow of languages like Fortran, Cobol, and Basic³ gave way to `while` loops, `case` (`switch`) statements, and similar higher level constructs. In the late 1980s the nested block structure of languages like Algol, Pascal, and Ada began to give way to the object-oriented structure of Smalltalk, C++, Eiffel, and the like.

Special Purposes. Many languages were designed for a specific problem domain. The various Lisp dialects are good for manipulating symbolic data and complex data structures. Icon and Awk are good for manipulating character strings. C is good for low-level systems programming. Prolog is good for reasoning about logical relationships among data. Each of these languages can be used successfully for a wider range of tasks, but the emphasis is clearly on the specialty.

Personal Preference. Different people like different things. Much of the parochialism of programming is simply a matter of taste. Some people love the terseness of C; some hate it. Some people find it natural to think recursively; others prefer iteration. Some people like to work with pointers; others prefer the implicit dereferencing of Lisp, Clu, Java, and ML. The strength and variety of personal preference make it unlikely that anyone will ever develop a universally acceptable programming language.

Of course, some languages are more successful than others. Of the many that have been designed, only a few dozen are widely used. What makes a language successful? Again there are several answers:

Expressive Power. One commonly hears arguments that one language is more "powerful" than another, though in a formal mathematical sense they are all *Turing complete*—each can be used, if awkwardly, to implement arbitrary algorithms. Still, language features clearly have a huge impact on the programmer's ability to write clear, concise, and maintainable code, especially for very large systems. There is no comparison, for example, between early versions of Basic on the one hand, and Common Lisp or Ada on the other. The factors that contribute to expressive power—abstraction facilities in particular—are a major focus of this book.

3 The names of these languages are sometimes written entirely in uppercase letters and sometimes in mixed case. For consistency's sake, I adopt the convention in this book of using mixed case for languages whose names are pronounced as words (e.g., Fortran, Cobol, Basic), and uppercase for those pronounced as a series of letters (e.g., APL, PL/I, ML).

Ease of Use for the Novice. While it is easy to pick on Basic, one cannot deny its success. Part of that success is due to its very low “learning curve.” Logo is popular among elementary-level educators for a similar reason: even a 5-year-old can learn it. Pascal was taught for many years in introductory programming language courses because, at least in comparison to other “serious” languages, it is compact and easy to learn. In recent years Java has come to play a similar role. Though substantially more complex than Pascal, it is much simpler than, say, C++.

Ease of Implementation. In addition to its low learning curve, Basic is successful because it could be implemented easily on tiny machines, with limited resources. Forth has a small but dedicated following for similar reasons. Arguably the single most important factor in the success of Pascal was that its designer, Niklaus Wirth, developed a simple, portable implementation of the language, and shipped it free to universities all over the world (see [Example 1.15](#)).⁴ The Java designers took similar steps to make their language available for free to almost anyone who wants it.

Standardization. Almost every widely used language has an official international standard or (in the case of several scripting languages) a single canonical implementation; and in the latter case the canonical implementation is almost invariably written in a language that has a standard. Standardization—of both the language and a broad set of libraries—is the only truly effective way to ensure the portability of code across platforms. The relatively impoverished standard for Pascal, which is missing several features considered essential by many programmers (separate compilation, strings, static initialization, random-access I/O), is at least partially responsible for the language’s drop from favor in the 1980s. Many of these features were implemented in different ways by different vendors.

Open Source. Most programming languages today have at least one open-source compiler or interpreter, but some languages—C in particular—are much more closely associated than others with freely distributed, peer-reviewed, community-supported computing. C was originally developed in the early 1970s by Dennis Ritchie and Ken Thompson at Bell Labs,⁵ in conjunction with the design of the original Unix operating system. Over the years Unix evolved into the world’s most portable operating system—the OS of choice for academic computer science—and C was closely associated with it. With the standardization of C, the language has become available on an enormous

⁴ Niklaus Wirth (1934–), Professor Emeritus of Informatics at ETH in Zürich, Switzerland, is responsible for a long line of influential languages, including Euler, Algol W, Pascal, Modula, Modula-2, and Oberon. Among other things, his languages introduced the notions of enumeration, subrange, and set types, and unified the concepts of records (structs) and variants (unions). He received the annual ACM Turing Award, computing’s highest honor, in 1984.

⁵ Ken Thompson (1943–) led the team that developed Unix. He also designed the B programming language, a child of BCPL and the parent of C. Dennis Ritchie (1941–) was the principal force behind the development of C itself. Thompson and Ritchie together formed the core of an incredibly productive and influential group. They shared the ACM Turing Award in 1983.

variety of additional platforms. Linux, the leading open-source operating system, is written in C. As of October 2008, C and its descendants account for 66% of the projects hosted at the sourceforge.net repository.

Excellent Compilers. Fortran owes much of its success to extremely good compilers. In part this is a matter of historical accident. Fortran has been around longer than anything else, and companies have invested huge amounts of time and money in making compilers that generate very fast code. It is also a matter of language design, however: Fortran dialects prior to Fortran 90 lack recursion and pointers, features that greatly complicate the task of generating fast code (at least for programs that can be written in a reasonable fashion without them!). In a similar vein, some languages (e.g., Common Lisp) are successful in part because they have compilers and supporting tools that do an unusually good job of helping the programmer manage very large projects.

Economics, Patronage, and Inertia. Finally, there are factors other than technical merit that greatly influence success. The backing of a powerful sponsor is one. PL/I, at least to first approximation, owes its life to IBM. Cobol and, more recently, Ada owe their life to the U.S. Department of Defense: Ada contains a wealth of excellent features and ideas, but the sheer complexity of implementation would likely have killed it if not for the DoD backing. Similarly, C#, despite its technical merits, would probably not have received the attention it has without the backing of Microsoft. At the other end of the life cycle, some languages remain widely used long after “better” alternatives are available because of a huge base of installed software and programmer expertise, which would cost too much to replace.

DESIGN & IMPLEMENTATION

Introduction

Throughout the book, sidebars like this one will highlight the interplay of language design and language implementation. Among other things, we will consider the following.

- Cases (such as those mentioned in this section) in which ease or difficulty of implementation significantly affected the success of a language
- Language features that many designers now believe were mistakes, at least in part because of implementation difficulties
- Potentially useful features omitted from some languages because of concern that they might be too difficult or slow to implement
- Language features introduced at least in part to facilitate efficient or elegant implementations
- Cases in which a machine architecture makes reasonable features unreasonably expensive
- Various other tradeoffs in which implementation plays a significant role

A complete list of sidebars appears in [Appendix B](#).

Clearly no single factor determines whether a language is “good.” As we study programming languages, we shall need to consider issues from several points of view. In particular, we shall need to consider the viewpoints of both the programmer and the language implementor. Sometimes these points of view will be in harmony, as in the desire for execution speed. Often, however, there will be conflicts and tradeoffs, as the conceptual appeal of a feature is balanced against the cost of its implementation. The tradeoff becomes particularly thorny when the implementation imposes costs not only on programs that use the feature, but also on programs that do not.

In the early days of computing the implementor’s viewpoint was predominant. Programming languages evolved as a means of telling a computer what to do. For programmers, however, a language is more aptly defined as a means of expressing algorithms. Just as natural languages constrain exposition and discourse, so programming languages constrain what can and cannot easily be expressed, and have both profound and subtle influence over what the programmer can *think*. Donald Knuth has suggested that programming be regarded as the art of telling another human being what one wants the computer to do [Knu84].⁶ This definition perhaps strikes the best sort of compromise. It acknowledges that both conceptual clarity and implementation efficiency are fundamental concerns. This book attempts to capture this spirit of compromise, by simultaneously considering the conceptual and implementation aspects of each of the topics it covers.

1.2 The Programming Language Spectrum

EXAMPLE 1.3

Classification of programming languages

The many existing languages can be classified into families based on their model of computation. Figure 1.1 shows a common set of families. The top-level division distinguishes between the *declarative* languages, in which the focus is on *what* the computer is to do, and the *imperative* languages, in which the focus is on *how* the computer should do it. ■

Declarative languages are in some sense “higher level”; they are more in tune with the programmer’s point of view, and less with the implementor’s point of view. Imperative languages predominate, however, mainly for performance reasons. There is a tension in the design of declarative languages between the desire to get away from “irrelevant” implementation details, and the need to remain close enough to the details to at least control the outline of an algorithm. The design of efficient algorithms, after all, is what much of computer science is about. It is not yet clear to what extent, and in what problem domains, we can expect compilers to

⁶ Donald E. Knuth (1938–), Professor Emeritus at Stanford University and one of the foremost figures in the design and analysis of algorithms, is also widely known as the inventor of the \TeX typesetting system (with which this book was produced) and of the *literate programming* methodology with which \TeX was constructed. His multivolume *The Art of Computer Programming* has an honored place on the shelf of most professional computer scientists. He received the ACM Turing Award in 1974.

declarative	
functional	Lisp/Scheme, ML, Haskell
dataflow	Id, Val
logic, constraint-based	Prolog, spreadsheets
template-based	XSLT
imperative	
von Neumann	C, Ada, Fortran, . . .
scripting	Perl, Python, PHP, . . .
object-oriented	Smalltalk, Eiffel, Java, . . .

Figure 1.1 Classification of programming languages. Note that the categories are fuzzy, and open to debate. In particular, it is possible for a functional language to be object-oriented, and many authors do not consider functional programming to be declarative.

discover good algorithms for problems stated at a very high level of abstraction. In any domain in which the compiler cannot find a good algorithm, the programmer needs to be able to specify one explicitly.

Within the declarative and imperative families, there are several important subclasses.

- *Functional* languages employ a computational model based on the recursive definition of functions. They take their inspiration from the *lambda calculus*, a formal computational model developed by Alonzo Church in the 1930s. In essence, a program is considered a function from inputs to outputs, defined in terms of simpler functions through a process of refinement. Languages in this category include Lisp, ML, and Haskell.
- *Dataflow* languages model computation as the flow of information (*tokens*) among primitive functional *nodes*. They provide an inherently parallel model: nodes are triggered by the arrival of input tokens, and can operate concurrently. Id and Val are examples of dataflow languages. Sisal, a descendant of Val, is more often described as a functional language.
- *Logic- or constraint-based* languages take their inspiration from predicate logic. They model computation as an attempt to find values that satisfy certain specified relationships, using goal-directed search through a list of logical rules. Prolog is the best-known logic language. The term is also sometimes applied to the SQL database language, the XSLT scripting language, and programmable aspects of spreadsheets such as Excel and its predecessors.
- The *von Neumann* languages are the most familiar and successful. They include Fortran, Ada 83, C, and all of the others in which the basic means of computation is the modification of variables.⁷ Whereas functional languages

⁷ John von Neumann (1903–1957) was a mathematician and computer pioneer who helped to develop the concept of *stored program* computing, which underlies most computer hardware. In a stored program computer, both programs and data are represented as bits in memory, which the processor repeatedly fetches, interprets, and updates.

are based on expressions that have values, von Neumann languages are based on statements (assignments in particular) that influence subsequent computation via the *side effect* of changing the value of memory.

- *Scripting* languages are a subset of the von Neumann languages. They are distinguished by their emphasis on “gluing together” components that were originally developed as independent programs. Several scripting languages were originally developed for specific purposes: `csh` and `bash`, for example, are the input languages of job control (shell) programs; `Awk` was intended for report generation; `PHP` and `JavaScript` are primarily intended for the generation of web pages with dynamic content (with execution on the server and the client, respectively). Other languages, including `Perl`, `Python`, `Ruby`, and `Tcl`, are more deliberately general purpose. Most place an emphasis on rapid prototyping, with a bias toward ease of expression over speed of execution.
- *Object-oriented* languages trace their roots to `Simula 67`. Most are closely related to the von Neumann languages, but have a much more structured and distributed model of both memory and computation. Rather than picture computation as the operation of a monolithic processor on a monolithic memory, object-oriented languages picture it as interactions among semi-independent *objects*, each of which has both its own internal state and sub-routines to manage that state. `Smalltalk` is the purest of the object-oriented languages; `C++` and `Java` are the most widely used. It is also possible to devise object-oriented functional languages (the best known of these is the `CLOS` [Kee89] extension to `Common Lisp`), but they tend to have a strong imperative flavor.

One might suspect that concurrent (parallel) languages also form a separate class (and indeed this book devotes a chapter to the subject), but the distinction between concurrent and sequential execution is mostly independent of the classifications above. Most concurrent programs are currently written using special library packages or compilers in conjunction with a sequential language such as `Fortran` or `C`. A few widely used languages, including `Java`, `C#`, and `Ada`, have explicitly concurrent features. Researchers are investigating concurrency in each of the language classes mentioned here.

As a simple example of the contrast among language classes, consider the greatest common divisor (GCD) problem introduced at the beginning of this chapter. The choice among, say, von Neumann, functional, or logic programming for this problem influences not only the appearance of the code, but how the programmer thinks. The von Neumann algorithm version of the algorithm is very imperative:

EXAMPLE 1.4

GCD function in C

To compute the gcd of `a` and `b`, check to see if `a` and `b` are equal. If so, print one of them and stop. Otherwise, replace the larger one by their difference and repeat.

C code for this algorithm appears at the top of [Figure 1.2](#). ■

```

int gcd(int a, int b) {                               // C
    while (a != b) {
        if (a > b) a = a - b;
        else b = b - a;
    }
    return a;
}

(define gcd                                           ; Scheme
  (lambda (a b)
    (cond ((= a b) a)
          (> a b) (gcd (- a b) b)
          (else (gcd (- b a) a))))

gcd(A,B,G) :- A = B, G = A.                          % Prolog
gcd(A,B,G) :- A > B, C is A-B, gcd(C,B,G).
gcd(A,B,G) :- B > A, C is B-A, gcd(C,A,G).

```

Figure 1.2 The GCD algorithm in C (top), Scheme (middle), and Prolog (bottom). All three versions assume (without checking) that their inputs are positive integers.

EXAMPLE 1.5

GCD function in Scheme

In a functional language, the emphasis is on the mathematical relationship of outputs to inputs:

The gcd of a and b is defined to be (1) a when a and b are equal, (2) the gcd of b and $a - b$ when $a > b$, and (3) the gcd of a and $b - a$ when $b > a$. To compute the gcd of a given pair of numbers, expand and simplify this definition until it terminates.

A Scheme version of this algorithm appears in the middle of [Figure 1.2](#). The keyword `lambda` introduces a function definition; `(a b)` is its argument list. The `cond` construct is essentially a multiway `if ... then ... else`. The difference of a and b is written `(- a b)`. ■

EXAMPLE 1.6

GCD rules in Prolog

In a logic language, the programmer specifies a set of axioms and proof rules that allows the system to find desired values:

The proposition `gcd(a, b, g)` is true if (1) a , b , and g are all equal; (2) a is greater than b and there exists a number c such that c is $a - b$ and `gcd(c, b, g)` is true; or (3) a is less than b and there exists a number c such that c is $b - a$ and `gcd(c, a, g)` is true. To compute the gcd of a given pair of numbers, search for a number g (and various numbers c) for which these rules allow one to prove that `gcd(a, b, g)` is true.

A Prolog version of this algorithm appears at the bottom of [Figure 1.2](#). It may be easier to understand if one reads “if” for `:-` and “and” for commas. ■

It should be emphasized that the distinctions among language classes are not clear-cut. The division between the von Neumann and object-oriented languages, for example, is often very fuzzy, and most of the functional and logic languages

include some imperative features. The descriptions above are meant to capture the general flavor of the classes, without providing formal definitions.

Imperative languages—von Neumann and object-oriented—receive the bulk of the attention in this book. Many issues cut across family lines, however, and the interested reader will discover much that is applicable to alternative computational models in most chapters of the book. [Chapters 10 through 13](#) contain additional material on functional, logic, concurrent, and scripting languages.

1.3 Why Study Programming Languages?

Programming languages are central to computer science, and to the typical computer science curriculum. Like most car owners, students who have become familiar with one or more high-level languages are generally curious to learn about other languages, and to know what is going on “under the hood.” Learning about languages is interesting. It’s also practical.

For one thing, a good understanding of language design and implementation can help one choose the most appropriate language for any given task. Most languages are better for some things than for others. Few programmers are likely to choose Fortran for symbolic computing or string processing, but other choices are not nearly so clear-cut. Should one choose C, C++, or C# for systems programming? Fortran or C for scientific computations? PHP or Ruby for a web-based application? Ada or C for embedded systems? Visual Basic or Java for a graphical user interface? This book should help equip you to make such decisions.

Similarly, this book should make it easier to learn new languages. Many languages are closely related. Java and C# are easier to learn if you already know C++; Common Lisp if you already know Scheme; Haskell if you already know ML. More important, there are basic concepts that underlie all programming languages. Most of these concepts are the subject of chapters in this book: types, control (iteration, selection, recursion, nondeterminacy, concurrency), abstraction, and naming. Thinking in terms of these concepts makes it easier to assimilate the syntax (form) and semantics (meaning) of new languages, compared to picking them up in a vacuum. The situation is analogous to what happens in natural languages: a good knowledge of grammatical forms makes it easier to learn a foreign language.

Whatever language you learn, understanding the decisions that went into its design and implementation will help you use it better. This book should help you with the following.

Understand obscure features. The typical C++ programmer rarely uses unions, multiple inheritance, variable numbers of arguments, or the `.*` operator. (If you don’t know what these are, don’t worry!) Just as it simplifies the assimilation of new languages, an understanding of basic concepts makes it easier to understand these features when you look up the details in the manual.

Choose among alternative ways to express things, based on a knowledge of implementation costs. In C++, for example, programmers may need to avoid unnecessary temporary variables, and use copy constructors whenever possible, to minimize the cost of initialization. In Java they may wish to use Executor objects rather than explicit thread creation. With certain (poor) compilers, they may need to adopt special programming idioms to get the fastest code: pointers for array traversal in C; with statements to factor out common address calculations in Pascal or Modula-3; $x*x$ instead of $x**2$ in Basic. In any language, they need to be able to evaluate the tradeoffs among alternative implementations of abstractions—for example between computation and table lookup for functions like bit set cardinality, which can be implemented either way.

Make good use of debuggers, assemblers, linkers, and related tools. In general, the high-level language programmer should not need to bother with implementation details. There are times, however, when an understanding of those details proves extremely useful. The tenacious bug or unusual system-building problem is sometimes a lot easier to handle if one is willing to peek at the bits.

Simulate useful features in languages that lack them. Certain very useful features are missing in older languages, but can be emulated by following a deliberate (if unenforced) programming style. In older dialects of Fortran, for example, programmers familiar with modern control constructs can use comments and self-discipline to write well-structured code. Similarly, in languages with poor abstraction facilities, comments and naming conventions can help imitate modular structure, and the extremely useful *iterators* of Clu, C#, Python, and Ruby (which we will study in [Section 6.5.3](#)) can be imitated with subroutines and static variables. In Fortran 77 and other languages that lack recursion, an iterative program can be derived via mechanical hand transformations, starting with recursive pseudocode. In languages without named constants or enumeration types, variables that are initialized once and never changed thereafter can make code much more readable and easy to maintain.

Make better use of language technology wherever it appears. Most programmers will never design or implement a conventional programming language, but most will need language technology for other programming tasks. The typical personal computer contains files in dozens of structured formats, encompassing web content, word processing, spreadsheets, presentations, raster and vector graphics, music, video, databases, and a wide variety of other application domains. Each of these structured formats has formal syntax and semantics, which tools must understand. Code to parse, analyze, generate, optimize, and otherwise manipulate structured data can thus be found in almost any sophisticated program, and all of this code is based on language technology. Programmers with a strong grasp of this technology will be in a better position to write well-structured, maintainable tools.

In a similar vein, most tools themselves can be customized, via start-up configuration files, command-line arguments, input commands, or built-in *extension languages* (considered in more detail in [Chapter 13](#)). My home directory holds more than 250 separate configuration (“preference”) files. My personal configuration files for the `emacs` text editor comprise more than 1200 lines of Lisp code. The user of almost any sophisticated program today will need to make good use of configuration or extension languages. The designers of such a program will need either to adopt (and adapt) some existing extension language, or to invent new notation of their own. Programmers with a strong grasp of language theory will be in a better position to design elegant, well-structured notation that meets the needs of current users and facilitates future development.

Finally, this book should help prepare you for further study in language design or implementation, should you be so inclined. It will also equip you to understand the interactions of languages with operating systems and architectures, should those areas draw your interest.

✓ CHECK YOUR UNDERSTANDING

1. What is the difference between machine language and assembly language?
 2. In what way(s) are high-level languages an improvement on assembly language? In what circumstances does it still make sense to program in assembler?
 3. Why are there so many programming languages?
 4. What makes a programming language successful?
 5. Name three languages in each of the following categories: von Neumann, functional, object-oriented. Name two logic languages. Name two widely used concurrent languages.
 6. What distinguishes declarative languages from imperative languages?
 7. What organization spearheaded the development of Ada?
 8. What is generally considered the first high-level programming language?
 9. What was the first functional language?
 10. Why aren't concurrent languages listed as a category in [Figure 1.1](#)?
-

1.4 Compilation and Interpretation

EXAMPLE 1.7
Pure compilation

At the highest level of abstraction, the compilation and execution of a program in a high-level language look something like this:

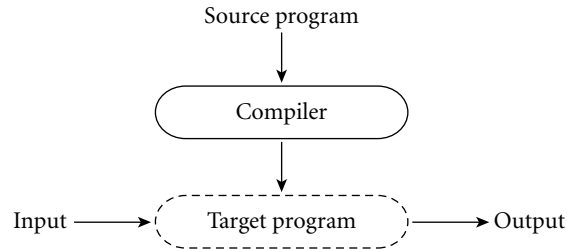

The compiler *translates* the high-level source program into an equivalent target program (typically in machine language), and then goes away. At some arbitrary later time, the user tells the operating system to run the target program. The compiler is the locus of control during compilation; the target program is the locus of control during its own execution. The compiler is itself a machine language program, presumably created by compiling some other high-level program. When written to a file in a format understood by the operating system, machine language is commonly known as *object code*. ■

EXAMPLE 1.8

Pure interpretation

An alternative style of implementation for high-level languages is known as *interpretation*.

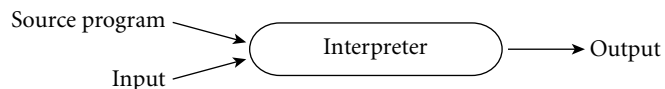

Unlike a compiler, an interpreter stays around for the execution of the application. In fact, the interpreter is the locus of control during that execution. In effect, the interpreter implements a virtual machine whose “machine language” is the high-level programming language. The interpreter reads statements in that language more or less one at a time, executing them as it goes along. ■

In general, interpretation leads to greater flexibility and better diagnostics (error messages) than does compilation. Because the source code is being executed directly, the interpreter can include an excellent source-level debugger. It can also cope with languages in which fundamental characteristics of the program, such as the sizes and types of variables, or even which names refer to which variables, can depend on the input data. Some language features are almost impossible to implement without interpretation: in Lisp and Prolog, for example, a program can write new pieces of itself and execute them on the fly. (Several scripting languages, including Perl, Tcl, Python, and Ruby, also provide this capability.) Delaying decisions about program implementation until run time is known as *late binding*; we will discuss it at greater length in [Section 3.1](#).

Compilation, by contrast, generally leads to better performance. In general, a decision made at compile time is a decision that does not need to be made at run time. For example, if the compiler can guarantee that variable *x* will always lie at location 49378, it can generate machine language instructions that access this location whenever the source program refers to *x*. By contrast, an interpreter may need to look *x* up in a table every time it is accessed, in order to find its location.

Since the (final version of a) program is compiled only once, but generally executed many times, the savings can be substantial, particularly if the interpreter is doing unnecessary work in every iteration of a loop.

EXAMPLE 1.9

Mixing compilation and interpretation

While the conceptual difference between compilation and interpretation is clear, most language implementations include a mixture of both. They typically look like this:

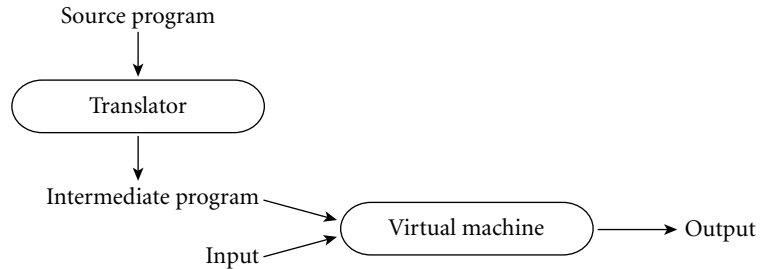

We generally say that a language is “interpreted” when the initial translator is simple. If the translator is complicated, we say that the language is “compiled.” The distinction can be confusing because “simple” and “complicated” are subjective terms, and because it is possible for a compiler (complicated translator) to produce code that is then executed by a complicated virtual machine (interpreter); this is in fact precisely what happens by default in Java. We still say that a language is compiled if the translator analyzes it thoroughly (rather than effecting some “mechanical” transformation), and if the intermediate program does not bear a strong resemblance to the source. These two characteristics—thorough analysis and nontrivial transformation—are the hallmarks of compilation. ■

In practice one sees a broad spectrum of implementation strategies:

EXAMPLE 1.10

Preprocessing

- Most interpreted languages employ an initial translator (a *preprocessor*) that removes comments and white space, and groups characters together into *tokens* such as keywords, identifiers, numbers, and symbols. The translator may also expand abbreviations in the style of a macro assembler. Finally, it may identify higher-level syntactic structures, such as loops and subroutines. The

DESIGN & IMPLEMENTATION**Compiled and interpreted languages**

Certain languages (e.g., Smalltalk and Python) are sometimes referred to as “interpreted languages” because most of their semantic error checking must be performed at run time. Certain other languages (e.g., Fortran and C) are sometimes referred to as “compiled languages” because almost all of their semantic error checking can be performed statically. This terminology isn’t strictly correct: interpreters for C and Fortran can be built easily, and a compiler can generate code to perform even the most extensive dynamic semantic checks. That said, language design has a profound effect on “compilability.”

goal is to produce an intermediate form that mirrors the structure of the source, but can be interpreted more efficiently. ■

In some very early implementations of Basic, the manual actually suggested removing comments from a program in order to improve its performance. These implementations were pure interpreters; they would re-read (and then ignore) the comments every time they executed a given part of the program. They had no initial translator.

EXAMPLE 1.11

Library routines and linking

- The typical Fortran implementation comes close to pure compilation. The compiler translates Fortran source into machine language. Usually, however, it counts on the existence of a *library* of subroutines that are not part of the original program. Examples include mathematical functions (*sin*, *cos*, *log*, etc.) and I/O. The compiler relies on a separate program, known as a *linker*, to merge the appropriate library routines into the final program:

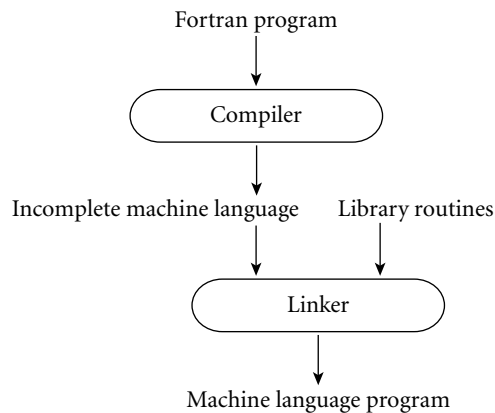

In some sense, one may think of the library routines as extensions to the hardware instruction set. The compiler can then be thought of as generating code for a virtual machine that includes the capabilities of both the hardware and the library.

In a more literal sense, one can find interpretation in the Fortran routines for formatted output. Fortran permits the use of `format` statements that control the alignment of output in columns, the number of significant digits and type of scientific notation for floating-point numbers, inclusion/suppression of leading zeros, and so on. Programs can compute their own formats on the fly. The output library routines include a format interpreter. A similar interpreter can be found in the `printf` routine of C and its descendants. ■

EXAMPLE 1.12

Post-compilation assembly

- Many compilers generate assembly language instead of machine language. This convention facilitates debugging, since assembly language is easier for people to read, and isolates the compiler from changes in the format of machine language files that may be mandated by new releases of the operating system (only the assembler must be changed, and it is shared by many compilers).

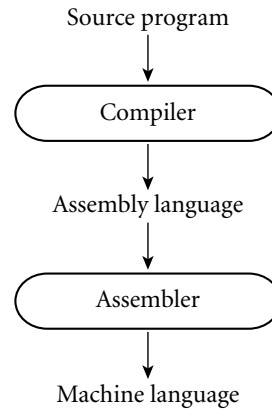
**EXAMPLE 1.13**

The C preprocessor

- Compilers for C (and for many other languages running under Unix) begin with a preprocessor that removes comments and expands macros. The preprocessor can also be instructed to delete portions of the code itself, providing a *conditional compilation* facility that allows several versions of a program to be built from the same source.

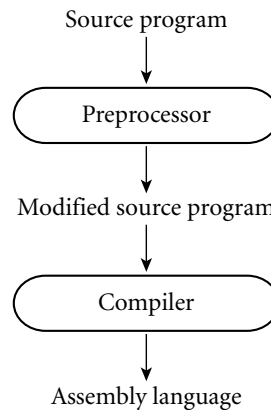
**EXAMPLE 1.14**

Source-to-source translation (C++)

- C++ implementations based on the early AT&T compiler actually generated an intermediate program in C, instead of in assembly language. This C++ compiler was indeed a true compiler: it performed a complete analysis of the syntax and semantics of the C++ source program, and with very few exceptions generated all of the error messages that a programmer would see prior to running the program. In fact, programmers were generally unaware that the C compiler was being used behind the scenes. The C++ compiler did not invoke the C compiler unless it had generated C code that would pass through the second round of compilation without producing any error messages.

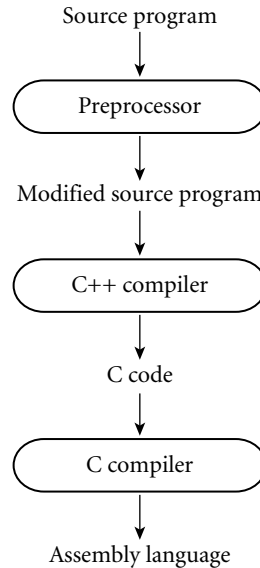

Occasionally one would hear the C++ compiler referred to as a preprocessor, presumably because it generated high-level output that was in turn compiled. I consider this a misuse of the term: compilers attempt to “understand” their source; preprocessors do not. Preprocessors perform transformations based on simple pattern matching, and may well produce output that will generate error messages when run through a subsequent stage of translation.

EXAMPLE 1.15

Bootstrapping

- Many compilers are *self-hosting*: they are written in the language they compile—Ada compilers in Ada, C compilers in C. This raises an obvious question: how does one compile the compiler in the first place? The answer is to use a technique known as *bootstrapping*, a term derived from the intentionally ridiculous notion of lifting oneself off the ground by pulling on one’s bootstraps. In a nutshell, one starts with a simple implementation—often an interpreter—and uses it to build progressively more sophisticated versions. We can illustrate the idea with an historical example.

Many early Pascal compilers were built around a set of tools distributed by Niklaus Wirth. These included the following.

- A Pascal compiler, written in Pascal, that would generate output in *P-code*, a stack-based language similar to the *byte code* of modern Java compilers
- The same compiler, already translated into P-code
- A P-code interpreter, written in Pascal

To get Pascal up and running on a local machine, the user of the tool set needed only to translate the P-code interpreter (by hand) into some locally available language. This translation was not a difficult task; the interpreter was

small. By running the P-code version of the compiler on top of the P-code interpreter, one could then compile arbitrary Pascal programs into P-code, which could in turn be run on the interpreter. To get a faster implementation, one could modify the Pascal version of the Pascal compiler to generate a locally available variety of assembly or machine language, instead of generating P-code (a somewhat more difficult task). This compiler could then be bootstrapped—run through itself—to yield a machine code version of the compiler.

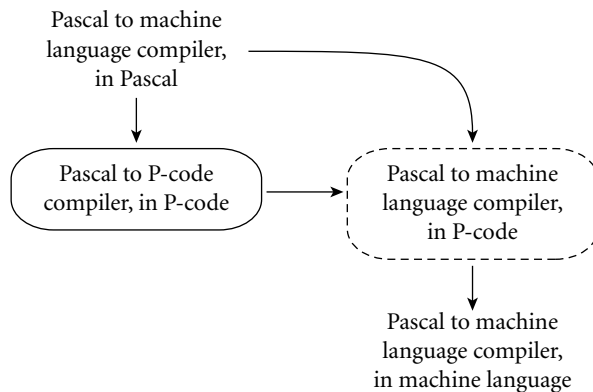

For a more modern example, suppose we were building one of the first compilers for Java. If we had a C compiler already, we might start by writing, in a simple subset of C, a compiler for an equally simple subset of Java. Once this compiler was working, we could hand-translate the C code into our subset of Java and run the compiler through itself. We could then repeatedly extend the compiler to accept a larger subset of Java, bootstrap it again, and use the extended language to implement an even larger subset. ■

DESIGN & IMPLEMENTATION

The early success of Pascal

The P-code-based implementation of Pascal, and its use of bootstrapping, are largely responsible for the language’s remarkable success in academic circles in the 1970s. No single hardware platform or operating system of that era dominated the computer landscape the way the x86, Linux, and Windows do today.⁸ Wirth’s toolkit made it possible to get an implementation of Pascal up and running on almost any platform in a week or so. It was one of the first great successes in system portability.

⁸ Throughout this book we will use the term “x86” to refer to the instruction set architecture of the Intel 8086 and its descendants, including the various Pentium processors. Intel calls this architecture the IA-32, but x86 is a more generic term that encompasses the offerings of competitors such as AMD as well.

EXAMPLE 1.16

Compiling interpreted languages

- One will sometimes find compilers for languages (e.g., Lisp, Prolog, Smalltalk, etc.) that permit a lot of late binding, and are traditionally interpreted. These compilers must be prepared, in the general case, to generate code that performs much of the work of an interpreter, or that makes calls into a library that does that work instead. In important special cases, however, the compiler can generate code that makes reasonable assumptions about decisions that won't be finalized until run time. If these assumptions prove to be valid the code will run very fast. If the assumptions are not correct, a dynamic check will discover the inconsistency, and revert to the interpreter. ■

EXAMPLE 1.17

Dynamic and just-in-time compilation

- In some cases a programming system may deliberately delay compilation until the last possible moment. One example occurs in implementations of Lisp or Prolog that invoke the compiler on the fly, to translate newly created source into machine language, or to optimize the code for a particular input set. Another example occurs in implementations of Java. The Java language definition defines a machine-independent intermediate form known as *byte code*. Byte code is the standard format for distribution of Java programs; it allows programs to be transferred easily over the Internet, and then run on any platform. The first Java implementations were based on byte-code interpreters, but more recent (faster) implementations employ a *just-in-time* compiler that translates byte code into machine language immediately before each execution of the program. C#, similarly, is intended for just-in-time translation. The main C# compiler produces .NET Common Intermediate Language (CIL), which is then translated into machine language immediately prior to execution. CIL is deliberately language independent, so it can be used for code produced by a variety of front-end compilers. ■

EXAMPLE 1.18

Microcode (firmware)

- On some machines (particularly those designed before the mid-1980s), the assembly-level instruction set is not actually implemented in hardware, but in fact runs on an interpreter. The interpreter is written in low-level instructions called *microcode* (or *firmware*), which is stored in read-only memory and executed by the hardware. Microcode and microprogramming are considered further in Section ©5.4.1. ■

As some of these examples make clear, a compiler does not necessarily translate from a high-level language into machine language. It is not uncommon for compilers, especially prototypes, to generate C as output. A little further afield, text formatters like \TeX and \troff are actually compilers, translating high level document descriptions into commands for a laser printer or phototypesetter. (Many laser printers themselves incorporate interpreters for the Postscript page-description language.) Query language processors for database systems are also compilers, translating languages like SQL into primitive operations on files. There are even compilers that translate logic-level circuit specifications into photographic masks for computer chips. Though the focus in this book is on imperative programming languages, the term “compilation” applies whenever we translate automatically from one nontrivial language to another, with full analysis of the meaning of the input.

1.5 Programming Environments

Compilers and interpreters do not exist in isolation. Programmers are assisted in their work by a host of other tools. Assemblers, debuggers, preprocessors, and linkers were mentioned earlier. Editors are familiar to every programmer. They may be augmented with cross-referencing facilities that allow the programmer to find the point at which an object is defined, given a point at which it is used. Pretty-printers help enforce formatting conventions. Style checkers enforce syntactic or semantic conventions that may be tighter than those enforced by the compiler (see Exploration 1.12). Configuration management tools help keep track of dependences among the (many versions of) separately compiled modules in a large software system. Perusal tools exist not only for text but also for intermediate languages that may be stored in binary. Profilers and other performance analysis tools often work in conjunction with debuggers to help identify the pieces of a program that consume the bulk of its computation time.

In older programming environments, tools may be executed individually, at the explicit request of the user. If a running program terminates abnormally with a “bus error” (invalid address) message, for example, the user may choose to invoke a debugger to examine the “core” file dumped by the operating system. He or she may then attempt to identify the program bug by setting breakpoints, enabling tracing and so on, and running the program again under the control of the debugger. Once the bug is found, the user will invoke the editor to make an appropriate change. He or she will then recompile the modified program, possibly with the help of a configuration manager.

More recent environments provide much more integrated tools. When an invalid address error occurs in an integrated development environment (IDE), a new window is likely to appear on the user’s screen, with the line of source code at which the error occurred highlighted. Breakpoints and tracing can then be set in this window without explicitly invoking a debugger. Changes to the source can be made without explicitly invoking an editor. If the user asks to rerun the program after making changes, a new version may be built without explicitly invoking the compiler or configuration manager.

The editor for an IDE may incorporate knowledge of language syntax, providing templates for all the standard control structures, and checking syntax as it is

DESIGN & IMPLEMENTATION

Powerful development environments

Sophisticated development environments can be a two-edged sword. The quality of the Common Lisp environment has arguably contributed to its widespread acceptance. On the other hand, the particularity of the graphical environment for Smalltalk (with its insistence on specific fonts, window styles, etc.) has made it difficult to port the language to systems accessed through a textual interface, or to graphical systems with a different “look and feel.”

typed in. Internally, the IDE is likely to maintain not only a program's source and object code, but also a syntax tree. When the source is edited, the tree will be updated automatically—often incrementally (without reparsing large portions of the source). In some cases, structural changes to the program may be implemented first in the syntax tree, and then automatically reflected in the source.

IDEs are fundamental to Smalltalk—it is nearly impossible to separate the language from its graphical environment—and have been routinely used for Common Lisp since the 1980s. In more recent years, integrated environments have largely displaced command-line tools for many languages and systems. Popular open-source IDEs include Eclipse and NetBeans. Commercial systems include the Visual Studio environment from Microsoft and the XCode environment from Apple. Much of the appearance of integration can also be achieved within sophisticated editors such as emacs.

✓ CHECK YOUR UNDERSTANDING

11. Explain the distinction between interpretation and compilation. What are the comparative advantages and disadvantages of the two approaches?
 12. Is Java compiled or interpreted (or both)? How do you know?
 13. What is the difference between a compiler and a preprocessor?
 14. What was the intermediate form employed by the original AT&T C++ compiler?
 15. What is P-code?
 16. What is bootstrapping?
 17. What is a just-in-time compiler?
 18. Name two languages in which a program can write new pieces of itself “on the fly.”
 19. Briefly describe three “unconventional” compilers—compilers whose purpose is not to prepare a high-level program for execution on a microprocessor.
 20. List six kinds of tools that commonly support the work of a compiler within a larger programming environment.
 21. Explain how an IDE differs from a collection of command-line tools.
-

1.6 An Overview of Compilation

Compilers are among the most well-studied classes of computer programs. We will consider them repeatedly throughout the rest of the book, and in [Chapters 2, 4, 14, and 16](#) in particular. The remainder of this section provides an introductory overview.

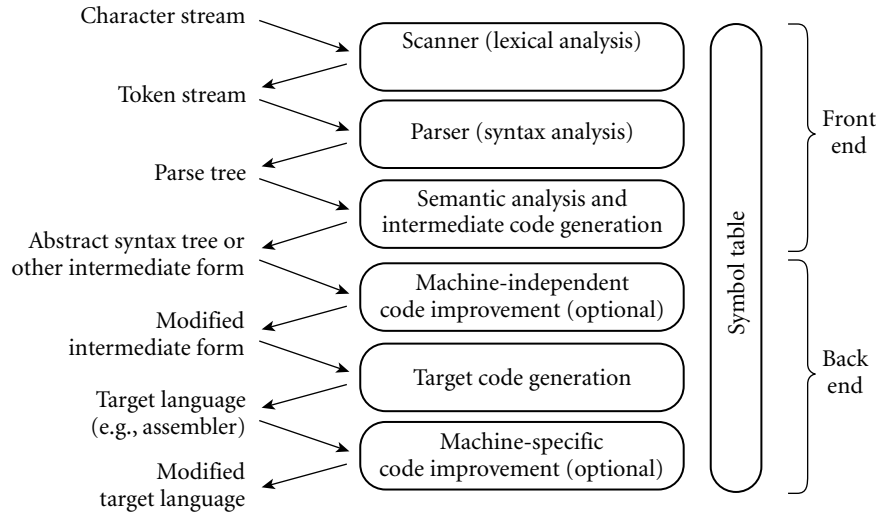

Figure 1.3 Phases of compilation. Phases are listed on the right and the forms in which information is passed between phases are listed on the left. The symbol table serves throughout compilation as a repository for information about identifiers.

EXAMPLE 1.19

Phases of compilation

In a typical compiler, compilation proceeds through a series of well-defined *phases*, shown in Figure 1.3. Each phase discovers information of use to later phases, or transforms the program into a form that is more useful to the subsequent phase. ■

The first few phases (up through semantic analysis) serve to figure out the meaning of the source program. They are sometimes called the *front end* of the compiler. The last few phases serve to construct an equivalent target program. They are sometimes called the *back end* of the compiler. Many compiler phases can be created automatically from a formal description of the source and/or target languages.

One will sometimes hear compilation described as a series of *passes*. A pass is a phase or set of phases that is serialized with respect to the rest of compilation: it does not start until previous phases have completed, and it finishes before any subsequent phases start. If desired, a pass may be written as a separate program, reading its input from a file and writing its output to a file. Compilers are commonly divided into passes so that the front end may be shared by compilers for more than one machine (target language), and so that the back end may be shared by compilers for more than one source language. In some implementations the front end and the back end may be separated by a “middle end” that is responsible for language- and machine-independent code improvement. Prior to the dramatic increases in memory sizes of the mid to late 1980s, compilers were also sometimes divided into passes to minimize memory usage: as each pass completed, the next could reuse its code space.

1.6.1 Lexical and Syntax Analysis

EXAMPLE 1.20

GCD program in C

Consider the greatest common divisor (GCD) problem introduced at the beginning of this chapter, and shown as a function in [Figure 1.2](#) (page 13). Hypothesizing trivial I/O routines and recasting the function as a stand-alone program, our code might look as follows in C.

```
int main() {
    int i = getint(), j = getint();
    while (i != j) {
        if (i > j) i = i - j;
        else j = j - i;
    }
    putint(i);
}
```

EXAMPLE 1.21

GCD program tokens

Scanning and parsing serve to recognize the structure of the program, without regard to its meaning. The scanner reads characters ('i', 'n', 't', ' ', 'm', 'a', 'i', 'n', '(', ')', ';', etc.) and groups them into *tokens*, which are the smallest meaningful units of the program. In our example, the tokens are

```
int      main      (      )      {      int      i      =
getint   (      )      ,      j      =      getint   (
)      ;      while  (      i      !=      j      )
{      if      (      i      >      j
=      i      -      j      ;      else  j      =
j      -      i      ;      }      putint  (      i
)      ;      }
```

Scanning is also known as *lexical analysis*. The principal purpose of the scanner is to simplify the task of the parser, by reducing the size of the input (there are many more characters than tokens) and by removing extraneous characters like white space. The scanner also typically removes comments and tags tokens with line and column numbers, to make it easier to generate good diagnostics in later phases. One could design a parser to take characters instead of tokens as input—dispensing with the scanner—but the result would be awkward and slow.

EXAMPLE 1.22

Context-free grammar and parsing

Parsing organizes tokens into a *parse tree* that represents higher-level constructs (statements, expressions, subroutines, and so on) in terms of their constituents. Each construct is a node in the tree; its constituents are its children. The root of the tree is simply “*program*”; the leaves, from left to right, are the tokens received from the scanner. Taken as a whole, the tree shows how the tokens fit together to make a valid program. The structure relies on a set of potentially recursive rules known as a *context-free grammar*. Each rule has an arrow sign (\rightarrow) with the construct name on the left and a possible expansion on the right.⁹ In C, for

⁹ Theorists also study *context-sensitive* grammars, in which the allowable expansions of a construct (the applicable rules) depend on the context in which the construct appears (i.e., on constructs to the left and right). Context sensitivity is important for natural languages like English, but it is almost never used in programming language design.

example, a `while` loop consists of the keyword `while` followed by a parenthesized Boolean expression and a statement:

$$\textit{iteration-statement} \longrightarrow \text{while (expression) statement}$$

The statement, in turn, is often a list enclosed in braces:

$$\textit{statement} \longrightarrow \textit{compound-statement}$$

$$\textit{compound-statement} \longrightarrow \{ \textit{block-item-list_opt} \}$$

where

$$\textit{block-item-list_opt} \longrightarrow \textit{block-item-list}$$

or

$$\textit{block-item-list_opt} \longrightarrow \epsilon$$

and

$$\textit{block-item-list} \longrightarrow \textit{block-item}$$

$$\textit{block-item-list} \longrightarrow \textit{block-item-list} \textit{block-item}$$

$$\textit{block-item} \longrightarrow \textit{declaration}$$

$$\textit{block-item} \longrightarrow \textit{statement}$$

Here ϵ represents the empty string; it indicates that *block-item-list_opt* can simply be deleted. Many more grammar rules are needed, of course, to explain the full structure of a program. ■

A context-free grammar is said to define the *syntax* of the language; parsing is therefore known as *syntax analysis*. There are many possible grammars for C (an infinite number, in fact); the fragment shown above is taken from the sample grammar contained in the official language definition [Int99]. A full parse tree for our GCD program (based on a full grammar not shown here) appears in [Figure 1.4](#). While the size of the tree may seem daunting, its details aren't particularly important at this point in the text. What *is* important is that (1) each individual branching point represents the application of a single grammar rule, and (2) the resulting complexity is more a reflection of the grammar than it is of the input program. Much of it stems from (a) the use of such artificial “constructs” as *block-item-list* and *block-item-list_opt* to generate lists of arbitrary length, and (b) the use of the equally artificial *assignment-expression*, *additive-expression*, *multiplicative-expression*, and so on, to capture precedence and associativity in arithmetic expressions. We shall see in the following subsection that much of this complexity can be discarded once parsing is complete. ■

In the process of scanning and parsing, the compiler checks to see that all of the program's tokens are well formed, and that the sequence of tokens conforms to the syntax defined by the context-free grammar. Any malformed tokens (e.g., `123abc` or `$@foo` in C) should cause the scanner to produce an error message. Any syntactically invalid token sequence (e.g., `A = X Y Z` in C) should lead to an error message from the parser.

EXAMPLE 1.23

GCD program parse tree

1.6.2 Semantic Analysis and Intermediate Code Generation

Semantic analysis is the discovery of *meaning* in a program. The semantic analysis phase of compilation recognizes when multiple occurrences of the same identifier are meant to refer to the same program entity, and ensures that the uses are consistent. In most languages the semantic analyzer tracks the *types* of both identifiers and expressions, both to verify consistent usage and to guide the generation of code in later phases.

To assist in its work, the semantic analyzer typically builds and maintains a *symbol table* data structure that maps each identifier to the information known about it. Among other things, this information includes the identifier's type, internal structure (if any), and scope (the portion of the program in which it is valid).

Using the symbol table, the semantic analyzer enforces a large variety of rules that are not captured by the hierarchical structure of the context-free grammar and the parse tree. In C, for example, it checks to make sure that

- Every identifier is declared before it is used.
- No identifier is used in an inappropriate context (calling an integer as a subroutine, adding a string to an integer, referencing a field of the wrong type of struct, etc.).
- Subroutine calls provide the correct number and types of arguments.
- Labels on the arms of a switch statement are distinct constants.
- Any function with a non-void return type returns a value explicitly.

In many compilers, the work of the semantic analyzer takes the form of *semantic action routines*, invoked by the parser when it realizes that it has reached a particular point within a grammar rule.

Of course, not all semantic rules can be checked at compile time. Those that can are referred to as the *static semantics* of the language. Those that must be checked at run time are referred to as the *dynamic semantics* of the language. C has very little in the way of dynamic checks (its designers opted for performance over safety). Examples of rules that other languages enforce at run time include the following.

- Variables are never used in an expression unless they have been given a value.¹⁰
- Pointers are never dereferenced unless they refer to a valid object.
- Array subscript expressions lie within the bounds of the array.
- Arithmetic operations do not overflow.

10 As we shall see in Section 6.1.3, Java and C# actually do enforce initialization at compile time, but only by adopting a conservative set of rules for “definite assignment,” outlawing programs for which correctness is difficult or impossible to verify at compile time.

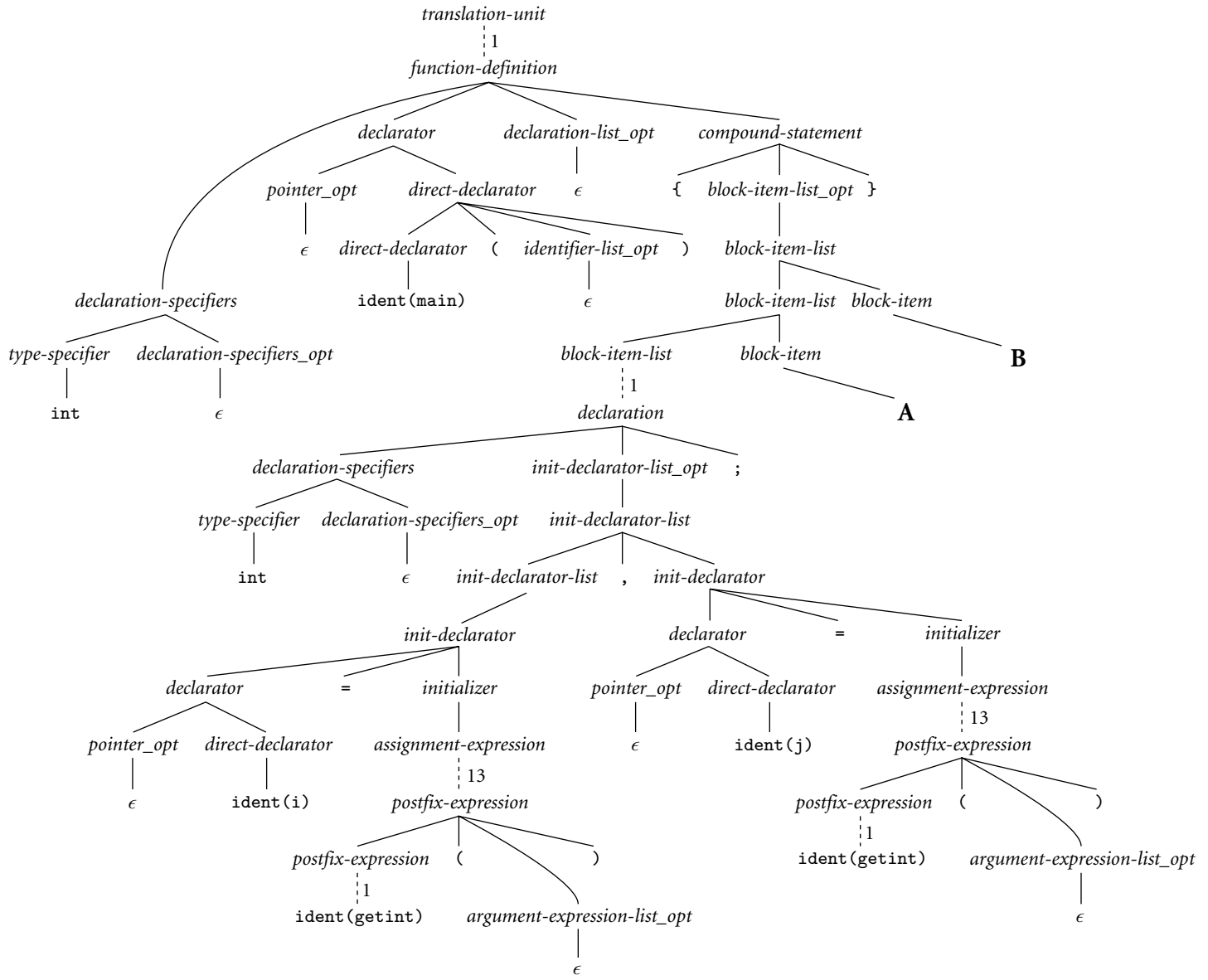

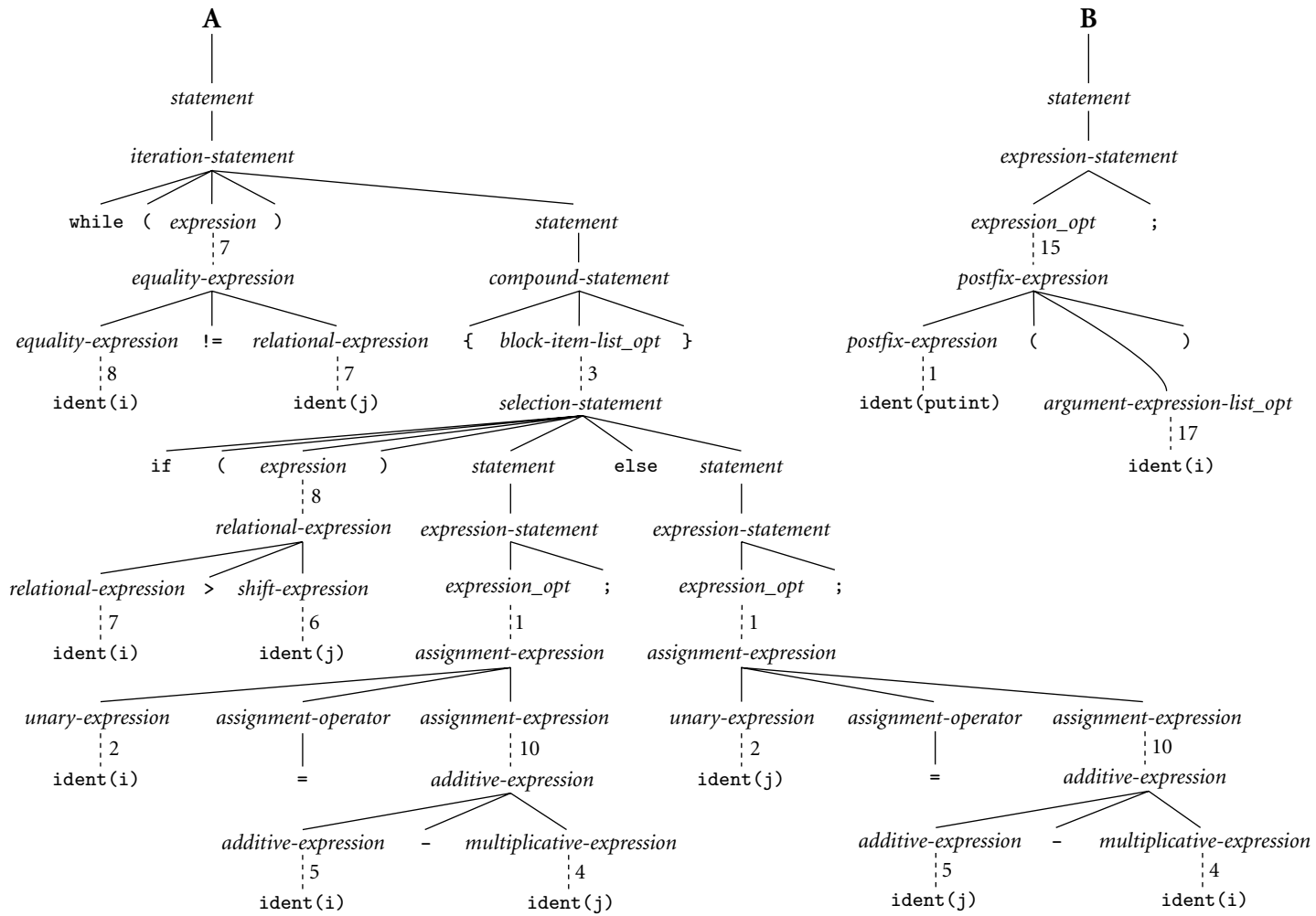

Figure 1.4 Parse tree for the GCD program. The symbol ϵ represents the empty string. Dotted lines indicate a chain of one-for-one replacements, elided to save space; the adjacent number indicates the number of omitted nodes. While the details of the tree aren't important to the current chapter, the sheer amount of detail is: it comes from having to fit the (much simpler) source code into the hierarchical structure of a context-free grammar.

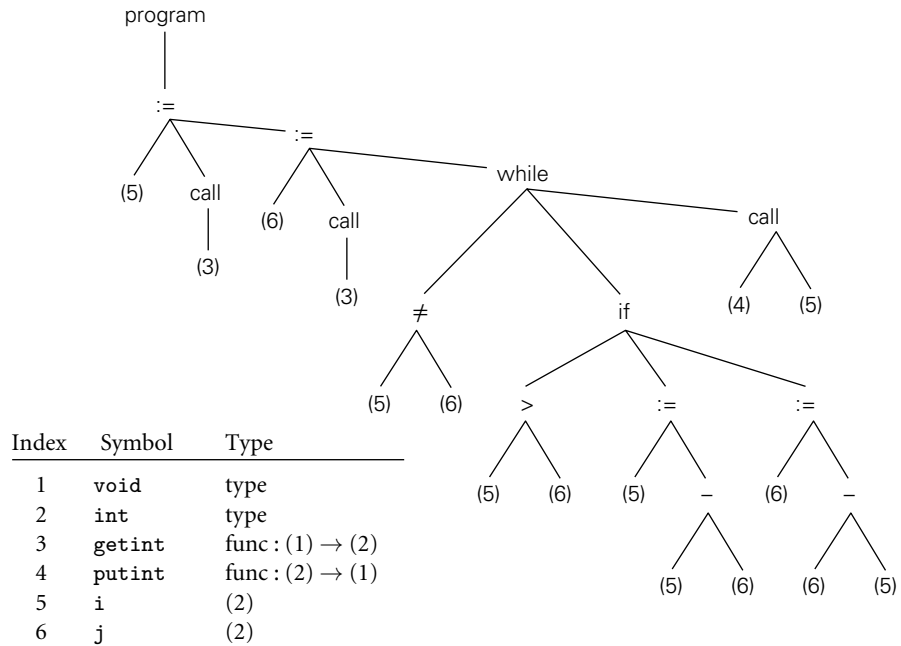

Figure 1.5 Syntax tree and symbol table for the GCD program. Note the contrast to Figure 1.4: the syntax tree retains just the essential structure of the program, omitting details that were needed only to drive the parsing algorithm.

When it cannot enforce rules statically, a compiler will often produce code to perform appropriate checks at run time, aborting the program or generating an *exception* if one of the checks then fails. (Exceptions will be discussed in Section 8.5.) Some rules, unfortunately, may be unacceptably expensive or impossible to enforce, and the language implementation may simply fail to check them. In Ada, a program that breaks such a rule is said to be *erroneous*; in C its behavior is said to be *undefined*.

A parse tree is sometimes known as a *concrete syntax tree*, because it demonstrates, completely and concretely, how a particular sequence of tokens can be derived under the rules of the context-free grammar. Once we know that a token sequence is valid, however, much of the information in the parse tree is irrelevant to further phases of compilation. In the process of checking static semantic rules, the semantic analyzer typically transforms the parse tree into an *abstract syntax tree* (otherwise known as an *AST*, or simply a *syntax tree*) by removing most of the “artificial” nodes in the tree’s interior. The semantic analyzer also *annotates* the remaining nodes with useful information, such as pointers from identifiers to their symbol table entries. The annotations attached to a particular node are known as its *attributes*. A syntax tree for our GCD program is shown in Figure 1.5. ■

In many compilers, the annotated syntax tree constitutes the intermediate form that is passed from the front end to the back end. In other compilers, semantic

EXAMPLE 1.24

GCD program abstract syntax tree

analysis ends with a traversal of the tree that generates some other intermediate form. One common such form consists of a *control flow graph* whose nodes resemble fragments of assembly language for a simple idealized machine. We will consider this option further in [Chapter 14](#), where a control flow graph for our GCD program appears in [Figure 14.3](#). In a suite of related compilers, the front ends for several languages and the back ends for several machines would share a common intermediate form.

1.6.3 Target Code Generation

The code generation phase of a compiler translates the intermediate form into the target language. Given the information contained in the syntax tree, generating correct code is usually not a difficult task (generating *good* code is harder, as we shall see in [Section 1.6.4](#)). To generate assembly or machine language, the code generator traverses the symbol table to assign locations to variables, and then traverses the intermediate representation of the program, generating loads and stores for variable references, interspersed with appropriate arithmetic operations, tests, and branches. Naive code for our GCD example appears in [Figure 1.6](#), in x86 assembly language. It was generated automatically by a simple pedagogical compiler.

EXAMPLE 1.25

GCD program assembly code

The assembly language mnemonics may appear a bit cryptic, but the comments on each line (not generated by the compiler!) should make the correspondence between [Figures 1.5](#) and [1.6](#) generally apparent. A few hints: `esp`, `ebp`, `eax`, `ebx`, and `edi` are registers (special storage locations, limited in number, that can be accessed very quickly). `-8(%ebp)` refers to the memory location 8 bytes before the location whose address is in register `ebp`; in this program, `ebp` serves as a *base* from which we can find variables `i` and `j`. The argument to a subroutine `call` instruction is passed by pushing it onto a stack, for which `esp` is the top-of-stack pointer. The return value comes back in register `eax`. Arithmetic operations overwrite their second argument with the result of the operation.¹¹ ■

Often a code generator will save the symbol table for later use by a symbolic debugger, by including it in a nonexecutable part of the target code.

1.6.4 Code Improvement

Code improvement is often referred to as *optimization*, though it seldom makes anything optimal in any absolute sense. It is an optional phase of compilation whose goal is to transform a program into a new version that computes the same result more efficiently—more quickly or using less memory, or both.

¹¹ As noted in footnote 1, these are GNU assembler conventions; Microsoft and Intel assemblers specify arguments in the opposite order.

```

    pushl   %ebp                # \
    movl   %esp, %ebp          # ) reserve space for local variables
    subl   $16, %esp           # /
    call   getint              # read
    movl   %eax, -8(%ebp)       # store i
    call   getint              # read
    movl   %eax, -12(%ebp)      # store j
A:  movl   -8(%ebp), %edi       # load i
    movl   -12(%ebp), %ebx      # load j
    cmpl   %ebx, %edi          # compare
    je     D                   # jump if i == j
    movl   -8(%ebp), %edi       # load i
    movl   -12(%ebp), %ebx      # load j
    cmpl   %ebx, %edi          # compare
    jle    B                   # jump if i < j
    movl   -8(%ebp), %edi       # load i
    movl   -12(%ebp), %ebx      # load j
    subl   %ebx, %edi           # i = i - j
    movl   %edi, -8(%ebp)       # store i
    jmp    C
B:  movl   -12(%ebp), %edi       # load j
    movl   -8(%ebp), %ebx      # load i
    subl   %ebx, %edi           # j = j - i
    movl   %edi, -12(%ebp)      # store j
C:  jmp    A
D:  movl   -8(%ebp), %ebx      # load i
    push   %ebx                # push i (pass to putint)
    call   putint              # write
    addl   $4, %esp            # pop i
    leave  %ebp                # deallocate space for local variables
    mov    $0, %eax            # exit status for program
    ret

```

Figure 1.6 Naive x86 assembly language for the GCD program.

Some improvements are machine independent. These can be performed as transformations on the intermediate form. Other improvements require an understanding of the target machine (or of whatever will execute the program in the target language). These must be performed as transformations on the target program. Thus code improvement often appears as two additional phases of compilation, one immediately after semantic analysis and intermediate code generation, the other immediately after target code generation.

EXAMPLE 1.26

GCD program
optimization

Applying a good code improver to the code in Figure 1.6 produces the code shown in Example 1.2 (page 5). Comparing the two programs, we can see that the improved version is quite a lot shorter. Conspicuously absent are most of the loads and stores. The machine-independent code improver is able to verify that *i* and *j* can be kept in registers throughout the execution of the main loop. (This would

not have been the case if, for example, the loop contained a call to a subroutine that might reuse those registers, or that might try to modify *i* or *j*.) The machine-specific code improver is then able to assign *i* and *j* to actual registers of the target machine. For modern microprocessor architectures, particularly those with so-called *superscalar* implementations (ones in which separate functional units can execute instructions simultaneously), compilers can usually generate better code than can human assembly language programmers. ■

✓ CHECK YOUR UNDERSTANDING

22. List the principal phases of compilation, and describe the work performed by each.
 23. Describe the form in which a program is passed from the scanner to the parser; from the parser to the semantic analyzer; from the semantic analyzer to the intermediate code generator.
 24. What distinguishes the front end of a compiler from the back end?
 25. What is the difference between a phase and a pass of compilation? Under what circumstances does it make sense for a compiler to have multiple passes?
 26. What is the purpose of the compiler's symbol table?
 27. What is the difference between static and dynamic semantics?
 28. On modern machines, do assembly language programmers still tend to write better code than a good compiler can? Why or why not?
-

1.7 Summary and Concluding Remarks

In this chapter we introduced the study of programming language design and implementation. We considered why there are so many languages, what makes them successful or unsuccessful, how they may be categorized for study, and what benefits the reader is likely to gain from that study. We noted that language design and language implementation are intimately related to one another. Obviously an implementation must conform to the rules of the language. At the same time, a language designer must consider how easy or difficult it will be to implement various features, and what sort of performance is likely to result for programs that use those features.

Language implementations are commonly differentiated into those based on interpretation and those based on compilation. We noted, however, that the difference between these approaches is fuzzy, and that most implementations include a bit of each. As a general rule, we say that a language is compiled if execution is preceded by a translation step that (1) fully analyzes both the structure (syntax)

and meaning (semantics) of the program, and (2) produces an equivalent program in a significantly different form. The bulk of the implementation material in this book pertains to compilation.

Compilers are generally structured as a series of *phases*. The first few phases—scanning, parsing, and semantic analysis—serve to analyze the source program. Collectively these phases are known as the compiler’s *front end*. The final few phases—intermediate code generation, code improvement, and target code generation—are known as the *back end*. They serve to build a target program—preferably a fast one—whose semantics match those of the source.

Chapters 3, 6, 7, 8, and 9 form the core of the rest of this book. They cover fundamental issues of language design, both from the point of view of the programmer and from the point of view of the language implementor. To support the discussion of implementations, Chapters 2 and 4 describe compiler front ends in more detail than has been possible in this introduction. Chapter 5 provides an overview of assembly-level architecture. Chapters 14 through 16 discuss compiler back ends, including assemblers and linkers, run-time systems, and code improvement techniques. Additional language paradigms are covered in Chapters 10 through 13. Appendix A lists the principal programming languages mentioned in the text, together with a genealogical chart and bibliographic references. Appendix B contains a list of “Design & Implementation” sidebars; Appendix C contains a list of numbered examples.

1.8 Exercises

- 1.1 Errors in a computer program can be classified according to when they are detected and, if they are detected at compile time, what part of the compiler detects them. Using your favorite imperative language, give an example of each of the following.
 - (a) A lexical error, detected by the scanner
 - (b) A syntax error, detected by the parser
 - (c) A static semantic error, detected by semantic analysis
 - (d) A dynamic semantic error, detected by code generated by the compiler
 - (e) An error that the compiler can neither catch nor easily generate code to catch (this should be a violation of the language definition, not just a program bug)
- 1.2 Consider again the Pascal tool set distributed by Niklaus Wirth (Example 1.15). After successfully building a machine language version of the Pascal compiler, one could in principle discard the P-code interpreter and the P-code version of the compiler. Why might one choose *not* to do so?
- 1.3 Imperative languages like Fortran and C are typically compiled, while scripting languages, in which many issues cannot be settled until run time, are typically interpreted. Is interpretation simply what one “has to do” when

compilation is infeasible, or are there actually some *advantages* to interpreting a language, even when a compiler is available?

- 1.4 The gcd program of [Example 1.20](#) might also be written

```
int main() {
    int i = getint(), j = getint();
    while (i != j) {
        if (i > j) i = i % j;
        else j = j % i;
    }
    putint(i);
}
```

Does this program compute the same result? If not, can you fix it? Under what circumstances would you expect one or the other to be faster?

- 1.5 In your local implementation of C, what is the limit on the size of integers? What happens in the event of arithmetic overflow? What are the implications of size limits on the portability of programs from one machine/compiler to another? How do the answers to these questions differ for Java? For Ada? For Pascal? For Scheme? (You may need to find a manual.)
- 1.6 The Unix `make` utility allows the programmer to specify *dependences* among the separately compiled pieces of a program. If file *A* depends on file *B* and file *B* is modified, `make` deduces that *A* must be recompiled, in case any of the changes to *B* would affect the code produced for *A*. How accurate is this sort of dependence management? Under what circumstances will it lead to unnecessary work? Under what circumstances will it fail to recompile something that needs to be recompiled?
- 1.7 Why is it difficult to tell whether a program is correct? How do you go about finding bugs in your code? What kinds of bugs are revealed by testing? What kinds of bugs are not? (For more formal notions of program correctness, see the bibliographic notes at the end of [Chapter 4](#).)

1.9 Explorations

- 1.8 (a) What was the first programming language you learned? If you chose it, why did you do so? If it was chosen for you by others, why do you think they chose it? What parts of the language did you find the most difficult to learn?
- (b) For the language with which you are most familiar (this may or may not be the first one you learned), list three things you wish had been differently designed. Why do you think they were designed the way they were? How would you fix them if you had the chance to do it over? Would there be any negative consequences, for example in terms of compiler complexity or program execution speed?

- 1.9 Get together with a classmate whose principal programming experience is with a language in a different category of Figure 1.1. (If your experience is mostly in C, for example, you might search out someone with experience in Lisp.) Compare notes. What are the easiest and most difficult aspects of programming, in each of your experiences? Pick a simple problem (e.g., sorting, or identification of connected components in a graph) and solve it using each of your favorite languages. Which solution is more elegant (do the two of you agree)? Which is faster? Why?
- 1.10 (a) If you have access to a Unix system, compile a simple program with the `-S` command-line flag. Add comments to the resulting assembly language file to explain the purpose of each instruction.
- (b) Now use the `-o` command-line flag to generate a *relocatable object file*. Using appropriate local tools (look in particular for `nm`, `objdump`, or a symbolic debugger like `gdb` or `dbx`), identify the machine language corresponding to each line of assembler.
- (c) Using `nm`, `objdump`, or a similar tool, identify the *undefined external symbols* in your object file. Now run the compiler to completion, to produce an *executable* file. Finally, run `nm` or `objdump` again to see what has happened to the symbols in part (b). Where did they come from—how did the linker resolve them?
- (d) Run the compiler to completion one more time, using the `-v` command-line flag. You should see messages describing the various subprograms invoked during the compilation process (some compilers use a different letter for this option; check the man page). The subprograms may include a preprocessor, separate passes of the compiler itself (often two), probably an assembler, and the linker. If possible, run these subprograms yourself, individually. Which of them produce the files described in the previous subquestions? Explain the purpose of the various command-line flags with which the subprograms were invoked.
- 1.11 Write a program that commits a dynamic semantic error (e.g., division by zero, access off the end of an array, dereference of a null pointer). What happens when you run this program? Does the compiler give you options to control what happens? Devise an experiment to evaluate the cost of run-time semantic checks. If possible, try this exercise with more than one language or compiler.
- 1.12 C has a reputation for being a relatively “unsafe” high-level language. In particular, it allows the programmer to mix operands of different sizes and types in many more ways than its “safer” cousins. The Unix `lint` utility can be used to search for potentially unsafe constructs in C programs. In effect, many of the rules that are enforced by the compiler in other languages are optional in C, and are enforced (if desired) by a separate program. What do you think of this approach? Is it a good idea? Why or why not?

- 1.13 Using an Internet search engine or magazine indexing service, read up on the history of Java and C#, including the conflict between Sun and Microsoft over Java standardization. Some have claimed that C# is, at least in part, Microsoft's attempt to kill Java. Defend or refute this claim.

1.10 Bibliographic Notes

The compiler-oriented chapters of this book attempt to convey a sense of what the compiler does, rather than explaining how to build one. A much greater level of detail can be found in other texts. Leading options include the work of Aho et al. [ALSU07] and of Cooper and Torczon [CT04]. Other excellent, though less current texts include those of Grune et al. [GBJL01], Appel [App97], and Fischer and LeBlanc [FL88]. Popular texts on programming language design include those of Louden [Lou03], Sebesta [Seb08], and Sethi [Set96].

Some of the best information on the history of programming languages can be found in the proceedings of conferences sponsored by the Association for Computing Machinery in 1978, 1993, and 2007 [Wex78, Ass93, Ass07]. Another excellent reference is Horowitz's 1987 text [Hor87]. A broader range of historical material can be found in the quarterly *IEEE Annals of the History of Computing*. Given the importance of personal taste in programming language design, it is inevitable that some language comparisons should be marked by strongly worded opinions. Examples include the writings of Dijkstra [Dij82], Hoare [Hoa81], Kernighan [Ker81], and Wirth [Wir85a].

Much modern software development takes place in integrated programming environments. Influential precursors to these environments include the Genera Common Lisp environment from Symbolics Corp. [WMWM87] and the Smalltalk [Gol84], Interlisp [TM81], and Cedar [SZBH86] environments at the Xerox Palo Alto Research Center.

This page intentionally left blank

Programming Language Syntax

2

EXAMPLE 2.1

Syntax of Arabic numerals

Unlike natural languages such as English or Chinese, computer languages must be precise. Both their form (syntax) and meaning (semantics) must be specified without ambiguity, so that both programmers and computers can tell what a program is supposed to do. To provide the needed degree of precision, language designers and implementors use formal syntactic and semantic notation. To facilitate the discussion of language features in later chapters, we will cover this notation first: syntax in the current chapter and semantics in [Chapter 4](#).

As a motivating example, consider the Arabic numerals with which we represent numbers. These numerals are composed of digits, which we can enumerate as follows (‘|’ means “or”):

$$\textit{digit} \longrightarrow 0 \mid 1 \mid 2 \mid 3 \mid 4 \mid 5 \mid 6 \mid 7 \mid 8 \mid 9$$

Digits are the syntactic building blocks for numbers. In the usual notation, we say that a natural number is represented by an arbitrary-length (nonempty) string of digits, beginning with a nonzero digit:

$$\textit{non_zero_digit} \longrightarrow 1 \mid 2 \mid 3 \mid 4 \mid 5 \mid 6 \mid 7 \mid 8 \mid 9$$
$$\textit{natural_number} \longrightarrow \textit{non_zero_digit} \textit{digit}^*$$

Here the “Kleene¹ star” metasympol (*) is used to indicate zero or more repetitions of the symbol to its left. ■

Of course, digits are only symbols: ink blobs on paper or pixels on a screen. They carry no meaning in and of themselves. We add semantics to digits when we say that they represent the natural numbers from zero to nine, as defined by mathematicians. Alternatively, we could say that they represent colors, or the days of the week in a decimal calendar. These would constitute alternative semantics for the same syntax. In a similar fashion, we define the semantics of natural

1 Stephen Kleene (1909–1994), a mathematician at the University of Wisconsin, was responsible for much of the early development of the theory of computation, including much of the material in Section ©2.4.

numbers by associating a base-10, place-value interpretation with each string of digits. Similar syntax rules and semantic interpretations can be devised for rational numbers, (limited-precision) real numbers, arithmetic, assignments, control flow, declarations, and indeed all of programming languages.

Distinguishing between syntax and semantics is useful for at least two reasons. First, different programming languages often provide features with very similar semantics but very different syntax. It is generally much easier to learn a new language if one is able to identify the common (and presumably familiar) ideas beneath the unfamiliar syntax. Second, there are some very efficient and elegant algorithms that a compiler or interpreter can use to discover the syntactic structure (but not the semantics!) of a computer program, and these algorithms can be used to drive the rest of the compilation or interpretation process.

In the current chapter we focus on syntax: how we specify the structural rules of a programming language, and how a compiler identifies the structure of a given input program. These two tasks—specifying syntax rules and figuring out how (and whether) a given program was built according to those rules—are distinct. The first is of interest mainly to programmers, who want to write valid programs. The second is of interest mainly to compilers, which need to analyze those programs. The first task relies on *regular expressions* and *context-free grammars*, which specify how to generate valid programs. The second task relies on *scanners* and *parsers*, which recognize program structure. We address the first of these tasks in [Section 2.1](#), the second in [Sections 2.2](#) and [2.3](#).

In [Section 2.4](#) (largely on the PLP CD) we take a deeper look at the formal theory underlying scanning and parsing. In theoretical parlance, a scanner is a *deterministic finite automaton* (DFA) that recognizes the tokens of a programming language. A parser is a deterministic *push-down automaton* (PDA) that recognizes the language's context-free syntax. It turns out that one can generate scanners and parsers automatically from regular expressions and context-free grammars. This task is performed by tools like Unix's `lex` and `yacc`.² Possibly nowhere else in computer science is the connection between theory and practice so clear and so compelling.

2.1 Specifying Syntax: Regular Expressions and Context-Free Grammars

Formal specification of syntax requires a set of rules. How complicated (expressive) the syntax can be depends on the kinds of rules we are allowed to use.

² At many sites, `lex` and `yacc` have been superseded by the GNU `flex` and `bison` tools. These independently developed, noncommercial alternatives are available without charge from the Free Software Foundation at www.gnu.org/software. They provide a superset of the functionality of `lex` and `yacc`.

It turns out that what we intuitively think of as tokens can be constructed from individual characters using just three kinds of formal rules: concatenation, alternation (choice among a finite set of alternatives), and so-called “Kleene closure” (repetition an arbitrary number of times). Specifying most of the rest of what we intuitively think of as syntax requires one additional kind of rule: recursion (creation of a construct from simpler instances of the same construct). Any set of strings that can be defined in terms of the first three rules is called a *regular set*, or sometimes a *regular language*. Regular sets are generated by *regular expressions* and recognized by scanners. Any set of strings that can be defined if we add recursion is called a *context-free language* (CFL). Context-free languages are generated by *context-free grammars* (CFGs) and recognized by parsers. (Terminology can be confusing here. The meaning of the word “language” varies greatly, depending on whether we’re talking about “formal” languages [e.g., regular or context-free], or programming languages. A formal language is just a set of strings, with no accompanying semantics.)

2.1.1 Tokens and Regular Expressions

Tokens are the basic building blocks of programs—the shortest strings of characters with individual meaning. Tokens come in many *kinds*, including keywords, identifiers, symbols, and constants of various types. Some kinds of token (e.g., the increment operator) correspond to only one string of characters. Others (e.g., *identifier*) correspond to a set of strings that share some common form. (In most languages, keywords are special strings of characters that have the right form to be identifiers, but are reserved for special purposes.) We will use the word “token” informally to refer to both the generic kind (an identifier, the increment operator) and the specific string (`foo`, `++`); the distinction between these should be clear from context.

EXAMPLE 2.2

Lexical structure of C99

Some languages have only a few kinds of token, of fairly simple form. Other languages are more complex. C, for example, has almost 100 kinds of tokens, including 37 keywords (`double`, `if`, `return`, `struct`, etc.); identifiers (`my_variable`, `your_type`, `sizeof`, `printf`, etc.); integer (`0765`, `0xf5`, `501`), floating-point (`6.022e23`), and character (`'x'`, `'\'`, `'\0170'`) constants; string literals (`"snerk"`, `"say \hi\"`); 54 “punctuators” (`+`, `]`, `->`, `*=`, `:`, `||`, etc.), and two different forms of comments. There are provisions for international character sets, string literals that span multiple lines of source code, constants of varying precision (width), alternative “spellings” for symbols that are missing on certain input devices, and preprocessor macros that build tokens from smaller pieces. Other large, modern languages (Java, Ada 95) are similarly complex. ■

To specify tokens, we use the notation of *regular expressions*. A regular expression is one of the following.

1. A character
2. The empty string, denoted ϵ

3. Two regular expressions next to each other, meaning any string generated by the first one followed by (concatenated with) any string generated by the second one
4. Two regular expressions separated by a vertical bar (|), meaning any string generated by the first one *or* any string generated by the second one
5. A regular expression followed by a Kleene star, meaning the concatenation of zero or more strings generated by the expression in front of the star

Parentheses are used to avoid ambiguity about where the various subexpressions start and end.³

EXAMPLE 2.3

Syntax of numeric constants

Consider, for example, the syntax of numeric constants accepted by a simple hand-held calculator:

```

number → integer | real
integer → digit digit*
real → integer exponent | decimal ( exponent | ε )
decimal → digit* ( . digit | digit . ) digit*
exponent → ( e | E ) ( + | - | ε ) integer
digit → 0 | 1 | 2 | 3 | 4 | 5 | 6 | 7 | 8 | 9

```

The symbols to the left of the \rightarrow signs provide names for the regular expressions. One of these (*number*) will serve as a token name; the others are simply for convenience in building larger expressions.⁴ Note that while we have allowed definitions to build on one another, nothing is ever defined in terms of itself, even indirectly. Such recursive definitions are the distinguishing characteristic of context-free grammars, described in the [Section 2.1.2](#). To generate a valid number, we expand out the sub-definitions and then scan the resulting expression from left to right, choosing among alternatives at each vertical bar, and choosing a number of repetitions at each Kleene star. Within each repetition we may make different choices at vertical bars, generating different substrings. ■

Character Sets and Formatting Issues

Upper- and lowercase letters in identifiers and keywords are considered distinct in some languages (e.g., Modula-2/3 and C and its descendants), and identical in others (e.g., Ada, Common Lisp, Fortran 90, and Pascal). Thus `f00`, `Foo`, and `F00` all represent the same identifier in Ada, but different identifiers in C. Modula-2 and Modula-3 require keywords and predefined (built-in) identifiers to be written

³ Some authors use λ to represent the empty string. Some use a period (.), rather than juxtaposition, to indicate concatenation. Some use a plus sign (+), rather than a vertical bar, to indicate alternation.

⁴ We have assumed here that all numeric constants are simply “numbers.” In many programming languages, integer and real constants are separate kinds of token. Their syntax may also be more complex than indicated here, to support such features as multiple lengths or nondecimal bases.

in uppercase; C and its descendants require them to be written in lowercase. A few languages (notably Modula-3 and Standard Pascal) allow only letters and digits in identifiers. Most (including many actual implementations of Pascal) allow underscores. A few (notably Lisp) allow a variety of additional characters. Some languages (e.g., Java, C#, and Modula-3) have standard conventions on the use of upper- and lowercase letters in names.⁵

With the globalization of computing, non-Latin character sets have become increasingly important. Many modern languages, including C99, C++, Ada 95, Java, C#, and Fortran 2003 have explicit support for multibyte character sets, generally based on the Unicode and ISO/IEC 10646 international standards. Most modern programming languages allow non-Latin characters to appear within comments and character strings; an increasing number allow them in identifiers as well. Conventions for portability across character sets and for *localization* to a given character set can be surprisingly complex, particularly when various forms of backward compatibility are required (the C99 Rationale devotes five full pages to this subject [Int99, pp. 19–23]); for the most part we ignore such issues here.

Some language implementations impose limits on the maximum length of identifiers, but most avoid such unnecessary restrictions. Most modern languages are also more-or-less *free format*, meaning that a program is simply a sequence of tokens: what matters is their order with respect to one another, not their physical position within a printed line or page. “White space” (blanks, tabs, carriage returns, and line and page feed characters) between tokens is usually ignored, except to the extent that it is needed to separate one token from the next. There are a few exceptions to these rules. Some language implementations limit the maximum length of a line, to allow the compiler to store the current line in a fixed-length buffer. Dialects of Fortran prior to Fortran 90 use a *fixed format*, with 72 characters per line (the width of a paper punch card, on which programs were once stored), and with different columns within the line reserved for different purposes. Linebreaks serve to separate statements in several other languages, including Haskell, Occam, SR, Tcl, and Python. Haskell, Occam, and Python also give special

DESIGN & IMPLEMENTATION

Formatting restrictions

Formatting limitations inspired by implementation concerns—as in the punch-card-oriented rules of Fortran 77 and its predecessors—have a tendency to become unwanted anachronisms as implementation techniques improve. Given the tendency of certain word processors to “fill” or auto-format text, the linebreak and indentation rules of languages like Haskell, Occam, and Python are somewhat controversial.

⁵ For the sake of consistency we do not always obey such conventions in this book: most examples follow the common practice of C programmers, in which underscores, rather than capital letters, separate the “subwords” of names.

significance to indentation. The body of a loop, for example, consists of precisely those subsequent lines that are indented farther than the header of the loop.

Other Uses of Regular Expressions

Many readers will be familiar with regular expressions from the `grep` family of tools in Unix, the search facilities of various text editors (notably `emacs`), or such scripting languages and tools as Perl, Python, Ruby, `awk`, and `sed`. Most of these provide a rich set of extensions to the notation of regular expressions. Some extensions, such as shorthand for “zero or one occurrences” or “anything other than white space,” do not change the power of the notation. Others, such as the ability to require a second occurrence, later in the input string, of the same character sequence that matched an earlier part of the expression, increase the power of the notation, so that it is no longer restricted to generating regular sets. Still other extensions are designed not to increase the expressiveness of the notation but rather to tie it to other language facilities. In many tools, for example, one can bracket portions of a regular expression in such a way that when a string is matched against it the contents of the corresponding substrings are assigned into named local variables. We will return to these issues in [Section 13.4.2](#), in the context of scripting languages.

2.1.2 Context-Free Grammars

Regular expressions work well for defining tokens. They are unable, however, to specify *nested* constructs, which are central to programming languages. Consider for example the structure of an arithmetic expression.

EXAMPLE 2.4
Syntactic nesting in
expressions

$$\begin{aligned} \text{expr} &\longrightarrow \text{id} \mid \text{number} \mid - \text{expr} \mid (\text{expr}) \\ &\quad \mid \text{expr op expr} \\ \text{op} &\longrightarrow + \mid - \mid * \mid / \end{aligned}$$

Here the ability to define a construct in terms of itself is crucial. Among other things, it allows us to ensure that left and right parentheses are matched, something that cannot be accomplished with regular expressions (see [Section 2.4.3](#) for more details). The arrow symbol (\longrightarrow) means “can have the form”; for brevity it is sometimes pronounced “goes to.” ■

Each of the rules in a context-free grammar is known as a *production*. The symbols on the left-hand sides of the productions are known as *variables*, or *nonterminals*. There may be any number of productions with the same left-hand side. Symbols that are to make up the strings derived from the grammar are known as *terminals* (shown here in typewriter font). They cannot appear on the left-hand side of any production. In a programming language, the terminals of the context-free grammar are the language’s tokens. One of the nonterminals, usually the one on the left-hand side of the first production, is called the *start symbol*. It names the construct defined by the overall grammar.

The notation for context-free grammars is sometimes called Backus-Naur Form (BNF), in honor of John Backus and Peter Naur, who devised it for the definition of the Algol-60 programming language [NBB⁺63].⁶ Strictly speaking, the Kleene star and meta-level parentheses of regular expressions are not allowed in BNF, but they do not change the expressive power of the notation, and are commonly included for convenience. Sometimes one sees a “Kleene plus” (+) as well; it indicates one or more instances of the symbol or group of symbols in front of it.⁷ When augmented with these extra operators, the notation is often called extended BNF (EBNF). The construct

EXAMPLE 2.5

Extended BNF (EBNF)

$$id_list \longrightarrow id (, id)^*$$

is shorthand for

$$id_list \longrightarrow id$$

$$id_list \longrightarrow id_list , id$$

“Kleene plus” is analogous. Note that the parentheses here are metasymbols. In [Example 2.4](#) they were part of the language being defined, and were written in fixed-width font.⁸

Like the Kleene star and parentheses, the vertical bar is in some sense superfluous, though it was provided in the original BNF. The construct

$$op \longrightarrow + \mid - \mid * \mid /$$

can be considered shorthand for

$$op \longrightarrow +$$

$$op \longrightarrow -$$

$$op \longrightarrow *$$

$$op \longrightarrow /$$

which is also sometimes written

$$op \longrightarrow +$$

$$\longrightarrow -$$

$$\longrightarrow *$$

$$\longrightarrow /$$

6 John Backus (1924–2007) was also the inventor of Fortran. He spent most of his professional career at IBM Corporation, and was named an IBM Fellow in 1987. He received the ACM Turing Award in 1977.

7 Some authors use curly braces ($\{ \}$) to indicate zero or more instances of the symbols inside. Some use square brackets ($[]$) to indicate zero or one instances of the symbols inside—that is, to indicate that those symbols are optional. In both regular and extended BNF, many authors use $::=$ instead of \longrightarrow .

8 To avoid confusion, some authors place quote marks around any single character that is part of the language being defined: $id_list \longrightarrow id (' , ' id)^*$; $expr \longrightarrow '(' expr ')'$.

Many tokens, such as `id` and `number` above, have many possible spellings (i.e., may be represented by many possible strings of characters). The parser is oblivious to these; it does not distinguish one identifier from another. The semantic analyzer does distinguish them, however; the scanner must save the spelling of each such “interesting” token for later use.

2.1.3 Derivations and Parse Trees

A context-free grammar shows us how to generate a syntactically valid string of terminals: Begin with the start symbol. Choose a production with the start symbol on the left-hand side; replace the start symbol with the right-hand side of that production. Now choose a nonterminal A in the resulting string, choose a production P with A on its left-hand side, and replace A with the right-hand side of P . Repeat this process until no nonterminals remain.

EXAMPLE 2.6

Derivation of `slope * x + intercept`

As an example, we can use our grammar for expressions to generate the string “`slope * x + intercept`”:

$$\begin{aligned}
 \text{expr} &\Rightarrow \text{expr op expr} \\
 &\Rightarrow \text{expr op id} \\
 &\Rightarrow \text{expr} + \text{id} \\
 &\Rightarrow \text{expr op expr} + \text{id} \\
 &\Rightarrow \text{expr op id} + \text{id} \\
 &\Rightarrow \text{expr} * \text{id} + \text{id} \\
 &\Rightarrow \text{id} * \text{id} + \text{id} \\
 &\quad (\text{slope}) \quad (\text{x}) \quad (\text{intercept})
 \end{aligned}$$

The \Rightarrow metasymbol is often pronounced “derives.” It indicates that the right-hand side was obtained by using a production to replace some nonterminal in the left-hand side. At each line we have underlined the symbol A that is replaced in the following line. ■

A series of replacement operations that shows how to derive a string of terminals from the start symbol is called a *derivation*. Each string of symbols along the way is called a *sentential form*. The final sentential form, consisting of only terminals, is called the *yield* of the derivation. We sometimes elide the intermediate steps and write $\text{expr} \Rightarrow^* \text{slope} * \text{x} + \text{intercept}$, where the metasymbol \Rightarrow^* means “derives after zero or more replacements.” In this particular derivation, we have chosen at each step to replace the right-most nonterminal with the right-hand side of some production. This replacement strategy leads to a *right-most* derivation. There are many other possible derivations, including *left-most* and options in-between.

We saw in [Chapter 1](#) that we can represent a derivation graphically as a *parse tree*. The root of the parse tree is the start symbol of the grammar. The leaves of the tree are its yield. Each internal node, together with its children, represents the use of a production.

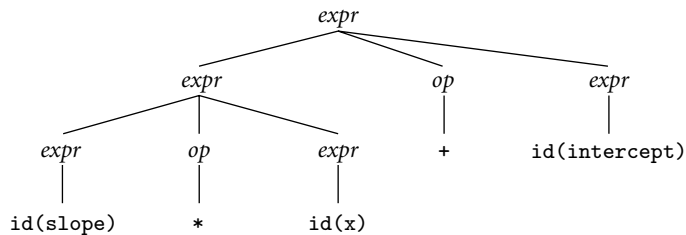

Figure 2.1 Parse tree for `slope * x + intercept` (grammar in Example 2.4).

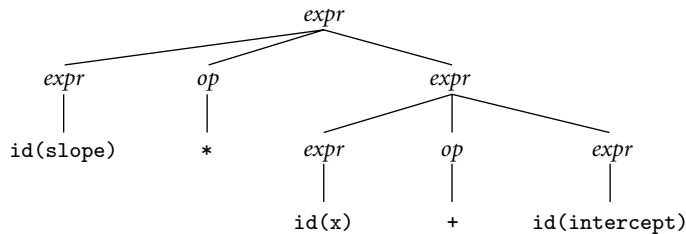

Figure 2.2 Alternative (less desirable) parse tree for `slope * x + intercept` (grammar in Example 2.4). The fact that more than one tree exists implies that our grammar is ambiguous.

EXAMPLE 2.7

Parse trees for `slope * x + intercept`

A parse tree for our example expression appears in Figure 2.1. This tree is not unique. At the second level of the tree, we could have chosen to turn the operator into a `*` instead of a `+`, and to further expand the expression on the right, rather than the one on the left (see Figure 2.2). A grammar that allows the construction of more than one parse tree for some string of terminals is said to be *ambiguous*. Ambiguity turns out to be a problem when trying to build a parser: it requires some extra mechanism to drive a choice between equally acceptable alternatives. ■

A moment's reflection will reveal that there are infinitely many context-free grammars for any given context-free language.⁹ Some grammars, however, are much more useful than others. In this text we will avoid the use of ambiguous grammars (though most parser generators allow them, by means of *disambiguating* rules). We will also avoid the use of so-called *useless* symbols: nonterminals that cannot generate any string of terminals, or terminals that cannot appear in the yield of any derivation.

When designing the grammar for a programming language, we generally try to find one that reflects the internal structure of programs in a way that is useful to the rest of the compiler. (We shall see in Section 2.3.2 that we also try to find one

⁹ Given a specific grammar, there are many ways to create other equivalent grammars. We could, for example, replace A with some new symbol B everywhere it appears in the right-hand side of a production, and then create a new production $B \rightarrow A$.

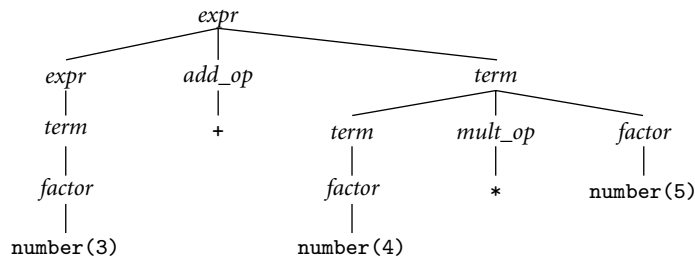

Figure 2.3 Parse tree for $3 + 4 * 5$, with precedence (grammar in Example 2.8).

that can be parsed efficiently, which can be a bit of a challenge.) One place in which structure is particularly important is in arithmetic expressions, where we can use productions to capture the *associativity* and *precedence* of the various operators. Associativity tells us that the operators in most languages group left to right, so that $10 - 4 - 3$ means $(10 - 4) - 3$ rather than $10 - (4 - 3)$. Precedence tells us that multiplication and division in most languages group more tightly than addition and subtraction, so that $3 + 4 * 5$ means $3 + (4 * 5)$ rather than $(3 + 4) * 5$. (These rules are not universal; we will consider them again in Section 6.1.1.)

EXAMPLE 2.8

Expression grammar with precedence and associativity

Here is a better version of our expression grammar:

1. $expr \rightarrow term \mid expr \text{ add_op } term$
2. $term \rightarrow factor \mid term \text{ mult_op } factor$
3. $factor \rightarrow id \mid number \mid - factor \mid (expr)$
4. $add_op \rightarrow + \mid -$
5. $mult_op \rightarrow * \mid /$

This grammar is unambiguous. It captures precedence in the way *factor*, *term*, and *expr* build on one another, with different operators appearing at each level. It captures associativity in the second halves of lines 1 and 2, which build sub*expr*s and sub*terms* to the left of the operator, rather than to the right. In Figure 2.3, we can see how building the notion of precedence into the grammar makes it clear that multiplication groups more tightly than addition in $3 + 4 * 5$, even without parentheses. In Figure 2.4, we can see that subtraction groups more tightly to the left, so that $10 - 4 - 3$ would evaluate to 3, rather than to 9. ■

✓ CHECK YOUR UNDERSTANDING

1. What is the difference between syntax and semantics?
2. What are the three basic operations that can be used to build complex regular expressions from simpler regular expressions?
3. What additional operation (beyond the three of regular expressions) is provided in context-free grammars?

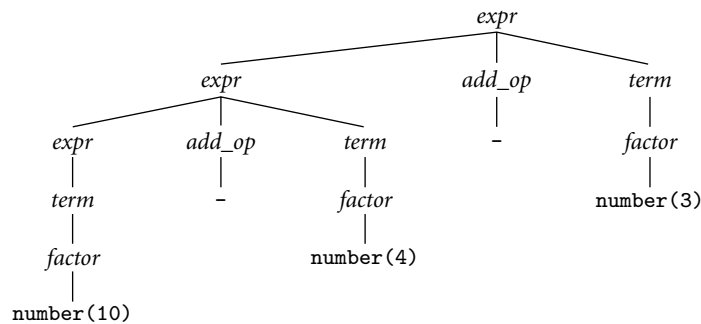

Figure 2.4 Parse tree for $10 - 4 - 3$, with left associativity (grammar in Example 2.8).

4. What is *Backus-Naur form*? When and why was it devised?
5. Name a language in which indentation affects program syntax.
6. When discussing context-free languages, what is a *derivation*? What is a *sentential form*?
7. What is the difference between a *right-most* derivation and a *left-most* derivation?
8. What does it mean for a context-free grammar to be *ambiguous*?
9. What are *associativity* and *precedence*? Why are they significant in parse trees?

2.2 Scanning

Together, the scanner and parser for a programming language are responsible for discovering the syntactic structure of a program. This process of discovery, or *syntax analysis*, is a necessary first step toward translating the program into an equivalent program in the target language. (It's also the first step toward interpreting the program directly. In general, we will focus on compilation, rather than interpretation, for the remainder of the book. Most of what we shall discuss either has an obvious application to interpretation, or is obviously irrelevant to it.)

By grouping input characters into tokens, the scanner dramatically reduces the number of individual items that must be inspected by the more computationally intensive parser. In addition, the scanner typically removes comments (so the parser doesn't have to worry about them appearing throughout the context-free grammar); saves the text of “interesting” tokens like identifiers, strings, and numeric literals; and tags tokens with line and column numbers, to make it easier to generate high-quality error messages in subsequent phases.

EXAMPLE 2.9

Tokens for a calculator language

In [Examples 2.4](#) and [2.8](#) we considered a simple language for arithmetic expressions. In [Section 2.3.1](#) we will extend this to create a simple “calculator language” with input, output, variables, and assignment. For this language we will use the following set of tokens.

```

assign → :=
plus → +
minus → -
times → *
div → /
lparen → (
rparen → )
id → letter (letter | digit)*
           except for read and write
number → digit digit* | digit* ( . digit | digit . ) digit*

```

In keeping with Algol and its descendants (and in contrast to the C-family languages), we have used `:=` rather than `=` for assignment. For simplicity, we have omitted the exponential notation found in [Example 2.3](#). We have also listed the tokens `read` and `write` as exceptions to the rule for `id` (more on this in [Section 2.2.2](#)). To make the task of the scanner a little more realistic, we borrow the two styles of comment from C:

```

comment → /* (non-* | * non-/** /
           | // (non-newline)* newline

```

Here we have used *non-**, *non-/***, and *non-newline* as shorthand for the alternation of all characters other than `*`, `/`, and *newline*, respectively. ■

EXAMPLE 2.10

An ad hoc scanner for calculator tokens

How might we go about recognizing the tokens of our calculator language? The simplest approach is entirely ad hoc. Pseudocode appears in [Figure 2.5](#). We can structure the code however we like, but it seems reasonable to check the simpler

DESIGN & IMPLEMENTATION**Nested comments**

Nested comments can be handy for the programmer (e.g., for temporarily “commenting out” large blocks of code). Scanners normally deal only with non-recursive constructs, however, so nested comments require special treatment. Some languages disallow them. Others require the language implementor to augment the scanner with special-purpose comment-handling code. C++ and C99 strike a compromise: `/* . . . */` style comments are not allowed to nest, but `/* . . . */` and `// . . .` style comments can appear inside each other. The programmer can thus use one style for “normal” comments and the other for “commenting out.” (The C99 designers note, however, that conditional compilation (`#if`) is preferable [[Int03a](#), p. 58].)

```

skip any initial white space (spaces, tabs, and newlines)
if cur_char ∈ { '(', ')', '+', '-', '*' }
    return the corresponding single-character token
if cur_char = ':'
    read the next character
    if it is '=' then return assign else announce an error
if cur_char = '/'
    peek at the next character
    if it is '*' or '/'
        read additional characters until "*" or newline is seen, respectively
        jump back to top of code
    else return div
if cur_char = .
    read the next character
    if it is a digit
        read any additional digits
        return number
    else announce an error
if cur_char is a digit
    read any additional digits and at most one decimal point
    return number
if cur_char is a letter
    read any additional letters and digits
    check to see whether the resulting string is read or write
    if so then return the corresponding token
    else return id
else announce an error

```

Figure 2.5 Outline of an ad hoc scanner for tokens in our calculator language.

and more common cases first, to peek ahead when we need to, and to embed loops for comments and for long tokens such as identifiers and numbers.

After finding a token the scanner returns to the parser. When invoked again it repeats the algorithm from the beginning, using the next available characters of input (including any that were peeked at but not consumed the last time). ■

As a rule, we accept the longest possible token in each invocation of the scanner. Thus `foobar` is always `foobar` and never `f` or `foo` or `foob`. More to the point, in a language like C, `3.14159` is a real number and never `3`, `.`, and `14159`. White space (blanks, tabs, newlines, comments) is generally ignored, except to the extent that it separates tokens (e.g., `foo bar` is different from `foobar`).

Figure 2.5 could be extended fairly easily to outline a scanner for some larger programming language. The result could then be fleshed out, by hand, to create code in some implementation language. Production compilers often use such ad hoc scanners; the code is fast and compact. During development, however, it is usually preferable to build a scanner in a more structured way, as an explicit representation of a *finite automaton*. Finite automata can be generated automatically

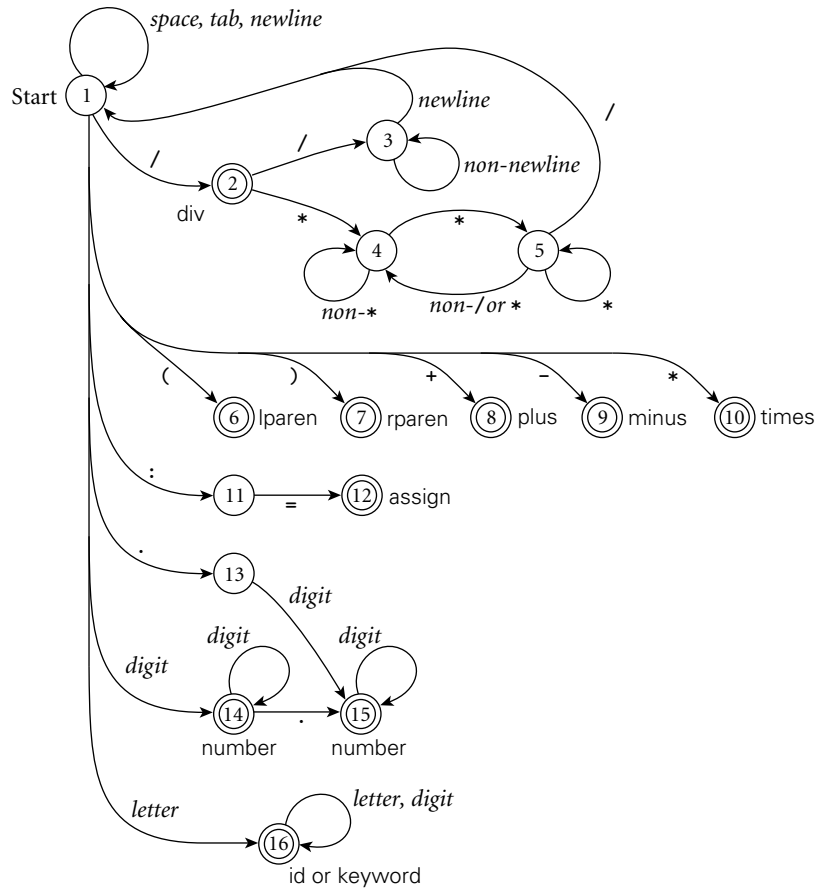

Figure 2.6 Pictorial representation of a scanner for calculator tokens, in the form of a finite automaton. This figure roughly parallels the code in Figure 2.5. States are numbered for reference in Figure 2.12. Scanning for each token begins in the state marked “Start.” The *final* states, in which a token is recognized, are indicated by double circles. Comments, when recognized, send the scanner back to its start state, rather than a final state.

from a set of regular expressions, making it easy to regenerate a scanner when token definitions change.

EXAMPLE 2.11

Finite automaton for a calculator scanner

An automaton for the tokens of our calculator language appears in pictorial form in Figure 2.6. The automaton starts in a distinguished initial state. It then moves from state to state based on the next available character of input. When it reaches one of a designated set of final states it recognizes the token associated with that state. The “longest possible token” rule means that the scanner returns to the parser only when the next character cannot be used to continue the current token. ■

2.2.1 Generating a Finite Automaton

While a finite automaton can in principle be written by hand, it is more common to build one automatically from a set of regular expressions, using a *scanner generator* tool. Because regular expressions are significantly easier to write and modify than is an ad hoc scanner, automatically generated scanners are often used during language or compiler development, or when ease of implementation is more important than the last little bit of run-time performance. In effect, regular expressions constitute a declarative programming language for a limited problem domain, namely that of scanning.

The example automaton of Figure 2.6 is *deterministic*: there is never any ambiguity about what it ought to do, because in a given state with a given input character there is never more than one possible outgoing transition (arrow) labeled by that character. As it turns out, however, there is no obvious one-step algorithm to convert a set of regular expressions into an equivalent deterministic finite automaton (DFA). The typical scanner generator implements the conversion as a series of three separate steps.

The first step converts the regular expressions into a *nondeterministic* finite automaton (NFA). An NFA is like a DFA except that (1) there may be more than one transition out of a given state labeled by a given character, and (2) there may be so-called *epsilon transitions*: arrows labeled by the empty string symbol, ϵ . The NFA is said to accept an input string (token) if there exists a path from the start state to a final state whose non-epsilon transitions are labeled, in order, by the characters of the token.

To avoid the need to search all possible paths for one that “works,” the second step of a scanner generator translates the NFA into an equivalent DFA: an automaton that accepts the same language, but in which there are no epsilon transitions, and no states with more than one outgoing transition labeled by the same character. The third step is a space optimization that generates a final DFA with the minimum possible number of states.

From a Regular Expression to an NFA

A trivial regular expression consisting of a single character c is equivalent to a simple two-state NFA (in fact, a DFA), illustrated in part (a) of Figure 2.7. Similarly, the regular expression ϵ is equivalent to a two-state NFA whose arc is labeled by ϵ . Starting with this base we can use three subconstructions, illustrated in parts (b) through (d) of the same figure, to build larger NFAs to represent the concatenation, alternation, or Kleene closure of the regular expressions represented by smaller NFAs. Each step preserves three invariants: there are no transitions into the initial state, there is a single final state, and there are no transitions out of the final state. These invariants allow smaller machines to be joined into larger machines without any ambiguity about where to create the connections, and without creating any unexpected paths. ■

EXAMPLE 2.12

Constructing an NFA for a given regular expression

EXAMPLE 2.13

NFA for $d^*(.d|d.)d^*$

To make these constructions concrete, we consider a small but nontrivial example—the *decimal* strings of Example 2.3. These consist of a string of decimal

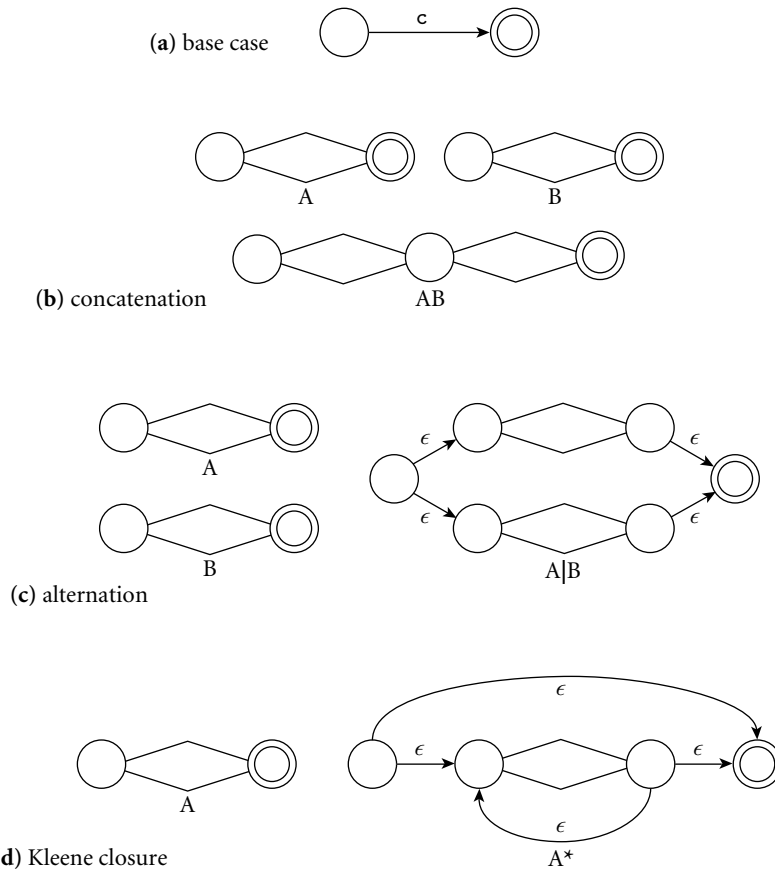

Figure 2.7 Construction of an NFA equivalent to a given regular expression. Part (a) shows the base case: the automaton for the single letter c . Parts (b), (c), and (d), respectively, show the constructions for concatenation, alternation, and Kleene closure. Each construction retains a unique start state and a single final state. Internal detail is hidden in the diamond-shaped center regions.

digits containing a single decimal point. With only one digit, the point can come at the beginning or the end: $(.d | d.)$, where for brevity we use d to represent any decimal digit. Arbitrary numbers of digits can then be added at the beginning or the end: $d^*(.d | d.)d^*$. Starting with this regular expression and using the constructions of Figure 2.7, we illustrate the construction of an equivalent NFA in Figure 2.8. ■

From an NFA to a DFA

EXAMPLE 2.14

DFA for $d^*(.d | d.)d^*$

With no way to “guess” the right transition to take from any given state, any practical implementation of an NFA would need to explore all possible transitions,

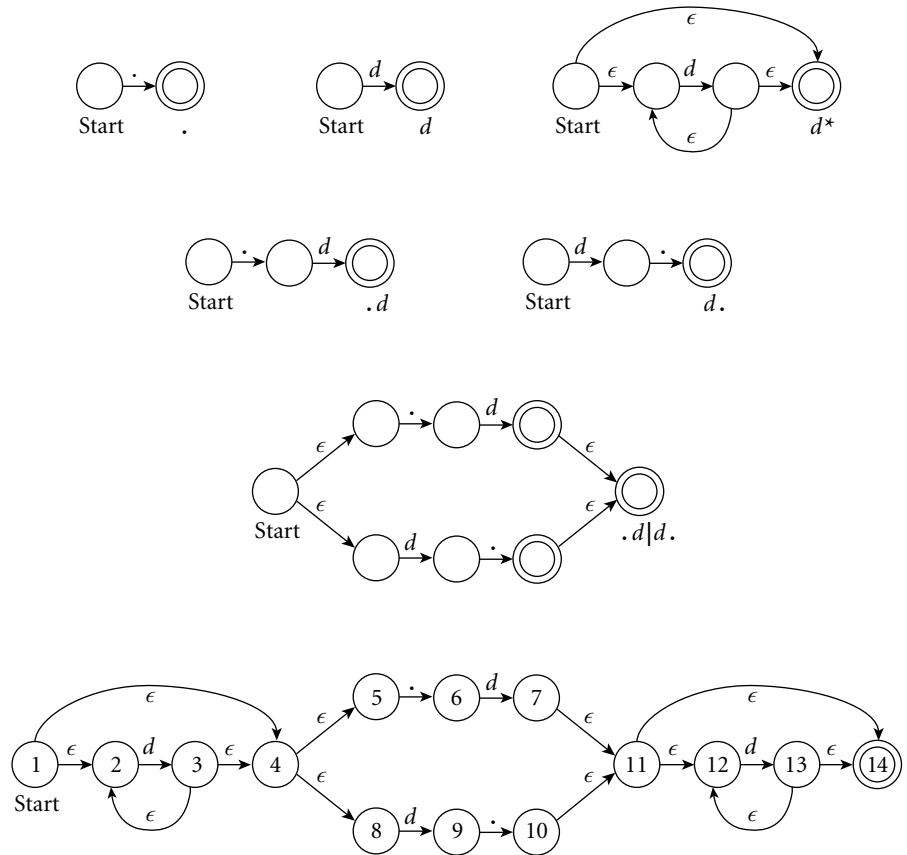

Figure 2.8 Construction of an NFA equivalent to the regular expression $d^*(.d|d.)d^*$. In the top row are the primitive automata for $.$ and d , and the Kleene closure construction for d^* . In the second and third rows we have used the concatenation and alternation constructions to build $.d$, $d.$, and $(.d|d.)$. The fourth row uses concatenation again to complete the NFA. We have labeled the states in the final automaton for reference in subsequent figures.

concurrently or via backtracking. To avoid such a complex and time-consuming strategy, we can use a “set of subsets” construction to transform the NFA into an equivalent DFA. The key idea is for the state of the DFA after reading a given input to represent the *set* of states that the NFA might have reached on the same input. We illustrate the construction in Figure 2.9 using the NFA from Figure 2.8. Initially, before it consumes any input, the NFA may be in State 1, or it may make epsilon transitions to States 2, 4, 5, or 8. We thus create an initial State A for our DFA to represent this set. On an input of d , our NFA may move from State 2 to State 3, or from State 8 to State 9. It has no other transitions on this input from any of the states in A . From State 3, however, the NFA may make epsilon transitions to any of States 2, 4, 5, or 8. We therefore create DFA State B as shown.

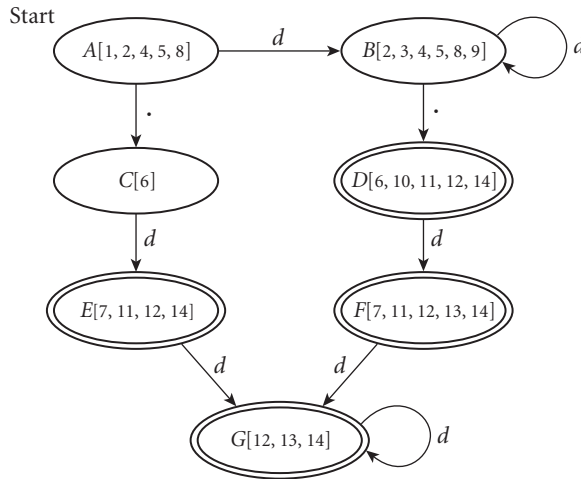

Figure 2.9 A DFA equivalent to the NFA at the bottom of Figure 2.8. Each state of the DFA represents the set of states that the NFA could be in after seeing the same input.

On a \cdot , our NFA may move from State 5 to State 6. There are no other transitions on this input from any of the states in A , and there are no epsilon transitions out of State 6. We therefore create the singleton DFA State C as shown. None of States A , B , or C is marked as final, because none contains a final state of the original NFA.

Returning to State B of the growing DFA, we note that on an input of d the original NFA may move from State 2 to State 3, or from State 8 to State 9. From State 3, in turn, it may move to States 2, 4, 5, or 8 via epsilon transitions. As these are exactly the states already in B , we create a self-loop in the DFA. Given a \cdot , on the other hand, the original NFA may move from State 5 to State 6, or from State 9 to State 10. From State 10, in turn, it may move to States 11, 12, or 14 via epsilon transitions. We therefore create DFA State D as shown, with a transition on \cdot from B to D . State D is marked as final because it contains state 14 of the original NFA. That is, given input $d\cdot$, there exists a path from the start state to the end state of the original NFA. Continuing our enumeration of state sets, we end up creating three more, labeled E , F , and G in Figure 2.9. Like State D , these all contain State 14 of the original NFA, and thus are marked as final. ■

In our example, the DFA ends up being smaller than the NFA, but this is only because our regular language is so simple. In theory, the number of states in the DFA may be exponential in the number of states in the NFA, but this extreme is also uncommon in practice. For a programming language scanner, the DFA tends to be larger than the NFA, but not outlandishly so. We consider space complexity in more detail in Section ©2.4.1.

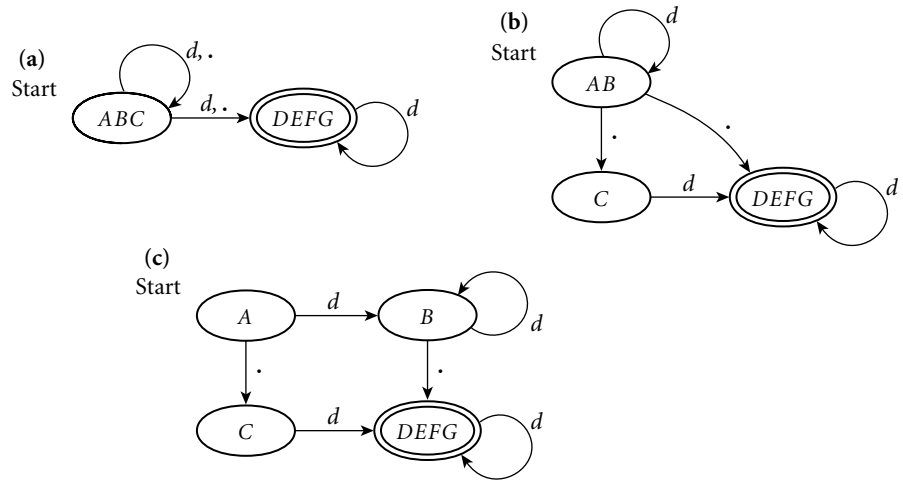

Figure 2.10 Minimization of the DFA of Figure 2.9. In each step we split a set of states to eliminate a transition ambiguity.

Minimizing the DFA

EXAMPLE 2.15

Minimal DFA for
 $d^*(\cdot d \mid d \cdot) d^*$

Starting from a regular expression we have now constructed an equivalent DFA. Though this DFA has seven states, a bit of thought suggests that a smaller one should exist. In particular, once we have seen both a d and a \cdot , the only valid transitions are on d , and we ought to be able to make do with a single final state. We can formalize this intuition, allowing us to apply it to any DFA, via the following inductive construction.

Initially we place the states of the (not necessarily minimal) DFA into two equivalence classes: final states and nonfinal states. We then repeatedly search for an equivalence class \mathcal{X} and an input symbol c such that when given c as input, the states in \mathcal{X} make transitions to states in $k > 1$ different equivalence classes. We then partition \mathcal{X} into k classes in such a way that all states in a given new class would move to a member of the same old class on c . When we are unable to find a class to partition in this fashion we are done.

In our example, the original placement puts States D , E , F , and G in one class (final states) and States A , B , and C in another, as shown in the upper left of Figure 2.10. Unfortunately, the start state has ambiguous transitions on both d and \cdot . To address the d ambiguity, we split ABC into AB and C , as shown in the upper right. New State AB has a self-loop on d ; new State C moves to State $DEFG$. State AB still has an ambiguity on \cdot , however, which we resolve by splitting it into States A and B , as shown at the bottom of the figure. At this point there are no further ambiguities, and we are left with a four-state minimal DFA. ■

2.2.2 Scanner Code

We can implement a scanner that explicitly captures the “circles-and-arrows” structure of a DFA in either of two main ways. One embeds the automaton in the control flow of the program using `gotos` or nested `case` (`switch`) statements; the other, described in the following subsection, uses a table and a driver. As a general rule, handwritten automata tend to use nested case statements, while most (but not all [BC93]) automatically generated automata use tables. Tables are hard to create by hand, but easier than code to create from within a program. Likewise, nested case statements are easier to write and to debug than the ad hoc approach of Figure 2.5, if not quite as efficient. Unix’s `lex/flex` tool produces C language output containing tables and a customized driver.

EXAMPLE 2.16

Nested case statement automaton

The nested case statement style of automaton has the following general structure.

DESIGN & IMPLEMENTATION

Recognizing multiple kinds of token

One of the chief ways in which a scanner differs from a formal DFA is that it *identifies* tokens in addition to recognizing them. That is, it not only determines whether characters constitute a valid token; it also indicates *which one*. In practice, this means that it must have separate final states for every kind of token. We glossed over this issue in our RE-to-DFA constructions.

To build a scanner for a language with n different kinds of tokens, we begin with an NFA of the sort suggested in the figure here. Given NFAs M_i , $1 \leq i \leq n$ (one machine for each kind of token), we create a new start state with epsilon transitions to the start states of the M_i s. In contrast to the alternation construction of Figure 2.7(c), however, we do *not* create a single final state; we keep the existing ones, each labeled by the token for which it is final. We then apply the NFA-to-DFA construction as before. (If final states for different tokens in the NFA ever end up in the same state of the DFA, then we have ambiguous token definitions. These may be resolved by changing the regular expressions from which the NFAs were derived, or by wrapping additional logic around the DFA.)

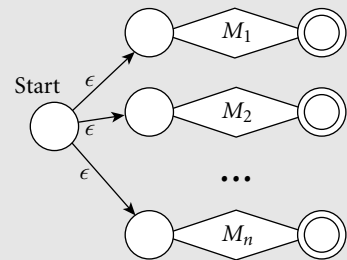

In the DFA minimization construction, instead of starting with two equivalence classes (final and nonfinal states), we begin with $n + 1$, including a separate class for final states for each of the kinds of token. Exercise 2.5 explores this construction for a scanner that recognizes both the *integer* and *decimal* types of Example 2.3.

```

state := 1          -- start state
loop
  read cur_char
  case state of
    1 : case cur_char of
        ' '; '\t', '\n' : ...
        'a'...'z' :     ...
        '0'...'9' :     ...
        '>' :           ...
        ...
    2 : case cur_char of
        ...
    ...
    n: case cur_char of
        ...

```

The outer case statement covers the states of the finite automaton. The inner case statements cover the transitions out of each state. Most of the inner clauses simply set a new state. Some return from the scanner with the current token. (If the current character should not be part of that token, it is pushed back onto the input stream before returning.) ■

Two aspects of the code typically deviate from the strict form of a formal finite automaton. One is the handling of keywords. The other is the need to peek ahead when a token can validly be extended by two or more additional characters, but not by only one.

As noted at the beginning of [Section 2.1.1](#), keywords in most languages look just like identifiers, but are reserved for a special purpose (some authors use the term *reserved word* instead of keyword¹⁰). It is possible to write a finite automaton that distinguishes between keywords and identifiers, but it requires a *lot* of states (see [Exercise 2.3](#)). Most scanners, both handwritten and automatically generated, therefore treat keywords as “exceptions” to the rule for identifiers. Before returning an identifier to the parser, the scanner looks it up in a hash table or trie (a tree of branching paths) to make sure it isn’t really a keyword.

Whenever one legitimate token is a prefix of another, the “longest possible token” rule says that we should continue scanning. If some of the intermediate strings are not valid tokens, however, we can’t tell whether a longer token is possible without looking more than one character ahead. This problem arises with dot characters (periods) in C. Suppose the scanner has just seen a 3 and has a dot coming up in the input. It needs to peek at characters beyond the dot in order to distinguish between 3.14 (a single token designating a real number), 3 . foo

EXAMPLE 2.17

The nontrivial prefix problem

10 Keywords (reserved words) are not the same as *predefined* identifiers. Predefined identifiers can be redefined to have a different meaning; keywords cannot. The scanner does not distinguish between predefined and other identifiers. It does distinguish between identifiers and keywords. C doesn’t really have any predefined identifiers, but many languages do. In Pascal, for example, the names of built-in types and standard library functions are predefined but not reserved.

(three tokens that the scanner should accept, even though the parser will object to seeing them in that order), and `3 . . . foo` (again not syntactically valid, but three separate tokens nonetheless). In general, upcoming characters that a scanner must examine in order to make a decision are known as its *look-ahead*. In [Section 2.3](#) we will see a similar notion of look-ahead *tokens* in parsing. ■

EXAMPLE 2.18

Look-ahead in Fortran scanning

In messier languages, a scanner may need to look an arbitrary distance ahead. In Fortran IV, for example, `DO 5 I = 1,25` is the header of a loop (it executes the statements up to the one labeled 5 for values of `I` from 1 to 25), while `DO 5 I = 1.25` is an assignment statement that places the value 1.25 into the variable `D05I`. Spaces are ignored in (pre-Fortran 90) Fortran input, even in the middle of variable names. Moreover, variables need not be declared, and the terminator for a `DO` loop is simply a label, which the parser can ignore. After seeing `DO`, the scanner cannot tell whether the 5 is part of the current token until it reaches the comma or dot. It has been widely (but apparently incorrectly) claimed that NASA's Mariner 1 space probe was lost due to accidental replacement of a comma with a dot in a case similar to this one in flight control software.¹¹ Dialects of Fortran starting with Fortran 77 allow (in fact encourage) the use of alternative syntax for loop headers, in which an extra comma makes misinterpretation less likely: `DO 5, I = 1, 25`. ■

In C, the the dot character problem can easily be handled as a special case. In languages requiring larger amounts of look-ahead, the scanner can take a more general approach. In any case of ambiguity, it assumes that a longer token will be possible, but remembers that a shorter token could have been recognized at some point in the past. It also buffers all characters read beyond the end of the shorter token. If the optimistic assumption leads the scanner into an error state, it “unreads” the buffered characters so that they will be seen again later, and returns the shorter token.

DESIGN & IMPLEMENTATION

Longest possible tokens

A little care in syntax design—avoiding tokens that are nontrivial prefixes of other tokens—can dramatically simplify scanning. In straightforward cases of prefix ambiguity the scanner can enforce the “longest possible token” rule automatically. In Fortran, however, the rules are sufficiently complex that no purely lexical solution suffices. Some of the problems, and a possible solution, are discussed in an article by Dyadkin [[Dya95](#)].

11 In actuality, the faulty software for Mariner 1 appears to have stemmed from a missing “bar” punctuation mark (indicating an average) in handwritten notes from which the software was derived [[Cer89](#), pp. 202–203]. The Fortran `DO` loop error does appear to have occurred in at least one piece of NASA software, but no serious harm resulted [[Web89](#)].

2.2.3 Table-Driven Scanning

EXAMPLE 2.19

Table-driven scanning

In the preceding subsection we sketched how control flow—a loop and nested case statements—can be used to represent a finite automaton. An alternative approach represents the automaton as a data structure: a two-dimensional *transition table*. A driver program (Figure 2.11) uses the current state and input character to index into the table. Each entry in the table specifies whether to move to a new state (and if so, which one), return a token, or announce an error. A second table indicates, for each state, whether we might be at the end of a token (and if so, which one). Separating this second table from the first allows us to notice when we pass a state that might have been the end of a token, so we can back up if we hit an error state. Example tables for our calculator tokens appear in Figure 2.12.

Like a handwritten scanner, the table-driven code of Figure 2.11 looks tokens up in a table of keywords immediately before returning. An outer loop serves to filter out comments and “white space”—spaces, tabs, and newlines. These character sequences are not meaningful to the parser, and would in fact be very difficult to represent in a grammar (Exercise 2.20). ■

2.2.4 Lexical Errors

The code in Figure 2.11 explicitly recognizes the possibility of *lexical errors*. In some cases the next character of input may be neither an acceptable continuation of the current token nor the start of another token. In such cases the scanner must print an error message and perform some sort of recovery so that compilation can continue, if only to look for additional errors. Fortunately, lexical errors are relatively rare—most character sequences do correspond to token sequences—and relatively easy to handle. The most common approach is simply to (1) throw away the current, invalid token; (2) skip forward until a character is found that can legitimately begin a new token; (3) restart the scanning algorithm; and (4) count on the error-recovery mechanism of the parser to cope with any cases in which the resulting sequence of tokens is not syntactically valid. Of course the need for error recovery is not unique to table-driven scanners; any scanner must cope with errors. We did not show the code in Figure 2.5, but it would have to be there in practice.

The code in Figure 2.11 also shows that the scanner must return both the kind of token found and its character-string image (spelling); again this requirement applies to all types of scanners. For some tokens the character-string image is redundant: all semicolons look the same, after all, as do all `while` keywords. For other tokens, however (e.g., identifiers, character strings, and numeric constants), the image is needed for semantic analysis. It is also useful for error messages: “undeclared identifier” is not as nice as “foo has not been declared.”

```

state = 0 .. number_of_states
token = 0 .. number_of_tokens
scan_tab : array [char, state] of record
    action : (move, recognize, error)
    new_state : state
token_tab : array [state] of token      -- what to recognize
keyword_tab : set of record
    k_image : string
    k_token : token
-- these three tables are created by a scanner generator tool

tok : token
cur_char : char
remembered_chars : list of char
repeat
    cur_state : state := start_state
    image : string := null
    remembered_state : state := 0      -- none
    loop
        read cur_char
        case scan_tab[cur_char, cur_state].action
        move:
            if token_tab[cur_state] ≠ 0
                -- this could be a final state
                remembered_state := cur_state
                remembered_chars := ε
                add cur_char to remembered_chars
                cur_state := scan_tab[cur_char, cur_state].new_state
            recognize:
                tok := token_tab[cur_state]
                unread cur_char      -- push back into input stream
                exit inner loop
            error:
                if remembered_state ≠ 0
                    tok := token_tab[remembered_state]
                    unread remembered_chars
                    remove remembered_chars from image
                    exit inner loop
                -- else print error message and recover; probably start over
                append cur_char to image
        -- end inner loop
until tok ∉ {white_space, comment}
look image up in keyword_tab and replace tok with appropriate keyword if found
return (tok, image)

```

Figure 2.11 Driver for a table-driven scanner, with code to handle the ambiguous case in which one valid token is a prefix of another, but some intermediate string is not.

State	Current input character														
	<i>space, tab</i>	<i>newline</i>	/	*	()	+	-	:	=	.	<i>digit</i>	<i>letter</i>		<i>other</i>
1	17	17	2	10	6	7	8	9	11	-	13	14	16	-	
2	-	-	3	4	-	-	-	-	-	-	-	-	-	-	div
3	3	18	3	3	3	3	3	3	3	3	3	3	3	3	
4	4	4	4	5	4	4	4	4	4	4	4	4	4	4	
5	4	4	18	5	4	4	4	4	4	4	4	4	4	4	
6	-	-	-	-	-	-	-	-	-	-	-	-	-	-	lparen
7	-	-	-	-	-	-	-	-	-	-	-	-	-	-	rparen
8	-	-	-	-	-	-	-	-	-	-	-	-	-	-	plus
9	-	-	-	-	-	-	-	-	-	-	-	-	-	-	minus
10	-	-	-	-	-	-	-	-	-	-	-	-	-	-	times
11	-	-	-	-	-	-	-	-	-	12	-	-	-	-	
12	-	-	-	-	-	-	-	-	-	-	-	-	-	-	assign
13	-	-	-	-	-	-	-	-	-	-	-	15	-	-	
14	-	-	-	-	-	-	-	-	-	-	15	14	-	-	number
15	-	-	-	-	-	-	-	-	-	-	-	15	-	-	number
16	-	-	-	-	-	-	-	-	-	-	-	16	16	-	identifier
17	17	17	-	-	-	-	-	-	-	-	-	-	-	-	white_space
18	-	-	-	-	-	-	-	-	-	-	-	-	-	-	comment

Figure 2.12 Scanner tables for the calculator language. These could be used by the code of Figure 2.11. States are numbered as in Figure 2.6, except for the addition of two states—17 and 18—to “recognize” white space and comments. The right-hand column represents table `token_tab`; the rest of the figure is `scan_tab`. Dashes indicate no way to extend the current token. Table `keyword_tab` (not shown) contains the strings `read` and `write`.

2.2.5 Pragmas

Some languages and language implementations allow a program to contain constructs called *pragmas* that provide directives or hints to the compiler. Pragmas that do not change program semantics—only the compilation process—are sometimes called *significant comments*. In some languages the name is also appropriate because, like comments, pragmas can appear anywhere in the source program. In this case they are usually processed by the scanner: allowing them anywhere in the grammar would greatly complicate the parser. In other languages (Ada, for example), pragmas are permitted only at certain well-defined places in the grammar. In this case they are best processed by the parser or semantic analyzer.

Pragmas that serve as directives may:

- Turn various kinds of run-time checks (e.g., pointer or subscript checking) on or off
- Turn certain code improvements on or off (e.g., on in inner loops to improve performance; off otherwise to improve compilation speed)

- Enable or disable performance profiling (statistics gathering to identify program bottlenecks)

Some directives “cross the line” and change program semantics. In Ada, for example, the `unchecked pragma` can be used to disable type checking. In OpenMP, which we will consider in [Chapter 12](#), pragmas specify significant parallel extensions to Fortran, C and C++: creating, scheduling, and synchronizing threads. In this case the principal rationale for expressing the extensions as pragmas rather than more deeply integrated changes is to sharply delineate the boundary between the core language and the extensions, and to share a common set of extensions across languages.

Pragmas that serve (merely) as hints provide the compiler with information about the source program that may allow it to do a better job:

- Variable `x` is very heavily used (it may be a good idea to keep it in a register).
- Subroutine `F` is a pure function: its only effect on the rest of the program is the value it returns.
- Subroutine `S` is not (indirectly) recursive (its storage may be statically allocated).
- 32 bits of precision (instead of 64) suffice for floating-point variable `x`.

The compiler may ignore these in the interest of simplicity, or in the face of contradictory information.

✓ CHECK YOUR UNDERSTANDING

10. List the tasks performed by the typical scanner.
 11. What are the advantages of an automatically generated scanner, in comparison to a handwritten one? Why do many commercial compilers use a handwritten scanner anyway?
 12. Explain the difference between deterministic and nondeterministic finite automata. Why do we prefer the deterministic variety for scanning?
 13. Outline the constructions used to turn a set of regular expressions into a minimal DFA.
 14. What is the “longest possible token” rule?
 15. Why must a scanner sometimes “peek” at upcoming characters?
 16. What is the difference between a *keyword* and an *identifier*?
 17. Why must a scanner save the text of tokens?
 18. How does a scanner identify lexical errors? How does it respond?
 19. What is a *pragma*?
-

2.3 Parsing

The parser is the heart of a typical compiler. It calls the scanner to obtain the tokens of the input program, assembles the tokens together into a syntax tree, and passes the tree (perhaps one subroutine at a time) to the later phases of the compiler, which perform semantic analysis and code generation and improvement. In effect, the parser is “in charge” of the entire compilation process; this style of compilation is sometimes referred to as *syntax-directed translation*.

As noted in the introduction to this chapter, a context-free grammar (CFG) is a *generator* for a CF language. A parser is a language *recognizer*. It can be shown that for any CFG we can create a parser that runs in $O(n^3)$ time, where n is the length of the input program.¹² There are two well-known parsing algorithms that achieve this bound: Earley’s algorithm [Ear70] and the Cocke-Younger-Kasami (CYK) algorithm [Kas65, You67]. Cubic time is much too slow for parsing sizable programs, but fortunately not all grammars require such a general and slow parsing algorithm. There are large classes of grammars for which we can build parsers that run in linear time. The two most important of these classes are called LL and LR.

LL stands for “Left-to-right, Left-most derivation.” LR stands for “Left-to-right, Right-most derivation.” In both classes the input is read left-to-right, and the parser attempts to discover (construct) a derivation of that input. For LL parsers, the derivation will be left-most; for LR parsers, right-most. We will cover LL parsers first. They are generally considered to be simpler and easier to understand. They can be written by hand or generated automatically from an appropriate grammar by a parser-generating tool. The class of LR grammars is larger (i.e., more grammars are LR than LL), and some people find the structure of the LR grammars more intuitive, especially in the handling of arithmetic expressions. LR parsers are almost always constructed by a parser-generating tool. Both classes of parsers are used in production compilers, though LR parsers are more common.

LL parsers are also called “top-down,” or “predictive” parsers. They construct a parse tree from the root down, predicting at each step which production will be used to expand the current node, based on the next available token of input. LR parsers are also called “bottom-up” parsers. They construct a parse tree from the leaves up, recognizing when a collection of leaves or other nodes can be joined together as the children of a single parent.

We can illustrate the difference between top-down and bottom-up parsing by means of a simple example. Consider the following grammar for a comma-separated list of identifiers, terminated by a semicolon:

$$id_list \rightarrow id\ id_list_tail$$

EXAMPLE 2.20

Top-down and bottom-up parsing

¹² In general, an algorithm is said to run in time $O(f(n))$, where n is the length of the input, if its running time $t(n)$ is proportional to $f(n)$ in the worst case. More precisely, we say $t(n) = O(f(n)) \iff \exists c, m [n > m \rightarrow t(n) < c f(n)]$.

$$\begin{aligned} id_list_tail &\rightarrow , id id_list_tail \\ id_list_tail &\rightarrow ; \end{aligned}$$

These are the productions that would normally be used for an identifier list in a top-down parser. They can also be parsed bottom-up (most top-down grammars can be). In practice they would not be used in a bottom-up parser, for reasons that will become clear in a moment, but the ability to handle them either way makes them good for this example.

Progressive stages in the top-down and bottom-up construction of a parse tree for the string *A, B, C*; appear in Figure 2.13. The top-down parser begins by predicting that the root of the tree (*id_list*) will be replaced by *id id_list_tail*. It then matches the *id* against a token obtained from the scanner. (If the scanner produced something different, the parser would announce a syntax error.) The parser then moves down into the first (in this case only) nonterminal child and predicts that *id_list_tail* will be replaced by *, id id_list_tail*. To make this prediction it needs to peek at the upcoming token (a comma), which allows it to choose between the two possible expansions for *id_list_tail*. It then matches the comma and the *id* and moves down into the next *id_list_tail*. In a similar, recursive fashion, the top-down parser works down the tree, left-to-right, predicting and expanding nodes and tracing out a left-most derivation of the fringe of the tree.

The bottom-up parser, by contrast, begins by noting that the left-most leaf of the tree is an *id*. The next leaf is a comma and the one after that is another *id*. The parser continues in this fashion, shifting new leaves from the scanner into a forest of partially completed parse tree fragments, until it realizes that some of those fragments constitute a complete right-hand side. In this grammar, that doesn't occur until the parser has seen the semicolon—the right-hand side of *id_list_tail* $\rightarrow ;$. With this right-hand side in hand, the parser reduces the semicolon to an *id_list_tail*. It then reduces *, id id_list_tail* into another *id_list_tail*. After doing this one more time it is able to reduce *id id_list_tail* into the root of the parse tree, *id_list*.

At no point does the bottom-up parser predict what it will see next. Rather, it shifts tokens into its forest until it recognizes a right-hand side, which it then reduces to a left-hand side. Because of this behavior, bottom-up parsers are sometimes called shift-reduce parsers. Moving up the figure, from bottom to top, we can see that the shift-reduce parser traces out a right-most derivation, in reverse. Because bottom-up parsers were the first to receive careful formal study, right-most derivations are sometimes called *canonical*. ■

There are several important subclasses of LR parsers, including SLR, LALR, and “full LR.” SLR and LALR are important for their ease of implementation, full LR for its generality. LL parsers can also be grouped into SLL and “full LL” subclasses. We will cover the differences among them only briefly here; for further information see any of the standard compiler-construction or parsing theory textbooks [App97, ALSU07, AU72, CT04, FL88].

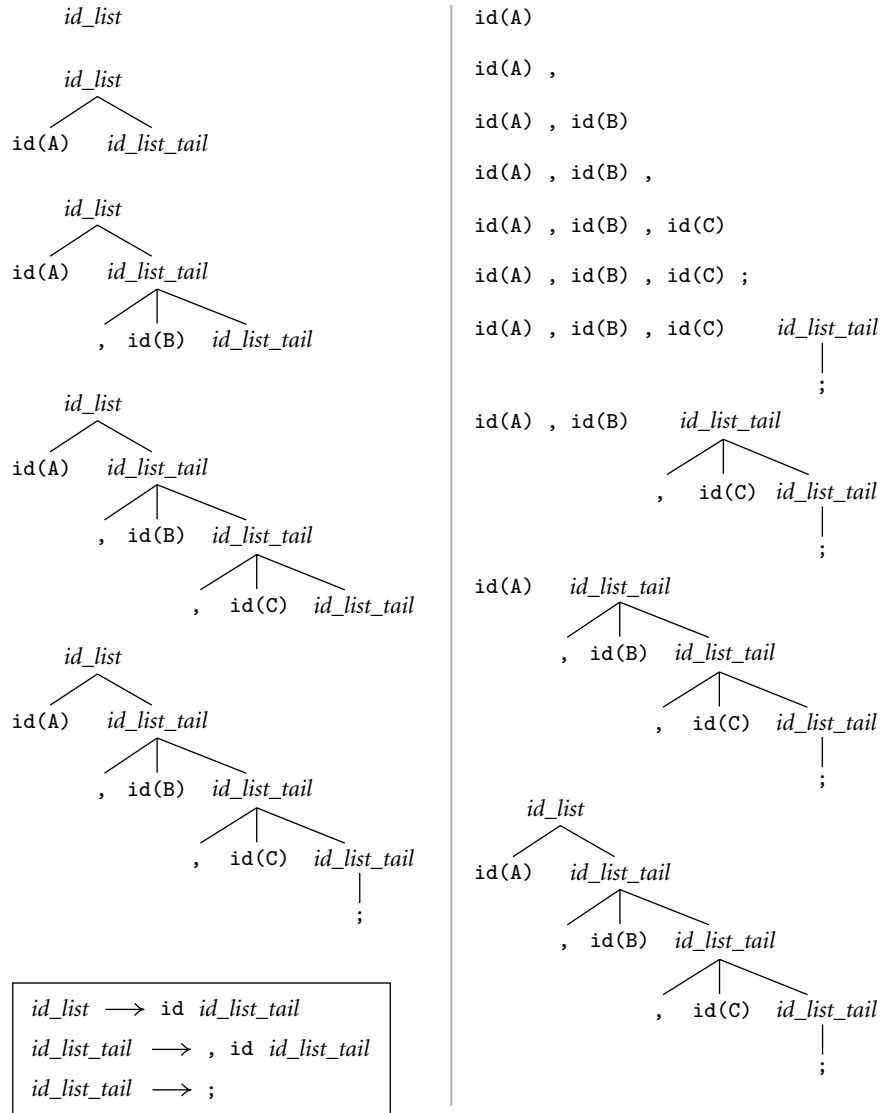

Figure 2.13 Top-down (left) and bottom-up parsing (right) of the input string *A, B, C;*. Grammar appears at lower left.

One commonly sees LL or LR (or whatever) written with a number in parentheses after it: LL(2) or LALR(1), for example. This number indicates how many tokens of look-ahead are required in order to parse. Most real compilers use just one token of look-ahead, though more can sometimes be helpful. Terrence Parr's open-source ANTLR tool, in particular, uses multitoken look-ahead to enlarge

the class of languages amenable to top-down parsing [PQ95]. In Section 2.3.1 we will look at LL(1) grammars and handwritten parsers in more detail. In Sections 2.3.2 and 2.3.3 we will consider automatically generated LL(1) and LR(1) (actually SLR(1)) parsers.

EXAMPLE 2.21

Bounding space with a bottom-up grammar

The problem with our example grammar, for the purposes of bottom-up parsing, is that it forces the compiler to shift all the tokens of an *id_list* into its forest before it can reduce any of them. In a very large program we might run out of space. Sometimes there is nothing that can be done to avoid a lot of shifting. In this case, however, we can use an alternative grammar that allows the parser to reduce prefixes of the *id_list* into nonterminals as it goes along:

$$\begin{aligned} id_list &\longrightarrow id_list_prefix ; \\ id_list_prefix &\longrightarrow id_list_prefix , id \\ &\longrightarrow id \end{aligned}$$

This grammar cannot be parsed top-down, because when we see an *id* on the input and we're expecting an *id_list_prefix*, we have no way to tell which of the two possible productions we should predict (more on this dilemma in Section 2.3.2). As shown in Figure 2.14, however, the grammar works well bottom-up. ■

2.3.1 Recursive Descent

EXAMPLE 2.22

Top-down grammar for a calculator language

To illustrate top-down (predictive) parsing, let us consider the grammar for a simple “calculator” language, shown in Figure 2.15. The calculator allows values to be read into (numeric) variables, which may then be used in expressions. Expressions in turn can be written to the output. Control flow is strictly linear (no loops, *if* statements, or other jumps). The end-marker ($\$$) pseudotoken is produced by the scanner at the end of the input. This token allows the parser to terminate cleanly once it has seen the entire program. As in regular expressions, we use the symbol ϵ to denote the empty string. A production with ϵ on the right-hand side is sometimes called an *epsilon production*.

It may be helpful to compare the *expr* portion of Figure 2.15 to the expression grammar of Example 2.8 (page 50). Most people find that previous, LR grammar to be significantly more intuitive. It suffers, however, from a problem similar to that of the *id_list* grammar of Example 2.21: if we see an *id* on the input when expecting an *expr*, we have no way to tell which of the two possible productions to predict. The grammar of Figure 2.15 avoids this problem by merging the common prefixes of right-hand sides into a single production, and by using new symbols (*term_tail* and *factor_tail*) to generate additional operators and operands as required. The transformation has the unfortunate side effect of placing the operands of a given operator in separate right-hand sides. In effect, we have sacrificed grammatical elegance in order to be able to parse predictively. ■

So how do we parse a string with our calculator grammar? We saw the basic idea in Figure 2.13. We start at the top of the tree and predict needed productions on the basis of the current left-most nonterminal in the tree and the current

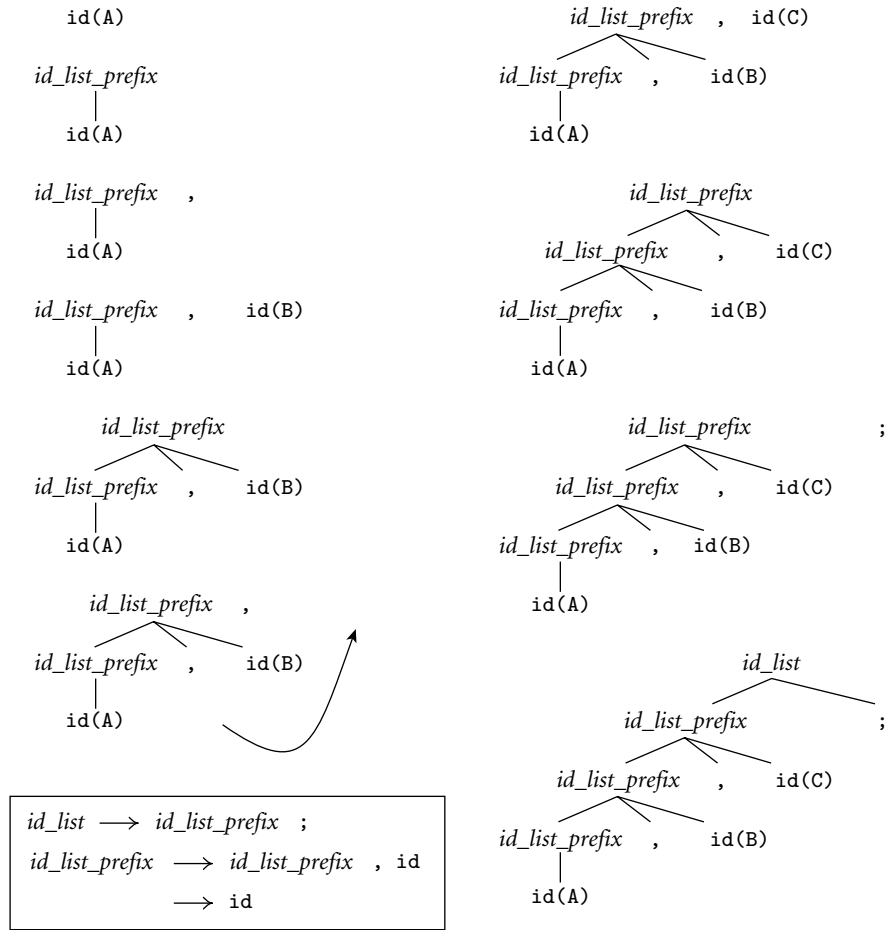

Figure 2.14 Bottom-up parse of A, B, C; using a grammar (lower left) that allows lists to be collapsed incrementally.

input token. We can formalize this process in one of two ways. The first, described in the remainder of this subsection, is to build a *recursive descent parser* whose subroutines correspond, one-one, to the nonterminals of the grammar. Recursive descent parsers are typically constructed by hand, though the ANTLR parser generator constructs them automatically from an input grammar. The second approach, described in [Section 2.3.2](#), is to build an *LL parse table* which is then read by a driver program. Table-driven parsers are almost always constructed automatically by a parser generator. These two options—recursive descent and table-driven—are reminiscent of the nested case statements and table-driven approaches to building a scanner that we saw in [Sections 2.2.2](#) and [2.2.3](#). It should be emphasized that they implement the same basic parsing algorithm.

```

program → stmt_list $$
stmt_list → stmt stmt_list | ε
stmt → id := expr | read id | write expr
expr → term term_tail
term_tail → add_op term term_tail | ε
term → factor factor_tail
factor_tail → mult_op factor factor_tail | ε
factor → ( expr ) | id | number
add_op → + | -
mult_op → * | /

```

Figure 2.15 LL(1) grammar for a simple calculator language.

Handwritten recursive descent parsers are most often used when the language to be parsed is relatively simple, or when a parser-generator tool is not available. There are exceptions, however. In particular, recursive descent appears in recent versions of the GNU compiler collection (`gcc`). Earlier versions used `bison` to create a bottom-up parser automatically. The change was made in part for performance reasons and in part to enable the generation of higher-quality syntax error messages. (The `bison` code was easier to write, and arguably easier to maintain.)

EXAMPLE 2.23

Recursive descent parser for the calculator language

Pseudocode for a recursive descent parser for our calculator language appears in Figure 2.16. It has a subroutine for every nonterminal in the grammar. It also has a mechanism `input_token` to inspect the next token available from the scanner and a subroutine (`match`) to consume and update this token, and in the process verify that it is the one that was expected (as specified by an argument). If `match` or any of the other subroutines sees an unexpected token, then a syntax error has occurred. For the time being let us assume that the `parse_error` subroutine simply prints a message and terminates the parse. In Section 2.3.4 we will consider how to recover from such errors and continue to parse the remainder of the input. ■

EXAMPLE 2.24

Recursive descent parse of a “sum and average” program

Suppose now that we are to parse a simple program to read two numbers and print their sum and average:

```

read A
read B
sum := A + B
write sum
write sum / 2

```

The parse tree for this program appears in Figure 2.17. The parser begins by calling the subroutine `program`. After noting that the initial token is a `read`,

program calls `stmt.list` and then attempts to match the end-of-file pseudotoken. (In the parse tree, the root, *program*, has two children, *stmt.list* and `$$`.) Procedure `stmt.list` again notes that the upcoming token is a `read`. This observation allows it to determine that the current node (*stmt.list*) generates *stmt stmt.list* (rather than ϵ). It therefore calls `stmt` and `stmt.list` before returning. Continuing in this fashion, the execution path of the parser traces out a left-to-right depth-first traversal of the parse tree. This correspondence between the dynamic execution trace and the structure of the parse tree is the distinguishing characteristic of recursive descent parsing. Note that because the *stmt.list* non-terminal appears in the right-hand side of a *stmt.list* production, the `stmt.list` subroutine must call itself. This recursion accounts for the name of the parsing technique. ■

Without additional code (not shown in Figure 2.16), the parser merely verifies that the program is syntactically correct (i.e., that none of the otherwise `parse_error` clauses in the case statements are executed and that match always sees what it expects to see). To be of use to the rest of the compiler—which must produce an equivalent target program in some other language—the parser must save the parse tree or some other representation of program fragments as an explicit data structure. To save the parse tree itself, we can allocate and link together records to represent the children of a node immediately before executing the recursive subroutines and match invocations that represent those children. We shall need to pass each recursive routine an argument that points to the record that is to be expanded (i.e., whose children are to be discovered). Procedure `match` will also need to save information about certain tokens (e.g., character-string representations of identifiers and literals) in the leaves of the tree.

As we saw in Chapter 1, the parse tree contains a great deal of irrelevant detail that need not be saved for the rest of the compiler. It is therefore rare for a parser to construct a full parse tree explicitly. More often it produces an abstract syntax tree or some other more terse representation. In a recursive descent compiler, a syntax tree can be created by allocating and linking together records in only a subset of the recursive calls.

The trickiest part of writing a recursive descent parser is figuring out which tokens should label the arms of the case statements. Each arm represents one production: one possible expansion of the symbol for which the subroutine was named. The tokens that label a given arm are those that *predict* the production. A token *X* may predict a production for either of two reasons: (1) the right-hand side of the production, when recursively expanded, may yield a string beginning with *X*, or (2) the right-hand side may yield nothing (i.e., it is ϵ , or a string of nonterminals that may recursively yield ϵ), and *X* may begin the yield of what comes *next*. In the following subsection we will formalize this notion of prediction using sets called `FIRST` and `FOLLOW`, and show how to derive them automatically from an LL(1) CFG.

```

procedure match(expected)
  if input_token = expected then consume input_token
  else parse_error

-- this is the start routine:
procedure program
  case input_token of
    id, read, write, $$ :
      stmt_list
      match($$)
    otherwise parse_error

procedure stmt_list
  case input_token of
    id, read, write : stmt; stmt_list
    $$ : skip      -- epsilon production
    otherwise parse_error

procedure stmt
  case input_token of
    id : match(id); match(:=); expr
    read : match(read); match(id)
    write : match(write); expr
    otherwise parse_error

procedure expr
  case input_token of
    id, number, ( : term; term_tail
    otherwise parse_error

procedure term_tail
  case input_token of
    +, - : add_op; term; term_tail
    ), id, read, write, $$ :
      skip      -- epsilon production
    otherwise parse_error

procedure term
  case input_token of
    id, number, ( : factor; factor_tail
    otherwise parse_error

```

Figure 2.16 Recursive descent parser for the calculator language. Execution begins in procedure program. The recursive calls trace out a traversal of the parse tree. Not shown is code to save this tree (or some similar structure) for use by later phases of the compiler. (*continued*)

```

procedure factor_tail
  case input_token of
    *, / : mult_op; factor; factor_tail
    +, -, ), id, read, write, $$ :
      skip      -- epsilon production
    otherwise parse_error

procedure factor
  case input_token of
    id : match(id)
    number : match(number)
    ( : match( (, expr; match() )
    otherwise parse_error

procedure add_op
  case input_token of
    + : match(+)
    - : match(-)
    otherwise parse_error

procedure mult_op
  case input_token of
    * : match(*)
    / : match(/)
    otherwise parse_error

```

Figure 2.16 (continued)

✓ CHECK YOUR UNDERSTANDING

20. What is the inherent “big-O” complexity of parsing? What is the complexity of parsers used in real compilers?
21. Summarize the difference between LL and LR parsing. Which one of them is also called “bottom-up”? “Top-down”? Which one is also called “predictive”? “Shift-reduce”? What do “LL” and “LR” stand for?
22. What kind of parser (top-down or bottom-up) is most common in production compilers?
23. Why are right-most derivations sometimes called *canonical*?
24. What is the significance of the “1” in LR(1)?
25. Why might we want (or need) different grammars for different parsing algorithms?
26. What is an *epsilon production*?
27. What are *recursive descent* parsers? Why are they used mostly for small languages?
28. How might a parser construct an explicit parse tree or syntax tree?

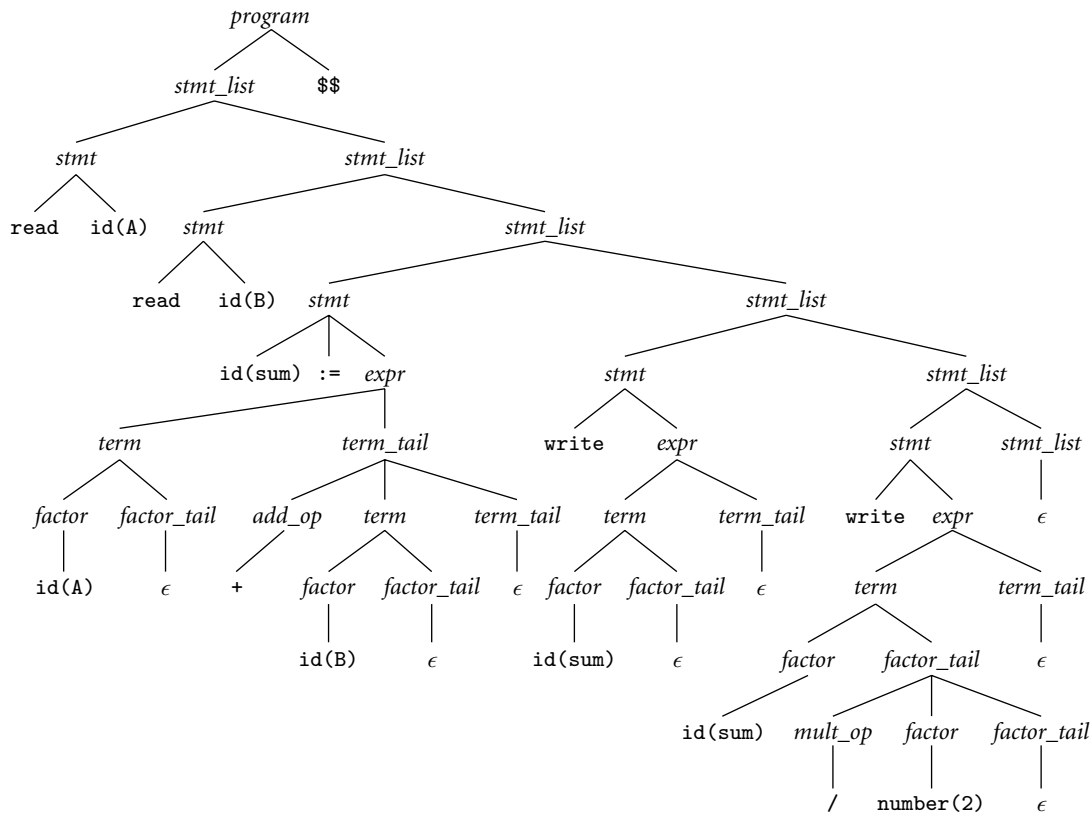

Figure 2.17 Parse tree for the sum-and-average program of Example 2.24, using the grammar of Figure 2.15.

2.3.2 Table-Driven Top-Down Parsing

EXAMPLE 2.25

Driver and table for top-down parsing

In a recursive descent parser, each arm of a case statement corresponds to a production, and contains parsing routine and match calls corresponding to the symbols on the right-hand side of that production. At any given point in the parse, if we consider the calls beyond the program counter (the ones that have yet to occur) in the parsing routine invocations currently in the call stack, we obtain a list of the symbols that the parser expects to see between here and the end of the program. A table-driven top-down parser maintains an explicit stack containing this same list of symbols.

Pseudocode for such a parser appears in Figure 2.18. The code is language independent. It requires a language-dependent parsing table, generally produced by an automatic tool. For the calculator grammar of Figure 2.15, the table appears in Figure 2.19. ■

EXAMPLE 2.26

Table-driven parse of the “sum and average” program

To illustrate the algorithm, Figure 2.20 shows a trace of the stack and the input over time, for the sum-and-average program of Example 2.24. The parser iterates around a loop in which it pops the top symbol off the stack and performs

```

terminal = 1 .. number_of_terminals
non_terminal = number_of_terminals + 1 .. number_of_symbols
symbol = 1 .. number_of_symbols
production = 1 .. number_of Productions

parse_tab : array [non_terminal, terminal] of record
    action : (predict, error)
    prod : production
prod_tab : array [production] of list of symbol
-- these two tables are created by a parser generator tool

parse_stack : stack of symbol

parse_stack.push(start_symbol)
loop
    expected_sym : symbol := parse_stack.pop
    if expected_sym ∈ terminal
        match(expected_sym)           -- as in Figure 2.16
        if expected_sym = $$ then return -- success!
    else
        if parse_tab[expected_sym, input_token].action = error
            parse_error
        else
            prediction : production := parse_tab[expected_sym, input_token].prod
            foreach sym : symbol in reverse prod_tab[prediction]
                parse_stack.push(sym)

```

Figure 2.18 Driver for a table-driven LL(1) parser.

Top-of-stack nonterminal	Current input token											
	id	number	read	write	:=	()	+	-	*	/	\$\$
<i>program</i>	1	-	1	1	-	-	-	-	-	-	-	1
<i>stmt_list</i>	2	-	2	2	-	-	-	-	-	-	-	3
<i>stmt</i>	4	-	5	6	-	-	-	-	-	-	-	-
<i>expr</i>	7	7	-	-	-	7	-	-	-	-	-	-
<i>term_tail</i>	9	-	9	9	-	-	9	8	8	-	-	9
<i>term</i>	10	10	-	-	-	10	-	-	-	-	-	-
<i>factor_tail</i>	12	-	12	12	-	-	12	12	12	11	11	12
<i>factor</i>	14	15	-	-	-	13	-	-	-	-	-	-
<i>add_op</i>	-	-	-	-	-	-	-	16	17	-	-	-
<i>mult_op</i>	-	-	-	-	-	-	-	-	-	18	19	-

Figure 2.19 LL(1) parse table for the calculator language. Table entries indicate the production to predict (as numbered in Figure 2.22). A dash indicates an error: When the top-of-stack symbol is a terminal, the appropriate action is always to match it against an incoming token from the scanner. An auxiliary table, not shown here, gives the right-hand-side symbols for each production.

Parse stack	Input stream	Comment
<i>program</i>	read A read B ...	initial stack contents
<i>stmt_list</i> \$\$	read A read B ...	predict <i>program</i> \rightarrow <i>stmt_list</i> \$\$
<i>stmt stmt_list</i> \$\$	read A read B ...	predict <i>stmt_list</i> \rightarrow <i>stmt stmt_list</i>
read id <i>stmt_list</i> \$\$	read A read B ...	predict <i>stmt</i> \rightarrow read id
id <i>stmt_list</i> \$\$	A read B ...	match read
<i>stmt_list</i> \$\$	read B sum := ...	match id
<i>stmt stmt_list</i> \$\$	read B sum := ...	predict <i>stmt_list</i> \rightarrow <i>stmt stmt_list</i>
read id <i>stmt_list</i> \$\$	read B sum := ...	predict <i>stmt</i> \rightarrow read id
id <i>stmt_list</i> \$\$	B sum := ...	match read
<i>stmt_list</i> \$\$	sum := A + B ...	match id
<i>stmt stmt_list</i> \$\$	sum := A + B ...	predict <i>stmt_list</i> \rightarrow <i>stmt stmt_list</i>
id := <i>expr stmt_list</i> \$\$	sum := A + B ...	predict <i>stmt</i> \rightarrow id := <i>expr</i>
:= <i>expr stmt_list</i> \$\$:= A + B ...	match id
<i>expr stmt_list</i> \$\$	A + B ...	match :=
<i>term term_tail stmt_list</i> \$\$	A + B ...	predict <i>expr</i> \rightarrow <i>term term_tail</i>
<i>factor factor_tail term_tail stmt_list</i> \$\$	A + B ...	predict <i>term</i> \rightarrow <i>factor factor_tail</i>
id <i>factor_tail term_tail stmt_list</i> \$\$	A + B ...	predict <i>factor</i> \rightarrow id
<i>factor_tail term_tail stmt_list</i> \$\$	+ B write sum ...	match id
<i>term_tail stmt_list</i> \$\$	+ B write sum ...	predict <i>factor_tail</i> \rightarrow ϵ
<i>add_op term term_tail stmt_list</i> \$\$	+ B write sum ...	predict <i>term_tail</i> \rightarrow <i>add_op term term_tail</i>
+ <i>term term_tail stmt_list</i> \$\$	+ B write sum ...	predict <i>add_op</i> \rightarrow +
<i>term term_tail stmt_list</i> \$\$	B write sum ...	match +
<i>factor factor_tail term_tail stmt_list</i> \$\$	B write sum ...	predict <i>term</i> \rightarrow <i>factor factor_tail</i>
id <i>factor_tail term_tail stmt_list</i> \$\$	B write sum ...	predict <i>factor</i> \rightarrow id
<i>factor_tail term_tail stmt_list</i> \$\$	write sum ...	match id
<i>term_tail stmt_list</i> \$\$	write sum write ...	predict <i>factor_tail</i> \rightarrow ϵ
<i>stmt_list</i> \$\$	write sum write ...	predict <i>term_tail</i> \rightarrow ϵ
<i>stmt stmt_list</i> \$\$	write sum write ...	predict <i>stmt_list</i> \rightarrow <i>stmt stmt_list</i>
write <i>expr stmt_list</i> \$\$	write sum write ...	predict <i>stmt</i> \rightarrow write <i>expr</i>
<i>expr stmt_list</i> \$\$	sum write sum / 2	match write
<i>term term_tail stmt_list</i> \$\$	sum write sum / 2	predict <i>expr</i> \rightarrow <i>term term_tail</i>
<i>factor factor_tail term_tail stmt_list</i> \$\$	sum write sum / 2	predict <i>term</i> \rightarrow <i>factor factor_tail</i>
id <i>factor_tail term_tail stmt_list</i> \$\$	sum write sum / 2	predict <i>factor</i> \rightarrow id
<i>factor_tail term_tail stmt_list</i> \$\$	write sum / 2	match id
<i>term_tail stmt_list</i> \$\$	write sum / 2	predict <i>factor_tail</i> \rightarrow ϵ
<i>stmt_list</i> \$\$	write sum / 2	predict <i>term_tail</i> \rightarrow ϵ
<i>stmt stmt_list</i> \$\$	write sum / 2	predict <i>stmt_list</i> \rightarrow <i>stmt stmt_list</i>
write <i>expr stmt_list</i> \$\$	write sum / 2	predict <i>stmt</i> \rightarrow write <i>expr</i>
<i>expr stmt_list</i> \$\$	sum / 2	match write
<i>term term_tail stmt_list</i> \$\$	sum / 2	predict <i>expr</i> \rightarrow <i>term term_tail</i>
<i>factor factor_tail term_tail stmt_list</i> \$\$	sum / 2	predict <i>term</i> \rightarrow <i>factor factor_tail</i>
id <i>factor_tail term_tail stmt_list</i> \$\$	sum / 2	predict <i>factor</i> \rightarrow id
<i>factor_tail term_tail stmt_list</i> \$\$	/ 2	match id
<i>mult_op factor factor_tail term_tail stmt_list</i> \$\$	/ 2	predict <i>factor_tail</i> \rightarrow <i>mult_op factor factor_tail</i>
/ <i>factor factor_tail term_tail stmt_list</i> \$\$	/ 2	predict <i>mult_op</i> \rightarrow /
<i>factor factor_tail term_tail stmt_list</i> \$\$	2	match /
number <i>factor_tail term_tail stmt_list</i> \$\$	2	predict <i>factor</i> \rightarrow number
<i>factor_tail term_tail stmt_list</i> \$\$		match number
<i>term_tail stmt_list</i> \$\$		predict <i>factor_tail</i> \rightarrow ϵ
<i>stmt_list</i> \$\$		predict <i>term_tail</i> \rightarrow ϵ
\$\$		predict <i>stmt_list</i> \rightarrow ϵ

Figure 2.20 Trace of a table-driven LL(1) parse of the sum-and-average program of Example 2.24.

the following actions. If the popped symbol is a terminal, the parser attempts to match it against an incoming token from the scanner. If the match fails, the parser announces a syntax error and initiates some sort of error recovery (see [Section 2.3.4](#)). If the popped symbol is a nonterminal, the parser uses that nonterminal together with the next available input token to index into a two-dimensional table that tells it which production to predict (or whether to announce a syntax error and initiate recovery).

Initially, the parse stack contains the start symbol of the grammar (in our case, *program*). When it predicts a production, the parser pushes the right-hand-side symbols onto the parse stack in reverse order, so the first of those symbols ends up at top-of-stack. The parse completes successfully when we match the end token, $\$ \$$. Assuming that $\$ \$$ appears only once in the grammar, at the end of the first production, and that the scanner returns this token only at end-of-file, any syntax error is guaranteed to manifest itself either as a failed match or as an error entry in the table. ■

Predict Sets

As we hinted at the end of [Section 2.3.1](#), predict sets are defined in terms of simpler sets called FIRST and FOLLOW, where $\text{FIRST}(A)$ is the set of all tokens that could be the start of an A and $\text{FOLLOW}(A)$ is the set of all tokens that could come after an A in some valid program. If we extend the domain of FIRST in the obvious way to include *strings* of symbols, we then say that the predict set of a production $A \rightarrow \beta$ is $\text{FIRST}(\beta)$, plus $\text{FOLLOW}(A)$ if $\beta \Rightarrow^* \epsilon$. For notational convenience, we define the predicate EPS such that $\text{EPS}(\beta) \equiv \beta \Rightarrow^* \epsilon$.¹³

We can illustrate the algorithm to construct these sets using our calculator grammar ([Figure 2.15](#)). We begin with “obvious” facts about the grammar and build on them inductively. If we recast the grammar in plain BNF (no EBNF ‘|’ constructs), then it has 19 productions. The “obvious” facts arise from adjacent pairs of symbols in right-hand sides. In the first production, we can see that $\$ \$ \in \text{FOLLOW}(\textit{stmt_list})$. In the second ($\textit{stmt_list} \rightarrow \epsilon$), $\text{EPS}(\textit{stmt_list}) = \text{true}$. In the fourth production ($\textit{stmt} \rightarrow \textit{id} := \textit{expr}$), $\textit{id} \in \text{FIRST}(\textit{stmt})$ and $:= \in \text{FOLLOW}(\textit{id})$. In the fifth and sixth productions ($\textit{stmt} \rightarrow \textit{read id} \mid \textit{write expr}$), $\{\textit{read}, \textit{write}\} \subset \text{FIRST}(\textit{stmt})$, and $\textit{id} \in \text{FOLLOW}(\textit{read})$. The complete set of “obvious” facts appears in [Figure 2.21](#).

From the “obvious” facts we can deduce a larger set of facts during a second pass over the grammar. For example, in the second production ($\textit{stmt_list} \rightarrow \textit{stmt stmt_list}$) we can deduce that $\{\textit{id}, \textit{read}, \textit{write}\} \subset \text{FIRST}(\textit{stmt_list})$, because we already know that $\{\textit{id}, \textit{read}, \textit{write}\} \subset \text{FIRST}(\textit{stmt})$, and a *stmt_list* can begin with

EXAMPLE 2.27

Predict sets for the calculator language

13 Following conventional notation, we use uppercase Roman letters near the beginning of the alphabet to represent nonterminals, uppercase Roman letters near the end of the alphabet to represent arbitrary grammar symbols (terminals or nonterminals), lowercase Roman letters near the beginning of the alphabet to represent terminals (tokens), lowercase Roman letters near the end of the alphabet to represent token strings, and lowercase Greek letters to represent strings of arbitrary symbols.

$program \rightarrow stmt_list \ \$\$$	$\$\$ \in FOLLOW(stmt_list)$
$stmt_list \rightarrow stmt \ stmt_list$	
$stmt_list \rightarrow \epsilon$	$EPS(stmt_list) = true$
$stmt \rightarrow id \ := \ expr$	$id \in FIRST(stmt) \text{ and } := \in FOLLOW(id)$
$stmt \rightarrow read \ id$	$read \in FIRST(stmt) \text{ and } id \in FOLLOW(read)$
$stmt \rightarrow write \ expr$	$write \in FIRST(stmt)$
$expr \rightarrow term \ term_tail$	
$term_tail \rightarrow add_op \ term \ term_tail$	
$term_tail \rightarrow \epsilon$	$EPS(term_tail) = true$
$term \rightarrow factor \ factor_tail$	
$factor_tail \rightarrow mult_op \ factor \ factor_tail$	
$factor_tail \rightarrow \epsilon$	$EPS(factor_tail) = true$
$factor \rightarrow (\ expr \)$	$(\in FIRST(factor) \text{ and }) \in FOLLOW(expr)$
$factor \rightarrow id$	$id \in FIRST(factor)$
$factor \rightarrow number$	$number \in FIRST(factor)$
$add_op \rightarrow +$	$+ \in FIRST(add_op)$
$add_op \rightarrow -$	$- \in FIRST(add_op)$
$mult_op \rightarrow *$	$* \in FIRST(mult_op)$
$mult_op \rightarrow /$	$/ \in FIRST(mult_op)$

Figure 2.21 “Obvious” facts about the LL(1) calculator grammar.

a *stmt*. Similarly, in the first production, we can deduce that $\$\$ \in FIRST(program)$, because we already know that $EPS(stmt_list) = true$.

In the eleventh production ($factor_tail \rightarrow mult_op \ factor \ factor_tail$), we can deduce that $\{ (, id, number \} \subset FOLLOW(mult_op)$, because we already know that $\{ (, id, number \} \subset FIRST(factor)$, and *factor* follows *mult_op* in the right-hand side. In the seventh production ($expr \rightarrow term \ term_tail$), we can deduce that $) \in FOLLOW(term_tail)$, because we already know that $) \in FOLLOW(expr)$, and a *term_tail* can be the last part of an *expr*. In this same production, we can also deduce that $) \in FOLLOW(term)$, because the *term_tail* can generate ϵ ($EPS(term_tail) = true$), allowing a *term* to be the last part of an *expr*.

There is more that we can learn from our second pass through the grammar, but the examples above cover all the different kinds of cases. To complete our calculation, we continue with additional passes over the grammar until we don’t learn any more (i.e., we don’t add anything to any of the FIRST and FOLLOW sets). We then construct the PREDICT sets. Final versions of all three sets appear in Figure 2.22. The parse table of Figure 2.19 follows directly from PREDICT. ■

The algorithm to compute EPS, FIRST, FOLLOW, and PREDICT sets appears, a bit more formally, in Figure 2.23. It relies on the following definitions.

$EPS(\alpha) \equiv \text{if } \alpha \Longrightarrow^* \epsilon \text{ then true else false}$

$FIRST(\alpha) \equiv \{ c : \alpha \Longrightarrow^* c \beta \}$

$FOLLOW(A) \equiv \{ c : S \Longrightarrow^+ \alpha A c \beta \}$

$PREDICT(A \rightarrow \alpha) \equiv FIRST(\alpha) \cup (\text{if } EPS(\alpha) \text{ then } FOLLOW(A) \text{ else } \emptyset)$

FIRST

```

program {id, read, write, $$}
stmt_list {id, read, write}
stmt {id, read, write}
expr { (, id, number }
term_tail {+, -}
term { (, id, number }
factor_tail {*, /}
factor { (, id, number }
add_op {+, -}
mult_op {*, /}

```

Also note that $\text{FIRST}(c) = \{c\} \forall \text{ tokens } c$.

FOLLOW

```

id {+, -, *, /, ), :=, id, read, write, $$}
number {+, -, *, /, ), id, read, write, $$}
read {id}
write {(, id, number }
( {(, id, number }
) {+, -, *, /, ), id, read, write, $$}
:= {(, id, number }
+ {(, id, number }
- {(, id, number }
* {(, id, number }
/ {(, id, number }
$$  $\emptyset$ 
program  $\emptyset$ 
stmt_list {$$}
stmt {id, read, write, $$}

```

```

expr {), id, read, write, $$}
term_tail {(, id, read, write, $$}
term {+, -, ), id, read, write, $$}
factor_tail {+, -, ), id, read, write, $$}
factor {+, -, *, /, ), id, read, write, $$}
add_op {(, id, number }
mult_op {(, id, number }

```

PREDICT

1. $program \rightarrow stmt_list \ \ \ \$\$ \ \ \ {id, read, write, \$\$}$
2. $stmt_list \rightarrow stmt \ stmt_list \ \ \ {id, read, write}$
3. $stmt_list \rightarrow \epsilon \ \ \ \{\$\$\}$
4. $stmt \rightarrow id \ := \ expr \ \ \ {id}$
5. $stmt \rightarrow read \ id \ \ \ \{read\}$
6. $stmt \rightarrow write \ expr \ \ \ \{write\}$
7. $expr \rightarrow term \ term_tail \ \ \ {(, id, number}$
8. $term_tail \rightarrow add_op \ term \ term_tail \ \ \ {+, -}$
9. $term_tail \rightarrow \epsilon \ \ \ \{(, id, read, write, \$\$}$
10. $term \rightarrow factor \ factor_tail \ \ \ {(, id, number}$
11. $factor_tail \rightarrow mult_op \ factor \ factor_tail \ \ \ {*, /}$
12. $factor_tail \rightarrow \epsilon \ \ \ \{+, -,), id, read, write, \$\$}$
13. $factor \rightarrow (\ expr \) \ \ \ \{(}$
14. $factor \rightarrow id \ \ \ \{id\}$
15. $factor \rightarrow number \ \ \ \{number\}$
16. $add_op \rightarrow + \ \ \ \{+\}$
17. $add_op \rightarrow - \ \ \ \{-}$
18. $mult_op \rightarrow * \ \ \ \{*\}$
19. $mult_op \rightarrow / \ \ \ \{/}$

Figure 2.22 FIRST, FOLLOW, and PREDICT sets for the calculator language. $\text{EPS}(A)$ is true iff $A \in \{stmt_list, term_tail, factor_tail\}$.

Note that FIRST sets and EPS values for strings of length greater than one are calculated on demand; they are not stored explicitly. The algorithm is guaranteed to terminate (i.e., converge on a solution), because the sizes of the FIRST and FOLLOW sets are bounded by the number of terminals in the grammar.

If in the process of calculating PREDICT sets we find that some token belongs to the PREDICT set of more than one production with the same left-hand side, then the grammar is not LL(1), because we will not be able to choose which of the productions to employ when the left-hand side is at the top of the parse stack (or we are in the left-hand side's subroutine in a recursive descent parser) and we see the token coming up in the input. This sort of ambiguity is known as a *predict-predict conflict*; it can arise either because the same token can begin more than one right-hand side, or because it can begin one right-hand side and can also appear after the left-hand side in some valid program, and one possible right-hand side can generate ϵ .

```

-- EPS values and FIRST sets for all symbols:
for all terminals  $c$ ,  $\text{EPS}(c) := \text{false}$ ;  $\text{FIRST}(c) := \{c\}$ 
for all nonterminals  $X$ ,  $\text{EPS}(X) := \text{if } X \rightarrow \epsilon \text{ then true else false}$ ;  $\text{FIRST}(X) := \emptyset$ 
repeat
  (outer) for all productions  $X \rightarrow Y_1 Y_2 \dots Y_k$ ,
    (inner) for  $i$  in  $1 \dots k$ 
      add  $\text{FIRST}(Y_i)$  to  $\text{FIRST}(X)$ 
      if not  $\text{EPS}(Y_i)$  (yet) then continue outer loop
     $\text{EPS}(X) := \text{true}$ 
until no further progress

-- Subroutines for strings, similar to inner loop above:

 $\text{EPS}(X_1 X_2 \dots X_n)$ 
  for  $i$  in  $1 \dots n$ 
    if not  $\text{EPS}(X_i)$  then return false
  return true

 $\text{FIRST}(X_1 X_2 \dots X_n)$ 
  return_value :=  $\emptyset$ 
  for  $i$  in  $1 \dots n$ 
    add  $\text{FIRST}(X_i)$  to return_value
    if not  $\text{EPS}(X_i)$  then return

-- FOLLOW sets for all symbols:
for all symbols  $X$ ,  $\text{FOLLOW}(X) := \emptyset$ 
repeat
  for all productions  $A \rightarrow \alpha B \beta$ ,
    add  $\text{FIRST}(\beta)$  to  $\text{FOLLOW}(B)$ 
  for all productions  $A \rightarrow \alpha B$ 
    or  $A \rightarrow \alpha B \beta$ , where  $\text{EPS}(\beta) = \text{true}$ ,
    add  $\text{FOLLOW}(A)$  to  $\text{FOLLOW}(B)$ 
until no further progress

-- PREDICT sets for all productions:
for all productions  $A \rightarrow \alpha$ 
   $\text{PREDICT}(A \rightarrow \alpha) := \text{FIRST}(\alpha) \cup (\text{if } \text{EPS}(\alpha) \text{ then } \text{FOLLOW}(A) \text{ else } \emptyset)$ 

```

Figure 2.23 Algorithm to calculate FIRST, FOLLOW, and PREDICT sets. The grammar is LL(1) if and only if the PREDICT sets are disjoint.

Writing an LL(1) Grammar

When working with a top-down parser generator, one has to acquire a certain facility in writing and modifying LL(1) grammars. The two most common obstacles to “LL(1)-ness” are *left recursion* and *common prefixes*.

EXAMPLE 2.28

Left recursion

A grammar is said to be left recursive if there is a nonterminal A such that $A \Rightarrow^+ A \alpha$ for some α . The trivial case occurs when the first symbol on the

right-hand side of a production is the same as the symbol on the left-hand side. Here again is the grammar from [Example 2.21](#), which cannot be parsed top-down:

$$\begin{aligned} id_list &\rightarrow id_list_prefix ; \\ id_list_prefix &\rightarrow id_list_prefix , id \\ &\rightarrow id \end{aligned}$$

The problem is in the second and third productions; with *id_list_prefix* at top-of-stack and an *id* on the input, a predictive parser cannot tell which of the productions it should use. (Recall that left recursion is *desirable* in bottom-up grammars, because it allows recursive constructs to be discovered incrementally, as in [Figure 2.14](#).) ■

EXAMPLE 2.29

Common prefixes

Common prefixes occur when two different productions with the same left-hand side begin with the same symbol or symbols. Here is an example that commonly appears in languages descended from Algol:

$$\begin{aligned} stmt &\rightarrow id := expr \\ &\rightarrow id (argument_list) \qquad \qquad \qquad \text{-- procedure call} \end{aligned}$$

Clearly *id* is in the FIRST set of both right-hand sides, and therefore in the PREDICT set of both productions. ■

Both left recursion and common prefixes can be removed from a grammar mechanically. The general case is a little tricky ([Exercise 2.22](#)), because the prediction problem may be an indirect one (e.g., $S \rightarrow A \alpha$ and $A \rightarrow S \beta$, or

DESIGN & IMPLEMENTATION

Recursive descent and table-driven LL parsing

When trying to understand the connection between recursive descent and table-driven LL parsing, it is tempting to imagine that the explicit stack of the table-driven parser mirrors the implicit call stack of the recursive descent parser, but this is not the case.

A better way to visualize the two implementations of top-down parsing is to remember that both are discovering a parse tree via depth-first left-to-right traversal. When we are at a given point in the parse—say the circled node in the tree shown here—the implicit call stack of a recursive descent parser holds a frame for each of the nodes on the path back to the root, created when the routine corresponding to that node was called. (This path is shown in grey.)

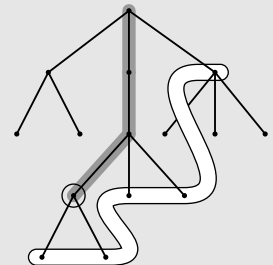

But these nodes are immaterial. What matters for the rest of the parse—as shown on the white path here—are the *upcoming calls* on the case statement arms of the recursive descent routines. Those calls—those parse tree nodes—are precisely the contents of the explicit stack of a table-driven LL parser.

$S \rightarrow A \alpha$, $S \rightarrow B \beta$, $A \Rightarrow^* c \gamma$, and $B \Rightarrow^* c \delta$). We can see the general idea in the examples above, however.

EXAMPLE 2.30

Eliminating left recursion

Our left-recursive definition of *id_list* can be replaced by the right-recursive variant we saw in Example 2.20:

$$\begin{aligned} id_list &\rightarrow id\ id_list_tail \\ id_list_tail &\rightarrow ,\ id\ id_list_tail \\ id_list_tail &\rightarrow ; \end{aligned}$$
EXAMPLE 2.31

Left factoring

Our common-prefix definition of *stmt* can be made LL(1) by a technique called *left factoring*:

$$\begin{aligned} stmt &\rightarrow id\ stmt_list_tail \\ stmt_list_tail &\rightarrow :=\ expr\ | (argument_list) \end{aligned}$$

Of course, simply eliminating left recursion and common prefixes is *not* guaranteed to make a grammar LL(1). There are infinitely many non-LL *languages*—languages for which no LL grammar exists—and the mechanical transformations to eliminate left recursion and common prefixes work on their grammars just fine. Fortunately, the few non-LL languages that arise in practice can generally be handled by augmenting the parsing algorithm with one or two simple heuristics.

EXAMPLE 2.32

Parsing a “dangling else”

The best known example of a “not quite LL” construct arises in languages like Pascal, in which the *else* part of an *if* statement is optional. The natural grammar fragment

$$\begin{aligned} stmt &\rightarrow if\ condition\ then_clause\ else_clause\ | other_stmt \\ then_clause &\rightarrow then\ stmt \\ else_clause &\rightarrow else\ stmt\ | \epsilon \end{aligned}$$

is ambiguous (and thus neither LL nor LR); it allows the *else* in *if* C_1 *then* *if* C_2 *then* S_1 *else* S_2 to be paired with either *then*. The less natural grammar fragment

$$\begin{aligned} stmt &\rightarrow balanced_stmt\ | unbalanced_stmt \\ balanced_stmt &\rightarrow if\ condition\ then\ balanced_stmt\ else\ balanced_stmt \\ &\quad | other_stmt \\ unbalanced_stmt &\rightarrow if\ condition\ then\ stmt \\ &\quad | if\ condition\ then\ balanced_stmt\ else\ unbalanced_stmt \end{aligned}$$

can be parsed bottom-up but not top-down (there is *no* pure top-down grammar for Pascal *else* statements). A *balanced_stmt* is one with the same number of *thens* and *elses*. An *unbalanced_stmt* has more *thens*. ■

The usual approach, whether parsing top-down or bottom-up, is to use the ambiguous grammar together with a “disambiguating rule,” which says that in the case of a conflict between two possible productions, the one to use is the one that occurs first, textually, in the grammar. In the ambiguous fragment above, the fact that *else_clause* \rightarrow *else stmt* comes before *else_clause* \rightarrow ϵ ends up pairing the *else* with the nearest *then*, as desired.

EXAMPLE 2.33

“Dangling else” program bug

Better yet, a language designer can avoid this sort of problem by choosing different syntax. The ambiguity of the *dangling else* problem in Pascal leads to problems not only in parsing, but in writing and maintaining correct programs. Most Pascal programmers have at one time or another written a program like this one:

```
if P <> nil then
  if P^.val = goal then
    foundIt := true
  else
    endOfList := true
```

Indentation notwithstanding, the Pascal manual states that an `else` clause matches the closest unmatched `then`—in this case the inner one—which is clearly not what the programmer intended. To get the desired effect, the Pascal programmer must write

```
if P <> nil then begin
  if P^.val = goal then
    foundIt := true
  end
else
  endOfList := true
```

Many other Algol-family languages (including Modula, Modula-2, and Oberon, all more recent inventions of Pascal’s designer, Niklaus Wirth) require explicit *end markers* on all structured statements. The grammar fragment for `if` statements in Modula-2 looks something like this:

```
stmt → IF condition then_clause else_clause END | other_stmt
then_clause → THEN stmt_list
else_clause → ELSE stmt_list | ε
```

The addition of the `END` eliminates the ambiguity. ■

Modula-2 uses `END` to terminate all its structured statements. Ada and Fortran 77 end an `if` with `end if` (and a `while` with `end while`, etc.). Algol 68 creates its terminators by spelling the initial keyword backward (`if...fi`, `case...esac`, `do...od`, etc.).

One problem with end markers is that they tend to bunch up. In Pascal one can write

EXAMPLE 2.34

End markers for structured statements

EXAMPLE 2.35

The need for `elsif`

DESIGN & IMPLEMENTATION**The dangling else**

A simple change in language syntax—eliminating the *dangling else*—not only reduces the chance of programming errors, but also significantly simplifies parsing. For more on the *dangling else* problem, see [Exercise 2.27](#) and [Section 6.4](#).

```

if A = B then ...
else if A = C then ...
else if A = D then ...
else if A = E then ...
else ...

```

With end markers this becomes

```

if A = B then ...
else if A = C then ...
else if A = D then ...
else if A = E then ...
else ...
end end end end

```

To avoid this awkwardness, languages with end markers generally provide an `elsif` keyword (sometimes spelled `elif`):

```

if A = B then ...
elsif A = C then ...
elsif A = D then ...
elsif A = E then ...
else ...
end

```

With `elsif` clauses added, the Modula-2 grammar fragment for `if` statements looks like this:

$$\begin{aligned}
\text{stmt} &\longrightarrow \text{IF } \text{condition } \text{then_clause } \text{elsif_clauses } \text{else_clause } \text{END} \mid \text{other_stmt} \\
\text{then_clause} &\longrightarrow \text{THEN } \text{stmt_list} \\
\text{elsif_clauses} &\longrightarrow \text{ELSIF } \text{condition } \text{then_clause } \text{elsif_clauses} \mid \epsilon \\
\text{else_clause} &\longrightarrow \text{ELSE } \text{stmt_list} \mid \epsilon
\end{aligned}$$

✓ CHECK YOUR UNDERSTANDING

29. Discuss the similarities and differences between recursive descent and table-driven top-down parsing.
30. What are FIRST and FOLLOW sets? What are they used for?
31. Under what circumstances does a top-down parser predict the production $A \rightarrow \alpha$?
32. What sorts of “obvious” facts form the basis of FIRST set and FOLLOW set construction?
33. Outline the algorithm used to complete the construction of FIRST and FOLLOW sets. How do we know when we are done?

34. How do we know when a grammar is not LL(1)?
35. Describe two common idioms in context-free grammars that cannot be parsed top-down.
36. What is the “dangling `else`” problem? How is it avoided in modern languages?

2.3.3 Bottom-Up Parsing

Conceptually, as we saw at the beginning of [Section 2.3](#), a bottom-up parser works by maintaining a forest of partially completed subtrees of the parse tree, which it joins together whenever it recognizes the symbols on the right-hand side of some production used in the right-most derivation of the input string. It creates a new internal node and makes the roots of the joined-together trees the children of that node.

In practice, a bottom-up parser is almost always table-driven. It keeps the roots of its partially completed subtrees on a stack. When it accepts a new token from the scanner, it *shifts* the token into the stack. When it recognizes that the top few symbols on the stack constitute a right-hand side, it *reduces* those symbols to their left-hand side by popping them off the stack and pushing the left-hand side in their place. The role of the stack is the first important difference between top-down and bottom-up parsing: a top-down parser’s stack contains a list of what the parser expects to see in the future; a bottom-up parser’s stack contains a record of what the parser has already seen in the past.

Canonical Derivations

We also noted earlier that the actions of a bottom-up parser trace out a right-most (canonical) derivation in reverse. The roots of the partial subtrees, left-to-right, together with the remaining input, constitute a sentential form of the right-most derivation. On the right-hand side of [Figure 2.13](#), for example, we have the following series of steps.

EXAMPLE 2.36

Derivation of an `id list`

Stack contents (roots of partial trees)	Remaining input
ϵ	A, B, C;
<code>id (A)</code>	, B, C;
<code>id (A) ,</code>	B, C;
<code>id (A) , id (B)</code>	, C;
<code>id (A) , id (B) ,</code>	C;
<code>id (A) , id (B) , id (C)</code>	;
<code>id (A) , id (B) , id (C) ;</code>	
<code>id (A) , id (B) , <u>id (C) id_list_tail</u></code>	
<code>id (A) , <u>id (B) id_list_tail</u></code>	
<code><u>id (A) id_list_tail</u></code>	
<code>id_list</code>	

1. $program \rightarrow stmt_list \ \ \$\$$
2. $stmt_list \rightarrow stmt_list \ stmt$
3. $stmt_list \rightarrow stmt$
4. $stmt \rightarrow id \ := \ expr$
5. $stmt \rightarrow read \ id$
6. $stmt \rightarrow write \ expr$
7. $expr \rightarrow term$
8. $expr \rightarrow expr \ add_op \ term$
9. $term \rightarrow factor$
10. $term \rightarrow term \ mult_op \ factor$
11. $factor \rightarrow (\ expr \)$
12. $factor \rightarrow id$
13. $factor \rightarrow number$
14. $add_op \rightarrow +$
15. $add_op \rightarrow -$
16. $mult_op \rightarrow *$
17. $mult_op \rightarrow /$

Figure 2.24 LR(1) grammar for the calculator language. Productions have been numbered for reference in future figures.

The last four lines (the ones that don't just shift tokens into the forest) correspond to the right-most derivation:

$$\begin{aligned}
 id_list &\Rightarrow id \ id_list_tail \\
 &\Rightarrow id \ , \ id \ id_list_tail \\
 &\Rightarrow id \ , \ id \ , \ id \ id_list_tail \\
 &\Rightarrow id \ , \ id \ , \ id \ ;
 \end{aligned}$$

The symbols that need to be joined together at each step of the parse to represent the next step of the backward derivation are called the *handle* of the sentential form. In the parse trace above, the handles are underlined. ■

EXAMPLE 2.37

Bottom-up grammar for the calculator language

In our *id_list* example, no handles were found until the entire input had been shifted onto the stack. In general this will not be the case. We can obtain a more realistic example by examining an LR version of our calculator language, shown in Figure 2.24. While the LL grammar of Figure 2.15 can be parsed bottom-up, the version in Figure 2.24 is preferable for two reasons. First, it uses a left-recursive production for *stmt_list*. Left recursion allows the parser to collapse long statement lists as it goes along, rather than waiting until the entire list is on the stack and then collapsing it from the end. Second, it uses left-recursive productions for *expr* and *term*. These productions capture left associativity while still keeping an operator and its operands together in the same right-hand side, something we were unable to do in a top-down grammar. ■

EXAMPLE 2.38

Bottom-up parse of the
“sum and average” program

Modeling a Parse with LR Items

Suppose we are to parse the sum-and-average program from [Example 2.24](#):

```
read A
read B
sum := A + B
write sum
write sum / 2
```

The key to success will be to figure out when we have reached the end of a right-hand side—that is, when we have a handle at the top of the parse stack. The trick is to keep track of the set of productions we might be “in the middle of” at any particular time, together with an indication of where in those productions we might be.

When we begin execution, the parse stack is empty and we are at the beginning of the production for *program*. (In general, we can assume that there is only one production with the start symbol on the left-hand side; it is easy to modify any grammar to make this the case.) We can represent our location—more specifically, the location represented by the top of the parse stack—with a \bullet in the right-hand side of the production:

$$program \longrightarrow \bullet \text{ stmt_list } \$\$$$

When augmented with a \bullet , a production is called an LR *item*. Since the \bullet in this item is immediately in front of a nonterminal—namely *stmt_list*—we may be about to see the yield of that nonterminal coming up on the input. This possibility implies that we may be at the beginning of some production with *stmt_list* on the left-hand side:

$$\begin{aligned} program &\longrightarrow \bullet \text{ stmt_list } \$\$ \\ \text{stmt_list} &\longrightarrow \bullet \text{ stmt_list } \text{ stmt} \\ \text{stmt_list} &\longrightarrow \bullet \text{ stmt} \end{aligned}$$

And, since *stmt* is a nonterminal, we may also be at the beginning of any production whose left-hand side is *stmt*:

$$\begin{aligned} program &\longrightarrow \bullet \text{ stmt_list } \$\$ && \text{(State 0)} \\ \text{stmt_list} &\longrightarrow \bullet \text{ stmt_list } \text{ stmt} \\ \text{stmt_list} &\longrightarrow \bullet \text{ stmt} \\ \text{stmt} &\longrightarrow \bullet \text{ id } := \text{ expr} \\ \text{stmt} &\longrightarrow \bullet \text{ read id} \\ \text{stmt} &\longrightarrow \bullet \text{ write expr} \end{aligned}$$

Since all of these last productions begin with a terminal, no additional items need to be added to our list. The original item ($program \longrightarrow \bullet \text{ stmt_list } \$\$$) is called the *basis* of the list. The additional items are its *closure*. The list represents the

initial state of the parser. As we shift and reduce, the set of items will change, always indicating which productions *may* be the right one to use next in the derivation of the input string. If we reach a state in which some item has the \bullet at the end of the right-hand side, we can reduce by that production. Otherwise, as in the current situation, we must shift. Note that if we need to shift, but the incoming token cannot follow the \bullet in any item of the current state, then a syntax error has occurred. We will consider error recovery in more detail in Section ©2.3.4.

Our upcoming token is a *read*. Once we shift it onto the stack, we know we are in the following state:

$$stmt \rightarrow read \bullet id \qquad \text{(State 1)}$$

This state has a single basis item and an empty closure—the \bullet precedes a terminal. After shifting the *A*, we have

$$stmt \rightarrow read id \bullet \qquad \text{(State 1')}$$

We now know that *read id* is the handle, and we must reduce. The reduction pops two symbols off the parse stack and pushes a *stmt* in their place, but what should the new state be? We can see the answer if we imagine moving back in time to the point at which we shifted the *read*—the first symbol of the right-hand side. At that time we were in the state labeled “State 0” above, and the upcoming tokens on the input (though we didn’t look at them at the time) were *read id*. We have now consumed these tokens, and we know that they constituted a *stmt*. By pushing a *stmt* onto the stack, we have in essence replaced *read id* with *stmt* on the input stream, and have then “shifted” the nonterminal, rather than its yield, into the stack. Since one of the items in State 0 was

$$stmt_list \rightarrow \bullet stmt$$

we now have

$$stmt_list \rightarrow stmt \bullet \qquad \text{(State 0')}$$

Again we must reduce. We remove the *stmt* from the stack and push a *stmt_list* in its place. Again we can see this as “shifting” a *stmt_list* when in State 0. Since two of the items in State 0 have a *stmt_list* after the \bullet , we don’t know (without looking ahead) which of the productions will be the next to be used in the derivation, but we don’t have to know. The key advantage of bottom-up parsing over top-down parsing is that we don’t need to predict ahead of time which production we shall be expanding.

Our new state is as follows:

$$program \rightarrow stmt_list \bullet \$\$ \qquad \text{(State 2)}$$

$$stmt_list \rightarrow stmt_list \bullet stmt$$

$$stmt \rightarrow \bullet id := expr$$

$$stmt \rightarrow \bullet read id$$

$$stmt \rightarrow \bullet write expr$$

The first two productions are the basis; the others are the closure. Since no item has a \bullet at the end, we shift the next token, which happens again to be a read, taking us back to State 1. Shifting the B takes us to State 1' again, at which point we reduce. This time however, we go back to State 2 rather than State 0 before shifting the left-hand-side *stmt*. Why? Because we were in State 2 when we began to read the right-hand-side. ■

The Characteristic Finite State Machine and LR Parsing Variants

An LR-family parser keeps track of the states it has traversed by pushing them into the parse stack, along with the grammar symbols. It is in fact the states (rather than the symbols) that drive the parsing algorithm: they tell us what state we were in at the beginning of a right-hand side. Specifically, when the combination of state and input tells us we need to reduce using production $A \rightarrow \alpha$, we pop $length(\alpha)$ symbols off the stack, together with the record of states we moved through while shifting those symbols. These pops expose the state we were in immediately prior to the shifts, allowing us to return to that state and proceed as if we had seen A in the first place.

We can think of the shift rules of an LR-family parser as the transition function of a finite automaton, much like the automata we used to model scanners. Each state of the automaton corresponds to a list of items that indicate where the parser might be at some specific point in the parse. The transition for input symbol X (which may be either a terminal or a nonterminal) moves to a state whose basis consists of items in which the \bullet has been moved across an X in the right-hand side, plus whatever items need to be added as closure. The lists are constructed by a bottom-up parser generator in order to build the automaton, but are not needed during parsing.

It turns out that the simpler members of the LR family of parsers—LR(0), SLR(1), and LALR(1)—all use the same automaton, called the *characteristic finite-state machine*, or CFSM. Full LR parsers use a machine with (for most grammars) a much larger number of states. The differences between the algorithms lie in how they deal with states that contain a *shift-reduce conflict*—one item with the \bullet in front of a terminal (suggesting the need for a shift) and another with the \bullet at the end of the right-hand side (suggesting the need for a reduction). An LR(0) parser works only when there are no such states. It can be proven that with the addition of an end-marker (i.e., $\$$), any language that can be deterministically parsed bottom-up has an LR(0) grammar. Unfortunately, the LR(0) grammars for real programming languages tend to be prohibitively large and unintuitive.

SLR (simple LR) parsers peek at upcoming input and use FOLLOW sets to resolve conflicts. An SLR parser will call for a reduction via $A \rightarrow \alpha$ only if the upcoming token(s) are in $FOLLOW(\alpha)$. It will still see a conflict, however, if the tokens are also in the FIRSTset of any of the symbols that follow a \bullet in other items of the state. As it turns out, there are important cases in which a token may follow a given nonterminal somewhere in a valid program, but never in a context described by the current state. For these cases global FOLLOW sets are too crude.

LALR (look-ahead LR) parsers improve on SLR by using *local* (state-specific) look-ahead instead.

Conflicts can still arise in an LALR parser when the same set of items can occur on two different paths through the CFSM. Both paths will end up in the same state, at which point state-specific look-ahead can no longer distinguish between them. A full LR parser duplicates states in order to keep paths disjoint when their local look-aheads are different.

LALR parsers are the most common bottom-up parsers in practice. They are the same size and speed as SLR parsers, but are able to resolve more conflicts. Full LR parsers for real programming languages tend to be very large. Several researchers have developed techniques to reduce the size of full-LR tables, but LALR works sufficiently well in practice that the extra complexity of full LR is usually not required. *Yacc/bison* produces C code for an LALR parser.

Bottom-Up Parsing Tables

Like a table-driven LL(1) parser, an SLR(1), LALR(1), or LR(1) parser executes a loop in which it repeatedly inspects a two-dimensional table to find out what action to take. However, instead of using the current input token and top-of-stack nonterminal to index into the table, an LR-family parser uses the current input token and the current parser state (which can be found at the top of the stack). “Shift” table entries indicate the state that should be pushed. “Reduce” table entries indicate the number of states that should be popped and the nonterminal that should be pushed back onto the input stream, to be shifted by the state uncovered by the pops. There is always one popped state for every symbol on the right-hand side of the reducing production. The state to be pushed next can be found by indexing into the table using the uncovered state and the newly recognized nonterminal.

EXAMPLE 2.39

CFSM for the bottom-up calculator grammar

The CFSM for our bottom-up version of the calculator grammar appears in [Figure 2.25](#). States 6, 7, 9, and 13 contain potential shift-reduce conflicts, but all of these can be resolved with global FOLLOW sets. SLR parsing therefore suffices. In State 6, for example, $\text{FIRST}(\text{add_op}) \cap \text{FOLLOW}(\text{stmt}) = \emptyset$. In addition to shift and reduce rules, we allow the parse table as an optimization to contain rules of the form “shift and then reduce.” This optimization serves to eliminate trivial states such as $1'$ and $0'$ in [Example 2.38](#), which had only a single item, with the \bullet at the end.

A pictorial representation of the CFSM appears in [Figure 2.26](#). A tabular representation, suitable for use in a table-driven parser, appears in [Figure 2.27](#). Pseudocode for the (language-independent) parser driver appears in [Figure 2.28](#). A trace of the parser’s actions on the sum-and-average program appears in [Figure 2.29](#). ■

Handling Epsilon Productions

EXAMPLE 2.40

Epsilon productions in the bottom-up calculator grammar

The careful reader may have noticed that the grammar of [Figure 2.24](#), in addition to using left-recursive rules for *stmt_list*, *expr*, and *term*, differs from the grammar of [Figure 2.15](#) in one other way: it defines a *stmt_list* to be a sequence of one or more *stmts*, rather than zero or more. (This means, of course, that it defines a

different language.) To capture the same language as Figure 2.15, production 3 in Figure 2.24,

$$stmt_list \longrightarrow stmt$$

would need to be replaced with

$$stmt_list \longrightarrow \epsilon$$

Note that it does in general make sense to have an empty statement list. In the calculator language it simply permits an empty program, which is admittedly silly. In real languages, however, it allows the body of a structured statement to be empty, which can be very useful. One frequently wants one arm of a case or multiway if... then ... else statement to be empty, and an empty while loop allows a parallel program (or the operating system) to wait for a signal from another process or an I/O device.

EXAMPLE 2.41

CFSM with epsilon productions

If we look at the CFSM for the calculator language, we discover that State 0 is the only state that needs to be changed in order to allow empty statement lists. The item

$$stmt_list \longrightarrow \bullet stmt$$

becomes

$$stmt_list \longrightarrow \bullet \epsilon$$

which is equivalent to

$$stmt_list \longrightarrow \epsilon \bullet$$

or simply

$$stmt_list \longrightarrow \bullet$$

The entire state is then

<u>$program \longrightarrow \bullet stmt_list$</u> $ \$\$$	on $stmt_list$ shift and goto 2
$stmt_list \longrightarrow \bullet stmt_list$ $ stmt$	
$stmt_list \longrightarrow \bullet$	on $ \$\$$ reduce (pop 0 states, push $stmt_list$ on input)
$stmt \longrightarrow \bullet id := expr$	on id shift and goto 3
$stmt \longrightarrow \bullet read\ id$	on $read$ shift and goto 1
$stmt \longrightarrow \bullet write\ expr$	on $write$ shift and goto 4

The look-ahead for item

$$stmt_list \longrightarrow \bullet$$

is FOLLOW($stmt_list$), which is the end-marker, $\$\$$. Since $\$\$$ does not appear in the look-aheads for any other item in this state, our grammar is still SLR(1). It is worth noting that epsilon productions commonly prevent a grammar from being LR(0): if such a production shares a state with an item in which the dot precedes a terminal, we won't be able to tell whether to "recognize" ϵ without peeking ahead.

State	Transitions
0. $program \rightarrow \bullet stmt_list \$\$$ $stmt_list \rightarrow \bullet stmt_list stmt$ $stmt_list \rightarrow \bullet stmt$ $stmt \rightarrow \bullet id := expr$ $stmt \rightarrow \bullet read id$ $stmt \rightarrow \bullet write expr$	on $stmt_list$ shift and goto 2 on $stmt$ shift and reduce (pop 1 state, push $stmt_list$ on input) on id shift and goto 3 on $read$ shift and goto 1 on $write$ shift and goto 4
1. $stmt \rightarrow read \bullet id$	on id shift and reduce (pop 2 states, push $stmt$ on input)
2. $program \rightarrow stmt_list \bullet \$\$$ $stmt_list \rightarrow stmt_list \bullet stmt$ $stmt \rightarrow \bullet id := expr$ $stmt \rightarrow \bullet read id$ $stmt \rightarrow \bullet write expr$	on $\$\$$ shift and reduce (pop 2 states, push $program$ on input) on $stmt$ shift and reduce (pop 2 states, push $stmt_list$ on input) on id shift and goto 3 on $read$ shift and goto 1 on $write$ shift and goto 4
3. $stmt \rightarrow id \bullet := expr$	on $:=$ shift and goto 5
4. $stmt \rightarrow write \bullet expr$ $expr \rightarrow \bullet term$ $expr \rightarrow \bullet expr add_op term$ $term \rightarrow \bullet factor$ $term \rightarrow \bullet term mult_op factor$ $factor \rightarrow \bullet (expr)$ $factor \rightarrow \bullet id$ $factor \rightarrow \bullet number$	on $expr$ shift and goto 6 on $term$ shift and goto 7 on $factor$ shift and reduce (pop 1 state, push $term$ on input) on $($ shift and goto 8 on id shift and reduce (pop 1 state, push $factor$ on input) on $number$ shift and reduce (pop 1 state, push $factor$ on input)
5. $stmt \rightarrow id := \bullet expr$ $expr \rightarrow \bullet term$ $expr \rightarrow \bullet expr add_op term$ $term \rightarrow \bullet factor$ $term \rightarrow \bullet term mult_op factor$ $factor \rightarrow \bullet (expr)$ $factor \rightarrow \bullet id$ $factor \rightarrow \bullet number$	on $expr$ shift and goto 9 on $term$ shift and goto 7 on $factor$ shift and reduce (pop 1 state, push $term$ on input) on $($ shift and goto 8 on id shift and reduce (pop 1 state, push $factor$ on input) on $number$ shift and reduce (pop 1 state, push $factor$ on input)
6. $stmt \rightarrow write expr \bullet$ $expr \rightarrow expr \bullet add_op term$ $add_op \rightarrow \bullet +$ $add_op \rightarrow \bullet -$	on FOLLOW($stmt$) = { id , $read$, $write$, $\$\$$ } reduce (pop 2 states, push $stmt$ on input) on add_op shift and goto 10 on $+$ shift and reduce (pop 1 state, push add_op on input) on $-$ shift and reduce (pop 1 state, push add_op on input)

Figure 2.25 CFSM for the calculator grammar (Figure 2.24). Basis and closure items in each state are separated by a horizontal rule. Trivial reduce-only states have been eliminated by use of “shift and reduce” transitions. (continued)

State	Transitions
7. $expr \rightarrow term \bullet$ $term \rightarrow term \bullet mult_op factor$ ----- $mult_op \rightarrow \bullet *$ $mult_op \rightarrow \bullet /$	on FOLLOW($expr$) = {id, read, write, \$\$, }, +, -} reduce (pop 1 state, push $expr$ on input) on $mult_op$ shift and goto 11 on * shift and reduce (pop 1 state, push $mult_op$ on input) on / shift and reduce (pop 1 state, push $mult_op$ on input)
8. $factor \rightarrow (\bullet expr)$ ----- $expr \rightarrow \bullet term$ $expr \rightarrow \bullet expr add_op term$ $term \rightarrow \bullet factor$ $term \rightarrow \bullet term mult_op factor$ $factor \rightarrow \bullet (expr)$ $factor \rightarrow \bullet id$ $factor \rightarrow \bullet number$	on $expr$ shift and goto 12 on $term$ shift and goto 7 on $factor$ shift and reduce (pop 1 state, push $term$ on input) on (shift and goto 8 on id shift and reduce (pop 1 state, push $factor$ on input) on number shift and reduce (pop 1 state, push $factor$ on input)
9. $stmt \rightarrow id := expr \bullet$ $expr \rightarrow expr \bullet add_op term$ ----- $add_op \rightarrow \bullet +$ $add_op \rightarrow \bullet -$	on FOLLOW($stmt$) = {id, read, write, \$\$} reduce (pop 3 states, push $stmt$ on input) on add_op shift and goto 10 on + shift and reduce (pop 1 state, push add_op on input) on - shift and reduce (pop 1 state, push add_op on input)
10. $expr \rightarrow expr add_op \bullet term$ ----- $term \rightarrow \bullet factor$ $term \rightarrow \bullet term mult_op factor$ $factor \rightarrow \bullet (expr)$ $factor \rightarrow \bullet id$ $factor \rightarrow \bullet number$	on $term$ shift and goto 13 on $factor$ shift and reduce (pop 1 state, push $term$ on input) on (shift and goto 8 on id shift and reduce (pop 1 state, push $factor$ on input) on number shift and reduce (pop 1 state, push $factor$ on input)
11. $term \rightarrow term mult_op \bullet factor$ ----- $factor \rightarrow \bullet (expr)$ $factor \rightarrow \bullet id$ $factor \rightarrow \bullet number$	on $factor$ shift and reduce (pop 3 states, push $term$ on input) on (shift and goto 8 on id shift and reduce (pop 1 state, push $factor$ on input) on number shift and reduce (pop 1 state, push $factor$ on input)
12. $factor \rightarrow (expr \bullet)$ $expr \rightarrow expr \bullet add_op term$ ----- $add_op \rightarrow \bullet +$ $add_op \rightarrow \bullet -$	on) shift and reduce (pop 3 states, push $factor$ on input) on add_op shift and goto 10 on + shift and reduce (pop 1 state, push add_op on input) on - shift and reduce (pop 1 state, push add_op on input)
13. $expr \rightarrow expr add_op term \bullet$ $term \rightarrow term \bullet mult_op factor$ ----- $mult_op \rightarrow \bullet *$ $mult_op \rightarrow \bullet /$	on FOLLOW($expr$) = {id, read, write, \$\$, }, +, -} reduce (pop 3 states, push $expr$ on input) on $mult_op$ shift and goto 11 on * shift and reduce (pop 1 state, push $mult_op$ on input) on / shift and reduce (pop 1 state, push $mult_op$ on input)

Figure 2.25 (continued)

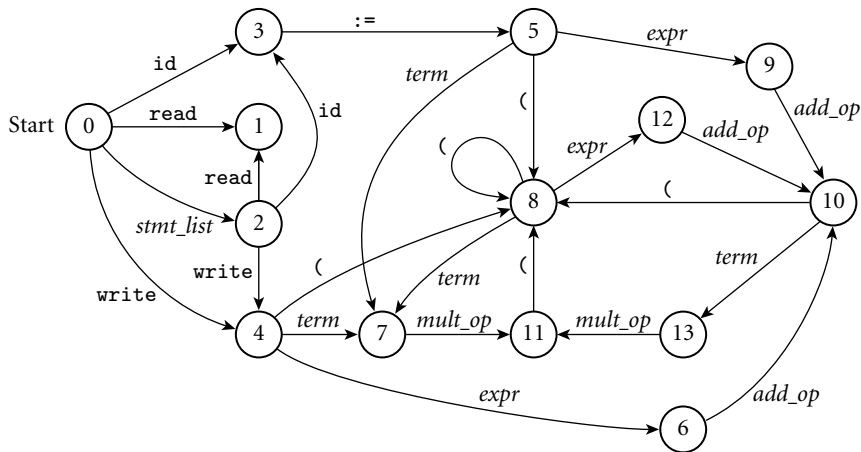

Figure 2.26 Pictorial representation of the CFSM of Figure 2.25. Reduce actions are not shown.

Top-of-stack state	Current input symbol																			
	sl	s	e	t	f	ao	mo	id	lit	r	w	:=	()	+	-	*	/	\$\$	
0	s2	b3	-	-	-	-	-	s3	-	s1	s4	-	-	-	-	-	-	-	-	-
1	-	-	-	-	-	-	-	b5	-	-	-	-	-	-	-	-	-	-	-	-
2	-	b2	-	-	-	-	-	s3	-	s1	s4	-	-	-	-	-	-	-	-	b1
3	-	-	-	-	-	-	-	-	-	-	-	s5	-	-	-	-	-	-	-	-
4	-	-	s6	s7	b9	-	-	b12	b13	-	-	-	s8	-	-	-	-	-	-	-
5	-	-	s9	s7	b9	-	-	b12	b13	-	-	-	s8	-	-	-	-	-	-	-
6	-	-	-	-	-	s10	-	r6	-	r6	r6	-	-	-	b14	b15	-	-	-	r6
7	-	-	-	-	-	-	s11	r7	-	r7	r7	-	-	r7	r7	r7	b16	b17	r7	-
8	-	-	s12	s7	b9	-	-	b12	b13	-	-	-	s8	-	-	-	-	-	-	-
9	-	-	-	-	-	s10	-	r4	-	r4	r4	-	-	-	b14	b15	-	-	-	r4
10	-	-	-	s13	b9	-	-	b12	b13	-	-	-	s8	-	-	-	-	-	-	-
11	-	-	-	-	b10	-	-	b12	b13	-	-	-	s8	-	-	-	-	-	-	-
12	-	-	-	-	-	s10	-	-	-	-	-	-	-	b11	b14	b15	-	-	-	-
13	-	-	-	-	-	-	s11	r8	-	r8	r8	-	-	r8	r8	r8	b16	b17	r8	-

Figure 2.27 SLR(1) parse table for the calculator language. Table entries indicate whether to shift (s), reduce (r), or shift and then reduce (b). The accompanying number is the new state when shifting, or the production that has been recognized when (shifting and) reducing. Production numbers are given in Figure 2.24. Symbol names have been abbreviated for the sake of formatting. A dash indicates an error. An auxiliary table, not shown here, gives the left-hand-side symbol and right-hand-side length for each production.

✓ CHECK YOUR UNDERSTANDING

37. What is the *handle* of a right sentential form?
38. Explain the significance of the characteristic finite-state machine in LR parsing.

```

state = 1 .. number_of_states
symbol = 1 .. number_of_symbols
production = 1 .. number_of_productions
action_rec = record
    action : (shift, reduce, shift_reduce, error)
    new_state : state
    prod : production

parse_tab : array [symbol, state] of action_rec
prod_tab : array [production] of record
    lhs : symbol
    rhs_len : integer
-- these two tables are created by a parser generator tool

parse_stack : stack of record
    sym : symbol
    st : state

parse_stack.push((null, start_state))
cur_sym : symbol := scan                -- get new token from scanner
loop
    cur_state : state := parse_stack.top.st -- peek at state at top of stack
    if cur_state = start_state and cur_sym = start_symbol
        return -- success!
    ar : action_rec := parse_tab[cur_state, cur_sym]
    case ar.action
    shift:
        parse_stack.push((cur_sym, ar.new_state))
        cur_sym := scan                -- get new token from scanner
    reduce:
        cur_sym := prod_tab[ar.prod].lhs
        parse_stack.pop(prod_tab[ar.prod].rhs_len)
    shift_reduce:
        cur_sym := prod_tab[ar.prod].lhs
        parse_stack.pop(prod_tab[ar.prod].rhs_len-1)
    error:
        parse_error

```

Figure 2.28 Driver for a table-driven SLR(1) parser. We call the scanner directly, rather than using the global `input_token` of Figures 2.16 and 2.18, so that we can set `cur_sym` to be an arbitrary symbol.

39. What is the significance of the dot (\bullet) in an LR item?
40. What distinguishes the *basis* from the *closure* of an LR state?
41. What is a *shift-reduce conflict*? How is it resolved in the various kinds of LR-family parsers?
42. Outline the steps performed by the driver of a bottom-up parser.

Parse stack	Input stream	Comment
0	read A read B...	
0 read 1	A read B...	shift read
0	stmt read B...	shift id(A) & reduce by <i>stmt</i> → read id
0	stmt_list read B...	shift <i>stmt</i> & reduce by <i>stmt_list</i> → <i>stmt</i>
0 stmt_list 2	read B sum...	shift <i>stmt_list</i>
0 stmt_list 2 read 1	B sum :=...	shift read
0 stmt_list 2	stmt sum :=...	shift id(B) & reduce by <i>stmt</i> → read id
0	stmt_list sum :=...	shift <i>stmt</i> & reduce by <i>stmt_list</i> → <i>stmt_list stmt</i>
0 stmt_list 2	sum := A...	shift <i>stmt_list</i>
0 stmt_list 2 id 3	:= A +...	shift id(sum)
0 stmt_list 2 id 3 := 5	A + B...	shift :=
0 stmt_list 2 id 3 := 5	factor + B...	shift id(A) & reduce by <i>factor</i> → id
0 stmt_list 2 id 3 := 5	term + B...	shift <i>factor</i> & reduce by <i>term</i> → <i>factor</i>
0 stmt_list 2 id 3 := 5 term 7	+ B write...	shift <i>term</i>
0 stmt_list 2 id 3 := 5	expr + B write...	reduce by <i>expr</i> → <i>term</i>
0 stmt_list 2 id 3 := 5 expr 9	+ B write...	shift <i>expr</i>
0 stmt_list 2 id 3 := 5 expr 9	add_op B write...	shift + & reduce by <i>add_op</i> → +
0 stmt_list 2 id 3 := 5 expr 9 add_op 10	B write sum...	shift <i>add_op</i>
0 stmt_list 2 id 3 := 5 expr 9 add_op 10	factor write sum...	shift id(B) & reduce by <i>factor</i> → id
0 stmt_list 2 id 3 := 5 expr 9 add_op 10	term write sum...	shift <i>factor</i> & reduce by <i>term</i> → <i>factor</i>
0 stmt_list 2 id 3 := 5 expr 9 add_op 10 term 13	write sum...	shift <i>term</i>
0 stmt_list 2 id 3 := 5	expr write sum...	reduce by <i>expr</i> → <i>expr add_op term</i>
0 stmt_list 2 id 3 := 5 expr 9	write sum...	shift <i>expr</i>
0 stmt_list 2	stmt write sum...	reduce by <i>stmt</i> → id := <i>expr</i>
0	stmt_list write sum...	shift <i>stmt</i> & reduce by <i>stmt_list</i> → <i>stmt</i>
0 stmt_list 2	write sum...	shift <i>stmt_list</i>
0 stmt_list 2 write 4	sum write sum...	shift write
0 stmt_list 2 write 4	factor write sum...	shift id(sum) & reduce by <i>factor</i> → id
0 stmt_list 2 write 4	term write sum...	shift <i>factor</i> & reduce by <i>term</i> → <i>factor</i>
0 stmt_list 2 write 4 term 7	write sum...	shift <i>term</i>
0 stmt_list 2 write 4	expr write sum...	reduce by <i>expr</i> → <i>term</i>
0 stmt_list 2 write 4 expr 6	write sum...	shift <i>expr</i>
0 stmt_list 2	stmt write sum...	reduce by <i>stmt</i> → write <i>expr</i>
0	stmt_list write sum...	shift <i>stmt</i> & reduce by <i>stmt_list</i> → <i>stmt_list stmt</i>
0 stmt_list 2	write sum / ...	shift <i>stmt_list</i>
0 stmt_list 2 write 4	sum / 2...	shift write
0 stmt_list 2 write 4	factor / 2...	shift id(sum) & reduce by <i>factor</i> → id
0 stmt_list 2 write 4	term / 2...	shift <i>factor</i> & reduce by <i>term</i> → <i>factor</i>
0 stmt_list 2 write 4 term 7	/ 2 \$\$	shift <i>term</i>
0 stmt_list 2 write 4 term 7	mult_op 2 \$\$	shift / & reduce by <i>mult_op</i> → /
0 stmt_list 2 write 4 term 7 mult_op 11	2 \$\$	shift <i>mult_op</i>
0 stmt_list 2 write 4 term 7 mult_op 11	factor \$\$	shift number (2) & reduce by <i>factor</i> → number
0 stmt_list 2 write 4	term \$\$	shift <i>factor</i> & reduce by <i>term</i> → <i>term mult_op factor</i>
0 stmt_list 2 write 4 term 7	\$\$	shift <i>term</i>
0 stmt_list 2 write 4	expr \$\$	reduce by <i>expr</i> → <i>term</i>
0 stmt_list 2 write 4 expr 6	\$\$	shift <i>expr</i>
0 stmt_list 2	stmt \$\$	reduce by <i>stmt</i> → write <i>expr</i>
0	stmt_list \$\$	shift <i>stmt</i> & reduce by <i>stmt_list</i> → <i>stmt_list stmt</i>
0 stmt_list 2	\$\$	shift <i>stmt_list</i>
0	program	shift \$\$ & reduce by <i>program</i> → <i>stmt_list \$\$</i>

Figure 2.29 Trace of a table-driven SLR(I) parse of the sum-and-average program. States in the parse stack are shown in boldface type. Symbols in the parse stack are for clarity only; they are not needed by the parsing algorithm. Parsing begins with the initial state of the CFSM (State 0) in the stack. It ends when we reduce by *program* → *stmt_list \$\$*, uncovering State 0 again and pushing *program* onto the input stream.

43. What kind of parser is produced by yacc/bison? By ANTLR?
 44. Why are there never any epsilon productions in an LR(0) grammar?
-

2.3.4 Syntax Errors

EXAMPLE 2.42

A syntax error in C

Suppose we are parsing a C program and see the following code fragment in a context where a statement is expected:

```
A = B : C + D;
```

We will detect a syntax error immediately after the B, when the colon appears from the scanner. At this point the simplest thing to do is just to print an error message and halt. This naive approach is generally not acceptable, however: it would mean that every run of the compiler reveals no more than one syntax error. Since most programs, at least at first, contain numerous such errors, we really need to find as many as possible now (we'd also like to continue looking for semantic errors). To do so, we must modify the state of the parser and/or the input stream so that the upcoming token(s) are acceptable. We shall probably want to turn off code generation, disabling the back end of the compiler: since the input is not a valid program, the code will not be of use, and there's no point in spending time creating it. ■

In general, the term *syntax error recovery* is applied to any technique that allows the compiler, in the face of a syntax error, to continue looking for other errors later in the program. High-quality syntax error recovery is essential in any production-quality compiler. The better the recovery technique, the more likely the compiler will be to recognize additional errors (especially nearby errors) correctly, and the less likely it will be to become confused and announce spurious *cascading errors* later in the program.

© IN MORE DEPTH

On the PLP CD we explore several possible approaches to syntax error recovery. In *panic mode*, the compiler writer defines a small set of “safe symbols” that delimit clean points in the input. Semicolons, which typically end a statement, are a good choice in many languages. When an error occurs, the compiler deletes input tokens until it finds a safe symbol, and then “backs the parser out” (e.g., returns from recursive descent subroutines) until it finds a context in which that symbol might appear. *Phrase-level recovery* improves on this technique by employing different sets of “safe” symbols in different productions of the grammar (right parentheses when in an expression; semicolons when in a declaration). *Context-specific look-ahead* obtains additional improvements by differentiating among the various contexts in which a given production might appear in a syntax tree. To respond gracefully to certain common programming errors, the compiler writer may augment the grammar with *error productions* that capture language-specific idioms that are incorrect but are often written by mistake.

Niklaus Wirth published an elegant implementation of phrase-level and context-specific recovery for recursive descent parsers in 1976 [Wir76, Sec. 5.9]. *Exceptions* (to be discussed further in Section 8.5) provide a simpler alternative if supported by the language in which the compiler is written. For table-driven top-down parsers, Fischer, Milton, and Quiring published an algorithm in 1980 that automatically implements a well-defined notion of *locally least-cost syntax repair*. Locally least-cost repair is also possible in bottom-up parsers, but it is significantly more difficult. Most bottom-up parsers rely on more straightforward phrase-level recovery; a typical example can be found in yacc/bison.

2.4 Theoretical Foundations

Our understanding of the relative roles and computational power of scanners, parsers, regular expressions, and context-free grammars is based on the formalisms of *automata theory*. In automata theory, a *formal language* is a set of strings of symbols drawn from a finite *alphabet*. A formal language can be specified either by a set of rules (such as regular expressions or a context-free grammar) that generates the language, or by a *formal machine* that *accepts* (*recognizes*) the language. A formal machine takes strings of symbols as input and outputs either “yes” or “no.” A machine is said to accept a language if it says “yes” to all and only those strings that are in the language. Alternatively, a language can be defined as the set of strings for which a particular machine says “yes.”

Formal languages can be grouped into a series of successively larger classes known as the *Chomsky hierarchy*.¹⁴ Most of the classes can be characterized in two ways: by the types of rules that can be used to generate the set of strings, or by the type of formal machine that is capable of recognizing the language. As we have seen, *regular languages* are defined by using concatenation, alternation, and Kleene closure, and are recognized by a scanner. *Context-free languages* are a proper superset of the regular languages. They are defined by using concatenation, alternation, and recursion (which subsumes Kleene closure), and are recognized by a parser. A scanner is a concrete realization of a *finite automaton*, a type of formal machine. A parser is a concrete realization of a *push-down automaton*. Just as context-free grammars add recursion to regular expressions, push-down automata add a stack to the memory of a finite automaton. There are additional levels in the Chomsky hierarchy, but they are less directly applicable to compiler construction, and are not covered here.

It can be proven, constructively, that regular expressions and finite automata are equivalent: one can construct a finite automaton that accepts the language defined by a given regular expression, and vice versa. Similarly, it is possible to

¹⁴ Noam Chomsky (1928–), a linguist and social philosopher at the Massachusetts Institute of Technology, developed much of the early theory of formal languages.

construct a push-down automaton that accepts the language defined by a given context-free grammar, and vice versa. The grammar-to-automaton constructions are in fact performed by scanner and parser generators such as `lex` and `yacc`. Of course, a real scanner does not accept just one token; it is called in a loop so that it keeps accepting tokens repeatedly. As noted in the sidebar on page 60, this detail is accommodated by having the scanner accept the alternation of all the tokens in the language (with distinguished final states), and by having it continue to consume characters until no longer token can be constructed.

© IN MORE DEPTH

On the PLP CD we consider finite and pushdown automata in more detail. We give an algorithm to convert a DFA into an equivalent regular expression. Combined with the constructions in [Section 2.2.1](#), this algorithm demonstrates the equivalence of regular expressions and finite automata. We also consider the sets of grammars and languages that can and cannot be parsed by the various linear-time parsing algorithms.

2.5 Summary and Concluding Remarks

In this chapter we have introduced the formalisms of regular expressions and context-free grammars, and the algorithms that underlie scanning and parsing in practical compilers. We also mentioned syntax error recovery, and presented a quick overview of relevant parts of automata theory. Regular expressions and context-free grammars are language *generators*: they specify how to construct valid strings of characters or tokens. Scanners and parsers are language *recognizers*: they indicate whether a given string is valid. The principal job of the scanner is to reduce the quantity of information that must be processed by the parser, by grouping characters together into tokens, and by removing comments and white space. Scanner and parser generators automatically translate regular expressions and context-free grammars into scanners and parsers.

Practical parsers for programming languages (parsers that run in linear time) fall into two principal groups: top-down (also called LL or predictive) and bottom-up (also called LR or shift-reduce). A top-down parser constructs a parse tree starting from the root and proceeding in a left-to-right depth-first traversal. A bottom-up parser constructs a parse tree starting from the leaves, again working left-to-right, and combining partial trees together when it recognizes the children of an internal node. The stack of a top-down parser contains a prediction of what will be seen in the future; the stack of a bottom-up parser contains a record of what has been seen in the past.

Top-down parsers tend to be simple, both in the parsing of valid strings and in the recovery from errors in invalid strings. Bottom-up parsers are more powerful, and in some cases lend themselves to more intuitively structured grammars,

though they suffer from the inability to embed action routines at arbitrary points in a right-hand side (we discuss this point in more detail in Section ©4.5.1). Both varieties of parser are used in real compilers, though bottom-up parsers are more common. Top-down parsers tend to be smaller in terms of code and data size, but modern machines provide ample memory for either.

Both scanners and parsers can be built by hand if an automatic tool is not available. Handbuilt scanners are simple enough to be relatively common. Handbuilt parsers are generally limited to top-down recursive descent, and are most commonly used for comparatively simple languages (e.g., Pascal but not Ada). Automatic generation of the scanner and parser has the advantage of increased reliability, reduced development time, and easy modification and enhancement.

Various features of language design can have a major impact on the complexity of syntax analysis. In many cases, features that make it difficult for a compiler to scan or parse also make it difficult for a human being to write correct, maintainable code. Examples include the lexical structure of Fortran and the `if...then...else` statement of languages like Pascal. This interplay among language design, implementation, and use will be a recurring theme throughout the remainder of the book.

2.6 Exercises

2.1 Write regular expressions to capture the following.

- (a) Strings in C. These are delimited by double quotes ("), and may not contain newline characters. They may contain double-quote or backslash characters if and only if those characters are “escaped” by a preceding backslash. You may find it helpful to introduce shorthand notation to represent any character that is *not* a member of a small specified set.
- (b) Comments in Pascal. These are delimited by (* and *) or by { and }.
- (c) Numeric constants in C. These are octal, decimal, or hexadecimal integers, or decimal or hexadecimal floating-point values. An octal integer begins with 0, and may contain only the digits 0–7. A hexadecimal integer begins with 0x or 0X, and may contain the digits 0–9 and a/A–f/F. A decimal floating-point value has a fractional portion (beginning with a dot) or an exponent (beginning with E or e). Unlike a decimal integer, it is allowed to start with 0. A hexadecimal floating-point value has an optional fractional portion and a mandatory exponent (beginning with P or p). In either decimal or hexadecimal, there may be digits to the left of the dot, the right of the dot, or both, and the exponent itself is given in decimal, with an optional leading + or – sign. An integer may end with an optional U or u (indicating “unsigned”), and/or L or l (indicating “long”) or LL or ll (indicating “long long”). A floating-point value may

end with an optional F or f (indicating “float”—single precision) or L or l (indicating “long”—double precision).

- (d) Floating-point constants in Ada. These match the definition of *real* in [Example 2.3](#) [page 44]), except that (1) a digit is required on both sides of the decimal point, (2) an underscore is permitted between digits, and (3) an alternative numeric base may be specified by surrounding the nonexponent part of the number with pound signs, preceded by a base in decimal (e.g., 16#6.a7#e+2). In this latter case, the letters a..f (both upper- and lowercase) are permitted as digits. Use of these letters in an inappropriate (e.g., decimal) number is an error, but need not be caught by the scanner.
- (e) Inexact constants in Scheme. Scheme allows real numbers to be explicitly *inexact* (imprecise). A programmer who wants to express all constants using the same number of characters can use sharp signs (#) in place of any lower-significance digits whose values are not known. A base-10 constant without exponent consists of one or more digits followed by zero or more sharp signs. An optional decimal point can be placed at the beginning, the end, or anywhere in-between. (For the record, numbers in Scheme are actually a good bit more complicated than this. For the purposes of this exercise, please ignore anything you may know about sign, exponent, radix, exactness and length specifiers, and complex or rational values.)
- (f) Financial quantities in American notation. These have a leading dollar sign (\$), an optional string of asterisks (*—used on checks to discourage fraud), a string of decimal digits, and an optional fractional part consisting of a decimal point (.) and two decimal digits. The string of digits to the left of the decimal point may consist of a single zero (0). Otherwise it must not start with a zero. If there are more than three digits to the left of the decimal point, groups of three (counting from the right) must be separated by commas (,). Example: \$**2,345.67. (Feel free to use “productions” to define abbreviations, so long as the language remains regular.)
- 2.2 Show (as “circles-and-arrows” diagrams) the finite automata for [Exercise 2.1](#).
- 2.3 Build a regular expression that captures all nonempty sequences of letters other than `file`, `for`, and `from`. For notational convenience, you may assume the existence of a **not** operator that takes a set of letters as argument and matches any *other* letter. Comment on the practicality of constructing a regular expression for all sequences of letters other than the keywords of a large programming language.
- 2.4 (a) Show the NFA that results from applying the construction of [Figure 2.7](#) to the regular expression `letter (letter | digit)*`.
- (b) Apply the transformation illustrated by [Example 2.14](#) to create an equivalent DFA.

- (c) Apply the transformation illustrated by [Example 2.15](#) to minimize the DFA.
- 2.5 Starting with the regular expressions for *integer* and *decimal* in [Example 2.3](#), construct an equivalent NFA, the set-of-subsets DFA, and the minimal equivalent DFA. Be sure to keep separate the final states for the two different kinds of token (see the sidebar on page 60). You will find the exercise easier if you undertake it by modifying the machines in [Examples 2.13 through 2.15](#).
- 2.6 Build an ad hoc scanner for the calculator language. As output, have it print a list, in order, of the input tokens. For simplicity, feel free to simply halt in the event of a lexical error.
- 2.7 Write a program in your favorite scripting language to remove comments from programs in the calculator language ([Example 2.9](#)).
- 2.8 Build a nested-case-statements finite automaton that converts all letters in its input to lowercase, except within Pascal-style comments and strings. A Pascal comment is delimited by { and }, or by (* and *). Comments do not nest. A Pascal string is delimited by single quotes (' ... '). A quote character can be placed in a string by doubling it ('Madam, I'm Adam.'). This upper-to-lower mapping can be useful if feeding a program written in standard Pascal (which ignores case) to a compiler that considers upper- and lowercase letters to be distinct.
- 2.9 (a) Describe in English the language defined by the regular expression $a^*(b a^* b a^*)^*$. Your description should be a high-level characterization—one that would still make sense if we were using a different regular expression for the same language.
- (b) Write an unambiguous context-free grammar that generates the same language.
- (c) Using your grammar from part (b), give a canonical (rightmost) derivation of the string $b a a b a a b b$.
- 2.10 Give an example of a grammar that captures right associativity for an exponentiation operator (e.g., ** in Fortran).
- 2.11 Prove that the following grammar is LL(1):

$$\begin{aligned} \text{decl} &\longrightarrow \text{ID } \text{decl_tail} \\ \text{decl_tail} &\longrightarrow \text{ , decl} \\ &\longrightarrow \text{ : ID ;} \end{aligned}$$

(The final ID is meant to be a type name.)

- 2.12 Consider the following grammar:

$$\begin{aligned} G &\longrightarrow S \$\$ \\ S &\longrightarrow A M \\ M &\longrightarrow S \mid \epsilon \end{aligned}$$

$$\begin{aligned}
 A &\longrightarrow a E \mid b A A \\
 E &\longrightarrow a B \mid b A \mid \epsilon \\
 B &\longrightarrow b E \mid a B B
 \end{aligned}$$

- Describe in English the language that the grammar generates.
- Show a parse tree for the string $a b a a$.
- Is the grammar LL(1)? If so, show the parse table; if not, identify a prediction conflict.

2.13 Consider the following grammar:

$$\begin{aligned}
 stmt &\longrightarrow assignment \\
 &\quad \longrightarrow subr_call \\
 assignment &\longrightarrow id := expr \\
 subr_call &\longrightarrow id (arg_list) \\
 expr &\longrightarrow primary expr_tail \\
 expr_tail &\longrightarrow op expr \\
 &\quad \longrightarrow \epsilon \\
 primary &\longrightarrow id \\
 &\quad \longrightarrow subr_call \\
 &\quad \longrightarrow (expr) \\
 op &\longrightarrow + \mid - \mid * \mid / \\
 arg_list &\longrightarrow expr args_tail \\
 args_tail &\longrightarrow , arg_list \\
 &\quad \longrightarrow \epsilon
 \end{aligned}$$

- Construct a parse tree for the input string $foo(a, b)$.
 - Give a canonical (rightmost) derivation of this same string.
 - Prove that the grammar is not LL(1).
 - Modify the grammar so that it is LL(1).
- 2.14 Consider the language consisting of all strings of properly balanced parentheses and brackets.
- Give LL(1) and SLR(1) grammars for this language.
 - Give the corresponding LL(1) and SLR(1) parsing tables.
 - For each grammar, show the parse tree for $([] ([])) [] (())$.
 - Give a trace of the actions of the parsers in constructing these trees.
- 2.15 Consider the following context-free grammar:

$$\begin{aligned}
 G &\longrightarrow G B \\
 &\quad \longrightarrow G N \\
 &\quad \longrightarrow \epsilon
 \end{aligned}$$

$$\begin{aligned}
 B &\longrightarrow (E) \\
 E &\longrightarrow E (E) \\
 &\longrightarrow \epsilon \\
 N &\longrightarrow (L] \\
 L &\longrightarrow L E \\
 &\longrightarrow L (\\
 &\longrightarrow \epsilon
 \end{aligned}$$

- (a) Describe, in English, the language generated by this grammar. (Hint: B stands for “balanced”; N stands for “nonbalanced”.) (Your description should be a high-level characterization of the language—one that is independent of the particular grammar chosen.)
- (b) Give a parse tree for the string $(([]))$.
- (c) Give a canonical (rightmost) derivation of this same string.
- (d) What is $\text{FIRST}(E)$ in our grammar? What is $\text{FOLLOW}(E)$? (Recall that FIRST and FOLLOW sets are defined for symbols in an arbitrary CFG, regardless of parsing algorithm.)
- (e) Given its use of left recursion, our grammar is clearly not LL(1). Does this language have an LL(1) grammar? Explain.
- 2.16** Give a grammar that captures all levels of precedence for arithmetic expressions in C, as shown in [Figure 6.1](#) (page 223). (Hint: This exercise is somewhat tedious. You’ll probably want to attack it with a text editor rather than a pencil.)
- 2.17** Extend the grammar of [Figure 2.24](#) to include `if` statements and `while` loops, along the lines suggested by the following examples:

```

abs := n
if n < 0 then abs := 0 - abs fi

sum := 0
read count
while count > 0 do
  read n
  sum := sum + n
  count := count - 1
od
write sum

```

Your grammar should support the six standard comparison operations in conditions, with arbitrary expressions as operands. It also should allow an arbitrary number of statements in the body of an `if` or `while` statement.

- 2.18** Consider the following LL(1) grammar for a simplified subset of Lisp:

$$\begin{aligned}
 P &\longrightarrow E \ \$\$ \\
 E &\longrightarrow \text{atom} \\
 &\longrightarrow ' E \\
 &\longrightarrow (E Es) \\
 Es &\longrightarrow E Es \\
 &\longrightarrow
 \end{aligned}$$

- (a) What is $\text{FIRST}(Es)$? $\text{FOLLOW}(E)$? $\text{PREDICT}(Es \longrightarrow \epsilon)$?
- (b) Give a parse tree for the string $(\text{cdr } '(a b c)) \ \$\$$.
- (c) Show the leftmost derivation of $(\text{cdr } '(a b c)) \ \$\$$.
- (d) Show a trace, in the style of [Figure 2.20](#), of a table-driven top-down parse of this same input.
- (e) Now consider a recursive descent parser running on the same input. At the point where the quote token ($'$) is matched, which recursive descent routines will be active (i.e., what routines will have a frame on the parser's run-time stack)?
- 2.19 Write top-down and bottom-up grammars for the language consisting of all well-formed regular expressions. Arrange for all operators to be left-associative. Give Kleene closure the highest precedence and alternation the lowest precedence.
- 2.20 Suppose that the expression grammar in [Example 2.8](#) were to be used in conjunction with a scanner that did *not* remove comments from the input, but rather returned them as tokens. How would the grammar need to be modified to allow comments to appear at arbitrary places in the input?
- 2.21 Build a complete recursive descent parser for the calculator language. As output, have it print a trace of its matches and predictions.
- 2.22 Flesh out the details of an algorithm to eliminate left recursion and common prefixes in an arbitrary context-free grammar.
- 2.23 In some languages an assignment can appear in any context in which an expression is expected: the value of the expression is the right-hand side of the assignment, which is placed into the left-hand-side as a side effect. Consider the following grammar fragment for such a language. Explain why it is not LL(1), and discuss what might be done to make it so.

$$\begin{aligned}
 \text{expr} &\longrightarrow \text{id} := \text{expr} \\
 &\longrightarrow \text{term } \text{term_tail} \\
 \text{term_tail} &\longrightarrow + \text{term } \text{term_tail} \mid \epsilon \\
 \text{term} &\longrightarrow \text{factor } \text{factor_tail} \\
 \text{factor_tail} &\longrightarrow * \text{factor } \text{factor_tail} \mid \epsilon \\
 \text{factor} &\longrightarrow (\text{expr}) \mid \text{id}
 \end{aligned}$$

- 2.24 Construct the CFSM for the *id_list* grammar in [Example 2.20](#) (page 67) and verify that it can be parsed bottom-up with *zero* tokens of look-ahead.

- 2.25 Modify the grammar in [Exercise 2.24](#) to allow an *id_list* to be empty. Is the grammar still LR(0)?
- 2.26 Consider the following grammar for a declaration list:

```

decl_list → decl_list decl ; | decl ;
decl → id : type
type → int | real | char
      → array const .. const of type
      → record decl_list end

```

Construct the CFSM for this grammar. Use it to trace out a parse (as in [Figure 2.29](#)) for the following input program:

```

foo : record
      a : char;
      b : array 1 .. 2 of real;
end;

```

- 2.27 The dangling `else` problem of Pascal is not shared by Algol 60. To avoid ambiguity regarding which `then` is matched by an `else`, Algol 60 prohibits `if` statements immediately inside a `then` clause. The Pascal fragment

```
if C1 then if C2 then S1 else S2
```

must be written as either

```
if C1 then begin if C2 then S1 end else S2
```

or

```
if C1 then begin if C2 then S1 else S2 end
```

in Algol 60. Show how to write a grammar for conditional statements that enforces this rule. (Hint: you will want to distinguish in your grammar between conditional statements and nonconditional statements; some contexts will accept either, some only the latter.)

- © 2.28–2.32 In More Depth.

2.7 Explorations

- 2.33 Some languages (e.g., C) distinguish between upper- and lowercase letters in identifiers. Others (e.g., Ada) do not. Which convention do you prefer? Why?

- 2.34 The syntax for type casts in C and its descendants introduces potential ambiguity: is $(x)-y$ a subtraction, or the unary negation of y , cast to type x ? Find out how C, C++, Java, and C# answer this question. Discuss how you would implement the answer(s).
- 2.35 What do you think of Haskell, Occam, and Python’s use of indentation to delimit control constructs (Section 2.1.1)? Would you expect this convention to make program construction and maintenance easier or harder? Why?
- 2.36 Skip ahead to Section 13.4.2 and learn about the “regular expressions” used in scripting languages, editors, search tools, and so on. Are these really regular? What can they express that cannot be expressed in the notation introduced in Section 2.1.1?
- 2.37 Rebuild the automaton of Exercise 2.8 using `lex/flex`.
- 2.38 Find a manual for `yacc/bison`, or consult a compiler textbook [ALSU07, Secs. 4.8.1 and 4.9.2] to learn about *operator precedence parsing*. Explain how it could be used to simplify the grammar of Exercise 2.16.
- 2.39 Use `lex/flex` and `yacc/bison` to construct a parser for the calculator language. Have it output a trace of its shifts and reductions.
- 2.40 Repeat the previous exercise using ANTLR.
- © 2.41–2.42 In More Depth.

2.8 Bibliographic Notes

Our coverage of scanning and parsing in this chapter has of necessity been brief. Considerably more detail can be found in texts on parsing theory [AU72] and compiler construction [ALSU07, FL88, App97, GBJL01, CT04]. Many compilers of the early 1960s employed recursive descent parsers. Lewis and Stearns [LS68] and Rosenkrantz and Stearns [RS70] published early formal studies of LL grammars and parsing. The original formulation of LR parsing is due to Knuth [Knu65]. Bottom-up parsing became practical with DeRemer’s discovery of the SLR and LALR algorithms [DeR71]. W. L. Johnson et al. [JPAR68] describe an early scanner generator. The Unix `lex` tool is due to Lesk [Les75]. `Yacc` is due to S. C. Johnson [Joh75].

Further details on formal language theory can be found in a variety of textbooks, including those of Hopcroft, Motwani, and Ullman [HMU01] and Sipser [Sip97]. Kleene [Kle56] and Rabin and Scott [RS59] proved the equivalence of regular expressions and finite automata.¹⁵ The proof that finite automata are unable to

¹⁵ Dana Scott (1932–), Professor Emeritus at Carnegie Mellon University, is known principally for inventing domain theory and launching the field of denotational semantics, which provides a mathematically rigorous way to formalize the meaning of programming languages. Michael Rabin (1931–), of Harvard University, has made seminal contributions to the concepts of non-determinism and randomization in computer science. Scott and Rabin shared the ACM Turing Award in 1976.

recognize nested constructs is based on a theorem known as the *pumping lemma*, due to Bar-Hillel, Perles, and Shamir [BHPS61]. Context-free grammars were first explored by Chomsky [Cho56] in the context of natural language. Independently, Backus and Naur developed BNF for the syntactic description of Algol 60 [NBB⁺63]. Ginsburg and Rice [GR62] recognized the equivalence of the two notations. Chomsky [Cho62] and Evey [Eve63] demonstrated the equivalence of context-free grammars and push-down automata.

Fischer and LeBlanc's text [FL88] contains an excellent survey of error recovery and repair techniques, with references to other work. The phrase-level recovery mechanism for recursive descent parsers described in Section ©2.3.4 is due to Wirth [Wir76, Sec. 5.9]. The locally least-cost recovery mechanism for table-driven LL parsers described in Section ©2.3.4 is due to Fischer, Milton, and Quiring [FMQ80]. Dion published a locally least-cost bottom-up repair algorithm in 1978 [Dio78]. It is quite complex, and requires very large precomputed tables. McKenzie, Yeatman, and De Vere subsequently showed how to effect the same repairs without the precomputed tables, at a higher but still acceptable cost in time [MYD95].

Names, Scopes, and Bindings

3

“High-level” programming languages take their name from the relatively high level, or degree of abstraction, of the features they provide, relative to those of the assembly languages they were originally designed to replace. The adjective “abstract,” in this context, refers to the degree to which language features are separated from the details of any particular computer architecture. The early development of languages like Fortran, Algol, and Lisp was driven by a pair of complementary goals: machine independence and ease of programming. By abstracting the language away from the hardware, designers not only made it possible to write programs that would run well on a wide variety of machines, but also made the programs easier for human beings to understand.

Machine independence is a fairly simple concept. Basically it says that a programming language should not rely on the features of any particular instruction set for its efficient implementation. Machine dependences still become a problem from time to time (standards committees for C, for example, are still debating how to accommodate multiprocessors with relaxed memory consistency), but with a few noteworthy exceptions (Java comes to mind) it has probably been 35 years since the desire for greater machine independence has really driven language design. Ease of programming, on the other hand, is a much more elusive and compelling goal. It affects every aspect of language design, and has historically been less a matter of science than of aesthetics and trial and error.

This chapter is the first of five to address core issues in language design. The others are [Chapters 6 through 9](#). In [Chapter 6](#) we will look at control-flow constructs, which allow the programmer to specify the order in which operations are to occur. In contrast to the jump-based control flow of assembly languages, high-level control flow relies heavily on the lexical nesting of constructs. In [Chapter 7](#) we will look at types, which allow the programmer to organize program data and the operations on them. In [Chapters 8 and 9](#) we will look at subroutines and classes. In the current chapter we will look at *names*.

A name is a mnemonic character string used to represent something else. Names in most languages are identifiers (alphanumeric tokens), though certain other symbols, such as `+` or `:=`, can also be names. Names allow us to refer to

variables, constants, operations, types, and so on using symbolic identifiers rather than low-level concepts like addresses. Names are also essential in the context of a second meaning of the word *abstraction*. In this second meaning, abstraction is a process by which the programmer associates a name with a potentially complicated program fragment, which can then be thought of in terms of its purpose or function, rather than in terms of how that function is achieved. By hiding irrelevant details, abstraction reduces conceptual complexity, making it possible for the programmer to focus on a manageable subset of the program text at any particular time. Subroutines are *control abstractions*: they allow the programmer to hide arbitrarily complicated code behind a simple interface. Classes are *data abstractions*: they allow the programmer to hide data representation details behind a (comparatively) simple set of operations.

We will look at several major issues related to names. [Section 3.1](#) introduces the notion of *binding time*, which refers not only to the binding of a name to the thing it represents, but also in general to the notion of resolving any design decision in a language implementation. [Section 3.2](#) outlines the various mechanisms used to allocate and deallocate storage space for objects, and distinguishes between the lifetime of an object and the lifetime of a binding of a name to that object.¹ Most name-to-object bindings are usable only within a limited region of a given high-level program. [Section 3.3](#) explores the *scope* rules that define this region; [Section 3.4](#) (mostly on the PLP CD) considers their implementation.

The complete set of bindings in effect at a given point in a program is known as the current *referencing environment*. [Section 3.6](#) expands on the notion of scope rules by considering the ways in which a referencing environment may be bound to a subroutine that is passed as a parameter, returned from a function, or stored in a variable. [Section 3.5](#) discusses aliasing, in which more than one name may refer to a given object in a given scope; overloading, in which a name may refer to more than one object in a given scope, depending on the context of the reference; and polymorphism, in which a single object may have more than one type, depending on context or execution history. [Section 3.7](#) discusses macro expansion, which can introduce new names via textual substitution, sometimes in ways that are at odds with the rest of the language. Finally, [Section 3.8](#) (mostly on the PLP CD) discusses separate compilation.

3.1 The Notion of Binding Time

A *binding* is an association between two things, such as a name and the thing it names. *Binding time* is the time at which a binding is created or, more generally, the time at which any implementation decision is made (we can think of this

¹ For want of a better term, we will use the term “object” throughout [Chapters 3–8](#) to refer to anything that might have a name: variables, constants, types, subroutines, modules, and others. In many modern languages “object” has a more formal meaning, which we will consider in [Chapter 9](#).

as binding an answer to a question). There are many different times at which decisions may be bound:

Language design time: In most languages, the control flow constructs, the set of fundamental (primitive) types, the available *constructors* for creating complex types, and many other aspects of language semantics are chosen when the language is designed.

Language implementation time: Most language manuals leave a variety of issues to the discretion of the language implementor. Typical (though by no means universal) examples include the precision (number of bits) of the fundamental types, the coupling of I/O to the operating system's notion of files, the organization and maximum sizes of stack and heap, and the handling of run-time exceptions such as arithmetic overflow.

Program writing time: Programmers, of course, choose algorithms, data structures, and names.

Compile time: Compilers choose the mapping of high-level constructs to machine code, including the layout of statically defined data in memory.

Link time: Since most compilers support *separate compilation*—compiling different modules of a program at different times—and depend on the availability of a library of standard subroutines, a program is usually not complete until the various modules are joined together by a linker. The linker chooses the overall layout of the modules with respect to one another, and resolves inter-module references. When a name in one module refers to an object in another module, the binding between the two is not finalized until link time.

Load time: Load time refers to the point at which the operating system loads the program into memory so that it can run. In primitive operating systems, the choice of machine addresses for objects within the program was not finalized until load time. Most modern operating systems distinguish between virtual and physical addresses. Virtual addresses are chosen at link time; physical addresses can actually change at run time. The processor's memory management hardware translates virtual addresses into physical addresses during each individual instruction at run time.

Run time: Run time is actually a very broad term that covers the entire span from the beginning to the end of execution. Bindings of values to variables occur at run time, as do a host of other decisions that vary from language to language.

DESIGN & IMPLEMENTATION

Binding time

It is difficult to overemphasize the importance of binding times in the design and implementation of programming languages. In general, early binding times are associated with greater efficiency, while later binding times are associated with greater flexibility. The tension between these goals provides a recurring theme for later chapters of this book.

Run time subsumes program start-up time, module entry time, elaboration time (the point at which a declaration is first “seen”), subroutine call time, block entry time, and statement execution time.

The terms *static* and *dynamic* are generally used to refer to things bound before run time and at run time, respectively. Clearly “static” is a coarse term. So is “dynamic.”

Compiler-based language implementations tend to be more efficient than interpreter-based implementations because they make earlier decisions. For example, a compiler analyzes the syntax and semantics of global variable declarations once, before the program ever runs. It decides on a layout for those variables in memory and generates efficient code to access them wherever they appear in the program. A pure interpreter, by contrast, must analyze the declarations every time the program begins execution. In the worst case, an interpreter may reanalyze the local declarations within a subroutine each time that subroutine is called. If a call appears in a deeply nested loop, the savings achieved by a compiler that is able to analyze the declarations only once may be very large. As we shall see in the following section, a compiler will not usually be able to predict the address of a local variable at compile time, since space for the variable will be allocated dynamically on a stack, but it can arrange for the variable to appear at a fixed offset from the location pointed to by a certain register at run time.

Some languages are difficult to compile because their definitions require fundamental decisions to be postponed until run time, generally in order to increase the flexibility or expressiveness of the language. Smalltalk, for example, delays all type checking until run time. All operations in Smalltalk are cast in the form of “messages” to “objects.” A message is acceptable if and only if the object provides a handler for it. References to objects of arbitrary types (classes) can then be assigned into arbitrary named variables, as long as the program never ends up sending a message to an object that is not prepared to handle it. This form of *polymorphism*—allowing a variable name to refer to objects of multiple types—allows the Smalltalk programmer to write very general-purpose code, which will correctly manipulate objects whose types had yet to be fully defined at the time the code was written. We will mention polymorphism again in [Section 3.5.3](#), and discuss it further in [Chapters 7 and 9](#).

3.2 Object Lifetime and Storage Management

In any discussion of names and bindings, it is important to distinguish between names and the objects to which they refer, and to identify several key events:

- Creation of objects
- Creation of bindings
- References to variables, subroutines, types, and so on, all of which use bindings

- Deactivation and reactivation of bindings that may be temporarily unusable
- Destruction of bindings
- Destruction of objects

The period of time between the creation and the destruction of a name-to-object binding is called the binding's *lifetime*. Similarly, the time between the creation and destruction of an object is the object's lifetime. These lifetimes need not necessarily coincide. In particular, an object may retain its value and the potential to be accessed even when a given name can no longer be used to access it. When a variable is passed to a subroutine by *reference*, for example (as it typically is in Fortran or with `var` parameters in Pascal or `&`' parameters in C++), the binding between the parameter name and the variable that was passed has a lifetime shorter than that of the variable itself. It is also possible, though generally a sign of a program bug, for a name-to-object binding to have a lifetime *longer* than that of the object. This can happen, for example, if an object created via the C++ `new` operator is passed as a `&` parameter and then deallocated (`delete`-ed) before the subroutine returns. A binding to an object that is no longer live is called a *dangling reference*. Dangling references will be discussed further in [Sections 3.6](#) and [7.7.2](#).

Object lifetimes generally correspond to one of three principal *storage allocation* mechanisms, used to manage the object's space:

1. *Static* objects are given an absolute address that is retained throughout the program's execution.
2. *Stack* objects are allocated and deallocated in last-in, first-out order, usually in conjunction with subroutine calls and returns.
3. *Heap* objects may be allocated and deallocated at arbitrary times. They require a more general (and expensive) storage management algorithm.

3.2.1 Static Allocation

Global variables are the obvious example of static objects, but not the only one. The instructions that constitute a program's machine language translation can also be thought of as statically allocated objects. In addition, we shall see examples in [Section 3.3.1](#) of variables that are local to a single subroutine, but retain their values from one invocation to the next; their space is statically allocated. Numeric and string-valued constant literals are also statically allocated, for statements such as `A = B/14.7` or `printf("hello, world\n")`. (Small constants are often stored within the instruction itself; larger ones are assigned a separate location.) Finally, most compilers produce a variety of tables that are used by run-time support routines for debugging, dynamic-type checking, garbage collection, exception handling, and other purposes; these are also statically allocated. Statically allocated objects whose value should not change during program execution (e.g., instructions, constants, and certain run-time tables) are often allocated in

protected, read-only memory, so that any inadvertent attempt to write to them will cause a processor interrupt, allowing the operating system to announce a run-time error.

Logically speaking, local variables are created when their subroutine is called, and destroyed when it returns. If the subroutine is called repeatedly, each invocation is said to create and destroy a separate *instance* of each local variable. It is not always the case, however, that a language implementation must perform work at run time corresponding to these create and destroy operations. Recursion was not originally supported in Fortran (it was added in Fortran 90). As a result, there can never be more than one invocation of a subroutine active in an older Fortran program at any given time, and a compiler may choose to use static allocation for local variables, effectively arranging for the variables of different invocations to share the same locations, and thereby avoiding any run-time overhead for creation and destruction. ■

EXAMPLE 3.1

Static allocation of local variables

In many languages a named constant is required to have a value that can be determined at compile time. Usually the expression that specifies the constant's value is permitted to include only other known constants and built-in functions and arithmetic operators. Named constants of this sort, together with constant literals, are sometimes called *manifest constants* or *compile-time constants*. Manifest constants can always be allocated statically, even if they are local to a recursive subroutine: multiple instances can share the same location.

In other languages (e.g., C and Ada), constants are simply variables that cannot be changed after elaboration time. Their values, though unchanging, can sometimes depend on other values that are not known until run time. These *elaboration-time constants*, when local to a recursive subroutine, must be allocated on the stack. C# provides both options, explicitly, with the `const` and `readonly` keywords.

Along with local variables and elaboration-time constants, the compiler typically stores a variety of other information associated with the subroutine, including:

Arguments and return values. Modern compilers keep these in registers whenever possible, but sometimes space in memory is needed.

Temporaries. These are usually intermediate values produced in complex calculations. Again, a good compiler will keep them in registers whenever possible.

DESIGN & IMPLEMENTATION

Recursion in Fortran

The lack of recursion in (pre-Fortran 90) Fortran is generally attributed to the expense of stack manipulation on the IBM 704, on which the language was first implemented. Many (perhaps most) Fortran implementations choose to use a stack for local variables, but because the language definition permits the use of static allocation instead, Fortran programmers were denied the benefits of language-supported recursion for over 30 years.

Bookkeeping information. This may include the subroutine's return address, a reference to the stack frame of the caller (also called the *dynamic link*), additional saved registers, debugging information, and various other values that we will study later.

3.2.2 Stack-Based Allocation

If a language permits recursion, static allocation of local variables is no longer an option, since the number of instances of a variable that may need to exist at the same time is conceptually unbounded. Fortunately, the natural nesting of subroutine calls makes it easy to allocate space for locals on a stack. A simplified picture of a typical stack appears in Figure 3.1. Each instance of a subroutine at run time has its own *frame* (also called an *activation record*) on the stack, containing arguments and return values, local variables, temporaries, and bookkeeping information. Arguments to be passed to subsequent routines lie at the top of the frame, where the callee can easily find them. The organization of the remaining information is implementation-dependent: it varies from one language, machine, and compiler to another. ■

EXAMPLE 3.2

Layout of the run-time stack

Maintenance of the stack is the responsibility of the subroutine *calling sequence*—the code executed by the caller immediately before and after the call—and of the *prologue* (code executed at the beginning) and *epilogue* (code executed at the end) of the subroutine itself. Sometimes the term “calling sequence” is used to refer to the combined operations of the caller, the prologue, and the epilogue. We will study calling sequences in more detail in Section 8.2.

While the location of a stack frame cannot be predicted at compile time (the compiler cannot in general tell what other frames may already be on the stack), the offsets of objects *within* a frame usually *can* be statically determined. Moreover, the compiler can arrange (in the calling sequence or prologue) for a particular register, known as the *frame pointer* to always point to a known location within the frame of the current subroutine. Code that needs to access a local variable within the current frame, or an argument near the top of the calling frame, can do so by adding a predetermined offset to the value in the frame pointer. As we discuss in Section 5.3.1, almost every processor provides a *displacement addressing* mechanism that allows this addition to be specified implicitly as part of an ordinary load or store instruction. The stack grows “downward” toward lower addresses in most language implementations. Some machines provide special push and pop instructions that assume this direction of growth. Local variables, temporaries, and bookkeeping information typically have negative offsets from the frame pointer. Arguments and returns typically have positive offsets; they reside in the caller's frame.

Even in a language without recursion, it can be advantageous to use a stack for local variables, rather than allocating them statically. In most programs the pattern of potential calls among subroutines does not permit all of those subroutines to be active at the same time. As a result, the total space needed for local variables

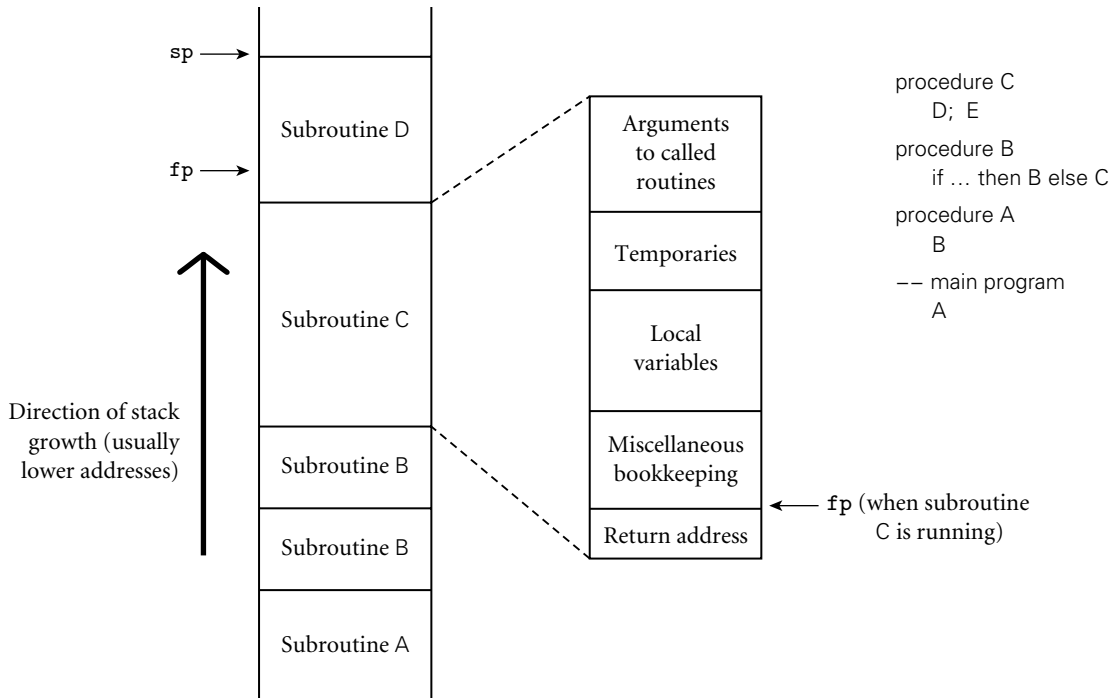

Figure 3.1 Stack-based allocation of space for subroutines. We assume here that subroutines have been called as shown in the upper right. In particular, B has called itself once, recursively, before calling C. If D returns and C calls E, E's frame (activation record) will occupy the same space previously used for D's frame. At any given time, the stack pointer (**sp**) register points to the first unused location on the stack (or the last used location on some machines), and the frame pointer (**fp**) register points to a known location within the frame of the current subroutine. The relative order of fields within a frame may vary from machine to machine and compiler to compiler.

of currently active subroutines is seldom as large as the total space across *all* subroutines, active or not. A stack may therefore require substantially less memory at run time than would be required for static allocation.

3.2.3 Heap-Based Allocation

A *heap* is a region of storage in which subblocks can be allocated and deallocated at arbitrary times.² Heaps are required for the dynamically allocated pieces of linked data structures, and for objects like fully general character strings, lists, and sets, whose size may change as a result of an assignment statement or other update operation.

² Unfortunately, the term “heap” is also used for the common tree-based implementation of a priority queue. These two uses of the term have nothing to do with one another.

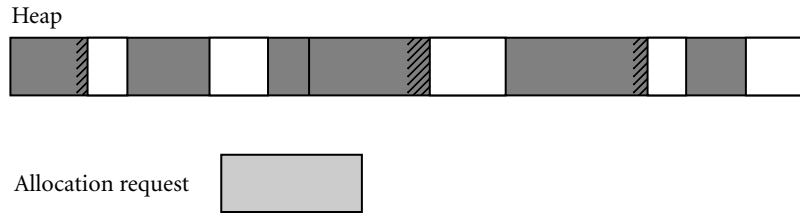

Figure 3.2 **Fragmentation.** The shaded blocks are in use; the clear blocks are free. Cross-hatched space at the ends of in-use blocks represents internal fragmentation. The discontinuous free blocks indicate external fragmentation. While there is more than enough total free space remaining to satisfy an allocation request of the illustrated size, no single remaining block is large enough.

There are many possible strategies to manage space in a heap. We review the major alternatives here; details can be found in any data-structures textbook. The principal concerns are speed and space, and as usual there are tradeoffs between them. Space concerns can be further subdivided into issues of internal and external *fragmentation*. Internal fragmentation occurs when a storage-management algorithm allocates a block that is larger than required to hold a given object; the extra space is then unused. External fragmentation occurs when the blocks that have been assigned to active objects are scattered through the heap in such a way that the remaining, unused space is composed of multiple blocks: there may be quite a lot of free space, but no one piece of it may be large enough to satisfy some future request (see [Figure 3.2](#)). ■

EXAMPLE 3.3

External fragmentation in the heap

Many storage-management algorithms maintain a single linked list—the *free list*—of heap blocks not currently in use. Initially the list consists of a single block comprising the entire heap. At each allocation request the algorithm searches the list for a block of appropriate size. With a *first fit* algorithm we select the first block on the list that is large enough to satisfy the request. With a *best fit* algorithm we search the entire list to find the smallest block that is large enough to satisfy the request. In either case, if the chosen block is significantly larger than required, then we divide it in two and return the unneeded portion to the free list as a smaller block. (If the unneeded portion is below some minimum threshold in size, we may leave it in the allocated block as internal fragmentation.) When a block is deallocated and returned to the free list, we check to see whether either or both of the physically adjacent blocks are free; if so, we coalesce them.

Intuitively, one would expect a best fit algorithm to do a better job of reserving large blocks for large requests. At the same time, it has higher allocation cost than a first fit algorithm, because it must always search the entire list, and it tends to result in a larger number of very small “left-over” blocks. Which approach—first fit or best fit—results in lower external fragmentation depends on the distribution of size requests.

In any algorithm that maintains a single free list, the cost of allocation is linear in the number of free blocks. To reduce this cost to a constant, some storage management algorithms maintain separate free lists for blocks of different sizes. Each

request is rounded up to the next standard size (at the cost of internal fragmentation) and allocated from the appropriate list. In effect, the heap is divided into “pools,” one for each standard size. The division may be static or dynamic. Two common mechanisms for dynamic pool adjustment are known as the *buddy system* and the *Fibonacci heap*. In the buddy system, the standard block sizes are powers of two. If a block of size 2^k is needed, but none is available, a block of size 2^{k+1} is split in two. One of the halves is used to satisfy the request; the other is placed on the k th free list. When a block is deallocated, it is coalesced with its “buddy”—the other half of the split that created it—if that buddy is free. Fibonacci heaps are similar, but use Fibonacci numbers for the standard sizes, instead of powers of two. The algorithm is slightly more complex, but leads to slightly lower internal fragmentation, because the Fibonacci sequence grows more slowly than 2^k .

The problem with external fragmentation is that the ability of the heap to satisfy requests may degrade over time. Multiple free lists may help, by clustering small blocks in relatively close physical proximity, but they do not eliminate the problem. It is always possible to devise a sequence of requests that cannot be satisfied, even though the total space required is less than the size of the heap. If memory is partitioned among size pools statically, one need only exceed the maximum number of requests of a given size. If pools are dynamically readjusted, one can “checkerboard” the heap by allocating a large number of small blocks and then deallocating every other one, in order of physical address, leaving an alternating pattern of small free and allocated blocks. To eliminate external fragmentation, we must be prepared to *compact* the heap, by moving already-allocated blocks. This task is complicated by the need to find and update all outstanding references to a block that is being moved. We will discuss compaction further in [Sections 7.7.2](#) and [7.7.3](#).

3.2.4 Garbage Collection

Allocation of heap-based objects is always triggered by some specific operation in a program: instantiating an object, appending to the end of a list, assigning a long value into a previously short string, and so on. Deallocation is also explicit in some languages (e.g., C, C++, and Pascal.) As we shall see in [Section 7.7](#), however, many languages specify that objects are to be deallocated implicitly when it is no longer possible to reach them from any program variable. The run-time library for such a language must then provide a *garbage collection* mechanism to identify and reclaim unreachable objects. Most functional and scripting languages require garbage collection, as do many more recent imperative languages, including Modula-3, Java, and C#.

The traditional arguments in favor of explicit deallocation are implementation simplicity and execution speed. Even naive implementations of automatic garbage collection add significant complexity to the implementation of a language with a rich type system, and even the most sophisticated garbage collector can consume nontrivial amounts of time in certain programs. If the programmer can correctly

identify the end of an object's lifetime, without too much run-time bookkeeping, the result is likely to be faster execution.

The argument in favor of automatic garbage collection, however, is compelling: manual deallocation errors are among the most common and costly bugs in real-world programs. If an object is deallocated too soon, the program may follow a *dangling reference*, accessing memory now used by another object. If an object is *not* deallocated at the end of its lifetime, then the program may “leak memory,” eventually running out of heap space. Deallocation errors are notoriously difficult to identify and fix. Over time, both language designers and programmers have increasingly come to consider automatic garbage collection an essential language feature. Garbage-collection algorithms have improved, reducing their run-time overhead; language implementations have become more complex in general, reducing the marginal complexity of automatic collection; and leading-edge applications have become larger and more complex, making the benefits of automatic collection ever more compelling.

✓ CHECK YOUR UNDERSTANDING

1. What is *binding time*?
 2. Explain the distinction between decisions that are bound statically and those that are bound dynamically.
 3. What is the advantage of binding things as early as possible? What is the advantage of delaying bindings?
 4. Explain the distinction between the *lifetime* of a name-to-object binding and its *visibility*.
 5. What determines whether an object is allocated statically, on the stack, or in the heap?
 6. List the objects and information commonly found in a stack frame.
 7. What is a *frame pointer*? What is it used for?
 8. What is a *calling sequence*?
 9. What are internal and external *fragmentation*?
 10. What is *garbage collection*?
 11. What is a *dangling reference*?
-

3.3 Scope Rules

The textual region of the program in which a binding is active is its *scope*. In most modern languages, the scope of a binding is determined statically, that is,

at compile time. In C, for example, we introduce a new scope upon entry to a subroutine. We create bindings for local objects and deactivate bindings for global objects that are “hidden” by local objects of the same name. On subroutine exit, we destroy bindings for local variables and reactivate bindings for any global objects that were hidden. These manipulations of bindings may at first glance appear to be run-time operations, but they do not require the execution of any code: the portions of the program in which a binding is active are completely determined at compile time. We can look at a C program and know which names refer to which objects at which points in the program based on purely textual rules. For this reason, C is said to be *statically scoped* (some authors say *lexically scoped*³). Other languages, including APL, Snobol, and early dialects of Lisp, are *dynamically scoped*: their bindings depend on the flow of execution at run time. We will examine static and dynamic scoping in more detail in [Sections 3.3.1](#) and [3.3.6](#).

In addition to talking about the “scope of a binding,” we sometimes use the word *scope* as a noun all by itself, without a specific binding in mind. Informally, a scope is a program region of maximal size in which no bindings change (or at least none are destroyed—more on this in [Section 3.3.3](#)). Typically, a scope is the body of a module, class, subroutine, or structured control flow statement, sometimes called a *block*. In C family languages it would be delimited with `{ . . . }` braces.

Algol 68 and Ada use the term *elaboration* to refer to the process by which declarations become active when control first enters a scope. Elaboration entails the creation of bindings. In many languages, it also entails the allocation of stack space for local objects, and possibly the assignment of initial values. In Ada it can entail a host of other things, including the execution of error-checking or heap-space-allocating code, the propagation of exceptions, and the creation of concurrently executing *tasks* (to be discussed in [Chapter 12](#)).

At any given point in a program’s execution, the set of active bindings is called the current *referencing environment*. The set is principally determined by static or dynamic *scope rules*. We shall see that a referencing environment generally corresponds to a sequence of scopes that can be examined (in order) to find the current binding for a given name.

In some cases, referencing environments also depend on what are (in a confusing use of terminology) called *binding rules*. Specifically, when a reference to a subroutine *S* is stored in a variable, passed as a parameter to another subroutine, or returned as a function value, one needs to determine when the referencing environment for *S* is chosen—that is, when the binding between the reference to *S* and the referencing environment of *S* is made. The two principal options are

3 *Lexical scope* is actually a better term than *static scope*, because scope rules based on nesting can be enforced at run time instead of compile time if desired. In fact, in Common Lisp and Scheme it is possible to pass the unevaluated text of a subroutine declaration into some other subroutine as a parameter, and then use the text to create a lexically nested declaration at run time.

deep binding, in which the choice is made when the reference is first created, and *shallow binding*, in which the choice is made when the reference is finally used. We will examine these options in more detail in [Section 3.6](#).

3.3.1 Static Scoping

In a language with static (lexical) scoping, the bindings between names and objects can be determined at compile time by examining the text of the program, without consideration of the flow of control at run time. Typically, the “current” binding for a given name is found in the matching declaration whose block most closely surrounds a given point in the program, though as we shall see there are many variants on this basic theme.

The simplest static scope rule is probably that of early versions of Basic, in which there was only a single, global scope. In fact, there were only a few hundred possible names, each of which consisted of a letter optionally followed by a digit. There were no explicit declarations; variables were declared implicitly by virtue of being used.

Scope rules are somewhat more complex in (pre-Fortran 90) Fortran, though not much more.⁴ Fortran distinguishes between global and local variables. The scope of a local variable is limited to the subroutine in which it appears; it is not visible elsewhere. Variable declarations are optional. If a variable is not declared, it is assumed to be local to the current subroutine and to be of type `integer` if its name begins with the letters I–N, or `real` otherwise. (Different conventions for implicit declarations can be specified by the programmer. In Fortran 90, the programmer can also turn off implicit declarations, so that use of an undeclared variable becomes a compile-time error.)

Global variables in Fortran may be partitioned into `common` blocks, which are then “imported” by subroutines. `Common` blocks are designed for separate compilation: they allow a subroutine to import only the sets of variables it needs. Unfortunately, Fortran requires each subroutine to declare the names and types of the variables in each of the `common` blocks it uses, and there is no standard mechanism to ensure that the declarations in different subroutines are the same.

Semantically, the lifetime of a local Fortran variable (both the object itself and the name-to-object binding) encompasses a single execution of the variable’s subroutine. Programmers can override this rule by using an explicit `save` statement.

⁴ Fortran and C have evolved considerably over the years. Unless otherwise noted, comments in this text apply to the Fortran 77 dialect [[Ame78a](#)] (still more widely used than the newer Fortran 90). Comments on C refer to all versions of the language (including the C99 standard [[Int99](#)]) unless otherwise noted. Comments on Ada, likewise, refer to both Ada 83 [[Ame83](#)] and Ada 95 [[Int95b](#)] unless otherwise noted.

```

/*
   Place into *s a new name beginning with the letter 'L' and
   continuing with the ASCII representation of a unique integer.
   Parameter s is assumed to point to space large enough to hold any
   such name; for the short ints used here, 7 characters suffice.
*/
void label_name (char *s) {
    static short int n;          /* C guarantees that static locals
                                   are initialized to zero */
    sprintf (s, "L%d\n", ++n); /* "print" formatted output to s */
}

```

Figure 3.3 C code to illustrate the use of static variables.

(Similar mechanisms appear in many other languages: in C one declares the variable *static*; in Algol one declares it *own*.) A *save-ed* (*static*, *own*) variable has a lifetime that encompasses the entire execution of the program. Instead of a logically separate object for every invocation of the subroutine, the compiler creates a single object that retains its value from one invocation of the subroutine to the next. (The name-to-variable binding, of course, is inactive when the subroutine is not executing, because the name is out of scope.)

EXAMPLE 3.4

Static variables in C

As an example of the use of static variables, consider the code in Figure 3.3. The subroutine `label_name` can be used to generate a series of distinct character-string names: L1, L2, A compiler might use these names in its assembly language output. ■

3.3.2 Nested Subroutines

The ability to nest subroutines inside each other, introduced in Algol 60, is a feature of many modern languages, including Pascal, Ada, ML, Python, Scheme, Common Lisp, and (to a limited extent) Fortran 90. Other languages, including C and its descendants, allow classes or other scopes to nest. Just as the local variables of a Fortran subroutine are not visible to other subroutines, any constants, types, variables, or subroutines declared within a block are not visible outside that block in Algol-family languages. More formally, Algol-style nesting gives rise to the *closest nested scope rule* for bindings from names to objects: a name that is introduced in a declaration is known in the scope in which it is declared, and in each internally nested scope, unless it is *hidden* by another declaration of the same name in one or more nested scopes. To find the object corresponding to a given use of a name, we look for a declaration with that name in the current, innermost scope. If there is one, it defines the active binding for the name. Otherwise, we look for a declaration in the immediately surrounding scope. We continue outward, examining successively surrounding scopes, until we reach the outer nesting level of the program, where global objects are declared. If no declaration is found at any level, then the program is in error.

Many languages provide a collection of *built-in*, or *predefined objects*, such as I/O routines, mathematical functions, and in some cases types such as `integer` and `char`. It is common to consider these to be declared in an extra, invisible, outermost scope, which surrounds the scope in which global objects are declared. The search for bindings described in the previous paragraph terminates at this extra, outermost scope, if it exists, rather than at the scope in which global objects are declared. This outermost scope convention makes it possible for a programmer to define a global object whose name is the same as that of some predefined object (whose “declaration” is thereby hidden, making it unusable).

EXAMPLE 3.5

Nested scopes

An example of nested scopes appears in Figure 3.4.⁵ In this example, procedure P2 is called only by P1, and need not be visible outside. It is therefore declared inside P1, limiting its scope (its region of visibility) to the portion of the program shown here. In a similar fashion, P4 is visible only within P1, P3 is visible only within P2, and F1 is visible only within P4. Under the standard rules for nested scopes, F1 could call P2 and P4 could call F1, but P2 could not call F1.

Though they are hidden from the rest of the program, nested subroutines are able to access the parameters and local variables (and other local objects) of the surrounding scope(s). In our example, P3 can name (and modify) A1, X, and A2, in addition to A3. Because P1 and F1 both declare local variables named X, the inner declaration hides the outer one within a portion of its scope. Uses of X in F1 refer to the inner X; uses of X in other regions of the code refer to the outer X. ■

A name-to-object binding that is hidden by a nested declaration of the same name is said to have a *hole* in its scope. In most languages the object whose name is hidden is inaccessible in the nested scope (unless it has more than one name). Some languages allow the programmer to access the outer meaning of a name by applying a *qualifier* or *scope resolution operator*. In Ada, for example, a name may be prefixed by the name of the scope in which it is declared, using syntax that resembles the specification of fields in a record. `My_proc.X`, for example, refers to the declaration of X in subroutine `My_proc`, regardless of whether some other X has been declared in a lexically closer scope. In C++, which does not allow subroutines to nest, `::X` refers to a global declaration of X, regardless of whether the current subroutine also has an X.⁶

Access to Nonlocal Objects

We have already seen (Section 3.2.2) that the compiler can arrange for a frame pointer register to point to the frame of the currently executing subroutine at run time. Using this register as a base for *displacement* (register plus offset) addressing, target code can access objects within the current subroutine. But what about

⁵ This code is not contrived; it was extracted from an implementation of the FMQ error repair algorithm described in Section ©2.3.4.

⁶ The C++ `::` operator is also used to name members (fields or methods) of a base class that are hidden by members of a derived class; we will consider this use in Section 9.2.2.

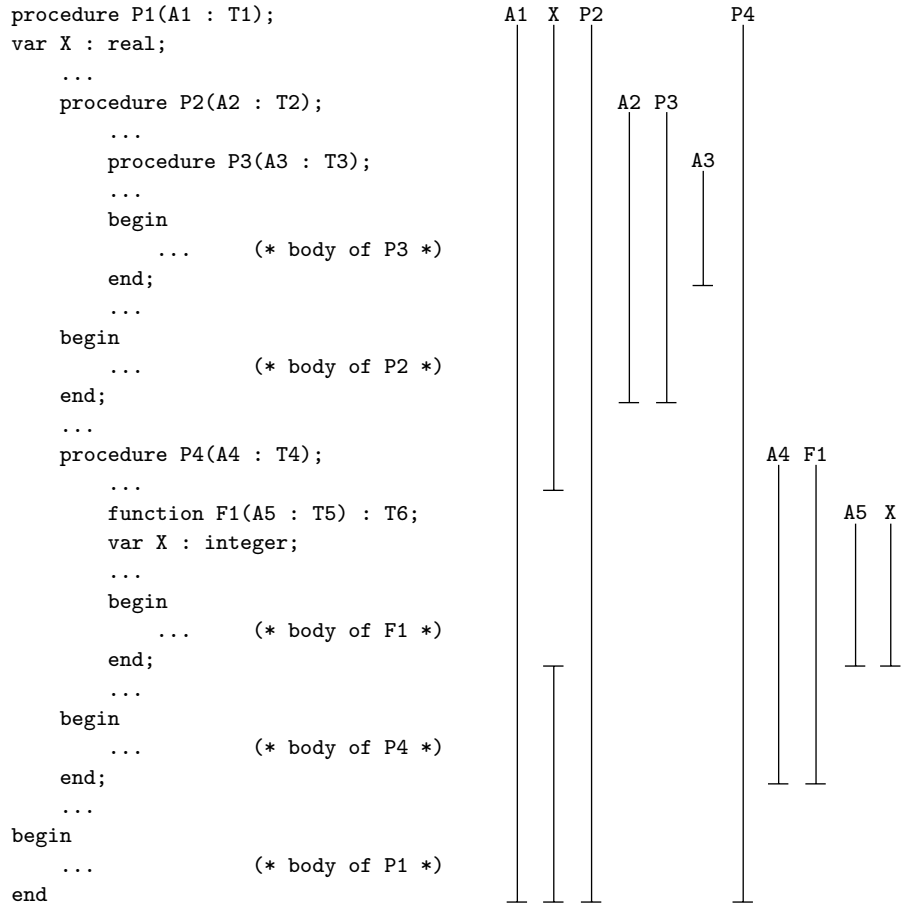

Figure 3.4 Example of nested subroutines in Pascal. Vertical bars show the scope of each name (note the hole in the scope of the outer X).

objects in lexically surrounding subroutines? To find these we need a way to find the frames corresponding to those scopes at run time. Since a nested subroutine may call a routine in an outer scope, the order of stack frames at run time may not necessarily correspond to the order of lexical nesting. Nonetheless, we can be sure that there *is* some frame for the surrounding scope already in the stack, since the current subroutine could not have been called unless it was visible, and it could not have been visible unless the surrounding scope was active. (It is actually possible in some languages to save a reference to a nested subroutine, and then call it when the surrounding scope is no longer active. We defer this possibility to [Section 3.6.2](#).)

The simplest way in which to find the frames of surrounding scopes is to maintain a *static link* in each frame that points to the “parent” frame: the frame

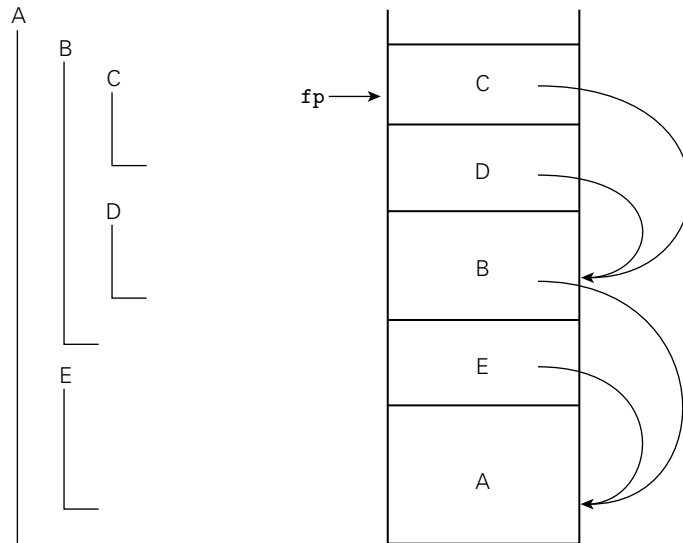

Figure 3.5 Static chains. Subroutines A, B, C, D, and E are nested as shown on the left. If the sequence of nested calls at run time is A, E, B, D, and C, then the static links in the stack will look as shown on the right. The code for subroutine C can find local objects at known offsets from the frame pointer: It can find local objects of the surrounding scope, B, by dereferencing its static chain once and then applying an offset. It can find local objects in B's surrounding scope, A, by dereferencing its static chain twice and then applying an offset.

of the most recent invocation of the lexically surrounding subroutine. If a subroutine is declared at the outermost nesting level of the program, then its frame will have a null static link at run time. If a subroutine is nested k levels deep, then its frame's static link, and those of its parent, grandparent, and so on, will form a *static chain* of length k at run time. To find a variable or parameter declared j subroutine scopes outward, target code at run time can dereference the static chain j times, and then add the appropriate offset. Static chains are illustrated in Figure 3.5. We will discuss the code required to maintain them in Section 8.2. ■

EXAMPLE 3.6
Static chains

3.3.3 Declaration Order

In our discussion so far we have glossed over an important subtlety: suppose an object x is declared somewhere within block B. Does the scope of x include the portion of B before the declaration, and if so can x actually be used in that portion of the code? Put another way, can an expression E refer to any name declared in the current scope, or only to names that are declared *before* E in the scope?

Several early languages, including Algol 60 and Lisp, required that all declarations appear at the beginning of their scope. One might at first think that this rule

EXAMPLE 3.7

A “gotcha” in
declare-before-use

would avoid the questions in the preceding paragraph, but it does not, because declarations may refer to one another.⁷

In an apparent attempt to simplify the implementation of the compiler, Pascal modified the requirement to say that names must be declared before they are used (with special-case mechanisms to accommodate recursive types and subroutines). At the same time, however, Pascal retained the notion that the scope of a declaration is the entire surrounding block. These two rules can interact in surprising ways:

```

1. const N = 10;
2. ...
3. procedure foo;
4. const
5.     M = N;      (* static semantic error! *)
6.     ...
7.     N = 20;    (* local constant declaration; hides the outer N *)
```

Pascal says that the second declaration of N covers all of foo, so the semantic analyzer should complain on line 5 that N is being used before its declaration. The error has the potential to be highly confusing, particularly if the programmer meant to use the outer N:

```

const N = 10;
...
procedure foo;
const
    M = N;          (* static semantic error! *)
var
    A : array [1..M] of integer;
    N : real;       (* hiding declaration *)
```

Here the pair of messages “N used before declaration” and “N is not a constant” are almost certainly not helpful.

DESIGN & IMPLEMENTATION

Mutual recursion

Some Algol 60 compilers were known to process the declarations of a scope in program order. This strategy had the unfortunate effect of implicitly outlawing mutually recursive subroutines and types, something the language designers clearly did not intend [Atk73].

⁷ We saw an example of mutually recursive subroutines in the recursive descent parsing of Section 2.3.1. Mutually recursive types frequently arise in linked data structures, where nodes of two types may need to point to each other.

In order to determine the validity of any declaration that appears to use a name from a surrounding scope, a Pascal compiler must scan the remainder of the scope's declarations to see if the name is hidden. To avoid this complication, most Pascal successors (and some dialects of Pascal itself) specify that the scope of an identifier is not the entire block in which it is declared (excluding holes), but rather the portion of that block from the declaration to the end (again excluding holes). If our program fragment had been written in Ada, for example, or in C, C++, or Java, no semantic errors would be reported. The declaration of *M* would refer to the first (outer) declaration of *N*. ■

C++ and Java further relax the rules by dispensing with the define-before-use requirement in many cases. In both languages, members of a class (including those that are not defined until later in the program text) are visible inside all of the class's methods. In Java, classes themselves can be declared in any order. Interestingly, while C# echos Java in requiring declaration before use for local variables (but not for classes and members), it returns to the Pascal notion of whole-block scope. Thus the following is invalid in C#.

EXAMPLE 3.8

Whole-block scope in C#

```
class A {
    const int N = 10;
    void foo() {
        const int M = N;    // uses inner N before it is declared
        const int N = 20;
    }
}
```

Perhaps the simplest approach to declaration order, from a conceptual point of view, is that of Modula-3, which says that the scope of a declaration is the entire block in which it appears (minus any holes created by nested declarations), and that the order of declarations doesn't matter. The principal objection to this approach is that programmers may find it counterintuitive to use a local variable before it is declared. Python takes the "whole block" scope rule one step further by dispensing with variable declarations altogether. In their place it adopts the unusual convention that the local variables of subroutine *S* are precisely those variables that are written by some statement in the (static) body of *S*. If *S* is nested inside of *T*, and the name *x* appears on the left-hand side of assignment statements in both *S* and *T*, then the *x*'s are distinct: there is one in *S* and one in *T*. Non-local variables are read-only unless explicitly imported (using Python's `global` statement). We will consider these conventions in more detail in [Section 13.4.1](#), as part of a general discussion of scoping in scripting languages. ■

EXAMPLE 3.9

"Local if written" in Python

In the interest of flexibility, modern Lisp dialects tend to provide several options for declaration order. In Scheme, for example, the `letrec` and `let*` constructs define scopes with, respectively, whole-block and declaration-to-end-of-block semantics. The most frequently used construct, `let`, provides yet another option:

EXAMPLE 3.10

Declaration order in Scheme

```
(let ((A 1))           ; outer scope, with A defined to be 1
  (let ((A 2)         ; inner scope, with A defined to be 2
        (B A))       ;           and B defined to be A
    B))              ; return the value of B
```

Here the nested declarations of A and B don't take effect until after the end of the declaration list. Thus when B is defined, the redefinition of A has not yet taken effect. B is defined to be the *outer* A, and the code as a whole returns 1. ■

Declarations and Definitions

Recursive types and subroutines introduce a problem for languages that require names to be declared before they can be used: how can two declarations each appear before the other? C and C++ handle the problem by distinguishing between the *declaration* of an object and its *definition*. A declaration introduces a name and indicates its scope, but may omit certain implementation details. A definition describes the object in sufficient detail for the compiler to determine its implementation. If a declaration is not complete enough to be a definition, then a separate definition must appear somewhere else in the scope. In C we can write

EXAMPLE 3.11

Declarations vs definitions
in C

```

struct manager;                /* declaration only */
struct employee {
    struct manager *boss;
    struct employee *next_employee;
    ...
};
struct manager {                /* definition */
    struct employee *first_employee;
    ...
};

```

and

```

void list_tail(follow_set fs);  /* declaration only */
void list(follow_set fs)
{
    switch (input_token) {
        case id : match(id); list_tail(fs);
        ...
    }
void list_tail(follow_set fs)    /* definition */
{
    switch (input_token) {
        case comma : match(comma); list(fs);
        ...
    }
}

```

The initial declaration of `manager` needed only to introduce a name: since pointers are all the same size, the compiler could determine the implementation of `employee` without knowing any `manager` details. The initial declaration of

`list_tail`, however, must include the return type and parameter list, so the compiler can tell that the call in `list` is correct. ■

Nested Blocks

In many languages, including Algol 60, C89, and Ada, local variables can be declared not only at the beginning of any subroutine, but also at the top of any `begin...end` (`{...}`) block. Other languages, including Algol 68, C99, and all of C's descendants, are even more flexible, allowing declarations wherever a statement may appear. In most languages a nested declaration hides any outer declaration with the same name (Java and C# make it a static semantic error if the outer declaration is local to the current subroutine).

Variables declared in nested blocks can be very useful, as for example in the following C code:

EXAMPLE 3.12

Inner declarations in C

```
{
    int temp = a;
    a = b;
    b = temp;
}
```

Keeping the declaration of `temp` lexically adjacent to the code that uses it makes the program easier to read, and eliminates any possibility that this code will interfere with another variable named `temp`. ■

No run-time work is needed to allocate or deallocate space for variables declared in nested blocks; their space can be included in the total space for local variables allocated in the subroutine prologue and deallocated in the epilogue. [Exercise 3.9](#) considers how to minimize the total space required.

DESIGN & IMPLEMENTATION

Redeclarations

Some languages, particularly those that are intended for interactive use, permit the programmer to redeclare an object: to create a new binding for a given name in a given scope. Interactive programmers commonly use redeclarations to fix bugs. In most interactive languages, the new meaning of the name replaces the old in all contexts. In ML, however, the old meaning of the name may remain accessible to functions that were elaborated before the name was redeclared. This design choice in ML can sometimes be counterintuitive. It probably reflects the fact that ML is usually compiled, bit by bit on the fly, rather than interpreted. A language like Scheme, which is lexically scoped but usually interpreted, stores the binding for a name in a known location. A program accesses the meaning of the name indirectly through that location: if the meaning of the name changes, all accesses to the name will use the new meaning. In ML, previously elaborated functions have already been compiled into a form (often machine code) that accesses the meaning of the name directly.

✓ CHECK YOUR UNDERSTANDING

12. What do we mean by the *scope* of a name-to-object binding?
 13. Describe the difference between static and dynamic scoping.
 14. What is *elaboration*?
 15. What is a *referencing environment*?
 16. Explain the *closest nested scope rule*.
 17. What is the purpose of a *scope resolution operator*?
 18. What is a *static chain*? What is it used for?
 19. What are *forward references*? Why are they prohibited or restricted in many programming languages?
 20. Explain the difference between a *declaration* and a *definition*. Why is the distinction important?
-

3.3.4 Modules

A major challenge in the construction of any large body of software is how to divide the effort among programmers in such a way that work can proceed on multiple fronts simultaneously. This modularization of effort depends critically on the notion of *information hiding*, which makes objects and algorithms invisible, whenever possible, to portions of the system that do not need them. Properly modularized code reduces the “cognitive load” on the programmer by minimizing the amount of information required to understand any given portion of the system. In a well-designed program the interfaces between modules are as “narrow” (i.e., simple) as possible, and any design decision that is likely to change is hidden inside a single module. This latter point is crucial, since maintenance (bug fixes and enhancement) consumes much more programmer time than does initial construction for most commercial software.

In addition to reducing cognitive load, information hiding reduces the risk of name conflicts: with fewer visible names, there is less chance that a newly introduced name will be the same as one already in use. It also safeguards the integrity of data abstractions: any attempt to access objects outside of the subroutine(s) to which they belong will cause the compiler to issue an “undefined symbol” error message. Finally, it helps to compartmentalize run-time errors: if a variable takes on an unexpected value, we can generally be sure that the code that modified it is in the variable’s scope.

Encapsulating Data and Subroutines

Unfortunately, the information hiding provided by nested subroutines is limited to objects whose lifetime is the same as that of the subroutine in which they

are hidden. When control returns from a subroutine, its local variables will no longer be live: their values will be discarded. We have seen a partial solution to this problem in the form of the `save` statement in Fortran and the `static` and `own` variables of C and Algol.

Static variables allow a subroutine to have “memory”—to retain information from one invocation to the next—while protecting that memory from accidental access or modification by other parts of the program. Put another way, static variables allow programmers to build single-subroutine abstractions. Unfortunately, they do not allow the construction of abstractions whose interface needs to consist of more than one subroutine. Suppose, for example, that we wish to construct a *stack* abstraction. We should like to hide the representation of the stack—its internal structure—from the rest of the program, so that it can be accessed only through its *push* and *pop* routines. We can achieve this goal in many languages through use of a *module* construct.

Modules as Abstractions

A module allows a collection of objects—subroutines, variables, types, and so on—to be encapsulated in such a way that (1) objects inside are visible to each other, but (2) objects on the inside are not visible on the outside unless explicitly *exported*, and (3) (in many languages) objects outside are not visible on the inside unless explicitly *imported*. Note that these rules affect only the *visibility* of objects; they do not affect their lifetime.

Modules were one of the principal language innovations of the late 1970s and early 1980s; they appear in Clu (which called them *clusters*), Modula (1, 2, and 3), Turing, and Ada 83. They also appear in Haskell; in C++, Java, and C#; and in the major scripting languages. Several languages, including Ada, Java, and Perl, use the term *package* instead of module. Others, including C++, C#, and PHP, use *namespace*. Modules can be emulated to some degree through use of the separate compilation facilities of C; we discuss this possibility in Section ©3.8.

EXAMPLE 3.13

Stack module in Modula-2

As an example of the use of modules, consider the stack abstraction shown in Figure 3.6. This stack can be embedded anywhere a subroutine might appear in a Modula-2 program. Bindings to variables declared in a module are inactive outside the module, not destroyed. In our stack example, `s` and `top` have the same lifetime they would have had if not enclosed in the module. If `stack` is declared at the program’s outermost nesting level, then `s` and `top` retain their values throughout the execution of the program, though they are visible only to the code inside *push* and *pop*. If `stack` is declared inside some subroutine `sub`, then `s` and `top` have the same lifetime as the local variables of `sub`. If `stack` is declared inside some other module `mod`, then `s` and `top` have the same lifetime as they would have had if not enclosed in either module. Type `stack_index`, which is also declared inside `stack`, is likewise visible only inside *push* and *pop*. The issue of lifetime is not relevant for types or constants, since they have no mutable state.

Our stack abstraction has two imports: the type (`element`) and maximum number (`stack_size`) of elements to be placed in the stack. `Element` and

```

CONST stack_size = ...
TYPE element = ...
...
MODULE stack;
IMPORT element, stack_size;
EXPORT push, pop;
TYPE
    stack_index = [1..stack_size];
VAR
    s : ARRAY stack_index OF element;
    top : stack_index;      (* first unused slot *)

PROCEDURE error; ...

PROCEDURE push(elem : element);
BEGIN
    IF top = stack_size THEN
        error;
    ELSE
        s[top] := elem;
        top := top + 1;
    END;
END push;

PROCEDURE pop() : element;      (* A Modula-2 function is just a *)
BEGIN                          (* procedure with a return type. *)
    IF top = 1 THEN
        error;
    ELSE
        top := top - 1;
        RETURN s[top];
    END;
END pop;

BEGIN
    top := 1;
END stack;

```

```

VAR x, y : element;
...
push(x);
...
y := pop;

```

Figure 3.6 Stack abstraction in Modula-2.

`stack_size` must be declared in a surrounding scope; the compiler will complain if they are not. With the exception of predefined (*pervasive*) names like `integer` and `arctan`, `element` and `stack_size` are the *only* names from surrounding scopes that will be visible inside `stack`. Our stack also has two exports: `push` and `pop`. These are the only names inside of `stack` that will be visible in the surrounding scope. ■

Imports and Exports

Most module-based languages allow the programmer to specify that certain exported names are usable only in restricted ways. Variables may be exported read-only, for example, or types may be exported *opaquely*, meaning that variables of that type may be declared, passed as arguments to the module's subroutines, and possibly compared or assigned to one another, but not manipulated in any other way.

Modules into which names must be explicitly imported are said to be *closed scopes*. By extension, modules that do not require imports are said to be *open scopes*. Imports serve to document the program: they increase modularity by requiring a module to specify the ways in which it depends on the rest of the program. They also reduce name conflicts by refraining from importing anything that isn't needed. Modules are closed in Modula (1, 2, and 3) and Haskell. An increasingly common option, found in the modules of Ada, Java, C#, and Python, among others, might be called *selectively open* scopes. In these languages a name `foo` exported from module `A` is automatically visible in peer module `B` as `A.foo`. It becomes visible as merely `foo` if `B` explicitly imports it.

Unlike modules, subroutines are open scopes in most Algol family languages. Important exceptions are Euclid, in which both module and subroutine scopes are closed; Turing, Modula (1), and Perl, in which subroutines are optionally closed (if a subroutine imports anything explicitly, then no other nonlocal names will be visible); and Clu, which outlaws the use of nonlocal variables entirely (though nonlocal constants and subroutines can still be used). As in the case of modules, import lists serve to document the interface between a subroutine and the rest of the program. It would appear that most language designers have decided the documentation isn't worth the inconvenience.⁸

Modules as Managers

Modules facilitate the construction of abstractions by allowing data to be made private to the subroutines that use them. When used as in Figure 3.6, however, each module defines a single abstraction. If we want to have several stacks, we must generally make the module a “manager” for instances of a stack *type*, which is then exported from the module, as shown in Figure 3.7. The manager idiom requires additional subroutines to create/initialize and possibly destroy stack instances, and it requires that every subroutine (`push`, `pop`, `create`) take an extra parameter, to specify the stack in question. Clu adopts the position that *every* module (“cluster”) is the manager for a type. Data declared in the cluster (other than static variables in subroutines) are automatically the representation of the managed type, and there are special language features to export an opaque version of the representation to users of the type. ■

EXAMPLE 3.14

Module as “manager” for a type

⁸ There is an interesting analogy here to exception propagation. As we shall see in Section 8.5.1, language designers display similar disagreement about whether the exceptions that may be thrown out of a subroutine must be listed in the subroutine's header.

```

CONST stack_size = ...
TYPE element = ...
...
MODULE stack_manager;
IMPORT element, stack_size;
EXPORT stack, init_stack, push, pop;
TYPE
    stack_index = [1..stack_size];
    stack = RECORD
        s : ARRAY stack_index OF element;
        top : stack_index;      (* first unused slot *)
    END;

PROCEDURE init_stack(VAR stk : stack);
BEGIN
    stk.top := 1;
END init_stack;

PROCEDURE push(VAR stk : stack; elem : element);
BEGIN
    IF stk.top = stack_size THEN
        error;
    ELSE
        stk.s[stk.top] := elem;
        stk.top := stk.top + 1;
    END;
END push;

PROCEDURE pop(VAR stk : stack) : element;
BEGIN
    IF stk.top = 1 THEN
        error;
    ELSE
        stk.top := stk.top - 1;
        RETURN stk.s[stk.top];
    END;
END pop;

END stack_manager;

```

```

var A, B : stack;
var x, y : element;
...
init_stack(A);
init_stack(B);
...
push(A, x);
...
y := pop(B);

```

Figure 3.7 Manager module for stacks in Modula-2.

3.3.5 Module Types and Classes

An alternative solution to the multiple instance problem can be found in Simula, Euclid, and (in a slightly different sense) ML, which treat modules *as types*, rather

EXAMPLE 3.15

Module types in Euclid

than simple encapsulation constructs. Given a module type, the programmer can declare an arbitrary number of similar module objects. The skeleton of a Euclid stack appears in Figure 3.8. As in the (single) Modula-2 stack of Figure 3.6, Euclid allows the programmer to provide initialization code that is executed whenever a new stack is created. Euclid also allows the programmer to specify finalization code that will be executed at the end of a module's lifetime. This feature is not needed for an array-based stack, but would be useful if elements were allocated from a heap, and needed to be reclaimed. ■

The difference between the module-as-manager and module-as-type approaches to abstraction is reflected in the lower right of Figures 3.7 and 3.8. With module types, the programmer can think of the module's subroutines as "belonging" to the stack in question (`A.push(x)`), rather than as outside entities to which the stack can be passed as an argument (`push(A, x)`). Conceptually, there is a separate pair of push and pop operations for every stack. In practice, of course, it would be highly wasteful to create multiple copies of the code. As we shall see in Chapter 9, all stacks share a single pair of push and pop operations, and the compiler arranges for a pointer to the relevant stack to be passed to the operation as an extra, hidden parameter. The implementation turns out to be very similar

DESIGN & IMPLEMENTATION**Modules and separate compilation**

One of the hallmarks of a good abstraction is that it tends to be useful in multiple contexts. To facilitate code reuse, many languages make modules the basis of separate compilation. Modula-2 actually provided two different kinds of modules: one (external modules) for separate compilation, the other (internal modules, as in Figure 3.6) for textual nesting within a larger scope. Experience with these options eventually led Niklaus Wirth, the designer of Modula-2, to conclude that external modules were by far the more useful variety; he omitted the internal version from his subsequent language, Oberon. Many would argue, however, that internal modules find their real utility only when extended with instantiation and inheritance. Indeed, as noted near the end of this section, many object-oriented languages provide both modules *and* classes. The former support separate compilation and serve to minimize name conflicts; the latter are for data abstraction.

To facilitate separate compilation, modules in many languages (Modula-2 and Oberon among them) can be divided into a declaration part (*header*) and an implementation part (*body*), each of which occupies a separate file. Code that uses the exports of a given module can be compiled as soon as the header exists; it is not dependent on the body. In particular, work on the bodies of cooperating modules can proceed concurrently once the headers exist. We will return to the subjects of separate compilation and code reuse in Sections ©3.8 and 9.1, respectively.

```

const stack_size := ...
type element : ...
...
type stack = module
  imports (element, stack_size)
  exports (push, pop)
type
  stack_index = 1..stack_size
var
  s : array stack_index of element
  top : stack_index

procedure push(elem : element) = ...
function pop returns element = ...
...
initially
  top := 1
end stack

```

```

var A, B : stack
var x, y : element
...
A.push(x)
...
y := B.pop

```

Figure 3.8 Module type for stacks in Euclid. Unlike the code in [Figure 3.6](#), the code here can be used to create an arbitrary number of stacks.

to the implementation of [Figure 3.7](#), but the programmer need not think of it that way.⁹

Object Orientation

As an extension of the module-as-type approach to data abstraction, many languages now provide a *class* construct for *object-oriented programming*. To first approximation, classes can be thought of as module types that have been augmented with an *inheritance* mechanism. Inheritance allows new classes to be defined as extensions or refinements of existing classes. Inheritance facilitates a programming style in which all or most operations are thought of as belonging to objects, and in which new objects can inherit most of their operations from existing objects, without the need to rewrite code. Classes have their roots in Simula-67. They are the central innovation of object-oriented languages such as Smalltalk, Eiffel, C++, Java, and C#. They are also fundamental to several scripting languages, notably Python and Ruby. In a different style, inheritance mechanisms can be found in several languages that are not usually considered object-oriented, including Modula-3, Ada 95, and Oberon. We will examine inheritance and its impact on scope rules in [Chapter 9](#) and in [Section 13.4.4](#).

Module types and classes (ignoring issues related to inheritance) require only simple changes to the scope rules defined for modules in the previous subsection.

⁹ It is interesting to note that Turing, which was derived from Euclid, reverts to Modula-2 style modules, in order to avoid implementation complexity [[HMRC88](#), p. 9].

EXAMPLE 3.16

N-ary methods in C++

Every instance *A* of a module type or class (e.g., every stack) has a separate copy of the module or class's variables. These variables are then visible when executing one of *A*'s operations. They may also be indirectly visible to the operations of some other instance *B* if *A* is passed as a parameter to one of those operations. This rule makes it possible in most object-oriented languages to construct binary (or more-ary) operations that can manipulate the variables of more than one instance of a class. In C++, for example, we could create an operation that determines which of two stacks contains a larger number of elements:

```
class stack {
...
    bool deeper_than(stack other) {    // function declaration
        return (top > other.top);
    }
...
}
...
if (A.deeper_than(B)) ...
```

Within the `deeper_than` operation of stack *A*, `top` refers to `A.top`. Because `deeper_than` is an operation of class `stack`, however, it is able to refer not only to the variables of *A* (which it can access directly by name), but also to the variables of any *other* stack to which it has a reference. Because these variables belong to a different stack, `deeper_than` must name that stack explicitly, as for example in `other.top`. In a module-as-manager style program, of course, module subroutines would access all instance variables via parameters. ■

Modules Containing Classes

While there is a clear progression from modules to module types to classes, it is not necessarily the case that classes are an adequate replacement for modules in all cases. Suppose we are developing a complex “first person” game. Class hierarchies may be just what we need to represent characters, possessions, buildings, goals, and a host of other data abstractions. At the same time, especially on a project with a large team of programmers, we will probably want to divide the functionality of the game into large-scale subsystems such as graphics and rendering, physics, and strategy. These subsystems are really not data abstractions, and we probably don't *want* the option to create multiple instances of them. They are naturally captured with traditional modules.

Many applications have a similar need for both multi-instance abstractions and functional subdivision. In recognition of this fact, many languages, including C++, Java, C#, Python, and Ruby, provide separate class and module mechanisms. ■

3.3.6 Dynamic Scoping

In a language with dynamic scoping, the bindings between names and objects depend on the flow of control at run time, and in particular on the order in which

EXAMPLE 3.17

Modules and classes in a large application

```

1. n : integer          -- global declaration
2. procedure first
3.     n := 1

4. procedure second
5.     n : integer      -- local declaration
6.     first()

7. n := 2
8. if read_integer() > 0
9.     second()
10. else
11.     first()
12. write_integer(n)

```

Figure 3.9 **Static versus dynamic scoping.** Program output depends on both scope rules and, in the case of dynamic scoping, a value read at run time.

subroutines are called. In comparison to the static scope rules discussed in the previous section, dynamic scope rules are generally quite simple: the “current” binding for a given name is the one encountered most recently *during execution*, and not yet destroyed by returning from its scope.

Languages with dynamic scoping include APL, Snobol, T_EX (the typesetting language with which this book was created), and early dialects of Lisp [MAE⁺65, Moo78, TM81] and Perl.¹⁰ Because the flow of control cannot in general be predicted in advance, the bindings between names and objects in a language with dynamic scoping cannot in general be determined by a compiler. As a result, many semantic rules in a language with dynamic scoping become a matter of dynamic semantics rather than static semantics. Type checking in expressions and argument checking in subroutine calls, for example, must in general be deferred until run time. To accommodate all these checks, languages with dynamic scoping tend to be interpreted, rather than compiled.

EXAMPLE 3.18

Static vs dynamic scoping

Consider the program in Figure 3.9. If static scoping is in effect, this program prints a 1. If dynamic scoping is in effect, the output depends on the value read at line 8 at run time: if the input is positive, the program prints a 2; otherwise it prints a 1. Why the difference? At issue is whether the assignment to the variable *n* at line 3 refers to the global variable declared at line 1 or to the local variable declared at line 5. Static scope rules require that the reference resolve to the closest lexically enclosing declaration, namely the global *n*. Procedure *first* changes *n* to 1, and line 12 prints this value. Dynamic scope rules, on the other hand, require that we choose the most recent, active binding for *n* at run time.

¹⁰ Scheme and Common Lisp are statically scoped, though the latter allows the programmer to specify dynamic scoping for individual variables. Static scoping was added to Perl in version 5. The programmer now chooses static or dynamic scoping explicitly in each variable declaration.

We create a binding for `n` when we enter the main program. We create another when and if we enter procedure `second`. When we execute the assignment statement at line 3, the `n` to which we are referring will depend on whether we entered first through `second` or directly from the main program. If we entered through `second`, we will assign the value 1 to `second`'s local `n`. If we entered from the main program, we will assign the value 1 to the global `n`. In either case, the write at line 12 will refer to the global `n`, since `second`'s local `n` will be destroyed, along with its binding, when control returns to the main program. ■

EXAMPLE 3.19

Run-time errors with dynamic scoping

With dynamic scoping, errors associated with the referencing environment may not be detected until run time. In [Figure 3.10](#), for example, the declaration of local variable `max_score` in procedure `foo` accidentally redefines a global variable used by function `scaled_score`, which is then called from `foo`. Since the global `max_score` is an integer, while the local `max_score` is a floating-point number, dynamic semantic checks in at least some languages will result in a type clash message at run time. If the local `max_score` had been an integer, no error would have been detected, but the program would almost certainly have produced incorrect results. This sort of error can be very hard to find. ■

EXAMPLE 3.20

Customization via dynamic scoping

The principal argument in *favor* of dynamic scoping is that it facilitates the customization of subroutines. Suppose, for example, that we have a library routine `print_integer` that is capable of printing its argument in any of several bases (decimal, binary, hexadecimal, etc.). Suppose further that we want the routine to use decimal notation most of the time, and to use other bases only in a few special cases; we do not want to have to specify a base explicitly on each individual call. We can achieve this result with dynamic scoping by having `print_integer` obtain its base from a nonlocal variable `print_base`. We can establish the default behavior by declaring a variable `print_base` and setting its value to 10 in a scope encountered early in execution. Then, any time we want to change the base temporarily, we can write:

```
begin      -- nested block
  print_base : integer := 16      -- use hexadecimal
  print_integer(n)
```

DESIGN & IMPLEMENTATION**Dynamic scoping**

It is not entirely clear whether the use of dynamic scoping in Lisp and other early interpreted languages was deliberate or accidental. One reason to think that it may have been deliberate is that it makes it very easy for an interpreter to look up the meaning of a name: all that is required is a stack of declarations (we examine this stack more closely in [Section ©3.4.2](#)). Unfortunately, this simple implementation has a very high run-time cost, and experience indicates that dynamic scoping makes programs harder to understand. The modern consensus seems to be that dynamic scoping is usually a bad idea (see [Exercise 3.17](#) and [Exploration 3.33](#) for two exceptions).

```

max_score : integer      -- maximum possible score

function scaled_score(raw_score : integer) : real
    return raw_score / max_score * 100
...
procedure foo
    max_score : real := 0    -- highest percentage seen so far
    ...
    foreach student in class
        student.percent := scaled_score(student.points)
        if student.percent > max_score
            max_score := student.percent

```

Figure 3.10 The problem with dynamic scoping. Procedure `scaled_score` probably does not do what the programmer intended when dynamic scope rules allow procedure `foo` to change the meaning of `max_score`.

EXAMPLE 3.21

Multiple interface
alternative

The problem with this argument is that there are usually other ways to achieve the same effect, without dynamic scoping. One option would be to have `print_integer` use decimal notation in all cases, and create another routine, `print_integer_with_base`, that takes a second argument. In a language like Ada or C++, one could make the base an optional (default) parameter of a single `print_integer` routine, or use overloading to give the same name to both routines. (We will consider default parameters in [Section 8.3.3](#); overloading is discussed in [Section 3.5.2](#).) ■

Unfortunately, using two different routines for printing (or one routine with two different sets of parameters) requires that the caller know what is going on. In our example, alternative routines work fine if the calls are all made in the scope in which the local `print_base` variable would have been declared. If that scope calls subroutines that in turn call `print_integer`, however, we cannot in general arrange for the called routines to use the alternative interface. A second alternative to dynamic scoping solves this problem: we can create a static variable, either global or encapsulated with `print_integer` inside an appropriate module, that controls the base. To change the print base temporarily, we can then write:

EXAMPLE 3.22

Static variable alternative

```

begin      -- nested block
    print_base_save : integer := print_base
    print_base := 16    -- use hexadecimal
    print_integer(n)
    print_base := print_base_save

```

The possibility that we may forget to restore the original value, of course, is a potential source of bugs. With dynamic scoping the value is restored automatically. ■

3.4 Implementing Scope

To keep track of the names in a statically scoped program, a compiler relies on a data abstraction called a *symbol table*. In essence, the symbol table is a dictionary: it maps names to the information the compiler knows about them. The most basic operations are to insert a new mapping (a name-to-object binding) or to look up the information that is already present for a given name. Static scope rules add complexity by allowing a given name to correspond to different objects—and thus to different information—in different parts of the program. Most variations on static scoping can be handled by augmenting a basic dictionary-style symbol table with `enter_scope` and `leave_scope` operations to keep track of visibility. Nothing is ever deleted from the table; the entire structure is retained throughout compilation, and then saved for use by debuggers or run-time reflection mechanisms.

In a language with dynamic scoping, an interpreter (or the output of a compiler) must perform operations analogous to symbol table insert and lookup at run-time. In principle, any organization used for a symbol table in a compiler could be used to track name-to-object bindings in an interpreter, and vice versa. In practice, implementations of dynamic scoping tend to adopt one of two specific organizations: an *association list* or a *central reference table*.

© IN MORE DEPTH

A symbol table with visibility support can be implemented in several different ways. One appealing approach, due to LeBlanc and Cook [CL83], is described on the PLP CD, along with both association lists and central reference tables.

An association list (or *A-list* for short) is simply a list of name/value pairs. When used to implement dynamic scoping it functions as a stack: new declarations are pushed as they are encountered, and popped at the end of the scope in which they appeared. Bindings are found by searching down the list from the top. A central reference table avoids the need for linear-time search by maintaining an explicit mapping from names to their current meanings. Lookup is faster, but scope entry and exit are somewhat more complex, and it becomes substantially more difficult to save a referencing environment for future use (we discuss this issue further in [Section 3.6.1](#)).

✓ CHECK YOUR UNDERSTANDING

21. Explain the importance of information hiding.
22. What is an *opaque* export?

23. Why might it be useful to distinguish between the *header* and the *body* of a module?
 24. What does it mean for a scope to be *closed*?
 25. Explain the distinction between “modules as managers” and “modules as types.”
 26. How do classes differ from modules?
 27. Why does the use of dynamic scoping imply the need for run-time type checking?
 28. Give an argument in favor of dynamic scoping. Describe how similar benefits can be achieved in a language without dynamic scoping.
 29. Explain the purpose of a compiler’s symbol table.
-

3.5 The Meaning of Names within a Scope

So far in our discussion of naming and scopes we have assumed that there is a one-to-one mapping between names and visible objects in any given point in a program. This need not be the case. Two or more names that refer to the same object at the same point in the program are said to be *aliases*. A name that can refer to more than one object at a given point in the program is said to be *overloaded*.

3.5.1 Aliases

Simple examples of aliases occur in the `common` blocks and `equivalence` statements of Fortran, and in the variant records and unions of languages like Pascal and C (we will discuss these topics in detail in Section ©7.3.4). They also arise naturally in programs that make use of pointer-based data structures. A more subtle way to create aliases in many languages is to pass a variable by reference to a subroutine that also accesses that variable directly. Consider the following code in C++.

EXAMPLE 3.23

Aliasing with parameters

```
double sum, sum_of_squares;
...
void accumulate(double& x)      // x is passed by reference
{
    sum += x;
    sum_of_squares += x * x;
}
...
accumulate(sum);
```

If `sum` is passed as an argument to `accumulate`, then `sum` and `x` will be aliases for one another, and the program will probably not do what the programmer intended. This type of error was one of the principal motivations for making subroutines closed scopes in Euclid and Turing, as described in [Section 3.3.4](#). Given import lists, the compiler can identify when a subroutine call would create an alias, and the language can prohibit it. ■

As a general rule, aliases tend to make programs more confusing than they otherwise would be. They also make it much more difficult for a compiler to perform certain important code improvements. Consider the following C code:

EXAMPLE 3.24

Aliases and code improvement

```
int a, b, *p, *q;
...
a = *p;    /* read from the variable referred to by p */
*q = 3;    /* assign to the variable referred to by q */
b = *p;    /* read from the variable referred to by p */
```

The initial assignment to `a` will, on most machines, require that `*p` be loaded into a register. Since accessing memory is expensive, the compiler will want to hang on to the loaded value and reuse it in the assignment to `b`. It will be unable to do so, however, unless it can verify that `p` and `q` cannot refer to the same object—that is, that `*p` and `*q` are not aliases. While verification of this sort is possible in many common cases, in general it's uncomputable. ■

DESIGN & IMPLEMENTATION**Pointers in C and Fortran**

The tendency of pointers to introduce aliases is one of the reasons why Fortran compilers have tended, historically, to produce faster code than C compilers: pointers are heavily used in C, but missing from Fortran 77 and its predecessors. It is only in recent years that sophisticated alias analysis algorithms have allowed C compilers to rival their Fortran counterparts in speed of generated code. Pointer analysis is sufficiently important that the designers of the C99 standard decided to add a new keyword to the language. The `restrict` qualifier, when attached to a pointer declaration, is an assertion on the part of the programmer that the object to which the pointer refers has no alias in the current scope. It is the programmer's responsibility to ensure that the assertion is correct; the compiler need not attempt to check it. C99 also introduces *strict aliasing*. This allows the compiler to assume that pointers of different types will never refer to the same location in memory. Most compilers provide a command-line option to disable optimizations that exploit this rule; otherwise (poorly written) legacy programs may behave incorrectly when compiled at higher optimization levels.

```

declare
    type month is (jan, feb, mar, apr, may, jun,
                  jul, aug, sep, oct, nov, dec);
    type print_base is (dec, bin, oct, hex);
    mo : month;
    pb : print_base;
begin
    mo := dec;           -- the month dec (since mo has type month)
    pb := oct;          -- the print_base oct (since pb has type print_base)
    print(oct);         -- error!  insufficient context
                        --           to decide which oct is intended

```

Figure 3.11 Overloading of enumeration constants in Ada.

3.5.2 Overloading

Most programming languages provide at least a limited form of overloading. In C, for example, the plus sign (+) is used to name several different functions, including signed and unsigned integer and floating-point addition. Most programmers don't worry about the distinction between these two functions—both are based on the same mathematical concept, after all—but they take arguments of different types and perform very different operations on the underlying bits. A slightly more sophisticated form of overloading appears in the enumeration constants of Ada. In Figure 3.11, the constants `oct` and `dec` refer either to months or to numeric bases, depending on the context in which they appear. ■

Within the symbol table of a compiler, overloading must be handled by arranging for the *lookup* routine to return a *list* of possible meanings for the requested name. The semantic analyzer must then choose from among the elements of the list based on context. When the context is not sufficient to decide, as in the call to `print` in Figure 3.11, then the semantic analyzer must announce an error. Most languages that allow overloaded enumeration constants allow the programmer to provide appropriate context explicitly. In Ada, for example, one can say

```
print(month'(oct));
```

In Modula-3 and C#, *every* use of an enumeration constant must be prefixed with a type name, even when there is no chance of ambiguity:

```
mo := month.dec;
pb := print_base.oct;
```

In C, C++, and standard Pascal, one cannot overload enumeration constants at all; every constant visible in a given scope must be distinct. ■

Both Ada and C++ have elaborate facilities for overloading subroutine names. (Most of the C++ facilities carry over to Java and C#.) A given name may refer to an arbitrary number of subroutines in the same scope, so long as the subroutines differ in the number or types of their arguments. C++ examples appear in Figure 3.12. ■

EXAMPLE 3.25

Overloaded enumeration constants in Ada

EXAMPLE 3.26

Resolving ambiguous overloads

EXAMPLE 3.27

Overloading in Ada and C++

```

struct complex {
    double real, imaginary;
};
enum base {dec, bin, oct, hex};

int i;
complex x;

void print_num(int n) { ...
void print_num(int n, base b) { ...
void print_num(complex c) { ...

print_num(i);           // uses the first function above
print_num(i, hex);     // uses the second function above
print_num(x);          // uses the third function above

```

Figure 3.12 Simple example of overloading in C++. In each case the compiler can tell which function is intended by the number and types of arguments.

Redefining Built-in Operators

Ada, C++, C#, Fortran 90, and Haskell also allow the built-in arithmetic operators (+, -, *, etc.) to be overloaded with user-defined functions. Ada, C++, and C# do this by defining alternative *prefix* forms of each operator, and defining the usual infix forms to be abbreviations (or “syntactic sugar”) for the prefix forms. In Ada, $A + B$ is short for “+”(A, B). If “+” is overloaded, it must be possible to determine the intended meaning from the types of A and B. ■

In C++ and C#, which are object-oriented, $A + B$ may be short for either `operator+(A, B)` or `A.operator+(B)`. In the latter case, A is an instance of a class (module type) that defines an `operator+` function. In C++:

```

class complex {
    double real, imaginary;
    ...
public:
    complex operator+(complex other) {
        return complex(real + other.real, imaginary + other.imaginary);
    }
    ...
};
...
complex A, B, C;
...
C = A + B;           // uses user-defined operator+

```

C# syntax is similar. ■

This class-based style of operator abbreviation resembles a similar facility in Clu. Since the abbreviation expands to an unambiguous name (i.e., A’s

EXAMPLE 3.28

Operator overloading
in Ada

EXAMPLE 3.29

Operator overloading
in C++

`operator+`; not any other), one might be tempted to say that no “real” overloading is involved, and this is in fact the case in Clu. In C++ and C#, however, there may be more than one definition of `A.operator+`, allowing the second argument to be of several types. Fortran 90 provides a special `interface` construct that can be used to associate an operator with some named binary function.

3.5.3 Polymorphism and Related Concepts

In the case of subroutine names, it is worth distinguishing overloading from the closely related concepts of coercion and polymorphism. All three can be used, in certain circumstances, to pass arguments of multiple types to (or return values of multiple types from) a given named routine. The syntactic similarity, however, hides significant differences in semantics and pragmatics.

EXAMPLE 3.30

Overloading vs coercion

Suppose, for example, that we wish to be able to compute the minimum of two values of either integer or floating-point type. In Ada we might obtain this capability using overloaded functions:

```
function min(a, b : integer) return integer is ...
function min(x, y : real) return real is ...
```

In C, however, we could get by with a single function:

```
double min(double x, double y) { ...
```

If the C function is called in a context that expects an integer (e.g., `i = min(j, k)`), the compiler will automatically convert the integer arguments (`j` and `k`) to floating-point numbers, call `min`, and then convert the result back to an integer (via truncation). So long as floating-point (`double`) variables have at least as many significant bits as integers (which they do in the case of 32-bit integers and 64-bit double-precision floating-point), the result will be numerically correct. ■

Coercion is the process by which a compiler automatically converts a value of one type into a value of another type when that second type is required by the surrounding context. Coercion is a somewhat controversial subject in language design. As we shall see in [Section 7.2.2](#), Ada coerces nothing but explicit constants, subranges, and in certain cases arrays with the same type of elements. Pascal will coerce integers to floating point in expressions and assignments. Fortran will also coerce floating-point values to integers in assignments, at a potential loss of precision. C will perform these same coercions on arguments to functions. Most scripting languages provide a very rich set of built-in coercions. C++ allows the programmer to extend its built-in set with user-defined coercions.

In [Example 3.30](#), overloading allows the Ada compiler to choose between two different versions of `min`, depending on the types of the arguments. Coercion allows the C compiler to modify the arguments to fit a *single* subroutine. *Polymorphism* provides yet another option: it allows a single subroutine to accept *unconverted* arguments of multiple types.

The term “polymorphic” comes from the Greek, and means “having multiple forms.” It is applied to code—both data structures and subroutines—that can work with values of multiple types. For this concept to make sense, the types must generally have certain characteristics in common, and the code must not depend on any other characteristics. The commonality is usually captured in one of two main ways. In *parametric polymorphism* the code takes a type (or set of types) as a parameter, either explicitly or implicitly. In *subtype polymorphism* the code is designed to work with values of some specific type T , but the programmer can define additional types to be extensions or refinements of T , and the polymorphic code will work with these *subtypes* as well.

Explicit parametric polymorphism is also known as *genericity*. Generic facilities appear in Ada, C++, Clu, Eiffel, Modula-3, Java, and C#, among others. Readers familiar with C++ will know them by the name of *templates*. We will consider them further in Sections 8.4 and 9.4.4. Implicit parametric polymorphism appears in the Lisp and ML families of languages, and in the various scripting languages; we will consider it further in Sections 7.2.4 and 10.3. Subtype polymorphism is fundamental to object-oriented languages, in which subtypes (classes) are said to *inherit* the methods of their parent types. We will consider inheritance further in Section 9.4.

Generics (explicit parametric polymorphism) are usually, though not always, implemented by creating multiple copies of the polymorphic code, one specialized for each needed concrete type. Inheritance (subtype polymorphism) is almost always implemented by creating a single copy of the code, and by including in the representation of objects sufficient “metadata” (data about the data) that the code can tell when to treat them differently. Implicit parametric polymorphism can be implemented either way. Most Lisp implementations use a single copy of the code, and delay all semantic checks until run time. ML and its descendants perform all type checking at compile time. They typically generate a single copy of the code where possible (e.g., when all the types in question are records that share a similar representation), and multiple copies when necessary (e.g., when polymorphic arithmetic must operate on both integer and floating-point numbers). Object-oriented languages that perform type checking at compile time, including C++, Eiffel, Java, and C#, generally provide both generics *and* inheritance. Smalltalk (Section 9.6.1), Objective-C, Python, and Ruby use a single

DESIGN & IMPLEMENTATION

Coercion and overloading

In addition to their semantic differences, coercion and overloading can have very different costs. Calling an integer-specific version of `min` would be much more efficient than calling the floating-point version of Example 3.30 with integer arguments: it would use integer arithmetic for the comparison (which may be cheaper in and of itself), and would avoid three conversion operations. One of the arguments against supporting coercion in a language is that it tends to impose hidden costs.

```

generic
  type T is private;
  with function "<"(x, y : T) return Boolean;
function min(x, y : T) return T;

function min(x, y : T) return T is
begin
  if x < y then return x;
  else return y;
  end if;
end min;

function string_min is new min(string, "<");
function date_min is new min(date, date_precedes);

```

Figure 3.13 Use of a generic subroutine in Ada.

mechanism (with run-time checking) to provide both parametric and subtype polymorphism.

EXAMPLE 3.31

Generic `min` function
in Ada

As a concrete example of generics, consider the overloaded `min` functions of [Example 3.30](#). The source code for the integer and floating-point versions is likely to be very similar. We can exploit this similarity to define a single version that works not only for integers and reals, but for any type whose values are totally ordered. This code appears in [Figure 3.13](#). The initial (bodyless) declaration of `min` is preceded by a `generic` clause specifying that two things are required in order to create a concrete instance of a minimum function: a type, `T`, and a corresponding comparison routine. This declaration is followed by the actual code for `min`. Given appropriate declarations of `string` and `date` types and comparison routines (not shown), we can create functions to return the lesser of pairs of objects of these types as shown in the last two lines. (The `<` operation mentioned in the definition of `string_min` is presumably overloaded; the compiler resolves the overloading by finding the version of `<` that takes arguments of type `T`, where `T` is already known to be `string`.) ■

EXAMPLE 3.32

Implicit polymorphism
in Scheme

With the *implicit* parametric polymorphism of Lisp, ML, and their descendants, the programmer need not specify a type parameter. The Scheme definition of `min` looks like this:

```
(define min (lambda (a b) (if (< a b) a b)))
```

It makes no mention of types. The typical Scheme implementation employs an interpreter that examines the arguments to `min` and determines, at run time, whether they support a `<` operator. (Like all Lisp dialects, Scheme puts function names *inside* parentheses, right in front of the arguments. The `lambda` keyword introduces the parameter list and body of a function.) Given the definition above, the expression `(min 123 456)` evaluates to 123; `(min 3.14159 2.71828)` evaluates to 2.71828. The expression `(min "abc" "def")` produces a run-time error when evaluated, because the string comparison operator is named `string<?`, not `<`. ■

EXAMPLE 3.33

Implicit polymorphism
in Haskell

The Haskell version of `min` is similar:

```
min a b = if a < b then a else b
```

This version works for values of any totally ordered type, including strings. It is type checked at compile time, using a sophisticated system of *type inference* (to be described in Section 7.2.4). ■

So what exactly is the difference between the overloaded `min` functions of Example 3.30 and the generic version of Figure 3.13? The answer lies in the generality of the code. With overloading the programmer must write a separate copy of the code, by hand, for every type with a `min` operation. Generics allow the compiler (in the typical implementation) to create a copy automatically for every needed type. The similarity of the calling syntax and of the generated code has led some authors to refer to overloading as *ad hoc* (special case) *polymorphism*. There is no particular reason, however, for the programmer to think of generics in terms of multiple copies: from a semantic (conceptual) point of view, overloaded subroutines use a single name for more than one thing; a polymorphic subroutine is a single thing.

✓ CHECK YOUR UNDERSTANDING

30. What are *aliases*? Why are they considered a problem in language design and implementation?
31. Explain the value of the `restrict` qualifier in C99.
32. Explain the differences among *overloading*, *coercion*, and *polymorphism*.
33. What is *operator overloading*? Explain its relationship to “ordinary” overloading in C++.
34. Define *parametric* and *subtype* polymorphism. Explain the distinction between *explicit* and *implicit* parametric polymorphism. Which is also known as *genericity*?
35. Why is overloading sometimes referred to as *ad hoc* polymorphism?

3.6 The Binding of Referencing Environments

We have seen in the Section 3.3 how scope rules determine the referencing environment of a given statement in a program. Static scope rules specify that the referencing environment depends on the lexical nesting of program blocks in which names are declared. Dynamic scope rules specify that the referencing environment depends on the order in which declarations are encountered at run time.

```

type person = record
  ...
  age : integer
  ...
threshold : integer
people : database

function older_than_threshold(p : person) : boolean
  return p.age ≥ threshold

procedure print_person(p : person)
  -- Call appropriate I/O routines to print record on standard output.
  -- Make use of nonlocal variable line_length to format data in columns.
  ...

procedure print_selected_records(db : database;
  predicate, print_routine : procedure)
  line_length : integer

  if device_type(stdout) = terminal
    line_length := 80
  else -- Standard output is a file or printer.
    line_length := 132
  foreach record r in db
    -- Iterating over these may actually be
    -- a lot more complicated than a 'for' loop.
    if predicate(r)
      print_routine(r)

-- main program
...
threshold := 35
print_selected_records(people, older_than_threshold, print_person)

```

Figure 3.14 Program to illustrate the importance of binding rules. One might argue that deep binding is appropriate for the environment of function `older_than_threshold` (for access to `threshold`), while shallow binding is appropriate for the environment of procedure `print_person` (for access to `line_length`).

An additional issue that we have not yet considered arises in languages that allow one to create a *reference* to a subroutine, for example by passing it as a parameter. When should scope rules be applied to such a subroutine: when the reference is first created, or when the routine is finally called? The answer is particularly important for languages with dynamic scoping, though we shall see that it matters even in languages with static scoping.

EXAMPLE 3.34

Deep and shallow binding

A dynamic scoping example appears in [Figure 3.14](#). Procedure `print_selected_records` is assumed to be a general-purpose routine that knows how to traverse the records in a database, regardless of whether they represent people, sprockets, or salads. It takes as parameters a database, a predicate to make print/don't print

decisions, and a subroutine that knows how to format the data in the records of this particular database. In [Section 3.3.6](#) we hypothesized a `print_integer` library routine that would print in any of several bases, depending on the value of a nonlocal variable `print_base`. Here we have hypothesized in a similar fashion that `print_person` uses the value of nonlocal variable `line_length` to calculate the number and width of columns in its output. In a language with dynamic scoping, it is natural for procedure `print_selected_records` to declare and initialize this variable locally, knowing that code inside `print_routine` will pick it up if needed. For this coding technique to work, the referencing environment of `print_routine` must not be created until the routine is actually called by `print_selected_records`. This late binding of the referencing environment of a subroutine that has been passed as a parameter is known as *shallow binding*. It is usually the default in languages with dynamic scoping.

For function `older_than_threshold`, by contrast, shallow binding may not work well. If, for example, procedure `print_selected_records` happens to have a local variable named `threshold`, then the variable set by the main program to influence the behavior of `older_than_threshold` will not be visible when the function is finally called, and the predicate will be unlikely to work correctly. In such a situation, the code that originally passes the function as a parameter has a particular referencing environment (the current one) in mind; it does not want the routine to be called in any other environment. It therefore makes sense to bind the environment at the time the routine is first passed as a parameter, and then restore that environment when the routine is finally called. This early binding of the referencing environment is known as *deep binding*. The need for deep binding is sometimes referred to as the *funarg problem* in Lisp. ■

3.6.1 Subroutine Closures

Deep binding is implemented by creating an explicit representation of a referencing environment (generally the one in which the subroutine would execute if called at the present time) and bundling it together with a reference to the subroutine. The bundle as a whole is referred to as a *closure*. Usually the subroutine itself can be represented in the closure by a pointer to its code. In a language with dynamic scoping, the representation of the referencing environment depends on whether the language implementation uses an association list or a central reference table for run-time lookup of names; we consider these alternatives at the end of [Section 3.4.2](#).

Although shallow binding is usually the default in languages with dynamic scoping, deep binding may be available as an option. In early dialects of Lisp, for example, the built-in primitive `function` takes a function as its argument and returns a closure whose referencing environment is the one in which the function would execute if called at the present time. This closure can then be passed as a parameter to another function. If and when it is eventually called, it will execute in the saved environment. (Closures work slightly differently from “bare” functions

in most Lisp dialects: they must be called by passing them to the built-in primitives `funcall` or `apply`.)

Deep binding is generally the default in languages with static (lexical) scoping. At first glance, one might be tempted to think that the binding time of referencing environments would not matter in languages with static scoping. After all, the meaning of a statically scoped name depends on its lexical nesting, not on the flow of execution, and this nesting is the same whether it is captured at the time a subroutine is passed as a parameter or at the time the subroutine is called. The catch is that a running program may have more than one *instance* of an object that is declared within a recursive subroutine. A closure in a language with static scoping captures the current instance of every object, at the time the closure is created. When the closure's subroutine is called, it will find these captured instances, even if newer instances have subsequently been created by recursive calls.

One could imagine combining static scoping with shallow binding [VF82], but the combination does not seem to make much sense, and does not appear to have been adopted in any language. Figure 3.15 contains a Pascal program that illustrates the impact of binding rules in the presence of static scoping. This program prints a 1. With shallow binding it would print a 2. ■

EXAMPLE 3.35

Binding rules with static scoping

It should be noted that binding rules matter with static scoping only when accessing objects that are neither local nor global, but are defined at some intermediate level of nesting. If an object is local to the currently executing subroutine, then it does not matter whether the subroutine was called directly or through a closure; in either case local objects will have been created when the subroutine started running. If an object is global, there will never be more than one instance, since the main body of the program is not recursive. Binding rules are therefore irrelevant in languages like C, which has no nested subroutines, or Modula-2, which allows only outermost subroutines to be passed as parameters, thus ensuring that any variable defined outside the subroutine is global. (Binding rules are also irrelevant in languages like PL/I and Ada 83, which do not permit subroutines to be passed as parameters at all.)

Suppose then that we have a language with static scoping in which nested subroutines can be passed as parameters, with deep binding. To represent a closure for subroutine *S*, we can simply save a pointer to *S*'s code together with the static link that *S* would use (see Figure 3.5) if it were called right now, in the current environment. When *S* is finally called, we temporarily restore the saved static link, rather than creating a new one. When *S* follows its static chain to access a nonlocal object, it will find the object instance that was current at the time the closure was created. This instance may not have the *value* it had at the time the closure was created, but its identity, at least, will reflect the intent of the closure's creator.

3.6.2 First-Class Values and Unlimited Extent

In general, a value in a programming language is said to have *first-class* status if it can be passed as a parameter, returned from a subroutine, or assigned into

```

program binding_example(input, output);

procedure A(I : integer; procedure P);

    procedure B;
    begin
        writeln(I);
    end;

begin (* A *)
    if I > 1 then
        P
    else
        A(2, B);
    end;

procedure C; begin end;

begin (* main *)
    A(1, C);
end.

```

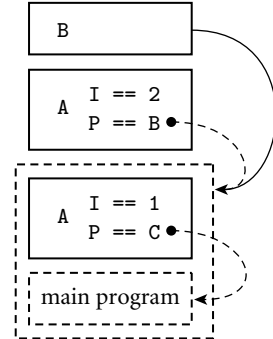

Figure 3.15 Deep binding in Pascal. At right is a conceptual view of the run-time stack. Referencing environments captured in closures are shown as dashed boxes and arrows. When `B` is called via formal parameter `P`, two instances of `I` exist. Because the closure for `P` was created in the initial invocation of `A`, `B`'s static link (solid arrow) points to the frame of that earlier invocation. `B` uses that invocation's instance of `I` in its `writeln` statement, and the output is a 1.

a variable. Simple types such as integers and characters are first-class values in most programming languages. By contrast, a “second-class” value can be passed as a parameter, but not returned from a subroutine or assigned into a variable, and a “third-class” value cannot even be passed as a parameter. As we shall see in [Section 8.3.2](#), labels are third-class values in most programming languages, but second-class values in Algol. Subroutines display the most variation. They are first-class values in all functional programming languages and most scripting languages. They are also first-class values in `C#` and, with some restrictions, in several other imperative languages, including Fortran, Modula-2 and -3, Ada 95, C, and `C++`.¹¹ They are second-class values in most other imperative languages, and third-class values in Ada 83.

Our discussion of binding so far has considered only second-class subroutines. First-class subroutines in a language with nested scopes introduce an additional level of complexity: they raise the possibility that a reference to a subroutine may

¹¹ Some authors would say that first-class status requires anonymous function definitions—lambda expressions—that can be embedded in other expressions. `C#`, most scripting languages, and all functional languages meet this requirement, but most imperative languages do not.

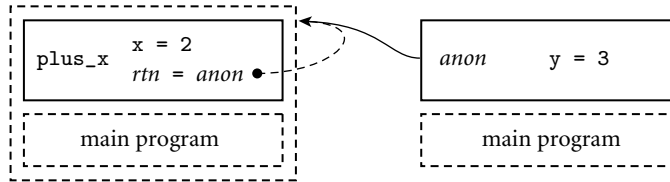

Figure 3.16 The need for unlimited extent. When function `plus_x` is called in Example 3.36, it returns (left side of the figure) a closure containing an anonymous function. The referencing environment of that function encompasses both `plus_x` and `main`—including the local variables of `plus_x` itself. When the anonymous function is subsequently called (right side of the figure), it must be able to access variables in the closure’s environment—in particular, the `x` inside `plus_x`.

EXAMPLE 3.36

Returning a first-class subroutine in Scheme

outline the execution of the scope in which that routine was declared. Consider the following example in Scheme:

```

1. (define plus-x (lambda (x)
2.   (lambda (y) (+ x y))))
3. ...
4. (let ((f (plus-x 2)))
5.   (f 3)) ; returns 5

```

Here the `let` construct on line 4 declares a new function, `f`, which is the result of calling `plus-x` with argument 2. Function `plus-x` is defined at line 1. It returns the (unnamed) function declared at line 2. But that function refers to parameter `x` of `plus-x`. When `f` is called at line 5, its referencing environment will include the `x` in `plus-x`, despite the fact that `plus-x` has already returned (see Figure 3.16). Somehow we must ensure that `x` remains available. ■

If local objects were destroyed (and their space reclaimed) at the end of each scope’s execution, then the referencing environment captured in a long-lived closure might become full of dangling references. To avoid this problem, most functional languages specify that local objects have *unlimited extent*: their lifetimes continue indefinitely. Their space can be reclaimed only when the garbage collection system is able to prove that they will never be used again. Local objects (other than `own/static` variables) in most imperative languages have *limited extent*: they are destroyed at the end of their scope’s execution. (C# and Smalltalk are exceptions to the rule, as are most scripting languages.) Space for local objects with limited extent can be allocated on a stack. Space for local objects with unlimited extent must generally be allocated on a heap.

Given the desire to maintain stack-based allocation for the local variables of subroutines, imperative languages with first-class subroutines must generally adopt alternative mechanisms to avoid the dangling reference problem for closures. C, C++, and (pre-Fortran 90) Fortran, of course, do not have nested subroutines. Modula-2 allows references to be created only to outermost subroutines (outermost routines are first-class values; nested routines are third-class

values). Modula-3 allows nested subroutines to be passed as parameters, but only outermost routines to be returned or stored in variables (outermost routines are first-class values; nested routines are second-class values). Ada 95 allows a nested routine to be returned, but only if the scope in which it was declared is the same as, or larger than, the scope of the declared return type. This containment rule, while more conservative than strictly necessary (it forbids the Ada equivalent of [Figure 3.15](#)), makes it impossible to propagate a subroutine reference to a portion of the program in which the routine's referencing environment is not active.

3.6.3 Object Closures

As noted in [Section 3.6.1](#), the referencing environment in a closure will be nontrivial only when passing a nested subroutine. This means that the implementation of first-class subroutines is trivial in a language without nested subroutines. At the same time, it means that a programmer working in such a language is missing a useful feature: the ability to pass a subroutine *with context*. In object-oriented languages, there is an alternative way to achieve a similar effect: we can encapsulate our subroutine as a method of a simple object, and let the object's fields hold context for the method. In Java we might write the equivalent of [Example 3.36](#) as follows.

EXAMPLE 3.37

An object closure in Java

```
interface IntFunc {
    public int call(int i);
}
class PlusX implements IntFunc {
    final int x;
    PlusX(int n) { x = n; }
    public int call(int i) { return i + x; }
}
...
IntFunc f = new PlusX(2);
System.out.println(f.call(3));    // prints 5
```

Here the *interface* `IntFunc` defines a static type for objects enclosing a function from integers to integers. Class `PlusX` is a concrete implementation of this type,

DESIGN & IMPLEMENTATION

Binding rules and extent

Binding mechanisms and the notion of extent are closely tied to implementation issues. A-lists make it easy to build closures ([Section ©3.4.2](#)), but so do the non-nested subroutines of C and the rule against passing nonglobal subroutines as parameters in Modula-2. In a similar vein, the lack of first-class subroutines in most imperative languages reflects in large part the desire to avoid heap allocation, which would be needed for local variables with unlimited extent.

and can be instantiated for any constant x . Where the Scheme code in [Example 3.36](#) captured x in the subroutine closure returned by `(plus-x 2)`, the Java code here captures x in the object closure returned by `new PlusX(2)`. ■

An object that plays the role of a function and its referencing environment may variously be called an *object closure*, a *function object*, or a *functor*. (This is unrelated to use of the term *functor* in Prolog.) Object closures are sufficiently important that some languages support them with special syntax. In C++, an object of a class that overrides `operator()` can be called as if it were a function:

EXAMPLE 3.38

Function objects in C++

```
class int_func {
public:
    virtual int operator()(int i) = 0;
};
class plus_x : public int_func {
    const int x;
public:
    plus_x(int n) : x(n) { }
    virtual int operator()(int i) { return i + x; }
};
...
plus_x f(2);
cout << f(3) << "\n";           // prints 5
```

Object `f` could also be passed to any function that expected a parameter of class `int_func`. ■

EXAMPLE 3.39

Delegates in C#

In C#, a first-class subroutine is an instance of a *delegate* type:

```
delegate int IntFunc(int i);
```

This type can be instantiated for any subroutine that matches the specified argument and return types. That subroutine may be static, or it may be a method of some object:

```
static int Plus2(int i) { return i + 2; }
...
IntFunc f = new IntFunc(Plus2);
Console.WriteLine(f(3));           // prints 5

class PlusX {
    int x;
    public PlusX(int n) { x = n; }
    public int call(int i) { return i + x; }
}
...
IntFunc g = new IntFunc(new PlusX(2).call);
Console.WriteLine(g(3));           // prints 5
```

Here `g` is roughly equivalent to the C++ code of [Example 3.38](#). ■

EXAMPLE 3.40

Delegates and unlimited extent

Remarkably, though C# does not permit subroutines to nest in the general case, version 2 of the language allows delegates to be instantiated in-line from *anonymous* (unnamed) methods. These allow us to mimic the code of [Example 3.36](#):

```
static IntFunc PlusY(int y) {
    return delegate(int i) { return i + y; };
}
...
IntFunc h = PlusY(2);
```

Here *y* has unlimited extent! The compiler arranges to allocate it in the heap, and to refer to it indirectly through a hidden pointer, included in the closure. This implementation incurs the cost of dynamic storage allocation (and eventual garbage collection) only when it is needed; local variables remain in the stack in the common case.

C# 3.0 provides an alternative *lambda expression* notation for anonymous methods. This notation is particularly convenient for functions whose bodies can be written as a single expression. The (one-line) body of `PlusY` above could be replaced with

```
return i => i + y;
```

Anonymous delegates are heavily used for *event handling* in C# programs; we will see examples in [Section 8.7.2](#). ■

3.7 Macro Expansion

Prior to the development of high-level programming languages, assembly language programmers could find themselves writing highly repetitive code. To ease the burden, many assemblers provided sophisticated *macro expansion* facilities. Consider the task of loading an element of a two-dimensional array from memory into a register. As we shall see in [Section 7.4.3](#), this operation can easily require half a dozen instructions, with details depending on the hardware instruction set; the size of the array elements; and whether the indices are constants, values in memory, or values in registers. In many assemblers one can define a macro that will replace an expression like `ld2d(target_reg, array_name, row, column, row_size, element_size)` with the appropriate multi-instruction sequence. In a numeric program containing hundreds or thousands of array access operations, this macro may prove extremely useful. ■

EXAMPLE 3.41

A simple assembly macro

EXAMPLE 3.42

Preprocessor macros in C

When C was created in the early 1970s, it was natural to include a macro preprocessing facility:

```
#define LINE_LEN 80
#define DIVIDES(a,n) (!(n) % (a))
    /* true iff n has zero remainder modulo a */
#define SWAP(a,b) {int t = (a); (a) = (b); (b) = t;}
#define MAX(a,b) ((a) > (b) ? (a) : (b))
```

Macros like `LINE_LEN` avoided the need (in early versions of C) to support named constants in the language itself. Perhaps more important, parameterized macros like `DIVIDES`, `MAX`, and `SWAP` were much more efficient than equivalent C functions. They avoided the overhead of the subroutine call mechanism (including register saves and restores), and the code they generated could be integrated into any code improvements that the compiler was able to effect in the code surrounding the call. ■

EXAMPLE 3.43

“Gotchas” in C macros

Unfortunately, C macros suffer from several limitations, all of which stem from the fact that they are implemented by textual substitution, and are not understood by the rest of the compiler. Put another way, they provide a naming and binding mechanism that is separate from—and often at odds with—the rest of the programming language.

In the definition of `DIVIDES`, the parentheses around the occurrences of `a` and `b` are essential. Without them, `DIVIDES(y + z, x)` would be replaced by `(!(x % y + z))`, which is the same as `(!(x % y) + z)`, according to the rules of precedence. In a similar vein, `SWAP` may behave unexpectedly if the programmer writes `SWAP(x, t)`: textual substitution of arguments allows the macro’s declaration of `t` to *capture* the `t` that was passed. `MAX(x++, y++)` may also behave unexpectedly, since the increment side effects will happen more than once. Unfortunately, in standard C we cannot avoid the extra side effects by assigning the parameters into temporary variables: a C macro that “returns” a value must be an expression, and declarations are one of many language constructs that cannot appear inside (see also [Exercise 3.22](#)). ■

Modern languages and compilers have, for the most part, abandoned macros as an anachronism. Named constants are type-safe and easy to implement, and *in-line* subroutines (to be discussed in [Section 8.2.4](#)) provide almost all the performance of parameterized macros without their limitations. A few languages (notably Scheme and Common Lisp) take an alternative approach, and integrate macros into the language in a safe and consistent way. So-called *hygienic* macros implicitly encapsulate their arguments, avoiding unexpected interactions with associativity and precedence. They rename variables when necessary to avoid the capture problem, and they can be used in any expression context. Unlike

DESIGN & IMPLEMENTATION

Generics as macros

In some sense, the local stack module of [Figure 3.6](#) (page 134) is a primitive sort of generic module. Because it imports the `element` type and `stack_size` constant, it can be inserted (with a text editor) into any context in which these names are declared, and will produce a “customized” stack for that context when compiled. Early versions of C++ formalized this mechanism by using macros to implement templates. Later versions of C++ have made templates (generics) a fully supported language feature, giving them much of the flavor of hygienic macros. (More on templates and on *template metaprogramming* can be found in [Section ©8.4.4](#).)

subroutines, however, they are expanded during semantic analysis, making them generally unsuitable for unbounded recursion. Their appeal is that, like all macros, they take *unevaluated* arguments, which they evaluate lazily on demand. Among other things, this means that they preserve the multiple side effect “gotcha” of our MAX example. Delayed evaluation was a bug in this context, but can sometimes be a feature. We will return to it in [Sections 6.1.5](#) (short-circuit Boolean evaluation), [8.3.2](#) (call-by-name parameters), and [10.4](#) (normal-order evaluation in functional programming languages).

✓ CHECK YOUR UNDERSTANDING

36. Describe the difference between deep and shallow *binding* of referencing environments.
 37. Why are binding rules particularly important for languages with dynamic scoping?
 38. What are *first-class* subroutines? What languages support them?
 39. What is a *subroutine closure*? What is it used for? How is it implemented?
 40. What is an *object closure*? How is it related to a subroutine closure?
 41. Describe how the *delegates* of C# extend and unify both subroutine and object closures.
 42. Explain the distinction between limited and unlimited *extent* of objects in a local scope.
 43. What are *macros*? What was the motivation for including them in C? What problems may they cause?
-

3.8 Separate Compilation

Since most large programs are constructed and tested incrementally, and since the compilation of a very large program can be a multihour operation, any language designed to support large programs must provide for separate compilation.

© IN MORE DEPTH

On the PLP CD we consider the relationship between modules and separate compilation. Because they are designed for encapsulation and provide a narrow interface, modules are the natural choice for the “compilation units” of many programming languages. The separate module headers and bodies of Modula-3 and Ada, for example, are explicitly intended for separate compilation, and reflect experience gained with more primitive facilities in other languages. C and C++, by contrast, must maintain backward compatibility with mechanisms designed in the early 1970s. C99 and C++ include a *namespace* mechanism that provides

module-like data hiding, but names must still be declared before they are used in every compilation unit, and the mechanisms used to accommodate this rule are purely a matter of convention. Java and C# break with the C tradition by requiring the compiler to infer header information automatically from separately compiled class definitions; no header files are required.

3.9 Summary and Concluding Remarks

This chapter has addressed the subject of names, and the *binding* of names to objects (in a broad sense of the word). We began with a general discussion of the notion of *binding time*—the time at which a name is associated with a particular object or, more generally, the time at which an answer is associated with any open question in language or program design or implementation. We defined the notion of *lifetime* for both objects and name-to-object bindings, and noted that they need not be the same. We then introduced the three principal storage allocation mechanisms—static, stack, and heap—used to manage space for objects.

In [Section 3.3](#) we described how the binding of names to objects is governed by *scope rules*. In some languages, scope rules are dynamic: the meaning of a name is found in the most recently entered scope that contains a declaration and that has not yet been exited. In most modern languages, however, scope rules are static, or *lexical*: the meaning of a name is found in the closest lexically surrounding scope that contains a declaration. We found that lexical scope rules vary in important but sometimes subtle ways from one language to another. We considered what sorts of scopes are allowed to nest, whether scopes are *open* or *closed*, whether the scope of a name encompasses the entire block in which it is declared, and whether a name must be declared before it is used. We explored the implementation of scope rules in [Section 3.4](#). In [Section 3.6](#) we considered the question of when to bind a referencing environment to a subroutine that is passed as a parameter, returned from a function, or stored in a variable.

Some of the more complicated aspects of lexical scoping illustrate the evolution of language support for data abstraction, a subject to which we will return in [Chapter 9](#). We began by describing the *own* or *static* variables of languages like Fortran, Algol 60, and C, which allow a variable that is local to a subroutine to retain its value from one invocation to the next. We then noted that simple modules can be seen as a way to make long-lived objects local to a group of subroutines, in such a way that they are not visible to other parts of the program. By selectively exporting names, a module may serve as the “manager” for one or more abstract data types. At the next level of complexity, we noted that some languages treat modules *as* types, allowing the programmer to create an arbitrary number of instances of the abstraction defined by a module. Finally, we noted that object-oriented languages extend the module-as-type approach (as well as the notion of lexical scope) by providing an inheritance mechanism that allows

new abstractions (classes) to be defined as extensions or refinements of existing classes.

In [Section 3.5](#) we examined several ways in which bindings relate to one another. Aliases arise when two or more names in a given scope are bound to the same object. Overloading arises when one name is bound to multiple objects. Polymorphism allows a single body of code to operate on objects of more than one type, depending on context or execution history. We noted that while similar effects can sometimes be achieved through overloading, coercion, and polymorphism, the underlying mechanisms are really very different. In [Section 3.8](#) we considered rules for separate compilation.

Among the topics considered in this chapter, we saw several examples of useful features (recursion, static scoping, forward references, first-class subroutines, unlimited extent) that have been omitted from certain languages because of concern for their implementation complexity or run-time cost. We also saw an example of a feature (the private part of a module specification) introduced expressly to facilitate a language's implementation, and another (separate compilation in C) whose design was clearly intended to mirror a particular implementation. In several additional aspects of language design (late vs early binding, static vs dynamic scoping, support for coercions and conversions, toleration of pointers and other aliases), we saw that implementation issues play a major role.

In a similar vein, apparently simple language rules can have surprising implications. In [Section 3.3.3](#), for example, we considered the interaction of whole-block scope with the requirement that names be declared before they can be used. Like the do loop syntax and white space rules of Fortran ([Section 2.2.2](#)) or the if... then... else syntax of Pascal ([Section 2.3.2](#)), poorly chosen scoping rules can make program analysis difficult not only for the compiler, but for human beings as well. In future chapters we shall see several additional examples of features that are both confusing and hard to compile. Of course, semantic utility and ease of implementation do not always go together. Many easy-to-compile features (e.g., goto statements) are of questionable value at best. We will also see several examples of highly useful and (conceptually) simple features, such as garbage collection ([Section 7.7.3](#)) and unification (Sections [7.2.4](#), [8.4.4](#), and [11.2.1](#)), whose implementations are quite complex.

3.10 Exercises

- 3.1 Indicate the binding time (when the language is designed, when the program is linked, when the program begins execution, etc.) for each of the following decisions in your favorite programming language and implementation. Explain any answers you think are open to interpretation.
 - The number of built-in functions (math, type queries, etc.)
 - The variable declaration that corresponds to a particular variable reference (use)

- The maximum length allowed for a constant (literal) character string
 - The referencing environment for a subroutine that is passed as a parameter
 - The address of a particular library routine
 - The total amount of space occupied by program code and data
- 3.2 In Fortran 77, local variables are typically allocated statically. In Algol and its descendants (e.g., Pascal and Ada), they are typically allocated in the stack. In Lisp they are typically allocated at least partially in the heap. What accounts for these differences? Give an example of a program in Pascal or Ada that would not work correctly if local variables were allocated statically. Give an example of a program in Scheme or Common Lisp that would not work correctly if local variables were allocated on the stack.
- 3.3 Give two examples in which it might make sense to delay the binding of an implementation decision, even though sufficient information exists to bind it early.
- 3.4 Give three concrete examples drawn from programming languages with which you are familiar in which a variable is live but not in scope.
- 3.5 Consider the following pseudocode.

```

1. procedure main
2.   a : integer := 1
3.   b : integer := 2

4.   procedure middle
5.     b : integer := a

6.     procedure inner
7.       print a, b

8.     a : integer := 3

9.     -- body of middle
10.    inner()
11.    print a, b

12.   -- body of main
13.   middle()
14.   print a, b

```

Suppose this was code for a language with the declaration-order rules of C (but with nested subroutines)—that is, names must be declared before use, and the scope of a name extends from its declaration through the end of the block. At each print statement, indicate which declarations of *a* and *b* are in the referencing environment. What does the program print (or will the compiler identify static semantic errors)? Repeat the exercise for the declaration-order rules of C# (names must be declared before use, but the

scope of a name is the entire block in which it is declared) and of Modula-3 (names can be declared in any order, and their scope is the entire block in which they are declared).

- 3.6 Consider the following pseudocode, assuming nested subroutines and static scope.

```

procedure main
  g : integer

  procedure B(a : integer)
    x : integer

    procedure A(n : integer)
      g := n

    procedure R(m : integer)
      write_integer(x)
      x /= 2 -- integer division
      if x > 1
        R(m + 1)
      else
        A(m)

    -- body of B
    x := a × a
    R(1)

  -- body of main
  B(3)
  write_integer(g)

```

- (a) What does this program print?
- (b) Show the frames on the stack when A has just been called. For each frame, show the static and dynamic links.
- (c) Explain how A finds g.
- 3.7 As part of the development team at MumbleTech.com, Janet has written a list manipulation library for C that contains, among other things, the code in [Figure 3.17](#).

- (a) Accustomed to Java, new team member Brad includes the following code in the main loop of his program:

```

list_node* L = 0;
while (more_widgets()) {
  L = insert(next_widget(), L);
}
L = reverse(L);

```

```

typedef struct list_node {
    void* data;
    struct list_node* next;
} list_node;

list_node* insert(void* d, list_node* L) {
    list_node* t = (list_node*) malloc(sizeof(list_node));
    t->data = d;
    t->next = L;
    return t;
}

list_node* reverse(list_node* L) {
    list_node* rtn = 0;
    while (L) {
        rtn = insert(L->data, rtn);
        L = L->next;
    }
    return rtn;
}

void delete_list(list_node* L) {
    while (L) {
        list_node* t = L;
        L = L->next;
        free(t->data);
        free(t);
    }
}

```

Figure 3.17 List management routines for [Exercise 3.7](#).

Sadly, after running for a while, Brad's program always runs out of memory and crashes. Explain what's going wrong.

- (b) After Janet patiently explains the problem to him, Brad gives it another try:

```

list_node* L = 0;
while (more_widgets()) {
    L = insert(next_widget(), L);
}
list_node* T = reverse(L);
delete_list(L);
L = T;

```

This seems to solve the insufficient memory problem, but where the program used to produce correct results (before running out of memory), now its output is strangely corrupted, and Brad goes back to Janet for advice. What will she tell him this time?

- 3.8 Rewrite Figures 3.6 and 3.7 in C.
- 3.9 Consider the following fragment of code in C:

```

{   int a, b, c;
    ...
    {   int d, e;
        ...
        {   int f;
            ...
        }
        ...
    }
    ...
    {   int g, h, i;
        ...
    }
    ...
}

```

- (a) Assume that each integer variable occupies 4 bytes. How much total space is required for the variables in this code?
- (b) Describe an algorithm that a compiler could use to assign stack frame offsets to the variables of arbitrary nested blocks, in a way that minimizes the total space required.
- 3.10 Consider the design of a Fortran 77 compiler that uses static allocation for the local variables of subroutines. Expanding on the solution to the previous question, describe an algorithm to minimize the total space required for these variables. You may find it helpful to construct a *call graph* data structure in which each node represents a subroutine, and each directed arc indicates that the subroutine at the tail may sometimes call the subroutine at the head.
- 3.11 Consider the following pseudocode:

```

procedure P(A, B : real)
  X : real

  procedure Q(B, C : real)
    Y : real
    ...

  procedure R(A, C : real)
    Z : real
    ...
    -- (*)
    ...

```

Assuming static scope, what is the referencing environment at the location marked by (*)?

- 3.12 Write a simple program in Scheme that displays three different behaviors, depending on whether we use `let`, `let*`, or `letrec` to declare a given set of names. (Hint: to make good use of `letrec`, you will probably want your names to be functions [lambda expressions].)
- 3.13 Consider the following program in Scheme:

```
(define A
  (lambda ()
    (let* ((x 2)
          (C (lambda (P)
                (let ((x 4))
                  (P))))
          (D (lambda ()
                x))
          (B (lambda ()
                (let ((x 3))
                  (C D))))))
      (B))))
```

What does this program print? What would it print if Scheme used dynamic scoping and shallow binding? Dynamic scoping and deep binding? Explain your answers.

- 3.14 Consider the following pseudocode:

```
x : integer    -- global

procedure set_x(n : integer)
  x := n

procedure print_x
  write_integer(x)

procedure first
  set_x(1)
  print_x

procedure second
  x : integer
  set_x(2)
  print_x

set_x(0)
first()
print_x
second()
print_x
```

What does this program print if the language uses static scoping? What does it print with dynamic scoping? Why?

- 3.15 As noted in [Section 3.6.3](#), C# has unusually sophisticated support for first-class subroutines. Among other things, it allows *delegates* to be instantiated from anonymous nested methods, and gives local variables and parameters unlimited extent when they may be needed by such a delegate. Consider the implications of these features in the following C# program.

```
using System;
public delegate int UnaryOp(int n);
    // type declaration: UnaryOp is a function from ints to ints

public class Foo {
    static int a = 2;
    static UnaryOp b(int c) {
        int d = a + c;
        Console.WriteLine(d);
        return delegate(int n) { return c + n; };
    }
    public static void Main(string[] args) {
        Console.WriteLine(b(3)(4));
    }
}
```

What does this program print? Which of *a*, *b*, *c*, and *d*, if any, is likely to be statically allocated? Which could be allocated on the stack? Which would need to be allocated in the heap? Explain.

- 3.16 Consider the programming idiom illustrated in [Example 3.22](#). One of the reviewers for this book suggests that we think of this idiom as a way to implement a central reference table for dynamic scoping. Explain what is meant by this suggestion.
- 3.17 If you are familiar with structured exception handling, as provided in Ada, C++, Java, C#, ML, Python, or Ruby, consider how this mechanism relates to the issue of scoping. Conventionally, a *raise* or *throw* statement is thought of as referring to an exception, which it passes as a parameter to a handler-finding library routine. In each of the languages mentioned, the exception itself must be declared in some surrounding scope, and is subject to the usual static scope rules. Describe an alternative point of view, in which the *raise* or *throw* is actually a reference to a *handler*, to which it transfers control directly. Assuming this point of view, what are the scope rules for handlers? Are these rules consistent with the rest of the language? Explain. (For further information on exceptions, see [Section 8.5](#).)
- 3.18 Consider the following pseudocode:

```
x : integer    -- global

procedure set_x(n : integer)
    x := n
```



```

procedure print_x
  write_integer(x)

procedure foo(S, P : function; n : integer)
  x : integer := 5
  if n in {1, 3}
    set_x(n)
  else
    S(n)
  if n in {1, 2}
    print_x
  else
    P

set_x(0); foo(set_x, print_x, 1); print_x
set_x(0); foo(set_x, print_x, 2); print_x
set_x(0); foo(set_x, print_x, 3); print_x
set_x(0); foo(set_x, print_x, 4); print_x

```

Assume that the language uses dynamic scoping. What does the program print if the language uses shallow binding? What does it print with deep binding? Why?

3.19 Consider the following pseudocode:

```

x : integer := 1
y : integer := 2

procedure add
  x := x + y

procedure second(P : procedure)
  x : integer := 2
  P()

procedure first
  y : integer := 3
  second(add)

first()
write_integer(x)

```

- (a) What does this program print if the language uses static scoping?
- (b) What does it print if the language uses dynamic scoping with deep binding?
- (c) What does it print if the language uses dynamic scoping with shallow binding?

3.20 In [Section 3.5.3](#) we noted that while a single `min` function in C would work for both integer and floating-point numbers, overloading would be

more efficient, because it would avoid the cost of type conversions. Give an example in which overloading does not seem advantageous—one in which it makes more sense to have a single function with floating-point parameters, and perform coercion when integers are supplied.

- 3.21 (a) Write a polymorphic sorting routine in Scheme or Haskell.
(b) Write a generic sorting routine in C++, Java, or C#. (For hints, see [Section 8.4](#).)
(c) Write a nongeneric sorting routine using subtype polymorphism in your favorite object-oriented language. Assume that the elements to be sorted are members of some class derived from class `ordered`, which has a method `precedes` such that `a.precedes(b)` is true if and only if `a` comes before `b` in some canonical total order. (For hints, see [Section 9.4](#).)
- 3.22 Can you write a macro in standard C that “returns” the greatest common divisor of a pair of arguments, without calling a subroutine? Why or why not?
- © 3.23–3.29 In More Depth.

3.11 Explorations

- 3.30 Experiment with naming rules in your favorite programming language. Read the manual, and write and compile some test programs. Does the language use lexical or dynamic scoping? Can scopes nest? Are they open or closed? Does the scope of a name encompass the entire block in which it is declared, or only the portion after the declaration? How does one declare mutually recursive types or subroutines? Can subroutines be passed as parameters, returned from functions, or stored in variables? If so, when are referencing environments bound?
- 3.31 List the keywords (reserved words) of one or more programming languages. List the predefined identifiers. (Recall that every keyword is a separate token. An identifier cannot have the same spelling as a keyword.) What criteria do you think were used to decide which names should be keywords and which should be predefined identifiers? Do you agree with the choices? Why or why not?
- 3.32 If you have experience with a language like C, C++, or Pascal, in which dynamically allocated space must be manually reclaimed, describe your experience with dangling references or memory leaks. How often do these bugs arise? How do you find them? How much effort does it take? Learn about open source or commercial tools for finding storage bugs (*Valgrind* is a popular open source example). Do such tools weaken the argument for automatic garbage collection?
- 3.33 We learned in [Section 3.3.6](#) that modern languages have generally abandoned dynamic scoping. One place it can still be found is in the so-called

environment variables of the Unix programming environment. If you are not familiar with these, read the manual page for your favorite shell (command interpreter—`csh/tcsh`, `ksh/bash`, etc.) to learn how these behave. Explain why the usual alternatives to dynamic scoping (default parameters and static variables) are not appropriate in this case.

- 3.34 Compare the mechanisms for overloading of enumeration names in Ada and Modula-3 (Section 3.5.2). One might argue that the (historically more recent) Modula-3 approach moves responsibility from the compiler to the programmer: it requires even an unambiguous use of an enumeration constant to be annotated with its type. Why do you think this approach was chosen by the language designers? Do you agree with the choice? Why or why not?
- 3.35 Learn about *tied variables* in Perl. These allow the programmer to associate an ordinary variable with an (object-oriented) object in such a way that operations on the variable are automatically interpreted as method invocations on the object. As an example, suppose we write `tie $my_var, "my_class";`. The interpreter will create a new object of class `my_class`, which it will associate with scalar variable `$my_var`. For purposes of discussion, call that object *O*. Now, any attempt to read the value of `$my_var` will be interpreted as a call to method `O->FETCH()`. Similarly, the assignment `$my_var = value` will be interpreted as a call to `O->STORE(value)`. Array, hash, and filehandle variables, which support a larger set of built-in operations, provide access to a larger set of methods when tied.
- Compare Perl's tying mechanism to the operator overloading of C++. Which features of each language can be conveniently emulated by the other?
- 3.36 Write a program in C++ or Ada that creates at least two concrete types or subroutines from the same template/generic. Compile your code to assembly language and look at the result. Describe the mapping from source to target code.
- 3.37 Do you think coercion is a good idea? Why or why not?
- 3.38 Give three examples of features that are *not* provided in some language with which you are familiar, but that are common in other languages. Why do you think these features are missing? Would they complicate the implementation of the language? If so, would the complication (in your judgment) be justified?
- © 3.39–3.43 In More Depth.

3.12 Bibliographic Notes

This chapter has traced the evolution of naming and scoping mechanisms through a very large number of languages, including Fortran (several versions), Basic, Algol 60 and 68, Pascal, Simula, C and C++, Euclid, Turing, Modula (1, 2, and 3),

Ada (83 and 95), Oberon, Eiffel, Perl, Tcl, Python, Ruby, Java, and C#. Bibliographic references for all of these can be found in [Appendix A](#).

Both modules and objects trace their roots to Simula, which was developed by Dahl, Nygaard, Myhrhaug, and others at the Norwegian Computing Centre in the mid-1960s. (Simula I was implemented in 1964; descriptions in this book pertain to Simula 67.) The encapsulation mechanisms of Simula were refined in the 1970s by the developers of Clu, Modula, Euclid, and related languages. Other Simula innovations—inheritance and dynamic method binding in particular—provided the inspiration for Smalltalk, the original and arguably purest of the object-oriented languages. Modern object-oriented languages, including Eiffel, C++, Java, C#, Python, and Ruby, represent to a large extent a reintegration of the evolutionary lines of encapsulation on the one hand and inheritance and dynamic method binding on the other.

The notion of information hiding originates in Parnas's classic paper, "On the Criteria to be Used in Decomposing Systems into Modules" [[Par72](#)]. Comparative discussions of naming, scoping, and abstraction mechanisms can be found, among other places, in Liskov et al.'s discussion of Clu [[LSAS77](#)], Liskov and Guttag's text [[LG86](#), Chap. 4], the Ada Rationale [[IBFW91](#), Chaps. 9–12], Harbison's text on Modula-3 [[Har92](#), Chaps. 8–9], Wirth's early work on modules [[Wir80](#)], and his later discussion of Modula and Oberon [[Wir88a](#), [Wir07](#)]. Further information on object-oriented languages can be found in [Chapter 9](#).

For a detailed discussion of overloading and polymorphism, see the survey by Cardelli and Wegner [[CW85](#)]. Cailliau [[Cai82](#)] provides a lighthearted discussion of many of the scoping pitfalls noted in [Section 3.3.3](#). Abelson and Sussman [[AS96](#), p. 11n] attribute the term "syntactic sugar" to Peter Landin.

This page intentionally left blank

Semantic Analysis

In Chapter 2 we considered the topic of programming language syntax. In the current chapter we turn to the topic of semantics. Informally, syntax concerns the *form* of a valid program, while semantics concerns its *meaning*. Meaning is important for at least two reasons: it allows us to enforce rules (e.g., type consistency) that go beyond mere form, and it provides the information we need in order to generate an equivalent output program.

It is conventional to say that the syntax of a language is precisely that portion of the language definition that can be described conveniently by a context-free grammar, while the semantics is that portion of the definition that cannot. This convention is useful in practice, though it does not always agree with intuition. When we require, for example, that the number of arguments contained in a call to a subroutine match the number of formal parameters in the subroutine definition, it is tempting to say that this requirement is a matter of syntax. After all, we can count arguments without knowing what they mean. Unfortunately, we cannot count them with context-free rules. Similarly, while it is possible to write a context-free grammar in which every function must contain at least one return statement, the required complexity makes this strategy very unattractive. In general, any rule that requires the compiler to compare things that are separated by long distances, or to count things that are not properly nested, ends up being a matter of semantics.

Semantic rules are further divided into *static* and *dynamic* semantics, though again the line between the two is somewhat fuzzy. The compiler enforces static semantic rules at compile time. It generates code to enforce dynamic semantic rules at run time (or to call library routines that do so). Certain errors, such as division by zero, or attempting to index into an array with an out-of-bounds subscript, cannot in general be caught at compile time, since they may occur only for certain input values, or certain behaviors of arbitrarily complex code. In special cases, a compiler may be able to tell that a certain error will always or never occur, regardless of run-time input. In these cases, the compiler can generate an error message at compile time, or refrain from generating code to perform the check at run time, as appropriate. Basic results from computability theory, however, tell us that no algorithm can make these predictions correctly for arbitrary

programs: there will inevitably be cases in which an error will always occur, but the compiler cannot tell, and must delay the error message until run time; there will also be cases in which an error can never occur, but the compiler cannot tell, and must incur the cost of unnecessary run-time checks.

Both semantic analysis and intermediate code generation can be described in terms of annotation, or *decoration* of a parse tree or syntax tree. The annotations themselves are known as *attributes*. Numerous examples of static and dynamic semantic rules will appear in subsequent chapters. In this current chapter we focus primarily on the mechanisms a compiler uses to enforce the static rules. We will consider intermediate code generation (including the generation of code for dynamic semantic checks) in [Chapter 14](#).

In [Section 4.1](#) we consider the role of the semantic analyzer in more detail, considering both the rules it needs to enforce and its relationship to other phases of compilation. Most of the rest of the chapter is then devoted to the subject of *attribute grammars*. Attribute grammars provide a formal framework for the decoration of a tree. This framework is a useful conceptual tool even in compilers that do not build a parse tree or syntax tree as an explicit data structure. We introduce the notion of an attribute grammar in [Section 4.2](#). We then consider various ways in which such grammars can be applied in practice. [Section 4.3](#) discusses the issue of *attribute flow*, which constrains the order(s) in which nodes of a tree can be decorated. In practice, most compilers require decoration of the parse tree (or the evaluation of attributes that would reside in a parse tree if there were one) to occur in the process of an LL or LR parse. [Section 4.4](#) presents *action routines* as an ad hoc mechanism for such “on-the-fly” evaluation. In [Section 4.5](#) (mostly on the PLP CD) we consider the management of space for parse tree attributes.

Because they have to reflect the structure of the CFG, parse trees tend to be very complicated (recall the example in [Figure 1.4](#)). Once parsing is complete, we typically want to replace the parse tree with a syntax tree that reflects the input program in a more straightforward way ([Figure 1.5](#)). One particularly common compiler organization uses action routines during parsing solely for the purpose of constructing the syntax tree. The syntax tree is then decorated during a separate traversal, which can be formalized, if desired, with a separate attribute grammar. We consider the decoration of syntax trees in [Section 4.6](#).

4.1 The Role of the Semantic Analyzer

Programming languages vary dramatically in their choice of semantic rules. In [Section 3.5.3](#), for example, we saw a range of approaches to coercion, from languages like Fortran and C, which allow operands of many types to be intermixed in expressions, to languages like Ada, which do not. Languages also vary in the extent to which they require their implementations to perform dynamic checks. At one extreme, C requires no checks at all, beyond those that come “free” with

the hardware (e.g., division by zero, or attempted access to memory outside the bounds of the program). At the other extreme, Java takes great pains to check as many rules as possible, in part to ensure that an untrusted program cannot do anything to damage the memory or files of the machine on which it runs. The role of the semantic analyzer is to enforce all static semantic rules and to annotate the program with information needed by the intermediate code generator. This information includes both clarifications (this is floating-point addition, not integer; this is a reference to the global variable *x*) and requirements for dynamic semantic checks.

In the typical compiler, the interface between semantic analysis and intermediate code generation defines the boundary between the *front end* and the *back end*. The exact division of labor varies a bit from compiler to compiler: it can be hard to say exactly where analysis (figuring out what the program means) ends and synthesis (expressing that meaning in some new form) begins. Many compilers actually carry a program through more than one intermediate form. In one common organization, described in more detail in [Chapter 14](#), the semantic analyzer creates an annotated syntax tree, which the intermediate code generator then translates into a linear form reminiscent of the assembly language for some idealized machine. After machine-independent code improvement, this linear form is then translated into yet another form, patterned more closely on the assembly language of the target machine. That form may then undergo machine-specific code improvement.

Compilers also vary in the extent to which semantic analysis and intermediate code generation are interleaved with parsing. With fully separated phases, the parser passes a full parse tree on to the semantic analyzer, which converts it to a syntax tree, fills in the symbol table, performs semantic checks, and passes it on to the code generator. With fully interleaved phases, there may be no need to build either the parse tree or the syntax tree in its entirety: the parser can call semantic check and code generation routines on the fly as it parses each expression, statement, or subroutine of the source. We will focus on an organization in which construction of the syntax tree is interleaved with parsing (and the parse tree is not built), but semantic analysis occurs during a separate traversal of the syntax tree.

Dynamic Checks

Many compilers that generate code for dynamic checks provide the option of disabling them if desired. It is customary in some organizations to enable dynamic checks during program development and testing, and then disable them for production use, to increase execution speed. The wisdom of this practice is questionable: Tony Hoare, one of the key figures in programming language design,¹

¹ Among other things, C. A. R. Hoare (1934–) invented the quicksort algorithm and the *case* statement, contributed to the design of Algol W, and was one of the leaders in the development of axiomatic semantics. In the area of concurrent programming, he refined and formalized the *monitor* construct (to be described in [Section 12.4.1](#)), and designed the CSP programming model and notation. He received the ACM Turing Award in 1980.

has likened the programmer who disables semantic checks to a sailing enthusiast who wears a life jacket when training on dry land, but removes it when going to sea [Hoa89, p. 198]. Errors may be less likely in production use than they are in testing, but the consequences of an undetected error are significantly worse. Moreover, on multiissue, superscalar processors (described in Section ©5.4.3), it is often possible for dynamic checks to execute in instruction slots that would otherwise go unused, making them virtually free. On the other hand, some dynamic checks (e.g., ensuring that pointer arithmetic in C remains within the bounds of an array) are sufficiently expensive that they are rarely implemented.

Assertions

When reasoning about the correctness of their algorithms (or when formally proving properties of programs via axiomatic semantics) programmers frequently write logical *assertions* regarding the values of program data. Some programming languages make these assertions a part of the language syntax. The compiler then generates code to check the assertions at run time. An assertion is a statement that a specified condition is expected to be true when execution reaches a certain point in the code. In Java one can write

EXAMPLE 4.1

Assertions in Java

```
assert denominator != 0;
```

An `AssertionError` exception will be thrown if the semantic check fails at run time. ■

Some languages (e.g., Euclid and Eiffel) also provide explicit support for *invariants*, *preconditions*, and *post-conditions*. These are essentially structured assertions. An invariant is expected to be true at all “clean points” of a given body of code. In Eiffel, the programmer can specify an invariant on the data inside a class: the invariant will be checked, automatically, at the beginning and end of each of the class’s methods (subroutines). Similar invariants for loops are expected to be true before and after every iteration. Pre- and post-conditions are expected to be true at the beginning and end of subroutines, respectively. In Euclid, a post-condition,

DESIGN & IMPLEMENTATION

Dynamic semantic checks

In the past, language theorists and researchers in programming methodology and software engineering tended to argue for more extensive semantic checks, while “real-world” programmers “voted with their feet” for languages like C and Fortran, which omitted those checks in the interest of execution speed. As computers have become more powerful, and as companies have come to appreciate the enormous costs of software maintenance, the “real-world” camp has become much more sympathetic to checking. Languages like Ada and Java have been designed from the outset with safety in mind, and languages like C and C++ have evolved (to the extent possible) toward increasingly strict definitions.

EXAMPLE 4.2

Assertions in C

specified once in the header of a subroutine, will be checked not only at the end of the subroutine's text, but at every `return` statement as well.

Many languages support assertions via standard library routines or macros. In C, for example, one can write

```
assert(denominator != 0);
```

If the assertion fails, the program will terminate abruptly with the message

```
myprog.c:42: failed assertion 'denominator != 0'
```

The C manual requires `assert` to be implemented as a macro (or built into the compiler) so that it has access to the textual representation of its argument, and to the filename and line number on which the call appears. ■

Assertions, of course, could be used to cover the other three sorts of checks, but not as clearly or succinctly. Invariants, preconditions, and post-conditions are a prominent part of the header of the code to which they apply, and can cover a potentially large number of places where an assertion would otherwise be required. Euclid and Eiffel implementations allow the programmer to disable assertions and related constructs when desired, to eliminate their run-time cost.

Static Analysis

In general, compile-time algorithms that predict run-time behavior are known as *static analysis*. Such analysis is said to be *precise* if it allows the compiler to determine whether a given program will always follow the rules. Type checking, for example, is static and precise in languages like Ada and ML: the compiler ensures that no variable will ever be used at run time in a way that is inappropriate for its type. By contrast, languages like Lisp and Smalltalk obtain greater flexibility, while remaining completely type-safe, by accepting the run-time overhead of dynamic type checks. (We will cover type checking in more detail in [Chapter 7](#).)

Static analysis can also be useful when it isn't precise. Compilers will often check what they can at compile time and then generate code to check the rest dynamically. In Java, for example, type checking is mostly static, but dynamically loaded classes and type casts may require run-time checks. In a similar vein, many compilers perform extensive static analysis in an attempt to eliminate the need for dynamic checks on array subscripts, variant record tags, or potentially dangling pointers (again, to be discussed in [Chapter 7](#)).

If we think of the omission of unnecessary dynamic checks as a performance optimization, it is natural to look for other ways in which static analysis may enable code improvement. We will consider this topic in more detail in [Chapter 16](#). Examples include *alias analysis*, which determines when values can be safely cached in registers, computed “out of order,” or accessed by concurrent threads; *escape analysis*, which determines when all references to a value will be confined to a given context, allowing it to be allocated on the stack instead of the heap, or to be accessed without locks; and *subtype analysis*, which determines when a variable

in an object-oriented language is guaranteed to have a certain subtype, so that its methods can be called without dynamic dispatch.

An optimization is said to be *unsafe* if it may lead to incorrect code in certain programs. It is said to be *speculative* if it usually improves performance, but may degrade it in certain cases. A compiler is said to be *conservative* if it applies optimizations only when it can guarantee that they will be both safe and effective. By contrast, an *optimistic* compiler may make liberal use of speculative optimizations. It may also pursue unsafe optimizations by generating two versions of the code, with a dynamic check that chooses between them based on information not available at compile time. Examples of speculative optimization include *nonbinding prefetches*, which try to bring data into the cache before they are needed, and *trace scheduling*, which rearranges code in hopes of improving the performance of the processor pipeline and the instruction cache.

To eliminate dynamic checks, language designers may choose to tighten semantic rules, banning programs for which conservative analysis fails. The ML type system, for example (Section ©7.2.4), avoids the dynamic type checks of Lisp, but disallows certain useful programming idioms that Lisp supports. Similarly, the *definite assignment* rules of Java and C# (Section 6.1.3) allow the compiler to ensure that a variable is always given a value before it is used in an expression, but disallow certain programs that are legal (and correct) in C.

4.2 Attribute Grammars

EXAMPLE 4.3

Bottom-up CFG for constant expressions

In Chapter 2 we learned how to use a context-free grammar to specify the syntax of a programming language. Here, for example, is an LR (bottom-up) grammar for arithmetic expressions composed of constants, with precedence and associativity:²

$$\begin{aligned} E &\longrightarrow E + T \\ E &\longrightarrow E - T \\ E &\longrightarrow T \\ T &\longrightarrow T * F \\ T &\longrightarrow T / F \\ T &\longrightarrow F \\ F &\longrightarrow - F \\ F &\longrightarrow (E) \\ F &\longrightarrow \text{const} \end{aligned}$$

This grammar will generate all properly formed constant expressions over the basic arithmetic operators, but it says nothing about their meaning. To tie

² The addition of semantic rules tends to make attribute grammars quite a bit more verbose than context-free grammars. For the sake of brevity, many of the examples in this chapter use very short symbol names: *E* instead of *expr*, *TT* instead of *term_tail*.

1. $E_1 \longrightarrow E_2 + T$
 $\triangleright E_1.\text{val} := \text{sum}(E_2.\text{val}, T.\text{val})$
2. $E_1 \longrightarrow E_2 - T$
 $\triangleright E_1.\text{val} := \text{difference}(E_2.\text{val}, T.\text{val})$
3. $E \longrightarrow T$
 $\triangleright E.\text{val} := T.\text{val}$
4. $T_1 \longrightarrow T_2 * F$
 $\triangleright T_1.\text{val} := \text{product}(T_2.\text{val}, F.\text{val})$
5. $T_1 \longrightarrow T_2 / F$
 $\triangleright T_1.\text{val} := \text{quotient}(T_2.\text{val}, F.\text{val})$
6. $T \longrightarrow F$
 $\triangleright T.\text{val} := F.\text{val}$
7. $F_1 \longrightarrow - F_2$
 $\triangleright F_1.\text{val} := \text{additive_inverse}(F_2.\text{val})$
8. $F \longrightarrow (E)$
 $\triangleright F.\text{val} := E.\text{val}$
9. $F \longrightarrow \text{const}$
 $\triangleright F.\text{val} := \text{const.val}$

Figure 4.1 A simple attribute grammar for constant expressions, using the standard arithmetic operations.

EXAMPLE 4.4

Bottom-up AG for
constant expressions

these expressions to mathematical concepts (as opposed to, say, floor tile patterns or dance steps), we need additional notation. The most common is based on *attributes*. In our expression grammar, we can associate a *val* attribute with each E , T , F , and const in the grammar. The intent is that for any symbol S , $S.\text{val}$ will be the meaning, as an arithmetic value, of the token string derived from S . We assume that the *val* of a const is provided to us by the scanner. We must then invent a set of rules for each production, to specify how the *vals* of different symbols are related. The resulting *attribute grammar* (AG) is shown in [Figure 4.1](#).

In this simple grammar, every production has a single rule. We shall see more complicated grammars later, in which productions can have several rules. The rules come in two forms. Those in productions 3, 6, 8, and 9 are known as *copy rules*; they specify that one attribute should be a copy of another. The other rules invoke *semantic functions* (*sum*, *quotient*, *additive_inverse*, etc.). In this example, the semantic functions are all familiar arithmetic operations. In general, they can be arbitrarily complex functions specified by the language designer. Each semantic function takes an arbitrary number of arguments (each of which must be an attribute of a symbol in the current production—no global variables are allowed), and each computes a single result, which must likewise be assigned into an attribute of a symbol in the current production. When more than one symbol of a production has the same name, subscripts are used to distinguish them. These subscripts are solely for the benefit of the semantic functions; they are not part of the context-free grammar itself. ■

In a strict definition of attribute grammars, copy rules and semantic function calls are the only two kinds of permissible rules. In our examples we use a \triangleright symbol to introduce each code fragment corresponding to a single rule. In practice, it is common to allow rules to consist of small fragments of code in some well-defined notation (e.g., the language in which a compiler is being written), so that simple semantic functions can be written out “in-line.” To count the elements of a list, we might write

EXAMPLE 4.5

AG to count the elements of a list

$$\begin{array}{ll} L \longrightarrow \text{id} & \triangleright L_1.c := 1 \\ L_1 \longrightarrow L_2, \text{id} & \triangleright L_1.c := L_2.c + 1 \end{array}$$

Here the rule on the second production performs an addition operation. Whether in-line or explicit, semantic functions are not allowed to refer to any variables or attributes outside the current production (we will relax this restriction when we discuss action routines in [Section 4.4](#)). ■

Semantic functions must be written in some already-existing notation, because attribute grammars do not really specify the meaning of a program; rather, they provide a way to associate a program with something else that presumably has meaning. Neither the notation for semantic functions nor the types of the attributes themselves (i.e., the domain of values passed to and returned from semantic functions) is intrinsic to the AG notion. In the example above, we have used an attribute grammar to associate numeric values with the symbols in our grammar, using semantic functions drawn from ordinary arithmetic. In the code generation phase of a compiler, we might associate fragments of target machine code with our symbols, using semantic functions written in some existing programming language. If we were interested in defining the meaning of a programming language in a machine-independent way, our attributes might be domain theory *denotations* (these are the basis of *denotational semantics*). If we were interested in proving theorems about the behavior of programs in our language, our attributes might be logical formulas (this is the basis of *axiomatic semantics*).³ These more formal concepts are beyond the scope of this text (but see the Bibliographic Notes at the end of the chapter). We will use attribute grammars primarily as a framework for building a syntax tree, checking semantic rules, and (in [Chapter 14](#)) generating code.

4.3 Evaluating Attributes

The process of evaluating attributes is called *annotation* or *decoration* of the parse tree. [Figure 4.2](#) shows how to decorate the parse tree for the expression

EXAMPLE 4.6

Decoration of a parse tree

3 It's actually stretching things a bit to discuss axiomatic semantics in the context of attribute grammars. Axiomatic semantics is intended not so much to define the meaning of programs as to permit one to prove that a given program satisfies some desired property (e.g., computes some desired function).

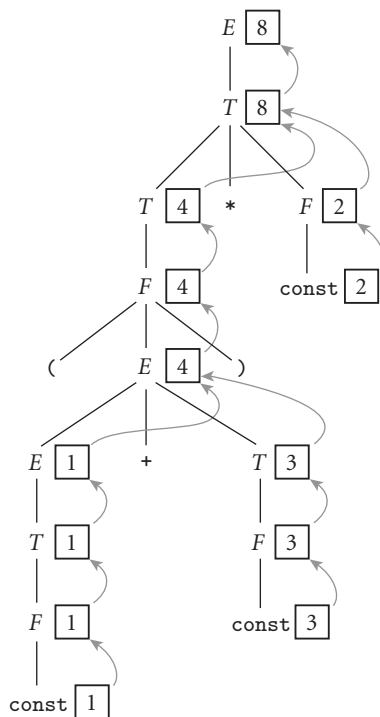

Figure 4.2 Decoration of a parse tree for $(1 + 3) * 2$, using the attribute grammar of Figure 4.1. The val attributes of symbols are shown in boxes. Curving arrows show the attribute flow, which is strictly upward in this case. Each box holds the output of a single semantic rule; the arrow(s) entering the box indicate the input(s) to the rule. At the second level of the tree, for example, the two arrows pointing into the box with the 8 represent application of the rule $T_1.val := product(T_2.val, F.val)$.

$(1 + 3) * 2$, using the AG of Figure 4.1. Once decoration is complete, the value of the overall expression can be found in the val attribute of the root of the tree. ■

Synthesized Attributes

The attribute grammar of Figure 4.1 is very simple. Each symbol has at most one attribute (the punctuation marks have none). Moreover, they are all so-called *synthesized attributes*: their values are calculated (synthesized) only in productions in which their symbol appears on the left-hand side. For annotated parse trees like the one in Figure 4.2, this means that the *attribute flow*—the pattern in which information moves from node to node—is entirely bottom-up.

An attribute grammar in which all attributes are synthesized is said to be *S-attributed*. The arguments to semantic functions in an S-attributed grammar are always attributes of symbols on the right-hand side of the current production, and the return value is always placed into an attribute of the left-hand side

of the production. Tokens (terminals) often have intrinsic properties (e.g., the character-string representation of an identifier or the value of a numeric constant); in a compiler these are synthesized attributes initialized by the scanner.

Inherited Attributes

In general, we can imagine (and will in fact have need of) attributes whose values are calculated when their symbol is on the right-hand side of the current production. Such attributes are said to be *inherited*. They allow contextual information to flow into a symbol from above or from the side, so that the rules of that production can be enforced in different ways (or generate different values) depending on surrounding context. Symbol table information is commonly passed from symbol to symbol by means of inherited attributes. Inherited attributes of the root of the parse tree can also be used to represent the external environment (characteristics of the target machine, command-line arguments to the compiler, etc.).

EXAMPLE 4.7

Top-down CFG and parse tree for subtraction

As a simple example of inherited attributes, consider the following simplified fragment of an LL(1) expression grammar (here covering only subtraction):

$$\begin{aligned} \text{expr} &\longrightarrow \text{const } \text{expr_tail} \\ \text{expr_tail} &\longrightarrow - \text{const } \text{expr_tail} \mid \epsilon \end{aligned}$$

For the expression $9 - 4 - 3$, we obtain the following parse tree:

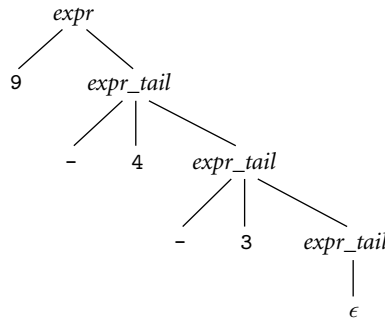

If we want to create an attribute grammar that accumulates the value of the overall expression into the root of the tree, we have a problem: because subtraction is left associative, we cannot summarize the right subtree of the root with a single numeric value. If we want to decorate the tree bottom-up, with an S-attributed grammar, we must be prepared to describe an arbitrary number of right operands in the attributes of the top-most *expr_tail* node (see [Exercise 4.4](#)). This is indeed possible, but it defeats the purpose of the formalism: in effect, it requires us to embed the entire tree into the attributes of a single node, and do all the real work inside a single semantic function.

EXAMPLE 4.8

Decoration with
left-to-right attribute flow

If, however, we are allowed to pass attribute values not only bottom-up but also left-to-right in the tree, then we can pass the 9 into the top-most *expr_tail* node, where it can be combined (in proper left-associative fashion) with the 4. The resulting 5 can then be passed into the middle *expr_tail* node, combined with the 3 to make 2, and then passed upward to the root:

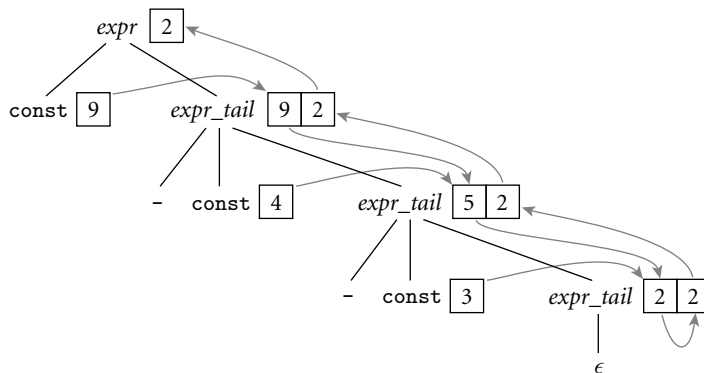
**EXAMPLE 4.9**

Top-down AG for
subtraction

To effect this style of decoration, we need the following attribute rules:

$$\begin{aligned} \text{expr} &\rightarrow \text{const expr_tail} \\ &\triangleright \text{expr_tail.st} := \text{const.val} \\ &\triangleright \text{expr.val} := \text{expr_tail.val} \\ \text{expr_tail}_1 &\rightarrow - \text{const expr_tail}_2 \\ &\triangleright \text{expr_tail}_2.\text{st} := \text{expr_tail}_1.\text{st} - \text{const.val} \\ &\triangleright \text{expr_tail}_1.\text{val} := \text{expr_tail}_2.\text{val} \\ \text{expr_tail} &\rightarrow \epsilon \\ &\triangleright \text{expr_tail.val} := \text{expr_tail.st} \end{aligned}$$

In each of the first two productions, the first rule serves to copy the left context (value of the expression so far) into a “subtotal” (st) attribute; the second rule copies the final value from the right-most leaf back up to the root. In the *expr_tail* nodes of the picture in [Example 4.8](#), the left box holds the st attribute; the right holds val.

EXAMPLE 4.10

Top-down AG for constant
expressions

We can flesh out the grammar fragment of [Example 4.7](#) to produce a more complete expression grammar, as shown (with shorter symbol names) in [Figure 4.3](#). The underlying CFG for this grammar accepts the same language as the one in [Figure 4.1](#), but where that one was SLR(1), this one is LL(1). Attribute flow for a parse of $(1 + 3) * 2$, using the LL(1) grammar, appears in [Figure 4.4](#). As in the grammar fragment of [Example 4.9](#), the value of the left operand of each operator is carried into the *TT* and *FT* productions by the st (subtotal) attribute. The relative complexity of the attribute flow arises from the fact that operators are left

1. $E \longrightarrow T TT$
 $\triangleright TT.st := T.val \qquad \triangleright E.val := TT.val$
2. $TT_1 \longrightarrow + T TT_2$
 $\triangleright TT_2.st := TT_1.st + T.val \qquad \triangleright TT_1.val := TT_2.val$
3. $TT_1 \longrightarrow - T TT_2$
 $\triangleright TT_2.st := TT_1.st - T.val \qquad \triangleright TT_1.val := TT_2.val$
4. $TT \longrightarrow \epsilon$
 $\triangleright TT.val := TT.st$
5. $T \longrightarrow F FT$
 $\triangleright FT.st := F.val \qquad \triangleright T.val := FT.val$
6. $FT_1 \longrightarrow * F FT_2$
 $\triangleright FT_2.st := FT_1.st \times F.val \qquad \triangleright FT_1.val := FT_2.val$
7. $FT_1 \longrightarrow / F FT_2$
 $\triangleright FT_2.st := FT_1.st \div F.val \qquad \triangleright FT_1.val := FT_2.val$
8. $FT \longrightarrow \epsilon$
 $\triangleright FT.val := FT.st$
9. $F_1 \longrightarrow - F_2$
 $\triangleright F_1.val := - F_2.val$
10. $F \longrightarrow (E)$
 $\triangleright F.val := E.val$
11. $F \longrightarrow \text{const}$
 $\triangleright F.val := \text{const.val}$

Figure 4.3 An attribute grammar for constant expressions based on an LL(1) CFG. In this grammar several productions have two semantic rules.

associative, but the grammar cannot be left recursive: the left and right operands of a given operator are thus found in separate productions. Grammars to perform semantic analysis for practical languages generally require some non-S-attributed flow. ■

Attribute Flow

Just as a context-free grammar does not specify how it should be parsed, an attribute grammar does not specify the order in which attribute rules should be invoked. Put another way, both notations are *declarative*: they define a set of valid trees, but they don't say how to build or decorate them. Among other things, this means that the order in which attribute rules are listed for a given production is immaterial; attribute flow may require them to execute in any order. If, in [Figure 4.3](#), we were to reverse the order in which the rules appear in productions 1, 2, 3, 5, 6, and/or 7 (listing the rule for `symbol.val` first), it would be a purely cosmetic change; the grammar would not be altered.

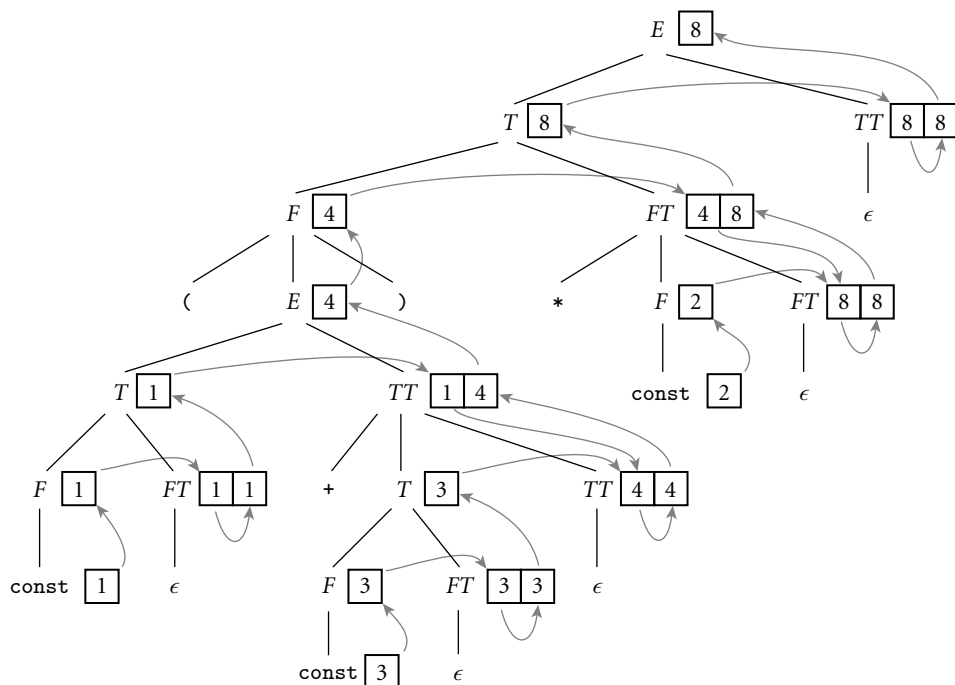

Figure 4.4 Decoration of a top-down parse tree for $(1 + 3) * 2$, using the AG of Figure 4.3. Curving arrows again indicate attribute flow; the arrow(s) entering a given box represent the application of a single semantic rule. Flow in this case is no longer strictly bottom-up, but it is still left-to-right. At FT and TT nodes, the left box holds the st attribute; the right holds val .

We say an attribute grammar is *well defined* if its rules determine a unique set of values for the attributes of every possible parse tree. An attribute grammar is *noncircular* if it never leads to a parse tree in which there are cycles in the attribute flow graph—that is, if no attribute, in any parse tree, ever depends (transitively) on itself. (A grammar can be circular and still be well defined if attributes are guaranteed to converge to a unique value.) As a general rule, practical attribute grammars tend to be noncircular.

An algorithm that decorates parse trees by invoking the rules of an attribute grammar in an order consistent with the tree's attribute flow is called a *translation scheme*. Perhaps the simplest scheme is one that makes repeated passes over a tree, invoking any semantic function whose arguments have all been defined, and stopping when it completes a pass in which no values change. Such a scheme is said to be *oblivious*, in the sense that it exploits no special knowledge of either the parse tree or the grammar. It will halt only if the grammar is well defined. Better performance, at least for noncircular grammars, may be achieved by a *dynamic* scheme that tailors the evaluation order to the structure of a given parse tree, for

example by constructing a topological sort of the attribute flow graph and then invoking rules in an order consistent with the sort.

The fastest translation schemes, however, tend to be *static*—based on an analysis of the structure of the attribute grammar itself, and then applied mechanically to any tree arising from the grammar. Like LL and LR parsers, linear-time static translation schemes can be devised only for certain restricted classes of grammars. S-attributed grammars, such as the one in Figure 4.1, form the simplest such class. Because attribute flow in an S-attributed grammar is strictly bottom-up (see Figure 4.2), attributes can be evaluated by visiting the nodes of the parse tree in exactly the same order that those nodes are generated by an LR-family parser. In fact, the attributes can be evaluated on the fly during a bottom-up parse, thereby interleaving parsing and semantic analysis (attribute evaluation).

The attribute grammar of Figure 4.3 is a good bit messier than that of Figure 4.1, but it is still *L-attributed*: its attributes can be evaluated by visiting the nodes of the parse tree in a single left-to-right, depth-first traversal (the same order in which they are visited during a top-down parse—see Figure 4.4). If we say that an attribute $A.s$ depends on an attribute $B.t$ if $B.t$ is ever passed to a semantic function that returns a value for $A.s$, then we can define L-attributed grammars more formally with the following two rules: (1) each synthesized attribute of a left-hand-side symbol depends only on that symbol's own inherited attributes or on attributes (synthesized or inherited) of the production's right-hand-side symbols, and (2) each inherited attribute of a right-hand-side symbol depends only on inherited attributes of the left-hand-side symbol or on attributes (synthesized or inherited) of symbols to its left in the right-hand-side.

Because L-attributed grammars permit rules that initialize attributes of the left-hand side of a production using attributes of symbols on the right-hand side, every S-attributed grammar is also an L-attributed grammar. The reverse is not the case: S-attributed grammars do not permit the initialization of attributes on the right-hand side, so there are L-attributed grammars that are not S-attributed.

S-attributed attribute grammars are the most general class of attribute grammars for which evaluation can be implemented on the fly during an LR parse. L-attributed grammars are the most general class for which evaluation can be implemented on the fly during an LL parse. If we interleave semantic analysis (and possibly intermediate code generation) with parsing, then a bottom-up parser must in general be paired with an S-attributed translation scheme; a top-down parser must be paired with an L-attributed translation scheme. (Depending on the structure of the grammar, it is often possible for a bottom-up parser to accommodate some non-S-attributed attribute flow; we consider this possibility in Section ©4.5.1.) If we choose to separate parsing and semantic analysis into separate passes, then the code that builds the parse tree or syntax tree must still use an S-attributed or L-attributed translation scheme (as appropriate), but the semantic analyzer can use a more powerful scheme if desired. There are certain tasks, such as the generation of code for “short-circuit” Boolean expressions (to be discussed in Sections 6.1.5 and 6.4.1), that are easiest to accomplish with a non-L-attributed scheme.

One-Pass Compilers

A compiler that interleaves semantic analysis and code generation with parsing is said to be a *one-pass compiler*.⁴ It is unclear whether interleaving semantic analysis with parsing makes a compiler simpler or more complex; it's mainly a matter of taste. If intermediate code generation is interleaved with parsing, one need not build a syntax tree at all (unless of course the syntax tree *is* the intermediate code). Moreover, it is often possible to write the intermediate code to an output file on the fly, rather than accumulating it in the attributes of the root of the parse tree. The resulting space savings were important for previous generations of computers, which had very small main memories. On the other hand, semantic analysis is easier to perform during a separate traversal of a syntax tree, because that tree reflects the program's semantic structure better than the parse tree does, especially with a top-down parser, and because one has the option of traversing the tree in an order other than that chosen by the parser.

Building a Syntax Tree

If we choose not to interleave parsing and semantic analysis, we still need to add attribute rules to the context-free grammar, but they serve only to create the syntax tree—not to enforce semantic rules or generate code. Figures 4.5 and 4.6 contain bottom-up and top-down attribute grammars, respectively, to build a syntax tree for constant expressions. The attributes in these grammars hold neither numeric values nor target code fragments; instead they point to nodes of the syntax tree. Function `make_leaf` returns a pointer to a newly allocated syntax tree node containing the value of a constant. Functions `make_un_op` and `make_bin_op` return pointers to newly allocated syntax tree nodes containing a unary or binary operator, respectively, and pointers to the supplied operand(s). Figures 4.7 and 4.8 show stages in the decoration of parse trees for $(1 + 3) * 2$,

EXAMPLE 4.11

Bottom-up and top-down AGs to build a syntax tree

DESIGN & IMPLEMENTATION

Forward references

In Sections 3.3.3 and ©3.4.1 we noted that the scope rules of many languages require names to be declared before they are used, and provide special mechanisms to introduce the forward references needed for recursive definitions. While these rules may help promote the creation of clear, maintainable code, an equally important motivation, at least historically, was to facilitate the construction of one-pass compilers. With increases in memory size, processing speed, and programmer expectations regarding the quality of code improvement, multipass compilers have become ubiquitous, and language designers have felt free (as, for example, in the class declarations of C++, Java, and C#) to abandon the requirement that declarations precede uses.

⁴ Most authors use the term *one-pass* only for compilers that translate all the way from source to target code in a single pass. Some authors insist only that intermediate code be generated in a single pass, and permit additional pass(es) to translate intermediate code to target code.

$$\begin{aligned}
 E_1 &\longrightarrow E_2 + T \\
 &\triangleright E_1.\text{ptr} := \text{make_bin_op}("+", E_2.\text{ptr}, T.\text{ptr}) \\
 E_1 &\longrightarrow E_2 - T \\
 &\triangleright E_1.\text{ptr} := \text{make_bin_op}("-", E_2.\text{ptr}, T.\text{ptr}) \\
 E &\longrightarrow T \\
 &\triangleright E.\text{ptr} := T.\text{ptr} \\
 T_1 &\longrightarrow T_2 * F \\
 &\triangleright T_1.\text{ptr} := \text{make_bin_op}("x", T_2.\text{ptr}, F.\text{ptr}) \\
 T_1 &\longrightarrow T_2 / F \\
 &\triangleright T_1.\text{ptr} := \text{make_bin_op}("/_", T_2.\text{ptr}, F.\text{ptr}) \\
 T &\longrightarrow F \\
 &\triangleright T.\text{ptr} := F.\text{ptr} \\
 F_1 &\longrightarrow - F_2 \\
 &\triangleright F_1.\text{ptr} := \text{make_un_op}("/_", F_2.\text{ptr}) \\
 F &\longrightarrow (E) \\
 &\triangleright F.\text{ptr} := E.\text{ptr} \\
 F &\longrightarrow \text{const} \\
 &\triangleright F.\text{ptr} := \text{make_leaf}(\text{const.val})
 \end{aligned}$$

Figure 4.5 Bottom-up (S-attributed) attribute grammar to construct a syntax tree. The symbol $+/_{-}$ is used (as it is on calculators) to indicate change of sign.

using the grammars of [Figures 4.5](#) and [4.6](#), respectively. Note that the final syntax tree is the same in each case. ■

✓ CHECK YOUR UNDERSTANDING

1. What determines whether a language rule is a matter of syntax or of static semantics?
2. Why is it impossible to detect certain program errors at compile time, even though they can be detected at run time?
3. What is an *attribute grammar*?
4. What are programming *assertions*? What is their purpose?
5. What is the difference between *synthesized* and *inherited* attributes?
6. Give two examples of information that is typically passed through inherited attributes.
7. What is *attribute flow*?
8. What is a *one-pass* compiler?
9. What does it mean for an attribute grammar to be *S-attributed*? *L-attributed*? *Noncircular*? What is the significance of these grammar classes?

```

E → T TT
    ▷ TT.st := T.ptr
    ▷ E.ptr := TT.ptr

TT1 → + T TT2
    ▷ TT2.st := make_bin_op("+", TT1.st, T.ptr)
    ▷ TT1.ptr := TT2.ptr

TT1 → - T TT2
    ▷ TT2.st := make_bin_op("-", TT1.st, T.ptr)
    ▷ TT1.ptr := TT2.ptr

TT → ε
    ▷ TT.ptr := TT.st

T → F FT
    ▷ FT.st := F.ptr
    ▷ T.ptr := FT.ptr

FT1 → * F FT2
    ▷ FT2.st := make_bin_op("×", FT1.st, F.ptr)
    ▷ FT1.ptr := FT2.ptr

FT1 → / F FT2
    ▷ FT2.st := make_bin_op("÷", FT1.st, F.ptr)
    ▷ FT1.ptr := FT2.ptr

FT → ε
    ▷ FT.ptr := FT.st

F1 → - F2
    ▷ F1.ptr := make_un_op("/=", F2.ptr)

F → ( E )
    ▷ F.ptr := E.ptr

F → const
    ▷ F.ptr := make_leaf(const.val)

```

Figure 4.6 Top-down (L-attributed) attribute grammar to construct a syntax tree. Here the *st* attribute, like the *ptr* attribute (and unlike the *st* attribute of Figure 4.3), is a pointer to a syntax tree node.

4.4 Action Routines

Just as there are automatic tools that will construct a parser for a given context-free grammar, there are automatic tools that will construct a semantic analyzer (attribute evaluator) for a given attribute grammar. Attribute evaluator generators have been used in syntax-based editors [RT88], incremental compilers [SDB84], and various aspects of programming language research. Most production compilers, however, use an ad hoc, handwritten translation scheme, interleaving parsing with at least the initial construction of a syntax tree, and possibly all of semantic analysis and intermediate code generation. Because they are able to evaluate the

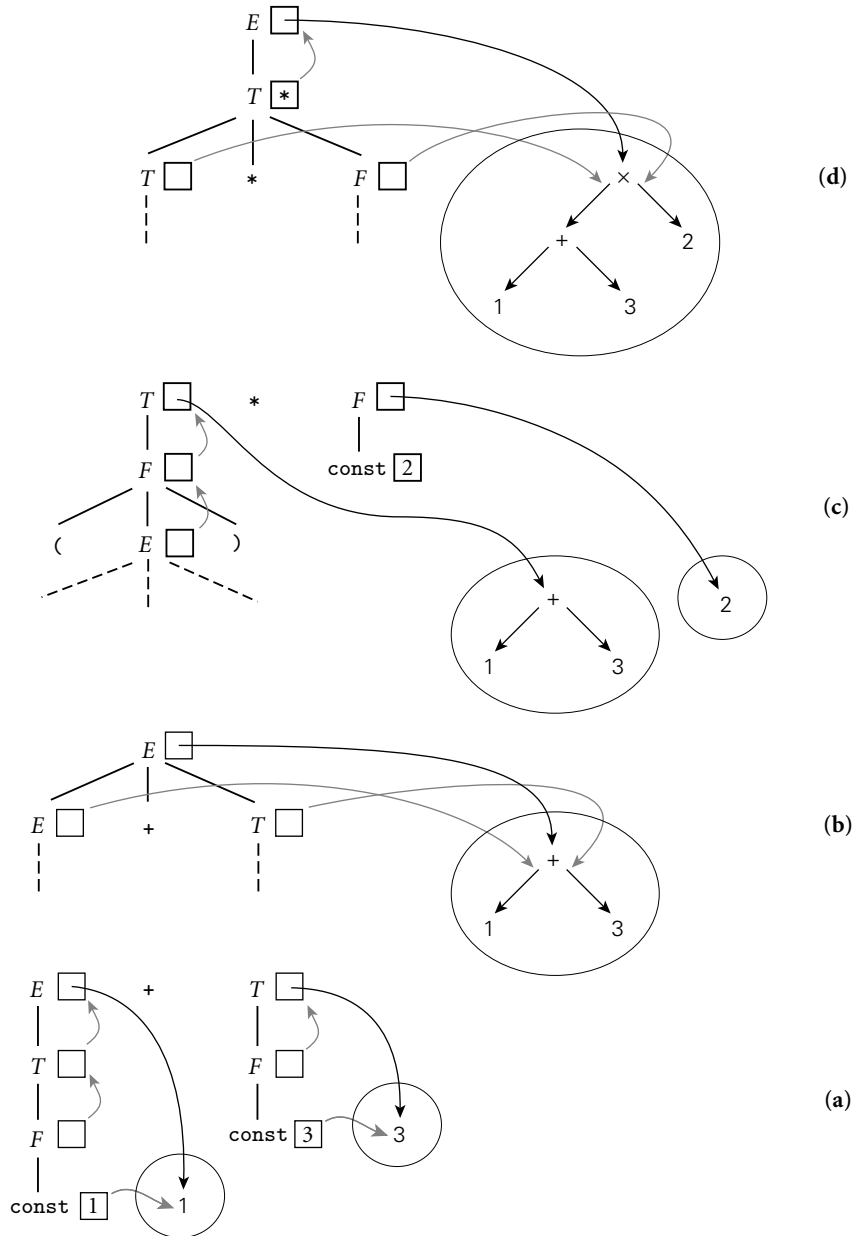

Figure 4.7 Construction of a syntax tree for $(1 + 3) * 2$ via decoration of a bottom-up parse tree, using the grammar of Figure 4.5. This figure reads from bottom to top. In diagram (a), the values of the constants 1 and 3 have been placed in new syntax tree leaves. Pointers to these leaves propagate up into the attributes of E and T . In (b), the pointers to these leaves become child pointers of a new internal $+$ node. In (c) the pointer to this node propagates up into the attributes of T , and a new leaf is created for 2. Finally, in (d), the pointers from T and F become child pointers of a new internal \times node, and a pointer to this node propagates up into the attributes of E .

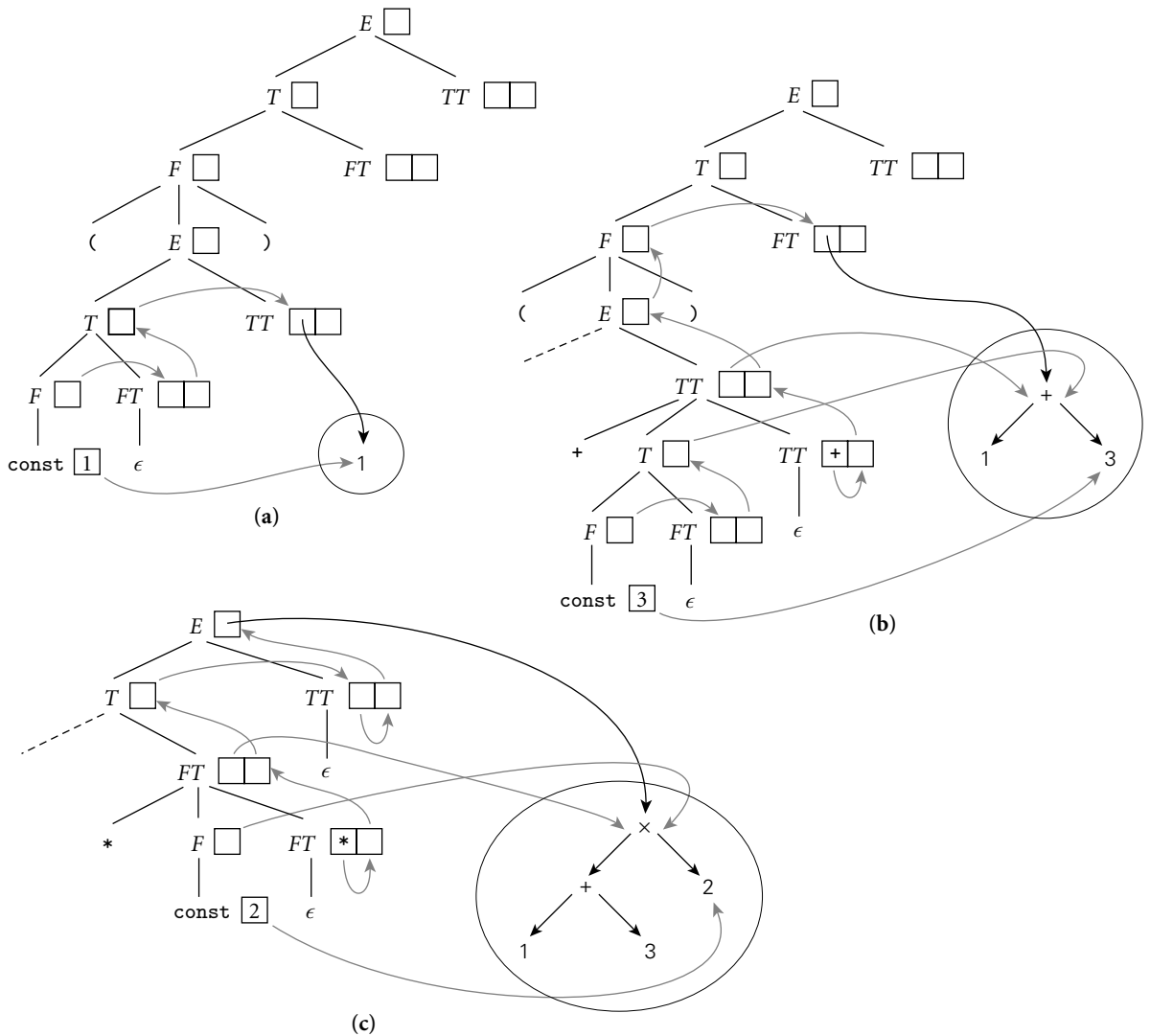

Figure 4.8 Construction of a syntax tree via decoration of a top-down parse tree, using the grammar of Figure 4.6. In the top diagram, (a), the value of the constant 1 has been placed in a new syntax tree leaf. A pointer to this leaf then propagates to the st attribute of TT . In (b), a second leaf has been created to hold the constant 3. Pointers to the two leaves then become child pointers of a new internal $+$ node, a pointer to which propagates from the st attribute of the bottom-most TT , where it was created, all the way up and over to the st attribute of the top-most FT . In (c), a third leaf has been created for the constant 2. Pointers to this leaf and to the $+$ node then become the children of a new \times node, a pointer to which propagates from the st of the lower FT , where it was created, all the way to the root of the tree.

attributes of each production as it is parsed, they do not need to build the full parse tree.

An ad hoc translation scheme that is interleaved with parsing takes the form of a set of *action routines*. An action routine is a semantic function that the programmer (grammar writer) instructs the compiler to execute at a particular point in the parse. Most parser generators allow the programmer to specify action routines. In an LL parser generator, an action routine can appear anywhere within a right-hand side. A routine at the beginning of a right-hand side will be called as soon as the parser predicts the production. A routine embedded in the middle of a right-hand side will be called as soon as the parser has matched (the yield of) the symbol to the left. The implementation mechanism is simple: when it predicts a production, the parser pushes *all* of the right-hand side onto the stack, including terminals (to be matched), nonterminals (to drive future predictions), and pointers to action routines. When it finds a pointer to an action routine at the top of the parse stack, the parser simply calls it.

EXAMPLE 4.12

Top-down action routines
to build a syntax tree

To make this process more concrete, consider again our LL(1) grammar for constant expressions. Action routines to build a syntax tree while parsing this grammar appear in Figure 4.9. The only difference between this grammar and the one in Figure 4.6 is that the action routines (delimited here with curly braces) are embedded among the symbols of the right-hand sides; the work performed is the same. The ease with which the attribute grammar can be transformed into the grammar with action routines is due to the fact that the attribute grammar is L-attributed. If it required more complicated flow, we would not be able to cast it in the form of action routines. ■

EXAMPLE 4.13

Recursive descent and
action routines

As in ordinary parsing, there is a strong analogy between recursive descent and table-driven parsing with action routines. Figure 4.10 shows the `term_tail` routine from Figure 2.16 (page 74), modified to do its part in constructing a syntax tree. The behavior of this routine mirrors that of productions 2 through 5 in Figure 4.9. The routine accepts as a parameter a pointer to the syntax tree fragment contained in the attribute grammar's TT_1 . Then, given an upcoming + or - symbol on the input, it (1) calls `add_op` to parse that symbol (returning a character string representation); (2) calls `term` to parse the attribute grammar's T ;

DESIGN & IMPLEMENTATION

Attribute evaluators

Automatic evaluators based on formal attribute grammars are popular in language research projects because they save developer time when the language definition changes. They are popular in syntax-based editors and incremental compilers because they save execution time: when a small change is made to a program, the evaluator may be able to “patch up” tree decorations significantly faster than it could rebuild them from scratch. For the typical compiler, however, semantic analysis based on a formal attribute grammar is overkill: it has higher overhead than action routines, and doesn't really save the compiler writer that much work.

$$\begin{aligned}
E &\longrightarrow T \{ TT.st := T.ptr \} TT \{ E.ptr := TT.ptr \} \\
TT_1 &\longrightarrow + T \{ TT_2.st := make_bin_op("+", TT_1.st, T.ptr) \} TT_2 \{ TT_1.ptr := TT_2.ptr \} \\
TT_1 &\longrightarrow - T \{ TT_2.st := make_bin_op("-", TT_1.st, T.ptr) \} TT_2 \{ TT_1.ptr := TT_2.ptr \} \\
TT &\longrightarrow \epsilon \{ TT.ptr := TT.st \} \\
T &\longrightarrow F \{ FT.st := F.ptr \} FT \{ T.ptr := FT.ptr \} \\
FT_1 &\longrightarrow * F \{ FT_2.st := make_bin_op("x", FT_1.st, F.ptr) \} FT_2 \{ FT_1.ptr := FT_2.ptr \} \\
FT_1 &\longrightarrow / F \{ FT_2.st := make_bin_op("÷", FT_1.st, F.ptr) \} FT_2 \{ FT_1.ptr := FT_2.ptr \} \\
FT &\longrightarrow \epsilon \{ FT.ptr := FT.st \} \\
F_1 &\longrightarrow - F_2 \{ F_1.ptr := make_un_op("+/-", F_2.ptr) \} \\
F &\longrightarrow (E) \{ F.ptr := E.ptr \} \\
F &\longrightarrow \text{const} \{ F.ptr := make_leaf(const.ptr) \}
\end{aligned}$$

Figure 4.9 LL(1) grammar with action routines to build a syntax tree.

```

procedure term_tail(lhs : tree_node_ptr)
  case input_token of
    +, - :
      op : string := add_op
      return term_tail(make_bin_op(op, lhs, term))
      -- term is a recursive call with no arguments
    ), id, read, write, $$ :
      return lhs
      -- epsilon production
  otherwise parse_error

```

Figure 4.10 Recursive descent parsing with embedded “action routines.” Compare to the routine with the same name in Figure 2.16 (page 74) and with productions 2 through 5 in Figure 4.9.

(3) calls `make_bin_op` to create a new tree node; (4) passes that node to `term_tail`, which parses the attribute grammar’s TT_2 ; and (5) returns the result. ■

Bottom-Up Evaluation

In an LR parser generator, one cannot in general embed action routines at arbitrary places in a right-hand side, since the parser does not in general know what production it is in until it has seen all or most of the yield. LR parser generators therefore permit action routines only after the point at which the production being parsed can be identified unambiguously (this is known as the *trailing part* of the right-hand side; the ambiguous part is the *left corner*). If the attribute flow of the action routines is strictly bottom-up (as it is in an S-attributed attribute grammar), then execution at the end of right-hand sides is all that is needed. The attribute grammars of Figures 4.1 and 4.5, in fact, are essentially identical to the action routine versions. If the action routines are responsible for a significant part of semantic analysis, however (as opposed to simply building a syntax tree), then they will often need contextual information in order to do their job. To obtain

and use this information in an LR parse, they will need some (necessarily limited) access to inherited attributes or to information outside the current production. We consider this issue further in Section ©4.5.1.

4.5 Space Management for Attributes

Any attribute evaluation method requires space to hold the attributes of the grammar symbols. If we are building an explicit parse tree, then the obvious approach is to store attributes in the nodes of the tree themselves. If we are not building a parse tree, then we need to find a way to keep track of the attributes for the symbols we have seen (or predicted) but not yet finished parsing. The details differ in bottom-up and top-down parsers.

For a bottom-up parser with an S-attributed grammar, the obvious approach is to maintain an *attribute stack* that directly mirrors the parse stack: next to every state number on the parse stack is an attribute record for the symbol we shifted when we entered that state. Entries in the attribute stack are pushed and popped automatically by the parser driver; space management is not an issue for the writer of action routines. Complications arise if we try to achieve the effect of inherited attributes, but these can be accommodated within the basic attribute-stack framework.

For a top-down parser with an L-attributed grammar, we have two principal options. The first option is automatic, but more complex than for bottom-up grammars. It still uses an attribute stack, but one that does not mirror the parse stack. The second option has lower space overhead, and saves time by “short-cutting” copy rules, but requires action routines to allocate and deallocate space for attributes explicitly.

In both families of parsers, it is common for some of the contextual information for action routines to be kept in global variables. The symbol table in particular is usually global. We can be sure that the table will always represent the current referencing environment, because we control the order in which action routines (including those that modify the environment at the beginnings and ends of scopes) are executed. In a pure attribute grammar we should need to pass symbol table information into and out of productions through inherited and synthesized attributes.

© IN MORE DEPTH

We consider attribute space management in more detail on the PLP CD. Using bottom-up and top-down grammars for arithmetic expressions, we illustrate automatic management for both bottom-up and top-down parsers, as well as the ad hoc option for top-down parsers.

$$\begin{aligned}
\text{program} &\longrightarrow \text{stmt_list } \$\$ \\
\text{stmt_list} &\longrightarrow \text{stmt_list decl} \mid \text{stmt_list stmt} \mid \epsilon \\
\text{decl} &\longrightarrow \text{int id} \mid \text{real id} \\
\text{stmt} &\longrightarrow \text{id} := \text{expr} \mid \text{read id} \mid \text{write expr} \\
\text{expr} &\longrightarrow \text{term} \mid \text{expr add_op term} \\
\text{term} &\longrightarrow \text{factor} \mid \text{term mult_op factor} \\
\text{factor} &\longrightarrow (\text{expr}) \mid \text{id} \mid \text{int_const} \mid \text{real_const} \mid \\
&\quad \text{float} (\text{expr}) \mid \text{trunc} (\text{expr}) \\
\text{add_op} &\longrightarrow + \mid - \\
\text{mult_op} &\longrightarrow * \mid /
\end{aligned}$$

Figure 4.11 Context-free grammar for a calculator language with types and declarations. The intent is that every identifier be declared before use, and that types not be mixed in computations.

4.6 Decorating a Syntax Tree

In our discussion so far we have used attribute grammars solely to decorate parse trees. As we mentioned in the chapter introduction, attribute grammars can also be used to decorate syntax trees. If our compiler uses action routines simply to build a syntax tree, then the bulk of semantic analysis and intermediate code generation will use the syntax tree as base.

Figure 4.11 contains a bottom-up CFG for a calculator language with types and declarations. The grammar differs from that of Example 2.37 (page 88) in three ways: (1) we allow declarations to be intermixed with statements, (2) we differentiate between integer and real constants (presumably the latter contain a decimal point), and (3) we require explicit conversions between integer and real operands. The intended semantics of our language requires that every identifier be declared before it is used, and that types not be mixed in computations. ■

Extrapolating from the example in Figure 4.5, it is easy to add semantic functions or action routines to the grammar of Figure 4.11 to construct a syntax tree for the calculator language (Exercise 4.21). The obvious structure for such a tree would represent expressions as we did in Figure 4.7, and would represent a program as a linked list of declarations and statements. As a concrete example, Figure 4.12 contains the syntax tree for a simple program to print the average of an integer and a real. ■

Much as a context-free grammar describes the possible structure of parse trees for a given programming language, we can use a *tree grammar* to represent the possible structure of syntax trees. As in a CFG, each production of a tree grammar represents a possible relationship between a parent and its children in the tree. The parent is the symbol on the left-hand side of the production; the children are

EXAMPLE 4.14

Bottom-up CFG for calculator language with types

EXAMPLE 4.15

Syntax tree to average an integer and a real

EXAMPLE 4.16

Tree grammar for the calculator language with types

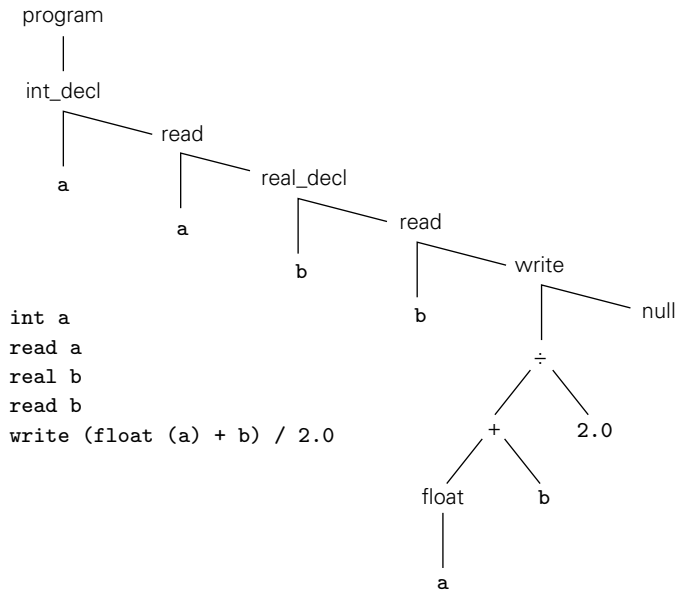

Figure 4.12 Syntax tree for a simple calculator program.

the symbols on the right-hand side. The productions used in Figure 4.12 might look something like the following.

$$\begin{aligned}
 \text{program} &\rightarrow \text{item} \\
 \text{int_decl} : \text{item} &\rightarrow \text{id item} \\
 \text{read} : \text{item} &\rightarrow \text{id item} \\
 \text{real_decl} : \text{item} &\rightarrow \text{id item} \\
 \text{write} : \text{item} &\rightarrow \text{expr item} \\
 \\
 \text{null} : \text{item} &\rightarrow \epsilon \\
 \text{'÷'} : \text{expr} &\rightarrow \text{expr expr} \\
 \text{'+'} : \text{expr} &\rightarrow \text{expr expr} \\
 \text{float} : \text{expr} &\rightarrow \text{expr} \\
 \text{id} : \text{expr} &\rightarrow \epsilon \\
 \text{real_const} : \text{expr} &\rightarrow \epsilon
 \end{aligned}$$

Here the notation $A : B$ on the left-hand side of a production means that A is one variant of B , and may appear anywhere a B is expected on a right-hand side. ■

Tree grammars and context-free grammars differ in important ways. A context-free grammar is meant to define (generate) a language composed of strings of tokens, where each string is the fringe (yield) of a parse tree. Parsing is the process of finding a tree that has a given yield. A tree grammar, as we use it here, is meant

Class of node	Variants	Attributes	
		Inherited	Synthesized
<i>program</i>	—	—	location, errors
<i>item</i>	<i>int_decl</i> , <i>real_decl</i> , <i>read</i> , <i>write</i> , <i>:=</i> , <i>null</i>	<i>symtab</i> , <i>errors_in</i>	location, <i>errors_out</i>
<i>expr</i>	<i>int_const</i> , <i>real_const</i> , <i>id</i> , <i>+</i> , <i>-</i> , <i>×</i> , <i>÷</i> , <i>float</i> , <i>trunc</i>	<i>symtab</i>	location, type, errors, name (<i>id</i> only)

Figure 4.13 Classes of nodes for the syntax tree attribute grammar of Figure 4.14. With the exception of name, all variants of a given class have all the class's attributes.

to define (or generate) the trees themselves. We have no need for a notion of parsing: we can easily inspect a tree and determine whether (and how) it can be generated by the grammar. Our purpose in introducing tree grammars is to provide a framework for the decoration of syntax trees. Semantic rules attached to the productions of a tree grammar can be used to define the attribute flow of a syntax tree in exactly the same way that semantic rules attached to the productions of a context-free grammar are used to define the attribute flow of a parse tree. We will use a tree grammar in the remainder of this section to perform static semantic checking. In Chapter 14 we will show how additional semantic rules can be used to generate intermediate code.

EXAMPLE 4.17

Tree AG for the calculator language with types

A complete tree attribute grammar for our calculator language with types can be constructed using the node classes, variants, and attributes shown in Figure 4.13. The grammar itself appears in Figure 4.14. Once decorated, the *program* node at the root of the syntax tree will contain a list, in a synthesized attribute, of all static semantic errors in the program. (The list will be empty if the program is free of such errors.) Each *item* or *expr* node has an inherited attribute *symtab* that contains a list, with types, of all identifiers declared to the left in the tree. Each *item* node also has an inherited attribute *errors_in* that lists all static semantic errors found to its left in the tree, and a synthesized attribute *errors_out* to propagate the final error list back to the root. Each *expr* node has one synthesized attribute that indicates its type and another that contains a list of any static semantic errors found inside.

Our handling of semantic errors illustrates a common technique. In order to continue looking for other errors we must provide values for any attributes that would have been set in the absence of an error. To avoid cascading error messages, we choose values for those attributes that will pass quietly through subsequent checks. In this specific case we employ a pseudotype called *error*, which we associate with any symbol table entry or expression for which we have already generated a message.

Though it takes a bit of checking to verify the fact, our attribute grammar is noncircular and well defined. No attribute is ever assigned a value more than once. (The helper routines at the end of Figure 4.14 should be thought of as macros,

```

program  $\longrightarrow$  item
  ▷ item.symtab := null
  ▷ program.errors := item.errors_out
  ▷ item.errors_in := null

int_decl : item1  $\longrightarrow$  id item2
  ▷ declare_name(id, item1, item2, int)
  ▷ item1.errors_out := item2.errors_out

real_decl : item1  $\longrightarrow$  id item2
  ▷ declare_name(id, item1, item2, real)
  ▷ item1.errors_out := item2.errors_out

read : item1  $\longrightarrow$  id item2
  ▷ item2.symtab := item1.symtab
  ▷ if  $\langle$ id.name, ? $\rangle \in$  item1.symtab
     item2.errors_in := item1.errors_in
  else
     item2.errors_in := item1.errors_in + [id.name “undefined at” id.location]
  ▷ item1.errors_out := item2.errors_out

write : item1  $\longrightarrow$  expr item2
  ▷ expr.symtab := item1.symtab
  ▷ item2.symtab := item1.symtab
  ▷ item2.errors_in := item1.errors_in + expr.errors
  ▷ item1.errors_out := item2.errors_out

‘:=’ : item1  $\longrightarrow$  id expr item2
  ▷ expr.symtab := item1.symtab
  ▷ item2.symtab := item1.symtab
  ▷ if  $\langle$ id.name, A $\rangle \in$  item1.symtab      -- for some type A
     if A  $\neq$  error and expr.type  $\neq$  error and A  $\neq$  expr.type
        item2.errors_in := item1.errors_in + [“type clash at” item1.location]
     else
        item2.errors_in := item1.errors_in + expr.errors
  else
     item2.errors_in := item1.errors_in + [id.name “undefined at” id.location] + expr.errors
  ▷ item1.errors_out := item2.errors_out

null : item  $\longrightarrow$   $\epsilon$ 
  ▷ item.errors_out := item.errors_in

```

Figure 4.14 Attribute grammar to decorate an abstract syntax tree for the calculator language with types. We use square brackets to delimit error messages and pointed brackets to delimit symbol table entries. Juxtaposition indicates concatenation within error messages; the ‘+’ and ‘-’ operators indicate insertion and removal in lists. We assume that every node has been initialized by the scanner or by action routines in the parser to contain an indication of the location (line and column) at which the corresponding construct appears in the source (see [Exercise 4.22](#)). The ‘?’ symbol is used as a “wild card”; it matches any type. (*continued*)

```

id : expr →  $\epsilon$ 
  ▷ if (id.name, A) ∈ expr.symtab           -- for some type A
     expr.errors := null
     expr.type := A
  else
     expr.errors := [id.name "undefined at" id.location]
     expr.type := error

int_const : expr →  $\epsilon$ 
  ▷ expr.type := int

real_const : expr →  $\epsilon$ 
  ▷ expr.type := real

‘+’ : expr1 → expr2 expr3
  ▷ expr2.symtab := expr1.symtab
  ▷ expr3.symtab := expr1.symtab
  ▷ check_types(expr1, expr2, expr3)

‘-’ : expr1 → expr2 expr3
  ▷ expr2.symtab := expr1.symtab
  ▷ expr3.symtab := expr1.symtab
  ▷ check_types(expr1, expr2, expr3)

‘×’ : expr1 → expr2 expr3
  ▷ expr2.symtab := expr1.symtab
  ▷ expr3.symtab := expr1.symtab
  ▷ check_types(expr1, expr2, expr3)

‘÷’ : expr1 → expr2 expr3
  ▷ expr2.symtab := expr1.symtab
  ▷ expr3.symtab := expr1.symtab
  ▷ check_types(expr1, expr2, expr3)

float : expr1 → expr2
  ▷ expr2.symtab := expr1.symtab
  ▷ convert_type(expr2, expr1, int, real, "float of non-int")

trunc : expr1 → expr2
  ▷ expr2.symtab := expr1.symtab
  ▷ convert_type(expr2, expr1, real, int, "trunc of non-real")

```

Figure 4.14 (continued on next page)

rather than semantic functions. For the sake of brevity we have passed them entire tree nodes as arguments. Each macro calculates the values of two different attributes. Under a strict formulation of attribute grammars each macro would be replaced by two separate semantic functions, one per calculated attribute.) ■

Figure 4.15 uses the grammar of Figure 4.14 to decorate the syntax tree of Figure 4.12. The pattern of attribute flow appears considerably messier than in previous examples in this chapter, but this is simply because type checking is more complicated than calculating constants or building a syntax tree. Symbol

EXAMPLE 4.18

Decorating a tree with the AG of Example 4.17

```

macro declare_name(id, cur_item, next_item : syntax_tree_node; t : type)
  if ⟨id.name, ?⟩ ∈ cur_item.symtab
    next_item.errors_in := cur_item.errors_in + ["redefinition of" id.name "at" cur_item.location]
    next_item.symtab := cur_item.symtab - ⟨id.name, ?⟩ + ⟨id.name, error⟩
  else
    next_item.errors_in := cur_item.errors_in
    next_item.symtab := cur_item.symtab + ⟨id.name, t⟩
macro check_types(result, operand1, operand2)
  if operand1.type = error or operand2.type = error
    result.type := error
    result.errors := operand1.errors + operand2.errors
  else if operand1.type ≠ operand2.type
    result.type := error
    result.errors := operand1.errors + operand2.errors + ["type clash at" result.location]
  else
    result.type := operand1.type
    result.errors := operand1.errors + operand2.errors
macro convert_type(old_expr, new_expr : syntax_tree_node; from_t, to_t : type; msg : string)
  if old_expr.type = from_t or old_expr.type = error
    new_expr.errors := old_expr.errors
    new_expr.type := to_t
  else
    new_expr.errors := old_expr.errors + [msg "at" old_expr.location]
    new_expr.type := error

```

Figure 4.14 (continued)

table information flows along the chain of *items* and down into *expr* trees. The *int_decl* and *real_decl* nodes add new information; other nodes simply pass the table along. Type information is synthesized at *id:expr* leaves by looking up an identifier's name in the symbol table. The information then propagates upward within an expression tree, and is used to type-check operators and assignments (the latter don't appear in this example). Error messages flow along the chain of *items* via the *errors_in* attributes, and then back to the root via the *errors_out* attributes. Messages also flow up out of *expr* trees. Whenever a type check is performed, the type attribute may be used to help create a new message to be appended to the growing message list. ■

In our example grammar we accumulate error messages into a synthesized attribute of the root of the syntax tree. In an ad hoc attribute evaluator we might be tempted to print these messages on the fly as the errors are discovered. In practice, however, particularly in a multipass compiler, it makes sense to buffer the messages, so they can be interleaved with messages produced by other phases of the compiler, and printed in program order at the end of compilation.

One could convert our attribute grammar into executable code using an automatic attribute evaluator generator. Alternatively, one could create an ad hoc evaluator in the form of mutually recursive subroutines (Exercise 4.20). In the

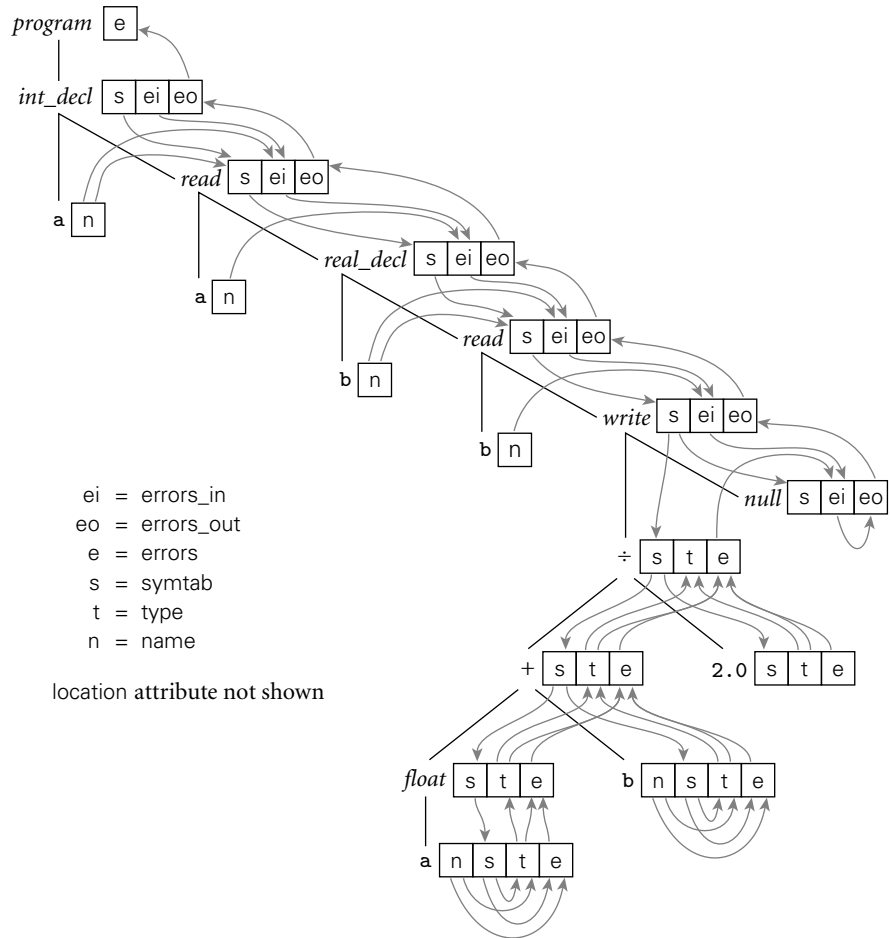

Figure 4.15 Decoration of the syntax tree of Figure 4.12, using the grammar of Figure 4.14. Location information, which we assume has been initialized in every node by the parser, contributes to error messages, but does not otherwise propagate through the tree.

latter case attribute flow would be explicit in the calling sequence of the routines. We could then choose if desired to keep the symbol table in global variables, rather than passing it from node to node through attributes. Most compilers employ the ad hoc approach.

✓ CHECK YOUR UNDERSTANDING

10. What is the difference between a semantic function and an action routine?
11. Why can't action routines be placed at arbitrary locations within the right-hand side of productions in an LR CFG?

12. What patterns of attribute flow can be captured easily with action routines?
13. Some compilers perform all semantic checks and intermediate code generation in action routines. Others use action routines to build a syntax tree and then perform semantic checks and intermediate code generation in separate traversals of the syntax tree. Discuss the tradeoffs between these two strategies.
14. What sort of information do action routines typically keep in global variables, rather than in attributes?
15. Describe the similarities and differences between context-free grammars and tree grammars.
16. How can a semantic analyzer avoid the generation of cascading error messages?

4.7 Summary and Concluding Remarks

This chapter has discussed the task of semantic analysis. We reviewed the sorts of language rules that can be classified as syntax, static semantics, and dynamic semantics, and discussed the issue of whether to generate code to perform dynamic semantic checks. We also considered the role that the semantic analyzer plays in a typical compiler. We noted that both the enforcement of static semantic rules and the generation of intermediate code can be cast in terms of annotation, or *decoration*, of a parse tree or syntax tree. We then presented attribute grammars as a formal framework for this decoration process.

An attribute grammar associates *attributes* with each symbol in a context-free grammar or tree grammar, and *attribute rules* with each production. *Synthesized* attributes are calculated only in productions in which their symbol appears on the left-hand side. The synthesized attributes of tokens are initialized by the scanner. *Inherited* attributes are calculated in productions in which their symbol appears within the right-hand side; they allow calculations internal to a symbol to depend on the context in which the symbol appears. Inherited attributes of the start symbol (goal) can represent the external environment of the compiler. Strictly speaking, attribute grammars allow only *copy rules* (assignments of one attribute to another) and simple calls to *semantic functions*, but we usually relax this restriction to allow more-or-less arbitrary code fragments in some existing programming language.

Just as context-free grammars can be categorized according to the parsing algorithm(s) that can use them, attribute grammars can be categorized according to the complexity of their pattern of *attribute flow*. S-attributed grammars, in which all attributes are synthesized, can naturally be evaluated in a single bottom-up pass over a parse tree, in precisely the order the tree is discovered by an LR-family parser. L-attributed grammars, in which all attribute flow is depth-first left-to-right, can be evaluated in precisely the order that the parse tree is predicted and matched by an LL-family parser. Attribute grammars with more complex patterns of attribute flow are not commonly used in production compilers, but

are valuable for syntax-based editors, incremental compilers, and various other tools.

While it is possible to construct automatic tools to analyze attribute flow and decorate parse trees, most compilers rely on *action routines*, which the compiler writer embeds in the right-hand sides of productions to evaluate attribute rules at specific points in a parse. In an LL-family parser, action routines can be embedded at arbitrary points in a production's right-hand side. In an LR-family parser, action routines must follow the production's *left corner*. Space for attributes in a bottom-up compiler is naturally allocated in parallel with the parse stack, but this complicates the management of inherited attributes. Space for attributes in a top-down compiler can be allocated automatically, or managed explicitly by the writer of action routines. The automatic approach has the advantage of regularity, and is easier to maintain; the ad hoc approach is slightly faster and more flexible.

In a *one-pass* compiler, which interleaves scanning, parsing, semantic analysis, and code generation in a single traversal of its input, semantic functions or action routines are responsible for all of semantic analysis and code generation. More commonly, action routines simply build a syntax tree, which is then decorated during separate traversal(s) in subsequent pass(es).

In subsequent chapters (6–9 in particular) we will consider a wide variety of programming language constructs. Rather than present the actual attribute grammars required to implement these constructs, we will describe their semantics informally, and give examples of the target code. We will return to attribute grammars in [Chapter 14](#), when we consider the generation of intermediate code in more detail.

4.8 Exercises

- 4.1 Basic results from automata theory tell us that the language $L = a^n b^n c^n = \epsilon, abc, aabbcc, aaabbbccc, \dots$ is not context free. It can be captured, however, using an attribute grammar. Give an underlying CFG and a set of attribute rules that associates a Boolean attribute `ok` with the root `R` of each parse tree, such that `R.ok = true` if and only if the string corresponding to the fringe of the tree is in L .
- 4.2 Modify the grammar of [Figure 2.24](#) so that it accepts only programs that contain at least one `write` statement. Make the same change in the solution to [Exercise 2.17](#). Based on your experience, what do you think of the idea of using the CFG to enforce the rule that every function in C must contain at least one `return` statement?
- 4.3 Give two examples of reasonable semantic rules that *cannot* be checked at reasonable cost, either statically or by compiler-generated code at run time.
- 4.4 Write an S-attributed attribute grammar, based on the CFG of [Example 4.7](#), that accumulates the value of the overall expression into the root of the tree. You will need to use dynamic memory allocation so that individual attributes can hold an arbitrary amount of information.

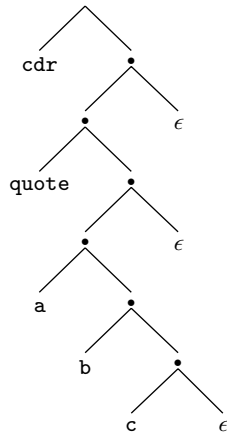

Figure 4.16 Natural syntax tree for the Lisp expression `(cdr '(a b c))`.

- 4.5 As we shall learn in Chapter 10, Lisp programs take the form of parenthesized lists. The natural syntax tree for a Lisp program is thus a tree of binary cells (known in Lisp as *cons* cells), where the first child represents the first element of the list and the second child represents the rest of the list. The syntax tree for `(cdr '(a b c))` appears in Figure 4.16. (The notation `'L` is syntactic sugar for `(quote L)`.)

Extend the CFG of Exercise 2.18 to create an attribute grammar that will build such trees. When a parse tree has been fully decorated, the root should have an attribute v that refers to the syntax tree. You may assume that each atom has a synthesized attribute v that refers to a syntax tree node that holds information from the scanner. In your semantic functions, you may assume the availability of a `cons` function that takes two references as arguments and returns a reference to a new `cons` cell containing those references.

- 4.6 Refer back to the context-free grammar of Exercise 2.13 (page 105). Add attribute rules to the grammar to accumulate into the root of the tree a count of the maximum depth to which parentheses are nested in the program string. For example, given the string `f1(a, f2(b * (c + (d - (e - f))))))`, the *stmt* at the root of the tree should have an attribute with a count of 3 (the parentheses surrounding argument lists don't count).
- 4.7 Suppose that we want to translate constant expressions into the postfix, or “reverse Polish” notation of logician Jan Lukasiewicz. Postfix notation does not require parentheses. It appears in stack-based languages such as Postscript, Forth, and the P-code and Java byte code intermediate forms mentioned in Section 1.4. It also serves as the input language of certain Hewlett-Packard (HP) brand calculators. When given a number, an HP

calculator pushes it onto an internal stack. When given an operator, it pops the top two numbers, applies the operator, and pushes the result. The display shows the value at the top of the stack. To compute $2 \times (5 - 3) / 4$ one would enter 2 5 3 - * 4 /.

Using the underlying CFG of Figure 4.1, write an attribute grammar that will associate with the root of the parse tree a sequence of calculator button pushes, *seq*, that will compute the arithmetic value of the tokens derived from that symbol. You may assume the existence of a function *buttons*(*c*) that returns a sequence of button pushes (ending with ENTER on an HP calculator) for the constant *c*. You may also assume the existence of a concatenation function for sequences of button pushes.

- 4.8 Repeat the previous exercise using the underlying CFG of Figure 4.3.
 4.9 Consider the following grammar for reverse Polish arithmetic expressions:

$$E \longrightarrow E E \text{ op} \mid \text{id}$$

$$\text{op} \longrightarrow + \mid - \mid * \mid /$$

Assuming that each *id* has a synthesized attribute *name* of type string, and that each *E* and *op* has an attribute *val* of type string, write an attribute grammar that arranges for the *val* attribute of the root of the parse tree to contain a translation of the expression into conventional infix notation. For example, if the leaves of the tree, left to right, were “A A B - * C /,” then the *val* field of the root would be “((A * (A - B)) / C).” As an extra challenge, write a version of your attribute grammar that exploits the usual arithmetic precedence and associativity rules to use as few parentheses as possible.

- 4.10 To reduce the likelihood of typographic errors, the digits comprising most credit card numbers are designed to satisfy the so-called *Luhn formula*, standardized by ANSI in the 1960s, and named for IBM mathematician Hans Peter Luhn. Starting at the right, we double every other digit (the second-to-last, fourth-to-last, etc.). If the doubled value is 10 or more, we add the resulting digits. We then sum together all the digits. In any valid number the result will be a multiple of 10. For example, 1234 5678 9012 3456 becomes 2264 1658 9022 6416, which sums to 64, so this is not a valid number. If the last digit had been 2, however, the sum would have been 60, so the number would potentially be valid.

Give an attribute grammar for strings of digits that accumulates into the root of the parse tree a Boolean value indicating whether the string is valid according to Luhn’s formula. Your grammar should accommodate strings of arbitrary length.

- 4.11 Consider the following CFG for floating-point constants, without exponential notation. (Note that this exercise is somewhat artificial: the language in question is regular, and would be handled by the scanner of a typical compiler.)

$$\begin{aligned}
C &\longrightarrow \text{digits} \cdot \text{digits} \\
\text{digits} &\longrightarrow \text{digit} \text{ more_digits} \\
\text{more_digits} &\longrightarrow \text{digits} \mid \epsilon \\
\text{digit} &\longrightarrow 0 \mid 1 \mid 2 \mid 3 \mid 4 \mid 5 \mid 6 \mid 7 \mid 8 \mid 9
\end{aligned}$$

Augment this grammar with attribute rules that will accumulate the value of the constant into a `val` attribute of the root of the parse tree. Your answer should be S-attributed.

- 4.12 One potential criticism of the obvious solution to the previous problem is that the values in internal nodes of the parse tree do not reflect the value, in context, of the fringe below them. Create an alternative solution that addresses this criticism. More specifically, create your grammar in such a way that the `val` of an internal node is the sum of the `vals` of its children. Illustrate your solution by drawing the parse tree and attribute flow for 12.34. (Hint: you will probably want a different underlying CFG, and non-L-attributed flow.)
- 4.13 Consider the following attribute grammar for type declarations, based on the CFG of [Exercise 2.11](#):

$$\begin{aligned}
\text{decl} &\longrightarrow \text{ID} \text{ decl_tail} \\
&\triangleright \text{decl.t} := \text{decl.tail.t} \\
&\triangleright \text{decl.tail.in_tab} := \text{insert}(\text{decl.in_tab}, \text{ID.n}, \text{decl.tail.t}) \\
&\triangleright \text{decl.out_tab} := \text{decl.tail.out_tab} \\
\text{decl_tail} &\longrightarrow \text{, decl} \\
&\triangleright \text{decl_tail.t} := \text{decl.t} \\
&\triangleright \text{decl.in_tab} := \text{decl.tail.in_tab} \\
&\triangleright \text{decl.tail.out_tab} := \text{decl.out_tab} \\
\text{decl_tail} &\longrightarrow \text{: ID ;} \\
&\triangleright \text{decl.tail.t} := \text{ID.n} \\
&\triangleright \text{decl.tail.out_tab} := \text{decl.tail.in_tab}
\end{aligned}$$

Show a parse tree for the string `A, B : C;`. Then, using arrows and textual description, specify the attribute flow required to fully decorate the tree. (Hint: note that the grammar is *not* L-attributed.)

- 4.14 A CFG-based attribute evaluator capable of handling non-L-attributed attribute flow needs to take a parse tree as input. Explain how to build a parse tree automatically during a top-down or bottom-up parse (i.e., without explicit action routines).
- 4.15 Building on [Example 4.13](#), modify the remainder of the recursive descent parser of [Figure 2.16](#) to build syntax trees for programs in the calculator language.
- 4.16 Write an LL(1) grammar with action routines and automatic attribute space management that generates the reverse Polish translation described in [Exercise 4.7](#).

- 4.17 (a) Write a context-free grammar for polynomials in x . Add semantic functions to produce an attribute grammar that will accumulate the polynomial's derivative (as a string) in a synthesized attribute of the root of the parse tree.
- (b) Replace your semantic functions with action routines that can be evaluated during parsing.
- 4.18 (a) Write a context-free grammar for `case` or `switch` statements in the style of Pascal or C. Add semantic functions to ensure that the same label does not appear on two different arms of the construct.
- (b) Replace your semantic functions with action routines that can be evaluated during parsing.
- 4.19 Write an algorithm to determine whether the rules of an arbitrary attribute grammar are noncircular. (Your algorithm will require exponential time in the worst case [JOR75].)
- 4.20 Rewrite the attribute grammar of Figure 4.14 in the form of an ad hoc tree traversal consisting of mutually recursive subroutines in your favorite programming language. Keep the symbol table in a global variable, rather than passing it through arguments.
- 4.21 Write an attribute grammar based on the CFG of Figure 4.11 that will build a syntax tree with the structure described in Figure 4.14.
- 4.22 Augment the attribute grammar of Figure 4.5, Figure 4.6, or Exercise 4.21 to initialize a synthesized attribute in every syntax tree node that indicates the location (line and column) at which the corresponding construct appears in the source program. You may assume that the scanner initializes the location of every token.
- 4.23 Modify the CFG and attribute grammar of Figures 4.11 and 4.14 to permit mixed integer and real expressions, without the need for `float` and `trunc`. You will want to add an annotation to any node that must be coerced to the opposite type, so that the code generator will know to generate code to do so. Be sure to think carefully about your coercion rules. In the expression `my_int + my_real`, for example, how will you know whether to coerce the integer to be a real, or to coerce the real to be an integer?
- 4.24 Explain the need for the $A : B$ notation on the left-hand sides of productions in a tree grammar. Why isn't similar notation required for context-free grammars?
- © 4.25–4.29 In More Depth.

4.9 Explorations

- 4.30 One of the most influential applications of attribute grammars was the Cornell Synthesizer Generator [Rep84, RT88]. Learn how the Generator

used attribute grammars not only for incremental update of semantic information in a program under edit, but also for automatic creation of language based editors from formal language specifications. How general is this technique? What applications might it have beyond syntax-directed editing of computer programs?

- 4.31 The attribute grammars used in this chapter are all quite simple. Most are S- or L-attributed. All are noncircular. Are there any practical uses for more complex attribute grammars? How about automatic attribute evaluators? Using the Bibliographic Notes as a starting point, conduct a survey of attribute evaluation techniques. Where is the line between practical techniques and intellectual curiosities?
- 4.32 The first validated Ada implementation was the Ada/Ed interpreter from New York University [DGAFS⁺80]. The interpreter was written in the set-based language SETL [SDDS86] using a denotational semantics definition of Ada. Learn about the Ada/Ed project, SETL, and denotational semantics. Discuss how the use of a formal definition aided the development process. Also discuss the limitations of Ada/Ed, and expand on the potential role of formal semantics in language design, development, and prototype implementation.
- 4.33 Version 5 of the Scheme language manual [ADH⁺98] included a formal definition of Scheme in denotational semantics. How long is this definition, compared to the more conventional definition in English? How readable is it? What do the length and the level of readability say about Scheme? About denotational semantics? (For more on denotational semantics, see the texts of Stoy [Sto77] or Gordon [Gor79].)
Version 6 of the manual [SDF⁺07] switched to operational semantics. How does this compare to the denotational version? Why do you suppose the standards committee made the change? (For more information, see the paper by Matthews and Findler [MF08].)

© 4.34–4.35 In More Depth.

4.10 Bibliographic Notes

Much of the early theory of attribute grammars was developed by Knuth [Knu68]. Lewis, Rosenkrantz, and Stearns [LRS74] introduced the notion of an L-attributed grammar. Watt [Wat77] showed how to use marker symbols to emulate inherited attributes in a bottom-up parser. Jazayeri, Ogden, and Rounds [JOR75] showed that exponential time may be required in the worst case to decorate a parse tree with arbitrary attribute flow. Articles by Courcelle [Cou84] and Engelfriet [Eng84] survey the theory and practice of attribute evaluation. The best-known attribute grammar system for language-based editing is the Synthesizer Generator [RT88] (a follow-on to the language-specific Cornell Program Synthesizer [TR81]) of

Reps and Teitelbaum. Magpie [SDB84] is an incremental compiler. Action routines to implement many language features can be found in the texts of Fischer and LeBlanc [FL88] or Appel [App97]. Further notes on attribute grammars can be found in the texts of Cooper and Torczon [CT04, pp. 171–188] or Aho et al. [ALSU07, Chap. 5].

Marcotty, Ledgard, and Bochmann [MLB76] provide a survey of formal notations for programming language semantics. The seminal paper on axiomatic semantics is by Hoare [Hoa69]. An excellent book on the subject is Gries's *The Science of Programming* [Gri81]. The seminal paper on denotational semantics is by Scott and Strachey [SS71]. Texts on the subject include those of Stoy [Sto77] and Gordon [Gor79].

This page intentionally left blank

Target Machine Architecture

5

As described in Chapter 1, a compiler is simply a translator. It translates programs written in one language into programs written in another language. This second language can be almost anything—some other high-level language, phototypesetting commands, VLSI (chip) layouts—but most of the time it's the machine language for some available computer.

Just as there are many different programming languages, there are many different machine languages, though the latter tend to display considerably less diversity than the former. Each machine language corresponds to a different *processor architecture*. Formally, an architecture is the interface between the hardware and the software, that is, the language generated by a compiler, or by a programmer writing for the bare machine. The *implementation* of the processor is a concrete realization of the architecture, generally in hardware. To generate correct code, it suffices for a compiler writer to understand the target architecture. To generate *fast* code, it is generally necessary to understand the implementation as well, because it is the implementation that determines the relative speeds of alternative translations of a given language construct.

© IN MORE DEPTH

Chapter 5 can be found in its entirety on the PLP CD. It provides a brief overview of those aspects of processor architecture and implementation of particular importance to compiler writers, and may be worth reviewing even by readers who have seen the material before. Principal topics include data representation, instruction set architecture, the evolution of implementation techniques, and the challenges of compiling for modern processors. Examples are drawn largely from the x86, a legacy CISC (complex instruction set) architecture that dominates the desktop/laptop market, and the MIPS, a more modern RISC (reduced instruction set) design used widely for embedded systems.

DESIGN & IMPLEMENTATION**Pseudo-assembly notation**

At various times throughout the remainder of this book, we will need to consider sequences of machine instructions corresponding to some high-level language construct. Rather than present these sequences in the assembly language of some particular processor architecture, we will (in most cases) rely on a simple notation designed to represent a generic RISC machine. The following is a brief example that sums the elements of an n -element floating-point vector, V , and places the results in s .

```

r1 = &V
r2 := n
f1 := 0
goto L2
L1: f2 := *r1      -- load
    f1 += f2
    r1 += 8       -- floating-point numbers are 8 bytes long
    r2 -= 1
L2: if r2 > 0 goto L1
    s := f1

```

The notation should in most cases be self-explanatory. It uses “assignment statements” and operators reminiscent of high-level languages, but each line of code corresponds to a single machine instruction, and registers are named explicitly (the names of integer registers begin with ‘ r ’; those of floating-point registers begin with ‘ f ’). Control flow is based entirely on *gotos* and subroutine calls (not shown). Conditional tests assume that the hardware can perform a comparison and branch in a single instruction, where the comparison tests the contents of a register against a small constant or the contents of another register.

Main memory in our notation can be accessed only by load and store instructions, which look like assignments to or from a register, with no arithmetic. We do, however, assume the availability of *displacement addressing*, which allows us to access memory at some constant offset from the address held in a register. For example, to store register $r1$ to a local variable at an offset of 12 bytes from the frame pointer (fp) register, we could say $*(fp-12) := r1$.

This page intentionally left blank



Core Issues in Language Design

Having laid the foundation in Part I, we now turn to issues that lie at the core of most programming languages: control flow, data types, and abstractions of both control and data.

[Chapter 6](#) considers *control flow*, including expression evaluation, sequencing, selection, iteration, and recursion. In many cases we will see design decisions that reflect the sometimes complementary but often competing goals of conceptual clarity and efficient implementation. Several issues, including the distinction between references and values and between applicative (eager) and lazy evaluation will recur in later chapters.

[Chapter 7](#), the longest in the book, considers the subject of *types*. It begins with *type systems* and *type checking*, including the notions of equivalence, compatibility, and inference of types. It then presents a survey of high-level *type constructors*, including records and variants, arrays, strings, sets, pointers, lists, and files. The section on pointers includes an introduction to garbage collection techniques.

Both control and data are amenable to *abstraction*, the process whereby complexity is hidden behind a simple and well-defined interface. *Control abstraction* is the subject of [Chapter 8](#). *Subroutines* are the most common control abstraction, but we also consider exceptions and coroutines, and return briefly to the subjects of continuations and iterators, introduced in [Chapter 6](#). The coverage of subroutines includes calling sequences, parameter-passing mechanisms, and *generics*, which support parameterization over types.

[Chapter 9](#) returns to the subject of *data abstraction*, introduced in [Chapter 3](#). In many modern languages this subject takes the form of *object orientation*, characterized by an encapsulation mechanism, inheritance, and dynamic method dispatch (subtype polymorphism). Our coverage of object-oriented languages will also touch on constructors, access control, polymorphism, closures, and multiple and mix-in inheritance.

This page intentionally left blank

6 Control Flow

Having considered the mechanisms that a compiler uses to enforce semantic rules (Chapter 4) and the characteristics of the target machines for which compilers must generate code (Chapter 5), we now return to core issues in language design. Specifically, we turn in this chapter to the issue of *control flow* or *ordering* in program execution. Ordering is fundamental to most (though not all) models of computing. It determines what should be done first, what second, and so forth, to accomplish some desired task. We can organize the language mechanisms used to specify ordering into eight principal categories:

1. *Sequencing*: Statements are to be executed (or expressions evaluated) in a certain specified order—usually the order in which they appear in the program text.
2. *Selection*: Depending on some run-time condition, a *choice* is to be made among two or more statements or expressions. The most common selection constructs are *if* and *case* (*switch*) statements. Selection is also sometimes referred to as *alternation*.
3. *Iteration*: A given fragment of code is to be executed repeatedly, either a certain number of times, or until a certain run-time condition is true. Iteration constructs include *for/do*, *while*, and *repeat* loops.
4. *Procedural abstraction*: A potentially complex collection of control constructs (a *subroutine*) is encapsulated in a way that allows it to be treated as a single unit, usually subject to parameterization.
5. *Recursion*: An expression is defined in terms of (simpler versions of) itself, either directly or indirectly; the computational model requires a stack on which to save information about partially evaluated instances of the expression. Recursion is usually defined by means of self-referential subroutines.
6. *Concurrency*: Two or more program fragments are to be executed/evaluated “at the same time,” either in parallel on separate processors, or interleaved on a single processor in a way that achieves the same effect.
7. *Exception handling* and *speculation*: A program fragment is executed optimistically, on the assumption that some expected condition will be true. If that

condition turns out to be false, execution branches to a handler that executes in place of the remainder of the protected fragment (in the case of exception handling), or in place of the *entire* protected fragment (in the case of speculation). For speculation, the language implementation must be able to undo, or “roll back,” any visible effects of the protected code.

8. *Nondeterminacy*: The ordering or choice among statements or expressions is deliberately left unspecified, implying that any alternative will lead to correct results. Some languages require the choice to be random, or fair, in some formal sense of the word.

Though the syntactic and semantic details vary from language to language, these eight principal categories cover all of the control-flow constructs and mechanisms found in most programming languages. A programmer who thinks in terms of these categories, rather than the syntax of some particular language, will find it easy to learn new languages, evaluate the tradeoffs among languages, and design and reason about algorithms in a language-independent way.

Subroutines are the subject of [Chapter 8](#). Concurrency is the subject of [Chapter 12](#). Exception handling and speculation are discussed in those chapters as well, in [Sections 8.5](#) and [12.4.4](#). The bulk of the current chapter ([Sections 6.3 through 6.7](#)) is devoted to the five remaining categories. We begin in [Section 6.1](#) by examining expression evaluation. We consider the syntactic form of expressions, the precedence and associativity of operators, the order of evaluation of operands, and the semantics of the assignment statement. We focus in particular on the distinction between variables that hold a *value* and variables that hold a *reference to a value*; this distinction will play an important role many times in future chapters. In [Section 6.2](#) we consider the difference between *structured* and *unstructured* (goto-based) control flow.

The relative importance of different categories of control flow varies significantly among the different classes of programming languages. Sequencing is central to imperative (von Neumann and object-oriented) languages, but plays a relatively minor role in functional languages, which emphasize the evaluation of expressions, de-emphasizing or eliminating statements (e.g., assignments) that affect program output in any way other than through the return of a value. Similarly, functional languages make heavy use of recursion, while imperative languages tend to emphasize iteration. Logic languages tend to de-emphasize or hide the issue of control flow entirely: The programmer simply specifies a set of inference rules; the language implementation must find an order in which to apply those rules that will allow it to deduce values that satisfy some desired property.

6.1 Expression Evaluation

An expression generally consists of either a simple object (e.g., a literal constant, or a named variable or constant) or an *operator* or function applied to a collection of operands or arguments, each of which in turn is an expression. It is conventional

EXAMPLE 6.1

A typical function call

to use the term *operator* for built-in functions that use special, simple syntax, and to use the term *operand* for an argument of an operator. In most imperative languages, function calls consist of a function name followed by a parenthesized, comma-separated list of arguments, as in

```
my_func(A, B, C)
```

EXAMPLE 6.2

Typical operators

Operators are typically simpler, taking only one or two arguments, and dispensing with the parentheses and commas:

```
a + b
- c
```

As we saw in [Section 3.5.2](#), some languages define their operators as *syntactic sugar* for more “normal”-looking functions. In Ada, for example, `a + b` is short for `+(a, b)`; in C++, `a + b` is short for `a.operator+(b)`.

In general, a language may specify that function calls (operator invocations) employ prefix, infix, or postfix notation. These terms indicate, respectively, whether the function name appears before, among, or after its several arguments:

```
prefix:  op a b    or   op(a, b)    or   (op a b)
infix:   a op b
postfix: a b op
```

Most imperative languages use infix notation for binary operators and prefix notation for unary operators and (with parentheses around the arguments) other functions. Lisp uses prefix notation for all functions, but with the third of the variants above: in what is known as *Cambridge Polish*¹ notation, it places the function name *inside* the parentheses:

```
(* (+ 1 3) 2)           ; that would be (1 + 3) * 2 in infix
(append a b c my_list)
```

EXAMPLE 6.3

Cambridge Polish (prefix) notation

EXAMPLE 6.4

Mixfix notation in Smalltalk

A few languages, notably ML and the R scripting language, allow the user to create new infix operators. Smalltalk uses infix notation for *all* functions (which it calls messages), both built-in and user-defined. The following Smalltalk statement sends a “displayOn: at:” message to graphical object `myBox`, with arguments `myScreen` and `100@50` (a pixel location). It corresponds to what other languages would call the invocation of the “displayOn: at:” function with arguments `myBox`, `myScreen`, and `100@50`.

```
myBox displayOn: myScreen at: 100@50
```

¹ Prefix notation was popularized by Polish logicians of the early 20th century; Lisp-like parenthesized syntax was first employed (for noncomputational purposes) by philosopher W. V. Quine of Harvard University (Cambridge, MA).

EXAMPLE 6.5

Conditional expressions

This sort of multiword infix notation occurs occasionally in other languages as well.² In Algol one can say

```
a := if b <> 0 then a/b else 0;
```

Here “if ... then ... else” is a three-operand infix operator. The equivalent operator in C is written “... ? ... : ...”:

```
a = b != 0 ? a/b : 0; ■
```

Postfix notation is used for most functions in Postscript, Forth, the input language of certain hand-held calculators, and the intermediate code of some compilers. Postfix appears in a few places in other languages as well. Examples include the pointer dereferencing operator (^) of Pascal and the post-increment and decrement operators (++ and --) of C and its descendants.

6.1.1 Precedence and Associativity

Most languages provide a rich set of built-in arithmetic and logical operators. When written in infix notation, without parentheses, these operators lead to ambiguity as to what is an operand of what. In Fortran, for example, which uses ** for exponentiation, how should we parse $a + b * c^{**d} ** e / f$? Should this be grouped as

```
((((a + b) * c)**d)**e)/f
```

or

```
a + (((b * c)**d)**(e/f))
```

or

```
a + ((b * (c**(d**e)))/f)
```

or yet some other option? (In Fortran, the answer is the last of the options shown.) ■

In any given language, the choice among alternative evaluation orders depends on the *precedence* and *associativity* of operators, concepts we introduced in [Section 2.1.3](#). Issues of precedence and associativity do not arise in prefix or postfix notation.

Precedence rules specify that certain operators, in the absence of parentheses, group “more tightly” than other operators. In most languages multiplication and division group more tightly than addition and subtraction, so $2 + 3 \times 4$ is 14 and not 20. Details vary widely from one language to another, however. [Figure 6.1](#) shows the levels of precedence for several well-known languages. ■

EXAMPLE 6.6

A complicated Fortran expression

EXAMPLE 6.7

Precedence in four influential languages

² Most authors use the term “infix” only for binary operators. Multiword operators may be called “mixfix,” or left unnamed.

Fortran	Pascal	C	Ada
		++, -- (post-inc., dec.)	
**	not	++, -- (pre-inc., dec.), +, - (unary), &, * (address, contents of), !, ~ (logical, bit-wise not)	abs (absolute value), not, **
*, /	*, /, div, mod, and	* (binary), /, % (modulo division)	*, /, mod, rem
+, - (unary and binary)	+, - (unary and binary), or	+, - (binary)	+, - (unary)
		<<, >> (left and right bit shift)	+, - (binary), & (concatenation)
.eq., .ne., .lt., .le., .gt., .ge. (comparisons)	<, <=, >, >=, =, <>, IN	<, <=, >, >= (inequality tests)	=, /=, <, <=, >, >=
.not.		==, != (equality tests)	
		& (bit-wise and)	
		^ (bit-wise exclusive or)	
		(bit-wise inclusive or)	
.and.		&& (logical and)	and, or, xor (logical operators)
.or.		(logical or)	
.eqv., .neqv. (logical comparisons)		?: (if... then... else)	
		=, +=, -=, *=, /=, %= >>=, <<=, &=, ^=, = (assignment)	
		, (sequencing)	

Figure 6.1 Operator precedence levels in Fortran, Pascal, C, and Ada. The operators at the top of the figure group most tightly.

The precedence structure of C (and, with minor variations, of its descendants, C++, Java, and C#) is substantially richer than that of most other languages. It is, in fact, richer than shown in [Figure 6.1](#), because several additional constructs, including type casts, function calls, array subscripting, and record field selection, are classified as operators in C. It is probably fair to say that most C programmers do not remember all of their language's precedence levels.

The intent of the language designers was presumably to ensure that “the right thing” will usually happen when parentheses are not used to force a particular evaluation order. Rather than count on this, however, the wise programmer will consult the manual or add parentheses.

EXAMPLE 6.8

A “gotcha” in Pascal precedence

It is also probably fair to say that the relatively flat precedence hierarchy of Pascal is a mistake. In particular, novice Pascal programmers frequently write conditions like

```
if A < B and C < D then (* ouch *)
```

Unless A, B, C, and D are all of type Boolean, which is unlikely, this code will result in a static semantic error, since the rules of precedence cause it to group as $A < (B \text{ and } C) < D$. (And even if all four operands are of type Boolean, the result is almost certain to be something other than what the programmer intended.) Most languages avoid this problem by giving arithmetic operators higher precedence than relational (comparison) operators, which in turn have higher precedence than the logical operators. Notable exceptions include APL and Smalltalk, in which all operators are of equal precedence; parentheses *must* be used to specify grouping. ■

EXAMPLE 6.9

Common rules for associativity

Associativity rules specify whether sequences of operators of equal precedence group to the right or to the left. Conventions here are somewhat more uniform across languages, but still display some variety. The basic arithmetic operators almost always associate left-to-right, so $9 - 3 - 2$ is 4 and not 8. In Fortran, as noted above, the exponentiation operator (******) follows standard mathematical convention, and associates right-to-left, so $4**3**2$ is 262144 and not 4096. In Ada, exponentiation does not associate: one must write either $(4**3)**2$ or $4**(3**2)$; the language syntax does not allow the unparenthesized form. In languages that allow assignments inside expressions (an option we will consider more in [Section 6.1.2](#)), assignment associates right-to-left. Thus in C, $a = b = a + c$ assigns $a + c$ into b and then assigns the same value into a . ■

Because the rules for precedence and associativity vary so much from one language to another, a programmer who works in several languages is wise to make liberal use of parentheses.

6.1.2 Assignments

In a purely functional language, expressions are the building blocks of programs, and computation consists entirely of expression evaluation. The effect of any individual expression on the overall computation is limited to the value that expression provides to its surrounding context. Complex computations employ recursion to generate a potentially unbounded number of values, expressions, and contexts.

In an imperative language, by contrast, computation typically consists of an ordered series of changes to the values of variables in memory. Assignments

provide the principal means by which to make the changes. Each assignment takes a pair of arguments: a value and a reference to a variable into which the value should be placed.

In general, a programming language construct is said to have a *side effect* if it influences subsequent computation (and ultimately program output) in any way other than by returning a value for use in the surrounding context. Assignment is perhaps the most fundamental side effect: while the evaluation of an assignment may sometimes yield a value, what we really care about is the fact that it changes the value of a variable, thereby influencing the result of any later computation in which the variable appears.

Many (though not all) imperative languages distinguish between *expressions*, which always produce a value, and may or may not have side effects, and *statements*, which are executed *solely* for their side effects, and return no useful value. Given the centrality of assignment, imperative programming is sometimes described as “computing by means of side effects.”

At the opposite extreme, purely functional languages have no side effects. As a result, the value of an expression in such a language depends only on the referencing environment in which the expression is evaluated, *not* on the time at which the evaluation occurs. If an expression yields a certain value at one point in time, it is guaranteed to yield the same value at any point in time. In fancier terms, expressions in a purely functional language are said to be *referentially transparent*.

Haskell and Miranda are purely functional. Many other languages are mixed: ML and Lisp are mostly functional, but make assignment available to programmers who want it. C#, Python, and Ruby are mostly imperative, but provide a variety of features (first-class functions, polymorphism, functional values and aggregates, garbage collection, unlimited extent) that allow them to be used in a largely functional style. (We will return to functional programming, and the features it requires, in several future sections, including 6.2.2, 6.6, 7.1.2, 7.7.3, 7.8, and all of [Chapter 10](#).)

References and Values

On the surface, assignment appears to be a very straightforward operation. Below the surface, however, there are some subtle but important differences in the semantics of assignment in different imperative languages. These differences are often invisible, because they do not affect the behavior of simple programs. They have a major impact, however, on programs that use pointers, and will be explored in further detail in [Section 7.7](#). We provide an introduction to the issues here.

Consider the following assignments in C:

```
d = a;  
a = b + c;
```

In the first statement, the right-hand side of the assignment refers to the *value* of *a*, which we wish to place into *d*. In the second statement, the left-hand side

EXAMPLE 6.10

L-values and r-values

refers to the *location* of `a`, where we want to put the sum of `b` and `c`. Both interpretations—value and location—are possible because a variable in C (and in Pascal, Ada, and many other languages) is a named container for a value. We sometimes say that languages like C use a *value model* of variables. Because of their use on the left-hand side of assignment statements, expressions that denote locations are referred to as *l-values*. Expressions that denote values (possibly the value stored in a location) are referred to as *r-values*. Under a value model of variables, a given expression can be either an l-value or an r-value, depending on the context in which it appears. ■

EXAMPLE 6.11

L-values in C

Of course, not all expressions can be l-values, because not all values have a location, and not all names are variables. In most languages it makes no sense to say `2 + 3 = a`, or even `a = 2 + 3`, if `a` is the name of a constant. By the same token, not all l-values are simple names; both l-values and r-values can be complicated expressions. In C one may write

```
(f(a)+3)->b[c] = 2;
```

In this expression `f(a)` returns a pointer to some element of an array of pointers to structures (records). The assignment places the value 2 into the `c`-th element of field `b` of the structure pointed at by the third array element after the one to which `f`'s return value points. ■

EXAMPLE 6.12

L-values in C++

In C++ it is even possible for a function to return a reference to a structure, rather than a pointer to it, allowing one to write

```
g(a).b[c] = 2;
```

We will consider references further in [Section 8.3.1](#).

A language can make the distinction between l-values and r-values more explicit by employing a *reference model* of variables. Languages that do this include Algol 68, Clu, Lisp/Scheme, ML, Haskell, and Smalltalk. In these languages, a variable is not a named container for a value; rather, it is a named *reference* to a value. The following fragment of code is syntactically valid in both Pascal and Clu:

EXAMPLE 6.13

Variables as values and references

```
b := 2;
c := b;
a := b + c;
```

A Pascal programmer might describe this code by saying: “We put the value 2 in `b` and then copy it into `c`. We then read these values, add them together, and place the resulting 4 in `a`.” The Clu programmer would say: “We let `b` refer to 2 and then let `c` refer to it also. We then pass these references to the `+` operator, and let `a` refer to the result, namely 4.”

These two ways of thinking are illustrated in [Figure 6.2](#). With a value model of variables, as in Pascal, any integer variable can contain the value 2. With a reference

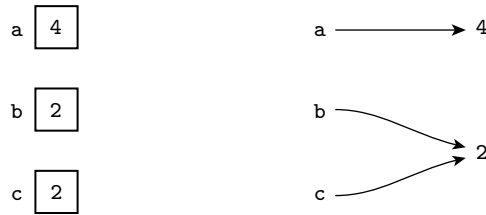

Figure 6.2 The value (left) and reference (right) models of variables. Under the reference model, it becomes important to distinguish between variables that refer to the same object and variables that refer to different objects whose values happen (at the moment) to be equal.

model of variables, as in Clu, there is (at least conceptually) only *one* 2—a sort of Platonic Ideal—to which any variable can refer. The practical effect is the same in this example, because integers are *immutable*: the value of 2 never changes, so we can’t tell the difference between two copies of the number 2 and two references to “the” number 2. ■

In a language that uses the reference model, every variable is an l-value. When it appears in a context that expects an r-value, it must be *dereferenced* to obtain the value to which it refers. In most languages with a reference model (including Clu), the dereference is implicit and automatic. In ML, the programmer must use an explicit dereference operator, denoted with a prefix exclamation point. We will revisit ML pointers in [Section 7.7.1](#).

The difference between the value and reference models of variables becomes particularly important (specifically, it can affect program output and behavior) if the values to which variables refer can change “in place,” as they do in many programs with linked data structures, or if it is possible for variables to refer to different objects that happen to have the “same” value. In this latter case it becomes important to distinguish between variables that refer to the same object and variables that refer to different objects whose values happen (at the moment) to be equal. (Lisp, as we shall see in [Sections 7.10](#) and [10.3.3](#), provides more than one notion of equality, to accommodate this distinction.) We will discuss the value and reference models of variables further in [Section 7.7](#).

DESIGN & IMPLEMENTATION

Implementing the reference model

It is tempting to assume that the reference model of variables is inherently more expensive than the value model, since a naive implementation would require a level of indirection on every access. As we shall see in [Section 7.7.1](#), however, most compilers for languages with a reference model use multiple copies of immutable objects for the sake of efficiency, achieving exactly the same performance for simple types that they would with a value model.

Java uses a value model for built-in types and a reference model for user-defined types (classes). C# and Eiffel allow the programmer to choose between the value and reference models for each individual user-defined type. A C# `class` is a reference type; a `struct` is a value type.

Boxing

A drawback of using a value model for built-in types is that they can't be passed uniformly to methods that expect class-typed parameters. Early versions of Java required the programmer to “wrap” objects of built-in types inside corresponding predefined class types in order to insert them in standard container (collection) classes:

EXAMPLE 6.14

Wrapper objects in Java 2

```
import java.util.Hashtable;
...
Hashtable ht = new Hashtable();
...
Integer N = new Integer(13);           // Integer is a "wrapper" class
ht.put(N, new Integer(31));
Integer M = (Integer) ht.get(N);
int m = M.intValue();
```

The wrapper class was needed here because `Hashtable` expects a parameter of a class derived from `Object`, and an `int` is not an `Object`. ■

EXAMPLE 6.15

Boxing in Java 5 and C#

More recent versions of Java perform automatic *boxing* and *unboxing* operations that avoid the need for wrappers in many cases:

```
ht.put(13, 31);
int m = (Integer) ht.get(13);
```

Here the compiler creates hidden `Integer` objects to hold the values 13 and 31, so they may be passed to `put` as references. The `Integer` cast on the return value is still needed, to make sure that the hash table entry for 13 is really an integer and not, say, a floating-point number or string. C# “boxes” not only the arguments, but the cast as well, eliminating the need for the `Integer` class entirely. ■

Orthogonality

One of the principal design goals of Algol 68 was to make the various features of the language as *orthogonal* as possible. Orthogonality means that features can be used in any combination, the combinations all make sense, and the meaning of a given feature is *consistent*, regardless of the other features with which it is combined. The name is meant to draw an explicit analogy to orthogonal vectors in linear algebra: none of the vectors in an orthogonal set depends on (or can be expressed in terms of) the others, and all are needed in order to describe the vector space as a whole.

Algol 68 was one of the first languages to make orthogonality a principal design goal, and in fact few languages since have given the goal such weight. Among

EXAMPLE 6.16

Expression orientation in
Algol 68

other things, Algol 68 is said to be *expression-oriented*: it has no separate notion of statement. Arbitrary expressions can appear in contexts that would call for a statement in a language like Pascal, and constructs that are considered to be statements in other languages can appear within expressions. The following, for example, is valid in Algol 68:

```
begin
  a := if b < c then d else e;
  a := begin f(b); g(c) end;
  g(d);
  2 + 3
end
```

Here the value of the `if... then... else` construct is either the value of its `then` part or the value of its `else` part, depending on the value of the condition. The value of the “statement list” on the right-hand side of the second assignment is the value of its final “statement,” namely the return value of `g(c)`. There is no need to distinguish between procedures and functions, because every subroutine call returns a value. The value returned by `g(d)` is discarded in this example. Finally, the value of the code fragment as a whole is 5, the sum of 2 and 3. ■

C takes an approach intermediate between Pascal and Algol 68. It distinguishes between statements and expressions, but one of the classes of statement is an “expression statement,” which computes the value of an expression and then throws it away; in effect, this allows an expression to appear in any context that would require a statement in most other languages. Unfortunately, as we noted in [Section 3.7](#), the reverse is not the case: statements cannot in general be used in an expression context. C provides special expression forms for selection and sequencing. Algol 60 defines `if... then... else` as both a statement and an expression.

Both Algol 68 and C allow assignments within expressions. The value of an assignment is simply the value of its right-hand side. Unfortunately, where most of the descendants of Algol 60 use the `:=` token to represent assignment, C follows Fortran in simply using `=`. It uses `==` to represent a test for equality (Fortran uses `.eq.`). Moreover, C lacks a separate Boolean type. (C99 has a new `_Bool` type, but it’s really just a 1-bit integer.) In any context that would require a Boolean value in other languages, C accepts an integer (or anything that can be coerced to be an integer). It interprets zero as false; any other value is true. As a result, both of the following constructs are valid—common—in C:

EXAMPLE 6.17

A “gotcha” in C conditions

```
if (a == b) {
  /* do the following if a equals b */

  if (a = b) {
    /* assign b into a and then do
       the following if the result is nonzero */
```

Programmers who are accustomed to Ada or some other language in which `=` is the equality test frequently write the second form above when the first is what is intended. This sort of bug can be very hard to find. ■

Though it provides a true Boolean type (`bool`), C++ shares the problem of C, because it provides automatic coercions from numeric, pointer, and enumeration types. Java and C# eliminate the problem by disallowing integers in Boolean contexts. The assignment operator is still `=`, and the equality test is still `==`, but the statement `if (a = b) ...` will generate a compile-time type clash error unless `a` and `b` are both `boolean` (Java) or `bool` (C#), which is generally unlikely.

Combination Assignment Operators

Because they rely so heavily on side effects, imperative programs must frequently *update* a variable. It is thus common in many languages to see statements like

```
a = a + 1;
```

or, worse

```
b.c[3].d = b.c[3].d * e;
```

Such statements are not only cumbersome to write and to read (we must examine both sides of the assignment carefully to see if they really are the same), they also result in redundant address calculations (or at least extra work to eliminate the redundancy in the code improvement phase of compilation). ■

If the address calculation has a side effect, then we may need to write a pair of statements instead. Consider the following code in C:

```
void update(int A[], int index_fn(int n)) {
    int i, j;
    /* calculate i */
    ...
    j = index_fn(i);
    A[j] = A[j] + 1;
}
```

Here we cannot safely write

```
A[index_fn(i)] = A[index_fn(i)] + 1;
```

We have to introduce the temporary variable `j` because we don't know whether `index_fn` has a side effect or not. If it is being used, for example, to keep a log of elements that have been updated, then we shall want to make sure that `update` calls it only once. ■

To eliminate the clutter and compile- or run-time cost of redundant address calculations, and to avoid the issue of repeated side effects, many languages, beginning with Algol 68, and including C and its descendants, provide so-called *assignment operators* to update a variable. Using assignment operators, the statements in [Example 6.18](#) can be written as follows.

EXAMPLE 6.18

Updating assignments

EXAMPLE 6.19

Side effects and updates

EXAMPLE 6.20

Assignment operators

```
a += 1;
b.c[3].d *= e;
```

and the two assignments in the update function can be replaced with

```
A[index_fn(i)] += 1;
```

In addition to being aesthetically cleaner, the assignment operator form guarantees that the address calculation is performed only once. ■

EXAMPLE 6.21

Prefix and postfix inc/dec

As shown in Figure 6.1, C provides 10 different assignment operators, one for each of its binary arithmetic and bit-wise operators. C also provides prefix and postfix increment and decrement operations. These allow even simpler code in update:

```
A[index_fn(i)]++;
```

or

```
++A[index_fn(i)];
```

More significantly, increment and decrement operators provide elegant syntax for code that uses an index or a pointer to traverse an array:

```
A[--i] = b;
*p++ = *q++;
```

When prefixed to an expression, the ++ or -- operator increments or decrements its operand *before* providing a value to the surrounding context. In the postfix form, ++ or -- updates its operand *after* providing a value. If *i* is 3 and *p* and *q* point to the initial elements of a pair of arrays, then *b* will be assigned into *A[2]* (not *A[3]*), and the second assignment will copy the initial elements of the arrays (not the second elements). ■

EXAMPLE 6.22

Advantages of postfix inc/dec

The prefix forms of ++ and -- are syntactic sugar for += and -=. We could have written

```
A[i -= 1] = b;
```

above. The postfix forms are not syntactic sugar. To obtain an effect similar to the second statement above we would need an auxiliary variable and a lot of extra notation:

```
*(t = p, p += 1, t) = *(t = q, q += 1, t);
```

Both the assignment operators (+=, -=) and the increment and decrement operators (++, --) do “the right thing” when applied to pointers in C (assuming those pointers point into an array). If *p* points to element *i* of an array, where each element occupies *n* bytes (including any bytes required for alignment, as discussed in Section ©5.1), then *p* += 3 points to element *i* + 3, 3*n* bytes later in memory. We will discuss pointers and arrays in C in more detail in Section 7.7.1.

Multiway Assignment**EXAMPLE 6.23**

Simple multiway
assignment

We have already seen that the right associativity of assignment (in languages that allow assignment in expressions) allows one to write things like `a = b = c`. In several languages, including Clu, ML, Perl, Python, and Ruby, it is also possible to write

```
a, b = c, d;
```

Here the comma in the right-hand side is *not* the sequencing operator of C. Rather, it serves to define a expression, or *tuple*, consisting of multiple r-values. The comma operator on the left-hand side produces a tuple of l-values. The effect of the assignment is to copy `c` into `a` and `d` into `b`.³ ■

EXAMPLE 6.24

Advantages of multiway
assignment

While we could just as easily have written

```
a = c; b = d;
```

the multiway (tuple) assignment allows us to write things like

```
a, b = b, a;           (* swap a and b *)
```

which would otherwise require auxiliary variables. Moreover, multiway assignment allows functions to return tuples, as well as single values:

```
a, b, c = foo(d, e, f);
```

This notation eliminates the asymmetry (nonorthogonality) of functions in most programming languages, which allow an arbitrary number of arguments, but only a single return. ■

✓ CHECK YOUR UNDERSTANDING

1. Name eight major categories of control-flow mechanisms.
2. What distinguishes *operators* from other sorts of functions?
3. Explain the difference between *prefix*, *infix*, and *postfix* notation. What is *Cambridge Polish* notation? Name two programming languages that use postfix notation.
4. Why don't issues of associativity and precedence arise in Postscript or Forth?
5. What does it mean for an expression to be *referentially transparent*?
6. What is the difference between a *value* model of variables and a *reference* model of variables? Why is the distinction important?

3 The syntax shown here is for Perl, Python, and Ruby. Clu uses `:=` for assignment. ML requires parentheses around each tuple.

7. What is an *l-value*? An *r-value*?
 8. Why is the distinction between *mutable* and *immutable* values important in the implementation of a language with a reference model of variables?
 9. Define *orthogonality* in the context of programming language design.
 10. What does it mean for a language to be *expression-oriented*?
 11. What are the advantages of updating a variable with an *assignment operator*, rather than with a regular assignment in which the variable appears on both the left- and right-hand sides?
-

6.1.3 Initialization

Because they already provide a construct (the assignment statement) to set the value of a variable, imperative languages do not always provide a means of specifying an initial value for a variable in its declaration. There are at least three reasons, however, why such initial values may be useful:

1. As suggested in [Figure 3.3](#) (page 124), a static variable that is local to a subroutine needs an initial value in order to be useful.
2. For any statically allocated variable, an initial value that is specified in the declaration can be preallocated in global memory by the compiler, avoiding the cost of assigning an initial value at run time.
3. Accidental use of an uninitialized variable is one of the most common programming errors. One of the easiest ways to prevent such errors (or at least ensure that erroneous behavior is repeatable) is to give every variable a value when it is first declared.

Most languages allow variables of built-in types to be initialized in their declarations. A more complete and orthogonal approach to initialization requires a notation for *aggregates*: built-up structured values of user-defined composite types. Aggregates can be found in several languages, including C, Ada, Fortran 90, and ML; we will discuss them further in [Section 7.1.5](#).

It should be emphasized that initialization saves time only for variables that are statically allocated. Variables allocated in the stack or heap at run time must be initialized at run time.⁴ It is also worth noting that the problem of using an uninitialized variable occurs not only after elaboration, but also as a result of any operation that destroys a variable's value without providing a new one. Two of the

⁴ For variables that are accessed indirectly (e.g., in languages that employ a reference model of variables), a compiler can often reduce the cost of initializing a stack or heap variable by placing the initial value in static memory, and only creating the pointer to it at elaboration time.

most common such operations are explicit deallocation of an object referenced through a pointer and modification of the *tag* of a variant record. We will consider these operations further in Sections 7.7 and ©7.3.4, respectively.

If a variable is not given an initial value explicitly in its declaration, the language may specify a default value. In C, for example, statically allocated variables for which the programmer does not provide an initial value are guaranteed to be represented in memory as if they had been initialized to zero. For most types on most machines, this is a string of zero bits, allowing the language implementation to exploit the fact that most operating systems (for security reasons) fill newly allocated memory with zeros. Zero-initialization applies recursively to the sub-components of variables of user-defined composite types. Java and C# provide a similar guarantee for the fields of all class-typed objects, not just those that are statically allocated. Most scripting languages provide a default initial value for *all* variables, of all types, regardless of scope or lifetime.

Dynamic Checks

Instead of giving every uninitialized variable a default value, a language or implementation can choose to define the use of an uninitialized variable as a dynamic semantic error, and can catch these errors at run time. The advantage of the semantic checks is that they will often identify a program bug that is masked or made more subtle by the presence of a default value. With appropriate hardware support, uninitialized variable checks can even be as cheap as default values, at least for certain types. In particular, a compiler that relies on the IEEE standard for floating-point arithmetic can fill uninitialized floating-point numbers with a *signaling NaN* value, as discussed in Section ©5.2.2. Any attempt to use such a value in a computation will result in a hardware interrupt, which the language implementation may catch (with a little help from the operating system), and use to trigger a semantic error message.

For most types on most machines, unfortunately, the costs of catching all uses of an uninitialized variable at run time are considerably higher. If every possible bit pattern of the variable's representation in memory designates some legitimate value (and this is often the case), then extra space must be allocated somewhere to hold an initialized/uninitialized flag. This flag must be set to "uninitialized" at elaboration time and to "initialized" at assignment time. It must also be checked (by extra code) at every use, or at least at every use that the code improver is unable to prove is redundant.

Definite Assignment

For local variables of methods, Java and C# define a notion of *definite assignment* that precludes the use of uninitialized variables. This notion is based on the control flow of the program, and can be statically checked by the compiler. Roughly speaking, every possible control path to an expression must assign a value to every variable in that expression. This is a conservative rule; it can sometimes prohibit programs that would never actually use an uninitialized variable. In Java:

EXAMPLE 6.25

Programs outlawed by definite assignment

```
int i;
int j = 3;
...
if (j > 0) {
    i = 2;
}
... // no assignments to j in here
if (j > 0) {
    System.out.println(i); // error: "i might not have been initialized"
}
```

While a human being might reason that `i` will be used only when it has previously been given a value, it is uncomputable to make such determinations in the general case, and the compiler does not attempt it. ■

Constructors

Many object-oriented languages (Java and C# among them) allow the programmer to define types for which initialization of dynamically allocated variables occurs automatically, even when no initial value is specified in the declaration. Some—notably C++—also distinguish carefully between initialization and assignment. Initialization is interpreted as a call to a *constructor* function for the variable's type, with the initial value as an argument. In the absence of coercion, assignment is interpreted as a call to the type's assignment operator or, if none has been defined, as a simple bit-wise copy of the value on the assignment's right-hand side. The distinction between initialization and assignment is particularly important for user-defined abstract data types that perform their own storage management. A typical example occurs in variable-length character strings. An assignment to such a string must generally deallocate the space consumed by the old value of the string before allocating space for the new value. An initialization of the string must simply allocate space. Initialization with a nontrivial value is generally cheaper than default initialization followed by assignment, because it avoids deallocation of the space allocated for the default value. We will return to this issue in [Section 9.3.2](#).

Neither Java nor C# distinguishes between initialization and assignment: an initial value can be given in a declaration, but this is the same as an immediate subsequent assignment. Java uses a reference model for all variables of user-defined object types, and provides for automatic storage reclamation, so assignment never copies values. C# allows the programmer to specify a value model when desired (in which case assignment does copy values), but otherwise mirrors Java.

6.1.4 Ordering within Expressions

While precedence and associativity rules define the order in which binary infix operators are applied within an expression, they do not specify the order in which the operands of a given operator are evaluated. For example, in the expression

$$a - f(b) - c * d$$

EXAMPLE 6.26

Indeterminate ordering

we know from associativity that $f(b)$ will be subtracted from a before performing the second subtraction, and we know from precedence that the right operand of that second subtraction will be the result of $c * d$, rather than merely c , but without additional information we do not know whether $a - f(b)$ will be evaluated before or after $c * d$. Similarly, in a subroutine call with multiple arguments

$$f(a, g(b), h(c))$$

we do not know the order in which the arguments will be evaluated. ■

There are two main reasons why the order can be important:

EXAMPLE 6.27

A value that depends on ordering

1. *Side effects*: If $f(b)$ may modify d , then the value of $a - f(b) - c * d$ will depend on whether the first subtraction or the multiplication is performed first. Similarly, if $g(b)$ may modify a and/or c , then the values passed to $f(a, g(b), h(c))$ will depend on the order in which the arguments are evaluated. ■

EXAMPLE 6.28

An optimization that depends on ordering

2. *Code improvement*: The order of evaluation of subexpressions has an impact on both register allocation and instruction scheduling. In the expression $a * b + f(c)$, it is probably desirable to call f before evaluating $a * b$, because the product, if calculated first, would need to be saved during the call to f , and f might want to use all the registers in which it might easily be saved. In a similar vein, consider the sequence

```
a := B[i];
c := a * 2 + d * 3;
```

Here it is probably desirable to evaluate $d * 3$ before evaluating $a * 2$, because the previous statement, $a := B[i]$, will need to load a value from memory.

DESIGN & IMPLEMENTATION

Safety versus performance

A recurring theme in any comparison between C++ and Java is the latter's willingness to accept additional run-time cost in order to obtain cleaner semantics or increased reliability. Definite assignment is one example: it may force the programmer to perform "unnecessary" initializations on certain code paths, but in so doing it avoids the many subtle errors that can arise from missing initialization in other languages. Similarly, the Java specification mandates automatic garbage collection, and its reference model of user-defined types forces most objects to be allocated in the heap. As we shall see in [Chapters 7 and 9](#), Java also requires both dynamic binding of all method invocations and run-time checks for out-of-bounds array references, type clashes, and other dynamic semantic errors. Clever compilers can reduce or eliminate the cost of these requirements in certain common cases, but for the most part the Java design reflects an evolutionary shift away from performance as *the* overriding design goal.

Because loads are slow, if the processor attempts to use the value of a in the next instruction (or even the next few instructions on many machines), it will have to wait. If it does something unrelated instead (i.e., evaluate $d * 3$), then the load can proceed in parallel with other computation. ■

Because of the importance of code improvement, most language manuals say that the order of evaluation of operands and arguments is undefined. (Java and C# are unusual in this regard: they require left-to-right evaluation.) In the absence of an enforced order, the compiler can choose whatever order results in faster code.

Applying Mathematical Identities

Some language implementations (e.g., for dialects of Fortran) allow the compiler to *rearrange* expressions involving operators whose mathematical abstractions are commutative, associative, and/or distributive, in order to generate faster code. Consider the following Fortran fragment:

EXAMPLE 6.29

Optimization and mathematical “laws”

```
a = b + c
d = c + e + b
```

Some compilers will rearrange this as

```
a = b + c
d = b + c + e
```

They can then recognize the *common subexpression* in the first and second statements, and generate code equivalent to

```
a = b + c
d = a + e
```

Similarly,

```
a = b/c/d
e = f/d/c
```

may be rearranged as

```
t = c * d
a = b/t
e = f/t
```

Unfortunately, while mathematical arithmetic obeys a variety of commutative, associative, and distributive laws, computer arithmetic is not as orderly. The problem is that numbers in a computer are of limited precision. Suppose a , b , and c are all integers between 2 billion and 3 billion. With 32-bit arithmetic, the

EXAMPLE 6.30

Overflow and arithmetic “identities”

expression $b - c + d$ can be evaluated safely left-to-right (2^{32} is a little less than 4.3 billion). If the compiler attempts to reorganize this expression as $b + d - c$, however (e.g., in order to delay its use of c), then arithmetic overflow will occur. Despite our intuition from math, this reorganization is unsafe. ■

Many languages, including Pascal and most of its descendants, provide dynamic semantic checks to detect arithmetic overflow. In some implementations these checks can be disabled to eliminate their run-time overhead. In C and C++, the effect of arithmetic overflow is implementation-dependent. In Java, it is well defined: the language definition specifies the size of all numeric types, and requires two's complement integer and IEEE floating-point arithmetic. In C#, the programmer can explicitly request the presence or absence of checks by tagging an expression or statement with the `checked` or `unchecked` keyword. In a completely different vein, Scheme, Common Lisp, and several scripting languages place no a priori limit on the size of integers; space is allocated to hold extra-large values on demand.

Even in the absence of overflow, the limited precision of floating-point arithmetic can cause different arrangements of the “same” expression to produce significantly different results, invisibly. Single-precision IEEE floating-point numbers devote 1 bit to the sign, 8 bits to the exponent (power of 2), and 23 bits to the mantissa. Under this representation, $a + b$ is guaranteed to result in a loss of information if $|\log_2(a/b)| > 23$. Thus if $b = -c$, then $a + b + c$ may appear to be zero, instead of a , if the magnitude of a is small, while the magnitude of b and c is large. In a similar vein, a number like 0.1 cannot be represented precisely, because its binary representation is a “repeating decimal”: 0.0001001001... For certain values of x , $(0.1 + x) * 10.0$ and $1.0 + (x * 10.0)$ can differ by as much as 25%, even when 0.1 and x are of the same magnitude. ■

EXAMPLE 6.31

Reordering and numerical stability

6.1.5 Short-Circuit Evaluation

Boolean expressions provide a special and important opportunity for code improvement and increased readability. Consider the expression $(a < b)$ and

EXAMPLE 6.32

Short-circuited expressions

DESIGN & IMPLEMENTATION

Evaluation order

Expression evaluation presents a difficult tradeoff between semantics and implementation. To limit surprises, most language definitions require the compiler, if it ever reorders expressions, to respect any ordering imposed by parentheses. The programmer can therefore use parentheses to prevent the application of arithmetic “identities” when desired. No similar guarantee exists with respect to the order of evaluation of operands and arguments. It is therefore unwise to write expressions in which a side effect of evaluating one operand or argument can affect the value of another. As we shall see in [Section 6.3](#), some languages, notably Euclid and Turing, outlaw such side effects.

($b < c$). If a is greater than b , there is really no point in checking to see whether b is less than c ; we know the overall expression must be false. Similarly, in the expression ($a > b$) or ($b > c$), if a is indeed greater than b there is no point in checking to see whether b is greater than c ; we know the overall expression must be true. A compiler that performs *short-circuit evaluation* of Boolean expressions will generate code that skips the second half of both of these computations when the overall value can be determined from the first half. ■

EXAMPLE 6.33

Saving time with short-circuiting

Short-circuit evaluation can save significant amounts of time in certain situations:

```
if (very_unlikely_condition && very_expensive_function()) ...
```

EXAMPLE 6.34

Short-circuit pointer chasing

But time is not the only consideration, or even the most important. Short-circuiting changes the *semantics* of Boolean expressions. In C, for example, one can use the following code to search for an element in a list:

```
p = my_list;
while (p && p->key != val)
    p = p->next;
```

C short-circuits its `&&` and `||` operators, and uses zero for both null and false, so `p->key` will be accessed if and only if `p` is non-null. The syntactically similar code in Pascal does not work, because Pascal does not short-circuit `and` and `or`:

```
p := my_list;
while (p <> nil) and (p^.key <> val) do      (* ouch! *)
    p := p^.next;
```

Here both of the `<>` relations will be evaluated before `and`-ing their results together. At the end of an unsuccessful search, `p` will be `nil`, and the attempt to access `p^.key` will be a run-time (dynamic semantic) error, which the compiler may or may not have generated code to catch. To avoid this situation, the Pascal programmer must introduce an auxiliary Boolean variable and an extra level of nesting:

```
p := my_list;
still_searching := true;
while still_searching do
    if p = nil then
        still_searching := false
    else if p^.key = val then
        still_searching := false
    else
        p := p^.next;
```

```

1. function tally(word : string) : integer;
2.     (* Look up word in hash table. If found, increment tally; If not
3.     found, enter with a tally of 1. In either case, return tally. *)
   ...
4. function misspelled(word : string) : Boolean;
5.     (* Check to see if word is mis-spelled and return appropriate
6.     indication. If yes, increment global count of mis-spellings. *)
   ...
7. while not eof(doc_file) do begin
8.     w := get_word(doc_file);
9.     if (tally(w) = 10) and misspelled(w) then
10.        writeln(w)
11. end;
12. writeln(total_misspellings);

```

Figure 6.3 Pascal code that counts on the evaluation of Boolean operands.

EXAMPLE 6.35

Short-circuiting and other errors

Short-circuit evaluation can also be used to avoid out-of-bound subscripts:

```

const MAX = 10;
int A[MAX];           /* indices from 0 to 9 */
...
if (i >= 0 && i < MAX && A[i] > foo) ...

```

division by zero:

```

if (d <> 0 && n/d > threshold) ...

```

and various other errors. ■

EXAMPLE 6.36

When not to use short-circuiting

Short circuiting is not necessarily as attractive for situations in which a Boolean subexpression can cause a side effect. Suppose we wish to count occurrences of words in a document, and print a list of all misspelled words that appear 10 or more times, together with a count of the total number of misspellings. Pascal code for this task appears in Figure 6.3. Here the `if` statement at line 9 tests the conjunction of two subexpressions, both of which have important side effects. If short-circuit evaluation is used, the program will not compute the right result. The code can be rewritten to eliminate the need for non-short-circuit evaluation, but one might argue that the result is more awkward than the version shown. ■

So now we have seen situations in which short-circuiting is highly desirable, and others in which at least some programmers would find it undesirable. A few languages provide both regular *and* short-circuit Boolean operators. In Ada, for example, the regular Boolean operators are `and` and `or`; the short-circuit operators are the two-word operators `and then` and `or else`:

EXAMPLE 6.37

Optional short-circuiting

```

found_it := p /= null and then p.key = val;
...
if d = 0 or else n/d < threshold then ...

```

(Ada uses `/=` for “not equal.”) In C, the bit-wise `&` and `|` operators can be used as non–short-circuiting alternatives to `&&` and `||` when their arguments are logical (0 or 1) values. ■

If we think of `and` and `or` as binary operators, short circuiting can be considered an example of delayed or *lazy* evaluation: the operands are “passed” unevaluated. Internally, the operator evaluates the first operand in any case, the second only when needed. In a language like Algol 68, which allows arbitrary control flow constructs to be used inside expressions, conditional evaluation can be specified explicitly with `if... then... else`; see [Exercise 6.12](#).

When used to determine the flow of control in a selection or iteration construct, short-circuit Boolean expressions do not really have to calculate a Boolean value; they simply have to ensure that control takes the proper path in any given situation. We will look more closely at the generation of code for short-circuit expressions in [Section 6.4.1](#).

✓ CHECK YOUR UNDERSTANDING

12. Given the ability to assign a value into a variable, why is it useful to be able to specify an *initial* value?
13. What are *aggregates*? Why are they useful?
14. Explain the notion of *definite assignment* in Java and C#.
15. Why is it generally expensive to catch all uses of uninitialized variables at run time?
16. Why is it impossible to catch all uses of uninitialized variables at compile time?
17. Why do most languages leave unspecified the order in which the arguments of an operator or function are evaluated?
18. What is *short-circuit* Boolean evaluation? Why is it useful?

6.2 Structured and Unstructured Flow

EXAMPLE 6.38

Control flow with `gotos` in Fortran

Control flow in assembly languages is achieved by means of conditional and unconditional jumps (branches). Early versions of Fortran mimicked the low level approach by relying heavily on `goto` statements for most nonprocedural control flow:

```

    if (A .lt. B) goto 10      ! ".lt." means "<"
    ...
10
```

The 10 on the bottom line is a *statement label*. `Goto` statements also featured prominently in other early imperative languages. ■

Beginning in the late 1960s, largely in response to an article by Edsger Dijkstra [Dij68b],⁵ language designers hotly debated the merits and evils of `gotos`. It seems fair to say the detractors won. Ada and C# allow `gotos` only in limited contexts. Modula (1, 2, and 3), Clu, Eiffel, Java, and most of the scripting languages do not allow them at all. Fortran 90 and C++ allow them primarily for compatibility with their predecessor languages. (Java reserves the token `goto` as a keyword, to make it easier for a Java compiler to produce good error messages when a programmer uses a C++ `goto` by mistake.)

The abandonment of `gotos` was part of a larger “revolution” in software engineering known as *structured programming*. Structured programming was the “hot trend” of the 1970s, in much the same way that object-oriented programming was the trend of the 1990s. Structured programming emphasizes top-down design (i.e., progressive refinement), modularization of code, structured types (records, sets, pointers, multidimensional arrays), descriptive variable and constant names, and extensive commenting conventions. The developers of structured programming were able to demonstrate that within a subroutine, almost any well-designed imperative algorithm can be elegantly expressed with only sequencing, selection, and iteration. Instead of labels, structured languages rely on the boundaries of lexically nested constructs as the targets of branching control.

Many of the structured control-flow constructs familiar to modern programmers were pioneered by Algol 60. These include the `if... then... else` construct and both enumeration (`for`) and logically (`while`) controlled loops. The modern case (`switch`) statement was introduced by Wirth and Hoare in Algol W [WH66] as an alternative to the more unstructured computed `goto` and `switch` constructs of Fortran and Algol 60, respectively. (The `switch` statement of C bears a closer resemblance to the Algol W case statement than to the Algol 60 `switch`.)

6.2.1 Structured Alternatives to `goto`

Once the principal structured constructs had been defined, most of the controversy surrounding `gotos` revolved around a small number of special cases, each of which was eventually addressed in structured ways. Where once a `goto` might have been used to jump to the end of the current subroutine, most modern languages provide an explicit `return` statement. Where once a `goto` might have been used to escape from the middle of a loop, most modern languages provide a `break` or `exit` statement for this purpose. (Some languages also provide a statement that will skip the remainder of the current iteration only: `continue` in C; `cycle` in Fortran 90; `next` in Perl.) More significantly, several languages allow a program to return from a nested chain of subroutine calls in a single operation, and most

⁵ Edsger W. Dijkstra (1930–2002) developed much of the logical foundation of our modern understanding of concurrency. He is also responsible, among many other contributions, for the semaphores of Section 12.3.4 and for much of the practical development of structured programming. He received the ACM Turing Award in 1972.

provide a way to raise an *exception* that propagates out to some surrounding context. Both of these capabilities might once have been attempted with (nonlocal) `gotos`.

Multilevel Returns

Returns and (local) `gotos` allow control to return from the current subroutine. On occasion it may make sense to return from a *surrounding* routine. Imagine, for example, that we are searching for an item matching some desired pattern within a collection of files. The search routine might invoke several nested routines, or a single routine multiple times, once for each place in which to search. In such a situation certain historic languages, including Algol 60, PL/I, and Pascal, permit a `goto` to branch to a lexically visible label *outside* the current subroutine:

EXAMPLE 6.39

Escaping a nested subroutine

```
function search(key : string) : string;
var rtn : string;
...
  procedure search_file(fname : string);
  ...
  begin
    ...
    for ... (* iterate over lines *)
      ...
      if found(key, line) then begin
        rtn := line;
        goto 100;
      end;
      ...
    end;
  ...
  begin (* search *)
    ...
    for ... (* iterate over files *)
      ...
      search_file(fname);
      ...
100:  return rtn;
    end;
```

In the event of a nonlocal `goto`, the language implementation must guarantee to repair the run-time stack of subroutine call information. This repair operation is known as *unwinding*. It requires not only that the implementation deallocate the stack frames of any subroutines from which we have escaped, but also that it perform any bookkeeping operations, such as restoration of register contents, that would have been performed when returning from those routines.

As a more structured alternative to the nonlocal `goto`, Common Lisp provides a `return-from` statement that names the lexically surrounding function or block from which to return, and also supplies a return value (eliminating the need for the artificial `rtn` variable in [Example 6.39](#)).

EXAMPLE 6.40

Structured nonlocal transfers

But what if `search_file` were not nested inside of `search`? We might, for example, wish to call it from routines that search files in different orders. Algol 60, Algol 68, and PL/I allow labels to be passed as parameters, so a dynamically nested subroutine can perform a `goto` to a caller-defined location. Common Lisp again provides a more structured alternative, also available in Ruby. In either language an expression can be surrounded with a `catch` block, whose value can be provided by any dynamically nested routine that executes a matching `throw`. In Ruby we might write

```
def searchFile(fname, pattern)
  file = File.open(fname)
  file.each {|line|
    throw :found, line if line =~ /#{pattern}/
  }
end

match = catch :found do
  searchFile("f1", key)
  searchFile("f2", key)
  searchFile("f3", key)
  "not found\n"
end
print match
```

default value for catch,
if control gets this far

Here the `throw` expression specifies a *tag*, which must appear in a matching `catch`, together with a value (`line`) to be returned as the value of the `catch`. (The `if` clause attached to the `throw` performs a regular-expression pattern match, looking for `pattern` within `line`. We will consider pattern matching in more detail in [Section 13.4.2.](#)) ■

Errors and Other Exceptions

The notion of a multilevel return assumes that the callee knows what the caller expects, and can return an appropriate value. In a related and arguably more common situation, a deeply nested block or subroutine may discover that it is unable to proceed with its usual function, and moreover lacks the contextual information it would need to recover in any graceful way. Eiffel formalizes this notion by saying that every software component has a *contract*—a specification of the function it performs. A component that is unable to fulfill its contract is said to *fail*. Rather than return in the normal way, it must arrange for control to “back out” to some context in which the program is able to recover. Conditions that require a program to “back out” are usually called *exceptions*. We mentioned an example in [Section 2.3.4](#), where we considered phrase-level recovery from syntax errors in a recursive-descent parser.

The most straightforward but generally least satisfactory way to cope with exceptions is to use auxiliary Boolean variables within a subroutine (`if still_ok then . . .`) and to return status codes from calls:

EXAMPLE 6.41

Error checking with status codes

```
status := my_proc(args);  
if status = ok then ...
```

The auxiliary Booleans can be eliminated by using a nonlocal `goto` or multilevel return, but the caller to which we return must still inspect status codes explicitly. As a structured alternative, many modern languages provide an *exception-handling* mechanism for convenient, nonlocal recovery from exceptions. We will discuss exception handling in more detail in [Section 8.5](#). Typically the programmer appends a block of code called a *handler* to any computation in which an exception may arise. The job of the handler is to take whatever remedial action is required to recover from the exception. If the protected computation completes in the normal fashion, execution of the handler is skipped.

Multilevel returns and structured exceptions have strong similarities. Both involve a control transfer from some inner, nested context back to an outer context, unwinding the stack on the way. The distinction lies in where the computing occurs. In a multilevel return the inner context has all the information it needs. It completes its computation, generating a return value if appropriate, and transfers to the outer context in a way that requires no post-processing. At an exception, by contrast, the inner context cannot complete its work—it cannot fulfill its contract. It performs an “abnormal” return, triggering execution of the handler.

Common Lisp and Ruby provide mechanisms for both multilevel returns and exceptions, but this dual support is relatively rare. Most languages support only exceptions; programmers implement multilevel returns by writing a trivial handler. In an unfortunate overloading of terminology, the names `catch` and `throw`, which Common Lisp and Ruby use for multilevel returns, are used for exceptions in several other languages.

6.2.2 Continuations

The notion of nonlocal `gotos` that unwind the stack can be generalized by defining what are known as *continuations*. In low-level terms, a continuation consists of

DESIGN & IMPLEMENTATION

Cleaning up continuations

The implementation of continuations in Scheme and Ruby is surprisingly straightforward. Because local variables have unlimited extent in both languages, activation records must in general be allocated on the heap. As a result, explicit deallocation is neither required nor appropriate when jumping through a continuation; frames that are no longer accessible will eventually be reclaimed by a general purpose *garbage collector* (to be discussed in [Section 7.7.3](#)). Restoration of state (e.g., saved registers) from escaped routines is not required either: the continuation closure holds everything required to resume the captured context.

a code address and a referencing environment to be restored when jumping to that address. In higher-level terms, a continuation is an abstraction that captures a *context* in which execution might continue. Continuations are fundamental to denotational semantics. They also appear as first-class values in certain languages (notably Scheme and Ruby), allowing the programmer to define new control flow constructs.

Continuation support in Scheme takes the form of a general-purpose function called `call-with-current-continuation`, sometimes abbreviated `call/cc`. This function takes a single argument f , which is itself a function. It calls f , passing as argument a continuation c that captures the current program counter and referencing environment. The continuation is represented by a closure, indistinguishable from the closures used to represent subroutines passed as parameters. At any point in the future, f can call c to reestablish the captured context. If nested calls have been made, control pops out of them, as it does with exceptions. More generally, however, c can be saved in variables, returned explicitly by subroutines, or called repeatedly, even after control has returned from f (recall that closures in Scheme have unlimited extent; see [Section 3.6](#)). `call/cc` suffices to build a wide variety of control abstractions, including `gotos`, `midloop exits`, `multilevel returns`, `exceptions`, `iterators` ([Section 6.5.3](#)), `call-by-name parameters` ([Section 8.3.1](#)), and `coroutines` ([Section 8.6](#)). It even subsumes the notion of returning from a subroutine, though it seldom replaces it in practice.

First-class continuations are an extremely powerful facility. They can be very useful if applied in well-structured ways (i.e., to define new control-flow constructs). Unfortunately, they also allow the undisciplined programmer to construct completely inscrutable programs.

6.3 Sequencing

Like assignment, sequencing is central to imperative programming. It is the principal means of controlling the order in which side effects (e.g., assignments) occur: when one statement follows another in the program text, the first statement executes before the second. In most imperative languages, lists of statements can be enclosed with `begin...end` or `{...}` delimiters and then used in any context in which a single statement is expected. Such a delimited list is usually called a *compound statement*. A compound statement optionally preceded by a set of declarations is sometimes called a *block*.

In languages like Algol 68, which blur or eliminate the distinction between statements and expressions, the value of a statement (expression) list is the value of its final element. In Common Lisp, the programmer can choose to return the value of the first element, the second, or the last. Of course, sequencing is a useless operation unless the subexpressions that do not play a part in the return value have side effects. The various sequencing constructs in Lisp are used only in program fragments that do not conform to a purely functional programming model.

Even in imperative languages, there is debate as to the value of certain kinds of side effects. In Euclid and Turing, for example, functions (i.e., subroutines that return values, and that therefore can appear within expressions) are not permitted to have side effects. Among other things, side-effect freedom ensures that a Euclid or Turing function, like its counterpart in mathematics, is always *idempotent*: if called repeatedly with the same set of arguments, it will always return the same value, and the number of consecutive calls (after the first) will not affect the results of subsequent execution. In addition, side-effect freedom for functions means that the value of a subexpression will never depend on whether that subexpression is evaluated before or after calling a function in some other subexpression. These properties make it easier for a programmer or theorem-proving system to reason about program behavior. They also simplify code improvement, for example by permitting the safe rearrangement of expressions.

EXAMPLE 6.42

Side effects in a random number generator

Unfortunately, there are some situations in which side effects in functions are highly desirable. We saw one example in the `label_name` function of [Figure 3.3](#) (page 124). Another arises in the typical interface to a pseudorandom number generator:

```
procedure srand(seed : integer)
  -- Initialize internal tables.
  -- The pseudorandom generator will return a different
  -- sequence of values for each different value of seed.

function rand() : integer
  -- No arguments; returns a new "random" number.
```

Obviously `rand` needs to have a side effect, so that it will return a different value each time it is called. One could always recast it as a procedure with a reference parameter:

```
procedure rand(var n : integer)
```

but most programmers would find this less appealing. Ada strikes a compromise: it allows side effects in functions in the form of changes to static or global variables, but does not allow a function to modify its parameters. ■

6.4 Selection

EXAMPLE 6.43

Selection in Algol 60

Selection statements in most imperative languages employ some variant of the `if... then... else` notation introduced in Algol 60:

```
if condition then statement
else if condition then statement
else if condition then statement
...
else statement
```

As we saw in [Section 2.3.2](#), languages differ in the details of the syntax. In Algol 60 and Pascal both the `then` clause and the `else` clause are defined to contain a single statement (this can of course be a `begin...end` compound statement). To avoid grammatical ambiguity, Algol 60 requires that the statement after the `then` begin with something other than `if` (`begin` is fine). Pascal eliminates this restriction in favor of a “disambiguating rule” that associates an `else` with the closest unmatched `then`. Algol 68, Fortran 77, and more modern languages avoid the ambiguity by allowing a statement *list* to follow either `then` or `else`, with a terminating keyword at the end of the construct.

EXAMPLE 6.44

Elsif/elif

To keep terminators from piling up at the end of nested `if` statements, most languages with terminators provide a special `elsif` or `elif` keyword. In *Module 2*, one writes

```
IF a = b THEN ...
ELSIF a = c THEN ...
ELSIF a = d THEN ...
ELSE ...
END
```

EXAMPLE 6.45

Cond in Lisp

In Lisp, the equivalent construct is

```
(cond
  ((= A B)
   (...))
  ((= A C)
   (...))
  ((= A D)
   (...))
  (T
   (...)))
```

Here `cond` takes as arguments a sequence of pairs. In each pair the first element is a condition; the second is an expression to be returned as the value of the overall construct if the condition evaluates to `T` (`T` means “true” in most Lisp dialects). ■

6.4.1 Short-Circuited Conditions

While the condition in an `if...then...else` statement is a Boolean expression, there is usually no need for evaluation of that expression to result in a Boolean value in a register. Most machines provide conditional branch instructions that capture simple comparisons. Put another way, the purpose of the Boolean expression in a selection statement is not to compute a value to be stored, but to cause control to branch to various locations. This observation allows us to generate particularly efficient code (called *jump code*) for expressions that are amenable to the short-circuit evaluation of [Section 6.1.5](#). Jump code is applicable not only to

selection statements such as `if... then... else`, but to logically controlled loops as well; we will consider the latter in [Section 6.5.5](#).

In the usual process of code generation, either via an attribute grammar or via ad hoc syntax tree decoration, a synthesized attribute of the root of an expression subtree acquires the name of a register into which the value of the expression will be computed at run time. The surrounding context then uses this register name when generating code that uses the expression. In jump code, *inherited* attributes of the root inform it of the addresses to which control should branch if the expression is true or false, respectively. Jump code can be generated quite elegantly by an attribute grammar, particularly one that is *not* L-attributed ([Exercise 6.11](#)).

Suppose, for example, that we are generating code for the following source:

EXAMPLE 6.46

Code generation for a Boolean condition

```
if ((A > B) and (C > D)) or (E ≠ F) then
    then_clause
else
    else_clause
```

In Pascal, which does not use short-circuit evaluation, the output code would look something like this:

```
r1 := A          -- load
r2 := B
r1 := r1 > r2
r2 := C
r3 := D
r2 := r2 > r3
r1 := r1 & r2
r2 := E
r3 := F
r2 := r2 ≠ r3
r1 := r1 | r2
if r1 = 0 goto L2
L1: then_clause  -- (label not actually used)
    goto L3
L2: else_clause
L3:
```

The root of the subtree for `((A > B) and (C > D)) or (E ≠ F)` would name `r1` as the register containing the expression value. ■

EXAMPLE 6.47

Code generation for short-circuiting

In jump code, by contrast, the inherited attributes of the condition's root would indicate that control should "fall through" to `L1` if the condition is true, or branch to `L2` if the condition is false. Output code would then look something like this:

```
r1 := A
r2 := B
if r1 <= r2 goto L4
r1 := C
r2 := D
```



```

        if r1 > r2 goto L1
L4: r1 := E
    r2 := F
    if r1 = r2 goto L2
L1: then_clause
    goto L3
L2: else_clause
L3:

```

Here the value of the Boolean condition is never explicitly placed into a register. Rather it is implicit in the flow of control. Moreover for most values of A, B, C, D, and E, the execution path through the jump code is shorter and therefore faster (assuming good branch prediction) than the straight-line code that calculates the value of every subexpression. ■

EXAMPLE 6.48

Short-circuit creation of a Boolean value

If the value of a short-circuited expression is needed explicitly, it can of course be generated, while still using jump code for efficiency. The Ada fragment

```
found_it := p /= null and then p.key = val;
```

is equivalent to

```

if p /= null and then p.key = val then
    found_it := true;
else
    found_it := false;
end if;

```

and can be translated as

```

r1 := p
if r1 = 0 goto L1
r2 := r1->key
if r2 ≠ val goto L1
r1 := 1
goto L2
L1: r1 := 0
L2: found.it := r1

```

DESIGN & IMPLEMENTATION**Short-circuit evaluation**

Short-circuit evaluation is one of those happy cases in programming language design where a clever language feature yields both more useful semantics *and* a faster implementation than existing alternatives. Other at least arguable examples include *case* statements, local scopes for *for* loop indices (Section 6.5.1), *with* statements in Pascal (Section 7.3.3), and parameter modes in Ada (Section 8.3.1).

The astute reader will notice that the first `goto L1` can be replaced by `goto L2`, since `r1` already contains a zero in this case. The code improvement phase of the compiler will notice this also, and make the change. It is easier to fix this sort of thing in the code improver than it is to generate the better version of the code in the first place. The code improver has to be able to recognize jumps to redundant instructions for other reasons anyway; there is no point in building special cases into the short-circuit evaluation routines. ■

6.4.2 Case/Switch Statements

EXAMPLE 6.49

Case statements and
nested ifs

The case statements of Algol W and its descendants provide alternative syntax for a special case of nested `if... then... else`. When each condition compares the same integer expression to a different compile-time constant, then the following code (written here in Modula-2)

```
i := ... (* potentially complicated expression *)
IF i = 1 THEN
    clause_A
ELSIF i IN 2, 7 THEN
    clause_B
ELSIF i IN 3..5 THEN
    clause_C
ELSIF (i = 10) THEN
    clause_D
ELSE
    clause_E
END
```

can be rewritten as

```
CASE ... (* potentially complicated expression *) OF
    1:      clause_A
|   2, 7:  clause_B
|   3..5:  clause_C
|   10:    clause_D
ELSE      clause_E
END
```

The elided code fragments (*clause_A*, *clause_B*, etc.) after the colons and the `ELSE` are called the *arms* of the `CASE` statement. The lists of constants in front of the colons are `CASE` statement *labels*. The constants in the label lists must be disjoint, and must be of a type compatible with the tested expression. Most languages allow this type to be anything whose values are discrete: integers, characters, enumerations, and subranges of the same. C# allows strings as well. ■

The `CASE` statement version of the code above is certainly less verbose than the `IF... THEN... ELSE` version, but syntactic elegance is not the principal motivation

EXAMPLE 6.50Translation of nested `if s`

for providing a CASE statement in a programming language. The principal motivation is to facilitate the generation of efficient target code. The IF... THEN ... ELSE statement is most naturally translated as follows:

```

r1 := ...           -- calculate tested expression
if r1 ≠ 1 goto L1
  clause_A
  goto L6
L1: if r1 = 2 goto L2
    if r1 ≠ 7 goto L3
L2: clause_B
    goto L6
L3: if r1 < 3 goto L4
    if r1 > 5 goto L4
    clause_C
    goto L6
L4: if r1 ≠ 10 goto L5
    clause_D
    goto L6
L5: clause_E
L6:

```

Rather than test its expression sequentially against a series of possible values, the case statement is meant to *compute* an address to which it jumps in a single instruction. The general form of the target code generated from a case statement appears in [Figure 6.4](#). The code at label L6 can take any of several forms. The most common of these simply indexes into an array:

EXAMPLE 6.51

Jump tables

```

T:  &L1           -- tested expression = 1
    &L2
    &L3
    &L3
    &L3
    &L5
    &L2
    &L5
    &L5
    &L4           -- tested expression = 10
L6: r1 := ...     -- calculate tested expression
    if r1 < 1 goto L5
    if r1 > 10 goto L5  -- L5 is the "else" arm
    r1 -= 1           -- subtract off lower bound
    r2 := T[r1]
    goto *r2
L7:

```

Here the “code” at label T is actually a table of addresses, known as a *jump table*. It contains one entry for each integer between the lowest and highest values, inclusive, found among the case statement labels. The code at L6 checks to make

```

        goto L6          -- jump to code to compute address
L1:  clause_A
        goto L7
L2:  clause_B
        goto L7
L3:  clause_C
        goto L7
        ...
L4:  clause_D
        goto L7
L5:  clause_E
        goto L7

L6:  r1 := ...          -- computed target of branch
        goto *r1
L7:

```

Figure 6.4 General form of target code generated for a five-arm case statement.

sure that the tested expression is within the bounds of the array (if not, we should execute the `else` arm of the `case` statement). It then fetches the corresponding entry from the table and branches to it. ■

Alternative Implementations

A linear jump table is fast. It is also space efficient when the overall set of case statement labels is dense and does not contain large ranges. It can consume an extraordinarily large amount of space, however, if the set of labels is nondense, or includes large value ranges. Alternative methods to compute the address to which to branch include sequential testing, hashing, and binary search. Sequential testing (as in an `if... then... else` statement) is the method of choice if the total number of case statement labels is small. It runs in time $O(n)$, where n is the number of labels. A hash table is attractive if the range of label values is large, but has many missing values and no large ranges. With an appropriate hash function it will run in time $O(1)$. Unfortunately, a hash table requires a separate entry for each possible value of the tested expression, making it unsuitable for statements with large value ranges. Binary search can accommodate ranges easily. It runs in time $O(\log n)$, with a relatively low constant factor.

To generate good code for all possible case statements, a compiler needs to be prepared to use a variety of strategies. During compilation it can generate code for the various arms of the case statement as it finds them, while simultaneously building up an internal data structure to describe the label set. Once it has seen all the arms, it can decide which form of target code to generate. For the sake of simplicity, most compilers employ only some of the possible implementations. Many use binary search in lieu of hashing. Some generate only indexed jump tables; others only that plus sequential testing. Users of less sophisticated compilers may need to restructure their case statements if the generated code turns out to be unexpectedly large or slow.

Syntax and Label Semantics

As with `if... then... else` statements, the syntactic details of `case` statements vary from language to language. Different languages use different punctuation to delimit labels and arms. More significantly, languages differ in whether they permit label ranges, whether they permit (or require) a default (`else`) clause, and in how they handle a value that fails to match any label at run time.

Standard Pascal does not permit a default clause: all values on which to take action must appear explicitly in label lists. It is a dynamic semantic error for the expression to evaluate to a value that does not appear. Most Pascal compilers permit the programmer to add a default clause, labeled either `else` or `otherwise`, as a language extension. Modula allows an optional `else` clause. If one does not appear in a given `case` statement, then it is a dynamic semantic error for the tested expression to evaluate to a missing value. Ada requires arm labels to cover *all* possible values in the domain of the tested expression's type. If the type of tested expression has a very large number of values, then this coverage must be accomplished using ranges or an `others` clause. In some languages, notably C and Fortran 90, it is *not* an error for the tested expression to evaluate to a missing value. Rather, the entire construct has no effect when the value is missing.

The C switch Statement

C's syntax for `case` (`switch`) statements (retained by C++ and Java) is unusual in several respects:

```
switch (... /* tested expression */) {
    case 1:  clause_A
            break;
    case 2:
    case 7:  clause_B
            break;
    case 3:
    case 4:
    case 5:  clause_C
            break;
    case 10: clause_D
            break;
    default: clause_E
            break;
}
```

DESIGN & IMPLEMENTATION

Case statements

Case statements are one of the clearest examples of language design driven by implementation. Their primary reason for existence is to facilitate the generation of jump tables. Ranges in label lists (not permitted in Pascal or C) may reduce efficiency slightly, but binary search is still dramatically faster than the equivalent series of `ifs`.

Here each possible value for the tested expression must have its own label within the `switch`; ranges are not allowed. In fact, lists of labels are not allowed, but the effect of lists can be achieved by allowing a label (such as 2, 3, and 4 above) to have an *empty* arm that simply “falls through” into the code for the subsequent label. Because of the provision for fall-through, an explicit `break` statement must be used to get out of the `switch` at the end of an arm, rather than falling through into the next. There are rare circumstances in which the ability to fall through is convenient:

EXAMPLE 6.52

Fall-through in C `switch` statements

```
letter_case = lower;
switch (c) {
    ...
    case 'A' :
        letter_case = upper;
        /* FALL THROUGH! */
    case 'a' :
        ...
        break;
    ...
}
```

Most of the time, however, the need to insert a `break` at the end of each arm—and the compiler’s willingness to accept arms without breaks, silently—is a recipe for unexpected and difficult-to-diagnose bugs. C# retains the familiar C syntax, including multiple consecutive labels, but requires every nonempty arm to end with a `break`, `goto`, `continue`, or `return`.

✓ CHECK YOUR UNDERSTANDING

19. List the principal uses of `goto`, and the structured alternatives to each.
20. Explain the distinction between exceptions and multilevel returns.
21. What are *continuations*? What other language features do they subsume?
22. Why is sequencing a comparatively unimportant form of control flow in Lisp?
23. Explain why it may sometimes be useful for a function to have side effects.
24. Describe the *jump code* implementation of the short-circuit Boolean evaluation.
25. Why do imperative languages commonly provide a `case` statement in addition to `if... then... else`?
26. Describe three different search strategies that might be employed in the implementation of a `case` statement, and the circumstances in which each would be desirable.

6.5 Iteration

Iteration and recursion are the two mechanisms that allow a computer to perform similar operations repeatedly. Without at least one of these mechanisms, the running time of a program (and hence the amount of work it can do and the amount of space it can use) would be a linear function of the size of the program text. In a very real sense, it is iteration and recursion that make computers useful. In this section we focus on iteration. Recursion is the subject of [Section 6.6](#).

Programmers in imperative languages tend to use iteration more than they use recursion (recursion is more common in functional languages). In most languages, iteration takes the form of *loops*. Like the statements in a sequence, the iterations of a loop are generally executed for their side effects: their modifications of variables. Loops come in two principal varieties, which differ in the mechanisms used to determine how many times to iterate. An *enumeration-controlled* loop is executed once for every value in a given finite set; the number of iterations is known before the first iteration begins. A *logically controlled* loop is executed until some Boolean condition (which must generally depend on values altered in the loop) changes value. The two forms of loops share a single construct in Algol 60 in Common Lisp. They are distinct in most other languages.

6.5.1 Enumeration-Controlled Loops

Enumeration-controlled iteration originated with the `do` loop of Fortran I. Similar mechanisms have been adopted in some form by almost every subsequent language, but syntax and semantics vary widely. Even Fortran's own loop has evolved considerably over time. The Fortran 90 version (retained by Fortran 2003 and 2008) looks something like this:

EXAMPLE 6.53

Fortran 90 `do` loop

```
do i = 1, 10, 2
  ...
enddo
```

Variable `i` is called the *index* of the loop. The expressions that follow the equals sign are `i`'s *initial value*, its *bound*, and the *step size*. With the values shown here, the *body* of the loop (the statements between the loop header and the `enddo` delimiter) will execute five times, with `i` set to 1, 3, ..., 9 in successive iterations. ■

EXAMPLE 6.54

Modula-2 `for` loop

```
FOR i := first TO last BY step DO
  ...
END
```

By choosing different values of `first`, `last`, and `step`, we can arrange to iterate over an arbitrary arithmetic sequence of integers, namely $i = \text{first}, \text{first} + \text{step}, \dots, \text{first} + (\lfloor (\text{last} - \text{first}) / \text{step} \rfloor) \times \text{step}$. ■

Following the lead of Clu, many modern languages allow enumeration-controlled loops to iterate over much more general finite sets—the nodes of a tree, for example, or the elements of a collection. We consider these more general *iterators* in Section 6.5.3. For the moment we focus on arithmetic sequences. For the sake of simplicity, we use the name “for loop” as a general term, even for languages that use a different keyword.

Code Generation for for Loops

EXAMPLE 6.55

Obvious translation of a for loop

Naively, the loop of Example 6.54 can be translated as

```

r1 := first
r2 := step
r3 := last
L1: if r1 > r3 goto L2
    ...
    r1 := r1 + r2
    goto L1
L2:

```

-- loop body; use r1 for i

EXAMPLE 6.56

For loop translation with test at the bottom

A slightly better if less straightforward translation is

```

r1 := first
r2 := step
r3 := last
goto L2
L1: ...
    r1 := r1 + r2
L2: if r1 ≤ r3 goto L1

```

-- loop body; use r1 for i

This version is likely to be faster, because each of the iterations contains a single conditional branch, rather than a conditional branch at the top and an unconditional branch at the bottom. (We will consider yet another version in Exercise ©16.4.) ■

Note that both of these translations employ a loop-ending test that is fundamentally *directional*: as shown, they assume that all the realized values of `i` will be smaller than `last`. If the loop goes “the other direction”—that is, if `first` > `last`, and `step` < 0—then we will need to use the inverse test to end the loop. To allow the compiler to make the right choice, many languages restrict the generality of their arithmetic sequences. Commonly, `step` is required to be a compile-time constant. Ada actually limits the choices to ± 1 . Several languages, including both Ada and Pascal, require special syntax for loops that iterate “backward” (`for i in reverse 10..1` in Ada; `for i := 10 downto 1` in Pascal).

EXAMPLE 6.57

FOR loop translation with an iteration count

Obviously, one can generate code that checks the sign of `step` at run time, and chooses a test accordingly. The obvious translations, however, are either time or space inefficient. An arguably more attractive approach, adopted by many Fortran compilers, is to precompute the number of iterations, place this *iteration count* in a register, decrement the register at the end of each iteration, and branch back to the top of the loop if the count is not yet zero:

```

r1 := first
r2 := step
r3 := max([(last - first + step)/step], 0)    -- iteration count
      -- NB: this calculation may require several instructions.
      -- It is guaranteed to result in a value within the precision of the machine,
      -- but we may have to be careful to avoid overflow during its calculation.
if r3 ≤ 0 goto L2
L1: ...                                     -- loop body; use r1 for i
   r1 := r1 + r2
   r3 := r3 - 1
   if r3 > 0 goto L1
   i := r1
L2:

```

EXAMPLE 6.58

A “gotcha” in the naive loop translation

The use of the iteration count avoids the need to test the sign of `step` within the loop. Assuming we have been suitably careful in precomputing the count, it also avoids a problem we glossed over in the naive translations of [Examples 6.55](#) and [6.56](#): If `last` is near the maximum value representable by integers on our machine, naively adding `step` to the final legitimate value of `i` may result in arithmetic overflow. The “wrapped” number may then appear to be smaller (much smaller!) than `last`, and we may have translated perfectly good source code into an infinite loop. ■

Some processors, including the PowerPC, PA-RISC, and most CISC machines, can decrement the iteration count, test it against zero, and conditionally branch, all in a single instruction. For many loops this results in very efficient code.

Semantic Complications

The astute reader may have noticed that use of an iteration count is fundamentally dependent on being able to predict the number of iterations before the loop begins to execute. While this prediction is possible in many languages, including Fortran and Ada, it is *not* possible in others, notably C and its descendants. The difference stems largely from the following question: is the `for` loop construct *only* for iteration, or is it simply meant to make enumeration easy? If the language insists on enumeration, then an iteration count works fine. If enumeration is only *one possible* purpose for the loop—more specifically, if the number of iterations or the sequence of index values may change as a result of executing the first few iterations—then we may need to use a more general implementation, along the lines of [Example 6.56](#), modified if necessary to handle dynamic discovery of the direction of the terminating test.

The choice between requiring and (merely) enabling enumeration manifests itself in several specific questions:

1. Can control enter or leave the loop in any way other than through the enumeration mechanism?
2. What happens if the loop body modifies variables that were used to compute the end-of-loop bound?
3. What happens if the loop body modifies the index variable itself?
4. Can the program read the index variable after the loop has completed, and if so, what will its value be?

Questions (1) and (2) are relatively easy to resolve. Most languages allow a `break/exit` statement to leave a `for` loop early. Fortran IV allowed a `goto` to jump *into* a loop, but this was generally regarded as a language flaw; Fortran 77 and most other languages prohibit such jumps. Similarly, most languages (but not C; see [Section 6.5.2](#)) specify that the bound is computed only once, before the first iteration, and kept in a temporary location. Subsequent changes to variables used to compute the bound have no effect on how many times the loop iterates.

Questions (3) and (4) are more difficult. Suppose we write (in no particular language)

```
for i := 1 to 10 by 2
...
if i = 3
    i := 6
```

EXAMPLE 6.59

Changing the index in a `for` loop

DESIGN & IMPLEMENTATION

Numerical imprecision

Among its many changes to the `do` loop of Fortran IV, Fortran 77 allowed the index, bounds, and step size of the loop to be floating-point numbers, not just integers. Interestingly, this feature was taken back out of the language in Fortran 90.

The problem with real-number sequences is that limited precision can cause comparisons (e.g., between the index and the bound) to produce unexpected or even implementation-dependent results when the values are close to one another. Should

```
for x := 1.0 to 2.0 by 1.0 / 3.0
```

execute three iterations or four? It depends on whether $1.0 / 3.0$ is rounded up or down. The Fortran 90 designers appear to have decided that such ambiguity is philosophically inconsistent with the idea of finite enumeration. The programmer who wants to iterate over floating-point values must use an explicit comparison in a pretest or post-test loop ([Section 6.5.5](#)).

What should happen at the end of the $i = 3$ iteration? Should the next iteration have $i = 5$ (the next element of the arithmetic sequence specified in the loop header), $i = 8$ (2 more than 6), or even conceivably $i = 7$ (the next value of the sequence after 6)? One can imagine reasonable arguments for each of these options. To avoid the need to choose, many languages prohibit changes to the loop index within the body of the loop. Fortran makes the prohibition a matter of programmer discipline: the implementation is not required to catch an erroneous update. Pascal provides an elaborate set of conservative rules [Int90, Sec. 6.8.3.9] that allow the compiler to catch all possible updates. These rules are complicated by the fact that the index variable is declared outside the loop; it may be visible to subroutines called from the loop even if it is not passed as a parameter. ■

EXAMPLE 6.60

Inspecting the index after a
for loop

If control escapes the loop with a `break/exit`, the natural value for the index would seem to be the one that was current at the time of the escape. For “normal” termination, on the other hand, the natural value would seem to be the first one that exceeds the loop bound. Certainly that is the value that will be produced by the implementation of [Example 6.56](#). Unfortunately, as we noted in [Example 6.57](#), the “next” value for some loops may be outside the range of integer precision. For other loops, it may be semantically invalid:

```
c : 'a'..'z'           -- character subrange
...
for c := 'a' to 'z' do
...
-- what comes after 'z'?
```

Requiring the post-loop value to always be the index of the final iteration is unattractive from an implementation perspective: it would force us to replace [Example 6.56](#) with a translation that has an extra branch instruction in every iteration:

```
    r1 := 'a'
    r2 := 'z'
    if r1 > r2 goto L3    -- Code improver may remove this test,
                        -- since 'a' and 'z' are constants.
L1: ...                  -- loop body; use r1 for i
    if r1 = r2 goto L2
    r1 := r1 + 1
    goto L1
L2: i := r1
L3:
```

Of course, the compiler must generate this sort of code in any event (or use an iteration count) if arithmetic overflow may interfere with testing the terminating condition. To permit the compiler to use the fastest correct implementation in all cases, several languages, including Fortran 90 and Pascal, say that the value of the index is undefined after the end of the loop. ■

An attractive solution to both the index modification problem and the post-loop value problem was pioneered by Algol W and Algol 68, and subsequently adopted by Ada, Modula 3, and many other languages. In these, the header of the loop is considered to contain a *declaration* of the index. Its type is inferred from the bounds of the loop, and its scope is the loop's body. Because the index is not visible outside the loop, its value is not an issue. Of course, the programmer must not give the index the same name as any variable that must be accessed within the loop, but this is a strictly local issue: it has no ramifications outside the loop.

6.5.2 Combination Loops

As noted briefly above, Algol 60 provides a single loop construct that subsumes the properties of more modern enumeration and logically controlled loops. It can specify an arbitrary number of “enumerators,” each of which can be a single value, a range of values similar to that of modern enumeration-controlled loops, or an expression with a terminating condition. Common Lisp provides an even more powerful facility, with four separate sets of clauses, to initialize index variables (of which there may be an arbitrary number), test for loop termination (in any of several ways), evaluate body expressions, and cleanup at loop termination.

A much simpler form of combination loop appears in C and its successors. Semantically, the C `for` loop is logically controlled. It was designed, however, to make enumeration easy. Our Modula-2 example

EXAMPLE 6.61

Combination (`for`) loop
in C

```
FOR i := first TO last BY step DO
  ...
END
```

would usually be written in C as

```
for (i = first; i <= last; i += step) {
  ...
}
```

C defines this to be precisely equivalent to

```
{
  i = first;
  while (i <= last) {
    ...
    i += step;
  }
}
```

This definition means that it is the programmer's responsibility to worry about the effect of overflow on testing of the terminating condition. It also means that both the index and any variables contained in the terminating condition can be

modified by the body of the loop, or by subroutines it calls, and these changes *will* affect the loop control. This, too, is the programmer’s responsibility.

Any of the three clauses in the `for` loop header can be null (the condition is considered true if missing). Alternatively, a clause can consist of a sequence of comma-separated expressions. The advantage of the C `for` loop over its `while` loop equivalent is compactness and clarity. In particular, all of the code affecting the flow of control is localized within the header. In the `while` loop, one must read both the top and the bottom of the loop to know what is going on.

While the logical iteration semantics of the C `for` loop eliminate any ambiguity about the value of the index variable after the end of the loop, it may still be convenient to make the index local to the body of the loop, by declaring it in the header’s initialization clause. In [Example 6.61](#), variable `i` must be declared in the surrounding scope. If we instead write

EXAMPLE 6.62

C `for` loop with a local index

```
for (int i = first; i <= last; i += step) {
    ...
}
```

then `i` will not be visible outside. It will still, however, be vulnerable to (deliberate or accidental) modification within the loop. ■

6.5.3 Iterators

In all of the examples we have seen so far (with the possible exception of the combination loops of Algol 60, Common Lisp, or C), a `for` loop iterates over the elements of an arithmetic sequence. In general, however, we may wish to iterate over the elements of any well-defined set (what are often called *containers* or *collections* in object-oriented code). Clu introduced an elegant *iterator* mechanism (also found in Python, Ruby, and C#) to do precisely that. Euclid and several more recent languages, notably C++ and Java, define a standard interface for *iterator objects* (sometimes called *enumerators*) that are equally easy to use, but not as

DESIGN & IMPLEMENTATION

For loops

Modern `for` loops reflect the impact of both semantic and implementation challenges. Semantic challenges include changes to loop indices or bounds from within the loop, the scope of the index variable (and its value, if any, outside the loop), and `gotos` that enter or leave the loop. Implementation challenges include the imprecision of floating-point values, the direction of the bottom-of-loop test, and overflow at the end of the iteration range. The “combination loops” of C ([Section 6.5.2](#)) move responsibility for these challenges out of the compiler and into the application program.

easy to write. Icon, conversely, provides a generalization of iterators, known as *generators*, that combines enumeration with backtracking search.⁶

True Iterators

Clu, Python, Ruby, and C# allow any container abstraction to provide an *iterator* that enumerates its items. The iterator resembles a subroutine that is permitted to contain `yield` statements, each of which produces a loop index value. For loops are then designed to incorporate a call to an iterator. The Modula-2 fragment

EXAMPLE 6.63

Simple iterator in Python

```
FOR i := first TO last BY step DO
    ...
END
```

would be written as follows in Python.

```
for i in range(first, last, step):
    ...
```

Here `range` is a built-in iterator that yields the integers from `first` to `first + [(last - first)/step] × step` in increments of `step`. ■

When called, the iterator calculates the first index value of the loop, which it returns to the main program by executing a `yield` statement. The `yield` behaves like `return`, except that when control transfers back to the iterator after completion of the first iteration of the loop, the iterator continues where it last left off—*not* at the beginning of its code. When the iterator has no more elements to yield it simply returns (without a value), thereby terminating the loop.

In effect, an iterator is a separate thread of control, with its own program counter, whose execution is interleaved with that of the `for` loop to which it supplies index values.⁷ The iteration mechanism serves to “decouple” the algorithm required to enumerate elements from the code that uses those elements.

EXAMPLE 6.64

Python iterator for tree enumeration

The `range` iterator is predefined in Python. As a more illustrative example, consider the preorder enumeration of values stored in a binary tree. A Python iterator for this task appears in Figure 6.5. Invoked from the header of a `for` loop, it yields the value in the root node (if any) for the first iteration and then calls itself recursively, twice, to enumerate values in the left and right subtrees. ■

⁶ Unfortunately, terminology is not consistent across languages. Euclid uses the term “generator” for what are called “iterator objects” here. Python uses it for what are called “true iterators” here.

⁷ Because iterators are interleaved with loops in a very regular way, they can be implemented more easily (and cheaply) than fully general threads. We will consider implementation options further in Section ©8.6.3.

```

class BinTree:
    def __init__(self):      # constructor
        self.data = self.lchild = self.rchild = None
        ...
    # other methods: insert, delete, lookup, ...

    def preorder(self):
        if self.data != None:
            yield self.data
        if self.lchild != None:
            for d in self.lchild.preorder():
                yield d
        if self.rchild != None:
            for d in self.rchild.preorder():
                yield d

```

Figure 6.5 Python iterator for preorder enumeration of the nodes of a binary tree. Because Python is dynamically typed, this code will work for any data that support the operations needed by `insert`, `lookup`, and so on (probably just `<`). In a statically typed language, the `BinTree` class would need to be generic.

Iterator Objects

As realized in most imperative languages, iteration involves both a special form of `for` loop and a mechanism to enumerate values for the loop. These concepts can be separated. Euclid, C++, and Java all provide enumeration-controlled loops reminiscent of those of Python. They have no `yield` statement, however, and no separate thread-like context to enumerate values; rather, an iterator is an ordinary object (in the object-oriented sense of the word) that provides methods for initialization, generation of the next index value, and testing for completion. Between calls, the state of the iterator must be kept in the object's data members.

[Figure 6.6](#) contains the Java equivalent of the `BinTree` class of [Figure 6.5](#). Given this code, we can write

```

BinTree<Integer> myTree = ...
...
for (Integer i : myTree) {
    System.out.println(i);
}

```

EXAMPLE 6.65

Java iterator for tree enumeration

DESIGN & IMPLEMENTATION

“True” iterators and iterator objects

While the iterator library mechanisms of C++ and Java are highly useful, it is worth emphasizing that they are *not* the functional equivalents of “true” iterators, as found in Clu, Python, Ruby, and C#. Their key limitation is the need to maintain all intermediate state in the form of explicit data structures, rather than in the program counter and local variables of a resumable execution context.

The loop here is syntactic sugar for

```
for (Iterator<Integer> it = myTree.iterator(); it.hasNext();) {
    Integer i = it.next();
    System.out.println(i);
}
```

The expression following the colon in the more concise version of the loop must be an object that supports the standard `Iterable` interface. This interface includes an `iterator()` method that returns an `Iterator` object. ■

EXAMPLE 6.66

Iterator objects in C++

C++ takes a different tack. Rather than propose a special version of the `for` loop that would interface with iterator objects, the designers of the C++ standard library used the language’s unusually flexible overloading and reference mechanisms (Sections 3.5.2 and 8.3.1) to redefine comparison (`!=`), increment (`++`), dereference (`*`), and so on in a way that makes iterating over the elements of a set look very much like using pointer arithmetic (Section 7.7.1) to traverse a conventional array:

```
bin_tree<int> *my_tree = ...
...
for (bin_tree<int>::iterator n = my_tree->begin();
     n != my_tree->end(); ++n) {
    cout << *n << "\n";
}
```

C++ encourages programmers to think of iterators as if they were pointers. Iterator `n` in this example encapsulates all the state encapsulated by iterator `it` in the (no syntactic sugar) Java code of Example 6.65. To obtain the next element of the set, however, the C++ programmer “dereferences” `n`, using the `*` or `->` operators. To advance to the following element, the programmer uses the increment (`++`) operator. The `end` method returns a reference to a special iterator that “points beyond the end” of the set. The increment (`++`) operator must return a reference that tests equal to this special iterator when the set has been exhausted. ■

We leave the code of the C++ tree iterator to Exercise 6.17. The details are somewhat messier than Figure 6.6, due to operator overloading, the value model of variables (which requires explicit references and pointers), and the lack of garbage collection. Also, because C++ lacks a common `Object` base class, its containers must always be declared as generics and instantiated for some particular element type.

Iterating with First-Class Functions

In functional languages, the ability to specify a function “in line” facilitates a programming idiom in which the body of a loop is written as a function, with the

```

class BinTree<T> implements Iterable<T> {
    BinTree<T> left;
    BinTree<T> right;
    T val;
    ...
    // other methods: insert, delete, lookup, ...

    public Iterator<T> iterator() {
        return new TreeIterator(this);
    }
    private class TreeIterator implements Iterator<T> {
        private Stack<BinTree<T>> s = new Stack<BinTree<T>>();
        TreeIterator(BinTree<T> n) {
            if (n.val != null) s.push(n);
        }
        public boolean hasNext() {
            return !s.empty();
        }
        public T next() {
            if (!hasNext()) throw new NoSuchElementException();
            BinTree<T> n = s.pop();
            if (n.right != null) s.push(n.right);
            if (n.left != null) s.push(n.left);
            return n.val;
        }
        public void remove() {
            throw new UnsupportedOperationException();
        }
    }
}

```

Figure 6.6 Java code for preorder enumeration of the nodes of a binary tree. The nested `TreeIterator` class uses an explicit `Stack` object (borrowed from the standard library) to keep track of subtrees whose nodes have yet to be enumerated. Java generics, specified as `<T>` type arguments for `BinTree`, `Stack`, `Iterator`, and `Iterable`, allow `next` to return an object of the appropriate type, rather than the undifferentiated `Object`. The `remove` method is part of the `Iterator` interface, and must therefore be provided, if only as a placeholder.

EXAMPLE 6.67

Passing the “loop body”
to an iterator in Scheme

loop index as an argument. This function is then passed as the final argument to an iterator. In Scheme we might write

```

(define uptoby
  (lambda (low high step f)
    (if (<= low high)
        (begin
          (f low)
          (uptoby (+ low step) high step f))
        '())))

```

We could then sum the first 50 odd numbers as follows.

```
(let ((sum 0))
  (uptoby 1 100 2
    (lambda (i)
      (set! sum (+ sum i))))
  sum)                               ⇒ 2500
```

Here the body of the loop, `(set! sum (+ sum i))`, is an assignment. The \Rightarrow symbol (not a part of Scheme) is used here to mean “evaluates to.” ■

EXAMPLE 6.68

Iteration with blocks in Smalltalk

Smalltalk, which we consider in Section ©9.6.1, supports a similar idiom:

```
sum <- 0.
1 to: 100 by: 2 do:
  [:i | sum <- sum + i]
```

Like a `lambda` expression in Scheme, a square-bracketed *block* in Smalltalk creates a first-class function, which we then pass as argument to the `to: by: do:` iterator. The iterator calls the function repeatedly, passing successive values of the index variable `i` as argument. Iterators in Ruby employ a similar but somewhat less general mechanism: where a Smalltalk method can take an arbitrary number of blocks as argument, a Ruby method can take only one. Continuations (Section 6.2.2) and lazy evaluation (Section 6.6.2) also allow the Scheme/Lisp programmer to create iterator objects and more traditional looking true iterators; we consider these options in Exercises 6.32 and 6.33. ■

Iterating without Iterators

EXAMPLE 6.69

Imitating iterators in C

In a language with neither true iterators nor iterator objects, we can still decouple set enumeration from element use through programming conventions. In C, for example, we might define a `tree_iter` type and associated functions that could be used in a loop as follows:

```
bin_tree *my_tree;
tree_iter ti;
...
for (ti_create(my_tree, &ti); !ti_done(ti); ti_next(&ti)) {
    bin_tree *n = ti_val(ti);
    ...
}
ti_delete(&ti);
```

There are two principal differences between this code and the more structured alternatives: (1) the syntax of the loop is a good bit less elegant (and arguably more prone to accidental errors), and (2) the code for the iterator is simply a type and some associated functions. C provides no abstraction mechanism to group them together as a module or a class. By providing a standard interface for iterator abstractions, object-oriented languages like C++, Python, Ruby, Java,

and C# facilitate the design of higher-order mechanisms that manipulate whole containers: sorting them, merging them, finding their intersection or difference, and so on. We leave the C code for `tree_iter` and the various `ti_` functions to [Exercise 6.18](#). ■

6.5.4 Generators in Icon

Icon generalizes the concept of iterators, providing a *generator* mechanism that causes any expression in which it is embedded to enumerate multiple values on demand.

© IN MORE DEPTH

We consider Icon generators in more detail on the PLP CD. The language's enumeration-controlled loop, the `every` loop, can contain not only a generator, but any expression that *contains* a generator. Generators can also be used in constructs like `if` statements, which will execute their nested code if *any* generated value makes the condition true, automatically searching through all the possibilities. When generators are nested, Icon explores all possible combinations of generated values, and will even *backtrack* where necessary to undo unsuccessful control flow branches or assignments.

6.5.5 Logically Controlled Loops

In comparison to enumeration-controlled loops, logically controlled loops have many fewer semantic subtleties. The only real question to be answered is where within the body of the loop the terminating condition is tested. By far the most common approach is to test the condition before each iteration. The familiar `while` loop syntax for this was introduced in Algol-W:

EXAMPLE 6.70

While loop in Pascal

```
while condition do statement
```

To allow the body of the loop to be a statement list, most modern languages use an explicit concluding keyword (e.g., `end`), or bracket the body with delimiters (e.g., `{ ... }`). A few languages (notably Python) indicate the body with an extra level of indentation. ■

Post-test Loops

Occasionally it is handy to be able to test the terminating condition at the bottom of a loop. Pascal introduced special syntax for this case, which was retained in Modula but dropped in Ada. A *post-test loop* allows us, for example, to write

EXAMPLE 6.71

Post-test loop in Pascal and Modula

```
repeat
  readln(line)
until line[1] = '$';
```

instead of

```
readln(line);
while line[1] <> '$' do
  readln(line);
```

The difference between these constructs is particularly important when the body of the loop is longer. Note that the body of a post-test loop is always executed at least once. ■

EXAMPLE 6.72

Post-test loop in C

C provides a post-test loop whose condition works “the other direction” (i.e., “while” instead of “until”):

```
do {
  line = read_line(stdin);
} while (line[0] != '$');
```

EXAMPLE 6.73

Break statement in C

Midtest Loops

Finally, as we noted in [Section 6.2.1](#), it is sometimes appropriate to test the terminating condition in the middle of a loop. In many languages this “midtest” can be accomplished with a special statement nested inside a conditional: `exit` in Ada, `break` in C, `last` in Perl. In [Section 6.4.2](#) we saw a somewhat unusual use of `break` to leave a C switch statement. More conventionally, C also uses `break` to exit the closest `for`, `while`, or `do` loop:

```
for (;;) {
  line = read_line(stdin);
  if (all_blanks(line)) break;
  consume_line(line);
}
```

Here the missing condition in the `for` loop header is assumed to always be true. (C programmers have traditionally preferred this syntax to the equivalent `while (1)`, presumably because it was faster in certain early C compilers.) ■

EXAMPLE 6.74

Exiting a nested loop in Ada

In some languages, an exit statement takes an optional loop-name argument that allows control to escape a nested loop. In Ada we might write

```
outer: loop
  get_line(line, length);
  for i in 1..length loop
    exit outer when line(i) = '$';
    consume_char(line(i));
  end loop;
end loop outer;
```

EXAMPLE 6.75

Exiting a nested loop in Perl

In Perl this would be

```

outer: while (>) {
    foreach $c (split //) {
        last outer if ($c =~ '$'); # exit main loop if we see a $ sign
        consume_char($c);
    }
}

```

Java extends the C/C++ `break` statement in a similar fashion, with optional labels on loops.

✓ CHECK YOUR UNDERSTANDING

27. Describe three subtleties in the implementation of enumeration-controlled loops.
28. Why do most languages not allow the bounds or increment of an enumeration-controlled loop to be floating-point numbers?
29. Why do many languages require the step size of an enumeration-controlled loop to be a compile-time constant?
30. Describe the “iteration count” loop implementation. What problem(s) does it solve?
31. What are the advantages of making an index variable local to the loop it controls?
32. Does C have enumeration-controlled loops? Explain.
33. What is a *container* (a *collection*)?
34. Explain the difference between true iterators and iterator objects.
35. Cite two advantages of iterator objects over the use of programming conventions in a language like C.
36. Describe the approach to iteration typically employed in languages with first-class functions.
37. Give an example in which a *midtest* loop results in more elegant code than does a pretest or post-test loop.

6.6 Recursion

Unlike the control-flow mechanisms discussed so far, recursion requires no special syntax. In any language that provides subroutines (particularly functions), all that

is required is to permit functions to call themselves, or to call other functions that then call them back in turn. Most programmers learn in a data structures class that recursion and (logically controlled) iteration provide equally powerful means of computing functions: any iterative algorithm can be rewritten, automatically, as a recursive algorithm, and vice versa. We will compare iteration and recursion in more detail in the first subsection below. In the following subsection we will consider the possibility of passing *unevaluated* expressions into a function. While usually inadvisable, due to implementation cost, this technique will sometimes allow us to write elegant code for functions that are only defined on a subset of the possible inputs, or that explore logically infinite data structures.

6.6.1 Iteration and Recursion

As we noted in [Section 3.2](#), Fortran 77 and certain other languages do not permit recursion. A few functional languages do not permit iteration. Most modern languages, however, provide both mechanisms. Iteration is in some sense the more “natural” of the two in imperative languages, because it is based on the repeated modification of variables. Recursion is the more natural of the two in functional languages, because it does *not* change variables. In the final analysis, which to use in which circumstance is mainly a matter of taste. To compute a sum,

EXAMPLE 6.76

A “naturally iterative” problem

$$\sum_{1 \leq i \leq 10} f(i)$$

it seems natural to use iteration. In C one would say:

```
typedef int (*int_func) (int);
int summation(int_func f, int low, int high) {
    /* assume low <= high */
    int total = 0;
    int i;
    for (i = low; i <= high; i++) {
        total += f(i);
    }
    return total;
}
```

EXAMPLE 6.77

A “naturally recursive” problem

To compute a value defined by a recurrence,

$$\text{gcd}(a, b) \equiv \begin{cases} a & \text{if } a = b \\ \text{gcd}(a-b, b) & \text{if } a > b \\ \text{gcd}(a, b-a) & \text{if } b > a \end{cases}$$

(positive integers, a, b)

recursion may seem more natural:

```

int gcd(int a, int b) {
    /* assume a, b > 0 */
    if (a == b) return a;
    else if (a > b) return gcd(a-b, b);
    else return gcd(a, b-a);
}

```

EXAMPLE 6.78

Implementing problems
“the other way”

In both these cases, the choice could go the other way:

```

typedef int (*int_func) (int);
int summation(int_func f, int low, int high) {
    /* assume low <= high */
    if (low == high) return f(low);
    else return f(low) + summation(f, low+1, high);
}

int gcd(int a, int b) {
    /* assume a, b > 0 */
    while (a != b) {
        if (a > b) a = a-b;
        else b = b-a;
    }
    return a;
}

```

Tail Recursion

It is sometimes argued that iteration is more efficient than recursion. It is more accurate to say that *naive implementation* of iteration is usually more efficient than naive implementation of recursion. In the examples above, the iterative implementations of summation and greatest divisors will be more efficient than the recursive implementations if the latter make real subroutine calls that allocate space on a run-time stack for local variables and bookkeeping information. An “optimizing” compiler, however, particularly one designed for a functional language, will often be able to generate excellent code for recursive functions. It is particularly likely to do so for *tail-recursive* functions such as `gcd` above. A tail-recursive function is one in which additional computation never follows a recursive call: the return value is simply whatever the recursive call returns. For such functions, dynamically allocated stack space is unnecessary: the compiler can *reuse* the space belonging to the current iteration when it makes the recursive call. In effect, a good compiler will recast the recursive `gcd` function above as follows.

EXAMPLE 6.79

Iterative implementation of
tail recursion

```

int gcd(int a, int b) {
    /* assume a, b > 0 */
    start:
    if (a == b) return a;
    else if (a > b) {
        a = a-b; goto start;
    }
}

```

```

    } else {
      b = b-a; goto start;
    }
  }
}

```

Even for functions that are not tail-recursive, automatic, often simple transformations can produce tail-recursive code. The general case of the transformation employs conversion to what is known as *continuation-passing style* [FWH01, Chaps. 7–8]. In effect, a recursive function can always avoid doing any work after returning from a recursive call by passing that work into the recursive call, in the form of a continuation.

Some specific transformations (not based on continuation passing) are often employed by skilled users of functional languages. Consider, for example, the recursive summation function above, written here in Scheme:

EXAMPLE 6.80

By-hand creation of tail-recursive code

```

(define summation (lambda (f low high)
  (if (= low high)
      (f low) ; then part
      (+ (f low) (summation f (+ low 1) high)))) ; else part

```

Recall that Scheme, like all Lisp dialects, uses Cambridge Polish notation for expressions. The `lambda` keyword is used to introduce a function. As recursive calls return, our code calculates the sum from “right to left”: from `high` down to `low`. If the programmer (or compiler) recognizes that addition is associative, we can rewrite the code in a tail-recursive form:

```

(define summation (lambda (f low high subtotal)
  (if (= low high)
      (+ subtotal (f low))
      (summation f (+ low 1) high (+ subtotal (f low)))))

```

Here the `subtotal` parameter accumulates the sum from left to right, passing it into the recursive calls. Because it is tail recursive, this function can be translated into machine code that does not allocate stack space for recursive calls. Of course, the programmer won’t want to pass an explicit `subtotal` parameter to the initial call, so we hide it (the parameter) in an auxiliary, “helper” function:

```

(define summation (lambda (f low high)
  (letrec ((sum-helper (lambda (low subtotal)
    (let ((new_subtotal (+ subtotal (f low))))
      (if (= low high)
          new_subtotal
          (sum-helper (+ low 1) new_subtotal))))))
    (sum-helper low 0)))

```

The `let` construct in Scheme serves to introduce a nested scope in which local names (e.g., `new_subtotal`) can be defined. The `letrec` construct permits the definition of recursive functions (e.g., `sum-helper`). ■

Thinking Recursively

Detractors of functional programming sometimes argue, incorrectly, that recursion leads to *algorithmically inferior* programs. Fibonacci numbers, for example, are defined by the mathematical recurrence

$$F_n \equiv \begin{cases} 1 & \text{if } n = 0 \text{ or } n = 1 \\ F_{n-1} + F_{n-2} & \text{otherwise} \end{cases}$$

(nonnegative integer n)

The naive way to implement this recurrence in Scheme is

```
(define fib (lambda (n)
  (cond ((= n 0) 1)
        ((= n 1) 1)
        (#t (+ (fib (- n 1)) (fib (- n 2))))))
; #t means 'true' in Scheme
```

Unfortunately, this algorithm takes exponential time, when linear time is possible.⁸ In C, one might write

```
int fib(int n) {
  int f1 = 1; int f2 = 1;
  int i;
  for (i = 2; i <= n; i++) {
    int temp = f1 + f2;
    f1 = f2; f2 = temp;
  }
  return f2;
}
```

One can write this iterative algorithm in Scheme: Scheme includes (nonfunctional) iterative features. It is probably better, however, to draw inspiration from the tail-recursive version of the summation example above, and write the following $O(n)$ recursive function:

```
(define fib (lambda (n)
  (letrec ((fib-helper (lambda (f1 f2 i)
    (if (= i n)
        f2
        (fib-helper f2 (+ f1 f2) (+ i 1))))))
    (fib-helper 0 1 0))))
```

EXAMPLE 6.81

Naive recursive Fibonacci function

EXAMPLE 6.82

Linear iterative Fibonacci function

EXAMPLE 6.83

Efficient tail-recursive Fibonacci function

⁸ Actually, one can do substantially better than linear time using algorithms based on binary matrix multiplication or closest-integer rounding of continuous functions, but these approaches suffer from high constant-factor costs or problems with numeric precision. For most purposes the linear-time algorithm is a reasonable choice.

For a programmer accustomed to writing in a functional style, this code is perfectly natural. One might argue that it isn't "really" recursive; it simply casts an iterative algorithm in a tail-recursive form, and this argument has some merit. Despite the algorithmic similarity, however, there is an important difference between the iterative algorithm in C and the tail-recursive algorithm in Scheme: the latter has no side effects. Each recursive call of the `fib-helper` function creates a new scope, containing new variables. The language implementation may be able to reuse the space occupied by previous instances of the same scope, but it guarantees that this optimization will never introduce bugs. ■

6.6.2 Applicative- and Normal-Order Evaluation

Throughout the discussion so far we have assumed implicitly that arguments are evaluated before passing them to a subroutine. This need not be the case. It is possible to pass a representation of the *unevaluated* arguments to the subroutine instead, and to evaluate them only when (if) the value is actually needed. The former option (evaluating before the call) is known as *applicative-order evaluation*; the latter (evaluating only when the value is actually needed) is known as *normal-order evaluation*. Normal-order evaluation is what naturally occurs in macros (Section 3.7). It also occurs in short-circuit Boolean evaluation (Section 6.1.5), *call-by-name* parameters (to be discussed in Section 8.3.1), and certain functional languages (to be discussed in Section 10.4).

Algol 60 uses normal-order evaluation by default for user-defined functions (applicative order is also available). This choice was presumably made to mimic the behavior of macros (Section 3.7). Most programmers in 1960 wrote mainly in assembler, and were accustomed to macro facilities. Because the parameter-passing mechanisms of Algol 60 are part of the language, rather than textual abbreviations, problems like misinterpreted precedence or naming conflicts do not arise. Side effects, however, are still very much an issue. We will discuss Algol 60 parameters in more detail in Section 8.3.1.

Lazy Evaluation

From the points of view of clarity and efficiency, applicative-order evaluation is generally preferable to normal-order evaluation. It is therefore natural for it to be employed in most languages. In some circumstances, however, normal-order evaluation can actually lead to faster code, or to code that works when applicative-order evaluation would lead to a run-time error. In both cases, what matters is that normal-order evaluation will sometimes not evaluate an argument at all, if its value is never actually needed. Scheme provides for optional normal-order evaluation in the form of built-in functions called `delay` and `force`.⁹ These

⁹ More precisely, `delay` is a *special form*, rather than a function. Its argument is passed to it unevaluated.

functions provide an implementation of *lazy evaluation*. In the absence of side effects, lazy evaluation has the same semantics as normal-order evaluation, but the implementation keeps track of which expressions have already been evaluated, so it can reuse their values if they are needed more than once in a given referencing environment.

A delayed expression is sometimes called a *promise*. The mechanism used to keep track of which promises have already been evaluated is sometimes called *memoization*.¹⁰ Because applicative-order evaluation is the default in Scheme, the programmer must use special syntax not only to pass an unevaluated argument, but also to use it. In Algol 60, subroutine headers indicate which arguments are to be passed which way; the point of call and the uses of parameters within subroutines look the same in either case.

A common use of lazy evaluation is to create so-called *infinite* or *lazy data structures* that are “fleshed out” on demand. The following example, adapted from version 5 of the Scheme manual [ADH⁺98, p. 28], creates a “list” of all the natural numbers:

EXAMPLE 6.84

Lazy evaluation of an infinite data structure

```
(define naturals
  (letrec ((next (lambda (n) (cons n (delay (next (+ n 1))))))
    (next 1)))
  (define head car)
  (define tail (lambda (stream) (force (cdr stream))))
```

Here `cons` can be thought of, roughly, as a concatenation operator. `car` returns the head of a list; `cdr` returns everything but the head. Given these definitions, we can access as many natural numbers as we want, as shown in the following on the next page.

DESIGN & IMPLEMENTATION

Normal-order evaluation

Normal-order evaluation is one of many examples we have seen where arguably desirable semantics have been dismissed by language designers because of fear of implementation cost. Other examples in this chapter include side-effect freedom (which allows normal order to be implemented via lazy evaluation), iterators (Section 6.5.3), and nondeterminacy (Section 6.7). As noted in the sidebar on page 236, however, there has been a tendency over time to trade a bit of speed for cleaner semantics and increased reliability. Within the functional programming community, Miranda and its successor Haskell are entirely side-effect free, and use normal order (lazy) evaluation for all parameters.

¹⁰ Within the functional programming community, the term “lazy evaluation” is often used for any implementation that declines to evaluate unneeded function parameters; this includes both naive implementations of normal-order evaluation and the memoizing mechanism described here.

```
(head naturals)           ⇒ 1
(head (tail naturals))   ⇒ 2
(head (tail (tail naturals))) ⇒ 3
```

The list will occupy only as much space as we have actually explored. More elaborate lazy data structures (e.g., trees) can be valuable in combinatorial search problems, in which a clever algorithm may explore only the “interesting” parts of a potentially enormous search space. ■

6.7 Nondeterminacy

Our final category of control flow is nondeterminacy. A nondeterministic construct is one in which the choice between alternatives (i.e., between control paths) is deliberately unspecified. We have already seen examples of nondeterminacy in the evaluation of expressions (Section 6.1.4): in most languages, operator or subroutine arguments may be evaluated in any order. Some languages, notably Algol 68 and various concurrent languages, provide more extensive nondeterministic mechanisms, which cover statements as well.

© IN MORE DEPTH

Further discussion of nondeterminism can be found on the PLP CD. Absent a nondeterministic construct, the author of a code fragment in which order does not matter must choose some arbitrary (artificial) order. Such a choice can make it more difficult to construct a formal correctness proof. Some language designers have also argued that it is inelegant. The most compelling uses for nondeterminacy arise in concurrent programs, where imposing an arbitrary choice on the order in which a thread interacts with its peers may cause the system as a whole to deadlock. For such programs one may need to ensure that the choice among nondeterministic alternatives is *fair* in some formal sense.

✓ CHECK YOUR UNDERSTANDING

38. What is a *tail-recursive* function? Why is tail recursion important?
39. Explain the difference between *applicative* and *normal order* evaluation of expressions. Under what circumstances is each desirable?
40. What is *lazy evaluation*? What are *promises*? What is *memoization*?
41. Give two reasons why lazy evaluation may be desirable.
42. Name a language in which parameters are always evaluated lazily.
43. Give two reasons why a programmer might sometimes want control flow to be *nondeterministic*.

6.8 Summary and Concluding Remarks

In this chapter we introduced the principal forms of control flow found in programming languages: sequencing, selection, iteration, procedural abstraction, recursion, concurrency, exception handling and speculation, and nondeterminacy. Sequencing specifies that certain operations are to occur in order, one after the other. Selection expresses a choice among two or more control-flow alternatives. Iteration and recursion are the two ways to execute operations repeatedly. Recursion defines an operation in terms of simpler instances of itself; it depends on procedural abstraction. Iteration repeats an operation for its side effect(s). Sequencing and iteration are fundamental to imperative (especially von Neumann) programming. Recursion is fundamental to functional programming. Nondeterminacy allows the programmer to leave certain aspects of control flow deliberately unspecified. We touched on concurrency only briefly; it will be the subject of [Chapter 12](#). Procedural abstractions (subroutines) are the subject of [Chapter 8](#). Exception handling and speculation will be covered in [Sections 8.5](#) and [12.4.4](#).

Our survey of control-flow mechanisms was preceded by a discussion of expression evaluation. We considered the distinction between l-values and r-values, and between the value model of variables, in which a variable is a named container for data, and the reference model of variables, in which a variable is a reference to a data object. We considered issues of precedence, associativity, and ordering within expressions. We examined short-circuit Boolean evaluation and its implementation via jump code, both as a semantic issue that affects the correctness of expressions whose subparts are not always well defined, and as an implementation issue that affects the time required to evaluate complex Boolean expressions.

In our survey we encountered many examples of control-flow constructs whose syntax and semantics have evolved considerably over time. Particularly noteworthy has been the phasing out of `goto`-based control flow and the emergence of a consensus on structured alternatives. While convenience and readability are difficult to quantify, most programmers would agree that the control flow constructs of a language like Ada are a dramatic improvement over those of, say, Fortran IV. Examples of features in Ada that are specifically designed to rectify control-flow problems in earlier languages include explicit terminators (`end if`, `end loop`, etc.) for structured constructs; `elsif` clauses; label ranges and default (`others`) clauses in `case` statements; implicit declaration of `for` loop indices as read-only local variables; explicit `return` statements; multilevel loop `exit` statements; and exceptions.

The evolution of constructs has been driven by many goals, including ease of programming, semantic elegance, ease of implementation, and run-time efficiency. In some cases these goals have proven complementary. We have seen for example that short-circuit evaluation leads both to faster code and (in many cases) to cleaner semantics. In a similar vein, the introduction of a new local scope for the index variable of an enumeration-controlled loop avoids both the semantic

problem of the value of the index after the loop and (to some extent) the implementation problem of potential overflow.

In other cases improvements in language semantics have been considered worth a small cost in run-time efficiency. We saw this in the development of iterators: like many forms of abstraction, they add a modest amount of run-time cost in many cases (e.g., in comparison to explicitly embedding the implementation of the enumerated set in the control flow of the loop), but with a large pay-back in modularity, clarity, and opportunities for code reuse. In a similar vein, the developers of Java would argue that for many applications the portability and safety provided by extensive semantic checking, standard-format numeric types, and so on are far more important than speed.

In several cases, advances in compiler technology or in the simple willingness of designers to build more complex compilers have made it possible to incorporate features once considered too expensive. Label ranges in Ada case statements require that the compiler be prepared to generate code employing binary search. In-line functions in C++ eliminate the need to choose between the inefficiency of tiny functions and the messy semantics of macros. Exceptions (as we shall see in [Section 8.5.3](#)) can be implemented in such a way that they incur no cost in the common case (when they do not occur), but the implementation is quite tricky. Iterators, boxing, generics ([Section 8.4](#)), and first-class functions are likewise rather tricky, but are increasingly found in mainstream imperative languages.

Some implementation techniques (e.g., rearranging expressions to uncover common subexpressions, or avoiding the evaluation of guards in a nondeterministic construct once an acceptable choice has been found) are sufficiently important to justify a modest burden on the programmer (e.g., adding parentheses where necessary to avoid overflow or ensure numeric stability, or ensuring that expressions in guards are side-effect-free). Other semantically useful mechanisms (e.g., lazy evaluation, continuations, or truly random nondeterminacy) are usually considered complex or expensive enough to be worthwhile only in special circumstances (if at all).

In comparatively primitive languages, we can often obtain some of the benefits of missing features through programming conventions. In early dialects of Fortran, for example, we can limit the use of `gotos` to patterns that mimic the control flow of more modern languages. In languages without short-circuit evaluation, we can write nested selection statements. In languages without iterators, we can write sets of subroutines that provide equivalent functionality.

6.9 Exercises

- 6.1 We noted in [Section 6.1.1](#) that most binary arithmetic operators are left-associative in most programming languages. In [Section 6.1.4](#), however, we also noted that most compilers are free to evaluate the operands of a binary operator in either order. Are these statements contradictory? Why or why not?

- 6.2 As noted in Figure 6.1, Fortran and Pascal give unary and binary minus the same level of precedence. Is this likely to lead to nonintuitive evaluations of certain expressions? Why or why not?
- 6.3 In Example 6.8 we described a common error in Pascal programs caused by the fact that `and` and `or` have precedence comparable to that of the arithmetic operators. Show how a similar problem can arise in the stream-based I/O of C++ (described in Section 7.9.3). (Hint: consider the precedence of `<<` and `>>`, and the operators that appear below them in the C column of Figure 6.1.)
- 6.4 Translate the following expression into postfix and prefix notation:

$$[-b + \text{sqrt}(b \times b - 4 \times a \times c)] / (2 \times a)$$

Do you need a special symbol for unary negation?

- 6.5 In Lisp, most of the arithmetic operators are defined to take two or more arguments, rather than strictly two. Thus `(* 2 3 4 5)` evaluates to 120, and `(- 16 9 4)` evaluates to 3. Show that parentheses are necessary to disambiguate arithmetic expressions in Lisp (in other words, give an example of an expression whose meaning is unclear when parentheses are removed).
In Section 6.1.1 we claimed that issues of precedence and associativity do not arise with prefix or postfix notation. Reword this claim to make explicit the hidden assumption.
- 6.6 Example 6.31 claims that “For certain values of x , $(0.1 + x) * 10.0$ and $1.0 + (x * 10.0)$ can differ by as much as 25%, even when 0.1 and x are of the same magnitude.” Verify this claim. (*Warning*: if you’re using an x86 processor, be aware that floating-point calculations [even on single-precision variables] are performed internally with 80 bits of precision. Roundoff errors will appear only when intermediate results are stored out to memory [with limited precision] and read back in again.)
- 6.7 Is `&&i` ever valid in C? Explain.
- 6.8 Languages that employ a reference model of variables also tend to employ automatic garbage collection. Is this more than a coincidence? Explain.
- 6.9 In Section 6.1.2 we noted that C uses `=` for assignment and `==` for equality testing. The language designers state: “Since assignment is about twice as frequent as equality testing in typical C programs, it’s appropriate that the operator be half as long” [KR88, p. 17]. What do you think of this rationale?
- 6.10 Consider a language implementation in which we wish to catch every use of an uninitialized variable. In Section 6.1.3 we noted that for types in which every possible bit pattern represents a valid value, extra space must be used to hold an initialized/uninitialized flag. Dynamic checks in such a system can be expensive, largely because of the address calculations needed to access the flags. We can reduce the cost in the common case by having the compiler generate code to automatically initialize every variable with a distinguished *sentinel* value. If at some point we find that a variable’s value is different

from the sentinel, then that variable must have been initialized. If its value is the sentinel, we must double-check the flag. Describe a plausible allocation strategy for initialization flags, and show the assembly language sequences that would be required for dynamic checks, with and without the use of sentinels.

- 6.11 Write an attribute grammar, based on the following context-free grammar, that accumulates jump code for Boolean expressions (with short-circuiting) into a synthesized attribute of *condition*, and then uses this attribute to generate code for *if* statements.

$$\begin{aligned} \text{stmt} &\longrightarrow \text{if } \text{condition} \text{ then } \text{stmt} \text{ else } \text{stmt} \\ &\longrightarrow \text{other_stmt} \\ \text{condition} &\longrightarrow \text{c_term} \mid \text{condition} \text{ or } \text{c_term} \\ \text{c_term} &\longrightarrow \text{relation} \mid \text{c_term} \text{ and } \text{relation} \\ \text{relation} &\longrightarrow \text{c_fact} \mid \text{c_fact} \text{ comparator } \text{c_fact} \\ \text{c_fact} &\longrightarrow \text{identifier} \mid \text{not } \text{c_fact} \mid (\text{condition}) \\ \text{comparator} &\longrightarrow < \mid \leq \mid = \mid <> \mid > \mid \geq \end{aligned}$$

(Hint: your task will be easier if you do *not* attempt to make the grammar L-attributed. For further details see Fischer and LeBlanc's compiler book [FL88, Sec. 14.1.4].)

- 6.12 Neither Algol 60 nor Algol 68 employs short-circuit evaluation for Boolean expressions. In both languages, however, an *if... then... else* construct can be used as an expression. Show how to use *if... then... else* to achieve the effect of short-circuit evaluation.
- 6.13 Consider the following expression in C: $a/b > 0 \ \&\& \ b/a > 0$. What will be the result of evaluating this expression when *a* is zero? What will be the result when *b* is zero? Would it make sense to try to design a language in which this expression is guaranteed to evaluate to *false* when either *a* or *b* (but not both) is zero? Explain your answer.
- 6.14 As noted in Section 6.4.2, languages vary in how they handle the situation in which the tested expression in a *case* statement does not appear among the labels on the arms. C and Fortran 90 say the statement has no effect. Pascal and Modula say it results in a dynamic semantic error. Ada says that the labels must *cover* all possible values for the type of the expression, so the question of a missing value can never arise at run time. What are the tradeoffs among these alternatives? Which do you prefer? Why?
- 6.15 Write the equivalent of Figure 6.5 in C# 2.0, Ruby, or Clu. Write a second version that performs an in-order enumeration, rather than preorder.
- 6.16 Revise the algorithm of Figure 6.6 so that it performs an in-order enumeration, rather than preorder.
- 6.17 Write a C++ preorder iterator to supply tree nodes to the loop in Example 6.66. You will need to know (or learn) how to use pointers, references,

inner classes, and operator overloading in C++. For the sake of (relative) simplicity, you may assume that the data in a tree node is always an `int`; this will save you the need to use generics. You may want to use the `stack` abstraction from the C++ standard library.

- 6.18 Write code for the `tree_iter` type (struct) and the `ti_create`, `ti_done`, `ti_next`, `ti_val`, and `ti_delete` functions employed in [Example 6.69](#).
- 6.19 Write, in C#, Python, or Ruby, an iterator that yields
- all permutations of the integers $1 \dots n$
 - all combinations of k integers from the range $1 \dots n$ ($0 \leq k \leq n$).

You may represent your permutations and combinations using either a list or an array.

- 6.20 Use iterators to construct a program that outputs (in some order) all *structurally distinct* binary trees of n nodes. Two trees are considered structurally distinct if they have different numbers of nodes or if their left or right subtrees are structurally distinct. There are, for example, five structurally distinct trees of three nodes:

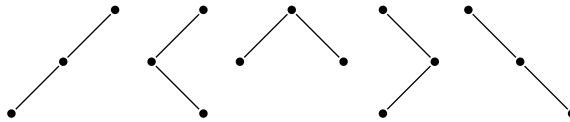

These are most easily output in “dotted parenthesized form”:

```
((().).)
((.().).)
((.).(.))
(.((.)).)
(.(.().))
```

(Hint: think recursively! If you need help, see [Section 2.2](#) of the text by Finkel [[Fin96](#)].)

- 6.21 Build true iterators in Java using threads. (This requires knowledge of material in [Chapter 12](#).) Make your solution as clean and as general as possible. In particular, you should provide the standard `Iterator` or `IEnumerable` interface, for use with extended `for` or `foreach` loops, but the programmer should not have to write these. Instead, he or she should write a class with an `Iterate` method, which should in turn be able to call a `Yield` method, which you should also provide. Evaluate the cost of your solution. How much more expensive is it than standard Java iterator objects?
- 6.22 In an expression-oriented language such as Algol 68 or Lisp, a `while` loop (a `do` loop in Lisp) has a value as an expression. How do you think this value should be determined? (How is it determined in Algol 68 and Lisp?)

Is the value a useless artifact of expression orientation, or are there reasonable programs in which it might actually be used? What do you think should happen if the condition on the loop is such that the body is never executed?

- 6.23 Consider a midtest loop, here written in C, that looks for blank lines in its input:

```
for (;;) {
    line = read_line();
    if (all_blanks(line)) break;
    consume_line(line);
}
```

Show how you might accomplish the same task using a `while` or `do (repeat)` loop, if midtest loops were not available. (Hint: one alternative duplicates part of the code; another introduces a Boolean flag variable.) How do these alternatives compare to the midtest version?

- 6.24 Rubin [Rub87] used the following example (rewritten here in C) to argue in favor of a `goto` statement:

```
int first_zero_row = -1;      /* none */
int i, j;
for (i = 0; i < n; i++) {
    for (j = 0; j < n; j++) {
        if (A[i][j]) goto next;
    }
    first_zero_row = i;
    break;
next: ;
}
```

The intent of the code is to find the first all-zero row, if any, of an $n \times n$ matrix. Do you find the example convincing? Is there a good structured alternative in C? In any language?

- 6.25 Bentley [Ben86, Chap. 4] provides the following informal description of binary search:

We are to determine whether the sorted array $X[1..N]$ contains the element T Binary search solves the problem by keeping track of a range within the array in which T must be if it is anywhere in the array. Initially, the range is the entire array. The range is shrunk by comparing its middle element to T and discarding half the range. The process continues until T is discovered in the array or until the range in which it must lie is known to be empty.

Write code for binary search in your favorite imperative programming language. What loop construct(s) did you find to be most useful? NB: when he asked more than a hundred professional programmers to solve this problem, Bentley found that only about 10% got it right the first time, without testing.

- 6.26** A *loop invariant* is a condition that is guaranteed to be true at a given point within the body of a loop on every iteration. Loop invariants play a major role in *axiomatic semantics*, a formal reasoning system used to prove properties of programs. In a less formal way, programmers who identify (and write down!) the invariants for their loops are more likely to write correct code. Show the loop invariant(s) for your solution to the preceding exercise. (Hint: you will find the distinction between $<$ and \leq [or between $>$ and \geq] to be crucial.)
- 6.27** If you have taken a course in automata theory or recursive function theory, explain why `while` loops are strictly more powerful than `for` loops. (If you haven't had such a course, skip this question!) Note that we're referring here to Pascal-style `for` loops, not C-style.
- 6.28** Show how to calculate the number of iterations of a general Fortran 90-style `do` loop. Your code should be written in an assembler-like notation, and should be guaranteed to work for all valid bounds and step sizes. Be careful of overflow! (Hint: While the bounds and step size of the loop can be either positive or negative, you can safely use an unsigned integer for the iteration count.)
- 6.29** Write a tail-recursive function in Scheme or ML to compute n factorial ($n! = \prod_{1 \leq i \leq n} i = 1 \times 2 \times \dots \times n$). (Hint: You will probably want to define a "helper" function, as discussed in [Section 6.6.1](#).)
- 6.30** Is it possible to write a tail-recursive version of the classic quicksort algorithm? Why or why not?
- 6.31** Give an example in C in which an in-line subroutine may be significantly faster than a functionally equivalent macro. Give another example in which the macro is likely to be faster. (Hint: think about applicative vs normal-order evaluation of arguments.)
- 6.32** Use lazy evaluation (`delay` and `force`) to implement iterator objects in Scheme. More specifically, let an iterator be either the null list or a pair consisting of an element and a promise which when `forced` will return an iterator. Give code for an `uptoby` function that returns an iterator, and a `for-iter` function that accepts as arguments a one-argument function and an iterator. These should allow you to evaluate such expressions as

```
(for-iter (lambda (e) (display e) (newline)) (uptoby 10 50 3))
```

Note that unlike the standard Scheme `for-each`, `for-iter` should not require the existence of a list containing the elements over which to iterate; the intrinsic space required for `(for-iter f (uptoby 1 n 1))` should be only $O(1)$, rather than $O(n)$.

- 6.33** (Difficult) Use `call-with-current-continuation` (`call/cc`) to implement the following structured nonlocal control transfers in Scheme. (This requires knowledge of material in [Chapter 10](#).) You will probably want to

consult a Scheme manual for documentation not only on `call/cc`, but on `define-syntax` and `dynamic-wind` as well.

- (a) Multilevel returns. Model your syntax after the `catch` and `throw` of Common Lisp.
- (b) True iterators. In a style reminiscent of [Exercise 6.32](#), let an iterator be a function which when `call/cc`-ed will return either a null list or a pair consisting of an element and an iterator. As in that previous exercise, your implementation should support expressions like

```
(for-iter (lambda (e)(display e) (newline))(uptoby 10 50 3))
```

Where the implementation of `uptoby` in [Exercise 6.32](#) required the use of `delay` and `force`, however, you should provide an iterator macro (a Scheme *special form*) and a `yield` function that allows `uptoby` to look like an ordinary tail-recursive function with an embedded `yield`:

```
(define uptoby
  (iterator (low high step)
    (letrec ((helper
              (lambda (next)
                (if (> next high) '()
                    (begin
                     ; else clause
                     (yield next)
                     (helper (+ next step)))))))
      (helper low))))
```

© 6.34–6.37 In More Depth.

6.10 Explorations

- 6.38** *Loop unrolling* (described in [Exercise ©5.23](#) and [Section ©16.7.1](#)) is a code transformation that replicates the body of a loop and reduces the number of iterations, thereby decreasing loop overhead and increasing opportunities to improve the performance of the processor pipeline by reordering instructions. Unrolling is traditionally implemented by the code improvement phase of a compiler. It can be implemented at source level, however, if we are faced with the prospect of “hand optimizing” time-critical code on a system whose compiler is not up to the task. Unfortunately, if we replicate the body of a loop k times, we must deal with the possibility that the original number of loop iterations, n , may not be a multiple of k . Writing in C, and letting $k = 4$, we might transform the main loop of [Exercise ©5.23](#) from

```
i = 0;
do {
    sum += A[i]; squares += A[i] * A[i]; i++;
} while (i < N);
```

```

to
    i = 0; j = N/4;
    do {
        sum += A[i]; squares += A[i] * A[i]; i++;
        sum += A[i]; squares += A[i] * A[i]; i++;
        sum += A[i]; squares += A[i] * A[i]; i++;
        sum += A[i]; squares += A[i] * A[i]; i++;
    } while (--j > 0);

    do {
        sum += A[i]; squares += A[i] * A[i]; i++;
    } while (i < N);

```

In 1983, Tom Duff of Lucasfilm realized that code of this sort can be “simplified” in C by interleaving a `switch` statement and a loop. The result is rather startling, but perfectly valid C. It’s known in programming folklore as “Duff’s device”:

```

i = 0; j = (N+3)/4;
switch (N%4) {
    case 0: do{ sum += A[i]; squares += A[i] * A[i]; i++;
    case 3:     sum += A[i]; squares += A[i] * A[i]; i++;
    case 2:     sum += A[i]; squares += A[i] * A[i]; i++;
    case 1:     sum += A[i]; squares += A[i] * A[i]; i++;
               } while (--j > 0);
}

```

Duff announced his discovery with “a combination of pride and revulsion.” He noted that “Many people ... have said that the worst feature of C is that `switch`s don’t break automatically before each `case` label. This code forms some sort of argument in that debate, but I’m not sure whether it’s for or against.” What do you think? Is it reasonable to interleave a loop and a `switch` in this way? Should a programming language permit it? Is automatic fall-through ever a good idea?

- 6.39 Using your favorite language and compiler, investigate the order of evaluation of subroutine parameters. Are they usually evaluated left-to-right or right-to-left? Are they ever evaluated in the other order? (Can you be sure?) Write a program in which the order makes a difference in the results of the computation.
- 6.40 Consider the different approaches to arithmetic overflow adopted by Pascal, C, Java, C#, and Common Lisp, as described in [Section 6.1.4](#). Speculate as to the differences in language design goals that might have caused the designers to adopt the approaches they did.
- 6.41 Learn more about container classes and the *design patterns* (structured programming idioms) they support. Explore the similarities and differences among the standard container libraries of C++, Java, and C#. Which of these libraries do you find the most appealing? Why?

6.42 One of the most popular idioms for large-scale systems is the so-called *visitor pattern*. It has several uses, one of which resembles the “iterating with first-class functions” idiom of [Examples 6.67](#) and [6.68](#). Briefly, elements of a container class provide an `accept` method that expects as argument an object that implements the visitor interface. This interface in turn has a method named `visit` that expects an argument of element type. To iterate over a collection, we implement the “loop body” in the `visit` method of a visitor object. This object constitutes a closure of the sort described in [Section 3.6.3](#). Any information that `visit` needs (beyond the identify of the “loop index” element) can be encapsulated in the object’s fields. An iterator method for the collection passes the visitor object to the `accept` method of each element. Each element in turn calls the `visit` method of the visitor object, passing itself as argument.

Learn more about the visitor pattern. Use it to implement iterators for a collection—preorder, inorder, and postorder traversals of a binary tree, for example. How do visitors compare with equivalent iterator-based code? Do they add new functionality? What else are visitors good for, in addition to iteration?

© **6.43–6.46** In More Depth.

6.11 Bibliographic Notes

Many of the issues discussed in this chapter feature prominently in papers on the history of programming languages. Pointers to several such papers can be found in the Bibliographic Notes for [Chapter 1](#). Fifteen papers comparing Ada, C, and Pascal can be found in the collection edited by Feuer and Gehani [[FG84](#)]. References for individual languages can be found in [Appendix A](#).

Niklaus Wirth has been responsible for a series of influential languages over a 30-year period, including Pascal [[Wir71](#)], its predecessor Algol W [[WH66](#)], and the successors Modula [[Wir77b](#)], Modula-2 [[Wir85b](#)], and Oberon [[Wir88b](#)]. The case statement of Algol W is due to Hoare [[Hoa81](#)]. Bernstein [[Ber85](#)] considers a variety of alternative implementations for `case`, including multilevel versions appropriate for label sets consisting of several dense “clusters” of values. Guarded commands are due to Dijkstra [[Dij75](#)]. Duff’s device was originally posted to netnews, the predecessor of Usenet news, in May of 1984. The original posting appears to have been lost, but Duff’s commentary on it can be found at many Internet sites, including www.lysator.liu.se/c/duffs-device.html.

Debate over the supposed merits or evils of the `goto` statement dates from at least the early 1960s, but became a good bit more heated in the wake of a 1968 article by Dijkstra (“Go To Statement Considered Harmful” [[Dij68b](#)]). The structured programming movement of the 1970s took its name from the text of Dahl, Dijkstra, and Hoare [[DDH72](#)]. A dissenting letter by Rubin in 1987

(“GOTO Considered Harmful’ Considered Harmful” [Rub87]; [Exercise 6.24](#)) elicited a flurry of responses.

What has been called the “reference model of variables” in this chapter is called the “object model” in Clu; Liskov and Guttag describe it in [Sections 2.3](#) and [2.4.2](#) of their text on abstraction and specification [LG86]. Clu iterators are described in an article by Liskov et al. [LSAS77], and in [Chapter 6](#) of the Liskov and Guttag text. Icon generators are discussed in [Chapters 11](#) and [14](#) of the text by Griswold and Griswold [GG96]. The tree-enumeration algorithm of [Exercise 6.20](#) was originally presented (without iterators) by Solomon and Finkel [SF80].

Several texts discuss the use of invariants ([Exercise 6.26](#)) as a tool for writing correct programs. Particularly noteworthy are the works of Dijkstra [Dij76] and Gries [Gri81]. Kernighan and Plauger provide a more informal discussion of the art of writing good programs [KP78].

The Blizzard [SFL⁺94] and Shasta [SG96] systems for software distributed shared memory (S-DSM) make use of sentinels ([Exercise 6.10](#)). We will discuss S-DSM in [Section 12.2.1](#).

Michaelson [Mic89, Chap. 8] provides an accessible formal treatment of applicative-order, normal-order, and lazy evaluation. Friedman, Wand, and Haynes provide an excellent discussion of continuation-passing style [FWH01, Chaps. 7–8].

7 Data Types

Most programming languages include a notion of type for expressions and/or objects.¹ Types serve two principal purposes:

EXAMPLE 7.1

Operations that leverage type information

1. Types provide implicit context for many operations, so that the programmer does not have to specify that context explicitly. In C, for instance, the expression `a + b` will use integer addition if `a` and `b` are of `integer` type; it will use floating-point addition if `a` and `b` are of `double` (floating-point) type. Similarly, the operation `new p` in Pascal, where `p` is a pointer, will allocate a block of storage from the heap that is the right size to hold an object of the type pointed to by `p`; the programmer does not have to specify (or even know) this size. In C++, Java, and C#, the operation `new my_type()` not only allocates (and returns a pointer to) a block of storage sized for an object of type `my_type`; it also automatically calls any user-defined initialization (*constructor*) function that has been associated with that type. ■

EXAMPLE 7.2

Errors captured by type information

2. Types limit the set of operations that may be performed in a semantically valid program. They prevent the programmer from adding a character and a record, for example, or from taking the arctangent of a set, or passing a file as a parameter to a subroutine that expects an integer. While no type system can promise to catch every nonsensical operation that a programmer might put into a program by mistake, good type systems catch enough mistakes to be highly valuable in practice. ■

Section 7.1 looks more closely at the meaning and purpose of types, and presents some basic definitions. Section 7.2 addresses questions of *type equivalence* and *type compatibility*: when can we say that two types are the same, and when can we use a value of a given type in a given context? Sections 7.3–7.9 consider syntactic, semantic, and pragmatic issues for some of the most important

¹ Recall that unless otherwise noted we are using the term “object” informally to refer to anything that might have a name. Object-oriented languages, which we will study in Chapter 9, assign a narrower, more formal, meaning to the term.

composite types: records, arrays, strings, sets, pointers, lists, and files. The section on pointers includes a more detailed discussion of the value and reference models of variables introduced in [Section 6.1.2](#), and of the heap management issues introduced in [Section 3.2](#). The section on files (mostly on the PLP CD) includes a discussion of input and output mechanisms. [Section 7.10](#) considers what it means to compare two complex objects for equality, or to assign one into the other.

7.1 Type Systems

Computer hardware can interpret bits in memory in several different ways: as instructions, addresses, characters, and integer and floating-point numbers of various lengths (see [Section 5.2](#) for more details). The bits themselves, however, are untyped; the hardware on most machines makes no attempt to keep track of which interpretations correspond to which locations in memory. Assembly languages reflect this lack of typing: operations of any kind can be applied to values in arbitrary locations. High-level languages, on the other hand, almost always associate types with values, to provide the contextual information and error checking alluded to above.

Informally, a *type system* consists of (1) a mechanism to define types and associate them with certain language constructs, and (2) a set of rules for *type equivalence*, *type compatibility*, and *type inference*. The constructs that must have types are precisely those that have values, or that can refer to objects that have values. These constructs include named constants, variables, record fields, parameters, and sometimes subroutines; literal constants (e.g., 17, 3.14, "foo"); and more complicated expressions containing these. Type equivalence rules determine when the types of two values are the same. Type compatibility rules determine when a value of a given type can be used in a given context. Type inference rules define the type of an expression based on the types of its constituent parts or (sometimes) the surrounding context. In a language with polymorphic variables or parameters, it may be important to distinguish between the type of a reference or pointer and the type of the object to which it refers: a given name may refer to objects of different types at different times.

Subroutines are considered to have types in some languages, but not in others. Subroutines need to have types if they are first- or second-class values (i.e., if they can be passed as parameters, returned by functions, or stored in variables). In each of these cases there is a construct in the language whose value is a dynamically determined subroutine; type information allows the language to limit the set of acceptable values to those that provide a particular subroutine interface (i.e., particular numbers and types of parameters). In a statically scoped language that never creates references to subroutines dynamically (one in which subroutines are always third-class values), the compiler can always identify the subroutine to

which a name refers, and can ensure that the routine is called correctly without necessarily employing a formal notion of subroutine types.

7.1.1 Type Checking

Type checking is the process of ensuring that a program obeys the language's type compatibility rules. A violation of the rules is known as a *type clash*. A language is said to be *strongly typed* if it prohibits, in a way that the language implementation can enforce, the application of any operation to any object that is not intended to support that operation. A language is said to be *statically typed* if it is strongly typed and type checking can be performed at compile time. In the strictest sense of the term, few languages are statically typed. In practice, the term is often applied to languages in which most type checking can be performed at compile time, and the rest can be performed at run time.

A few examples: Ada is strongly typed, and for the most part statically typed (certain type constraints must be checked at run time). A Pascal implementation can also do most of its type checking at compile time, though the language is not quite strongly typed: untagged variant records (to be discussed in [Section 7.3.4](#)) are its only loophole. C89 is significantly more strongly typed than its predecessor dialects, but still significantly less strongly typed than Pascal. Its loopholes include unions, subroutines with variable numbers of parameters, and the interoperability of pointers and arrays (to be discussed in [Section 7.7.1](#)). Implementations of C rarely check anything at run time.

Dynamic (run-time) type checking is a form of late binding, and tends to be found in languages that delay other issues until run time as well. Lisp and Smalltalk are dynamically (though strongly) typed. Most scripting languages are also dynamically typed; some (e.g., Python and Ruby) are strongly typed. Languages with dynamic scoping are generally dynamically typed (or not typed at all): if the compiler can't identify the object to which a name refers, it usually can't determine the type of the object either.

7.1.2 Polymorphism

Polymorphism ([Section 3.5.3](#)) allows a single body of code to work with objects of multiple types. It may or may not imply the need for run-time type checking. As implemented in Lisp, Smalltalk, and the various scripting languages, fully dynamic typing allows the programmer to apply arbitrary operations to arbitrary objects. Only at run time does the language implementation check to see that the objects actually implement the requested operations. Because the types of objects can be thought of as implied (unspecified) parameters, dynamic typing is said to support *implicit parametric polymorphism*.

Unfortunately, while powerful and straightforward, dynamic typing incurs significant run-time cost, and delays the reporting of errors. ML and its descendants

employ a sophisticated system of *type inference* to support implicit parametric polymorphism in conjunction with static typing. The ML compiler infers for every object and expression a (possibly unique) type that captures precisely those properties that the object or expression must have to be used in the context(s) in which it appears. With rare exceptions, the programmer need not specify the types of objects explicitly. The task of the compiler is to determine whether there exists a consistent assignment of types to expressions that guarantees, statically, that no operation will ever be applied to a value of an inappropriate type at run time. This job can be formalized as the problem of *unification*; we discuss it further in Section 7.2.4.

In object-oriented languages, *subtype polymorphism* allows a variable X of type T to refer to an object of any type derived from T . Since derived types are required to support all of the operations of the base type, the compiler can be sure that any operation acceptable for an object of type T will be acceptable for any object referred to by X . Given a straightforward model of inheritance, type checking for subtype polymorphism can be implemented entirely at compile time. Most languages that envision such an implementation, including C++, Eiffel, Java, and C#, also provide *explicit parametric polymorphism (generics)*, which allow the programmer to define classes with type parameters. Generics are particularly useful for *container (collection)* classes: “list of T ” (`List<T>`), “stack of T ” (`Stack<T>`), and so on, where T is left unspecified. Like subtype polymorphism, generics can usually be type checked at compile time, though Java sometimes performs redundant checks at run time for the sake of interoperability with preexisting nongeneric code. Smalltalk, Objective-C, Python, and Ruby use a single mechanism for both parametric and subtype polymorphism, with

DESIGN & IMPLEMENTATION

Dynamic typing

The growing popularity of scripting languages has led a number of prominent software developers to publicly question the value of static typing. They ask: given that we can't check everything at compile time, how much pain is it worth to check the things we can? As a general rule, it is easier to write type-correct code than to prove that we have done so, and static typing requires such proofs. As type systems become more complex (due to object orientation, generics, etc.), the complexity of static typing increases correspondingly. Anyone who has written extensively in Ada or C++ on the one hand, and in Python or Scheme on the other, cannot help but be struck at how much easier it is to write code, at least for modest-sized programs, without complex type declarations. Dynamic checking incurs some run-time overhead, of course, and may delay the discovery of bugs, but this is increasingly seen as insignificant in comparison to the potential increase in human productivity. The choice between static and dynamic typing promises to provide one of the most interesting language debates of the coming decade.

checking delayed until run time. We will consider generics further in [Section 8.4](#), and derived types in [Chapter 9](#).

7.1.3 The Meaning of “Type”

Some early high-level languages (e.g., Fortran 77, Algol 60, and Basic) provided a small, built-in, and nonextensible set of types. As we saw in [Section 3.3.1](#), Fortran does not require variables to be declared; it incorporates default rules to determine the type of undefined variables based on the spelling of their names (Basic has similar rules). As noted in the previous subsection, some languages (ML, Miranda, Haskell) infer types automatically at compile time, while others (Lisp, Smalltalk, scripting languages) track them at run time. In most languages, however, users must explicitly declare the type of every object, together with the characteristics of every type that is not built in.

There are at least three ways to think about types, which we may call the *denotational*, *constructive*, and *abstraction-based* points of view. From the denotational point of view, a type is simply a set of values. A value has a given type if it belongs to the set; an object has a given type if its value is guaranteed to be in the set. From the constructive point of view, a type is either one of a small collection of *built-in* types (integer, character, Boolean, real, etc.; also called *primitive* or *predefined* types), or a *composite* type created by applying a type *constructor* (record, array, set, etc.) to one or more simpler types. (This use of the term “constructor” is unrelated to the initialization functions of object-oriented languages. It also differs in a more subtle way from the use of the term in ML.) From the abstraction-based point of view, a type is an *interface* consisting of a set of operations with well-defined and mutually consistent semantics. For most programmers (and language designers), types usually reflect a mixture of these viewpoints.

In denotational semantics (one of the leading ways to formalize the meaning of programs), a set of values is known as a *domain*. Types are domains, and the meaning of an expression is a value from the domain that represents the expression’s type. Some domains—the integers, for example—are simple and familiar. Others can be quite complex. In fact, in denotational semantics *everything* has a type—even statements with side effects. The meaning of an assignment statement is a value from a domain whose elements are functions. Each function maps a *store*—a mapping from names to values that represents the current contents of memory—to another store, which represents the contents of memory after the assignment.

One of the nice things about the denotational view of types is that it allows us in many cases to describe user-defined composite types (records, arrays, etc.) in terms of mathematical operations on sets. We will allude to these operations again in [Section 7.1.4](#). Because it is based on mathematical objects, the denotational view of types usually ignores such implementation issues as limited precision and word length. This limitation is less serious than it might at first appear: Checks for such errors as arithmetic overflow are usually implemented outside of the type system

of a language anyway. They result in a run-time error, but this error is not called a type clash.

When a programmer defines an enumerated type (e.g., `enum hue {red, green, blue}` in C), he or she certainly thinks of this type as a set of values. For most other varieties of user-defined type, however, one typically does not think in terms of sets of values. Rather, one usually thinks in terms of the way the type is built from simpler types, or in terms of its meaning or purpose. These ways of thinking reflect the constructive and abstraction-based points of view. The constructive point of view was pioneered by Algol W and Algol 68, and is characteristic of most languages designed in the 1970s and 1980s. The abstraction-based point of view was pioneered by Simula-67 and Smalltalk, and is characteristic of modern object-oriented languages. It can also be adopted as a matter of programming discipline in non-object-oriented languages. We will discuss the abstraction-based point of view in more detail in [Chapter 9](#). The remainder of this chapter focuses on the constructive point of view.

7.1.4 Classification of Types

The terminology for types varies some from one language to another. This subsection presents definitions for the most common terms. Most languages provide built-in types similar to those supported in hardware by most processors: integers, characters, Booleans, and real (floating-point) numbers.

Booleans (sometimes called *logicals*) are typically implemented as single-byte quantities, with 1 representing `true` and 0 representing `false`. C is unusual in its lack of a Boolean type: where most languages would expect a Boolean value, C expects an integer; zero means `false`, and anything else means `true`. As noted in [Section 6.5.4](#), Icon replaces Booleans with a more general notion of *success* and *failure*.

Characters have traditionally been implemented as one-byte quantities as well, typically (but not always) using the ASCII encoding. More recent languages (e.g., Java and C#) use a two-byte representation designed to accommodate (the commonly used portion of) the *Unicode* character set. Unicode is an international standard designed to capture the characters of a wide variety of languages (see sidebar on page 295). The first 128 characters of Unicode (`\u0000` through `\u007f`) are identical to ASCII. C++ provides both regular and “wide” characters, though for wide characters both the encoding and the actual width are implementation dependent. Fortran 2003 supports four-byte Unicode characters.

Numeric Types

A few languages (e.g., C and Fortran) distinguish between different lengths of integers and real numbers; most do not, and leave the choice of precision to the implementation. Unfortunately, differences in precision across language implementations lead to a lack of portability: programs that run correctly on one system may produce run-time errors or erroneous results on another. Java and C# are

unusual in providing several lengths of numeric types, with a specified precision for each.

A few languages, including C, C++, C# and Modula-2, provide both signed and unsigned integers (Modula-2 calls unsigned integers *cardinals*). A few languages (e.g., Fortran, C99, Common Lisp, and Scheme) provide a built-in complex type, usually implemented as a pair of floating-point numbers that represent the real and imaginary Cartesian coordinates; other languages support these as a standard library class. A few languages (e.g., Scheme and Common Lisp) provide a built-in rational type, usually implemented as a pair of integers that represent the numerator and denominator. Most scripting languages support integers of arbitrary

DESIGN & IMPLEMENTATION

Multilingual character sets

The ISO 10646 international standard defines a *Universal Character Set (UCS)* intended to include all characters of all known human languages. (It also sets aside a “private use area” for such artificial [constructed] languages as Klingon, Tengwar, and Cirth [Tolkein Elvish]. Allocation of this private space is coordinated by a volunteer organization known as the ConScript Unicode Registry.) All natural languages currently employ codes in the 16-bit *Basic Multilingual Plane (BMP)*: 0x0000 through 0xffffd.

Unicode is an expanded version of ISO 10646, maintained by an international consortium of software manufacturers. In addition to mapping tables, it covers such topics as rendering algorithms, directionality of text, and sorting and comparison conventions.

While recent languages have moved toward 16- or 32-bit internal character representations, these cannot be used for external storage—text files—without causing severe problems with backward compatibility. To accommodate Unicode without breaking existing tools, Ken Thompson in 1992 proposed a multibyte “expanding” code known as *UTF-8* (UCS/Unicode Transformation Format, 8-bit), and codified as a formal annex (appendix) to ISO 10646. UTF-8 characters occupy a maximum of 6 bytes—3 if they lie in the BMP, and only 1 if they are ordinary ASCII. The trick is to observe that ASCII is a 7-bit code; in any legacy text file the most significant bit of every byte is 0. In UTF-8 a most significant bit of 1 indicates a multibyte character. Two-byte codes begin with the bits 110. Three-byte codes begin with 1110. Second and subsequent bytes of multibyte characters always begin with 10.

On some systems one also finds files encoded in one of 10 variants of the older 8-bit ISO 8859 standard, but these are inconsistently rendered across platforms. On the web, non-ASCII characters are typically encoded with *numeric character references*, which bracket a Unicode value, written in decimal or hex, with an ampersand and a semicolon. The copyright symbol (©), for example, is `©`; . Many characters also have symbolic *entity names* (e.g., `©`), but not all browsers support these.

precision; the implementation uses multiple words of memory where appropriate. Ada supports *fixed-point* types, which are represented internally by integers, but have an implied decimal point at a programmer-specified position among the digits. Several languages support *decimal* types that use a base-10 encoding to avoid round-off anomalies in financial and human-centered arithmetic (see sidebar at bottom of this page).

Integers, Booleans, and characters are all examples of *discrete* types (also called *ordinal* types): the domains to which they correspond are countable (they have a one-to-one correspondence with some subset of the integers), and have a well-defined notion of predecessor and successor for each element other than the first and the last. (In most implementations the number of possible integers is finite, but this is usually not reflected in the type system.) Two varieties of user-defined types, enumerations and subranges, are also discrete. Discrete, rational, real, and

DESIGN & IMPLEMENTATION

Decimal types

A few languages, notably Cobol and PL/I, provide a *decimal* type for fixed-point representation of integer quantities. These types were designed primarily to exploit the *binary-coded decimal (BCD)* integer format supported by many traditional CISC machines. BCD devotes one *nibble* (four bits—half a byte) to each decimal digit. Machines that support BCD in hardware can perform arithmetic directly on the BCD representation of a number, without converting it to and from binary form. This capability is particularly useful in business and financial applications, which treat their data as both numbers and character strings.

With the growth in on-line commerce, the past few years have seen renewed interest in decimal arithmetic. The latest version of the IEEE 754 floating-point standard, adopted in June 2008, includes decimal floating-point types in 32-, 64-, and 128-bit lengths. These represent both the mantissa (significant bits) and exponent in binary, but interpret the exponent as a power of 10, not a power of 2. At a given length, values of decimal type have greater precision but smaller range than binary floating-point values. They are ideal for financial calculations, because they capture decimal fractions precisely. Designers hope the new standard will displace existing incompatible decimal formats, not only in hardware but also in software libraries, thereby providing the same portability and predictability that the original 754 standard provided for binary floating-point.

C# includes a 128-bit `decimal` type that is compatible with the new standard. Specifically, a C# decimal variable includes 96 bits of precision, a sign, and a decimal *scaling factor* that can vary between 10^{-28} and 10^{28} . IBM, for which business and financial applications have always been an important market, has included a hardware implementation of the standard (64- and 128-bit widths) in its POWER6 processor chips.

complex types together constitute the *scalar* types. Scalar types are also sometimes called *simple* types.

Enumeration Types

Enumerations were introduced by Wirth in the design of Pascal. They facilitate the creation of readable programs, and allow the compiler to catch certain kinds of programming errors. An enumeration type consists of a set of named elements. In Pascal, one can write:

```
type weekday = (sun, mon, tue, wed, thu, fri, sat);
```

The values of an enumeration type are ordered, so comparisons are generally valid (`mon < tue`), and there is usually a mechanism to determine the predecessor or successor of an enumeration value (in Pascal, `tomorrow := succ(today)`). The ordered nature of enumerations facilitates the writing of enumeration-controlled loops:

```
for today := mon to fri do begin ...
```

It also allows enumerations to be used to index arrays:

```
var daily_attendance : array [weekday] of integer; ■
```

An alternative to enumerations, of course, is simply to declare a collection of constants:

```
const sun = 0; mon = 1; tue = 2; wed = 3; thu = 4; fri = 5; sat = 6;
```

In C, the difference between the two approaches is purely syntactic:

```
enum weekday {sun, mon, tue, wed, thu, fri, sat};
```

is essentially equivalent to

```
typedef int weekday;
const weekday sun = 0, mon = 1, tue = 2,
              wed = 3, thu = 4, fri = 5, sat = 6; ■
```

In Pascal and most of its descendants, however, the difference between an enumeration and a set of integer constants is much more significant: the enumeration is a full-fledged type, incompatible with integers. Using an integer or an enumeration value in a context expecting the other will result in a type clash error at compile time.

Values of an enumeration type are typically represented by small integers, usually a consecutive range of small integers starting at zero. In many languages these *ordinal values* are semantically significant, because built-in functions can be used

EXAMPLE 7.3

Enumerations in Pascal

EXAMPLE 7.4

Enumerations as constants

EXAMPLE 7.5

Converting to and from enumeration type

to convert an enumeration value to its ordinal value, and sometimes vice versa. In Ada, these conversions employ the *attributes* `pos` and `val`: `weekday'pos(mon) = 1` and `weekday'val(1) = mon`. ■

Several languages allow the programmer to specify the ordinal values of enumeration types, if the default assignment is undesirable. In C, C++, and C#, one could write

```
enum mips_special_regs {gp = 28, fp = 30, sp = 29, ra = 31};
```

(The intuition behind these values is explained in Section ©5.4.5.)

In Ada this declaration would be written

```
type mips_special_regs is (gp, sp, fp, ra);      -- must be sorted
for mips_special_regs use (gp => 28, sp => 29, fp => 30, ra => 31); ■
```

EXAMPLE 7.6

Distinguished values for enums

EXAMPLE 7.7

Emulating distinguished enum values in Java 5

In recent versions of Java one can obtain a similar effect by giving values an extra field (here named `register`):

```
enum mips_special_regs { gp(28), fp(30), sp(29), ra(31);
    private final int register;
    mips_special_regs(int r) { register = r; }
    public int reg() { return register; }
}
...
int n = mips_special_regs.fp.reg(); ■
```

As noted in Section 3.5.2, Pascal and C do not allow the same element name to be used in more than one enumeration type in the same scope. Java and C# do, but the programmer must identify elements using fully qualified names: `mips_special_regs.fp`. Ada relaxes this requirement by saying that element names are overloaded; the type prefix can be omitted whenever the compiler can infer it from context.

Subrange Types

Like enumerations, subranges were first introduced in Pascal, and are found in many subsequent languages. A subrange is a type whose values compose a contiguous subset of the values of some discrete *base* type (also called the *parent* type). In Pascal and most of its descendants, one can declare subranges of integers, characters, enumerations, and even other subranges. In Pascal, subranges look like this:

```
type test_score = 0..100;
    workday = mon..fri; ■
```

EXAMPLE 7.8

Subranges in Pascal

EXAMPLE 7.9

Subranges in Ada

In Ada one would write

```
type test_score is new integer range 0..100;
subtype workday is weekday range mon..fri;
```

The `range . . .` portion of the definition in Ada is called a type *constraint*. In this example `test_score` is a *derived* type, incompatible with integers. The `workday` type, on the other hand, is a *constrained subtype*; `workdays` and `weekdays` can be more or less freely intermixed. The distinction between derived types and subtypes is a valuable feature of Ada; we will discuss it further in [Section 7.2.1](#). ■

One could of course use integers to represent test scores, or a `weekday` to represent a `workday`. Using an explicit subrange has several advantages. For one thing, it helps to document the program. A comment could also serve as documentation, but comments have a bad habit of growing out of date as programs change, or of being omitted in the first place. Because the compiler analyzes a subrange declaration, it knows the expected range of subrange values, and can generate code to perform dynamic semantic checks to ensure that no subrange variable is ever assigned an invalid value. These checks can be valuable debugging tools. In addition, since the compiler knows the number of values in the subrange, it can sometimes use fewer bits to represent subrange values than it would need to use to represent arbitrary integers. In the example above, `test_score` values can be stored in a single byte.

EXAMPLE 7.10

Space requirements of
subrange type

Most implementations employ the same bit patterns for integers and subranges, so subranges whose values are large require large storage locations, even if the number of distinct values is small. The following type, for example,

```
type water_temperature = 273..373; (* degrees Kelvin *)
```

would be stored in at least two bytes. While there are only 101 distinct values in the type, the largest (373) is too large to fit in a single byte in its natural encoding. (An unsigned byte can hold values in the range `0..255`; a signed byte can hold values in the range `-128..127`.) ■

DESIGN & IMPLEMENTATION

Multiple sizes of integers

The space savings possible with (small-valued) subrange types in Pascal and Ada is achieved in several other languages by providing more than one size of built-in integer type. C and C++, for example, support integer arithmetic on signed and unsigned variants of `char`, `short`, `int`, `long`, and (in C99) `long long` types, with monotonically nondecreasing sizes.²

² More specifically, the C99 standard requires ranges for these types corresponding to lengths of at least 1, 2, 2, 4, and 8 bytes, respectively. In practice, one finds implementations in which plain `ints` are 2, 4, or 8 bytes long, including some in which they are the same size as `shorts` but shorter than `longs`, and some in which they are the same size as `longs`, and longer than `shorts`.

Composite Types

Nonscalar types are usually called *composite*, or *constructed* types. They are generally created by applying a *type constructor* to one or more simpler types. Common composite types include records (structures), variant records (unions), arrays, sets, pointers, lists, and files. All but pointers and lists are easily described in terms of mathematical set operations (pointers and lists can be described mathematically as well, but the description is less intuitive).

Records (structures) were introduced by Cobol, and have been supported by most languages since the 1960s. A record consists of collection of *fields*, each of which belongs to a (potentially different) simpler type. Records are akin to mathematical *tuples*; a record type corresponds to the Cartesian product of the types of the fields.

Variant records (unions) differ from “normal” records in that only one of a variant record’s fields (or collections of fields) is valid at any given time. A variant record type is the *union* of its field types, rather than their Cartesian product.

Arrays are the most commonly used composite types. An array can be thought of as a function that maps members of an *index* type to members of a *component* type. Arrays of characters are often referred to as *strings*, and are often supported by special-purpose operations not available for other arrays.

Sets, like enumerations and subranges, were introduced by Pascal. A set type is the mathematical powerset of its base type, which must often be discrete. A variable of a set type contains a collection of distinct elements of the base type.

Pointers are l-values. A pointer value is a *reference* to an object of the pointer’s base type. Pointers are often but not always implemented as addresses. They are most often used to implement *recursive* data types. A type *T* is recursive if an object of type *T* may contain one or more references to other objects of type *T*.

Lists, like arrays, contain a sequence of elements, but there is no notion of mapping or indexing. Rather, a list is defined recursively as either an empty list or a pair consisting of a head element and a reference to a sublist. While the length of an array must be specified at elaboration time in most (though not all) languages, lists are always of variable length. To find a given element of a list, a program must examine all previous elements, recursively or iteratively, starting at the head. Because of their recursive definition, lists are fundamental to programming in most functional languages.

Files are intended to represent data on mass-storage devices, outside the memory in which other program objects reside. Like arrays, most files can be conceptualized as a function that maps members of an index type (generally integer) to members of a component type. Unlike arrays, files usually have a notion of *current position*, which allows the index to be implied implicitly in consecutive operations. Files often display idiosyncrasies inherited from

physical input/output devices. In particular, the elements of some files must be accessed in sequential order.

We will examine composite types in more detail in [Sections 7.3 through 7.9](#).

7.1.5 Orthogonality

In [Section 6.1.2](#) we discussed the importance of orthogonality in the design of expressions, statements, and control-flow constructs. In a highly orthogonal language, these features can be used, with consistent behavior, in almost any combination. Orthogonality is equally important in type system design. A highly orthogonal language tends to be easier to understand, to use, and to reason about in a formal way. We have noted that languages like Algol 68 and C enhance orthogonality by eliminating (or at least blurring) the distinction between statements and expressions. To characterize a statement that is executed for its side effect(s), and that has no useful values, some languages provide an “empty” type. In C and Algol 68, for example, a subroutine that is meant to be used as a procedure is generally declared with a “return” type of `void`. In ML, the empty type is called `unit`. If the programmer wishes to call a subroutine that does return a value, but the value is not needed in this particular case (all that matters is the side effect[s]), then the return value in C can be discarded by “casting” it to `void` (casts will be discussed in [Section 7.2.1](#)):

EXAMPLE 7.11

Void (empty) type

```
foo_index = insert_in_symbol_table(foo);
...
(void) insert_in_symbol_table(bar);    /* don't care where it went */
/* cast is optional; implied if omitted */
```

EXAMPLE 7.12

Making do without void

In a language (e.g., Pascal) without an empty type, the latter of these two calls would need to use a dummy variable:

```
var dummy : symbol_table_index;
...
dummy := insert_in_symbol_table(bar);
```

The type systems of C and Pascal are more orthogonal than that of (pre-Fortran 90) Fortran. Where array elements in traditional Fortran were always of scalar type, C and Pascal allow arbitrary types. Where array indices were always integers (and still are in C), Pascal allows any discrete type. Where function return values were always scalars (and still are in Pascal), C allows structures and pointers to functions. At the same time, both C and Pascal retain significant nonorthogonality. As in traditional Fortran, Pascal requires the bounds of each array to be specified at compile time, except when the array is a formal parameter of a subroutine. C requires a lower bound of zero on all array indices. Pascal has only second-class functions. A much more uniformly orthogonal type system can be found in ML; we consider it in [Section 7.2.4](#)

One particularly useful aspect of type orthogonality is the ability to specify literal values of arbitrary composite types. Composite literals are sometimes known as *aggregates*. They are particularly valuable for the initialization of static data structures; without them, a program may need to waste time performing initialization at run time.

EXAMPLE 7.13

Aggregates in Ada

Ada provides aggregates for all its structured types. Given the following declarations

```
type person is record
    name : string (1..10);
    age : integer;
end record;
p, q : person;
A, B : array (1..10) of integer;
```

we can write the following assignments.

```
p := ("Jane Doe ", 37);
q := (age => 36, name => "John Doe ");
A := (1, 0, 3, 0, 3, 0, 3, 0, 0, 0);
B := (1 => 1, 3 | 5 | 7 => 3, others => 0);
```

Here the aggregates assigned into *p* and *A* are *positional*; the aggregates assigned into *q* and *B* name their elements explicitly. The aggregate for *B* uses a shorthand notation to assign the same value (3) into array elements 3, 5, and 7, and to assign a 0 into all unnamed fields. Several languages, including C, Fortran 90, and Lisp, provide similar capabilities. ML provides a very general facility for composite expressions, based on the use of *constructors* (discussed in Section ©7.2.4). ■

✓ CHECK YOUR UNDERSTANDING

1. What purpose(s) do types serve in a programming language?
2. What does it mean for a language to be *strongly typed*? *Statically typed*? What prevents, say, C from being strongly typed?
3. Name two important programming languages that are strongly but dynamically typed.
4. What is a *type clash*?
5. Discuss the differences among the *denotational*, *constructive*, and *abstraction-based* views of types.
6. What is the difference between *discrete* and *scalar* types?
7. Give two examples of languages that lack a Boolean type. What do they use instead?
8. In what ways may an enumeration type be preferable to a collection of named constants? In what ways may a subrange type be preferable to its base type? In what ways may a string be preferable to an array of characters?

9. What does it mean for a set of language features (e.g., a type system) to be *orthogonal*?
 10. What are *aggregates*?
-

7.2 Type Checking

In most statically typed languages, every definition of an object (constant, variable, subroutine, etc.) must specify the object's type. Moreover, many of the contexts in which an object might appear are also typed, in the sense that the rules of the language constrain the types that an object in that context may validly possess. In the subsections below we will consider the topics of *type equivalence*, *type compatibility*, and *type inference*. Of the three, type compatibility is the one of most concern to programmers. It determines when an object of a certain type can be used in a certain context. At a minimum, the object can be used if its type and the type expected by the context are equivalent (i.e., the same). In many languages, however, compatibility is a looser relationship than equivalence: objects and contexts are often compatible even when their types are different. Our discussion of type compatibility will touch on the subjects of *type conversion* (also called *casting*), which changes a value of one type into a value of another; *type coercion*, which performs a conversion automatically in certain contexts; and *nonconverting* type casts, which are sometimes used in systems programming to interpret the bits of a value of one type as if they represented a value of some other type.

Whenever an expression is constructed from simpler subexpressions, the question arises: given the types of the subexpressions (and possibly the type expected by the surrounding context), what is the type of the expression as a whole? This question is answered by type inference. Type inference is often trivial: the sum of two integers is still an integer, for example. In other cases (e.g., when dealing with sets) it is a good bit trickier. Type inference plays a particularly important role in ML, Miranda, and Haskell, in which all type information is inferred.

7.2.1 Type Equivalence

In a language in which the user can define new types, there are two principal ways of defining type equivalence. *Structural equivalence* is based on the *content* of type definitions: roughly speaking, two types are the same if they consist of the same components, put together in the same way. *Name equivalence* is based on the *lexical occurrence* of type definitions: roughly speaking, each definition introduces a new type. Structural equivalence is used in Algol-68, Modula-3, and (with various wrinkles) C and ML. Name equivalence is the more popular approach in recent languages. It is used in Java, C#, standard Pascal, and most Pascal descendants, including Ada.

The exact definition of structural equivalence varies from one language to another. It requires that one decide which potential differences between types are important, and which may be considered unimportant. Most people would probably agree that the format of a declaration should not matter—otherwise identical declarations that differ only in spacing or line breaks should still be considered equivalent. Likewise, in a Pascal-like language with structural equivalence,

EXAMPLE 7.14

Trivial differences in type

```
type R2 = record
  a, b : integer
end;
```

should probably be considered the same as

```
type R3 = record
  a : integer;
  b : integer
end;
```

But what about

```
type R4 = record
  b : integer;
  a : integer
end;
```

Should the reversal of the order of the fields change the type? ML says no; most languages say yes. ■

EXAMPLE 7.15

Other minor differences in type

In a similar vein, consider the following arrays, again in a Pascal-like notation:

```
type str = array [1..10] of char;

type str = array [0..9] of char;
```

Here the length of the array is the same in both cases, but the index values are different. Should these be considered equivalent? Most languages say no, but some (including Fortran and Ada) consider them compatible. ■

To determine if two types are structurally equivalent, a compiler can expand their definitions by replacing any embedded type names with their respective definitions, recursively, until nothing is left but a long string of type constructors, field names, and built-in types. If these expanded strings are the same, then the types are equivalent, and conversely. Recursive and pointer-based types complicate matters, since their expansion does not terminate, but the problem is not insurmountable; we consider a solution in [Exercise 7.19](#).

EXAMPLE 7.16

The problem with structural equivalence

Structural equivalence is a straightforward but somewhat low-level, implementation-oriented way to think about types. Its principal problem is an inability to distinguish between types that the programmer may think of as distinct, but which happen by coincidence to have the same internal structure:

```

1. type student = record
2.     name, address : string
3.     age : integer

4. type school = record
5.     name, address : string
6.     age : integer

7. x : student;
8. y : school;
9. ...
10. x := y;           -- is this an error?

```

Most programmers would probably want to be informed if they accidentally assigned a value of type `school` into a variable of type `student`, but a compiler whose type checking is based on structural equivalence will blithely accept such an assignment.

Name equivalence is based on the assumption that if the programmer goes to the effort of writing two type definitions, then those definitions are probably meant to represent different types. In the example above, variables `x` and `y` will be considered to have different types under name equivalence: `x` uses the type declared at line 1; `y` uses the type declared at line 4. ■

Variants of Name Equivalence

One subtlety in the use of name equivalence arises in the simplest of type declarations:

EXAMPLE 7.17

Alias types

```
TYPE new_type = old_type;           (* Modula-2 *)
```

Here `new_type` is said to be an *alias* for `old_type`. Should we treat them as two names for the same type, or as names for two different types that happen to have the same internal structure? The “right” approach may vary from one program to another. ■

EXAMPLE 7.18

Semantically equivalent
alias types

In [Example 3.13](#) we considered a module that needs to import a type name:

```

TYPE stack_element = INTEGER;       (* alias *)
MODULE stack;
IMPORT stack_element;
EXPORT push, pop;
...
PROCEDURE push(elem : stack_element);
...
PROCEDURE pop() : stack_element;
...

```

Here `stack` is meant to serve as an abstraction that allows the programmer, via textual inclusion, to create a stack of any desired type (in this case `INTEGER`). This code depends on alias types being considered equivalent; if they were not, the

EXAMPLE 7.19

Semantically distinct alias types

programmer would have to replace `stack_element` with `INTEGER` everywhere it occurs.³ ■

Unfortunately, there are other times when aliased types should probably not be the same:

```
TYPE celsius_temp = REAL;
    fahrenheit_temp = REAL;
VAR  c : celsius_temp;
     f : fahrenheit_temp;
...
f := c;                (* this should probably be an error *)
```

EXAMPLE 7.20

Derived types and subtypes in Ada

A language in which aliased types are considered distinct is said to have *strict name equivalence*. A language in which aliased types are considered equivalent is said to have *loose name equivalence*. Most Pascal-family languages (including Modula-2) use loose name equivalence. Ada achieves the best of both worlds by allowing the programmer to indicate whether an alias represents a *derived* type or a *subtype*. A subtype is compatible with its base (parent) type; a derived type is incompatible. (Subtypes of the same base type are also compatible with each other.) Our examples above would be written:

```
subtype stack_element is integer;
...
type celsius_temp is new integer;
type fahrenheit_temp is new integer;
```

One way to think about the difference between strict and loose name equivalence is to remember the distinction between declarations and definitions (Section 3.3.3). Under strict name equivalence, a declaration `type A = B` is considered a definition. Under loose name equivalence it is merely a declaration; A shares the definition of B.

EXAMPLE 7.21

Name vs structural equivalence

Consider the following example:

1. `type cell = ...` -- whatever
2. `type alink = pointer to cell`
3. `type blink = alink`
4. `p, q : pointer to cell`
5. `r : alink`
6. `s : blink`
7. `t : pointer to cell`
8. `u : alink`

3 One might argue here that the generics of more modern languages (Section 8.4) are a better way to build abstractions, but there are many single-use cases where generics would be overkill, and yet alias types still yield a more readable program.

Here the declaration at line 3 is an alias; it defines `blink` to be “the same as” `alink`. Under strict name equivalence, line 3 is both a declaration and a definition, and `blink` is a new type, distinct from `alink`. Under loose name equivalence, line 3 is just a declaration; it uses the definition at line 2.

Under strict name equivalence, `p` and `q` have the same type, because they both use the *anonymous* (unnamed) type definition on the right-hand side of line 4, and `r` and `u` have the same type, because they both use the definition at line 2. Under loose name equivalence, `r`, `s`, and `u` all have the same type, as do `p` and `q`. Under structural equivalence, all six of the variables shown have the same type, namely pointer to whatever cell is. ■

Both structural and name equivalence can be tricky to implement in the presence of separate compilation. We will return to this issue in [Section 14.6](#).

Type Conversion and Casts

In a language with static typing, there are many contexts in which values of a specific type are expected. In the statement

```
a := expression
```

we expect the right-hand side to have the same type as `a`. In the expression

```
a + b
```

the overloaded `+` symbol designates either integer or floating-point addition; we therefore expect either that `a` and `b` will both be integers, or that they will both be reals. In a call to a subroutine,

```
foo(arg1, arg2, ..., argN)
```

we expect the types of the arguments to match those of the formal parameters, as declared in the subroutine’s header. ■

Suppose for the moment that we require in each of these cases that the types (expected and provided) be exactly the same. Then if the programmer wishes to use a value of one type in a context that expects another, he or she will need to specify an explicit *type conversion* (also sometimes called a *type cast*). Depending on the types involved, the conversion may or may not require code to be executed at run time. There are three principal cases:

1. The types would be considered structurally equivalent, but the language uses name equivalence. In this case the types employ the same low-level representation, and have the same set of values. The conversion is therefore a purely conceptual operation; no code will need to be executed at run time.
2. The types have different sets of values, but the intersecting values are represented in the same way. One type may be a subrange of the other, for example, or one may consist of two’s complement signed integers, while the other is

EXAMPLE 7.22

Contexts that expect a given type

unsigned. If the provided type has some values that the expected type does not, then code must be executed at run time to ensure that the current value is among those that are valid in the expected type. If the check fails, then a dynamic semantic error results. If the check succeeds, then the underlying representation of the value can be used, unchanged. Some language implementations may allow the check to be disabled, resulting in faster but potentially unsafe code.

3. The types have different low-level representations, but we can nonetheless define some sort of correspondence among their values. A 32-bit integer, for example, can be converted to a double-precision IEEE floating-point number with no loss of precision. Most processors provide a machine instruction to effect this conversion. A floating-point number can be converted to an integer by rounding or truncating, but fractional digits will be lost, and the conversion will overflow for many exponent values. Again, most processors provide a machine instruction to effect this conversion. Conversions between different lengths of integers can be effected by discarding or sign-extending high-order bytes.

EXAMPLE 7.23

Type conversions in Ada

We can illustrate these options with the following examples of type conversions in Ada:

```
n : integer;           -- assume 32 bits
r : real;             -- assume IEEE double-precision
t : test_score;      -- as in Example 7.9
c : celsius_temp;    -- as in Example 7.20
...
t := test_score(n);  -- run-time semantic check required
n := integer(t);     -- no check req.; every test_score is an int
r := real(n);        -- requires run-time conversion
n := integer(r);     -- requires run-time conversion and check
n := integer(c);     -- no run-time code required
c := celsius_temp(n); -- no run-time code required
```

In each of the six assignments, the name of a type is used as a pseudofunction that performs a type conversion. The first conversion requires a run-time check to ensure that the value of `n` is within the bounds of a `test_score`. The second conversion requires no code, since every possible value of `t` is acceptable for `n`. The third and fourth conversions require code to change the low-level representation of values. The fourth conversion also requires a semantic check. It is generally understood that converting from a floating-point value to an integer results in the loss of fractional digits; this loss is not an error. If the conversion results in integer overflow, however, an error needs to result. The final two conversions require no run-time code; the `integer` and `celsius_temp` types (at least as we have defined them) have the same sets of values and the same underlying representation. A purist might say that `celsius_temp` should be defined as `new integer range -273..integer'last`, in which case a run-time semantic check would be required on the final conversion. ■

EXAMPLE 7.24

Type conversions in C

A type conversion in C (what C calls a type cast) is specified by using the name of the desired type, in parentheses, as a prefix operator:

```
r = (float) n; /* generates code for run-time conversion */
n = (int) r;   /* also run-time conversion, with no overflow check */
```

C and its descendants do not by default perform run-time checks for arithmetic overflow on any operation, though such checks can be enabled if desired in C#. ■

Nonconverting Type Casts Occasionally, particularly in systems programs, one needs to change the type of a value *without* changing the underlying implementation; in other words, to interpret the bits of a value of one type as if they were another type. One common example occurs in memory allocation algorithms, which use a large array of bytes to represent a heap, and then reinterpret portions of that array as pointers and integers (for bookkeeping purposes), or as various user-allocated data structures. Another common example occurs in high-performance numeric software, which may need to reinterpret a floating-point number as an integer or a record, in order to extract the exponent, significand, and sign fields. These fields can be used to implement special-purpose algorithms for square root, trigonometric functions, and so on.

A change of type that does not alter the underlying bits is called a *nonconverting type cast*, or sometimes a *type pun*. It should not be confused with use of the term *cast* for conversions in languages like C. In Ada, nonconverting casts can be effected using instances of a built-in generic subroutine called `unchecked_conversion`:

EXAMPLE 7.25

Unchecked conversions in Ada

```
-- assume 'float' has been declared to match IEEE single-precision
function cast_float_to_int is
    new unchecked_conversion(float, integer);
function cast_int_to_float is
    new unchecked_conversion(integer, float);
...
f := cast_int_to_float(n);
n := cast_float_to_int(f);
```

EXAMPLE 7.26

Conversions and nonconverting casts in C++

C++ inherits the casting mechanism of C, but also provides a family of semantically cleaner alternatives. Specifically, `static_cast` performs a type conversion, `reinterpret_cast` performs a nonconverting type cast, and `dynamic_cast` allows programs that manipulate pointers of polymorphic types to perform assignments whose validity cannot be guaranteed statically, but can be checked at run time (more on this in [Chapter 9](#)). Syntax for each of these is that of a generic function:

```
double d = ...
int n = static_cast<int>(d);
```

There is also a `const_cast` that can be used to remove read-only qualification. C-style type casts in C++ are defined in terms of `const_cast`, `static_cast`,

and `reinterpret_cast`; the precise behavior depends on the source and target types. ■

Any nonconverting type cast constitutes a dangerous subversion of the language's type system. In a language with a weak type system such subversions can be difficult to find. In a language with a strong type system, the use of explicit nonconverting type casts at least labels the dangerous points in the code, facilitating debugging if problems arise.

7.2.2 Type Compatibility

Most languages do not require equivalence of types in every context. Instead, they merely say that a value's type must be *compatible* with that of the context in which it appears. In an assignment statement, the type of the right-hand side must be compatible with that of the left-hand side. The types of the operands of `+` must both be compatible with some common type that supports addition (integers, real numbers, or perhaps strings or sets). In a subroutine call, the types of any arguments passed into the subroutine must be compatible with the types of the corresponding formal parameters, and the types of any formal parameters

DESIGN & IMPLEMENTATION

Nonconverting casts

C programmers sometimes attempt a nonconverting type cast (type pun) by taking the address of an object, converting the type of the resulting pointer, and then dereferencing:

```
r = *((float *) &n);
```

This arcane bit of hackery usually incurs no run-time cost, because most (but not all!) implementations use the same representation for pointers to integers and pointers to floating-point values—namely, an address. The ampersand operator (`&`) means “address of,” or “pointer to.” The parenthesized `(float *)` is the type name for “pointer to float” (float is a built-in floating-point type). The prefix `*` operator is a pointer dereference. The overall construct causes the compiler to interpret the bits of `n` as if it were a `float`. The reinterpretation will succeed only if `n` is an l-value (has an address), and `ints` and `floats` have the same size (again, this second condition is often but not always true in C). If `n` does not have an address then the compiler will announce a static semantic error. If `int` and `float` do not occupy the same number of bytes, then the effect of the cast may depend on a variety of factors, including the relative size of the objects, the alignment and “endian-ness” of memory (Section ©5.2), and the choices the compiler has made regarding what to place in adjacent locations in memory. Safer and more portable nonconverting casts can be achieved in C by means of unions (variant records); we consider this option in Exercise ©7.30.

passed back to the caller must be compatible with the types of the corresponding arguments.

The definition of type compatibility varies greatly from language to language. Ada takes a relatively restrictive approach: an Ada type *S* is compatible with an expected type *T* if and only if (1) *S* and *T* are equivalent, (2) one is a subtype of the other (or both are subtypes of the same base type), or (3) both are arrays, with the same numbers and types of elements in each dimension. Pascal is only slightly more lenient: in addition to allowing the intermixing of base and subrange types, it allows an integer to be used in a context where a real is expected.

Coercion

Whenever a language allows a value of one type to be used in a context that expects another, the language implementation must perform an automatic, implicit conversion to the expected type. This conversion is called a *type coercion*. Like the explicit conversions discussed above, a coercion may require run-time code to perform a dynamic semantic check, or to convert between low-level representations. Ada coercions sometimes need the former, though never the latter:

EXAMPLE 7.27

Coercion in Ada

```
d : weekday;           -- as in Example 7.3
k : workday;          -- as in Example 7.9
type calendar_column is new weekday;
c : calendar_column;
...
k := d;              -- run-time check required
d := k;              -- no check required; every workday is a weekday
c := d;              -- static semantic error;
                    -- weekdays and calendar_columns are not compatible
```

To perform this third assignment in Ada we would have to use an explicit conversion:

```
c := calendar_column(d);
```

As we noted in [Section 3.5.3](#), coercions are a controversial subject in language design. Because they allow types to be mixed without an explicit indication of intent on the part of the programmer, they represent a significant weakening of type security. C, which has a relatively weak type system, performs quite a bit of coercion. It allows values of most numeric types to be intermixed in expressions, and will coerce types back and forth “as necessary.” Here are some examples:

EXAMPLE 7.28

Coercion in C

```
short int s;
unsigned long int l;
char c;      /* may be signed or unsigned -- implementation-dependent */
float f;     /* usually IEEE single-precision */
double d;    /* usually IEEE double-precision */
...
s = l; /* l's low-order bits are interpreted as a signed number. */
l = s; /* s is sign-extended to the longer length, then
        its bits are interpreted as an unsigned number. */
```

```

s = c; /* c is either sign-extended or zero-extended to s's length;
       the result is then interpreted as a signed number. */
f = l; /* l is converted to floating-point. Since f has fewer
       significant bits, some precision may be lost. */
d = f; /* f is converted to the longer format; no precision lost. */
f = d; /* d is converted to the shorter format; precision may be lost.
       If d's value cannot be represented in single-precision, the
       result is undefined, but NOT a dynamic semantic error. */ ■

```

Fortran 90 allows arrays and records to be intermixed if their types have the same *shape*. Two arrays have the same shape if they have the same number of dimensions, each dimension has the same size (i.e., the same number of elements), and the individual elements have the same shape. (In some other languages, the actual bounds of each dimension must be the same for the shapes to be considered the same.) Two records have the same shape if they have the same number of fields, and corresponding fields, in order, have the same shape. Field *names* do not matter, nor do the actual high and low bounds of array dimensions.

Ada's compatibility rules for arrays are roughly equivalent to those of Fortran 90. C provides no operations that take an entire array as an operand. C does, however, allow arrays and *pointers* to be intermixed in many cases; we will discuss this unusual form of type compatibility further in [Section 7.7.1](#). Neither Ada nor C allows records (structures) to be intermixed unless their types are name equivalent.

In general, modern compiled languages display a trend toward static typing and away from type coercion. Some language designers have argued, however, that coercions are a natural way in which to support abstraction and program extensibility, by making it easier to use new types in conjunction with existing ones. This ease-of-programming argument is particularly important for scripting languages ([Chapter 13](#)). Among more traditional languages, C++ provides an extremely rich, *programmer-extensible* set of coercion rules. When defining a new type (a *class* in C++), the programmer can define coercion operations to convert values of the new type to and from existing types. These rules interact in complicated ways with the rules for resolving overloading ([Section 3.5.2](#)); they add significant flexibility to the language, but are one of the most difficult C++ features to understand and use correctly.

Overloading and Coercion

We have noted (in [Section 3.5.3](#)) that overloading and coercion (as well as various forms of polymorphism) can sometimes be used to similar effect. It is worth repeating some of the distinctions here. An overloaded name can refer to more than one object; the ambiguity must be resolved by context. Consider the addition of numeric quantities. In the expression `a + b`, `+` may refer to either the integer or the floating-point addition operation. In a language without coercion, `a` and `b` must either both be integer or both be real; the compiler chooses the appropriate interpretation of `+` depending on their type. In a language with coercion, `+` refers

EXAMPLE 7.29

Coercion vs overloading
of addends

to the floating-point addition operation if either `a` or `b` is real; otherwise it refers to the integer addition operation. If only one of `a` and `b` is real, the other is coerced to match. One could imagine a language in which `+` was not overloaded, but rather referred to floating-point addition in all cases. Coercion could still allow `+` to take integer arguments, but they would always be converted to real. The problem with this approach is that conversions from integer to floating-point format take a non-negligible amount of time, especially on machines without hardware conversion instructions, and floating-point addition is significantly more expensive than integer addition. ■

In most languages literal constants (e.g., numbers, character strings, the empty set `[[]]` or the null pointer `[nil]`) can be intermixed in expressions with values of many types. One might say that constants are overloaded: `nil` for example might be thought of as referring to the null pointer value for whatever type is needed in the surrounding context. More commonly, however, constants are simply treated as a special case in the language's type-checking rules. Internally, the compiler considers a constant to have one of a small number of built-in "constant types" (int const, real const, string, null), which it then coerces to some more appropriate type as necessary, even if coercions are not supported elsewhere in the language. Ada formalizes this notion of "constant type" for numeric quantities: an integer constant (one without a decimal point) is said to have type `universal_integer`; a floating-point constant (one with an embedded decimal point and/or an exponent) is said to have type `universal_real`. The `universal_integer` type is compatible with any type derived from `integer`; `universal_real` is compatible with any type derived from `real`.

Universal Reference Types

For systems programming, or to facilitate the writing of general-purpose *container* (*collection*) objects (lists, stacks, queues, sets, etc.) that hold references to other objects, several languages provide a *universal* reference type. In C and C++, this type is called `void *`. In Clu it is called `any`; in Modula-2, `address`; in Modula-3, `refany`; in Java, `Object`; in C#, `object`. Arbitrary l-values can be assigned into an object of universal reference type, with no concern about type safety: because the type of the object referred to by a universal reference is unknown, the compiler will not allow any operations to be performed on that object. Assignments back into objects of a particular reference type (e.g., a pointer to a programmer-specified record type) are a bit trickier, if type safety is to be maintained. We would not want a universal reference to a floating-point number, for example, to be assigned into a variable that is supposed to hold a reference to an integer, because subsequent operations on the "integer" would interpret the bits of the object incorrectly. In object-oriented languages, the question of how to ensure the validity of a universal to specific assignment generalizes to the question of how to ensure the validity of any assignment in which the type of the object on left-hand side supports operations that the object on the right-hand side may not.

One way to ensure the safety of universal to specific assignments (or, in general, less specific to more specific assignments) is to make objects self-descriptive—that

is, to include in the representation of each object a *tag* that indicates its type. This approach is common in object-oriented languages, which generally need it for dynamic method binding. Type tags in objects can consume a nontrivial amount of space, but allow the implementation to prevent the assignment of an object of one type into a variable of another. In Java and C#, a universal to specific assignment requires a type cast, and will generate an exception if the universal reference does not refer to an object of the casted type. In Eiffel, the equivalent operation uses a special assignment operator (`?=` instead of `:=`); in C++ it uses a `dynamic_cast` operation.

EXAMPLE 7.30

Java container of Object

Java and C# programmers frequently create container classes that hold objects of the universal reference class (`Object` or `object`, respectively). When an object is removed from a container, it must be assigned (with a type cast) into a variable of an appropriate class before anything interesting can be done with it:⁴

```
import java.util.*;    // library containing Stack container class
...
Stack myStack = new Stack();
String s = "Hi, Mom";
Foo f = new Foo();    // f is of user-defined class type Foo
...
myStack.push(s);
myStack.push(f);    // we can push any kind of object on a stack
...
s = (String) myStack.pop();
    // type cast is required, and will generate an exception at run
    // time if element at top-of-stack is not a string
```

In a language without type tags, the assignment of a universal reference into an object of a specific reference type cannot be checked, because objects are not self-descriptive: there is no way to identify their type at run time. The programmer must therefore resort to an (unchecked) type conversion.

7.2.3 Type Inference

We have seen how type checking ensures that the components of an expression (e.g., the arguments of a binary operator) have appropriate types. But what determines the type of the overall expression? In most cases, the answer is easy. The result of an arithmetic operator usually has the same type as the operands. The result of a comparison is usually Boolean. The result of a function call has the type declared in the function's header. The result of an assignment (in languages in which assignments are expressions) has the same type as the left-hand side. In

⁴ If the programmer knows that a container will be used to hold objects of only one type, then it may be possible to eliminate the type cast and, ideally, its run-time cost by using generics (Section 8.4).

a few cases, however, the answer is not obvious. In particular, operations on subranges and on composite objects do not necessarily preserve the types of the operands. We examine these cases in the remainder of this subsection. We then consider (on the PLP CD) a more elaborate form of type inference found in ML, Miranda, and Haskell.

Subranges

For simple arithmetic operators, the principal type system subtlety arises when one or more operands have subrange types (what Ada calls subtypes with range constraints). Given the following Pascal definitions, for example,

EXAMPLE 7.31

Inference of subrange types

```
type Atype = 0..20;
    Btype = 10..20;
var  a : Atype;
     b : Btype;
```

what is the type of `a + b`? Certainly it is neither `Atype` nor `Btype`, since the possible values range from 10 to 40. One could imagine it being a new anonymous subrange type with 10 and 40 as bounds. The usual answer in Pascal and its descendants is to say that the result of any arithmetic operation on a subrange has the subrange's base type, in this case integer.

If the result of an arithmetic operation is assigned into a variable of a subrange type, then a dynamic semantic check may be required. To avoid the expense of some unnecessary checks, a compiler may keep track at compile time of the largest and smallest possible values of each expression, in essence computing the anonymous `10 .. 40` type. More sophisticated techniques can be used to eliminate many checks in loops; we will consider these in Section ©16.5.2. ■

In languages like Ada, the type of an arithmetic expression assumes special significance in the header of a `for` loop (Section 6.5.1), because it determines the type of the index variable. For the sake of uniformity, Ada says that the index of a `for` loop always has the base type of the loop bounds, whether they are built-up expressions or simple variables or constants. A similar convention appears in C# 3.0, which allows a variable declaration to use the placeholder `var` instead of a type name when an appropriate type can be inferred from the initialization expression:

EXAMPLE 7.32

The `var` placeholder in C# 3.0

```
var i = 123; // equiv. to int i = 123;
var map = new Dictionary<int, string>(); // equiv. to
    Dictionary<int, string> map = new Dictionary<int, string>(); ■
```

Composite Types

Most built-in operators in most languages take operands of built-in types. Some operators, however, can be applied to values of composite types, including aggregates. Type inference becomes an issue when an operation on composites yields a result of a different type than the operands.

EXAMPLE 7.33

Type inference on string operations

Character strings provide a simple example. In Pascal, the literal string 'abc' has type array [1..3] of char. In Ada, the analogous string (denoted "abc") is considered to have an incompletely specified type that is compatible with any three-element array of characters. In the Ada expression "abc" & "defg", "abc" is a three-character array, "defg" is a four-character array, and the result is a seven-character array formed by concatenating the two. For all three, the size of the array is known but the bounds and the index type are not; they must be inferred from context. The seven-character result of the concatenation could be assigned into an array of type array (1..7) of character or into an array of type array (weekday) of character, or into any other seven-element character array. ■

EXAMPLE 7.34

Type inference for sets

Operations on composite values also occur when manipulating sets. Pascal and Modula, for example, support union (+), intersection (*), and difference (-) on sets of discrete values. Set operands are said to have compatible types if their elements have the same base type T. The result of a set operation is then of type set of T. As with subranges, a compiler can avoid the need for run-time bounds checks in certain cases by keeping track of the minimum and maximum possible members of the set expression. Because a set may have many members, some of which may be known at compile time, it can be useful to track not only the largest and smallest values that may be in a set, but also the values that are known to be in the set (see [Exercise 7.7](#)). ■

7.2.4 The ML Type System

The most sophisticated form of type inference occurs in certain functional languages, notably ML, Miranda, and Haskell. Programmers have the option of declaring the types of objects in these languages, in which case the compiler behaves much like that of a more traditional statically typed language. As we noted near the beginning of [Section 7.1](#), however, programmers may also choose not to declare certain types, in which case the compiler will infer them, based on the known types of literal constants, the explicitly declared types of any objects that have them, and the syntactic structure of the program. ML-style type inference is the invention of the language's creator, Robin Milner.⁵

© IN MORE DEPTH

An introduction to the type system of ML and its descendants appears on the PLP CD. The key to its inference mechanism is to *unify* the (partial) type information

5 Robin Milner (1934–), of Cambridge University's Computer Laboratory, is responsible not only for the development of ML and its type system, but for the Logic of Computable Functions, which provides a formal basis for machine-assisted proof construction, and the Calculus of Communicating Systems, which provides a general theory of concurrency. He received the ACM Turing Award in 1991.

available for two expressions whenever the rules of the type system say that their types must be the same. Information known about each is then known about the other as well. Any discovered inconsistencies are identified as static semantic errors. Any expression whose type remains incompletely specified after inference is automatically polymorphic; this is the *implicit parametric polymorphism* referred to in [Section 3.5.3](#). ML family languages also incorporate a powerful run-time pattern-matching facility, and several unconventional structured types, including ordered tuples, (unordered) records, lists, and a datatype mechanism that subsumes unions and recursive types.

✓ **CHECK YOUR UNDERSTANDING**

11. What is the difference between *type equivalence* and *type compatibility*?
 12. Discuss the comparative advantages of *structural* and *name* equivalence for types. Name three languages that use each approach.
 13. Explain the differences among *strict* and *loose* name equivalence.
 14. Explain the distinction between *derived* types and *subtypes* in Ada.
 15. Explain the differences among *type conversion*, *type coercion*, and *nonconverting type casts*.
 16. Summarize the arguments for and against coercion.
 17. Under what circumstances does a type conversion require a run-time check?
 18. What purpose is served by *universal* reference types?
 19. What is *type inference*? Describe three contexts in which it occurs.
-

7.3 Records (Structures) and Variants (Unions)

Record types allow related data of heterogeneous types to be stored and manipulated together. Some languages (notably Algol 68, C, C++, and Common Lisp) use the term *structure* (declared with the keyword `struct`) instead of *record*. Fortran 90 simply calls its records “types”: they are the only form of programmer-defined type other than arrays, which have their own special syntax. Structures in C++ are defined as a special form of *class* (one in which members are globally visible by default). Java has no distinguished notion of `struct`; its programmers use classes in all cases. C# uses a reference model for variables of `class` types, and a value model for variables of `struct` types. C# `structs` do not support inheritance. For the sake of simplicity, we will use the term “record” in most of our discussion to refer to the relevant construct in all these languages.

7.3.1 Syntax and Operations

EXAMPLE 7.35

A C struct

```
struct element {
    char name[2];
    int atomic_number;
    double atomic_weight;
    _Bool metallic;
};
```

In C, a simple record might be defined as follows.

EXAMPLE 7.36

A Pascal record

```
type two_chars = packed array [1..2] of char;
    (* Packed arrays will be explained in Example 7.43.
       Packed arrays of char are compatible with quoted strings. *)
type element = record
    name : two_chars;
    atomic_number : integer;
    atomic_weight : real;
    metallic : Boolean
end;
```

In Pascal, the corresponding declarations would be

EXAMPLE 7.37

Accessing record fields

```
element copper;
const double AN = 6.022e23;    /* Avogadro's number */
...
copper.name[0] = 'C'; copper.name[1] = 'u';
double atoms = mass / copper.atomic_weight * AN;
```

Each of the record components is known as a *field*. To refer to a given field of a record, most languages use “dot” notation. In C:

Pascal notation is similar to that of C. In Fortran 90 one would say `copper%name` and `copper%atomic_weight`. Cobol and Algol 68 reverse the order of the field and record names: `name of copper` and `atomic_weight of copper`. ML's notation is

DESIGN & IMPLEMENTATION

Struct tags and typedef in C and C++

One of the peculiarities of the C type system is that struct tags are not exactly type names. In [Example 7.35](#), the name of the type is the two-word phrase `struct element`. We used this name to declare the `element_yielded` field of the second struct in [Example 7.38](#). To obtain a one-word name, one can say `typedef struct element element_t`, or even `typedef struct element element`: struct tags and typedef names have separate name spaces, so the same name can be used in each. C++ eliminates this idiosyncrasy by allowing the struct tag to be used as a type name without the `struct` prefix; in effect, it performs the typedef implicitly.

also “reversed,” but uses a prefix #: `#name copper` and `#atomic_weight copper`. (Fields of an ML record can also be extracted using patterns.) In Common Lisp, one would say (element-name copper) and (element-atomic_weight copper).

EXAMPLE 7.38

Nested records

Most languages allow record definitions to be nested. Again in C:

```
struct ore {
    char name[30];
    struct {
        char name[2];
        int atomic_number;
        double atomic_weight;
        _Bool metallic;
    } element_yielded;
};
```

Alternatively, one could say

```
struct ore {
    char name[30];
    struct element element_yielded;
};
```

In Fortran 90 and Common Lisp, only the second alternative is permitted: record fields can have record types, but the declarations cannot be lexically nested. Naming for nested records is straightforward: `malachite.element_yielded.atomic_number` in Pascal or C; `atomic_number` of `element_yielded` of `malachite` in Cobol; `#atomic_number #element_yielded malachite` in ML; (element-atomic_number (ore-element_yielded malachite)) in Common Lisp.

EXAMPLE 7.39

ML records and tuples

As noted in [Example 7.14](#), ML differs from most languages in specifying that the order of record fields is insignificant. The ML record value `{name = "Cu", atomic_number = 29, atomic_weight = 63.546, metallic = true}` is the same as the value `{atomic_number = 29, name = "Cu", atomic_weight = 63.546, metallic = true}` (they will test true for equality). ML tuples are defined as abbreviations for records whose field names are small integers. The values `("Cu", 29)`, `{1 = "Cu", 2 = 29}`, and `{2 = 29, 1 = "Cu"}` will all test true for equality.

7.3.2 Memory Layout and Its Impact

The fields of a record are usually stored in adjacent locations in memory. In its symbol table, the compiler keeps track of the offset of each field within each record type. When it needs to access a field, the compiler typically generates a load or store instruction with displacement addressing. For a local object, the base register is the frame pointer; the displacement is the sum of the record’s offset from the register and the field’s offset within the record. On a RISC machine, a global record

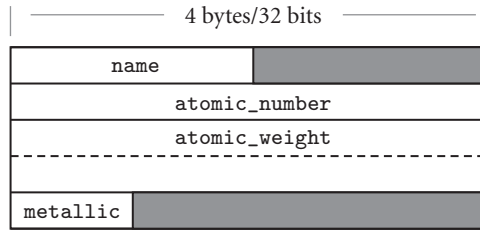

Figure 7.1 Likely layout in memory for objects of type `element` on a 32-bit machine. Alignment restrictions lead to the shaded “holes.”

is accessed in a similar way, using a dedicated *globals pointer* register as base. On a CISC machine, the compiler may access the field directly at its absolute address or, if many fields are to be accessed in a short period of time, it may load a temporary register with the (absolute) address of the record and then use the field’s offset as displacement.

EXAMPLE 7.40

Memory layout for a record type

A likely layout for our `element` type on a 32-bit machine appears in [Figure 7.1](#). Because the `name` field is only two characters long, it occupies two bytes in memory. Since `atomic_number` is an integer, and must (on most machines) be word-aligned, there is a two-byte “hole” between the end of `name` and the beginning of `atomic_number`. Similarly, since Boolean variables (in most language implementations) occupy a single byte, there are three bytes of empty space between the end of the `metallic` field and the next aligned location. In an array of `elements`, most compilers would devote 20 bytes to every member of the array. ■

In a language with a value model of variables, nested records are naturally embedded in the parent record, where they function as large fields with word or double-word alignment. In a language with a reference model of variables, fields of record type are typically references to data in another location. The difference is a matter not only of memory layout, but also of semantics. In Pascal, the following program prints a 0.

EXAMPLE 7.41

Nested records as values

```

type
  T = record
    j : integer;
  end;
  S = record
    i : integer;
    n : T;
  end;
var s1, s2 : S;
...
s1.n.j := 0;
s2 := s1;
s2.n.j := 7;
writeln(s1.n.j);           (* prints 0 *)

```

The assignment of `s1` into `s2` copies the embedded `T`. ■

EXAMPLE 7.42

Nested records as references

By contrast, the following Java program prints a 7. (Simple classes in Java play the role of structs.)

```
class T {
    public int j;
}
class S {
    public int i;
    public T n;
}
...
S s1 = new S();
s1.n = new T();           // fields initialized to 0
S s2 = s1;
s2.n.j = 7;
System.out.println(s1.n.j); // prints 7
```

Here the assignment of `s1` into `s2` has copied only the reference, so `s2.n.j` is an alias for `s1.n.j`. ■

EXAMPLE 7.43

Layout of packed types

A few languages—notably Pascal—allow the programmer to specify that a record type (or an array, set, or file type) should be *packed*:

```
type element = packed record
    name : two_chars;
    atomic_number : integer;
    atomic_weight : real;
    metallic : Boolean
end;
```

The keyword `packed` indicates that the compiler should optimize for space instead of speed. In most implementations a compiler will implement a packed record without holes, by simply “pushing the fields together.” To access a nonaligned field, however, it will have to issue a multi-instruction sequence that retrieves the pieces of the field from memory and then reassembles them in a register. A likely packed layout for our `element` type (again for a 32-bit machine) appears in [Figure 7.2](#). It is 15 bytes in length. An array of packed `element` records would probably devote 16 bytes to each member of the array; that is, it would align each element. A packed array of packed records might devote only 15 bytes to each; only every fourth element would be aligned. Ada, Modula-3, and C provide more elaborate packing mechanisms, which allow the programmer to specify precisely how many bits are to be devoted to each field. ■

EXAMPLE 7.44

Assignment and comparison of records

Most languages allow a value to be assigned to an entire record in a single operation:

```
my_element := copper;
```

Ada also allows records to be compared for equality (`if my_element = copper then ...`), but most other languages (including Pascal, C, and their successors)

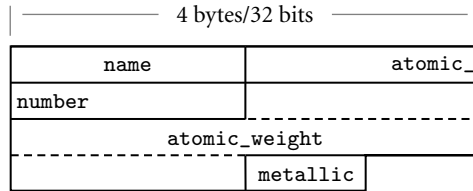

Figure 7.2 Likely memory layout for packed element records. The `atomic_number` and `atomic_weight` fields are nonaligned, and can only be read or written (on most machines) via multi-instruction sequences.

do not, though C++ allows the programmer to define equality tests for individual record types. ■

For small records, both copies and comparisons can be performed in-line on a field-by-field basis. For longer records, we can save significantly on code space by deferring to a library routine. A `block_copy` routine can take source address, destination address, and length as arguments, but the analogous `block_compare` routine would fail on records with different (garbage) data in the holes. One solution is to arrange for all holes to contain some predictable value (e.g., zero), but this requires code at every elaboration point. Another is to have the compiler generate a customized field-by-field comparison routine for every record type. Different routines would be called to compare records of different types. Languages like Pascal and C avoid the whole issue by simply outlawing full-record comparisons.

EXAMPLE 7.45

Minimizing holes by sorting fields

In addition to complicating comparisons, holes in records waste space. Packing eliminates holes, but at potentially heavy cost in access time. A compromise, adopted by some compilers, is to sort a record's fields according to the size of their alignment constraints. All byte-aligned fields might come first, followed by any half-word aligned fields, word-aligned fields, and (if the hardware requires) double-word-aligned fields. For our `element` type, the resulting rearrangement is shown in [Figure 7.3](#). ■

In most cases, reordering of fields is purely an implementation issue: the programmer need not be aware of it, so long as all instances of a record type are

DESIGN & IMPLEMENTATION

The order of record fields

Issues of record field order are intimately tied to implementation tradeoffs: Holes in records waste space, but alignment makes for faster access. If holes contain garbage we can't compare records by looping over words or bytes, but zeroing out the holes would incur costs in time and code space. Predictable layout is important for mirroring hardware structures in "systems" languages, but reorganization may be advantageous in large records if we can group frequently accessed fields together, so they lie in the same cache line.

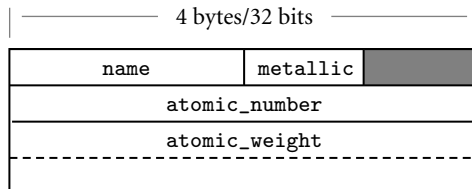

Figure 7.3 Rearranging record fields to minimize holes. By sorting fields according to the size of their alignment constraint, a compiler can minimize the space devoted to holes, while keeping the fields aligned.

reordered in the same way. The exception occurs in systems programs, which sometimes “look inside” the implementation of a data type with the expectation that it will be mapped to memory in a particular way. A kernel programmer, for example, may count on a particular layout strategy in order to define a record that mimics the organization of memory-mapped control registers for a particular Ethernet device. C and C++, which are designed in large part for systems programs, guarantee that the fields of a `struct` will be allocated in the order declared. The first field is guaranteed to have the coarsest alignment required by the hardware for any type (generally a four- or eight-byte boundary). Subsequent fields have the natural alignment for their type. Fortran 90 allows the programmer to specify that fields must not be reordered; in the absence of such a specification the compiler can choose its own order. To accommodate systems programs, Ada and C++ allow the programmer to specify nonstandard alignment for the fields of specific record types.

7.3.3 With Statements

EXAMPLE 7.46

Pascal with statement

In programs with complicated data structures, manipulating the fields of a deeply nested record can be awkward:

```
ruby.chemical_composition.elements[1].name := 'Al';
ruby.chemical_composition.elements[1].atomic_number := 13;
ruby.chemical_composition.elements[1].atomic_weight := 26.98154;
ruby.chemical_composition.elements[1].metallic := true;
```

Pascal provides a `with` statement to simplify such constructions:

```
with ruby.chemical_composition.elements[1] do begin
  name := 'Al';
  atomic_number := 13;
  atomic_weight := 26.98154;
  metallic := true
end;
```

© IN MORE DEPTH

Pascal `with` statements are examined in more detail on the PLP CD. They are generally considered an improvement on the earlier *elliptical references* of Cobol and PL/I. They still suffer from several limitations, however, most of which are addressed in Modula-3 and Fortran 2003. Similar functionality can be achieved with nested scopes in languages like Lisp and ML (which use a reference model of variables), and in languages like C and C++, which allow the programmer to create pointers or references to arbitrary objects.

7.3.4 Variant Records (Unions)

Programming languages of the 1960s and 1970s were designed in an era of severe memory constraints. Many allowed the programmer to specify that certain variables (presumably ones that would never be used at the same time) should be allocated “on top of” one another, sharing the same bytes in memory. C’s syntax, heavily influenced by Algol 68, looks very much like a struct:

```
union {
    int i;
    double d;
    _Bool b;
};
```

The overall size of this *union* would be that of its largest member (presumably `d`). Exactly which bytes of `d` would be overlapped by `i` and `b` is implementation dependent, and presumably influenced by the relative sizes of types, their alignment constraints, and the endianness of the hardware.

In practice, unions have been used for two main purposes. The first arises in systems programs, where unions allow the same set of bytes to be interpreted in different ways at different times. The canonical example occurs in memory management, where storage may sometimes be treated as unallocated space (perhaps in need of “zeroing out”), sometimes as bookkeeping information (length and header fields to keep track of free and allocated blocks), and sometimes as user-allocated data of arbitrary type. While nonconverting type casts can be used to implement heap management routines, as described on page 309, unions are a better indication of the programmer’s intent: the bits are not being reinterpreted, they are being used for independent purposes.⁶

The second common purpose for unions is to represent alternative sets of fields within a record. A record representing an employee, for example, might

EXAMPLE 7.47

Motivation for variant records

⁶ By contrast, the other example on page 309—examination of the internal structure of a floating-point number—does indeed reinterpret bits. Unions can also be used in this case (Exercise ©7.30), but here a nonconverting cast is a better indication of intent.

have several common fields (name, address, phone, department, ID number) and various other fields depending on whether the person in question works on a salaried, hourly, or consulting basis. C unions are awkward when used for this purpose. A much cleaner syntax appears in the *variant records* of Pascal and its successors, which allow the programmer to specify that certain (potentially hierarchical) sets of fields should overlap one another in memory. ■

© IN MORE DEPTH

We discuss unions and variant records in more detail on the PLP CD. Topics we consider include syntax, safety, and memory layout issues. Safety is a particular concern: where nonconverting type casts allow a programmer to circumvent the language's type system explicitly, a naive realization of unions makes it easy to do so by accident. Algol 68 and Ada impose limits on the use of unions and variant records that allow the compiler to verify, statically, that all programs are type-safe. We also note that inheritance in object-oriented languages provides an attractive alternative to type-safe variant records in most cases. This observation largely accounts for the omission of unions and variant records from more recent languages.

✓ CHECK YOUR UNDERSTANDING

20. What are *struct tags* in C? How are they related to type names? How did they change in C++?
 21. Summarize the distinction between records and *tuples* in ML. How do these compare to the records of languages like C and Ada?
 22. Discuss the significance of “holes” in records. Why do they arise? What problems do they cause?
 23. Why is it easier to implement assignment than comparison for records?
 24. What is *packing*? What are its advantages and disadvantages?
 25. Why might a compiler reorder the fields of a record? What problems might this cause?
 26. Briefly describe two purposes for unions/variant records.
-

7.4 Arrays

Arrays are the most common and important composite data types. They have been a fundamental part of almost every high-level language, beginning with Fortran I. Unlike records, which group related fields of disparate types, arrays are usually

homogeneous. Semantically, they can be thought of as a mapping from an *index type* to a *component* or *element type*. Some languages (e.g., Fortran) require that the index type be `integer`; many languages allow it to be any discrete type. Some languages (e.g., Fortran 77) require that the element type of an array be scalar. Most (including Fortran 90) allow any element type.

Some languages (notably scripting languages) allow nondiscrete index types. The resulting *associative* arrays must generally be implemented with hash tables or search trees; we consider them in [Section 13.4.3](#). Associative arrays also resemble the *dictionary* or *map* types supported by the standard libraries of many object-oriented languages. In C++, operator overloading allows these types to use conventional array-like syntax. For the purposes of this chapter, we will assume that array indices are discrete. This admits a (much more efficient) contiguous allocation scheme, to be described in [Section 7.4.3](#).

7.4.1 Syntax and Operations

Most languages refer to an element of an array by appending a subscript—delimited by parentheses or square brackets—to the name of the array. In Fortran and Ada, one says `A(3)`; in Pascal and C, one says `A[3]`. Since parentheses are generally used to delimit the arguments to a subroutine call, square bracket subscript notation has the advantage of distinguishing between the two. The difference in notation makes a program easier to compile and, arguably, easier to read. Fortran’s use of parentheses for arrays stems from the absence of square bracket characters on IBM keypunch machines, which at one time were widely used to enter Fortran programs. Ada’s use of parentheses represents a deliberate decision on the part of the language designers to embrace notational ambiguity for functions and arrays. If we think of an array as a mapping from the index type to the element type, it makes perfectly good sense to use the same notation used for functions. In some cases, a programmer may even choose to change from an array to a function-based implementation of a mapping, or vice versa ([Exercise 7.10](#)).

Declarations

EXAMPLE 7.48

Array declarations

In some languages one declares an array by appending subscript notation to the syntax that would be used to declare a scalar. In C:

```
char upper[26];
```

In Fortran:

```
character, dimension (1:26) :: upper
character (26) upper      ! shorthand notation
```

In C, the lower bound of an index range is always zero: the indices of an n -element array are $0 \dots n - 1$. In Fortran, the lower bound of the index range is one by

default. Fortran 90 allows a different lower bound to be specified if desired, using the notation shown in the first of the two declarations above.

In other languages, arrays are declared with an array constructor. In Pascal:

```
var upper : array ['a'..'z'] of char;
```

In Ada:

```
upper : array (character range 'a'..'z') of character; ■
```

EXAMPLE 7.49

Multidimensional arrays

Most languages make it easy to declare multidimensional arrays:

```
mat : array (1..10, 1..10) of real;    -- Ada

real, dimension (10,10) :: mat       ! Fortran
```

DESIGN & IMPLEMENTATION

Is [] an operator?

Associative arrays in C++ are typically defined by overloading operator []. C#, like C++, provides extensive facilities for operator overloading, but it does not use these facilities to support associative arrays. Instead, the language provides a special *indexer* mechanism, with its own unique syntax:

```
class directory {
    Hashtable table;                // from standard library
    ...
    public directory() {            // constructor
        table = new Hashtable();
    }
    ...
    public string this[string name] { // indexer method
        get {
            return (string) table[name];
        }
        set {
            table[name] = value;    // value is implicitly
        } } }                      // a parameter of set
    ...
    directory d = new directory();
    ...
    d["Jane Doe"] = "234-5678";
    Console.WriteLine(d["Jane Doe"]);
```

Why the difference? In C++, operator [] can return a reference (an explicit l-value—see [Section 8.3.1](#)), which can be used on either side of an assignment. C# has no comparable notion of reference, so it needs separate methods to get and set the value of `d["Jane Doe"]`.

In some languages (e.g., Pascal, Ada, and Modula-3), one can also declare a multi-dimensional array by using the array constructor more than once in the same declaration. In Modula-3,

```
VAR mat : ARRAY [1..10], [1..10] OF REAL;
```

is syntactic sugar for

```
VAR mat : ARRAY [1..10] OF ARRAY [1..10] OF REAL;
```

and `mat[3, 4]` is syntactic sugar for `mat[3][4]`. Similar equivalences hold in Pascal. ■

EXAMPLE 7.50

Multidimensional vs
built-up arrays

In Ada, by contrast,

```
mat1 : array (1..10, 1..10) of real;
```

is not the same as

```
type vector is array (integer range <>) of real;
type matrix is array (integer range <>) of vector (1..10);
mat2 : matrix (1..10);
```

Variable `mat1` is a two-dimensional array; `mat2` is an array of one-dimensional arrays. With the former declaration, we can access individual real numbers as `mat1(3, 4)`; with the latter we must say `mat2(3)(4)`. The two-dimensional array is arguably more elegant, but the array of arrays supports additional operations: it allows us to name the rows of `mat2` individually (`mat2(3)` is a 10-element, single-dimensional array), and it allows us to take *slices*, as discussed below (`mat2(3)(2..6)` is a five-element array of real numbers; `mat2(3..7)` is a five-element array of ten-element arrays). ■

EXAMPLE 7.51

Arrays of arrays in C

In C, one must also declare an array of arrays, and use two-subscript notation, but C's integration of pointers and arrays (to be discussed in [Section 7.7.1](#)) means that slices are not supported.

```
double mat[10][10];
```

Given this definition, `mat[3][4]` denotes an individual element of the array, but `mat[3]` denotes a *reference*, either to the third row of the array or to the first element of that row, depending on context. ■

Slices and Array Operations

EXAMPLE 7.52

Array slice operations

A *slice* or *section* is a rectangular portion of an array. Fortran 90 and Single Assignment C provide extensive facilities for slicing, as do many scripting languages, including Perl, Python, Ruby, and R. [Figure 7.4](#) illustrates some of the possibilities in Fortran 90, using the declaration of `mat` from Example 7.49.

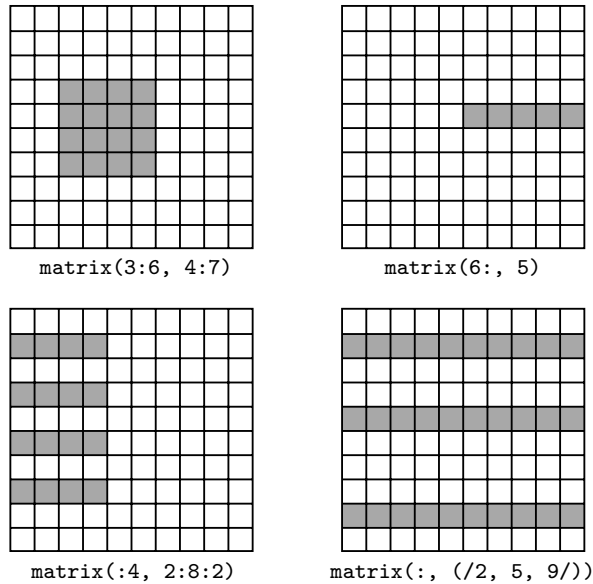

Figure 7.4 Array slices (sections) in Fortran 90. Much like the values in the header of an enumeration-controlled loop (Section 6.5.1), $a : b : c$ in a subscript indicates positions a , $a + c$, $a + 2c, \dots$ through b . If a or b is omitted, the corresponding bound of the array is assumed. If c is omitted, 1 is assumed. It is even possible to use negative values of c in order to select positions in reverse order. The slashes in the second subscript of the lower right example delimit an explicit list of positions.

Ada provides more limited support: a slice is simply a contiguous range of elements in a one-dimensional array. As we saw in Example 7.50, the elements can themselves be arrays, but there is no way to extract a slice along both dimensions as a single operation. ■

In most languages, the only operations permitted on an array are selection of an element (which can then be used for whatever operations are valid on its type), and assignment. A few languages (e.g., Ada and Fortran 90) allow arrays to be compared for equality. Ada allows one-dimensional arrays whose elements are discrete to be compared for *lexicographic ordering*: $A < B$ if the first element of A that is not equal to the corresponding element of B is less than that corresponding element. Ada also allows the built-in logical operators (`or`, `and`, `xor`) to be applied to Boolean arrays.

Fortran 90 has a very rich set of *array operations*: built-in operations that take entire arrays as arguments. Because Fortran uses structural type equivalence, the operands of an array operator need only have the same element type and shape. In particular, slices of the same shape can be intermixed in array operations, even if the arrays from which they were sliced have very different shapes. Any of the built-in arithmetic operators will take arrays as operands; the result is an array,

of the same shape as the operands, whose elements are the result of applying the operator to corresponding elements. As a simple example, $A + B$ is an array each of whose elements is the sum of the corresponding elements of A and B . Fortran 90 also provides a huge collection of *intrinsic*, or built-in functions. More than 60 of these (including logic and bit manipulation, trigonometry, logs and exponents, type conversion, and string manipulation) are defined on scalars, but will also perform their operation element-wise if passed arrays as arguments. The function `tan(A)`, for example, returns an array consisting of the tangents of the elements of A . Many additional intrinsic functions are defined solely on arrays. These include searching and summarization, transposition, and reshaping and subscript permutation.

An equally rich set of array operations can be found in Single Assignment C (SAC), a purely functional language for high-performance computing developed by Sven-Bodo Scholz and others in the mid to late 1990s, and currently in active use at a variety of sites. Both SAC and Fortran 90 take significant inspiration from APL, an array manipulation language developed by Iverson and others in the early to mid-1960s.⁷ APL was designed primarily as a terse mathematical notation for array manipulations. It employs an enormous character set that made it difficult to use with traditional keyboards and textual displays. Its variables are all arrays, and many of the special characters denote array operations. APL implementations are designed for interpreted, interactive use. They are best suited to “quick and dirty” solution of mathematical problems. The combination of very powerful operators with very terse notation makes APL programs notoriously difficult to read and understand. The J notation, a successor to APL, uses a conventional character set.

7.4.2 Dimensions, Bounds, and Allocation

In all of the examples in the previous subsection, the shape of the array (including bounds) was specified in the declaration. For such static shape arrays, storage can be managed in the usual way: static allocation for arrays whose lifetime is the entire program; stack allocation for arrays whose lifetime is an invocation of a subroutine; heap allocation for dynamically allocated arrays with more general lifetime.

Storage management is more complex for arrays whose shape is not known until elaboration time, or whose shape may change during execution. For these the compiler must arrange not only to allocate space, but also to make shape information available at run time (without such information, indexing would not be possible). Some dynamically typed languages allow run-time binding of

⁷ Kenneth Iverson (1920–2004), a Canadian mathematician, joined the faculty at Harvard University in 1954, where he conceived APL as a notation for describing mathematical algorithms. He moved to IBM in 1960, where he helped develop the notation into a practical programming language. He was named an IBM Fellow in 1970, and received the ACM Turing Award in 1979.

both the number and bounds of dimensions. Compiled languages may allow the bounds to be dynamic, but typically require the number of dimensions to be static. A local array whose shape is known at elaboration time may still be allocated in the stack. An array whose size may change during execution must generally be allocated in the heap.

In the first subsection below we consider the *descriptors*, or *dope vectors*,⁸ used to hold shape information at run time. We then consider stack- and heap-based allocation, respectively, for dynamic shape arrays.

Dope Vectors

During compilation, the symbol table maintains dimension and bounds information for every array in the program. For every record, it maintains the offset of every field. When the number and bounds of array dimensions are statically known, the compiler can look them up in the symbol table in order to compute the address of elements of the array. When these values are not statically known, the compiler must generate code to look them up in a dope vector at run time.

Typically, a dope vector will contain the lower bound of each dimension and the size of each dimension other than the last (which will always be the size of the element type, and will thus be statically known). If the language implementation performs dynamic semantic checks for out-of-bounds subscripts in array references, then the dope vector may contain upper bounds as well. Given lower bounds and sizes, the upper bound information is redundant, but it is usually included anyway, to avoid computing it repeatedly at run time.

The contents of the dope vector are initialized at elaboration time, or whenever the number or bounds of dimensions change. In a language like Fortran 90, whose notion of shape includes dimension sizes but not lower bounds, an assignment statement may need to copy not only the data of an array, but dope vector contents as well.

In a language that provides both a value model of variables and arrays of dynamic shape, we must consider the possibility that a record will contain a field whose size is not statically known. In this case the compiler may use dope vectors not only for dynamic shape arrays, but also for dynamic shape records. The dope vector for a record typically indicates the offset of each field from the beginning of the record.

Stack Allocation

EXAMPLE 7.53

Conformant array
parameters in Pascal

Subroutine parameters are the simplest example of dynamic shape arrays. Early versions of Pascal required the shape of all arrays to be specified statically. Standard Pascal relaxes this requirement by allowing array parameters to have bounds that

8 The name “dope vector” presumably derives from the notion of “having the dope on (something),” a colloquial expression that originated in horse racing: advance knowledge that a horse has been drugged (“doped”) is of significant, if unethical, use in placing bets.

are symbolic names rather than constants. It calls these parameters *conformant arrays*:

```
function DotProduct(A, B:array [lower..upper:integer] of real):real;
var i : integer;
    rtn : real;
begin
    rtn := 0;
    for i := lower to upper do rtn := rtn + A[i] * B[i];
    DotProduct := rtn
end;
```

Here `lower` and `upper` are initialized at the time of call, providing `DotProduct` with the information it needs to understand the shape of `A` and `B`. In effect, `lower` and `upper` are extra parameters of `DotProduct`.

Conformant arrays are highly useful in scientific applications, many of which rely on numerical libraries for linear algebra and the manipulation of systems of equations. Since different programs use arrays of different shapes, the subroutines in these libraries need to be able to take arguments whose size is not known at compile time.

Pascal allows conformant arrays to be passed by reference or by value (Section 8.3.1). In either case, the caller passes both the data of the array and an appropriate dope vector, in which `lower` and `upper` can be found. If the array is of dynamic shape in the caller's context, the dope vector will already exist. If the array is of static shape in the caller's context, the caller will need to create an appropriate dope vector prior to the call. ■

Conformant arrays appear in several other languages. Modula-2 inherits them from Pascal. C supports single-dimensional arrays of dynamic shape as a natural consequence of its merger of arrays and pointers (to be discussed in Section 7.7.1). Ada and C99 support not only conformant arrays, but also *local* arrays of dynamic shape. Among other things, local arrays can be declared to match the shape of conformant array parameters, facilitating the implementation of algorithms that require temporary space for calculations. Figure 7.5 contains a simple example in C99. Function `square` accepts an array parameter `M` of dynamic shape and allocates a local variable `T` of the same dynamic shape. ■

EXAMPLE 7.54

Local arrays of dynamic shape in C99

EXAMPLE 7.55

Stack allocation of elaborated arrays

In many languages, including Ada and C99, the shape of a local array becomes fixed at elaboration time. For such arrays it is still possible to place the space for the array in the stack frame of its subroutine, but an extra level of indirection is required (see Figure 7.6). In order to ensure that every local object can be found using a known offset from the frame pointer, we divide the stack frame into a *fixed-size part* and a *variable-size part*. An object whose size is statically known goes in the fixed-size part. An object whose size is not known until elaboration time goes in the variable-size part, and a pointer to it, together with a dope vector, goes in the fixed-size part. If the elaboration of the array is buried in a nested block, the compiler delays allocating space (i.e., changing the stack pointer) until the block is entered. It still allocates space for the pointer and the dope vector among the

```

void square(int n, double M[n][n]) {
    double T[n][n];
    for (int i = 0; i < n; i++) {          // compute product into T
        for (int j = 0; j < n; j++) {
            double s = 0;
            for (int k = 0; k < n; k++) {
                s += M[i][k] * M[k][j];
            }
            T[i][j] = s;
        }
    }
    for (int i = 0; i < n; i++) {          // copy back into M
        for (int j = 0; j < n; j++) {
            M[i][j] = T[i][j];
        }
    }
}

```

Figure 7.5 A dynamic local array in C99. Function `square` multiplies a matrix by itself and replaces the original with the product. To do so it needs a scratch array of the same shape as the parameter. Note that the declarations of `M` and `T` both rely on parameter `n`.

local variables when the subroutine itself is entered. Records of dynamic shape are handled in a similar way. ■

EXAMPLE 7.56

Elaborated arrays in
Fortran 90

Fortran 90 allows specification of the bounds of an array to be delayed until after elaboration, but it does not allow those bounds to change once they have been defined:

```

real, dimension (:,:), allocatable :: mat
    ! mat is two-dimensional, but with unspecified bounds
...
allocate (mat (a:b, 0:m-1))
    ! first dimension has bounds a..b; second has bounds 0..m-1
...
deallocate (mat)
    ! implementation is now free to reclaim mat's space

```

Execution of an `allocate` statement can be treated like the elaboration of a dynamic shape array in a nested block. Execution of a `deallocate` statement can be treated like the end of the nested block (restoring the previous stack pointer) if there are no other arrays beyond the specified one in the stack. Alternatively, dynamic shape arrays can be allocated in the stack, as described in the following subsection. ■

Heap Allocation

Arrays that can change shape at arbitrary times are sometimes said to be *fully dynamic*. Because changes in size do not in general occur in FIFO order, stack allocation will not suffice; fully dynamic arrays must be allocated in the heap.

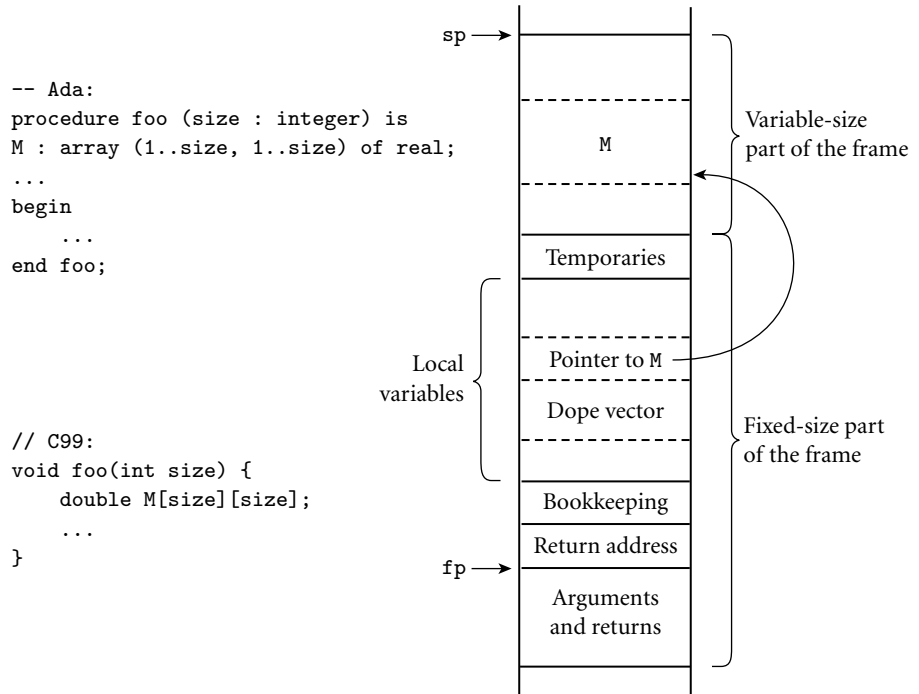

Figure 7.6 Elaboration-time allocation of arrays in Ada or C99. Here `M` is a square two-dimensional array whose bounds are determined by a parameter passed to `foo` at run time. The compiler arranges for a pointer to `M` and a dope vector to reside at static offsets from the frame pointer. `M` cannot be placed among the other local variables because it would prevent those higher in the frame from having static offsets. Additional variable-size arrays or records are easily accommodated.

EXAMPLE 7.57

Dynamic strings in Java and C#

Several languages, including Snobol, Icon, and all the scripting languages, allow strings—arrays of characters—to change size after elaboration time. Java and C# provide a similar capability (with a similar implementation), but describe the semantics differently: string variables in these languages are references to immutable string objects:

```

String s = "short";    // This is Java; use lowercase 'string' in C#
...
s = s + " but sweet"; // + is the concatenation operator

```

Here the declaration `String s` introduces a string variable, which we initialize with a reference to the constant string `"short"`. In the subsequent assignment, `+` creates a new string containing the concatenation of the old `s` and the constant `" but sweet"`; `s` is then set to refer to this new string, rather than the old.

Java and C# strings, by the way, are *not* the same as arrays of characters: strings are immutable, but elements of an array can be changed in place. ■

Dynamically resizable arrays (other than strings) appear in APL, Common Lisp, and the various scripting languages. They are also supported by the `vector`, `Vector`, and `ArrayList` classes of the C++, Java, and C# libraries, respectively. In contrast to the `allocate`-able arrays of Fortran 90, these arrays can change their shape—in particular, can grow—while retaining their current content. In most cases, increasing the size will require that the run-time system allocate a larger block, copy any data that are to be retained from the old block to the new, and then deallocate the old.

If the number of dimensions of a fully dynamic array is statically known, the *dope* vector can be kept, together with a pointer to the data, in the stack frame of the subroutine in which the array was declared. If the number of dimensions can change, the *dope* vector must generally be placed at the beginning of the heap block instead.

In the absence of garbage collection, the compiler must arrange to reclaim the space occupied by fully dynamic arrays when control returns from the subroutine in which they were declared. Space for stack-allocated arrays is of course reclaimed automatically by popping the stack.

7.4.3 Memory Layout

Arrays in most language implementations are stored in contiguous locations in memory. In a one-dimensional array, the second element of the array is stored immediately after the first (subject to alignment constraints); the third is stored immediately after the second, and so forth. For arrays of records, it is common for each subsequent element to be aligned at an address appropriate for any type; small holes between consecutive records may result.

For multidimensional arrays, it still makes sense to put the first element of the array in the array's first memory location. But which element comes next? There are two reasonable answers, called *row-major* and *column-major* order. In row-major order, consecutive locations in memory hold elements that differ by one in the final subscript (except at the ends of rows). $A[2, 4]$, for example, is followed by $A[2, 5]$. In column-major order, consecutive locations hold elements that differ by one in the *initial* subscript: $A[2, 4]$ is followed by $A[3, 4]$. These options are illustrated for two-dimensional arrays in Figure 7.7. The layouts for three or more dimensions are analogous. Fortran uses column-major order; most other languages use row-major order. (Correspondence with Fran Allen⁹

EXAMPLE 7.58

Row-major vs
column-major array layout

⁹ Fran Allen (1932–) joined IBM's T. J. Watson Research Center in 1957, and stayed for her entire professional career. Her seminal paper, *Program Optimization* [All69] helped launch the field of code improvement. Her PTRAN (Parallel TRANslation) group, founded in the early 1980s, developed much of the theory of automatic parallelization. In 1989 Dr. Allen became the first woman to be named in IBM Fellow. In 2006 she became the first to receive the ACM Turing Award.

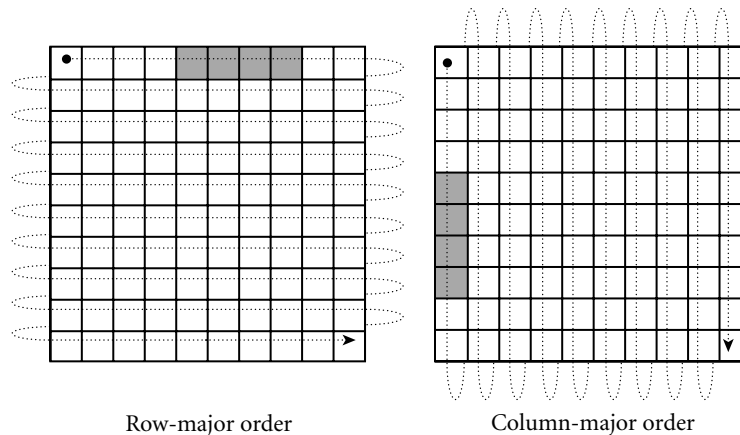

Figure 7.7 Row- and column-major memory layout for two-dimensional arrays. In row-major order; the elements of a row are contiguous in memory; in column-major order; the elements of a column are contiguous. The second cache line of each array is shaded, on the assumption that each element is an eight-byte floating-point number; that cache lines are 32 bytes long (a common size), and that the array begins at a cache line boundary. If the array is indexed from $A[0,0]$ to $A[9,9]$, then in the row-major case elements $A[0,4]$ through $A[0,7]$ share a cache line; in the column-major case elements $A[4,0]$ through $A[7,0]$ share a cache line.

suggests that column-major order was originally adopted in order to accommodate idiosyncrasies of the console debugger and instruction set of the IBM model 704 computer, on which the language was first implemented.) The advantage of row-major order is that it makes it easy to define a multidimensional array as an array of subarrays, as described in Section 7.4.1. With column-major order, the elements of the subarray would not be contiguous in memory. ■

The difference between row- and column-major layout can be important for programs that use nested loops to access all the elements of a large, multi-dimensional array. On modern machines the speed of such loops is often limited by memory system performance, which depends heavily on the effectiveness of caching (Section 5.1). Figure 7.7 shows the orientation of cache lines for row- and column-major layout of arrays. When code traverses a small array, all or most of its elements are likely to remain in the cache through the end of the nested loops, and the orientation of cache lines will not matter. For a large array, however, lines that are accessed early in the traversal are likely to be evicted to make room for lines accessed later in the traversal. If array elements are accessed in order of consecutive addresses, then each miss will bring into the cache not only the desired element, but the next several elements as well. If elements are accessed *across* cache lines instead (i.e., along the rows of a Fortran array, or the columns of an array in most other languages), then there is a good chance that almost every access will result in a cache miss, dramatically reducing the performance of the code. In C, one should write

EXAMPLE 7.59

Array layout and cache performance

```

for (i = 0; i < N; i++) {           /* rows */
    for (j = 0; j < N; j++) {      /* columns */
        ... A[i][j] ...
    }
}

```

In Fortran:

```

do j = 1, N                         ! columns
  do i = 1, N                       ! rows
    ... A(i, j) ...
  end do
end do

```

Row-Pointer Layout

Some languages employ an alternative to contiguous allocation for some arrays. Rather than require the rows of an array to be adjacent, they allow them to lie anywhere in memory, and create an auxiliary array of pointers to the rows. If the array has more than two dimensions, it may be allocated as an array of pointers to arrays of pointers to . . . This *row-pointer* memory layout requires more space in most cases, but has three potential advantages. First, it sometimes allows individual elements of the array to be accessed more quickly, especially on CISC machines with slow multiplication instructions (see the discussion of address calculations below). Second, it allows the rows to have different lengths, without devoting space to holes at the ends of the rows. This representation is sometimes called a *ragged array*. The lack of holes may sometimes offset the increased space for pointers. Third, it allows a program to construct an array from preexisting rows (possibly scattered throughout memory) without copying. C, C++, and C# provide both contiguous and row-pointer organizations for multidimensional arrays. Technically speaking, the contiguous layout is a true multidimensional array, while the row-pointer layout is an array of pointers to arrays. Java uses the row-pointer layout for all arrays.

DESIGN & IMPLEMENTATION

Array layout

The layout of arrays in memory, like the ordering of record fields, is intimately tied to tradeoffs in design and implementation. While column-major layout appears to offer no advantages on modern machines, its continued use in Fortran means that programmers must be aware of the underlying implementation in order to achieve good locality in nested loops. Row-pointer layout, likewise, has no performance advantage on modern machines (and a likely performance *penalty*, at least for numeric code), but it is a more natural fit for the “reference to object” data organization of languages like Java. Its impacts on space consumption and locality may be positive or negative, depending on the details of individual applications.

```
char days[][10] = {
    "Sunday", "Monday", "Tuesday",
    "Wednesday", "Thursday",
    "Friday", "Saturday"
};
...
days[2][3] == 's'; /* in Tuesday */
```

```
char *days[] = {
    "Sunday", "Monday", "Tuesday",
    "Wednesday", "Thursday",
    "Friday", "Saturday"
};
...
days[2][3] == 's'; /* in Tuesday */
```

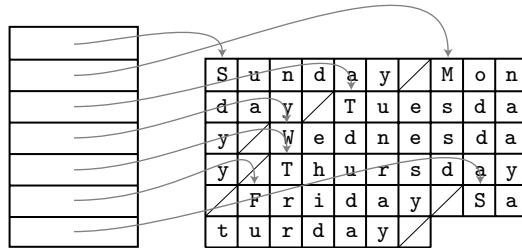
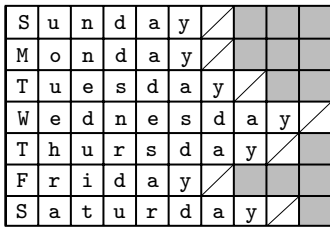

Figure 7.8 Contiguous array allocation vs row pointers in C. The declaration on the left is a true two-dimensional array. The slashed boxes are NUL bytes; the shaded areas are holes. The declaration on the right is a ragged array of pointers to arrays of characters. In both cases, we have omitted bounds in the declaration that can be deduced from the size of the initializer (aggregate). Both data structures permit individual characters to be accessed using double subscripts, but the memory layout (and corresponding address arithmetic) is quite different.

EXAMPLE 7.60
Contiguous vs row-pointer array layout

By far the most common use of the row-pointer layout in C is to represent arrays of strings. A typical example appears in Figure 7.8. In this example (representing the days of the week), the row-pointer memory layout consumes 57 bytes for the characters themselves (including a NUL byte at the end of each string), plus 28 bytes for pointers (assuming a 32-bit architecture), for a total of 85 bytes. The contiguous layout alternative devotes 10 bytes to each day (room enough for Wednesday and its NUL byte), for a total of 70 bytes. The additional space required for the row-pointer organization comes to 21%. In other cases, row pointers may actually save space. A Java compiler written in C, for example, would probably use row pointers to store the character-string representations of the 51 Java keywords and word-like literals. This data structure would use $51 \times 4 = 204$ bytes for the pointers, plus 343 bytes for the keywords, for a total of 547 bytes (548 when aligned). Since the longest keyword (*synchronized*) requires 13 bytes (including space for the terminating NUL), a contiguous two-dimensional array would consume $51 \times 13 = 663$ bytes (664 when aligned). In this case, row pointers *save* a little over 21%. ■

Address Calculations

For the usual contiguous layout of arrays, calculating the address of a particular element is somewhat complicated, but straightforward. Suppose a compiler is given the following declaration for a three-dimensional array:

```
A : array [L1 .. U1] of array [L2 .. U2] of array [L3 .. U3] of elem_type;
```

EXAMPLE 7.61
Indexing a contiguous array

Let us define constants for the sizes of the three dimensions:

$$\begin{aligned} S_3 &= \text{size of elem_type} \\ S_2 &= (U_3 - L_3 + 1) \times S_3 \\ S_1 &= (U_2 - L_2 + 1) \times S_2 \end{aligned}$$

Here the size of a row (S_2) is the size of an individual element (S_3) times the number of elements in a row (assuming row-major layout). The size of a plane (S_1) is the size of a row (S_2) times the number of rows in a plane. The address of $A[i, j, k]$ is then

$$\begin{aligned} &\text{address of } A \\ &+ (i - L_1) \times S_1 \\ &+ (j - L_2) \times S_2 \\ &+ (k - L_3) \times S_3 \end{aligned}$$

As written, this computation involves three multiplications and six additions/subtractions. We could compute the entire expression at run time, but in most cases a little rearrangement reveals that much of the computation can be performed at compile time. In particular, if the bounds of the array are known at compile time, then S_1 , S_2 , and S_3 are compile-time constants, and the subtractions of lower bounds can be distributed out of the parentheses:

$$\begin{aligned} &(i \times S_1) + (j \times S_2) + (k \times S_3) + \text{address of } A \\ &- [(L_1 \times S_1) + (L_2 \times S_2) + (L_3 \times S_3)] \end{aligned}$$

The bracketed expression in this formula is a compile-time constant (assuming the bounds of A are statically known). If A is a global variable, then the address of A is statically known as well, and can be incorporated in the bracketed expression. If A is a local variable of a subroutine (with static shape), then the address of A can be decomposed into a static offset (included in the bracketed expression) plus the contents of the frame pointer at run time. We can think of the address of A plus the bracketed expression as calculating the location of an imaginary array whose $[i, j, k]$ th element coincides with that of A , but whose lower bound in each dimension is zero. This imaginary array is illustrated in [Figure 7.9](#). ■

EXAMPLE 7.62

Pseudo-assembler for contiguous array indexing

If A 's elements are integers, and are allocated contiguously in memory, then the instruction sequence to load $A[i, j, k]$ into a register looks something like this:

```
-- assume i is in r1, j is in r2, and k is in r3
1. r4 := r1 × S1
2. r5 := r2 × S2
3. r6 := &A - L1 × S1 - L2 × S2 - L3 × S3    -- one or two instructions
4. r6 := r6 + r4
5. r6 := r6 + r5
6. r7 := *r6[r3]                                -- load
```

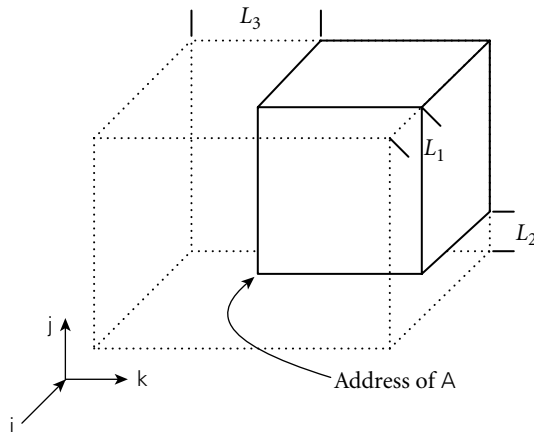

Figure 7.9 Virtual location of an array with nonzero lower bounds. By computing the constant portions of an array index at compile time, we effectively index into an array whose starting address is offset in memory, but whose lower bounds are all zero.

We have assumed that the hardware provides an indexed addressing mode, and that it scales its indexing by the size of the quantity loaded (in this case a four-byte integer). ■

EXAMPLE 7.63

Static and dynamic portions of an array index

If i , j , and/or k is known at compile time, then additional portions of the calculation of the address of $A[i, j, k]$ will move from the dynamic to the static part of the formula shown above. If all of the subscripts are known, then the entire address can be calculated statically. Conversely, if any of the bounds of the array are not known at compile time, then portions of the calculation will move from the static to the dynamic part of the formula. For example, if L_1 is not known until run time, but k is known to be 3 at compile time, then the calculation becomes

$$(i \times S_1) + (j \times S_2) - (L_1 \times S_1) + \text{address of } A - [(L_2 \times S_2) + (L_3 \times S_3) - (3 \times S_3)]$$

Again, the bracketed part can be computed at compile time. If lower bounds are always restricted to zero, as they are in C, then they never contribute to run-time cost. ■

In all our examples, we have ignored the issue of dynamic semantic checks for out-of-bound subscripts. We explore the code for these in [Exercise 7.18](#). In Section ©16.5.2 we will consider code improvement techniques that can be used to eliminate many checks statically, particularly in enumeration-controlled loops.

EXAMPLE 7.64

Indexing complex structures

The notion of “static part” and “dynamic part” of an address computation generalizes to more than just arrays. Suppose, for example, that V is a messy local array of records containing a nested, two-dimensional array in field M . The address of $V[i].M[3, j]$ could be calculated as

$$\begin{array}{l}
 i \times S_1^V \\
 -L_1^V \times S_1^V \\
 +M\text{'s offset as a field} \\
 +(3 - L_1^V) \times S_1^V \\
 +j \times S_2^V \\
 -L_2^V \times S_2^V \\
 +fp \\
 +\text{offset of } V \text{ in frame}
 \end{array}$$

Here the calculations on the left must be performed at run time; the calculations on the right can be performed at compile time. (The notation for bounds and size places the name of the variable in a superscript and the dimension in a subscript: L_2^M is the lower bound of the second dimension of M .)

EXAMPLE 7.65

Pseudo-assembler for
row-pointer array indexing

Address calculation for arrays that use row pointers is comparatively straightforward. Using our three-dimensional array A as an example, the expression $A[i, j, k]$ is equivalent, in C notation, to $(*A[i])[j][k]$. The instruction sequence to load $A[i, j, k]$ into a register looks something like this:

- assume i is in $r1$, j is in $r2$, and k is in $r3$
- 1. $r4 := \&A$ -- one or two instructions
- 2. $r4 := *r4[r1]$
- 3. $r4 := *r4[r2]$
- 4. $r7 := r4[r3]$

Assuming that the loads at lines 2 and 3 hit in the cache, this code will be comparable in cost to the instruction sequence for contiguous allocation shown above

DESIGN & IMPLEMENTATION

Lower bounds on array indices

In C, the lower bound of every array dimension is always zero. It is often assumed that the language designers adopted this convention in order to avoid subtracting lower bounds from indices at run time, thereby avoiding a potential source of inefficiency. As our discussion has shown, however, the compiler can avoid any run-time cost by translating to a virtual starting location. (The one exception to this statement occurs when the lower bound has a very large absolute value: if any index (scaled by element size) exceeds the maximum offset available with displacement mode addressing [typically 2^{15} bytes on RISC machines], then subtraction may still be required at run time.)

A more likely explanation lies in the interoperability of arrays and pointers in C (Section 7.7.1): C's conventions allow the compiler to generate code for an index operation on a pointer without worrying about the lower bound of the array into which the pointer points. Interestingly, Fortran array dimensions have a default lower bound of 1; unless the programmer explicitly specifies a lower bound of 0, the compiler must always translate to a virtual starting location.

(given load delays). If the intermediate loads miss in the cache, it will be slower. On a 1970s CISC machine, the balance would probably tip in favor of the row-pointer code: multiplies would be slower, and memory accesses faster. In any event (contiguous or row-pointer allocation, old or new machine), important code improvements will often be possible when several array references use the same subscript expression, or when array references are embedded in loops. ■

✓ CHECK YOUR UNDERSTANDING

27. What is an array *slice*? For what purposes are slices useful?
28. Is there any significant difference between a two-dimensional array and an array of one-dimensional arrays?
29. What is the *shape* of an array?
30. What is a *dope vector*? What purpose does it serve?
31. Under what circumstances can an array declared within a subroutine be allocated in the stack? Under what circumstances must it be allocated in the heap?
32. What is a *conformant* array?
33. Discuss the comparative advantages of *contiguous* and *row-pointer* layout for arrays.
34. Explain the difference between *row-major* and *column-major* layout for contiguously allocated arrays. Why does a programmer need to know which layout the compiler uses? Why do most language designers consider row-major layout to be better?
35. How much of the work of computing the address of an element of an array can be performed at compile time? How much must be performed at run time?

7.5 Strings

In many languages, a string is simply an array of characters. In other languages, strings have special status, with operations that are not available for arrays of other sorts. Particularly powerful string facilities are found in Snobol, Icon, and the various scripting languages.

As we saw in Section ©6.5.4, mechanisms to search for patterns within strings are a key part of Icon's distinctive generator-based control flow. Icon has dozens of built-in string operators, functions, and generators, including sophisticated pattern-matching facilities based on regular expressions. Perl, Python, Ruby, and other scripting languages provide similar functionality, though none includes the full power of Icon's backtracking search. We will consider the string and pattern-matching facilities of scripting languages in more detail in [Section 13.4.2](#). In the

remainder of this section we focus on the role of strings in more traditional languages.

Almost all programming languages allow literal strings to be specified as a sequence of characters, usually enclosed in single or double quote marks. Many languages, including C and its descendants, distinguish between literal characters (usually delimited with single quotes) and literal strings (usually delimited with double quotes). Other languages (e.g., Pascal) make no distinction: a character is just a string of length one. Most languages also provide *escape sequences* that allow nonprinting characters and quote marks to appear inside of strings.

EXAMPLE 7.66

Character escapes in C and C++

C99 and C++ provide a very rich set of escape sequences. An arbitrary character can be represented by a backslash followed by (a) 1 to 3 octal (base-8) digits, (b) an `x` and one or more hexadecimal (base-16) digits, (c) a `u` and exactly four hexadecimal digits, or (d) a `U` and exactly eight hexadecimal digits. The `\U` notation is meant to capture the four-byte (32-bit) Unicode character set described in the sidebar on page 295. The `\u` notation is for characters in the Basic Multilingual Plane. Many of the most common control characters also have single-character escape sequences, many of which have been adopted by other languages as well. For example, `\n` is a line feed; `\t` is a tab; `\r` is a carriage return; `\\` is a backslash. C# omits the octal sequences of C99 and C++; Java also omits the 32-bit extended sequences. ■

The set of operations provided for strings is strongly tied to the implementation envisioned by the language designer(s). Several languages that do not in general allow arrays to change size dynamically do provide this flexibility for strings. The rationale is twofold. First, manipulation of variable-length strings is fundamental to a huge number of computer applications, and in some sense “deserves” special treatment. Second, the fact that strings are one-dimensional, have one-byte elements, and never contain references to anything else makes dynamic-size strings easier to implement than general dynamic arrays.

Some languages require that the length of a string-valued variable be bound no later than elaboration time, allowing the variable to be implemented as a contiguous array of characters in the current stack frame. Pascal and Ada support a few string operations, including assignment and comparison for lexicographic ordering. C, on the other hand, provides only the ability to create a pointer to a string literal. Because of C’s unification of arrays and pointers, even assignment is not supported. Given the declaration `char *s`, the statement `s = "abc"` makes `s` point to the constant “abc” in static storage. If `s` is declared as an array, rather than a pointer (`char s[4]`), then the statement will trigger an error message from the compiler. To assign one array into another in C, the program must copy the elements individually. ■

EXAMPLE 7.67

Char* assignment in C

Other languages allow the length of a string-valued variable to change over its lifetime, requiring that the variable be implemented as a block or chain of blocks in the heap. ML and Lisp provide strings as a built-in type. C++, Java, and C# provide them as predefined classes of object, in the formal, object-oriented sense. In all these languages a string variable is a *reference* to a string. Assigning a new value to such a variable makes it refer to a different object. Concatenation and

other string operators implicitly create new objects. The space used by objects that are no longer reachable from any variable is reclaimed automatically.

7.6 Sets

A programming language set is an unordered collection of an arbitrary number of distinct values of a common type. Sets were introduced by Pascal, and are found in many more recent languages as well. The type from which elements of a set are drawn is known as the *base* or *universe* type. Pascal supports sets of any discrete type, and provides union, intersection, and difference operations:

EXAMPLE 7.68

Set types in Pascal

```
var A, B, C : set of char;
    D, E : set of weekday;
...
A := B + C; (* union; A := {x | x is in B or x is in C} *)
A := B * C; (* intersection; A := {x | x is in B and x is in C} *)
A := B - C; (* difference; A := {x | x is in B and x is not in C} *)
```

Icon supports sets of characters (called *csets*), but not sets of any other base type. Python supports sets of arbitrary type; we describe these in [Example 13.69](#) (page 708). Ada does not provide a type constructor for sets, but its generic facility can be used to define a set package (module) with functionality comparable to the sets of Pascal [IBFW91, pp. 242–244]. In a similar vein, sets appear in the standard libraries of many object-oriented languages, including C++, Java, and C#. ■

There are many ways to implement sets, including arrays, hash tables, and various forms of trees. For discrete base types with a modest number of elements,

DESIGN & IMPLEMENTATION

Representing sets

Unfortunately, bit vectors do not work well for large base types: a set of integers, represented as a bit vector, would consume some 500 megabytes on a 32-bit machine. With 64-bit integers, a bit-vector set would consume more memory than is currently contained on all the computers in the world. Because of this problem, many languages (including early versions of Pascal, but not the ISO standard) limit sets to base types of fewer than some fixed number of members. Both 128 and 256 are common limits; they suffice to cover ASCII characters. A few languages (e.g., early versions of Modula-2) limit base types to the number of elements that can be represented by a one-word bit vector, but there is really no excuse for such a severe restriction. A language that permits sets with very large base types must employ an alternative implementation (e.g., a hash table). It will still be expensive to represent sets with enormous numbers of elements, but reasonably easy to represent sets with a modest number of elements drawn from a very large universe.

a *characteristic array* is a particularly appealing implementation: it employs a bit vector whose length (in bits) is the number of distinct values of the base type. A one in the k th position in the bit vector indicates that the k th element of the base type is a member of the set; a zero indicates that it is not. In a language that uses ASCII, a set of characters would occupy 128 bits—16 bytes. Operations on bit-vector sets can make use of fast logical instructions on most machines. Union is bit-wise or; intersection is bit-wise and; difference is bit-wise not, followed by bit-wise and.

7.7 Pointers and Recursive Types

A recursive type is one whose objects may contain one or more references to other objects of the type. Most recursive types are records, since they need to contain something in addition to the reference, implying the existence of heterogeneous fields. Recursive types are used to build a wide variety of “linked” data structures, including lists and trees.

In languages that use a reference model of variables, it is easy for a record of type `foo` to include a reference to another record of type `foo`: every variable (and hence every record field) *is* a reference anyway. In languages that use a value model of variables, recursive types require the notion of a *pointer*: a variable (or field) whose value is a reference to some object. Pointers were first introduced in PL/I.

In some languages (e.g., Pascal, Ada 83, and Modula-3), pointers are restricted to point only to objects in the heap. The only way to create a new pointer value (without using variant records or casts to bypass the type system) is to call a built-in function that allocates a new object in the heap and returns a pointer to it. In other languages (e.g., PL/I, Algol 68, C, C++, and Ada 95), one can create a pointer to a nonheap object by using an “address of” operator. We will examine pointer operations and the ramifications of the reference and value models in more detail in the first subsection below.

In any language that permits new objects to be allocated from the heap, the question arises: how and when is storage reclaimed for objects that are no longer

DESIGN & IMPLEMENTATION

Implementation of pointers

It is common for programmers (and even textbook writers) to equate pointers with addresses, but this is a mistake. A pointer is a high-level concept: a reference to an object. An address is a low-level concept: the location of a word in memory. Pointers are often implemented as addresses, but not always. On a machine with a *segmented* memory architecture, a pointer may consist of a segment id and an offset within the segment. In a language that attempts to catch uses of dangling references, a pointer may contain both an address and an access key.

needed? In short-lived programs it may be acceptable simply to leave the storage unused, but in most cases unused space must be reclaimed, to make room for other things. A program that fails to reclaim the space for objects that are no longer needed is said to “leak memory.” If such a program runs for an extended period of time, it may run out of space and crash.

Many languages, including C, C++, Pascal, and Modula-2, require the programmer to reclaim space explicitly. Other languages, including Modula-3, Java, C#, and all the functional and scripting languages, require the language implementation to reclaim unused objects automatically. Explicit storage reclamation simplifies the language implementation, but raises the possibility that the programmer will forget to reclaim objects that are no longer live (thereby leaking memory), or will accidentally reclaim objects that are still in use (thereby creating *dangling references*). Automatic storage reclamation (otherwise known as *garbage collection*) dramatically simplifies the programmer’s task, but imposes certain run-time costs, and raises the question of how the language implementation is to distinguish garbage from active objects. We will discuss dangling references and garbage collection further in [Sections 7.7.2](#) and [7.7.3](#), respectively.

7.7.1 Syntax and Operations

Operations on pointers include allocation and deallocation of objects in the heap, dereferencing of pointers to access the objects to which they point, and assignment of one pointer into another. The behavior of these operations depends heavily on whether the language is functional or imperative, and on whether it employs a reference or value model for variables/names.

Functional languages generally employ a reference model for names (a purely functional language has no variables or assignments). Objects in a functional language tend to be allocated automatically as needed, with a structure determined by the language implementation. Variables in an imperative language may use either a value or a reference model, or some combination of the two. In C, Pascal, or Ada, which employ a value model, the assignment $A := B$ puts the value of B into A. If we want B to refer to an object, and we want $A := B$ to make A refer to the object to which B refers, then A and B must be pointers. In Clu and Smalltalk, which employ a reference model, the assignment $A := B$ always makes A refer to the same object to which B refers.

Java charts an intermediate course, in which the usual implementation of the reference model is made explicit in the language semantics. Variables of built-in Java types (integers, floating-point numbers, characters, and Booleans) employ a value model; variables of user-defined types (strings, arrays, and other objects in the object-oriented sense of the word) employ a reference model. The assignment $A := B$ in Java places the value of B into A if A and B are of built-in type; it makes A refer to the object to which B refers if A and B are of user-defined type. C# mirrors Java by default, but additional language features, explicitly labeled “unsafe,” allow systems programmers to use pointers when desired.

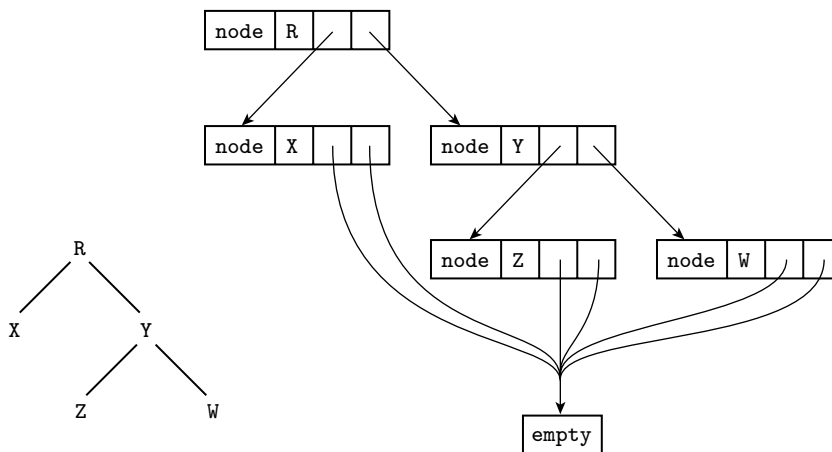

Figure 7.10 Implementation of a tree in ML. The abstract (conceptual) tree is shown at the lower left.

Reference Model

EXAMPLE 7.69

Tree type in ML

In ML, the datatype mechanism can be used to declare recursive types:

```
datatype chr_tree = empty | node of char * chr_tree * chr_tree;
```

Here a `chr_tree` is either an empty leaf or a node consisting of a character and two child trees. (Further details can be found in Section 7.2.4.)

It is natural in ML to include a `chr_tree` within a `chr_tree` because every variable is a reference. The tree node `(#R, node (#X, empty, empty), node (#Y, node (#Z, empty, empty), node (#W, empty, empty)))` would most likely be represented in memory as shown in Figure 7.10. Each individual rectangle in the right-hand portion of this figure represents a block of storage allocated from the heap. In effect, the tree is a tuple (record) tagged to indicate that it is a node. This tuple in turn refers to two other tuples that are also tagged as nodes. At the fringe of the tree are tuples that are tagged as empty; these contain no further references. Because all empty tuples are the same, the implementation is free to use just one, and to have every reference point to it. ■

EXAMPLE 7.70

Tree type in Lisp

In Lisp, which uses a reference model of variables but is not statically typed, our tree could be specified textually as `'(#R (#X () ()) (#Y (#Z () ()) (#W () ())))`. Each level of parentheses brackets the elements of a *list*. In this case, the outermost such list contains three elements: the character `R` and nested lists to represent the left and right subtrees. (The prefix `#\` notation serves the same purpose as surrounding quotes in other languages.) Semantically, each list is a pair of references: one to the head and one to the remainder of the list. As we noted in Section 7.7.1, these semantics are almost always reflected in the implementation by a `cons` cell containing two pointers. A binary tree can thus be represented as

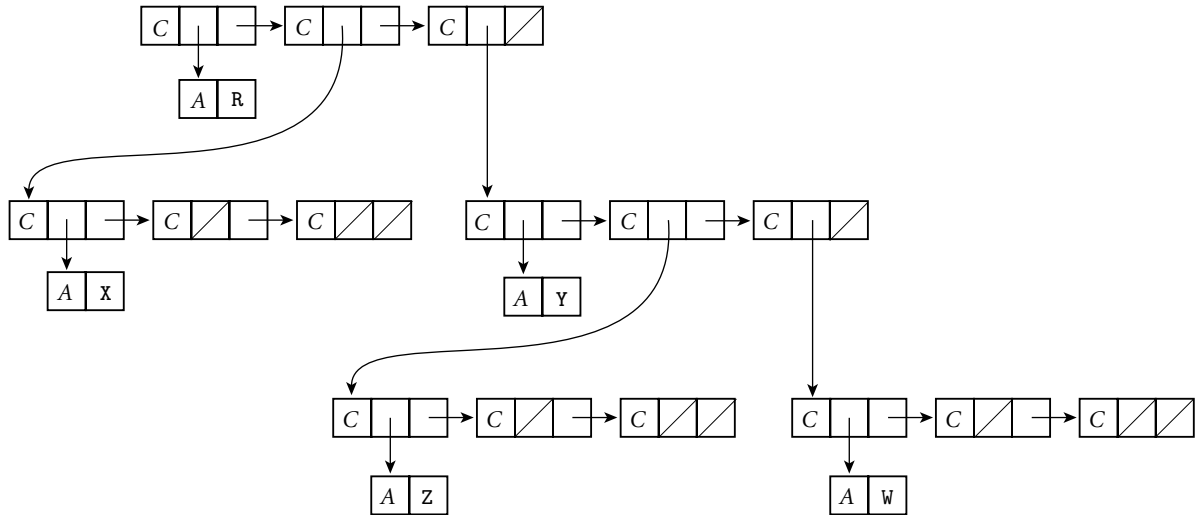

Figure 7.11 Implementation of a tree in Lisp. A diagonal slash through a box indicates a null pointer. The C and A tags serve to distinguish the two kinds of memory blocks: cons cells and blocks containing atoms.

a three-element (three cons cell) list, as shown in Figure 7.11. At the top level of the figure, the first cons cell points to R; the second and third point to nested lists representing the left and right subtrees. Each block of memory is tagged to indicate whether it is a cons cell or an *atom*. An atom is anything other than a cons cell; that is, an object of a built-in type (integer, real, character, string, etc.), or a user-defined structure (record) or array. The uniformity of Lisp lists (everything is a cons cell or an atom) makes it easy to write polymorphic functions, though without the static type checking of ML. ■

If one programs in a purely functional style in ML or in Lisp, the data structures created with recursive types turn out to be acyclic. New objects refer to old ones, but old ones never change, and thus never point to new ones. Circular structures can be defined only by using the imperative features of the languages. In ML, these features include an explicit notion of pointer, discussed briefly under “Value Model” below.

Even when writing in a functional style, one often finds a need for *types* that are *mutually recursive*. In a compiler, for example, it is likely that symbol table records and syntax tree nodes will need to refer to each other. A syntax tree node that represents a subroutine call will need to refer to the symbol table record that represents the subroutine. The symbol table record, for its part, will need to refer to the syntax tree node at the root of the subtree that represents the subroutine’s code. If types are declared one at a time, and if names must be declared before they can be used, then whichever mutually recursive type is declared first will be unable to refer to the other. ML addresses this problem by allowing types to be declared together in a group:

EXAMPLE 7.11

Mutually recursive types
in ML

```

datatype sym_tab_rec = variable of ...
  | type of ...
  | ...
  | subroutine of {code : syn_tree_node, ...}
and syn_tree_node = expression of ...
  | loop of ...
  | ...
  | subr_call of {subr : sym_tab_rec, ...};

```

Mutually recursive types of this sort are trivial in Lisp, since it is dynamically typed. (Common Lisp includes a notion of structures, but field types are not declared. In simpler Lisp dialects programmers use nested lists in which fields are merely positional conventions.) ■

Value Model

EXAMPLE 7.72

Tree types in Pascal,
Ada, and C

In Pascal, our tree data type would be declared as follows:

```

type chr_tree_ptr = ^chr_tree;
chr_tree = record
  left, right : chr_tree_ptr;
  val : char
end;

```

The Ada declaration is similar:

```

type chr_tree;
type chr_tree_ptr is access chr_tree;
type chr_tree is record
  left, right : chr_tree_ptr;
  val : character;
end record;

```

In C, the equivalent declaration is

```

struct chr_tree {
  struct chr_tree *left, *right;
  char val;
};

```

As mentioned in [Section 3.3.3](#), Pascal permits forward references in the declaration of pointer types, to support recursive types. Ada and C use incomplete type declarations instead. ■

No aggregate syntax is available for linked data structures in Pascal, Ada, or C; a tree must be constructed node by node. To allocate a new node from the heap, the programmer calls a built-in function. In Pascal:

```

new(my_ptr);

```

EXAMPLE 7.73

Allocating heap nodes

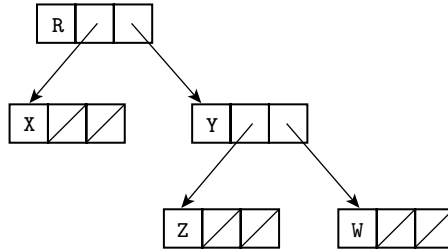

Figure 7.12 Typical implementation of a tree in a language with explicit pointers. As in Figure 7.11, a diagonal slash through a box indicates a null pointer.

In Ada:

```
my_ptr := new chr_tree;
```

In C:

```
my_ptr = malloc(sizeof(struct chr_tree));
```

C's `malloc` is defined as a library function, not a built-in part of the language (though some compilers recognize and optimize it as a special case). The programmer must specify the size of the allocated object explicitly, and while the return value (of type `void*`) can be assigned into any pointer, the assignment is not type-safe. ■

EXAMPLE 7.74

Object-oriented allocation of heap nodes

C++, Java, and C# replace `malloc` with a built-in, type-safe `new`:

```
my_ptr = new chr_tree( arg_list );
```

In addition to “knowing” the size of the requested type, the C++/Java/C# `new` will automatically call any user-specified *constructor* (initialization) function, passing the specified argument list. In a similar but less flexible vein, Ada’s `new` may specify an initial value for the allocated object:

```
my_ptr := new chr_tree'(null, null, 'X');
```

EXAMPLE 7.75

Pointer-based tree

After we have allocated and linked together appropriate nodes in C, Pascal, or Ada, our tree example is likely to be implemented as shown in Figure 7.12. As in Lisp, a leaf is distinguished from an internal node simply by the fact that its two pointer fields are null. ■

EXAMPLE 7.76

Pointer dereferencing

To access the object referred to by a pointer, most languages use an explicit dereferencing operator. In Pascal and Modula this operator takes the form of a postfix “up-arrow”:

```
my_ptr^.val := 'X';
```

In C it is a prefix star:

```
(*my_ptr).val = 'X';
```

Because pointers so often refer to records (structs), for which the prefix notation is awkward, C also provides a postfix “right-arrow” operator that plays the role of the “up-arrow dot” combination in Pascal:

```
my_ptr->val = 'X';
```

EXAMPLE 7.77

Implicit dereferencing in
Ada

On the assumption that pointers almost always refer to records, Ada dispenses with dereferencing altogether. The same dot-based syntax can be used to access either a field of the record `foo` or a field of the record *pointed to* by `foo`, depending on the type of `foo`:

```
T : chr_tree;
P : chr_tree_ptr;
...
T.val := 'X';
P.val := 'Y';
```

In those cases in which one actually wants to name the *entire* object referred to by a pointer, Ada provides a special “pseudofield” called `all`:

```
T := P.all;
```

EXAMPLE 7.78

Pointer dereferencing in
ML

In essence, pointers in Ada are automatically dereferenced when needed.

The imperative features of ML include an assignment statement, but this statement requires that the left-hand side be a pointer: its effect is to make the pointer refer to the object on the right-hand side. To access the object referred to by a pointer, one uses an exclamation point as a prefix dereferencing operator:

```
val p = ref 2; (* p is a pointer to 2 *)
...
p := 3;      (* p now points to 3 *)
...
let val n = !p in ...
    (* n is simply 3 *)
```

ML thus makes the distinction between l-values and r-values very explicit. Most languages blur the distinction by implicitly dereferencing variables on the right-hand side of every assignment statement. Ada blurs the distinction further by dereferencing pointers automatically in certain circumstances.

The imperative features of Lisp do not include a dereferencing operator. Since every object has a self-evident type, and assignment is performed using a small set of built-in operators, there is never any ambiguity as to what is intended.

EXAMPLE 7.79

Assignment in Lisp

Assignment in Common Lisp employs the `setf` operator (Scheme uses `set!`, `set-car!`, and `set-cdr!`), rather than the more common `:=`. For example, if `foo` refers to a list, then `(cdr foo)` is the right-hand (“rest of list”) pointer of the first node in the list, and the assignment `(set-cdr! foo foo)` makes this pointer refer back to `foo`, creating a one-node circular list:

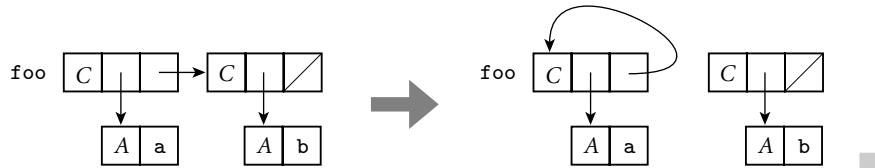
**Pointers and Arrays in C****EXAMPLE 7.80**

Array names and pointers in C

Pointers and arrays are closely linked in C. Consider the following declarations:

```
int n;
int *a;      /* pointer to integer */
int b[10];  /* array of 10 integers */
```

Now all of the following are valid:

1. `a = b;` /* make a point to the initial element of b */
2. `n = a[3];`
3. `n = *(a+3);` /* equivalent to previous line */
4. `n = b[3];`
5. `n = *(b+3);` /* equivalent to previous line */

In most contexts, an unsubscripted array name in C is automatically converted to a pointer to the array’s first element (the one with index zero), as shown here in line 1. (Line 5 embodies the same conversion.) Lines 3 and 5 illustrate *pointer arithmetic*: Given a pointer to an element of an array, the addition of an integer k produces a pointer to the element k positions later in the array (earlier if k is negative.) The prefix `*` is a pointer dereference operator. Pointer arithmetic is valid only within the bounds of a single array, but C compilers are not required to check this.

Remarkably, the subscript operator `[]` in C is actually defined in terms of pointer arithmetic: lines 2 and 4 are syntactic sugar for lines 3 and 5, respectively. More precisely, `E1[E2]`, for any expressions `E1` and `E2`, is defined to be `(*((E1)+(E2)))`, which is of course the same as `(*((E2)+(E1)))`. (Extra parentheses have been used in this definition to avoid any questions of precedence if `E1` and `E2` are complicated expressions.) Correctness requires only that one operand of `[]` have an array or pointer type and the other have an integral type. Thus `A[3]` is equivalent to `3[A]`, something that comes as a surprise to most programmers. ■

EXAMPLE 7.81

Pointer comparison and subtraction in C

In addition to allowing an integer to be added to a pointer, C allows pointers to be subtracted from one another or compared for ordering, provided that they refer to elements of the same array. The comparison $p < q$, for example, tests to see if p refers to an element closer to the beginning of the array than the one referred to by q . The expression $p - q$ returns the number of array positions that separate the elements to which p and q refer. All arithmetic operations on pointers “scale” their results as appropriate, based on the size of the referenced objects. For multidimensional arrays with row-pointer layout, $a[i][j]$ is equivalent to $*(a+i)[j]$ or $*(a[i]+j)$ or $*(*(a+i)+j)$. ■

EXAMPLE 7.82

Pointer and array declarations in C

Despite the interoperability of pointers and arrays in C, programmers need to be aware that the two are not the same, particularly in the context of variable declarations, which need to allocate space when elaborated. The declaration of

DESIGN & IMPLEMENTATION**Stack smashing**

The lack of bounds checking on array subscripts and pointer arithmetic is a major source of bugs and security problems in C. Many of the most infamous Internet viruses have propagated by means of *stack smashing*, a particularly nasty form of *buffer overflow attack*. Consider a (very naive) routine designed to read a number from an input stream:

```
int get_acct_num(FILE *s) {
    char buf[100];
    char *p = buf;
    do {
        /* read from stream s: */
        *p = getc(s);
    } while (*p++ != '\n');
    *p = '\0';
    /* convert ascii to int: */
    return atoi(buf);
}
```

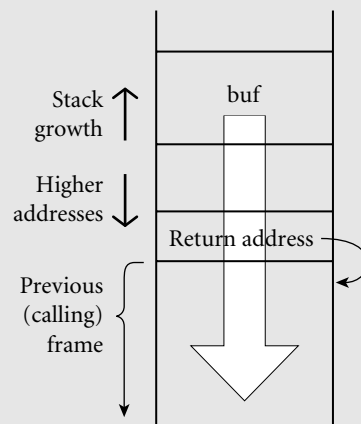

If the stream provides more than 100 characters without a newline (`'\n'`), those characters will overwrite memory beyond the confines of `buf`, as shown by the large white arrow in the figure. A careful attacker may be able to invent a string whose bits include both a sequence of valid machine instructions and a replacement value for the subroutine’s return address. When the routine attempts to return, it will jump into the attacker’s instructions instead.

Stack smashing can be prevented by manually checking array bounds in C, or by configuring the hardware to prevent the execution of instructions in the stack (see the sidebar on page ©179). It would never have been a problem in the first place, however, if C had been designed for automatic bounds checks.

a pointer variable allocates space to hold a pointer, while the declaration of an array variable allocates space to hold the whole array. In the case of an array the declaration must specify a size for each dimension. Thus `int *a[n]`, when elaborated, will allocate space for n row pointers; `int a[n][m]` will allocate space for a two-dimensional array with contiguous layout.¹⁰ As a convenience, a variable declaration that includes initialization to an aggregate can omit the size of the outermost dimension if that information can be inferred from the contents of the aggregate:

```
int a[][2] = {{1, 2}, {3, 4}, {5, 6}}; // three rows
```

EXAMPLE 7.83

Arrays as parameters in C

When an array is included in the argument list of a function call, C passes a pointer to the first element of the array, not the array itself. For a one-dimensional array of integers, the corresponding formal parameter may be declared as `int a[]` or `int *a`. For a two-dimensional array of integers with row-pointer layout, the formal parameter may be declared as `int *a[]` or `int **a`. For a two-dimensional array with contiguous layout, the formal parameter may be declared as `int a[][m]` or `int (*a)[m]`. The size of the first dimension is irrelevant; all that is passed is a pointer, and C performs no dynamic checks to ensure that references are within the bounds of the array.

DESIGN & IMPLEMENTATION

Pointers and arrays

Many C programs use pointers instead of subscripts to iterate over the elements of arrays. Before the development of modern optimizing compilers, pointer-based array traversal often served to eliminate redundant address calculations, thereby leading to faster code. With modern compilers, however, the opposite may be true: redundant address calculations can be identified as common subexpressions, and certain other code improvements are easier for indices than they are for pointers. In particular, as we shall see in [Chapter 16](#), pointers make it significantly more difficult for the code improver to determine when two l-values may be *aliases* for one other.

Today the use of pointer arithmetic is mainly a matter of personal taste: some C programmers consider pointer-based algorithms to be more elegant than their array-based counterparts; others simply find them harder to read. Certainly the fact that arrays are passed as pointers makes it natural to write subroutines in the pointer style.

¹⁰ To read declarations in C, it is helpful to follow the following rule: start at the name of the variable and work right as far as possible, subject to parentheses; then work left as far as possible; then jump out a level of parentheses and repeat. Thus `int *a[n]` means that `a` is an n -element array of pointers to integers, while `int (*a)[n]` means that `a` is a pointer to an n -element array of integers.

In all cases, a declaration must allow the compiler (or human reader) to determine the size of the *elements* of an array or, equivalently, the size of the objects referred to by a pointer. Thus neither `int a[][]` nor `int (*a)[]` is a valid variable or parameter declaration: neither provides the compiler with the size information it needs to generate code for `a + i` or `a[i]`.

EXAMPLE 7.84

Sizeof in C

The built-in `sizeof` operator returns the size in bytes of an object or type. When given an array as argument it returns the size of the entire array. When given a pointer as argument it returns the size of the pointer itself. If `a` is an array, `sizeof(a) / sizeof(a[0])` returns the number of elements in the array. Similarly, if pointers occupy 4 bytes and double-precision floating-point numbers occupy 8 bytes, then given

```
double *a;           /* pointer to double */
double (*b)[10];    /* pointer to array of 10 doubles */
```

we have `sizeof(a) = sizeof(b) = 4`, `sizeof(*a) = sizeof(*b[0]) = 8`, and `sizeof(*b) = 80`. In most cases, `sizeof` can be evaluated at compile time. The principal exception occurs for variable-length arrays, whose size may not be known until elaboration time:

```
void f(int len) {
    int A[len];           /* sizeof(A) == len * sizeof(int) */
```

✓ CHECK YOUR UNDERSTANDING

36. Name three languages that provide particularly extensive support for character strings.
37. Why might a language permit operations on strings that it does not provide for arrays?
38. What are the strengths and weaknesses of the bit-vector representation for sets? How else might sets be implemented?
39. Discuss the tradeoffs between pointers and the recursive types that arise naturally in a language with a reference model of variables.
40. Summarize the ways in which one dereferences a pointer in various programming languages.
41. What is the difference between a *pointer* and an *address*?
42. Discuss the advantages and disadvantages of the interoperability of pointers and arrays in C.
43. Under what circumstances must the bounds of a C array be specified in its declaration?

7.7.2 Dangling References

When a heap-allocated object is no longer live, a long-running program needs to reclaim the object's space. Stack objects are reclaimed automatically as part of the subroutine calling sequence. How are heap objects reclaimed? There are two alternatives. Languages like Pascal, C, and C++ require the programmer to reclaim an object explicitly. In Pascal:

EXAMPLE 7.85

Explicit storage
reclamation

```
dispose(my_ptr);
```

In C:

```
free(my_ptr);
```

In C++:

```
delete my_ptr;
```

C++ provides additional functionality: prior to reclaiming the space, it automatically calls any user-provided *destructor* function for the object. A destructor can reclaim space for subsidiary objects, remove the object from indices or tables, print messages, or perform any other operation appropriate at the end of the object's lifetime. ■

EXAMPLE 7.86

Dangling reference to a
stack variable in C++

A *dangling reference* is a live pointer that no longer points to a valid object. In languages like Algol 68 or C, which allow the programmer to create pointers to stack objects, a dangling reference may be created when a subroutine returns while some pointer in a wider scope still refers to a local object of that subroutine:

```
int i = 3;
int *p = &i;
...
void foo() { int n = 5; p = &n; }
...
cout << *p; // prints 3
foo();
...
cout << *p; // undefined behavior: n is no longer live ■
```

EXAMPLE 7.87

Dangling reference to a
heap variable in C++

In a language with explicit reclamation of heap objects, a dangling reference is created whenever the programmer reclaims an object to which pointers still refer:

```
int *p = new int;
*p = 3;
...
cout << *p; // prints 3
delete p;
...
cout << *p; // undefined behavior: *p has been reclaimed
```

Note that even if the reclamation operation were to change its argument to a null pointer, this would not solve the problem, because *other* pointers might still refer to the same object. ■

Because a language implementation may reuse the space of reclaimed stack and heap objects, a program that uses a dangling reference may read or write bits in memory that are now part of some other object. It may even modify bits that are now part of the implementation's bookkeeping information, corrupting the structure of the stack or heap.

Algol 68 addresses the problem of dangling references to stack objects by forbidding a pointer from pointing to any object whose lifetime is briefer than that of the pointer itself. Unfortunately, this rule is difficult to enforce. Among other things, since both pointers and objects to which pointers might refer can be passed as arguments to subroutines, dynamic semantic checks are possible only if reference parameters are accompanied by a hidden indication of lifetime. Ada 95 has a more restrictive rule that is easier to enforce: it forbids a pointer from pointing to any object whose lifetime is briefer than that of the pointer's *type*.

© IN MORE DEPTH

On the PLP CD we consider two mechanisms that are sometimes used to catch dangling references at run time. *Tombstones* introduce an extra level of indirection on every pointer access. When an object is reclaimed, the indirection word (tombstone) is marked in a way that invalidates future references to the object. *Locks* and *keys* add a word to every pointer and to every object in the heap; these words must match for the pointer to be valid. Tombstones can be used in languages that permit pointers to nonheap objects, but they introduce the secondary problem of reclaiming the tombstones themselves. Locks and keys are somewhat simpler, but they work only for objects in the heap.

7.7.3 Garbage Collection

Explicit reclamation of heap objects is a serious burden on the programmer and a major source of bugs (memory leaks and dangling references). The code required to keep track of object lifetimes makes programs more difficult to design, implement, and maintain. An attractive alternative is to have the language implementation notice when objects are no longer useful and reclaim them automatically. Automatic reclamation (otherwise known as *garbage collection*) is more-or-less essential for functional languages: `delete` is a very imperative sort of operation, and the ability to construct and return arbitrary objects from functions means that many objects that would be allocated on the stack in an imperative language must be allocated from the heap in a functional language, to give them unlimited extent.

Over time, automatic garbage collection has become popular for imperative languages as well. It can be found in, among others, Clu, Cedar, Modula-3, Java,

C#, and all the major scripting languages. Automatic collection is difficult to implement, but the difficulty pales in comparison to the convenience enjoyed by programmers once the implementation exists. Automatic collection also tends to be slower than manual reclamation, though it eliminates any need to check for dangling references.

Reference Counts

When is an object no longer useful? One possible answer is: when no pointers to it exist.¹¹ The simplest garbage collection technique simply places a counter in each object that keeps track of the number of pointers that refer to the object. When the object is created, this *reference count* is set to 1, to represent the pointer returned by the `new` operation. When one pointer is assigned into another, the run-time system decrements the reference count of the object formerly referred to by the assignment's left-hand side, and increments the count of the object referred to by the right-hand side. On subroutine return, the calling sequence epilogue must decrement the reference count of any object referred to by a local pointer

DESIGN & IMPLEMENTATION

Garbage collection

Garbage collection presents a classic tradeoff between convenience and safety on the one hand and performance on the other. Manual storage reclamation, implemented correctly by the application program, is almost invariably faster than any automatic garbage collector. It is also more predictable: automatic collection is notorious for its tendency to introduce intermittent “hiccups” in the execution of real-time or interactive programs.

Ada takes the unusual position of refusing to take a stand: the language design makes automatic garbage collection possible, but implementations are not required to provide it, and programmers can request manual reclamation with a built-in routine called `Unchecked_Deallocation`. The Ada 95 version of the language provides extensive facilities whereby programmers can implement their own storage managers (garbage collected or not), with different types of pointers corresponding to different storage “pools.”

In a similar vein, the Real Time Specification for Java allows the programmer to create so-called *scoped memory* areas that are accessible to only a subset of the currently running threads. When all threads with access to a given area terminate, the area is reclaimed in its entirety. Objects allocated in a scoped memory area are never examined by the garbage collector; performance anomalies due to garbage collection can therefore be avoided by providing scoped memory to every real-time thread.

11 Throughout the following discussion we will use the pointer-based terminology of languages with a value model of variables. The techniques apply equally well, however, to languages with a reference model of variables.

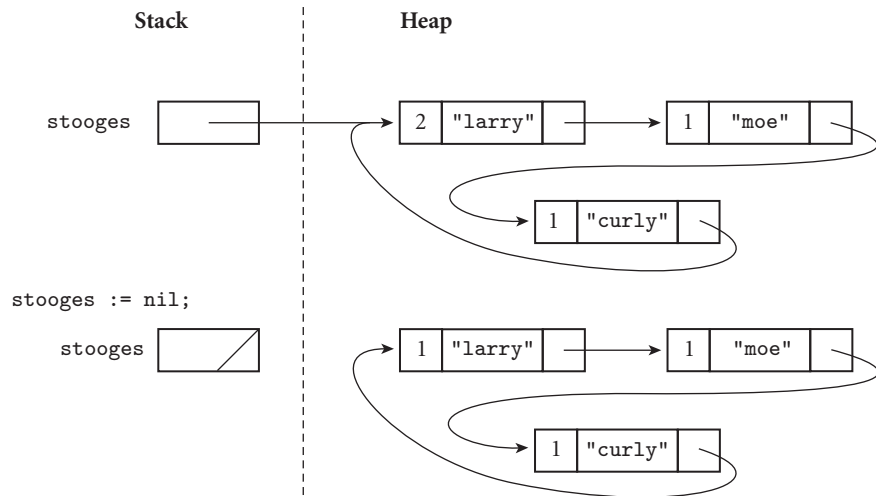

Figure 7.13 Reference counts and circular lists. The list shown here cannot be found via any program variable, but because it is circular, every cell contains a nonzero count.

that is about to be destroyed. When a reference count reaches zero, its object can be reclaimed. Recursively, the run-time system must decrement counts for any objects referred to by pointers within the object being reclaimed, and reclaim those objects if their counts reach zero. To prevent the collector from following garbage addresses, each pointer must be initialized to null at elaboration time.

In order for reference counts to work, the language implementation must be able to identify the location of every pointer. When a subroutine returns, it must be able to tell which words in the stack frame represent pointers; when an object in the heap is reclaimed, it must be able to tell which words within the object represent pointers. The standard technique to track this information relies on *type descriptors* generated by the compiler. There is one descriptor for every distinct type in the program, plus one for the stack frame of each subroutine, and one for the set of global variables. Most descriptors are simply a table that lists the offsets within the type at which pointers can be found, together with the addresses of descriptors for the types of the objects referred to by those pointers. For a tagged variant record (discriminated union) type, the descriptor is a bit more complicated: it must contain a list of values (or ranges) for the tag, together with a table for the corresponding variant. For *untagged* variant records, there is no acceptable solution: reference counts work only if the language is strongly typed (but see the discussion of “Conservative Collection” on page 364).

EXAMPLE 7.88

Reference counts and circular structures

The most important problem with reference counts stems from their definition of a “useful object.” While it is definitely true that an object is useless if no references to it exist, it may also be useless when references *do* exist. As shown in Figure 7.13, reference counts may fail to collect circular structures. They work well only for structures that are guaranteed to be noncircular. Many language

implementations use reference counts for variable-length strings; strings never contain references to anything else. Perl uses reference counts for all dynamically allocated data; the manual warns the programmer to break cycles manually when data aren't needed anymore. Some purely functional languages may also be able to use reference counts safely in all cases, if the lack of an assignment statement prevents them from introducing circularity. Finally, reference counts can be used to reclaim tombstones. While it is certainly possible to create a circular structure with tombstones, the fact that the programmer is responsible for explicit deallocation of heap objects implies that reference counts will fail to reclaim tombstones only when the programmer has failed to reclaim the objects to which they refer. ■

Tracing Collection

A better definition of a “useful” object is one that can be reached by following a chain of valid pointers starting from something that has a name (i.e., something outside the heap). According to this definition, the blocks in the bottom half of [Figure 7.13](#) are useless, even though their reference counts are nonzero. Tracing collectors work by recursively exploring the heap, starting from external pointers, to determine what is useful.

Mark-and-Sweep The classic mechanism to identify useless blocks, under this more accurate definition, is known as *mark-and-sweep*. It proceeds in three main steps, executed by the garbage collector when the amount of free space remaining in the heap falls below some minimum threshold.

DESIGN & IMPLEMENTATION

What exactly is garbage?

Reference counting implicitly defines a garbage object as one to which no pointers exist. Tracing implicitly defines it as an object that is no longer reachable from outside the heap. Ideally, we'd like an even stronger definition: a garbage object is one that the program will never use again. We settle for nonreachability because this ideal definition is uncomputable. The difference can matter in practice: if a program maintains a pointer to an object it will never use again, then the garbage collector will be unable to reclaim it. If the number of such objects grows with time, then the program has a memory leak, despite the presence of a garbage collector. (Trivially we could imagine a program that added every newly allocated object to a global list, but never actually perused the list. Such a program would defeat the collector entirely.)

For the sake of space efficiency, programmers are advised to “zero out” any pointers they no longer need. Doing this can be difficult, but not as difficult as fully manual reclamation—in particular, we do not need to realize when we are zeroing the *last* pointer to a given object. For the same reason, dangling references can never arise: the garbage collector will refrain from reclaiming any object that is reachable along some other path.

1. The collector walks through the heap, tentatively marking every block as “useless.”
2. Beginning with all pointers outside the heap, the collector recursively explores all linked data structures in the program, marking each newly discovered block as “useful.” (When it encounters a block that is already marked as “useful,” the collector knows it has reached the block over some previous path, and returns without recursing.)
3. The collector again walks through the heap, moving every block that is still marked “useless” to the free list.

Several potential problems with this algorithm are immediately apparent. First, both the initial and final walks through the heap require that the collector be able to tell where every “in-use” block begins and ends. In a language with variable-size heap blocks, every block must begin with an indication of its size, and of whether it is currently free. Second, the collector must be able in Step 2 to find the pointers contained within each block. The standard solution is to place a pointer to a type descriptor near the beginning of each block.

Pointer Reversal The exploration step (Step 2) of mark-and-sweep collection is naturally recursive. The obvious implementation needs a stack whose maximum depth is proportional to the longest chain through the heap. In practice, the space for this stack may not be available: after all, we run garbage collection when we’re about to run out of space!¹² An alternative implementation of the exploration step uses a technique first suggested by Schorr and Waite [SW67] to embed the equivalent of the stack in already-existing fields in heap blocks. More specifically, as the collector explores the path to a given block, it *reverses* the pointers it follows, so that each points *back* to the previous block instead of forward to the next. This pointer-reversal technique is illustrated in Figure 7.14. As it explores, the collector keeps track of the current block and the block from whence it came.

To return from block X to block U (after part (d) of the figure), the collector will use the reversed pointer in U to restore its notion of previous block (T). It will then flip the reversed pointer back to X and update its notion of current block to U. If the block to which it has returned contains additional pointers, the collector will proceed forward again; otherwise it will return across the previous reversed pointer and try again. At most one pointer in every block will be reversed at any given time. This pointer must be marked, probably by means of another bookkeeping field at the beginning of each block. (We could mark the pointer by setting one of its low-order bits, but the cost in time would probably be prohibitive: we’d have to search the block on every visit.) ■

EXAMPLE 7.89

Heap tracing with pointer reversal

12 In many language implementations, the stack and heap grow toward each other from opposite ends of memory (Section 14.4); if the heap is full, the stack can’t grow. In a system with virtual memory the distance between the two may theoretically be enormous, but the space that backs them up on disk is still limited, and shared between them.

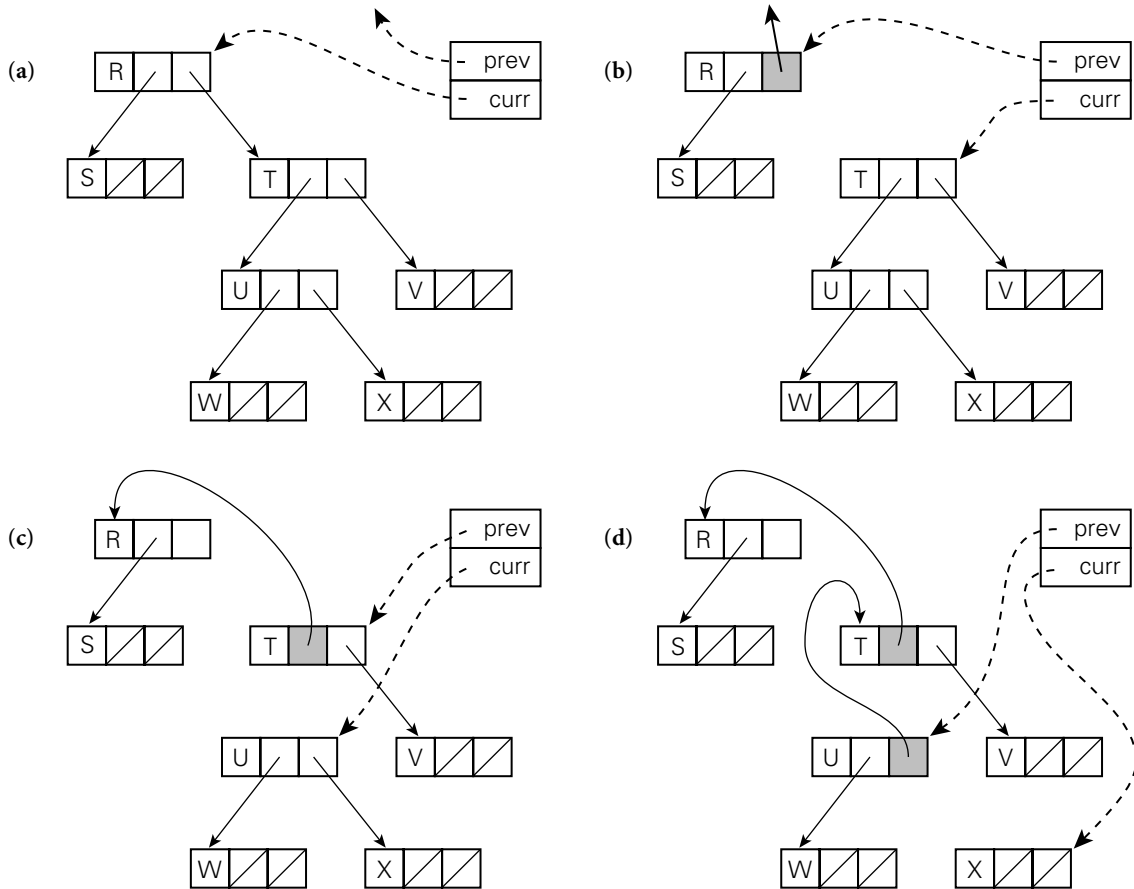

Figure 7.14 Heap exploration via pointer reversal. The block currently under examination is indicated by the curr pointer; the previous block is indicated by the prev pointer. As the garbage collector moves from one block to the next, it changes the pointer it follows to refer back to the previous block. When it returns to a block it restores the pointer. Each reversed pointer must be marked (indicated with a shaded box), to distinguish it from other, forward pointers in the same block.

Stop-and-Copy In a language with variable-size heap blocks, the garbage collector can reduce external fragmentation by performing storage compaction. Many garbage collectors employ a technique known as *stop-and-copy* that achieves compaction while simultaneously eliminating Steps 1 and 3 in the standard mark-and-sweep algorithm. Specifically, they divide the heap into two regions of equal size. All allocation happens in the first half. When this half is (nearly) full, the collector begins its exploration of reachable data structures. Each reachable block is copied into the second half of the heap, with no external fragmentation. The old version of the block, in the first half of the heap, is overwritten with a “useful” flag and a pointer to the new location. Any other pointer that refers to the same block (and is found later in the exploration) is set to point to the new location. When the

collector finishes its exploration, all useful objects have been moved (and compacted) into the second half of the heap, and nothing in the first half is needed anymore. The collector can therefore swap its notion of first and second halves, and the program can continue. Obviously, this algorithm suffers from the fact that only half of the heap can be used at any given time, but in a system with virtual memory it is only the virtual space that is underutilized; each “half” of the heap can occupy most of physical memory as needed. Moreover, by eliminating Steps 1 and 3 of standard mark-and-sweep, stop-and-copy incurs overhead proportional to the number of nongarbage blocks, rather than the total number of blocks.

Generational Collection To further reduce the cost of collection, some garbage collectors employ a “generational” technique, exploiting the observation that most dynamically allocated objects are short-lived. The heap is divided into multiple regions (often two). When space runs low the collector first examines the youngest region (the “nursery”), which it assumes is likely to have the highest proportion of garbage. Only if it is unable to reclaim sufficient space in this region does the collector examine the next-older region. To avoid leaking storage in long-running systems, the collector must be prepared, if necessary, to examine the entire heap. In most cases, however, the overhead of collection will be proportional to the size of the youngest region only.

Any object that survives some small number of collections (often one) in its current region is promoted (moved) to the next older region, in a manner reminiscent of stop-and-copy. Promotion requires, of course, that pointers from old objects

DESIGN & IMPLEMENTATION

Reference counts versus tracing

Reference counts require a counter field in every heap object. For small objects such as cons cells, this space overhead may be significant. The ongoing expense of updating reference counts when pointers are changed can also be significant in a program with large amounts of pointer manipulation. Other garbage collection techniques, however, have similar overheads. Tracing generally requires a reversed pointer indicator in every heap block, which reference counting does not, and generational collectors must generally incur overhead on every pointer assignment in order to keep track of pointers into the newest section of the heap.

The two principal tradeoffs between reference counting and tracing are the inability of the former to handle cycles and the tendency of the latter to “stop the world” periodically in order to reclaim space. On the whole, implementors tend to favor reference counting for applications in which circularity is not an issue, and tracing collectors in the general case. The “stop the world” problem can be addressed with *incremental* or *concurrent* collectors, which interleave their execution with the rest of the program, but these tend to have higher total overhead. Efficient, effective garbage collection techniques remain an active area of research.

to new objects be updated to reflect the new locations. While such old-space-to-new-space pointers tend to be rare, a generational collector must be able to find them all quickly. At each pointer assignment, the compiler generates code to check whether the new value is an old-to-new pointer; if so, it adds the pointer to a hidden list accessible to the collector. This instrumentation on assignments is known as a *write barrier*.¹³

Conservative Collection Language implementors have traditionally assumed that automatic storage reclamation is possible only in languages that are strongly typed: both reference counts and tracing collection require that we be able to find the pointers within an object. If we are willing to admit the possibility that some garbage will go unreclaimed, it turns out that we can implement mark-and-sweep collection without being able to find pointers [BW88]. The key is to observe that any given block in the heap spans a relatively small number of addresses. There is only a very small probability that some word in memory that is not a pointer will happen to contain a bit pattern that looks like one of those addresses.

If we assume, conservatively, that everything that seems to point into a heap block is in fact a valid pointer, then we can proceed with mark-and-sweep collection. When space runs low, the collector (as usual) tentatively marks all blocks in the heap as useless. It then scans all word-aligned quantities in the stack and in global storage. If any of these words appears to contain the address of something in the heap, the collector marks the block that contains that address as useful. Recursively, the collector then scans all word-aligned quantities in the block, and marks as useful any other blocks whose addresses are found therein. Finally (as usual), the collector reclaims any blocks that are still marked useless.

The algorithm is completely safe (in the sense that it never reclaims useful blocks) so long as the programmer never “hides” a pointer. In C, for example, the collector is unlikely to function correctly if the programmer casts a pointer to `int` and then `xors` it with a constant, with the expectation of restoring and using the pointer at a later time. In addition to sometimes leaving garbage unclaimed, conservative collection suffers from the inability to perform compaction: the collector can never be sure which “pointers” should be changed.

7.8 Lists

A list is defined recursively as either the empty list or a pair consisting of an object (which may be either a list or an atom) and another (shorter) list. Lists are ideally suited to programming in functional and logic languages, which do most of their work via recursion and higher-order functions (to be described in [Section 10.5](#)).

13 Unfortunately, the word “barrier” is heavily overloaded. Garbage collection barriers are unrelated to the synchronization barriers of [Section 12.3.1](#), the memory barriers of [Section 12.3.3](#), or the RTL barriers of [Section 14.2.2](#).

In Lisp, in fact, a program *is* a list, and can extend itself at run time by constructing a list and executing it (this capability will be examined further in [Section 10.3.5](#); it depends heavily on the fact that Lisp delays almost all semantic checking until run time).

Lists can also be used in imperative programs. Clu provides a built-in type constructor for lists, and a list class is easy to write in most object-oriented languages. Most scripting languages provide extensive list support. In any language with records and pointers, the programmer can build lists by hand. Since many of the standard list operations tend to generate garbage, lists work best in a language with automatic garbage collection.

We have already discussed certain aspects of lists in ML ([Section 7.2.4](#)) and Lisp ([Section 7.7.1](#)). As we noted in those sections, lists in ML are homogeneous: every element of the list must have the same type. Lisp lists, by contrast, are heterogeneous: any object may be placed in a list, so long as it is never used in an inconsistent fashion.¹⁴ The different approaches to type in ML and in Lisp lead to different implementations. An ML list is usually a chain of blocks, each of which contains an element and a pointer to the next block. A Lisp list is a chain of cons cells, each of which contains *two* pointers, one to the element and one to the next cons cell (see [Figures 7.10](#) and [7.11](#), pages 347 and 348). For historical reasons, the two pointers in a cons cell are known as the *car* and the *cdr*; they represent the head of the list and the remaining elements, respectively. In both semantics (homogeneity vs heterogeneity) and implementation (chained blocks vs cons cells), Clu resembles ML, while Python and Prolog (to be discussed in [Section 11.2](#)) resemble Lisp. ■

EXAMPLE 7.90

Lists in ML and Lisp

EXAMPLE 7.91

List notation

Both ML and Lisp provide convenient notation for lists. An ML list is enclosed in square brackets, with elements separated by commas: [a, b, c, d]. A Lisp list is enclosed in parentheses, with elements separated by white space: (a b c d). In both cases, the notation represents a *proper* list—one whose innermost pair consists of the final element and the empty list. In Lisp, it is also possible to construct an *improper* list, whose final pair contains two elements. (Strictly speaking, such a list does not conform to the standard recursive definition.) Lisp systems provide a more general, but cumbersome *dotted* list notation that captures both proper and improper lists. A dotted list is either an atom (possibly null) or a pair consisting of two dotted lists separated by a period and enclosed in parentheses. The dotted list (a . (b . (c . (d . null)))) is the same as (a b c d). The list (a . (b . (c . d))) is improper; its final cons cell contains a pointer to d in the second position, where a pointer to a list is normally required. ■

Both ML and Lisp provide a wealth of built-in polymorphic functions to manipulate arbitrary lists. Because programs are lists in Lisp, Lisp must distinguish between lists that are to be evaluated and lists that are to be left “as is,” as structures. To prevent a literal list from being evaluated, the Lisp programmer may

¹⁴ Recall that objects are self-descriptive in Lisp. The only type checking occurs when a function “deliberately” inspects an argument to see whether it is a list or an atom of some particular type.

quote it: `(quote (a b c d))`, abbreviated `'(a b c d)`. To evaluate an internal list (e.g., one returned by a function), the programmer may pass it to the built-in function `eval`. In ML, programs are not lists, so a literal list is always a structural aggregate.

EXAMPLE 7.92

Basic list operations in Lisp

The most fundamental operations on lists are those that construct them from their components or extract their components from them. In Lisp:

```
(cons 'a '(b))      => (a b)
(car '(a b))       => a
(car nil)          => ??
(cdr '(a b c))     => (b c)
(cdr '(a))         => nil
(cdr nil)          => ??
(append '(a b) '(c d)) => (a b c d)
```

Here we have used \implies to mean “evaluates to.” The `car` and `cdr` of the empty list (`nil`) are defined to be `nil` in Common Lisp; in Scheme they result in a dynamic semantic error. ■

EXAMPLE 7.93

Basic list operations in ML

In ML the equivalent operations are written as follows:

```
a :: [b]           => [a, b]
hd [a, b]         => a
hd []             => run-time exception
tl [a, b, c]     => [b, c]
tl [a]           => nil
tl []            => run-time exception
[a, b] @ [c, d]  => [a, b, c, d]
```

Run-time exceptions may be *caught* by the program if desired; further details will appear in [Section 8.5](#). ■

DESIGN & IMPLEMENTATION**Car and cdr**

The names of the functions `car` and `cdr` are historical accidents: they derive from the original (1959) implementation of Lisp on the IBM 704 at MIT. The machine architecture included 15-bit “address” and “decrement” fields in some of the (36-bit) loop-control instructions, together with additional instructions to load an index register from, or store it to, one of these fields within a 36-bit memory word. The designers of the Lisp interpreter decided to make `cons` cells mimic the internal format of instructions, so they could exploit these special instructions. In now archaic usage, memory words were also known as “registers.” What might appropriately have been called “first” and “rest” pointers thus came to be known as the `CAR` (contents of address of register) and `CDR` (contents of decrement of register). The 704, incidentally, was also the machine on which Fortran was first developed, and the first commercial machine to include hardware floating-point and magnetic core memory.

Both ML and Lisp provide many additional list functions, including ones that test a list to see if it is empty; return the length of a list; return the n th element of a list, or a list consisting of all but the first n elements; reverse the order of the elements of a list; search a list for elements matching some predicate; or apply a function to every element of a list, returning the results as a list.

Miranda, Haskell, Python, and F# provide lists that resemble those of ML, but with an important additional mechanism, known as *list comprehensions*. These are adapted from traditional mathematical set notation. A common form comprises an expression, an enumerator, and one or more filters. In Haskell, the following denotes a list of the squares of all odd numbers less than 100:

EXAMPLE 7.94

List comprehensions

```
[i*i | i <- [1..100], i `mod` 2 == 1]
```

In Python we would write

```
[i*i for i in range(1, 100) if i % 2 == 1]
```

In F# the equivalent is

```
[for i in 1..100 do if i % 2 = 1 then yield i*i]
```

All of these are the equivalent of the mathematical

$$\{i \times i \mid i \in \{1, \dots, 100\} \wedge i \bmod 2 = 1\}$$

We could of course create an equivalent list with a series of appropriate function calls. The brevity of the list comprehension syntax, however, can sometimes lead to remarkably elegant programs (see, e.g., [Exercise 7.26](#)). ■

7.9 Files and Input/Output

Input/output (I/O) facilities allow a program to communicate with the outside world. In discussing this communication, it is customary to distinguish between *interactive* I/O and I/O with files. Interactive I/O generally implies communication with human users or physical devices, which work in parallel with the running program, and whose input to the program may depend on earlier output from the program (e.g., prompts). Files generally refer to off-line storage implemented by the operating system. Files may be further categorized into those that are *temporary* and those that are *persistent*. Temporary files exist for the duration of a single program run; their purpose is to store information that is too large to fit in the memory available to the program. Persistent files allow a program to read data that existed before the program began running, and to write data that will continue to exist after the program has ended.

I/O is one of the most difficult aspects of a language to design, and one that displays the least commonality from one language to the next. Some languages provide built-in `file` data types and special syntactic constructs for I/O. Others relegate I/O entirely to library packages, which export a (usually opaque) `file` type and a variety of input and output subroutines. The principal advantage of language integration is the ability to employ non-subroutine-call syntax, and to perform operations (e.g., type checking on subroutine calls with varying numbers of parameters) that may not otherwise be available to library routines. A purely library-based approach to I/O, on the other hand, may keep a substantial amount of “clutter” out of the language definition.

© IN MORE DEPTH

An overview of language-level I/O mechanisms can be found on the PLP CD. After a brief introduction to interactive and file-based I/O, we focus mainly on the common case of *text files*. The data in a text file are stored in character form, but may be converted to and from internal types during `read` and `write` operations. As examples, we consider the text I/O facilities of Fortran, Ada, C, and C++.

7.10 Equality Testing and Assignment

For simple, primitive data types such as integers, floating-point numbers, or characters, equality testing and assignment are relatively straightforward operations, with obvious semantics and obvious implementations (bit-wise comparison or copy). For more complicated or abstract data types, however, both semantic and implementation subtleties arise.

Consider for example the problem of comparing two character strings. Should the expression `s = t` determine whether `s` and `t`

- are aliases for one another?
- occupy storage that is bit-wise identical over its full length?
- contain the same sequence of characters?
- would appear the same if printed?

The second of these tests is probably too low-level to be of interest in most programs; it suggests the possibility that a comparison might fail because of garbage in currently unused portions of the space reserved for a string. The other three alternatives may all be of interest in certain circumstances, and may generate different results.

In many cases the definition of equality boils down to the distinction between l-values and r-values: in the presence of references, should expressions be considered equal only if they refer to the same object, or also if the objects to which

they refer are in some sense equal? The first option (refer to the same object) is known as a *shallow* comparison. The second (refer to equal objects) is called a *deep* comparison. For complicated data structures (e.g., lists or graphs) a deep comparison may require recursive traversal.

In imperative programming languages, assignment operations may also be deep or shallow. Under a reference model of variables, a shallow assignment `a := b` will make `a` refer to the object to which `b` refers. A deep assignment will create a copy of the object to which `b` refers, and make `a` refer to the copy. Under a value model of variables, a shallow assignment will copy the value of `b` into `a`, but if that value is a pointer (or a record containing pointers), then the objects to which the pointer(s) refer will not be copied.

Most programming languages employ both shallow comparisons and shallow assignment. A few (notably Python and the various dialects of Lisp) provide more than one option for comparison. Scheme, for example, has three general-purpose equality-testing functions:

EXAMPLE 7.95

Equality testing in Scheme

```
(eq? a b)           ; do a and b refer to the same object?
(eqv? a b)         ; are a and b known to be semantically equivalent?
(equal? a b)       ; do a and b have the same recursive structure?
```

Both `eq?` and `eqv?` perform a shallow comparison. The former may be faster for certain types in certain implementations; in particular, `eqv?` is required to detect the equality of values of the same discrete type, stored in different locations; `eq?` is not. The simpler `eq?` behaves as one would expect for Booleans, symbols (names), and pairs (things built by `cons`), but can have implementation-defined behavior on numbers, characters, and strings:

```
(eq? #t #t)        ⇒ #t (true)
(eqv? 'foo 'foo)   ⇒ #t
(eqv? '(a b) '(a b)) ⇒ #f (false); created by separate cons-es
(let ((p '(a b)))
  (eq? p p))       ⇒ #t; created by the same cons
(eqv? 2 2)         ⇒ implementation dependent
(eqv? "foo" "foo") ⇒ implementation dependent
```

In any particular implementation, numeric, character, and string tests will always work the same way; if `(eq? 2 2)` returns `true`, then `(eq? 37 37)` will return `true` also. Implementations are free to choose whichever behavior results in the fastest code.

The exact rules that govern the situations in which `eqv?` is guaranteed to return `true` or `false` are quite involved. Among other things, they specify that `eqv?` should behave as one might expect for numbers, characters, and nonempty strings, and that two objects will never test `true` for `eqv?` if there are any circumstances under which they would behave differently. (Conversely, however, `eqv?` is allowed to return `false` for certain objects—functions, for example—that would behave

identically in all circumstances.)¹⁵ The `eqv?` predicate is “less discriminating” than `eq?`, in the sense that `eqv?` will never return `false` when `eq?` returns `true`.

For structures (lists), `eqv?` returns `false` if its arguments refer to different root cons cells. In many programs this is not the desired behavior. The `equal?` predicate recursively traverses two lists to see if their internal structure is the same and their leaves are `eqv?`. The `equal?` predicate may lead to an infinite loop if the programmer has used the imperative features of Scheme to create a circular list. ■

Deep assignments are relatively rare. They are used primarily in distributed computing, and in particular for parameter passing in remote procedure call (RPC) systems. These will be discussed in Section ©12.5.4.

For user-defined abstractions, no single language-specified mechanism for equality testing or assignment is likely to produce the desired results in all cases. Languages with sophisticated data abstraction mechanisms usually allow the programmer to define the comparison and assignment operators for each new data type—or to specify that equality testing and/or assignment is not allowed.

✓ CHECK YOUR UNDERSTANDING

44. What are *dangling references*? How are they created, and why are they a problem?
45. What is *garbage*? How is it created, and why is it a problem? Discuss the comparative advantages of *reference counts* and *tracing collection* as a means of solving the problem.
46. Summarize the differences among mark-and-sweep, stop-and-copy, and generational garbage collection.
47. What is *pointer reversal*? What problem does it address?
48. What is “conservative” garbage collection? How does it work?
49. Do dangling references and garbage ever arise in the same programming language? Why or why not?
50. Why was automatic garbage collection so slow to be adopted by imperative programming languages?
51. What are the advantages and disadvantages of allowing pointers to refer to objects that do not lie in the heap?
52. Why are lists so heavily used in functional programming languages?
53. Why is equality testing more subtle than it first appears?

¹⁵ Significantly, `eqv?` is also allowed to return `false` when comparing numeric values of different types: `(eqv? 1 1.0)` may evaluate to `#f`. For numeric code, one generally wants the separate `=` function: `(= val1 val2)` will perform the necessary coercion and test for numeric equality (subject to rounding errors).

7.11 Summary and Concluding Remarks

This section concludes the third of our five core chapters on language design (names [from Part I], control flow, types, subroutines, and classes). In the first two sections we looked at the general issues of type systems and type checking. In the remaining sections we examined the most important composite types: records and variants, arrays and strings, sets, pointers and recursive types, lists, and files. We noted that types serve two principal purposes: they provide implicit context for many operations, freeing the programmer from the need to specify that context explicitly, and they allow the compiler to catch a wide variety of common programming errors. A *type system* consists of a set of built-in types, a mechanism to define new types, and rules for *type equivalence*, *type compatibility*, and *type inference*. Type equivalence determines when two names or values have the same type. Type compatibility determines when a value of one type may be used in a context that “expects” another type. Type inference determines the type of an expression based on the types of its components or (sometimes) the surrounding context. A language is said to be *strongly typed* if it never allows an operation to be applied to an object that does not support it; a language is said to be *statically typed* if it enforces strong typing at compile time.

In our general discussion of types we distinguished between the denotational, constructive, and abstraction-based points of view, which regard types, respectively, in terms of their values, their substructure, and the operations they support. We introduced terminology for the common built-in types and for enumerations, subranges, and the common type *constructors*. We discussed several different approaches to type equivalence, compatibility, and inference, including (on the PLP CD) a detailed examination of the inference rules of ML. We also examined type *conversion*, *coercion*, and *nonconverting casts*. In the area of type equivalence, we contrasted the *structural* and *name-based* approaches, noting that while name equivalence appears to have gained in popularity, structural equivalence retains its advocates.

In our survey of composite types, we spent the most time on records, arrays, and recursive types. Key issues for records include the syntax and semantics of variant records, whole-record operations, type safety, and the interaction of each of these with memory layout. Memory layout is also important for arrays, in which it interacts with binding time for shape; static, stack, and heap-based allocation strategies; efficient array traversal in numeric applications; the interoperability of pointers and arrays in C; and the available set of whole-array and *slice*-based operations.

For recursive data types, much depends on the choice between the *value* and *reference models* of variables/names. Recursive types are a natural fallout of the reference model; with the value model they require the notion of a *pointer*: a variable whose value is a reference. The distinction between values and references is important from an implementation point of view: it would be wasteful to implement built-in types as references, so languages with a reference model generally

implement built-in and user-defined types differently. Java reflects this distinction in the language semantics, calling for a value model of built-in types and a reference model for objects of user-defined class types.

Recursive types are generally used to create linked data structures. In most cases these structures must be allocated from a heap. In some languages, the programmer is responsible for deallocating heap objects that are no longer needed. In other languages, the language run-time system identifies and reclaims such *garbage* automatically. Explicit deallocation is a burden on the programmer, and leads to the problems of *memory leaks* and *dangling references*. While language implementations almost never attempt to catch memory leaks (see Exploration 3.32 and Exercise ©7.36, however, for some ideas on this subject) *tombstones* or *locks* and *keys* are sometimes used to catch dangling references. Automatic garbage collection can be expensive, but has proven increasingly popular. Most garbage-collection techniques rely either on *reference counts* or on some form of recursive exploration (*tracing*) of currently accessible structures. Techniques in this latter category include *mark-and-sweep*, *stop-and-copy*, and *generational* collection.

Few areas of language design display as much variation as I/O. Our discussion (largely on the PLP CD) distinguished between *interactive I/O*, which tends to be very platform specific, and *file-based I/O*, which subdivides into *temporary files*, used for voluminous data within a single program run, and *persistent files*, used for off-line storage. Files also subdivide into those that represent their information in a binary form that mimics layout in memory and those that convert to and from character-based *text*. In comparison to binary files, text files generally incur both time and space overhead, but they have the important advantages of portability and human readability.

In our examination of types, we saw many examples of language innovations that have served to improve the clarity and maintainability of programs, often with little or no performance overhead. Examples include the original idea of user-defined types (Algol 68), enumeration and subrange types (Pascal), the integration of records and variants (Pascal), and the distinction between subtypes and derived types in Ada. In [Chapter 9](#) we will examine what many consider the most important innovation of the past 30 years, namely object orientation.

In some cases, the distinctions between languages are less a matter of evolution than of fundamental differences in philosophy. We have already mentioned the choice between the value and reference models of variables/names. In a similar vein, most languages have adopted static typing, but Smalltalk, Lisp, and the many scripting languages work well with dynamic types. Most statically typed languages have adopted name equivalence, but ML and Modula-3 work well with structural equivalence. Most languages have moved away from type coercions, but C++ embraces them: together with operator overloading, they make it possible to define terse, type-safe I/O routines outside the language proper.

As in the previous chapter, we saw several cases in which a language's convenience, orthogonality, or type safety appears to have been compromised in order to simplify the compiler, or to make compiled programs smaller or faster. Examples include the lack of an equality test for records in most languages, the requirement

in Pascal and Ada that the variant portion of a record lie at the end, the limitations in many languages on the maximum size of sets, the lack of type checking for I/O in C, and the general lack of dynamic semantic checks in many language implementations. We also saw several examples of language features introduced at least in part for the sake of efficient implementation. These include packed types, multi-length numeric types, `with` statements, decimal arithmetic, and C-style pointer arithmetic.

At the same time, one can identify a growing willingness on the part of language designers and users to tolerate complexity and cost in language implementation in order to improve semantics. Examples here include the type-safe variant records of Ada; the standard-length numeric types of Java and C#; the variable-length strings and string operators of Icon, Java, and C#; the late binding of array bounds in Ada; and the wealth of whole-array and slice-based array operations in Fortran 90. One might also include the polymorphic type inference of ML. Certainly one should include the trend toward automatic garbage collection. Once considered too expensive for production-quality imperative languages, garbage collection is now standard not only in such experimental languages as Clu and Cedar, but in Ada, Modula-3, Java, and C# as well. Many of these features, including variable-length strings, slices, and garbage collection, have been embraced by scripting languages.

7.12 Exercises

- 7.1 Most statically typed languages developed since the 1970s (including Java, C#, and the descendants of Pascal) use some form of name equivalence for types. Is structural equivalence a bad idea? Why or why not?
- 7.2 In the following code, which of the variables will a compiler consider to have compatible types under structural equivalence? Under strict name equivalence? Under loose name equivalence?

```

type T = array [1..10] of integer
      S = T
A : T
B : T
C : S
D : array [1..10] of integer

```

- 7.3 Consider the following declarations:

1. `type cell` -- a forward declaration
2. `type cell_ptr = pointer to cell`
3. `x : cell`
4. `type cell = record`
5. `val : integer`
6. `next : cell_ptr`
7. `y : cell`

Should the declaration at line 4 be said to introduce an alias type? Under strict name equivalence, should x and y have the same type? Explain.

- 7.4 Suppose you are implementing an Ada compiler, and must support arithmetic on 32-bit fixed-point binary numbers with a programmer-specified number of fractional bits. Describe the code you would need to generate to add, subtract, multiply, or divide two fixed-point numbers. You should assume that the hardware provides arithmetic instructions only for integers and IEEE floating-point. You may assume that the integer instructions preserve full precision; in particular, integer multiplication produces a 64-bit result. Your description should be general enough to deal with operands and results that have different numbers of fractional bits.
- 7.5 When Sun Microsystems ported Berkeley Unix from the Digital VAX to the Motorola 680x0 in the early 1980s, many C programs stopped working, and had to be repaired. In effect, the 680x0 revealed certain classes of program bugs that one could “get away with” on the VAX. One of these classes of bugs occurred in programs that use more than one size of integer (e.g., `short` and `long`), and arose from the fact that the VAX is a little-endian machine, while the 680x0 is big-endian (Section ©5.2). Another class of bugs occurred in programs that manipulate both null and empty strings. It arose from the fact that location zero in a Unix process’s address space on the VAX always contained a zero, while the same location on the 680x0 is not in the address space, and will generate a protection error if used. For both of these classes of bugs, give examples of program fragments that would work on a VAX but not on a 680x0.
- 7.6 Ada provides two “remainder” operators, `rem` and `mod` for integer types, defined as follows [Ame83, Sec. 4.5.5]:

Integer division and remainder are defined by the relation $A = (A/B)*B + (A \text{ rem } B)$, where $(A \text{ rem } B)$ has the sign of A and an absolute value less than the absolute value of B . Integer division satisfies the identity $(-A)/B = -(A/B) = A/(-B)$.

The result of the modulus operation is such that $(A \text{ mod } B)$ has the sign of B and an absolute value less than the absolute value of B ; in addition, for some integer value N , this result must satisfy the relation $A = B*N + (A \text{ mod } B)$.

Give values of A and B for which $A \text{ rem } B$ and $A \text{ mod } B$ differ. For what purposes would one operation be more useful than the other? Does it make sense to provide both, or is it overkill?

Consider also the `%` operator of C and the `mod` operator of Pascal. The designers of these languages could have picked semantics resembling those of either Ada’s `rem` or its `mod`. Which did they pick? Do you think they made the right choice?

- 7.7 Consider the problem of performing range checks on set expressions in Pascal. Given that a set may contain many elements, some of which may be known at compile time, describe the information that a compiler might maintain in order to track both the elements known to belong to the set and the possible range of unknown elements. Then explain how to update

this information for the following set operations: union, intersection, and difference. The goal is to determine (1) when subrange checks can be eliminated at run time and (2) when subrange errors can be reported at compile time. Bear in mind that the compiler *cannot* do a perfect job: some unnecessary run-time checks will inevitably be performed, and some operations that must always result in errors will not be caught at compile time. The goal is to do as good a job as possible at reasonable cost.

- 7.8 Suppose we are compiling for a machine with 1-byte characters, 2-byte shorts, 4-byte integers, and 8-byte reals, and with alignment rules that require the address of every primitive data element to be an even multiple of the element's size. Suppose further that the compiler is not permitted to reorder fields. How much space will be consumed by the following array? Explain.

```
A : array [0..9] of record
  s : short
  c : char
  t : short
  d : char
  r : real
  i : integer
```

- 7.9 In [Example 7.45](#) we suggested the possibility of sorting record fields by their alignment requirement, to minimize holes. In the example, we sorted smallest-alignment-first. What would happen if we sorted longest-alignment-first? Do you see any advantages to this scheme? Any disadvantages? If the record as a whole must be an even multiple of the longest alignment, do the two approaches ever differ in total space required?
- 7.10 Give Ada code to map from lowercase to uppercase letters, using
- an array
 - a function

Note the similarity of syntax: in both cases `upper('a')` is `'A'`.

- 7.11 In [Section 7.4.2](#) we noted that in a language with dynamic arrays and a value model of variables, records could have fields whose size is not known at compile time. To accommodate these, we suggested using a dope vector for the record, to track the offsets of the fields.

Suppose instead that we want to maintain a static offset for each field. Can we devise an alternative strategy inspired by the stack frame layout of [Figure 7.6](#), and divide each record into a fixed-size part and a variable-size part? What problems would we need to address? (Hint: consider nested records.)

- 7.12 Explain how to extend [Figure 7.6](#) to accommodate subroutine arguments that are passed by value, but whose shape is not known until the subroutine is called at run time.

- 7.13 Explain how to obtain the effect of Fortran 90's `allocate` statement for one-dimensional arrays using pointers in C. You will probably find that your solution does not generalize to multidimensional arrays. Why not? If you are familiar with C++, show how to use its `class` facilities to solve the problem.
- 7.14 In [Section 7.4.3](#) we discussed how to differentiate between the constant and variable portions of an array reference, in order to efficiently access the subparts of array and record objects. An alternative approach is to generate naive code and count on the compiler's code improver to find the constant portions, group them together, and calculate them at compile time. Discuss the advantages and disadvantages of each approach.
- 7.15 Consider the following C declaration, compiled on a 32-bit Pentium machine:

```
struct {
    int n;
    char c;
} A[10][10];
```

If the address of `A[0][0]` is 1000 (decimal), what is the address of `A[3][7]`?

- 7.16 Suppose we are generating code for a Pascal-like language on a RISC machine with the following characteristics: 8-byte floating-point numbers, 4-byte integers, 1-byte characters, and 4-byte alignment for both integers and floating-point numbers. Suppose further that we plan to use contiguous row-major layout for multidimensional arrays, that we do not wish to reorder fields of records or pack either records or arrays, and that we will assume without checking that all array subscripts are in bounds.

- (a) Consider the following variable declarations.

```
var A : array [1..10, 10..100] of real;
    i : integer;
    x : real;
```

Show the code that our compiler should generate for the following assignment: `x := A[3, i]`. Explain how you arrived at your answer.

- (b) Consider the following more complex declarations.

```
var r : record
    x : integer;
    y : char;
    A : array [1..10, 10..20] of record
        z : real;
        B : array [0..71] of char;
    end;
end;
var j, k : integer;
```

Assume that these declarations are local to the current subroutine. Note the lower bounds on indices in A; the first element is $A[1, 10]$.

Describe how r would be laid out in memory. Then show code to load $r.A[2, j].B[k]$ into a register. Be sure to indicate which portions of the address calculation could be performed at compile time.

- 7.17 Suppose A is a 10×10 array of (4-byte) integers, indexed from $[0][0]$ through $[9][9]$. Suppose further that the address of A is currently in register $r1$, the value of integer i is currently in register $r2$, and the value of integer j is currently in register $r3$.

Give pseudo-assembly language for a code sequence that will load the value of $A[i][j]$ into register $r1$ (a) assuming that A is implemented using (row-major) contiguous allocation; (b) assuming that A is implemented using row pointers. Each line of your pseudocode should correspond to a single instruction on a typical modern machine. You may use as many registers as you need. You need not preserve the values in $r1$, $r2$, and $r3$. You may assume that i and j are in bounds, and that addresses are 4 bytes long.

Which code sequence is likely to be faster? Why?

- 7.18 In [Examples 7.62](#) and [7.63](#), show the code that would be required to access $A[i, j, k]$ if subscript bounds checking were required.
- 7.19 Pointers and recursive type definitions complicate the algorithm for determining structural equivalence of types. Consider, for example, the following definitions:

```

type A = record
  x : pointer to B
  y : real
type B = record
  x : pointer to A
  y : real

```

The simple definition of structural equivalence given in [Section 7.2.1](#) (expand the subparts recursively until all you have is a string of built-in types and type constructors; then compare them) does not work: we get an infinite expansion (type A = record x : pointer to record x : pointer to record x : pointer to record ...). The obvious reinterpretation is to say two types A and B are equivalent if any sequence of field selections, array subscripts, pointer dereferences, and other operations that takes one down into the structure of A, and that ends at a built-in type, always ends at the same built-in type when used to dive into the structure of B (and encounters the same field names along the way). Under this reinterpretation, A and B above have the same type. Give an algorithm based on this reinterpretation that could be used in a compiler to determine structural equivalence. (Hint: the fastest approach is due to J. Král [[Král73](#)]. It is based on the algorithm used to find the smallest deterministic finite automaton that accepts a given regular

language. This algorithm was outlined in [Example 2.15](#) [page 59]; details can be found in any automata theory textbook [e.g., [HMU01]].)

7.20 Explain the meaning of the following C declarations:

```
double *a[n];
double (*b)[n];
double (*c[n])();
double (*d())[n];
```

7.21 In Ada 83, as in Pascal, pointers (access variables) can point only to objects in the heap. Ada 95 allows a new kind of pointer, the `access all` type, to point to other objects as well, provided that those objects have been declared to be aliased:

```
type int_ptr is access all Integer;
foo : aliased Integer;
ip : int_ptr;
...
ip := foo'Access;
```

The `'Access` attribute is roughly equivalent to C's “address of” (`&`) operator. How would you implement `access all` types and aliased objects? How would your implementation interact with automatic garbage collection (assuming it exists) for objects in the heap?

7.22 As noted in [Section 7.7.2](#), Ada 95 forbids an `access all` pointer from referring to any object whose lifetime is briefer than that of the pointer's type. Can this rule be enforced completely at compile time? Why or why not?

7.23 In much of the discussion of pointers in [Section 7.7](#), we assumed implicitly that every pointer into the heap points to the *beginning* of a dynamically allocated block of storage. In some languages, including Algol 68 and C, pointers may also point to data *inside* a block in the heap. If you were trying to implement dynamic semantic checks for dangling references or, alternatively, automatic garbage collection (precise or conservative), how would your task be complicated by the existence of such “internal pointers”?

7.24 (a) Occasionally one encounters the suggestion that a garbage-collected language should provide a `delete` operation as an optimization: by explicitly `delete`-ing objects that will never be used again, the programmer might save the garbage collector the trouble of finding and reclaiming those objects automatically, thereby improving performance. What do you think of this suggestion? Explain.

(b) Alternatively, one might allow the programmer to “tenure” an object, so that it will never be a candidate for reclamation. Is this a good idea?

7.25 In [Example 7.88](#) we noted that functional languages can safely use reference counts since the lack of an assignment statement prevents them from introducing circularity. This isn't strictly true; constructs like the Lisp `letrec`

can also be used to make cycles, so long as uses of circularly defined names are hidden inside lambda expressions in each definition:

```
(define foo (lambda ()
  (letrec ((a (lambda(f) (if f #\A b)))
           (b (lambda(f) (if f #\B c)))
           (c (lambda(f) (if f #\C a))))
    a)))
```

Each of the functions a, b, and c contains a reference to the next:

```
((foo) #t)           ⇒ #\A
(((foo) #f) #t)      ⇒ #\B
((((foo) #f) #f) #t) ⇒ #\C
((((((foo) #f) #f) #f) #t) ⇒ #\A
```

How might you address this circularity without giving up on reference counts?

7.26 Here is a skeleton for the standard quicksort algorithm in Haskell:

```
quicksort [] = []
quicksort (a : l) = quicksort [...] ++ [a] ++ quicksort [...]
```

The ++ operator denotes list concatenation (similar to @ in ML). The : operator is equivalent to ML's :: or Lisp's cons. Show how to express the two elided expressions as list comprehensions.

© 7.27–7.39 In More Depth.

7.13 Explorations

- 7.40** Some language definitions specify a particular representation for data types in memory, while others specify only the semantic behavior of those types. For languages in the latter class, some implementations guarantee a particular representation, while others reserve the right to choose different representations in different circumstances. Which approach do you prefer? Why?
- 7.41** If you have access to a compiler that provides optional dynamic semantic checks for out-of-bounds array subscripts, use of an inappropriate record variant, and/or dangling or uninitialized pointers, experiment with the cost of these checks. How much do they add to the execution time of programs that make a significant number of checked accesses? Experiment with different levels of optimization (code improvement) to see what effect each has on the overhead of checks.

- 7.42 Investigate the *typestate* mechanism employed by Strom et al. in the Hermes programming language [SBG⁺91]. Discuss its relationship to the notion of definite assignment in Java and C# (Section 6.1.3).
- 7.43 Investigate the notion of *type conformance*, employed by Black et al. in the Emerald programming language [BHJL07]. Discuss how conformance relates to the type inference of ML and to the class-based typing of object-oriented languages.
- 7.44 Write a library package that might be used by a language implementation to manage sets of elements drawn from a very large base type (e.g., `integer`). You should support membership tests, union, intersection, and difference. Does your package allocate memory from the heap? If so, what would a compiler that assumed the use of your package need to do to make sure that space was reclaimed when no longer needed?
- 7.45 Learn about SETL [SDDS86], a programming language based on sets, designed by Jack Schwartz of New York University. List the mechanisms provided as built-in set operations. Compare this list with the set facilities of other programming languages. What data structure(s) might a SETL implementation use to represent sets in a program?
- 7.46 The HotSpot Java compiler and virtual machine implements an entire suite of garbage collectors: a traditional generational collector, a compacting collector for the old generation, a low pause-time parallel collector for the nursery, a high-throughput parallel collector for the old generation, and a “mostly concurrent” collector for the old generation that runs in parallel with the main program. Learn more about these algorithms. When is each used, and why?
- 7.47 Implement your favorite garbage collection algorithm in Ada 95. Alternatively, implement a special pointer class in C++ for which storage is garbage collected. You’ll want to use templates (generics) so that your class can be instantiated for arbitrary pointed-to types.
- 7.48 Experiment with the cost of garbage collection in your favorite language implementation. What kind of collector does it use? Can you create artificial programs for which it performs particularly well or poorly?
- 7.49 Learn about *weak references* in Java. How do they interact with garbage collection? Describe several scenarios in which they may be useful.
- © 7.50–7.53 In More Depth.

7.14 Bibliographic Notes

References to general information on the various programming languages mentioned in this chapter can be found in [Appendix A](#), and in the Bibliographic Notes for [Chapters 1](#) and [6](#). Welsh, Sneeringer, and Hoare [WSH77] provide a critique of the original Pascal definition, with a particular emphasis on its type system.

Tanenbaum's comparison of Pascal and Algol 68 also focuses largely on types [Tan78]. Cleaveland [Cle86] provides a book-length study of many of the issues in this chapter. Pierce [Pie02] provides a formal and detailed modern coverage of the subject. The ACM Special Interest Group on Programming Languages launched a biennial workshop on *Types in Language Design and Implementation* in 2003.

What we have referred to as the denotational model of types originates with Hoare [DDH72]. Denotational formulations of the overall semantics of programming languages are discussed in the Bibliographic Notes for Chapter 4. A related but distinct body of work uses algebraic techniques to formalize data abstraction; key references include Gutttag [Gut77] and Goguen et al. [GTW78]. Milner's original paper [Mil78] is the seminal reference on type inference in ML. Mairson [Mai90] proves that the cost of unifying ML types is $O(2^n)$, where n is the length of the program. Fortunately, the cost is linear in the size of the program's type expressions, so the worst case arises only in programs whose semantics are too complex for a human being to understand anyway.

Hoare [Hoa75] discusses the definition of recursive types under a reference model of variables. Cardelli and Wegner survey issues related to polymorphism, overloading, and abstraction [CW85]. The new Character Model standard for the World Wide Web provides a remarkably readable introduction to the subtleties and complexities of multilingual character sets [Wor05].

Tombstones are due to Lomet [Lom75, Lom85]. Locks and keys are due to Fischer and LeBlanc [FL80]. The latter also discuss how to check for various other dynamic semantic errors in Pascal, including those that arise with variant records. Constant-space (pointer-reversing) mark-and-sweep garbage collection is due to Schorr and Waite [SW67]. Stop-and-copy collection was developed by Fenichel and Yochelson [FY69], based on ideas due to Minsky. Deutsch and Bobrow [DB76] describe an *incremental* garbage collector that avoids the "stop-the-world" phenomenon. Wilson and Johnstone [WJ93] describe a later incremental collector. The conservative collector described at the end of Section 7.7.3 is due to Boehm and Weiser [BW88]. Cohen [Coh81] surveys garbage-collection techniques as of 1981; Wilson [Wil92b] and Jones and Lins [JL96] provide somewhat more recent views.

This page intentionally left blank

Subroutines and Control Abstraction

8

In the introduction to [Chapter 3](#), we defined *abstraction* as a process by which the programmer can associate a name with a potentially complicated program fragment, which can then be thought of in terms of its purpose or function, rather than in terms of its implementation. We sometimes distinguish between *control abstraction*, in which the principal purpose of the abstraction is to perform a well-defined operation, and *data abstraction*, in which the principal purpose of the abstraction is to represent information.¹ We will consider data abstraction in more detail in [Chapter 9](#).

Subroutines are the principal mechanism for control abstraction in most programming languages. A subroutine performs its operation on behalf of a *caller*, who waits for the subroutine to finish before continuing execution. Most subroutines are parameterized: the caller passes arguments that influence the subroutine's behavior, or provide it with data on which to operate. Arguments are also called *actual parameters*. They are mapped to the subroutine's *formal parameters* at the time a call occurs. A subroutine that returns a value is usually called a *function*. A subroutine that does not return a value is usually called a *procedure*. Most languages require subroutines to be declared before they are used, though a few (including Fortran, C, and Lisp) do not. Declarations allow the compiler to verify that every call to a subroutine is consistent with the declaration; for example, that it passes the right number and types of arguments.

As noted in [Section 3.2.2](#), the storage consumed by parameters and local variables can in most languages be allocated on a stack. We therefore begin this chapter, in [Section 8.1](#), by reviewing the layout of the stack. We then turn in [Section 8.2](#) to the *calling sequences* that serve to maintain this layout. In the process, we revisit the use of static chains to access nonlocal variables in nested subroutines, and consider (on the PLP CD) an alternative mechanism, known as a *display*, that serves a similar purpose. We also consider subroutine inlining and the representation of

I The distinction between control and data abstraction is somewhat fuzzy, because the latter usually encapsulates not only information, but also the operations that access and modify that information. Put another way, most data abstractions include control abstraction.

closures. To illustrate some of the possible implementation alternatives, we present (again on the PLP CD) a pair of case studies: the SGI MIPSpro C compiler for the MIPS instruction set, and the GNU `gpc` Pascal compiler for the x86 instruction set, as well as the *register window* mechanism of the SPARC instruction set.

In [Section 8.3](#) we look more closely at subroutine parameters. We consider parameter-passing *modes*, which determine the operations that a subroutine can apply to its formal parameters and the effects of those operations on the corresponding actual parameters. We also consider conformant arrays, named and default parameters, variable numbers of arguments, and function return mechanisms. In [Section 8.4](#) we turn to *generic* subroutines and modules (classes), which support explicit parametric polymorphism, as defined in [Section 3.5.3](#). Where conventional parameters allow a subroutine to operate on many different values, generic parameters allow it to operate on data of many different *types*.

In [Section 8.5](#), we consider the handling of exceptional conditions. While exceptions can sometimes be confined to the current subroutine, in the general case they require a mechanism to “pop out of” a nested context without returning, so that recovery can occur in the calling context. In [Section 8.6](#), we consider *coroutines*, which allow a program to maintain two or more execution contexts, and to switch back and forth among them. Coroutines can be used to implement iterators ([Section 6.5.3](#)), but they have other uses as well, particularly in simulation and in server programs. In [Chapter 12](#) we will use them as the basis for concurrent (“quasiparallel”) threads. Finally, in [Section 8.7](#) we consider asynchronous *events*—things that happen outside a program, but to which it needs to respond.

8.1 Review of Stack Layout

EXAMPLE 8.1

Layout of run-time stack
(reprise)

In [Section 3.2.2](#) we discussed the allocation of space on a subroutine call stack ([Figure 3.1](#), page 118). Each routine, as it is called, is given a new *stack frame*, or *activation record*, at the top of the stack. This frame may contain arguments and/or return values, bookkeeping information (including the return address and saved registers), local variables, and/or temporaries. When a subroutine returns, its frame is popped from the stack. ■

At any given time, the *stack pointer* register contains the address of either the last used location at the top of the stack, or the first unused location, depending on convention. The *frame pointer* register contains an address within the frame. Objects in the frame are accessed via displacement addressing with respect to the frame pointer. If the size of an object (e.g., a local array) is not known at compile time, then the object is placed in a variable-size area at the top of the frame; its address and dope vector (descriptor) are stored in the fixed-size portion of the frame, at a statically known offset from the frame pointer ([Figure 7.6](#), page 334). If there are no variable-size objects, then every object within the frame has a statically known offset from the stack pointer, and the implementation may dispense with the frame pointer, freeing up a register for other use. If the size of an argument is not known at compile time, then the argument may be placed in a variable-size

EXAMPLE 8.2

Offsets from frame pointer

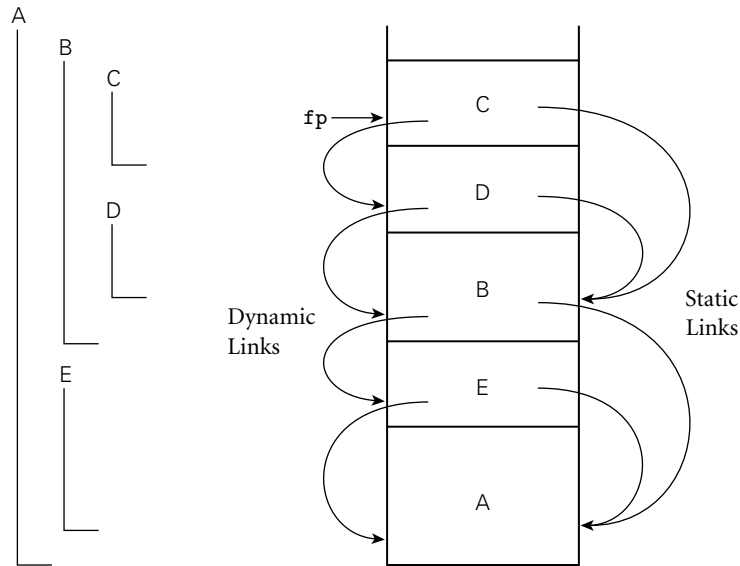

Figure 8.1 Example of subroutine nesting, taken from Figure 3.5. Within B, C, and D, all five routines are visible. Within A and E, routines A, B, and E are visible, but C and D are not. Given the calling sequence A, E, B, D, C, in that order, frames will be allocated on the stack as shown at right, with the indicated static and dynamic links.

portion of the frame *below* the other arguments, with its address and dope vector at known offsets from the frame pointer. Alternatively, the caller may simply pass a temporary address and dope vector, counting on the called routine to copy the argument into the variable-size area at the top of the frame. ■

EXAMPLE 8.3

Static and dynamic links

In a language with nested subroutines and static scoping (e.g., Pascal, Ada, ML, Common Lisp, or Scheme), objects that lie in surrounding subroutines, and that are thus neither local nor global, can be found by maintaining a *static chain* (Figure 8.1). Each stack frame contains a reference to the frame of the lexically surrounding subroutine. This reference is called the *static link*. By analogy, the saved value of the frame pointer, which will be restored on subroutine return, is called the *dynamic link*. The static and dynamic links may or may not be the same, depending on whether the current routine was called by its lexically surrounding routine, or by some other routine nested in that surrounding routine. ■

EXAMPLE 8.4

Visibility of nested routines

Whether or not a subroutine is called directly by the lexically surrounding routine, we can be sure that the surrounding routine is active; there is no other way that the current routine could have been visible, allowing it to be called. Consider, for example, the subroutine nesting shown in Figure 8.1. If subroutine D is called directly from B, then clearly B's frame will already be on the stack. How else could D be called? It is not visible in A or E, because it is nested inside of B. A moment's thought makes clear that it is only when control enters B (placing B's frame on the stack) that D comes into view. It can therefore be called by C, or by

any other routine (not shown) that is nested inside C or D, but only because these are also within B. ■

8.2 Calling Sequences

Maintenance of the subroutine call stack is the responsibility of the *calling sequence*—the code executed by the caller immediately before and after a subroutine call—and of the *prologue* (code executed at the beginning) and *epilogue* (code executed at the end) of the subroutine itself. Sometimes the term “calling sequence” is used to refer to the combined operations of the caller, the prologue, and the epilogue.

Tasks that must be accomplished on the way into a subroutine include passing parameters, saving the return address, changing the program counter, changing the stack pointer to allocate space, saving registers (including the frame pointer) that contain important values and that may be overwritten by the callee, changing the frame pointer to refer to the new frame, and executing initialization code for any objects in the new frame that require it. Tasks that must be accomplished on the way out include passing return parameters or function values, executing finalization code for any local objects that require it, deallocating the stack frame (restoring the stack pointer), restoring other saved registers (including the frame pointer), and restoring the program counter. Some of these tasks (e.g., passing parameters) must be performed by the caller, because they differ from call to call. Most of the tasks, however, can be performed either by the caller or the callee. In general, we will save space if the callee does as much work as possible: tasks performed in the callee appear only once in the target program, but tasks performed in the caller appear at every call site, and the typical subroutine is called in more than one place.

Saving and Restoring Registers

Perhaps the trickiest division-of-labor issue pertains to saving registers. The ideal approach (see Section ©5.5.2) is to save precisely those registers that are both in use in the caller and needed for other purposes in the callee. Because of separate compilation, however, it is difficult (though not impossible) to determine this intersecting set. A simpler solution is for the caller to save all registers that are in use, or for the callee to save all registers that it will overwrite.

Calling sequence conventions for many processors, including the MIPS and x86 described in the case studies of Section ©8.2.2, strike something of a compromise: registers not reserved for special purposes are divided into two sets of approximately equal size. One set is the caller’s responsibility, the other is the callee’s responsibility. A callee can assume that there is nothing of value in any of the registers in the caller-saves set; a caller can assume that no callee will destroy the contents of any registers in the callee-saves set. In the interests of code size, the compiler uses the callee-saves registers for local variables and other long-lived

values whenever possible. It uses the caller-saves set for transient values, which are less likely to be needed across calls. The result of these conventions is that the caller-saves registers are seldom saved by either party: the callee knows that they are the caller's responsibility, and the caller knows that they don't contain anything important.

Maintaining the Static Chain

In languages with nested subroutines, at least part of the work required to maintain the static chain must be performed by the caller, rather than the callee, because this work depends on the lexical nesting depth of the caller. The standard approach is for the caller to compute the callee's static link and to pass it as an extra, hidden parameter. Two subcases arise:

1. The callee is nested (directly) inside the caller. In this case, the callee's static link should refer to the caller's frame. The caller therefore passes its own frame pointer as the callee's static link.
2. The callee is $k \geq 0$ scopes "outward"—closer to the outer level of lexical nesting. In this case, all scopes that surround the callee also surround the caller (otherwise the callee would not be visible). The caller dereferences its own static link k times and passes the result as the callee's static link.

A Typical Calling Sequence

EXAMPLE 8.5

A typical calling sequence

Figure 8.2 shows one plausible layout for a stack frame, consistent with Figure 3.1. The stack pointer (sp) points to the first unused location on the stack (or the last used location, depending on the compiler and machine). The frame pointer (fp) points to a location near the bottom of the frame. Space for all arguments is reserved in the stack, even if the compiler passes some of them in registers (the callee will need a place to save them if it calls a nested routine).

To maintain this stack layout, the calling sequence might operate as follows. The caller

1. saves any caller-saves registers whose values will be needed after the call
2. computes the values of arguments and moves them into the stack or registers
3. computes the static link (if this is a language with nested subroutines), and passes it as an extra, hidden argument
4. uses a special subroutine call instruction to jump to the subroutine, simultaneously passing the return address on the stack or in a register

In its prologue, the callee

1. allocates a frame by subtracting an appropriate constant from the sp
2. saves the old frame pointer into the stack, and assigns it an appropriate new value

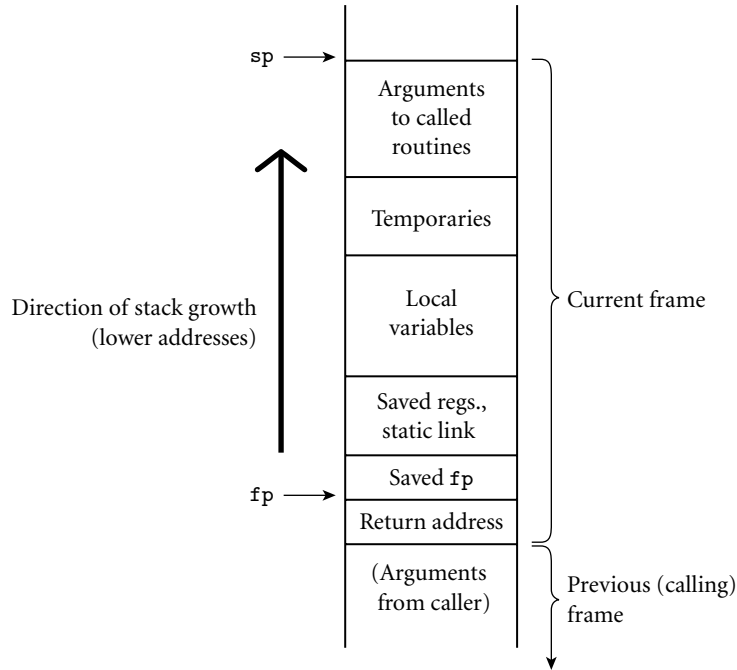

Figure 8.2 A typical stack frame. Though we draw it growing upward on the page, the stack actually grows downward toward lower addresses on most machines. Arguments are accessed at positive offsets from the fp. Local variables and temporaries are accessed at negative offsets from the fp. Arguments to be passed to called routines are assembled at the top of the frame, using positive offsets from the sp.

3. saves any callee-saves registers that may be overwritten by the current routine (including the static link and return address, if they were passed in registers)

After the subroutine has completed, the epilogue

1. moves the return value (if any) into a register or a reserved location in the stack
2. restores callee-saves registers if needed
3. restores the fp and the sp
4. jumps back to the return address

Finally, the caller

1. moves the return value to wherever it is needed
2. restores caller-saves registers if needed

Special-Case Optimizations

Many parts of the calling sequence, prologue, and epilogue can be omitted in common cases. If the hardware passes the return address in a register, then a *leaf*

routine (a subroutine that makes no additional calls before returning)² can simply leave it there; it does not need to save it in the stack. Likewise it need not save the static link or any caller-saves registers.

A subroutine with no local variables and nothing to save or restore may not even need a stack frame on a RISC machine. The simplest subroutines (e.g., library routines to compute the standard mathematical functions) may not touch memory at all, except to fetch instructions: they may take their arguments in registers, compute entirely in (caller-saves) registers, call no other routines, and return their results in registers. As a result they may be extremely fast.

8.2.1 Displays

One disadvantage of static chains is that access to an object in a scope k levels out requires that the static chain be dereferenced k times. If a local object can be loaded into a register with a single (displacement mode) memory access, an object k levels out will require $k + 1$ memory accesses. This number can be reduced to a constant by use of a *display*.

© IN MORE DEPTH

As described on the PLP CD, a display is a small array that replaces the static chain. The j th element of the display contains a reference to the frame of the most recently active subroutine at lexical nesting level j . If the currently active routine is nested $i > 3$ levels deep, then elements $i - 1$, $i - 2$, and $i - 3$ of the display contain the values that would have been the first three links of the static chain. An object k levels out can be found at a statically known offset from the address stored in element $j = i - k$ of the display.

For most programs the cost of maintaining a display in the subroutine calling sequence tends to be slightly higher than that of maintaining a static chain. At the same time, the cost of dereferencing the static chain has been reduced by modern compilers, which tend to do a good job of caching the links in registers when appropriate. These observations, combined with the trend toward languages (those descended from C in particular) in which subroutines do not nest, has made displays less common today than they were in the 1970s.

8.2.2 Case Studies: C on the MIPS; Pascal on the x86

Calling sequences differ significantly from machine to machine and even compiler to compiler (though typically a hardware manufacturer publishes a suggested set of

² A leaf routine is so named because it is a leaf of the *subroutine call graph*, a data structure mentioned in Exercise 3.10.

conventions for a given architecture, to promote interoperability among program components produced by different compilers). Some of the most significant differences can be found in a comparison of CISC and RISC conventions.

- Compilers for CISC machines tend to pass arguments on the stack; compilers for RISC machines tend to pass arguments in registers.
- Compilers for CISC machines usually dedicate a register to the frame pointer; compilers for RISC machines often do not.
- Compilers for CISC machines often rely on special-purpose instructions to implement parts of the calling sequence; available instructions on a RISC machine are typically much simpler.

The use of the stack to pass arguments reflects the technology of the 1970s, when register sets were significantly smaller and memory access was significantly faster (in comparison to processor speed) than is the case today. Most CISC instruction sets include `push` and `pop` instructions that combine a `store` or `load` with automatic update of the stack pointer. The `push` instruction, in particular, was traditionally used to pass arguments to subroutines, effectively allocating stack space on demand. The resulting instability in the value of the `sp` made it difficult (though not impossible) to use that register as the base for access to local variables. A separate frame pointer made code generation easier and, perhaps more important, made it practical to locate local variables from within a simple symbolic debugger.

© IN MORE DEPTH

On the PLP CD we look in some detail at the stack layout conventions and calling sequences of a representative pair of compilers: the SGI MIPSpro C compiler for the 64-bit MIPS architecture, and the GNU Pascal compiler (`gpc`) for the 32-bit x86. The MIPSpro compiler is the predecessor to the widely used Open64 research compiler. It illustrates the heavy use of registers on modern RISC machines. The `gpc` compiler, while adjusted somewhat to reflect modern implementations of the x86, still retains vestiges of its CISC ancestry, with heavier use of the stack. It also illustrates the use of the static chain to accommodate nested subroutines, and the creation of closures when such routines are passed as parameters.

8.2.3 Register Windows

As an alternative to saving and restoring registers on subroutine calls and returns, the original Berkeley RISC machines [PD80, Pat85] introduced a hardware mechanism known as *register windows*. The basic idea is to map the ISA's limited set of register names onto some subset (window) of a much larger collection of physical registers, and to change the mapping when making subroutine calls. Old and new mappings overlap a bit, allowing arguments to be passed (and function results returned) in the intersection.

© IN MORE DEPTH

We consider register windows in more detail on the PLP CD. They have appeared in several commercial processors, most notably the Sun SPARC and the Intel IA-64 (Itanium).

8.2.4 In-Line Expansion

As an alternative to stack-based calling conventions, many language implementations allow certain subroutines to be expanded in-line at the point of call. A copy of the “called” routine becomes a part of the “caller”; no actual subroutine call occurs. In-line expansion avoids a variety of overheads, including space allocation, branch delays from the call and return, maintaining the static chain or display, and (often) saving and restoring registers. It also allows the compiler to perform code improvements such as global register allocation, instruction scheduling, and common subexpression elimination across the boundaries between subroutines, something that most compilers can’t do otherwise.

In many implementations, the compiler chooses which subroutines to expand in-line and which to compile conventionally. In some languages, the programmer can suggest that particular routines be in-lined. In C++ and C99, the keyword `inline` can be prefixed to a function declaration:

EXAMPLE 8.6

Requesting an `inline` subroutine

```
inline int max(int a, int b) {return a > b ? a : b;}
```

In Ada, the programmer can request in-line expansion with a *significant comment*, or *pragma*:

DESIGN & IMPLEMENTATION**Hints and directives**

Formally, the `inline` keyword is a *hint* in C++ and C99, rather than a *directive*: it suggests but does not require that the compiler actually expand the subroutine in-line. The compiler is free to use a conventional implementation when `inline` has been specified, or to use an in-line implementation when `inline` has *not* been specified, if it has reason to believe that this will result in better code.

In effect, the inclusion of hints like `inline` in a programming language represents an acknowledgment that advice from the expert programmer may sometimes be useful with current compiler technology, but that this may change in the future. By contrast, the use of pointer arithmetic in place of array subscripts, as discussed in the sidebar on page 354, is more of a *directive* than a hint, and may complicate the generation of high-quality code from legacy programs.

```

function max(a, b : integer) return integer is
begin
    if a > b then return a; else return b; end if;
end max;
pragma inline(max);

```

Like the `inline` of C99 and C++, this `pragma` is a hint; the compiler is permitted to ignore it. ■

In [Section 3.7](#) we noted the similarity between in-line expansion and macros, but argued that the former is semantically preferable. In fact, in-line expansion is semantically neutral: it is purely an implementation technique, with no effect on the meaning of the program. In comparison to real subroutine calls, in-line expansion has the obvious disadvantage of increasing code size, since the entire body of the subroutine appears at every call site. In-line expansion is also not an option in the general case for recursive subroutines. For the occasional case in which a recursive call is possible but unlikely, it may be desirable to generate a true recursive subroutine, but to expand one level of that routine in-line at each call site. As a simple example, consider a binary tree whose leaves contain character strings. A routine to return the fringe of this tree (the left-to-right concatenation of the values in its leaves) might look like this:

EXAMPLE 8.7

In-lining and recursion

```

string fringe(bin_tree *t) {
    // assume both children are nil or neither is
    if (t->left == 0) return t->val;
    return fringe(t->left) + fringe(t->right);
}

```

A compiler can expand this code in-line if it makes each nested invocation a true subroutine call. Since half the nodes in a binary tree are leaves, this expansion will eliminate half the dynamic calls at run-time. If we expand not only the root calls but also (one level of) the two calls within the true subroutine version, only a quarter of the original dynamic calls will remain. ■

DESIGN & IMPLEMENTATION

In-line and modularity

Probably the most important argument for in-line expansion is that it allows programmers to adopt a very modular programming style, with lots of tiny subroutines, without sacrificing performance. This modular programming style is essential for object-oriented languages, as we shall see in [Chapter 9](#). The benefit of in-lining is undermined to some degree by the fact that changing the definition of an in-lined function forces the recompilation of every user of the function; changing the definition of an ordinary function (without changing its interface) forces relinking only. The best of both worlds may be achieved in systems with just-in-time compilation ([Section 15.2.1](#)).

✓ CHECK YOUR UNDERSTANDING

1. What is a subroutine *calling sequence*? What does it do? What is meant by the subroutine *prologue* and *epilogue*?
 2. How do calling sequences typically differ in CISC and RISC compilers?
 3. Describe how to maintain the *static chain* during a subroutine call.
 4. What is a *display*? How does it differ from a static chain?
 5. What are the purposes of the *stack pointer* and *frame pointer* registers? Why does a subroutine often need both?
 6. Why do RISC machines typically pass subroutine parameters in registers rather than on the stack?
 7. Why do subroutine calling conventions often give the caller responsibility for saving half the registers and the callee responsibility for saving the other half?
 8. If work can be done in either the caller or the callee, why do we typically prefer to do it in the callee?
 9. Why do compilers typically allocate space for arguments in the stack, even when they pass them in registers?
 10. List the optimizations that can be made to the subroutine calling sequence in important special cases (e.g., *leaf routines*).
 11. How does an *in-line subroutine* differ from a *macro*?
 12. Under what circumstances is it desirable to expand a subroutine in-line?
-

8.3 Parameter Passing

Most subroutines are parameterized: they take arguments that control certain aspects of their behavior, or specify the data on which they are to operate. Parameter names that appear in the declaration of a subroutine are known as *formal parameters*. Variables and expressions that are passed to a subroutine in a particular call are known as *actual parameters*. We have been referring to actual parameters as *arguments*. In the following two subsections, we discuss the most common parameter-passing *modes*, most of which are implemented by passing values, references, or closures. In [Section 8.3.3](#) we will look at additional mechanisms, including conformant array parameters, missing and default parameters, named parameters, and variable-length argument lists. Finally, in [Section 8.3.4](#) we will consider mechanisms for returning values from functions.

As we noted in [Section 6.1](#), most languages use a prefix notation for calls to user-defined subroutines, with the subroutine name followed by a parenthesized argument list. Lisp places the function name inside the parentheses, as in `(max a b)`. ML allows the programmer to specify that certain names represent infix operators, which appear between a pair of arguments:

EXAMPLE 8.8

Infix operators

```
infixr 8 tothe;      (* exponentiation *)
fun x tothe 0 = 1.0
  | x tothe n = x * (x tothe(n-1));    (* assume n >= 0 *)
```

The `infixr` declaration indicates that `tothe` will be a right-associative binary infix operator, at precedence level 8 (multiplication and division are at level 7, addition and subtraction at level 6). Fortran 90 also allows the programmer to define new infix operators, but it requires their names to be bracketed with periods (e.g., `A .cross. B`), and it gives them all the same precedence. Smalltalk uses infix (or “mixfix”) notation (without precedence) for all its operations. ■

EXAMPLE 8.9

Control abstraction in Lisp and Smalltalk

The uniformity of Lisp and Smalltalk syntax makes control abstraction particularly effective: user-defined subroutines (functions in Lisp, “messages” in Smalltalk) use the same style of syntax as built-in operations. As an example, consider `if... then... else`:

```
if a > b then max := a else max := b;          (* Pascal *)

(if (> a b) (setf max a) (setf max b))        ; Lisp

(a > b) ifTrue: [max <- a] ifFalse: [max <- b]. "Smalltalk"
```

In Pascal or C it is clear that `if... then... else` is a built-in language construct: it does not look like a subroutine call. In Lisp and Smalltalk, on the other hand, the analogous conditional constructs are syntactically indistinguishable from user-defined operations. They are in fact defined in terms of simpler concepts, rather than being built in, though they require a special mechanism to evaluate their arguments in normal, rather than applicative, order ([Section 6.6.2](#)). ■

8.3.1 Parameter Modes

In our discussion of subroutines so far, we have glossed over the semantic rules that govern parameter passing, and that determine the relationship between actual and formal parameters. Some languages—including C, Fortran, ML, and Lisp—define a single set of rules that apply to all parameters. Other languages, including Pascal, Modula, and Ada, provide two or more sets of rules, corresponding to different parameter-passing *modes*. As in many aspects of language design, the semantic details are heavily influenced by implementation issues.

EXAMPLE 8.10

Passing an argument to a subroutine

Suppose for the moment that x is a global variable in a language with a value model of variables, and that we wish to pass x as a parameter to subroutine p :

```
p(x);
```

From an implementation point of view, we have two principal alternatives: we may provide p with a copy of x 's value, or we may provide it with x 's address. The two most common parameter-passing modes, called *call-by-value* and *call-by-reference*, are designed to reflect these implementations. ■

With value parameters, each actual parameter is assigned into the corresponding formal parameter when a subroutine is called; from then on, the two are independent. With reference parameters, each formal parameter introduces, within the body of the subroutine, a new name for the corresponding actual parameter. If the actual parameter is also visible within the subroutine under its original name (as will generally be the case if it is declared in a surrounding scope), then the two names are *aliases* for the same object, and changes made through one will be visible through the other. In most languages (Fortran is an exception; see below) an actual parameter that is to be passed by reference must be an l-value; it cannot be the result of an arithmetic operation, or any other value without an address.

As a simple example, consider the following pseudocode:

EXAMPLE 8.11

Value and reference parameters

```
x : integer                -- global
procedure fooy (integer)
  y := 3
  print x
  ...
x := 2
foo(x)
print x
```

If y is passed to `foo` by value, then the assignment inside `foo` has no visible effect— y is private to the subroutine—and the program prints 2 twice. If y is passed to `foo` by reference, then the assignment inside `foo` changes x — y is just a local name for x —and the program prints 3 twice. ■

DESIGN & IMPLEMENTATION**Parameter modes**

While it may seem odd to introduce parameter modes (a semantic issue) in terms of implementation, the distinction between value and reference parameters is fundamentally an implementation issue. Most languages with more than one mode (Ada is the principal exception) might fairly be characterized as an attempt to paste acceptable semantics onto the desired implementation, rather than to find an acceptable implementation of the desired semantics.

Variations on Value and Reference Parameters

If the purpose of call-by-reference is to allow the called routine to modify the actual parameter, we can achieve a similar effect using *call-by-value/result*, a mode first introduced in Algol W. Like call-by-value, call-by-value/result copies the actual parameter into the formal parameter at the beginning of subroutine execution. Unlike call-by-value, it *also* copies the formal parameter back into the actual parameter when the subroutine returns. In [Example 8.11](#), value/result would copy x into y at the beginning of `foo`, and y into x at the end of `foo`. Because `foo` accesses x directly in-between, the program's visible behavior would be different than it was with call-by-reference: the assignment of 3 into y would not affect x until after the inner `print` statement, so the program would print 2 and then 3. ■

EXAMPLE 8.12

Call-by-value/result

In Pascal, parameters are passed by value by default; they are passed by reference if preceded by the keyword `var` in their subroutine header's formal parameter list. Parameters in C are always passed by value, though the effect for arrays is unusual: because of the interoperability of arrays and pointers in C ([Section 7.7.1](#)), what is passed by value is a pointer; changes to array elements accessed through this pointer are visible to the caller. To allow a called routine to modify a variable other than an array in the caller's scope, the C programmer must pass the address of the variable explicitly:

EXAMPLE 8.13

Emulating call-by-reference in C

```
void swap(int *a, int *b) { int t = *a; *a = *b; *b = t; }
...
swap(&v1, &v2);
```

Fortran passes all parameters by reference, but does not require that every actual parameter be an l-value. If a built-up expression appears in an argument list, the compiler creates a temporary variable to hold the value, and passes this variable by reference. A Fortran subroutine that needs to modify the values of its formal parameters without modifying its actual parameters must copy the values into local variables, and modify those instead.

Call-by-Sharing Call-by-value and call-by-reference make the most sense in a language with a value model of variables: they determine whether we copy the variable or pass an alias for it. Neither option really makes sense in a language like Smalltalk, Lisp, ML, or Clu, in which a variable is already a reference. Here it is most natural simply to pass the reference itself, and let the actual and formal parameters refer to the same object. Clu calls this mode *call-by-sharing*. It is different from call-by-value because, although we do copy the actual parameter into the formal parameter, both of them are references; if we modify the object to which the formal parameter refers, the program will be able to see those changes through the actual parameter after the subroutine returns. Call-by-sharing is also different from call-by-reference, because although the called routine can change the value of the object to which the actual parameter refers, it cannot change the *identity* of that object.

As we noted in [Sections 6.1.2](#) (page 227) and [7.7.1](#), a reference model of variables does not necessarily require that every object be accessed indirectly by address: the implementation can create multiple copies of immutable objects (numbers, characters, etc.) and access them directly. Call-by-sharing is thus commonly implemented the same as call-by-value for objects of immutable type.

In keeping with its hybrid model of variables, Java uses call-by-value for variables of built-in type (all of which are values), and call-by-sharing for variables of user-defined class types (all of which are references). An interesting consequence is that a Java subroutine cannot change the value of an actual parameter of built-in type. A similar approach is the default in C#, but because the language allows users to create both value (`struct`) and reference (`class`) types, both cases are considered call-by-value. That is, whether a variable is a value or a reference, we always pass it by copying. (Some authors describe Java the same way.)

When desired, parameters in C# can be passed by reference instead, by labeling both a formal parameter *and each corresponding argument* with the `ref` or `out` keyword. Both of these modes are implemented by passing an address; they differ in that a `ref` argument must be *definitely assigned* prior to the call, as described in [Section 6.1.3](#); an `out` argument need not. In contrast to Java, therefore, a C# subroutine *can* change the value of an actual parameter of built-in type, if the parameter is passed `ref` or `out`. Similarly, if a variable of `class` (reference) type is passed as a `ref` or `out` parameter, it may end up referring to a different object as a result of subroutine execution—something that is not possible with call-by-sharing.

The Purpose of Call-by-Reference In a language that provides both value and reference parameters (e.g., Pascal or Modula), there are two principal reasons why the programmer might choose one over the other. First, if the called routine is supposed to change the value of an actual parameter (argument), then the programmer must pass the parameter by reference. Conversely, to ensure that the called routine cannot modify the argument, the programmer can pass the parameter by value. Second, the implementation of value parameters requires copying actuals to formals, a potentially time-consuming operation when arguments are large. Reference parameters can be implemented simply by passing an address. (Of course, accessing a parameter that is passed by reference requires an extra level of indirection. If the parameter is used often enough, the cost of this indirection may outweigh the cost of copying the argument.)

The potential inefficiency of large value parameters sometimes prompts programmers to pass an argument by reference when passing by value would be semantically more appropriate. Pascal programmers, for example, were commonly taught to use `var` (reference) parameters both for arguments that need to be modified and for arguments that are very large. Unfortunately, the latter justification often leads to buggy code, in which a subroutine modifies an argument that the caller meant to leave unchanged.

Read-Only Parameters To combine the efficiency of reference parameters and the safety of value parameters, Modula-3 provides a `READONLY` parameter mode. Any formal parameter whose declaration is preceded by `READONLY` cannot be changed by the called routine: the compiler prevents the programmer from using that formal parameter on the left-hand side of any assignment statement, reading it from a file, or passing it by reference to any other subroutine. Small `READONLY` parameters are generally implemented by passing a value; larger `READONLY` parameters are implemented by passing an address. As in Fortran, a Modula-3 compiler will create a temporary variable to hold the value of any built-up expression passed as a large `READONLY` parameter.

The equivalent of `READONLY` parameters is also available in C, which allows any variable or parameter declaration to be preceded by the keyword `const`. `Const` variables are “elaboration-time constants,” as described in [Section 3.2](#). `Const` parameters are particularly useful when passing addresses:

EXAMPLE 8.14

Const parameters in C

```
void append_to_log(const huge_record* r) { ...
...
append_to_log(&my_record);
```

Here the keyword `const` applies to the record to which `r` points;³ the callee will be unable to change the record’s contents. Note, however, that in C the caller must take the address of the record explicitly, and the compiler does not have the option of passing by value. ■

One traditional problem with parameter modes—and with the `READONLY` mode in particular—is that they tend to confuse the key pragmatic issue (does the implementation pass a value or a reference?) with two semantic issues: is the callee allowed to change the formal parameter and, if so, will the changes be reflected in the actual parameter? C keeps the pragmatic issue separate, by forcing the programmer to pass references explicitly with pointers. Still, its `const` mode serves double duty: is the intent of `const foo* p` to protect the actual parameter from change, or to document the fact that the subroutine thinks of the formal parameter as a constant rather than a variable, or both?

Parameter Modes in Ada

Ada provides three parameter-passing modes, called `in`, `out`, and `in out`. `In` parameters pass information from the caller to the callee; they can be read by the callee but not written. `Out` parameters pass information from the callee to the caller. In Ada 83 they can be written by the callee but not read; in Ada 95 they can be both read and written, but they begin their life uninitialized. `In out` parameters pass information in both directions; they can be both read and written. Changes to `out` or `in out` parameters always change the actual parameter.

3 Following the usual rules for parsing C declarations (page 354), `r` is a pointer to a `huge_record` whose value is constant. If we wanted `r` to be a constant that points to a `huge_record`, we should need to say `huge_record* const r`.

For parameters of scalar and access (pointer) types, Ada specifies that all three modes are to be implemented by copying values. For these parameters, then, `in` is call-by-value, `in out` is call-by-value/result, and `out` is simply *call-by-result* (the value of the formal parameter is copied into the actual parameter when the subroutine returns). For parameters of most constructed types, however, Ada specifically permits an implementation to pass either values or addresses. In most languages, these two different mechanisms would lead to different semantics: changes made to an `in out` parameter that is passed as an address will affect the actual parameter immediately; changes made to an `in out` parameter that is passed as a value will not affect the actual parameter until the subroutine returns. As noted in [Example 8.12](#), the difference can lead to different behavior in the presence of aliases.

One possible way to hide the distinction between reference and value/result would be to outlaw the creation of aliases, as Euclid does. Ada takes a simpler tack: a program that can tell the difference between value and address-based implementations of (nonscalar, nonpointer) `in out` parameters is said to be *erroneous*—incorrect, but in a way that the language implementation is not required to catch.

Ada's semantics for parameter passing allow a single set of modes to be used not only for subroutine parameters, but also for communication among concurrently executing tasks (to be discussed in [Chapter 12](#)). When tasks are executing on separate machines, with no memory in common, passing the address of an actual parameter is not a practical option. Most Ada compilers pass large arguments to subroutines as addresses; they pass them to the entry points of tasks by copying.

References in C++

Programmers who switch to C after some experience with Pascal, Modula, or Ada (or with call-by-sharing in Java or Lisp) are often frustrated by C's lack of reference parameters. As noted above, one can always arrange to modify an object by passing its address, but then the formal parameter is a pointer, and must be explicitly dereferenced whenever it is used. C++ addresses this problem by introducing an explicit notion of a *reference*. Reference parameters are specified by preceding their name with an ampersand in the header of the function:

```
void swap(int &a, int &b) { int t = a; a = b; b = t; }
```

In the code of this `swap` routine, `a` and `b` are ints, not pointers to ints; no dereferencing is required. Moreover, the caller passes as arguments the variables whose values are to be swapped, rather than passing their addresses. ■

As in C, a C++ parameter can be declared to be `const` to ensure that it is not modified. For large types, `const` reference parameters in C++ provide the same combination of speed and safety found in the `READONLY` parameters of Modula-3: they can be passed by address, and cannot be changed by the called routine.

EXAMPLE 8.15

Reference parameters in C++

EXAMPLE 8.16

References as aliases in C++

References in C++ see their principal use as parameters, but they can appear in other contexts as well. Any variable can be declared to be a reference:

```
int i;
int &j = i;
...
i = 2;
j = 3;
cout << i;           // prints 3
```

Here `j` is a reference to (an alias for) `i`. The initializer in the declaration is required; it identifies the object for which `j` is an alias. Moreover it is not possible later to change the object to which `j` refers; it will always refer to `i`.

Any change to `i` or `j` can be seen by reading the other. Most C++ compilers implement references with addresses. In this example, `i` will be assigned a location that contains an integer, while `j` will be assigned a location that contains the address of `i`. Despite their different implementation, however, there is no semantic difference between `i` and `j`; the exact same operations can be applied to either, with precisely the same results. ■

While there is seldom any reason to create aliases on purpose in straight-line code, references in C++ are highly useful for at least one purpose other than parameters—namely, function returns. Some objects—file buffers, for example—do not support a copy operation, and therefore cannot be passed or returned by value. One can always return a pointer, but just as with subroutine parameters, the subsequent dereferencing operations can be cumbersome.

EXAMPLE 8.17

Returning a reference from a function

Section ©7.9 explains how references are used for I/O in C++. The overloaded `<<` and `>>` operators return a reference to their first argument, which can in turn be passed to subsequent `<<` or `>>` operations. The syntax

```
cout << a << b << c;
```

is short for

```
((cout.operator<<(a)).operator<<(b)).operator<<(c);
```

Without references, `<<` and `>>` would have to return a pointer to their stream:

```
((cout.operator<<(a))->operator<<(b))->operator<<(c);
```

or

```
*(*(cout.operator<<(a)).operator<<(b)).operator<<(c);
```

This change would spoil the cascading syntax of the operator form:

```
*(*(cout << a) << b) << c; ■
```

It should be noted that the ability to return references from functions is not new in C++: Algol 68 provides the same capability. The object-oriented features of C++, and its operator overloading, make reference returns particularly useful.

Closures as Parameters

A closure (a reference to a subroutine, together with its referencing environment) may be passed as a parameter for any of several reasons. The most obvious of these arises when the parameter is declared to be a subroutine (sometimes called a *formal subroutine*). In Standard Pascal one might write:

EXAMPLE 8.18

Subroutines as parameters
in Pascal

```

1. procedure apply_to_A(function f(n : integer) : integer;
2.                       var A : array [low..high : integer] of integer);
3. var i : integer;
4. begin
5.   for i := low to high do A[i] := f(A[i]);
6. end;
...
7.   var k : integer;           (* in nested scope *)
...
8.   function add_k (m : integer) : integer;
9.   begin
10.    add_k := m + k;
11.   end;
...
12.   k := 3;
13.   apply_to_A(add_k, my_array);

```

As discussed in [Section 3.6.1](#), a closure needs to include both a code address and a referencing environment because, in a language with nested subroutines, we need to make sure that the environment available to `f` at line 5 is the same that would have been available to `add_k` if it had been called directly at line 13—in particular, that it includes the binding for `k`. ■

Ada 83 did not permit subroutines to be passed as parameters. Some of the same effect could be obtained through generic subroutines, but not enough: Ada 95 added first-class pointer-to-subroutine types, with semantics and implementation similar to Pascal. Fortran has always allowed subroutines to be passed as parameters, but only allowed them to nest beginning in Fortran 90 (and then only one level deep).

EXAMPLE 8.19

First-class subroutines in
Scheme

Subroutines are routinely passed as parameters (and returned as results) in functional languages. A list-based version of `apply_to_A` would look something like this in Scheme (for the meanings of `car`, `cdr`, and `cons`, see [Section 7.8](#)):

```

(define apply-to-L (lambda (f l)
  (if (null? l) '()
      (cons (f (car l)) (apply-to-L f (cdr l))))))

```

Because Scheme (like Lisp) is not statically typed, there is no need to specify the type of `f`. At run time, a Scheme implementation will announce a dynamic semantic error in `(f (car l))` if `f` is not a function, and in `(null? l)`, `(car l)`, or `(cdr l)` if `l` is not a list. ■

EXAMPLE 8.20

First-class subroutines in ML

The code in ML is similar, but the implementation uses inference (Section ©7.2.4) to determine the types of `f` and `l` at compile time:

```
fun apply_to_L(f, l) =
  case l of
    nil => nil
  | h :: t => f(h) :: apply_to_L(f, t);
```

EXAMPLE 8.21

Subroutine pointers in C and C++

As noted in Section 3.6, C and C++ have no need of subroutine closures, because their subroutines do not nest. Simple *pointers* to subroutines suffice. These are permitted both as parameters and as variables.

```
void apply_to_A(int (*f)(int), int A[], int A_size) {
  int i;
  for (i = 0; i < A_size; i++) A[i] = f(A[i]);
}
```

The syntax `f(n)` is used not only when `f` is the name of a function, but also when `f` is a pointer to a subroutine; the pointer need not be dereferenced explicitly. ■

In object-oriented languages, one can approximate the behavior of a subroutine closure, even without nested subroutines, by packaging a method and its “environment” within an explicit object. We described these *object closures* in Section 3.6.3. Because they are ordinary objects, they require no special mechanisms to pass them as parameters or to store them in objects.

The *delegates* of C# significantly extend the notion of object closures. Delegates provide type safety without the restrictions of inheritance. A delegate can be instantiated not only with a specified object method (subsuming the object closures of C++ and Java), but also with a static function (subsuming the subroutine pointers of C and C++) or with an anonymous nested delegate or lambda expression (subsuming true subroutine closures). If an anonymous delegate or lambda expression refers to objects declared in the surrounding method, then those objects have unlimited extent. Finally, as we shall see in Section 8.7.2, a C# delegate can actually contain a *list* of closures, in which case calling the delegate has the effect of calling *all* the entries on the list, in turn. (This behavior generally makes sense only when each entry has a void return type. It is used primarily when processing *events*.)

8.3.2 Call-by-Name

Explicit subroutine parameters are not the only language feature that requires a closure to be passed as a parameter. In general, a language implementation must pass a closure whenever the eventual use of the parameter requires the restoration of a previous referencing environment. Interesting examples occur in the *call-by-name* parameters of Algol 60 and Simula, the label parameters of Algol 60 and Algol 68, and the *call-by-need* parameters of Miranda, Haskell, and R.

© IN MORE DEPTH

We consider call-by-name in more detail on the PLP CD. When Algol 60 was defined, most programmers programmed in assembly language (Fortran was only a few years old, and Lisp was even newer). The assembly languages of the day made heavy use of macros, and it was natural for the Algol designers to propose a parameter-passing mechanism that mimicked the behavior of macros, namely normal-order argument evaluation (Section 6.6.2). It was also natural, given common practice in assembly language, to allow a `goto` to jump to a label that was passed as a parameter. Call-by-name parameters have some interesting and powerful applications, but they are more difficult to implement (and more expensive to use) than one might at first expect: they require the passing of closures, sometimes referred to as *thunks*. Label parameters are typically implemented by closures as well. Both call-by-name and label parameters tend to lead to inscrutable code; modern languages encourage programmers to use explicit formal subroutines (Section 8.3.1) and structured exceptions (Section 8.5) instead.

8.3.3 Special-Purpose Parameters

Figure 8.3 contains a summary of the common parameter-passing modes. In this subsection we examine other aspects of parameter passing.

Conformant Arrays

As we saw in Section 7.4.2, the binding time for array dimensions and bounds varies greatly from language to language, ranging from compile time (Basic and Pascal) to elaboration time (Ada and Fortran 90) to arbitrary times during execution (APL, Perl, and Common Lisp). In several languages, the rules for parameters are looser than they are for variables. A formal array parameter whose shape is finalized at run time (in a language that usually determines shape at compile time), is called a *conformant*, or *open*, array parameter. Example 7.53 (page 331) illustrates the use of conformant arrays in Pascal, as does Example 8.18. The C equivalent of the latter appeared in Example 8.21. A multi-dimensional example (valid only since C99) can be found in Example 7.54 (page 332).

Default (Optional) Parameters

In Section 3.3.6 we noted that the principal use of dynamic scoping is to change the default behavior of a subroutine. We also noted that the same effect can be achieved with *default* parameters. A default parameter is one that need not necessarily be provided by the caller; if it is missing, then a preestablished default value will be used instead.

Parameter mode	Representative languages	Implementation mechanism	Permissible operations	Change to actual?	Alias?
value	C/C++, Pascal, Java/C# (value types)	value	read, write	no	no
in, const	Ada, C/C++, Modula-3	value or reference	read only	no	maybe
out	Ada	value or reference	write only	yes	maybe
value/result	Algol W	value	read, write	yes	no
var, ref	Fortran, Pascal, C++	reference	read, write	yes	yes
sharing	Lisp/Scheme, ML, Java/C# (reference types)	value or reference	read, write	yes	yes
in out	Ada	value or reference	read, write	yes	maybe
name	Algol 60, Simula	closure (thunk)	read, write	yes	yes
need	Haskell, R	closure (thunk) with memoization	read, write*	yes*	yes*

Figure 8.3 Parameter-passing modes. Column 1 indicates common names for modes. Column 2 indicates prominent languages that use the modes, or that introduced them. Column 3 indicates implementation via passing of values, references, or closures. Column 4 indicates whether the callee can read or write the formal parameter. Column 5 indicates whether changes to the formal parameter affect the actual parameter. Column 6 indicates whether changes to the formal or actual parameter, during the execution of the subroutine, may be visible through the other. *Changes to arguments passed by need in R will happen only on the first use; changes in Haskell are not permitted.

EXAMPLE 8.22

Default parameters in Ada

One common use of default parameters is in I/O library routines (described in Section ©7.9.3). In Ada, for example, the `put` routine for integers has the following declaration in the `text_IO` library package:

```

type field is integer range 0..integer'last;
type number_base is integer range 2..16;
default_width : field := integer'width;
default_base : number_base := 10;
procedure put(item : in integer;
              width : in field := default_width;
              base : in number_base := default_base);

```

Here the declaration of `default_width` uses the built-in type *attribute* `width` to determine the maximum number of columns required to print an integer in decimal on the current machine (e.g., a 32-bit integer requires no more than 11 columns, including the optional minus sign).

Any formal parameter that is “assigned” a value in its subroutine heading is optional in Ada. In our `text_IO` example, the programmer can call `put` with one, two, or three arguments. No matter how many are provided in a particular call, the code for `put` can always assume it has all three parameters. The implementation is straightforward: in any call in which actual parameters are missing, the compiler

pretends as if the defaults had been provided; it generates a calling sequence that loads those defaults into registers or pushes them onto the stack, as appropriate. On a 32-bit machine, `put(37)` will print the string “37” in an 11-column field (with nine leading blanks) in base-10 notation. `Put(37, 4)` will print “37” in a four-column field (two leading blanks), and `put(37, 4, 8)` will print “45” ($37 = 45_8$) in a four-column field.

Because the `default_width` and `default_base` variables are part of the `text_IO` interface, the programmer can change them if desired. When using default values in calls with missing actuals, the compiler loads the defaults from the variables of the package. As noted in Section 7.9.3, there are overloaded instances of `put` for all the built-in types. In fact, there are two overloaded instances of `put` for every type, one of which has an additional first parameter that specifies the output file to which to write a value.⁴ It should be emphasized that there is nothing special about I/O as far as default parameters are concerned: defaults can be used in any subroutine declaration. In addition to Ada, default parameters appear in C++, Common Lisp, Fortran 90, and Python. ■

Named Parameters

In all of our discussions so far we have been assuming that parameters are *positional*: the first actual parameter corresponds to the first formal parameter, the second actual to the second formal, and so on. In some languages, including Ada, Common Lisp, Fortran 90, Modula-3, and Python, this need not be the case. These languages allow parameters to be *named*. Named parameters (also called *keyword* parameters) are particularly useful in conjunction with default parameters. Positional notation allows us to write `put(37, 4)` to print “37” in a four-column field, but it does not allow us to print in octal in a field of default width: any call (with positional notation) that specifies a base must also specify a width, explicitly, because the width parameter precedes the base in `put`’s parameter list. Named parameters provide the Ada programmer with a way around this problem:

EXAMPLE 8.23

Named parameters in Ada

```
put(item => 37, base => 8);
```

Because the parameters are named, their order does not matter; we can also write

```
put(base => 8, item => 37);
```

We can even mix the two approaches, using positional notation for the first few parameters, and names for all the rest:

```
put(37, base => 8);
```

⁴ The real situation is actually a bit more complicated: The `put` routine for integers is nested inside `integer_IO`, a generic package that is in turn inside of `text_IO`. The programmer must *instantiate* a separate version of the `integer_IO` package for each variety (size) of integer type.

In addition to allowing parameters to be specified in arbitrary order, omitting any intermediate default parameters for which special values are not required, named parameter notation has the advantage of documenting the purpose of each parameter. For a subroutine with a very large number of parameters, it can be difficult to remember which is which. Named notation makes the meaning of arguments explicit in the call, as in the following hypothetical example:

EXAMPLE 8.24

Self-documentation with named parameters

```
format_page(columns => 2,
            window_height => 400, window_width => 200,
            header_font => Helvetica, body_font => Times,
            title_font => Times_Bold, header_point_size => 10,
            body_point_size => 11, title_point_size => 13,
            justification => true, hyphenation => false,
            page_num => 3, paragraph_indent => 18,
            background_color => white);
```

Variable Numbers of Arguments

Lisp, Python, and C and its descendants are unusual in that they allow the user to define subroutines that take a variable number of arguments. Examples of such subroutines can be found in Section ©7.9.3: the `printf` and `scanf` functions of C's `stdio` I/O library. In C, `printf` can be declared as follows:

```
int printf(char *format, ...)
{ ...
```

The ellipsis (...) in the function header is a part of the language syntax. It indicates that there are additional parameters following the format, but that their types and numbers are unspecified. Since C and C++ are statically typed, additional parameters are not type safe. They are type safe in Common Lisp and Python, however, thanks to dynamic typing.

Within the body of a function with a variable-length argument list, the C or C++ programmer must use a collection of standard routines to access the extra arguments. Originally defined as macros, these routines have implementations that vary from machine to machine, depending on how arguments are passed to functions; today the necessary support is often built into the compiler. For `printf`, variable arguments would be used as follows in C:

EXAMPLE 8.25

Variable number of arguments in C

```
#include <stdarg.h> /* macros and type definitions */
int printf(char *format, ...)
{
    va_list args;
    va_start(args, format);
    ...
    char cp = va_arg(args, char);
    ...
    double dp = va_arg(args, double);
    ...
    va_end(args);
}
```

Here `args` is defined as an object of type `va_list`, a special (implementation-dependent) type used to enumerate the elided parameters. The `va_start` routine takes the last declared parameter (in this case, `format`) as its second argument. It initializes its first argument (in this case `args`) so that it can be used to enumerate the rest of the caller's actual parameters. At least one formal parameter must be declared; they can't all be elided.

Each call to `va_arg` returns the value of the next elided parameter. Two examples appear above. Each specifies the expected type of the parameter, and assigns the result into a variable of the appropriate type. If the expected type is different from the type of the actual parameter, chaos can result. In `printf`, the `%X` placeholders in the `format` string are used to determine the type: `printf` contains a large `switch` statement, with one arm for each possible `X`. The arm for `%c` contains a call to `va_arg(args, char)`; the arm for `%f` contains a call to `va_arg(args, double)`. All C floating-point types are extended to double-precision before being passed to a subroutine, so there is no need inside `printf` to worry about the distinction between floats and doubles. `scanf`, on the other hand, must distinguish between pointers to floats and pointers to doubles. The call to `va_end` allows the implementation to perform any necessary cleanup operations (e.g., deallocation of any heap space used for the `va_list`, or repair of any changes to the stack frame that might confuse the epilogue code). ■

Like C and C++, C# and recent versions of Java support variable numbers of parameters, but unlike their parent languages they do so in a type-safe manner, by requiring all trailing parameters to share a common type. In Java, for example, one can write

EXAMPLE 8.26

Variable number of arguments in Java

```
static void print_lines(String foo, String... lines) {
    System.out.println("First argument is \"" + foo + "\".");
    System.out.println("There are " +
        lines.length + " additional arguments:");
    for (String str: lines) {
        System.out.println(str);
    }
}
...
print_lines("Hello, world", "This is a message", "from your sponsor.");
```

Here again the ellipsis in the method header is part of the language syntax. Method `print_lines` has two arguments. The first, `foo`, is of type `String`; the second, `lines`, is of type `String...` Within `print_lines`, `lines` functions as if it had type `String[]` (array of `String`). The caller, however, need not package the second and subsequent parameters into an explicit array; the compiler does this automatically, and the program prints

```
First argument is "Hello, world".
There are 2 additional arguments:
This is a message
from your sponsor.
```

EXAMPLE 8.27

Variable number of arguments in C#

The parameter declaration syntax is slightly different in C#:

```
static void print_lines(String foo, params String[] lines) {
    Console.WriteLine("First argument is \"" + foo + "\".");
    Console.WriteLine("There are " +
        lines.Length + " additional arguments:");
    for (int i = 0; i < lines.Length; i++) {
        Console.WriteLine(lines[i]);
    }
}
```

The calling syntax is the same. ■

8.3.4 Function Returns

The syntax by which a function indicates the value to be returned varies greatly. In languages like Lisp, ML, and Algol 68, which do not distinguish between expressions and statements, the value of a function is simply the value of its body, which is itself an expression.

In several early imperative languages, including Algol 60, Fortran, and Pascal, a function specifies its return value by executing an assignment statement whose left-hand side is the name of the function. This approach has an unfortunate interaction with the usual static scope rules ([Section 3.3.1](#)): the compiler must forbid any immediately nested declaration that would hide the name of the function, since the function would then be unable to return. This special case is avoided in more recent imperative languages by introducing an explicit `return` statement:

```
return expression
```

In addition to specifying a value, `return` causes the immediate termination of the subroutine. A function that has figured out what to return but doesn't want to return yet can always assign the return value into a temporary variable, and then return it later:

```
rtn := expression
...
return rtn
```

Fortran separates early termination of a subroutine from the specification of return values: it specifies the return value by assigning to the function name, and has a `return` statement that takes no arguments.

EXAMPLE 8.29

Incremental computation of a return value

Argument-bearing `return` statements and assignment to the function name both force the programmer to employ a temporary variable in incremental computations. Here is an example in Ada:

```

type int_array is array (integer range <>) of integer;
-- array of integers with unspecified integer bounds
function A_max(A : int_array) return integer is
rtn : integer;
begin
  rtn := integer'first;
  for i in A'first .. A'last loop
    if A(i) > rtn then rtn := A(i); end if;
  end loop;
  return rtn;
end A_max;

```

Here `rtn` must be declared as a variable so that the function can read it as well as write it. Because `rtn` is a local variable, most compilers will allocate it within the stack frame of `A_max`. The return statement must then perform an unnecessary copy to move that variable's value into the return location allocated by the caller. ■

Some languages eliminate the need for a local variable by allowing the result of a function to have a name in its own right. In SR one can write the following.⁵

EXAMPLE 8.30

Explicitly named return values in SR

```

procedure A_max(ref A[1:]: int) returns rtn : int
  rtn := low(int)
  fa i := 1 to ub(A) ->
    if A[i] > rtn -> rtn := A[i] fi
  af
end

```

Here `rtn` can reside throughout its lifetime in the return location allocated by the caller. A similar facility can be found in Eiffel, in which every function contains an implicitly declared object named `Result`. This object can be both read and written, and is returned to the caller when the function returns. ■

Many languages place restrictions on the types of objects that can be returned from a function. In Algol 60 and Fortran 77, a function must return a scalar value. In Pascal and early versions of Modula-2, it must return a scalar or a pointer. Most imperative languages are more flexible: Algol 68, Ada, C, Fortran 90, and many (nonstandard) implementations of Pascal allow functions to return values of composite type. ML, its descendants, and several scripting languages allow a function to return a *tuple* of values. In Python, for example, we might write

EXAMPLE 8.31

Multivalued returns

```

def foo():
  return 2, 3
...
i, j = foo()

```

⁵ The `fa` in SR stands for “for all”; `ub` stands for “upper bound.” The `->` symbol is roughly equivalent to `do` and `then` in other languages. All structured statements in SR are terminated by spelling the opening keyword backwards. Semicolons between statements may be omitted if they occur at end-of-line.

Modula-3 and Ada 95 allow a function to return a subroutine, implemented as a closure. C has no closures, but allows a function to return a pointer to a subroutine. In functional languages such as Lisp and ML, returning a closure is commonplace.

✓ CHECK YOUR UNDERSTANDING

13. What is the difference between *formal* and *actual* parameters?
 14. Describe four common parameter-passing modes. How does a programmer choose which one to use when?
 15. Explain the rationale for READONLY parameters in Modula-3.
 16. What parameter mode is typically used in languages with a reference model of variables?
 17. Describe the parameter modes of Ada. How do they differ from the modes of other modern languages?
 18. What does it mean for an Ada program to be *erroneous*?
 19. Give an example in which it is useful to return a reference from a function in C++.
 20. List three reasons why a language implementation might implement a parameter as a closure.
 21. What is a *conformant (open) array*?
 22. What are *default* parameters? How are they implemented?
 23. What are *named (keyword) parameters*? Why are they useful?
 24. Explain the value of variable-length argument lists. What distinguishes such lists in Java and C# from their counterparts in C and C++?
 25. Describe three common mechanisms for specifying the return value of a function. What are their relative strengths and drawbacks?
-

8.4 Generic Subroutines and Modules

Subroutines provide a natural way to perform an operation for a variety of different object (parameter) values. In large programs, the need also often arises to perform an operation for a variety of different object *types*. An operating system, for example, tends to make heavy use of queues, to hold processes, memory descriptors, file buffers, device control blocks, and a host of other objects. The characteristics of the queue data structure are independent of the

characteristics of the items placed in the queue. Unfortunately, the standard mechanisms for declaring enqueue and dequeue subroutines in most languages require that the type of the items be declared, statically. In a language like Pascal or Fortran, this static declaration of item type means that the programmer must create separate copies of enqueue and dequeue for every type of item, even though the entire text of these copies (other than the type names in the procedure headers) is the same. In some languages (C is an obvious example) it is possible to define a queue of pointers to arbitrary objects, but use of such a queue requires type casts that abandon compile-time checking (Exercise 8.17).

Implicit parametric polymorphism, as suggested in Section 3.5.3, provides a way around the problem, allowing us to declare subroutines whose parameter types are incompletely specified, but still type-safe. This approach has its drawbacks, however. As realized in Lisp (Section 10.3) or the various scripting languages, it delays type checking until run time. As realized in ML (Section ©7.2.4), it makes the compiler substantially slower and more complicated, and it forces the adoption of a structural view of type equivalence (Section 7.2.1). An alternative, also mentioned in Section 3.5.3, is to provide an explicitly polymorphic *generic* facility that allows a collection of similar subroutines or modules—with different types in each—to be created from a single copy of the source code. Languages that provide generics include Ada, C++ (which calls them *templates*), Clu, Eiffel, Modula-3, Java, and C#.

Generic modules or classes are particularly valuable for creating *containers*—data abstractions that hold a collection of objects, but whose operations are generally oblivious to the type of those objects. Examples of containers include stack, queue, heap, set, and dictionary (mapping) abstractions, implemented as lists, arrays, trees, or hash tables. Ada and C++ examples of a generic queue appear in Figure 8.4. ■

Generic subroutines (methods) are needed in generic modules (classes), and may also be useful in their own right. A generic “minimum” function in Ada appears in Figure 3.13 (page 150). A sorting routine would have a similar flavor: it needs to be able to tell when objects are smaller or larger than each other, but does not need to know anything else about them. ■

Exactly what can be passed as a generic parameter varies from language to language. Java and C# pass only types. Ada and C++ are a bit more general. In particular, both allow values of ordinary (nongeneric) types, including subroutines and classes. We can see examples in Figure 8.4, where an integer parameter specifies the maximum length of the queue. In Ada, which supports dynamic arrays (Section 7.4.2), the value of `max_items` need not be known until run time; in C++ it must be a compile-time constant. Often, as in the case of a sorting routine, the generic code needs to be able to count on certain minimal properties of the type parameters. Appropriate *constraints* may be specified explicitly (as in Ada) or inferred by the compiler (as in C++). We will discuss constraints in more detail in Section 8.4.2. ■

EXAMPLE 8.32

Generic queues in Ada and C++

EXAMPLE 8.33

Generic `min` function in Ada (reprise)

EXAMPLE 8.34

Generic parameters

```

generic
  type item is private;
  -- can be assigned; other characteristics are hidden
  max_items : in integer := 100;      -- 100 items max by default
package queue is
  procedure enqueue(it : in item);
  function dequeue return item;
private
  subtype index is integer range 1..max_items;
  items : array(index) of item;
  next_free, next_full : index := 1;
end queue;

package body queue is
  procedure enqueue(it : in item) is
  begin
    items(next_free) := it;
    next_free := next_free mod max_items + 1;
  end enqueue;
  function dequeue return item is
  rtn : item := items(next_full);
  begin
    next_full := next_full mod max_items + 1;
    return rtn;
  end dequeue;
end queue;
...
package ready_list is new queue(process);
  -- assume type process has previously been declared
package int_queue is new queue(integer, 50);
  -- only 50 items long, instead of the default 100

```

Figure 8.4 Generic array-based queues in Ada (above) and C++ (next). C++ calls its generics *templates*. Checks for overflow and underflow have been omitted for brevity of presentation. (continued)

8.4.1 Implementation Options

Generics can be implemented several ways. In most implementations of Ada and C++ they are a purely static mechanism: all the work required to create and use multiple instances of the generic code takes place at compile time. In the usual case, the compiler creates a *separate copy* of the code for every instance. (C++ goes farther, and arranges to type-check each of these instances independently.) If several queues are instantiated with the same set of arguments, then the compiler may share the code of the enqueue and dequeue routines among them. A clever compiler may arrange to share the code for a queue of integers with the code for a queue of single-precision floating-point numbers, if the two types have the same

```

template<class item, int max_items = 100>
class queue {
    item items[max_items];
    int next_free;
    int next_full;
public:
    queue() {
        next_free = next_full = 0;        // initialization
    }
    void enqueue(item it) {
        items[next_free] = it;
        next_free = (next_free + 1) % max_items;
    }
    item dequeue() {
        item rtn = items[next_full];
        next_full = (next_full + 1) % max_items;
        return rtn;
    }
};
...
queue<process> ready_list;
queue<int, 50> int_queue;

```

Figure 8.4 (continued)

size, but this sort of optimization is not required, and the programmer should not be surprised if it doesn't occur.

Java 5, by contrast, guarantees that *all* instances of a given generic will share the same code at run time. In effect, if *T* is a generic type parameter in Java, then objects of class *T* are treated as instances of the standard base class `Object`, except that the programmer does not have to insert explicit casts to use them as objects of class *T*, and the compiler guarantees, statically, that the elided casts will never fail. C# plots an intermediate course. Like C++, it will create specialized implementations of a generic for different built-in or value types. Like Java, however, it requires that the generic code itself be demonstrably type-safe, independent of the arguments provided in any particular instantiation. We will examine the tradeoffs among C++, Java, and C# generics in more detail in Section ©8.4.4.

As we noted in Section 3.5.3, statically implemented generics have much in common with macros. The designers of Ada describe generics as “a restricted form of context-sensitive macro facility” [IBFW91, p. 236]. The designer of C++ describes templates as “a clever kind of macro that obeys the scope, naming, and type rules of C++” [Str97, 2nd ed., p. 257]. The difference between macros and generics is much like the difference between macros and in-line subroutines (Sections 3.7 and 8.2.4): generics are integrated into the rest of the language, and are understood by the compiler, rather than being tacked on as an afterthought, to be expanded by a preprocessor. Generic parameters are type checked. Arguments

to generic subroutines are evaluated exactly once. Names declared inside generic code obey the normal scoping rules. In Ada, which allows nested subroutines and modules, names passed as generic arguments are resolved in the referencing environment in which the instance of the generic was created, but all other names in the generic are resolved in the environment in which the generic itself was declared.

8.4.2 Generic Parameter Constraints

Because a generic is an abstraction, it is important that its interface (the header of its declaration) provide all the information that must be known by a user of the abstraction. Several languages, including Clu, Ada, Java, and C#, attempt to enforce this rule by *constraining* generic parameters. Specifically, they require that the operations permitted on a generic parameter type be explicitly declared. In the Ada portion of [Figure 8.4](#), the generic clause said

EXAMPLE 8.35

Simple constraints in Ada

```
type item is private;
```

A `private` type in Ada is one for which the only permissible operations are assignment, testing for equality and inequality, and accessing a few standard attributes (e.g., `size`). To prohibit testing for equality and inequality, the programmer can declare the parameter to be `limited private`. To allow additional operations, the programmer must provide additional information. In simple cases, it may be possible to specify a *type pattern* such as

```
type item is (>);
```

Here the parentheses indicate that `item` is a discrete type, and will thus support such operations as comparison for ordering (`<`, `>`, etc.) and the attributes `first` and `last`. (As always in Ada, the “box” symbol, `<>`, is a placeholder for missing information: enumeration values, subrange bounds, etc.) ■

EXAMPLE 8.36

With constraints in Ada

In more complex cases, the Ada programmer can specify the operations of a generic type parameter by means of a trailing `with` clause. We saw a simple example in the “minimum” function of [Figure 3.13](#) (page 150). The declaration of a generic sorting routine in Ada might be similar:

```
generic
  type T is private;
  type T_array is array (integer range <>) of T;
  with function "<"(a1, a2 : T) return boolean;
  procedure sort(A : in out T_array);
```

Without the `with` clause, procedure `sort` would be unable to compare elements of `A` for ordering, because type `T` is `private`. ■

Java and C# employ a particularly clean approach to constraints that exploits the ability of object-oriented types to *inherit* methods from a parent type or

EXAMPLE 8.37

Generic sorting routine
in Java

interface. We defer a full discussion of inheritance to [Chapter 9](#). For now, we note that it allows the Java or C# programmer to require that a generic parameter support a particular set of methods. In Java, for example, we might declare and use our sorting routine as follows:

```
public static <T extends Comparable<T>> void sort(T A[]) {
    ...
    if (A[i].compareTo(A[j]) >= 0) ...
    ...
}
...
Integer[] myArray = new Integer[50];
...
sort(myArray);
```

Where C++ requires a `template<type_args>` prefix before a generic method, Java puts the type parameters immediately in front of the method's return type. The `extends` clause constitutes a generic constraint: `Comparable` is an interface (a set of required methods) from the Java standard library that includes the method `compareTo`. This method returns `-1`, `0`, or `1`, respectively, depending on whether the current object is less than, equal to, or greater than the object passed as a parameter. The compiler checks to make sure that the objects in any array passed to `sort` are of a type that implements `Comparable`, and are therefore guaranteed to provide `compareTo`. If `T` had needed additional interfaces (that is, if we had wanted more constraints), they could have been specified with a comma-separated list: `<T extends I1, I2, I3>`. ■

EXAMPLE 8.38

Generic sorting routine
in C#

C# syntax is similar:

```
static void sort<T>(T[] A) where T : IComparable {
    ...
    if (A[i].CompareTo(A[j]) >= 0) ...
    ...
}
...
int[] myArray = new int[50];
sort(myArray);
```

C# puts the type parameters after the name of the subroutine, and the constraints (the `where` clause) after the regular parameter list. The compiler is smart enough to recognize that `int` is a built-in type, and generates a customized implementation of `sort`, eliminating the need for Java's `Integer` wrapper class, and producing faster code. ■

EXAMPLE 8.39

Generic sorting routine in
C++

A few languages (notably C++ and Modula-3) forgo explicit constraints, but still check how parameters are used. The header of a generic sorting routine in C++ can be extremely simple:

```
template<class T>
void sort(T A[], int A_size) { ...
```

No mention is made of the need for a comparison operator. The body of a generic can (attempt to) perform arbitrary operations on objects of a generic parameter type, but if the generic is instantiated with a type that does not support that operation, the compiler will announce a static semantic error. Unfortunately, because the header of the generic does not necessarily specify which operations will be required, it can be difficult for the programmer to predict whether a particular instantiation will cause an error message. Worse, in some cases the type provided in a particular instantiation may support an operation required by the generic's code, but that operation may not do "the right thing." Suppose in our C++ sorting example that the code for `sort` makes use of the `<` operator. For `ints` and `doubles`, this operator will do what one would expect. For character strings, however, it will compare pointers, to see which referenced character has a lower address. If the programmer is expecting comparison for lexicographic ordering, the results may be surprising!

To avoid surprises, it is best to avoid implicit use of the operations of a generic parameter type. There are several ways to make things more explicit in C++: the comparison routine can be provided as a method of class `T`, an extra argument to the `sort` routine, or an extra generic parameter. To facilitate the first of these options, the programmer may choose to emulate Java or C#, encapsulating the required methods in an abstract base class from which the type `T` may inherit. ■

8.4.3 Implicit Instantiation

EXAMPLE 8.40

Generic class instance in C++

Because a class is a type, one must generally create an instance of a generic class (i.e., an object) before the generic can be used. The declaration provides a natural place to provide generic arguments:

```
queue<int, 50> *my_queue = new queue<int, 50>(); // C++ ■
```

EXAMPLE 8.41

Generic subroutine instance in Ada

Some languages (Ada among them) also require generic subroutines to be instantiated explicitly before they can be used:

```
procedure int_sort is new sort(integer, int_array, "<");
...
int_sort(my_array); ■
```

EXAMPLE 8.42

Implicit instantiation in C++

Other languages (C++, Java, and C# among them) do not require this. Instead they treat generic subroutines as a form of overloading. Given the C++ sorting routine of [Example 8.39](#) and the following objects:

```
int ints[10];
double reals[50];
string strings[30]; // library class string has lexicographic operator<
```

	Explicit (generics)				Implicit	
	Ada	C++	Java	C#	Lisp	ML
Applicable to	subroutines, modules	subroutines, classes	subroutines, classes	subroutines, classes	functions	functions
Abstract over	types; subroutines; values of arbitrary types	types; enum, int, and pointer constants	types only	types only	types only	types only
Constraints	explicit (varied)	implicit	explicit (inheritance)	explicit (inheritance)	implicit	implicit
Checked at	compile time (definition)	compile time (instantiation)	compile time (definition)	compile time (definition)	run time	compile time (inferred)
Natural implementation	multiple copies	multiple copies	single copy (erasure)	multiple copies (reification)	single copy	single copy
Subroutine instantiation	explicit	implicit	—	implicit	—	—

Figure 8.5 Mechanisms for parametric polymorphism in Ada, C++, Java, C#, Lisp, and ML. Erasure and reification are discussed in Section 8.4.4.

we can perform the following calls without instantiating anything explicitly:

```
sort(ints, 10);
sort(reals, 50);
sort(strings, 30);
```

In each case, the compiler will implicitly instantiate an appropriate version of the `sort` routine. Java and C# have similar conventions. To keep the language manageable, the rules for implicit instantiation in C++ are more restrictive than the rules for resolving overloaded subroutines in general. In particular, the compiler will not coerce a subroutine argument to match a type expression containing a generic parameter (Exercise 8.44). ■

Figure 8.5 summarizes the features of Ada, C++, Java, and C# generics, and of the implicit parametric polymorphism of Lisp and ML. Further explanation of some of the details appears in Section 8.4.4.

8.4.4 Generics in C++, Java, and C#

Several of the key tradeoffs in the design of generics can be illustrated by comparing the features of C++, Java, and C#. C++ is by far the most ambitious of the three. Its templates are intended for almost any programming task that requires substantially similar but not identical copies of an abstraction. Java 5 and C# 2.0 provide generics purely for the sake of polymorphism. Java's design was heavily

influenced by the desire for backward compatibility, not only with existing versions of the language, but with existing virtual machines and libraries. The C# designers, though building on an existing language, did not feel as constrained. They had been planning for generics from the outset, and were able to engineer substantial new support into the .NET virtual machine.

© IN MORE DEPTH

On the PLP CD we discuss C++, Java, and C# generics in more detail, and consider the impact of their differing designs on the quality of error messages, the speed and size of generated code, and the expressive power of the notation. We note in particular the very different mechanisms used to make generic classes and methods support as broad a class of generic arguments as possible.

✓ CHECK YOUR UNDERSTANDING

26. What is the principal purpose of generics? In what sense do generics serve a broader purpose in C++ and Ada than they do in Java and C#?
27. How does a generic subroutine differ from a macro?
28. Under what circumstances can a language implementation share code among separate instances of a generic?
29. Summarize the relative strengths and weaknesses of generic container classes and classes containing instances of a universal reference type, as defined in [Section 7.2.2](#) (page 313).
30. What does it mean for a generic parameter to be *constrained*? Explain the difference between explicit and implicit constraints.
31. Why will C# accept `int` as a generic argument, but Java won't?
32. Under what circumstances will C++ instantiate a generic function implicitly?

8.5 Exception Handling

Several times in the preceding chapters and sections we have referred to *exception-handling* mechanisms. We have delayed detailed discussion of these mechanisms until now because exception handling generally requires the language implementation to “unwind” the subroutine call stack.

An exception can be defined as an unexpected—or at least unusual—condition that arises during program execution, and that cannot easily be handled in the local context. It may be detected automatically by the language implementation, or the program may *raise* it explicitly. The most common exceptions are various

sorts of run-time errors. In an I/O library, for example, an input routine may encounter the end of its file before it can read a requested value, or it may find punctuation marks or letters on the input when it is expecting digits. To cope with such errors without an exception-handling mechanism, the programmer has basically three options, none of which is entirely satisfactory:

1. “Invent” a value that can be used by the caller when a real value could not be returned.
2. Return an explicit “status” value to the caller, who must inspect it after every call. The status may be written into an extra, explicit parameter, stored in a global variable, or encoded as otherwise invalid bit patterns of a function’s regular return value.
3. Rely on the caller to pass a closure (in languages that support them) for an error-handling routine that the normal routine can call when it runs into trouble.

The first of these options is fine in certain cases, but does not work in the general case. Options 2 and 3 tend to clutter up the program, and impose overhead that we should like to avoid in the common case. The tests in option 2 are particularly offensive: they obscure the normal flow of events in the common case. Because they are so tedious and repetitive, they are also a common source of errors; one can easily forget a needed test. Exception-handling mechanisms address these issues by moving error-checking code “out of line,” allowing the normal case to be specified simply, and arranging for control to branch to a *handler* when appropriate.

EXAMPLE 8.43

ON conditions in PL/I

Exception handling was pioneered by PL/I, which includes an executable statement of the form

```
ON condition  
  statement
```

The nested statement (often a GOTO or a BEGIN . . . END block) is a handler. It is not executed when the ON statement is encountered, but is “remembered” for future reference. It will be executed later if exception *condition* (e.g., OVERFLOW) arises. Because the ON statement is executable, the binding of handlers to exceptions depends on the flow of control at run time. ■

If a PL/I exception handler is invoked and then “returns” (i.e., does not perform a GOTO to somewhere else in the program), then one of two things will happen. For exceptions that the language designers considered to be fatal, the program itself will terminate. For “recoverable” exceptions, execution will resume at the statement following the one in which the exception occurred. Experience with PL/I indicates that both the dynamic binding of handlers to exceptions and the automatic resumption of code in which an exception occurred are confusing and error-prone.

Many more recent languages, including Clu, Ada, Modula-3, Python, PHP, Ruby, C++, Java, C#, and ML, all provide exception-handling facilities in which

handlers are lexically bound to blocks of code, and in which the execution of the handler *replaces* the yet-to-be-completed portion of the block. In C++ we might write

EXAMPLE 8.44

A simple try block in C++

```
try {
    ...
    if (something_unexpected)
        throw my_exception();
    ...
    cout << "everything's ok\n";
    ...
} catch (my_exception) {
    cout << "oops\n";
}
```

If `something_unexpected` occurs, this code will *throw* an exception, and the catch block will execute in place of the remainder of the try block. ■

EXAMPLE 8.45

Propagation of an exception out of a called routine

As a general rule, if an exception is not handled within the current subroutine, then the subroutine returns abruptly and the exception is raised at the point of call:

```
try {
    ...
    foo();
    ...
    cout << "everything's ok\n";
    ...
} catch (my_exception) {
    cout << "oops\n";
}

void foo() {
    ...
    if (something_unexpected)
        throw my_exception();
    ...
}
```

If the exception is not handled in the calling routine, it continues to propagate back up the dynamic chain. If it is not handled in the program's main routine, then a predefined outermost handler is invoked, and usually terminates the program. ■

In a sense, the dependence of exception handling on the order of subroutine calls might be considered a form of dynamic binding, but it is a much more restricted form than is found in PL/I. Rather than say that a handler in a calling routine has been dynamically bound to an error in a called routine, we prefer to say that the handler is lexically bound to the expression or statement that *calls* the called routine. An exception that is not handled inside a called routine can then be modeled as an “exceptional return”; it causes the calling expression or statement to raise an exception, which is again handled lexically within its subroutine.

In practice, exception handlers tend to perform three kinds of operations. First, ideally, a handler will *compensate* for the exception in a way that allows the program to recover and continue execution. For example, in response to an “out of memory” exception in a storage management routine, a handler might request

the operating system to allocate additional space to the application, after which it could complete the requested operation. Second, when an exception occurs in a given block of code but cannot be handled locally, it is often important to declare a local handler that cleans up any resources allocated in the local block, and then “reraises” the exception, so that it will continue to propagate back to a handler that can (hopefully) recover. Third, if recovery is not possible, a handler can at least print a helpful error message before the program terminates.

As discussed in [Section 6.2.1](#), exceptions are related to, but distinct from, the notion of multilevel returns. A routine that performs a multilevel return is functioning as expected; in Eiffel terminology, it is fulfilling its contract. A routine that raises an exception is *not* functioning as expected; it cannot fulfill its contract. Common Lisp and Ruby distinguish between these two related concepts, but most languages do not; in most, a multilevel return requires the outer caller to provide a trivial handler.

Common Lisp is also unusual in providing four different versions of its exception-handling mechanism. Two of these provide the usual “exceptional return” semantics; the others are designed to repair the problem and restart evaluation of some dynamically enclosing expression. Orthogonally, two perform their work in the referencing environment where the handler is declared; the others perform their work in the environment where the exception first arises. The latter option allows an abstraction to provide several alternative strategies for recovery from exceptions. The user of the abstraction can then specify, dynamically, which of these strategies should be used in a given context. We will consider Common Lisp further in [Exercise 8.31](#) and [Exploration 8.55](#). The “exceptional return” mechanism, with work performed in the environment of the handler, is known as `handler-case`; it provides semantics comparable to those of most other modern languages.

8.5.1 Defining Exceptions

In many languages, dynamic semantic errors automatically result in exceptions, which the program can then catch. The programmer can also define additional, application-specific exceptions. Examples of predefined exceptions include arithmetic overflow, division by zero, end-of-file on input, subscript and subrange errors, and null pointer dereference. The rationale for defining these as exceptions (rather than as fatal errors) is that they may arise in certain valid programs. Some other dynamic errors (e.g., return from a subroutine that has not yet designated a return value) are still fatal in most languages. In C++ and Common Lisp, exceptions are all programmer defined. In PHP, the `set_error_handler` function can be used to turn built-in semantic errors into ordinary exceptions. In Ada, some of the predefined exceptions can be *suppressed* by means of a pragma.

In Ada, `exception` is a built-in type; an exception is simply an object of this type:

```
declare empty_queue : exception;
```

EXAMPLE 8.46

What is an exception?

In Modula-3, exceptions are another “kind” of object, akin to constants, types, variables, or subroutines:

```
EXCEPTION empty_queue;
```

In most object-oriented languages, an exception is an instance of some predefined or user-defined class type:

```
class empty_queue {};
```

In ML, `exception` is a constructor, akin to datatype (as described in Section ©7.2.4). ■

EXAMPLE 8.47

Parameterized exceptions

Most languages allow an exception to be “parameterized,” so the code that raises the exception can pass information to the code that handles it. In object-oriented languages, the “parameters” are simply the fields of the class:

```
class duplicate_in_set {                // C++
    item dup;                          // element that was inserted twice
};
...
throw duplicate_in_set(d);
```

In Clu and Modula-3, the parameters are included in the exception declaration, much as they are in a subroutine header (the Modula-3 `empty_queue` in [Example 8.46](#) has no parameters). Ada is unusual in that its exceptions are simply tags: they contain no information other than their name. ■

Most languages use a `throw` or `raise` statement, embedded in an `if` statement, to raise an exception at run time. PL/I and Clu both use `signal` instead, and both provide semantics significantly different from those of other exception-handling languages. As noted earlier, PL/I handlers are dynamically bound; exceptions do not propagate back down the dynamic chain. In Clu, `signal` is always an “exceptional return”: it cannot be handled locally, but rather causes an immediate return from the current subroutine, forcing the caller to recover.

If a subroutine raises an exception but does not catch it internally, it may “return” in an unexpected way. This possibility is an important part of the routine’s interface to the rest of the program. Consequently, several languages, including Clu, Modula-3, C++, and Java, include in each subroutine header a list of the exceptions that may propagate out of the routine. This list is mandatory in Modula-3: it is a run-time error if an exception arises that does not appear in the header, but is not caught internally. The list is optional in C++: if it appears, the semantics are the same as in Modula-3; if it is omitted, all exceptions are permitted to propagate. Java adopts an intermediate approach: it segregates its exceptions into “checked” and “unchecked” categories. Checked exceptions must be declared in subroutine headers; unchecked exceptions need not. Unchecked exceptions are typically run-time errors that most programs will want to be fatal (e.g., subscript out of bounds)—and that would therefore be a nuisance to declare in every function—but that a highly robust program may want to catch if they occur in library routines.

8.5.2 Exception Propagation

EXAMPLE 8.48

Multiple handlers in C++

In most languages, a block of code can have a *list* of exception handlers. In C++:

```
try {
    // try to read from file
    ...
    // potentially complicated sequence of operations
    // involving many calls to stream I/O routines
    ...
} catch(end_of_file) {
    ...
} catch(io_error e) {
    // handler for any io_error other than end_of_file
    ...
} catch(...) {
    // handler for any exception not previously named
    // (in this case, the triple-dot ellipsis is a valid C++ token;
    // it does not indicate missing code)
}
}
```

When an exception arises, the handlers are examined in order; control is transferred to the first one that *matches* the exception. In C++, a handler matches if it names a class from which the exception is derived, or if it is a catch-all (...). In the example here, let us assume that `end_of_file` is a subclass of `io_error`. Then an `end_of_file` exception, if it arises, will be handled by the first of the three catch clauses. All other I/O errors will be caught by the second; all non-I/O errors will be caught by the third. If the last clause were missing, non-I/O errors would continue to propagate up the dynamic chain. ■

An exception that is declared in a recursive subroutine will be caught by the innermost handler for that exception at run time. If an exception propagates out of the scope in which it was declared, it can no longer be named by a handler, and thus can be caught only by a “catch-all” handler. In a language with concurrency, one must consider what will happen if an exception is not handled at the outermost level of a concurrent thread of control. In Modula-3, the entire program terminates abnormally; in Ada and Java, the affected thread terminates quietly; in C# the behavior is implementation defined.

Handlers on Expressions

In an expression-oriented language such as ML or Common Lisp, an exception handler is attached to an expression, rather than to a statement. Since execution of the handler replaces the unfinished portion of the protected code when an exception occurs, a handler attached to an expression must provide a value for the expression. (In a statement-oriented language, the handler—like most statements—is executed for its side effects.) In ML, a handler looks like this:

EXAMPLE 8.49

Exception handler in ML

```
val foo = (f(a) * b) handle Overflow => max_int;
```

Here $(f(a) * b)$ is the protected expression, `handle` is a keyword, `Overflow` is a predefined exception (a value built from the `exc` constructor), and `max_int` is an expression (in this case a constant) whose value replaces the value of the expression in which the `Overflow` exception arose. Both the protected expression and the handler could in general be arbitrarily complicated, with many nested function calls. Exceptions that arise within a nested call (and are not handled locally) propagate back down the dynamic chain, just as they do in Ada or C++.

Cleanup Operations

In the process of searching for a matching handler, the exception-handling mechanism must “unwind” the run-time stack by reclaiming the stack frames of any subroutines from which the exception escapes. Reclaiming a frame requires not only that its space be popped from the stack, but also that any registers that were saved as part of the calling sequence be restored. (We discuss implementation issues in more detail in [Section 8.5.3](#).)

In C++, an exception that leaves a scope, whether a subroutine or just a nested block, requires the language implementation to call *destructor* functions for any objects declared within that scope. Destructors (to be discussed in more detail in [Section 9.3](#)) are often used to deallocate heap space and other resources (e.g., open files). Similar functionality is provided in Common Lisp by an `unwind-protect` expression, and in Modula-3, Python, Java, and C# by means of `try...finally` constructs. Code in Modula-3 might look like this:

EXAMPLE 8.50

Finally clause in
Modula-3

```

TRY
    myStream := OpenRead(myFileName);      (* protected block *)
    Parse(myStream);
    FINALLY                                (* cleanup code *)
        Close(myStream);
    END;
```

A `FINALLY` clause will be executed whenever control escapes from the protected block, whether the escape is due to normal completion, an exit from a loop, a return from the current subroutine, or the propagation of an exception. In fact, `EXITs` and `RETURNs` in Modula-3 are modeled as exceptions. We have assumed in our example that `myStream` is not bound to anything at the beginning of the code, and that it is harmless to `Close` a not-yet-opened stream.

DESIGN & IMPLEMENTATION

Structured exceptions

Exception-handling mechanisms are among the most complex aspects of modern language design, from both a semantic and a pragmatic point of view. Programmers have used subroutines since before there were computers (they appear, among other places, in the 19th-century notes of Countess Ada Augusta Byron). Structured exceptions, by contrast, were not invented until the 1970s, and did not become commonplace until the 1980s.

8.5.3 Implementation of Exceptions

EXAMPLE 8.51

Stacked exception handlers

The most obvious implementation for exceptions maintains a linked-list stack of handlers. When control enters a protected block, the handler for that block is added to the head of the list. When an exception arises, either implicitly or as a result of a `raise` statement, the language run-time system pops the innermost handler off the list and calls it. The handler begins by checking to see if it matches the exception that occurred; if not, it simply reraises it:

```

if exception matches duplicate_in_set
    ...
else
    reraise exception

```

To implement propagation back down the dynamic chain, each subroutine has an implicit handler that performs the work of the subroutine epilogue code and then reraises the exception. ■

EXAMPLE 8.52

Multiple exceptions per handler

If a protected block of code has handlers for several different exceptions, they are implemented as a single handler containing a multiarm `if` statement:

```

if exception matches end_of_file
    ...
elsif exception matches io_error
    ...
else
    ... -- "catch-all" handler

```

The problem with this implementation is that it incurs run-time overhead in the common case. Every protected block and every subroutine begins with code to push a handler onto the handler list, and ends with code to pop it back off the list. We can usually do better.

The only real purpose of the handler list is to determine which handler is active. Since blocks of source code tend to translate into contiguous blocks of machine language instructions, we can capture the correspondence between handlers and protected blocks in the form of a table generated at compile time. Each entry in the table contains two fields: the starting address of a block of code and the address of the corresponding handler. The table is sorted on the first field. When an exception occurs, the language run-time system performs binary search in the table, using the program counter as key, to find the handler for the current block. If that handler reraises the exception, the process repeats: handlers themselves are blocks of code, and can be found in the table. The only subtlety arises in the case of the implicit handlers associated with propagation out of subroutines: such a handler must ensure that the `raise` code uses the return address of the subroutine, rather than the current program counter, as the key for table lookup.

The cost of raising an exception is higher in this second implementation, by a factor logarithmic in the total number of handlers. But this cost is paid only when

an exception actually occurs. Assuming that exceptions are unusual events, the net impact on performance is clearly beneficial: the cost in the common case is zero. In its pure form the table-based approach requires that the compiler have access to the entire program, or that the linker provide a mechanism to glue subtables together. If code fragments are compiled independently, we can employ a hybrid approach in which the compiler creates a separate table for each subroutine, and each stack frame contains a pointer to the appropriate table.

Exception Handling without Exceptions

It is worth noting that exceptions can sometimes be simulated in a language that does not provide them as a built-in. In [Section 6.2](#) we noted that Pascal permits `gotos` to labels outside the current subroutine, that Algol 60 allows labels to be passed as parameters, and that PL/I allows them to be stored in variables. These mechanisms permit the program to escape from a deeply nested context, but in a very unstructured way.

A much more attractive alternative appears in Scheme, which provides a general-purpose function called `call-with-current-continuation`, sometimes abbreviated `call/cc`. This function takes a single argument f , which is itself a function. It calls f , passing as argument a continuation c (a closure) that captures the current program counter and referencing environment. At any point in the future, f can call c to reestablish the saved environment. If nested calls have been made, control abandons them, as it does with exceptions. More generally, however, c can be saved in variables, returned explicitly by subroutines, or called repeatedly, even after control has returned from f (recall that closures in Scheme have unlimited extent; see [Section 3.6](#)). `Call/cc` suffices to build a wide variety of control abstractions, including iterators and coroutines. It even subsumes the notion of returning from a subroutine, though it seldom replaces it in practice.

EXAMPLE 8.53

`Setjmp` and `longjmp` in C

Intermediate between the anarchy of nonlocal `gotos` and the generality of `call/cc`, most versions of C (including the ISO standard) provide a pair of library routines entitled `setjmp` and `longjmp`. `Setjmp` takes as argument a buffer into which to capture a representation of the program's current state. This buffer can later be passed to `longjmp` to restore the captured state. `Setjmp` has an integer return type: zero indicates "normal" return; nonzero indicates "return" from a `longjmp`. The usual programming idiom looks like this:

```
if (!setjmp(buffer)) {
    /* protected code */
} else {
    /* handler */
}
```

When initially called, `setjmp` returns a 0, and control enters the protected code. If `longjmp(buffer, v)` is called anywhere within the protected code, or in subroutines called by that code, then `setjmp` will appear to return again, this time with a return value of v , causing control to enter the handler. Unlike the closure created

by `call/cc`, the information captured by `setjmp` has limited extent; once the protected code completes, the behavior of `longjmp(buffer)` is undefined. ■

`setjmp` and `longjmp` are usually implemented by saving the current machine registers in the `setjmp` buffer, and by restoring them in `longjmp`. There is no list of handlers; rather than “unwinding” the stack, the implementation simply tosses all the nested frames by restoring old values of the `sp` and `fp`. The problem with this approach is that the register contents at the beginning of the handler do not reflect the effects of the successfully completed portion of the protected code: they were saved before that code began to run. Any changes to variables that have been written through to memory will be visible in the handler, but changes that were cached in registers will be lost. To address this limitation, C allows the programmer to specify that certain variables are `volatile`. A volatile variable is one whose value in memory can change “spontaneously,” for example as the result of activity by an I/O device or a concurrent thread of control. C implementations are required to store volatile variables to memory whenever they are written, and to load them from memory whenever they are read. If a handler needs to see changes to a variable that may be modified by the protected code, then the programmer must include the `volatile` keyword in the variable’s declaration.

✓ CHECK YOUR UNDERSTANDING

33. Describe the algorithm used to identify an appropriate handler when an exception is raised in a language like Ada or C++.
34. Explain why it is useful to define exceptions as classes in C++, Java, and C#.
35. Explain how to implement exceptions in a way that incurs no cost in the common case (when exceptions don’t arise).
36. How do the exception handlers of a functional language like ML differ from those of an imperative language like C++?
37. Describe the operations that must be performed by the implicit handler for a subroutine.
38. Describe the `call-with-current-continuation` function of Scheme.

DESIGN & IMPLEMENTATION

`setjmp`

Because it saves multiple registers to memory, the usual implementation of `setjmp` is quite expensive—more so than entry to a protected block in the “obvious” implementation of exceptions described above. While implementors are free to use a more efficient, table-driven approach if desired, the usual implementation minimizes the complexity of the run-time system and eliminates the need for linker-supported integration of tables from separately compiled modules and libraries.

39. Summarize the shortcomings of the `setjmp` and `longjmp` library routines of C.
40. What is a `volatile` variable in C? Under what circumstances is it useful?

8.6 Coroutines

Given an understanding of the layout of the run-time stack, we can now consider the implementation of more general control abstractions—*coroutines* in particular. Like a continuation, a coroutine is represented by a closure (a code address and a referencing environment), into which we can jump by means of a nonlocal `goto`, in this case a special operation known as *transfer*. The principal difference between the two abstractions is that a continuation is a constant—it does not change once created—while a coroutine changes every time it runs. When we `goto` a continuation, our old program counter is lost, unless we explicitly create a new continuation to hold it. When we transfer from one coroutine to another, our old program counter is saved: the coroutine we are leaving is updated to reflect it. Thus, if we perform a `goto` into the same continuation multiple times, each jump will start at precisely the same location, but if we perform a *transfer* into the same coroutine multiple times, each jump will take up where the previous one left off.

In effect, coroutines are execution contexts that exist concurrently, but that execute one at a time, and that transfer control to each other explicitly, by name. Coroutines can be used to implement iterators (Section 6.5.3) and threads (to be discussed in Chapter 12). They are also useful in their own right, particularly for certain kinds of servers, and for discrete event simulation. Threads appear in a variety of languages, including Algol 68, Modula (1), Modula-3, Ada, SR, Occam, Java, and C#. They are also commonly provided (though with somewhat less attractive syntax and semantics) outside the language proper by means of library packages. Coroutines are less common as a user-level programming abstraction. Languages that provide them include Simula and Modula-2. We focus in the following subsections on the implementation of coroutines and (on the PLP CD) on their use in iterators (Section ©8.6.3) and discrete event simulation (Section ©8.6.4).

EXAMPLE 8.54

Explicit interleaving of concurrent computations

As a simple example of an application in which coroutines might be useful, imagine that we are writing a “screen-saver” program, which paints a mostly black picture on the screen of an inactive workstation, and which keeps the picture moving, to avoid phosphor or liquid-crystal “burn-in.” Imagine also that our screen-server performs “sanity checks” on the file system in the background, looking for corrupted files. We could write our program as follows:

```

loop
    -- update picture on screen
    -- perform next sanity check

```

The problem with this approach is that successive sanity checks (and to a lesser extent successive screen updates) are likely to depend on each other. On most systems, the file-system checking code has a deeply nested control structure containing many loops. To break it into pieces that can be interleaved with the screen updates, the programmer must follow each check with code that saves the state of the nested computation, and must precede the following check with code that restores that state. ■

EXAMPLE 8.55

Interleaving coroutines

A much more attractive approach is to cast the operations as coroutines:⁶

```

us, cfs : coroutine

coroutine check_file_system
  -- initialize
  detach
  for all files
  ...
  transfer(us)
  ...
  transfer(us)
  ...
  transfer(us)
  ...

coroutine update_screen
  -- initialize
  detach
  loop
  ...
  transfer(cfs)
  ...

begin -- main
  us := new update_screen
  cfs := new check_file_system
  transfer(us)

```

The syntax here is based loosely on that of Simula. When first created, a coroutine performs any necessary initialization operations, and then detaches itself from the main program. The detach operation creates a coroutine object to which control can later be transferred, and returns a reference to this coroutine to the caller. The transfer operation saves the current program counter in the current coroutine object and resumes the coroutine specified as a parameter. The main body of the program plays the role of an initial, default coroutine.

DESIGN & IMPLEMENTATION**Threads and coroutines**

As we shall see in [Section 12.2.4](#), it is easy to build a simple thread package given coroutines. Most programmers would agree, however, that threads are substantially easier to use, because they eliminate the need for explicit transfer operations. This contrast—a lot of extra functionality for a little extra implementation complexity—probably explains why coroutines as an explicit programming abstraction are relatively rare.

⁶ Threads could also be used in this example, and might in fact serve our needs a bit better. Coroutines suffice because there is a small number of execution contexts (namely two), and because it is easy to identify points at which one should transfer to the other.

Calls to transfer from within the body of `check_file_system` can occur at arbitrary places, including nested loops and conditionals. A coroutine can also call subroutines, just as the main program can, and calls to transfer may appear inside these routines. The context needed to perform the “next” sanity check is captured by the program counter, together with the local variables of `check_file_system` and any called routines, at the time of the transfer.

As in [Example 8.54](#), the programmer must specify when to stop checking the file system and update the screen; coroutines make the job simpler by providing a transfer operation that eliminates the need to save and restore state explicitly. To decide where to place the calls to transfer, we must consider both performance and correctness. For performance, we must avoid doing too much work between calls, so that screen updates aren’t too infrequent. For correctness, we must avoid doing a transfer in the middle of any check that might be compromised by file access in `update_screen`. Parallel threads (to be described in [Chapter 12](#)) would eliminate the first of these problems by ensuring that the screen updater receives a share of the processor on a regular basis, but would complicate the second problem: we should need to synchronize the two routines explicitly if their references to files could interfere. ■

8.6.1 Stack Allocation

Because they are concurrent (i.e., simultaneously started but not completed), coroutines cannot share a single stack: their subroutine calls and returns, taken as a whole, do not occur in last-in-first-out order. If each coroutine is declared at the outermost level of lexical nesting (as required in Modula-2), then their stacks are entirely disjoint: the only objects they share are global, and thus statically allocated. Most operating systems make it easy to allocate one stack, and to increase its portion of the virtual address space as necessary during execution. It is usually not easy to allocate an arbitrary number of such stacks; space for coroutines is something of an implementation challenge.

The simplest solution is to give each coroutine a fixed amount of statically allocated stack space. This approach is adopted in Modula-2, which requires the programmer to specify the size and location of the stack when initializing a coroutine. It is a run-time error for the coroutine to need additional space. Some Modula-2 implementations catch the overflow and halt with an error message; others display abnormal behavior. If the coroutine uses less space than it is given, the excess is simply wasted.

If stack frames are allocated from the heap, as they are in most Lisp and Scheme implementations, then the problems of overflow and internal fragmentation are avoided. At the same time, the overhead of each subroutine call is significantly increased. An intermediate option is to allocate the stack in large, fixed-size “chunks.” At each call, the subroutine calling sequence checks to see whether there is sufficient space in the current chunk to hold the frame of the called routine. If not, another chunk is allocated and the frame is put there instead. At each

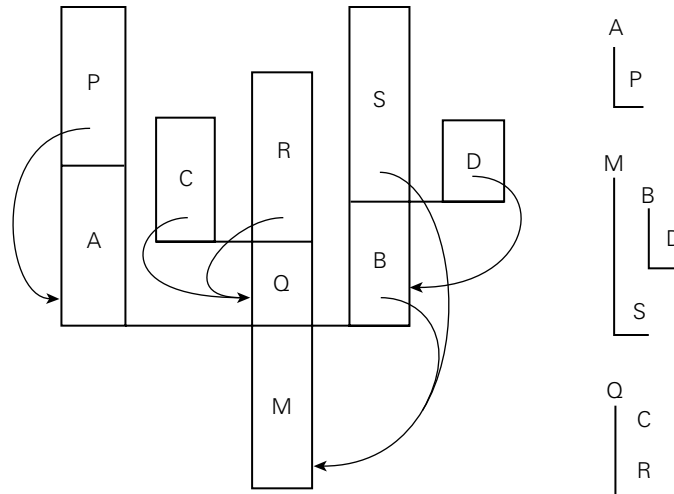

Figure 8.6 A cactus stack. Each branch to the side represents the creation of a coroutine (A, B, C, and D). The static nesting of blocks is shown at right. Static links are shown with arrows. Dynamic links are indicated simply by vertical arrangement: each routine has called the one above it. (Coroutine B, for example, was created by the main program, M. B in turn called subroutine S and created coroutine D.)

subroutine return, the epilogue code checks to see whether the current frame is the last one in its chunk. If so, the chunk is returned to a “free chunk” pool.

In any of these implementations, subroutine calls can use the ordinary central stack if the compiler is able to verify that they will not perform a transfer before returning [Sco91].

EXAMPLE 8.56
Cactus stacks

If coroutines can be created at arbitrary levels of lexical nesting (as they can in Simula), then two or more coroutines may be declared in the same nonglobal scope, and must thus share access to objects in that scope. To implement this sharing, the run-time system must employ a so-called *cactus stack* (named for its resemblance to the Saguaro cacti of the American Southwest; see Figure 8.6).

Each branch off the stack contains the frames of a separate coroutine. The dynamic chain of a given coroutine ends in the block in which the coroutine began execution. The *static* chain of the coroutine, however, extends down into the remainder of the cactus, through any lexically surrounding blocks. In addition

DESIGN & IMPLEMENTATION

Coroutine stacks

Many languages require coroutines or threads to be declared at the outermost level of lexical nesting, to avoid the complexity of noncontiguous stacks. Most thread libraries for sequential languages (the POSIX standard `pthread` library among them) likewise require or at least permit the use of contiguous stacks.

to the coroutines of Simula, cactus stacks are needed for the threads of several parallel languages, including Ada. “Returning” from the main block of a coroutine will generally terminate the program as a whole. Because a coroutine only runs when specified as the target of a transfer, there is never any need to terminate it explicitly. When a given coroutine is no longer needed, the Modula-2 programmer can simply reuse its stack space. In Simula, the space will be reclaimed via garbage collection when it is no longer accessible. ■

8.6.2 Transfer

To transfer from one coroutine to another, the run-time system must change the program counter (PC), the stack, and the contents of the processor’s registers. These changes are encapsulated in the transfer operation: one coroutine calls transfer; a different one returns. Because the change happens inside transfer, changing the PC from one coroutine to another simply amounts to remembering the right return address: the old coroutine calls transfer from one location in the program; the new coroutine returns to a potentially different location. If transfer saves its return address in the stack, then the PC will change automatically as a side effect of changing stacks.

So how do we change stacks? The usual approach is simply to change the stack pointer register, and to avoid using the frame pointer inside of transfer itself. At the beginning of transfer we push the return address and all of the other callee-saves registers onto the current stack. We then change the sp, pop the (new) return address (ra) and other registers off the new stack, and return:

EXAMPLE 8.57

Switching coroutines

```
transfer:
    push all registers other than sp (including ra)
    *current_coroutine := sp
    current_coroutine := r1    -- argument passed to transfer
    sp := *r1
    pop all registers other than sp (including ra)
    return
```

The data structure that represents a coroutine or thread is called a *context block*. In a simple coroutine package, the context block contains a single value: the coroutine’s sp as of its most recent transfer. (A thread package generally places additional information in the context block, such as an indication of priority, or pointers to link the thread onto various scheduling queues. Some coroutine or thread packages choose to save registers in the context block, rather than at the top of the stack; either approach works fine.)

In Modula-2, the coroutine creation routine initializes the coroutine’s stack to look like the frame of transfer, with a return address and register contents initialized to permit a “return” into the beginning of the coroutine’s code. The creation routine sets the sp value in the context block to point into this artificial

frame, and returns a pointer to the context block. To begin execution of the coroutine, some existing routine must transfer to it.

In Simula (and in the code in [Example 8.55](#)), the coroutine creation routine begins to execute the new coroutine immediately, as if it were a subroutine. After the coroutine completes any application-specific initialization, it performs a detach operation. Detach sets up the coroutine stack to look like the frame of transfer, with a return address that points to the following statement. It then allows the creation routine to return to its own caller.

In all cases, transfer expects a pointer to a context block as argument; by dereferencing the pointer it can find the sp of the next coroutine to run. A global (static) variable, called `current_coroutine` in the code above, contains a pointer to the context block of the currently running coroutine. This pointer allows transfer to find the location in which it should save the old sp.

8.6.3 Implementation of Iterators

Given an implementation of coroutines, iterators are almost trivial: one coroutine is used to represent the main program; a second is used to represent the iterator. Additional coroutines may be needed if iterators nest.

© IN MORE DEPTH

Additional details appear on the PLP CD. As it turns out, coroutines are overkill for iterator implementation. Most compilers use one of two simpler alternatives. The first of these keeps all state in a single stack, but sometimes executes in a frame other than the topmost. The second employs a compile-time code transformation to replace true iterators, transparently, with equivalent iterator objects.

8.6.4 Discrete Event Simulation

One of the most important applications of coroutines (and the one for which Simula was designed and named) is *discrete event simulation*. Simulation in general refers to any process in which we create an abstract model of some real-world system, and then experiment with the model in order to infer properties of the real-world system. Simulation is desirable when experimentation with the real world would be complicated, dangerous, expensive, or otherwise impractical. A *discrete event* simulation is one in which the model is naturally expressed in terms of events (typically interactions among various interesting objects) that happen at specific times. Discrete event simulation is usually not appropriate for the continuous processes, such as the growth of crystals or the flow of water over a surface, unless these processes are captured at the level of individual particles.

© IN MORE DEPTH

On the PLP CD we consider a traffic simulation, in which events model interactions among automobiles, intersections, and traffic lights. We use a separate coroutine for each trip to be taken by car. At any given time we run the coroutine with the earliest expected arrival time at an upcoming intersection. We keep inactive coroutines in a priority queue ordered by those arrival times.

8.7 Events

An *event* is something to which a running program (a process) needs to respond, but which occurs outside the program, at an unpredictable time. The most common events are inputs to a graphical user interface (GUI) system: keystrokes, mouse motions, button clicks. They may also be network operations or other asynchronous I/O activity: the arrival of a message, the completion of a previously requested disk operation.

In the I/O operations discussed in Section ©7.9, and in Section ©7.9.3 in particular, we assumed that a program looking for input will request it explicitly, and will wait if it isn't yet available. This sort of *synchronous* (at a specified time) and *blocking* (potentially wait-inducing) input is generally not acceptable for modern applications with graphical interfaces. Instead, the programmer usually wants a *handler*—a special subroutine—to be invoked when a given event occurs. Handlers are sometimes known as *callback* functions, because the run-time system calls back into the main program instead of being called *from* it. In an object-oriented language, the callback function may be a method of some *handler object*, rather than a static subroutine.

8.7.1 Sequential Handlers

Traditionally, event handlers were implemented in sequential programming languages as “spontaneous” subroutine calls, typically using a mechanism defined and implemented by the operating system, outside the language proper. To prepare to receive events through this mechanism, a program—call it *P*—invokes a `setup_handler` library routine, passing as argument the subroutine it wants to have invoked when the event occurs.

At the hardware level, asynchronous device activity during *P*'s execution will trigger an *interrupt* mechanism that saves *P*'s registers, switches to a different stack, and jumps to a predefined address in the OS kernel. Similarly, if some other process *Q* is running when the interrupt occurs (or if some action in *Q* itself needs to be reflected to *P* as an event), the kernel will have saved *P*'s state at the end of its last time slice. Either way, the kernel must arrange to invoke the appropriate event handler despite the fact that *P* may be at a place in its code where a subroutine

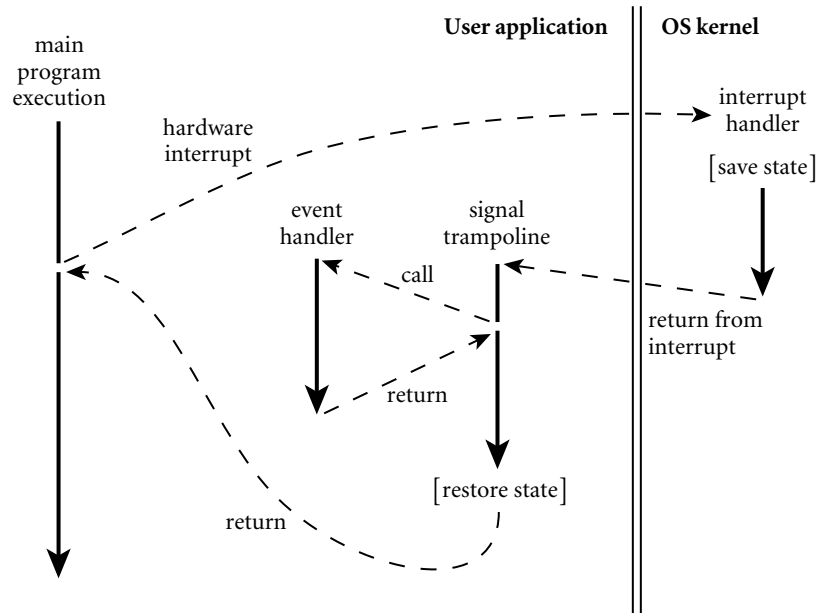

Figure 8.7 Signal delivery through a trampoline. When an interrupt occurs (or when another process performs an operation that should appear as an event), the main program may be at an arbitrary place in its code. The kernel saves state and invokes a *trampoline* routine that in turn calls the event handler through the normal calling sequence. After the event handler returns, the trampoline restores the saved state and returns to where the main program left off.

call cannot normally occur (e.g., it may be halfway through the calling sequence for some other subroutine).

EXAMPLE 8.58

Signal trampoline

Figure 8.7 illustrates the typical implementation of spontaneous subroutine calls—as used, for example, by the Unix *signal* mechanism. The language run-time library contains a block of code known as the *signal trampoline*. It also includes a buffer writable by the kernel and readable by the runtime. Before delivering a signal, the kernel places the saved state of *P* into the shared buffer. It then switches back to *P*'s user-level stack and jumps into the signal trampoline. The trampoline creates a frame for itself in the stack and then calls the event handler using the normal subroutine calling sequence. (The correctness of this mechanism depends on there being nothing important in the stack beyond the location specified by the stack pointer register at the time of the interrupt.) When the event handler returns, the trampoline restores state (including all registers) from the buffer written by the kernel, and jumps back into the main program. To avoid recursive events, the kernel typically disables further signals when it jumps to the signal trampoline. Immediately before jumping back to the user program, the trampoline performs a kernel call to reenables signals. Depending on the details of the operating system, the kernel may buffer some modest number of signals while they are disabled, and deliver them once the handler reenables them. ■

In practice, most event handlers need to share data structures with the main program (otherwise, how would they get the program to do anything interesting in response to the event?). We must take care to make sure neither the handler nor the main program ever sees these shared structures in an inconsistent state. Specifically, we must prevent a handler from looking at data when the main program is halfway through modifying it, or modifying data when the main program is halfway through reading it. The typical solution is to *synchronize* access to such shared structures by bracketing blocks of code in the main program with kernel calls that disable and reenables signals. We will use a similar mechanism to implement threads in [Section 12.2.4](#). More general forms of synchronization will appear in [Section 12.3](#).

8.7.2 Thread-Based Handlers

In modern programming languages and run-time systems, events are often handled by a separate thread of control, rather than by spontaneous subroutine calls. (This use of threads is closely related to the implementation of remote procedure calls, which we will study in [Section 12.5.4](#).) With a separate handler thread, input can again be synchronous: the handler thread makes a system call to request the next event, and waits for it to occur. Meanwhile, the main program continues to execute. If the program wishes to be able to handle multiple events concurrently, it may create multiple handler threads, each of which calls into the kernel to wait for an event. To protect the integrity of shared data structures, the main program and the handler thread(s) will generally require a full-fledged synchronization mechanism, as discussed in [Section 12.3](#): disabling signals will not suffice.

Many contemporary GUI systems are thread-based. Examples include the OpenGL Utility Toolkit (GLUT), the GNU Image Manipulation Program (GIMP) Tool Kit (Gtk), the Java Swing library, Windows Forms, and the newer .NET Windows Presentation Foundation (WPF). In C#, an event handler is an instance of a *delegate* type—essentially, a list of subroutine closures ([Section 3.6.3](#)). Using Gtk#, the standard GUI for the Mono project, we might create and initialize a button as follows.

EXAMPLE 8.59

An event handler in C#

```
void Paused(object sender, EventArgs a) {
    // do whatever needs doing when the pause button is pushed
}
...
Button pauseButton = new Button("pause");
pauseButton.Clicked += new EventHandler(Paused);
```

`Button` and `EventHandler` are defined in the `Gtk#` library. `Button` is a class that represents the graphical widget. `EventHandler` is a delegate type, with which `Paused` is compatible. Its first argument indicates the object that caused the event; its second argument describes the event itself. `Button.Clicked` is the button's

event handler: a field of `EventHandler` type. The `+=` operator adds a new closure to the delegate's list.⁷ The graphics library arranges for a thread to call into the kernel to wait for user interface events. When our button is pushed, the call will return from the kernel, and the thread will invoke each of the entries on the delegate list. ■

EXAMPLE 8.60

An anonymous delegate handler

As described in the [Section 3.6.3](#), C# allows the handler to be specified more succinctly as an *anonymous delegate*:

```
pauseButton.Clicked += delegate(object sender, EventArgs a) {
    // do whatever needs doing
};
```

EXAMPLE 8.61

An event handler in Java

Other languages and systems are similar. In Java Swing, an event handler is typically an instance of a class that implements the `ActionListener` interface, with a method named `actionPerformed`:

```
class PauseListener implements ActionListener {
    public void actionPerformed(ActionEvent e) {
        // do whatever needs doing
    }
}
...
JButton pauseButton = new JButton("pause");
pauseButton.addActionListener(new PauseListener());
```

EXAMPLE 8.62

An anonymous inner class handler

The lack of syntactic sugar for delegates makes this slightly more verbose than it was in C#, but most of the simplicity can be regained by using an *anonymous inner class*:

```
pauseButton.addActionListener(new ActionListener() {
    public void actionPerformed(ActionEvent e) {
        // do whatever needs doing
    }
});
```

Here the definition of our `PauseListener` class is embedded, without the name, in a call to `new`, which is in turn embedded in the argument list of `addActionListener`. Like an anonymous delegate in C#, an anonymous class in Java can have only a single instance. ■

The action performed by a handler needs to be simple and brief, so the handler thread can call back into the kernel for another event. If the handler takes too

⁷ Technically, `Clicked` is of event `EventHandler` type. The `event` modifier makes the delegate private, so it can be invoked only from within the class in which it was declared. At the same time, it creates a public *property*, with `add` and `remove` *accessors*, similar to the `put` and `get` accessors mentioned in [Section 9.1](#). These allow code outside the class to add handlers to the event (with `+=`) and remove them from it (with `-=`).

long, the user is likely to find the application nonresponsive. If an event needs to initiate something that is computationally demanding, or that may need to perform additional I/O, the handler may create a new thread to do the work; alternatively, it may pass a request to some existing worker thread.

✓ CHECK YOUR UNDERSTANDING

41. What was the first high-level programming language to provide coroutines?
 42. What is the difference between a *coroutine* and a *thread*?
 43. Why doesn't the *transfer* library routine need to change the program counter when switching between coroutines?
 44. Describe three alternative means of allocating coroutine stacks. What are their relative strengths and weaknesses?
 45. What is a *cactus stack*? What is its purpose?
 46. What is *discrete event simulation*? What is its connection with coroutines?
 47. What is an *event* in the programming language sense of the word?
 48. Summarize the two main implementation strategies for events.
 49. Explain the appeal of *anonymous delegates* (C#) and *anonymous inner classes* (Java) for handling events.
-

8.8 Summary and Concluding Remarks

This chapter has focused on the subject of control abstraction, and on subroutines in particular. Subroutines allow the programmer to encapsulate code behind a narrow interface, which can then be used without regard to its implementation. Control abstraction is crucial to the design and maintenance of any large software system. It is particularly effective from an aesthetic point of view in languages like Lisp and Smalltalk, which use the same syntax for both built-in and user-defined control constructs.

We began our study of subroutines in [Section 8.1](#) by reviewing the management of the subroutine call stack. We then considered the *calling sequences* used to maintain the stack, with extra sections on the PLP CD devoted to *displays*; case studies for the MIPSpro C compiler and the GNU x86 Pascal compiler (`gpc`); and the *register windows* of the SPARC. After a brief consideration of in-line expansion, we turned in [Section 8.3](#) to the subject of parameters. We first considered parameter-passing *modes*, all of which are implemented by passing values, references, or closures. We noted that the goals of semantic clarity and implementation speed sometimes conflict: it is usually most efficient to pass a large parameter by

reference, but the aliasing that results can lead to program bugs. In [Section 8.3.3](#) we considered special parameter-passing mechanisms, including conformant arrays, default (optional) parameters, named parameters, and variable-length parameter lists. We noted that default and named parameters provide an attractive alternative to the use of dynamic scoping. In [Section 8.4](#) we considered the design and implementation of generic subroutines and modules. Generics allow a control abstraction to be parameterized (at compile time) in terms of the types of its parameters, rather than just their values.

In the final three major sections we considered exception-handling mechanisms, which allow a program to “unwind” in a well-structured way from a nested sequence of subroutine calls; coroutines, which allow a program to maintain (and switch between) two or more execution contexts; and events, which allow a program to respond to asynchronous external activity. On the PLP CD we explained how coroutines are used for discrete event simulation. We also noted that they could be used to implement iterators, but here simpler alternatives exist. In [Chapter 12](#), we will build on coroutines to implement *threads*, which run (or appear to run) in parallel with one another.

In several cases we can discern an evolving consensus about the sorts of control abstractions that a language should provide. The limited parameter-passing modes of languages like Fortran and Algol 60 have been replaced by more extensive or flexible options. The standard positional notation for arguments has been augmented in languages like Ada and C++ with default and named parameters. Less-structured error-handling mechanisms, such as label parameters, nonlocal *gotos*, and dynamically bound handlers, have been replaced by structured exception handlers that are lexically scoped within subroutines, and can be implemented at zero cost in the common (no-exception) case. The spontaneous subroutine call of traditional signal-handling mechanisms have been replaced by callbacks in a dedicated thread. In many cases, implementing these newer features has required that compilers and run-time systems become more complex. Occasionally, as in the case of call-by-name parameters, label parameters, or nonlocal *gotos*, features that were semantically confusing were also difficult to implement, and abandoning them has made compilers simpler. In yet other cases language features that are useful but difficult to implement continue to appear in some languages but not in others. Examples in this category include first-class subroutines, coroutines, iterators, continuations, and local objects with unlimited extent.

8.9 Exercises

- 8.1 Describe as many ways as you can in which functions in imperative programming languages differ from functions in mathematics.
- 8.2 Consider the following code in C++.



```

class string_map {
    string cached_key;
    string cached_val;
    const string complex_lookup(const string key);
    // body specified elsewhere
public:
    const string operator[](const string key) {
        if (key == cached_key) return cached_val;
        string rtn_val = complex_lookup(key);
        cached_key = key;
        cached_val = rtn_val;
        return rtn_val;
    }
};

```

Suppose that `string_map::operator[]` contains the only call to `complex_lookup` anywhere in the program. Explain why it would be unwise for the programmer to expand that call textually in-line and eliminate the separate function.

- 8.3** Using your favorite language and compiler, write a program that can tell the order in which certain subroutine parameters are evaluated.
- 8.4** Consider the following (erroneous) program in C:

```

void foo() {
    int i;
    printf("%d ", i++);
}

int main() {
    int j;
    for (j = 1; j <= 10; j++) foo();
}

```

Local variable `i` in subroutine `foo` is never initialized. On many systems, however, the program will display repeatable behavior, printing 0 1 2 3 4 5 6 7 8 9. Suggest an explanation. Also explain why the behavior on other systems might be different, or nondeterministic.

- 8.5** The standard calling sequence for the Digital VAX instruction set employs not only a stack pointer (`sp`) and frame pointer (`fp`), but a separate *arguments pointer* (`ap`) as well. Under what circumstances might this separate pointer be useful? In other words, when might it be handy not to have to place arguments at statically known offsets from the `fp`?
- 8.6** Write (in the language of your choice) a procedure or function that will have four different effects, depending on whether arguments are passed by value, by reference, by value/result, or by name.

- 8.7 Consider an expression like $a + b$ that is passed to a subroutine in Fortran. Is there any semantically meaningful difference between passing this expression as a reference to an unnamed temporary (as Fortran does) or passing it by value (as one might, for example, in Pascal)? That is, can the programmer tell the difference between a parameter that is a value and a parameter that is a reference to a temporary?
- 8.8 Consider the following subroutine in Fortran 77:

```

subroutine shift(a, b, c)
  integer a, b, c
  a = b
  b = c
end

```

Suppose we want to call `shift(x, y, 0)` but we don't want to change the value of `y`. Knowing that built-up expressions are passed as temporaries, we decide to call `shift(x, y+0, 0)`. Our code works fine at first, but then (with some compilers) fails when we enable optimization. What is going on? What might we do instead?

- 8.9 In some implementations of Fortran IV, the following code would print a 3. Can you suggest an explanation? How do you suppose more recent Fortran implementations get around the problem?

```

c  main program
   call foo(2)
   print*, 2
   stop
end
subroutine foo(x)
  x = x + 1
  return
end

```

- 8.10 Suppose you are writing a program in which all parameters must be passed by name. Can you write a subroutine that will swap the values of its actual parameters? Explain. (Hint: consider mutually dependent parameters like `i` and `A[i]`.)
- 8.11 Can you write a swap routine in Java, or in any other language with only call-by-sharing parameters? What exactly should `swap` *do* in such a language? (Hint: think about the distinction between the object to which a variable refers and the value [contents] of that object.)
- 8.12 As noted in [Section 8.3.1](#), out parameters in Ada 83 can be written by the callee but not read. In Ada 95 they can be both read and written, but they begin their life uninitialized. Why do you think the designers of Ada 95 made this change? Does it have any drawbacks?

- 8.13** Fields of *packed* records (Example 7.43) cannot be passed by reference in Pascal. Likewise, when passing a subrange variable by reference, Pascal requires that all possible values of the corresponding formal parameter be valid for the subrange:

```

type small = 1..100;
   R = record x, y : small; end;
   S = packed record x, y : small; end;
var  a : 1..10;
     b : 1..1000;
     c : R;
     d : S;
procedure foo(var n : small);
begin
    n := 100;
    writeln(a);
end;
...
a := 2;
foo(b);    (* ok *)
foo(a);    (* static semantic error *)
foo(c.x);  (* ok *)
foo(d.x);  (* static semantic error *)

```

Using what you have learned about parameter-passing modes, explain these language restrictions.

- 8.14** Consider the following declaration in C:

```
double(*foo(double (*)(double, double[]), double))(double, ...);
```

Describe in English the type of `foo`.

- 8.15** Does a program run faster when the programmer leaves optional parameters out of a subroutine call? Why or why not?
- 8.16** Why do you suppose that variable-length argument lists are so seldom supported by high-level programming languages?
- 8.17** In Section 7.2.2 we introduced the notion of a *universal reference type* (`void*` in C) that refers to an object of unknown type. Using such references, implement a “poor man’s generic queue” in C, as suggested at the beginning of Section 8.4. Where do you need type casts? Why? Give an example of a use of the queue that will fail catastrophically at run time, due to the lack of type checking.
- 8.18** Rewrite the code of Figure 8.4 in Java or C#.
- 8.19** (a) Give a generic solution to Exercise 6.17.
 (b) Translate this solution into Ada, Java, or C#.

- 8.20 In your favorite language with generics, write code for simple versions of the following abstractions:
- a stack, implemented as a linked list
 - a priority queue, implemented as a skip list or a partially ordered tree embedded in an array
 - a dictionary (mapping), implemented as a hash table
- 8.21 [Figure 8.4](#) (C++ version) passes integer `max_items` to the queue abstraction as a generic parameter. Write an alternative version of the code that makes `max_items` a parameter to the queue constructor instead. What is the advantage of the generic parameter version?
- 8.22 Flesh out the C++ sorting routine of [Example 8.39](#). Demonstrate that this routine does “the wrong thing” when asked to sort an array of `char*` strings.
- 8.23 In the [Example 8.39](#) discussion we mentioned three ways to make the need for comparisons more explicit when defining a generic sort routine in C++: make the comparison routine a method of the generic parameter class `T`, an extra argument to the sort routine, or an extra generic parameter. Implement each option and discuss their comparative strengths and weaknesses.
- 8.24 Consider the following code skeleton in C++:

```
#include <list>
using std::list;

class foo { ...
class bar : public foo { ...

static void print_all(list<foo*> &L) { ...

list<foo*> LF;
list<bar*> LB;
...
print_all(LF);           // works fine
print_all(LB);           // static semantic error
```

Explain why the compiler won't allow the second call. Give an example of bad things that could happen if it did.

- 8.25 In [Section 8.3.1](#) we noted that Ada 83 does not permit subroutines to be passed as parameters, but that some of the same effect can be achieved with generics. Suppose we want to apply a function to every member of an array. We might write the following in Ada 83:

```
generic
  type item is private;
  type item_array is array (integer range <>) of item;
  with function F(it : in item) return item;
procedure apply_to_array(A : in out item_array);
```

```

procedure apply_to_array(A : in out item_array) is
begin
  for i in A'first..A'last loop
    A(i) := F(A(i));
  end loop;
end apply_to_array;

```

Given an array of integers, `scores`, and a function on integers, `foo`, we can write:

```

procedure apply_to_ints is
  new apply_to_array(integer, int_array, foo);
  ...
  apply_to_ints(scores);

```

How general is this mechanism? What are its limitations? Is it a reasonable substitute for formal (i.e., second-class, as opposed to third-class) subroutines?

- 8.26** Modify the code of [Figure 8.4](#) (C++ version) or your solution to [Exercise 8.21](#) to throw an exception if an attempt is made to enqueue an item in a full queue, or to dequeue an item from an empty queue.
- 8.27** Building on [Exercise 6.33](#), show how to implement exceptions using `call-with-current-continuation` in Scheme. Model your syntax after the `handler-case` of Common Lisp.
- 8.28** Given what you have learned about the implementation of structured exceptions, describe how you might implement the nonlocal `gotos` of Pascal or the label parameters of Algol 60 ([Section 6.2](#)). Do you need to place any restrictions on how these features can be used?
- 8.29** Describe a plausible implementation of C++ destructors or Java `try...finally` blocks. What code must the compiler generate, at what points in the program, to ensure that cleanup always occurs when leaving a scope?
- 8.30** Use threads to build support for true iterators in Java. Try to hide as much of the implementation as possible behind a reasonable interface. In particular, hide any uses of `new thread`, `thread.start`, `thread.join`, `wait`, and `notify` inside implementations of routines named `yield` (to be called by an iterator) and in the standard Java `Iterator` interface routines (to be called in the body of a loop). Compare the performance of your iterators to that of the built-in iterator objects (it probably won't be good). Discuss any weaknesses you encounter in the abstraction facilities of the language.

```

#include <signal.h>
#include <stdio.h>
#include <string.h>

char* days[7] = {"Sunday", "Monday", "Tuesday",
                "Wednesday", "Thursday", "Friday", "Saturday"};
char today[10];

void handler(int n) {
    printf(" %s\n", today);
}

int main() {
    signal(SIGTSTP, handler);      // ^Z at keyboard
    for(int n = 0; ; n++) {
        strcpy(today, days[n%7]);
    }
}

```

Figure 8.8 A problematic program in C to illustrate the use of signals. In most Unix systems, the `SIGTSTP` signal is generated by typing control-Z at the keyboard.

- 8.31** In Common Lisp multilevel returns use `catch` and `throw`; exception handling in the style of most other modern languages uses `handler-case` and `error`. Show that the distinction between these is mainly a matter of style, rather than expressive power. In other words, show that each facility can be used to emulate the other.
- 8.32** Compile and run the program in [Figure 8.8](#). Explain its behavior. Create a new version that behaves more predictably.
- 8.33** In C#, Java, or some other language with thread-based event handling, build a simple program around the “pause button” of [Examples 8.59–8.62](#). Your program should open a small window containing a text field and two buttons, one labeled “pause”, the other labeled “resume”. It should then display an integer in the text field, starting with zero and counting up once per second. If the pause button is pressed, the count should suspend; if the resume button is pressed, it should continue.
- Note that your program will need at least two threads—one to do the counting, one to handle events. In Java, Swing will create the handler thread automatically, and your main program can do the counting. In C#, some existing thread will need to call `Application.Run` in order to become a handler thread. In this case you’ll need a second thread to do the counting.
- 8.34** Extend your answer to the previous problem by adding a “clone” button. Pushing this button should create an additional window containing another counter. This will, of course, require additional threads.

© **8.35–8.47** In More Depth.

8.10 Explorations

- 8.48 Obtain a copy of the GNU Ada translator `gnat`. Explore its subroutine calling conventions. How do they compare to those of `gpc`? Pay particular attention to language features present in Ada but not in Pascal, including declarations in nested blocks (Section 3.3.2), dynamic-size arrays (Section 7.4.2), value-result parameters (Section 8.3.1), optional and named parameters (Section 8.3.3), generic subroutines (Section 8.4), exceptions (Section 8.5), and concurrency (Section 12.2.3).
- 8.49 If you were designing a new imperative language, what set of parameter modes would you pick? Why?
- 8.50 Learn about references and the reference assignment operator in PHP. Discuss the similarities and differences between these and the references of C++. In particular, note that assignments in PHP can change the object to which a reference variable refers. Why does PHP allow this but C++ does not?
- 8.51 Learn about pointers to methods in C++. What are they useful for? How do they differ from a C# delegate that encapsulates a method?
- 8.52 While Haskell does not include generics (its parametric polymorphism is implicit), its *type-class* mechanism, mentioned briefly in Section ©7.2.4 (page ©129) can be considered a generalization of type constraints. Learn more about this mechanism. Discuss both its relevance to polymorphic functions (e.g., the quicksort example of Exercise 7.26) and its more general uses. You might want to look ahead to the discussion of *monads* in Section 10.4.2.
- 8.53 Find manuals for several languages with exceptions and look up the set of predefined exceptions—those that may be raised automatically by the language implementation. Discuss the differences among the sets defined by different languages. If you were designing an exception-handling facility, what exceptions, if any, would you make predefined? Why?
- 8.54 Eiffel is an exception to the “replacement model” of exception handling. Its `rescue` clause is superficially similar to a `catch` block, but it must either `retry` the routine to which it is attached or allow the exception to propagate up the call chain. Put another way, the default behavior when control falls off the end of the `rescue` clause is to *re-raise* the exception. Read up on “Design by Contract,” the programming methodology supported by this exception-handling mechanism. Do you agree or disagree with the argument against replacement? Explain.
- 8.55 Learn the details of nonlocal control transfer in Common Lisp. Write a tutorial that explains `tagbody` and `go`; `block` and `return-from`; `catch` and `throw`; and `restart-case`, `restart-bind`, `handler-case`, `handler-bind`, `find-restart`, `invoke-restart`, `ignore-errors`, `signal`, and `error`. What do you think of all this machinery? Is it overkill? Be sure to give an example that illustrates the use of `handler-bind`.

- 8.56 If you have manuals for Common Lisp, Modula-3, and Java, compare the semantics they provide for `unwind-protect` and `try...finally`. Specifically, what happens if an exception arises within a cleanup clause?
- 8.57 Compare and contrast the event-handling mechanisms of several GUI systems. How are handlers bound to events? Can you control the order in which they are invoked? How many event-handling threads does each system support? How and when are handler threads created? How do they synchronize with the rest of the program?
- © 8.58–8.61 In More Depth.

8.11 Bibliographic Notes

Recursive subroutines became known primarily through McCarthy's work on Lisp [McC60].⁸ Stack-based space management for recursive subroutines developed with compilers for Algol 60 (e.g., see Randell and Russell [RR64]). (Because of issues of extent, subroutine space in Lisp requires more general, heap-based allocation.) Dijkstra [Dij60] presents an early discussion of the use of displays to access nonlocal data. Hanson [Han81] argues that nested subroutines are unnecessary.

Calling sequences and stack conventions for `gpc` are partially documented in the `texinfo` files distributed with `gcc`, on which `gpc` is based (see www.gnu.org/software). Documentation for the MIPSpro C compiler can be found at techpubs.sgi.com. Several of the details described on the PLP CD were “reverse engineered” by examining the output of the two compilers.

The Ada language rationale [IBFW91, Chap. 8] contains an excellent discussion of parameter-passing modes. Harbison [Har92, Secs. 6.2–6.3] describes the Modula-3 modes and compares them to those of other languages. Liskov and Guttag [LG86, p. 25] liken call-by-sharing in Clu to parameter passing in Lisp. Call-by-name parameters have their roots in the lambda calculus of Alonzo Church [Chu41], which we consider in more detail in Section ©10.6. Thunks were first described by Ingerman [Ing61]. Fleck [Fle76] discusses the problems involved in trying to write a swap routine with call-by-name parameters (Exercise 8.10).

Garcia et al. provide a detailed comparison of generic facilities in ML, C++, Haskell, Eiffel, Java, and C# [GJL⁺03]. The C# generic facility is described by Kennedy and Syme [KS01]. Java generics are based on the work of Bracha et al. [BOSW98].

⁸ John McCarthy (1927–), Professor Emeritus at Stanford University, is one of the founders of the field of Artificial Intelligence. He introduced Lisp in 1958, and also made key contributions to the early development of time-sharing and the use of mathematical logic to reason about computer programs. He received the ACM Turing Award in 1971.

MacLaren [Mac77] describes exception handling in PL/I. The lexically scoped alternative of Ada, and of several more recent languages, draws heavily on the work of Goodenough [Goo75]. Ada's semantics are described formally by Luckam and Polak [LP80]. Liskov and Snyder [LS79] discuss exception handling in Clu. Meyer [Mey92a] discusses Design by Contract and exception handling in Eiffel. Friedman, Wand, and Haynes [FWH01, Chaps. 8–9] provide an excellent explanation of continuation-passing style in Scheme.

An early description of coroutines appears in the work of Conway [Con63], who uses them to represent the phases of compilation. Birtwistle et al. [BDMN73] provide a tutorial introduction to the use of coroutines for simulation in Simula 67. Cactus stacks date from at least the mid-1960s; they were supported directly in hardware by the Burroughs B6500 and B7500 computers [HD68]. Murer et al. [MOSS96] discuss the implementation of iterators in the Sather programming language (a descendant of Eiffel).

Data Abstraction and Object Orientation

In [Chapter 3](#) we presented several stages in the development of data abstraction, with an emphasis on the scoping mechanisms that control the visibility of names. We began with global variables, whose lifetime spans program execution. We then added local variables, whose lifetime is limited to the execution of a single subroutine; nested scopes, which allow subroutines themselves to be local; and static variables, whose lifetime spans execution, but whose names are visible only within a single scope. These were followed by modules, which allow a collection of subroutines to share a set of static variables; module *types*, which allow the programmer to instantiate multiple instances of a given abstraction, and *classes*, which allow the programmer to define families of related abstractions.

Ordinary modules encourage a “manager” style of programming, in which a module exports an abstract type. Module types and classes allow the module itself to *be* the abstract type. The distinction becomes apparent in two ways. First, the explicit `create` and `destroy` routines typically exported from a manager module are replaced by creation and destruction of an instance of the module type. Second, invocation of a routine in a particular module instance replaces invocation of a general routine that expects a variable of the exported type as argument. Classes build on the module-as-type approach by adding mechanisms for *inheritance*, which allows new abstractions to be defined as refinements or extensions to existing ones, and *dynamic method binding*, which allows a new version of an abstraction to display newly refined behavior, even when used in a context that expects an earlier version. An instance of a class is known as an *object*; languages and programming techniques based on classes are said to be *object-oriented*.¹

The stepwise evolution of data abstraction mechanisms presented in [Chapter 3](#) is a useful way to organize ideas, but it does not completely reflect the historical development of language features. In particular, it would be inaccurate to suggest that object-oriented programming developed as an outgrowth of modules.

¹ In previous chapters we used the term “object” informally to refer to almost anything that can have a name. In this chapter we will use it only to refer to an instance of a class.

Rather, all three of the fundamental concepts of object-oriented programming—encapsulation, inheritance, and dynamic method binding—have their roots in the Simula programming language, developed in the mid-1960s by Ole-Johan Dahl and Kristen Nygaard of the Norwegian Computing Centre.² In comparison to modern object-oriented languages, Simula was weak in the data hiding part of encapsulation, and it was in this area that Clu, Modula, Euclid, and related languages made important contributions in the 1970s. At the same time, the ideas of inheritance and dynamic method binding were adopted and refined in Smalltalk over the course of the 1970s.

Smalltalk employs a distinctive “message-based” programming model, with dynamic typing and unusual terminology and syntax. The dynamic typing tends to make Smalltalk implementations relatively slow, and delays the reporting of errors. The language is also tightly integrated into a graphical programming environment, making it difficult to port across systems. For these reasons, Smalltalk is less widely used than one might expect, given the influence it has had on subsequent developments. More recent object-oriented languages, including Eiffel, C++, Modula-3, Ada 95, Fortran 2003, Python, Ruby, Java, and C# represent to a large extent a reintegration of the inheritance and dynamic method binding of Smalltalk with “mainstream” imperative syntax and semantics. In an alternative vein, Objective-C [App08] combines Smalltalk-style messaging and dynamic typing, in a relatively pure and unadulterated form, with traditional C syntax for intra-object operations. Object orientation has also become important in functional languages; the leading notation is CLOS, the Common Lisp Object System [Kee89; Ste90, Chap. 28].

In Section 9.1 we provide an overview of object-oriented programming and of its three fundamental concepts. We consider encapsulation and data hiding in more detail in Section 9.2. We then consider object initialization and finalization in Section 9.3, and dynamic method binding in Section 9.4. In Section 9.5 (mostly on the PLP CD) we consider the subject of *multiple inheritance*, in which a class is defined in terms of more than one existing class. As we shall see, multiple inheritance introduces some particularly thorny semantic and implementation challenges. Finally, in Section 9.6, we revisit the definition of object orientation, considering the extent to which a language can or should model everything as an object. Most of our discussion will focus on Smalltalk, Eiffel, C++, and Java, though we shall have occasion to mention many other languages as well.

2 Kristen Nygaard (1926–2002) was widely admired as a mathematician, computer language pioneer, and social activist. His career included positions with the Norwegian Defense Research Establishment, the Norwegian Operational Research Society, the Norwegian Computing Center, the Universities of Aarhus and Oslo, and a variety of labor, political, and social organizations. Ole-Johan Dahl (1931–2002) also held positions at the Norwegian Defense Research Establishment and the Norwegian Computing Center, and was the founding member of the Informatics department at Oslo. Together, Nygaard and Dahl shared the 2001 ACM Turing Award.

9.1 Object-Oriented Programming

With the development of ever-more complicated computer applications, data abstraction has become essential to software engineering. The abstraction provided by modules and module types has at least three important benefits:

1. It reduces *conceptual load* by minimizing the amount of detail that the programmer must think about at one time.
2. It provides *fault containment* by preventing the programmer from using a program component in inappropriate ways, and by limiting the portion of a program's text in which a given component can be used, thereby limiting the portion that must be considered when searching for the cause of a bug.
3. It provides a significant degree of *independence* among program components, making it easier to assign their construction to separate individuals, to modify their internal implementations without changing external code that uses them, or to install them in a library where they can be used by other programs.

Unfortunately, experience with modules and module types indicates that the reuse implied by the third of these points is difficult to achieve in practice. One often finds that a previously constructed module has almost, but not quite, the properties required by some new application. Perhaps one has a preexisting queue abstraction, but would like to be able to insert and delete from either end, rather than being limited to first-in-first-out (FIFO) order. Perhaps one has a preexisting dialog box abstraction for a graphical user interface, but without any mechanism to highlight a default response. Perhaps one has a package for symbolic math, but it assumes that all values are real numbers, rather than complex. In all these cases much of the advantage of abstraction will be lost if the programmer must copy the preexisting code, figure out how it works inside, and modify it by hand, rather than using it “as-is.” If it becomes necessary to change the abstraction at some point in the future (to fix a bug or implement an enhancement), the programmer will need to remember to fix all copies—a tedious and error-prone activity.

Object-oriented programming can be seen as an attempt to enhance opportunities for code reuse by making it easy to define new abstractions as *extensions* or *refinements* of existing abstractions. As a starting point for examples, consider a set of records, implemented as a doubly-linked list. Figure 9.1 contains C++ code for the elements of such a list. The example employs a “module-as-type” style of abstraction: each element of a list is an object of class `list_node`. The class contains both *data members* (`prev`, `next`, `head_node`, and `val`) and *subroutine members* (`predecessor`, `successor`, `insert_before` and `remove`). Subroutine members are called *methods* in many object-oriented languages; data members are also called *fields*. The keyword `this` in C++ refers to the object of which the currently executing method is a member. In Smalltalk and Objective-C, the equivalent keyword is `self`; in Eiffel it is `current`. ■

EXAMPLE 9.1

`List_node` class in C++

```

class list_err {                                // exception
public:
    char *description;
    list_err(char *s) {description = s;}
};

class list_node {
    list_node* prev;
    list_node* next;
    list_node* head_node;
public:
    int val;                                    // the actual data in a node
    list_node() {                               // constructor
        prev = next = head_node = this;       // point to self
        val = 0;                               // default value
    }
    list_node* predecessor() {
        if (prev == this || prev == head_node) return 0;
        return prev;
    }
    list_node* successor() {
        if (next == this || next == head_node) return 0;
        return next;
    }
    bool singleton() {
        return (prev == this);
    }
    void insert_before(list_node* new_node) {
        if (!new_node->singleton())
            throw new list_err("attempt to insert node already on list");
        prev->next = new_node;
        new_node->prev = prev;
        new_node->next = this;
        prev = new_node;
        new_node->head_node = head_node;
    }
    void remove() {
        if (singleton())
            throw new list_err("attempt to remove node not currently on list");
        prev->next = next;
        next->prev = prev;
        prev = next = head_node = this;       // point to self
    }
    ~list_node() {                               // destructor
        if (!singleton())
            throw new list_err("attempt to delete node still on list");
    }
};

```

Figure 9.1 A simple class for list nodes in C++. In this example we envision a list of integers.

EXAMPLE 9.2

List class that uses
list_node

Given the existence of the `list_node` class, we could define a list as follows:

```
class list {
    list_node header;
public:
    // no explicit constructor required;
    // implicit construction of 'header' suffices
    int empty() {
        return header.singleton();
    }
    list_node* head() {
        return header.successor();
    }
    void append(list_node *new_node) {
        header.insert_before(new_node);
    }
    ~list() { // destructor
        if (!header.singleton())
            throw new list_err("attempt to delete non-empty list");
    }
};
```

To create an empty list, one could then write

```
list* my_list_ptr = new list;
```

Records to be inserted into a list are created in much the same way:

```
list_node* elem_ptr = new list_node; ■
```

EXAMPLE 9.3

Declaration of in-line
(expanded) objects

In C++, one can also simply declare an object of a given class:

```
list my_list;
list_node elem;
```

Our `list` class includes such an object (`header`) as a field. When created with `new`, an object is allocated in the heap; when created via elaboration of a declaration it is allocated statically or on the stack, depending on lifetime. In either case, creation causes the invocation of a programmer-specified initialization routine, known as a *constructor*. In C++ and its descendants, Java and C#, the name of the constructor is the same as that of the class itself. C++ also allows the programmer to specify a *destructor* method that will be invoked automatically when an object is destroyed, either by explicit programmer action or by return from the subroutine in which it was declared. The destructor's name is also the same as that of the class, but with a leading tilde (`~`). Destructors are commonly used for storage management and error checking. ■

Public and Private Members

The `public` label within the list of members of `list_node` separates members required by the implementation of the abstraction from members available to users of the abstraction. In the terminology of [Section 3.3.4](#), members that appear after the `public` label are exported from the class; members that appear before the label are not. C++ also provides a `private` label, so the publicly visible portions of a class can be listed first if desired (or even intermixed). In many other languages, public data and subroutine members (fields or methods) must be individually so labeled (more on this in [Section 9.2.2](#)). Note that C++ classes are open scopes, as defined in [Section 3.3.4](#); nothing needs to be explicitly imported.

Like packages in Ada or external (separately compiled) modules in Modula-2, C++ classes allow certain information to be left out of the declaration, and provided in a separate file not visible to users of the abstraction. In our running example, we could declare the public methods of `list_node` without providing their bodies:

EXAMPLE 9.4

Method declaration
without definition

```
class list_node {
    list_node* prev;
    list_node* next;
    list_node* head_node;
public:
    int val;
    list_node();
    list_node* predecessor();
    list_node* successor();
    bool singleton();
    void insert_before(list_node* new_node);
};
```

DESIGN & IMPLEMENTATION**What goes in a class declaration?**

Two rules govern the choice of what to put in the declaration of a class, rather than in separate definitions. First, the declaration must contain all the information that a programmer needs in order to use the abstraction correctly. Second, the declaration must contain all the information that the compiler needs in order to generate code. The second rule is generally broader: it tends to force information that is not required by the first rule into (the private part of) the interface, particularly in languages that use a value model of variables, instead of a reference model. If the compiler must generate code to allocate space (e.g., in stack frames) to hold an instance of a class, then it must know the size of that instance; this is the rationale for including private fields in the class declaration. In addition, if the compiler is to expand any method calls in-line then it must have their code available. In-line expansion of the smallest, most common methods of an object-oriented program tends to be crucial for good performance.

```

void remove();
~list_node();
};

```

This somewhat abbreviated class declaration might then be put in a .h “header” file, with method bodies relegated to a .cc “implementation” file. (Conventions for separate compilation in C were discussed in Section ©3.8. The filename suffixes used here are those expected by the GNU g++ compiler.) Within a .cc file, the header of a method definition must identify the class to which it belongs by using a :: *scope resolution* operator:

EXAMPLE 9.5

Separate method definition

```

void list_node::insert_before(list_node* new_node) {
    if (!new_node->singleton())
        throw new list_err("attempt to insert node already on list");
    prev->next = new_node;
    new_node->prev = prev;
    new_node->next = this;
    prev = new_node;
    new_node->head_node = head_node;
}

```

Tiny Subroutines

Object-oriented programs tend to make many more subroutine calls than do ordinary imperative programs, and the subroutines tend to be shorter. Lots of things that would be accomplished by direct access to record fields in a von Neumann language tend to be hidden inside object methods in an object-oriented language. Many programmers in fact consider it bad style to declare public fields, because they give users of an abstraction direct access to the internal representation. Arguably, we should make the `val` field of `list_node` private, with `get_val` and `set_val` methods to read and write it.

EXAMPLE 9.6

Property and indexer methods in C#

C# provides a *property* mechanism specifically designed to facilitate the declaration of methods (called *accessors*) to “get” and “set” values. Using this mechanism, our `val` field could be written as follows:

```

class list_node {
    ...
    int val;           // val (lower case 'v') is private
    public int Val {
        get {         // presence of get accessor and optional
            return val; // set accessor means that Val is a property
        }
        set {
            val = value; // value is a keyword: argument to set
        }
    }
    ...
}

```

Users of the `list_node` class can now access the (private) `val` field through the (public) `Val` property as if it were a field:

```
list_node n;
...
int a = n.Val;      // implicit call to get method
n.Val = 3;         // implicit call to set method
```

A similar *indexer* mechanism can make objects of arbitrary classes look like arrays, with conventional subscript syntax in both l-value and r-value contexts. An example appears in the sidebar on page 327. In C++, operator overloading and references (Section 8.3.1, page 399) can be used to provide the equivalent of indexers, but not of properties. ■

Derived Classes

EXAMPLE 9.7

Queue class derived from
list

Suppose now that we already have a list abstraction, and would like a queue abstraction. We could define the queue from scratch, but much of the code would look the same as in Figure 9.1. In an object-oriented language we have a better alternative: we can *derive* the queue from the list, allowing it to *inherit* preexisting fields and methods:

```
class queue : public list {           // derive from list
public:
    // no specialized constructor or destructor required
    void enqueue(list_node* new_node) {
        append(new_node);
    }
    list_node* dequeue() {
        if (empty())
            throw new list_err("attempt to dequeue from empty queue");
        list_node* p = head();
        p->remove();
        return p;
    }
};
```

Here `queue` is said to be a *derived class* (also called a *child class* or *subclass*); `list` is said to be a *base class* (also called a *parent class* or *superclass*). The derived class automatically has all the fields and methods of the base class.³ All the programmer needs to declare explicitly are members that a `queue` has but a `list` lacks—in this case, the `enqueue` and `dequeue` methods. We shall see examples shortly in which derived classes have new fields as well. ■

3 Actually, users of a derived class in C++ can see the members of the base class only if the base class name is preceded with the keyword `public` in the first line of the derived class's declaration. We will discuss the visibility rules of C++ in more detail in Section 9.2.

By deriving new classes from old ones, the programmer can create arbitrarily deep *class hierarchies*, with additional functionality at every level of the tree. The standard libraries for Smalltalk and Java are as many as seven and eight levels deep, respectively. (Unlike C++, both Smalltalk and Java have a single root superclass, *Object*, from which all other classes are derived. C#, Objective-C, and Eiffel have a similar class; Eiffel calls it *ANY*.)

General-Purpose Base Classes

The astute reader may have noticed that our original list abstraction made the unfortunate assumption that the data in every item was to be an integer. This assumption really isn't necessary. Given an inheritance mechanism, we can create a general-purpose element base class that contains only the fields and methods needed to implement list operations:

EXAMPLE 9.8

Base class for
general-purpose lists

```
class gp_list_node {
    gp_list_node* prev;
    gp_list_node* next;
    gp_list_node* head_node;
public:
    gp_list_node();           // assume method bodies given separately
    gp_list_node* predecessor();
    gp_list_node* successor();
    bool singleton();
    void insert_before(gp_list_node* new_node);
    void remove();
    ~gp_list_node();
};
```

Now we can use this general-purpose class to derive lists and queues with specific types of fields:

```
class int_list_node : public gp_list_node {
public:
    int val;                 // the actual data in a node
    int_list_node() {
        val = 0;
    }
    int_list_node(int v) {
        val = v;
    }
};
```

Better yet, we can use templates (generics) to define a `list_node<T>` class that can be instantiated for any data type `T`, without the need to use inheritance. We will discuss this option further in [Section 9.4.4](#). ■

EXAMPLE 9.9

Overloaded
int_list_node
constructor

Overloaded Constructors

We have overloaded the constructor in `int_list_node`, providing two alternative implementations. One takes an argument, the other does not. Now the programmer can create `int_list_nodes` with or without specifying an initial value:

```
int_list_node element1;           // val = 0
int_list_node *e_ptr = new int_list_node(13); // val = 13
```

In C++, the compiler ensures that constructors for base classes are executed before those of derived classes. In our example, the constructor for `gp_list_node` will be executed first, followed by the constructor for `int_list_node`. We will discuss constructors further in [Section 9.3](#). ■

Modifying Base Class Methods

In addition to defining new fields and methods, a derived class can hide or redefine members of base class(es). We will discuss data hiding in [Section 9.2](#). To *redefine* a method of a base class, a derived class simply declares a new version. Suppose that we are creating an `int_list_node` class, but we want somewhat different semantics for the `remove` method. If written as in [Figure 9.1](#), `gp_list_node::remove` will throw a `list_err` exception if the node to be removed is not currently on a list. If we want `int_list_node::remove` simply to return without doing anything in this situation, we can declare it that way explicitly:

EXAMPLE 9.10

Redefining a method in a
derived class

```
class int_list_node : public gp_list_node {
public:
    ...
    void remove() {
        if (!singleton()) {
            prev->next = next;
            next->prev = prev;
            prev = next = head_node = this;
        }
    }
};
```

The disadvantage of this redefinition is that it pulls implementation details of `gp_list_node` into an `int_list_node` method, a potential violation of abstraction. (As a matter of fact, a C++ compiler will not accept the preceding code. As we shall see in [Section 9.2](#), we would need to change the `gp_list_node` base class to make its `next` and `prev` fields visible to derived classes.) ■

EXAMPLE 9.11

Redefinition that builds on
the base class method

A better approach is to leave the implementation details to the base class and simply catch the exception if it arises:

```
void int_list_node::remove() {
    try {
        gp_list_node::remove();
    } catch(list_err) {} // do nothing
}
```

This version of the code may be slightly slower than the previous one, depending on how `try` blocks are implemented, but it does a better job of maintaining abstraction. Note that the scope resolution operator (`::`) allows us to access the `remove` method of the base class explicitly, even though we have redefined it for `int_list_node`. ■

EXAMPLE 9.12

Accessing base class members

Other object-oriented languages provide other means of accessing the members of a base class. In Smalltalk, Objective-C, Java, and C#, one uses the keyword `base` or `super`:

```
gp_list_node::remove(); // C++
super.remove();        // Java
base.remove();         // C#
super remove.          // Smalltalk
[super remove]         // Objective-C
```

EXAMPLE 9.13

Renaming methods in Eiffel

In Eiffel, one must explicitly *rename* methods inherited from a base class, in order to make them accessible:

```
class int_list_node
inherit
  gp_list_node
  rename
    remove as old_remove
    ...      -- other renames
end
```

Within methods of `int_list_node`, the `remove` method of `gp_list_node` can be invoked as `old_remove`. C++ and Eiffel cannot use the keyword `super`, because it would be ambiguous in the presence of multiple inheritance. ■

Containers/Collections

In object-oriented programming, an abstraction that holds a collection of objects of some given class is often called a *container*. Common containers include sets, stacks, queues, and dictionaries. There are several different ways to build containers. In this section we have explored an approach in which objects are derived from a container element base class. The principal problem with this approach is that an object cannot be placed in a container unless its class is derived from the element class of the container.

In order to put an *arbitrary* object into, say, a list, we can adopt an alternative approach, in which list nodes are separate objects containing *pointers* (or references) to the listed objects, rather than the data of the objects themselves. Examples of this approach can be found in the binary trees of [Section 6.5.3](#), and in the standard libraries of C++, Java, and C#, among others. A third alternative is to make the list node a member (a subobject) of the listed object. In general, the design of consistent, intuitive, and useful class hierarchies is a complex and difficult art. Containers are only the tip of the iceberg.

✓ CHECK YOUR UNDERSTANDING

1. What are generally considered to be the three defining characteristics of object-oriented programming?
 2. In what programming language of the 1960s does object orientation find its roots? Who invented that language? Summarize the evolution of the three defining characteristics since that time.
 3. Name three important benefits of abstraction.
 4. What are the more common names for *subroutine member* and *data member*?
 5. What is a *property* in C#?
 6. What is the purpose of the “private” part of an object interface? Why is it required?
 7. What is the purpose of the `::` operator in C++?
 8. What is a *container* class?
 9. Explain why in-line subroutines are particularly important in object-oriented languages.
 10. What are *constructors* and *destructors*?
 11. Give two other terms, each, for *base class* and *derived class*.
-

9.2 Encapsulation and Inheritance

Encapsulation mechanisms enable the programmer to group data and the subroutines that operate on them together in one place, and to hide irrelevant details from the users of an abstraction. In the discussion above we have cast object-oriented programming as an extension of the “module-as-type” mechanisms of Simula and Euclid. It is also possible to cast object-oriented programming in a “module-as-manager” framework. In the first subsection below we consider the data-hiding mechanisms of modules in non-object-oriented languages. In the second subsection we consider the new data-hiding issues that arise when we add inheritance to modules to make classes. In the third subsection we briefly return to the module-as-manager approach, and show how several languages, including Ada 95 and Fortran 2003, add inheritance to records, allowing (static) modules to continue to provide data hiding.

9.2.1 Modules

Scope rules for data hiding were one of the principal innovations of Clu, Modula, Euclid, and other module-based languages of the 1970s. In Clu and Euclid, the declaration and definition (header and body) of a module always appear together.

The header clearly states which of the module's names are to be exported. If a Euclid module M exports a type T , by default the remainder of the program can do nothing with objects of type T other than pass them to subroutines exported from M . T is said to be an *opaque* type.

EXAMPLE 9.14

Opaque types in Modula-2

In Modula-2, programmers have the option of separating the header and body of a module. In [Chapter 3](#) ([Figures 3.6](#) and [3.7](#)) we looked only at so-called “internal” modules, in which the two parts appear together. In an “external” module (meant for separate compilation), the header appears in one source file and the body in another. Unfortunately, there is no way to divide the header into public and private parts; everything in it is public (i.e., exported). The only concession to data hiding is that a type may be made opaque by listing only its name in the header:

```
TYPE T;
```

In this case variables of type T can only be assigned, compared for equality, and passed to the module's subroutines. As noted in the sidebar on [page 137](#), Modula-2's successor, Oberon, provides only external modules. ■

EXAMPLE 9.15

Data hiding in Ada

Ada, which also allows the headers and bodies of modules (called packages) to be separated, eliminates the problems of Modula-2 by allowing the header of a package to be divided into public and private parts. A type can be exported opaquely by putting its definition in the private part of the header and simply naming it in the public part:

```
package foo is          -- header
  ...
  type T is private;
  ...
private                -- definitions below here are inaccessible to users
  ...
  type T is ...        -- full definition
  ...
end foo;                ■
```

DESIGN & IMPLEMENTATION**Opaque exports in Modula-2**

Because opaque types are not defined in a Modula-2 header module, there is no obvious way for the compiler to determine the size of an object (in the informal sense of the word) of an opaque type when compiling code that uses the module. Modula-2 therefore requires that all opaque types be pointers. Assuming that all pointers have the same size (which they do on most machines), objects of opaque type can then be allocated statically or on the stack without knowledge of internal structure. Some Modula-2 implementations permit certain additional opaque types, but only if they are implemented with the same number of bits as a pointer.

When the header and body of a module appear in separate files, a change to a module body never requires us to recompile any of the module's users. A change to the private part of a module header may require us to recompile the module's users, but never requires us to change their code. A change to the public part of a header is a change to the module's interface: it will often require us to change the code of users.

Because they affect only the visibility of names, static, manager-style modules introduce no special code generation issues. Storage for variables and other data inside a module is managed in precisely the same way as storage for data immediately outside the module. If the module appears in a global scope, then its data can be allocated statically. If the module appears within a subroutine, then its data can be allocated on the stack, at known offsets, when the subroutine is called, and reclaimed when it returns.

Module types, as in Euclid, are somewhat more complicated: they allow a module to have an arbitrary number of *instances*. The obvious implementation then resembles that of a record. If all of the data in the module have a statically known size, then each individual datum can be assigned a static offset within the module's storage. If the size of some of the data is not known until run time, then the module's storage can be divided into fixed-size and variable-size portions, with a dope vector (descriptor) at the beginning of the fixed-size portion. Instances of the module can be allocated statically, on the stack, or in the heap, as appropriate.

The “this” Parameter

One additional complication arises for subroutines inside a module. How do they know which variables to use? We could, of course, replicate the code for each subroutine in each instance of the module, just as we replicate the data. This replication would be highly wasteful, however, as the copies would vary only in the details of address computations. A better technique is to create a single instance of each module subroutine, and to pass that instance, at run time, the address of the storage of the appropriate module instance. This address takes the form of an extra, hidden first parameter for every module subroutine. A Euclid call of the form

EXAMPLE 9.16

The hidden this parameter

```
my_stack.push(x)
```

is translated as if it were really

```
push(my_stack, x)
```

where `my_stack` is passed by reference. The same translation occurs in object-oriented languages. ■

Making Do without Module Headers

As noted in Section ©3.8, Java packages and C/C++/C# namespaces can be spread across multiple compilation units (files). In C, C++, and C#, a single file can also contain pieces of more than one namespace. More significantly, Java and C#

dispense with the notion of separate headers and bodies. While the programmer must still define the interface (and specify it via `public` declarations), there is no need to manually identify code that needs to be in the header for implementation reasons: instead the compiler is responsible for extracting this information automatically from the full text of the module. For software engineering purposes it may still be desirable to create preliminary versions of a module, against which other modules can be compiled, but this is optional. To assist in project management and documentation, many Java and C# implementations provide a tool that will extract from the complete text of a module the minimum information required by its users.

9.2.2 Classes

With the introduction of inheritance, object-oriented languages must supplement the scope rules of module-based languages to cover additional issues. For example, should private members of a base class be visible to methods of a derived class? Should public members of a base class always be public members of a derived class (i.e., be visible to users of the derived class)? How much control should a base class exercise over the visibility of its members in derived classes?

EXAMPLE 9.17

Private base class in C++

We glossed over most of these questions in our examples in [Section 9.1](#). For example, we might want to hide the `append` method of a `queue`, since it is superseded by `enqueue`. To effect this hiding in C++, the definition of class `queue` can specify that its base class is to be `private`:

```
class queue : private list {
public:
    using list::empty;
    using list::head;
    // but NOT using list::append
    void enqueue(gp_list_node* new_node);
    gp_list_node* dequeue();
};
```

Here the appearance of `private` in the first line of the declaration indicates that public members of `list` will be visible to users of `queue` only if specifically made so by later parts of the declaration. We have made the `empty` and `head` methods visible by means of `using` declarations in `queue`'s public part. ■

In addition to the `public` and `private` labels, C++ allows members of a class to be designated `protected`. A protected member is visible only to methods of its own class or of classes derived from that class. In our examples, a protected member `M` of `list` would be accessible not only to methods of `list` itself, but also to methods of `queue`. Unlike public members, however, `M` would not be visible to arbitrary users of `list` or `queue` objects.

The `protected` keyword can also be used when specifying a base class:

```
class derived : protected base { ...
```

EXAMPLE 9.18

Protected base class in C++

Here public members of the base class act like protected members of the derived class. ■

The basic philosophy behind the visibility rules of C++ can be summarized as follows:

- Any class can limit the visibility of its members. Public members are visible anywhere the class declaration is in scope. Private members are visible only inside the class's methods. Protected members are visible inside methods of the class or its descendants. (As an exception to the normal rules, a class can specify that certain other `friend` classes or subroutines should have access to its private members.)
- A derived class can restrict the visibility of members of a base class, but can never increase it. Private members of a base class are never visible in a derived class. Protected and public members of a public base class are protected or public, respectively, in a derived class. Protected and public members of a protected base class are protected members of a derived class. Protected and public members of a private base class are private members of a derived class.
- A derived class that limits the visibility of members of a base class by declaring that base class `protected` or `private` can restore the visibility of individual members of the base class by inserting a `using` declaration in the `protected` or `public` portion of the derived class declaration.

Other object-oriented languages take different approaches to visibility. Eiffel is more flexible than C++ in the patterns of visibility it can support, but it does not adhere to the first of the C++ principles above. Derived classes in Eiffel can both restrict *and increase* the visibility of members of base classes. Every method (called a `feature` in Eiffel) can specify its own *export status*. If the status is `{NONE}` then the member is effectively private (called *secret* in Eiffel). If the status is `{ANY}` then the member is effectively public (called *generally available* in Eiffel). In the general case the status can be an arbitrary list of class names, in which case the feature is said to be *selectively available* to those classes and their descendants only. Any feature inherited from a base class can be given a new status in a derived class.

Java and C# follow C++ in the declaration of `public`, `protected`, and `private` members, but do not provide the `protected` and `private` designations for base classes; a derived class can neither increase *nor* restrict the visibility of members of a base class. (Of course, a derived class can always redefine a data or subroutine member with a method that generates a run-time error if used.) The `protected` keyword has a slightly different meaning in Java than it does in C++: a `protected` member of a Java class is visible not only within derived classes, but also within the entire package (namespace) in which the class is declared. A class member with no explicit access modifier in Java is visible through the package in which the class is declared, but *not* in any derived classes that reside in other packages. C# defines `protected` as C++ does, but provides an additional `internal` keyword that makes a member visible throughout the *assembly* in which the class appears. (An assembly is a collection of linked-together compilation units, comparable to a `.jar` file in Java.) Members of a C# class are `private` by default.

In Smalltalk and Objective-C, the issue of member visibility never arises: the language allows code at run time to attempt to make a call to any method name in any object. If the method exists (with the right number of parameters), then the invocation proceeds; otherwise a run-time error results. There is no way in these languages to make a method available to some parts of a program but not to others. In a related vein, Python class members are always public.

9.2.3 Nesting (Inner Classes)

Many languages allow class declarations to nest. This raises an immediate question: if `Inner` is a member of `Outer`, can `Inner`'s methods see `Outer`'s members, and if so, which instance do they see? The simplest answer, adopted in C++ and C#, is to allow access to only the static members of the outer class, since these have only a single instance. In effect, nesting serves simply as a means of information hiding. Java takes a more sophisticated approach. It allows a nested (*inner*) class to access arbitrary members of its surrounding class. Each instance of the inner class must therefore *belong to* an instance of the outer class.

EXAMPLE 9.19

Inner classes in Java

```
class Outer {
    int n;
    class Inner {
        public void bar() { n = 1; }
    }
    Inner i;
    Outer() { i = new Inner(); } // constructor
    public void foo() {
        n = 0;
        System.out.println(n); // prints 0
        i.bar();
        System.out.println(n); // prints 1
    }
}
```

If there are multiple instances of `Outer`, each instance will have a different `n`, and calls to `Inner.bar` will access the appropriate `n`. To make this work, each instance of `Inner` (of which there may of course be an arbitrary number) must contain a hidden pointer to the instance of `Outer` to which it belongs. If a nested class in Java is declared to be `static`, it behaves as in C++ and C#, with access to only the static members of the surrounding class.

Java classes can also be nested inside methods. Such a *local* class not only has access to (all) members of the surrounding class; it also has (a copy of) any `final` parameters and variables of the method in which it is nested. Because `final` objects cannot be changed, copies are indistinguishable from the original, and the implementation does not need to maintain a reference (a static link) to the frame of the method in which the class is nested. Non-`final` objects are inaccessible to the local class. ■

Inner and local classes in Java are widely used to create *object closures*, as described in [Section 3.6.3](#). In [Section 8.7.2](#) we used them as handlers for events.

```

package gp_list is
  list_err : exception;
  type gp_list_node is tagged private;
  -- 'tagged' means extendable; 'private' means opaque
  type gp_list_node_ptr is access all gp_list_node;
  -- 'all' means that this can point at 'aliased' nonheap data
  procedure initialize(self : access gp_list_node);
  procedure finalize(self : access gp_list_node);
  function predecessor(self : access gp_list_node) return gp_list_node_ptr;
  function successor(self : access gp_list_node) return gp_list_node_ptr;
  function singleton(self : access gp_list_node) return boolean;
  procedure insert_before(self : access gp_list_node; new_node : gp_list_node_ptr);
  procedure remove(self : access gp_list_node);

  type list is tagged private;
  type list_ptr is access all list;
  procedure initialize(self : access list);
  procedure finalize(self : access list);
  function empty(self : access list) return boolean;
  function head(self : access list) return gp_list_node_ptr;
  procedure append(self : access list; new_node : gp_list_node_ptr);
private
  type gp_list_node is tagged record
    prev, next, head_node : gp_list_node_ptr;
  end record;
  type list is tagged record
    header : aliased gp_list_node;
    -- 'aliased' means that an 'all' pointer can refer to this
  end record;
end gp_list;
...
package body gp_list is
  -- definitions of subroutines
  ...
end gp_list;

```

Figure 9.2 List and queue abstractions in Ada 95. The tagged types `list` and `queue` provide inheritance; the packages provide encapsulation. An `int_list_node` could be derived from `gp_list_node` in a similar manner. Declaring `self` to have type `access XX` (instead of `XX_ptr`) causes the compiler to recognize the subroutine as a method of the tagged type. (*continued*)

We also noted that a local class in Java can be *anonymous*: it can appear, in-line, inside a call to `new` (Example 8.62).

9.2.4 Type Extensions

Smalltalk, Objective-C, Eiffel, C++, Java, and C# were all designed from the outset as object-oriented languages, either starting from scratch or from an existing language without a strong encapsulation mechanism. They all support a module-as-type approach to abstraction, in which a single mechanism (the class) provides

```

package gp_list.queue is      -- 'child' of gp_list
  type queue is new list with private
    -- 'new' means it's a subtype; 'with' means it's an extension
  procedure initialize(self : access queue);
  procedure finalize(self : access queue);
  procedure enqueue(self : access queue; new_node : gp_list_node_ptr);
  function dequeue(self : access queue) return gp_list_node_ptr;
private
  type queue is new list with null record;    -- no new fields
end gp_list.queue;
...
package body gp_list.queue is
  procedure initialize(self : access queue) is
  begin
    initialize(list_ptr(self));
  end initialize;

  procedure finalize(self : access queue) is
  begin
    finalize(list_ptr(self));
  end finalize;

  procedure enqueue(self : access queue; new_node : gp_list_node_ptr) is
  begin
    append(list_ptr(self), new_node);
  end enqueue;

  function dequeue(self : access queue) return gp_list_node_ptr is
  rtn : gp_list_node_ptr;
  begin
    if empty(list_ptr(self)) then
      raise list_err;
    end if;
    rtn := head(list_ptr(self));
    remove(rtn);
    return rtn;
  end dequeue;
end gp_list.queue;

```

Figure 9.2 (continued)

both encapsulation and inheritance. Several other languages, including Modula-3, Ada 95, Oberon, CLOS, and Fortran 2003, can be characterized as object-oriented extensions to languages in which modules already provide encapsulation. (Neither Modula-3 nor Oberon is strictly an extension to Modula-2, but both draw heavily on the syntax and semantics of their common predecessor.) Rather than alter the existing module mechanism, these languages provide inheritance and dynamic method binding through a mechanism for *extending* records. In Ada 95, for example, our list and queue abstractions could be defined as in Figure 9.2.

EXAMPLE 9.20

List and queue abstractions
in Ada 95

To control access to the structure of types, we hide them inside Ada packages. The procedures `initialize`, `finalize`, `enqueue`, and `dequeue` of `gp_list.queue` can convert their parameter `self` to a `list_ptr`, because `queue` is an extension of `list`. Package `gp_list.queue` is said to be a *child* of package `gp_list` because its name is prefixed with that of its parent. A child package in Ada 95 is similar to a derived class in Eiffel or C++, except that it is still a manager, not a type. Like Eiffel, but unlike C++, Ada 95 allows the body of a child package to see the private parts of the parent package.

All of the list and queue subroutines in Figure 9.2 take an explicit first parameter; Ada 95, Oberon, and CLOS do not use “`object.method()`” notation. Modula-3, Python, and Ada 2005 do use this notation, but only as syntactic sugar: a call to `A.B(C, D)` is interpreted as a call to `B(A, C, D)`, where `B` is declared as a three-parameter subroutine. Arbitrary Ada code can pass an object of type `queue` to any routine that expects a `list`; as in Java, there is no way for a derived type to hide the public members of a base type. ■

9.2.5 Extending without Inheritance

The desire to extend the functionality to an existing abstraction is one of the principal motivations for object-oriented programming. Inheritance is the standard mechanism that makes such extension possible. There are times, however, when inheritance is not an option, particularly when dealing with preexisting code. The class one wants to extend may not permit inheritance, for instance: in Java, it may be labeled `final`; in C#, it may be `sealed`. Even if inheritance is possible in principle, there may be a large body of existing code that uses the original class name, and it may not be feasible to go back and change all the variable and parameter declarations to use a new derived type.

EXAMPLE 9.21

Extension methods in
C# 3.0

For situations like these, C# 3.0 provides *extension methods*, which give the appearance of extending an existing class:

```
static class AddToString {
    public static int toInt(this string s) {
        return int.Parse(s);
    }
}
```

An extension method must be `static`, and must be declared in a `static` class. Its first parameter must be prefixed with the keyword `this`. The method can then be invoked as if it were a member of the class of which `this` is an instance:

```
int n = myString.toInt();
```

Together, the method declaration and use are syntactic sugar for

```

static class AddToString {
    public static int toInt(string s) {          // no 'this'
        return int.Parse(s);
    }
}
...
int n = AddToString.ToInt(myString);

```

No special functionality is available to extension methods. In particular, they cannot access private members of the class that they extend, nor do they support dynamic method binding (Section 9.4). By contrast, several scripting languages, including JavaScript and Ruby, really do allow the programmer to add new methods to existing classes—or even to individual objects. We explore these options further in Section 13.4.4.

✓ CHECK YOUR UNDERSTANDING

12. What is meant by an *opaque* export from a module?
 13. What are *private* types in Ada?
 14. Explain the significance of the `this` parameter in object-oriented languages.
 15. How do Java and C# make do without explicit class headers?
 16. Explain the distinctions among `private`, `protected`, and `public` class members in C++.
 17. Explain the distinctions among `private`, `protected`, and `public` base classes in C++.
 18. Describe the notion of *selective availability* in Eiffel.
 19. How do the rules for member name visibility in Smalltalk and Objective-C differ from the rules of most other object-oriented languages?
 20. How do *inner* classes in Java differ from most other nested classes?
 21. Describe the key design difference between Smalltalk, Eiffel, and C++ on the one hand, and Oberon, Modula-3, and Ada 95 on the other.
 22. What are *extension methods* in C#? What purpose do they serve?
-

9.3 Initialization and Finalization

In Section 3.2 we defined the lifetime of an object to be the interval during which it occupies space and can thus hold data. Most object-oriented languages provide some sort of special mechanism to *initialize* an object automatically at

the beginning of its lifetime. When written in the form of a subroutine, this mechanism is known as a *constructor*. Though the name might be thought to imply otherwise, a constructor does not allocate space; it initializes space that has already been allocated. A few languages provide a similar *destructor* mechanism to *finalize* an object automatically at the end of its lifetime. Several important issues arise:

Choosing a constructor: An object-oriented language may permit a class to have zero, one, or many distinct constructors. In the latter case, different constructors may have different names, or it may be necessary to distinguish among them by number and types of arguments.

References and values: If variables are references, then every object must be created explicitly, and it is easy to ensure that an appropriate constructor is called. If variables are values, then object creation can happen implicitly as a result of elaboration. In this latter case, the language must either permit objects to begin their lifetime uninitialized, or it must provide a way to choose an appropriate constructor for every elaborated object.

Execution order: When an object of a derived class is created in C++, the compiler guarantees that the constructors for any base classes will be executed, outermost first, before the constructor for the derived class. Moreover, if a class has members that are themselves objects of some class, then the constructors for the members will be called before the constructor for the object in which they are contained. These rules are a source of considerable syntactic and semantic complexity: when combined with multiple constructors, elaborated objects, and multiple inheritance, they can sometimes induce a complicated sequence of nested constructor invocations, with overload resolution, before control even enters a given scope. Other languages have simpler rules.

Garbage collection: Most object-oriented languages provide some sort of constructor mechanism. Destructors are comparatively rare. Their principal purpose is to facilitate manual storage reclamation in languages like C++. If the language implementation collects garbage automatically, then the need for destructors is greatly reduced.

In the remainder of this section we consider these issues in more detail.

9.3.1 Choosing a Constructor

Smalltalk, Eiffel, C++, Java, and C# all allow the programmer to specify more than one constructor for a given class. In C++, Java, and C#, the constructors behave like overloaded subroutines: they must be distinguished by their numbers and types of arguments. In Smalltalk and Eiffel, different constructors can have different names; code that creates an object must name a constructor explicitly. In Eiffel one might say

EXAMPLE 9.22

Naming constructors in Eiffel

```

class COMPLEX
creation
  new_cartesian, new_polar
feature {ANY}
  x, y : REAL

  new_cartesian(x_val, y_val : REAL) is
  do
    x := x_val; y := y_val
  end

  new_polar(rho, theta : REAL) is
  do
    x := rho * cos(theta)
    y := rho * sin(theta)
  end

  -- other public methods

feature {NONE}

  -- private methods

end -- class COMPLEX
...
a, b : COMPLEX
...
!!b.new_cartesian(0, 1)
!!a.new_polar(pi/2, 1)

```

The !! operator is Eiffel’s equivalent of `new`. Because class `COMPLEX` specified constructor (“creator”) methods, the compiler will insist that every use of !! specify a constructor name and arguments. There is no straightforward analog of this code in C++; the fact that both constructors take two `real` arguments means that they could not be distinguished by overloading. ■

Smalltalk resembles Eiffel in the use of multiple named constructors, but it distinguishes more sharply between operations that pertain to an individual object and operations that pertain to a class of objects. Smalltalk also adopts an anthropomorphic programming model in which every operation is seen as being executed by some specific object in response to a request (a “message”) from some other object. Since it makes little sense for an object *O* to create itself, *O* must be created by some other object (call it *C*) that represents *O*’s class. Of course, because *C* is an object, it must itself belong to some class. The result of this reasoning is a system in which each class definition really introduces a *pair* of classes and a pair of objects to represent them. Objective-C and CLOS have similar dual hierarchies.

Consider, for example, the standard class named `Date`. Corresponding to `Date` is a single object (call it *D*) that performs operations on behalf of the class. In

EXAMPLE 9.23

Metaclasses in Smalltalk

particular, it is *D* that creates new objects of class `Date`. Because only objects execute operations (classes don't), we don't really need a name for *D*; we can simply use the name of the class it represents:

```
todayDate <- Date today
```

This code causes *D* to execute the `today` constructor of class `Date`, and assigns a reference to the newly created object into a variable named `todayDate`.

So what is the class of *D*? It clearly isn't `Date`, because *D* represents class `Date`. Smalltalk says that *D* is an object (in fact the only object) of the *metaclass* `Date class`. For technical reasons, it is also necessary for `Date class` to be represented by an object. To avoid an infinite regression, all objects that represent metaclasses are instances of a single class named `Metaclass`. ■

Modula-3 and Oberon provide no constructors at all: the programmer must initialize everything explicitly. Ada 95 supports constructors and destructors (called `Initialize` and `Finalize` routines) only for objects of types derived from the standard library type `Controlled`.

9.3.2 References and Values

Several object-oriented languages, including Simula, Smalltalk, Python, Ruby, and Java, use a programming model in which variables refer to objects. Other languages, including C++, Modula-3, Ada 95, and Oberon, allow a variable to have a value that *is* an object. Eiffel uses a reference model by default, but allows the programmer to specify that certain classes should be `expanded`, in which case variables of those classes will use a value model. In a similar vein, C# uses `struct` to define types whose variables are values, and `class` to define types whose variables are references.

With a reference model for variables every object is created explicitly, and it is easy to ensure that an appropriate constructor is called. With a value model

DESIGN & IMPLEMENTATION

The value/reference tradeoff

The reference model of variables is arguably more elegant than the value model, particularly for object-oriented languages, but generally requires that objects be allocated from the heap, and imposes (in the absence of compiler optimizations) an extra level of indirection on every access. The value model tends to be more efficient, but makes it difficult to control initialization. In languages like Java, an optimization known as *escape analysis* can sometimes allow the compiler to determine that references to a given object will always be contained within (will never escape) a given method. In this case the object can be allocated in the method's stack frame, avoiding the overhead of heap allocation and, more significantly, eventual garbage collection.

for variables object creation can happen implicitly as a result of elaboration. In Modula-3, Ada 95, and Oberon, which don't really have constructors, elaborated objects begin life uninitialized and it is possible to accidentally attempt to use a variable before it has a value. In C++, the compiler ensures that an appropriate constructor is called for every elaborated object, but the rules it uses to identify constructors and their arguments can sometimes be confusing.

EXAMPLE 9.24

Declarations and constructors in C++

If a C++ variable of class type `foo` is declared with no initial value, then the compiler will call `foo`'s zero-argument constructor (if no such constructor exists, but other constructors do, then the declaration is a static semantic error—a call to a nonexistent subroutine):

```
foo b; // calls foo::foo()
```

If the programmer wants to call a different constructor, the declaration must specify constructor arguments to drive overload resolution:

```
foo b(10, 'x'); // calls foo::foo(int, char) ■
```

EXAMPLE 9.25

Copy constructors

The most common argument list consists of a single object, of the same or different class:

```
foo a;
bar b;
...
foo c(a); // calls foo::foo(foo&)
foo d(b); // calls foo::foo(bar&)
```

Usually the programmer's intent is to declare a new object whose initial value is "the same" as that of the existing object. In this case it is more natural to write

```
foo a; // calls foo::foo()
bar b; // calls bar::bar()
...
foo c = a; // calls foo::foo(foo&)
foo d = b; // calls foo::foo(bar&)
```

In recognition of this intent, a single-argument constructor in C++ is called a *copy constructor*. It is important to realize here that the equals sign (=) in these declarations indicates initialization, not assignment. The effect is *not* the same as that of the similar code fragment

```
foo a, c, d; // calls foo::foo() three times
bar b; // calls bar::bar()
...
c = a; // calls foo::operator=(foo&)
d = b; // calls foo::operator=(bar&)
```

Here `c` and `d` are initialized with the zero-argument constructor, and the later use of the equals sign indicates *assignment*, not initialization. The distinction is a common source of confusion in C++ programs. It arises from the combination of a value model of variables and an insistence that every elaborated object be initialized by a constructor. In CLOS, which requires objects to be passed to methods as explicit first parameters, object creation and initialization relies on overloaded versions of subroutines named `make-instance` and `initialize-instance`. Because CLOS employs a reference model uniformly, the issue of initializing elaborated objects does not arise. ■

EXAMPLE 9.26

Eiffel constructors and expanded objects

In Eiffel, every variable is initialized to a default value. For built-in types (integer, floating-point, character, etc.), which are considered to be expanded, the default values are all zero. For references to objects, the default value is `void` (null). For variables of expanded class types, the defaults are applied recursively to

DESIGN & IMPLEMENTATION**Initialization and assignment**

The distinction between initialization and assignment in C++ can sometimes have a surprising effect on performance. Consider, for example, the seemingly innocuous declaration

```
foo a = b + c;
```

If `foo` is a nontrivial class, the compiler will need to create a hidden, temporary object to be the target of the `+` operation, roughly equivalent to the following:

```
foo t;
t = b.operator+(c);
foo a = t;
```

The generated code will then include calls to both the zero-argument constructor and the destructor for `t`, as well as a copy constructor to move `t` into `a`. The less elegant

```
foo a = b; a += c;
```

will call the copy constructor for `a`, followed by `operator+=`, avoiding the need for `t`. Programmers who create explicit temporary objects to break up complex expressions may see similar unexpected costs.

A similar issue arises in subroutine calls. A parameter that is passed by value typically induces an implicit call to a copy constructor. A parameter that is passed by reference does not. Of course the reference parameter imposes the cost of indirection on accesses within the subroutine. It also creates an alias, which may inhibit certain code improvements, as noted in [Section 3.5.1](#). Which parameter mode will result in the fastest code will depend on details of the individual program. Unfortunately, C++ semantics are sufficiently complex that it is difficult for the typical programmer to evaluate this tradeoff in practice.

members. As noted above, new objects are created by invoking Eiffel's `!!` creation operator:

```
!!var.creator(args)
```

where `var` is a variable of some class type T and `creator` is a constructor for T . In the common case, `var` will be a reference, and the creation operator will allocate space for an object of class T and then call the object's constructor. This same syntax is permitted, however, when T is an expanded class type, in which case `var` will actually be an object, rather than a reference. In this case, the `!!` operator simply passes to the constructor (a reference to) the already-allocated object. ■

9.3.3 Execution Order

As we have seen, C++ insists that every object be initialized before it can be used. Moreover, if the object's class (call it B) is derived from some other class (call it A), C++ insists on calling an A constructor before calling a B constructor, so that the derived class is guaranteed never to see its inherited fields in an inconsistent state. When the programmer creates an object of class B (either via declaration or with a call to `new`), the creation operation specifies arguments for a B constructor. These arguments allow the C++ compiler to resolve overloading when multiple constructors exist. But where does the compiler obtain arguments for the A constructor? Adding them to the creation syntax (as Simula does) would be a clear violation of abstraction. The answer adopted in C++ is to allow the header of the constructor of a derived class to specify base class constructor arguments:

EXAMPLE 9.27

Specification of base class constructor arguments

```
foo::foo( foo_params ) : bar( bar_args ) {
    ...
}
```

DESIGN & IMPLEMENTATION

Initialization of "expanded" objects

C++ inherits from C a design philosophy that emphasizes execution speed, minimal run-time support, and suitability for "systems" programming, in which the programmer needs to be able to write code whose mapping to assembly language is straightforward and self-evident. The use of a value model for variables in C++ is thus more than an attempt to be backward compatible with C; it reflects the desire to allocate variables statically or on the stack whenever possible, to avoid the overhead of dynamic allocation, deallocation, and frequent indirection. In later sections we shall see several other ramifications of the C++ philosophy, including manual storage reclamation (Section 9.3.4) and static method binding (Section 9.4.1).

Here `foo` is derived from `bar`. The list `foo_params` consists of formal parameters for this particular `foo` constructor. Between the parameter list and the opening brace of the subroutine definition is a “call” to a constructor for the base class `bar`. The arguments to the `bar` constructor can be arbitrarily complicated expressions involving the `foo` parameters. The compiler will arrange to execute the `bar` constructor before beginning execution of the `foo` constructor. ■

EXAMPLE 9.28

Specification of member constructor arguments

Similar syntax allows the C++ programmer to specify constructor arguments or initial values for members of the class. In [Figure 9.1](#), for example, we could have used this syntax to initialize `prev`, `next`, `head_node`, and `val` in the constructor for `list_node`:

```
list_node() : prev(this), next(this), head_node(this), val(0) {
    // empty body -- nothing else to do
}
```

Given that all of these members have simple (pointer or integer) types, there will be no significant difference in the generated code. But suppose we have members that are themselves objects of some nontrivial class:

```
class foo : bar {
    mem1_t member1;    // mem1_t and
    mem2_t member2;    // mem2_t are classes
    ...
}

foo::foo( foo_params ) : bar( bar_args ), member1( mem1_args ),
    member2( mem2_args ) {
    ...
}
```

Here the use of embedded calls in the header of the `foo` constructor causes the compiler to call the copy constructors for the member objects, rather than calling the default (zero-argument) constructors, followed by `operator=`. Both semantics and performance may be different as a result. ■

EXAMPLE 9.29

Invocation of base class constructor in Java

Like C++, Java insists that a constructor for a base class be called before the constructor for a derived class. The syntax is a bit simpler, however; the initial line of the code for the derived class constructor may consist of a “call” to the base class constructor:

```
super( args );
```

(C# has a similar mechanism.) As noted in [Section 9.1](#), `super` is a Java keyword that refers to the base class of the class in whose code it appears. If the call to `super` is missing, the Java compiler automatically inserts a call to the base class’s zero-argument constructor (in which case such a constructor must exist). ■

Because Java uses a reference model uniformly for all objects, any class members that are themselves objects will actually be *references*, rather than “expanded” objects (to use the Eiffel term). Java simply initializes such members to `null`.

If the programmer wants something different, he or she must call `new` explicitly within the constructor of the surrounding class. Smalltalk and (in the common case) C# and Eiffel adopt a similar approach. In C#, members whose types are structs are initialized by setting all of their fields to zero or null. In Eiffel, if a class contains members of an expanded class type, that type is required to have a single constructor, with no arguments; the Eiffel compiler arranges to call this constructor when the surrounding object is created.

Smalltalk, Eiffel, and CLOS are all more lax than C++ regarding the initialization of base classes. The compiler or interpreter arranges to call the constructor (creator, initializer) for each newly created object automatically, but it does *not* arrange to call constructors for base classes automatically; all it does is initialize base class data members to default (zero or null) values. If the derived class wants different behavior, its constructor(s) must call a constructor for the base class explicitly. Objective-C has no special notion of constructor: programmers must write and explicitly invoke their own initialization methods.

9.3.4 Garbage Collection

When a C++ object is destroyed, the destructor for the derived class is called first, followed by those of the base class(es), in reverse order of derivation. By far the most common use of destructors in C++ is manual storage reclamation. Suppose, for example, that we were to create a list or queue of character-string names:

EXAMPLE 9.30

Reclaiming space with destructors

```
class name_list_node : public gp_list_node {
    char *name;           // pointer to the data in a node
public:
    name_list_node() {
        name = 0;        // empty string
    }
    name_list_node(char *n) {
        name = new char[strlen(n)+1];
        strcpy(name, n); // copy argument into member
    }
    ~name_list_node() {
        if (name != 0) {
            delete[] name; // reclaim space
        }
    }
};
```

The destructor in this class serves to reclaim space that was allocated in the heap by the constructor. ■

In languages with automatic garbage collection, there is much less need for destructors. In fact, the entire idea of destruction is suspect in a garbage-collected language, because the programmer has little or no control over when an object is going to be destroyed. Java and C# allow the programmer to declare a `finalize`

method that will be called immediately before the garbage collector reclaims the space for an object, but the feature is not widely used.

✓ CHECK YOUR UNDERSTANDING

23. Does a constructor allocate space for an object? Explain.
24. What is a *metaclass* in Smalltalk?
25. Why is object initialization simpler in a language with a reference model of variables (as opposed to a value model)?
26. How does a C++ (or Java or C#) compiler tell which constructor to use for a given object? How does the answer differ for Eiffel and Smalltalk?
27. What is *escape analysis*?
28. Summarize the rules in C++ that determine the order in which constructors are called for a class, its base class(es), and the classes of its fields. How are these rules simplified in other languages?
29. Explain the difference between initialization and assignment in C++.
30. Why does C++ need destructors more than Eiffel does?

9.4 Dynamic Method Binding

One of the principal consequences of inheritance/type extension is that a derived class *D* has all the members—data and subroutines—of its base class *C*. As long as *D* does not hide any of the publicly visible members of *C* (see [Exercise 9.16](#)), it makes sense to allow an object of class *D* to be used in any context that expects an object of class *C*: anything we might want to do to an object of class *C* we can also do to an object of class *D*. In Ada terminology, a derived class that does not hide any publicly visible members of its base class is a *subtype* of that base class.

The ability to use a derived class in a context that expects its base class is called *subtype polymorphism*. If we imagine an administrative computing system for a university, we might derive classes `student` and `professor` from class `person`:

EXAMPLE 9.31

Derived class objects in a base class context

```
class person { ...
class student : public person { ...
class professor : public person { ...
```

Because both `student` and `professor` objects have all the properties of a `person` object, we should be able to use them in a `person` context:

```
student s;
professor p;
...
```

```
person *x = &s;
person *y = &p;
```

Moreover a subroutine like

```
void person::print_mailing_label() { ...
```

would be polymorphic—capable of accepting arguments of multiple types:

```
s.print_mailing_label(); // i.e., print_mailing_label(s)
p.print_mailing_label(); // i.e., print_mailing_label(p)
```

As with other forms of polymorphism, we depend on the fact that `print_mailing_label` uses only those features of its formal parameter that all actual parameters will have in common. ■

EXAMPLE 9.32

Static and dynamic method binding

But now suppose that we have redefined `print_mailing_label` in each of the two derived classes. We might, for example, want to encode certain information (student's year in school, professor's home department) in the corner of the label. Now we have multiple versions of our subroutine—`student::print_mailing_label` and `professor::print_mailing_label`, rather than the single, polymorphic `person::print_mailing_label`. Which version we will get depends on the object:

```
s.print_mailing_label(); // student::print_mailing_label(s)
p.print_mailing_label(); // professor::print_mailing_label(p)
```

But what about

```
x->print_mailing_label(); // ??
y->print_mailing_label(); // ??
```

Does the choice of the method to be called depend on the types of the *variables* `x` and `y`, or on the classes of the *objects* `s` and `p` to which those variables refer? ■

The first option (use the type of the reference) is known as *static method binding*. The second option (use the class of the object) is known as *dynamic method binding*. Dynamic method binding is central to object-oriented programming. Imagine, for example, that our administrative computing program has created a list of persons who have overdue library books. The list may contain both students and professors. If we traverse the list and print a mailing label for each person, dynamic method binding will ensure that the correct printing routine is called for each individual. In this situation the definitions in the derived classes are said to *override* the definition in the base class.

Semantics and Performance

The principal argument against static method binding—and thus in favor of dynamic binding based on the type of the referenced object—is that the static

EXAMPLE 9.33

The need for dynamic binding

approach denies the derived class control over the consistency of its own state. Suppose, for example, that we are building an I/O library that contains a `text_file` class:

```
class text_file {
    char *name;
    long position;           // file pointer
public:
    void seek(long whence);
    ...
};
```

Now suppose we have a derived class `read_ahead_text_file`:

```
class read_ahead_text_file : public text_file {
    char *upcoming_characters;
public:
    void seek(long whence);    // redefinition
    ...
};
```

The code for `read_ahead_text_file::seek` will undoubtedly need to change the value of the cached `upcoming_characters`. If the method is not dynamically dispatched, however, we cannot guarantee that this will happen: if we pass a `read_ahead_text_file` reference to a subroutine that expects a `text_file` reference as argument, and if that subroutine then calls `seek`, we'll get the version of `seek` in the base class. ■

Unfortunately, as we shall see in [Section 9.4.3](#), dynamic method binding imposes run-time overhead. While this overhead is generally modest, it is nonetheless a concern for small subroutines in performance-critical applications. Smalltalk, Objective-C, Modula-3, Python, and Ruby use dynamic method binding for all methods. Java and Eiffel use dynamic method binding by default, but allow individual methods and (in Java) classes to be labeled `final` (Java) or `frozen` (Eiffel), in which case they cannot be overridden by derived classes, and can therefore employ an optimized implementation. Simula, C++, C#, and Ada 95 use static method binding by default, but allow the programmer to specify dynamic binding when desired. In these latter languages it is common terminology to distinguish between *overriding* a method that uses dynamic binding and (merely) *redefining* a method that uses static binding. For the sake of clarity, C# requires explicit use of the keywords `override` and `new` whenever a method in a derived class overrides or redefines (respectively) a method of the same name in a base class.

9.4.1 Virtual and Nonvirtual Methods

In Simula, C++, and C#, which use static method binding by default, the programmer can specify that particular methods should use dynamic binding by labeling

EXAMPLE 9.34

Virtual methods in C++
and C#

them as `virtual`. Calls to virtual methods are *dispatched* to the appropriate implementation at run time, based on the class of the object, rather than the type of the reference. In C++ and C#, the keyword `virtual` prefixes the subroutine declaration:⁴

```
class person {
public:
    virtual void print_mailing_label();
    ...
```

EXAMPLE 9.35

Virtual methods in Simula

In Simula, virtual methods are listed at the beginning of the class declaration:

```
CLASS Person;
    VIRTUAL: PROCEDURE PrintMailingLabel;
BEGIN
    ...
    PROCEDURE PrintMailingLabel...
        COMMENT body of subroutine
    ...
END Person;
```

EXAMPLE 9.36

Class-wide types in Ada 95

Ada 95 adopts a different approach. Rather than associate dynamic dispatch with particular methods, the Ada 95 programmer associates it with certain *references*. In our mailing label example, a formal parameter or an access variable (pointer) can be declared to be of the *class-wide* type `person'Class`, in which case all calls to all methods of that parameter or variable will be dispatched based on the class of the object to which it refers:

```
type person is tagged record ...
type student is new person with ...
type professor is new person with ...

procedure print_mailing_label(r : person) is ...
procedure print_mailing_label(s : student) is ...
procedure print_mailing_label(p : professor) is ...

procedure print_appropriate_label(r : person'Class) is
begin
    print_mailing_label(r);
    -- calls appropriate overloaded version, depending
    -- on type of r at run time
end print_appropriate_label;
```

⁴ C++ also uses the `virtual` keyword in certain circumstances to prefix the name of a base class in the header of the declaration of a derived class. This usage supports the very different purpose of *shared multiple inheritance*, which we will consider in Section 9.5.3.

9.4.2 Abstract Classes

EXAMPLE 9.37

Abstract methods in Java and C#

In most object-oriented languages it is possible to omit the body of a virtual method in a base class. In Java and C#, one does so by labeling both the class and the missing method as `abstract`:

```
abstract class person {
    ...
    public abstract void print_mailing_label();
    ...
}
```

EXAMPLE 9.38

Abstract methods in C++

The notation in C++ is somewhat less intuitive: one follows the subroutine declaration with an “assignment” to zero:

```
class person {
    ...
public:
    virtual void print_mailing_label() = 0;
    ...
}
```

C++ refers to abstract methods as *pure virtual* methods. In Simula all virtual methods are abstract.

Regardless of declaration syntax, a *class* is said to be abstract if it has at least one abstract method. It is not possible to declare an object of an abstract class, because it would be missing at least one member. The only purpose of an abstract class is to serve as a base for other, *concrete* classes. A concrete class (or one of its intermediate ancestors) must provide a real definition for every abstract method it inherits. The existence of an abstract method in a base class provides a “hook” for dynamic method binding; it allows the programmer to write code that calls methods of (references to) objects of the base class, under the assumption that appropriate concrete methods will be invoked at run time. Classes that have no members other than abstract methods—no fields or method bodies—are called *interfaces* in Java, C#, and Ada 2005. They support a restricted, “mix-in” form of multiple inheritance, which we will consider in Section ©9.5.4.⁵

9.4.3 Member Lookup

With static method binding (as in Simula, C++, C#, or Ada 95), the compiler can always tell which version of a method to call, based on the type of the variable

⁵ An abstract virtual method in Eiffel is called a *deferred feature*. (Recall that all features are virtual.) An abstract class is called a *deferred class*. A concrete class is called an *effective class*. An interface in the Java or C# sense of the word is called a *fully deferred class*.

```

class foo {
    int a;
    double b;
    char c;
public:
    virtual void k( ...
    virtual int l( ...
    virtual void m();
    virtual double n( ...
    ...
} F;

```

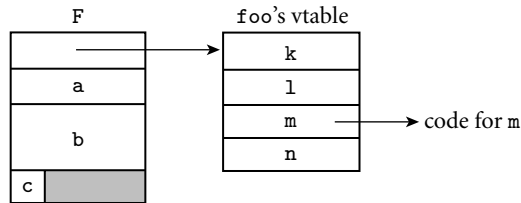

Figure 9.3 Implementation of virtual methods. The representation of object `F` begins with the address of the vtable for class `foo`. (All objects of this class will point to the same vtable.) The vtable itself consists of an array of addresses, one for the code of each virtual method of the class. The remainder of `F` consists of the representations of its fields.

EXAMPLE 9.39

Vtables

being used. With dynamic method binding, however, the object referred to by a reference or pointer variable must contain sufficient information to allow the code generated by the compiler to find the right version of the method at run time. The most common implementation represents each object with a record whose first field contains the address of a *virtual method table* (*vtable*) for the object's class (see Figure 9.3). The vtable is an array whose *i*th entry indicates the address of the code for the object's *i*th virtual method. All objects of a given class share the same vtable. ■

EXAMPLE 9.40

Implementation of a virtual method call

Suppose that the `this` (`self`) pointer for methods is passed in register `r1`, that `m` is the third method of class `foo`, and that `f` is a pointer to an object of class `foo`. Then the code to call `f->m()` looks something like this:

```

r1 := f
r2 := *r1                -- vtable address
r2 := *(r2 + (3-1) × 4)  -- assuming 4 = sizeof (address)
call *r2

```

On a typical RISC machine this calling sequence is two instructions (both of which access memory) longer than a call to a statically identified method. The extra overhead can be avoided whenever the compiler can deduce the type of the relevant object at compile time. The deduction is trivial for calls to methods of object-valued variables (as opposed to references and pointers). ■

EXAMPLE 9.41

Implementation of single inheritance

If `bar` is derived from `foo`, we place its additional fields at the end of the “record” that represents it. We create a vtable for `bar` by copying the vtable for `foo`, replacing the entries of any virtual methods overridden by `bar`, and appending entries for any virtual methods declared in `bar` (see Figure 9.4). If we have an object of class `bar` we can safely assign its address into a variable of type `foo*`:

```

class bar : public foo {
    int w;
public:
    void m(); //override
    virtual double s( ...
    virtual char *t( ...
    ...
} B;

```

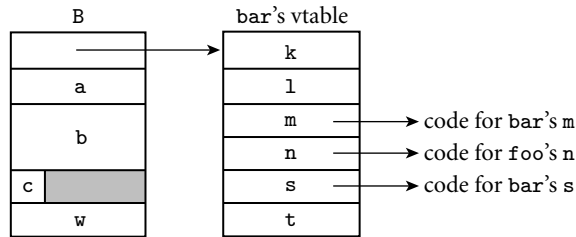

Figure 9.4 Implementation of single inheritance. As in Figure 9.3, the representation of object **B** begins with the address of its class's vtable. The first four entries in the table represent the same members as they do for **foo**, except that one—**m**—has been overridden and now contains the address of the code for a different subroutine. Additional fields of **bar** follow the ones inherited from **foo** in the representation of **B**; additional virtual methods follow the ones inherited from **foo** in the vtable of class **bar**.

```

class foo { ...
class bar : public foo { ...
...
foo F;
bar B;
foo* q;
bar* s;
...
q = &B;    // ok; references through q will use prefixes
           // of B's data space and vtable
s = &F;    // static semantic error; F lacks the additional
           // data and vtable entries of a bar

```

In C++ (as in all statically typed object-oriented languages), the compiler can verify the type correctness of this code statically. It does not know what the class of the object referred to by **q** will be at run time, but it knows that it will either be **foo** or something derived (directly or indirectly) from **foo**, and this ensures that it will have all the members that may be accessed by **foo**-specific code. ■

C++ allows “backward” assignments by means of a `dynamic_cast` operator:

```
s = dynamic_cast<bar*>(q);    // performs a run-time check
```

EXAMPLE 9.42

Casts in C++

DESIGN & IMPLEMENTATION

Reverse assignment

Implementations of Eiffel, Java, C#, and C++ support dynamic checks on reverse assignment by including in each vtable the address of a run-time *type descriptor*. In C++, `dynamic_cast` is permitted only on pointers and references of polymorphic types (classes with virtual methods), since objects of nonpolymorphic types do not have vtables. A separate `static_cast` operation can be used on nonpolymorphic types, but it performs no run-time check, and is thus inherently unsafe when applied to a pointer of a derived class type.

If the run-time check fails, `s` is assigned a null pointer. For backward compatibility C++ also supports traditional C-style casts of object pointers and references:

```
s = (bar*) q;           // permitted, but risky
```

With a C-style cast it is up to the programmer to ensure that the actual object involved is of an appropriate type: no dynamic semantic check is performed. ■

EXAMPLE 9.43

Reverse assignment in Eiffel and C#

Java and C# employ the traditional cast notation, but perform the dynamic check. Eiffel has a *reverse assignment* operator, `?=`, which (like the C++ `dynamic_cast`) assigns an object reference into a variable if and only if the type at run time is acceptable:

```
class foo ...
class bar inherit foo ...
...
f : foo
b : bar
...
f := b    -- always ok
b ?= f    -- reverse assignment: b gets f if f refers to a bar object
           -- at run time; otherwise b gets void
```

C# provides an `as` operator that performs a similar function. ■

In Smalltalk, variables are *untyped* references. A reference to any object may be assigned into any variable. Only when code actually attempts to invoke an

DESIGN & IMPLEMENTATION

The fragile base class problem

Under certain circumstances, it can be desirable to perform method lookup at run time even when the language permits compile-time lookup. In Java, for example, programs are usually distributed in a portable “byte code” format that is either interpreted or “just-in-time” compiled. The standard “virtual machine” interpreter for byte code looks methods up at run time. By doing so it avoids what is known as the *fragile base class* problem. Java implementations depend on the presence of a large standard library. This library is expected to evolve over time. Though the designers of the library will presumably be careful to maximize backward compatibility—seldom if ever deleting any members of a class—it is likely that users of old versions of the library will on occasion attempt to run code that was written with a new version of the library in mind. In such a situation it would be disastrous to rely on static assumptions about the representation of library classes: code that tries to use a newly added library feature could end up accessing memory beyond the end of the available representation. Run-time method lookup, by contrast, will produce a helpful “member not found in your version of the class” dynamic error message.

operation (send a “message”) at run time does the language implementation check to see whether the operation is supported by the object. The implementation is straightforward: fields of an object are never public; methods provide the only means of object interaction. The representation of an object begins with the address of a type descriptor. The type descriptor contains a dictionary that maps method names to code fragments. At run time, the Smalltalk interpreter performs a lookup operation in the dictionary to see if the method is supported. If not, it generates a “message not understood” error—the equivalent of a type-clash error in Lisp. CLOS, Objective-C, and the object-oriented scripting languages provide similar semantics, and invite similar implementations. The dynamic approach is arguably more flexible than the static, but it incurs significant run-time cost, and delays the reporting of errors.

In addition to imposing the overhead of indirection, virtual methods often preclude the in-line expansion of subroutines at compile time. The lack of in-line subroutines can be a serious performance problem when subroutines are small and frequently called. Like C, C++ attempts to avoid run-time overhead whenever possible: hence its use of static method binding as the default, and its heavy reliance on object-valued variables, for which even virtual methods can be dispatched at compile time.

9.4.4 Polymorphism

We have already noted that dynamic method binding introduces polymorphism (specifically, *subtype* polymorphism) into any code that expects a reference to an object of some base class `foo`. So long as objects of the derived class support the operations of the base class, the code will work equally well with references to objects of any class derived from `foo`. By declaring a reference parameter to be of class `foo`, for example, the programmer asserts that the subroutine uses only the “`foo` features” of the parameter, and will work on any object that provides those features.

One might be tempted to think that the combination of inheritance and dynamic method binding would eliminate the need for generics, but this is not the case. We can see an example in the `gp_list_node` class and its descendants of [Section 9.1](#). By placing the structural aspects of an abstraction (in this case a list) in a base class, we make it easy to create type-specific lists: `int_list_node`, `float_list_node`, `student_list_node`, etc. Unfortunately, base class methods like `predecessor` and `successor` return references of the base class type, which do not then support type-specific operations. To allow us to access the values stored in objects returned by the list-manipulation routines, we must perform an explicit type cast:

```
int_list_node_ptr q, r;
...
r = q->successor();           // error: type clash
gp_list_node_ptr p = q->successor();
cout << p.val;                // error: gp_list_nodes have no val
```

EXAMPLE 9.44

Inheritance and method signatures

```

r = (int_list_node_ptr) q->successor();
cout << r.val;           // ok

```

The cast on the penultimate line here is both awkward and unsafe. We can't use a `dynamic_cast` operation because `gp_list_node` has no virtual members, and hence (in C++) no vtable. We can confine the awkwardness to the definition of `int_list_node` by redefining methods:

```

int_list_node* int_list_node::predecessor() {           // redefine
    return (int_list_node*) gp_list_node::predecessor();
}
int_list_node* int_list_node::successor() {           // redefine
    return (int_list_node*) gp_list_node::successor();
}

```

Unfortunately, redefining all of the appropriate arguments and return types of base class methods in every derived class is still a frustratingly tedious exercise, and the code is still unsafe: the compiler cannot verify type correctness. Generics get around both problems. In C++, we can write

EXAMPLE 9.45

Generics and inheritance

```

template<class V>
class list_node {
    list_node<V>* prev;
    list_node<V>* next;
    list_node<V>* head_node;
public:
    V val;
    list_node<V>* predecessor() { ...
    list_node<V>* successor() { ...
    void insert_before(list_node<V>* new_node) { ...
    ...
};

template<class V>
class list {
    list_node<V> header;
public:
    list_node<V>* head() { ...
    void append(list_node<V> *new_node) { ...
    ...
};

typedef list_node<int> int_list_node;
typedef list<int> int_list;
...
int_list numbers;
int_list_node* first_int;
...
first_int = numbers->head();

```

In a nutshell, generics exist for the purpose of abstracting over unrelated types, something that inheritance does not support. (NB: the type inference of ML and related languages *does* suffice to abstract over unrelated types; ML does not require generics. Also, while ML provides Euclid-like module types, it does not provide inheritance, and thus cannot be considered an object-oriented language.)

Eiffel, Java, and C# all provide generics as well. Java's version is somewhat simpler than the others: because object variables are always references, they always have the same size, and a single copy of the code can generally be shared by every instance of a generic. A detailed comparison of the generic facilities in C++, Java, and C# can be found in Section ©8.4.4.

EXAMPLE 9.46

Like in Eiffel

As a convenient shorthand, Eiffel allows the programmer to declare parameters and return values of methods to be of the same type as some “anchor” field of the class. Then if a derived class redefines the anchor, the parameters and return values are automatically redefined as well, without the need to specify them explicitly:

```

class gp_list_node ...
...
class gp_list
feature {NONE}                -- private
  header : gp_list_node      -- to be redefined by derived classes
feature {ALL}                  -- public
  head : like header is ...   -- methods
  append(new_node : like header) is ...
...
end
...
class student_list_node inherit gp_list_node ...
...
class student_list
  inherit gp_list
  redefine header end
feature {NONE}
  header : student_list_node
  -- don't need to redefine head and append
end

```

DESIGN & IMPLEMENTATION**Generics and dynamic method dispatch**

As noted in [Section 3.5.3](#), generics (explicit parametric polymorphism) are usually implemented by creating multiple copies of the polymorphic code, one specialized for each needed concrete type. (Java is an exception: it uses a single copy. Other languages may share specializations when possible.) Subtype polymorphism is almost always implemented by creating a single copy of the code, and relying on vtables for dynamic method dispatch. So in object-oriented languages parametric and subtype polymorphism not only serve different purposes, they typically have very different implementations.

The `like` mechanism does not eliminate the need for generics, but it makes it easier to define them, or to do without them in simple situations. ■

9.4.5 Object Closures

We have noted several times that object closures can be used in an object-oriented language to achieve roughly the same effect as subroutine closures in a language with nested subroutines: namely, to encapsulate a method with *context* for later execution. It should be noted that this mechanism relies, for its full generality, on dynamic method binding. Recall the `plus_x` object closure from [Example 3.38](#) in [Chapter 3](#), here adapted to the `apply_to_A` code of 8.21, and rewritten in generic form:

EXAMPLE 9.47

Virtual methods in an object closure

```
template<class T>
class un_op {
public:
    virtual T operator()(T i) const = 0;
};

class plus_x : public un_op<int> {
    const int x;
public:
    plus_x(int n) : x(n) { }
    virtual int operator()(int i) const { return i + x; }
};

void apply_to_A(const un_op<int>& f, int A[], int A_size) {
    int i;
    for (i = 0; i < A_size; i++) A[i] = f(A[i]);
}

...
int A[10];
apply_to_A(plus_x(2), A, 10);
```

Any object derived from `un_op<int>` can be passed to `apply_to_A`. The “right” function will always be called because `operator()` is virtual. ■

EXAMPLE 9.48

Encapsulating arguments

A particularly useful idiom for many applications is to encapsulate a method *and its arguments* in an object closure for later execution. Suppose, for example, that we are writing a discrete event simulation, as described in Section ©8.6.4. We might like a general mechanism that allows us to schedule a call to an arbitrary subroutine, with an arbitrary set of parameters, to occur at some future point in time. If the subroutines we want to have called vary in their numbers and types of parameters, we won’t be able to pass them to a general-purpose `schedule_at` routine. We can solve the problem with object closures, as shown in [Figure 9.5](#). As we shall see in [Section 12.2.3](#), this same technique is used in Java (and several other

```

class fn_call {
public:
    virtual void trigger() = 0;
};
void schedule_at(fn_call& fc, time t) {
    ...
}
...
void foo(int a, double b, char c) {
    ...
}
class call_foo : public fn_call {
    int arg1;
    double arg2;
    char arg3;
public:
    call_foo(int a, double b, char c) :    // constructor
        arg1(a), arg2(b), arg3(c) {
        // member initialization is all that is required
    }
    void trigger() {
        foo(arg1, arg2, arg3);
    }
};
...
call_foo cf(3, 3.14, 'x');           // declaration/constructor call
schedule_at(cf, now() + delay);
    // at some point in the future, the discrete event system
    // will call cf.trigger(), which will cause a call to
    // foo(3, 3.14, 'x')

```

Figure 9.5 Subroutine pointers and virtual methods. Class `call_foo` encapsulates a subroutine pointer and values to be passed to the subroutine. It exports a parameter-less subroutine that can be used to trigger the encapsulated call.

languages) to encapsulate start-up arguments for newly created threads of control. In Exploration 6.42 we also noted that it can be used to implement iterators via the *visitor pattern*. ■

✓ CHECK YOUR UNDERSTANDING

31. Explain the difference between dynamic and static method binding (i.e., between *virtual* and *nonvirtual* methods).
32. Summarize the fundamental argument for dynamic method binding. Why do C++ and C# use static method binding by default?
33. Explain the distinction between *redefining* and *overriding* a method.

34. What is a *class-wide* type in Ada 95?
 35. Explain the connection between dynamic method binding and polymorphism.
 36. What is an *abstract* method (also called a *pure* virtual method in C++ and a *deferred feature* in Eiffel)?
 37. What is *reverse assignment*? Why does it require a run-time check?
 38. What is a *vtable*? How is it used?
 39. What is the *fragile base class* problem?
 40. What is an *abstract (deferred) class*?
 41. Explain why generics may be useful in an object-oriented language, despite the extensive polymorphism already provided by inheritance.
 42. Explain the use of `like` in Eiffel.
 43. Explain the importance of virtual methods for object closures.
-

9.5 Multiple Inheritance

EXAMPLE 9.49

Deriving from two base classes

At times it can be useful for a derived class to inherit features from more than one base class. Suppose, for example, that we want our administrative computing system to keep all students of the same year (freshmen, sophomores, juniors, seniors, nonmatriculated) on some list. It may then be desirable to derive class `student` from both `person` and `gp_list_node`. In C++ we can say

```
class student : public person, public gp_list_node { ...
```

Now an object of class `student` will have all the fields and methods of both a `person` and a `gp_list_node`. The declaration in Eiffel is analogous:

```
class student
inherit
    person
    gp_list_node
feature
    ...
```

Multiple inheritance also appears in CLOS and Python. Simula, Smalltalk, Objective-C, Modula-3, Ada 95, and Oberon have only single inheritance. Java, C#, and Ruby provide a limited, “mix-in” form of multiple inheritance, in which only one parent class is permitted to have fields. ■

© IN MORE DEPTH

Multiple inheritance introduces a wealth of semantic and pragmatic issues, which we consider on the PLP CD.

- Suppose two parent classes provide a method with the same name. Which one do we use in the child? Can we access both?
- Suppose two parent classes are both derived from some common “grandparent” class. Does the “grandchild” have one copy or two of the grandparent’s fields?
- Our implementation of single inheritance relies on the fact that the representation of an object of the parent class is a prefix of the representation of an object of a derived class. With multiple inheritance, how can *each* parent be a prefix of the child?

Multiple inheritance with a common “grandparent” is known as *repeated* inheritance. Repeated inheritance with separate copies of the grandparent is known as *replicated* inheritance; repeated inheritance with a single copy of the grandparent is known as *shared* inheritance. Shared inheritance is the default in Eiffel. Replicated inheritance is the default in C++. Both languages allow the programmer to obtain the other option when desired.

Much of the complexity disappears if we insist, as Java, C#, or Ada 2005, that all but one of the parent classes consist of methods only. All three languages call such a class an *interface*.

9.6 Object-Oriented Programming Revisited

At the beginning of this chapter, we characterized object-oriented programming in terms of three fundamental concepts: encapsulation, inheritance, and dynamic method binding. Encapsulation allows the implementation details of an abstraction to be hidden behind a simple interface. Inheritance allows a new abstraction to be defined as an extension or refinement of some existing abstraction, obtaining some or all of its characteristics automatically. Dynamic method binding allows the new abstraction to display its new behavior even when used in a context that expects the old abstraction.

Different programming languages support these fundamental concepts to different degrees. In particular, languages differ in the extent to which they *require* the programmer to write in an object-oriented style. Some authors argue that a *truly* object-oriented language should make it difficult or impossible to write programs that are not object-oriented. From this purist point of view, an object-oriented language should present a *uniform object model* of computing, in which every data type is a class, every variable is a reference to an object, and every subroutine is an object method. Moreover, objects should be thought of in *anthropomorphic terms*: as active entities responsible for all computation.

Smalltalk and Ruby come close to this ideal. In fact, as described in the subsection below (mostly on the PLP CD), even such control flow mechanisms as selection and iteration are modeled as method invocations in Smalltalk. On the other hand, Modula-3 and Ada 95 are probably best characterized as von Neumann languages that *permit* the programmer to write in an object-oriented style if desired.

So what about C++? It certainly has a wealth of features, including several (multiple inheritance, elaborate access control, strict initialization order, destructors, generics) that are useful in object-oriented programs and that are not found in Smalltalk. At the same time, it has a wealth of problematic wrinkles. Its simple types are not classes. It has subroutines outside of classes. It uses static method binding and replicated multiple inheritance by default, rather than the more costly `virtual` alternatives. Its unchecked C-style type casts provide a major loophole for type checking and access control. Its lack of garbage collection is a major obstacle to the creation of correct, self-contained abstractions. Probably most serious of all, C++ retains all of the low-level mechanisms of C, allowing the programmer to escape or subvert the object-oriented model of programming entirely. It has been suggested that the best C++ programmers are those who did *not* learn C first: they are not as tempted to write “C-style” programs in the newer language. On balance, it is probably safe to say that C++ is an object-oriented language in the same sense that Common Lisp is a functional language. With the possible exception of garbage collection, C++ provides all of the necessary tools, but it requires substantial discipline on the part of the programmer to use those tools “correctly.”

9.6.1 The Object Model of Smalltalk

Smalltalk is to a large extent the canonical object-oriented language. The original version of Smalltalk was designed by Alan Kay as part of his doctoral work at the University of Utah in the late 1960s. It was then adopted by the Software Concepts Group at the Xerox Palo Alto Research Center (PARC), and went through five major revisions in the 1970s, culminating in the Smalltalk-80 language.⁶

© IN MORE DEPTH

We have mentioned several features of Smalltalk in previous sections. A somewhat longer treatment can be found on the PLP CD, where we focus in particular on Smalltalk’s anthropomorphic programming model. A full introduction to the language is beyond the scope of this book.

⁶ Alan Kay (1940–) joined PARC in 1972. In addition to developing Smalltalk and its graphical user interface, he conceived and promoted the idea of the laptop computer, well before it was feasible to build one. He became a Fellow at Apple Computer in 1984, and has subsequently held positions at Disney and Hewlett-Packard. He received the ACM Turing Award in 2003.

9.7 Summary and Concluding Remarks

This has been the last of our five core chapters on language design: names (Chapter 3), control flow (Chapter 6), types (Chapter 7), subroutines (Chapter 8), and objects (Chapter 9).

We began in Section 9.1 by identifying three fundamental concepts of object-oriented programming: *encapsulation*, *inheritance*, and *dynamic method binding*. We also introduced the terminology of classes, objects, and methods. We had already seen encapsulation in the modules of Chapter 3. Encapsulation allows the details of a complicated data abstraction to be hidden behind a comparatively simple interface. Inheritance extends the utility of encapsulation by making it easy for programmers to define new abstractions as refinements or extensions of existing abstractions. Inheritance provides a natural basis for polymorphic subroutines: if a subroutine expects an instance of a given class as argument, then an object of any class derived from the expected one can be used instead (assuming that it retains the entire existing interface). Dynamic method binding extends this form of polymorphism by arranging for a call to one of the parameter's methods to use the implementation associated with the class of the actual object at run time, rather than the implementation associated with the declared class of the parameter. We noted that some languages, including Modula-3, Oberon, Ada 95, and Fortran 2003, support object orientation through a *type extension* mechanism, in which encapsulation is associated with modules, but inheritance and dynamic method binding are associated with a special form of record.

In later sections we covered object initialization and finalization, dynamic method binding, and (on the PLP CD) multiple inheritance in some detail. In many cases we discovered tradeoffs between functionality on the one hand and simplicity and execution speed on the other. Treating variables as references, rather than values, often leads to simpler semantics, but requires extra indirection. Garbage collection, as previously noted in Section 7.7.3, dramatically eases the creation and maintenance of software, but imposes run-time costs. Dynamic method binding requires (in the general case) that methods be dispatched using vtables or some other lookup mechanism. Simple implementations of multiple inheritance impose overheads even when unused.

In several cases we saw time/space tradeoffs as well. In-line subroutines, as previously noted in Section 8.2.4, can dramatically improve the performance of code with many small subroutines, not only by eliminating the overhead of the subroutine calls themselves, but by allowing register allocation, common subexpression analysis, and other “global” code improvements to be applied across calls. At the same time, in-line expansion generally increases the size of object code. Exercises ©9.28 and ©9.30 explore similar tradeoffs in the implementation of multiple inheritance.

Despite its lack of multiple inheritance, Smalltalk is widely regarded as the purest and most flexible of the object-oriented languages. Its lack of compile-time type checking, however, together with its “message-based” model of computation

and its need for dynamic method lookup, render its implementations rather slow. C++, with its object-valued variables, default static binding, minimal dynamic checks, and high-quality compilers, is largely responsible for the growing popularity of object-oriented programming. Improvements in reliability, maintainability, and code reuse may or may not justify the high performance overhead of Smalltalk. They almost certainly justify the relatively modest overhead of C++, and probably the slightly higher overhead of Eiffel as well. With the ever-increasing size of software systems, the explosive growth of distributed computing on the Internet, and the development of highly portable object-oriented languages (Java), object-oriented scripting languages (Python, Ruby, PHP, JavaScript), and binary object standards (.NET [WHA03], CORBA [Sie96], JavaBeans [Sun97]), object-oriented programming will clearly play a central role in 21st-century computing.

9.8 Exercises

- 9.1 Some language designers argue that object orientation eliminates the need for nested subroutines. Do you agree? Why or why not?
- 9.2 Design a class hierarchy to represent syntax trees for the CFG of [Figure 4.5](#) (page 190). Provide a method in each class to return the value of a node. Provide constructors that play the role of the `make_leaf`, `make_un_op`, and `make_bin_op` subroutines.
- 9.3 Repeat the previous exercise, but using a variant record (union) type to represent syntax tree nodes. Repeat again using type extensions. Compare the three solutions in terms of clarity, abstraction, type safety, and extensibility.
- 9.4 Write a C# class that represents complex numbers. Provide four *properties*, for x , y , ρ , and θ . Discuss the time and space tradeoffs between maintaining all four values in the state of the object, or keeping only two and computing the others on demand.
- 9.5 Rewrite the list and queue classes of [Section 9.1](#) in such a way that objects not derived from a container base class can still be inserted in a list or queue. You will probably want to include a pointer to data, rather than the data itself, in each node of a list/queue.
- 9.6 In the spirit of [Example 9.7](#), write a *double-ended queue* (deque) abstraction (pronounced “deck”), derived from a doubly-linked list base class. Borrowing terminology from Icon, name your methods `put` (add at tail), `get` (remove at head), `push` (add at head), and `pull` (remove at tail).
- 9.7 Use templates (generics) to abstract your solutions to the previous two questions over the type of data in the container.
- 9.8 Repeat [Exercise 9.6](#) in Python or Ruby. Write a simple program to demonstrate that generics are not needed to abstract over types. What happens if you mix objects of different types in the same deque?

```

1. interface Pingable {
2.     public void ping();
3. }

4. class Counter implements Pingable {
5.     int count = 0;
6.     public void ping() {
7.         ++count;
8.     }
9.     public int val() {
10.        return count;
11.    }
12. }

13. public class Ping {
14.     public static void main(String args[]) {
15.         Counter c = new Counter();
16.
17.         c.ping();
18.         c.ping();
19.         int v = c.val();
20.         System.out.println(v);
21.     }
22. }

```

Figure 9.6 A simple program in Java.

- 9.9 Can you emulate the inner class of [Example 9.19](#) in C# or C++? (Hint: you'll need an explicit version of Java's hidden reference to the surrounding class.)
- 9.10 Write a package body for the list abstraction of [Figure 9.2](#).
- 9.11 Rewrite the list and queue abstractions in Eiffel, Java, and/or C#.
- 9.12 Using C++, Java, or C#, implement a `Complex` class in the spirit of [Example 9.22](#).
- 9.13 Repeat the previous two exercises for Python and/or Ruby.
- 9.14 Compare Java `final` methods with C++ nonvirtual methods. How are they the same? How are they different?
- 9.15 Consider the Java program shown in [Figure 9.6](#). Assume that this is to be compiled to native code on a machine with 4-byte addresses.
 - (a) Draw a picture of the layout in memory of the object created at line 15. Show all virtual function tables.
 - (b) Give assembly-level pseudocode for the call to `c.val` at line 19. You may assume that the address of `c` is in register `r1` immediately before the call, and that this same register should be used to pass the hidden

this parameter. You may ignore the need to save and restore registers, and don't worry about where to put the return value.

- (c) Give assembly-level pseudocode for the call to `c.ping` at line 17. Again, assume that the address of `c` is in register `r1`, that this is the same register that should be used to pass `this`, and that you don't need to save or restore any registers.
- (d) Give assembly-level pseudocode for the body of method `Counter.ping` (again ignoring register save/restore).

- 9.16** In several object-oriented languages, including C++ and Eiffel, a derived class can hide members of the base class. In C++, for example, we can declare a base class to be `public`, `protected`, or `private`:

```
class B : public A { ...
    // public members of A are public members of B
    // protected members of A are protected members of B
    ...
class C : protected A { ...
    // public and protected members of A are protected members of C
    ...
class D : private A { ...
    // public and protected members of A are private members of D
```

In all cases, `private` members of `A` are inaccessible to methods of `B`, `C`, or `D`.

Consider the impact of `protected` and `private` base classes on dynamic method binding. Under what circumstances can a reference to an object of class `B`, `C`, or `D` be assigned into a variable of type `A*`?

- 9.17** What happens to the implementation of a class if we redefine a data member? For example, suppose we have:

```
class foo {
public:
    int a;
    char *b;
};
...
class bar : public foo {
public:
    float c;
    int b;
};
```

Does the representation of a `bar` object contain one `b` field or two? If two, are both accessible, or only one? Under what circumstances?

- 9.18** Discuss the relative merits of classes and type extensions. Which do you prefer? Why?

- 9.19 Building on the outline of [Example 9.25](#), write a program that illustrates the difference between copy constructors and `operator=` in C++. Your code should include examples of each situation in which one of these may be called (don't forget parameter passing and function returns). Instrument the copy constructors and assignment operators in each of your classes so that they will print their names when called. Run your program to verify that its behavior matches your expectations.
- 9.20 What do you think of the decision, in C++, C#, and Ada 95, to use static method binding, rather than dynamic, by default? Is the gain in implementation speed worth the loss in abstraction and reusability? Assuming that we sometimes want static binding, do you prefer the method-by-method approach of C++ and C#, or the variable-by-variable approach of Ada 95? Why?
- 9.21 If `foo` is an abstract class in a C++ program, why is it acceptable to declare variables of type `foo*`, but not of type `foo`?
- © 9.22–9.32 In More Depth.

9.9 Explorations

- 9.33 Return for a moment to [Exercise 3.7](#). Build a (more complete) C++ version of the singly-linked list library of [Figure 3.17](#). Discuss the issue of storage management. Under what circumstances should one delete the elements of a list when deleting the list itself? What should the destructor for `list_node` do? Should it delete its `data` member? Should it recursively delete `node next`?
- 9.34 Learn about the *indexer* mechanism in C#, and use it to create a hash table class that can be indexed like an array. (In effect, create a simple version of the `System.Collections.Hashtable` container class.) Alternatively, use an overloaded version of `operator[]` to build a similar class in C++.
- 9.35 The discussion in this chapter has focused on the classic “class-based” approach to object-oriented programming languages, pioneered by Simula and Smalltalk. There is an alternative, “object-based” approach that dispenses with the notion of class. In object-based programming, methods are directly associated with objects, and new objects are created using existing objects as *prototypes*. Learn about Self, the canonical object-based programming language, and JavaScript, the most widely used. What do you think of their approach? How does it compare to the class-based alternative? You may find it helpful to read the coverage of JavaScript in [Section 13.4.4](#).
- 9.36 As described in [Section ©5.5.1](#), performance on pipelined processors depends critically on the ability of the hardware to successfully predict the outcome of branches, so that processing of subsequent instructions can begin before processing of the branch has completed. In object-oriented

programs, however, knowing the outcome of a branch is not enough: because branches are so often dispatched through vtables, one must also predict the *destination*. Learn how branch prediction works in one or more modern processors. How well do these processors handle object-oriented programs?

- 9.37 Learn about *type hierarchy analysis* and *type propagation*, which can often be used in languages like C++ to infer the concrete type of objects at compile time, allowing the compiler to generate direct calls to methods, rather than indirecting through vtables. How effective are these techniques? What fraction of method calls are they able to optimize in typical benchmarks? What are their limitations? (You might start with the papers of Bacon and Sweeney [BS96] and Diwan et al. [DMM96].)

© 9.38–9.40 In More Depth.

9.10 Bibliographic Notes

Appendix A contains bibliographic citations for the various languages discussed in this chapter, including Simula, Smalltalk, C++, Eiffel, Java, C#, Modula-3, Python, Ruby, Ada 95, Oberon, and CLOS. Other object-oriented versions of Lisp include Loops [BS83a] and Flavors [Moo86].

Ellis and Stroustrup [ES90] provide extensive discussion of both semantic and pragmatic issues for C++. Chapters 16 through 19 of Stroustrup's text on C++ [Str97] contain a good introduction to the design and implementation of container classes. Deutsch and Schiffman [DS84] describe techniques to implement Smalltalk efficiently. Borning and Ingalls [BI82] discuss multiple inheritance in an extension to Smalltalk-80. Gil and Sweeney [GS99] describe optimizations that can be used to reduce the time and space complexity of multiple inheritance.

Dolby describes how an optimizing compiler can identify circumstances in which a nested object can be expanded (in the Eiffel sense) while retaining reference semantics [Dol97]. Bacon and Sweeney [BS96] and Diwan et al. [DMM96] discuss techniques to infer the concrete type of objects at compile time, thereby avoiding the overhead of vtable indirection. Driesen presents an alternative to vtables that requires whole-program analysis, but provides extremely efficient method dispatch, even in languages with dynamic typing and multiple inheritance [Dri93].

Component systems provide a standard for the specification of object interfaces, allowing code produced by arbitrary compilers for arbitrary languages to be joined together into a working program, often spanning a distributed collection of machines. CORBA [Sie96] is a component standard promulgated by the Object Management Group, a consortium of over 700 companies. .NET [WHA03] is a competing standard from Microsoft Corporation, based in part on their earlier ActiveX, DCOM, and OLE [Bro96] products. JavaBeans [Sun97] is a CORBA-compliant binary standard for components written in Java.

Many of the seminal papers in object-oriented programming have appeared in the proceedings of the *ACM OOPSLA* conferences (Object-Oriented Programming Systems, Languages, and Applications), held annually since 1986, and published as special issues of *ACM SIGPLAN Notices*. Wegner [Weg90] enumerates the defining characteristics of object orientation. Meyer [Mey92b, Sec. 21.10] explains the rationale for dynamic method binding. Ungar and Smith [US91] describe Self, the canonical object-based (as opposed to class-based) language.

This page intentionally left blank



Alternative Programming Models

As we noted in [Chapter 1](#), programming languages are traditionally though imperfectly classified into various imperative and declarative families. We have had occasion in [Parts I and II](#) to mention issues of particular importance to each of the major families. Moreover much of what we have covered—syntax, semantics, naming, types, abstraction—applies uniformly to all. Still, our attention has focused mostly on mainstream imperative languages. In [Part III](#) we shift this focus.

Functional and logic languages are the principal nonimperative options. We consider them in [Chapters 10 and 11](#), respectively. In each case we structure our discussion around a representative language: Scheme for functional programming, Prolog for logic programming. In [Chapter 10](#) we also cover eager and lazy evaluation, and first-class and higher-order functions. In [Chapter 11](#) we cover issues that make fully automatic, general purpose logic programming difficult, and describe restrictions used in practice to keep the model tractable. Optional sections in both chapters consider mathematical foundations: Lambda Calculus for functional programming, Predicate Calculus for logic programming.

The remaining two chapters consider concurrent and scripting models, both of which are increasingly popular, and cut across the imperative/declarative divide. Concurrency is driven by the hardware parallelism of internetworked computers and by the coming explosion in multithreaded processors and chip-level multiprocessors. Scripting is driven by the growth of the World Wide Web and by an increasing emphasis on programmer productivity, which places rapid development and reusability above sheer run-time performance.

[Chapter 12](#) begins with the fundamentals of concurrency, including communication and synchronization, thread creation syntax, and the implementation of threads. The remainder of the chapter is divided between *shared-memory* models, in which threads use explicit or implicit synchronization mechanisms to manage a common set of variables, and *message-passing* models, in which threads interact only through explicit communication.

The first half of [Chapter 13](#) surveys problem domains in which scripting plays a major role: shell (command) languages, text processing and report generation, mathematics and statistics, the “gluing” together of program components, extension mechanisms for complex applications, and client and server-side Web scripting. The second half considers some of the more important language innovations championed by scripting languages: flexible scoping and naming conventions, string and pattern manipulation (extended regular expressions), and high level data types.

This page intentionally left blank

10 Functional Languages

Previous chapters of this text have focused largely on imperative programming languages. In the current chapter and the next we emphasize functional and logic languages instead. While imperative languages are far more widely used, “industrial-strength” implementations exist for both functional and logic languages, and both models have commercially important applications. Lisp has traditionally been popular for the manipulation of symbolic data, particularly in the field of artificial intelligence. In recent years functional languages—statically typed ones in particular—have become increasingly popular for scientific and business applications as well. Logic languages are widely used for formal specifications and theorem proving and, less widely, for many other applications.

Of course, functional and logic languages have a great deal in common with their imperative cousins. Naming and scoping issues arise under every model. So do types, expressions, and the control-flow concepts of selection and recursion. All languages must be scanned, parsed, and analyzed semantically. In addition, functional languages make heavy use of subroutines—more so even than most von Neumann languages—and the notions of concurrency and nondeterminacy are as common in functional and logic languages as they are in the imperative case.

As noted in [Chapter 1](#), the boundaries between language categories tend to be rather fuzzy. One can write in a largely functional style in many imperative languages, and many functional languages include imperative features (assignment and iteration). The most common logic language—Prolog—provides certain imperative features as well. Finally, it is easy to build a logic programming system in most functional programming languages.

Because of the overlap between imperative and functional concepts, we have had occasion several times in previous chapters to consider issues of particular importance to functional programming languages. Most such languages depend heavily on polymorphism (the implicit parametric kind—[Sections 3.5.3](#) and [©7.2.4](#)). Most make heavy use of lists ([Section 7.8](#)). Several, historically, were dynamically scoped ([Sections 3.3.6](#) and [©3.4.2](#)). All employ recursion ([Section 6.6](#)) for repetitive execution, with the result that program behavior and performance depend heavily on the evaluation rules for parameters

(Section 6.6.2). All have a tendency to generate significant amounts of temporary data, which their implementations reclaim through garbage collection (Section 7.7.3).

Our chapter begins with a brief introduction to the historical origins of the imperative, functional, and logic programming models. We then enumerate fundamental concepts in functional programming and consider how these are realized in the Scheme dialect of Lisp. More briefly, we also consider Caml, Common Lisp, Erlang, Haskell, ML, Miranda, pH, Single Assignment C, and Sisal. We pay particular attention to issues of evaluation order and higher-order functions. For those with an interest in the theoretical foundations of functional programming, we provide (on the PLP CD) an introduction to functions, sets, and the lambda calculus. The formalism helps to clarify the notion of a “pure” functional language, and illuminates the differences between the pure notation and its realization in more practical programming languages.

10.1 Historical Origins

To understand the differences among programming models, it can be helpful to consider their theoretical roots, all of which predate the development of electronic computers. The imperative and functional models grew out of work undertaken by mathematicians Alan Turing, Alonzo Church, Stephen Kleene, Emil Post, and others in the 1930s. Working largely independently, these individuals developed several very different formalizations of the notion of an algorithm, or *effective procedure*, based on automata, symbolic manipulation, recursive function definitions, and combinatorics. Over time, these various formalizations were shown to be equally powerful: anything that could be computed in one could be computed in the others. This result led Church to conjecture that *any* intuitively appealing model of computing would be equally powerful as well; this conjecture is known as *Church’s thesis*.

Turing’s model of computing was the *Turing machine*, an automaton reminiscent of a finite or pushdown automaton, but with the ability to access arbitrary cells of an unbounded storage “tape.”¹ The Turing machine computes in an imperative way, by changing the values in cells of its tape, just as a high-level imperative program computes by changing the values of variables. Church’s model of computing is called the *lambda calculus*. It is based on the notion of parameterized expressions (with each parameter introduced by an occurrence of the

¹ Alan Turing (1912–1954), for whom the Turing Award is named, was a British mathematician, philosopher, and computer visionary. As intellectual leader of Britain’s cryptanalytic group during World War II, he was instrumental in cracking the German “Enigma” code and turning the tide of the war. He also laid the theoretical foundations of modern computer science, conceived the general purpose electronic computer, and pioneered the field of Artificial Intelligence. Persecuted as a homosexual after the war, stripped of his security clearance, and sentenced to “treatment” with drugs, he committed suicide.

letter λ —hence the notation’s name).² Lambda calculus was the inspiration for functional programming: one uses it to compute by substituting parameters into expressions, just as one computes in a high level functional program by passing arguments to functions. The computing models of Kleene and Post are more abstract, and do not lend themselves directly to implementation as a programming language.

The goal of early work in computability was not to understand computers (aside from purely mechanical devices, computers did not exist) but rather to formalize the notion of an effective procedure. Over time, this work allowed mathematicians to formalize the distinction between a *constructive* proof (one that shows how to obtain a mathematical object with some desired property) and a *nonconstructive* proof (one that merely shows that such an object must exist, perhaps by contradiction, or counting arguments, or reduction to some other theorem whose proof is nonconstructive). In effect, a program can be seen as a constructive proof of the proposition that, given any appropriate inputs, there exist outputs that are related to the inputs in a particular, desired way. Euclid’s algorithm, for example, can be thought of as a constructive proof of the proposition that every pair of non-negative integers has a greatest common divisor.

Logic programming is also intimately tied to the notion of constructive proofs, but at a more abstract level. Rather than write a general constructive proof that works for all appropriate inputs, the logic programmer writes a set of *axioms* that allow the *computer* to discover a constructive proof for each particular set of inputs. We will consider logic programming in more detail in [Chapter 11](#).

10.2 Functional Programming Concepts

In a strict sense of the term, *functional programming* defines the outputs of a program as a mathematical function of the inputs, with no notion of internal state, and thus no side effects. Among the languages we consider here, Miranda, Haskell, pH, Sisal, and Single Assignment C are purely functional. Erlang is nearly so. Most others include imperative features. To make functional programming practical, functional languages provide a number of features that are often missing in imperative languages, including:

- First-class function values and higher-order functions
- Extensive polymorphism

² Alonzo Church (1903–1995) was a member of the mathematics faculty at Princeton University from 1929 to 1967, and at UCLA from 1967 to 1990. While at Princeton he supervised the doctoral theses of, among many others, Alan Turing, Stephen Kleene, Michael Rabin, and Dana Scott. His codiscovery, with Turing, of uncomputable problems was a major breakthrough in understanding the limits of mathematics.

- List types and operators
- Structured function returns
- Constructors (aggregates) for structured objects
- Garbage collection

In [Section 3.6.2](#) we defined a first-class value as one that can be passed as a parameter, returned from a subroutine, or (in a language with side effects) assigned into a variable. Under a strict interpretation of the term, first-class status also requires the ability to create (compute) new values at run time. In the case of subroutines, this notion of first-class status requires nested lambda expressions that can capture values (with unlimited extent) defined in surrounding scopes. Subroutines are second-class values in most imperative languages, but first-class values (in the strict sense of the term) in all functional programming languages. A *higher-order function* takes a function as an argument, or returns a function as a result.

Polymorphism is important in functional languages because it allows a function to be used on as general a class of arguments as possible. As we have seen in [Sections 7.1](#) and [7.2.4](#), Lisp and its dialects are dynamically typed, and thus inherently polymorphic, while ML and its relatives obtain polymorphism through the mechanism of type inference. Lists are important in functional languages because they have a natural recursive definition, and are easily manipulated by operating on their first element and (recursively) the remainder of the list. Recursion is important because in the absence of side effects it provides the only means of doing anything repeatedly.

Several of the items in our list of functional language features (recursion, structured function returns, constructors, garbage collection) can be found in some but not all imperative languages. Fortran 77 has no recursion, nor does it allow structured types (i.e., arrays) to be returned from functions. Pascal and early versions of Modula-2 allow only simple and pointer types to be returned from functions. As we saw in [Section 7.1.5](#), several imperative languages, including Ada, C, and Fortran 90, provide aggregate constructs that allow a structured value to be specified in-line. In most imperative languages, however, such constructs are lacking or incomplete. C# 3.0 and several scripting languages—Python and Ruby among them—provide aggregates capable of representing an (unnamed) functional value (a *lambda expression*), but few imperative languages are so expressive. A pure functional language must provide completely general aggregates: because there is no way to update existing objects, newly created ones must be initialized “all at once.” Finally, though garbage collection is increasingly common in imperative languages, it is by no means universal, nor does it usually apply to the local variables of subroutines, which are typically allocated in the stack. Because of the desire to provide unlimited extent for first-class functions and other objects, functional languages tend to employ a (garbage-collected) heap for *all* dynamically allocated data (or at least for all data for which the compiler is unable to prove that stack allocation is safe).

Because Lisp was the original functional language, and is probably still the most widely used, several characteristics of Lisp are commonly, though inaccurately,

described as though they pertained to functional programming in general. We will examine these characteristics (in the context of Scheme) in [Section 10.3](#). They include:

- Homogeneity of programs and data: A program in Lisp is itself a list, and can be manipulated with the same mechanisms used to manipulate data.
- Self-definition: The operational semantics of Lisp can be defined elegantly in terms of an interpreter written in Lisp.
- Interaction with the user through a “read-eval-print” loop.

Many programmers—probably most—who have written significant amounts of software in both imperative and functional styles find the latter more aesthetically appealing. Moreover experience with a variety of large commercial projects (see the Bibliographic Notes at the end of the chapter) suggests that the absence of side effects makes functional programs significantly easier to write, debug, and maintain than their imperative counterparts. When passed a given set of arguments, a pure function can always be counted on to return the same results. Issues of undocumented side effects, misordered updates, and dangling or (in most cases) uninitialized references simply don’t occur. At the same time, most implementations of functional languages still fall short in terms of portability, richness of library packages, interfaces to other languages, and debugging and profiling tools. We will return to the tradeoffs between functional and imperative programming in [Section 10.7](#).

10.3 A Review/Overview of Scheme

Most Scheme implementations employ an interpreter that runs a “read-eval-print” loop. The interpreter repeatedly reads an expression from standard input (generally typed by the user), evaluates that expression, and prints the resulting value. If the user types

```
(+ 3 4)
```

the interpreter will print

```
7
```

If the user types

```
7
```

the interpreter will also print

```
7
```

EXAMPLE 10.1

The read-eval-print loop

(The number 7 is already fully evaluated.) To save the programmer the need to type an entire program verbatim at the keyboard, most Scheme implementations provide a `load` function that reads (and evaluates) input from a file:

```
(load "my_scheme_program")
```

As we noted in [Section 6.1](#), Scheme (like all Lisp dialects) uses *Cambridge Polish* notation for expressions. Parentheses indicate a function application (or in some cases the use of a macro). The first expression inside the left parenthesis indicates the function; the remaining expressions are its arguments. Suppose the user types

EXAMPLE 10.2

Significance of parentheses

```
((+ 3 4))
```

When it sees the inner set of parentheses, the interpreter will call the function `+`, passing 3 and 4 as arguments. Because of the outer set of parentheses, it will then attempt to call 7 as a zero-argument function—a run-time error:

```
eval: 7 is not a procedure
```

Unlike the situation in almost all other programming languages, extra parentheses change the semantics of Lisp/Scheme programs.

```
(+ 3 4)    => 7
((+ 3 4)) => error
```

Here the \implies means “evaluates to.” This symbol is not a part of the syntax of Scheme itself.

EXAMPLE 10.3

Quoting

One can prevent the Scheme interpreter from evaluating a parenthesized expression by *quoting* it:

```
(quote (+ 3 4)) => (+ 3 4)
```

Here the result is a three-element list. More commonly, quoting is specified with a special shorthand notation consisting of a leading single quote mark:

```
'(+ 3 4) => (+ 3 4)
```

EXAMPLE 10.4

Dynamic typing

Though every expression has a type in Scheme, that type is generally not determined until run time. Most predefined functions check dynamically to make sure that their arguments are of appropriate types. The expression

```
(if (> a 0) (+ 2 3) (+ 2 "foo"))
```

will evaluate to 5 if `a` is positive, but will produce a run-time type clash error if `a` is negative or zero. More significantly, as noted in [Section 3.5.3](#), functions that make sense for arguments of multiple types are implicitly polymorphic:

```
(define min (lambda (a b) (if (< a b) a b)))
```

The expression `(min 123 456)` will evaluate to 123; `(min 3.14159 2.71828)` will evaluate to 2.71828. ■

EXAMPLE 10.5

Type predicates

User-defined functions can implement their own type checks using predefined *type predicate* functions:

```
(boolean? x)    ; is x a Boolean?
(char? x)      ; is x a character?
(string? x)    ; is x a string?
(symbol? x)    ; is x a symbol?
(number? x)    ; is x a number?
(pair? x)      ; is x a (not necessarily proper) pair?
(list? x)      ; is x a (proper) list?
```

(This is not an exhaustive list.) ■

A *symbol* in Scheme is comparable to what other languages call an identifier. The lexical rules for identifiers vary among Scheme implementations, but are in general much looser than they are in other languages. In particular, identifiers are permitted to contain a wide variety of punctuation marks:

EXAMPLE 10.6

Liberal syntax for symbols

```
(symbol? 'x$_%:&=*) ⇒ #t
```

The symbol `#t` represents the Boolean value true. False is represented by `#f`. Note the use here of quote (`'`); the symbol begins with `x`. ■

EXAMPLE 10.7

Lambda expressions

To create a function in Scheme one evaluates a *lambda expression*:³

```
(lambda (x) (* x x)) ⇒ function
```

The first “argument” to `lambda` is a list of formal parameters for the function (in this case the single parameter `x`). The remaining “arguments” (again just one in this case) constitute the body of the function. As we shall see in [Section 10.4](#), Scheme differentiates between functions and so-called *special forms* (`lambda` among them), which resemble functions but have special evaluation rules. Strictly speaking, only functions have arguments, but we will also use the term informally to refer to the subexpressions that look like arguments in a special form. ■

A `lambda` expression does not give its function a name; this can be done using `let` or `define` (to be introduced in the next subsection). In this sense, a `lambda`

3 A word of caution for readers familiar with Common Lisp: A `lambda` expression in Scheme *evaluates to* a function. A `lambda` expression in Common Lisp *is* a function (or, more accurately, is automatically coerced to be a function, without evaluation). The distinction becomes important whenever `lambda` expressions are passed as parameters or returned from functions: they must be quoted in Common Lisp (with `function` or `#'`) to prevent evaluation. Common Lisp also distinguishes between a symbol's *value* and its meaning as a function; Scheme does not: if a symbol represents a function, then the function is the symbol's value.

EXAMPLE 10.8

Function evaluation

expression is like the aggregates that we used in [Section 7.1.5](#) to specify array or record values.

When a function is called, the language implementation restores the referencing environment that was in effect when the `lambda` expression was evaluated (like all languages with static scope and first-class, nested subroutines, Scheme employs deep binding). It then augments this environment with bindings for the formal parameters and evaluates the expressions of the function body in order. The value of the last such expression (most often there *is* only one) becomes the value returned by the function:

```
((lambda (x) (* x x)) 3)  $\implies$  9
```

EXAMPLE 10.9

If expressions

Simple conditional expressions can be written using `if`:

```
(if (< 2 3) 4 5)  $\implies$  4
(if #f 2 3)  $\implies$  3
```

In general, Scheme expressions are evaluated in applicative order, as described in [Section 6.6.2](#). Special forms such as `lambda` and `if` are exceptions to this rule. The implementation of `if` checks to see whether the first argument evaluates to `#t`. If so, it returns the value of the second argument, without evaluating the third argument. Otherwise it returns the value of the third argument, without evaluating the second. We will return to the issue of evaluation order in [Section 10.4](#). ■

10.3.1 Bindings

EXAMPLE 10.10Nested scopes with `let`

Names can be bound to values by introducing a nested scope:

```
(let ((a 3)
      (b 4)
      (square (lambda (x) (* x x)))
      (plus +))
  (sqrt (plus (square a) (square b))))  $\implies$  5.0
```

The special form `let` takes two or more arguments. The first of these is a list of pairs. In each pair, the first element is a name and the second is the value that the name is to represent within the remaining arguments to `let`. Remaining arguments are then evaluated in order; the value of the construct as a whole is the value of the final argument.

The scope of the bindings produced by `let` is `let`'s second argument only:

```
(let ((a 3))
  (let ((a 4)
        (b a))
    (+ a b)))  $\implies$  7
```

Here `b` takes the value of the *outer* `a`. The way in which names become visible “all at once” at the end of the declaration list precludes the definition of recursive functions. For these one employs `letrec`:

```
(letrec ((fact
          (lambda (n)
            (if (= n 1) 1
                (* n (fact (- n 1)))))))
  (fact 5))           ⇒ 120
```

There is also a `let*` construct in which names become visible “one at a time” so that later ones can make use of earlier ones, but not vice versa. ■

As noted in [Section 3.3](#), Scheme is statically scoped. (Common Lisp is also statically scoped. Most other Lisp dialects are dynamically scoped.) While `let` and `letrec` allow the user to create nested scopes, they do not affect the meaning of global names (names known at the outermost level of the Scheme interpreter). For these Scheme provides a special form called `define` that has the side effect of creating a global binding for a name:

```
(define hypot
  (lambda (a b)
    (sqrt (+ (* a a) (* b b)))))
(hypot 3 4)           ⇒ 5
```

EXAMPLE 10.11

Global bindings with
`define`

10.3.2 Lists and Numbers

Like all Lisp dialects, Scheme provides a wealth of functions to manipulate lists. We saw many of these in [Section 7.8](#); we do not repeat them all here. The three most important are `car`, which returns the head of a list, `cdr` (“coulder”), which returns the rest of the list (everything after the head), and `cons`, which joins a head to the rest of a list:

```
(car '(2 3 4)) ⇒ 2
(cdr '(2 3 4)) ⇒ (3 4)
(cons 2 '(3 4)) ⇒ (2 3 4)
```

Also useful is the `null?` predicate, which determines whether its argument is the empty list. Recall that the notation `'(2 3 4)` indicates a *proper* list, in which the final element is the empty list:

```
(cdr '(2)) ⇒ ()
(cons 2 3) ⇒ (2 . 3) ; an improper list
```

For fast access to arbitrary elements of a sequence, Scheme provides a `vector` type that is indexed by integers, like an array, and may have elements of heterogeneous types, like a record. Interested readers are referred to the Scheme manual [[SDF⁺07](#)] for further information. ■

EXAMPLE 10.12

Basic list operations

Scheme also provides a wealth of numeric and logical (Boolean) functions and special forms. The language manual describes a hierarchy of five numeric types: `integer`, `rational`, `real`, `complex`, and `number`. The last two levels are optional: implementations may choose not to provide any numbers that are not real. Most but not all implementations employ arbitrary-precision representations of both integers and rationals, with the latter stored internally as (numerator, denominator) pairs.

10.3.3 Equality Testing and Searching

Scheme provides several different equality-testing functions. For numerical comparisons, `=` performs type conversions where necessary (e.g., to compare an integer and a floating-point number). For general-purpose use, `eqv?` performs a *shallow* comparison, while `equal?` performs a *deep* (recursive) comparison, using `eqv?` at the leaves. The `eq?` function also performs a shallow comparison, and may be cheaper than `eqv?` in certain circumstances (in particular, `eq?` is not required to detect the equality of discrete values stored in different locations, though it may in some implementations). Further details were presented in [Section 7.10](#).

To search for elements in lists, Scheme provides two sets of functions, each of which has variants corresponding to the three general-purpose equality predicates. The functions `memq`, `memv`, and `member` take an element and a list as argument, and return the longest suffix of the list (if any) beginning with the element:

EXAMPLE 10.13

List search functions

```
(memq 'z '(x y z w))      => (z w)
(memv '(z) '(x y (z) w)) => #f      ; (eq? '(z) '(z)) => #f
(member '(z) '(x y (z) w)) => ((z) w) ; (equal? '(z) '(z)) => #t
```

The `memq`, `memv`, and `member` functions perform their comparisons using `eq?`, `eqv?`, and `equal?`, respectively. They return `#f` if the desired element is not found. It turns out that Scheme's conditional expressions (e.g., `if`) treat anything other than `#f` as true.⁴ One therefore often sees expressions of the form

```
(if (memq desired-element list-that-might-contain-it) ...)
```

EXAMPLE 10.14

Searching association lists

The functions `assq`, `assv`, and `assoc` search for values in *association lists* (otherwise known as *A-lists*). A-lists were introduced in [Section 3.4.2](#) in the context of name lookup for languages with dynamic scoping. An A-list is a dictionary

⁴ One of the more confusing differences between Scheme and Common Lisp is that Common Lisp uses the empty list `()` for false, while most implementations of Scheme (including all that conform to the version 5 standard) treat it as true.

implemented as a list of pairs.⁵ The first element of each pair is a key of some sort; the second element is information corresponding to that key. `Assq`, `assv`, and `assoc` take a key and an A-list as argument, and return the first pair in the list, if there is one, whose first element is `eq?`, `eqv?`, or `equal?`, respectively, to the key. If there is no matching pair, `#f` is returned. ■

10.3.4 Control Flow and Assignment

EXAMPLE 10.15

Multiway conditional expressions

We have already seen the special form `if`. It has a cousin named `cond` that resembles a more general `if...elseif...else`:

```
(cond
  ((< 3 2) 1)
  ((< 4 3) 2)
  (else 3))  ⇒ 3
```

The arguments to `cond` are pairs. They are considered in order from first to last. The value of the overall expression is the value of the second element of the first pair in which the first element evaluates to `#t`. If none of the first elements evaluates to `#t`, then the overall value is `#f`. The symbol `else` is permitted only as the first element of the last pair of the construct, where it serves as syntactic sugar for `#t`. ■

Recursion, of course, is the principal means of doing things repeatedly in Scheme. Many issues related to recursion were discussed in [Section 6.6](#); we do not repeat that discussion here.

EXAMPLE 10.16

Assignment

For programmers who wish to make use of side effects, Scheme provides assignment, sequencing, and iteration constructs. Assignment employs the special form `set!` and the functions `set-car!` and `set-cdr!`:

```
(let ((x 2)                               ; initialize x to 2
      (l '(a b)))                         ; initialize l to (a b)
  (set! x 3)                               ; assign x the value 3
  (set-car! l '(c d))                      ; assign head of l the value (c d)
  (set-cdr! l '(e))                        ; assign rest of l the value (e)
  ... x                                     ⇒ 3
  ... l                                     ⇒ ((c d) e)
```

The return values of the various varieties of `set!` are implementation-dependent. ■

EXAMPLE 10.17

Sequencing

Sequencing uses the special form `begin`:

```
(begin
  (display "hi ")
  (display "mom"))
```

⁵ For clarity, the figures in [Section 3.4.2](#) elided the internal structure of the pairs.

EXAMPLE 10.18

Iteration

Iteration uses the special form `do` and the function `for-each`:

```
(define iter-fib (lambda (n)
  ; print the first n+1 Fibonacci numbers
  (do ((i 0 (+ i 1))      ; initially 0, inc'ed in each iteration
      (a 0 b)            ; initially 0, set to b in each iteration
      (b 1 (+ a b)))    ; initially 1, set to sum of a and b
      ((= i n) b)       ; termination test and final value
      (display b)       ; body of loop
      (display " ")))   ; body of loop

  (for-each (lambda (a b) (display (* a b)) (newline))
    '(2 4 6)
    '(3 5 7)))
```

The first argument to `do` is a list of triples, each of which specifies a new variable, an initial value for that variable, and an expression to be evaluated and placed in a fresh instance of the variable at the end of each iteration. The second argument to `do` is a pair that specifies the termination condition and the expression to be returned. At the end of each iteration all new values of loop variables (e.g., `a` and `b`) are computed using the current values. Only after all new values are computed are the new variable instances created.

The function `for-each` takes as argument a function and a sequence of lists. There must be as many lists as the function takes arguments, and the lists must all be of the same length. `For-each` calls its function argument repeatedly, passing successive sets of arguments from the lists. In the example shown here, the unnamed function produced by the lambda expression will be called on the arguments 2 and 3, 4 and 5, and 6 and 7. The interpreter will print

```
6
20
42
()
```

The last line is the return value of `for-each`, assumed here to be the empty list. The language definition allows this value to be implementation-dependent; the construct is executed for its side effects. ■

DESIGN & IMPLEMENTATION**Iteration in functional programs**

It is important to distinguish between iteration as a notation for repeated execution and iteration as a means of orchestrating side effects. One can in fact define iteration as syntactic sugar for tail recursion, and `Val`, `Sisal`, and `pH` do precisely that (with special syntax to facilitate the passing of values from one iteration to the next). Such a notation may still be entirely side-effect free, that is, entirely functional. In Scheme, assignment and I/O are the truly imperative features. We think of iteration as imperative because most Scheme programs that use it have assignments or I/O in their loops.

Two other control-flow constructs—`delay` and `force`—have been mentioned in previous chapters. `Delay` and `force` (Section 6.6.2) permit the lazy evaluation of expressions. `Call-with-current-continuation` (`call/cc`; Section 6.2.2) allows the current program counter and referencing environment to be saved in the form of a closure, and passed to a specified subroutine. We will discuss `delay` and `force` further in Section 10.4.

10.3.5 Programs as Lists

As should be clear by now, a program in Scheme takes the form of a list. In technical terms, we say that Lisp and Scheme are *homoiconic*—self-representing. A parenthesized string of symbols (in which parentheses are balanced) is called an *S-expression* regardless of whether we think of it as a program or as a list. In fact, an unevaluated program *is* a list, and can be constructed, deconstructed, and otherwise manipulated with all the usual list functions.

EXAMPLE 10.19

Evaluating data as code

Just as `quote` can be used to inhibit the evaluation of a list that appears as an argument in a function call, Scheme provides an `eval` function that can be used to evaluate a list that has been created as a data structure:

```
(define compose
  (lambda (f g)
    (lambda (x) (f (g x)))))
((compose car cdr) '(1 2 3)) ⇒ 2

(define compose2
  (lambda (f g)
    (eval (list 'lambda '(x) (list f (list g 'x)))
          (scheme-report-environment 5))))
((compose2 car cdr) '(1 2 3)) ⇒ 2
```

In the first of these declarations, `compose` takes as arguments a pair of functions `f` and `g`. It returns as result a function that takes as parameter a value `x`, applies `g` to it, then applies `f`, and finally returns the result. In the second declaration, `compose2` performs the same function, but in a different way. The function `list` returns a list consisting of its (evaluated) arguments. In the body of `compose2`, this list is the *unevaluated* expression `(lambda (x) (f (g x)))`. When passed to `eval`, this list evaluates to the desired function. The second argument of `eval` specifies the referencing environment in which the expression is to be evaluated. In our example we have specified the environment defined by the Scheme version 5 report [ADH⁺98]. ■

Eval **and** Apply

The original description of Lisp [MAE⁺65] included a *self-definition* of the language: code for a Lisp interpreter, written in Lisp. Though Scheme differs in a number of ways from this early Lisp (most notably in its use of lexical scoping),

such a *metacircular* interpreter can still be written easily [AS96, Chap. 4]. The code is based on the functions `eval` and `apply`. The first of these we have just seen. The second, `apply`, takes two arguments: a function and a list. It achieves the effect of calling the function, with the elements of the list as arguments.

The functions `eval` and `apply` can be defined as mutually recursive. When passed a number or a string, `eval` simply returns that number or string. When passed a symbol, it looks that symbol up in the specified environment and returns the value to which it is bound. When passed a list it checks to see whether the first element of the list is one of a small number of symbols that name so-called *primitive* special forms, built into the language implementation. For each of these special forms (`lambda`, `if`, `define`, `set!`, `quote`, etc.) `eval` provides a direct implementation. For other lists, `eval` calls itself recursively on each element and then calls `apply`, passing as arguments the value of the first element (which must be a function) and a list of the values of the remaining elements. Finally, `eval` returns what `apply` returned.

When passed a function f and a list of arguments l , `apply` inspects the internal representation of f to see whether it is primitive. If so it invokes the built-in implementation. Otherwise it retrieves (from the representation of f) the referencing environment in which f 's lambda expression was originally evaluated. To this environment it adds the names of f 's parameters, with values taken from l . Call this resulting environment e . Next `apply` retrieves the list of expressions that make up the body of f . It passes these expressions, together with e , one at a time to `eval`. Finally, `apply` returns what the `eval` of the last expression in the body of f returned.

Formalizing Self-Definition

The idea of self-definition—a Scheme interpreter written in Scheme—may seem a bit confusing unless one keeps in mind the distinction between the Scheme code that constitutes the interpreter and the Scheme code that the interpreter is interpreting. In particular, the interpreter is not running itself, though it could run a *copy* of itself. What we really mean by “self-definition” is that for all expressions E , we get the same result by evaluating E under the interpreter I that we get by evaluating E directly.

EXAMPLE 10.20

Denotational semantics of Scheme

Suppose now that we wish to formalize the semantics of Scheme as some as-yet-unknown mathematical function \mathcal{M} that takes a Scheme expression as an argument and returns the expression's value. (This value may be a number, a list, a function, or a member of any of a small number of other domains.) How might we go about this task? For certain simple strings of symbols we can define a value directly: strings of digits, for example, map onto the natural numbers. For more complex expressions, we note that

$$\forall E[\mathcal{M}(E) = (\mathcal{M}(I))(E)]$$

Put another way,

$$\mathcal{M}(I) = \mathcal{M}$$

Suppose now that we let $H(\mathcal{F}) = \mathcal{F}(I)$ where \mathcal{F} can be any function that takes a Scheme expression as its argument. Clearly

$$H(\mathcal{M}) = \mathcal{M}$$

Our desired function \mathcal{M} is said to be a *fixed point* of H . Because H is well defined (it simply applies its argument to I), we can use it to obtain a rigorous definition of \mathcal{M} . The tools to do so come from the field of denotational semantics, a subject beyond the scope of this book.⁶ ■

10.3.6 Extended Example: DFA Simulation

EXAMPLE 10.21

Simulating a DFA in Scheme

To conclude our introduction to Scheme, we present a complete program to simulate the execution of a DFA (deterministic finite automaton). The code appears in [Figure 10.1](#). Finite automata details can be found in Sections 2.2 and ©2.4.1. Here we represent a DFA as a list of three items: the start state, the transition function, and a list of final states. The transition function in turn is represented by a list of pairs. The first element of each pair is another pair, whose first element is a state and whose second element is an input symbol. If the current state and next input symbol match the first element of a pair, then the finite automaton enters the state given by the second element of the pair.

To make this concrete, consider the DFA of [Figure 10.2](#). It accepts all strings of zeros and ones in which each digit appears an even number of times. To simulate this machine, we pass it to the function `simulate` along with an input string. As it runs, the automaton accumulates as a list a trace of the states through which it has traveled, ending with the symbol `accept` or `reject`. For example, if we type

```
(simulate
  zero-one-even-dfa ; machine description
  '(0 1 1 0 1))   ; input string
```

then the Scheme interpreter will print

```
(q0 q2 q3 q2 q0 q1 reject)
```

⁶ Actually, H has an infinite number of fixed points. What we want (and what denotational semantics will give us) is the *least* fixed point: the one that defines a value for as few strings of symbols as possible, while still producing the “correct” value for numbers and other simple strings. Another example of least fixed points appears in Section ©16.4.2.

```

(define simulate
  (lambda (dfa input)
    (cons (current-state dfa)                ; start state
          (if (null? input)
              (if (infinal? dfa) '(accept) '(reject))
              (simulate (move dfa (car input)) (cdr input))))))

;; access functions for machine description:
(define current-state car)
(define transition-function cadr)
(define final-states caddr)
(define infinal?
  (lambda (dfa)
    (memq (current-state dfa) (final-states dfa))))

(define move
  (lambda (dfa symbol)
    (let ((cs (current-state dfa)) (trans (transition-function dfa)))
      (list
        (if (eq? cs 'error)
            'error
            (let ((pair (assoc (list cs symbol) trans)))
              (if pair (cadr pair) 'error))) ; new start state
        trans ; same transition function
        (final-states dfa)))) ; same final states

```

Figure 10.1 Scheme program to simulate the actions of a DFA. Given a machine description and an input symbol i , function `move` searches for a transition labeled i from the start state to some new state s . It then returns a new machine with the same transition function and final states, but with s as its “start” state. The main function, `simulate`, tests to see if it is in a final state. If not, it passes the current machine description and the first symbol of input to `move`, and then calls itself recursively on the new machine and the remainder of the input. The functions `cadr` and `caddr` are defined as `(lambda (x) (car (cdr x)))` and `(lambda (x) (car (cdr (cdr x))))`, respectively. Scheme provides a large collection of such abbreviations.

If we change the input string to 010010, the interpreter will print

```
(q0 q2 q3 q1 q3 q2 q0 accept)
```

✓ CHECK YOUR UNDERSTANDING

1. What mathematical formalism underlies functional programming?
2. List several distinguishing characteristics of functional programming languages.
3. Briefly describe the behavior of the Lisp/Scheme *read-eval-print* loop.
4. What is a *first-class* value?
5. Explain the difference between `let`, `let*`, and `letrec` in Scheme.

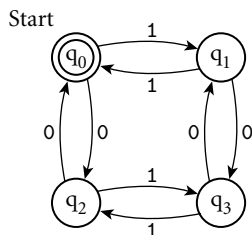

```

(define zero-one-even-dfa
  '(q0                                     ; start state
    (((q0 0) q2) ((q0 1) q1) ((q1 0) q3) ((q1 1) q0) ; transition fn
     ((q2 0) q0) ((q2 1) q3) ((q3 0) q1) ((q3 1) q2))
    (q0))) ; final states
  
```

Figure 10.2 DFA to accept all strings of zeros and ones containing an even number of each. At the bottom of the figure is a representation of the machine as a Scheme data structure, using the conventions of Figure 10.1.

6. Explain the difference between `eq?`, `eqv?`, and `equal?`.
7. Describe three ways in which Scheme programs can depart from a purely functional programming model.
8. What is an *association list*?
9. What does it mean for a language to be *homoiconic*?
10. What is an *S-expression*?
11. Outline the behavior of `eval` and `apply`.

10.4 Evaluation Order Revisited

In Section 6.6.2 we observed that the subcomponents of many expressions can be evaluated in more than one order. In particular, one can choose to evaluate function arguments before passing them to a function, or to pass them unevaluated. The former option is called *applicative-order* evaluation; the latter is called *normal-order* evaluation. Like most imperative languages, Scheme uses applicative order in most cases. Normal order, which arises in the macros and call-by-name parameters of imperative languages, is available in special cases.

Suppose, for example, that we have defined the following function:

```
(define double (lambda (x) (+ x x)))
```

Evaluating the expression `(double (* 3 4))` in applicative order (as Scheme does), we have

EXAMPLE 10.22

Applicative and
normal-order evaluation

```

      (double (* 3 4))
    => (double 12)
    => (+ 12 12)
    => 24

```

Under normal-order evaluation we would have

```

      (double (* 3 4))
    => (+ (* 3 4) (* 3 4))
    => (+ 12 (* 3 4))
    => (+ 12 12)
    => 24

```

Here we end up doing extra work: normal order causes us to evaluate `(* 3 4)` twice. ■

EXAMPLE 10.23

Normal-order avoidance of unnecessary work

In other cases, applicative-order evaluation can end up doing extra work. Suppose we have defined the following:

```

(define switch (lambda (x a b c)
  (cond ((< x 0) a)
        ((= x 0) b)
        (> x 0) c)))

```

Evaluating the expression `(switch -1 (+ 1 2) (+ 2 3) (+ 3 4))` in applicative order, we have

```

      (switch -1 (+ 1 2) (+ 2 3) (+ 3 4))
    => (switch -1 3 (+ 2 3) (+ 3 4))
    => (switch -1 3 5 (+ 3 4))
    => (switch -1 3 5 7)
    => (cond ((< -1 0) 3)
            ((= -1 0) 5)
            (> -1 0) 7))
    => (cond (#t 3)
            ((= -1 0) 5)
            (> -1 0) 7))
    => 3

```

(Here we have assumed that `cond` is built in, and evaluates its arguments lazily, even though `switch` is doing so eagerly.) Under normal-order evaluation we would have

```

      (switch -1 (+ 1 2) (+ 2 3) (+ 3 4))
    => (cond ((< -1 0) (+ 1 2))
            ((= -1 0) (+ 2 3))
            (> -1 0) (+ 3 4)))
    => (cond (#t (+ 1 2))
            ((= -1 0) (+ 2 3))
            (> -1 0) (+ 3 4)))
    => (+ 1 2)
    => 3

```

Here normal-order evaluation avoids evaluating $(+ 2 3)$ or $(+ 3 4)$. (In this case, we have assumed that arithmetic and logical functions such as $+$ and $<$ are built in, and force the evaluation of their arguments.) ■

In our overview of Scheme we have differentiated on several occasions between special forms and functions. Arguments to functions are always passed by sharing (Section 8.3.1), and are evaluated before they are passed (i.e., in applicative order). Arguments to special forms are passed unevaluated—in other words, by name. Each special form is free to choose internally when (and if) to evaluate its parameters. `Cond`, for example, takes a sequence of unevaluated pairs as arguments. It evaluates their `cars` internally, one at a time, stopping when it finds one that evaluates to `#t`.

Together, special forms and functions are known as *expression types* in Scheme. Some expression types are *primitive*, in the sense that they must be built into the language implementation. Others are *derived*; they can be defined in terms of primitive expression types. In an `eval/apply`-based interpreter, primitive special forms are built into `eval`; primitive functions are recognized by `apply`. We have seen how the special form `lambda` can be used to create derived functions, which can be bound to names with `let`. Scheme provides an analogous special form, `syntax-rules`, that can be used to create derived special forms. These can then be bound to names with `define-syntax` and `let-syntax`. Derived special forms are known as *macros* in Scheme, but unlike most other macros, they are *hygienic*—lexically scoped, integrated into the language’s semantics, and immune from the problems of mistaken grouping and variable capture described in Section 3.7. Like C++ templates (Section ©8.4.4), Scheme macros are Turing complete. They behave like functions whose arguments are passed by name (Section ©8.3.2) instead of by sharing. They are implemented, however, via logical expansion in the interpreter’s parser and semantic analyzer, rather than by delayed evaluation with `thunks`.

10.4.1 Strictness and Lazy Evaluation

Evaluation order can have an effect not only on execution speed, but on program correctness as well. A program that encounters a dynamic semantic error or an infinite regression in an “unnecessary” subexpression under applicative-order evaluation may terminate successfully under normal-order evaluation. A (side-effect-free) function is said to be *strict* if it is undefined (fails to terminate, or encounters an error) when any of its arguments is undefined. Such a function can safely evaluate all its arguments, so its result will not depend on evaluation order. A function is said to be *nonstrict* if it does not impose this requirement—that is, if it is sometimes defined even when one of its arguments is not. A *language* is said to be strict if it is defined in such a way that functions are always strict. A language is said to be nonstrict if it permits the definition of nonstrict functions. If a language always evaluates expressions in applicative order, then every function is guaranteed to be strict, because whenever an argument is undefined,

its evaluation will fail and so will the function to which it is being passed. Contrapositively, a nonstrict language cannot use applicative order; it must use normal order to avoid evaluating unneeded arguments. ML and (with the exception of macros) Scheme are strict. Miranda and Haskell are nonstrict.

Lazy evaluation (as described here—see the footnote on page 276) gives us the advantage of normal-order evaluation (not evaluating unneeded subexpressions) while running within a constant factor of the speed of applicative-order evaluation for expressions in which everything is needed. The trick is to tag every argument internally with a “memo” that indicates its value, if known. Any attempt to evaluate the argument sets the value in the memo as a side effect, or returns the value (without recalculating it) if it is already set.

EXAMPLE 10.24

Avoiding work with lazy evaluation

Returning to the expression of [Example 10.22](#), `(double (* 3 4))` will be compiled as `(double (f))`, where `f` is a hidden closure with an internal side effect:

```
(define f
  (lambda ()
    (let ((done #f) ; memo initially unset
          (memo '())
          (code (lambda () (* 3 4))))
      (if done memo ; if memo is set, return it
          (begin
             (set! memo (code)) ; remember value
             memo)))) ; and return it
  ...
  (double (f))
  => (+ (f) (f))
  => (+ 12 (f)) ; first call computes value
  => (+ 12 12) ; second call returns remembered value
  => 24
```

Here `(* 3 4)` will be evaluated only once. While the cost of manipulating memos will clearly be higher than that of the extra multiplication in this case, if we were to replace `(* 3 4)` with a very expensive operation, the savings could be substantial. ■

DESIGN & IMPLEMENTATION

Lazy evaluation

One of the beauties of a purely functional language is that it makes lazy evaluation a completely transparent performance optimization: the programmer can think in terms of nonstrict functions and normal-order evaluation, counting on the implementation to avoid the cost of repeated evaluation. For languages with imperative features, however, this characterization does not hold: lazy evaluation is *not* transparent in the presence of side effects.

Lazy evaluation is particularly useful for “infinite” data structures, as described in [Section 6.6.2](#). It can also be useful in programs that need to examine only a prefix of a potentially long list (see [Exercise 10.10](#)). Lazy evaluation is used for all arguments in Miranda and Haskell. It is available in Scheme through explicit use of `delay` and `force`. (Recall that the first of these is a special form that creates a [memo, closure] pair; the second is a function that returns the value in the memo, using the closure to calculate it first if necessary.) Where normal-order evaluation can be thought of as function evaluation using call-by-name parameters, lazy evaluation is sometimes said to employ “call-by-need.” In addition to Miranda and Haskell, call-by-need can be found in the R scripting language, widely used by statisticians.

The principal problem with lazy evaluation is its behavior in the presence of side effects. If an argument contains a reference to a variable that may be modified by an assignment, then the value of the argument will depend on whether it is evaluated before or after the assignment. Likewise, if the argument contains an assignment, values elsewhere in the program may depend on when evaluation occurs. These problems do not arise in Miranda or Haskell because they are purely functional: there are no side effects. Scheme leaves the problem up to the programmer, but requires that every use of a `delay`-ed expression be enclosed in `force`, making it relatively easy to identify the places where side effects are an issue. ML provides no built-in mechanism for lazy evaluation. The same effect can be achieved with assignment and explicit functions ([Exercise 10.11](#)), but the code is rather awkward.

10.4.2 I/O: Streams and Monads

A major source of side effects can be found in traditional I/O, including the built-in functions `read` and `display` of Scheme: `read` will generally return a different value every time it is called, and multiple calls to `display`, though they never return a value, must occur in the proper order if the program is to be considered correct.

One way to avoid these side effects is to model input and output as *streams*—unbounded-length lists whose elements are generated lazily. We saw an example of a stream in [Section 6.6.2](#), where we used Scheme’s `delay` and `force` to implement a “list” of the natural numbers. Similar code in ML appears in [Exercise 10.11](#).⁷

If we model input and output as streams, then a program takes the form

```
(define output (my_prog input))
```

When it needs an input value, function `my_prog` forces evaluation of the `car` of `input`, and passes the `cdr` on to the rest of the program. To drive execution,

EXAMPLE 10.25

Stream-based program execution

⁷ Note that `delay` and `force` automatically *memoize* their stream, so that values are never computed more than once. [Exercise 10.11](#) asks the reader to write a memoizing version of a nonmemoizing stream.

the language implementation repeatedly forces evaluation of the car of output, prints it, and repeats:

```
(define driver (lambda (s)
  (if (null? s) '() ; nothing left
      (display (car s))
      (driver (cdr s))))
(driver output) ■
```

EXAMPLE 10.26

Interactive I/O with streams

To make things concrete, suppose we want to write a purely functional program that prompts the user for a sequence of numbers (one at a time!) and prints their squares. If Scheme employed lazy evaluation of input and output streams (it doesn't), then we could write:

```
(define squares (lambda (s)
  (cons "please enter a number\n"
        (let ((n (car s)))
          (if (eof-object? n) '()
              (cons (* n n) (cons #\newline (squares (cdr s))))))))
(define output (squares input))
```

Prompts, inputs, and outputs (i.e., squares) would be interleaved naturally in time. In effect, *lazy* evaluation would *force* things to happen in the proper order: The car of output is the first prompt. The cadr of output is the first square, a value that requires evaluation of the car of input. The caddr of output is the second prompt. The caddr of output is the second square, a value that requires evaluation of the cadr of input. ■

Streams formed the basis of the I/O system in early versions of Haskell. Unfortunately, while they successfully encapsulate the imperative nature of interaction at a terminal, streams don't work very well for graphics or random access to files. They also make it difficult to accommodate I/O of different kinds (since all elements of a list in Haskell must be of a single type). More recent versions of Haskell employ a more general concept known as *monads*. Monads are drawn from a branch of mathematics known as *category theory*, but one doesn't need to understand the theory to appreciate their usefulness in practice. In Haskell, monads are essentially a clever use of higher-order functions, coupled with a bit of syntactic sugar, that allow the programmer to chain together a sequence of *actions* (function calls) that have to happen in order. The power of the idea comes from the ability to carry a hidden, structured value of arbitrary complexity from one action to the next. In many applications of monads, this extra hidden value plays the role of mutable state: differences between the values carried to successive actions act as side effects.

EXAMPLE 10.27

Pseudorandom numbers in Haskell

As a motivating example somewhat simpler than I/O, consider the possibility of creating a pseudorandom number generator (RNG) along the lines of [Example 6.42](#) (page 247). In that example we assumed that `rand()` would modify hidden state as a side effect, allowing it to return a different value every time it is

called. This idiom isn't possible in a pure functional language, but we can obtain a similar effect by passing the state to the function and having it return new state along with the random number. This is exactly how the built-in function `random` works in Haskell. The following code calls `random` twice to illustrate its interface.

```
twoRandomInts :: StdGen -> ([Integer], StdGen)
-- type signature: twoRandomInts is a function that takes an
-- StdGen (the state of the RNG) and returns a tuple containing
-- a list of Integers and a new StdGen.
twoRandomInts gen = let
    (rand1, gen2) = random gen
    (rand2, gen3) = random gen2
in ([rand1, rand2], gen3)

main = let
    gen = mkStdGen 123 -- new RNG, seeded with 123
    ints = fst (twoRandomInts gen) -- extract first element
in print ints -- of returned tuple
```

Note that `gen2`, one of the return values from the first call to `random`, has been passed as an argument to the second call. Then `gen3`, one of the return values from the second call, is returned to `main`, where it could, if we wished, be passed to another function. This mechanism works, but it's far from pretty: copies of the RNG state must be “threaded through” every function that needs a random number. This is particularly complicated for deeply nested functions. It is easy to make a mistake, and difficult to verify that one has not.

Monads provide a more general solution to the problem of threading mutable state through a functional program. Here is our example rewritten to use Haskell's standard IO monad, which includes a random number generator:

```
twoMoreRandomInts :: IO [Integer]
-- twoMoreRandomInts returns a list of Integers. It also
-- implicitly accepts, and returns, all the state of the IO monad.
twoMoreRandomInts = do
    rand1 <- randomIO
    rand2 <- randomIO
    return [rand1, rand2]

main = do
    moreInts <- twoMoreRandomInts
    print moreInts
```

There are several differences here. First, the type of the `twoMoreRandomInts` function has become `IO [Integer]`. This identifies it as an *IO action*—a function that (in addition to returning an explicit list of integers) invisibly accepts and returns the state of the IO monad (including the standard RNG). Similarly, the type of `randomIO` is `IO Integer`. To thread the IO state from one action to the next, the bodies of `twoMoreRandomInts` and `main` use `do` notation rather than

`let`. A `do` block packages a sequence of actions together into a single, compound action. At each step along the way, it passes the (potentially modified) state of the monad from one action to the next. It also supports the “assignment” operator, `<-`, which separates the explicit return value from the hidden state and opens a nested scope for its left-hand side, so all values “assigned” earlier in the sequence are visible to actions later in the sequence.

The `return` operator in `twoMoreRandomInts` packages an explicit return value (in our case, a two-element list) together with the hidden state, to be returned to the caller. A similar use of `return` presumably appears inside `randomIO`. Everything we have done is purely functional—`do` and `<-` are simply syntactic sugar—but the bookkeeping required to pass the state of the RNG from one invocation of `random` to the next has been hidden in a way that makes our code look imperative. ■

EXAMPLE 10.28

The state of the IO monad

So what does this have to do with I/O? Consider the `getChar` function, which reads a character from standard input. Like `rand`, we expect it to return a different value every time we call it. Haskell therefore arranges for `getChar` to be of type `IO Char`: it returns a character, but also accepts, and passes on, the hidden state of the monad.

In most Haskell monads, hidden state can be explicitly extracted and examined. The IO monad, however, is *abstract*: only part of its state is defined in library header files; the rest is implemented by the language run-time system. This is unavoidable, because, in effect, *the hidden state of the IO monad encompasses the real world*. If this state were visible, a program could capture and reuse it, with the nonsensical expectation that we could “go back in time” and see what the user would have done in response to a different prompt last Tuesday. Unfortunately, IO state hiding means that a value of type `IO T` is permanently tainted: it can never be extracted from the monad to produce a “pure T.” ■

EXAMPLE 10.29

Functional composition of actions

Because IO actions are just ordinary values, we can manipulate them in the same way as values of other data types. The most basic output action is `putChar`, of type `Char -> IO ()` (monadic function with an explicit character argument and no explicit return). Given `putChar`, we can define `putStr`:

```
putStr :: String -> IO ()
putStr s = sequence_ (map putChar s)
```

Strings in Haskell are simply lists of characters. The `map` function takes a function `f` and a list `l` as argument, and returns a list that contains the results of applying `f` to the elements of `l`:

```
map :: (a->b) -> [a] -> [b]
map f [] = []                                -- base case
map f (h:t) = f h : map f t                 -- tail recursive case
-- ':' is like cons in Scheme
```

The result of `map putChar s` is a list of actions, each of which prints a character: it has type `[IO ()]`. The built-in function `sequence_` converts this to a single action that prints a list. It could be defined as follows.

```
sequence_ :: [IO ()] -> IO ()
sequence_ [] = return ()           -- base case
sequence_ (a:more) = do a; sequence_more -- tail recursive case
```

As before, `do` provides a convenient way to chain actions together. For brevity, we have written the actions on a single line, separated by a semicolon. ■

The entry point of a Haskell program is always the function `main`. It has type `IO ()`. Because Haskell is lazy (nonstrict), the action sequence returned by `main` remains hypothetical until the run-time system forces its evaluation. In practice, Haskell programs tend to have a small top-level structure of `IO` monad code that sequences I/O operations. The bulk of the program—both the computation of values *and the determination of the order in which I/O actions should occur*—is then purely functional. For a program whose I/O can be expressed in terms of streams, the top-level structure may consist of a single line:

EXAMPLE 10.30
Streams and the I/O monad

```
main = interact my_program
```

The library function `interact` is of type `(String -> String) -> IO ()`. It takes as argument a function from strings to strings (in this case `my_program`). It calls this function, passing the contents of standard input as argument, and writes the result to standard output. Internally, `interact` uses the function `getContents`, which returns the program's input as a lazily evaluated string: a stream. In a more sophisticated program, `main` may orchestrate much more complex I/O actions, including graphics and random access to files. ■

DESIGN & IMPLEMENTATION

Monads

Monads are very heavily used in Haskell. The `IO` monad serves as the central repository for imperative language features—not only I/O and random numbers, but also mutable global variables and shared-memory synchronization. Additional monads (with accessible hidden state) support partial functions and various container classes (lists and sets). When coupled with lazy evaluation, monadic containers in turn provide a natural foundation for backtracking search, nondeterminism, and the functional equivalent of iterators. (In the list monad, for example, hidden state can carry the continuation needed to generate the tail of an infinite list.)

The inability to extract values from the `IO` monad reflects the fact that the physical world is imperative, and that a language that needs to interact with the physical world in nontrivial ways must include imperative features. Put another way, the `IO` monad (unlike monads in general) is more than syntactic sugar: by hiding the state of the physical world it makes it possible to express things that could not otherwise be expressed in a functional way, provided that we are willing to enforce a sequential evaluation order. The beauty of monads is that they confine sequentiality to a relatively small fraction of the typical program, so that side effects cannot interfere with the bulk of the computation.

10.5 Higher-Order Functions

A function is said to be a *higher-order function* (also called a *functional form*) if it takes a function as an argument, or returns a function as a result. We have seen several examples already of higher-order functions: `call/cc` (Section 6.2.2), `for-each` (Example 10.18), `compose` (Example 10.19), and `apply` (page 518). We also saw a Haskell version of the higher-order function `map` in Section 10.4.2. The Scheme version of `map` is slightly more general. Like `for-each`, it takes as argument a function and a *sequence* of lists. There must be as many lists as the function takes arguments, and the lists must all be of the same length. `Map` calls its function argument on corresponding sets of elements from the lists:

EXAMPLE 10.31

Map function in Scheme

```
(map * '(2 4 6) '(3 5 7)) ⇒ (6 20 42)
```

Where `for-each` is executed for its side effects, and has an implementation-dependent return value, `map` is purely functional: it returns a list composed of the values returned by its function argument. ■

EXAMPLE 10.32

Folding (reduction) in Scheme

Programmers in Scheme (or in ML, Haskell, or other functional languages) can easily define other higher-order functions. Suppose, for example, that we want to be able to “fold” the elements of a list together, using an associative binary operator:

```
(define fold (lambda (f i l)
  (if (null? l) i      ; i is commonly the identity element for f
      (f (car l) (fold f i (cdr l))))))
```

Now `(fold + 0 '(1 2 3 4 5))` gives us the sum of the first five natural numbers, and `(fold * 1 '(1 2 3 4 5))` gives us their product. ■

EXAMPLE 10.33

Combining higher-order functions

One of the most common uses of higher-order functions is to build new functions from existing ones:

```
(define total (lambda (l) (fold + 0 l)))
(total '(1 2 3 4 5)) ⇒ 15

(define total-all (lambda (l)
  (map total l)))
(total-all '((1 2 3 4 5)
             (2 4 6 8 10)
             (3 6 9 12 15))) ⇒ (15 30 45)

(define make-double (lambda (f) (lambda (x) (f x x))))
(define twice (make-double +))
(define square (make-double *))
```

EXAMPLE 10.34

Partial application with currying

Currying

A common operation, named for logician Haskell Curry, is to replace a multiargument function with a function that takes a single argument and returns a function that expects the remaining arguments:

```
(define curried-plus (lambda (a) (lambda (b) (+ a b))))
((curried-plus 3) 4)           ⇒ 7
(define plus-3 (curried-plus 3))
(plus-3 4)                     ⇒ 7
```

Among other things, currying gives us the ability to pass a “partially applied” function to a higher-order function:

```
(map (curried-plus 3) '(1 2 3)) ⇒ (4 5 6) ■
```

EXAMPLE 10.35

General-purpose curry function

It turns out that we can write a general-purpose function that “curries” its (binary) function argument:

```
(define curry (lambda (f) (lambda (a) (lambda (b) (f a b)))))
(((curry +) 3) 4)           ⇒ 7
(define curried-plus (curry +)) ■
```

EXAMPLE 10.36

Tuples as ML function arguments

ML and its descendants (Miranda, Haskell, Caml, F#) make it especially easy to define curried functions. Consider the following function in ML:

```
fun plus (a, b) : int = a + b;
==> val plus = fn : int * int -> int
```

DESIGN & IMPLEMENTATION**Higher-order functions**

If higher-order functions are so powerful and useful, why aren't they more common in imperative programming languages? There would appear to be at least two important answers. First, much of the power of first-class functions depends on the ability to create new functions on the fly, and for that we need a function *constructor*—something like Scheme's `lambda` or ML's `fn`. Though they appear in certain recent languages, notably Python and C#, function constructors are a significant departure from the syntax and semantics of traditional imperative languages. Second, the ability to specify functions as return values, or to store them in variables (if the language has side effects) requires either that we eliminate function nesting (something that would again erode the ability of programs to create functions with desired behaviors on the fly), or that we give local variables unlimited extent, thereby increasing the cost of storage management.

The last line is printed by the ML interpreter, and indicates the inferred type of `plus`. The type declaration is required to disambiguate the overloaded `+` operator. Though one may think of `plus` as a function of two arguments, the ML definition says that all functions take a *single* argument. What we have declared is a function that takes a two-element *tuple* as argument. To call `plus`, we juxtapose its name and the tuple that is its argument:

```
plus (3, 4);
==> val it = 7 : int
```

The parentheses here are not part of the function call syntax; they delimit the tuple `(3, 4)`. ■

EXAMPLE 10.37

Optional parentheses on singleton arguments

We can declare a single-argument function without parenthesizing its formal argument:

```
fun twice n : int = n + n;
==> val twice = fn : int -> int
twice 2;
==> val it = 4 : int
```

We can add parentheses in either the declaration or the call if we want, but because there is no comma inside, no tuple is implied:

```
fun double (n) : int = n + n;
twice (2);
==> val it = 4 : int
twice 2;
==> val it = 4 : int
double (2);
==> val it = 4 : int
double 2;
==> val it = 4 : int
```

EXAMPLE 10.38

Simple curried function in ML

Ordinary parentheses can be placed around any expression in ML. ■

Now consider the definition of a curried function:

```
fun curried_plus a = fn b : int => a + b;
==> val curried_plus = fn : int -> int -> int
```

Note the type of `curried_plus`: `int -> int -> int` groups implicitly as `int -> (int -> int)`. Where `plus` is a function mapping a pair (tuple) of integers to an integer, `curried_plus` is a function mapping an integer to a function that maps an integer to an integer:

```
curried_plus 3;
==> val it = fn : int -> int
```

```
plus 3;
==> Error: operator domain (int * int) and operand (int) don't agree
```

EXAMPLE 10.39

Shorthand notation for currying

To make it easier to declare functions like `curried_plus`, ML allows a sequence of operands in the formal parameter position of a function declaration:

```
fun curried_plus a b : int = a + b;
==> val curried_plus = fn : int -> int -> int
```

This form is simply shorthand for the declaration in the previous example; it does not declare a function of two arguments. `Curried_plus` has a single formal parameter, `a`. Its return value is a function with formal parameter `b` that in turn returns `a + b`.

EXAMPLE 10.40

Folding (reduction) in ML

Using tuple notation, our `fold` function might be declared as follows in ML:

```
fun fold (f, i, l) =
  case l of
    nil => i
  | h :: t => f (h, fold (f, i, t));
==> val fold = fn : ('a * 'b -> 'b) * 'b * 'a list -> 'b
```

EXAMPLE 10.41

Curried `fold` in ML

The curried version would be declared as follows:

```
fun curried_fold f i l =
  case l of
    nil => i
  | h :: t => f (h, curried_fold f i t);
==> val fold = fn : ('a * 'b -> 'b) -> 'b -> 'a list -> 'b

curried_fold plus;
==> val it = fn : int -> int list -> int
curried_fold plus 0;
==> val it = fn : int list -> int
curried_fold plus 0 [1, 2, 3, 4, 5];
==> val it = 15 : int
```

Note again the difference in the inferred types of the functions.

It is of course possible to define `curried_fold` by nesting occurrences of the explicit `fn` notation within the function's body. The shorthand notation, however, is substantially more intuitive and convenient. Note also that ML's syntax for function calls—juxtaposition of function and argument—makes the use of a curried function more intuitive and convenient than it is in Scheme:

EXAMPLE 10.42

Currying in ML vs Scheme

```
curried_fold plus 0 [1, 2, 3, 4, 5];      (* ML *)
(((curried_fold +) 0) '(1 2 3 4 5))      ; Scheme
```

10.6 Theoretical Foundations

EXAMPLE 10.43

Declarative
(nonconstructive) function
definition

Mathematically, a function is a single-valued mapping: it associates every element in one set (the *domain*) with (at most) one element in another set (the *range*). In conventional notation, we indicate the domain and range of, say, the square root function by writing

$$\text{sqrt} : \mathcal{R} \rightarrow \mathcal{R}$$

We can also define functions using conventional set notation:

$$\text{sqrt} \equiv \{(x, y) \in \mathcal{R} \times \mathcal{R} \mid y > 0 \wedge x = y^2\}$$

Unfortunately, this notation is *nonconstructive*: it doesn't tell us how to *compute* square roots. Church designed the lambda calculus to address this limitation. ■

© IN MORE DEPTH

Lambda calculus is a *constructive* notation for function definitions. We consider it in more detail on the PLP CD. Any computable function can be written as a lambda expression. Computation amounts to macro substitution of arguments into the function definition, followed by reduction to simplest form via simple and mechanical rewrite rules. The order in which these rules are applied captures the distinction between applicative and normal-order evaluation, as described in [Section 6.6.2](#). Conventions on the use of certain simple functions (e.g., the identity function) allow selection, structures, and even arithmetic to be captured as lambda expressions. Recursion is captured through the notion of *fixed points*.

10.7 Functional Programming in Perspective

Side-effect-free programming is a very appealing idea. As discussed in [Sections 6.1.2](#) and [6.3](#), side effects can make programs both hard to read and hard to compile. By contrast, the lack of side effects makes expressions *referentially transparent*—independent of evaluation order. Programmers and compilers of a purely functional language can employ *equational reasoning*, in which the equivalence of two expressions at any point in time implies their equivalence at all times. Equational reasoning in turn is highly appealing for parallel execution: In a purely functional language, the arguments to a function can safely be evaluated in parallel with each other. In a lazy functional language, they can be evaluated in parallel with (the beginning of) the function to which they are passed. We will consider these possibilities further in [Section 12.4.5](#).

Unfortunately, there are common programming idioms in which the canonical side effect—assignment—plays a central role. Critics of functional programming often point to these idioms as evidence of the need for imperative language features. I/O is one example. We have seen (in [Section 10.4](#)) that sequential access to files can be modeled in a functional manner using streams. For graphics and random file access we have also seen that the monads of Haskell can cleanly isolate the invocation of actions from the bulk of the language, and allow the full power of equational reasoning to be applied to both the computation of values and the determination of the order in which I/O actions should occur.

Other commonly cited examples of “naturally imperative” idioms include:

Initialization of complex structures: The heavy reliance on lists in Lisp, ML, and Haskell reflects the ease with which functions can build new lists out of the components of old lists. Other data structures—multidimensional arrays in particular—are much less easy to put together incrementally, particularly if the natural order in which to initialize the elements is not strictly row-major or column-major.

Summarization: Many programs include code that scans a large data structure or a large amount of input data, counting the occurrences of various items or patterns. The natural way to keep track of the counts is with a dictionary data structure in which one repeatedly updates the count associated with the most recently noticed key.

In-place mutation: In programs with very large data sets, one must economize as much as possible on memory usage, to maximize the amount of data that will fit in memory or the cache. Sorting programs, for example, need to sort in place, rather than copying elements to a new array or list. Matrix-based scientific programs, likewise, need to update values in place.

These last three idioms are examples of what has been called the *trivial update problem*. If the use of a functional language forces the underlying implementation to create a new copy of the entire data structure every time one of its elements must change, then the result will be very inefficient. In imperative programs, the problem is avoided by allowing an existing structure to be modified in place.

One can argue that while the trivial update problem causes trouble in Lisp and its relatives, it does not reflect an inherent weakness of functional programming per se. What is required for a solution is a combination of convenient notation—to access arbitrary elements of a complex structure—and an implementation that is able to determine when the old version of the structure will never be used again, so it can be updated in place instead of being copied.

Sisal, pH, and Single Assignment C (SAC) combine array types and iterative syntax with purely functional semantics. The iterative constructs are defined as syntactic sugar for tail-recursive functions. When nested, these constructs can easily be used to initialize a multidimensional array. The semantics of the language say that each iteration of the loop returns a new copy of the entire array. The compiler can easily verify, however, that the old copy is never used after the return, and

can therefore arrange to perform all updates in place. Similar optimizations could be performed in the absence of the imperative syntax, but require somewhat more complex analysis. Cann reports that the Livermore Sisal compiler was able to eliminate 99 to 100% of all copy operations in standard numeric benchmarks [Can92]. Scholz reports performance for SAC competitive with that of carefully optimized modern Fortran programs [Sch03].

Significant strides in both the theory and practice of functional programming have been made in recent years. Wadler [Wad98b] argued in the late 1990s that the principal remaining obstacles to the widespread adoption of functional languages were social and commercial, not technical: most programmers have been trained in an imperative style; software libraries and development environments for functional programming are not yet as mature as those of their imperative cousins. Experience over the past decade appears to have borne out this characterization: with the development of better tools and a growing body of practical experience, functional languages have begun to see much wider use. Functional features have also begun to appear in such mainstream imperative languages as C#, Python, and Ruby.

✓ CHECK YOUR UNDERSTANDING

12. What is the difference between *normal-order* and *applicative-order* evaluation? What is *lazy* evaluation?
13. What is the difference between a function and a *special form* in Scheme?
14. What does it mean for a function to be *strict*?
15. What is *memoization*?

DESIGN & IMPLEMENTATION

Side effects and compilation

As noted in Section 10.2, side-effect freedom has a strong conceptual appeal: it frees the programmer from concern over undocumented access to nonlocal variables, misordered updates, aliases, and dangling pointers. Side-effect freedom also has the potential, at least in theory, to allow the compiler to generate faster code: like aliases, side effects often preclude the caching of values in registers (Section 3.5.1) or the use of constant and copy propagation (Sections ©16.3 and ©16.4).

So what are the technical obstacles to generating fast code for functional programs? The trivial update problem is certainly a challenge, as is the cost of heap management for values with unlimited extent. Type checking imposes significant run-time costs in languages descended from Lisp, but not in those descended from ML. Memoization is expensive in Miranda and Haskell, though so-called *strictness analysis* may allow the compiler to eliminate it in cases where applicative order evaluation is provably equivalent. These challenges are all the subject of continuing research.

16. How can one accommodate I/O in a purely functional programming model?
 17. What is a *higher-order* function (also known as a *functional form*)? Give three examples.
 18. What is *currying*? What purpose does it serve in practical programs?
 19. What is the *trivial update problem* in functional programming?
 20. Summarize the arguments for and against side-effect-free programming.
 21. Why do functional languages make such heavy use of lists?
-

10.8 Summary and Concluding Remarks

In this chapter we have focused on the functional model of computing. Where an imperative program computes principally through iteration and side effects (i.e., the modification of variables), a functional program computes principally through substitution of parameters into functions. We began by enumerating a list of key issues in functional programming, including first-class and higher-order functions, polymorphism, control flow and evaluation order, and support for list-based data. We then turned to a concrete example—the Scheme dialect of Lisp—to see how these issues may be addressed in a programming language. We also considered, more briefly, ML and its descendants: Miranda, Haskell, Caml, and F#.

For imperative programming languages, the underlying formal model is often taken to be a Turing machine. For functional languages, the model is the lambda calculus. Both models evolved in the mathematical community as a means of formalizing the notion of an effective procedure, as used in constructive proofs. Aside from hardware-imposed limits on arithmetic precision, disk and memory space, and so on, the full power of lambda calculus is available in functional languages. While a full treatment of the lambda calculus could easily consume another book, we provided an overview on the PLP CD. We considered rewrite rules, evaluation order, and the Church-Rosser theorem. We noted that conventions on the use of very simple notation provide the computational power of integer arithmetic, selection, recursion, and structured data types.

For practical reasons, many functional languages extend the lambda calculus with additional features, including assignment, I/O, and iteration. Lisp dialects, moreover, are *homoiconic*: programs look like ordinary data structures, and can be created, modified, and executed on the fly.

Lists feature prominently in most functional programs, largely because they can easily be built incrementally, without the need to allocate and then modify state as separate operations. Many functional languages provide other structured data types as well. In Sisal and Single Assignment C, an emphasis on iterative

syntax, tail-recursive semantics, and high-performance compilers allows multidimensional array-based functional programs to achieve performance comparable to that of imperative programs.

10.9 Exercises

- 10.1 Is the `define` primitive of Scheme an imperative language feature? Why or why not?
- 10.2 It is possible to write programs in a purely functional subset of an imperative language such as C, but certain limitations of the language quickly become apparent. What features would need to be added to your favorite imperative language to make it genuinely useful as a functional language? (Hint: what does Scheme have that C lacks?)
- 10.3 Explain the connection between short-circuit Boolean expressions and normal-order evaluation. Why is `cond` a special form in Scheme, rather than a function?
- 10.4 Write a program in your favorite imperative language that has the same input and output as the Scheme program of [Figure 10.1](#). Can you make any general observations about the usefulness of Scheme for symbolic computation, based on your experience?
- 10.5 Suppose we wish to remove adjacent duplicate elements from a list (e.g., after sorting). The following Scheme function accomplishes this goal:

```
(define unique
  (lambda (L)
    (cond
      ((null? L) L)
      ((null? (cdr L)) L)
      ((eq? (car L) (car (cdr L))) (unique (cdr L)))
      (else (cons (car L) (unique (cdr L)))))))
```

Write a similar function that uses the imperative features of Scheme to modify L “in place,” rather than building a new list. Compare your function to the code above in terms of brevity, conceptual clarity, and speed.

- 10.6 Write tail-recursive versions of the following:
 - (a)

```
;; compute integer log, base 2
;; (number of bits in binary representation)
;; works only for positive integers
(define log2
  (lambda (n)
    (if (= n 1) 0 (+ 1 (log2 (quotient (+ n 1) 2))))))
```

```
(b) ;; find minimum element in a list
(define min
  (lambda (l)
    (cond
      ((null? l) '())
      ((null? (cdr l)) (car l))
      (#t (let ((a (car l))
                (b (min (cdr l))))
             (if (< b a) b a))))))
```

10.7 Write purely functional Scheme functions to

- (a) return all *rotations* of a given list. For example, `(rotate '(a b c d e))` should return `((a b c d e) (b c d e a) (c d e a b) (d e a b c) (e a b c d))` (in some order).
- (b) return a list containing all elements of a given list that satisfy a given predicate. For example, `(filter (lambda (x) (< x 5)) '(3 9 5 8 2 4 7))` should return `(3 2 4)`.

10.8 Write a purely functional Scheme function that returns a list of all permutations of a given list. For example, given `(a b c)` it should return `((a b c) (b a c) (b c a) (a c b) (c a b) (c b a))` (in some order).

10.9 Modify the Scheme program of [Figure 10.1](#) to simulate an NFA (nondeterministic finite automaton), rather than a DFA. (The distinction between these automata is described in [Section 2.2.1](#).) Since you cannot “guess” correctly in the face of a multivalued transition function, you will need either to use explicitly coded backtracking to search for an accepting series of moves (if there is one), or keep track of *all* possible states that the machine could be in at a given point in time.

10.10 Consider the problem of determining whether two trees have the same *fringe*: the same set of leaves in the same order, regardless of internal structure. An obvious way to solve this problem is to write a function `flatten` that takes a tree as argument and returns an ordered list of its leaves. Then we can say

```
(define same-fringe
  (lambda (T1 T2)
    (equal (flatten T1) (flatten T2))))
```

Write a straightforward version of `flatten` in Scheme. How efficient is `same-fringe` when the trees differ in their first few leaves? How would your answer differ in a language like Haskell, which uses lazy evaluation for all arguments? How hard is it to get Haskell’s behavior in Scheme, using `delay` and `force`?

10.11 We can use encapsulation within functions to delay evaluation in ML:

```

datatype 'a delayed_list =
  pair of 'a * 'a delayed_list
  | promise of unit -> 'a * 'a delayed_list;
fun head (pair (h, r)) = h
  | head (promise (f)) = let val (a, b) = f () in a end;
fun rest (pair (h, r)) = r
  | rest (promise (f)) = let val (a, b) = f () in b end;

```

Now given

```

fun next_int (n) = (n, promise (fn () => next_int (n + 1)));
val naturals = promise (fn () => next_int (1));

```

we have

```

head (naturals)           => 1
head (rest (naturals))   => 2
head (rest (rest (naturals))) => 3
...

```

The delayed list `naturals` is effectively of unlimited length. It will be computed out only as far as actually needed. If a value is needed more than once, however, it will be recomputed every time. Show how to use pointers and assignment ([Example 7.78](#), page 351) to memoize the values of a `delayed_list`, so that elements are computed only once.

10.12 In [Example 10.26](#) we showed how to implement interactive I/O in terms of the lazy evaluation of streams. Unfortunately, our code would not work as written, because Scheme uses applicative-order evaluation. We can make it work, however, with calls to `delay` and `force`.

Suppose we define `input` to be a function that returns an “istream”—a promise that when forced will yield a pair, the `cdr` of which is an istream:

```
(define input (lambda () (delay (cons (read) (input)))))
```

Now we can define the driver to expect an “ostream”—an empty list or a pair, the `cdr` of which is an ostream:

```
(define driver
  (lambda (s)
    (if (null? s) '()
        (display (car s))
        (driver (force (cdr s))))))
```

Note the use of `force`.

Show how to write the function `squares` so that it takes an istream as argument and returns an ostream. You should then be able to type `(driver (squares (input)))` and see appropriate behavior.

- 10.13 Write new versions of `cons`, `car`, and `cdr` that operate on streams. Using them, rewrite the code of the previous exercise to eliminate the calls to `delay` and `force`. Note that the stream version of `cons` will need to avoid evaluating its second argument; you will need to learn how to define macros (derived special forms) in Scheme.
- 10.14 Write the standard quicksort algorithm in Scheme, without using any imperative language features. Be careful to avoid the trivial update problem; your code should run in expected time $n \log n$.
Rewrite your code using arrays (you will probably need to consult a Scheme manual for further information). Compare the running time and space requirements of your two sorts.
- 10.15 Write `insert` and `find` routines that manipulate binary search trees in Scheme (consult an algorithms text if you need more information). Explain why the trivial update problem does *not* impact the asymptotic performance of `insert`.
- 10.16 Write an LL(1) parser generator in purely functional Scheme. If you consult [Figure 2.23](#), remember that you will need to use tail recursion in place of iteration. Assume that the input CFG consists of a list of lists, one per nonterminal in the grammar. The first element of each sublist should be the nonterminal; the remaining elements should be the right-hand sides of the productions for which that nonterminal is the left-hand side. You may assume that the sublist for the start symbol will be the first one in the list. If we use quoted strings to represent grammar symbols, the calculator grammar of [Figure 2.15](#) would look like this:

```
'(("program" ("stmt_list" "$$"))
  ("stmt_list" ("stmt" "stmt_list") ())
  ("stmt" ("id" "!=" "expr") ("read" "id") ("write" "expr"))
  ("expr" ("term" "term_tail"))
  ("term" ("factor" "factor_tail"))
  ("term_tail" ("add_op" "term" "term_tail") ())
  ("factor_tail" ("mult_op" "factor" "FT") ())
  ("add_op" ("+" "-"))
  ("mult_op" ("*" "/"))
  ("factor" ("id") ("number") ("(" "expr" "))))
```

Your output should be a parse table that has this same format, except that every right-hand side is replaced by a *pair* (a two-element list) whose first element is the predict set for the corresponding production, and whose second element is the right-hand side. For the calculator grammar, the table looks like this:

```
((("program" (( "$$" "id" "read" "write") ("stmt_list" "$$"))))
  ("stmt_list"
    (( "id" "read" "write") ("stmt" "stmt_list"))
    (( "$$" ) ())))
```

```

(stmt
  (id) (id " := " expr))
(read) (read id)
(write) (write expr))
(expr (((" id " number) (term "term_tail")))
(term (((" id " number) (factor "factor_tail")))
(term_tail
  (+ " -") (add_op "term" "term_tail")
  ($$ " ") "id" "read" "write") ()))
(factor_tail
  (* "/" ) (mult_op "factor" "factor_tail")
  ($$ " ") "+ " - "id" "read" "write") ()))
(add_op ((+) (+)) ((-) (-))
(mult_op ((*)) (/)) (/))
(factor
  (id) (id))
  (number) (number))
  (((" (" "expr" "))))

```

(Hint: you may want to define a `right_context` function that takes a nonterminal B as argument and returns a list of all pairs (A, β) , where A is a nonterminal and β is a list of symbols, such that for some potentially different list of symbols α , $A \rightarrow \alpha B \beta$. This function is useful for computing FOLLOW sets. You may also want to build a tail-recursive function that recomputes FIRST and FOLLOW sets until they converge. You will find it easier if you do not include ϵ in either set, but rather keep a separate estimate, for each nonterminal, of whether it may generate ϵ .)

- 10.17 Write an ML version of the code in [Figure 10.1](#). Alternatively (or in addition), solve [Exercises 10.9](#), [10.10](#), [10.14](#), [10.15](#), or [10.16](#) in ML.

© 10.18–10.21 In More Depth.

10.10 Explorations

- 10.22 Read the original self-definition of Lisp [[MAE⁺65](#)]. Compare it to a similar definition of Scheme [[AS96](#), Chap. 4]. What is different? What has stayed the same? What is built into `apply` and `eval` in each definition? What do you think of the whole idea? Does a metacircular interpreter really define anything, or is it “circular reasoning”?
- 10.23 Read the Turing Award lecture of John Backus [[Bac78](#)], in which he argues for functional programming. How does his FP notation compare to the Lisp and ML language families?
- 10.24 Learn more about monads in Haskell. Pay particular attention to the definition of lists. Explain the relationship of the list monad to list

comprehensions (Example 7.94), iterators, continuations (Section 6.2.2), and backtracking search.

- 10.25 Read ahead and learn about *transactional memory* (Section 12.4.4). Then read up on STM Haskell [HMPH05]. Explain how monads facilitate the serialization of updates to locations shared between threads.
- 10.26 We have seen that Lisp and ML include such imperative features as assignment and iteration. How important are these? What do languages like Haskell give up (conversely, what do they gain) by insisting on a purely functional programming style? In a similar vein, what do you think of attempts in several recent imperative languages (notably Python and C#—see the sidebar on page 531) to facilitate functional programming with function constructors and unlimited extent?
- 10.27 Investigate the compilation of functional programs. What special issues arise? What techniques are used to address them? Starting places for your search might include the compiler texts of Appel [App97], Wilhelm and Maurer [WM95], and Grune et al. [GBJL01].

© 10.28–10.30 In More Depth.

10.11 Bibliographic Notes

Lisp, the original functional programming language, dates from the work of McCarthy and his associates in the late 1950s. Bibliographic references for Caml, Erlang, Haskell, Lisp, Miranda, ML, Scheme, Single Assignment C, and Sisal can be found in Appendix A. Historically important dialects of Lisp include Lisp 1.5 [MAE⁺65], MacLisp [Moo78] (no relation to the Apple Macintosh), and Interlisp [TM81].

The book by Abelson and Sussman [AS96], long used for introductory programming classes at MIT and elsewhere, is a classic guide to fundamental programming concepts, and to functional programming in particular. Additional historical references can be found in the paper by Hudak [Hud89], which surveys the field from the point of view of Haskell.

The lambda calculus was introduced by Church in 1941 [Chu41]. A classic reference is the text of Curry and Feys [CF58]. Barendregt's book [Bar84] is a standard modern reference. Michaelson [Mic89] provides an accessible introduction to the formalism, together with a clear explanation of its relationship to Lisp and ML. Stansifer [Sta95, Sec. 7.6] provides a good informal discussion and correctness proof for the fixed-point combinator Y (see Exercise ©10.9).

John Backus, one of the original developers of Fortran, argued forcefully for a move to functional programming in his 1977 Turing Award lecture [Bac78]. His functional programming notation is known as FP. Peyton Jones [Pey87, Pey92], Wilhelm and Maurer [WM95, Chap. 3], Appel [App97, Chap. 15], and Grune et al. [GBJL01, Chap. 7] discuss the implementation of functional

languages. Peyton Jones’s paper on the “awkward squad” [Pey01] is widely considered the definitive introduction to monads in Haskell.

While Lisp dates from the early 1960s, it is only in recent years that functional languages have seen widespread use in large commercial systems. Wadler [Wad98a, Wad98b] describes the situation as of the late 1990s, when the tide began to turn. Descriptions of many subsequent projects can be found in the proceedings of the Commercial Users of Functional Programming workshop (cufp.galois.com), held annually since 2004. The *Journal of Functional Programming* also publishes a special category of articles on commercial use. Armstrong reports [Arm07] that the Ericsson AXD301, a telephone switching system comprising more than two million lines of Erlang code, has achieved an astonishing “nine nines” level of reliability—the equivalent of less than 32 ms of downtime per year.

Logic Languages

Having considered functional languages in some detail, we now turn to the other principal declarative paradigm: logic languages. The overlap between imperative and functional concepts in programming language design has led us to discuss the latter at numerous points throughout the text. We have had less occasion to remark on features of logic programming languages. Logic of course is used heavily in the design of digital circuits, and most programming languages provide a logical (Boolean) type and operators. Logic is also heavily used in the formal study of language semantics, specifically in *axiomatic semantics*.¹ It was only in the 1970s, however, with the work of Alain Colmerauer and Philippe Roussel of the University of Aix–Marseille in France and Robert Kowalski and associates at the University of Edinburgh in Scotland, that researchers began to employ the process of logical deduction as a general-purpose model of computing.

We introduce the basic concepts of logic programming in [Section 11.1](#). We then survey the most widely used logic language, Prolog, in [Section 11.2](#). We consider, in turn, the concepts of resolution and unification, support for lists and arithmetic, and the search-based execution model. After presenting an extended example based on the game of tic-tac-toe, we turn to the more advanced topics of imperative control flow and database manipulation.

Much as functional programming is based on the formalism of lambda calculus, Prolog and other logic languages are based on *first-order predicate calculus*. A brief introduction to this formalism appears in [Section 11.3](#) on the PLP CD. Where functional languages capture the full capabilities of the lambda calculus, however (within the limits, at least, of memory and other resources), logic languages do not capture the full power of predicate calculus. We consider the relevant limitations as part of a general evaluation of logic programming in [Section 11.4](#).

I Axiomatic semantics models each statement or expression in the language as a *predicate transformer*—an inference rule that takes a set of conditions known to be true initially and derives a new set of conditions guaranteed to be true after the construct has been evaluated. The study of formal semantics is beyond the scope of this book.

11.1 Logic Programming Concepts

Logic programming systems allow the programmer to state a collection of *axioms* from which theorems can be proven. The user of a logic program states a theorem, or *goal*, and the language implementation attempts to find a collection of axioms and inference steps (including choices of values for variables) that together imply the goal. Of the several existing logic languages, Prolog is by far the most widely used.

EXAMPLE 11.1

Horn clauses

In almost all logic languages, axioms are written in a standard form known as a *Horn clause*. A Horn clause consists of a *head*² or *consequent* term H , and a *body* consisting of terms B_i :

$$H \leftarrow B_1, B_2, \dots, B_n$$

The semantics of this statement are that when the B_i are all true, we can deduce that H is true as well. When reading aloud, we say “ H , if B_1, B_2, \dots , and B_n .” Horn clauses can be used to capture most, but not all, logical statements. (We return to the issue of completeness in Section ©11.3.) ■

EXAMPLE 11.2

Resolution

In order to derive new statements, a logic programming system combines existing statements, canceling like terms, through a process known as *resolution*. If we know that A and B imply C , for example, and that C implies D , we can deduce that A and B imply D :

$$\begin{array}{l} C \leftarrow A, B \\ D \leftarrow C \\ \hline D \leftarrow A, B \end{array}$$

In general, terms like A, B, C , and D may consist not only of constants (“Rochester is rainy”), but also of *predicates* applied to *atoms* or to *variables*: rainy(Rochester), rainy(Seattle), rainy(X). ■

EXAMPLE 11.3

Unification

During resolution, free variables may acquire values through *unification* with expressions in matching terms, much as variables acquire types in ML (Section ©7.2.4):

$$\begin{array}{l} \text{flowery}(X) \leftarrow \text{rainy}(X) \\ \text{rainy}(\text{Rochester}) \\ \hline \text{flowery}(\text{Rochester}) \end{array}$$

In the following section we consider Prolog in more detail. We return to formal logic, and to its relationship to Prolog, in Section ©11.3. ■

² Note that the word “head” is used for two different things in Prolog: the head of a Horn clause and the head of a list. The distinction between these is usually clear from context.

11.2 Prolog

Much as a Scheme interpreter evaluates functions in the context of a referencing environment in which other functions and constants have been defined, a Prolog interpreter runs in the context of a *database of clauses* (Horn clauses) that are assumed to be true.³ Each clause is composed of *terms*, which may be constants, variables, or *structures*. A constant is either an atom or a number. A structure can be thought of as either a logical predicate or a data structure.

EXAMPLE 11.4

Atoms, variables, scope, and type

Atoms in Prolog are similar to symbols in Lisp. Lexically, an atom looks like an identifier beginning with a lowercase letter, a sequence of “punctuation” characters, or a quoted character string:

```
foo      my_Const  +      'Hi, Mom'
```

Numbers resemble the integers and floating-point constants of other programming languages. A variable looks like an identifier beginning with an uppercase letter:

```
Foo      My_var    X
```

Variables can be *instantiated* to (i.e., can take on) arbitrary values at run time as a result of unification. The scope of every variable is limited to the clause in which it appears. There are no declarations. As in Lisp, type checking occurs only when a program attempts to use a value in a particular way at run time. ■

EXAMPLE 11.5

Structures and predicates

Structures consist of an atom called the *functor* and a list of arguments:

```
rainy(rochester)
teaches(scott, cs254)
bin_tree(foo, bin_tree(bar, glarch))
```

Prolog requires the opening parenthesis to come immediately after the functor, with no intervening space. Arguments can be arbitrary terms: constants, variables, or (nested) structures. Internally, a Prolog implementation can represent a structure using Lisp-like cons cells. Conceptually, the programmer may prefer to think of certain structures (e.g., *rainy*) as logical predicates. We use the term “predicate” to refer to the combination of a functor and an “arity” (number of arguments). The predicate *rainy* has arity 1. The predicate *teaches* has arity 2. ■

EXAMPLE 11.6

Facts and rules

The clauses in a Prolog database can be classified as *facts* or *rules*, each of which ends with a period. A fact is a Horn clause without a right-hand side. It looks like a single term (the implication symbol is implicit):

```
rainy(rochester).
```

3 In fact, for any given program, the database is assumed to characterize *everything* that is true. This *closed world assumption* imposes certain limits on the expressiveness of the language; we will return to this topic in [Section 11.4.3](#).

A rule has a right-hand side:

```
snowy(X) :- rainy(X), cold(X).
```

The token `:-` is the implication symbol; the comma indicates “and.” Variables that appear in the head of a Horn clause are universally quantified: for all X , X is snowy if X is rainy and X is cold. ■

It is also possible to write a clause with an empty left-hand side. Such a clause is called a *query*, or a *goal*. Queries do not appear in Prolog programs. Rather, one builds a database of facts and rules and then initiates execution by giving the Prolog interpreter (or the compiled Prolog program) a query to be answered (i.e., a goal to be proven).

In most implementations of Prolog, queries are entered with a special `?-` version of the implication symbol. If we were to type the following:

EXAMPLE 11.7

Queries

```
rainy(seattle).
rainy(rochester).
?- rainy(C).
```

the Prolog interpreter would respond with

```
C = seattle
```

Of course, `C = rochester` would also be a valid answer, but Prolog will find `seattle` first, because it comes first in the database. (Dependence on ordering is one of the ways in which Prolog departs from pure logic; we discuss this issue further below.) If we want to find all possible solutions, we can ask the interpreter to continue by typing a semicolon:

```
C = seattle ;
C = rochester
```

If we type another semicolon, the interpreter will indicate that no further solutions are possible:

```
C = seattle ;
C = rochester ;
No
```

Similarly, given

```
rainy(seattle).
rainy(rochester).
cold(rochester).
snowy(X) :- rainy(X), cold(X).
```

the query

```
?- snowy(C).
```

will yield only one solution. ■

11.2.1 Resolution and Unification

The *resolution principle*, due to Robinson [Rob65], says that if C_1 and C_2 are Horn clauses and the head of C_1 matches one of the terms in the body of C_2 , then we can replace the term in C_2 with the body of C_1 . Consider the following example:

EXAMPLE 11.8

Resolution in Prolog

```
takes(jane_doe, his201).
takes(jane_doe, cs254).
takes(ajit_chandra, art302).
takes(ajit_chandra, cs254).
classmates(X, Y) :- takes(X, Z), takes(Y, Z).
```

If we let X be `jane_doe` and Z be `cs254`, we can replace the first term on the right-hand side of the last clause with the (empty) body of the second clause, yielding the new rule

```
classmates(jane_doe, Y) :- takes(Y, cs254).
```

In other words, Y is a classmate of `jane_doe` if Y takes `cs254`. ■

Note that the last rule has a variable (Z) on the right-hand side that does not appear in the head. Such variables are existentially quantified: for all X and Y , X and Y are classmates if there exists a class Z that they both take.

The pattern-matching process used to associate X with `jane_doe` and Z with `cs254` is known as *unification*. Variables that are given values as a result of unification are said to be *instantiated*.

The unification rules for Prolog state that

- A constant unifies only with itself.
- Two structures unify if and only if they have the same functor and the same arity, and the corresponding arguments unify recursively.
- A variable unifies with anything. If the other thing has a value, then the variable is instantiated. If the other thing is an uninstantiated variable, then the two variables are associated in such a way that if either is given a value later, that value will be shared by both.

EXAMPLE 11.9

Unification in Prolog and ML

Unification of structures in Prolog is very much akin to ML's unification of the types of formal and actual parameters. A formal parameter of type `int * 'b list`, for example, will unify with an actual parameter of type `'a * real list` in ML by instantiating `'a` to `int` and `'b` to `real`. ■

EXAMPLE 11.10

Equality and unification

Equality in Prolog is defined in terms of “unifiability.” The goal `=(A, B)` succeeds if and only if A and B can be unified. For the sake of convenience, the goal may be written as `A = B`; the infix notation is simply syntactic sugar. In keeping with the rules above, we have

```

?- a = a.
Yes                % constant unifies with itself
?- a = b.
No                 % but not with another constant
?- foo(a, b) = foo(a, b).
Yes                % structures are recursively identical
?- X = a.
X = a ;           % variable unifies with constant
No                % only once
?- foo(a, b) = foo(X, b).
X = a ;           % arguments must unify
No                % only one possibility

```

EXAMPLE 11.11

Unification without
instantiation

It is possible for two variables to be unified without instantiating them. If we type

```
?- A = B.
```

the interpreter will simply respond

```
A = B
```

If, however, we type

```
?- A = B, A = a, B = Y.
```

(unifying A and B before binding a to A) the interpreter will respond

```
A = a
B = a
Y = a
```

In a similar vein, suppose we are given the following rules:

```
takes_lab(S) :- takes(S, C), has_lab(C).
has_lab(D) :- meets_in(D, R), is_lab(R).
```

(S takes a lab class if S takes C and C is a lab class. Moreover D is a lab class if D meets in room R and R is a lab.) An attempt to resolve these rules will unify the head of the second with the second term in the body of the first, causing C and D to be unified, even though neither is instantiated. ■

11.2.2 Lists

EXAMPLE 11.12

List notation in Prolog

Like equality checking, list manipulation is a sufficiently common operation in Prolog to warrant its own notation. The construct `[a, b, c]` is syntactic sugar for the structure `.(a, .(b, .(c, [])))`, where `[]` is the empty list and `.` is a built-in `cons`-like predicate. This notation should be familiar to users of ML. Prolog adds an extra convenience, however: an optional vertical bar that delimits the “tail” of the list. Using this notation, `[a, b, c]` could be expressed as `[a | [b, c]]`, `[a, b | [c]]`, or `[a, b, c | []]`. The vertical-bar notation is particularly handy when the tail of the list is a variable:

```

member(X, [X | _]).
member(X, [_ | T]) :- member(X, T).

sorted([]).           % empty list is sorted
sorted([_]).         % singleton is sorted
sorted([A, B | T]) :- A =< B, sorted([B | T]).
                    % compound list is sorted if first two elements are in order and
                    % remainder of list (after first element) is sorted

```

Here `=<` is a built-in predicate that operates on numbers. The underscore is a placeholder for a variable that is not needed anywhere else in the clause. Note that `[a, b | c]` is the *improper* list `.(a, .(b, c))`. The sequence of tokens `[a | b, c]` is syntactically invalid. ■

EXAMPLE 11.13

Functions, predicates, and two-way rules

One of the interesting things about Prolog resolution is that it does not in general distinguish between “input” and “output” arguments (there are certain exceptions, such as the `is` predicate described in the following subsection). Thus, given

```

append([], A, A).
append([H | T], A, [H | L]) :- append(T, A, L).

```

we can type

```

?- append([a, b, c], [d, e], L).
L = [a, b, c, d, e]
?- append(X, [d, e], [a, b, c, d, e]).
X = [a, b, c]
?- append([a, b, c], Y, [a, b, c, d, e]).
Y = [d, e]

```

This example highlights the difference between functions and Prolog predicates. The former have a clear notion of inputs (arguments) and outputs (results); the latter do not. In an imperative or functional language we apply functions to arguments to generate results. In a logic language we search for values for which a predicate is true. (Not all logic languages are equally flexible. Mercury, for example, requires the programmer to specify `in` or `out` modes on arguments. These allow the compiler to generate substantially faster code.) ■

11.2.3 Arithmetic

EXAMPLE 11.14

Arithmetic and the `is` predicate

The usual arithmetic operators are available in Prolog, but they play the role of predicates, not of functions. Thus `+(2, 3)`, which may also be written `2 + 3`, is a two-argument structure, not a function call. In particular, it will not unify with `5`:

```

?- (2 + 3) = 5.
No

```

To handle arithmetic, Prolog provides a built-in predicate, `is`, that unifies its first argument with the arithmetic value of its second argument:

```
?- is(X, 1+2).
X = 3
?- X is 1+2.
X = 3                % infix is also ok
?- 1+2 is 4-1.
No                  % first argument (1+2) is already instantiated
?- X is Y.
ERROR              % second argument (Y) must already be instantiated
?- Y is 1+2, X is Y.
Y = 3
X = 3              % Y is instantiated by the time it is needed ■
```

11.2.4 Search/Execution Order

So how does Prolog go about answering a query (satisfying a goal)? What it needs is a sequence of resolution steps that will build the goal out of clauses in the database, or a proof that no such sequence exists. In the realm of formal logic, one can imagine two principal search strategies:

- Start with existing clauses and work forward, attempting to derive the goal. This strategy is known as *forward chaining*.
- Start with the goal and work backward, attempting to “unresolve” it into a set of preexisting clauses. This strategy is known as *backward chaining*.

If the number of existing rules is very large, but the number of facts is small, it is possible for forward chaining to discover a solution more quickly than backward chaining. In most circumstances, however, backward chaining turns out to be more efficient. Prolog is defined to use backward chaining.

Because resolution is associative and commutative ([Exercise 11.5](#)), a backward-chaining theorem prover can limit its search to sequences of resolutions in which terms on the right-hand side of a clause are unified with the heads of other clauses one by one in some particular order (e.g., left to right). The resulting search can be described in terms of a tree of subgoals, as shown in [Figure 11.1](#). The Prolog interpreter (or program) explores this tree depth first, from left to right. It starts at the beginning of the database, searching for a rule R whose head can be unified with the top-level goal. It then considers the terms in the body of R as subgoals, and attempts to satisfy them, recursively, left to right. If at any point a subgoal fails (cannot be satisfied), the interpreter returns to the previous subgoal and attempts to satisfy it in a different way (i.e., to unify it with the head of a different clause). ■

The process of returning to previous goals is known as *backtracking*. It strongly resembles the control flow of generators in Icon ([Section ©6.5.4](#)). Whenever a unification operation is “undone” in order to pursue a different path through the search tree, variables that were given values or associated with one another as

EXAMPLE 11.15

Search tree exploration

```

rainy(seattle).
rainy(rochester).
cold(rochester).
snowy(X) :- rainy(X), cold(X).

```

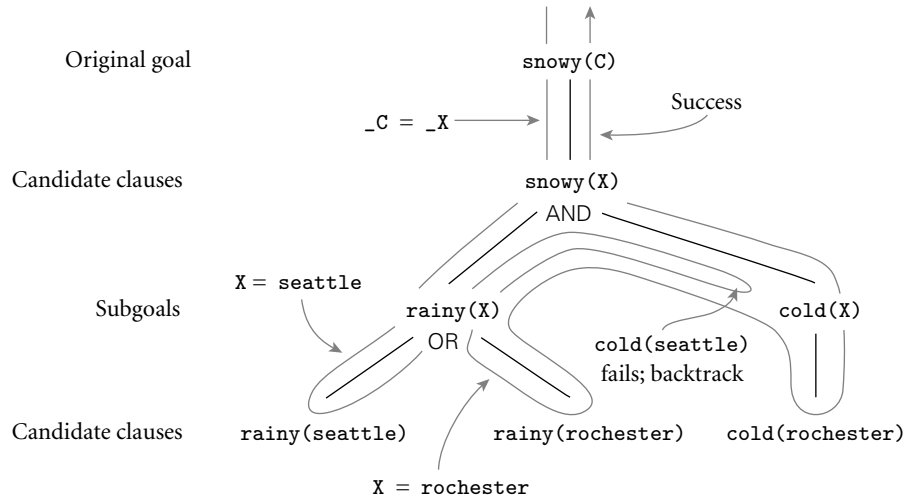

Figure 11.1 Backtracking search in Prolog. The tree of potential resolutions consists of alternating AND and OR levels. An AND level consists of subgoals from the right-hand side of a rule, all of which must be satisfied. An OR level consists of alternative database clauses whose head will unify with the subgoal above; one of these must be satisfied. The notation `_C = _X` is meant to indicate that while both `C` and `X` are uninstantiated, they have been associated with one another in such a way that if either receives a value in the future it will be shared by both.

EXAMPLE 11.16

Backtracking and instantiation

a result of that unification are returned to their uninstantiated or unassociated state. In Figure 11.1, for example, the binding of `X` to `seattle` is broken when we backtrack to the `rainy(X)` subgoal. The effect is similar to the breaking of bindings between actual and formal parameters in an imperative programming language, except that Prolog couches the bindings in terms of unification rather than subroutine calls. ■

Space management for backtracking search in Prolog usually follows the single-stack implementation of iterators described in Section ©8.6.3. The interpreter pushes a frame onto its stack every time it begins to pursue a new subgoal G . If G fails, the frame is popped from the stack and the interpreter begins to backtrack. If G succeeds, control returns to the “caller” (the parent in the search tree), but G ’s frame remains on the stack. Later subgoals will be given space *above* this dormant frame. If subsequent backtracking causes the interpreter to search for alternative ways of satisfying G , control will be able to resume where it last left off. Note that G will not fail unless all of its subgoals (and all of its siblings to the right in the search tree) have also failed, implying that there is nothing above G ’s frame in the stack. At the top level of the interpreter, a semicolon typed by the user is treated the same as failure of the most recently satisfied subgoal.

The fact that clauses are ordered, and that the interpreter considers them from first to last, means that the results of a Prolog program are deterministic and predictable. In fact, the combination of ordering and depth-first search means that the Prolog programmer must often consider the order to ensure that recursive programs will terminate. Suppose for example that we have a database describing a directed acyclic graph:

EXAMPLE 11.17

Order of rule evaluation

```
edge(a, b). edge(b, c). edge(c, d).
edge(d, e). edge(b, e). edge(d, f).
path(X, X).
path(X, Y) :- edge(Z, Y), path(X, Z).
```

The last two clauses tell us how to determine whether there is a path from node X to node Y. If we were to reverse the order of the terms on the right-hand side of the final clause, then the Prolog interpreter would search for a node Z that is reachable from X before checking to see whether there is an edge from Z to Y. The program would still work, but it would not be as efficient. ■

EXAMPLE 11.18

Infinite regression

Now consider what would happen if in addition we were to reverse the order of the last two clauses:

```
path(X, Y) :- path(X, Z), edge(Z, Y).
path(X, X).
```

From a logical point of view, our database still defines the same relationships. A Prolog interpreter, however, will no longer be able to find answers. Even a simple query like `?- path(a, a)` will never terminate. To see why, consider [Figure 11.2](#). The interpreter first unifies `path(a, a)` with the left-hand side of `path(X, Y) :- path(X, Z), edge(Z, Y)`. It then considers the goals on the right-hand side, the first of which (`path(X, Z)`), unifies with the left-hand side of the very same rule, leading to an infinite regression. In effect, the Prolog interpreter gets lost in an infinite branch of the search tree, and never discovers finite branches to the right. We could avoid this problem by exploring the tree in breadth-first order, but that strategy was rejected by Prolog's designers because of its expense: it can require substantially more space, and does not lend itself to a stack-based implementation. ■

11.2.5 Extended Example: Tic-Tac-Toe

EXAMPLE 11.19

Tic-tac-toe in Prolog

In the previous subsection we saw how the order of clauses in the Prolog database, and the order of terms within a right-hand side, can affect both the efficiency of a Prolog program and its ability to terminate. Ordering also allows the Prolog programmer to indicate that certain resolutions are *preferred*, and should be considered before other, “fallback” options. Consider, for example, the problem of making a move in tic-tac-toe. (Tic-tac-toe is a game played on a 3×3 grid of squares. Two players, X and O, take turns placing markers in empty squares.

```

edge(a, b). edge(b, c). edge(c, d).
edge(d, e). edge(b, e). edge(d, f).
path(X, Y) :- path(X, Z), edge(Z, Y).
path(X, X).

```

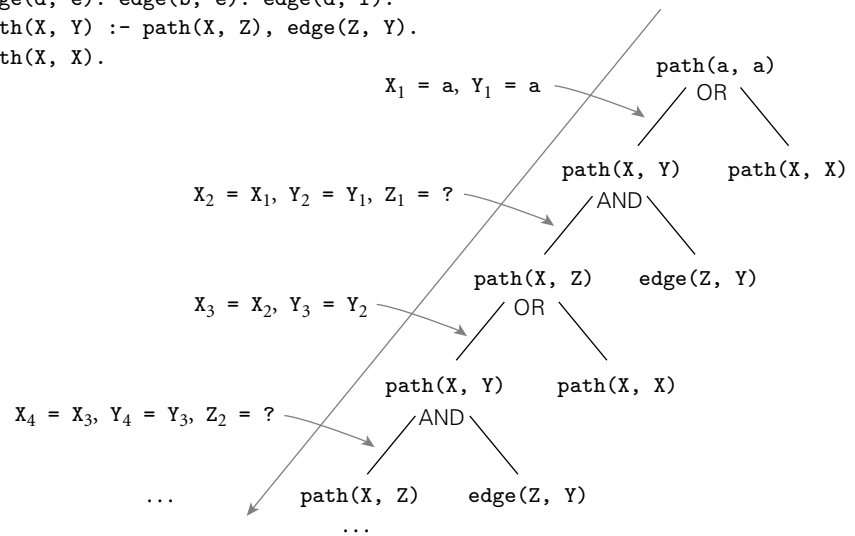

Figure 11.2 Infinite regression in Prolog. In this figure even a simple query like `?- path(a, a)` will never terminate: the interpreter will never find the trivial branch.

A player wins if he or she places three markers in a row, horizontally, vertically, or diagonally.)

Let us number the squares from 1 to 9 in row-major order. Further, let us use the Prolog fact `x(n)` to indicate that player X has placed a marker in square *n*, and `o(m)` to indicate that player O has placed a marker in square *m*. For simplicity, let us assume that the computer is player X, and that it is X's turn to move. We should like to be able to issue a query `?- move(A)` that will cause the Prolog interpreter to choose a good square A for the computer to occupy next.

Clearly we need to be able to tell whether three given squares lie in a row. One way to express this is:

```

ordered_line(1, 2, 3).    ordered_line(4, 5, 6).
ordered_line(7, 8, 9).   ordered_line(1, 4, 7).
ordered_line(2, 5, 8).   ordered_line(3, 6, 9).
ordered_line(1, 5, 9).   ordered_line(3, 5, 7).
line(A, B, C) :- ordered_line(A, B, C).
line(A, B, C) :- ordered_line(A, C, B).
line(A, B, C) :- ordered_line(B, A, C).
line(A, B, C) :- ordered_line(B, C, A).
line(A, B, C) :- ordered_line(C, A, B).
line(A, B, C) :- ordered_line(C, B, A).

```

It is easy to prove that there is no winning strategy for tic-tac-toe: either player can force a draw. Let us assume, however, that our program is playing against a

O	1	2	3
	4	X	6 O
	7	8	9 X

Figure 11.3 A “split” in *tac-tac-toe*. If X takes the bottom center square (square 8), no future move by O will be able to stop X from winning the game—O cannot block both the 2–5–8 line and the 7–8–9 line.

less-than-perfect opponent. Our task then is never to lose, and to maximize our chances of winning if our opponent makes a mistake. The following rules work well.

```

move(A) :- good(A), empty(A).

full(A) :- x(A).
full(A) :- o(A).
empty(A) :- \+(full(A)).

% strategy:
good(A) :- win(A).           good(A) :- block_win(A).
good(A) :- split(A).        good(A) :- strong_build(A).
good(A) :- weak_build(A).

```

The initial rule indicates that we can satisfy the goal `move(A)` by choosing a good, empty square. The `\+` is a built-in predicate that succeeds if its argument (a goal) cannot be proven; we discuss it further in [Section 11.2.6](#). Square `n` is empty if we cannot prove it is full; that is, if neither `x(n)` nor `o(n)` is in the database.

The key to strategy lies in the ordering of the last five rules. Our first choice is to win:

```
win(A) :- x(B), x(C), line(A, B, C).
```

Our second choice is to prevent our opponent from winning:

```
block_win(A) :- o(B), o(C), line(A, B, C).
```

Our third choice is to create a “split”—a situation in which our opponent cannot prevent us from winning on the next move (see [Figure 11.3](#)):

```
split(A) :- x(B), x(C), different(B, C),
           line(A, B, D), line(A, C, E), empty(D), empty(E).
same(A, A).
different(A, B) :- \+(same(A, B)).

```

Here we have again relied on the built-in predicate `\+`.

Our fourth choice is to build toward three in a row (i.e., to get two in a row) in such a way that the obvious blocking move won't allow our opponent to build toward three in a row:

```
strong_build(A) :- x(B), line(A, B, C), empty(C), \+(risky(C)).
risky(C) :- o(D), line(C, D, E), empty(E).
```

Barring that, our fifth choice is to build toward three in a row in such a way that the obvious blocking move won't give our opponent a split:

```
weak_build(A) :- x(B), line(A, B, C), empty(C), \+(double_risky(C)).
double_risky(C) :- o(D), o(E), different(D, E), line(C, D, F),
    line(C, E, G), empty(F), empty(G).
```

If none of these goals can be satisfied, our final, default choice is to pick an unoccupied square, giving priority to the center, the corners, and the sides in that order:

```
good(5).
good(1). good(3). good(7). good(9).
good(2). good(4). good(6). good(8). ■
```

✓ CHECK YOUR UNDERSTANDING

1. What mathematical formalism underlies logic programming?
2. What is a *Horn clause*?
3. Briefly describe the process of *resolution* in logic programming.
4. What is a *unification*? Why is it important in logic programming?
5. What are *clauses*, *terms*, and *structures* in Prolog? What are *facts*, *rules*, and *queries*?
6. Explain how Prolog differs from imperative languages in its handling of arithmetic.
7. Describe the difference between *forward chaining* and *backward chaining*. Which is used in Prolog by default?
8. Describe the Prolog search strategy. Discuss *backtracking* and the *instantiation* of variables.

11.2.6 Imperative Control Flow

We have seen that the ordering of clauses and of terms in Prolog is significant, with ramifications for efficiency, termination, and choice among alternatives. In addition to simple ordering, Prolog provides the programmer with several explicit control-flow features. The most important of these features is known as the *cut*.

EXAMPLE 11.20

The cut

The cut is a zero-argument predicate written as an exclamation point: `!`. As a subgoal it always succeeds, but with a crucial side effect: it commits the interpreter to whatever choices have been made since unifying the parent goal with the left-hand side of the current rule, including the choice of that unification itself. For example, recall our definition of list membership:

```
member(X, [X | _]).
member(X, [_ | T]) :- member(X, T).
```

If a given atom `a` appears in list `L` n times, then the goal `?- member(a, L)` can succeed n times. These “extra” successes may not always be appropriate. They can lead to wasted computation, particularly for long lists, when `member` is followed by a goal that may fail:

```
prime_candidate(X) :- member(X, candidates), prime(X).
```

Suppose that `prime(X)` is expensive to compute. To determine whether `a` is a prime candidate, we first check to see whether it is a member of the `candidates` list, and then check to see whether it is prime. If `prime(a)` fails, Prolog will backtrack and attempt to satisfy `member(a, candidates)` again. If `a` is in the `candidates` list more than once, then the subgoal will succeed again, leading to reconsideration of the `prime(a)` subgoal, even though that subgoal is doomed to fail. We can save substantial time by cutting off all further searches for `a` after the first is found:

```
member(X, [X | _]) :- !.
member(X, [_ | T]) :- member(X, T).
```

The cut on the right-hand side of the first rule says that if `X` is the head of `L`, we should not attempt to unify `member(X, L)` with the left-hand side of the second rule; the cut commits us to the first rule. ■

EXAMPLE 11.21`\+` and its implementation

An alternative way to ensure that `member(X, L)` succeeds no more than once is to embed a use of `\+` in the second clause:

```
member(X, [X | _]).
member(X, [H | T]) :- X \= H, member(X, T).
```

Here `X \= H` means `X` and `H` will not unify; that is, `\+(X = H)`. (In some Prolog dialects, `\+` is written `not`. This name suggests an interpretation that may be somewhat misleading; we discuss the issue in [Section 11.4.3](#).) Our new version of `member` will display the same high-level behavior as before, but will be slightly less efficient: now the interpreter will actually consider the second rule, abandoning it only after (re)unifying `X` with `H` and reversing the sense of the test.

It turns out that `\+` is actually implemented by a combination of the cut and two other built-in predicates, `call` and `fail`:

```
\+(P) :- call(P), !, fail.
\+(P).
```

The `call` predicate takes a term as argument and attempts to satisfy it as a goal (terms are first-class values in Prolog). The `fail` predicate always fails. ■

In principle, it is possible to replace all uses of the cut with uses of `\+`—to confine the cut to the implementation of `\+`. Doing so often makes a program easier to read. As we have seen, however, it often makes it less efficient. In some cases, explicit use of the cut may actually make a program *easier* to read. Consider our tic-tac-toe example. If we type semicolons at the program, it will continue to generate a series of increasingly poor moves from the same board position, even though we only want the first move. We can cut off consideration of the others by using the cut:

```
move(A) :- good(A), empty(A), !.
```

To achieve the same effect with `\+` we would have to do more major surgery ([Exercise 11.8](#)). ■

EXAMPLE 11.22

Pruning unwanted answers with the cut

EXAMPLE 11.23

Using the cut for selection

In general, the cut can be used whenever we want the effect of `if... then... else`:

```
statement :- condition, !, then_part.
statement :- else_part.
```

EXAMPLE 11.24

Looping with `fail`

The `fail` predicate can be used in conjunction with a “generator” to implement a loop. We have already seen (in [Example 11.13](#)) how to effect a generator by driving a set of rules “backward.” Recall our definition of `append`:

```
append([], A, A).
append([H | T], A, [H | L]) :- append(T, A, L).
```

If we use `write append(A, B, L)`, where `L` is instantiated but `A` and `B` are not, the interpreter will find an `A` and `B` for which the predicate is true. If backtracking forces it to return, the interpreter will look for *another* `A` and `B`; `append` will *generate* pairs on demand. (There is a strong analogy here to the generators of Icon, discussed in Section ©6.5.4.) Thus, to enumerate the ways in which a list can be partitioned into pairs, we can follow a use of `append` with `fail`:

```
print_partitions(L) :- append(A, B, L),
                        write(A), write(' '), write(B), nl,
                        fail.
```

The `nl` predicate prints a newline character. The query `print_partitions([a, b, c])` produces the following output:

```

[] [a, b, c]
[a] [b, c]
[a, b] [c]
[a, b, c] []
No

```

If we don't want the overall predicate to fail, we can add a final rule:

```
print_partitions(_).
```

Assuming this rule appears last, it will succeed after the output has appeared, and the interpreter will finish with “Yes.” ■

In some cases, we may have a generator that produces an unbounded sequence of values. The following, for example, generates all of the natural numbers:

EXAMPLE 11.25

Looping with an unbounded generator

```

natural(1).
natural(N) :- natural(M), N is M+1.

```

We can use this generator in conjunction with a “test-cut” combination to iterate over the first n numbers:

```

my_loop(N) :- natural(I),
              write(I), nl,           % loop body (nl prints a newline)
              I = N, !.

```

So long as I is less than N , the equality (unification) predicate will fail and backtracking will pursue another alternative for `natural`. If $I = N$ succeeds, however, then the cut will be executed, committing us to the current (final) choice of I , and successfully terminating the loop. ■

This programming idiom—an unbounded generator with a test-cut terminator—is known as *generate-and-test*. Like the iterative constructs of Scheme (Section 10.3.4), it is generally used in conjunction with side effects. One such side effect, clearly, is I/O. Another is modification of the program database.

Prolog provides a variety of I/O features. In addition to `write` and `nl`, which print to the current output file, the `read` predicate can be used to read terms from the current input file. Individual characters are read and written with `get` and `put`. Input and output can be redirected to different files using `see` and `tell`. Finally, the built-in predicates `consult` and `reconsult` can be used to read database clauses from a file, so they don't have to be typed into the interpreter by hand. (Some interpreters *require* this, allowing only queries to be entered interactively.)

EXAMPLE 11.26

Character input with `get`

The predicate `get` attempts to unify its argument with the next *printable* character of input, skipping over ASCII characters with codes below 32.⁴ In effect, it behaves as if it were implemented in terms of the simpler predicates `get0` and `repeat`:

```
get(X) :- repeat, get0(X), X >= 32, !.
```

⁴ Surprisingly, the ISO Prolog standard does not cover Unicode conformance.

The `get0` predicate attempts to unify its argument with the single next character of input, regardless of value and, like `get`, cannot be resatisfied during backtracking. The `repeat` predicate, by contrast, can succeed an arbitrary number of times; it behaves as if it were implemented with the following pair of rules:

```
repeat.
repeat :- repeat.
```

Within the above definition of `get`, backtracking will return to `repeat` as often as needed to produce a printable character (one with ASCII code at least 32). In general, `repeat` allows us to turn any predicate with side effects into a generator. ■

11.2.7 Database Manipulation

EXAMPLE 11.27
Prolog programs as data

Clauses in Prolog are simply collections of terms, connected by the built-in predicates `:-` and `,`, both of which can be written in either infix or prefix form:

```
rainy(rochester).
rainy(seattle).
cold(rochester).
snowy(X) :- rainy(X), cold(X).
```

$$\left. \vphantom{\begin{array}{l} \text{rainy(rochester).} \\ \text{rainy(seattle).} \\ \text{cold(rochester).} \\ \text{snowy(X) :- rainy(X), cold(X).} \end{array}} \right\} \equiv ', '(rainy(rochester), \\ ', '(rainy(seattle), \\ ', '(cold(rochester), \\ :- (snowy(X), ', '(rainy(X), \\ cold(X))))))$$

Here the single quotes around the prefix commas serve to distinguish them from the commas that separate the arguments of a predicate. ■

EXAMPLE 11.28
Modifying the Prolog database

The structural nature of clauses and database contents implies that Prolog, like Scheme, is *homoiconic*: it can represent itself. It can also modify itself. A running Prolog program can add clauses to its database with the built-in predicate `assert`, or remove them with `retract`:

```
?- rainy(X).
X = seattle ;
X = rochester ;
No
?- assert(rainy(syracuse)).
Yes
?- rainy(X).
X = seattle ;
X = rochester ;
X = syracuse ;
No
?- retract(rainy(rochester)).
Yes
```



```
?- rainy(X).
X = seattle ;
X = syracuse ;
No
```

There is also a `retractall` predicate that removes all matching clauses from the database. ■

EXAMPLE 11.29

Tic-tac-toe (full game)

Figure 11.4 contains a complete Prolog program for tic-tac-toe. It uses `assert`, `retractall`, the `cut`, `fail`, `repeat`, and `write` to play an entire game. Moves are added to the database with `assert`. They are cleared with `retractall` at the beginning of each game. This way the user can play multiple games without restarting the interpreter. ■

EXAMPLE 11.30

The functor predicate

Individual terms in Prolog can be created, or their contents extracted, using the built-in predicates `functor`, `arg`, and `=..`. The goal `functor(T, F, N)` succeeds if and only if `T` is a term with functor `F` and arity `N`:

```
?- functor(foo(a, b, c), foo, 3).
Yes
?- functor(foo(a, b, c), F, N).
F = foo
N = 3
?- functor(T, foo, 3).
T = foo(_10, _37, _24)
```

In the last line of output, the atoms with leading underscores are placeholders for uninstantiated variables. ■

EXAMPLE 11.31

Creating terms at run time

The goal `arg(N, T, A)` succeeds if and only if its first two arguments (`N` and `T`) are instantiated, `N` is a natural number, `T` is a term, and `A` is the `N`th argument of `T`:

```
?- arg(3, foo(a, b, c), A).
A = c
```

DESIGN & IMPLEMENTATION**Homoiconic languages**

As we have noted, both Lisp/Scheme and Prolog are *homoiconic*. A few other languages, notably Snobol, Forth, and Tcl, share this property. What is its significance? For most programs the answer is: not much. So long as we write the sorts of programs that we'd write in other languages, the fact that programs and data look the same is really just a curiosity. It becomes something more if we are interested in *metacomputing*—the creation of programs that create or manipulate other programs, or that extend themselves. Metacomputing requires, at the least, that we have true first-class functions in the strict sense of the term, that is, that we be able to generate new functions whose behavior is determined dynamically. A homoiconic language can simplify metacomputing by eliminating the need to translate between internal (data structure) and external (syntactic) representations of programs or program extensions.

```

ordered_line(1, 2, 3). ordered_line(4, 5, 6). ordered_line(7, 8, 9).
ordered_line(1, 4, 7). ordered_line(2, 5, 8). ordered_line(3, 6, 9).
ordered_line(1, 5, 9). ordered_line(3, 5, 7).
line(A, B, C) :- ordered_line(A, B, C). line(A, B, C) :- ordered_line(A, C, B).
line(A, B, C) :- ordered_line(B, A, C). line(A, B, C) :- ordered_line(B, C, A).
line(A, B, C) :- ordered_line(C, A, B). line(A, B, C) :- ordered_line(C, B, A).

full(A) :- x(A). full(A) :- o(A). empty(A) :- \+(full(A)).
% NB: empty must be called with an already-instantiated A.
same(A, A). different(A, B) :- \+(same(A, B)).

move(A) :- good(A), empty(A), !.

% strategy:
good(A) :- win(A). good(A) :- block_win(A). good(A) :- split(A).
good(A) :- strong_build(A). good(A) :- weak_build(A).
good(5). good(1). good(3). good(7). good(9). good(2). good(4). good(6). good(8).

win(A) :- x(B), x(C), line(A, B, C).
block_win(A) :- o(B), o(C), line(A, B, C).
split(A) :- x(B), x(C), different(B, C), line(A, B, D), line(A, C, E), empty(D), empty(E).
strong_build(A) :- x(B), line(A, B, C), empty(C), \+(risky(C)).
weak_build(A) :- x(B), line(A, B, C), empty(C), \+(double_risky(C)).
risky(C) :- o(D), line(C, D, E), empty(E).
double_risky(C) :- o(D), o(E), different(D, E), line(C, D, F), line(C, E, G), empty(F), empty(G).

all_full :- full(1), full(2), full(3), full(4), full(5),
            full(6), full(7), full(8), full(9).
done :- ordered_line(A, B, C), x(A), x(B), x(C), write('I won. '), nl.
done :- all_full, write('Draw. '), nl.

getmove :- repeat, write('Please enter a move: '), read(X), empty(X), assert(o(X)).
makemove :- move(X), !, assert(x(X)).
makemove :- all_full.

printsquare(N) :- o(N), write(' o ').
printsquare(N) :- x(N), write(' x ').
printsquare(N) :- empty(N), write(' ').
printboard :- printsquare(1), printsquare(2), printsquare(3), nl,
              printsquare(4), printsquare(5), printsquare(6), nl,
              printsquare(7), printsquare(8), printsquare(9), nl.
clear :- retractall(x(_)), retractall(o(_)).

% main goal:
play :- clear, repeat, getmove, respond.
respond :- ordered_line(A, B, C), o(A), o(B), o(C),
           printboard, write('You won. '), nl. % shouldn't ever happen!
respond :- makemove, printboard, done.

```

Figure 11.4 Tic-tac-toe program in Prolog.

Using functor and arg together, we can create an arbitrary term:

```
?- functor(T, foo, 3), arg(1, T, a), arg(2, T, b), arg(3, T, c).
T = foo(a, b, c)
```

Alternatively, we can use the (infix) =.. predicate, which “equates” a term with a list:

```
?- T =.. [foo, a, b, c].
T = foo(a, b, c)

?- foo(a, b, c) =.. [F, A1, A2, A3].
F = foo
A1 = a
A2 = b
A3 = c
```

Note that

```
?- foo(a, b, c) = F(A1, A2, A3).
```

and

```
?- F(A1, A2, A3) = foo(a, b, c).
```

do not work: the term preceding a left parenthesis must be an atom, not a variable. ■

EXAMPLE 11.32

Pursuing a dynamic goal

Using =.. and call, the programmer can arrange to pursue (attempt to satisfy) a goal created at run-time:

```
param_loop(L, H, F) :- natural(I), I >= L,
                       G =.. [F, I], call(G),
                       I = H, !.
```

The goal param_loop(5, 10, write) will produce the following output:

```
5678910
Yes
```

If we want the numbers on separate lines we can write

```
?- param_loop(5, 10, writeln).
```

where

```
writeln(X) :- write(X), nl. ■
```

EXAMPLE 11.33

Custom database perusal

Taken together, the predicates described above allow a Prolog program to create and decompose clauses, and to add and subtract them from the database. So far, however, the only mechanism we have for *perusing* the database (i.e., to determine its contents) is the built-in search mechanism. To allow programs to “reason” in more general ways, Prolog provides a `clause` predicate that attempts to match its two arguments against the head and body of some existing clause in the database:

```
?- clause(snowy(X), B).
B = rainy(X), cold(X) ;
No
```

Here we have discovered (by entering a query and requesting further matches with a semicolon) that there is a single rule in the database whose head is a single-argument term with functor `snowy`. The body of that rule is the conjunction `B = rainy(X), cold(X)`. Prolog requires that the first argument to `clause` be sufficiently instantiated that its functor and arity can be determined.

A clause with no body (a fact) matches the body `true`:

```
?- clause(rainy(rochester), true).
Yes
```

Note that `clause` is quite different from `call`: it does not attempt to satisfy a goal, but simply to match it against an existing clause:

```
?- clause(snowy(rochester), true).
No
```

DESIGN & IMPLEMENTATION**Reflection**

A *reflection* mechanism allows a program to reason about itself. While no widely used language is *fully reflective*, in the sense that it can inspect every aspect of its structure and current state, significant forms of reflection appear in several major languages, Prolog among them. Given the functor and arity of a starting goal, the `clause` predicate allows us to find everything related to that goal in the database. Using `clause`, we can in fact create a *metacircular interpreter* (Exercise 11.12)—an implementation of Prolog in itself—much as we could for Lisp using `eval` and `apply` (Section 10.3.5). We can also write evaluators that use nonstandard search orders (e.g., breadth-first or forward chaining; see Exercise 11.13). Other examples of rich reflection facilities appear in Java, C#, and the major scripting languages. As we shall see in Section 15.3.1, these allow a program to inspect and reason about its complete type structure. A few languages (e.g., Python) allow a program to inspect its source code as text, but this is not as powerful as the homoiconic inspection of Prolog or Scheme, which allows a program to *reason about* its own code structure directly.

Various other built-in predicates can also be used to “deconstruct” the contents of a clause. The `var` predicate takes a single argument; it succeeds as a goal if and only if its argument is an uninstantiated variable. The `atom` and `integer` predicates succeed as goals if and only if their arguments are atoms and integers, respectively. The `name` predicate takes two arguments. It succeeds as a goal if and only if its first argument is an atom and its second is a list composed of the ASCII codes for the characters of that atom.

11.3 Theoretical Foundations

EXAMPLE 11.34

Predicates as mathematical objects

In mathematical logic, a *predicate* is a function that maps constants (atoms) or variables to the values true and false. If `rainy` is a predicate, for example, we might have `rainy(Seattle) = true` and `rainy(Tijuana) = false`. *Predicate calculus* provides a notation and inference rules for constructing and reasoning about *propositions* (*statements*) composed of predicate applications, *operators* (and, or, not, etc.), and the *quantifiers* \forall and \exists . Logic programming formalizes the search for variable values that will make a given proposition true. ■

© IN MORE DEPTH

In conventional logical notation there are many ways to state a given proposition. Logic programming is built on *clausal form*, which provides a unique expression for every proposition. Many though not all clausal forms can be cast as a collection of Horn clauses, and thus translated into Prolog. On the PLP CD we trace the steps required to translate an arbitrary proposition into clausal form. We also characterize the cases in which this form can and cannot be translated into Prolog.

11.4 Logic Programming in Perspective

In the abstract, logic programming is a very compelling idea: it suggests a model of computing in which we simply list the logical properties of an unknown value, and then the computer figures out how to find it (or tells us it doesn't exist). Unfortunately, the current state of the art falls quite a bit short of the vision, for both theoretical and practical reasons.

11.4.1 Parts of Logic Not Covered

As noted in [Section 11.3](#), Horn clauses do not capture all of first-order predicate calculus. In particular, they cannot be used to express statements whose clausal form includes a disjunction with more than one non-negated term. We can sometimes get around this problem in Prolog by using the `\+` predicate, but the semantics are not the same (see [Section 11.4.3](#)).

11.4.2 Execution Order

While logic is inherently declarative, most logic languages explore the tree of possible resolutions in deterministic order. Prolog provides a variety of predicates, including the `cut`, `fail`, and `repeat`, to control that execution order (Section 11.2.6). It also provides predicates, including `assert`, `retract`, and `call`, to manipulate its database explicitly during execution.

In Section 11.2.4, we saw that one must often consider execution order to ensure that a Prolog search will terminate. Even for searches that terminate, naive code can be *very* inefficient. Consider the problem of sorting. A natural declarative way to say that `L2` is the sorted version of `L1` is to say that `L2` is a permutation of `L1` and `L2` is sorted:

EXAMPLE 11.35

Sorting incredibly slowly

```
declarative_sort(L1, L2) :- permutation(L1, L2), sorted(L2).
permutation([], []).
permutation(L, [H | T]) :- append(P, [H | S], L), append(P, S, W),
    permutation(W, T).
```

(The `append` and `sorted` predicates are defined in Section 11.2.2.) Unfortunately, Prolog’s default search strategy will take exponential time to sort a list based on these rules: it will generate permutations until it finds one that is sorted. ■

DESIGN & IMPLEMENTATION

Implementing logic

Predicate calculus is a significantly higher-level notation than lambda calculus. It is much more abstract—much less algorithmic. It is natural, therefore, that a language like Prolog not provide the full power of predicate calculus, and that it include extensions to make it more algorithmic. We may someday reach the point where programming systems are capable of discovering good algorithms from very high-level declarative specifications, but we are not there yet.

DESIGN & IMPLEMENTATION

Alternative search strategies

Some approaches to logic programming attempt to customize the run-time search strategy in a way that is likely to satisfy goals quickly. Darlington [Dar90], for example, describes a technique in which, when an intermediate goal `G` fails, we try to find alternative instantiations of the variables in `G` that will allow it to succeed, *before* backing up to previous goals and seeing whether the alternative instantiations will work in them as well. This “failure-directed search” seems to work well for certain classes of problems. Unfortunately, no general technique is known that will automatically discover the best algorithm (or even just a “good” one) for any given problem.

EXAMPLE 11.36

Quicksort in Prolog

To obtain a more efficient sort, the Prolog programmer must adopt a less natural, “imperative” definition:

```
quicksort([], []).
quicksort([A | L1], L2) :- partition(A, L1, P1, S1),
    quicksort(P1, P2), quicksort(S1, S2), append(P2, [A | S2], L2).
partition(A, [], [], []).
partition(A, [H | T], [H | P], S) :- A >= H, partition(A, T, P, S).
partition(A, [H | T], P, [H | S]) :- A <= H, partition(A, T, P, S).
```

Even this sort is less efficient than one might hope in certain cases. When given an already-sorted list, for example, it takes quadratic time, instead of $O(n \log n)$. A good heuristic for quicksort is to partition the list using the median of the first, middle, and last elements. Unfortunately, Prolog provides no easy way to access the middle and final elements of a list (it has no arrays). ■

As we saw in [Chapter 9](#), it can be useful to distinguish between the *specification* of a program and its *implementation*. The specification says what the program is to do; the implementation says how it is to do it. Horn clauses provide an excellent notation for specifications. When augmented with search rules (as in Prolog) they allow implementations to be expressed in the same notation.

11.4.3 Negation and the “Closed World” Assumption

A collection of Horn clauses, such as the facts and rules of a Prolog database, constitutes a list of things assumed to be true. It does not include any things assumed to be false. This reliance on purely “positive” logic implies that Prolog’s $\backslash+$ predicate is different from logical negation. Unless the database is assumed to contain *everything* that is true (this is the *closed world assumption*), the goal $\backslash+(T)$ can succeed simply because our current knowledge is insufficient to prove T . Moreover, negation in Prolog occurs *outside* any implicit existential quantifiers on the right-hand side of a rule. Thus

EXAMPLE 11.37

Negation as failure

```
?- \+(takes(X, his201)).
```

where X is uninstantiated, means

$$? \neg \exists X [\text{takes}(X, \text{his201})]$$

rather than

$$? \exists X [\neg \text{takes}(X, \text{his201})]$$

If our database indicates that `jane_doe` takes `his201`, then the goal `takes(X, his201)` can succeed, and `\+(takes(X, his201))` will fail:

```
?- \+(takes(X, his201)).
No
```

If we had a way to put the negation inside the quantifier, we might hope for an implementation that would respond

```
?- \+(takes(X, his201)).
X = ajit_chandra
```

or even

```
?- \+(takes(X, his201)).
X != jane_doe
```

A complete characterization of the values of X for which $\neg\text{takes}(X, \text{his201})$ is true would require a complete exploration of the resolution tree, something that Prolog does only when all goals fail, or when repeatedly prompted with semicolons. Mechanisms to incorporate some sort of “constructive negation” into logic programming are an active topic of research. ■

EXAMPLE 11.38

Negation and instantiation

It is worth noting that the definition of $\backslash+$ in terms of failure means that variable bindings are lost whenever $\backslash+$ succeeds. For example,

```
?- takes(X, his201).
X = jane_doe
?- \+(takes(X, his201)).
No
?- \+(\+(takes(X, his201))).
Yes                                     % no value for X provided
```

When `takes` first succeeds, X is bound to `jane_doe`. When the inner $\backslash+$ fails, the binding is broken. Then when the outer $\backslash+$ succeeds, a new binding is created to an uninstantiated value. Prolog provides no way to pull the binding of X out through the double negation. ■

✓ CHECK YOUR UNDERSTANDING

9. Explain the purpose of the cut (!) in Prolog. How does it relate to $\backslash+$?
10. Describe three ways in which Prolog programs can depart from a pure logic programming model.
11. Describe the *generate-and-test* programming idiom.
12. Summarize Prolog’s facilities for database manipulation. Be sure to mention `assert`, `retract`, and `clause`.
13. What sorts of logical statements cannot be captured in Horn clauses?
14. What is the *closed world assumption*? What problems does it cause for logic programming?

11.5 Summary and Concluding Remarks

In this chapter we have focused on the logic model of computing. Where an imperative program computes principally through iteration and side effects, and a functional program computes principally through substitution of parameters into functions, a logic program computes through the resolution of logical statements, driven by the ability to unify variables and terms.

Much of our discussion was driven by an examination of the principal logic language, Prolog, which we used to illustrate clauses and terms, resolution and unification, search/execution order, list manipulation, and high-order predicates for inspection and modification of the logic database.

Like imperative and functional programming, logic programming is related to constructive proofs. But where an imperative or functional program in some sense *is* a proof (of the ability to generate outputs from inputs), a logic program is a set of axioms from which the computer attempts to construct a proof. And where imperative and functional programming provide the full power of Turing machines and lambda calculus, respectively (ignoring hardware-imposed limits on arithmetic precision, disk and memory space, etc.), Prolog provides less than the full generality of resolution theorem proving, in the interests of time and space efficiency. At the same time, Prolog extends its formal counterpart with true arithmetic, I/O, imperative control flow, and higher-order predicates for self-inspection and modification.

Like Lisp/Scheme, Prolog makes heavy use of lists, largely because they can easily be built incrementally, without the need to allocate and then modify state as separate operations. And like Lisp/Scheme (but unlike ML and its descendants), Prolog is *homoiconic*: programs look like ordinary data structures, and can be created, modified, and executed on the fly.

As we stressed in [Chapter 1](#), different models of computing are appealing in different ways. Imperative programs more closely mirror the underlying hardware, and can more easily be “tweaked” for high performance. Purely functional programs avoid the semantic complexity of side effects, and have proven particularly handy for the manipulation of symbolic (nonnumeric) data. Logic programs, with their highly declarative semantics and their emphasis on unification, are well suited to problems that emphasize relationships and search. At the same time, their de-emphasis of control flow can lead to inefficiency. At the current state of the art, computers have surpassed people in their ability to deal with lowlevel details (e.g., of instruction scheduling), but people are still better at inventing good algorithms.

As we also stressed in [Chapter 1](#), the borders between language classes are often very fuzzy. The backtracking search of Prolog strongly resembles the execution of generators in Icon. Unification in Prolog resembles (but is more powerful than) the pattern-matching capabilities of ML and Haskell. (Unification is also used for type checking in ML and Haskell, and for template instantiation in C++, but those are *compile-time* activities.)

There is much to be said for programming in a purely functional or logic-based style. While most Scheme and Prolog programs make some use of imperative language features, those features tend to be responsible for a disproportionate share of program bugs. At the same time, there seem to be programming tasks—graphical I/O, for example—that are almost impossible to accomplish without side effects.

11.6 Exercises

- 11.1 Starting with the clauses at the beginning of [Example 11.17](#), use resolution (as illustrated in [Example 11.3](#)) to show, in two different ways, that there is a path from `a` to `e`.
- 11.2 Solve [Exercise 6.20](#) in Prolog.
- 11.3 Consider the Prolog `gcd` program in [Figure 1.2](#) (page 13). Does this program work “backward” as well as forward? (Given integers d and n , can you use it to generate a sequence of integers m such that $\text{gcd}(n, m) = d$?) Explain your answer.
- 11.4 In the spirit of [Example 10.21](#), write a Prolog program that exploits backtracking to simulate the execution of a *nondeterministic* finite automaton.
- 11.5 Show that resolution is commutative and associative. Specifically, if A , B , and C are Horn clauses, show that $(A \oplus B) = (B \oplus A)$ and that $((A \oplus B) \oplus C) = (A \oplus (B \oplus C))$, where \oplus indicates resolution. Be sure to think about what happens to variables that are instantiated as a result of unification.
- 11.6 In [Example 11.8](#), the query `?- classmates(jane_doe, X)` will succeed three times: twice with $X = \text{jane_doe}$, and once with $X = \text{ajit_chandra}$. Show how to modify the `classmates(X, Y)` rule so that a student is not considered a classmate of him or herself.
- 11.7 Modify [Example 11.17](#) so that the goal `path(X, Y)`, for arbitrary already-instantiated X and Y , will succeed no more than once, even if there are multiple paths from X to Y .
- 11.8 Using only `\+` (no cuts), modify the tic-tac-toe example of [Section 11.2.5](#) so it will generate only one candidate move from a given board position. How does your solution compare to the cut-based one ([Example 11.22](#))?
- 11.9 Prove that the tic-tac-toe strategy of [Example 11.19](#) is optimal (wins whenever possible, draws otherwise), or give a counterexample.
- 11.10 Starting with the tic-tac-toe program of [Figure 11.4](#), draw a directed acyclic graph in which every clause is a node and an arc from A to B indicates that it is important, either for correctness or efficiency, that A come before B in the program. (Do not draw any other arcs.) Any topological sort of your graph should constitute an equally efficient version of the program. (Is the existing program one of them?)

- 11.11 Write Prolog rules to define a version of the `member` predicate that will generate all members of a list during backtracking, but without generating duplicates. Note that the `cut` and `\+` based versions of [Example 11.20](#) will not suffice; when asked to look for an uninstantiated member, they find only the head of the list.
- 11.12 Use the `clause` predicate of Prolog to implement the `call` predicate (pretend that it isn't built in). You needn't implement all of the built-in predicates of Prolog; in particular, you may ignore the various imperative control-flow mechanisms and database manipulators. Extend your code by making the database an explicit argument to `call`, effectively producing a metacircular interpreter.
- 11.13 Use the `clause` predicate of Prolog to write a predicate `call_bfs` that attempts to satisfy goals breadth-first. (Hint: you will want to keep a queue of yet-to-be-pursued subgoals, each of which is represented by a stack that captures backtracking alternatives.)
- 11.14 Write a (list-based) *insertion sort* algorithm in Prolog. Here's what it looks like in C, using arrays:

```
void insertion_sort(int A[], int N)
{
    int i, j, t;
    for (i = 1; i < N; i++) {
        t = A[i];
        for (j = i; j > 0; j--) {
            if (t >= A[j-1]) break;
            A[j] = A[j-1];
        }
        A[j] = t;
    }
}
```

- 11.15 Quicksort works well for large lists, but has higher overhead than insertion sort for short lists. Write a sort algorithm in Prolog that uses quicksort initially, but switches to insertion sort (as defined in the previous exercise) for sublists of 15 or fewer elements. (Hint: you can count the number of elements during the `partition` operation.)
- 11.16 Write a Prolog sorting routine that is guaranteed to take $O(n \log n)$ time in the worst case. (Hint: try *merge sort*; a description can be found in almost any algorithms or data structures text.)
- 11.17 Consider the following interaction with a Prolog interpreter:

```
?- Y = X, X = foo(X).
Y = foo(foo(foo(foo(foo(foo(foo(foo(foo(foo(
foo(foo(foo(foo(foo(foo(foo(foo(foo(foo(
foo(foo(foo(foo(foo(foo(foo(foo(foo(foo(
foo(foo(foo(foo(foo(foo(foo(foo(foo(foo(
foo(foo(foo(foo(foo(foo(...
```

What is going on here? Why does the interpreter fall into an infinite loop? Can you think of any circumstances (presumably not requiring output) in which a structure like this one would be useful? If not, can you suggest how a Prolog interpreter might implement checks to forbid its creation? How expensive would those checks be? Would the cost in your opinion be justified?

© 11.18–11.20 In More Depth.

11.7 Explorations

- 11.21 Learn about alternative search strategies for Prolog and other logic languages. How do backward chaining solvers work? What are the prospects for intelligent hybrid strategies?
- 11.22 Between 1982 and 1992 the Japanese government invested large sums of money in logic programming. Research the *Fifth Generation* project, administered by the Japanese Ministry of International Trade and Industry (MITI). What were its goals? What was achieved? What was not? How tightly were the goals and outcomes tied to Prolog? What lessons can we learn from the project today?
- 11.23 Read ahead to [Chapter 13](#) and learn about XSLT, a language used to manipulate data represented in XML, the extended markup language (of which XHTML, the latest standard for web pages, is an example). XSLT is generally described as declarative. Is it logic based? How does it compare to Prolog in expressive power, level of abstraction, and execution efficiency?
- 11.24 Repeat the previous question for SQL, the database query language (for an introduction, type “SQL tutorial” into your favorite Internet search engine).
- 11.25 Spreadsheets like Microsoft Excel and the older VisiCalc and Lotus 1-2-3 are sometimes characterized as declarative programming. Is this fair? Ignoring extensions like Visual Basic macros, does the ability to define relationships among cells provide Turing complete expressive power? Compare the execution model to that of Prolog. How is the order of update for cells determined? Can data be pushed “both ways,” as they can in Prolog?

© 11.26–11.29 In More Depth.

11.8 Bibliographic Notes

Logic programming has its roots in automated theorem proving. Much of the theoretical groundwork was laid by Horn in the early 1950s [[Hor51](#)], and by Robinson in the early 1960s [[Rob65](#)]. The breakthrough for computing came in the early

1970s, when Colmerauer and Roussel at the University of Aix–Marseille in France and Kowalski and his colleagues at the University of Edinburgh in Scotland developed the initial version of Prolog. The early history of the language is recounted by Robinson [Rob83]. Theoretical foundations are covered by Lloyd [Llo87].

Prolog was originally intended for research in natural language processing, but it soon became apparent that it could serve as a general-purpose language. Several versions of Prolog have since evolved. The one described here is the widely used Edinburgh dialect. The ISO standard [Int95c] is similar.

Several other logic languages have been developed, though none rivaled Prolog in popularity. OPS5 [BFKM86] uses forward chaining. Gödel [HL94] includes modules, strong typing, a richer variety of logical operators, and enhanced control of execution order. Parlog is a parallel Prolog dialect; we will mention it briefly in Section 12.4.5. Mercury [SHC96] adopts a variety of features from ML-family functional languages, including static type inference, monad-like I/O, higher-order predicates, closures, currying, and lambda expressions. It is compiled, rather than interpreted, and requires the programmer to specify modes (in, out) for predicate arguments.

Database query languages stemming from Datalog [Ull85][UW97, Secs. 4.2–4.4] are implemented using forward chaining. CLP (Constraint Logic Programming) and its variants are largely based on Prolog, but employ a more general constraint-satisfaction mechanism in place of unification [JM94]. Extensive on-line resources for logic programming can be found at www2.cs.kuleuven.be/~dtai/projects/ALP/.

12 Concurrency

The bulk of this text has focused, implicitly, on *sequential* programs: programs with a single active execution context. As we saw in [Chapter 6](#), sequentiality is fundamental to imperative programming. It also tends to be implicit in declarative programming, partly because practical functional and logic languages usually include some imperative features, and partly because people tend to develop imperative implementations and mental models of declarative programs (applicative order reduction, backward chaining with backtracking), even when language semantics do not require such a model.

By contrast, a program is said to be *concurrent* if it may have more than one active execution context—more than one “thread of control.” Concurrency has at least three important motivations:

1. *To capture the logical structure of a problem.* Many programs, particularly servers and graphical applications, must keep track of more than one largely independent “task” at the same time. Often the simplest and most logical way to structure such a program is to represent each task with a separate thread of control. We touched on this “multithreaded” structure when discussing coroutines ([Section 8.6](#)) and events ([Section 8.7](#)); we will return to it in [Section 12.1.1](#).
2. *To exploit extra processors, for speed.* Long a staple of high-end servers and supercomputers, multiple processors have recently become ubiquitous in desktop and laptop machines. To use them effectively, programs must generally be written (or rewritten) with concurrency in mind.
3. *To cope with separate physical devices.* Applications that run across the Internet or a more local group of machines are inherently concurrent. Likewise, many embedded applications—the control systems of a modern automobile, for example—often have separate processors for each of several devices.

In general, we use the word *concurrent* to characterize any system in which two or more tasks may be underway (at an unpredictable point in their execution) at the same time. Under this definition, coroutines are not concurrent, because at any given time, all but one of them is stopped at a well-known place. A concurrent

system is *parallel* if more than one task can be physically *active* at once; this requires more than one processor. The distinction is purely an implementation and performance issue: from a semantic point of view, there is no difference between true parallelism and the “quasiparallelism” of a system that switches between tasks at unpredictable times. A parallel system is *distributed* if its processors are associated with people or devices that are physically separated from one another in the real world. Under these definitions, “concurrent” applies to all three motivations above. “Parallel” applies to the second and third; “distributed” applies to only the third.

We will focus in this chapter on concurrency and parallelism. Parallelism in particular has become a pressing concern in recent years, with the proliferation of multicore processors. We will have less occasion to touch on distribution. While languages have been designed for distributed computing, they are not widely used. Most distributed systems run separate programs on every networked processor, and use message-passing library routines to communicate among them.

We begin our study with an overview of the ways in which parallelism may be used in modern programs. Our overview will touch on the motivation for concurrency (even on uniprocessors) and the concept of *races*, which are the principal source of complexity in concurrent programs. We will also briefly survey the architectural features of modern multicore and multiprocessor machines. In [Section 12.2](#) we consider the contrast between shared-memory and message-passing models of concurrency, and between language and library-based implementations. Building on coroutines, we explain how a language or library can create and schedule threads. [Section 12.3](#) focuses on low-level mechanisms for shared-memory synchronization. [Section 12.4](#) extends the discussion to language-level mechanisms. Message-passing models of concurrency are considered in [Section 12.5](#) (mostly on the PLP CD).

12.1 Background and Motivation

Concurrency is not a new idea. Much of the theoretical groundwork was laid in the 1960s, and Algol 68 includes concurrent programming features. Widespread interest in concurrency is a relatively recent phenomenon, however; it stems in part from the availability of low-cost multicore and multiprocessor machines, and in part from the proliferation of graphical, multimedia, and web-based applications, all of which are naturally represented by concurrent threads of control.

Levels of Parallelism

Parallelism arises at every level of a modern computer system. It is comparatively easy to exploit at the level of circuits and gates, where signals can propagate down thousands of connections at once. As we move up first to processors and then to the many layers of software that run on top of them, the *granularity* of parallelism—the size and complexity of tasks—increases at every level, and it

becomes increasingly difficult to figure out what work should be done by each task and how tasks should coordinate.

For 40 years, microarchitectural research was largely devoted to finding more and better ways to exploit the *instruction-level* parallelism (ILP) available in machine language programs. As we saw in [Chapter 5](#), the combination of deep, superscalar pipelines and aggressive speculation allows a modern processor to track dependences among hundreds of “in-flight” instructions, make progress on scores of them, and complete several in every cycle. Shortly after the turn of the century, it became apparent that a limit had been reached: there simply wasn’t any more instruction-level parallelism available in conventional programs.

At the next higher level of granularity, so-called *vector parallelism* is available in programs that perform operations repeatedly on every element of a very large data set. Processors designed to exploit this parallelism were the dominant form of supercomputer from the late 1960s through the early 1990s. Their legacy lives on in today’s single-chip graphics processors, which have recently reached the level of one trillion floating-point operations per second (FLOPS)—100 times the performance of the typical general-purpose processor.

Unfortunately, vector parallelism arises in only certain kinds of programs. Given the end of ILP, and the limits on clock frequency imposed by heat dissipation (Section ©5.4.4), general-purpose computing has moved to *multicore* processors, which require coarser-grain *thread-level* parallelism. This move represents a fundamental shift in the nature of computing: where parallelism was once a largely invisible implementation detail, it must now be written explicitly into high-level program structure.

Levels of Abstraction

With the spread of thread-level parallelism, different kinds of programmers will need to understand concurrency at different levels of detail, and use it in different ways.

The simplest, most abstract case will arise when using “black box” parallel libraries. A sorting routine or a linear algebra package, for example, may execute in parallel without its caller needing to understand how. In the database world, queries expressed in SQL (Structured Query Language) often execute in parallel as well. Recent releases of the .NET Framework include a *Language Integrated Query* mechanism (LINQ) that allows database-style queries to be made of program data structures, again with parallelism “under the hood.”

At a slightly less abstract level, a programmer may know that certain tasks are mutually independent (because, for example, they access disjoint sets of variables). Such tasks can safely execute in parallel.¹ In C# 3.0, for example, we can write the following using the Parallel FX Library.

```
Parallel.For(0, 100, i => { A[i] = foo(A[i]); } );
```

EXAMPLE 12.1

Independent tasks in
Parallel FX

¹ Ideally, we might like the compiler to figure this out automatically, but the analysis required to prove independence is uncomputable in the general case.

The first two arguments to `Parallel.For` are “loop” bounds; the third is a delegate, here written as a lambda expression. Assuming `A` is a 100-element array, and that the invocations of `foo` are truly independent, this code will have the same effect as the obvious traditional `for` loop, except that it will run faster, making use of as many processors (up to 100) as possible. ■

If our tasks are *not* independent, it may still be possible to run them in parallel if we explicitly *synchronize* their interactions. Synchronization serves to eliminate *Races* between threads by controlling the ways in which their actions can interleave in time. Suppose function `foo` in the previous example subtracts 1 from `A[i]` and also counts the number of times that the result is zero. Naively we might implement `foo` as

EXAMPLE 12.2

A simple race condition

```
int zero_count;
public static int foo(int n) {
    int rtn = n - 1;
    if (rtn == 0) zero_count++;
    return rtn;
}
```

Consider now what may happen when two or more instances of this code run concurrently.

Thread 1	Thread 2
...	...
r1 := zero_count	r1 := zero_count
r1 := r1 + 1	r1 := r1 + 1
zero_count := r1	zero_count := r1
...	...

If the instructions interleave roughly as shown, both threads may load the same value of `zero_count`, both may increment it by 1, and both may store the (only 1 greater) value back into `zero_count`. The result may be 1 less than what we expect.

In general, a *race condition* occurs whenever two or more threads are “racing” toward points in the code at which they touch some common object, and the behavior of the system depends on which thread gets there first. In this particular example, the store of `zero_count` in Thread 1 is racing with the load in Thread 2. If Thread 1 gets there first, we will get the “right” result; if Thread 2 gets there first, we won’t. ■

The most common purpose of synchronization is to make some sequence of instructions, known as a *critical section*, appear to be *atomic*—to happen “all at once” from the point of view of every other thread. In our example, the critical section is a load, an increment, and a store. The most common way to make the sequence atomic is with a *mutual exclusion lock*, which we *acquire* before the first instruction of the sequence and *release* after the last. We will study locks in

Sections 12.3.1 and 12.3.5. In Sections 12.3.2 and 12.4.4 we will also consider mechanisms that achieve atomicity without locks.

At the lowest level of abstraction, expert programmers may need to understand the hardware and run-time system in sufficient detail to *implement* synchronization mechanisms. This chapter should convey a sense of the issues, but a full treatment at this level is beyond the scope of the current text.

12.1.1 The Case for Multithreaded Programs

Our first motivation for concurrency—to capture the logical structure of certain applications—has arisen several times in earlier chapters. In Section 7.9.1 we noted that interactive I/O must often interrupt the execution of the current program. In a video game, for example, we must handle keystrokes and mouse or joystick motions while continually updating the image on the screen. The standard way to structure such a program, as described in Section 8.7.2, is to execute the input handlers in a separate thread of control, which coexists with one or more threads responsible for updating the screen. In Section 8.6, we considered a screen saver program that used coroutines to interleave “sanity checks” on the file system with updates to a moving picture on the screen. We also considered discrete-event simulation, which uses coroutines to represent the active entities of some real-world system.

The semantics of discrete-event simulation require that events occur atomically at fixed points in time. Coroutines provide a natural implementation, because they execute one at a time. In our other examples, however—and indeed in most “naturally concurrent” programs—there is no need for coroutine semantics. By assigning concurrent tasks to threads instead of to coroutines, we acknowledge that those tasks can proceed in parallel if more than one processor is available. We also move responsibility for figuring out which thread should run when from the programmer to the language implementation.

EXAMPLE 12.3

Multithreaded web browser

The need for multithreaded programs has become particularly apparent in recent years with the development of web-based applications. In a browser such as Firefox or Internet Explorer (see Figure 12.1), there are typically many different threads simultaneously active, each of which is likely to communicate with a remote (and possibly very slow) server several times before completing its task. When the user clicks on a link, the browser creates a thread to request the specified document. For all but the tiniest pages, this thread will then receive a long series of message “packets.” As these packets begin to arrive the thread must format them for presentation on the screen. The formatting task is akin to typesetting: the thread must access fonts, assemble words, and break the words into lines. For many special tags within the page, the formatting thread will spawn additional threads: one for each image, one for the background if any, one to format each table, and possibly more to handle separate frames. Each spawned thread will communicate with the server to obtain the information it needs (e.g., the contents of an image) for its particular task. The user, meanwhile, can access items in menus

```

procedure parse_page(address : url)
  contact server, request page contents
  parse_html_header
  while current_token in {"<p>","<h1>","<ul>","...",
    "<background>","<image>","<table>","<frameset>"...}
  case current_token of
    "<p>" : break_paragraph
    "<h1>" : format_heading; match("</h1>")
    "<ul>" : format_list; match("</ul>")
    ...
    "<background>" :
      a : attributes := parse_attributes
      fork render_background(a)
    "<image>" : a : attributes := parse_attributes
      fork render_image(a)
    "<table>" : a : attributes := parse_attributes
      scan forward for "</table>" token
      token_stream s := ... -- table contents
      fork format_table(s, a)
    "<frameset>" :
      a : attributes := parse_attributes
      parse_frame_list(a)
      match("</frameset>")
    ...
  ...
procedure parse_frame_list(a1 : attributes)
  while current_token in {"<frame>","<frameset>","<noframes>"}
  case current_token of
    "<frame>" : a2 : attributes := parse_attributes
      fork format_frame(a1, a2)
    ...

```

Figure 12.1 Thread-based code from a hypothetical Web browser. To first approximation, the `parse_page` subroutine is the root of a recursive descent parser for HTML. In several cases, however, the actions associated with recognition of a construct (background, image, table, frameset) proceed concurrently with continued parsing of the page itself. In this example, concurrent threads are created with the `fork` operation. An additional thread would likely execute in response to keyboard and mouse events.

to create new browser windows, edit bookmarks, change preferences, and so on, all in “parallel” with the rendering of page elements. ■

The use of many threads ensures that comparatively fast operations (e.g., display of text) do not wait for slow operations (e.g., display of large images). Whenever one thread *blocks* (waits for a message or I/O), the implementation automatically switches to a different thread. In a *preemptive* thread package, the implementation switches among threads at other times as well (i.e., it performs a *context switch*), to prevent any one thread from hogging the CPU. Any reader who remembers the

early, more sequential browsers will appreciate the difference that multithreading makes in perceived performance and responsiveness.

The Dispatch Loop Alternative

EXAMPLE 12.4

Dispatch loop web browser

Without language or library support for threads, a browser must either adopt a more sequential structure, or centralize the handling of all delay-inducing events in a single *dispatch loop* (see [Figure 12.2](#)). Data structures associated with the dispatch loop keep track of all the tasks the browser has yet to complete. The state of a task may be quite complicated. For the high-level task of rendering a page, the state must indicate which packets have been received and which are still outstanding. It must also identify the various subtasks of the page (images, tables, frames, etc.) so that we can find them all and reclaim their state if the user clicks on a “stop” button.

To guarantee good interactive response, we must make sure that no subaction of `continue_task` takes very long to execute. Clearly we must end the current action whenever we wait for a message. We must also end it whenever we read from a file, since disk operations are slow. Finally, if any task needs to compute for longer than about a tenth of a second (the typical human perceptual threshold), then we must divide the task into pieces, between which we save state and return to the top of the loop. These considerations imply that the condition at the top of the loop must cover the full range of asynchronous events, and that evaluations of the condition must be interleaved with continued execution of any tasks that were subdivided due to lengthy computation. (In practice we would probably need a more sophisticated mechanism than simple interleaving to ensure that neither input-driven nor compute-bound tasks hog more than their share of resources.) ■

The principal problem with a dispatch loop—beyond the complexity of subdividing tasks and saving state—is that it hides the algorithmic structure of the program. Every distinct task (retrieving a page, rendering an image, walking through nested menus) could be described elegantly with standard control-flow mechanisms, if not for the fact that we must return to the top of the dispatch loop at every delay-inducing operation. In effect, the dispatch loop turns the program “inside out,” making the management of tasks explicit and the control flow within tasks implicit. The resulting complexity is similar to what we encountered when trying to enumerate a recursive set with iterator objects in [Section 6.5.3](#), only worse. Like true iterators, a thread package turns the program “right side out,” making the management of tasks (threads) implicit and the control flow within threads explicit.

12.1.2 Multiprocessor Architecture

Single-site (nondistributed) parallel computers can be grouped into two broad categories: those in which processors share access to common memory, and those

```

type task_descriptor = record
    -- fields in lieu of thread-local variables, plus control-flow information
    ...
ready_tasks : queue of task_descriptor
...
procedure dispatch
    loop
        -- try to do something input-driven
        if a new event E (message, keystroke, etc.) is available
            if an existing task T is waiting for E
                continue_task(T, E)
            else if E can be handled quickly, do so
            else
                allocate and initialize new task T
                continue_task(T, E)
        -- now do something compute bound
        if ready_tasks is nonempty
            continue_task(dequeue(ready_tasks), 'ok')

procedure continue_task(T : task, E : event)
    if T is rendering an image
        and E is a message containing the next block of data
            continue_image_render(T, E)
    else if T is formatting a page
        and E is a message containing the next block of data
            continue_page_parse(T, E)
    else if T is formatting a page
        and E is 'ok' -- we're compute bound
            continue_page_parse(T, E)
    else if T is reading the bookmarks file
        and E is an I/O completion event
            continue_goto_page(T, E)
    else if T is formatting a frame
        and E is a push of the "stop" button
            deallocate T and all tasks dependent upon it
    else if E is the "edit preferences" menu item
        edit_preferences(T, E)
    else if T is already editing preferences
        and E is a newly typed keystroke
            edit_preferences(T, E)
    ...

```

Figure 12.2 Dispatch loop from a hypothetical non-thread-based Web browser. The clauses in `continue_task` must cover all possible combinations of task state and triggering event. The code in each clause performs the next coherent unit of work for its task, returning when (1) it must wait for an event, (2) it has consumed a significant amount of compute time, or (3) the task is complete. Prior to returning, respectively, code (1) places the task in a dictionary (used by `dispatch`) that maps awaited events to the tasks that are waiting for them, (2) enqueues the task in `ready_tasks`, or (3) deallocates the task.

in which they must communicate with messages. Shared-memory machines are typically referred to as *multiprocessors*, though occasionally one hears that term applied to message-based machines as well. A multiprocessor typically occupies a single chassis, in which the processors share not only memory, but also disks, power supplies, and a single copy of the operating system. Some vendors in the 1980s and 1990s sold single-chassis message-based machines as well, but these have for the most part been displaced by *clusters* of PC-class machines.

From the point of view of language or library implementation, the principal distinction between shared-memory and message-passing hardware is that messages typically require the active participation of processors at both ends of the connection: one to send, the other to receive. On a shared-memory machine, a processor can read and write remote memory without the assistance of a remote processor. In most cases remote reads and writes use the same interface (i.e., load and store instructions) as local reads and writes.

Historically, small shared-memory multiprocessors (2–8 processors) were often *symmetric*, in the sense that all memory was equally distant from all processors. Most larger multiprocessors (and some more recent small machines) employ

DESIGN & IMPLEMENTATION

What, exactly, is a processor?

Terminology has yet to gel completely in the multicore era. For 30 years, a processor was almost always a single chip, and only microarchitects talked about “cores” (the core was the portion of the chip devoted to the CPU, as opposed to the cache or other components). Today most vendors are using “processor” to refer to the physical device that plugs into a socket on the motherboard, but this definition is likely to become problematic as future machines evolve toward denser, socket-less designs. Even today, a single “processor” may have more than one chip inside the physical package. More significantly, each chip may have multiple cores, each core may have multiple hardware threads (independent register sets), and different levels of cache may be shared among different subsets of the cores.

From a software perspective, the good news is that operating systems and programming languages generally model every concurrent activity as a thread, whether or not it shares a core, a chip, or a package with other threads. We will follow this convention for most of the rest of this chapter, ignoring the complexity of the underlying hardware. We will also, from time to time, use the term “processor” to refer to the hardware on which a thread runs, even when that hardware is actually only one core, or one register set within a core. The bad news is that such simplifications make it difficult to understand or tune the performance of parallel programs. Future chips are likely to include ever larger numbers of heterogeneous cores and complex on-chip networks. To use these chips effectively, researchers will need to develop much better scheduling algorithms and performance analysis tools.

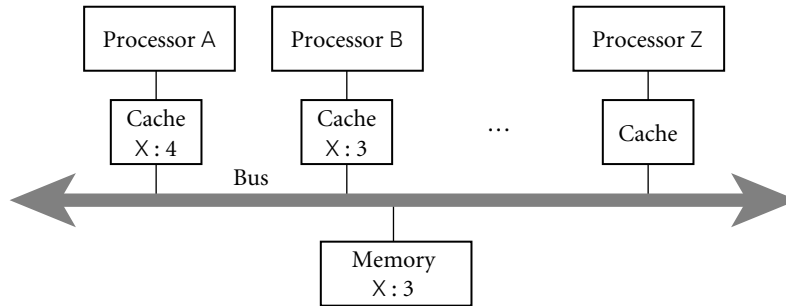

Figure 12.3 The cache coherence problem for shared-memory multiprocessors. Here processors A and B have both read variable X from memory. As a side effect, a copy of X has been created in the cache of each processor. If A now changes X to 4 and B reads X again, how do we ensure that the result is a 4 and not the still-cached 3? Similarly, if Z reads X into its cache, how do we ensure that it obtains the 4 from A's cache instead of the stale 3 from memory?

a *distributed-memory* architecture, in which each memory bank is physically adjacent to a particular processor or small group of processors. Any processor can access the memory of any other, but local memory is faster. Assuming all memory is cached, the difference appears only on cache misses, where the penalty for local memory is lower.

Memory Coherence

On a message-passing machine, each processor caches its own memory independently. On a shared-memory machine, however, caches introduce a serious problem: unless we do something special, a processor that has cached a particular memory location will not see changes that are made to that location by other processors. This problem—how to keep cached copies of a memory location consistent with one another—is known as the *coherence* problem (see Figure 12.3). On bus-based symmetric machines, the problem is relatively easy to solve: the broadcast nature of the communication medium allows cache controllers to eavesdrop (*snoop*) on the memory traffic of other processors. When a processor needs to write a cache line, it requests an *exclusive* copy, and waits for other processors to *invalidate* their copies. On a bus the waiting is trivial, and the natural ordering of messages determines who wins in the event of near-simultaneous requests. Processors that try to access a line in the wake of invalidation must go back to memory (or to another processor's cache) to obtain an up-to-date copy. ■

Bus-based cache coherence algorithms are now a standard, built-in part of most commercial microprocessors. On large machines, the lack of a broadcast bus makes cache coherence a significantly more difficult problem; commercial implementations are available, but the subject remains an active topic of research. On both small and large machines, the fact that coherence is not instantaneous

EXAMPLE 12.5

The cache coherence problem

(it takes time for notifications to propagate) means that we must consider the *order* in which updates to different locations appear to occur from the point of view of different processors. Ensuring a *consistent* view is a surprisingly difficult problem; we will return to it in [Section 12.3.3](#).

As of 2008, there are multicore versions of every major instruction set architecture, including ARM, x86, PowerPC, SPARC, x86-64, and IA-64 (Itanium). Small, cache-coherent multiprocessors built from these are available from dozens of manufacturers. Larger, cache-coherent shared-memory multiprocessors are available from several manufacturers, including Sun, HP, IBM, and SGI.

Supercomputers

Though dwarfed financially by the rest of the computer industry, supercomputing has always played a disproportionate role in the development of computer technology and the advancement of human knowledge. Supercomputers have changed dramatically over time, and they continue to evolve at a very rapid pace. They have always, however, been parallel machines.

Because of the complexity of cache coherence, it is difficult to build large shared-memory machines. SGI sells machines with as many as 512 processors (1024 cores). Cray builds even larger shared-memory machines, but without the ability to cache remote locations. For the most part, however, traditional vector machines were displaced not by large multiprocessors, but by modest numbers of smaller multiprocessors or by very large numbers of commodity (mainstream) uniprocessors, connected by custom high-performance networks. As network technology “trickled down” into the broader market, these machines have in turn given way to clusters composed of both commodity processors (often multicore) and commodity networks (Gigabit Ethernet or Infiniband). As of 2008, clusters have come to dominate everything from modest server farms up to all but the very fastest supercomputer sites. Large-scale on-line services like Google, Amazon, or eBay are typically backed by clusters with hundreds or even thousands of processors (in Google’s case, probably hundreds of thousands).

Today’s fastest machines are constructed from special high-density, low-power multicore chips. IBM’s BlueGene/P systems use custom four-core, 16W PowerPC processors. IBM’s recently completed RoadRunner system (the fastest in the world as of June 2008) uses 90W PowerXCell processors similar (but not identical) to the ones in the Sony Playstation 3. Each Cell processor contains a dual-thread PowerPC and eight small vector cores. Given current trends, it seems likely that future machines, both high-end and commodity, will be increasingly dense and increasingly heterogeneous.

From a programming language perspective, the special challenge of supercomputing is to accommodate nonuniform access times and (in most cases) the lack of hardware support for shared memory across the full machine. Today’s supercomputers are programmed mostly with message-passing libraries (MPI in particular) and with languages and libraries in which there is a clear syntactic distinction between local and remote memory access.

✓ CHECK YOUR UNDERSTANDING

1. Explain the distinctions among *concurrent*, *parallel*, and *distributed*.
 2. Explain the motivation for concurrency. Why do people write concurrent programs? What accounts for the increased interest in concurrency in recent years?
 3. Describe the implementation levels at which parallelism appears in modern systems, and the levels of abstraction at which it may be considered by the programmer.
 4. What is a *race condition*? What is *synchronization*?
 5. What is a *context switch*? *Preemption*?
 6. Explain the concept of a *dispatch loop*. What are its advantages and disadvantages with respect to multithreaded code?
 7. Explain the distinction between a *multiprocessor* and a *cluster*.
 8. Explain the *coherence problem* for multiprocessor caches.
 9. What does it mean for a multiprocessor to be *symmetric*? What is the alternative?
 10. What is a *vector machine*? Where does vector technology appear in modern systems?
-

12.2 Concurrent Programming Fundamentals

Within a concurrent program, we will use the term *thread* to refer to the active entity that the programmer thinks of as running concurrently with other threads. In most systems, the threads of a given program are implemented on top of one or more *processes* provided by the operating system. OS designers often distinguish between a *heavyweight* process, which has its own address space, and a collection of *lightweight* processes, which may share an address space. Lightweight processes were added to most variants of Unix in the late 1980s and early 1990s, to accommodate the proliferation of shared-memory multiprocessors.

We will sometimes use the word *task* to refer to a well-defined unit of work that must be performed by some thread. In one common programming idiom, a collection of threads shares a common “bag of tasks”—a list of work to be done. Each thread repeatedly removes a task from the bag, performs it, and goes back for another. Sometimes the work of a task entails adding new tasks to the bag.

Unfortunately, terminology is inconsistent across systems and authors. Several languages call their threads processes. Ada calls them tasks. Several operating systems call lightweight processes threads. The Mach OS, from which OSF Unix and Mac OS X are derived, calls the address space shared by lightweight processes a

task. A few systems try to avoid ambiguity by coining new words, such as “actors” or “filaments.” We will attempt to use the definitions of the preceding two paragraphs consistently, and to identify cases in which the terminology of particular languages or systems differs from this usage.

12.2.1 Communication and Synchronization

In any concurrent programming model, two of the most crucial issues to be addressed are *communication* and *synchronization*. Communication refers to any mechanism that allows one thread to obtain information produced by another. Communication mechanisms for imperative programs are generally based on either *shared memory* or *message passing*. In a shared-memory programming model, some or all of a program’s variables are accessible to multiple threads. For a pair of threads to communicate, one of them writes a value to a variable and the other simply reads it. In a message-passing programming model, threads have no common state. For a pair of threads to communicate, one of them must perform an explicit send operation to transmit data to another.

Synchronization refers to any mechanism that allows the programmer to control the relative order in which operations occur in different threads. Synchronization is generally implicit in message-passing models: a message must be sent before it can be received. If a thread attempts to receive a message that has not yet been sent, it will wait for the sender to catch up. Synchronization is generally not implicit in shared-memory models: unless we do something special, a “receiving” thread could read the “old” value of a variable, before it has been written by the “sender.”

In both shared-memory and message-based programs, synchronization can be implemented either by *spinning* (also called *busy-waiting*) or by *blocking*. In busy-wait synchronization, a thread runs a loop in which it keeps reevaluating some condition until that condition becomes true (e.g., until a message queue becomes nonempty or a shared variable attains a particular value)—presumably as a result of action in some other thread, running on some other processor. Note

DESIGN & IMPLEMENTATION

Hardware and software communication

As described in [Section 12.1.2](#), the distinction between shared memory and message passing applies not only to languages and libraries but also to computer hardware. It is important to note that the model of communication and synchronization provided by the language or library need not necessarily agree with that of the underlying hardware. It is easy to implement message passing on top of shared-memory hardware. With a little more effort, one can also implement shared memory on top of message-passing hardware. Systems in this latter camp are sometimes referred to as *software distributed shared memory* (S-DSM).

	Shared memory	Message passing	Distributed computing
Language	Java, C#		
Extension	OpenMP		Remote procedure call
Library	pthread, Win32 threads	MPI	Internet libraries

Figure 12.4 Widely used parallel programming systems. There is also a very large number of experimental, pedagogical, or niche proposals for each of the regions in the table (including regions where no system is currently widely used).

that busy-waiting makes no sense on a uniprocessor: we cannot expect a condition to become true while we are monopolizing a resource (the processor) required to make it true. (A thread on a uniprocessor may sometimes busy-wait for the completion of I/O, but that’s a different situation: the I/O device runs in parallel with the processor.)

In blocking synchronization (also called *scheduler-based* synchronization), the waiting thread voluntarily relinquishes its processor to some other thread. Before doing so, it leaves a note in some data structure associated with the synchronization condition. A thread that makes the condition true at some point in the future will find the note and take action to make the blocked thread run again. We will consider synchronization again briefly in [Section 12.2.4](#), and then more thoroughly in [Section 12.3](#).

12.2.2 Languages and Libraries

Thread-level concurrency can be provided to the programmer in the form of explicitly concurrent languages, compiler-supported extensions to traditional sequential languages, or library packages outside the language proper. All three options are widely used, though shared-memory languages are more common at the “low end” (for multicore and small multiprocessor machines), and message-passing libraries are more common at the “high end” (for massively parallel supercomputers). The systems in widest use are categorized in [Figure 12.4](#).

For many years, almost all parallel programming employed traditional sequential languages (largely C and Fortran) augmented with libraries for synchronization or message passing, and this approach still dominates today. In the Unix world, shared memory parallelism has largely converged on the POSIX `pthread` standard, which includes mechanisms to create, destroy, schedule, and synchronize threads. While the standard requires no changes to the syntax of languages that use it, POSIX-compliant compilers must refrain from performing optimizations that may introduce races into programs with multiple threads. Similar functionality for Windows platforms is provided by Microsoft’s Win32 threads package

and compilers. For high-end scientific computing, message-based parallelism has likewise converged on the MPI (Message Passing Interface) standard, with open-source and commercial implementations available for almost every platform.

While language support for concurrency goes back all the way to Algol 68 (and coroutines to Simula), and while such support was widely available in Ada by the late 1980s, widespread interest in these features didn't really arise until the mid-1990s, when the explosive growth of the World Wide Web began to drive the development of parallel servers and concurrent client programs. This development coincided nicely with the introduction of Java, and Microsoft followed with C# a few years later.

In the realm of scientific programming, there is a long history of extensions to Fortran designed to facilitate the parallel execution of loop iterations. By the turn of the century this work had largely converged on a set of extensions known as OpenMP, available not only in Fortran, but in C and C++ as well. Syntactically, OpenMP comprises a set of *pragmas* (compiler directives) to create and synchronize threads, and to schedule work among them. On machines composed of a network of multiprocessors, it is increasingly common to see hybrid programs that use OpenMP within a multiprocessor and MPI across them.

In both the shared memory and message passing columns of [Figure 12.4](#), the parallel constructs are intended for use within a single multithreaded program. For communication across program boundaries in distributed systems, programmers have traditionally employed library implementations of the standard Internet protocols, in a manner reminiscent of file-based I/O ([Section ©7.9](#)). For client-server interaction, however, it can be attractive to provide a higher-level interface based on *remote procedure calls* (RPC), an alternative we consider further in [Section ©12.5.4](#).

In comparison to library packages, an explicitly concurrent programming language has the advantage of compiler support. It can make use of syntax other than subroutine calls, and can integrate communication and thread management more tightly with such concepts as type checking, scoping, and exceptions. At the same time, since most programs have historically been sequential, concurrent languages have been slow to gain widespread acceptance, particularly given that the presence of concurrent features can sometime make the sequential case more difficult to understand.

12.2.3 Thread Creation Syntax

Almost every concurrent system allows threads to be created (and destroyed) dynamically. Syntactic and semantic details vary considerably from one language or library to another, but most conform to one of six principal options: co-begin, parallel loops, launch-at-elaboration, fork (with optional join), implicit receipt, and early reply. The first two options delimit threads with special control-flow constructs. The others use syntax resembling (or identical to) subroutines.

At least one language (SR) provides all six options. Most others pick and choose. Most libraries use `fork/join`, as do Java and C#. Ada uses both `launch-at-elaboration` and `fork`. OpenMP uses `co-begin` and parallel loops. RPC systems are typically based on implicit receipt.

Co-begin

EXAMPLE 12.6

General form of `co-begin`

The usual semantics of a compound statement (sometimes delimited with `begin...end`) call for sequential execution of the constituent statements. A `co-begin` construct calls instead for concurrent execution:

```
co-begin                -- all n statements run concurrently
    stmt_1
    stmt_2
    ...
    stmt_n
end
```

Each statement can itself be a sequential or parallel compound, or (commonly) a subroutine call. ■

EXAMPLE 12.7

`Co-begin` in OpenMP

`Co-begin` was the principal means of creating threads in Algol-68. It appears in a variety of other systems as well, including OpenMP:

```
#pragma omp sections
{
#   pragma omp section
    { printf("thread 1 here\n"); }

#   pragma omp section
    { printf("thread 2 here\n"); }
}
```

In C, OpenMP directives all begin with `#pragma omp`. (The `#` sign must appear in column 1.) Most directives, like those shown here, must appear immediately before a loop construct or a compound statement delimited with curly braces. ■

Parallel Loops

Many concurrent systems, including OpenMP, several dialects of Fortran, and the recently announced Parallel FX Library for .NET, provide a loop whose iterations are to be executed concurrently. In OpenMP for C, we might say

EXAMPLE 12.8

A parallel loop in OpenMP

```
#pragma omp parallel for
for (int i = 0; i < 3; i++) {
    printf("thread %d here\n", i);
}
```

EXAMPLE 12.9

A parallel loop in C#

In C# with Parallel FX, the equivalent code looks like this:

```
Parallel.For(0, 3, i => {  
    Console.WriteLine("Thread " + i + " here");  
});
```

The third argument to `Parallel.For` is a delegate, in this case a lambda expression. A similar `Foreach` method expects two arguments—an iterator and a delegate. ■

In many systems it is the programmer's responsibility to make sure that concurrent execution of the loop iterations is safe, in the sense that correctness will never depend on the outcome of race conditions. Access to global variables, for example, must generally be synchronized, to make sure that iterations do not conflict with one another. In a few languages (e.g., Occam), language rules prohibit conflicting accesses. The compiler checks to make sure that a variable written by one thread is neither read nor written by any concurrently active thread.

Several parallel dialects of Fortran have provided parallel loops, with varying semantics. The `forall` loop of High Performance Fortran (HPF) was subsequently incorporated into Fortran 95. Like the loops above, it indicates that iterations can proceed in parallel. To resolve race conditions, however, it imposes automatic, internal synchronization on the constituent statements of the loop, each of which must be an assignment or a nested `forall` loop. Specifically, all reads of variables in a given assignment statement, in all iterations, must occur before any write to the left-hand side, in any iteration. The writes of the left-hand side in turn must occur before any reads in the next assignment statement. In the following example, the first assignment in the loop will read $n - 1$ elements of `B` and $n - 1$ elements of `C`, and then update $n - 1$ elements of `A`. Subsequently, the second assignment statement will read all n elements of `A` and then update $n - 1$ of them.

EXAMPLE 12.10

`forall` in Fortran 95

```
forall (i=1:n-1)  
    A(i) = B(i) + C(i)  
    A(i+1) = A(i) + A(i+1)  
end forall
```

Note in particular that all of the updates to `A(i)` in the first assignment statement occur before any of the reads in the second assignment statement. Moreover in the second assignment statement the update to `A(i+1)` is *not* seen by the read of `A(i)` in the “subsequent” iteration: the iterations occur in parallel and each reads the variables on its right-hand side before updating its left-hand side. ■

For loops that iterate over the elements of an array, the `forall` semantics are ideally suited for execution on a vector machine. For more conventional multiprocessors, HPF provides an extensive set of *data distribution* and *alignment* directives that allow the programmer to scatter elements across the memory associated with a large number of processors. Within a `forall` loop, the computation in a given assignment statement is usually performed by the processor that “owns” the element on the assignment's left-hand side. In many cases an HPF or Fortran 95 compiler can prove that there are no dependences among certain (portions of)

constituent statements of a `forall` loop, and can allow them to proceed without actually implementing synchronization.

OpenMP does not enforce the statement-by-statement synchronization of `forall`, but it does provide significant support for scheduling and data management. Optional “clauses” on `parallel` directives can specify how many threads to create, and which iterations of the loop to perform in which thread. They can also specify which program variables should be shared by all threads, and which should be split into a separate copy for each thread. It is even possible to specify that a private variable should be *reduced* across all threads at the end of the loop, using a commutative operator. To sum the elements of a very large vector, for example, one might write

EXAMPLE 12.11

Reduction in OpenMP

```
double A[N];
...
double sum = 0;
#pragma omp parallel for schedule(static) \
    default(shared) reduction(+:sum)
for (int i = 0; i < N; i++) {
    sum += A[i];
}
printf("parallel sum: %f\n", sum);
```

Here the `schedule(static)` clause indicates that the compiler should divide the iterations evenly among threads, in contiguous groups. So if there are t threads, the first thread should get the first N/t iterations, the second should get the next N/t iterations, and so on. The `default(shared)` clause indicates that all variables (other than `i`) should be shared by all threads, unless otherwise specified. The `reduction(+:sum)` clause makes `sum` an exception: every thread should have its own copy (initialized from the value in effect before the loop), and the copies should be combined (with `+`) at the end. If t is large, the compiler will probably sum the values using a tree of depth $\log(t)$. ■

Launch-at-Elaboration

In several languages, Ada among them, the code for a thread may be declared with syntax resembling that of a subroutine with no parameters. When the declaration is elaborated, a thread is created to execute the code. In Ada (which calls its threads `tasks`) we may write

EXAMPLE 12.12

Elaborated tasks in Ada

```
procedure P is
  task T is
    ...
  end T;
begin -- P
  ...
end P;
```

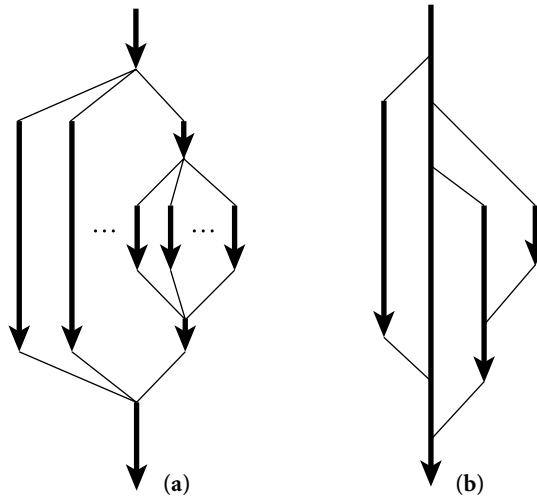

Figure 12.5 Lifetime of concurrent threads. With `co-begin`, parallel loops, or launch-at-elaboration (a), threads are always properly nested. With `fork/join` (b), more general patterns are possible.

Task `T` has its own `begin...end` block, which it begins to execute as soon as control enters procedure `P`. If `P` is recursive, there may be many instances of `T` at the same time, all of which execute concurrently with each other and with whatever task is executing (the current instance of) `P`. The main program behaves like an initial default task.

When control reaches the end of procedure `P`, it will wait for the appropriate instance of `T` (the one that was created at the beginning of this instance of `P`) to complete before returning. This rule ensures that the local variables of `P` (which are visible to `T` under the usual static scope rules) are never deallocated before `T` is done with them. ■

Fork/Join

EXAMPLE 12.13

Co-begin vs fork/join

`Co-begin`, parallel loops, and launch-at-elaboration all lead to a concurrent control-flow pattern in which thread executions are properly nested (see [Figure 12.5a](#)). The `fork` operation is more general: it makes the creation of threads an explicit, executable operation. The companion `join` operation, when provided, allows a thread to wait for the completion of a previously forked thread. Because `fork` and `join` are not tied to nested constructs, they can lead to arbitrary patterns of concurrent control flow ([Figure 12.5b](#)). ■

EXAMPLE 12.14

Task types in Ada

In addition to providing launch-at-elaboration tasks, Ada allows the programmer to define task *types*:

```

task type T is
...
begin
...
end T;

```

The programmer may then declare variables of type `access T` (pointer to T), and may create new tasks via dynamic allocation:

```
pt : access T := new T;
```

The `new` operation is a fork; it creates a new thread and starts it executing. There is no explicit join operation in Ada, though parent and child tasks can always synchronize with one another explicitly if desired (e.g., immediately before the child completes its execution). As with launch-at-elaboration, control will wait automatically at the end of any scope in which task types are declared for all threads using the scope to terminate. ■

Any information an Ada task needs in order to do its job must be communicated through shared variables or through explicit messages sent after the task has started execution. Most systems, by contrast, allow parameters to be passed to a thread at start-up time. In Java one obtains a thread by constructing an object of some class derived from a predefined class called `Thread`:

EXAMPLE 12.15

Thread creation in Java 2

DESIGN & IMPLEMENTATION

Task-parallel and data-parallel computing

One of the most basic decisions a programmer has to make when writing a parallel program is how to divide work among threads. One common strategy, which works well on small machines, is to use a separate thread for each of the program's major tasks or functions, and to pipeline or otherwise overlap their execution. In a word processor, for example, one thread might be devoted to breaking paragraphs into lines, another to pagination and figure placement, another to spelling and grammar checking, and another to rendering the image on the screen. This strategy is often known as *task parallelism*. Its principal disadvantage is that it doesn't naturally scale to very large numbers of processors. For that, one generally needs *data parallelism*, in which more-or-less the same operations are applied concurrently to the elements of some very large data set. An image manipulation program, for example, may divide the screen into n small tiles, and use a separate thread to process each tile. A game may use a separate thread for every moving character or object.

A programming system whose features are designed for data parallelism is sometimes referred to as a data-parallel language or library. Data parallel programs are commonly based on parallel loops: each thread executes the same code, using different data. Task parallel programs are commonly based on co-begin, launch-at-elaboration, or fork/join: the code in different threads can be different.

```

class ImageRenderer extends Thread {
    ...
    ImageRenderer( args ) {
        // constructor
    }
    public void run() {
        // code to be run by the thread
    }
}
...
ImageRenderer rend = new ImageRenderer( constructor_args );

```

Superficially, the use of `new` resembles the creation of dynamic tasks in Ada. In Java, however, the new thread does *not* begin execution when first created. To start it, the parent (or some other thread) must call the method named `start`, which is defined in `Thread`:

```
rend.start();
```

`start` makes the thread runnable, arranges for it to execute its `run` method, and returns to the caller. The programmer must define an appropriate `run` method in every class derived from `Thread`. The `run` method is meant to be called only by `start`; programmers should not call it directly, nor should they redefine `start`. There is also a `join` method:

```
rend.join();           // wait for completion
```

The constructor for a Java thread typically saves its arguments in fields that are later accessed by `run`. In effect, the class derived from `Thread` functions as an *object closure*, as described in [Section 3.6.3](#). Several languages, Modula-3 and C# among them, use closures more explicitly. Rather than require every thread to be derived from a common `Thread` class, C# allows one to be created from an arbitrary `ThreadStart` delegate:

EXAMPLE 12.16
Thread creation in C#

```

class ImageRenderer {
    ...
    public ImageRenderer( args ) {
        // constructor
    }
    public void Foo() {           // Foo is compatible with ThreadStart;
                                // its name is not significant
        // code to be run by the thread
    }
}
...
ImageRenderer rendObj = new ImageRenderer( constructor_args );
Thread rend = new Thread(new ThreadStart( rendObj.Foo ));

```

If thread arguments can be gleaned from the local context, this can even be written as

```
Thread rend = new Thread(delegate() {
    // code to be run by the thread
});
```

(Remember, C# has unlimited extent for anonymous delegates.) Either way, the new thread is started and awaited just as it is in Java:

```
rend.Start();
...
rend.Join();
```

EXAMPLE 12.17

Thread pools in Java 5

As of Java 5 (with its `java.util.concurrent` library), programmers are discouraged from creating threads explicitly. Rather, tasks to be accomplished are represented by objects that support the `Runnable` interface, and these are passed to an `Executor` object. The `Executor` in turn farms them out to a managed pool of threads.

```
class ImageRenderer implements Runnable {
    ...
    // constructor and run() method same as before
}
...
Executor pool = Executors.newFixedThreadPool(4);
...
pool.execute(new ImageRenderer( constructor_args ));
```

Here the argument to `newFixedThreadPool` (one of a large number of standard `Executor` *factories*) indicates that `pool` should manage four threads. Each task specified in a call to `pool.execute` will be run by one of these threads. By separating the concepts of task and thread, Java allows the programmer (or run-time code) to choose an `Executor` class whose level of true concurrency and the scheduling discipline are appropriate to the underlying OS and hardware. (In this example we have used a particularly simple pool, with exactly four threads.) C# has similar thread pool facilities. Like C# threads, they are based on delegates. ■

EXAMPLE 12.18

Spawn and sync in Cilk

A particularly elegant realization of `fork` and `join` appears in the Cilk programming language, developed by researchers at MIT, and recently licensed to a commercial start-up venture. To fork a logically concurrent task in Cilk, one simply prepends the keyword `spawn` to an ordinary function call:

```
spawn foo( args );
```

At some later time, invocation of the built-in operation `sync` will join with all tasks previously spawned by the calling task. The principal innovation of Cilk is the mechanism for scheduling tasks. The language implementation includes a highly efficient thread pool mechanism that explores the task-creation graph

depth first with a near-minimal number of context switches and automatic load balancing across threads. ■

Implicit Receipt

We have assumed in all our examples so far that newly created threads will run in the address space of the creator. In RPC systems it is often desirable to create a new thread automatically in response to an incoming request from some *other* address space. Rather than have an existing thread execute a receive operation, a server can *bind* a communication channel to a local thread body or subroutine. When a request comes in, a new thread springs into existence to handle it.

In effect, the `bind` operation grants remote clients the ability to perform a `fork` within the server's address space, though the process is often less than fully automatic. We will consider RPC in more detail in Section ©12.5.4.

Early Reply

We normally think of sequential subroutines in terms of a single thread, which saves its current context (its program counter and registers), executes the subroutine, and returns to what it was doing before. The effect is the same, however, if we have two threads—one that executes the caller and another that executes the callee. In this case, the call is essentially a `fork/join` pair. The caller waits for the callee to terminate before continuing execution. ■

Nothing dictates, however, that the callee has to terminate in order to release the caller; all it really has to do is complete the portion of its work on which result parameters depend. In several languages, including SR and Hermes [SBG⁺91],

EXAMPLE 12.19

Modeling subroutines with `fork/join`

DESIGN & IMPLEMENTATION

Counterintuitive implementation

Over the course of 12 chapters we have seen numerous cases in which the implementation of a language feature may run counter to the programmer's intuition. Early reply—in which thread creation is usually delayed until the reply actually occurs—is but the most recent example. Others have included expression evaluation order (Section 6.1.4), subroutine in-lining (Section 8.2.4), tail recursion (Section 6.6.1), nonstack allocation of activation records (for unlimited extent—Section 3.6.2), out-of-order or even noncontiguous layout of record fields (Section 7.3.2), variable lookup in a central reference table (Section ©3.4.2), immutable objects under a reference model of variables (Section 6.1.2), and implementations of generics (Sections 3.5.3 and 8.4) that share code among instances with different type parameters. A compiler may, particularly at higher levels of code improvement, produce code that differs dramatically from the form and organization of its input. Unless otherwise constrained by the language definition, an implementation is free to choose any translation that is provably equivalent to the input.

the callee can execute a reply operation that returns results to the caller *without* terminating. After an early reply, the two threads continue concurrently.

Semantically, the portion of the callee prior to the reply plays much the same role as the constructor of a Java or C# thread; the portion after the reply plays the role of the `run` method. The usual implementation is also similar, and may run counter to the programmer's intuition: since early reply is optional, and can appear in any subroutine, we can use the caller's thread to execute the initial portion of the callee, and create a new thread only when—and if—the callee replies instead of returning.

12.2.4 Implementation of Threads

As we noted near the beginning of [Section 12.2](#), the threads of a concurrent program are usually implemented on top of one or more *processes* provided by the operating system. At one extreme, we could use a separate OS process for every thread; at the other extreme we could multiplex all of a program's threads on top of a single process. On a supercomputer with a separate processor for every concurrent activity, or in a language in which threads are relatively heavyweight abstractions (long-lived, and created by the dozens rather than the thousands), the one-process-per-thread extreme is often acceptable. In a simple language on a uniprocessor, the all-threads-on-one-process extreme may be acceptable. Many language implementations adopt an intermediate approach, with a potentially very large number of threads running on top of some smaller number of processes (see [Figure 12.6](#)). ■

EXAMPLE 12.20

Multiplexing threads on processes

The problem with putting every thread on a separate process is that processes (even “lightweight” ones) are simply too expensive in many operating systems. Because they are implemented in the kernel, performing any operation on them requires a system call. Because they are general purpose, they provide features that most languages do not need, but have to pay for anyway. (Examples include separate address spaces, priorities, accounting information, and signal and I/O interfaces, all of which are beyond the scope of this book.) At the other extreme, there are two problems with putting all threads on top of a single process: first, it precludes parallel execution on a multicore or multiprocessor machine; second, if the currently running thread makes a system call that blocks (e.g., waiting for I/O), then none of the program's other threads can run, because the single process is suspended by the OS.

In the common two-level organization of concurrency (user-level threads on top of kernel-level processes), similar code appears at both levels of the system: the language run-time system implements threads on top of one or more processes in much the same way that the operating system implements processes on top of one or more physical processors. We will use the terminology of threads on top of processes in the remainder of this section.

The typical implementation starts with coroutines ([Section 8.6](#)). Recall that coroutines are a sequential control-flow mechanism: the programmer can suspend

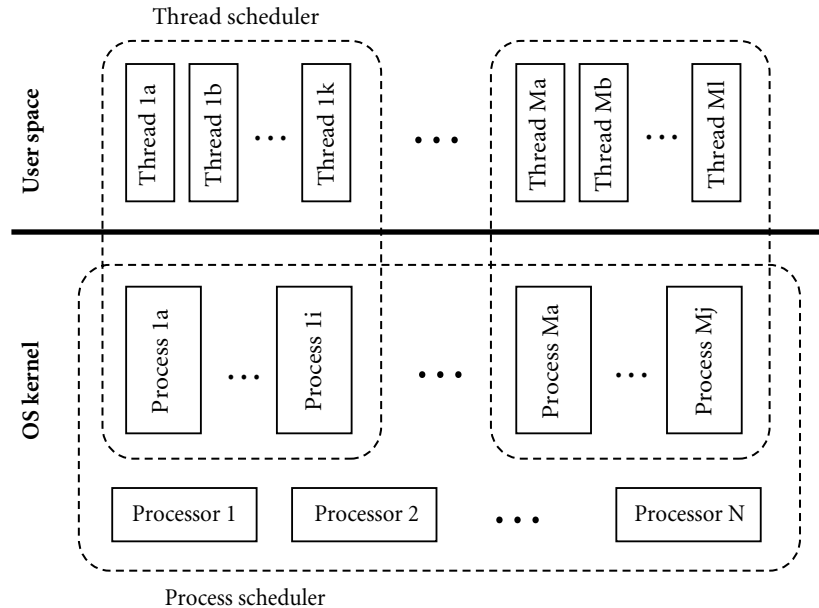

Figure 12.6 Two-level implementation of threads. A thread scheduler, implemented in a library or language run-time package, multiplexes threads on top of one or more kernel-level processes, just as the process scheduler, implemented in the operating system kernel, multiplexes processes on top of one or more physical processors.

the current coroutine and resume a specific alternative by calling the transfer operation. The argument to transfer is typically a pointer to the context block of the coroutine.

To turn coroutines into threads, we proceed in a series of three steps. First, we hide the argument to transfer by implementing a *scheduler* that chooses which thread to run next when the current thread yields the processor. Second, we implement a *preemption* mechanism that suspends the current thread automatically on a regular basis, giving other threads a chance to run. Third, we allow the data structures that describe our collection of threads to be shared by more than one OS process, possibly on separate processors, so that threads can run on any of the processes.

Uniprocessor Scheduling

Figure 12.7 illustrates the data structures employed by a simple scheduler. At any particular time, a thread is either *blocked* (i.e., for synchronization) or *runnable*. A runnable thread may actually be running on some process or it may be awaiting its chance to do so. Context blocks for threads that are runnable but not currently running reside on a queue called the *ready list*. Context blocks for threads that are blocked for scheduler-based synchronization reside in data structures (usually

EXAMPLE 12.21

Cooperative
multithreading on a
uniprocessor

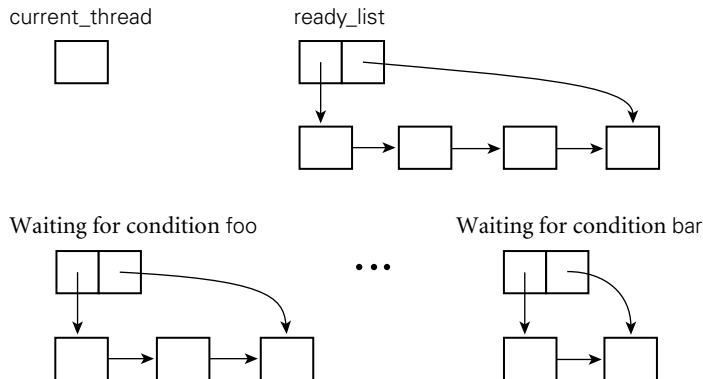

Figure 12.7 Data structures of a simple scheduler. A designated `current_thread` is running. Threads on the ready list are runnable. Other threads are blocked, waiting for various conditions to become true. If threads run on top of more than one OS-level process, each such process will have its own `current_thread` variable. If a thread makes a call into the operating system, its process may block in the kernel.

queues) associated with the conditions for which they are waiting. To yield the processor to another thread, a running thread calls the scheduler:

```
procedure reschedule
  t : thread := dequeue(ready_list)
  transfer(t)
```

Before calling into the scheduler, a thread that wants to run again at some point in the future must place its own context block in some appropriate data structure. If it is blocking for the sake of fairness—to give some other thread a chance to run—then it enqueues its context block on the ready list:

```
procedure yield
  enqueue(ready_list, current_thread)
  reschedule
```

To block for synchronization, a thread adds itself to a queue associated with the awaited condition:

```
procedure sleep_on(ref Q : queue of thread)
  enqueue(Q, current_thread)
  reschedule
```

When a running thread performs an operation that makes a condition true, it removes one or more threads from the associated queue and enqueues them on the ready list. ■

Fairness becomes an issue whenever a thread may run for a significant amount of time while other threads are runnable. To give the illusion of concurrent activity, even on a uniprocessor, we need to make sure that each thread gets a frequent “slice” of the processor. With *cooperative multithreading*, any long-running thread must yield the processor explicitly from time to time (e.g., at the tops of loops), to allow other threads to run. As noted in [Section 12.1.1](#), this approach allows one improperly written thread to monopolize the system. Even with properly written threads, it leads to less-than-perfect fairness due to nonuniform times between yields in different threads.

Preemption

Ideally, we should like to multiplex the processor fairly and at a relatively fine grain (i.e., many times per second) *without* requiring that threads call `yield` explicitly. On many systems we can do this in the language implementation by using timer signals for *preemptive multithreading*. When switching between threads we ask the operating system (which has access to the hardware clock) to deliver a signal to the currently running process at a specified time in the future. The OS delivers the signal by saving the context (registers and pc) of the process and transferring control to a previously specified *handler* routine in the language run-time system, as described in [Section 8.7.1](#). When called, the handler modifies the state of the currently running thread to make it appear that the thread had just executed a call to the standard `yield` routine, and was about to execute its prologue. The handler then “returns” into `yield`, which transfers control to some other thread, as if the one that had been running had relinquished control of the process voluntarily.

Unfortunately, the fact that a signal may arrive at an arbitrary time introduces a race between voluntary calls to the scheduler and the automatic calls triggered by preemption. To illustrate the problem, suppose that a signal arrives when the currently running process has just enqueued the currently running thread onto the ready list in `yield`, and is about to call `reschedule`. When the signal handler “returns” into `yield`, the process will put the current thread into the ready list a second time. If at some point in the future the thread blocks for synchronization, its second entry in the ready list may cause it to run again immediately, when it should be waiting. Even worse problems can arise if a signal occurs in the middle of an `enqueue`, at a moment when the ready list is not even a properly structured queue. To resolve the race and avoid corruption of the ready list, thread packages commonly disable signal delivery during scheduler calls:

```
procedure yield
    disable_signals
    enqueue(ready_list, current_thread)
    reschedule
    reenable_signals
```

For this convention to work, *every* fragment of code that calls `reschedule` must disable signals prior to the call, and must reenable them afterward. (Recall that

EXAMPLE 12.22

A race condition in preemptive multithreading

a similar mechanism served to protect data shared between the main program and event handlers in [Section 8.7.1](#).) In this case, because `reschedule` contains a call to `transfer`, signals may be disabled in one thread and reenabled in another. ■

EXAMPLE 12.23

Disabling signals during context switch

It turns out that the `sleep_on` routine must also assume that signals are disabled and enabled by the caller. To see why, suppose that a thread checks a condition, finds that it is false, and then calls `sleep_on` to suspend itself on a queue associated with the condition. Suppose further that a timer signal occurs immediately after checking the condition, but before the call to `sleep_on`. Finally, suppose that the thread that is allowed to run after the signal makes the condition true. Since the first thread never got a chance to put itself on the condition queue, the second thread will not find it to make it runnable. When the first thread runs again, it will immediately suspend itself, and may never be awakened. To close this *timing window*—this interval in which a concurrent event may compromise program correctness—the caller must ensure that signals are disabled before checking the condition:

```

disable_signals
if not desired_condition
    sleep_on(condition_queue)
reenable_signals

```

On a uniprocessor, disabling signals allows the check and the sleep to occur as a single, *atomic* operation. ■

Multiprocessor Scheduling

We can extend our preemptive thread package to run on top of more than one OS-provided process by arranging for the processes to share the ready list and related data structures (condition queues, etc.; note that each process must have a *separate* `current_thread` variable). If the processes run on different physical processors, then more than one thread will be able to run at once. If the processes share a single processor, then the program will be able to make forward progress even when all but one of the processes are blocked in the operating system. Any thread that is runnable is placed in the ready list, where it becomes a candidate for execution by any of the application's processes. When a process calls `reschedule`, the queue-based ready list we have been using in our examples will give it the longest-waiting thread. The ready list of a more elaborate scheduler might give priority to interactive or time-critical threads, or to threads that last ran on the current processor, and may therefore still have data in the cache.

Just as preemption introduced a race between voluntary and automatic calls to scheduler operations, true or quasiparallelism introduces races between calls in separate OS processes. To resolve the races, we must implement additional synchronization to make scheduler operations in separate processes atomic. We will return to this subject in [Section 12.3.4](#).

✓ CHECK YOUR UNDERSTANDING

11. Explain the differences among a *coroutine*, a *thread*, a *lightweight process*, and a *heavyweight process*.
 12. What is *quasiparallelism*?
 13. Describe the *bag of tasks* programming model.
 14. What is *busy-waiting*? What is its principal alternative?
 15. Name four explicitly concurrent programming languages.
 16. Why don't message-passing programs require explicit synchronization mechanisms?
 17. What are the tradeoffs between language-based and library-based implementations of concurrency?
 18. Explain the difference between *data parallelism* and *task parallelism*.
 19. Describe six different mechanisms commonly used to create new threads of control in a concurrent program.
 20. In what sense is `fork/join` more powerful than *co-begin*?
 21. What is a *thread pool* in Java? What purpose does it serve?
 22. Why is meant by a *two-level* thread implementation?
 23. What is a *ready list*?
 24. Describe the progressive implementation of scheduling, preemption, and (true) parallelism on top of coroutines.
-

12.3 Implementing Synchronization

As noted in [Section 12.2.1](#), synchronization is the principal semantic challenge for shared-memory concurrent programs. Typically, synchronization serves either to make some operation *atomic* or to delay that operation until some necessary precondition holds. As noted in [Section 12.1](#), atomicity is most commonly achieved with *mutual exclusion locks*. Mutual exclusion ensures that only one thread is executing some *critical section* of code at a given point in time. Critical sections typically transform a shared data structure from one consistent state to another.

Condition synchronization allows a thread to wait for a precondition, often expressed as a predicate on the value(s) in one or more shared variables. It is tempting to think of mutual exclusion as a form of condition synchronization

(don't proceed until no other thread is in its critical section), but this sort of condition would require *consensus* among all extant threads, something that condition synchronization doesn't generally provide.

Our implementation of parallel threads, sketched at the end of [Section 12.2.4](#), requires both atomicity and condition synchronization. Atomicity of operations on the ready list and related data structures ensures that they always satisfy a set of logical invariants: the lists are well formed, each thread is either running or resides in exactly one list, and so forth. Condition synchronization appears in the requirement that a process in need of a thread to run must wait until the ready list is nonempty.

It is worth emphasizing that we do not in general want to overly synchronize programs. To do so would eliminate opportunities for parallelism, which we generally want to maximize in the interest of performance. Moreover not all races are bad. If two processes are racing to dequeue the last thread from the ready list, we don't really care which succeeds and which waits for another thread. We *do* care that the implementation of dequeue does not have *internal*, instruction-level races that might compromise the ready list's integrity. In general, our goal is to provide only as much synchronization as is necessary to eliminate "bad" races—those that might otherwise cause the program to produce incorrect results.

In the first subsection below we consider busy-wait synchronization. In the second we present an alternative, called *nonblocking synchronization*, in which atomicity is achieved without the need for mutual exclusion. In the third subsection we return to the subject of memory consistency (originally mentioned in [Section 12.1.2](#)), and discuss its implications for the semantics and implementation of language-level synchronization mechanisms. Finally, in [Sections 12.3.4](#) and [12.3.5](#), we use busy-waiting among processes to implement a parallelism-safe thread scheduler, and then use this scheduler in turn to implement the most basic scheduler-based synchronization mechanism: namely, semaphores.

12.3.1 **Busy-Wait Synchronization**

Busy-wait condition synchronization is easy if we can cast a condition in the form of "location *X* contains value *Y*": a thread that needs to wait for the condition can simply read *X* in a loop, waiting for *Y* to appear. To wait for a condition involving more than one location, one needs atomicity to read the locations together, but given that, the implementation is again a simple loop.

Other forms of busy-wait synchronization are somewhat trickier. In the remainder of this section we consider *spin locks*, which provide mutual exclusion, and *barriers*, which ensure that no thread continues past a given point in a program until all threads have reached that point.

Spin Locks

Dekker is generally credited with finding the first two-thread mutual exclusion algorithm that requires no atomic instructions other than load and store. Dijkstra [[Dij65](#)] published a version that works for *n* threads in 1965. Peterson

```

type lock = Boolean := false;

procedure acquire_lock(ref L : lock)
  while not test_and_set(L)
    while L
      -- nothing -- spin
procedure release_lock(ref L : lock)
  L := false

```

Figure 12.8 A simple `test-and-test_and_set` lock. Waiting processes spin with ordinary read (`load`) instructions until the lock appears to be free, then use `test_and_set` to acquire it. The very first access is a `test_and_set`, for speed in the common (no competition) case.

[Pet81] published a much simpler two-thread algorithm in 1981. Building on Peterson’s algorithm, one can construct a hierarchical n -thread lock, but it requires $O(n \log n)$ space and $O(\log n)$ time to get one thread into its critical section [YA93]. Lamport [Lam87] published an n -thread algorithm in 1987 that takes $O(n)$ space and $O(1)$ time in the absence of competition for the lock. Unfortunately, it requires $O(n)$ time when multiple threads attempt to enter their critical section at once.

While all of these algorithms are historically important, a practical spin lock needs to run in constant time and space, and for this one needs an atomic instruction that does more than load or store. Beginning in the 1960s, hardware designers began to equip their processors with instructions that read, modify, and write a memory location as a single atomic operation. The simplest such instruction is known as `test_and_set`. It sets a Boolean variable to `true` and returns an indication of whether the variable was previously `false`. Given `test_and_set`, acquiring a spin lock is almost trivial:

EXAMPLE 12.24

The basic `test_and_set` lock

```

while not test_and_set(L)
  -- nothing -- spin

```

In practice, embedding `test_and_set` in a loop tends to result in unacceptable amounts of communication on a multiprocessor, as the cache coherence mechanism attempts to reconcile writes by multiple processors attempting to acquire the lock. This overdemand for hardware resources is known as *contention*, and is a major obstacle to good performance on large machines.

EXAMPLE 12.25

Test-and-test_and_set

To reduce contention, the writers of synchronization libraries often employ a `test-and-test_and_set` lock, which spins with ordinary reads (satisfied by the cache) until it appears that the lock is free (see Figure 12.8). When a thread releases a lock there still tends to be a flurry of bus or interconnect activity as waiting threads perform their `test_and_sets`, but at least this activity happens only at the boundaries of critical sections. On a large machine, contention can be further reduced by implementing a *backoff* strategy, in which a thread that is unsuccessful in attempting to acquire a lock waits for a while before trying again.

Many processors provide atomic instructions more powerful than `test_and_set`. Several can swap the contents of a register and a memory location atomically.

A few can add a constant to a memory location atomically, returning the previous value. Several processors, including the x86, the IA-64, and the SPARC, provide a particularly useful instruction called `compare_and_swap` (CAS).² This instruction takes three arguments: a location, an expected value, and a new value. It checks to see whether the expected value appears in the specified location, and if so replaces it with the new value, atomically. In either case, it returns an indication of whether the change was made. Using instructions like `atomic_add` or `compare_and_swap`, one can build spin locks that are *fair*, in the sense that threads are guaranteed to acquire the lock in the order in which they first attempt to do so. One can also build locks that work well—with no contention, even at release time—on arbitrarily large machines [MCS91]. These topics are beyond the scope of the current text. (It is perhaps worth mentioning that fairness is a two-edged sword: while it may be desirable from a semantic point of view, it tends to undermine cache locality, and interacts very badly with preemption.)

An important variant on mutual exclusion is the *reader–writer lock* [CHP71]. Reader–writer locks recognize that if several threads wish to *read* the same data structure, they can do so simultaneously without mutual interference. It is only when a thread wants to *write* the data structure that we need to prevent other threads from reading or writing simultaneously. Most busy-wait mutual exclusion locks can be extended to allow concurrent access by readers (see [Exercise 12.8](#)).

Barriers

Data-parallel algorithms are often structured as a series of high-level steps, or *phases*, typically expressed as iterations of some outermost loop. Correctness often depends on making sure that every thread completes the previous step before any moves on to the next. A *barrier* serves to provide this synchronization.

As a concrete example, *finite element analysis* models a physical object—a bridge, let us say—as an enormous collection of tiny fragments. Each fragment of the bridge imparts forces to the fragments adjacent to it. Gravity exerts a downward force on all fragments. Abutments exert an upward force on the fragments that make up base plates. The wind exerts forces on surface fragments. To evaluate stress on the bridge as a whole (e.g., to assess its stability and resistance to failures), a finite element program might divide the fragments among a large collection of threads (probably one per processor). Beginning with the external forces, the program would then proceed through a sequence of iterations. In each iteration, each thread would recompute the forces on its fragments based on the forces found in the previous iteration. Between iterations, the threads would synchronize with a barrier. The program would halt when no thread found a significant change in any forces during the last iteration. ■

The simplest way to implement a busy-wait barrier is to use a globally shared counter, modified by an atomic `fetch_and_decrement` instruction. The counter begins at n , the number of threads in the program. As each thread reaches the

EXAMPLE 12.26

Barriers in finite element analysis

EXAMPLE 12.27

The “sense-reversing” barrier

² Some authors call this *compare_and_set*.

```

shared count : integer := n
shared sense : Boolean := true
per-thread private local_sense : Boolean := true

procedure central_barrier
  local_sense := not local_sense
  -- each thread toggles its own sense
  if fetch_and_decrement(count) = 1
    -- last arriving thread
    count := n          -- reinitialize for next iteration
    sense := local_sense -- allow other threads to proceed
  else
    repeat
      -- spin
    until sense = local_sense

```

Figure 12.9 A simple “sense-reversing” barrier. Each thread has its own copy of `local_sense`. Threads share a single copy of `count` and `sense`.

barrier it decrements the counter. If it is not the last to arrive, the thread then spins on a Boolean flag. The final thread (the one that changes the counter from 1 to 0) flips the Boolean flag, allowing the other threads to proceed. To make it easy to reuse the barrier data structures in successive iterations (known as barrier *episodes*), threads wait for alternating values of the flag each time through. Code for this simple barrier appears in [Figure 12.9](#). ■

Like a simple spin lock, the “sense-reversing” barrier can lead to unacceptable levels of contention on large machines. Moreover the serialization of access to the counter implies that the time to achieve an n -thread barrier is $O(n)$. It is possible to do better, but even the fastest software barriers require $O(\log n)$ time to synchronize n threads [MCS91]. Several large multiprocessors, including contemporary Cray and IBM BlueGene machines, provide special hardware for near-constant-time busy-wait barriers.

12.3.2 Nonblocking Algorithms

When a lock is acquired at the beginning of a critical section, and released at the end, no other thread can execute a similarly protected piece of code at the same time. As long as every thread follows the same conventions, code within the critical section is atomic—it appears to happen all at once. But this is not the only possible way to achieve atomicity. Suppose we wish to make an arbitrary update to a shared location:

EXAMPLE 12.28

Atomic update with CAS

```
x := foo(x);
```

Note that this update involves at least two accesses to `x`: one to read the old value and one to write the new. We could protect the sequence with a lock:

```

acquire(L)
  r1 := x
  r2 := foo(r1)      -- probably a multi-instruction sequence
  x := r2
release(L)

```

But we can also do this without a lock, using `compare_and_swap`:

```

start:
  r1 := x
  r2 := foo(r1)      -- probably a multi-instruction sequence
  r2 := CAS(x, r1, r2) -- replace x if it hasn't changed
  if !r2 goto start

```

If several processors execute this code simultaneously, one of them is guaranteed to succeed the first time around the loop. The others will fail and try again. This example illustrates that CAS is a *universal* primitive for single-location atomic update. A similar primitive, known as `load_linked/store_conditional`, is available on MIPS, Alpha, and PowerPC processors; we consider it in [Exercise 12.7](#). ■

In our discussions thus far, we have used a definition of “blocking” that comes from operating systems: a thread that blocks gives up the processor instead of actively spinning. An alternative comes from the theory of concurrent algorithms. Here the choice between spinning and giving up the processor is immaterial: a thread is said to be “blocked” if it cannot make forward progress without action by other threads. Conversely, an operation is said to be *nonblocking* if in every reachable state of the system, any thread executing that operation is guaranteed to complete in a finite number of steps if it gets to run by itself (without further interference by other threads).

In this theoretical sense of the word, locks are inherently blocking, regardless of implementation: if one thread holds a lock, no other thread that needs that lock can proceed. By contrast, the CAS-based code of [Example 12.28](#) is *nonblocking*: if the CAS operation fails, it is because some other thread has made progress. Moreover if all threads but one stop running (e.g., because of preemption), the remaining thread is guaranteed to make progress.

We can generalize from [Example 12.28](#) to design special-purpose concurrent data structures that operate without locks. Modifications to these structures generally follow the pattern

```

repeat
  prepare
  CAS      -- (or some other atomic operation)
until success
clean up

```

If it reads more than one location, the “prepare” part of the algorithm may need to double-check to make sure that none of the values has changed (i.e., that all

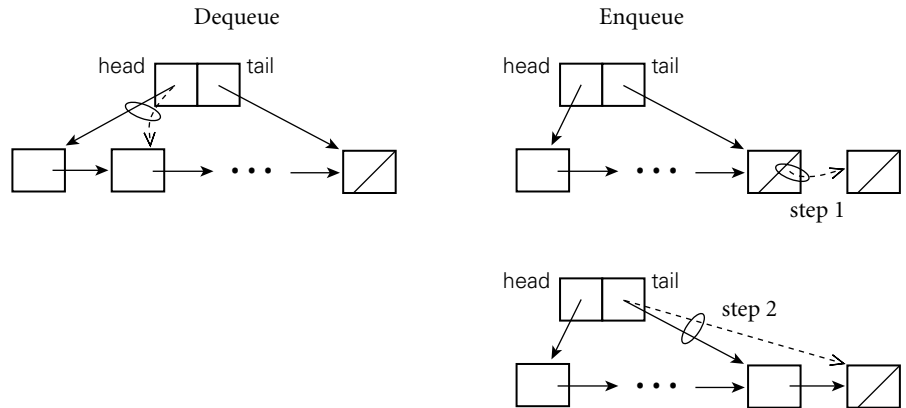

Figure 12.10 Operations on a nonblocking concurrent queue. In the dequeue operation (*left*), a single CAS swings the head pointer to the next node in the queue. In the enqueue operation (*right*), a first CAS changes the next pointer of the tail node to point at the new node, at which point the operation is said to have logically completed. A subsequent “cleanup” CAS, which can be performed by any thread, swings the tail pointer to point at the new node as well.

were read consistently) before moving on to the CAS. A read-only operation may simply return once this double-checking is successful.

In the CAS-based update of [Example 12.28](#), the “prepare” part of the algorithm reads the old value of x and figures out what the new value ought to be; the “cleanup” part is empty. In other algorithms there may be significant cleanup. In all cases, the keys to correctness are that (1) the “prepare” part is harmless if we need to repeat; (2) the CAS, if successful, logically completes the operation in a way that is visible to all other threads; and (3) the “cleanup,” if needed, can be performed by any thread if the original thread is delayed. Performing cleanup for another thread’s operation is often referred to as *helping*.

EXAMPLE 12.29
The M&S queue

[Figure 12.10](#) illustrates a widely used nonblocking concurrent queue. The dequeue operation does not require cleanup, but the enqueue operation does. To add an element to the end of the queue, a thread reads the current tail pointer to find the last node in the queue, and uses a CAS to change the next pointer of that node to point to the new node instead of being null. If the CAS succeeds (no other thread has already updated the relevant next pointer), then the new node has been inserted. As cleanup, the tail pointer must be updated to point to the new node, but any thread can do this—and will, if it discovers that $\text{tail} \rightarrow \text{next}$ is not null. ■

Nonblocking algorithms have several advantages over blocking algorithms. They are inherently tolerant of page faults and preemption: if a thread stops running partway through an operation, it never prevents other threads from making progress. They can also safely be used in signal (event) and interrupt handlers, avoiding problems like the one described in [Example 12.22](#). For several important data structures and algorithms, including stacks, queues [MS98], hash tables, and

memory management [Mic04], nonblocking algorithms can also be faster than locks. Unfortunately, these algorithms tend to be exceptionally subtle and difficult to devise. They are used primarily in the implementation of language-level concurrency mechanisms and in standard library packages.

12.3.3 Memory Consistency Models

In all our discussions so far, we have depended, implicitly, on hardware memory coherence. Unfortunately, coherence alone is not enough to make a multiprocessor behave as most programmers would expect. We must also worry, when more than one location is written at about the same time, about the *order* in which the writes become visible to different processors.

Intuitively, most programmers expect a multiprocessor to be *sequentially consistent*—to make all writes visible to all processors in the same order, and to make any given processor’s writes visible in the order they were performed. Unfortunately, this behavior turns out to be very hard to implement efficiently—hard enough that most hardware designers simply don’t provide it. Instead, they provide one of several *relaxed memory models*, in which certain loads and stores may appear to occur “out of order”. Relaxed consistency has important ramifications for language designers, compiler writers, and the implementors of synchronization mechanisms and nonblocking algorithms.

The Cost of Ordering

The fundamental problem with sequential consistency is that straightforward implementations require both hardware and compilers to serialize operations that we would rather be able to perform in arbitrary order.

EXAMPLE 12.30

Write buffers and consistency

Consider, for example, the implementation of an ordinary store instruction. In the event of a cache miss, this instruction can take hundreds of cycles to complete. Rather than wait, most processors are designed to continue executing subsequent instructions while the store completes “in the background.” Stores that are not yet visible in even the L1 cache (or that occurred after a store that is not yet visible) are kept in a queue called the *write buffer*. Loads are checked against the entries in this buffer, so a processor always sees its own previous stores, and sequential programs execute correctly.

But consider a concurrent program in which thread A sets a flag (call it *inspected*) to true and then reads location X. At roughly the same time, thread B updates X from 0 to 1 and then reads the flag. If B’s read reveals that that *inspected* has not yet been set, the programmer might naturally assume that A is going to read new value (1) for X: after all, B updates X before checking the flag, and A sets the flag before reading X, so A cannot have read X already. On most machines, however, A can read X while its write of *inspected* is still in its write buffer. Likewise, B can read *inspected* while its write of X is still in its write buffer. The result can be very unintuitive behavior:

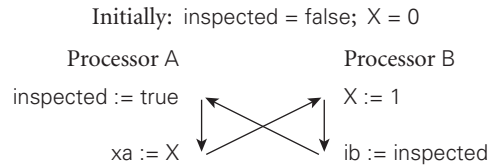

A's write of inspected precedes its read of X in program order. B's write of X precedes its read of inspected in program order. B's read of inspected appears to precede A's write of inspected, because it sees the unset value. And yet A's read of X appears to precede B's write of X as well, leaving us with $x_A = 0$ and $ib = \text{false}$.

This sort of “temporal loop” may also be caused by standard compiler optimizations. Traditionally, a compiler is free to reorder instructions (in the absence of a data dependence) to improve the expected performance of the processor pipeline. In this example, a compiler that generates code for either A or B (without considering the other) may choose to reverse the order of operations on inspected and X, producing an apparent temporal loop even in the absence of hardware reordering. ■

Forcing Order with Fences and Synchronization Instructions

To avoid temporal loops, implementors of concurrent languages and libraries must generally use special *synchronization* or *memory fence* instructions. At some expense, these force orderings not normally guaranteed by the hardware.³ Their presence also inhibits instruction reordering in the compiler.

In [Example 12.30](#), both A and B must prevent their read from *bypassing* (completing before) the logically earlier write. Typically this can be accomplished by identifying either the read or the write as a synchronization instruction (e.g., by implementing it with an XCHG instruction on the x86) or by inserting a fence between them (e.g., `membar StoreLoad` on the SPARC).

Sometimes, as in [Example 12.30](#), the use of synchronization or fence instructions is enough to restore intuitive behavior. Other cases, however, require more significant changes to the program. An example appears in [Figure 12.11](#). Processors A and B write locations X and Y, respectively. Both locations are read by processors C and D. If C is physically close to A in a distributed memory machine, and D is close to B, and if coherence messages propagate concurrently, we must consider the possibility that C and D will see the writes in opposite orders, leading to another temporal loop.

On machines where this problem arises, fences and synchronization instructions may not suffice to solve the problem. The language or library implementor (or even the application programmer) may need to bracket the writes of X and Y with (fenced) writes to some common location, to ensure that one of the original

EXAMPLE 12.31

Distributed consistency

³ Fences are also sometimes known as *memory barriers*. They are unrelated to the garbage collection barriers of [Section 7.7.3](#), the synchronization barriers of [Section 12.3.1](#), or the RTL barriers of [Section 14.2.2](#).

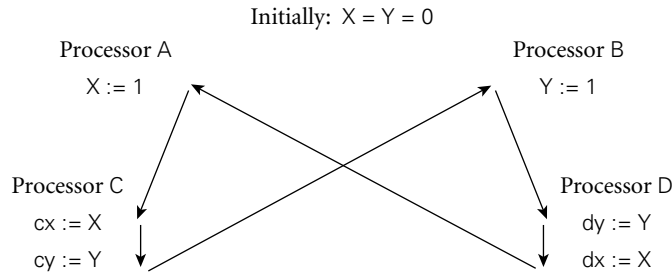

Figure 12.11 **Concurrent propagation of writes.** On some machines, it is possible for concurrent writes to reach processors in different orders. Arrows show apparent temporal ordering. Here C may read $cy = 0$ and $cx = 1$, while D reads $dx = 0$ and $dy = 1$.

writes completes before the other starts. The most straightforward way to do this is to enclose the writes in a lock-based critical section. ■

Data Race Freedom

Multiprocessor memory behavior can in general be described in terms of a transitive *happens before* relationship between instructions. Every manufacturer ensures that instructions within a given processor appear to occur in program order—that is, every instruction before the current program counter happens before every instruction after the current program counter. In a multiprocessor, manufacturers also guarantee that in certain cases an instruction on one processor happens before an instruction on another processor. Exactly which cases varies from one architecture to another. Some implementations of the MIPS and PA-RISC processors were sequentially consistent: if a load on processor B saw a value written by a store on processor A, then, transitively, everything before the write on A was guaranteed to have happened before everything after the read on B. Other processors and implementations are more relaxed. In particular, most machines admit the loop of [Example 12.30](#). The SPARC precludes the loop of [Example 12.31](#) ([Figure 12.11](#)), but the PowerPC, the Itanium, and, in theory, the x86 all allow it (as of 2008 it will not arise on any existing x86).

Given this variation across machines, what is a programmer to do? The answer, first suggested by Adve and now almost universally accepted, is to write *data-race-free* programs according to some (language-specific) *memory model*. The model specifies which language-level operations are guaranteed to be ordered across threads. A data-race-free program never performs *conflicting* operations unless they are ordered by the model; operations are said to conflict if they occur in different threads, they access the same program data, and at least one of them writes that data.

Memory models vary from one language to another. Critical sections protected by the same lock are typically ordered with respect to one another. Other atomic operations (e.g., the *transactions* we will study in [Section 12.4.4](#)) may be totally

ordered. And in several languages, including Java and C++, accesses to a variable that has been declared to be `volatile` will be individually ordered across threads.

In general, memory consistency models tend to distinguish between *data races* (races between ordinary loads and stores) and synchronization races (races between lock operations, `volatile` loads and stores, or other distinguished operations). Data races (also known as *memory races*) are generally considered program bugs; they can be eliminated by adding extra synchronization operations (or by labeling variables as `volatile`). Synchronization races, because they occur among operations that are guaranteed to occur in a consistent order from every thread's point of view, are easier to reason about. Whether they are bugs or normal behavior depends on the application.

In [Example 12.30](#), we might avoid a temporal loop by declaring both `X` and inspecting as `volatile`, or by enclosing accesses to them in atomic operations. In [Example 12.31](#), we would probably need both `C` and `D` to read `X` and `Y` together in a single atomic operation; `volatile` declarations would not suffice.

In any concurrent language, the compiler and run-time system must map the language-level memory model onto the underlying hardware in such a way that data-race-free programs can safely be ported from one machine to another, and are guaranteed, on each machine, to behave as if the hardware were sequentially consistent. But what about programs that don't follow the rules? In some languages (Ada and C++ among them), a program with races is simply erroneous. In other languages (notably Java), the behavior of racy programs is constrained in ways that help ensure system integrity. In particular, if a C++ program contains an unordered read and write of the same location `l`, the semantics of the program as a whole are entirely unspecified; it can display *any behavior whatsoever*; a similar Java program must continue to follow all the normal language rules, and the read must return the value written by some actual write of `l` that is either unordered with respect to the read, or ordered before it with no intervening write of `l`. We will return to the Java Memory Model in [Section 12.4.3](#) (page 626), after we have discussed its synchronization mechanisms.

12.3.4 Scheduler Implementation

To implement user-level threads, OS-level processes must synchronize access to the ready list and condition queues, generally by means of spinning. Code for a simple *reentrant* thread scheduler (one that can be “reentered” safely by a second process before the first one has returned) appears in [Figure 12.12](#). As in the code in [Section 12.2.4](#), we disable timer signals before entering scheduler code, to protect the ready list and condition queues from concurrent access by a process and its own signal handler. ■

Our code assumes a single “low-level” lock (`scheduler_lock`) that protects the entire scheduler. Before saving its context block on a queue (e.g., in `yield` or `sleep_on`), a thread must acquire the scheduler lock. It must then release the lock after returning from `reschedule`. Of course, because `reschedule` calls `transfer`, the

EXAMPLE 12.32

Scheduling threads on processes

EXAMPLE 12.33

A race condition in thread scheduling

```

shared scheduler_lock : low_level_lock
shared ready_list : queue of thread
per-process private current_thread : thread

procedure reschedule
  -- assume that scheduler_lock is already held
  -- and that timer signals are disabled
  t : thread
  loop
    t := dequeue(ready_list)
    if t ≠ null
      exit
    -- else wait for a thread to become runnable
    release_lock(scheduler_lock)
    -- window allows another thread to access ready_list
    -- (no point in reenabling signals;
    -- we're already trying to switch to a different thread)
    acquire_lock(scheduler_lock)
  transfer(t)
  -- caller must release scheduler_lock
  -- and reenable timer signals after we return

procedure yield
  disable_signals
  acquire_lock(scheduler_lock)
  enqueue(ready_list, current_thread)
  reschedule
  release_lock(scheduler_lock)
  reenable_signals

procedure sleep_on(ref Q : queue of thread)
  -- assume that caller has already disabled timer signals
  -- and acquired scheduler_lock, and will reverse
  -- these actions when we return
  enqueue(Q, current_thread)
  reschedule

```

Figure 12.12 Pseudocode for part of a simple reentrant (parallelism-safe) scheduler. Every process has its own copy of `current_thread`. There is a single shared `scheduler_lock` and a single `ready_list`. If processes have dedicated processors, then the `low_level_lock` can be an ordinary spin lock; otherwise it can be a “spin-then-yield” lock (Figure 12.13). The loop inside `reschedule` busy-waits until the ready list is nonempty. The code for `sleep_on` cannot disable timer signals and acquire the scheduler lock itself, because the caller needs to test a condition and then block as a single atomic operation.

lock will usually be acquired by one thread (the same one that disables timer signals) and released by another (the same one that reenables timer signals). The code for `yield` can implement synchronization itself, because its work is self-contained. The code for `sleep_on`, on the other hand, cannot, because a thread must generally check a condition and block if necessary as a single atomic operation:

```

disable_signals
acquire_lock(scheduler_lock)
if not desired_condition
    sleep_on(condition_queue)
release_lock(scheduler_lock)
reenable_signals

```

If the signal and lock operations were moved inside of `sleep_on`, the following race could arise: thread *A* checks the condition and finds it to be false; thread *B* makes the condition true, but finds the condition queue to be empty; thread *A* sleeps on the condition queue forever. ■

A spin lock will suffice for the “low-level” lock that protects the ready list and condition queues, so long as every process runs on a different processor. As we noted in [Section 12.2.1](#), however, it makes little sense to spin for a condition that can only be made true by some other process using the processor on which we are spinning. If we know that we’re running on a uniprocessor, then we don’t need a lock on the scheduler (just the disabled signals). If we *might* be running on a uniprocessor, however, or on a multiprocessor with fewer processors than processes, then we must be prepared to give up the processor if unable to obtain a lock. The easiest way to do this is with a “spin-then-yield” lock, first suggested by Ousterhout [[Ous82](#)]. A simple example of such a lock appears in [Figure 12.13](#). On a multiprogrammed machine, it might also be desirable to relinquish the processor inside `reschedule` when the ready list is empty: though no other process of the current application will be able to do anything, overall system throughput may improve if we allow the operating system to give the processor to a process from another application. ■

On a large multiprocessor we might increase concurrency by employing a separate lock for each condition queue, and another for the ready list. We would have to be careful, however, to make sure it wasn’t possible for one process to put a thread into a condition queue (or the ready list) and for another process to attempt to transfer into that thread before the first process had finished transferring out of it (see [Exercise 12.13](#)).

Scheduler-Based Synchronization

The problem with busy-wait synchronization is that it consumes processor cycles, cycles that are therefore unavailable for other computation. Busy-wait synchronization makes sense only if (1) one has nothing better to do with the current processor, or (2) the expected wait time is less than the time that would be required to switch contexts to some other thread and then switch back again.

EXAMPLE 12.34

A “spin-then-yield” lock

```

type lock = Boolean := false;

procedure acquire_lock(ref L : lock)
  while not test_and_set(L)
    count := TIMEOUT
  while L
    count -= 1
    if count = 0
      OS_yield          -- relinquish processor and drop priority
      count := TIMEOUT

procedure release_lock(ref L : lock)
  L := false

```

Figure 12.13 A simple spin-then-yield lock, designed for execution on a multiprocessor that may be multiprogrammed (i.e., on which OS-level processes may be preempted). If unable to acquire the lock in a fixed, short amount of time, a process calls the OS scheduler to yield its processor and to lower its priority enough that other processes (if any) will be allowed to run. Hopefully the lock will be available the next time the yielding is scheduled for execution.

To ensure acceptable performance on a wide variety of systems, most concurrent programming languages employ scheduler-based synchronization mechanisms, which switch to a different thread when the one that was running blocks.

In the following subsection we consider *semaphores*, the most common form of scheduler-based synchronization. In [Section 12.4](#) we consider the higher-level notions of monitors conditional critical regions, and transactional memory. In each case, scheduler-based synchronization mechanisms remove the waiting thread from the scheduler’s ready list, returning it only when the awaited condition is true (or is likely to be true). By contrast, a spin-then-yield lock is still a busy-wait mechanism: the currently running process relinquishes the processor, but remains on the ready list. It will perform a `test_and_set` operation every time every time the lock appears to be free, until it finally succeeds. It is worth noting that busy-wait synchronization is generally “level-independent”—it can be thought of as synchronizing threads, processes, or processors, as desired. Scheduler-based synchronization is “level-dependent”—it is specific to threads when implemented in the language run-time system, or to processes when implemented in the operating system.

EXAMPLE 12.35

The bounded buffer problem

We will use a *bounded buffer* abstraction to illustrate the semantics of various scheduler-based synchronization mechanisms. A bounded buffer is a concurrent queue of limited size into which *producer* threads insert data, and from which *consumer* threads remove data. The buffer serves to even out fluctuations in the relative rates of progress of the two classes of threads, increasing system throughput. A correct implementation of a bounded buffer requires both atomicity and condition synchronization: the former to ensure that no thread sees the buffer in an inconsistent state in the middle of some other thread’s operation; the latter to force consumers to wait when the buffer is empty and producers to wait when the buffer is full. ■

```

type semaphore = record
  N : integer -- usually initialized to something nonnegative
  Q : queue of threads

procedure P(ref S : semaphore)
  disable_signals
  acquire_lock(scheduler_lock)
  S.N -= 1
  if S.N < 0
    sleep_on(S.Q)
  release_lock(scheduler_lock)
  reenableView_signals

procedure V(ref S : semaphore)
  disable_signals
  acquire_lock(scheduler_lock)
  S.N += 1
  if N ≤ 0
    -- at least one thread is waiting
    enqueue(ready_list, dequeue(S.Q))
  release_lock(scheduler_lock)
  reenableView_signals

```

Figure 12.14 Semaphore operations, for use with the scheduler code of Figure 12.12.

12.3.5 Semaphores

Semaphores are the oldest of the scheduler-based synchronization mechanisms. They were described by Dijkstra in the mid-1960s [Dij68a], and appear in Algol 68. They are still heavily used today, particularly in library-based implementations of concurrency.

EXAMPLE 12.36

Semaphore
implementation

A semaphore is basically a counter with two associated operations, P and V.⁴ A thread that calls P atomically decrements the counter and then waits until it is non-negative. A thread that calls V atomically increments the counter and wakes up a waiting thread, if any. It is generally assumed that semaphores are fair, in the sense that threads complete P operations in the same order they start them. Implementations of P and V in terms of our scheduler operations appear in Figure 12.14. ■

A semaphore whose counter is initialized to 1 and for which P and V operations always occur in matched pairs is known as a *binary semaphore*. It serves as a scheduler-based mutual exclusion lock: the P operation acquires the lock; V

⁴ P and V stand for the Dutch words *passeren* (to pass) and *vrijgeven* (to release). To keep them straight, speakers of English may wish to think of P as standing for “pause,” since a thread will pause at a P operation if the semaphore count is negative. Algol 68 calls the P and V operations *down* and *up*, respectively.

```

shared buf : array [1..SIZE] of bdata
shared next_full, next_empty : integer := 1, 1
shared mutex : semaphore := 1
shared empty_slots, full_slots : semaphore := SIZE, 0

procedure insert(d : bdata)
  P(empty_slots)
  P(mutex)
  buf[next_empty] := d
  next_empty := next_empty mod SIZE + 1
  V(mutex)
  V(full_slots)

function remove : bdata
  P(full_slots)
  P(mutex)
  d : bdata := buf[next_full]
  next_full := next_full mod SIZE + 1
  V(mutex)
  V(empty_slots)
  return d

```

Figure 12.15 Semaphore-based code for a bounded buffer. The mutex binary semaphore protects the data structure proper. The full_slots and empty_slots general semaphores ensure that no operation starts until it is safe to do so.

releases it. More generally, a semaphore whose counter is initialized to k can be used to arbitrate access to k copies of some resource. The value of the counter at any particular time is always k more than the difference between the number of P operations ($\#P$) and the number of V operations ($\#V$) that have occurred so far in the program. A P operation blocks the caller until $\#P \leq \#V + k$. [Exercise 12.19](#) notes that binary semaphores can be used to implement general semaphores, so the two are of equal expressive power, if not of equal convenience.

[Figure 12.15](#) shows a semaphore-based solution to the bounded buffer problem. It uses a binary semaphore for mutual exclusion, and two general (or *counting*) semaphores for condition synchronization. [Exercise 12.17](#) considers the use of semaphores to construct an n -thread barrier. ■

EXAMPLE 12.37

Bounded buffer with semaphores

✓ CHECK YOUR UNDERSTANDING

25. What is *mutual exclusion*? What is a *critical section*?
26. What does it mean for an operation to be *atomic*? Explain the difference between atomicity and *condition synchronization*.
27. Describe the behavior of a `test_and_set` instruction. Show how to use it to build a *spin lock*.
28. Describe the behavior of the `compare_and_swap` instruction. What advantages does it offer in comparison to `test_and_set`?

29. Explain how a *reader–writer lock* differs from an “ordinary” lock.
 30. What is a *barrier*? In what types of programs are barriers common?
 31. What does it mean for an algorithm to be *nonblocking*? What advantages do nonblocking algorithms have over algorithms based on locks?
 32. What is *sequential consistency*? Why is it difficult to implement?
 33. What information is provided by a *memory consistency model*? What is the relationship between hardware-level and language-level memory models?
 34. Explain how to extend a preemptive uniprocessor scheduler to work correctly on a multiprocessor.
 35. What is a *spin-then-yield* lock?
 36. What is a *bounded buffer*?
 37. What is a *semaphore*? What operations does it support? How do *binary* and *general* semaphores differ?
-

12.4 Language-Level Mechanisms

Though widely used, semaphores are also widely considered to be too “low level” for well-structured, maintainable code. They suffer from two principal problems. First, because their operations are simply subroutine calls, it is easy to leave one out (e.g., on a control path with several nested `if` statements). Second, unless they are hidden inside an abstraction, uses of a given semaphore tend to get scattered throughout a program, making it difficult to track them down for purposes of software maintenance.

12.4.1 Monitors

Monitors were suggested by Dijkstra [Dij72] as a solution to the problems of semaphores. They were developed more thoroughly by Brinch Hansen [Bri73], and formalized by Hoare [Hoa74] in the early 1970s. They have been incorporated into at least a score of languages, of which Concurrent Pascal [Bri75], Modula (1) [Wir77b], and Mesa [LR80] have probably been the most influential.⁵

⁵ Together with Smalltalk and Interlisp, Mesa was one of three influential languages to emerge from Xerox’s Palo Alto Research Center in the 1970s. All three were developed on the Alto personal computer, which pioneered such concepts as the bitmapped display, the mouse, the graphical user interface, WYSIWYG editing, Ethernet networking, and the laser printer. The Mesa project was led by Butler Lampson (1943–), who played a key role in the later development of Euclid and Cedar as well. For his contributions to personal and distributed computing, Lampson received the ACM Turing Award in 1992.

```

monitor bounded_buf
imports bdata, SIZE
exports insert, remove

  buf : array [1..SIZE] of bdata
  next_full, next_empty : integer := 1, 1
  full_slots : integer := 0
  full_slot, empty_slot : condition

entry insert(d : bdata)
  if full_slots = SIZE
    wait(empty_slot)
  buf[next_empty] := d
  next_empty := next_empty mod SIZE + 1
  full_slots += 1
  signal(full_slot)

entry remove : bdata
  if full_slots = 0
    wait(full_slot)
  d : bdata := buf[next_full]
  next_full := next_full mod SIZE + 1
  full_slots -= 1
  signal(empty_slot)
  return d

```

Figure 12.16 Monitor-based code for a bounded buffer. Insert and remove are *entry* subroutines: they require exclusive access to the monitor's data. Because conditions are memory-less, both insert and remove can safely end their operation with a signal.

A monitor is a module or object with operations, internal state, and a number of *condition variables*. Only one operation of a given monitor is allowed to be active at a given point in time. A thread that calls a busy monitor is automatically delayed until the monitor is free. On behalf of its calling thread, any operation may suspend itself by *waiting* on a condition variable. An operation may also *signal* a condition variable, in which case one of the waiting threads is resumed, usually the one that waited first.

Because the operations (*entries*) of a monitor automatically exclude one another in time, the programmer is relieved of the responsibility of using P and V operations correctly. Moreover because the monitor is an abstraction, all operations on the encapsulated data, including synchronization, are collected together in one place. Figure 12.16 shows a monitor-based solution to the bounded buffer problem. It is worth emphasizing that monitor condition variables are not the same as semaphores. Specifically, they have no “memory”: if no thread is waiting on a condition at the time that a signal occurs, then the signal has no effect. By contrast a V operation on a semaphore increments the semaphore's counter, allowing some future P operation to succeed, even if none is waiting now. ■

EXAMPLE 12.38

Bounded buffer monitor

Semantic Details

Hoare's definition of monitors employs one thread queue for every condition variable, plus two bookkeeping queues: the *entry queue* and the *urgent queue*. A thread that attempts to enter a busy monitor waits in the entry queue. When a thread executes a signal operation from within a monitor, and some other thread is waiting on the specified condition, then the signaling thread waits on the monitor's urgent queue and the first thread on the appropriate condition queue obtains control of the monitor. If no thread is waiting on the signaled condition, then the signal operation is a no-op. When a thread leaves a monitor, either by completing its operation or by waiting on a condition, it unblocks the first thread on the urgent queue or, if the urgent queue is empty, the first thread on the entry queue, if any.

Many monitor implementations dispense with the urgent queue, or make other changes to Hoare's original definition. From the programmer's point of view, the two principal areas of variation are the semantics of the signal operation and the management of mutual exclusion when a thread waits inside a nested sequence of two or more monitor calls. We will return to these issues below.

Correctness for monitors depends on the notion of a *monitor invariant*. The invariant is a predicate that captures the notion that "the state of the monitor is consistent." The invariant needs to be true initially, and at monitor exit. It also needs to be true at every wait statement and, in a Hoare monitor, at signal operations as well. For our bounded buffer example, a suitable invariant would assert that `full_slots` correctly indicates the number of items in the buffer, and that those items lie in slots numbered `next_full` through `next_empty - 1 (mod SIZE)`. Careful inspection of the code in [Figure 12.16](#) reveals that the invariant does indeed hold initially, and that anytime we modify one of the variables mentioned in the invariant, we always modify the others accordingly before waiting, signaling, or returning from an entry.

Hoare defined his monitors in terms of semaphores. Conversely, it is easy to define semaphores in terms of monitors ([Exercise 12.18](#)). Together, the two definitions prove that semaphores and monitors are equally powerful: each can express all forms of synchronization expressible with the other.

Signals as Hints and Absolutes

In general, one signals a condition variable when some condition on which a thread may be waiting has become true. If we want to guarantee that the condition is still true when the thread wakes up, then we need to switch to the thread as soon as the signal occurs—hence the need for the urgent queue, and the need to ensure the monitor invariant at signal operations. In practice, switching contexts on a signal tends to induce unnecessary scheduling overhead: a signaling thread seldom changes the condition associated with the signal during the remainder of its operation. To reduce the overhead, and to eliminate the need to ensure the monitor invariant, Mesa specifies that signals are only *hints*: the language run-time system moves some waiting thread to the ready list, but the signaler retains

EXAMPLE 12.39

How to wait for a signal
(hint or absolute)

control of the monitor, and the waiter must recheck the condition when it awakes. In effect, the standard idiom

```
if not desired_condition
    wait(condition_variable)
```

in a Hoare monitor becomes the following in Mesa.

```
while not desired_condition
    wait(condition_variable)
```

DESIGN & IMPLEMENTATION

Monitor signal semantics

By specifying that signals are hints, instead of absolutes, Mesa and Modula-3 (and similarly Java and C#, which we consider in [Section 12.4.3](#)) avoid the need to perform an immediate context switch from a signaler to a waiting thread. They also admit simpler, though less efficient implementations that lack a one-to-one correspondence between signals and thread queues, or that do not necessarily guarantee that a waiting thread will be the first to run in its monitor after the signal occurs. This approach can lead to complications, however, if we want to ensure that an appropriate thread always runs in the wake of a signal. Suppose an awakened thread rechecks its condition and discovers that it still can't run. If there may be some other thread that could run, the erroneously awakened thread may need to resignal the condition before it waits again:

```
if not desired_condition
    loop
        wait(condition_variable)
        if desired_condition
            break
        signal(condition_variable)
```

In effect the signal “cascades” from thread to thread until some thread is able to run. (If it is possible that *no* waiting thread will be able to run, then we will need additional logic to stop the cascading when every thread has been checked.) Alternatively, the thread that makes a condition (potentially) true can use a special broadcast version of the signal operation to awaken *all* waiting threads at once. Each thread will then recheck the condition and if appropriate wait again, without the need for explicit cascading. In either case (cascading signals or broadcast), signals as hints trade potentially high overhead in the worst case for potentially low overhead in the common case and a potentially simpler implementation.

Modula-3 takes a similar approach. An alternative appears in Concurrent Pascal, which specifies that a `signal` operation causes an immediate return from the monitor operation in which it appears. This rule keeps overhead low, and also preserves invariants, but precludes algorithms in which a thread does useful work in a monitor after signaling a condition. ■

Nested Monitor Calls

In most monitor languages, a `wait` in a nested sequence of monitor operations will release mutual exclusion on the innermost monitor, but will leave the outer monitors locked. This situation can lead to *deadlock* if the only way for another thread to reach a corresponding `signal` operation is through the same outer monitor(s). In general, we use the term “deadlock” to describe any situation in which a collection of threads are all waiting for each other, and none of them can proceed. In this specific case, the thread that entered the outer monitor first is waiting for the second thread to execute a `signal` operation; the second thread, however, is waiting for the first to leave the monitor.

The alternative—to release exclusion on outer monitors when waiting in an inner one—was adopted by several early monitor implementations for uniprocessors, including the original implementation of Modula [Wir77a]. It has a significant semantic drawback, however: it requires that the monitor invariant hold not only at monitor exit and (perhaps) at `signal` operations, but also at any subroutine call that may result in a `wait` or (with Hoare semantics) a `signal` in a nested monitor. Such calls may not all be known to the programmer; they are certainly not syntactically distinguished in the source.

DESIGN & IMPLEMENTATION

The nested monitor problem

While maintaining exclusion on outer monitor(s) when waiting in an inner one may lead to deadlock with a signaling thread, releasing those outer monitors may lead to similar (if a bit more subtle) deadlocks. When a waiting thread awakens it must reacquire exclusion on both inner and outer monitors. The innermost monitor is of course available, because the matching `signal` happened there, but there is in general no way to ensure that unrelated threads will not be busy in the outer monitor(s). Moreover one of those threads may need access to the inner monitor in order to complete its work and release the outer monitor(s). If we insist that the awakened thread be the first to run in the inner monitor after the `signal`, then deadlock will result. One way to avoid this problem is to arrange for mutual exclusion across *all* the monitors of a program. This solution severely limits concurrency in multiprocessor implementations, but may be acceptable on a uniprocessor. A more general solution is addressed in [Exercise 12.20](#).

12.4.2 Conditional Critical Regions

EXAMPLE 12.40

Original CCR syntax

Conditional critical regions (CCRs) are another alternative to semaphores, proposed by Brinch Hansen at about the same time as monitors [Bri73]. A critical region is a syntactically delimited critical section in which code is permitted to access a *protected* variable. A *conditional* critical region also specifies a Boolean condition, which must be true before control will enter the region:

```
region protected_variable, when Boolean_condition do
    ...
end region
```

No thread can access a protected variable except within a region statement for that variable, and any thread that reaches a region statement waits until the condition is true and no other thread is currently in a region for the same variable. Regions can nest, though as with nested monitor calls, the programmer needs to worry about deadlock. Figure 12.17 uses CCRs to implement a bounded buffer. ■

Conditional critical regions appear in the concurrent language Edison [Bri81], and also seem to have influenced the synchronization mechanisms of Ada 95 and Java/C#. These later languages might be said to blend the features of monitors and CCRs, albeit in different ways.

Synchronization in Ada 95

The principal mechanism for synchronization in Ada, introduced in Ada 83, is based on message passing; we will describe it in Section 12.5. Ada 95 augments this mechanism with a notion of *protected object*. A protected object can have three

DESIGN & IMPLEMENTATION

Conditional critical regions

Conditional critical regions avoid the question of `signal` semantics, because they use explicit Boolean conditions instead of condition variables, and because conditions can be awaited only at the beginning of critical regions. At the same time, they introduce potentially significant inefficiency. In the general case, the code used to exit a conditional critical region must tentatively resume each waiting thread, allowing that thread to recheck its condition in its own referencing environment. Optimizations are possible in certain special cases (e.g., for conditions that depend only on global variables, or that consist of only a single Boolean variable), but in the worst case it may be necessary to perform context switches in and out of every waiting thread on every exit from a region.

```

buffer : record
  buf : array [1..SIZE] of bdata
  next_full, next_empty : integer := 1, 1
  full_slots : integer := 0

procedure insert(d : bdata)
  region buffer when full_slots < SIZE
    buf[next_empty] := d
    next_empty := next_empty mod SIZE + 1
    full_slots += 1

function remove : bdata
  region buffer when full_slots > 0
    d : bdata := buf[next_full]
    next_full := next_full mod SIZE + 1
    full_slots -= 1
  return d

```

Figure 12.17 Conditional critical regions for a bounded buffer. Boolean conditions on the region statements eliminate the need for explicit condition variables.

types of methods: functions, procedures, and *entries*. Functions can only read the fields of the object; procedures and entries can read and write them. An implicit reader–writer lock on the protected object ensures that potentially conflicting operations exclude one another in time: a procedure or entry obtains exclusive access to the object; a function can operate concurrently with other functions, but not with a procedure or entry.

Procedures and entries differ from one another in two important ways. First, an entry can have a Boolean expression *guard*, for which the calling task (thread) will wait before beginning execution (much as it would for the condition of a CCR). Second, an entry supports three special forms of call: *timed* calls, which abort after waiting for a specified amount of time, *conditional* calls, which execute alternative code if the call cannot proceed immediately, and *asynchronous* calls, which begin executing alternative code immediately, but abort it if the call is able to proceed before the alternative completes.

In comparison to the conditions of CCRs, the guards on entries of protected objects in Ada 95 admit a more efficient implementation, because they do not have to be evaluated in the context of the calling thread. Moreover, because all guards are gathered together in the definition of the protected object, the compiler can generate code to test them as a group as efficiently as possible, in a manner suggested by Kessels [Kes77]. Though an Ada task cannot wait on a condition in the middle of an entry (only at the beginning), it can *requeue* itself on another entry, achieving much the same effect. Ada 95 code for a bounded buffer would closely resemble the pseudocode of Figure 12.17; we leave the details to Exercise 12.22.

12.4.3 Synchronization in Java

EXAMPLE 12.41

Synchronized statement
in Java

In Java, every object accessible to more than one thread has an implicit mutual exclusion lock, acquired and released by means of `synchronized` statements:

```
synchronized (my_shared_obj) {
    ...    // critical section
}
```

All executions of `synchronized` statements that refer to the same shared object exclude one another in time. `Synchronized` statements that refer to different objects may proceed concurrently. As a form of syntactic sugar, a method of a class may be prefixed with the `synchronized` keyword, in which case the body of the method is considered to have been surrounded by an implicit `synchronized (this)` statement. Invocations of nonsynchronized methods of a shared object—and direct accesses to public fields—can proceed concurrently with each other, or with a `synchronized` statement or method. ■

Within a `synchronized` statement or method, a thread can suspend itself by calling the predefined method `wait`. `Wait` has no arguments in Java: the core language does not distinguish among the different reasons why threads may be suspended on a given object (the `java.util.concurrent` library, which became standard with Java 5, does provide a mechanism for multiple conditions; more on this below). Like Mesa, Java allows a thread to be awoken for spurious reasons; programs must therefore embed the use of `wait` within a condition-testing loop:

EXAMPLE 12.42

Notify as hint in Java

```
while (!condition) {
    wait();
}
```

A thread that calls the `wait` method of an object releases the object’s lock. With nested `synchronized` statements, however, or with nested calls to `synchronized` methods, the thread does *not* release locks on any other objects. ■

To resume a thread that is suspended on a given object, some other thread must execute the predefined method `notify` from within a `synchronized` statement or method that refers to the same object. Like `wait`, `notify` has no arguments. In response to a `notify` call, the language run-time system picks an arbitrary thread suspended on the object and makes it runnable. If there are no such threads, then the `notify` is a no-op. As in Mesa, it may sometimes be appropriate to awaken *all* threads waiting in a given object. Java provides a built-in `notifyAll` method for this purpose.

If threads are waiting for more than one condition (i.e., if their `waits` are embedded in dissimilar loops), there is no guarantee that the “right” thread will awaken. To ensure that an appropriate thread does wake up, the programmer may choose to use `notifyAll` instead of `notify`. To ensure that only *one* thread continues after wakeup, the first thread to discover that its condition has been satisfied must modify the state of the object in such a way that other awakened

threads, when they get to run, will simply go back to sleep. Unfortunately, since all waiting threads will end up reevaluating their conditions every time one of them can run, this “solution” to the multiple-condition problem can be prohibitively expensive.

The mechanisms for synchronization in C# are similar to the Java mechanisms just described. The C# `lock` statement is similar to Java’s `synchronized`. It cannot be used to label a method, but a similar effect can be achieved (a bit more clumsily) by specifying a *Synchronized attribute* for the method. The methods `Pulse` and `PulseAll` are used instead of `notify` and `notifyAll`.

Lock Variables

In C# and in versions of Java prior to Java 5, programmers concerned with efficiency must generally look for algorithms in which threads are never waiting for more than one condition within a given object at a given time. The `java.util.concurrent` package, included with Java 5, provides a more general solution. As an alternative to `synchronized` statements and methods, the programmer may now create explicit Lock variables. Code that might once have been written

EXAMPLE 12.43

Lock variables in Java 5

```
synchronized (my_shared_obj) {  
    ...    // critical section  
}
```

DESIGN & IMPLEMENTATION

Condition variables in Java

As illustrated by Mesa and Java, the distinction between monitors and CCRs is somewhat blurry. It turns out to be possible (see [Exercise 12.21](#)) to solve completely general synchronization problems in such a way that for every protected object there is only one Boolean condition on which threads ever spin. The solutions, however, may not be pretty: they amount to low-level use of semaphores, without the implicit mutual exclusion of *synchronized* statements and methods. For programs that are naturally expressed with multiple conditions, Java’s basic synchronization mechanism (and the similar mechanism in C#) may force the programmer to choose between elegance and efficiency. The concurrency enhancements of Java 5 are a deliberate attempt to lessen this dilemma: Lock variables retain the distinction between mutual exclusion and condition synchronization characteristic of both monitors and CCRs, while allowing the programmer to partition waiting threads into equivalence classes that can be awoken independently. By varying the fineness of the partition the programmer can choose essentially any point on the spectrum between the simplicity of CCRs and the efficiency of Hoare-style monitors. [Exercises 12.23](#) [though 12.25](#) explore this issue further using bounded buffers as a running example.

may now be written

```
Lock l = new ReentrantLock();
l.lock();
try {
    ... // critical section
} finally {
    l.unlock();
}
```

A similar interface supports reader–writer locks. ■

Like semaphores, Java Lock variables lack the implicit release at the end of scope associated with `synchronized` statements and methods. The need for an explicit release introduces a potential source of bugs, but allows programmers to create algorithms in which locks are acquired and released in non-LIFO order (see [Example 12.14](#)). In a manner reminiscent of the `timed` entry calls of Ada 95, Java Lock variables also support a `tryLock` method, which acquires the lock only if it is available immediately, or within an optionally specified timeout interval (a Boolean return value indicates whether the attempt was successful). Finally, a Lock variable may have an arbitrary number of associated Condition variables, making it easy to write algorithms in which threads wait for multiple conditions, without resorting to `notifyAll`:

EXAMPLE 12.44

Multiple Conditions in
Java 5

```
Condition c1 = l.newCondition();
Condition c2 = l.newCondition();
...
c1.await();
...
c2.signal();
```

Java objects that use only `synchronized` methods (no locks or `synchronized` statements) closely resemble Mesa monitors in which there is a limit of one condition variable per monitor (and in fact objects with `synchronized` statements are sometimes referred to as monitors in Java). By the same token, a `synchronized` statement in Java that begins with a `wait` in a loop resembles a CCR in which the retesting of conditions has been made explicit. Because `notify` also is explicit, a Java implementation need not reevaluate conditions on every exit from a critical section—only those in which a `notify` occurs.

The Java Memory Model

The Java Memory Model, to which we alluded in [Section 12.3.3](#), specifies exactly which operations are guaranteed to be ordered across threads. It also specifies, for every pair of reads and writes in a program execution, whether the read is permitted to return the value written by the write.

Informally, a Java thread is allowed to buffer or reorder its writes (in hardware or in software) until the point at which it writes a `volatile` variable or leaves a

monitor (releases a lock, leaves a `synchronized` block, or waits). At that point all its previous writes must be visible to other threads. Similarly, a thread is allowed to keep cached copies of values written by other threads until it reads a `volatile` variable or enters a monitor (acquires a lock, enters a `synchronized` block, or wakes up from a wait). At that point any subsequent reads must obtain new copies of anything that has been written by other threads.

The compiler is free to reorder ordinary reads and writes in the absence of intrathread data dependences. It can also move ordinary reads and writes down past a subsequent `volatile` read, up past a previous `volatile` write, or into a `synchronized` block from above or below. It cannot reorder `volatile` accesses, monitor entry, or monitor exit with respect to one another.

If the compiler can prove that a `volatile` variable or monitor isn't used by more than one thread during a given interval of time, it can reorder its operations like ordinary accesses. For data-race-free programs, these rules ensure the appearance of sequential consistency. Even in the presence of races, reads and writes of object references and of 32-bit and smaller quantities must be atomic, and a read is allowed to return values only from unordered writes and from immediately preceding ordered writes.

The upcoming revised standard for C++ (nearing completion as of summer 2008) will include a formal memory model inspired by, but different from, the Java model. In particular, the C++ model will not guarantee type safety, nor will it constrain the behavior of programs with data races.

12.4.4 Transactional Memory

All the general-purpose mechanisms we have considered for atomicity—semaphores, monitors, conditional critical regions—are essentially syntactic variants on locks. Critical sections that need to exclude one another must acquire and release the same lock. Critical sections that are mutually independent can run in parallel only if they acquire and release separate locks. This creates an unfortunate tradeoff for programmers: it is easy to write a data-race-free program with a single lock, but such a program will not *scale*: as processors and threads are added, the lock will become a bottleneck, and program performance will stagnate. To increase scalability, skillful programmers partition their program data into equivalence classes, each protected by a separate lock. A critical section must then acquire the locks for every accessed equivalence class. If different critical sections acquire locks in different orders, deadlock can result. Enforcing a common order can be difficult, however, because we may not be able to predict, when an operation starts, which data it will eventually need to access. Worse, the fact that correctness depends on locking order means that lock-based program fragments do not *compose*: we cannot take existing lock-based abstractions and safely call them from within a new critical section.

These issues suggest that locks may be too *low level* a mechanism. From a semantic point of view, the mapping between locks and critical sections is an

implementation detail; all we really want is a composable atomic construct. Transactional memory (TM) is an attempt to provide exactly that.

Atomicity without Locks

Transactions have long been used, with great success, to achieve atomicity for database operations. The usual implementation is *speculative*: transactions in different threads proceed concurrently until they *conflict* for access to some common record in the database. The underlying system then arbitrates between the conflicting threads. One gets to continue, and hopefully *commit* its updates to the database; the others *abort* and start over (after “rolling back” the work they had done so far). The overall effect is that transactions achieve significant parallelism at the implementation level, but appear to *serialize* in some global total order at the level of program semantics.

The idea of using more lightweight transactions to achieve atomicity for operations on in-memory data structures dates from 1993, when Herlihy and Moss proposed what was essentially a multiword generalization of the `load_linked/store_conditional`, instructions mentioned in [Example 12.28](#). Their *transactional memory* (TM) began to receive renewed attention (and higher-level semantics) about a decade later, when it became clear to many researchers that multicore processors were going to be successful only with the development of simpler programming techniques.

The basic idea of TM is very simple: the programmer labels code blocks as atomic—

```
atomic {
    -- your code here
}
```

—and the underlying system takes responsibility for executing these blocks in parallel whenever possible. If the code inside the atomic block can safely be rolled back in the event of conflict, then the implementation can be based on speculation. ■

In many speculation-based systems, a transaction that needs to wait for some precondition can “deliberately” abort itself with an explicit retry primitive. The system will refrain from restarting the transaction until some previously read location has been changed by another thread. Transactional code for a bounded buffer would be very similar to that of [Figure 12.17](#). We would simply replace

```
region buffer when full_slots < SIZE      and      region buffer when full_slots > 0
    ...                                     ...

with

atomic                                     atomic
    if full_slots = SIZE then retry        and      if full_slots = 0 then retry
    ...                                     ...
```

EXAMPLE 12.45

A simple atomic block

EXAMPLE 12.46

Bounded buffer with transactions

TM avoids the need to specify object(s) on which to implement mutual exclusion. It also allows the condition test to be placed anywhere inside the atomic block. ■

Many different implementations of TM have been proposed, both in hardware and in software. Hardware support is expected to be commercially available in at least one processor—Sun’s “Rock” implementation of the SPARC—sometime in 2009. Language and compiler support is expected to follow shortly; experimental prototypes have been developed by a dozen different academic and industrial groups, in C, C++, Java, C#, and Haskell. It will be several years before we know how much TM can simplify concurrency in practice, but current signs are promising.

An Example Implementation

There is a surprising amount of variety among software TM systems. We outline one possible implementation here, based, in large part, on the TL2 system of Dice et al. [DSS06] and the TinySTM system of Riegel et al. [FRF08].

Every active transaction keeps track of the locations it has read and the locations and values it has written. It also maintains a `valid_time` value that indicates the most recent *logical time* at which all of the values it has read so far were known to be correct. Times are obtained from a global clock variable that increases by one each time a transaction attempts to commit. Finally, threads share a global table of *ownership records* (orecs), indexed by hashing the address of a shared location. Each orec contains either (1) the most recent logical time at which any of the locations covered by (hashing to) that orec was updated, or (2) the ID t of a transaction that is currently trying to commit a change to one of those locations. In case (1), the orec is said to be *unowned*; in case (2) the orec—and, by extension, all locations that hash to it—is said to be *owned* by t .

The compiler translates each atomic block into code roughly equivalent to the following.

EXAMPLE 12.47

Translation of an atomic block

```

loop
  valid_time := clock
  read_set := write_map := ∅
  try
    -- your code here
    commit
    break
  except when abort
    -- continue loop

```

In the body of the transaction (your code here), reads and writes of a location with address x are replaced with calls to `read(x)` and `write(x, v)`, using the code shown in Figure 12.18. Also shown is the commit routine, called at the end of the try block above. ■

Briefly, a transaction buffers its (speculative) writes until it is ready to commit. It then locks all the locations it needs to write, verifies that all the locations it

```

struct orec
  owned : Boolean
  val : union (time, transaction_id)

function read(x : address) : value
  if x ∈ write_map.domain then return write_map[x]
  loop
    repeat
      o : orec := orecs[hash(x)]
    until not o.owned
    t : time := o.val  -- when last modified
    if t > valid_time
      -- may be inconsistent with previous reads
      validate  -- attempt to extend valid_time
    v : value := *x
    if o = orecs[hash(x)]
      read_set += {x}
    return v

procedure validate
  t : time := clock
  for x : address ∈ read_set
    o : orec := orecs[hash(x)]
    if (not o.owned and o.val > valid_time)
      or (o.owned and o.val ≠ me)
      throw abort
  valid_time := t

procedure write(x : address, v : value)
  write_map[x] := v

procedure commit
  try
    lock_map : map address → orec := ∅
    done : Boolean := false
    for x : address ∈ write_map.domain
      o : orec := orecs[hash(x)]
      if o ≠ ⟨true, me⟩
        if o.owned then throw abort
        if not CAS(&orecs[hash(x)], o, ⟨true, me⟩)
          throw abort
      lock_map[x] := o
    n : time := 1 + fetch_and_increment(&clock)
    validate
    done := true
    for ⟨x, v⟩ : ⟨address, value⟩ ∈ write_map
      *x = v  -- write back
  finally
    -- do this however control leaves the try block
    for ⟨x, o⟩ : ⟨address, orec⟩ ∈ lock_map
      orecs[hash(x)] := if done
        then ⟨false, n⟩  -- update
        else o  -- restore

```

Figure 12.18 Possible pseudocode for a software TM system. The read and write routines are used to replace ordinary loads and stores within the body of the transaction. The validate routine is called from both read and commit. It attempts to verify that no previously read value has since been overwritten and, if successful, updates `valid_time`. Various fence instructions (not shown) may be needed if the underlying hardware is not sequentially consistent.

previously read have not been overwritten since, and then writes back and unlocks the locations. At all times, the transaction knows that all of its reads were mutually consistent at time `valid_time`. If it ever tries to read a new location that has been updated since `valid_time`, it attempts to *extend* this time to the current value of the global clock. If it is able to perform a similar extension at commit time, after having locked all locations it needs to change, then the aggregate effect of the transaction as a whole will be as if it had occurred instantaneously at commit time.

To implement retry (not shown in Figure 12.18), we can add an optional list of threads to every orec. A retrying thread will add itself to the list of every location in its `read_set` and then perform a P operation on a thread-specific semaphore. Meanwhile, any thread that commits a change to an orec with waiting threads performs a V on the semaphore of each of those threads. This mechanism will sometimes result in unnecessary wakeups, but these do not impact correctness.

Upon wakeup, a thread removes itself from all thread lists before restarting its transaction.

Challenges

Many subtleties have been glossed over in our example implementation. The translation in [Example 12.47](#) will not behave correctly if code inside the atomic block throws an exception (other than abort) or executes a return or an exit out of some surrounding loop. The pseudocode of [Figure 12.18](#) also fails to consider that transactions may be nested.

Several additional issues are still the subject of debate among TM designers. What should we do about operations inside transactions (I/O, system calls, etc.) that cannot easily be rolled back, and how do we prevent such transactions from ever calling retry? How do we discourage programmers from creating transactions so large they almost always conflict with one another, and cannot run in parallel? Should a program ever be able to detect that transactions are aborting? How should transactions interact with locks and with nonblocking data structures? Should races between transactions and nontransactional code be considered program bugs? If so, should there be any constraints on the behavior that may result? These and similar questions will need to be answered before TM can enter the mainstream.

12.4.5 Implicit Synchronization

In several shared-memory languages, the operations that threads can perform on shared data are restricted in such a way that synchronization can be implicit in the operations themselves, rather than appearing as separate, explicit operations. We have seen one example of implicit synchronization already: the `forall` loop of HPF and Fortran 95 ([Example 12.10](#)). Separate iterations of a `forall` loop proceed concurrently, semantically in lock-step with each other: each iteration reads all data used in its instance of the first assignment statement before any iteration updates its instance of the left-hand side. The left-hand side updates in turn occur before any iteration reads the data used in its instance of the second assignment statement, and so on. Compilation of `forall` loops for vector machines, while far from trivial, is more or less straightforward. On a more conventional multiprocessor, however, good performance usually depends on high-quality *dependence analysis*, which allows the compiler to identify situations in which statements within a loop do not in fact depend on one another, and can proceed without synchronization.

Dependence analysis plays a crucial role in other languages as well. In the sidebar on page 516 we mentioned the purely functional languages Sisal, pH, and Single Assignment C (recall that iterative constructs in these languages are syntactic sugar for tail recursion). Because all of these languages are side-effect free, their constructs can be evaluated in any order, or concurrently, as long as no construct attempts to use a value that has yet to be computed. The Sisal

implementation developed at Lawrence Livermore National Lab used extensive compiler analysis to identify promising constructs for parallel execution. It also employed tags on data objects that indicate whether the object's value had been computed yet. When the compiler was unable to guarantee that a value would have been computed by the time it was needed at run time, the generated code used tag bits for synchronization, spinning or blocking until they were properly set. Sisal's developers claimed (in 1992) that their language and compiler rivaled parallel Fortran in performance [Can92].

Automatic parallelization, first for vector machines and then for general-purpose machines, was a major topic of research in the 1980s and 1990s. It achieved considerable success with well-structured data-parallel programs, largely for scientific applications, and largely but not entirely in Fortran. Automatic identification of thread-level parallelism in more general, irregularly structured programs proved elusive, however, as did compilation for message-passing hardware. Research in this area continues, and has branched out to languages like Matlab and R.

Futures

EXAMPLE 12.48

Future construct in
Multilisp

Implicit synchronization can also be achieved without compiler analysis. The Multilisp [Hal85, MKH91] dialect of Scheme allowed the programmer to enclose any function evaluation in a special future construct:

```
(future (my-function my-args))
```

In a purely functional program, `future` is semantically neutral: assuming all evaluations terminate, program behavior will be exactly the same as if `(my-function my-args)` had appeared without the surrounding call. In the implementation, however, `future` arranges for the embedded function to be evaluated by a separate thread of control. The parent thread continues to execute until it actually tries to use the return value of `my-function`, at which point it waits for execution of the `future` to complete. If two or more arguments to a function are enclosed in `futures`, then evaluation of the arguments can proceed in parallel:

```
(parent (future (child1 args1)) (future (child2 args2)))
```

There were no additional synchronization mechanisms in Multilisp: `future` itself was the language's only addition to Scheme. Several subsequent languages and systems have provided `future` as part of a larger feature set. In C# 3.0 with Parallel FX we might write

EXAMPLE 12.49

Futures in C#

```
var description = Future.Create(() => GetDescription());
var numberInStock = Future.Create(() => GetInventory());
...
Console.WriteLine("We have " + numberInStock.Value
    + " copies of " + description.Value + " in stock.");
```

Static class `Future` is a factory; its `Create` method supports generic type inference, allowing us to pass a delegate compatible with `Func<T>` (function returning `T`), for any `T`. We've specified the delegates here as lambda expressions. If `GetDescription` returns a `String`, `description` will be of type `Future<String>`; if `GetInventory` returns an `int`, `numberInStock` will be of type `Future<int>`.

The Java 5 standard library provides similar facilities, but the lack of delegates, properties (like `Value`), type inference (`var`) and boxing (of the `int` returned by `GetInventory`) make the syntax quite a bit more cumbersome. Java also requires that the programmer pass newly created `Futures` to an explicitly created `Executor` object that will be responsible for running them. ■

Multilisp, Sisal, and the various concurrent Haskell dialects employ the same basic idea: concurrent evaluation of functions in a language that is (at least mostly) side-effect free. The Sisal and pH compilers attempt to find code fragments that can profitably be executed in parallel; in Multilisp and in other concurrent versions of Haskell, the programmer must identify them explicitly. In some ways the future construct of Multilisp resembles the built-in `delay` and `force` of Scheme (Section 6.6.2). Where future supports concurrency, however, `delay` supports lazy evaluation: it defers evaluation of its embedded function until the return value is known to be needed. Any use of a delayed expression in Scheme must be surrounded by `force`. By contrast, synchronization on a future is implicit and eager—there is no analog of `force`.

Some of the ideas embodied in concurrent functional languages can be adapted to imperative languages as well. CC++ [Fos95], for example, is a concurrent

DESIGN & IMPLEMENTATION

Side-effect freedom and implicit synchronization

In a partially imperative Multilisp (or C# or Java) program, the programmer must take care to make sure that concurrent execution of futures will not compromise program correctness. The expression `(parent (future (child1 args1)) (future (child2 args2)))` may produce unpredictable behavior if the evaluations of `child1` and `child2` depend on one another, or if the evaluation of `parent` depends on any aspect of `child1` and `child2` other than their return values. Such behavior may be very difficult to debug. Sisal and Haskell avoid the problem by permitting only side-effect-free programs.

In a key sense, Sisal and Haskell are ideally suited to parallel execution: they eliminate all artificial connections—all anti- and output dependences (Section ©16.6)—among expressions: all that remains is the actual *data flow*. Two principal barriers to performance remain: (1) the standard challenges of efficient code generation for functional programs (Section 10.7), and (2) the need to identify which potentially parallel code fragments are large enough and independent enough to merit the overhead of thread creation and implicit synchronization.

extension to C++ in which synchronization is implicit in the use of *single-assignment* variables. To declare a single-assignment variable, the CC++ programmer prepends the keyword `synch` to an ordinary variable declaration. The value of a `synch` variable is initially undefined. A thread that attempts to read the variable will wait until it is assigned a value by some other thread. It is a run-time error for any thread to attempt to assign to a `synch` variable that already has a value.

In a similar vein, Linda [ACG86] is a set of concurrent programming mechanisms that can be embedded into almost any imperative language. It consists of a set of subroutines that manipulate a shared abstraction called the *tuple space*. The elements of tuple space resemble the tuples of ML (Example ©7.104) and Python (Example 13.68), except that they have single assignment semantics, and are accessed associatively by content, rather than by name. The `in` procedure adds a tuple to the tuple space. The `out` procedure extracts a tuple that matches a specified *pattern*, waiting if no such tuple currently exists. The `read` procedure is a nondestructive `out`. A special form of `in` forks a concurrent thread to calculate the value to be inserted, much like a `future` in Multilisp. All three subroutines can be supported as ordinary library calls, but performance is substantially better when using a specially designed compiler that generates optimized code for commonly occurring patterns of tuple space operations.

A few multiprocessors, including the Denelcor HEP [Jor85] and the Tera machine [ACC⁺90], have provided special hardware support for single-assignment variables in the form of so-called *full-empty* bits. Each memory location contains a bit that indicates whether the variable in that location has been initialized. Any attempt to access an uninitialized variable stalls the current processor, causing it to switch contexts (in hardware) to another thread of control.

Parallel Logic Programming

Several researchers have noted that the backtracking search of logic languages such as Prolog is also amenable to parallelization. Two strategies are possible. The first is to pursue in parallel the subgoals found in the right-hand side of a rule. This strategy is known as *AND parallelism*. The fact that variables in logic, once initialized, are never subsequently modified ensures that parallel branches of an AND cannot interfere with one another. The second strategy is known as *OR parallelism*; it pursues alternative resolutions in parallel. Because they will generally employ different unifications, branches of an OR must use separate copies of their variables. In a search tree such as that of Figure 11.1 (page 553), AND parallelism and OR parallelism create new threads at alternating levels.

OR parallelism is *speculative*: since success is required on only one branch, work performed on other branches is in some sense wasted. OR parallelism works well, however, when a goal cannot be satisfied (in which case the entire tree must be searched), or when there is high variance in the amount of execution time required to satisfy a goal in different ways (in which case exploring several branches at once reduces the expected time to find the first solution). Both AND and OR parallelism are problematic in Prolog, because they fail to adhere to the deterministic search

order required by language semantics. Parlog [Che92], which supports both AND and OR parallelism, is the best known of the parallel Prolog dialects.

✓ CHECK YOUR UNDERSTANDING

38. What is a *monitor*? How do monitor *condition variables* differ from semaphores?
 39. Explain the difference between treating monitor signals as *hints* and treating them as *absolutes*.
 40. What is a *monitor invariant*? Under what circumstances must it be guaranteed to hold?
 41. Describe the *nested monitor problem* and some potential solutions.
 42. What is *deadlock*?
 43. What is a *conditional critical region*? How does it differ from a monitor?
 44. Summarize the synchronization mechanisms of Ada 95, Java, and C#. Contrast them with one another, and with monitors and conditional critical regions. Be sure to explain the features added to Java 5.
 45. What is *transactional memory*? What advantages does it offer over algorithms based on locks? What challenges will need to be overcome before it appears in mainstream programming languages?
 46. Describe the semantics of the HPF/Fortran 95 `forall` loop.
 47. Why might pure functional languages be said to provide a particularly attractive notation for concurrent programming?
 48. Explain the difference between AND *parallelism* and OR *parallelism* in Prolog.
 49. What are *futures* and *single-assignment variables*? In what languages do they appear?
-

12.5 Message Passing

Shared-memory concurrency has become ubiquitous on multicore processors and multiprocessor servers. Message passing, however, still dominates both distributed and high-end computing. Supercomputers and large-scale clusters are programmed primarily in Fortran or C/C++ with the MPI library package. Distributed computing increasingly relies on client–server abstractions layered on top of libraries that implement the TCP/IP Internet standard. As in shared-memory computing, scores of message-passing languages have also been developed for particular application domains, or for research or pedagogical purposes.

© IN MORE DEPTH

Three central issues in message-based concurrency—naming, sending, and receiving—are explored on the PLP CD. A name may refer directly to a process, to some communication resource associated with a process (often called an *entry* or *port*), or to an independent *socket* or *channel* abstraction. A *send* operation may be entirely asynchronous, in which case the sender continues while the underlying system attempts to deliver the message, or the sender may wait, typically for acknowledgment of receipt or for the return of a reply. A *receive* operation, for its part, may be executed explicitly, or it may implicitly trigger execution of some previously specified handler routine. When implicit receipt is coupled with senders waiting for replies, the combination is typically known as *remote procedure call* (RPC). In addition to message-passing libraries, RPC systems typically rely on a language-aware tool known as a *stub compiler*.

12.6 Summary and Concluding Remarks

Concurrency and parallelism have become ubiquitous in modern computer systems. It is probably safe to say that most computer research and development today involves concurrency in one form or another. High-end computer systems have always been parallel, and multicore PCs are now ubiquitous. And even on uniprocessors, graphical and networked applications are typically concurrent.

In this chapter we have provided an introduction to concurrent programming with an emphasis on programming language issues. We began with an overview of the motivations for concurrency and of the architecture of modern multiprocessors. We then surveyed the fundamentals of concurrent software, including communication, synchronization, and the creation and management of threads. We distinguished between shared-memory and message-passing models of communication and synchronization, and between language- and library-based implementations of concurrency.

Our survey of thread creation and management described some six different constructs for creating threads: *co-begin*, *parallel loops*, *launch-at-elaboration*, *fork/join*, *implicit receipt*, and *early reply*. Of these *fork/join* is the most common; it is found in Ada, Java, C#, Modula-3, SR, and library-based packages such as MPI and OpenMP. RPC systems typically use *fork/join* internally to implement implicit receipt. Regardless of the thread-creation mechanism, most concurrent programming systems implement their language- or library-level threads on top of a collection of OS-level processes, which the operating system implements in a similar manner on top of a collection of hardware processors. We built our sample implementation in stages, beginning with coroutines on a uniprocessor, then adding a ready list and scheduler, then timers for preemption, and finally parallel scheduling on multiple processors.

The bulk of the chapter focused on shared-memory programming models, and on synchronization in particular. We distinguished between atomicity and

condition synchronization, and between busy-wait and scheduler-based implementations. Among busy-wait mechanisms we looked in particular at spin locks and barriers. Among scheduler-based mechanisms we looked at semaphores, monitors, and conditional critical regions. Of the three, semaphores are the simplest and most common. Monitors and conditional critical regions provide a better degree of encapsulation and abstraction, but are not amenable to implementation in a library. Conditional critical regions might be argued to provide the most pleasant programming model, but cannot in general be implemented as efficiently as monitors.

We also considered the implicit synchronization provided by parallel functional languages and by parallelizing compilers for such data-parallel languages as High Performance Fortran. For programs written in a functional style, we considered the future mechanism introduced by Multilisp and subsequently incorporated into several other languages, including Java and C#.

As an alternative to lock-based atomicity, we considered nonblocking data structures, which avoid performance anomalies due to inopportune preemption and page faults. For certain common structures, nonblocking algorithms can outperform locks even in the common case. Unfortunately, they tend to be extraordinarily subtle and difficult to create.

Transactional memory (TM) was originally conceived as a general-purpose means of building nonblocking code for arbitrary data structures. Most recent implementations, however, have given up on nonblocking guarantees, focusing instead on the ability to specify atomicity without devising an explicit locking protocol. Like conditional critical regions, TM sacrifices performance for the sake of programmability. Prototype implementations are now available for a wide variety of languages, with hardware support on at least one commercial architecture.

Our section on message passing, mostly on the PLP CD, drew examples from several libraries and languages, and considered how processes name each other, how long they block when sending a message, and whether receipt is implicit or explicit. Distributed computing increasingly relies on remote procedure calls, which combine remote-invocation send (wait for a reply) with implicit message receipt.

As in previous chapters, we saw many cases in which language design and language implementation influence one another. Some mechanisms (cactus stacks, conditional critical regions, content-based message screening) are sufficiently complex that many language designers have chosen not to provide them. Other mechanisms (Ada-style parameter modes) have been developed specifically to facilitate an efficient implementation technique. And in still other cases (the semantics of no-wait send, blocking inside a monitor) implementation issues play a major role in some larger set of tradeoffs.

Despite the very large number of concurrent languages that have been designed to date, much concurrent programming continues to employ conventional sequential languages augmented with library packages. As of 2008, explicitly parallel languages have yet to seriously undermine the dominance of MPI for high-end scientific computing, though OpenMP is increasingly used within multicore

or multiprocessor nodes. For smaller-scale shared-memory computing, many programmers continue to rely on library packages in C and C++, though Java and C# are also challenging that state of affairs. Java's suitability for network-based computing and its extreme portability across platforms have earned it a very strong base of support. Microsoft clearly hopes that C# will prove equally popular, though only time will tell whether it will be successful beyond the x86/Windows platform.

12.7 Exercises

- 12.1 Give an example of a “benign” race condition—one whose outcome affects program behavior, but not correctness.
- 12.2 We have defined the *ready list* of a thread package to contain all threads that are runnable but not running, with a separate variable to identify the currently running thread. Could we just as easily have defined the ready list to contain *all* runnable threads, with the understanding that the one at the head of the list is running? (Hint: think about multiprocessors.)
- 12.3 Imagine you are writing the code to manage a hash table that will be shared among several concurrent threads. Assume that operations on the table need to be atomic. You could use a single mutual exclusion lock to protect the entire table, or you could devise a scheme with one lock per hash-table bucket. Which approach is likely to work better, under what circumstances? Why?
- 12.4 The typical spin lock holds only one bit of data, but requires a full word of storage, because only full words can be read, modified, and written atomically in hardware. Consider, however, the hash table of the previous exercise. If we choose to employ a separate lock for each bucket of the table, explain how to implement a “two-level” locking scheme that couples a conventional spin lock for the table as a whole with a *single bit* of locking information for each bucket. Explain why such a scheme might be desirable, particularly in a table with external chaining. (Hint: See the paper by Stumm et al. [UKGS94].)
- 12.5 Drawing inspiration from Examples 12.28 and 12.29, design a nonblocking linked-list implementation of a stack using `compare_and_swap`. (When CAS was first introduced, on the IBM 370 architecture, this algorithm was one of the driving applications [Tre86].)
- 12.6 Building on the previous exercise, suppose that stack nodes are dynamically allocated. If we read a pointer and then are delayed (e.g., due to preemption), the node to which the pointer refers may be reclaimed and then reallocated for a different purpose. A subsequent `compare-and-swap` may then succeed when logically it should not. This issue is known as the *ABA problem*.

Give a concrete example—an interleaving of operations in two or more threads—where the ABA problem may result in incorrect behavior for your stack. Explain why this behavior cannot occur in systems with automatic garbage collection. Suggest what might be done to avoid it in systems with manual storage management.

- 12.7 We noted in [Section 12.3.2](#) that several processors, including the PowerPC, MIPS, and Alpha, provide an alternative to `compare_and_swap` (CAS) known as `load_linked/store_conditional` (LL/SC). A `load_linked` instruction loads a memory location into a register and stores certain book-keeping information into hidden processor registers. A `store_conditional` instruction stores the register back into the memory location, but only if the location has not been modified by any other processor since the `load_linked` was executed. Like `compare_and_swap`, `store_conditional` returns an indication of whether it succeeded or not.
- (a) Rewrite the code sequence of [Example 12.28](#) using LL/SC.
 - (b) On most machines, an SC instruction can fail for any of several “spurious” reasons, including a page fault, a cache miss, or the occurrence of an interrupt in the time since the matching LL. What steps must a programmer take to make sure that algorithms work correctly in the face of such failures?
 - (c) Discuss the relative advantages of LL/SC and CAS. Consider how they might be implemented on a cache-coherent multiprocessor. Are there situations in which one would work but the other would not? (Hints: consider algorithms in which a thread may need to touch more than one memory location. Also consider algorithms in which the contents of a memory location might be changed and then restored, as in the previous exercise.)
- 12.8 Starting with the `test-and-test_and_set` lock of [Figure 12.8](#), implement busy-wait code that will allow readers to access a data structure concurrently. Writers will still need to lock out both readers and other writers. You may use any reasonable atomic instruction(s) (e.g., LL/SC). Consider the issue of fairness. In particular, if there are *always* readers interested in accessing the data structure, your algorithm should ensure that writers are not locked out forever.
- 12.9 Assuming the Java memory model,
- (a) Explain why it is not sufficient in [Figure 12.11](#) to label X and Y as `volatile`.
 - (b) Explain why it *is* sufficient, in that same figure, to enclose C’s reads (and similarly those of D) in a `synchronized` block for some common shared object O.
 - (c) Explain why it is sufficient, in [Example 12.30](#), to label both `inspected` and X as `volatile`, but not to label only one.

(Hint: you may find it useful to consult Doug Lea’s Java Memory Model “Cookbook for Compiler Writers,” at <http://gee.cs.oswego.edu/dl/jmm/cookbook.html>).

- 12.10 Implement the nonblocking queue of [Example 12.29](#) on an x86. (Complete pseudocode can be found in the paper by Michael and Scott [MS98].) Do you need fence instructions to ensure consistency? If you have access to appropriate hardware, port your code to a machine with a more relaxed memory model (e.g., a PowerPC). What new fences do you need?
- 12.11 Consider the implementation of software transactional memory in [Figure 12.18](#).
- (a) How would you implement the `read_set`, `write_map`, and `lock_map` data structures? You will want to minimize the cost not only of insert and lookup operations, but also of (1) “zeroing out” the table at the end of a transaction, so it can be used again; and (2) extending the table if it becomes too full.
 - (b) The `validate` routine is called in two different places. Expand these calls in-line and customize them to the calling context. What optimizations can you achieve?
 - (c) Optimize the `commit` routine to exploit the fact that a final validation is unnecessary if no other transaction has committed since `valid_time`.
 - (d) Further optimize `commit` by observing that the `for` loop in the `finally` clause really needs to iterate over `orecs`, not over addresses (there may be a difference, if more than one address hashes to the same `orec`). What data, ideally, should `lock_map` hold?
- 12.12 The code of [Example 12.33](#) could fairly be accused of displaying poor abstraction. If we make `desired_condition` a delegate (a subroutine or object closure), can we pass it as an extra parameter, and move the `signal` and `scheduler_lock` management inside `sleep_on`? (Hint: consider the code for the `P` operation in [Figure 12.14](#).)
- 12.13 The mechanism used in [Figure 12.12](#) (page 614) to make scheduler code reentrant employs a single OS-provided lock for all the scheduling data structures of the application. Among other things, this mechanism prevents threads on separate processors from performing `P` or `V` operations on unrelated semaphores, even when none of the operations needs to block. Can you devise another synchronization mechanism for scheduler-related operations that admits a higher degree of concurrency but that is still correct?
- 12.14 Show how to implement a lock-based concurrent set as a singly linked sorted list. Your implementation should support `insert`, `find`, and `remove` operations, and should permit operations on separate portions of the list to occur concurrently (so a single lock for the entire list will not suffice). (Hint: you will want to use a “walking lock” idiom in which `acquire` and `release` operations are interleaved in non-LIFO order.)

- 12.15 (Difficult) Implement a nonblocking version of the set of the previous exercise. (Hint: You will probably discover that insertion is easy but deletion is hard. Consider a *lazy deletion* mechanism in which cleanup [physical removal of a node] may occur well after logical completion of the removal.)
- 12.16 To make spin locks useful on a multiprogrammed multiprocessor, one might want to ensure that no process is ever preempted in the middle of a critical section. That way it would always be safe to spin in user space, because the process holding the lock would be guaranteed to be running on some other processor, rather than preempted and possibly in need of the current processor. Explain why an operating system designer might not want to give user processes the ability to disable preemption arbitrarily. (Hint: Think about fairness and multiple users.) Can you suggest a way to get around the problem? (References to several possible solutions can be found in the paper by Kontothanassis, Wisniewski, and Scott [KWS97].)
- 12.17 Show how to use semaphores to construct a scheduler-based n -thread barrier.
- 12.18 Prove that monitors and semaphores are equally powerful. That is, use each to implement the other. In the monitor-based implementation of semaphores, what is your monitor invariant?
- 12.19 Show how to use binary semaphores to implement general semaphores.
- 12.20 Suppose that every monitor has a separate mutual exclusion lock, so that different threads can run in different monitors concurrently, and that we want to release exclusion on both inner and outer monitors when a thread waits in a nested call. When the thread awakens it will need to reacquire the outer locks. How can we ensure its ability to do so? (Hint: think about the order in which to acquire locks, and be prepared to abandon Hoare semantics. For further hints, see Wettstein [Wet78].)
- 12.21 Show how general semaphores can be implemented with conditional critical regions in which all threads wait for the same condition, thereby avoiding the overhead of unproductive wake-ups.
- 12.22 Write code for a bounded buffer using the protected object mechanism of Ada 95.
- 12.23 Repeat the previous exercise in Java using `synchronized` statements or methods. Try to make your solution as simple and conceptually clear as possible. You will probably want to use `notifyAll`.
- 12.24 Give a more efficient solution to the previous exercise that avoids the use of `notifyAll`. (*Warning*: It is tempting to observe that the buffer can never be both full and empty at the same time, and to assume therefore that waiting threads are either all producers or all consumers. This need not be the case, however: if the buffer ever becomes even a temporary performance bottleneck, there may be an arbitrary number of waiting threads, including both producers and consumers.)

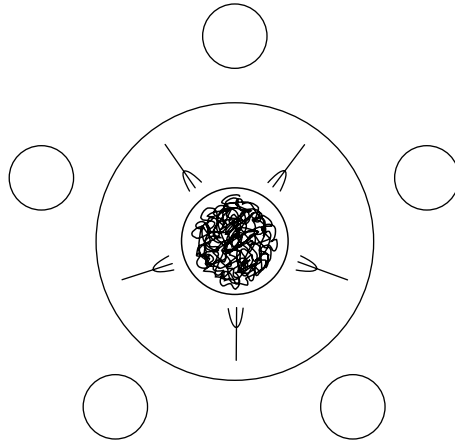

Figure 12.19 The Dining Philosophers. Hungry philosophers must contend for the forks to their left and right in order to eat.

- 12.25** Repeat the previous exercise using Java Lock variables.
- 12.26** Explain how *escape analysis*, mentioned briefly in the sidebar on page 472, could be used to reduce the cost of certain synchronized statements and methods in Java.
- 12.27** The *dining philosophers problem* [Dij72] is a classic exercise in synchronization (Figure 12.19). Five philosophers sit around a circular table. In the center is a large communal plate of spaghetti. Each philosopher repeatedly thinks for a while and then eats for a while, at intervals of his or her own choosing. On the table between each pair of adjacent philosophers is a single fork. To eat, a philosopher requires both adjacent forks: the one on the left and the one on the right. Because they share a fork, adjacent philosophers cannot eat simultaneously.

Write a solution to the dining philosophers problem in which each philosopher is represented by a process and the forks are represented by shared data. Synchronize access to the forks using semaphores, monitors, or conditional critical regions. Try to maximize concurrency.

- 12.28** In the previous exercise you may have noticed that the dining philosophers are prone to deadlock. One has to worry about the possibility that all five of them will pick up their right-hand forks simultaneously, and then wait forever for their left-hand neighbors to finish eating.

Discuss as many strategies as you can think of to address the deadlock problem. Can you describe a solution in which it is provably impossible for any philosopher to go hungry forever? Can you describe a solution that is fair in a strong sense of the word (i.e., in which no one philosopher gets more chance to eat than some other over the long term)? For a particularly elegant solution, see the paper by Chandy and Misra [CM84].

12.29 In some concurrent programming systems, global variables are shared by all threads. In others, each newly created thread has a separate copy of the global variables, commonly initialized to the values of the globals of the creating thread. Under this private globals approach, shared data must be allocated from a special heap. In still other programming systems, the programmer can specify which global variables are to be private and which are to be shared.

Discuss the tradeoffs between private and shared global variables. Which would you prefer to have available, for which sorts of programs? How would you implement each? Are some options harder to implement than others? To what extent do your answers depend on the nature of processes provided by the operating system?

12.30 Rewrite [Example 12.49](#) in Java 5.

12.31 AND parallelism in logic languages is analogous to the parallel evaluation of arguments in a functional language (e.g., Multilisp). Does OR parallelism have a similar analog? (Hint: think about special forms [[Section 10.4](#)].) Can you suggest a way to obtain the effect of OR parallelism in Multilisp?

12.32 In [Section 12.4.5](#) we claimed that both AND parallelism and OR parallelism were problematic in Prolog, because they failed to adhere to the deterministic search order required by language semantics. Elaborate on this claim. What specifically can go wrong?

© **12.33–12.37** In More Depth.

12.8 Explorations

12.38 The MMX and SSE extensions to the x86 instruction set and the AltiVec extensions to the PowerPC instruction set make vector operations available to general-purpose code. Learn about these instructions and research their history. What sorts of code are they used for? How are they related to vector supercomputers? To modern graphics processors?

12.39 The “Top 500” list (top500.org) maintains information, over time, on the 500 most powerful computers in the world, as measured on the Linpack performance benchmark. Explore the site. Pay particular attention to the historical trends in the kinds of machines deployed. Can you explain these trends? How many cases can you find of supercomputer technology moving into the mainstream, and vice versa?

12.40 In [Section 12.3.3](#) we noted that different processors provide different levels of memory consistency and different mechanisms to force additional ordering when needed. Learn more about these hardware memory models. You might want to start with the tutorial by Adve and Gharachorloo [[AG96](#)].

- 12.41 In Sections 12.3.3 and 12.4.3 we presented a very high-level summary of the Java memory model. Learn its details. Also investigate the model recently proposed for C++, and the (more poorly specified) models of Ada and C#. How do these compare? How efficiently can each be implemented on various real machines? What are the challenges for implementors? Note in particular the controversy that arose around the memory model in the original definition of Java (fixed in Java 5—see the paper by Manson et al. [MPA05] for a discussion).
- 12.42 In Section 12.3.2 we presented a brief introduction to the design of *non-blocking* concurrent data structures, which work correctly without locks. Learn more about this topic. How hard is it to write correct nonblocking code? How does the performance compare to that of lock-based code? You might want to start with the work of Michael [MS98] and Sundell [Sun04]. For a more theoretical foundation, start with Herlihy's original article on *wait freedom* [Her91] and the more recent concept of *obstruction freedom* [HLM03].
- 12.43 The first software transactional memory systems grew out of work on nonblocking concurrent data structures, and were in fact nonblocking. Most recent systems, however, are lock based. Read the position paper by Ennals [Enn06] and the more recent papers of Marathe and Moir [MM08] and Tabbā et al. [TWGM07]. What do you think? Should TM systems be nonblocking?
- 12.44 Study the documentation for some of your favorite library packages (the C standard library, perhaps, or the C++ Standard Template Library, the .NET or Java libraries, or the many available packages for mathematical computing). Which routines can safely be called from a multithreaded program? Which cannot? What accounts for the difference? Why not make all routines thread-safe?
- 12.45 Undertake a detailed study of several concurrent languages. Download implementations and use them to write parallel programs of several different sorts. (You might, for example, try Conway's Game of Life, Delaunay Triangulation, and Gaussian Elimination; descriptions of all of these can easily be found on the Web.) Write a paper about your experience. What worked well? What didn't?
- Languages you might consider include Ada (www.gnu.org/software/gnat/gnat.html), C# (www.mono-project.com/), C-Linda (www.lindaspaces.com/), Cilk (supertech.csail.mit.edu/cilk/), Concurrent and Parallel Haskell (haskell.org/ghc/), Erlang (www.erlang.org/), Java (java.sun.com/), Modula-3 (www.modula3.org/), NESL (www.cs.cmu.edu/~scandal/nsl.html), Occam (www.wotug.org/occam/compilers/), and SR (www.cs.arizona.edu/sr/).
- 12.46 Learn about the supercomputing languages discussed in the Bibliographic Notes at the end of the chapter: Co-Array Fortran, Titanium, and UPC; and Chapel, Fortress, and X10. How do these compare to one another?

To MPI and OpenMP? To languages with less of a focus on “high-end” computing?

- 12.47 In the spirit of the previous question, learn about the `shmem` library package, originally developed by Robert Numrich of Cray, Inc., for the T3D supercomputer. `Shmem` is widely used for parallel programming on both large-scale multiprocessors and clusters. It has been characterized as a cross between shared memory and message passing. Is this a fair characterization? Under what circumstances might a `shmem` program be expected to outperform solutions in MPI or OpenMP? (Note: as of this writing, `shmem` has not been standardized, so implementations may differ some across platforms. The Cray man pages are available at docs.cray.com/books/S-2383-23/S-2383-23-manual.pdf.)
- 12.48 Much of this chapter has been devoted to the management of races in parallel programs. The complexity of the task suggests a tantalizing question: is it possible to design a concurrent programming language that is powerful enough to be widely useful, and in which programs are inherently race-free? For two very different takes on a (mostly) affirmative answer, see the work of Edward Lee [Lee06] and the various concurrent dialects of Haskell [NA01, JGF96].

© 12.49–12.51 In More Depth.

12.9 Bibliographic Notes

Much of the early study of concurrency stems from a pair of articles by Dijkstra [Dij68a, Dij72]. Andrews and Schneider [AS83] provided an excellent snapshot of the field in the early 1980s. Holt et al. [HGLS78] is a useful reference for many of the classic problems in concurrency and synchronization.

Peterson’s two-process synchronization algorithm appears in a remarkably elegant and readable two-page paper [Pet81]. Lamport’s 1978 article on “Time, Clocks, and the Ordering of Events in a Distributed System” [Lam78] argued convincingly that the notion of global time cannot be well defined, and that distributed algorithms must therefore be based on causal *happens before* relationships among individual processes. Reader–writer locks are due to Courtois, Heymans, and Parnas [CHP71]. Mellor-Crummey and Scott [MCS91] survey the principal busy-wait synchronization algorithms and introduce locks and barriers that scale without contention to very large machines.

The seminal paper on lock-free synchronization is that of Herlihy [Her91]. The nonblocking concurrent queue of Example 12.29 is due to Michael and Scott. Herlihy and Shavit provide the definitive modern treatment of synchronization and concurrent data structures [HS08]. The premiere overview of hardware memory models is by Adve and Gharachorloo [AG96]. Pugh explains the problems with the original Java Memory Model [Pug00]; the revised model is described by Manson, Pugh, and Adve [MPA05]. Boehm has argued convincingly that threads

cannot be implemented correctly without compiler support [Boe05]. The emerging memory model for C++ is described by Boehm and Adve [BA08].

The original paper on transactional memory is by Herlihy and Moss [HM93]. Larus and Rajwar provide a book-length survey of the field as of fall 2006 [LR06]. Larus and Kozyrakis provide a more recent overview [LK08]. Researchers at the University of Wisconsin maintain a bibliography at www.cs.wisc.edu/trans-memory/.

The 1980s saw the invention of a very large number of concurrent programming languages—far too many to mention here. Surveys can be found in the July 1989 issue of *IEEE Software* and the September 1989 issue of *ACM Computing Surveys*. Buhr et al. [BFC95] present a comprehensive survey of monitor semantics and implementations.

Two recent generations of parallel languages for high-end computing have been highly influential. The Partitioned Global Address Space (PGAS) languages include Co-Array Fortran (CAF), Unified Parallel C (UPC), and Titanium (a dialect of Java). They support a single global name space for variables, but employ an “extra dimension” of addressing to access data not on the local processor. Survey presentations can be found at psc.edu/training/PPS_May04/. The so-called HPCS languages—Chapel, Fortress, and X10—build on experience with the PGAS languages, but target a broader range of hardware, applications, and styles of parallelism. All three include transactional features. They are being developed under funding from the High Productivity Computing Systems program of the Defense Advanced Research Projects Agency. Because they are still under development, the best source of information is the various project web sites: chapel.cs.washington.edu/, projectfortress.sun.com/, and x10-lang.org/.

Oskin offers an exceptionally clear and compelling explanation of the multicore revolution [Osk08]. The text of Culler, Singh, and Gupta [CS98], though growing somewhat dated, contains a wealth of information on parallel programming and multiprocessor architecture.

MPI [BDH⁺95, SOHL⁺98] is documented in a variety of articles and books. The latest version draws several features from an earlier, competing system known as PVM (Parallel Virtual Machine) [Sun90, GBD⁺94]. Remote procedure call received increasing attention in the wake of Nelson’s doctoral research [BN84]. The Open Network Computing RPC standard is documented in Internet RFC number 1831 [Sri95]. RPC also forms the basis of such higher-level standards as CORBA, COM, JavaBeans, and SOAP.

Software distributed shared memory (S-DSM) was originally proposed by Li as part of his doctoral research [LH89]. The TreadMarks system from Rice University is widely considered the most mature and robust of the various implementations [ACD⁺96].

13 Scripting Languages

Traditional programming languages are intended primarily for the construction of self-contained applications: programs that accept some sort of input, manipulate it in some well-understood way, and generate appropriate output. But most actual *uses* of computers require the coordination of multiple programs. A large institutional payroll system, for example, must process time-reporting data from card readers, scanned paper forms, and manual (keyboard) entry; execute thousands of database queries; enforce hundreds of legal and institutional rules; create an extensive “paper trail” for record-keeping, auditing, and tax preparation purposes; print paychecks; and communicate with servers around the world for on-line direct deposit, tax withholding, retirement accumulation, medical insurance, and so on. These tasks are likely to involve dozens or hundreds of separately executable programs. Coordination among these programs is certain to require tests and conditionals, loops, variables and types, subroutines and abstractions—the same sorts of logical tools that a conventional language provides *inside* an application.

On a much smaller scale, a graphic artist or photojournalist may routinely download pictures from a digital camera; convert them to a favorite format; rotate the pictures that were shot in vertical orientation; down-sample them to create browsable thumbnail versions; index them by date, subject, and color histogram; back them up to a remote archive; and then reinitialize the camera’s memory. Performing these steps by hand is likely to be both tedious and error-prone. In a similar vein, the creation of a dynamic web page may require authentication and authorization, database lookup, image manipulation, remote communication, and the reading and writing of HTML text. All these scenarios suggest a need for programs that coordinate other programs.

It is of course possible to write coordination code in Java, C, or some other conventional language, but it isn’t always easy. Conventional languages tend to stress efficiency, maintainability, portability, and the static detection of errors. Their type systems tend to be built around such hardware-level concepts as fixed-size integers, floating-point numbers, characters, and arrays. By contrast *scripting languages* tend to stress flexibility, rapid development, local customization, and

dynamic (run-time) checking. Their type systems, likewise, tend to embrace such high-level concepts as tables, patterns, lists, and files.

General-purpose scripting languages like Perl and Python are sometimes called *glue languages*, because they were originally designed to “glue” existing programs together to build a larger system. With the growth of the World Wide Web, scripting languages have gained new prominence in the generation of dynamic content. They are also widely used as *extension languages*, which allow the user to customize or extend the functionality of “scriptable” tools.

We consider the history and nature of scripting in more detail in [Section 13.1](#). We then turn in [Section 13.2](#) to some of the problem domains in which scripting is widely used. These include command interpretation (shells), text processing and report generation, mathematics and statistics, general-purpose program coordination, and configuration and extension. In [Section 13.3](#) we consider several forms of scripting used on the World Wide Web, including CGI scripts, server- and client-side processing of scripts embedded in web pages, Java applets, and (on the PLP CD) XSLT. Finally, in [Section 13.4](#), we consider some of the more interesting language features, common to many scripting languages, that distinguish them from their more traditional “mainstream” cousins. We look in particular at naming, scoping, and typing; string and pattern manipulation; and high-level structured data. We will not provide a detailed introduction to any one scripting language, though we will consider concrete examples in several. As in most of this book, the emphasis will be on underlying concepts.

13.1 What Is a Scripting Language?

Modern scripting languages have two principal sets of ancestors. In one set are the command interpreters or “shells” of traditional batch and “terminal” (command-line) computing. In the other set are various tools for text processing and report generation. Examples in the first set include IBM’s JCL, the MS-DOS command interpreter, and the Unix `sh` and `csh` shell families. Examples in the second set include IBM’s RPG and Unix’s `sed` and `awk`. From these evolved Rexx, IBM’s “Restructured Extended Executor,” which dates from 1979, and Perl, originally devised by Larry Wall in the late 1980s, and now the most widely used general-purpose scripting language. Other general-purpose scripting languages include Tcl (“tickle”), Python, Ruby, VBScript (for Windows) and AppleScript (for the Mac).

With the growth of the World Wide Web in the late 1990s, Perl was widely adopted for “server-side” web scripting, in which a web-server executes a program (on the server’s machine) to generate the content of a page. One early web-scripting enthusiast was Rasmus Lerdorf, who created a collection of scripts to track access to his personal home page. Originally written in Perl but soon redesigned as a full-fledged and independent language, these scripts evolved into PHP, now the most popular platform for server-side web scripting. PHP competitors include

JSP (Java Server Pages), Ruby on Rails, and, on Microsoft platforms, VBScript. For scripting on the client computer, all major browsers implement JavaScript, a language developed by Netscape Corporation in the mid 1990s, and standardized by ECMA (the European standards body) in 1999 [ECM99].

In his classic paper on scripting [Ous98], John Ousterhout, the creator of Tcl, notes that “Scripting languages assume that a collection of useful components already exist in other languages. They are intended not for writing applications from scratch but rather for combining components.” Ousterhout envisions a future in which programmers increasingly rely on scripting languages for the top-level structure of their systems, where clarity, reusability, and ease of development are crucial. Traditional “systems languages” like C, C++, or Java, he argues, will be used for self-contained, reusable system components, which emphasize complex algorithms or execution speed. As a general rule of thumb, he suggests that code

DESIGN & IMPLEMENTATION

Scripting on Microsoft platforms

As in several other aspects of computing, Microsoft tends to rely on internally developed technology in the area of scripting languages. Most of its scripting applications are based on VBScript, a dialect of Visual Basic. At the same time, Microsoft has developed a very general scripting interface (Windows Script) that is implemented uniformly by the operating system (Windows Script Host [WSH]), the web server (Active Server Pages [ASP]), and the Internet Explorer browser. A Windows Script implementation of JScript, the company’s version of JavaScript, comes preinstalled on Windows machines, but languages like Perl and Python can be installed as well, and used to drive the same interface. Many other Microsoft applications, including the entire Office suite, use VBScript as an extension language, but for these the implementation framework (Visual Basic for Applications [VBA]) does not make it easy to use other languages instead.

Given Microsoft’s share of the desktop computing market, VBScript is one of the most widely used scripting languages. It is almost never used on other platforms, however, while Perl, Tcl, Python, PHP, and others see significant use on Windows. For server-side web scripting, PHP currently predominates: as of August 2008, some 47% of the 175 million Internet web sites surveyed by Netcraft LTD were running the open-source Apache web server,¹ and most of the ones with active content were using PHP. Microsoft’s Internet Information Server (IIS) was second to Apache, with 37% of the sites, and many of those had PHP installed as well. For client-side scripting, Internet Explorer controls barely over half of the browser market (52% as of August 2008),² and most website administrators need their content to be visible to the other 48%. Explorer supports JavaScript (JScript), but other browsers do not support VBScript.

¹news.netcraft.com/archives/web_server_survey.html

²www.w3schools.com/browsers/browsers_stats.asp

can be developed 5 to 10 times faster in a scripting language, but will run 10 to 20 times faster in a traditional systems language.

Some authors reserve the term “scripting” for the glue languages used to coordinate multiple programs. In common usage, however, scripting is a broader and vaguer concept. It clearly includes web scripting. For most authors it also includes *extension languages*.

Many readers will be familiar with the Visual Basic “macros” of Microsoft Office and related applications. Others may be familiar with the Lisp-based extension language of the emacs text editor. Several languages, including Tcl, Rexx, Python, and the Guile and Elk dialects of Scheme, have implementations designed in such a way that they can be incorporated into a larger program and used to extend its features. Extension was in fact the original purpose of Tcl. In a similar vein, several widely used commercial applications provide their own proprietary extension languages. For graphical user interface (GUI) programming, the Tk toolkit, originally designed for use with Tcl, has been incorporated into several scripting languages, including Perl, Python, and Ruby.

One can also view XSLT (extensible stylesheet language transformations) as a scripting language, albeit somewhat different from the others considered in this chapter. XSLT is part of the growing family of XML (extensible markup language) tools. We consider it further in [Section 13.3.5](#).

13.1.1 Common Characteristics

While it is difficult to define scripting languages precisely, there are several characteristics that they tend to have in common.

Both batch and interactive use. A few scripting languages (notably Perl) have a compiler that insists on reading the entire source program before it produces any output. Most other languages, however, are willing to compile or interpret their input line by line. Rexx, Python, Tcl, Guile, and (with a short helper script) Ruby will all accept commands from the keyboard.

Economy of expression. To support both rapid development and interactive use, scripting languages tend to require a minimum of “boilerplate.” Some make heavy use of punctuation and very short identifiers (Perl is notorious for this), while others (e.g., Rexx, Tcl, and AppleScript) tend to be more “English-like,” with lots of words and not much punctuation. All attempt to avoid the extensive declarations and top-level structure common to conventional languages. Where a trivial program looks like this in Java,

EXAMPLE 13.1

Trivial programs in conventional and scripting languages

```
class Hello {
    public static void main(String[] args) {
        System.out.println("Hello, world!");
    }
}
```

and like this in Ada,

```
with ada.text_IO; use ada.text_IO;
procedure hello is
begin
    put_line("Hello, world!");
end hello;
```

in Perl, Python, or Ruby it is simply

```
print "Hello, world!\n" ■
```

Lack of declarations; simple scoping rules. Most scripting languages dispense with declarations, and provide simple rules to govern the scope of names. In some languages (e.g., Perl) everything is global by default; optional declarations can be used to limit a variable to a nested scope. In other languages (e.g., PHP and Tcl), everything is local by default; globals must be explicitly imported. Python adopts the interesting rule that any variable that is assigned a value is local to the block in which the assignment appears. Special syntax is required to assign to a variable in a surrounding scope.

Flexible dynamic typing. In keeping with the lack of declarations, most scripting languages are dynamically typed. In some (e.g., PHP, Python, Ruby, and Scheme), the type of a variable is checked immediately prior to use. In others (e.g., Rexx, Perl, and Tcl), a variable will be interpreted differently in different contexts. In Perl, for example, the program

EXAMPLE 13.2

Coercion in Perl

```
$a = "4";
print $a . 3 . "\n"; # '.' is concatenation
print $a + 3 . "\n"; # '+' is addition
```

will print

```
43
7
```

DESIGN & IMPLEMENTATION

Compiling interpreted languages

Several times in this chapter we will make reference to “the compiler” for a scripting language. As we saw in [Examples 1.9](#) and [1.10](#), interpreters almost never work with source code; a front-end translator first replaces that source with some sort of intermediate form. For most implementations of most of the languages described in this chapter, the front end is sufficiently complex to deserve the name “compiler.” Intermediate forms are typically internal data structures (e.g., a syntax tree) or “byte-code” representations reminiscent of those of Java.

This contextual interpretation is similar to coercion, except that there isn't necessarily a notion of "natural" type from which an object must be converted; the various possible interpretations may all be equally "natural." We shall have more to say about context in Perl in [Section 13.4.3](#). ■

Easy access to system facilities. Most programming languages provide a way to ask the underlying operating system to run another program, or to perform some operation directly. In scripting languages, however, these requests are much more fundamental, and have much more direct support. Perl, for one, provides well over 100 built-in commands that access operating system functions for input and output, file and directory manipulation, process management, database access, sockets, interprocess communication and synchronization, protection and authorization, time-of-day clock, and network communication. These built-in commands are generally a good bit easier to use than corresponding library calls in languages like C.

Sophisticated pattern-matching and string manipulation. In keeping with their text processing and report generation ancestry, and to facilitate the manipulation of textual input and output for external programs, scripting languages tend to have extraordinarily rich facilities for pattern matching, search, and string manipulation. Typically these are based on *extended regular expressions*. We discuss them further in [Section 13.4.2](#).

High-level data types. High-level data types like sets, bags, dictionaries, lists, and tuples are increasingly common in the standard library packages of conventional programming languages. A few languages (notably C++) allow users to redefine standard infix operators to make these types as easy to use as more primitive, hardware-centric types. Scripting languages go one step further by

DESIGN & IMPLEMENTATION

Canonical implementations

Because they are implemented with interpreters, scripting languages tend to be easy to port from one machine to another—substantially easier than compilers for which one must write a new code generator. Given a native compiler for the language in which the interpreter is written, the only difficult part (and it may indeed be difficult) is to implement any necessary modifications to the part of the interpreter that provides the interface to the operating system.

At the same time, the ease of porting an interpreter means that several scripting languages, including Perl, Python, Tcl, and Ruby, have a single widely used implementation, which serves as the de facto language definition. Reading a book on Perl, it can be difficult to tell how a subtle program will behave. When in doubt, one may need to "try it out." Rexx and JavaScript appear to be unique among widely used scripting languages in having a formal definition codified by an international standards body and independent of any one implementation. (Sed, awk, and sh have also been standardized by POSIX [[Int03b](#)], but none of these has the complexity of Perl, Python, Tcl, or Ruby.)

building high-level types into the syntax and semantics of the language itself. In most scripting languages, for example, it is commonplace to have an “array” that is indexed by character strings, with an underlying implementation based on hash tables. Storage is invariably garbage collected.

Much of the most rapid change in programming languages today is occurring in scripting languages. This can be attributed to several causes, including the continued growth of the web, the dynamism of the open-source community, and the comparatively low investment required to create a new scripting language. Where a compiled, industrial-quality language like Java or C# requires a multiyear investment by a very large programming team, a single talented designer, working alone, can create a usable implementation of a new scripting language in only a year or two.

Due in part to this rapid change, newer scripting languages have been able to incorporate some of the most innovative concepts in language design. Ruby, for example, has a uniform object model (much like Smalltalk), true iterators (like Clu), array slices (like Fortran 90), structured exception handling, multiway assignment, and reflection. Python also provides several of these features, together with anonymous first-class functions and Haskell-like list comprehensions.

13.2 Problem Domains

Some general-purpose languages—Scheme and Visual Basic in particular—are widely used for scripting. Conversely, some scripting languages, including Perl, Python, and Ruby, are intended by their designers for general-purpose use, with features intended to support “programming in the large”: modules, separate compilation, reflection, program development environments, and so on. For the most part, however, scripting languages tend to see their principal use in well-defined problem domains. We consider some of these in the following subsections.

13.2.1 Shell (Command) Languages

In the days of punch-card computing, simple command languages allowed the user to “script” the processing of a card deck. A control card at the front of the deck, for example, might indicate that the upcoming cards represented a program to be compiled, or perhaps machine language for the compiler itself, or input for a program already compiled and stored on disk. A control card embedded later in the deck might test the exit status of the most recently executed program and choose what to do next based on whether that program completed successfully. Given the linear nature of a card deck, however (one can’t in general back up), command languages for batch processing tend not to be very sophisticated. JCL, for example, has no iteration constructs.

With the development of interactive timesharing in the 1960s and early 1970s, command languages became much more sophisticated. Louis Pouzin wrote a simple command interpreter for CTSS, the Compatible Time Sharing System at MIT, in 1963 and 1964. When work began on the groundbreaking Multics system in 1964, Pouzin sketched the design of an extended command language, with quoting and argument-passing mechanisms, for which he coined the term “shell.” The subsequent implementation served as inspiration for Ken Thompson in the design of the original Unix shell in 1973. In the mid-1970s, Stephen Bourne and John Mashey separately extended the Thompson shell with control flow and variables; Bourne’s design was adopted as the Unix standard, taking the place (and the name) of the Thompson shell, `sh`.

In the late 1970s Bill Joy developed the so-called “C shell” (`cs`h), inspired at least in part by Mashey’s syntax, and introducing significant enhancements for interactive use, including history, aliases, and job control. The `tcsh` version of `cs`h adds command-line editing and command completion. David Korn incorporated these mechanisms into a direct descendant of the Bourne shell, `ksh`, which is very similar to the standard POSIX shell [Int03b]. The popular “Bourne-again” shell, `bash`, is an open-source version of `ksh`. While `tcsh` is still popular in some quarters, `ksh`/`bash`/POSIX `sh` is substantially better for writing shell scripts, and comparable for interactive use.

In addition to features designed for interactive use, which we will not consider further here, shell languages provide a wealth of mechanisms to manipulate filenames, arguments, and commands, and to glue together other programs. Most of these features are retained by more general scripting languages. We consider a few of them here, using `bash` syntax. The discussion is of necessity heavily simplified; full details can be found in the `bash` man page, or in various on-line tutorials.

Filename and Variable Expansion

Most users of a Unix shell are familiar with “wildcard” expansion of filenames. The following command will list all files in the current directory whose names end in `.pdf`:

EXAMPLE 13.3

“Wildcards” and “globbing”

```
ls *.pdf
```

The shell expands the pattern `*.pdf` into a list of all matching names. If there are three of them (say `fig1.pdf`, `fig2.pdf`, and `fig3.pdf`), the result is equivalent to

```
ls fig1.pdf fig2.pdf fig3.pdf
```

Filename expansion is sometimes called “globbing,” after the original Unix `glob` command that implemented it. In addition to `*` wildcards, one can usually specify “don’t care” or alternative characters or substrings. The pattern `fig?.pdf` will match (expand to) any file(s) with a single character between the `g` and the dot. The pattern `fig[0-9].pdf` will require that character to be a digit. The pattern `fig3.{eps,pdf}` will match both `fig3.eps` and `fig3.pdf`. ■

EXAMPLE 13.4

For loops in the shell

Filename expansion is particularly useful in loops. Such loops may be typed directly from the keyboard, or embedded in scripts intended for later execution. Suppose, for example, that we wish to create PDF versions of all our EPS figures:³

```
for fig in *.eps
do
    ps2pdf $fig
done
```

The `for` construct arranges for the shell variable `fig` to take on the names in the expansion of `*.eps`, one at a time, in consecutive iterations of the loop. The dollar sign in line 3 causes the value of `fig` to be expanded into the `ps2pdf` command before it is executed. (Interestingly, `ps2pdf` is itself a shell script that calls the `gs` Postscript interpreter.) Optional braces can be used to separate a variable name from following characters, as in `cp $foo ${foo}_backup`. ■

EXAMPLE 13.5

A whole loop on one line

Multiple commands can be entered on a single line if they are separated by semicolons. The following, for example, is equivalent to the loop in the previous example:

```
for fig in *.eps; do ps2pdf $fig; done
```

Tests, Queries, and Conditions

The loop above will execute `ps2pdf` for every EPS file in the current directory. Suppose, however, that we already have some PDF files, and only want to create the ones that are missing.

EXAMPLE 13.6

Conditional tests in the shell

```
for fig in *.eps
do
    target=${fig%.eps}.pdf
    if [ $fig -nt $target ]
    then
        ps2pdf $fig
    fi
done
```

The third line of this script is a variable assignment. The expression `${fig%.eps}` within the right-hand side expands to the value of `fig` with any trailing `.eps` removed. Similar special expansions can be used to test or modify the value of a

3 Postscript is a programming language developed at Adobe Systems, Inc. for the description of images and documents (we consider it again in the sidebar on page 738). Encapsulated Postscript (EPS) is a restricted form of Postscript intended for figures that are to be embedded in other documents. Portable Document Format (PDF, also by Adobe) is a self-contained file format that combines a subset of Postscript with font embedding and compression mechanisms. It is strictly less powerful than Postscript from a computational perspective, but much more portable, and faster and easier to render.

variable in many different ways. The square brackets in line 4 delimit a conditional test. The `-nt` operator checks to see whether the file named by its left operand is newer than the file named by its right operand (or if the left operand exists but the right does not). Similar *file query* operators can be used to check many other properties of files. Additional operators can be used for arithmetic or string comparisons. ■

Pipes and Redirection

One of the principal innovations of Unix was the ability to chain commands together, “piping” the output of one to the input of the next. Like most shells, `bash` uses the vertical bar character (`|`) to indicate a pipe. To count the number of figures in our directory, without distinguishing between EPS and PDF versions, we might type

EXAMPLE 13.7

Pipes

```
for fig in *; do echo ${fig%.*}; done | sort -u | wc -l
```

Here the first command, a `for` loop, prints the names of all files with extensions (dot-suffixes) removed. The `echo` command inside the loop simply prints its arguments. The `sort -u` command after the loop removes duplicates, and the `wc -l` command counts lines. ■

Like most shells, `bash` also allows output to be directed to a file, or input read from a file. To create a list of figures, we might type

EXAMPLE 13.8

Output redirection

```
for fig in *; do echo ${fig%.*}; done | sort -u > all_figs
```

DESIGN & IMPLEMENTATION

Built-in commands in the shell

Commands in the shell generally take the form of a sequence of *words*, the first of which is the name of the command. Most commands are executable programs, found in directories on the shell’s *search path*. A large number, however (about 50 in `bash`), are *built-ins*—commands that the shell recognizes and executes itself, rather than starting an external program. Interestingly, several commands that are available as separate programs are duplicated as built-ins, either for the sake of efficiency or to provide additional semantics. Conditional tests, for example, were originally supported by the external `test` command (for which square brackets are syntactic sugar), but these occur sufficiently often in scripts that execution speed improved significantly when a built-in version was added. By contrast, while the `kill` command is not used very often, the built-in version allows processes to be identified by small integer or symbolic names from the shell’s *job control* mechanism. The external version supports only the longer and comparatively unintuitive process identifiers supplied by the operating system.

The “greater than” sign indicates output redirection. If doubled (`sort -u >> all_figs`) it causes output to be appended to the specified file, rather than overwriting the previous contents.

In a similar vein, the “less than” sign indicates input redirection. Suppose we want to print our list of figures all on one line, separated by spaces, instead of on multiple lines. On a Unix system we can type

```
tr '\n' ' ' < all_figs
```

This invocation of the standard `tr` command converts all newline characters to spaces. Because `tr` was written as a simple filter, it does not accept a list of files on the command line; it only reads standard input. ■

For any executing Unix program, the operating system keeps track of a list of open files. By convention, *standard input* and *standard output* (`stdin` and `stdout`) are files numbers 0 and 1. File number 2 is by convention *standard error* (`stderr`), to which programs are supposed to print diagnostic error messages. One of the advantages of the `sh` family of shells over the `csh` family is the ability to redirect `stderr` and other open files independent of `stdin` and `stdout`. Consider, for example, the `ps2pdf` script. Under normal circumstances this script works silently. If it encounters an error, however, it prints a message to `stdout` and quits. This violation of convention (the message should go to `stderr`) is harmless when the command is invoked from the keyboard. If it is embedded in a script, however, and the output of the script is directed to a file, the error message may end up in the file instead of on the screen, and go unnoticed by the user. With `bash` we can type

```
ps2pdf my_fig.eps 1>&2
```

Here `1>&2` means “make `ps2pdf` send file 1 (`stdout`) to the same place that the surrounding context would normally send file 2 (`stderr`).” ■

Finally, like most shells, `bash` allows the user to provide the input to a command in-line:

```
tr '\n' ' ' <<END
list
of
input
lines
END
```

The `<<END` indicates that subsequent input lines, up to a line containing only `END`, are to be supplied as input to `tr`. Such in-line input (traditionally called a “here document”) is seldom used interactively, but is highly useful in shell scripts. ■

EXAMPLE 13.9

Redirection of `stderr` and `stdout`

EXAMPLE 13.10

Here docs (in-line input)

Quoting and Expansion**EXAMPLE 13.11**

Single and double quotes

Shells typically provide several *quoting* mechanisms to group words together into strings. Single (forward) quotes inhibit filename and variable expansion in the quoted text, and cause it to be treated as a single word, even if it contains white space. Double quotes also cause the contents to be treated as a single word, but do not inhibit expansion. Thus

```
foo=bar
single='foo'
double="foo"
echo $single $double
```

will print “\$foo bar”.

EXAMPLE 13.12

Subshells

Several other bracketing constructs in `bash` group the text inside, for various purposes. Command lists enclosed in parentheses are passed to a subshell for evaluation. If the opening parenthesis is preceded by a dollar sign, the output of the nested command list is expanded into the surrounding context:

```
for fig in $(cat my_figs); do ps2pdf ${fig}.eps; done
```

Here `cat` is the standard command to print the content of a file. Most shells use backward single quotes for the same purpose (`'cat my_figs'`); `bash` supports this syntax as well, for backward compatibility.

EXAMPLE 13.13

Brace-quoted blocks in the shell

Command lists enclosed in braces are treated by `bash` as a single unit. They can be used, for example, to redirect the output of a sequence of commands:

```
{ date; ls; } >> file_list
```

Unlike parenthesized lists, commands enclosed in braces are executed by the current shell. From a programming languages perspective, parentheses and braces behave “backward” from the way they do in C: parentheses introduce a nested dynamic scope in `bash`, while braces are purely for grouping. In particular, variables that are assigned new values within a parenthesized command list will revert to their previous values once the list has completed execution.

EXAMPLE 13.14

Pattern-based list generation

When not surrounded by white space, braces perform pattern-based list generation, in a manner similar to filename expansion, but without the connection to the file system. For example, `echo abc{12,34,56} xyz` prints `abc12xyz abc34xyz abc56xyz`. Also, as we have seen, braces serve to delimit variable names when the opening brace is preceded by a dollar sign.

In [Example 13.6](#) we used square brackets to enclose a conditional expression. Double square brackets serve a similar purpose, but with more C-like expression syntax, and without filename expansion. Double parentheses are used to enclose arithmetic computations, again with C-like syntax.

The interpolation of commands in `$()` or backquotes, patterns in `{ }`, and arithmetic expressions in `(())` are all considered forms of expansion, analogous

to filename expansion and variable expansion. The splitting of strings into words is also considered a form of expansion, as is the replacement, in certain contexts, of tilde (~) characters with the name of the user's home directory. All told, these give us seven different kinds of expansion in `bash`.

All of the various bracketing constructs have rules governing which kinds of expansion are performed within. The rules are intended to be as intuitive as possible, but they are not uniform across constructs. Filename expansion, for example, does not occur within `[[]]`-bracketed conditions. Similarly, a double quote character may appear inside a double-quoted string if escaped with a backslash, but a single-quote character may not appear inside a single-quoted string.

Functions

Users can define functions in `bash` that then work like built-in commands. Many users, for example, define `ll` as a shortcut for `ls -l`, which lists files in the current directory in “long format.”

```
function ll () {
    ls -l "$@"
}
```

Within the function, `$1` represents the first parameter, `$2` represents the second, and so on. In the definition of `ll`, `$@` represents the entire parameter list. Functions can be arbitrarily complex. In particular, `bash` supports both local variables and recursion. Shells in the `csh` family provide a more primitive `alias` mechanism that works via macro expansion. ■

The #! Convention

As noted above, shell commands can be read from a *script* file. To execute them in the current shell, one uses the “dot” command:

```
. my_script
```

where `my_script` is the name of the file. Many operating systems, including most versions of Unix, allow one to make a script function as an executable program, so that users can simply type

```
my_script
```

Two steps are required. First, the file must be marked *executable* in the eyes of the operating system. On Unix one types `chmod +x my_script`. Second, the file must be self-descriptive in a way that allows the operating system to tell which shell (or other interpreter) will understand the contents. Under Unix, the file must begin with the characters `#!`, followed by the name of the shell. The typical `bash` script thus begins with

```
#!/bin/bash
```

EXAMPLE 13.15

User-defined shell functions

EXAMPLE 13.16

The #! convention in script files

Specifying the full path name is a safety feature: it anticipates the possibility that the user may have a search path for commands on which some other program named `bash` appears before the shell. (Unfortunately, the requirement for full path names makes `#!` lines nonportable, since shells and other interpreters may be installed in different places on different machines.) ■

✓ CHECK YOUR UNDERSTANDING

1. Give a plausible one-sentence definition of “scripting language.”
2. List the principal ways in which scripting languages differ from conventional “systems” languages.
3. From what two principal sets of ancestors are modern scripting languages descended?
4. What IBM creation is generally considered the first general-purpose scripting language?
5. What is the most popular language for server-side web scripting?
6. How does the notion of *context* in Perl differ from coercion?
7. What is *globbing*? What is a *wildcard*?
8. What is a *pipe* in Unix? What is *redirection*?
9. Describe the three standard I/O streams provided to every Unix process.
10. Explain the significance of the `#!` convention in Unix shell scripts.

DESIGN & IMPLEMENTATION

Magic numbers

When the Unix kernel is asked to execute a file (via the `execve` system call), it checks the first few bytes of the file for a “magic number” that indicates the file’s type. Some values correspond to directly executable object file formats. Under Linux, for example, the first four bytes of an object file are `0x7f45_4c46` (`(\del)ELF` in ASCII). Under Mac OS X they are `0xfeed_face`. If the first two bytes are `0x2321` (`#!` in ASCII), the kernel assumes that the file is a script, and reads subsequent characters to find the name of the interpreter.

The `#!` convention in Unix is the main reason that most scripting languages use `#` as the opening comment delimiter. Early versions of `sh` used the `no-op` command `(:)` as a way to introduce comments. Joy’s C shell introduced `#`, whereupon some versions of `sh` were modified to launch `csh` when asked to execute a script that appeared to begin with a C shell comment. This mechanism evolved into the more general mechanism used in many (though not all) variants of Unix today.

```

# label (target for branch):
:top
/\<[hH] [123]>.*<\/[hH] [123]>/ {           ;# match whole heading
    h                                       ;# save copy of pattern space
    s/\(<\/[hH] [123]>\).*$/\1/             ;# delete text after closing tag
    s/^\.*\(<[hH] [123]>\)/\1/             ;# delete text before opening tag
    p                                       ;# print what remains
    g                                       ;# retrieve saved pattern space
    s/<\/[hH] [123]>\/\/                     ;# delete closing tag
    b top
}                                           ;# and branch to top of script
/\<[hH] [123]>/ {                               ;# match opening tag (only)
    N                                       ;# extend search to next line
    b top
}                                           ;# and branch to top of script
d                                           ;# if no match at all, delete

```

Figure 13.1 Script in `sed` to extract headers from an HTML file. The script assumes that opening and closing tags are properly matched, and that headers do not nest.

13.2.2 Text Processing and Report Generation

Shell languages tend to be heavily string-oriented. Commands are strings, parsed into lists of words. Variables are string-valued. Variable expansion mechanisms allow the user to extract prefixes, suffixes, or arbitrary substrings. Concatenation is indicated by simple juxtaposition. There are elaborate quoting conventions. Few more conventional languages have similar support for strings.

At the same time, shell languages are clearly not intended for the sort of text manipulation commonly performed in editors like `emacs` or `vi`. Search and substitution, in particular, are missing, and many other tasks that editors accomplish with a single keystroke—insertion, deletion, replacement, bracket matching, forward and backward motion—would be awkward to implement, or simply make no sense, in the context of the shell. For repetitive text manipulation it is natural to want to automate the editing process. Tools to accomplish this task constitute the second principal class of ancestors for modern scripting languages.

Sed

EXAMPLE 13.17

Extracting HTML headers
with `sed`

As a simple text processing example, consider the problem of extracting all headers from a web page (an HTML file). These are strings delimited by `<H1> ... </H1>`, `<H2> ... </H2>`, and `<H3> ... </H3>` tags. Accomplishing this task in an editor like `emacs`, `vi`, or even Microsoft Word is straightforward but tedious: one must search for an opening tag, delete preceding text, search for a closing tag, mark the current position (as the starting point for the next deletion), and repeat. A program to perform these tasks in `sed`, the Unix “stream editor,” appears in [Figure 13.1](#). The code consists of a label and three commands, the first two of which are compound. The first compound command prints the first header, if

any, found in the portion of the input currently being examined (what `sed` calls the *pattern space*). The second compound command appends a new line to the pattern space whenever it already contains a header-opening tag. Both compound commands, and several of the subcommands, use regular expression patterns, delimited by slashes. We will discuss these patterns further in [Section 13.4.2](#). The third command (the lone `d`) simply deletes the current line. Because each compound command ends with a branch back to the top of the script, the second will execute only if the first does not, and the delete will execute only if neither compound does. ■

The editor heritage of `sed` is clear in this example. Commands are generally one character long, and there are no variables—no state of any kind beyond the program counter and text that is being edited. These limitations make `sed` best suited to “one-line programs,” typically entered verbatim from the keyboard with the `-e` command-line switch. The following, for example, will read from standard input, delete blank lines, and (implicitly) print the nonblank lines to standard output:

EXAMPLE 13.18

One-line scripts in `sed`

```
sed -e '/^[[:space:]]*$/d'
```

Here `^` represents the beginning of the line and `$` represents the end. The `[[:space:]]` expression matches any white-space character in the local character set, to be repeated an arbitrary number of times, as indicated by the Kleene star (`*`). The `d` indicates deletion. Nondeleted lines are printed by default. ■

Awk

In an attempt to address the limitations of `sed`, Alfred Aho, Peter Weinberger, and Brian Kernighan designed `awk` in 1977 (the name is based on the initial letters of their last names). `Awk` is in some sense an evolutionary link between stream editors like `sed` and full-fledged scripting languages. It retains `sed`'s line-at-a-time filter model of computation, but allows the user to escape this model when desired, and replaces single-character editing commands with syntax reminiscent of C. `Awk` provides (typeless) variables and a variety of control-flow constructs, including subroutines.

An `awk` program consists of a sequence of *patterns*, each of which has an associated *action*. For every line of input, the interpreter executes, in order, the actions whose patterns evaluate to true. An example with a single pattern-action pair appears in [Figure 13.2](#). It performs essentially the same task as the `sed` script of [Figure 13.1](#). Lines that contain no opening tag are ignored. In a line with an opening tag, we delete any text that precedes the header. We then print lines until we find the closing tag, and repeat if there is another opening tag on the same line. We fall back into the interpreter's main loop when we're cleanly outside any header.

Several conventions can be seen in this example. The current input line is available in the pseudovariable `$0`. The `getline` function reads into this variable by

EXAMPLE 13.19

Extracting HTML headers with `awk`

```

/<[hH][123]>/ {
  # execute this block if line contains an opening tag
  do {
    open_tag = match($0, /<[hH][123]>/)
    $0 = substr($0, open_tag)      # delete text before opening tag
                                   # $0 is the current input line
    while (!/<\/[hH][123]>/) {     # print interior lines
      print                        #   in their entirety
      if (getline != 1) exit
    }
    close_tag = match($0, /<\/[hH][123]>/) + 4

    print substr($0, 0, close_tag) # print through closing tag
    $0 = substr($0, close_tag + 1) # delete through closing tag
  } while (/<[hH][123]>/)        # repeat if more opening tags
}

```

Figure 13.2 Script in `awk` to extract headers from an HTML file. Unlike the `sed` script, this version prints interior lines incrementally. It again assumes that the input is well formed.

default. The `substr(s, a, b)` function extracts the portion of string `s` starting at position `a` and with length `b`. If `b` is omitted, the extracted portion runs to the end of `s`. Conditions, like patterns, can use regular expressions; we can see an example in the `do...while` loop. By default, regular expressions match against `$0`. ■

Perhaps the two most important innovations of `awk` are *fields* and *associative arrays*, neither of which appears in Figure 13.2. Like the shell, `awk` parses each input line into a series of words (fields). By default these are delimited by white space, though the user can change this behavior dynamically by assigning a regular expression to the built-in variable `FS` (field separator). The fields of the current input line are available in the pseudovariables `$1`, `$2`, `...`. The built-in variable `NR` gives the total number of fields. `Awk` is frequently used for field-based one-line programs. The following, for example, will print the second word of every line of standard input:

```
awk '{print $2}'
```

EXAMPLE 13.20

Fields in `awk`

EXAMPLE 13.21

Capitalizing a title in `awk`

Associative arrays will be considered in more detail in Section 13.4.3. Briefly, they combine the functionality of hash tables with the syntax of arrays. We can illustrate both fields and associative arrays with an example script (Figure 13.3) that capitalizes each line of its input as if it were a title. The script declines to modify “noise” words (articles, conjunctions, and short prepositions) unless they are the first word of the title or of a subtitle, where a subtitle follows a word ending with a colon or a dash. The script also declines to modify words in which any letter other than the first is already capitalized. ■

```

BEGIN {
    # "noise" words
    nw["a"] = 1;    nw["an"] = 1;    nw["and"] = 1;    nw["but"] = 1
    nw["by"] = 1;  nw["for"] = 1;    nw["from"] = 1;  nw["in"] = 1
    nw["into"] = 1; nw["nor"] = 1;    nw["of"] = 1;    nw["on"] = 1
    nw["or"] = 1;  nw["over"] = 1;   nw["the"] = 1;   nw["to"] = 1
    nw["via"] = 1; nw["with"] = 1
}
{
    for (i=1; i <= NF; i++) {
        if ((!nw[$i] || i == 0 || $(i-1)~/[:-$]/) && ($i !~/.[A-Z]/)){
            # capitalize
            $i = toupper(substr($i, 1, 1)) substr($i, 2)
        }
        printf $i " ";    # don't add trailing line feed
    }
    printf "\n";
}

```

Figure 13.3 Script in `awk` to capitalize a title. The `BEGIN` block is executed before reading any input lines. The main block has no explicit pattern, so it is applied to every input line.

Perl

Perl was originally developed by Larry Wall in 1987, while he was working at the National Security Agency. The original version was, to first approximation, an attempt to combine the best features of `sed`, `awk`, and `sh`. It was a Unix-only tool, meant primarily for text processing (the name stands for “practical extraction and report language”). Over the years Perl has grown into a large and complex language, with an enormous user community. Though it is hard to judge such things, Perl is almost certainly the most popular and widely used scripting language. It is also fast enough for much general-purpose use, and includes separate compilation, modularization, and dynamic library mechanisms appropriate for large-scale projects. It has been ported to almost every known operating system.

Perl consists of a relatively simple language core, augmented with an enormous number of built-in library functions and an equally enormous number of shortcuts and special cases. A hint at this richness of expression can be found in the standard language reference [WCO00, p. 622], which lists (only) the 97 built-in functions “whose behavior varies the most across platforms.” The cover of the book is emblazoned with the language motto: “There’s more than one way to do it.”

We will return to Perl several times in this chapter, notably in [Sections 13.2.4](#) and [13.4](#). For the moment we content ourselves with a simple text-processing example, again to extract headers from an HTML file ([Figure 13.4](#)). We can see several Perl shortcuts in this figure, most of which help to make the code shorter than the equivalent programs in `sed` ([Figure 13.1](#)) and `awk` ([Figure 13.2](#)). Angle brackets (`<>`) are the “readline” operator, used for text file input. Normally they surround a *file handle* variable name, but as a special case, empty angle brackets

EXAMPLE 13.22

Extracting HTML headers with Perl

```

while (>) {
    next if !/<[hH] [123]>/;
    while (!/<\[/[hH] [123]>/) { $_ .= <> ; }
    s/.*?([hH] [123]).*?<\[/[hH] [123]>)//s;
    # perform minimal matching; capture parenthesized expression in $1
    print $1, "\n";
    redo unless eof;
}

```

Figure 13.4 Script in Perl to extract headers from an HTML file. For simplicity we have again adopted the strategy of buffering entire headers, rather than printing them incrementally.

generate as input the concatenation of all files specified on the command line when the script was first invoked (or standard input, if there were no such files). When a readline operator appears by itself in the control expression of a `while` loop (but nowhere else in the language), it generates its input a line at a time into the pseudovariable `$_`. Several other operators work on `$_` by default. Regular expressions, for example, can be used to search within arbitrary strings, but when none is specified, `$_` is assumed.

The `next` statement is similar to `continue` in C or Fortran: it jumps to the bottom of the innermost loop and begins the next iteration. The `redo` statement also skips the remainder of the current iteration, but returns to the top of the loop, *without* reevaluating the control expression. In our example program, `redo` allows us to append additional input to the current line, rather than reading a new line. Because end-of-file is normally detected by an undefined return value from `<>`, and because that failure will happen only once per file, we must explicitly test for `eof` when using `redo` here. Note that `if` and its symmetric opposite, `unless`, can be used as either a prefix or a postfix test.

Readers familiar with Perl may have noticed two subtle but key innovations in the substitution command of line 4 of the script. First, where the expression `.*` (in `sed`, `awk`, and Perl) matches the longest possible string of characters that permits subsequent portions of the match to succeed, the expression `.*?` in Perl matches the *shortest* possible such string. This distinction allows us to easily isolate the first header in a given line. Second, much as `sed` allows later portions of a regular expression to refer back to earlier, parenthesized portions (line 4 of Figure 13.1), Perl allows such *captured* strings to be used *outside* the regular expression. We have leveraged this feature to print matched headers in line 6 of Figure 13.4. In general, the regular expressions of Perl are significantly more powerful than those of `sed` and `awk`; we will return to this subject in more detail in Section 13.4.2. ■

13.2.3 Mathematics and Statistics

As we noted in our discussions of `sed` and `awk`, one of the distinguishing characteristics of text processing and report generation is the frequent use of “one-line

programs” and other simple scripts. Anyone who owns a programmable calculator realizes that similar needs arise in mathematics and statistics. And just as shell and report generation tools have evolved into powerful languages for general-purpose computing, so too have notations and tools for mathematical and statistical computing.

In [Section 7.4.1](#) we mentioned APL, one of the more unusual languages of the 1960s. Originally conceived as a pen-and-paper notation for teaching applied mathematics, APL retained its emphasis on the concise, elegant expression of mathematical algorithms when it evolved into a programming language. Though it lacks both easy access to other programs and sophisticated string manipulation, APL displays all the other characteristics of scripting described in [Section 13.1.1](#), and one sometimes finds it listed as a scripting language.

The modern successors to APL include a trio of commercial packages for mathematical computing: Maple, Mathematica, and Matlab. Though their design philosophies differ, each provides extensive support for numerical methods, symbolic mathematics (formula manipulation), data visualization, and mathematical modeling. All three provide powerful scripting languages, with a heavy orientation toward scientific and engineering applications.

As the “3 Ms” are to mathematical computing, so the S and R languages are to statistical computing. Originally developed at Bell Labs by John Chambers and colleagues in the late 1970s, S is a commercial package widely used in the statistics community and in quantitative branches of the social and behavioral sciences. R is an open-source alternative to S that is largely though not entirely compatible with its commercial cousin. Among other things, R supports multidimensional array and list types, array slice operations, user-defined infix operators, call-by-need parameters, first-class functions, and unlimited extent.

13.2.4 “Glue” Languages and General-Purpose Scripting

From their text-processing ancestors, scripting languages inherit a rich set of pattern matching and string manipulation mechanisms. From command interpreter shells they inherit a wide variety of additional features including simple syntax; flexible typing; easy creation and management of subprograms, with I/O redirection and access to completion status; file queries; easy interactive and file-based I/O; easy access to command-line arguments, environment strings, process identifiers, time-of-day clock, and so on; and automatic interpreter start-up (the #! convention). As noted in [Section 13.1.1](#), many scripting languages have interpreters that will accept commands interactively.

The combination of shell- and text-processing mechanisms allows a scripting language to prepare input to, and parse output from, subsidiary processes. As a simple example, consider the (Unix-specific) “force quit” Perl script shown in [Figure 13.5](#). Invoked with a regular expression as argument, the script identifies all of the user’s currently running processes whose name, process id, or command-line arguments match that regular expression. It prints the information for each, and prompts the user for an indication of whether the process should be killed.

EXAMPLE 13.23

“Force quit” script in Perl

```

$#ARGV == 0 || die "usage: $0 pattern\n";
open(PS, "ps -w -w -x -o'pid,command' |"); # 'process status' command
<PS>; # discard header line
while (PS>) {
    @words = split; # parse line into space-separated words
    if (/ $ARGV[0]/i && $words[0] ne $$) {
        chomp; # delete trailing newline
        print;
        do {
            print "? ";
            $answer = <STDIN>;
        } until $answer =~ /^[yn]/i;
        if ($answer =~ /y/i) {
            kill 9, $words[0]; # signal 9 in Unix is always fatal
            sleep 1; # wait for 'kill' to take effect
            die "unsuccessful; sorry\n" if kill 0, $words[0];
        } # kill 0 tests for process existence
    }
}

```

Figure 13.5 Script in Perl to “force quit” errant processes. Perl’s text processing features allow us to parse the output of `ps`, rather than filtering it through an external tool like `sed` or `awk`.

The second line of the code starts a subsidiary process to execute the Unix `ps` command. The command-line arguments cause `ps` to print the process id and name of all processes owned by the current user, together with their full command-line arguments. The pipe symbol (`|`) at the end of the command indicates that the output of `ps` is to be fed to the script through the `PS` file handle. The main `while` loop then iterates over the lines of this output. Within the loop, the `if` condition matches each line against `$ARGV[0]`, the regular expression provided on the script’s command line. It also compares the first word of the line (the process id) against `$$`, the id of the Perl interpreter currently running the script.

Scalar variables (which in Perl include strings) begin with a dollar sign (`$`). Arrays begin with an at sign (`@`). In the first line of the `while` loop in [Figure 13.5](#), the input line (`$_`, implicitly) is split into space-separated words, which are then assigned into the array `@words`. In the following line, `$words[0]` refers to the first element of this array, a scalar. A single variable name may have different values when interpreted as a scalar, an array, a hash table, a subroutine, or a file handle. The choice of interpretation depends on the leading punctuation mark and on the *context* in which the name appears. We shall have more to say about context in Perl in [Section 13.4.3](#). ■

Beyond the combination of shell- and text-processing mechanisms, the typical glue language provides an extensive library of built-in operations to access features of the underlying operating system, including files, directories, and I/O; processes and process groups; protection and authorization; interprocess communication and synchronization; timing and signals; and sockets, name service, and network

communication. Just as text-processing mechanisms minimize the need to employ external tools like `sed`, `awk`, and `grep`, operating system built-ins minimize the need for other external tools.

At the same time, scripting languages have, over time, developed a rich set of features for internal computation. Most have significantly better support for mathematics than is typically found in a shell. Several, including Scheme, Python, and Ruby, support arbitrary precision arithmetic. Most provide extensive support for higher-level types, including arrays, strings, tuples, lists, and hashes (associative arrays). Several support classes and object orientation. Some support iterators, continuations, threads, reflection, and first-class and higher-order functions. Some, including Perl, Tcl, Python, and Ruby, support modules and dynamic loading, for “programming in the large.” These features serve to maximize the amount of code that can be written in the scripting language itself, and to minimize the need to escape to a more traditional, compiled language.

In summary, the philosophy of general-purpose scripting is make it as easy as possible to construct the overall framework of a program, escaping to external tools only for special-purpose tasks, and to compiled languages only when performance is at a premium.

Tcl

Tcl was originally developed in the late 1980s by Prof. John Ousterhout of the University of California, Berkeley. Over the previous several years his group had developed a suite of VLSI design automation tools, each of which had its own idiosyncratic command language. The initial motivation for Tcl (“tool command language”) was the desire for an *extension language* that could be embedded in all the tools, providing them with uniform command syntax and reducing the complexity of development and maintenance. Tk, a set of extensions for graphical user interface programming, was added to Tcl early in its development, and both Tcl and Tk were made available to other researchers starting in 1990. The user community grew rapidly in the 1990s, and Tcl quickly evolved beyond its emphasis on command extension to encompass “glue” applications as well. Ousterhout joined Sun Microsystems in 1994, where for three years he led a multiperson team devoted to Tcl development. In 1997 he launched a start-up company specializing in Tcl applications and tools.

In comparison to Perl, Tcl is somewhat more verbose. It makes less use of punctuation, and has fewer special cases. Everything in the language, including control-flow constructs, takes the form of a (possibly quoted) *command* (an identifier) followed by a series of arguments. In the spirit of Unix command-line invocation, the first few, optional arguments typically begin with a minus sign (-) and are known as “switches.”

A simple Tcl script, equivalent to the Perl script of [Figure 13.5](#), appears in [Figure 13.6](#). The `set` command is an assignment; it copies the value of its second argument into the variable named by the first argument. In most other contexts a variable name needs to be preceded by a dollar sign (\$); as in shell languages, this indicates that the value of the variable should be expanded in-line. (Note the

EXAMPLE 13.24

“Force quit” script in Tcl

```

if {$argc != 1} {puts stderr "usage: $argv0 pattern"; exit 1}
set PS [open "|/bin/ps -w -w -x -opid,command" r]

gets $PS                                     ;# discard header line
while {! [eof $PS]} {
    set line [gets $PS]                       ;# returns blank line at eof
    regexp {[0-9]+} $line proc
    if {[regexp [lindex $argv 0] $line] && [expr $proc != [pid]]} {
        puts -nonewline "$line? "
        flush stdout                         ;# force prompt out to screen
        set answer [gets stdin]
        while {! [regexp -nocase {^[yn]} $answer]} {
            puts -nonewline "? "
            flush stdout
            set answer [gets stdin]
        }
        if {[regexp -nocase {^y} $answer]} {
            set stat [catch {exec kill -9 $proc}]
            exec sleep 1
            if {$stat || ![catch {exec ps -p $proc}]} {
                puts stderr "unsuccessful; sorry"; exit 1
            }
        }
    }
}
}

```

Figure 13.6 Script in Tcl to “force quit” errant processes. Compare to the Perl script of Figure 13.5.

contrast to Perl, in which the dollar sign indicates scalar type, and must appear even when the variable is used as an l-value.) As in most scripting languages, variables in Tcl need not be declared.

Double quote marks (as in "\$line? ") behave in the familiar way: variable references inside are expanded before the string is used. Braces ({ }) work much as the single quotes of shell languages or Perl: they inhibit internal expansion. Brackets ([]) are a bit like traditional backquotes, but instead of interpreting the enclosed string as a program name and arguments, they interpret that string as a Tcl script, whose output should be expanded in place of the bracketed string. In the header of the while loop of Figure 13.6, the eof command returns a 1 or a 0, which is then interpreted as true or false. Like \$-prefixed variable names, bracketed expressions are expanded inside double quotes and brackets, but not inside braces.

In the third line of the while loop there are two pairs of nested brackets. The expression [lindex \$argv 0] returns the first element of the list \$argv (the one with index zero). This is the pattern specified on the command line of the script. It is passed as the first argument to the regexp command, along with the current line of output from the ps program. The regexp command in turn returns a

1 or a 0, depending on whether the pattern could be found within the line. The `expr` command interprets its remaining arguments as an arithmetic/logical expression with infix operators. The `pid` command returns the process id of the Tcl interpreter currently running the script. To facilitate the use of infix notation in conditions, the first argument to the `if` and `while` commands is automatically passed to `expr`.

Multiple Tcl commands can be written on a single line, so long as they are separated by semicolons. A newline character terminates the current command unless it is escaped with a backslash (`\`) or appears within a brace-quoted string. Control structures like `if` and `while` can thus span multiple lines so long as the nested commands are enclosed in braces, and the opening brace appears on the same line as the condition. All variables and arguments, including nested bracketed scripts, are represented internally as character strings. Moreover arguments are expanded and evaluated lazily, so `if` and `while` behave as one would expect. The sharp character (`#`) introduces a comment, but as in `sed` (and in contrast to most programming languages) this is permitted only where a command might otherwise appear. In particular, a comment that follows a command on the same line of the script must be separated from the command by a semicolon.

The `exec` command interprets its remaining arguments as the name and arguments of an external program; it executes that program and returns its output. Many functions that are built into Perl must be invoked as external programs in Tcl; the `kill` and `sleep` functions of [Figures 13.5](#) and [13.6](#) are two examples. The `catch` command executes the nested `exec` in a protected environment that produces no error messages, but returns a status code that can be inspected later (nonzero indicates error). The second use of `catch` (for `ps -p $proc`) checks for process existence.

Python

As noted in [Section 13.1](#), Rexx is generally considered the first of the general-purpose scripting languages, predating Perl and Tcl by almost a decade. Perl and Tcl are roughly contemporaneous: both were initially developed in the late 1980s. Perl was originally intended for glue and text-processing applications. Tcl was originally an extension language, but soon grew into glue applications as well. As the popularity of scripting grew in the 1990s, users were motivated to develop additional languages, to provide additional features, address the needs of specific application domains (more on this in subsequent sections), or support a style of programming more in keeping with the personal taste of their designers.

Python was originally developed by Guido van Rossum at CWI in Amsterdam, the Netherlands, in the early 1990s. He continued his work at CNRI in Reston, Virginia, beginning in 1995. After a series of subsequent moves, he joined Google in 2005. Recent versions of the language are owned by the Python Software Foundation. All releases are open source.

EXAMPLE 13.25

“Force quit” script in Python

[Figure 13.7](#) presents a Python version of our “force quit” program. Reflecting the maturation of programming language design, Python was from the beginning

```

import sys, os, re, time
if len(sys.argv) != 2:
    sys.stderr.write('usage: ' + sys.argv[0] + ' pattern\n')
    sys.exit(1)

PS = os.popen("/bin/ps -w -w -x -o'pid,command'")
line = PS.readline()           # discard header line
line = PS.readline().rstrip()  # prime pump
while line != "":
    proc = int(re.search('\S+', line).group())
    if re.search(sys.argv[1], line) and proc != os.getpid():
        print line + '? ',
        answer = sys.stdin.readline()
        while not re.search('^[yn]', answer, re.I):
            print '? ',          # trailing comma inhibits newline
            answer = sys.stdin.readline()
        if re.search('~y', answer, re.I):
            os.kill(proc, 9)
            time.sleep(1)
        try:
            os.kill(proc, 0)     # expect exception if process
                                # no longer exists
            sys.stderr.write("unsuccessful; sorry\n"); sys.exit(1)
        except: pass           # do nothing
        sys.stdout.write('')    # inhibit prepended blank on next print
    line = PS.readline().rstrip()

```

Figure 13.7 Script in Python to “force quit” errant processes. Compare to [Figures 13.5](#) and [13.6](#).

an object-oriented language.⁴ It includes a standard library as rich as that of Perl, but partitioned into a collection of namespaces reminiscent of those of C++, Java, or C#. The first line of our script imports symbols from the `sys`, `os`, `re`, and `time` library modules. The fifth line launches `ps` as an external program, and ties its output to the file object `PS`. In standard object-oriented style, `readline` is then invoked as a method of this object.

Perhaps the most distinctive feature of Python, though hardly the most important, is its reliance on indentation for syntactic grouping. We have already seen that Tcl uses linebreaks to separate commands. Python does so also, and further specifies that the body of a structured statement consists of precisely those subsequent statements that are indented one more tab stop. Like the “more than one way to do it” philosophy of Perl, Python’s use of indentation tends to arouse strong feelings among users: some strongly positive, some strongly negative.

4 Rexx and Tcl have object-oriented extensions, named Object Rexx and Incr Tcl, respectively. Perl 5 includes some (rather awkward) object-oriented features; Perl 6 will have more uniform object support.

The regular expression (`re`) library has all of the power available in Perl, but employs the somewhat more verbose syntax of method calls, rather than the built-in notation of Perl. The `search` routine returns a “match object” that captures, lazily, the places in the string at which the pattern appears. If no match is found, `search` returns `None`, the empty object, instead. In a condition, `None` is interpreted as `false`, while a true match object is interpreted as `true`. The match object in turn supports a variety of methods, including `group`, which returns the substring corresponding to the first match. The `re.I` flag to `search` indicates case insensitivity. Note that `group` returns a string. Unlike Perl and Tcl, Python will not coerce this to an integer—hence the need for the explicit type conversion on the first line of the body of the `while` loop.

As in Perl (and in contrast to Tcl), the `readline` method does not remove the newline character at the end of an input line; we use the `rstrip` method to do this. The `print` routine adds a newline to the end of its argument list unless that list ends with a trailing comma. The `print` routine also prepends a space to its output unless a set of well-defined heuristics indicate that the output will appear at the beginning of a line. The `write` of a null string at the bottom of the `while` loop serves to defeat these heuristics in the wake of the user’s input, avoiding a spurious blank at the beginning of the next process prompt.

The `sleep` and `kill` routines are built into Python, much as they are in Perl. When given a signal number of 0, `kill` tests for process existence. Instead of returning a status code, however, as it does in Perl, the Python `kill` throws an exception if the process does not exist. We use a `try` block to catch this exception in the expected case. ■

While our “force quit” program may convey, at least in part, the “feel” of various languages, it cannot capture the breadth of their features. Python includes many of the more interesting features discussed in earlier chapters, including nested functions with static scoping, lambda expressions and higher-order functions, true iterators, list comprehensions, array slice operations, reflection, structured exception handling, multiple inheritance, and modules and dynamic loading.

Ruby

Ruby is the newest of the widely used glue languages. It was developed in Japan in the early 1990s by Yukihiro “Matz” Matsumoto. Matz writes that he “wanted a language more powerful than Perl, and more object-oriented than Python” [TFH04, Foreword]. The first public release was made available in 1995, and quickly gained widespread popularity in Japan. With the publication in 2001 of English-language documentation [TFH04, 1st ed.], Ruby spread rapidly elsewhere as well. Much of its recent success can be credited to the Ruby on Rails web-development framework. Originally released by David Heinemeier Hansson in 2004, Rails has been adopted by several major players—notably Apple, which included it in the 10.5 “Leopard” release of the Mac OS.

In keeping with Matz’s original motivation, Ruby is a pure object-oriented language, in the sense of Smalltalk: everything—even instances of built-in

EXAMPLE 13.26

Method call syntax in Ruby

```

ARGV.length() == 1 or begin
  $stderr.print("usage: #{$0} pattern\n"); exit(1)
end

pat = Regexp.new(ARGV[0])
IO.popen("ps -w -w -x -o'pid,command'") {|PS|
  PS.gets # discard header line
  PS.each {|line|
    proc = line.split[0].to_i
    if line =~ pat and proc != Process.pid then
      print line.chomp
      begin
        print "? "
        answer = $stdin.gets
      end until answer =~ /^[yn]/i
      if answer =~ /^y/i then
        Process.kill(9, proc)
        sleep(1)
        begin # expect exception (process gone)
          Process.kill(0, proc)
          $stderr.print("unsuccessful; sorry\n"); exit(1)
        rescue # handler -- do nothing
        end
      end
    end
  }
}

```

Figure 13.8 Script in Ruby to “force quit” errant processes. Compare to Figures 13.5, 13.6, and 13.7.

types—is an object. Integers have more than 25 built-in methods. Strings have more than 75. Smalltalk-like syntax is even supported: `2 * 4 + 5` is syntactic sugar for `(2.*(4)).+(5)`, which is in turn equivalent to `(2.send('* ', 4)).send('+ ', 5)`.⁵ ■

EXAMPLE 13.27

“Force quit” script in Ruby

Figure 13.8 presents a Ruby version of our “force quit” program. As in Tcl, a newline character serves to end the current statement, but indentation is not significant. A dollar sign (\$) at the beginning of an identifier indicates a global name. Though it doesn’t appear in this example, an at sign (@) indicates an instance variable of the current object. Double at signs (@@) indicate an instance variable of the current *class*.

5 Parentheses here are significant. Infix arithmetic follows conventional precedence rules, but method invocation proceeds from left to right. Likewise, parentheses can be omitted around argument lists, but the method-selecting dot (.) groups more tightly than the argument-separating comma (,), so `2.send '* ', 4.send '+ ', 5` evaluates to 18, not 13.

Probably the most distinctive feature of [Figure 13.8](#) is its use of *blocks* and iterators. The `IO.popen` class method takes as argument a string that specifies the name and arguments of an external program. The method also accepts, in a manner reminiscent of Smalltalk, an *associated block*, specified as a multiline fragment of Ruby code delimited with curly braces. This block is invoked by `popen`, passing as parameter a file handle (an object of class `IO`) that represents the output of the external command. The `|PS|` at the beginning of the block specifies the name by which this handle is known within the block. In a similar vein, the `each` method of object `PS` is an iterator that invokes the associated block (the code in braces beginning with `|line|`) once for every line of data. For those more comfortable with traditional `for` loop syntax, the iterator can also be written

```
for line in PS
  ...
end
```

In addition to (true) iterators, Ruby provides continuations, first-class and higher-order functions, and closures with unlimited extent. Its *module* mechanism supports an extended form of mix-in inheritance. Though a class cannot inherit data members from a module, it *can* inherit code. Run-time type checking makes such inheritance more or less straightforward. Methods of modules that have not been explicitly included into the current class can be accessed as qualified names; `Process.kill` is an example in [Figure 13.8](#). Methods `sleep` and `exit` belong to module `Kernel`, which is included by class `Object`, and is thus available everywhere without qualification. Like `popen`, they are class methods, rather than instance methods; they have no notion of “current object.” Variables `stdin` and `stderr` refer to global objects of class `IO`.

Regular expression operations in Ruby are methods of class `Regexp`, and can be invoked with standard object-oriented syntax. For convenience, Perl-like notation is also supported as syntactic sugar; we have used this notation in [Figure 13.8](#).

The `rescue` clause of the innermost `begin...end` block is an exception handler. As in the Python code of [Figure 13.7](#), it allows us to determine whether the `kill` operation has succeeded by catching the (expected) exception that arises when we attempt to refer to a process after it has died. ■

13.2.5 Extension Languages

Most applications accept some sort of *commands*, which tell them what to do. Sometimes these commands are entered textually; more often they are triggered by user interface events such as mouse clicks, menu selections, and keystrokes. Commands in a graphical drawing program might save or load a drawing; select, insert, delete, or modify its parts; choose a line style, weight, or color; zoom or rotate the display; or modify user preferences.

An *extension language* serves to increase the usefulness of an application by allowing the user to create new commands, generally using the existing commands

as primitives. Extension languages are increasingly seen as an essential feature of sophisticated tools. Adobe's graphics suite (Illustrator, Photoshop, InDesign, etc.) can be extended (scripted) using JavaScript, Visual Basic (on Windows), or AppleScript (on the Mac). AOLserver, an open source web server from America Online, can be scripted using Tcl. Disney and Industrial Light & Magic use Python to extend their internal (proprietary) tools. Many commercially available packages, including AutoCAD, Maya, Director, and Flash have their own unique scripting languages. This list barely scratches the surface.

To admit extension, a tool must

- incorporate, or communicate with, an interpreter for a scripting language.
- provide hooks that allow scripts to call the tool's existing commands.
- allow the user to tie newly defined commands to user interface events.

With care, these mechanisms can be made independent of any particular scripting language. As we noted in the sidebar on page 651, Microsoft's Windows Script interface allows arbitrary languages to be used to script the operating system, web server, and browser. GIMP, the widely used GNU Image Manipulation Program, has a comparably general interface, and can be scripted in Scheme, Tcl, Python, and Perl, among others. There is a tendency, of course, for user communities to converge on a favorite language, to facilitate sharing of code. Microsoft tools are usually scripted with Visual Basic. GIMP is usually scripted with the SIOD dialect of Scheme. Adobe tools are usually scripted with Visual Basic on the PC, or AppleScript on the Mac.

One of the oldest existing extension mechanisms is that of the `emacs` text editor, used to write this book. An enormous number of extension packages have been created for `emacs`; many of them are installed by default in the standard distribution. In fact much of what users consider the editor's core functionality is actually provided by extensions; the truly built-in parts are comparatively small.

EXAMPLE 13.28

Numbering lines with
Emacs Lisp

The extension language for `emacs` is a dialect of Lisp called Emacs Lisp. An example script appears in [Figure 13.9](#). It assumes that the user has used the standard *marking* mechanism to select a region of text. It then inserts a line number at the beginning of every line in the region. The first line is numbered 1 by default, but an alternative starting number can be specified with an optional parameter. Line numbers are bracketed with a prefix and suffix that are "" (empty) and "" by default, but can be changed by the user if desired. To maintain existing alignment, small numbers are padded on the left with enough spaces to match the width of the number on the final line.

Many features of Emacs Lisp can be seen in this example. The `setq-default` command is an assignment that is visible in the current buffer (editing session) and in any concurrent buffers that haven't explicitly overridden the previous value. The `defun` command defines a new command. Its arguments are, in order, the command name, formal parameter list, documentation string, interactive specification, and body. The argument list for `number-region` includes the start and

```

(setq-default line-number-prefix "")
(setq-default line-number-suffix ") ")
(defun number-region (start end &optional initial)
  "Add line numbers to all lines in region.
With optional prefix argument, start numbering at num.
Line number is bracketed by strings line-number-prefix
and line-number-suffix (default \"\`\" and \"\`)\".")
  (interactive "*r\np") ; how to parse args when invoked from keyboard
  (let* ((i (or initial 1))
         (num-lines (+ -1 initial (count-lines start end)))
         (fmt (format "%%dd" (length (number-to-string num-lines))))
         ; yields "%1d", "%2d", etc. as appropriate
         (finish (set-marker (make-marker) end)))
    (save-excursion
      (goto-char start)
      (beginning-of-line)
      (while (< (point) finish)
        (insert line-number-prefix (format fmt i) line-number-suffix)
        (setq i (1+ i))
        (forward-line 1))
      (set-marker finish nil))))

```

Figure 13.9 Emacs Lisp function to number the lines in a selected region of text.

end locations of the currently marked region, and the optional initial line number. The documentation string is automatically incorporated into the on-line help system. The interactive specification controls how arguments are passed when the command is invoked through the user interface. (The command can also be called from other scripts, in which case arguments are passed in the conventional way.) The “*” raises an exception if the buffer is read-only. The “r” represents the beginning and end of the currently marked region. The “\n” separates the “r” from the following “p,” which indicates an optional numeric *prefix argument*. When the command is bound to a keystroke, a prefix argument of, say, 10 can be specified by preceding the keystroke with “C-u 10” (control-U 10).

As usual in Lisp, the `let*` command introduces a set of local variables in which later entries in the list (`fmt`) can refer to earlier entries (`num-lines`). A *marker* is an index into the buffer that is automatically updated to maintain its position when text is inserted in front of it. We create the `finish` marker so that newly inserted line numbers do not alter our notion of where the to-be-numbered region ends. We set `finish` to `nil` at the end of the script to relieve Emacs of the need to keep updating the marker between now and whenever the garbage collector gets around to reclaiming it.

The `format` command is similar to `sprintf` in C. We have used it, once in the declaration of `fmt` and again in the call to `insert`, to pad all line numbers out to an appropriate length. The `save-excursion` command is roughly equivalent to an exception handler (e.g., a Java `try` block) with a `finally` clause that restores the current focus of attention (`(point)`) and the borders of the marked region.

Our script can be supplied to `emacs` by including it in a personal start-up file (usually `~/.emacs`), by using the interactive `load-file` command to read some other file in which it resides, or by loading it into a buffer, placing the focus of attention immediately after it, and executing the interactive `eval-last-sexp` command. Once any of these has been done, we can invoke our command interactively by typing `M-x number-region <RET>` (meta-X, followed by the command name and the return key). Alternatively, we can *bind* our command to a keyboard shortcut:

```
(define-key global-map [?\C-#] 'number-region)
```

This one-line script, executed in any of the ways described above, binds our `number-region` command to the key combination “control-number-sign”. ■

✓ CHECK YOUR UNDERSTANDING

11. What is the most widely used scripting language?
 12. List the principal limitations of `sed`.
 13. What is meant by the *pattern space* in `sed`?
 14. Briefly describe the *fields* and *associative arrays* of `awk`.
 15. What is the Perl motto?
 16. Explain the special relationship between `while` loops and file handles in Perl. What is the meaning of the empty file handle, `<>`?
 17. Name three widely used commercial packages for mathematical computing.
 18. List several distinctive features of the R statistical scripting language.
 19. Explain the meaning of the `$` and `@` characters at the beginning of variable names in Perl. Explain the different meaning for the `$` sign in Tcl, and the still different meanings of `$`, `@`, and `@@` in Ruby.
 20. Describe the semantics of braces (`{ }`) and square brackets (`[]`) in Tcl.
 21. Which of the languages described in [Section 13.2.4](#) uses indentation to control syntactic grouping?
 22. List several distinctive features of Python.
 23. Describe, briefly, how Ruby uses *blocks* and *iterators*.
 24. What capabilities must a scripting language provide in order to be used for extension?
 25. Name several commercial tools that use extension languages.
-

13.3 Scripting the World Wide Web

Much of the content of the World Wide Web—particularly the content that is visible to search engines—is static: pages that seldom, if ever, change. But hypertext, the abstract notion on which the Web is based, was always conceived as a way to represent “the complex, the changing, and the indeterminate” [Nel65]. Much of the power of the Web today lies in its ability to deliver pages that move, play sounds, respond to user actions, or—perhaps most important—contain information created or formatted on demand, in response to the page-fetch request.

From a programming languages point of view, simple playback of recorded audio or video is not particularly interesting. We therefore focus our attention here on content that is generated on the fly by a program—a script—associated with an Internet URI (uniform resource identifier).⁶ Suppose we type a URI into a browser on a client machine, and the browser sends a request to the appropriate web server. If the content is dynamically created, an obvious first question is: does the script that creates it run on the server or the client machine? These options are known as *server-side* and *client-side* web scripting, respectively.

Server-side scripts are typically used when the service provider wants to retain complete control over the content of the page, but can't (or doesn't want to) create the content in advance. Examples include the pages returned by search engines, Internet retailers, auction sites, and any organization that provides its clients with on-line access to personal accounts. Client-side scripts are typically used for tasks that don't need access to proprietary information, and are more efficient if executed on the client's machine. Examples include interactive animation, error-checking of fill-in forms, and a wide variety of other self-contained calculations.

13.3.1 CGI Scripts

The original mechanism for server-side web scripting is the Common Gateway Interface (CGI). A CGI script is an executable program residing in a special directory known to the web server program. When a client requests the URI corresponding to such a program, the server executes the program and sends its output back to the client. Naturally, this output needs to be something that the browser will understand—typically HTML.

CGI scripts may be written in any language available on the server's machine, though Perl is particularly popular: its string-handling and “glue” mechanisms are ideally suited to generating HTML, and it was already widely available during

⁶ The term “URI” is often used interchangeably with “URL” (uniform resource locator), but the World Wide Web Consortium distinguishes between the two. All URIs are hierarchical (multipart) names. URLs are one kind of URIs; they use a naming scheme that indicates where to find the resource. Other URIs can use other naming schemes.

```
#!/usr/bin/perl

print "Content-type: text/html\n\n";

$host = `hostname`; chop $host;
print "<HTML>\n<HEAD>\n<TITLE>Status of ", $host,
      "\n</TITLE>\n</HEAD>\n<BODY>\n";
print "<H1>", $host, "\n";
print "<PRE>\n", `uptime`, "\n", `who`;
print "</PRE>\n</BODY>\n</HTML>\n";
```

Figure 13.10 A simple CGI script in Perl. If this script is named `status.perl`, and is installed in the server's `cgi-bin` directory, then a user anywhere on the Internet can obtain summary statistics and a list of users currently logged in to the server by typing `hostname/cgi-bin/status.perl` into a browser window.

EXAMPLE 13.29

Remote monitoring with a CGI script

the early years of the Web. As a simple if somewhat artificial example, suppose we would like to be able to monitor the status of a server machine shared by some community of users. The Perl script in [Figure 13.10](#) creates a web page titled by the name of the server machine, and containing the output of the `uptime` and `who` commands (two simple sources of status information). The script's initial `print` command produces an HTTP message header, indicating that what follows is HTML. Sample output from executing the script appears in [Figure 13.11](#). ■

EXAMPLE 13.30

Adder web form with a CGI script

CGI scripts are commonly used to process on-line forms. A simple example appears in [Figure 13.12](#). The `FORM` element in the HTML file specifies the URI of the CGI script, which is invoked when the user hits the Submit button. Values previously entered into the `INPUT` fields are passed to the script either as a trailing part of the URI (for a `get`-type form) or on the standard input stream (for a `post`-type form, shown here).⁷ With either method, we can access the values using the `param` routine of the standard CGI Perl library, loaded at the beginning of our script. ■

13.3.2 Embedded Server-Side Scripts

Though widely used, CGI scripts have several disadvantages:

- The web server must launch each script as a separate program, with potentially significant overhead (though a CGI script compiled to native code can be very fast once running).
- Because the server has little control over the behavior of a script, scripts must generally be installed in a trusted directory by trusted system administrators; they cannot reside in arbitrary locations as ordinary pages do.

⁷ One typically uses `post` type forms for one-time requests. A `get` type form appears a little clumsier, because arguments are visibly embedded in the URI, but this gives it the advantage of repeatability: it can be “bookmarked” by client browsers.

```

<HTML>
<HEAD>
<TITLE>Status of sigma.cs.rochester.edu</TITLE>
</HEAD>
<BODY>
<H1>sigma.cs.rochester.edu</H1>
<PRE>
22:10 up 5 days, 12:50, 5 users, load averages: 0.40 0.37 0.31

scott console Feb 13 09:21
scott tty2 Feb 17 15:27
test tty3 Feb 18 17:10
test tty4 Feb 18 17:11
</PRE>
</BODY>
</HTML>

```

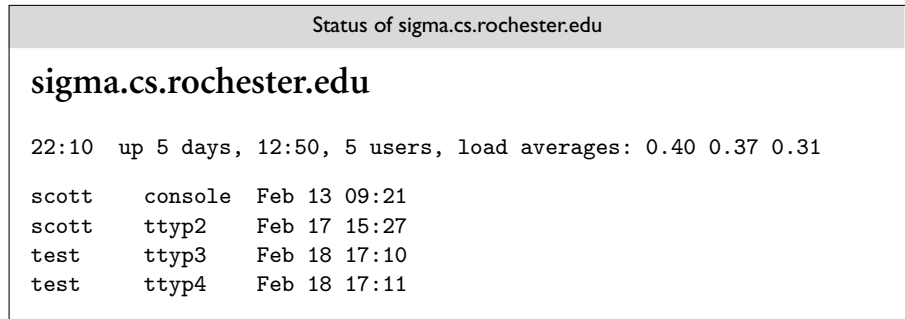

Figure 13.11 Sample output from the script of [Figure 13.10](#). HTML source appears at top; the rendered page is below.

- The name of the script appears in the URI, typically prefixed with the name of the trusted directory, so static and dynamic pages look different to end users.
- Each script must generate not only dynamic content, but also the HTML tags that are needed to format and display it. This extra “boilerplate” makes scripts more difficult to write.

To address these disadvantages, most web servers now provide a “module-loading” mechanism that allows interpreters for one or more scripting languages to be incorporated into the server itself. Scripts in the supported language(s) can then be embedded in “ordinary” web pages. The web server interprets such scripts directly, without launching an external program. It then replaces the scripts with the output they produce, before sending the page to the client. Clients have no way to even know that the scripts exist.

Embeddable server-side scripting languages include PHP, Visual Basic (in Microsoft Active Server Pages), Ruby, Cold Fusion (from Macromedia Corp.), and Java (via “Servlets” in Java Server Pages). The most common of these is

```

<HTML>
<HEAD>
<TITLE>Adder</TITLE>
</HEAD>
<BODY>
<FORM action="/cgi-bin/add.perl" method="post">
<P><INPUT name="argA" size=3>First addend<BR>
  <INPUT name="argB" size=3>Second addend
<P><INPUT type="submit">
</FORM>
</BODY>
</HTML>

```

Adder	
<input type="text" value="12"/>	First addend
<input type="text" value="34"/>	Second addend
<input type="submit" value="Submit"/>	

```

#!/usr/bin/perl

use CGI qw(:standard);      # provides access to CGI input fields
$argA = param("argA"); $argB = param("argB"); $sum = $argA + $argB;

print "Content-type: text/html\n\n";

print "<HTML>\n<HEAD>\n<TITLE>Sum</TITLE>\n</HEAD>\n<BODY>\n";
print "<P>$argA plus $argB is $sum";
print "</BODY>\n</HTML>\n";

```

```

<HTML>
<HEAD>
<TITLE>Sum</TITLE>
</HEAD>
<BODY>
<P>12 plus 34 is 46</BODY>
</HTML>

```

Sum
12 plus 34 is 46

Figure 13.12 An interactive CGI form. Source for the original web page is shown at the upper left, with the rendered page to the right. The user has entered 12 and 34 in the text fields. When the Submit button is pressed, the client browser sends a request to the server for URI `/cgi-bin/add.perl`. The values 12 and 13 are contained within the request. The Perl script, shown in the middle, uses these values to generate a new web page, shown in HTML at the bottom left, with the rendered page to the right.

PHP. Though descended from Perl, PHP has been extensively customized for its target domain, with built-in support for (among other things) email and MIME encoding, all the standard Internet communication protocols, authentication and security, HTML and URI manipulation, and interaction with dozens of database systems.

EXAMPLE 13.31

Remote monitoring with a PHP script

The PHP equivalent of Figure 13.10 appears in Figure 13.13. Most of the text in this figure is standard HTML. PHP code is embedded between `<?php` and `>` delimiters. These delimiters are not themselves HTML; rather they indicate a

```

<HTML>
<HEAD>
<TITLE>Status of <?php echo $host = chop('hostname') ?></TITLE>
</HEAD>
<BODY>
<H1><?php echo $host ?></H1>
<PRE>
<?php echo 'uptime', "\n", 'who' ?>
</PRE>
</BODY>
</HTML>

```

Figure 13.13 A simple PHP script embedded in a web page. When served by a PHP-enabled host, this page performs the equivalent of the CGI script of Figure 13.10.

```

<HTML><BODY><P>
<?php
    for ($i = 0; $i < 20; $i++) {
        if ($i % 2) { ?>
<B><?php
            echo " $i"; ?>
</B><?php
        } else echo " $i";
    }
?>
</BODY></HTML>

```

Figure 13.14 A fragmented PHP script. The `if` and `for` statements work as one might expect, despite the intervening raw HTML. When requested by a browser, this page displays the numbers from 0 to 19, with odd numbers written in bold.

processing instruction that needs to be executed by the PHP interpreter to generate replacement text. The “boilerplate” parts of the page can thus appear verbatim; they need not be generated by `print` (Perl) or `echo` (PHP) commands. Note that the separate script fragments are part of a single program. The `$host` variable, for example, is set in the first fragment and used again in the second. ■

EXAMPLE 13.32

A fragmented PHP script

PHP scripts can even be broken into fragments in the middle of structured statements. Figure 13.14 contains a script in which `if` and `for` statements span fragments. In effect, the HTML text between the end of one script fragment and the beginning of the next behaves as if it had been output by an `echo` command. Web designers are free to use whichever approach (`echo` or `escape` to raw HTML) seems most convenient for the task at hand. ■

Self-Posting Forms

EXAMPLE 13.33

Adder web form with a PHP script

By changing the `action` attribute of the FORM element, we can arrange for the Adder page of Figure 13.12 to invoke a PHP script instead of a CGI script:

```
<FORM action="add.php" method="post">
```

```

<HTML><HEAD><TITLE>Sum</TITLE></HEAD><BODY><P>
<?php
    $argA = $_REQUEST['argA']; $argB = $_REQUEST['argB'];
    $sum = $argA + $argB;
    echo "$argA plus $argB is $sum\n";
?>
</BODY></HTML>

<?php
    $argA = $_REQUEST['argA']; $argB = $_REQUEST['argB'];
    if (!isset($_REQUEST['argA']) || $argA == "" || $argB == "") {
        # form has not been posted, or arguments are incomplete
    }

    <HTML><HEAD><TITLE>Adder</TITLE></HEAD><BODY>
    <FORM action="adder.php" method="post">
    <P>First addend: <INPUT name="argA" size=3>
        Second addend: <INPUT name="argB" size=3>
    <P><INPUT type="submit">
    </FORM></BODY></HTML>

<?php
    } else { # form is complete; return results
    }

    <HTML><HEAD><TITLE>Sum</TITLE></HEAD><BODY><P>

<?php
    $sum = $argA + $argB;
    echo "$argA plus $argB is $sum\n";

?>

</BODY></HTML>

<?php
    }
?>

```

Figure 13.15 An interactive PHP web page. The script at top could be used in place of the script in the middle of [Figure 13.12](#). The lower script in the current figure replaces both the web page at the top and the script in the middle of [Figure 13.12](#). It checks to see if it has received a full set of arguments. If it hasn't, it displays the fill-in form; if it has, it displays results.

The PHP script itself is shown in the top half of [Figure 13.15](#). Form values are made available to the script in an associative array (hash table) named `_REQUEST`. No special library is required. ■

Because our PHP script is executed directly by the web server, it can safely reside in an arbitrary web directory, including the one in which the Adder page resides. In fact, by checking to see how a page was requested, we can merge the form and the script into a single page, and let it service its own requests! We illustrate this option in the bottom half of [Figure 13.15](#). ■

EXAMPLE 13.34
Self-posting Adder web
form

13.3.3 Client-Side Scripts

While embedded server-side scripts are generally faster than CGI scripts, at least when start-up cost predominates, communication across the Internet is still too slow for truly interactive pages. If we want the behavior or appearance of the page to change as the user moves the mouse, clicks, types, or hides or exposes windows, we really need to execute some sort of script on the client's machine.

Because they run on the web designer's site, CGI scripts and, to a lesser extent, embeddable server-side scripts can be written in many different languages. All the client ever sees is standard HTML. Client-side scripts, by contrast, require an interpreter on the client's machine. As a result, there is a powerful incentive for convergence in client-side scripting languages: most designers want their pages to be viewable by as wide an audience as possible. While Visual Basic is widely used within specific organizations, where all the clients of interest are known to run Internet Explorer, pages intended for the general public almost always use JavaScript for interactive features.

EXAMPLE 13.35

Adder web form in JavaScript

Figure 13.16 shows a page with embedded JavaScript that imitates (on the client) the behavior of the Adder scripts of Figures 13.12 and 13.15. Function `doAdd` is defined in the header of the page so it is available throughout. In particular, it will be invoked when the user clicks on the Calculate button. By default the input values are character strings; we use the `parseInt` function to convert them to integers. The parentheses around `(argA + argB)` in the final assignment statement then force the use of integer addition. The other occurrences of `+` are string concatenation. To disable the usual mechanism whereby input data are submitted to the server when the user hits the enter or return key, we have specified a dummy behavior for the `onsubmit` attribute of the form.

Rather than replace the page with output text, as our CGI and PHP scripts did, we have chosen in our JavaScript version to append the output at the bottom. The HTML `SPAN` element provides a named place in the document where this output can be inserted, and the `getElementById` JavaScript method provides us with a reference to this element. The HTML *Document Object Model (DOM)*, standardized by the World Wide Web Consortium, specifies a very large number of other elements, attributes, and user actions, all of which are accessible in JavaScript. Through them scripts can, at appropriate times, inspect or alter almost any aspect of the content, structure, or style of a page. ■

13.3.4 Java Applets

An applet is a program designed to run inside some other program. The term is most often used for Java programs that display their output in (a portion of) a web page. To support the execution of applets, most modern browsers contain a Java virtual machine.

Like JavaScript, Java applets can be used to create animated or interactive pages. Together with the similarity in language names, the fact that many tasks

```

<HTML>
<HEAD>
<TITLE>Adder</TITLE>
<SCRIPT type="text/javascript">
function doAdd() {
    argA = parseInt(document.adder.argA.value)
    argB = parseInt(document.adder.argB.value)
    x = document.getElementById('sum')
    while (x.hasChildNodes())
        x.removeChild(x.lastChild) // delete old content
    t = document.createTextNode(argA + " plus "
        + argB + " is " + (argA + argB))
    x.appendChild(t)
}
</SCRIPT>
</HEAD>
<BODY>
<FORM name="adder" onsubmit="return false">
<P><INPUT name="argA" size=3> First addend<BR>
    <INPUT name="argB" size=3> Second addend
<P><INPUT type="button" onclick="doAdd()" value="Calculate">
</FORM>
<P><SPAN id="sum"></SPAN>
</BODY>
</HTML>

```

Figure 13.16 An interactive JavaScript web page. Source appears at left. The rendered version on the right shows the appearance of the page after the user has entered two values and hit the Calculate button, causing the output message to appear. By entering new values and clicking again, the user can calculate as many sums as desired. Each new calculation will replace the output message.

can be accomplished with either mechanism has created a great deal of confusion between the two (see sidebar on page 688). In fact, however, they are very different.

EXAMPLE 13.36

Embedding an applet in a web page

To embed an applet in a web page, one would traditionally use an APPLET tag:

```
<APPLET width=150 height=150 code="Clock.class">
```

Seeing this element embedded in the page, the client browser would request the URI *Clock.class* from the server. Assuming the server returned an applet, it would run this applet and display the output on the page. ■

Unlike a JavaScript script, an applet does not produce HTML output for the browser to render. Rather it directly controls a portion of the page's real estate, in which it uses routines from one of Java's graphical user interface (GUI) libraries (typically AWT or Swing) to display whatever it wants. The *width* and *height* attributes of the APPLET element tell the browser how big the applet's portion of the page should be.

EXAMPLE 13.37

Embedding an object in a web page

In effect, applets allow the web designer to escape from HTML entirely, and to create a very precise “look and feel,” independent of any design choices embodied by the browser. Images, of course, provide another way to escape from HTML, with static or simple animated content, as do embedded objects of other kinds (movies in Flash or QuickTime format are popular examples). Most modern browsers provide a “plug-in” mechanism that allows the installation of interpreters for arbitrary formats. In support of these, the HTML 4.0 standard provides a generic OBJECT element that is meant to be used for any embedded content not rendered by the browser itself. The APPLET element is now officially deprecated:⁸ one is supposed to use the following instead:

```
<P><OBJECT codetype="application/java" classid="java:Clock.class"
width=150 height=150>
```

Applets are subject to certain restrictions intended to prevent them from damaging the client’s machine. For the most part, however, they can make use of the entire Java language, and it is usually a simple task to convert an applet to a stand-alone program or vice versa. The typical applet has no significant interaction with the browser or any other program. For this reason, applets are generally *not* considered a scripting mechanism.

DESIGN & IMPLEMENTATION

JavaScript and Java

Despite its name, JavaScript has no connection to Java beyond some superficial syntactic similarity. The language was originally developed by Brendan Eich at Netscape Corp. in 1995. Eich called his creation *LiveScript*, but the company chose to rename it as part of a joint marketing agreement with Sun Microsystems, prior to its public release. Trademark on the JavaScript name is actually owned by Sun.

Netscape’s browser was still the market leader in 1995, and JavaScript usage grew extremely fast. To remain competitive, developers at Microsoft added JavaScript support to Internet Explorer, but they used the name *JScript* instead, and they introduced a number of incompatibilities with the Netscape version of the language. A common version was standardized as *ECMAScript* by the European standards body in 1997 (and subsequently by the ISO), but major incompatibilities remained in the Document Object Models provided by different browsers. These have been gradually resolved through a series of standards from the World Wide Web Consortium, but legacy pages and legacy browsers continue to plague web developers.

⁸ A deprecated feature is one whose use is officially discouraged, but permitted on a temporary basis, to ease the transition to new and presumably better alternatives.

13.3.5 XSLT

Most readers will undoubtedly have had the opportunity to write, or at least to read, the HTML (hypertext markup language) used to compose web pages. HTML has, for the most part, a nested structure in which fragments of documents (*elements*) are delimited by *tags* that indicate their purpose or appearance. We saw in [Section 13.2.2](#), for example, that top-level headings are delimited with `<H1>` and `</H1>`. Unfortunately, as a result of the chaotic and informal way in which the web evolved, HTML ended up with many inconsistencies in its design, and incompatibilities among the versions implemented by different vendors.

XML (extensible markup language) is a more recent and general language in which to capture structured data. Compared to HTML, its syntax and semantics are more regular and consistent, and more consistently implemented across

DESIGN & IMPLEMENTATION

How far can you trust a script?

Security becomes an issue whenever code is executed using someone else's resources. Web servers are usually installed with very limited access rights, and with only a limited view of the file system of the server machine. This generally limits the set of pages they can serve to a well-defined subset of what would be visible to users logged in to the server machine directly. Because they are separate executable programs, CGI scripts can be designed to run with the privileges of whoever installed them. To prevent users on the server machine from accidentally or intentionally passing their privileges to arbitrary users on the Internet, most system administrators configure their servers so that CGI scripts must reside in a special directory, and be installed by a trusted user. Embedded server-side scripts can reside in any file because they are guaranteed to run with the (limited) rights of the server.

A larger risk is posed by code downloaded over the Internet and executed on a client machine. Because such code is in general untrusted, it must be executed in a carefully controlled environment, sometimes called a *sandbox*, to prevent it from doing any damage. As a general rule, JavaScript scripts cannot access the local file system, memory management system, or network, nor can they manipulate documents from other sites. Java applets, likewise, have only limited ability to access external resources. Reality is a bit more complicated, of course: Sometimes a script needs access to, say, a temporary file of limited size, or a network connection to a trusted server. Mechanisms exist to certify sites as *trusted*, or to allow a trusted site to certify the trustworthiness of pages from other sites. Scripts on pages obtained through a trusted mechanism may then be given extended rights. Such mechanisms must be used with care. Finding the right balance between security and functionality remains one of the central challenges of the Web, and of distributed computing in general. (More on this topic can be found in [Section 15.2.4](#), and in Explorations 15.17 and 15.18.)

platforms. It is *extensible*, meaning that users can define their own tags. It also makes a clear distinction between the *content* of a document (the data it captures) and the *presentation* of that data. Presentation, in fact, is deferred to a companion standard known as XSL (extensible stylesheet language). XSLT is a portion of XSL devoted to *transforming* XML: selecting, reorganizing, and modifying tags and the elements they delimit—in effect, scripting the processing of data represented in XML.

© IN MORE DEPTH

XML can be used to create specialized markup languages for a very wide range of application domains. XHTML is an almost (but not quite) backward compatible variant of HTML that conforms to the XML standard. Web tools are increasingly being designed to generate XHTML.

On the PLP CD we consider a variety of topics related to XML, with a particular emphasis on XSLT. We elaborate on the distinction between content and presentation, introduce the general notion of stylesheet languages, and describe the *document type definitions* (DTDs) and *schemas* used to define domain-specific applications of XML, using XHTML as an example.

Because tags are required to nest, an XML document has a natural tree-based structure. XSLT is designed to process these trees via recursive traversal. Though it can be used for almost any task that takes XML as input, perhaps its most common use is to transform XML into formatted output—often XHTML to be presented in a browser. As an extended example, we consider the formatting of an XML-based bibliographic database.

✓ CHECK YOUR UNDERSTANDING

26. Explain the distinction between *server-side* and *client-side* web scripting.
 27. List the tradeoffs between CGI scripts and embedded PHP.
 28. Why are CGI scripts usually installed only in a special directory?
 29. Explain how a PHP page can service its own requests.
 30. Why might we prefer to execute a web script on the server rather than the client? Why might we sometimes prefer the client instead?
 31. What is the HTML *Document Object Model*? What is its significance for client-side scripting?
 32. What is the relationship between JavaScript and Java?
 33. What is an *applet*? Why are applets usually not considered a form of scripting?
 34. What is HTML? XML? XSLT? How are they related to one another?
-

13.4 Innovative Features

In [Section 13.1.1](#) we listed several common characteristics of scripting languages:

1. Both batch and interactive use
2. Economy of expression
3. Lack of declarations; simple scoping rules
4. Flexible dynamic typing
5. Easy access to other programs
6. Sophisticated pattern matching and string manipulation
7. High-level data types

Several of these are discussed in more detail in the subsections below. Specifically, [Section 13.4.1](#) considers naming and scoping in scripting languages; [Section 13.4.2](#) discusses string and pattern manipulation; and [Section 13.4.3](#) considers data types. Items (1), (2), and (5) in our list, while important, are not particularly difficult or subtle, and will not be considered further here.

13.4.1 Names and Scopes

Most scripting languages (Scheme is the obvious exception) do not require variables to be declared. A few languages, notably Perl and JavaScript, permit optional declarations, primarily as a sort of compiler-checked documentation. Perl can be run in a mode (use `strict 'vars'`) that requires declarations.

With or without declarations, most scripting languages use dynamic typing. Values are generally self-descriptive, so the interpreter can perform type checking at run time, or coerce values when appropriate. Tcl is unusual in that all values—even lists—are represented internally as strings, which are parsed as appropriate to support arithmetic, indexing, and so on.

Nesting and scoping conventions vary quite a bit. Scheme, Python, JavaScript, and R provide the classic combination of nested subroutines and static (lexical) scope. Tcl allows subroutines to nest, but uses dynamic scoping (more on this below). Named subroutines (methods) do not nest in PHP or Ruby, and they only sort of nest in Perl (more on this below as well), but Perl and Ruby join Scheme, Python, JavaScript, and R in providing first-class anonymous local subroutines. Nested blocks are statically scoped in Perl. In Ruby they are part of the named scope in which they appear. Scheme, Perl, Python, Ruby, JavaScript, and R all provide unlimited extent for variables captured in closures. PHP, R, and the major glue languages (Perl, Tcl, Python, Ruby) all have sophisticated namespace mechanisms for information hiding and the selective import of names from separate modules.

```

i = 1; j = 3
def outer():
    def middle(k):
        def inner():
            global i          # from main program, not outer
            i = 4
        inner()
        return i, j, k      # 3-element tuple
    i = 2                   # new local i
    return middle(j)       # old (global) j

print outer()
print i, j

```

Figure 13.17 A program to illustrate scope rules in Python. There is one instance each of `j` and `k`, but two of `i`: one global and one local to `outer`. The scope of the latter is all of `outer`, not just the portion after the assignment. The `global` statement provides `inner` with access to the outermost `i`, so it can write it without defining a new instance.

What Is the Scope of an Undeclared Variable?

In languages with static scoping, the lack of declarations raises an interesting question: when we access a variable `x`, how do we know if it is local, global, or (if scopes can nest) something in-between? Existing languages take several different approaches. In Perl all variables are global unless explicitly declared. In PHP they are local unless explicitly imported (and all imports are global, since scopes do not nest). Ruby, too, has only two real levels of scoping, but as we saw in [Section 13.2.4](#) it distinguishes between them using prefix characters on names: `foo` is a local variable; `$foo` is a global variable; `@foo` is an instance variable of the current object (the one whose method is currently executing); `@@foo` is an instance variable of the current object's *class* (shared by all sibling instances). (Note: as we shall see in [Section 13.4.3](#), Perl uses similar prefix characters to indicate *type*. These very different uses are a potential source of confusion for programmers who switch between the two languages.)

Perhaps the most interesting scope-resolution rule is that of Python and R. In these languages a variable that is written is assumed to be local, unless it is explicitly imported. A variable that is only read in a given scope is found in the closest enclosing scope that contains a defining write. Consider, for example, the Python program of [Figure 13.17](#). Here we have a set of nested subroutines, as indicated by indentation level. The main program calls `outer`, which calls `middle`, which in turn calls `inner`. Before its call, the main program writes both `i` and `j`. `Outer` reads `j` (to pass it to `middle`), but does not write it. It does, however, write `i`. Consequently, `outer` reads the global `j`, but has its own `i`, different from the global one. `Middle` reads both `i` and `j`, but it does not write either, so it must find them in surrounding scopes. It finds `i` in `outer`, and `j` at the global

EXAMPLE 13.38

Scoping rules in Python

```

proc bar { } {
    upvar i j      ;# j is local name for caller's i
    puts "$j"
    uplevel 2 { puts [expr $a + $b] }
        # execute 'puts' two scopes up the dynamic chain
}

proc foo { i } {
    bar
}

set a 1; set b 2; foo 5

```

Figure 13.18 A program to illustrate scope rules in Tcl. The `upvar` command allows `bar` to access variable `i` in its caller's scope, using the name `j`. The `uplevel` command allows `bar` to execute a nested Tcl script (the `puts` command) in its caller's caller's scope.

level. Inner, for its part, also writes the global `i`. When executed the program prints

```

(2, 3, 3)
4 3

```

Note that while the tuple returned from `middle` (forwarded on by `outer`, and printed by the main program) has a 2 as its first element, the global `i` still contains the 4 that was written by `inner`. Note also that while the write to `i` in `outer` appears textually after the read of `i` in `middle`, its scope extends over all of `outer`, including the body of `middle`. ■

EXAMPLE 13.39
Superassignment in R

Interestingly, there is no way in Python for a nested routine to write a variable that belongs to a surrounding but nonglobal scope. In [Figure 13.17](#), `inner` could not be modified to write `outer`'s `i`. R provides an alternative mechanism that does provide this functionality. Rather than declare `i` to be `global`, R uses a “superassignment” operator. Where a normal assignment `i <- 4` assigns the value 4 into a local variable `i`, the superassignment `i <<- 4` assigns 4 into whatever `i` would be found under the normal rules of static (lexical) scoping. ■

EXAMPLE 13.40
Scoping rules in Tcl

In a completely different vein, Tcl not only makes the unusual choice of employing dynamic scoping, but also implements that choice in an unusual way. Variables in calling scopes are never accessed automatically. The programmer must ask for them explicitly, as shown in [Figure 13.18](#). The `upvar` and `uplevel` commands take an optional first argument that specifies a frame on the dynamic chain, either as an absolute value prefaced with a sharp sign (`#`) or, as in the call to `uplevel` shown in our example, as a distance below the current frame. If omitted, as in our call to `upvar`, the argument defaults to 1. The `upvar` command accesses a variable in the specified frame, and gives it a local name. The `uplevel` command provides a nested Tcl script, which is executed in the context of the specified

```

sub outer($) {
    # must be called with scalar arg
    $sub_A = sub {
        print "sub_A $lex, $dyn\n";
    };
    my $lex = $_[0];           # static local initialized to first arg
    local $dyn = $_[0];       # dynamic local initialized to first arg
    $sub_B = sub {
        print "sub_B $lex, $dyn\n";
    };
    print "outer $lex, $dyn\n";
    $sub_A->();
    $sub_B->();
}

$lex = 1; $dyn = 1;
print "main $lex, $dyn\n";
outer(2);
print "main $lex, $dyn\n";

```

Figure 13.19 A program to illustrate scope rules in Perl. The `my` operator creates a statically scoped local variable; the `local` operator creates a new dynamically scoped instance of a global variable. The static scope extends from the point of declaration to the lexical end of the block; the dynamic scope extends from elaboration to the end of the block's execution.

frame, in a manner reminiscent of call-by-name parameters. In our example we use `upvar` to obtain a local name for `foo`'s `i`, and `uplevel` to execute a command that uses the global `a` and `b`. The program prints a 5 and a 3. Note that the usual behavior of dynamic scoping, in which we automatically obtain the most recently created variable of a given name, regardless of the scope that created it, is not available in Tcl. ■

Scoping in Perl

Perl has evolved over the years. At first there were only global variables. Locals were soon added for the sake of modularity, so a subroutine with a variable named `i` wouldn't have to worry about modifying a global `i` that was needed elsewhere in the code. Unfortunately, locals were originally defined in terms of dynamic scoping, and the need for backward compatibility required that this behavior be retained when static scoping was added in Perl 5. Consequently, the language provides both mechanisms.

Any variable that is not declared is global in Perl by default. Variables declared with the `local` operator are dynamically scoped. Variables declared with the `my` operator are statically scoped. The difference can be seen in [Figure 13.19](#), in which subroutine `outer` declares two local variables, `lex` and `dyn`. The former is statically scoped; the latter is dynamically scoped. Both are initialized to be a copy of `foo`'s first parameter. (Parameters are passed in the pseudovariable `@_`. The first element of this array is `$_[0]`.)

Two lexically identical anonymous subroutines are nested inside `outer`, one before and one after the redeclarations of `$lex` and `$dyn`. References to these are

EXAMPLE 13.41

Static and dynamic scoping
in Perl

stored in local variables `sub_A` and `sub_B`. Because static scopes in Perl extend from a declaration to the end of its block, `sub_A` sees the global `$lex`, while `sub_B` sees `outer`'s `$lex`. In contrast, because the declaration of `local $dyn` occurs before either `sub_A` or `sub_B` is called, both see this local version. Our program prints

```
main 1, 1
outer 2, 2
sub_A 1, 2
sub_B 2, 2
main 1, 1
```

EXAMPLE 13.42

Accessing globals in Perl

In cases where static scoping would normally access a variable at an in-between level of nesting, Perl allows the programmer to force the use of a global variable with the `our` operator, whose name is intended to contrast with `my`:

```
($x, $y, $z) = (1, 1, 1);      # global scope
{                               # middle scope
    my ($x, $y) = (2, 2);
    local $z = 3;
    {                           # inner scope
        our ($x, $z);          # use globals
        print "$x, $y, $z\n";
    }
}
```

Here there is one lexical instance of `z` and two of `x` and `y`: one global, one in the middle scope. There is also a dynamic `z` in the middle scope. When it executes its

DESIGN & IMPLEMENTATION

Thinking about dynamic scoping

In [Section 3.3.6](#) we described dynamic scope rules as introducing a new meaning for a name that remains visible, wherever we are in the program, until control leaves the scope in which the new meaning was created. This conceptual model mirrors the association list implementation described in [Section 3.4.2](#) and, as described in the sidebar on [page 141](#), probably accounts for the use of dynamic scoping in early dialects of Lisp.

Documentation for Perl suggests a semantically equivalent but conceptually different model. Rather than saying that a `local` declaration introduces a new variable whose name hides previous declarations, Perl says that there is a *single* variable, at the global level, whose previous *value* is saved when the new declaration is encountered, and then automatically restored when control leaves the new declaration's scope. This model mirrors the underlying implementation in Perl, which uses a central reference table (also described in [Section 3.4.2](#)). In keeping with this model and implementation, Perl does not allow a `local` operator to create a dynamic instance of a variable that is not global.

`print` statement, the inner scope finds the `y` from the middle scope. It finds the global `x`, however, because of the `our` operator on line 6. Now what about `z`? The rules require us to start with static scoping, ignoring `local` operators. According, then, to the `our` operator in the inner scope, we are using the global `z`. Once we know this, we look to see whether a dynamic (`local`) redeclaration of `z` is in effect. In this case indeed it is, and our program prints 1, 2, 3. As it turns out, the `our` declaration in the inner scope had no effect on this program. If only `x` had been declared `our`, we would still have used the global `z`, and then found the dynamic instance from the middle scope. ■

13.4.2 String and Pattern Manipulation

When we first considered regular expressions, in [Section 2.1.1](#), we noted that many scripting languages and related tools employ extended versions of the notation. Some extensions are simply a matter of convenience. Others increase the expressive power of the notation, allowing us to generate (match) nonregular sets of strings. Still other extensions serve to tie the notation to other language features.

We have already seen examples of extended regular expressions in `sed` ([Figure 13.1](#)), `awk` ([Figures 13.2](#) and [13.3](#)), Perl ([Figures 13.4](#) and [13.5](#)), Tcl ([Figure 13.6](#)), Python ([Figure 13.7](#)), and Ruby ([Figure 13.8](#)). Many readers will also be familiar with `grep`, the stand-alone Unix pattern-matching tool (see sidebar on page 697).

While there are many different implementations of extended regular expressions (“REs” for short), with slightly different syntax, most fall into two main groups. The first group includes `awk`, `egrep` (the most widely used of several different versions of `grep`), the `regex` library for C, and older versions of Tcl. These implement REs as defined in the POSIX standard [[Int03b](#)]. Languages in the second group follow the lead of Perl, which provides a large set of extensions, sometimes referred to as “advanced REs.” Perl-like advanced REs appear in PHP, Python, Ruby, JavaScript, Emacs Lisp, Java, C#, and recent versions of Tcl. They can also be found in third-party packages for C++ and other languages. A few tools, including `sed`, classic `grep`, and older Unix editors, provide so-called “basic” REs, less capable than those of `egrep`.

In certain languages and tools—notably `sed`, `awk`, Perl, PHP, Ruby, and JavaScript—regular expressions are tightly integrated into the rest of the language, with special syntax and built-in operators. In these languages an RE is typically delimited with slash characters, though other delimiters may be accepted in some cases (and Perl in fact provides slightly different semantics for a few alternative delimiters). In most other languages, REs are expressed as ordinary character strings, and are manipulated by passing them to library routines. Over the next few pages we will consider POSIX and advanced REs in more detail. Following Perl, we will use slashes as delimiters. Our coverage will of necessity be incomplete. The chapter on REs in the Perl book [[WCO00](#), Chap. 5] is nearly 80 pages long. The corresponding Unix man page runs to more than 20 pages.

EXAMPLE 13.43

Basic operations in POSIX REs

POSIX Regular Expressions

Like the “true” regular expressions of formal language theory, extended REs support concatenation, alternation, and Kleene closure. Parentheses are used for grouping.

`/ab(cd|ef)g*/` matches `abcd`, `abcdg`, `abefg`, `abefgg`, `abcdggg`, etc. ■

EXAMPLE 13.44

Extra quantifiers in POSIX REs

Several other *quantifiers* (generalizations of Kleene closure) are also available: `?` indicates zero or one repetitions, `+` indicates one or more repetitions, `{n}` indicates exactly n repetitions, `{n,}` indicates at least n repetitions, and `{n,m}` indicates n – m repetitions:

<code>/a(bc)*/</code>	matches <code>a</code> , <code>abc</code> , <code>abcbc</code> , <code>abcbcbc</code> , etc.
<code>/a(bc)?/</code>	matches <code>a</code> or <code>abc</code>
<code>/a(bc)+/</code>	matches <code>abc</code> , <code>abcbc</code> , <code>abcbcbc</code> , etc.
<code>/a(bc){3}/</code>	matches <code>abcbcbc</code> only
<code>/a(bc){2,}/</code>	matches <code>abcbcbc</code> , <code>abcbcbcbc</code> , etc.
<code>/a(bc){1,3}/</code>	matches <code>abc</code> , <code>abcbc</code> , and <code>abcbcbc</code> (only)

EXAMPLE 13.45

Zero-length assertions

Two *zero-length assertions*, `^` and `$`, match only at the beginning and end, respectively, of a target string. Thus while `/abe/` will match `abe`, `abet`, `babe`, and `label`, `/^abe/` will match only the first two of these, `/abe$/` will match only the first and the third, and `/^abe$/` will match only the first. ■

EXAMPLE 13.46

Character classes

As an abbreviation for `/a|b|c|d/`, extended REs permit *character classes* to be specified with square brackets:

`/b[aeiou]d/` matches `bad`, `bed`, `bid`, `bod`, and `bud`

DESIGN & IMPLEMENTATION**The `grep` command and the birth of Unix tools**

Historically, regular expression tools have their roots in the pattern matching mechanism of the `ed` line editor, which dates from the earliest days of Unix. In 1973, Doug McIlroy, head of the department where Unix was born, was working on a project in computerized voice synthesis. As part of this project he was using the editor to search for potentially challenging words in an on-line dictionary. The process was both tedious and slow. At McIlroy’s request, Ken Thompson extracted the pattern matcher from `ed` and made it a stand-alone tool. He named his creation `grep`, after the `g/re/p` command sequence in the editor: `g` for “global”; `/` to search for a regular expression (*re*); `p` to print [HH97a, Chapter 9].

Thompson’s creation was one of the first in a large suite of stream-based Unix tools. As described in Section 13.2.1 (page 658), such tools are frequently combined with pipes to perform a variety of filtering, transforming, and formatting operations.

Ranges are also permitted:

```
/0x[0-9a-fA-F]+/    matches any hexadecimal integer
```

EXAMPLE 13.47

The dot (.) character

Outside a character class, a dot (.) matches any character other than a newline. The expression `/b.d/`, for example, matches not only `bad`, `bbd`, `bcd`, and so on, but also `b:d`, `b7d`, and many, many others, including sequences in which the middle character isn't printable. In a Unicode-enabled version of Perl, there are tens of thousands of options.

EXAMPLE 13.48

Negation and quoting in character classes

A caret (^) at the beginning of a character class indicates negation: the class expression matches anything *other* than the characters inside. Thus `/b[^aq]d/` matches anything matched by `/b.d/` except for `bad` and `bqd`. A caret, right bracket, or hyphen can be specified inside a character class by preceding it with a backslash. A backslash will similarly protect any of the special characters `| () [] { } $. * + ?` outside a character class.⁹ To match a literal backslash, use two of them in a row:

```
/a\\b/    matches a\b
```

EXAMPLE 13.49

Predefined POSIX character classes

Several character classes expressions are predefined in the POSIX standard. As we saw in [Example 13.18](#), the expression `[:space:]` can be used to capture white space. For punctuation there is `[:punct:]`. The exact definition of these classes depends on the local character set and language. Note, too, that these expressions must be used *inside* a built-up character class; they aren't classes by themselves. A variable name in C, for example, might be matched by `/[[:alpha:]]_[[:alpha:]][[:digit:]]_*/` or, a bit more simply, `/[[:alpha:]]_[[:alnum:]]_*/`. Additional syntax, not described here, allows character classes to capture Unicode *collating elements* (multibyte sequences such as a character and associated accents) that collate (sort) as if they were single elements. Perl provides less cumbersome versions of most of these special classes.

Perl Extensions

EXAMPLE 13.50

RE matching in Perl

Extended REs are a central part of Perl. The built-in `=~` operator is used to test for matching:

```
$foo = "albatross";
if ($foo =~ /ba.*s+/) ...      # true
if ($foo =~ /^ba.*s+/) ...    # false (no match at start of string)
```

⁹ Strictly speaking, `]` and `}` don't require a protective backslash unless there is a preceding unmatched (and unprotected) `[` or `{`, respectively.

The string to be matched against can also be left unspecified, in which case Perl uses the pseudovariable `$_` by default:

```
$_ = "albatross";
if (/ba.*s+/) ...           # true
if (/^ba.*s+/) ...         # false
```

Recall that (as we noted in [Section 13.2.2](#) [page 666]), `$_` is set automatically when iterating over the lines of a file. It is also the default index variable in `for` loops. ■

EXAMPLE 13.51

Negating a match in Perl

The `!~` operator returns true when a pattern *does not* match:

```
if ("albatross" !~ /^ba.*s+/) ... # true
```

EXAMPLE 13.52

RE substitution in Perl

For substitution, the binary “mixfix” operator `s///` replaces whatever lies between the first and second slashes with whatever lies between the second and the third:

```
$foo = "albatross";
$foo =~ s/lbat/c/;           # "across"
```

Again, if a left-hand side is not specified, `s///` matches and modifies `$_`. ■

Modifiers and Escape Sequences

Both matches and substitutions can be *modified* by adding one or more characters after the closing delimiter. A trailing `i`, for example, makes the match case-insensitive:

EXAMPLE 13.53

Trailing modifiers on RE matches

```
$foo = "Albatross";
if ($foo =~ /^al/i) ...     # true
```

DESIGN & IMPLEMENTATION

Automata for regular expressions

POSIX regular expressions are typically implemented using the constructions described in [Section 2.2.1](#), which transform the RE into an NFA and then a DFA. Advanced REs of the sort provided by Perl are typically implemented via backtracking search in the obvious NFA. The NFA-to-DFA construction is usually not employed, because it fails to preserve some of the advanced RE extensions (notably the *capture* mechanism described in [Examples 13.57–13.60](#)) [WCO00, pp. 197–202]. Some implementations use a DFA first to determine whether there *is* a match, and then an NFA or backtracking search to actually effect the match. This strategy pays the price of the slower automaton only when it’s sure to be worthwhile.

Escape	Meaning
<code>\0</code>	NUL character
<code>\a</code>	alarm (BEL) character
<code>\b</code>	backspace (within character class)
<code>\e</code>	escape (ESC) character
<code>\f</code>	form-feed (FF) character
<code>\n</code>	newline
<code>\r</code>	return
<code>\t</code>	tab
<code>\NNN</code>	character given by <i>NNN</i> in octal
<code>\x{abcd}</code>	character given by <i>abcd</i> in hexadecimal
<code>\b</code>	word boundary (outside character classes)
<code>\B</code>	not a word boundary
<code>\A</code>	beginning of string
<code>\z</code>	end of string
<code>\Z</code>	prior to final newline, or end of string if none
<code>\d</code>	digit (decimal)
<code>\D</code>	not a digit
<code>\s</code>	white space (space, tab, newline, return, form feed)
<code>\S</code>	not white space
<code>\w</code>	word character (letter, digit, underscore)
<code>\W</code>	not a word character

Figure 13.20 Regular expression escape sequences in Perl. Sequences in the top portion of the table represent individual characters. Sequences in the middle are zero-width assertions. Sequences at the bottom are built-in character classes.

A trailing `g` on a substitution replaces *all* occurrences of the regular expression:

```
$foo = "albatross";
$foo =~ s/[aeiou]/-/g;           # "-lb-tr-ss" ■
```

For matching in multiline strings, a trailing `s` allows a dot (`.`) to match an embedded newline (which it normally cannot). A trailing `m` allows `$` and `^` to match immediately before and after such a newline, respectively. A trailing `x` causes Perl to ignore both comments and embedded white space in the pattern, so that particularly complicated expressions can be broken across multiple lines, documented, and indented.

In the tradition of C and its relatives (Example 7.66, page 343), Perl allows nonprinting characters to be specified in REs using backslash *escape sequences*. These are summarized in the top portion of Figure 13.20. Perl also provides several zero-width assertions, in addition to the standard `^` and `$`. These are shown in the middle of the figure. The `\A` and `\Z` escapes differ from `^` and `$` in that they continue to match only at the beginning and end of the string, respectively,

even in multiline searches that use the modifier `m`. Finally, Perl provides several built-in character classes, shown at the bottom of the figure. These can be used both inside and outside user-defined (i.e., bracket-delimited) classes. Note that `\b` has *different* meanings inside and outside such classes.

Greedy and Minimal Matches

The usual rule for matching in REs is sometimes called “left-most longest”: when a pattern can match at more than one place within a string, the chosen match will be the one that starts at the earliest possible position within the string, and then extends as far as possible. In the string `abcbcbcbde`, for example, the pattern `/(bc)+/` can match in six different ways:

EXAMPLE 13.54

Greedy and minimal matching

```

abcbcbcbde
abcbcbcbde
abcbcbcbde
abcbcbcbde
abcbcbcbde
abcbcbcbde

```

The third of these is “left-most longest,” also known as *greedy*. In some cases, however, it may be desirable to obtain a “left-most shortest” or *minimal* match. This corresponds to the first alternative above. ■

EXAMPLE 13.55

Minimal matching of HTML headers

We saw a more realistic example in [Example 13.22](#) ([Figure 13.4](#)), which contains the following substitution:

```
s/. *?([hH] [123]>.*?<\/[hH] [123]>)//s;
```

Assuming that the HTML input is well formed, and that headers do not nest, this substitution deletes everything between the beginning of the string (implicitly `$_`) and the end of the first embedded header. It does so by using the `*?` quantifier instead of the usual `*`. Without the question marks, the pattern would match through (and the substitution would delete through) the end of the *last* header in the string. Recall that the trailing `s` modifier allows our headers to span lines.

In general, `*?` matches the smallest number of instances of the preceding subexpression that will allow the overall match to succeed. Similarly, `+?` matches at least one instance, but no more than necessary to allow the overall match to succeed, and `??` matches either zero or one instances, with a preference for zero. ■

Variable Interpolation and Capture

Like double-quoted strings, regular expressions in Perl support *variable interpolation*. Any dollar sign that does not immediately proceed a vertical bar, closing parenthesis, or end of string is assumed to introduce the name of a Perl variable,

EXAMPLE 13.56

Variable interpolation in extended REs

whose value as a string is expanded prior to passing the pattern to the regular expression evaluator. This allows us to write code that generates patterns at run time:

```
$prefix = ...
$suffix = ...
if ($foo =~ /^$prefix.*$suffix$/) ...
```

Note the two different roles played by \$ in this example. ■

The flow of information can go the other way as well: we can pull the values of variables out of regular expressions. We saw a simple example in the sed script of [Figure 13.1](#):

EXAMPLE 13.57

Variable capture in extended REs

```
s/^.*(<[hH] [123]>)/\1/      ;# delete text before opening tag
```

The equivalent in Perl would look something like this:

```
$line =~ s/^.*([hH] [123]>)/\1/;
```

DESIGN & IMPLEMENTATION**Compiling regular expressions**

Before it can be used as the basis of a search, a regular expression must be compiled into a deterministic or nondeterministic (backtracking) automaton. Patterns that are clearly constant can be compiled once, either when the program is loaded or when they are first encountered. Patterns that contain interpolated strings, however, must in the general case be recompiled whenever they are encountered, at potentially significant run-time cost. A programmer who knows that interpolated variables will never change can inhibit recompilation by attaching a trailing `o` modifier to the regular expression, in which case the expression will be compiled the first time it is encountered, and never thereafter. For expressions that must sometimes but not always be recompiled, the programmer can use the `qr` operator to force recompilation of a pattern, yielding a result that can be used repeatedly and efficiently:

```
for (@patterns) {           # iterate over patterns
    my $pat = qr($_);      # compile to automaton
    for (@strings) {       # iterate over strings
        if (/$pat/) {     # no recompilation required
            print;         # print all strings that match
            print "\n";
        }
    }
    print "\n";
}
```

Every parenthesized fragment of a Perl RE is said to *capture* the text that it matches. The captured strings may be referenced in the right-hand side of the substitution as `\1`, `\2`, and so on. Outside the expression they remain available (until the next substitution is executed) as `$1`, `$2`, and so on:

```
print "Opening tag: ", $1, "\n";
```

EXAMPLE 13.58

Backreferences in extended REs

One can even use a captured string later in the RE itself. Such a string is called a *backreference*:

```
if (/.*?([hH]([123])>.*?<\/[hH]\2>)/) {
    print "header: $1\n";
}
```

Here we have used `\2` to insist that the closing tag of an HTML header match the opening tag.

EXAMPLE 13.59

Dissecting a floating-point literal

One can, of course capture multiple strings:

```
if (/^( [+ - ]? ) ( ( \d + ) \. | ( \d * ) \. ( \d + ) ) ( e ( [ + - ] ? \d + ) ? $ ) / ) {
    # floating-point number
    print "sign:      ", $1, "\n";
    print "integer:   ", $3, $4, "\n";
    print "fraction:  ", $5, "\n";
    print "mantissa:  ", $2, "\n";
    print "exponent:  ", $7, "\n";
}
```

As in the previous example, the numbering corresponds to the occurrence of left parentheses, read from left to right. With input `-123.45e-6` we see

```
sign:      -
integer:   123
fraction:  45
mantissa:  123.45
exponent:  -6
```

Note that because of alternation, exactly one of `$3` and `$4` is guaranteed to be set. Note also that while we need the sixth set of parentheses for grouping (it has a `?` quantifier), we don't really need it for capture.

For simple matches, Perl also provides pseudovariables named `$'`, `$&`, and `$'`. These name the portions of the string before, in, and after the most recent match, respectively:

EXAMPLE 13.60

Implicit capture of prefix, match, and suffix

```
$line = <>;
chop $line;                # delete trailing newline
$line =~ /is/;
print "prefix($') match($&) suffix($')\n";
```

With input "now is the time", this code prints

```
prefix(now ) match(is) suffix( the time)
```

✓ CHECK YOUR UNDERSTANDING

35. What popular scripting language uses dynamic scoping?
 36. Summarize the strategies used in Perl, PHP, Ruby, and Python to determine the scope of variables that are not declared.
 37. Describe the conceptual model for dynamically scoped variables in Perl.
 38. List the principal features found in POSIX regular expressions, but not in the regular expressions of formal language theory ([Section 2.1.1](#)).
 39. List the principal features found in Perl REs, but not in those of POSIX.
 40. Explain the purpose of search *modifiers* (characters following the final delimiter) in Perl-type regular expressions.
 41. Describe the three different categories of *escape sequences* in Perl-type regular expressions.
 42. Explain the difference between *greedy* and *minimal* matches.
 43. Describe the notion of *capture* in regular expressions.
-

13.4.3 Data Types

As we have seen, scripting languages don't generally require (or even permit) the declaration of types for variables. Most perform extensive run-time checks to make sure that values are never used in inappropriate ways. Some languages (e.g., Scheme, Python, and Ruby) are relatively strict about this checking; the programmer who wants to convert from one type to another must say so explicitly. If we type the following in Ruby,

EXAMPLE 13.61

Coercion in Ruby and Perl

```
a = "4"
print a + 3, "\n"
```

we get the following message at run time: “In '+': failed to convert Fixnum into String (TypeError).” Perl is much more forgiving. As we saw in [Example 13.2](#), the program

```
$a = "4";
print $a . 3 . "\n";           # '.' is concatenation
print $a + 3 . "\n";         # '+' is addition
```

prints 43 and 7. ■

In general, Perl (and likewise Rexx and Tcl) takes the position that programmers should check for the errors they care about, and in the absence of such checks the program should do something reasonable. Perl is willing, for example, to accept the following (though it prints a warning if run with the `-w` compile-time switch):

EXAMPLE 13.62

Coercion and context in Perl

```
$a[3] = "1";                   # (array @a was previously undefined)
print $a[3] + $a[4], "\n";
```

Here `$a[4]` is uninitialized and hence has value `undef`. In a numeric context (as an operand of `+`) the string `"1"` evaluates to 1, and `undef` evaluates to 0. Added together, these yield 1, which is converted to a string and printed. ■

EXAMPLE 13.63

Explicit conversion in Ruby

A comparable code fragment in Ruby requires a bit more care. Before we can subscript `a` we must make sure that it refers to an array:

```
a = [] # empty array assignment
a[3] = "1"
```

If the first line were not present (and `a` had not been initialized in any other way), the second line would have generated an “undefined local variable” error. After these assignments, `a[3]` is a string, but other elements of `a` are `nil`. We cannot concatenate a string and `nil`, nor can we add them (both operators are specified in Ruby using the operator `+`). If we want concatenation, and `a[4]` may be `nil`, we must say

```
print a[3] + String(a[4]), "\n"
```

If we want addition, we must say

```
print Integer(a[3]) + Integer(a[4]), "\n"
```

As these examples suggest, Perl (and likewise Tcl) uses a value model of variables. Scheme, Python, and Ruby use a reference model. PHP and JavaScript, like Java, use a value model for variables of primitive type and a reference model for variables of object type. The distinction is less important in PHP and JavaScript than it is in Java, because the same variable can hold a primitive value at one point in time and an object reference at another.

Numeric Types

As we have seen in [Section 13.4.2](#), scripting languages generally provide a very rich set of mechanisms for string and pattern manipulation. Syntax and interpolation conventions vary, but the underlying functionality is remarkably consistent, and heavily influenced by Perl. The underlying support for numeric types shows a bit more variation across languages, but the programming model is again remarkably consistent: users are, to first approximation, encouraged to think of numeric values as “simply numbers,” and not to worry about the distinction between fixed and floating point, or about the limits of available precision.

Internally, numbers in JavaScript are always double-precision floating point. In Tcl they are strings, converted to integers or floating-point numbers (and back again) when arithmetic is needed. PHP uses integers (guaranteed to be at least 32 bits wide), plus double-precision floating point. To these Perl and Ruby add arbitrary precision (multiword) integers, sometimes known as *bignums*. Python has *bignums*, too, plus support for complex numbers. Scheme has all of the above, plus precise rationals, maintained as ⟨numerator, denominator⟩ pairs. In all cases the interpreter “up-converts” as necessary when doing arithmetic on values with different representations, or when overflow would otherwise occur.

Perl is scrupulous about hiding the distinctions among different numeric representations. Most other languages allow the user to determine which is being used, though this is seldom necessary. Ruby is perhaps the most explicit about the existence of different representations: classes `Fixnum`, `Bignum`, and `Float` (double-precision floating point) have overlapping but not identical sets of built-in methods. In particular, integers have iterator methods, which floating-point numbers do not, and floating-point numbers have rounding and error checking methods, which integers do not. `Fixnum` and `Bignum` are both descendants of `Integer`.

Composite Types

The type constructors of compiled languages like C, Fortran, and Ada were chosen largely for the sake of efficient implementation. Arrays and records, in particular, have straightforward time- and space-efficient implementations, which we studied in [Chapter 7](#). Efficiency, however, is less important in scripting languages. Designers have felt free to choose type constructors oriented more toward ease of understanding than pure run-time performance. In particular, most scripting languages place a heavy emphasis on *mappings*, sometimes called *dictionaries*, *hashes*, or *associative arrays*. As might be guessed from the third of these names, a mapping is typically implemented with a hash table. Access time for a hash remains $O(1)$, but with a significantly higher constant than is typical for a compiled array or record.

Perl, the oldest of the widely used scripting languages, inherits its principal composite types—the array and the hash—from `awk`. It also uses prefix characters on variable names as an indication of type: `$foo` is a scalar (a number, Boolean, string, or pointer [which Perl calls a “reference”]); `@foo` is an array; `%foo` is a hash; `&foo` is a subroutine; and plain `foo` is a filehandle or an I/O format, depending on context.

EXAMPLE 13.64

Perl arrays

Ordinary arrays in Perl are indexed using square brackets and integers starting with 0:

```
@colors = ("red", "green", blue);      # initializer syntax
print $colors[1];                     # green
```

Note that we use the `@` prefix when referring to the array as a whole, and the `$` prefix when referring to one of its (scalar) elements. Arrays are self-expanding: assignment to an out-of-bounds element simply makes the array larger (at the cost of dynamic memory allocation and copying). Uninitialized elements have the value `undef` by default. ■

EXAMPLE 13.65

Perl hashes

Hashes are indexed using curly braces and character string names:

```
%complements = ("red" => "cyan",
                "green" => "magenta", "blue" => "yellow");
print $complements{"blue"};          # yellow
```

These, too, are self-expanding.

Records and objects are typically built from hashes. Where the C programmer would write `fred.age = 19`, the Perl programmer writes `$fred{"age"} = 19`. In object-oriented code, `$fred` is more likely to be a reference, in which case we have `$fred->{"age"} = 19`. ■

EXAMPLE 13.66

Arrays and hashes in Python and Ruby

Python and Ruby, like Perl, provide both conventional arrays and hashes. They use square brackets for indexing in both cases, and distinguish between array and hash initializers (aggregates) using bracket and brace delimiters, respectively:

```
colors = ["red", "green", "blue"]
complements = {"red" => "cyan",
               "green" => "magenta", "blue" => "yellow"}
print colors[2], complements["blue"]
```

(This is Ruby syntax; Python uses `:` in place of `=>`.) ■

EXAMPLE 13.67

Array access methods in Ruby

As a purely object-oriented language, Ruby defines subscripting as syntactic sugar for invocations of the `[]` (get) and `[]=` (put) methods:

DESIGN & IMPLEMENTATION**Typeglobs in Perl**

It turns out that a global name in Perl can have multiple independent meanings. It is possible, for example, to use `$foo`, `@foo`, `%foo`, and `&foo` and two different meanings of `foo`, all in the same program. To keep track of these multiple meanings, Perl interposes a level of indirection between the symbol table entry for `foo` and the various values `foo` may have. The intermediate structure is called a *typeglob*. It has one slot for each of `foo`'s meanings. It also has a name of its own: `*foo`. By manipulating typeglobs, the expert Perl programmer can actually modify the table used by the interpreter to look up names at run time. The simplest use is to create an alias:

```
*a = *b;
```

After executing this statement, `a` and `b` are indistinguishable; they both refer to the same typeglob, and changes made to (any meaning of) one of them will be visible through the other. Perl also supports *selective* aliasing, in which *one slot* of a typeglob is made to point to a value from a different typeglob:

```
*a = \&b;
```

The backslash operator (`\`) in Perl is used to create a pointer. After executing this statement, `&a` (the meaning of `a` as a function) will be the same as `&b`, but all other meanings of `a` will remain the same. Selective aliasing is used, among other things, to implement the mechanism that imports names from libraries in Perl.

```
c = colors[2]           # same as c = colors.[](2)
colors[2] = c           # same as colors.[]=(2, c)
```

EXAMPLE 13.68

Tuples in Python

In addition to arrays (which it calls *lists*) and hashes (which it calls *dictionaries*), Python provides two other composite types: tuples and sets. A tuple is essentially an immutable list (array). The initializer syntax uses parentheses rather than brackets:

```
crimson = (0xdc, 0x14, 0x3c) # R,G,B components
```

Tuples are more efficient to access than arrays: their immutability eliminates the need for most bounds and resizing checks. They also form the basis of multiway assignment:

```
a, b = b, a # swap
```

Parentheses can be omitted in this example: the comma groups more tightly than the assignment operator.

EXAMPLE 13.69

Sets in Python

Python sets are like dictionaries that don't map to anything of interest, but simply serve to indicate whether elements are present or absent. Unlike dictionaries, they also support union, intersection, and difference operations:

```
X = set(['a', 'b', 'c', 'd']) # set constructor
Y = set(['c', 'd', 'e', 'f']) # takes array as parameter
U = X | Y                     # (['a', 'b', 'c', 'd', 'e', 'f'])
I = X & Y                     # (['c', 'd'])
D = X - Y                     # (['a', 'b'])
O = X ^ Y                     # (['a', 'b', 'e', 'f'])
'c' in I                      # True
```

EXAMPLE 13.70

Conflated types in PHP, Tcl, and JavaScript

PHP and Tcl have simpler composite types: they eliminate the distinction between arrays and hashes. An array is simply a hash for which the programmer chooses to use numeric keys. JavaScript employs a similar simplification, unifying arrays, hashes, and objects. The usual `obj.attr` notation to access a member of an object (what JavaScript calls a *property*) is simply syntactic sugar for `obj["attr"]`. So objects are hashes, and arrays are objects with integer property names.

Higher-dimensional types are straightforward to create in most scripting languages: one can define arrays of (references to) hashes, hashes of (references to) arrays, and so on. Alternatively, one can create a “flattened” implementation by using composite objects as keys in a hash. Tuples in Python work particularly well:

EXAMPLE 13.71

Multidimensional arrays in Python and other languages

```
matrix = {} # empty dictionary (hash)
matrix[2, 3] = 4 # key is (2, 3)
```

This idiom provides the appearance and functionality of multidimensional arrays, though not their efficiency. There exist extension libraries for Python that provide

more efficient homogeneous arrays, with only slightly more awkward syntax. Numeric and statistical scripting languages, such as Maple, Mathematica, Matlab, and R, have much more extensive support for multidimensional arrays. ■

Context

In [Section 7.2.2](#) we defined the notion of *type compatibility*, which determines, in a statically typed language, which types can be used in which *contexts*. In this definition the term “context” refers to information about how a value will be used. In C, for example, one might say that in the declaration

```
double d = 3;
```

the 3 on the right-hand side occurs in a context that expects a floating-point number. The C compiler *coerces* the 3 to make it a `double` instead of an `int`.

In [Section 7.2.3](#) we went on to define the notion of *type inference*, which allows a compiler to determine the type of an expression based on the types of its constituent parts and, in some cases, the context in which it appears. We saw an extreme example in ML and its descendants, which use a sophisticated form of inference to determine types for most objects without the need for declarations.

In both of these cases—compatibility and inference—contextual information is used at compile time only. Perl extends the notion of context to drive decisions made at run time. More specifically, each operator in Perl determines, at compile time, and for each of its arguments, whether that argument should be interpreted as a *scalar* or a *list*. Conversely each argument (which may itself be a nested operator) is able to tell, at run time, which kind of context it occupies, and can consequently exhibit different behavior.

As a simple example, the assignment operator (=) provides a scalar or list context to its right-hand side based on the type of its left-hand side. This type is always known at compile time, and is usually obvious to the casual reader, because the left-hand side is a name and its prefix character is either a dollar sign (\$), implying a scalar context, or an at (@) or percent (%) sign, implying a list context. If we write

```
$time = gmtime();
```

Perl’s standard `gmtime()` library function will return the time as a character string, along the lines of “Sun Aug 17 15:10:32 2008”. On the other hand, if we write

```
@time_array = gmtime();
```

the same function will return (39, 09, 21, 15, 2, 105, 2, 73), an 8-element array indicating seconds, minutes, hours, day of month, month of year (with

EXAMPLE 13.72

Scalar and list context in Perl

January = 0), year (counting from 1900), day of week (with Sunday = 0), and day of year. ■

EXAMPLE 13.73

Using `wantarray` to determine calling context

So how does `gmtime` know what to do? By calling the built-in function `wantarray`. This returns `true` if the current function was called in a list context, and `false` if it was called in a scalar context. By convention, functions typically indicate an error by returning the empty array when called in a list context, and the undefined value (`undef`) when called in a scalar context:

```
if ( something went wrong ) {
    return wantarray ? () : undef;
}
```

13.4.4 Object Orientation

Though not an object-oriented language, Perl 5 has features that allow one to program in an object-oriented style.¹⁰ PHP and JavaScript have cleaner, more conventional-looking object-oriented features, but both allow the programmer to use a more traditional imperative style as well. Python and Ruby are explicitly and uniformly object-oriented.

Perl uses a value model for variables; objects are always accessed via pointers. In PHP and JavaScript, a variable can hold either a value of a primitive type or a reference to an object of composite type. In contrast to Perl, however, these languages provide no way to speak of the reference itself, only the object to which it refers. Python and Ruby use a uniform reference model.

Classes are themselves objects in Python and Ruby, much as they are in Smalltalk. They are merely types in PHP, much as they are in C++, Java, or C#. Classes in Perl are simply an alternative way of looking at packages (namespaces). JavaScript, remarkably, has objects but no classes; its inheritance is based on a concept known as *prototypes*, initially introduced by the Self programming language.

Perl 5

Object support in Perl 5 boils down to two main things: (1) a *blessing* mechanism that associates a reference with a package, and (2) special syntax for method calls that automatically passes an object reference or package name as the initial argument to a function. While any reference can in principle be blessed, the usual convention is to use a hash, so that fields can be named as shown in [Example 13.65](#).

EXAMPLE 13.74

A simple class in Perl

As a very simple example, consider the Perl code of [Figure 13.21](#). Here we have defined a package, `Integer`, that plays the role of a class. It has three functions, one of which (`new`) is intended to be used as a constructor, and two of which (`set` and `get`) are intended to be used as accessors. Given this definition we can write

¹⁰ More extensive features, currently under design for Perl 6, will not be covered here.

```

{ package Integer;

  sub new {
    my $class = shift;      # probably "Integer"
    my $self = {};         # reference to new hash
    bless($self, $class);
    $self->{val} = (shift || 0);
    return $self;
  }
  sub set {
    my $self = shift;
    $self->{val} = shift;
  }
  sub get {
    my $self = shift;
    return $self->{val};
  }
}

```

Figure 13.21 Object-oriented programming in Perl. Blessing a reference (object) into package `Integer` allows `Integer`'s functions to serve as the object's methods.

```

$c1 = Integer->new(2);      # Integer::new("Integer", 2)
$c2 = new Integer(3);     # alternative syntax
$c3 = new Integer;        # no initial value specified

```

Both `Integer->new` and `new Integer` are syntactic sugar for calls to `Integer::new` with an additional first argument that contains the name of the package (class) as a character string. In the first line of function `new` we assign this string into the variable `$class`. (The `shift` operator returns the first element of pseudovisible `@_` [the function's arguments], and shifts the remaining arguments, if any, so they will be seen if `shift` is used again.) We then create a reference to a new hash, store it in local variable `$self`, and invoke the `bless` operator to associate it with the appropriate class. With a second call to `shift` we retrieve the initial value for our integer, if any. (The "or" expression `[||]` allows us to use 0 instead if no explicit argument was present.) We assign this initial value into the `val` field of `$self` using the usual Perl syntax to dereference a pointer and subscript a hash. Finally we return a reference to the newly created object. ■

EXAMPLE 13.75

Invoking methods in Perl

Once a reference has been blessed, Perl allows it to be used with method invocation syntax: `c1->get()` and `get c1()` are syntactic sugar for `Integer::get($c1)`. Note that this call passes a reference as the additional first parameter, rather than the name of a package. Given the declarations of `$c1`, `$c2`, and `$c3` above, the following code

```

print $c1->get, " ", $c2->get, " ", $c3->get, " ", "\n";
$c1->set(4); $c2->set(5); $c3->set(6);
print $c1->get, " ", $c2->get, " ", $c3->get, " ", "\n";

```

will print

```
2 3 0
4 5 6
```

As usual in Perl, if an argument list is empty, the parentheses can be omitted. ■

EXAMPLE 13.76

Inheritance in Perl

Inheritance in Perl is obtained by means of the `@ISA` array, initialized at the global level of a package. Extending the previous example, we might define a `Tally` class that inherits from `Integer`:

```
{ package Tally;
  @ISA = ("Integer");

  sub inc {
    my $self = shift;
    $self->{val}++;
  }
}
...
$t1 = new Tally(3);
$t1->inc;
$t1->inc;
print $t1->get, "\n";           # prints 5
```

The `inc` method of `t1` works as one might expect. However when Perl sees a call to `Tally::new` or `Tally::get` (neither of which is actually in the package), it uses the `@ISA` array to locate additional package(s) in which these methods may be found. We can list as many packages as we like in the `@ISA` array; Perl supports multiple inheritance. The possibility that `new` may be called through `Tally` rather than `Integer` explains the use of `shift` to obtain the class name in [Figure 13.21](#). If we had used `"Integer"` explicitly we would not have obtained the desired behavior when creating a `Tally` object. ■

EXAMPLE 13.77

Inheritance via `use base`

Most often packages (and thus classes) in Perl are declared in separate modules (files). In this case, one must import the module corresponding to a superclass in addition to modifying `@ISA`. The standard base module provides convenient syntax for this combined operation, and is the preferred way to specify inheritance relationships:

```
{ package Tally;
  use base ("Integer");
  ...
}
```

PHP and JavaScript

While Perl's mechanisms suffice to create object-oriented programs, dynamic lookup makes them slower than equivalent imperative programs, and it seems fair to characterize the syntax as less than elegant. Objects are more fundamental to PHP and JavaScript.

PHP 4 provided a variety of object-oriented features, which were heavily revised in PHP 5. The newer version of the language provides a reference model of (class-typed) variables, interfaces and mix-in inheritance, abstract methods and classes, final methods and classes, static and constant members, and access control specifiers (`public`, `protected`, and `private`) reminiscent of those of Java, C#, and C++. In contrast to all other languages discussed in this subsection, class declarations in PHP must include declarations of all members (fields and methods), and the set of members in a given class cannot subsequently change (though one can of course declare derived classes with additional members).

JavaScript takes the unusual approach of providing objects—with inheritance and dynamic method dispatch—without providing classes. Such a language is said to be *object-based*, as opposed to object-oriented. Functions are first-class entities in JavaScript—objects, in fact. A method is simply a function that is referred to by a *property* (member) of an object. When we call `o.m`, the keyword `this` will refer to `o` during the execution of the function referred to by `m`. Likewise when we call `new f`, `this` will refer to a newly created (initially empty) object during the execution of `f`. A constructor in JavaScript is thus a function whose purpose is to assign values into properties (fields and methods) of a newly created object.

Associated with every constructor `f` is an object `f.prototype`. If object `o` was constructed by `f`, then JavaScript will look in `f.prototype` whenever we attempt to use a property of `o` that `o` itself does not provide. In effect, `o` inherits from `f.prototype` anything that it does not override. Prototype properties are commonly used to hold methods. They can also be used for constants or for what other languages would call “class variables.”

Figure 13.22 illustrates the use of prototypes. It is roughly equivalent to the Perl code of Figure 13.21. Function `Integer` serves as a constructor. Assignments to properties of `Integer.prototype` serve to establish methods for objects constructed by `Integer`. Using the code in the figure, we can write

```
c2 = new Integer(3);
c3 = new Integer;

document.write(c2.get() + "&nbsp;&nbsp;&nbsp;" + c3.get() + "<BR>");
c2.set(4); c3.set(5);
document.write(c2.get() + "&nbsp;&nbsp;&nbsp;" + c3.get() + "<BR>");
```

This code will print

```
3 0
4 5
```

EXAMPLE 13.78

Prototypes in JavaScript

EXAMPLE 13.79

Overriding instance methods in JavaScript

Interestingly, the lack of a formal notion of class means that we can override methods and fields on an object-by-object basis:

```
c2.set = new Function("n", "this.val = n * n;");
// anonymous function constructor
c2.set(3); c3.set(4); // these call different methods!
document.write(c2.get() + "&nbsp;&nbsp;&nbsp;" + c3.get() + "<BR>");
```



```

function Integer(n) {
    this.val = n || 0;    // use 0 if n is missing (undefined)
}
function Integer_set(n) {
    this.val = n;
}
function Integer_get() {
    return this.val;
}
Integer.prototype.set = Integer_set;
Integer.prototype.get = Integer_get;

```

Figure 13.22 Object-oriented programming in JavaScript. The `Integer` function is used as a constructor. Assignments to members of its prototype object serve to establish methods. These will be available to any object created by `Integer` that doesn't have corresponding members of its own.

If nothing else has changed since the previous example, this code will print

```
9 4
```

EXAMPLE 13.80

Inheritance in JavaScript

To obtain the effect of inheritance, we can write

```

function Tally(n) {
    this.base(n);    // call to base constructor
}
function Tally_inc() {
    this.val++;
}
Tally.prototype = new Integer;    // inherit methods
Tally.prototype.base = Integer;    // make base constructor available
Tally.prototype.inc = Tally_inc;    // new method
...
t1 = new Tally(3);
t1.inc(); t1.inc();
document.write(t1.get() + "<br>");

```

This code will print a 5.

Python and Ruby

As we have noted, both Python and Ruby are explicitly object-oriented. Both employ a uniform reference model for variables. Like Smalltalk, both incorporate an object hierarchy in which classes themselves are represented by objects. The root class in Python is called `object`; in Ruby it is `Object`.

In both Python and Ruby, each class has a single distinguished constructor, which cannot be overloaded. In Python it is `__init__`; in Ruby it is `initialize`. To create a new object in Python one says `my_object = My_class(args)`; in

EXAMPLE 13.81

Constructors in Python and Ruby

Ruby one says `my_object = My_class.new(args)`. In each case the *args* are passed to the constructor. To achieve the effect of overloading, with different numbers or types of arguments, one must arrange for the single constructor to inspect its arguments explicitly. We employed a similar idiom in Perl (in the new routine of Figure 13.21) and JavaScript (in the Integer function of Figure 13.22). ■

Both Python and Ruby are more flexible than PHP or more traditional object-oriented languages regarding the contents (members) of a class. New fields can be added to a Python object simply by assigning to them: `my_object.new_field = value`. The set of methods, however, is fixed when the class is first defined. In Ruby only methods are visible outside a class (“put” and “get” methods must be used to access fields), and all methods must be explicitly declared. It is possible, however, to modify an existing class declaration, adding or overriding methods. One can even do this on an object-by-object basis. As a result, two objects of the same class may not display the same behavior.

Python and Ruby differ in many other ways. The initial parameter to methods is explicit in Python; by convention it is usually named `self`. In Ruby `self` is a keyword, and the parameter it represents is invisible. Any variable beginning with

EXAMPLE 13.82

Naming class members in Python and Ruby

DESIGN & IMPLEMENTATION

Executable class declarations

Both Python and Ruby take the interesting position that class declarations are executable code. Elaboration of a declaration executes the code inside. Among other things, we can use this mechanism to achieve the effect of conditional compilation:

```
class My_class                                # Ruby code
  def initialize(a, b)
    @a = a;  @b = b;
  end
  if expensive_function()
    def get()
      return @a
    end
  else
    def get()
      return @b
    end
  end
end
```

Instead of computing the expensive function inside `get`, on every invocation, we compute it once, ahead of time, and define an appropriate specialized version of `get`.

a single `@` sign in Ruby is a field of the current object. Within a Python method, uses of object members must name the object explicitly. One must, for example, write `self.print()`; just `print()` will not suffice. ■

Ruby methods may be `public`, `protected`, or `private`.¹¹ Access control in Python is purely a matter of convention; both methods and fields are universally accessible. Finally, Python has multiple inheritance. Ruby has mix-in inheritance: a class cannot obtain data from more than one ancestor. Unlike most other languages, however, Ruby allows an interface (mix-in) to define not only the signatures of methods, but also their implementation (code).

✓ CHECK YOUR UNDERSTANDING

44. Contrast the philosophies of Perl and Ruby with regard to error checking and reporting.
 45. Compare the numeric types of popular scripting languages to those of compiled languages like C or Fortran.
 46. What are *bignums*? Which languages support them?
 47. What are *associative arrays*? By what other names are they sometimes known?
 48. Why don't most scripting languages provide direct support for records?
 49. What is a *typeglob* in Perl? What purpose does it serve?
 50. Describe the *tuple* and *set* types of Python.
 51. Explain the unification of arrays and hashes in PHP and Tcl.
 52. Explain the unification of arrays and objects in JavaScript.
 53. Explain how tuples and hashes can be used to emulate multidimensional arrays in Python.
 54. Explain the concept of *context* in Perl. How is it related to type compatibility and type inference? What are the two principal contexts defined by the language's operators?
 55. Compare the approaches to object orientation taken by Perl 5, PHP 5, JavaScript, Python, and Ruby.
 56. What is meant by the *blessing* of a reference in Perl?
 57. What are *prototypes* in JavaScript? What purpose do they serve?
-

¹¹ The meanings of `private` and `protected` in Ruby are different from those in C++, Java, or C#: `private` methods in Ruby are available only to the current instance of an object; `protected` methods are available to any instance of the current class or its descendants.

13.5 Summary and Concluding Remarks

Scripting languages serve primarily to control and coordinate other software components. Though their roots go back to interpreted languages of the 1960s, they have received relatively little attention from academic computer science. With an increasing emphasis on programmer productivity, however, and with the birth of the World Wide Web, scripting languages have seen enormous growth in interest and popularity, both in industry and in academia. Many significant advances have been made by commercial developers and by the open-source community. Scripting languages may well come to dominate programming in the 21st century, with traditional compiled languages more and more seen as special-purpose tools.

In comparison to their traditional cousins, scripting languages emphasize flexibility and richness of expression over sheer run-time performance. Common characteristics include both batch and interactive use, economy of expression, lack of declarations, simple scoping rules, flexible dynamic typing, easy access to other programs, sophisticated pattern matching and string manipulation, and high-level data types.

We began our chapter by tracing the historical development of scripting, starting with the command interpreter, or *shell* programs of the mid-1970s, and the text processing and report generation tools that followed soon thereafter. We looked in particular at the “Bourne-again” shell, *bash*, and the Unix tools *sed* and *awk*. We also mentioned such special-purpose domains as mathematics and

DESIGN & IMPLEMENTATION

Worse Is Better

Any discussion of the relative merits of scripting and “systems” languages invariably ends up addressing the tradeoffs between expressiveness and flexibility on the one hand and compile-time safety and performance on the other. It may also digress into questions of “quick-and-dirty” versus “polished” applications. An interesting take on this debate can be found in the widely circulated essays of Richard Gabriel (www.dreamsongs.com/WorseIsBetter.html). While working for Lucid Corp. in 1989, Gabriel found himself asking why Unix and C had been so successful at attracting users, while Common Lisp (Lucid’s principal focus) had not. His explanation contrasts “The Right Thing,” as exemplified by Common Lisp, with a “Worse Is Better” philosophy, as exemplified by C and Unix. “The Right Thing” emphasizes complete, correct, consistent, and elegant design. “Worse Is Better” emphasizes the rapid development of software that does most of what users need most of the time, and can be tuned and improved incrementally, based on field experience. Much of scripting, and Perl in particular, fits the “Worse Is Better” philosophy (Ruby and Scheme enthusiasts might beg to disagree). Gabriel, for his part, says he still hasn’t made up his mind; his essays argue both points of view.

statistics, where scripting languages are widely used for data analysis, visualization, modeling, and simulation. We then turned to the three domains that dominate scripting today: “glue” (coordination) applications, configuration and extension, and scripting of the World Wide Web.

In terms of “market share,” Perl is almost certainly the most popular of the general-purpose scripting languages, widely used for report generation, glue, and server-side (CGI) web scripting. Python and Ruby both appear to be growing in popularity, and Tcl retains a strong core of support. Several scripting languages, including Scheme, Python, and Tcl, are widely used to extend the functionality of complex applications. In addition, many commercial packages have their own proprietary extension languages. Visual Basic has historically been the language of choice for scripting on Microsoft platforms, but will probably give way over time to C# and the various cross-platform options.

Web scripting comes in many forms. On the server side of an HTTP connection, the Common Gateway Interface (CGI) standard allows a URI to name a program that will be used to generate dynamic content. Alternatively, web-page-embedded scripts, often written in PHP, can be used to create dynamic content in a way that is invisible to users. To reduce the load on servers, and to improve interactive responsiveness, scripts can also be executed within the client browser. JavaScript is the dominant notation in this domain; it uses the HTML Document Object Model (DOM) to manipulate web-page elements. For more demanding tasks, most browsers can be directed to run a Java *applet*, which takes full responsibility for some portion of the “screen real estate.” With the continued evolution of the Web, XML is likely to become the standard vehicle for storing and transmitting structured data. XSL, the Extensible Stylesheet Language, will then play a major role in transforming and formatting dynamic content.

Because of their rapid evolution, scripting languages have been able to take advantage of many of the most powerful and elegant mechanisms described in previous chapters, including first-class and higher-order functions, garbage collection, unlimited extent, iterators, list comprehensions, and object orientation—not to mention extended regular expressions and such high-level data types as dictionaries, sets, and tuples. Given current technological trends, scripting languages are likely to become increasingly ubiquitous, and to remain a principal focus of language innovation.

13.6 Exercises

- 13.1 Does filename “globbing” provide the expressive power of standard regular expressions? Explain.
- 13.2 Write shell scripts to
 - (a) Replace blanks with underscores in the names of all files in the current directory.

- (b) Rename every file in the current directory by prepending to its name a textual representation of its modification date.
 - (c) Find all `eps` files in the file hierarchy below the current directory, and create any corresponding `pdf` files that are missing or out of date.
 - (d) Print the names of all files in the file hierarchy below the current directory for which a given predicate evaluates to true. Your (quoted) predicate should be specified on the command line using the syntax of the Unix `test` command, with one or more at signs (`@`) standing in for the name of the candidate file.
- 13.3 In [Example 13.15](#) we used `"$@"` to refer to the parameters passed to `11`. What would happen if we removed the quote marks? (Hint: try this for files whose names contain spaces!) Read the man page for `bash` and learn the difference between `$@` and `$*`. Create versions of `11` that use `$*` or `"$*"` instead of `"$@"`. Explain what's going on.
- 13.4 (a) Extend the code in [Figure 13.5](#), [13.6](#), [13.7](#), or [13.8](#) to try to kill processes more gently. You'll want to read the man page for the standard `kill` command. Use a `TERM` signal first. If that doesn't work, ask the user if you should resort to `KILL`.
- (b) Extend your solution to part (a) so that the script accepts an optional argument specifying the signal to be used. Alternatives to `TERM` and `KILL` include `HUP`, `INT`, `QUIT`, and `ABRT`.
- 13.5 Write a Perl, Python, or Ruby script that creates a simple *concordance*: a sorted list of significant words appearing in an input document, with a sublist for each that indicates the lines on which the word occurs, with up to six words of surrounding context. Exclude from your list all common articles, conjunctions, prepositions, and pronouns.
- 13.6 Write Emacs Lisp scripts to
- (a) Insert today's date into the current buffer at the insertion point (current cursor location).
 - (b) Place quote marks (`" "`) around the word surrounding the insertion point.
 - (c) Fix end-of-sentence spaces in the current buffer. Use the following heuristic: if a period, question mark, or exclamation point is followed by a single space (possibly with closing quote marks, parentheses, brackets, or braces in-between), then add an extra space, unless the character preceding the period, question mark, or exclamation point is a capital letter (in which case we assume it is an abbreviation).
 - (d) Run the contents of the current buffer through your favorite spell checker, and create a new buffer containing a list of misspelled words.

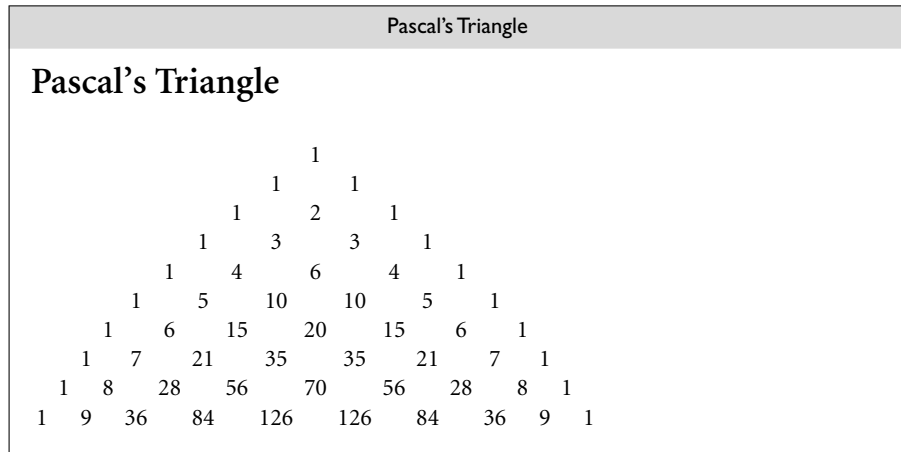

Figure 13.23 Pascal's triangle rendered in a web page ([Exercise 13.8](#)).

- (e) Delete one misspelled word from the buffer created in (d), and place the cursor (insertion point) on top of the first occurrence of that misspelled word in the current buffer.
- 13.7** Explain the circumstances under which it makes sense to realize an interactive task on the Web as a CGI script, an embedded server-side script, or a client-side script. For each of these implementation choices, give three examples of tasks for which it is clearly the preferred approach.
- 13.8** (a) Write a web page with embedded PHP to print the first 10 rows of Pascal's triangle (see Example ©16.10 if you don't know what this is). When rendered, your output should look like [Figure 13.23](#).
 (b) Modify your page to create a self-posting form that accepts the number of desired rows in an input field.
 (c) Rewrite your page in JavaScript.
- 13.9** Create a fill-in web form that uses a JavaScript implementation of the Luhn formula ([Exercise 4.10](#)) to check for typos in credit card numbers. (But don't use real credit card numbers; homework exercises don't tend to be very secure!)
- 13.10** (a) Modify the code of [Figure 13.16](#) ([Example 13.35](#)) so that it replaces the form with its output, as the CGI and PHP versions of [Figures 13.12](#) and [13.15](#) do.
 (b) Modify the CGI and PHP scripts of [Figures 13.12](#) and [13.15](#) ([Examples 13.30](#) and [13.34](#)) so they appear to append their output to the bottom of the form, as the JavaScript version of [Figure 13.16](#) does.

13.11 Run the following program in Perl:

```
sub foo {
  my $lex = $_[0];
  sub bar {
    print "$lex\n";
  }
  bar();
}

foo(2); foo(3);
```

You may be surprised by the output. Perl 5 allows named subroutines to nest, but does not create closures for them properly. Rewrite the code above to create a reference to an anonymous local subroutine and verify that it does create closures correctly. Add the line `use diagnostics;` to the beginning of the original version and run it again. Based on the explanation this will give you, speculate as to how nested named subroutines are implemented in Perl 5.

13.12 Write a program that will map the web pages stored in the file hierarchy below the current directory. Your output should itself be a web page, containing the names of all directories and `.html` files, printed at levels of indentation corresponding to their level in the file hierarchy. Each `.html` filename should be a live link to its file. Use whatever language(s) seem most appropriate to the task.

13.13 In [Section 13.4.1](#) we claimed that nested blocks in Ruby were part of the named scope in which they appear. Verify this claim by running the following Ruby script and explaining its output:

```
def foo(x)
  y = 2
  bar = proc {
    print x, "\n"
    y = 3
  }
  bar.call()
  print y, "\n"
end

foo(3)
```

Now comment out the second line (`y = 2`) and run the script again. Explain what happens. Restate our claim about scoping more carefully and precisely.

- 13.14 Write a Perl script to translate English measurements (in, ft, yd, mi) into metric equivalents (cm, m, km). You may want to learn about the `e` modifier on regular expressions, which allows the right-hand side of an `s///e` expression to contain executable code.
- 13.15 Write a Perl script to find, for each input line, the longest substring that appears at least twice within the line, without overlapping. (*Warning*: This is harder than it sounds. Remember that by default Perl searches for a *left-most longest* match.)
- 13.16 Perl provides an alternative (`?:...`) form of parentheses that supports grouping in regular expressions without performing capture. Using this syntax, [Example 13.59](#) could have been written as follows:

```
if (/^( [+ ]? ) ( ( \d+ ) \. | ( \d* ) \. ( \d+ ) ) (?: e ( [+ ]? \d+ ) )? $ /) {
    # floating-point number
    print "sign:      ", $1, "\n";
    print "integer:   ", $3, $4, "\n";
    print "fraction:  ", $5, "\n";
    print "mantissa:  ", $2, "\n";
    print "exponent:  ", $6, "\n";           # not $7
}
```

What purpose does this extra notation serve? Why might the code here be preferable to that of [Example 13.59](#)?

- 13.17 Consider again the `sed` code of [Figure 13.1](#). It is tempting to write the first of the compound statements as follows (note the differences in the three substitution commands):

```
</[hH] [123]>.*<\/[hH] [123]>/ {    ;# match whole heading
    h                                ;# save copy of pattern space
    s/^.*<[hH] [123]>\)/\1/          ;# delete text before opening tag
    s/\(<\/[hH] [123]>\).*$/\1/      ;# delete text after closing tag
    p                                ;# print what remains
    g                                ;# retrieve saved pattern space
    s/^.*<\/[hH] [123]>>//          ;# delete through closing tag
    b top
```

Explain why this doesn't work. (Hint: remember the difference between *greedy* and *minimal* matches [[Example 13.55](#)]. `Sed` lacks the latter.)

- 13.18 Consider the following regular expression in Perl: `/^(?:((?:ab)+)|a(?:ba)*))/`. Describe, in English, the set of strings it will match. Show a natural NFA for this set, together with the minimal DFA. Describe the substrings that should be captured in each matching string. Based on this example, discuss the practicality of using DFAs to match strings in Perl.

13.7 Explorations

- 13.22 Learn about the Scheme shell, `scsh`. Compare it to `sh`/`bash`. Which would you rather use from the keyboard? Which would you rather use for scripting?
- 13.23 Learn about $\text{T}_{\text{E}}\text{X}$ [Knu86] and $\text{L}_{\text{A}}\text{T}_{\text{E}}\text{X}$ [Lam94], the typesetting system used to create this book. Explore the ways in which its specialized target domain—professional typesetting—influenced its design. Features you might wish to consider include dynamic scoping, the relatively impoverished arithmetic and control-flow facilities, and the use of macros as the fundamental control abstraction.
- 13.24 Research the security mechanisms of JavaScript and/or Java applets. What exactly are programs allowed to do and why? What potentially useful features have not been provided because they can't be made secure? What potential security holes remain in the features that *are* provided?
- 13.25 Learn about *web crawlers*—programs that explore the World Wide Web. Build a crawler that searches for something of interest. What language features or tools seem most useful for the task? *Warning*: Automated web-crawling is a public activity, subject to strict rules of etiquette. Before creating a crawler, do a web search and learn the rules, and test your code *very* carefully before letting it outside your local subnet (or even your own machine). In particular, be aware that rapid-fire requests to the same server constitute a *denial of service attack*, a potentially criminal offense.
- 13.26 In the sidebar on page 699 we noted that the “extended” REs of `awk` and `egrep` are typically implemented by translating first to an NFA and then to a DFA, while those of Perl et al. are typically implemented via backtracking search. Some tools, including GNU `grep`, use a variant of the Boyer-Moore-Gosper algorithm [BM77, KMP77] for faster deterministic search. Find out how this algorithm works. What are its advantages? Could it be used in languages like Perl?
- 13.27 In the sidebar on page 702 we noted that nonconstant patterns must generally be recompiled whenever they are used. Perl programmers who wish to reduce the resulting overhead can inhibit recompilation using the `o` trailing modifier or the `qr` quoting operator. Investigate the impact of these mechanisms on performance. Also speculate as to the extent to which it might be possible for the language implementation to determine, automatically and efficiently, when recompilation should occur.
- 13.28 Our coverage of Perl REs in Section 13.4.2 was incomplete. Features not covered include look-ahead and look-behind (context) assertions, comments, incremental enabling and disabling of modifiers, embedded code, conditionals, Unicode support, nonslash delimiters, and the transliteration (`tr///`) operator. Learn how these work. Explain if (and how) they extend

the expressive power of the notation. How could each be emulated (possibly with surrounding Perl code) if it were not available?

- 13.29 Investigate the details of RE support in PHP, Tcl, Python, Ruby, JavaScript, Emacs Lisp, Java, and C#. Write a paper that documents, as concisely as possible, the differences among these, using Perl as a reference for comparison.
- 13.30 Do a web search for Perl 6, which seems to be nearing completion as of summer 2008. Write a report that summarizes the changes with respect to Perl 5. What do you think of these changes? If you were in charge of the revision, what would you do differently?
- © 13.31–13.33 In More Depth.

13.8 Bibliographic Notes

Most of the major scripting languages are described in books by the language designers or their close associates: awk [AKW88], Perl [WCO00], PHP [LT02], Tcl [Ous94, WJH03], Python [vRD03], and Ruby [TFH04]. Several of these have versions available on-line. Most of the languages are also described in a variety of other texts, and most have dedicated web sites: *perl.com*, *php.net*, *tcl.tk*, *python.org*, *ruby-lang.org*. Extensive documentation for Perl is available on-line at many sites; type `man perl` for an index.

Rexx [Ame96a] has been standardized by ANSI, the American National Standards Institute. JavaScript [ECM99] has been standardized by ECMA, the European standards body. Scheme implementations intended for scripting include Elk (www-rn.informatik.uni-bremen.de/software/elk/ and <http://sam.zoy.org/projects/elk/>), Guile (gnu.org/software/guile/), and SIOD (Scheme in One Defun) (people.delphiforums.com/gjc/siod.html). Standards for the World Wide Web, including HTML, XML, XSL, XPath, and XHTML, are promulgated by the World Wide Web Consortium: www.w3.org. For those experimenting with the conversion to XHTML, the validation service at validator.w3.org is particularly useful. High-quality tutorials on many web-related topics can be found at w3schools.com.

Hauben and Hauben [HH97a] describe the historical roots of the Internet, including early work on Unix. Original articles on the various Unix shell languages include those of Mashey [Mas76], Bourne [Bou78], and Korn [Kor94]. Information on the Scheme shell, `scsh`, is available at scsh.net. The original reference on APL is by Iverson [Ive62]. Ousterhout [Ous98] makes the case for scripting languages in general, and Tcl in particular. Chonacky and Winch [CW05] compare and contrast Maple, Mathematica, and Matlab. Richard Gabriel's collection of "Worse Is Better" papers can be found at www.dreamsongs.com/WorseIsBetter.html. A similar comparison of Tcl and Scheme can be found in the introductory chapter of Abelson, Greenspun, and Sandon's on-line *Tcl for Web Nerds* guide (philip.greenspun.com/tcl/index.adp).

This page intentionally left blank



A Closer Look at Implementation

IV

In this, the final and shortest of the major parts of the text, we return our focus to implementation issues.

[Chapter 14](#) considers the work that must be done, in the wake of semantic analysis, to generate a runnable program. The first half of the chapter describes, in general terms, the structure of the *back end* of the typical compiler, surveys intermediate program representations, and uses the attribute grammar framework of [Chapter 4](#) to describe how a compiler produces assembly-level code. The second half of the chapter describes the structure of the typical process address space, and explains how the *assembler* and *linker* transform the output of the compiler into executable code.

In any nontrivial language implementation, the compiler assumes the existence of a large body of preexisting code for storage management, exception handling, dynamic linking, and the like. A more sophisticated language may require events, threads, and messages as well. When the libraries that implement these features depend on knowledge of the compiler or of the structure of the running program, they are said to constitute a *run-time system*. We consider such systems in [Chapter 15](#). We focus in particular on *virtual machines*; run-time manipulation of machine code; and *reflection* mechanisms, which allow a program to reason about its run-time structure and types.

The back-end compiler description in [Chapter 14](#) is by necessity simplistic. Entire books and courses are devoted to the fuller story, most of which focuses on the *code improvement* or *optimization* techniques used to produce efficient code. [Chapter 16](#) of the current text, contained entirely on the PLP CD, provides an overview of code improvement. Since most programmers will never write the back end of a compiler, the goal of [Chapter 16](#) is more to convey a sense of what the compiler does than exactly how it does it. Programmers who understand this material will be in a better position to “work with” the compiler, knowing what is possible, what to expect in common cases, and how to avoid programming idioms that are hard to optimize. Topics include local and “global” (procedure-level) redundancy elimination, data-flow analysis, loop optimization, and register allocation.

This page intentionally left blank

Building a Runnable Program

As noted in [Section 1.6](#), the various phases of compilation are commonly grouped into a *front end* responsible for the analysis of source code, a *back end* responsible for the synthesis of target code, and sometimes a “middle end” responsible for language- and machine-independent code improvement. [Chapters 2 and 4](#) discussed the work of the front end, culminating in the construction of a syntax tree. The current chapter turns to the work of the back end, and specifically to code generation, assembly, and linking. We will continue with code improvement in [Chapter 16](#).

In [Chapters 6 through 9](#), we often discussed the code that a compiler would generate to implement various imperative language features. Now we will look at how the compiler produces that code from a syntax tree, and how it combines the output of multiple compilations to produce a runnable program. We begin in [Section 14.1](#) with a more detailed overview of the work of program synthesis than was possible in [Chapter 1](#). We focus in particular on one of several plausible ways of dividing that work into phases. In [Section 14.2](#) we then consider the many possible forms of intermediate code passed between these phases. On the PLP CD we provide a bit more detail on two concrete examples: Diana, commonly used by Ada compilers, and RTL, used by the GNU compilers. We will consider two additional intermediate forms in [Chapter 15](#): Java Byte Code (JBC) and the Common Intermediate Language (CIL) used by Microsoft and other implementors of the Common Language Infrastructure.

In [Section 14.3](#) we discuss the generation of assembly code from an abstract syntax tree, using attribute grammars as a formal framework. In [Section 14.4](#) we discuss the internal organization of binary object files and the layout of programs in memory. [Section 14.5](#) describes assembly. [Section 14.6](#) considers linking.

14.1 Back-End Compiler Structure

As we noted in [Chapter 4](#), there is less uniformity in back-end compiler structure than there is in front-end structure. Even such unconventional compilers as text

processors, source-to-source translators, and VLSI layout tools must scan, parse, and analyze the semantics of their input. When it comes to the back end, however, even compilers for the same language on the same machine can have very different internal structure.

As we shall see in [Section 14.2](#), different compilers may use different intermediate forms to represent a program internally. Depending on the preferences of the programmers building a compiler, the constraints under which those programmers are working, and the expected user community, compilers may also differ dramatically in the forms of code improvement they perform. A simple compiler, or one designed for speed of compilation rather than speed of target code execution (e.g., a “just-in-time” compiler) may not do much improvement at all. A just-in-time or “load-and-go” compiler (one that compiles and then executes a program as a single high-level operation, without writing the target code to a file) may not use a separate linker. In many compilers, much or all of the code generator may be written automatically by a tool (a “code generator generator”) that takes a formal description of the target machine as input.

14.1.1 A Plausible Set of Phases

EXAMPLE 14.1

Phases of compilation

[Figure 14.1](#) illustrates a plausible seven-phase structure for a conventional compiler. The first three phases (scanning, parsing, and semantic analysis) are language dependent; the last two (target code generation and machine specific code improvement) are machine dependent, and the middle two (intermediate code generation and machine-independent code improvement) are (to first approximation) dependent on neither the language nor the machine. The scanner and parser drive a set of action routines that build a syntax tree. The semantic analyzer traverses the tree, performing all static semantic checks and initializing various attributes (mainly symbol table pointers and indications of the need for dynamic checks) of use to the back end. ■

While certain code improvements can be performed on syntax trees, a less hierarchical representation of the program makes most code improvement easier. Our example compiler therefore includes an explicit phase for intermediate code generation. The code generator begins by grouping the nodes of the tree into *basic blocks*, each of which consists of a maximal-length set of operations that should execute sequentially at run time, with no branches in or out. It then creates a *control flow graph* in which the nodes are basic blocks and the arcs represent interblock control flow. Within each basic block, operations are represented as instructions for an idealized RISC machine with an unlimited number of registers. We will call these *virtual registers*. By allocating a new one for every computed value, the compiler can avoid creating artificial connections between otherwise independent computations too early in the compilation process.

EXAMPLE 14.2

GCD program abstract
syntax tree (reprise)

In [Section 1.6](#) we used a simple greatest common divisor (GCD) program (source code on page 27) to illustrate the phases of compilation. The syntax tree for this program appeared in [Figure 1.5](#); it is reproduced here (in slightly altered

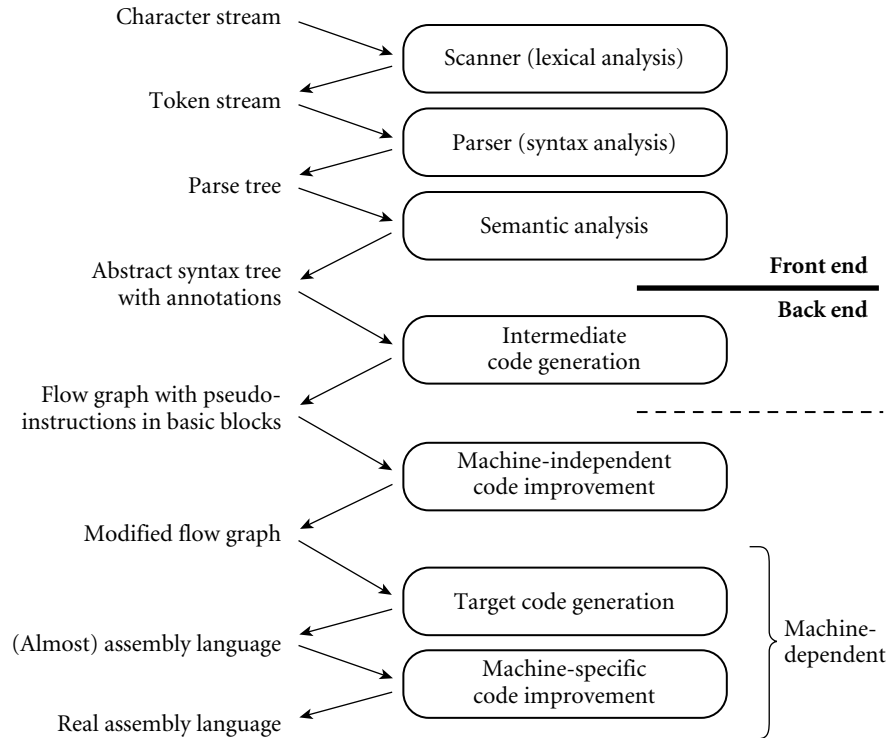

Figure 14.1 A plausible structure for the compiler back end. Here we have shown a sharper separation between semantic analysis and intermediate code generation than we considered in Chapter 1 (see Figure 1.3, page 26). Machine-independent code improvement employs an intermediate form that resembles the assembly language for an idealized machine with an unlimited number of registers. Machine-specific code improvement—register allocation and instruction scheduling in particular—employs the assembly language of the target machine. The dashed line shows a common alternative “break point” between the front end and back end of a two-pass compiler. In some implementations, machine-independent code improvement may be located in a separate “middle end” pass.

form) as Figure 14.2. A corresponding control flow graph appears in Figure 14.3. We will discuss techniques to generate this graph in Section 14.3 and Exercise 14.6. Additional examples of control flow graphs will appear in Chapter 16. ■

The second phase of the back end, machine-independent code improvement, performs a variety of transformations on the control flow graph. It modifies the instruction sequence within each basic block to eliminate redundant loads, stores, and arithmetic computations; this is *local code improvement*. It also identifies and removes a variety of redundancies across the boundaries between basic blocks within a subroutine; this is *global code improvement*. As an example of the latter, an expression whose value is computed immediately before an `if` statement need not be recomputed within the code that follows the `else`. Likewise an expression

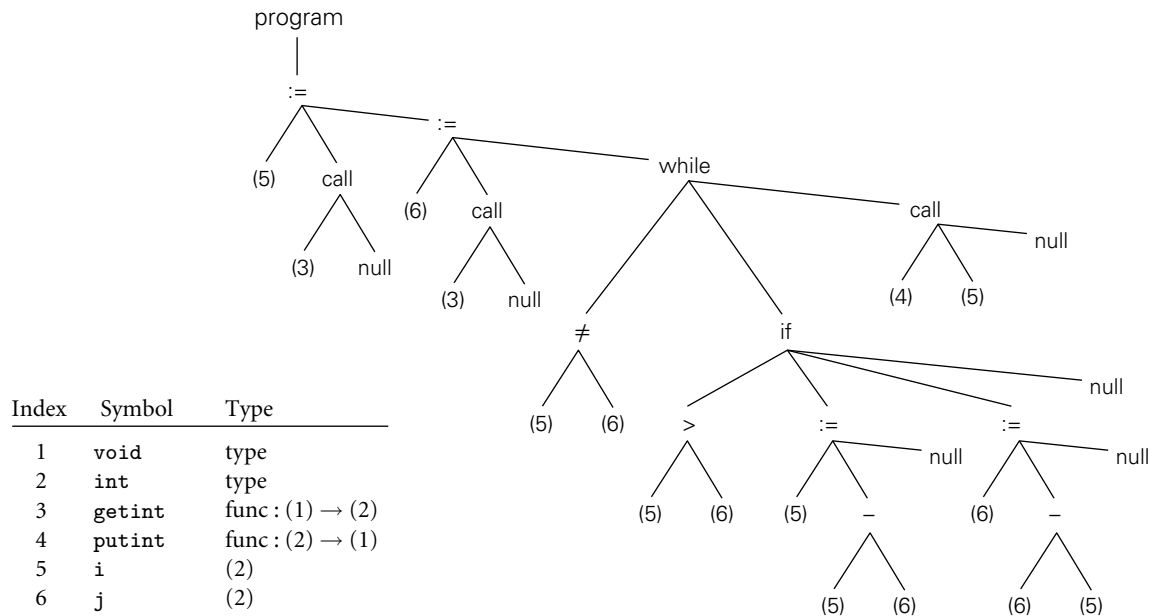

Figure 14.2 Syntax tree and symbol table for the GCD program. The only difference from Figure 1.5 is the addition of explicit null nodes to indicate empty argument lists and to terminate statement lists.

that appears within the body of a loop need only be evaluated once if its value will not change in subsequent iterations. Some global improvements change the number of basic blocks and/or the arcs among them.

It is worth noting that “global” code improvement typically considers only the current subroutine, not the program as a whole. Much recent research in compiler technology has been aimed at “truly global” techniques, known as *interprocedural code improvement*. Since programmers are generally unwilling to give up separate compilation (recompiling hundreds of thousands of lines of code is a very time-consuming operation), a practical interprocedural code improver must do much of its work at link time. One of the (many) challenges to be overcome is to develop a division of labor and an intermediate representation that allow the compiler to do as much work as possible during (separate) compilation, but leave enough of the details undecided that the link-time code improver is able to do its job.

Following machine-independent code improvement, the next phase of compilation is target code generation. This phase strings the basic blocks together into a linear program, translating each block into the instruction set of the target machine and generating branch instructions (or “fall-throughs”) that correspond to the arcs of the control flow graph. The output of this phase differs from real assembly language primarily in its continued reliance on virtual registers. So long

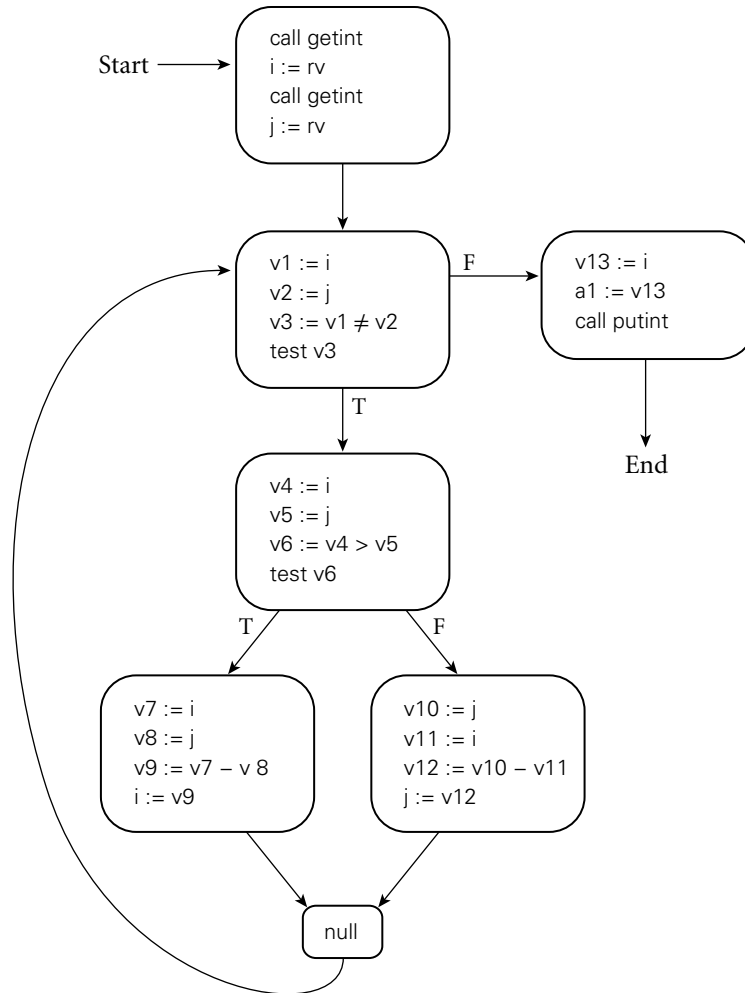

Figure 14.3 Control flow graph for the GCD program. Code within basic blocks is shown in the pseudo-assembly notation introduced on page 214, with a different virtual register (here named v1...v13) for every computed value. Registers a1 and rv are used to pass values to and from subroutines.

as the pseudoinstructions of the intermediate form are reasonably close to those of the target machine, this phase of compilation, though tedious, is more or less straightforward.

To reduce programmer effort and increase the ease with which a compiler can be ported to a new target machine, target code generators are often generated automatically from a formal description of the machine. Automatically generated code generators all rely on some sort of pattern-matching algorithm to replace

sequences of intermediate code instructions with equivalent sequences of target machine instructions. References to several such algorithms can be found in the Bibliographic Notes at the end of this chapter; details are beyond the scope of this book.

The final phase of our example compiler structure consists of register allocation and instruction scheduling, both of which can be thought of as machine-specific code improvement. Register allocation requires that we map the unlimited virtual registers employed in earlier phases onto the bounded set of architectural registers available in the target machine. If there aren't enough architectural registers to go around, we may need to generate additional loads and stores to multiplex a given architectural register among two or more virtual registers. Instruction scheduling (described in Sections 15.5 and 16.6) consists of reordering the instructions of each basic block in an attempt to fill the pipeline(s) of the target machine.

14.1.2 Phases and Passes

In Section 1.6 we defined a *pass* of compilation as a phase or sequence of phases that is serialized with respect to the rest of compilation: it does not start until previous phases have completed, and it finishes before any subsequent phases start. If desired, a pass may be written as a separate program, reading its input from a file and writing its output to a file. Two-pass compilers are particularly common. They may be divided between the front end and the back end (i.e., between semantic analysis and intermediate code generation) or between intermediate code generation and global code improvement. In the latter case, the first pass is still commonly referred to as the front end and the second pass as the back end.

Like most compilers, our example generates symbolic assembly language as its output (a few compilers, including those written by IBM for the PowerPC, generate binary machine code directly). The assembler (not shown in Figure 14.1) behaves as an extra pass, assigning addresses to fragments of data and code, and translating symbolic operations into their binary encodings. In most cases, the input to the compiler will have consisted of source code for a single compilation unit. After assembly, the output will need to be *linked* to other fragments of the application, and to various preexisting subroutine libraries. Some of the work of linking may be delayed until load time (immediately prior to program execution) or even until run time (during program execution). We will discuss assembly and linking in Sections 14.5 through 14.7.

14.2 Intermediate Forms

An *intermediate form* (IF) provides the connection between the front end and the back end of the compiler, and continues to represent the program during the various back-end phases.

IFs can be classified in terms of their *level*, or degree of machine dependence. High-level IFs are often based on trees or directed acyclic graphs (DAGs) that directly capture the hierarchical structure of modern programming languages. A high-level IF facilitates certain kinds of machine-independent code improvement, incremental program updates (e.g., in a language-based editor), and direct interpretation (most interpreters employ a tree-based internal IF). Because the permissible structure of a tree can be described formally by a set of productions (as described in [Section 4.6](#)), manipulations of tree-based forms can be written as attribute grammars.

The most common medium-level IFs employ three-address instructions for a simple idealized machine, typically one with an unlimited number of registers. Often the instructions are embedded in a control flow graph. Since the typical instruction specifies two operands, an operator, and a destination, three-address instructions are sometimes called *quadruples*. Low-level IFs usually resemble the assembly language of some particular target machine, most often the physical machine on which the target code will execute.

Different compilers use different IFs. Many compilers use more than one IF internally, though in the common two-pass organization one of these is distinguished as “the” intermediate form by virtue of being the externally visible connection between the front end and the back end. In the example of [Section 14.1.1](#), the syntax trees passed from semantic analysis to intermediate code generation constitute a high-level IF. Control flow graphs containing pseudo-assembly language (passed in and out of machine-independent code improvement) are a medium-level IF. The assembly language of the target machine (initially with virtual registers; later with architectural registers) serves as a low-level IF.

The distinction between “high-,” “medium-,” and “low-level” IFs is of course somewhat arbitrary: the plausible design space is very large, with a nearly continuous spectrum from abstract to machine dependent. ■

Compilers that have back ends for several different target architectures tend to do as much work as possible on a high- or medium-level IF, so that the machine-independent parts of the code improver can be shared by different back ends. By contrast, some (but not all) compilers that generate code for a single architecture perform most code improvement on a comparatively low-level IF, closely modeled after the assembly language of the target machine.

In a multilanguage compiler family, an IF that is independent of both source language and target machine allows a software vendor who wishes to sell compilers for n languages on m machines to build just n front ends and m back ends, rather than $n \times m$ integrated compilers. Even in a single-language compiler family, a common, possibly language-dependent IF simplifies the task of porting to a new machine by isolating the code that needs to be changed. In a rich program development environment, there may be a variety of tools in addition to the passes of the compiler that understand and operate on the IF. Examples include editors, assemblers, linkers, debuggers, pretty-printers, and version-management software. In a language system capable of interprocedural (whole-program) code improvement, separately compiled modules and libraries may be compiled only

EXAMPLE 14.3

Intermediate forms in
[Figure 14.1](#)

to the IF, rather than the target language, leaving the final stages of compilation to the linker.

To be stored in a file, an IF requires a linear representation. Sequences of three-address instructions are naturally linear. Tree-based IFs can be linearized via ordered traversal. Structures like control flow graphs can be linearized by replacing pointers with indices relative to the beginning of the file.

© IN MORE DEPTH

On the PLP CD we consider three widely used IFs. The first is a high-level tree-based form called Diana [GWEB83], used by most Ada compilers. The other two, GIMPLE and RTL, are used in the various gcc compilers, including gnat (the GNU Ada translator). GIMPLE, like Diana, is a high-level tree-based IF, but somewhat less abstract. RTL (Register Transfer Language) is a medium-level IF, but a bit higher level than most; it consists of a linear sequence of pseudoinstructions with an overlaid control flow graph. RTL was, for many years, the principal IF for gcc. GIMPLE was introduced in 2005 as a more suitable form for machine-independent code improvement.

14.2.3 Stack-Based Intermediate Forms

In situations where simplicity and brevity are paramount, designers often turn to stack-based languages. Operations in a such a language pop arguments from—and push results to—a common implicit stack. The lack of named operands means that a stack-based language can be very compact. In certain HP calculators (Exercise 4.7), stack-based expression evaluation serves to minimize the number of keystrokes required to enter equations. For embedded devices and printers, stack-based evaluation in Forth and Postscript serves to reduce memory and bandwidth requirements, respectively (see sidebar on page 738).

Medium-level stack-based intermediate languages are similarly attractive when passing code from a compiler to an interpreter or virtual machine. Some 35 years ago, P-code (Example 1.15) made it easy to port Pascal to new machines, and helped to speed the language's adoption. Today, the compactness of Java Byte Code (JBC) helps minimize the download time for applets. Common Intermediate Language (CIL), the analogue of JBC for .NET and other implementations of the Common Language Infrastructure (CLI), is similarly compact and machine independent. As of 2008, .NET runs only on the x86, but the open-source Mono CLI is available for all the major instruction sets. We will consider JBC and CIL in some detail in Chapter 15.

Unfortunately, stack-based IF is not well suited to many code improvement techniques: it limits the ability to eliminate redundancy or improve pipeline performance by reordering calculations. For this reason, languages like JBC and CIL tend to be used mainly as an external format, not as a representation for code *within* a compiler.

push a	r2 := a	
push b	r3 := b	
push c	r4 := c	
add	r1 := r2 + r3	
add	r1 := r1 + r4	
push 2	r1 := r1 / 2	-- s
divide		
pop s		
push s		
push s	r2 := r1 - r2	-- s - a
push a		
subtract		
push s	r3 := r1 - r3	-- s - b
push b		
subtract		
push s	r4 := r1 - r4	-- s - c
push c		
subtract		
multiply	r3 := r3 × r4	
multiply	r2 := r2 × r3	
multiply	r1 := r1 × r2	
push sqrt	call sqrt	
call		

Figure 14.4 Stack-based versus three-address IF. Shown are two versions of code to compute the area of a triangle using Heron's formula. At left is a stylized version of Java Byte Code or CLI Common Intermediate Language. At right is corresponding pseudo-assembler for a machine with three-address instructions. The byte code requires a larger number of instructions, but occupies less space.

EXAMPLE 14.4

Computing Heron's formula

In many cases, stack-based code for an expression will occupy fewer bytes, but specify more instructions, than corresponding three-address code. As a concrete example, consider Heron's formula to compute the area of a triangle given the lengths of its sides, a , b , and c :

$$A = \sqrt{s(s-a)(s-b)(s-c)}, \quad \text{where } s = \frac{a+b+c}{2}$$

Figure 14.4 compares byte code and three-address versions of this formula. Each line represents a single instruction. If we assume that a , b , c , and s are all among the first few local variables of the current subroutine, both the Java Virtual Machine (JVM) and the CLI will be able to move them to or from the stack with single-byte instructions. Consequently, the second-to-last instruction in the left column is the only one that needs more than a single byte (it takes three: one for the push operation and two to specify the sqrt routine). This gives us a total of 23 instructions in 25 bytes.

By contrast, three-address code for the same formula keeps a , b , c , and s in registers, and requires only 13 instructions. Unfortunately, in typical notation each

instruction but the last will be four bytes in length (the last will be eight), and our 13 instructions will occupy 56 bytes. ■

14.3 Code Generation

EXAMPLE 14.5

Simpler compiler structure

The back end of [Figure 14.1](#) is too complex to present in any detail in a single chapter. To limit the scope of our discussion, we will content ourselves in this chapter with producing correct but naive code. This choice will allow us to consider a significantly simpler back end. Starting with the structure of [Figure 14.1](#), we drop the machine-independent code improver and then merge intermediate and target code generation into a single phase. This merged phase generates pure, linear assembly language; because we are not performing code improvements that alter the program's control flow, there is no need to represent that flow explicitly in a control flow graph. We also adopt a much simpler register allocation algorithm, which can operate directly on the syntax tree prior to code generation, eliminating the need for virtual registers and the subsequent mapping onto architectural registers. Finally, we drop instruction scheduling. The resulting compiler structure appears in [Figure 14.5](#). Its code generation phase closely resembles the intermediate code generation of [Figure 14.1](#). ■

14.3.1 An Attribute Grammar Example

Like semantic analysis, intermediate code generation can be formalized in terms of an attribute grammar, though it is most commonly implemented via handwritten ad hoc traversal of a syntax tree. We present an attribute grammar here for the sake of clarity.

DESIGN & IMPLEMENTATION

Postscript

One of the most pervasive uses of stack-based languages today occurs in document preparation. Many document compilers (\TeX , \troff , Microsoft Word, etc.) generate Postscript as their target language (most employ some special-purpose intermediate language as well, and have multiple back ends, so they can also generate other target languages). Postscript is stack-based. It is portable, compact, and easy to generate. It is also written in ASCII, so it can be read (albeit with some difficulty) by human beings. Postscript interpreters are embedded in most professional-quality printers. Issues of code improvement are relatively unimportant: most of the time required for printing is consumed by network delays, mechanical paper transport, and data manipulations embedded in (optimized) library routines; interpretation time is seldom a bottleneck. Compactness on the other hand is crucial, because it contributes to network delays. (See discussion concerning this in [Section 14.2](#) and its subsections.)

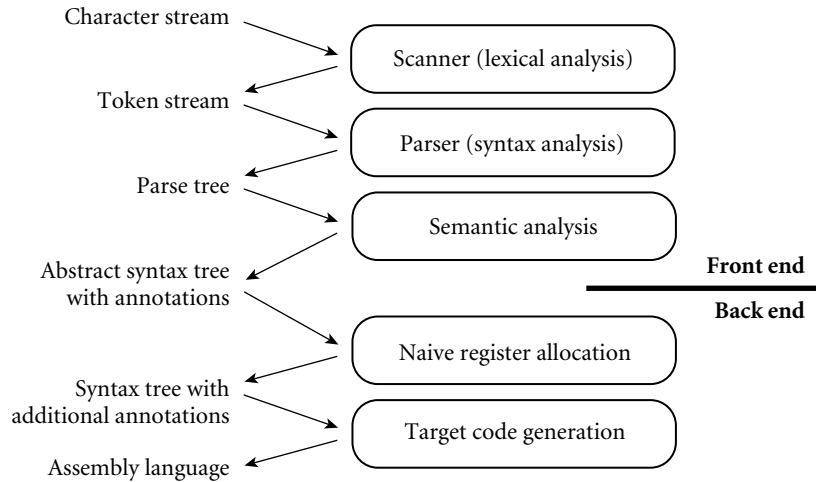

Figure 14.5 A simpler, nonoptimizing compiler structure, assumed in Section 14.3. The target code generation phase closely resembles the intermediate code generation phase of Figure 14.1.

In Figure 1.6 (page 34) we presented naive x86 assembly language for the GCD program. We will use our attribute grammar example to generate a similar version here, but for a RISC-like machine, and in pseudo-assembly notation. Because this notation is now meant to represent target code, rather than medium- or low-level intermediate code, we will assume a fixed, limited register set reminiscent of real machines (but larger than provided by the 32-bit version of the x86). We will reserve several registers (*a1*, *a2*, *sp*, *rv*) for special purposes; others (*r1* . . . *rk*) will be available for temporary values and expression evaluation.

EXAMPLE 14.6

An attribute grammar for code generation

Figure 14.6 contains a fragment of our attribute grammar. To save space, we have shown only those productions that actually appear in Figure 14.2. As in Chapter 4, notation like *while* : *stmt* on the left-hand side of a production indicates that a *while* node in the syntax tree is one of several kinds of *stmt* node; it may serve as the *stmt* in the right-hand side of its parent production. In our attribute grammar fragment, *program*, *expr*, and *stmt* all have a synthesized attribute code that contains a sequence of instructions. *Program* has an inherited attribute name of type string, obtained from the compiler command line. *Id* has a synthesized attribute *stp* that points to the symbol table entry for the identifier. *Expr* has a synthesized attribute *reg* that indicates the register that will hold the value of the computed expression at run time. *Expr* and *stmt* have an inherited attribute *next_free_reg* that indicates the next register (in an ordered set of temporaries) that is available for use (i.e., that will hold no useful value at run time) immediately before evaluation of a given expression or statement. ■

Because we use a symbol table in our example, and because symbol tables lie outside the formal attribute grammar framework, we must augment our attribute grammar with some extra code for storage management. Specifically, prior to evaluating the attribute rules of Figure 14.6, we must traverse the symbol table in

```

reg_names : array [0..k-1] of register_name := ["r1", "r2", ..., "rk"]
-- ordered set of temporaries

program → stmt
  ▷ stmt.next_free_reg := 0
  ▷ program.code := ["main:"] + stmt.code + ["goto exit"]

while : stmt1 → expr stmt2 stmt3
  ▷ expr.next_free_reg := stmt2.next_free_reg := stmt3.next_free_reg := stmt1.next_free_reg
  ▷ L1 := new_label(); L2 := new_label()
  stmt1.code := ["goto" L1] + [L2 ":"] + stmt2.code + [L1 ":"] + expr.code
  + ["if" expr.reg "goto" L2] + stmt3.code

if : stmt1 → expr stmt2 stmt3 stmt4
  ▷ expr.next_free_reg := stmt2.next_free_reg := stmt3.next_free_reg := stmt4.next_free_reg :=
  stmt1.next_free_reg
  ▷ L1 := new_label(); L2 := new_label()
  stmt1.code := expr.code + ["if" expr.reg "goto" L1] + stmt3.code + ["goto" L2]
  + [L1 ":"] + stmt2.code + [L2 ":"] + stmt4.code

assign : stmt1 → id expr stmt2
  ▷ expr.next_free_reg := stmt2.next_free_reg := stmt1.next_free_reg
  ▷ stmt1.code := expr.code + [id.stp→name " := " expr.reg] + stmt2.code

read : stmt1 → id1 id2 stmt2
  ▷ stmt1.code := ["a1 := &" id1.stp→name] -- file
  + ["call" if id2.stp→type = int then "readint" else ...]
  + [id2.stp→name " := rv"] + stmt2.code

write : stmt1 → id expr stmt2
  ▷ expr.next_free_reg := stmt2.next_free_reg := stmt1.next_free_reg
  ▷ stmt1.code := ["a1 := &" id.stp→name] -- file
  + ["a2 := " expr.reg] -- value
  + ["call" if id.stp→type = int then "writeint" else ...] + stmt2.code

writeln : stmt1 → id stmt2
  ▷ stmt1.code := ["a1 := &" id.stp→name] + ["call writeln"] + stmt2.code

null : stmt → ε
  ▷ stmt.code := null

'<>' : expr1 → expr2 expr3
  ▷ handle_op(expr1, expr2, expr3, "≠")

'>' : expr1 → expr2 expr3
  ▷ handle_op(expr1, expr2, expr3, ">")

'-' : expr1 → expr2 expr3
  ▷ handle_op(expr1, expr2, expr3, "-")

id : expr → ε
  ▷ expr.reg := reg_names[expr.next_free_reg mod k]
  ▷ expr.code := [expr.reg " := " expr.stp→name]

```

Figure 14.6 Attribute grammar to generate code from a syntax tree. Square brackets delimit individual target instructions. Juxtaposition indicates concatenation within instructions; the '+' operator indicates concatenation of instruction lists. The handle_op macro is used in three of the attribute rules. (*continued*)

```

macro handle_op(ref result, L_operand, R_operand, op : syntax_tree_node)
  result.reg := L_operand.reg
  L_operand.next_free_reg := result.next_free_reg
  R_operand.next_free_reg := result.next_free_reg + 1
  if R_operand.next_free_reg < k
    spill_code := restore_code := null
  else
    spill_code := ["*sp := " reg_names[R_operand.next_free_reg mod k]]
      + ["sp := sp - 4"]
    restore_code := ["sp := sp + 4"]
      + [reg_names[R_operand.next_free_reg mod k] " := *sp"]
  result.code := L_operand.code + spill_code + R_operand.code
    + [result.reg " := " L_operand.reg op R_operand.reg] + restore_code

```

Figure 14.6 (continued)

order to calculate stack-frame offsets for local variables and parameters (two of which—*i* and *j*—occur in the GCD program) and in order to generate assembler directives to allocate space for global variables (of which our program has none). Storage allocation and other assembler directives will be discussed in more detail in Section 14.5.

14.3.2 Register Allocation

Evaluation of the rules of the attribute grammar itself consists of two main tasks. In each subtree we first determine the registers that will be used to hold various quantities at run time; then we generate code. Our naive register allocation strategy uses the `next_free_reg` inherited attribute to manage registers $r_1 \dots r_k$ as an expression evaluation stack. To calculate the value of $(a + b) \times (c - (d / e))$, for example, we would generate the following:

EXAMPLE 14.7

Stack-based register allocation

```

r1 := a          -- push a
r2 := b          -- push b
r1 := r1 + r2    -- add
r2 := c          -- push c
r3 := d          -- push d
r4 := e          -- push e
r3 := r3 / r4    -- divide
r2 := r2 - r3    -- subtract
r1 := r1 × r2    -- multiply

```

Allocation of the next register on the “stack” occurs in the production $id : expr \rightarrow \epsilon$, where we use `expr.next_free_reg` to index into `reg_names`, the array of temporary register names, and in macro `handle_op`, where we increment `next_free_reg` to make this register unavailable during evaluation of the right-hand operand. There is no need to “pop” the “register stack” explicitly; this happens automatically when the attribute evaluator returns to a parent node and uses the parent’s (unmodified) `next_free_reg` attribute. In our example grammar, left-hand

operands are the only constructs that tie up a register during the evaluation of anything else. In a more complete grammar, other long-term uses of registers would probably occur in constructs like `for` loops (for the step size, index, and bound).

In a particularly complicated fragment of code it is possible to run out of architectural registers. In this case we must *spill* one or more registers to memory. Our naive register allocator pushes a register onto the program's subroutine call stack, reuses the register for another purpose, and then pops the saved value back into the register before it is needed again. In effect, architectural registers hold the top k elements of an expression evaluation stack of effectively unlimited size. ■

It should be emphasized that our register allocation algorithm, while correct, makes very poor use of machine resources. We have made no attempt to reorganize expressions to minimize the number of registers used, or to keep commonly used variables in registers over extended periods of time (avoiding loads and stores). If we were generating medium-level intermediate code, instead of target code, we would employ virtual registers, rather than architectural ones, and would allocate a new one every time we needed it, never reusing one to hold a different value. Mapping of virtual registers to architectural registers would occur much later in the compilation process.

EXAMPLE 14.8

GCD program target code

Target code for the GCD program appears in [Figure 14.7](#). The first few lines are generated during symbol table traversal, prior to attribute evaluation. Attribute `program.name` might be passed to the assembler, to tell it the name of the file into which to place the runnable program. A production-quality compiler would probably also generate assembler directives to embed symbol-table information in the target program. As in [Figure 1.6](#), the quality of our code is very poor. We will investigate techniques to improve it in [Chapter 16](#). In the remaining sections of the current chapter we will consider assembly and linking. ■

✓ CHECK YOUR UNDERSTANDING

1. What is a *code generator generator*? Why might it be useful?
2. What is a *basic block*? A *control flow graph*?
3. What are *virtual registers*? What purpose do they serve?
4. What is the difference between *local* and *global* code improvement?
5. What is *register spilling*?
6. Explain what is meant by the “level” of an intermediate form (IF). What are the comparative advantages and disadvantages of high-, medium-, and low-level IFs?
7. What is the IF most commonly used in Ada compilers?
8. Name two advantages of a stack-based IF. Name one disadvantage.

```

-- first few lines generated during symbol table traversal
.data          -- begin static data
i: .word 0     -- reserve one word to hold i
j: .word 0     -- reserve one word to hold j
.text          -- begin text (code)
-- remaining lines accumulated into program.code
main:
a1 := &input   -- "input" and "output" are file control blocks
                -- located in a library, to be found by the linker
call readint  -- "readint", "writeint", and "writeln" are library subroutines
i := rv
a1 := &input
call readint
j := rv
goto L1
L2: r1 := i     -- body of while loop
    r2 := j
    r1 := r1 > r2
    if r1 goto L3
    r1 := j     -- "else" part
    r2 := i
    r1 := r1 - r2
    j := r1
    goto L4
L3: r1 := i     -- "then" part
    r2 := j
    r1 := r1 - r2
    i := r1
L4:
L1: r1 := i     -- test terminating condition
    r2 := j
    r1 := r1 ≠ r2
    if r1 goto L2
a1 := &output
r1 := i
a2 := r1
call writeint
a1 := &output
call writeln
goto exit     -- return to operating system

```

Figure 14.7 Target code for the GCD program, generated from the syntax tree of Figure 14.2, using the attribute grammar of Figure 14.6.

9. Explain the rationale for basing a family of compilers (several languages, several target machines) on a single IF.
 10. Why might a compiler employ more than one IF?
 11. Outline some of the major design alternatives for back-end compiler organization and structure.
 12. What is sometimes called the “middle end” of a compiler?
-

14.4 Address Space Organization

Assemblers, linkers, and loaders typically operate on a pair of related file formats: *relocatable* object code and *executable* object code. Relocatable object code is acceptable as input to a linker; multiple files in this format can be combined to create an executable program. Executable object code is acceptable as input to a loader: it can be brought into memory and run. A relocatable object file includes the following descriptive information:

- Import table:* Identifies instructions that refer to named locations whose addresses are unknown, but are presumed to lie in other files yet to be linked to this one.
- Relocation table:* Identifies instructions that refer to locations within the current file, but that must be modified at link time to reflect the offset of the current file within the final, executable program.
- Export table:* Lists the names and addresses of locations in the current file that may be referred to in other files.

Imported and exported names are known as *external symbols*.

An executable object file is distinguished by the fact that it contains no references to external symbols (at least if statically linked—more on this below). It also defines a starting address for execution. An executable file may or may not be relocatable, depending on whether it contains the tables above.

Details of object file structure vary from one operating system to another. Typically, however, an object file is divided into several sections, each of which is handled differently by the linker, loader, or operating system. The first section includes the import, export, and relocation tables, together with an indication of how much space will be required by the program for noninitialized static data. Other sections commonly include code (instructions), read-only data (constants, jump tables for case statements, etc.), initialized but writable static data, and high-level symbol table information saved by the compiler. The initial descriptive section is used by the linker and loader. The high-level symbol table section is used by debuggers and performance profilers (Sections 15.3.2 and 15.3.3). Neither of these tables is usually brought into memory at run time; neither is needed by most running programs (an exception occurs in the case of programs

that employ *reflection* mechanisms [Section 15.3.1] to examine their own type structure).

In its runnable (loaded) form, a program is typically organized into several *segments*. On some machines (e.g., the 80286 or PA-RISC), segments are visible to the assembly language programmer, and may be named explicitly in instructions. More commonly on modern machines, segments are simply subsets of the address space that the operating system manages in different ways. Two or three of them—code, constants, and initialized data—correspond to sections of the object file. Code and constants are usually read-only, and are often combined in a single segment; the operating system arranges to receive an interrupt if the program attempts to modify them. (In response to such an interrupt it will most likely print an error message and terminate the program.) Initialized data are writable. At load time, the operating system either reads code, constants, and initialized data from disk, or arranges to read them in at run time, in response to “invalid access” (page fault) interrupts or dynamic linking requests.

In addition to code, constants, and initialized data, the typical running program has several additional segments:

Uninitialized data: May be allocated at load time or on demand in response to page faults. Usually zero-filled, both to provide repeatable symptoms for programs that erroneously read data they have not yet written, and to enhance security on multiuser systems, by preventing a program from reading the contents of pages written by previous users.

Stack: May be allocated in some fixed amount at load time. More commonly, is given a small initial size, and is then extended automatically by the operating system in response to (faulting) accesses beyond the current segment end.

Heap: Like stack, may be allocated in some fixed amount at load time. More commonly, is given a small initial size, and is then extended in response to explicit requests (via system call) from heap-management library routines.

Files: In many systems, library routines allow a program to *map* a file into memory. The *map* routine interacts with the operating system to create a new segment for the file, and returns the address of the beginning of the segment. The contents of the segment are usually fetched from disk on demand, in response to page faults.

Dynamic libraries: Modern operating systems typically arrange for most programs to share a single copy of the code for popular libraries (Section ©14.7). From the point of view of an individual process, each such library tends to occupy a pair of segments: one for the shared code, one for *linkage information* and for a private copy of any writable data the library may need.

EXAMPLE 14.9
Linux address space layout

The layout of these segments for a contemporary 32-bit Linux system on the x86 appears in Figure 14.8. Relative placements and addresses may be different for other operating systems and machines. ■

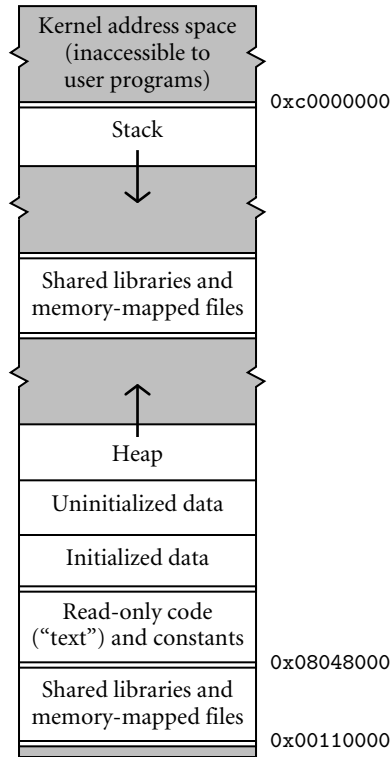

In early Unix systems with very limited memory, the stack grew downward from the bottom of the text segment; the number 0x08048000 is a legacy of these systems. The sections marked “Shared libraries and memory-mapped files” typically comprise multiple segments with varying permissions and addresses. (Modern Linux systems randomize the choice of addresses to discourage malware.) The top quarter of the address space belongs to the kernel. Just over 1 MB of space is left unmapped at the bottom of the address space to help catch program bugs in which small integer values are accidentally used as pointers.

Figure 14.8 Layout of process address space in x86 Linux (not to scale). Double lines separate regions with potentially different access permissions.

14.5 Assembly

Some compilers translate source files directly into object files acceptable to the linker. More commonly, they generate assembly language that must subsequently be processed by an assembler to create an object file.

In our examples we have consistently employed a symbolic (textual) notation for code. Within a compiler, the representation would not be textual, but it would still be symbolic, most likely consisting of records and linked lists. To translate this symbolic representation into executable code, we must:

1. Replace opcodes and operands with their machine language encodings.
2. Replace uses of symbolic names with actual addresses.

These are the principal tasks of an assembler.

In the early days of computing, most programmers wrote in assembly language. To simplify the more tedious and repetitive aspects of assembly programming, assemblers often provided extensive macro expansion facilities. With the move to

high-level languages, such programmer-centric features have largely disappeared. Most assembly language programs now are written by compilers.

EXAMPLE 14.10

Assembly as a final compiler pass

When passing assembly language from the compiler to the assembler, it makes sense to use some internal (records and linked lists) representation. At the same time, we must provide a textual front end to accommodate the occasional need for human input:

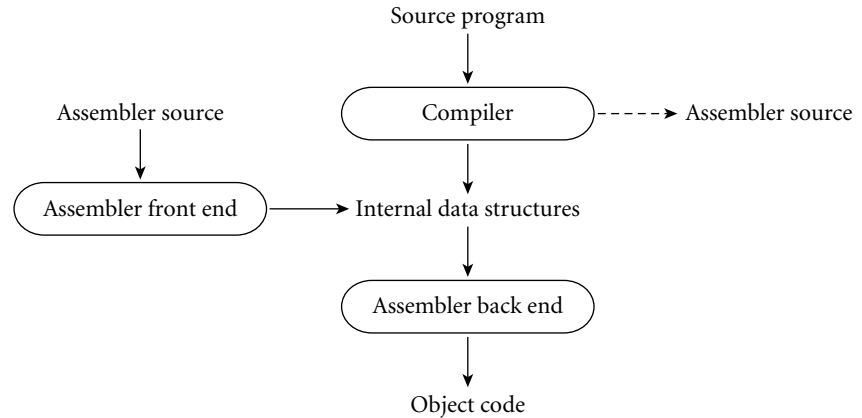

The assembler front end simply translates textual source into internal symbolic form. By sharing the assembler back end, the compiler and assembler front end avoid duplication of effort. For debugging purposes, the compiler will generally have an option to dump a textual representation of the code it passes to the assembler. ■

EXAMPLE 14.11

Direct generation of object code

An alternative organization has the compiler generate object code directly:

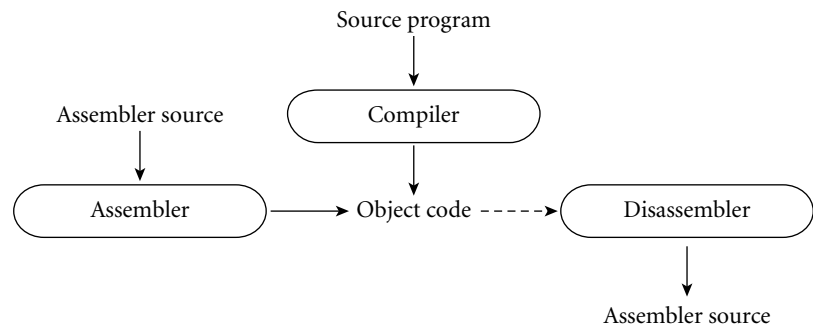

This organization gives the compiler a bit more flexibility: operations normally performed by an assembler (e.g., assignment of addresses to variables) can be performed earlier if desired. Because there is no separate assembly pass, the overall translation to object code may be slightly faster. The stand-alone assembler can be relatively simple. If it is used only for small, special purpose code fragments, it probably doesn't need to perform instruction scheduling or other machine-specific code improvement. Using a disassembler instead of an assembly language

dump from the compiler ensures that what the programmer sees corresponds precisely to what is in the object file. If the compiler uses a fancier assembler as a back end, then any program modifications effected by the assembler will not be visible in the assembly language dumped by the compiler. ■

14.5.1 Emitting Instructions

The most basic task of the assembler is to translate symbolic representations of instructions into binary form. In some assemblers this is an entirely straightforward task, because there is a one-to-one correspondence between mnemonic operations and instruction op-codes. Many assemblers, however, make minor changes to their input in order to improve performance, or extend the instruction set in ways that make the assembly language easier for human beings to read. The GNU assembler, *gas*, is among the more conservative, but even it takes a few liberties:

EXAMPLE 14.12

Compressing nops

- Some compilers generate nop instructions to cache-align certain basic blocks (e.g., function prologues). To reduce the number of cycles these consume, *gas* will combine multiple consecutive nops into multibyte instructions that have no effect. (On the x86, there are 2-, 4-, and 7-byte variants of the *lea* instruction that can be used to move a register into itself.) ■

EXAMPLE 14.13

Relative and absolute branches

- For jumps to nearby addresses, *gas* uses an instruction variant that specifies an offset from the pc. For jumps to distant addresses (or to addresses not known until link time), it uses a longer variant that specifies an absolute address. A few x86 instructions (not typically generated by modern compilers) don't have the longer variant. For these, some assemblers will reverse the sense of the conditional test to hop over an unconditional jump (*gas* simply fails to handle them). ■

EXAMPLE 14.14

Pseudoinstructions

At the more aggressive end of the spectrum, SGI's assembler for the MIPS instruction set provides a large number of *pseudoinstructions* that translate into different real instructions depending on their arguments, or that correspond to multi-instruction sequences. For example, there are two integer add instructions on the MIPS: one of them adds two registers; the other adds a register and a constant. The assembler provides a single pseudoinstruction, which it translates into the appropriate variant. In a similar vein, the assembler provides a pseudoinstruction to load an arbitrary constant into a register. Since all instructions are 32 bits long, this pseudoinstruction must be translated into a pair of real instructions when the constant won't fit in 16 bits. Some pseudoinstructions may generate even longer sequences. Integer division can take as many as 11 real instructions, to check for errors and to move the quotient from a temporary location into the desired register. ■

In effect, the SGI assembler implements a “cleaned-up” variant of the real machine. In addition to providing pseudoinstructions, it reorganizes instructions

to hide the existence of delayed branches (Section ©5.5.1) and to improve the expected performance of the processor pipeline. This reorganization constitutes a final pass of *instruction scheduling* (Sections ©5.5.1 and ©16.6). Though the job could be handled by the compiler, the existence of pseudoinstructions such as the division example above argues strongly for doing it in the assembler. In addition to having two branch delays that might be filled by neighboring instructions, the expanded division sequence can be used as a source of instructions to fill nearby branch, load, or functional unit delays.

EXAMPLE 14.15

Assembler directives

In addition to translating from symbolic to binary instruction representations, most assemblers respond to a variety of *directives*. Gas provides more than 100 of these. A few examples follow.

Segment switching: The `.text` directive indicates that subsequent instructions and data should be placed in the code (text) segment. The `.data` directive indicates that subsequent instructions and data should be placed in the initialized data segment. (It is possible, though uncommon, to put instructions in the data segment, or data in the code segment.) The `.space n` directive indicates that *n* bytes of space should be reserved in the uninitialized data segment. (This latter directive is usually preceded by a label.)

Data generation: The `.byte`, `.hword`, `.word`, `.float`, and `.double` directives each take a sequence of arguments, which they place in successive locations in the current segment of the output program. They differ in the types of operands. The related `.ascii` directive takes a single character string as argument, which it places in consecutive bytes.

Symbol identification: The `.globl name` directive indicates that *name* should be entered into the table of exported symbols.

Alignment: The `.align n` directive causes the subsequent output to be aligned at an address evenly divisible by 2^n . ■

14.5.2 Assigning Addresses to Names

Like compilers, assemblers commonly work in several phases. If the input is textual, an initial phase scans and parses the input, and builds an internal representation. In the most common organization there are two additional phases. The first identifies all internal and external (imported) symbols, assigning locations to the internal ones. This phase is complicated by the fact that the length of some instructions (on a CISC machine) or the number of real instructions produced by a pseudoinstruction (on a RISC machine) may depend on the number of significant bits in an address. Given values for symbols, the final phase produces object code.

Within the object file, any symbol mentioned in a `.globl` directive must appear in the table of exported symbols, with an entry that indicates the symbol's address. Any symbol referred to in a directive or an instruction, but not defined in the

input program, must appear in the table of imported symbols, with an entry that identifies all places in the code at which such references occur. Finally, any instruction or datum whose value depends on the placement of the current file within the address space of a running program must be listed in the relocation table.

EXAMPLE 14.16

Encoding of addresses in object files

Traditionally, assemblers for CISC machines distinguished between *absolute* and *relocatable* words in an object file. Absolute words are known at assembly time; they need not be changed by the linker. Examples include constants and register–register instructions. A relocatable word, on the other hand, must be modified by adding to it the address within the final program of the code or data segment of the current object file. A CISC jump instruction, for example, might consist of a 1-byte `jmp` opcode followed by a 4-byte target address. For a local target, the address bytes in the object file would contain the symbol’s offset within the file. The linker would finalize the address by adding the offset of the file’s code segment within the final program.

On RISC machines, this single form of relocation no longer suffices. Addresses are encoded into instructions in many different ways, and these encodings must be reflected in the relocation table and the import table. On a MIPS processor, for example, a `j` (jump) instruction has a 26-bit target field. The processor left-shifts this field by two bits and tacks on the high-order four bits of the address of the instruction in the delay slot. To relocate such an instruction, the linker must right-shift and left-truncate the address of the file’s code segment, add it into the low-order 26 bits of the instruction, and verify that the target and delay slot instructions share the same top four address bits. In a similar vein, a two-instruction load of a 32-bit quantity (as described in [Example 14.14](#)) requires the linker to recalculate the 16-bit operands of both instructions. ■

14.6 Linking

Most language implementations—certainly all that are intended for the construction of large programs—support separate compilation: fragments of the program can be compiled and assembled more or less independently. After compilation, these fragments (known as *compilation units*) are “glued together” by a *linker*. In many languages and environments, the programmer explicitly divides the program into modules or files, each of which is separately compiled. More integrated environments may abandon the notion of a file in favor of a database of subroutines, each of which is separately compiled.

The task of a linker is to join together compilation units. A *static linker* does its work prior to program execution, producing an executable object file. A *dynamic linker* (described in Section ©14.7) does its work after the program has been brought into memory for execution.

Each of the compilation units of a program to be linked must be a relocatable object file. Typically, some of these files will have been produced by compiling

fragments of the application being constructed, while others will be general-purpose library packages needed by the application. Since most programs make use of libraries, even a “one-file” application typically needs to be linked.

Linking involves two subtasks: relocation and the resolution of external references. Some authors refer to relocation as *loading*, and call the entire “joining together” process “link-loading.” Other authors (including the current one) use “loading” to refer to the process of bringing an executable object file into memory for execution. On very simple machines, or on machines with very simple operating systems, loading entails relocation. More commonly, the operating system uses virtual memory to give every program the impression that it starts at some standard address. In many systems loading also entails a certain amount of linking (Section ©14.7).

14.6.1 Relocation and Name Resolution

Each relocatable object file contains the information required for linking: the import, export, and relocation tables. A static linker uses this information in a two-phase process analogous to that described for assemblers in Section 14.5. In the first phase, the linker gathers all of the compilation units together, chooses an order for them in memory, and notes the address at which each will consequently lie. In the second phase, the linker processes each unit, replacing unresolved external references with appropriate addresses, and modifying instructions that need to be relocated to reflect the addresses of their units. These phases are illustrated pictorially in Figure 14.9. Addresses and offsets are assumed to be written in hexadecimal notation, with a page size of 4K (1000_{16}) bytes. ■

EXAMPLE 14.17

Static linking

Libraries present a bit of a challenge. Many consist of hundreds of separately compiled program fragments, most of which will not be needed by any particular application. Rather than link the entire library into every application, the linker needs to search the library to identify the fragments that are referenced from the main program. If these refer to additional fragments, then those must be included also, recursively. Many systems support a special library format for relocatable object files. A library in this format may contain an arbitrary number of code and data sections, together with an index that maps symbol names to the sections in which they appear.

14.6.2 Type Checking

Within a compilation unit, the compiler enforces static semantic rules. Across the boundaries between units, it uses module headers to enforce the rules pertaining to external references. In effect, the header for module M makes a set of promises regarding M 's interface to its users. When compiling the body of M , the compiler ensures that those promises are kept. Imagine what could happen, however, if we

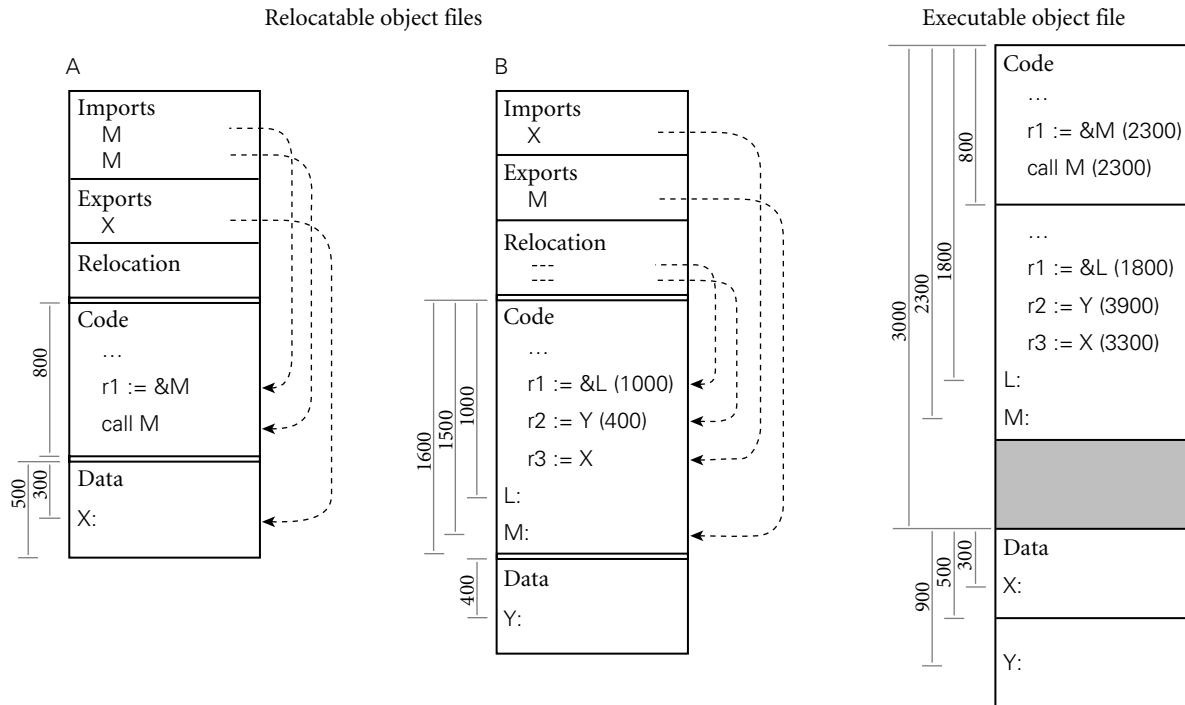

Figure 14.9 Linking relocatable object files A and B to make an executable object file. A's code section has been placed at offset 0, with B's code section immediately after, at offset 800 (addresses increase down the page). To allow the operating system to establish different protections for the code and data segments, A's data section has been placed at the next page boundary (offset 3000), with B's data section immediately after (offset 3500). External references to M and X have been set to use the appropriate addresses. Internal references to L and Y have been updated by adding in the starting addresses of B's code and data sections, respectively.

compiled the body of *M*, and then changed the numbers and types of parameters for some of the subroutines in its header file before compiling some user module *U*. If both compilations succeed, then *M* and *U* will have very different notions of how to interpret the parameters passed between them; while they may still link together, chaos is likely to ensue at run time. To prevent this sort of problem, we must ensure whenever *M* and *U* are linked together that both were compiled using the same version of *M*'s header.

In most module-based languages, the following technique suffices. When compiling the body of module *M* we create a dummy symbol whose name uniquely characterizes the contents of *M*'s header. When compiling the body of *U* we create a reference to the dummy symbol. An attempt to link *M* and *U* together will succeed only if they agree on the name of the symbol.

One way to create the symbol name that characterizes *M* is to use a textual representation of the time of the most recent modification of *M*'s header. Because files may be moved across machines, however (e.g., to deliver source files to

EXAMPLE 14.18

Checksumming headers
for consistency

geographically distributed customers), modification times are problematic: clocks on different machines are often poorly synchronized, and file copy operations often change the modification time. A better candidate is a *checksum* of the header file: essentially the output of a hash function that uses the entire text of the file as key. It is possible in theory for two different but valid files to have the same checksum, but with a good choice of hash function the odds of this error are exceedingly small. ■

The checksum strategy does require that we know when we're using a module header. Unfortunately, as described in Section 3.8, we don't know this in C and C++: headers in these languages are simply a programming convention, supported by the textual inclusion mechanism of the language's preprocessor. Most implementations of C do not enforce consistency of interfaces at link time; instead, programmers rely on configuration management tools (e.g., Unix's *make*) to recompile files when necessary. Such tools are typically driven by file modification times.

Most implementations of C++ adopt a different approach, sometimes called *name mangling*. The name of each imported or exported symbol in an object file is created by concatenating the corresponding name from the program source with a representation of its type. For an object, the type consists of the class name and a terse encoding of its structure. For a function, it consists of an encoding of the types of the arguments and the return value. For complicated objects or functions of many arguments, the resulting names can be very long. If the linker limits symbols to some too-small maximum length, the type information can be compressed by hashing, at some small loss in security [SF88].

One problem with any technique based on file modification times or checksums is that a trivial change to a header file (e.g., modification of a comment, or definition of a new constant not needed by existing users of the interface) can prevent files from linking correctly. A similar problem occurs with configuration management tools: a trivial change may cause the tool to recompile files unnecessarily. A few programming environments address this issue by tracking changes at a granularity smaller than compilation units [Tic86]. Most just live with the need to recompile.

DESIGN & IMPLEMENTATION

Type checking for separate compilation

The encoding of type information in symbol names works well in C++, but is too strict for use in C: it would outlaw programming tricks that, while questionable, are permitted by the language definition. Symbol-name encoding is facilitated in C++ by the use of structural equivalence for types. In principle, one could use it in a language with name equivalence, but given that such languages generally have well-structured modules, it is simpler just to use a checksum of the header.

14.7 Dynamic Linking

On a multiuser system, it is common for several instances of a program (e.g., an editor or web browser) to be executing simultaneously. It would be highly wasteful to allocate space in memory for a separate, identical copy of the code of such a program for every running instance. Many operating systems therefore keep track of the programs that are running, and set up memory mapping tables so that all instances of the same program share the same read-only copy of the program's code segment. Each instance receives its own writable copy of the data segment. Code segment sharing can save enormous amounts of space. It does not work, however, for instances of programs that are similar but not identical.

Many sets of programs, while not identical, have large amounts of library code in common, for example to manage a graphical user interface. If every application has its own copy of the library, then large amounts of memory may be wasted. Moreover, if programs are statically linked, then much larger amounts of disk space may be wasted on nearly identical copies of the library in separate executable object files.

© IN MORE DEPTH

In the early 1990s, most operating system vendors adopted *dynamic linking* in order to save space in memory and on disk. We consider this option in more detail on the PLP CD. Each dynamically linked library resides in its own code and data segments. Every program instance that uses a given library has a private copy of the library's data segment, but shares a single system-wide read-only copy of the library's code segment. These segments may be linked to the remainder of the code when the program is loaded into memory, or they may be linked incrementally on demand, during execution. In addition to saving space, dynamic linking allows a programmer or system administrator to install backward-compatible updates to a library without rebuilding all existing executable object files: the next time it runs, each program will obtain the new version of the library automatically.

✓ CHECK YOUR UNDERSTANDING

13. What are the distinguishing characteristics of a *relocatable* object file? An *executable* object file?
14. Why do operating systems typically *zero-fill* pages used for uninitialized data?
15. List four tasks commonly performed by an *assembler*.
16. Summarize the comparative advantages of assembly language and object code as the output of a compiler.

17. Give three examples of *pseudoinstructions* and three examples of *directives* that an assembler might be likely to provide.
 18. Why might a RISC assembler perform its own final pass of instruction scheduling?
 19. Explain the distinction between *absolute* and *relocatable* words in an object file. Why is the notion of “relocatability” more complicated than it used to be?
 20. What is the difference between *linking* and *loading*?
 21. What are the principal tasks of a *linker*?
 22. How can a linker enforce type checking across compilation units?
 23. What is the motivation for *dynamic* linking?
-

14.8 Summary and Concluding Remarks

In this chapter we focused our attention on the back end of the compiler, and on *code generation*, *assembly*, and *linking* in particular.

Compiler back ends vary greatly in internal structure. We discussed one plausible structure, in which semantic analysis is followed by, in order, intermediate code generation, machine-independent code improvement, target code generation, and machine-specific code improvement (including register allocation and instruction scheduling). The semantic analyzer passes a syntax tree to the intermediate code generator, which in turn passes a *control flow graph* to the machine-independent code improver. Within the nodes of the control flow graph, we suggested that code be represented by instructions in a pseudo-assembly language with an unlimited number of *virtual registers*. In order to delay discussion of code improvement to [Chapter 16](#), we also presented a simpler back-end structure in which code improvement is dropped, naive register allocation happens early, and intermediate and target code generation are merged into a single phase. This simpler structure provided the context for our discussion of code generation.

We also discussed intermediate forms (IFs). These can be categorized in terms of their *level*, or degree of machine independence. On the PLP CD we considered three examples: the high-level, tree-based Diana language used by most Ada compilers, and the GIMPLE and RTL IFs of the Free Software Foundation GNU compilers. A well-defined IF facilitates the construction of *compiler families*, in which front ends for one or more languages can be paired with back ends for many machines. In many systems that compile for a virtual machine (to be discussed at greater length in [Chapter 15](#)), the compiler produces a stack-based medium-level IF. While not generally suitable for use inside the compiler, such an IF can be simple and very compact.

Intermediate code generation is typically performed via ad hoc traversal of a syntax tree. Like semantic analysis, the process can be formalized in terms of attribute grammars. We presented part of a small example grammar and used it to generate code for the GCD program introduced in [Chapter 1](#). We noted in passing that target code generation is often automated, in whole or in part, using a *code generator* that takes as input a formal description of the target machine and produces code that performs pattern matching on instruction sequences or trees.

In our discussion of assembly and linking we described the format of *relocatable* and *executable* object files, and discussed the notions of *name resolution* and *relocation*. We noted that while not all compilers include an explicit assembly phase, all compilation systems must make it possible to generate assembly code for debugging purposes, and must allow the programmer to write special-purpose routines in assembler. In compilers that use an assembler, the assembly phase is sometimes responsible for instruction scheduling and other low-level code improvement. The linker, for its part, supports separate compilation, by “gluing” together object files produced by multiple compilations. In many modern systems, significant portions of the linking task are delayed until load time or even run time, to allow programs to share the code segments of large, popular libraries. For many languages the linker must perform a certain amount of semantic checking, to guarantee type consistency. In more aggressive optimizing compilation systems (not discussed in this text), the linker may also perform interprocedural code improvement.

As noted in [Section 1.5](#), the typical programming environment includes a host of additional tools, including debuggers, performance profilers, configuration and version managers, style checkers, preprocessors, pretty-printers, and perusal and cross-referencing utilities. Many of these tools, particularly in well-integrated environments, are directly supported by the compiler. Many make use, for example, of symbol-table information embedded in object files. Performance profilers often rely on special instrumentation code inserted by the compiler at subroutine calls, loop boundaries, and other key points in the code. Perusal, style-checking, and pretty-printing programs may share the compiler’s scanner and parser. Configuration tools often rely on lists of interfile dependences, again generated by the compiler, to tell when a change to one part of a large system may require that other parts be recompiled.

14.9 Exercises

- 14.1 If you were writing a two-pass compiler, why might you choose a high-level IF as the link between the front end and the back end? Why might you choose a medium-level IF?
- 14.2 Consider a language like Ada or Modula-2, in which a module M can be divided into a specification (header) file and an implementation (body) file for the purpose of separate compilation ([Section 9.2.1](#)). Should M ’s

specification itself be separately compiled, or should the compiler simply read it in the process of compiling M 's body and the bodies of other modules that use abstractions defined in M ? If the specification is compiled, what should the output consist of?

- 14.3 Many research compilers (e.g., for SR [AO93], Cedar [SZBH86], Lynx [Sco91], and Modula-3 [Har92]) use C as their IF. C is well documented and mostly machine independent, and C compilers are much more widely available than alternative back ends. What are the disadvantages of generating C, and how might they be overcome?
- 14.4 List as many ways as you can think of in which the back end of a just-in-time compiler might differ from that of a more conventional compiler. What design goals dictate the differences?
- 14.5 Suppose that k (the number of temporary registers) in Figure 14.6 is 4 (this is an artificially small number for modern machines). Give an example of an expression that will lead to register spilling under our naive register allocation algorithm.
- 14.6 Modify the attribute grammar of Figure 14.6 in such a way that it will generate the control flow graph of Figure 14.3 instead of the linear assembly code of Figure 14.7.
- 14.7 Add productions and attribute rules to the grammar of Figure 14.6 to handle Ada-style `for` loops (described in Section 6.5.1). Using your modified grammar, hand-translate the syntax tree of Figure 14.10 into pseudo-assembly notation. Keep the index variable and the upper loop bound in registers.
- 14.8 One problem (of many) with the code we generated in Section 14.3 is that it computes at run time the value of expressions that could have been computed at compile time. Modify the grammar of Figure 14.6 to perform a simple form of *constant folding*: whenever both operands of an operator are compile-time constants, we should compute the value at compile time and then generate code that uses the value directly. Be sure to consider how to handle overflow.
- 14.9 Modify the grammar of Figure 14.6 to generate jump code for Boolean expressions, as described in Section 6.4.1. You should assume short-circuit evaluation (Section 6.1.5).
- 14.10 Our GCD program did not employ subroutines. Extend the grammar of Figure 14.6 to handle procedures without parameters (feel free to adopt any reasonable conventions on the structure of the syntax tree). Be sure to generate appropriate prologue and epilogue code for each subroutine, and to save and restore any needed temporary registers.
- 14.11 The grammar of Figure 14.6 assumes that all variables are global. In the presence of subroutines, we would need to generate different code (with fp-relative displacement mode addressing) to access local variables and parameters. In a language with nested scopes we would need to dereference the static chain (or index into the display) to access objects that are neither

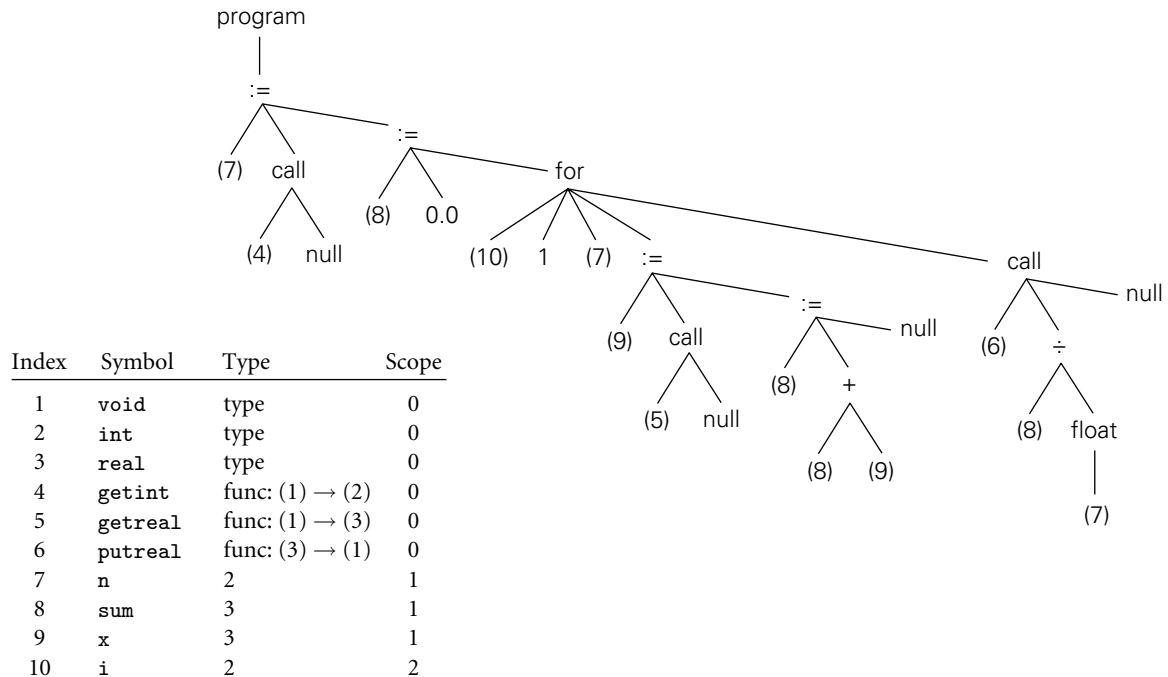

Figure 14.10 Syntax tree and symbol table for a program that computes the average of N real numbers. The children of the for node are the index variable, the lower bound, the upper bound, and the body.

local nor global. Suppose that we are compiling a language with nested subroutines, and are using a static chain. Modify the grammar of Figure 14.6 to generate code to access objects correctly, regardless of scope. You may find it useful to define a `to_register` subroutine that generates the code to load a given object. Be sure to consider both l-values and r-values, and parameters passed by both value and result.

© 14.12–14.14 In More Depth.

14.10 Explorations

- 14.15** Investigate and describe the IF of the compiler you use most often. Can you instruct the compiler to dump it to a file which you can then inspect? Are there tools other than the back end of the compiler that operate on the IF (e.g., debuggers, code improvers, configuration managers, etc.)? Is the same IF used by compilers for other languages or machines?
- 14.16** Implement Figure 14.6 in your favorite programming language. Define appropriate data structures to represent a syntax tree; then generate code for some sample trees via ad hoc tree traversal.

- 14.17 Augment your solution to the previous exercise to handle various other language features. Several interesting options have been mentioned in earlier exercises. Others include functions, first-class subroutines, case statements, records and with statements, arrays (particularly those of dynamic size), and iterators.
- 14.18 Find out what tools are available on your favorite system to inspect the content of object files (on a Unix system, use `nm` or `objdump`). Consider some program consisting of a modest number (three to six, say) of compilation units. Using the appropriate tool, list the imported and exported symbols in each compilation unit. Then link the files together. Draw an address map showing the locations at which the various code and data segments have been placed. Which instructions within the code segments have been changed by relocation?
- 14.19 In your favorite C++ compiler, investigate the encoding of type information in the names of external symbols. Are there strange strings of characters at the end of every name? If so, can you “reverse engineer” the algorithm used to generate them? For hints, type “C++ name mangling” into your favorite search engine.

© 14.20–14.22 In More Depth.

14.11 Bibliographic Notes

Standard compiler textbooks (e.g., those by Aho et al. [ALSU07], Cooper and Torczon [CT04], Grune et al. [GBJL01], Appel [App97], or Fischer and LeBlanc [FL88]) are an accessible source of information on back-end compiler technology, though the last has grown a bit dated. More detailed information can be found in the text of Muchnick [Muc97]. Fraser and Hanson provide a wealth of detail on code generation and (simple) code improvement in their `1cc` compiler [FH95].

The Diana intermediate form is documented by Goos, Wulf, Evans, and Butler [GWEB83]. A simpler tree-based IF is described by Fraser and Hanson [FH95, Chap. 5]. RTL is documented in a set of `texinfo` files distributed with `gcc` (available from www.gnu.org/software). Java byte code is documented by Lindholm and Yellin [LY99].

Ganapathi, Fischer, and Hennessy provide an early survey of automatic code generator generators [GFH82]. A later and more comprehensive survey is that of Henry and Damron [HD89]. The most widely used automatic code generation technique is based on LR parsing, and is due to Glanville and Graham [GG78].

Sources of information on assemblers, linkers, and software development tools include the texts of Beck [Bec97] and of Kernighan and Plauger [KP76]. Gingell et al. describe the implementation of shared libraries for the SPARC architecture and the SunOS variant of Unix [GLDW87]. Ho and Olsson describe a particularly ambitious dynamic linker for Unix [HO91]. Tichy presents a compilation system that avoids unnecessary recompilations by tracking dependences at a granularity finer than the source file [Tic86].

This page intentionally left blank

Run-time Program Management

Every nontrivial implementation of a high-level programming language makes extensive use of libraries. Some library routines are very simple: they may copy memory from one place to another, or perform arithmetic functions not directly supported by the hardware. Others are more sophisticated. Heap management routines, for example, maintain significant amounts of internal state, as do libraries for buffered or graphical I/O.

In general, we use the term *run-time system* (or sometimes just *runtime*, without the hyphen) to refer to the set of libraries on which the language implementation depends for correct operation. Some parts of the runtime, like heap management, obtain all the information they need from subroutine arguments, and can easily be replaced with alternative implementations. Others, however, require more extensive knowledge of the compiler or the generated program. In simpler cases, this knowledge is really just a set of conventions (e.g., for the subroutine calling sequence) that the compiler and runtime both respect. In more complex cases, the compiler generates program-specific *metadata* that the runtime must inspect to do its job. A tracing garbage collector (Section 7.7.3), for example, depends on metadata identifying all the “root pointers” in the program (all global, static, and stack-based pointer or reference variables), together with the type of every reference and of every allocated block.

Many examples of compiler/runtime integration have been discussed in previous chapters; we review these in the sidebar on pages 762–763. The length and complexity of the list generally means that the compiler and the run-time system must be developed together.

Some languages (notably C) have very small run-time systems: most of the user-level code required to execute a given source program is either generated directly by the compiler or contained in language-independent libraries. Other languages have extensive run-time systems. C#, for example, is heavily dependent on a run-time system defined by the Common Language Infrastructure (CLI) standard [Int06].

DESIGN & IMPLEMENTATION**Run-time systems**

Many of the most interesting topics in language implementation revolve around the run-time system, and have been covered in previous chapters. To set the stage for virtual machines, we review those topics here.

Garbage Collection (Section 7.7.3). As noted in the chapter introduction, a tracing garbage collector must be able to find all the “root pointers” in the program, and to identify the type of every reference and every allocated block. A compacting collector must be able to *modify* every pointer in the program. A generational collector must have access to a list of old-to-new pointer references, maintained by write barriers in the main program. A collector for a language like Java must call appropriate `finalize` methods. And in implementations that support concurrent or incremental collection, the main program and the collector must agree on some sort of locking protocol to preserve the consistency of the heap.

Variable Numbers of Arguments (Section 8.3.3). Several languages allow the programmer to declare functions that take an arbitrary number of arguments, of arbitrary type. In C, a call to `va_arg(my_args, arg_type)` must return the next argument in the previously identified list `my_args`. To find the argument, `va_arg` must understand which arguments are passed in which registers, and which arguments are passed on the stack (with what alignment, padding, and offset). If the code for `va_arg` is generated entirely in-line, this knowledge may be embedded entirely in the compiler. If any of the code is in library routines, however, those routines are compiler-specific, and thus a (simple) part of the run-time system.

Exception Handling (Section 8.5). Exception propagation requires that we “unwind” the stack whenever control escapes the current subroutine. Code to deallocate the current frame may be generated by the compiler on a subroutine-by-subroutine basis. Alternatively, a general-purpose routine to deallocate any given frame may be part of the run-time system. In a similar vein, the closest exception handler around a given point in the program may be found by compiler-generated code that maintains a stack of active handlers, or by a general-purpose run-time routine that inspects a table of program-counter-to-handler mappings generated at compile time. The latter approach avoids any run-time cost when entering and leaving a protected region (`try` block).

Event Handling (Section 8.7). Events are commonly implemented as “spontaneous” subroutine calls in a single-threaded program, or as “callbacks” in a separate, dedicated thread of a concurrent program. Depending on implementation strategy, they may be able to exploit knowledge of the compiler’s

subroutine calling conventions. They also require synchronization between the main program and the event handler, to protect the consistency of shared data structures. A truly asynchronous call—one that may interrupt execution of the main program at any point—may need to save the entire register set of the machine. Calls that occur only at well-defined “safe points” in the program (implemented via polling) may be able to save a smaller amount of state. In either case, calls to any handler not at the outermost level of lexical nesting may need to interpret a closure to establish the proper referencing environment.

Coroutine and Thread Implementation (Sections 8.6 and 12.2.4). Code to create a coroutine or thread must allocate and initialize a stack, establish a referencing environment, perform any set-up needed to handle future exceptions, and invoke a specified start-up routine. Routines like `transfer`, `yield`, `reschedule`, and `sleep_on` (as well as any scheduler-based synchronization mechanisms) must likewise understand a wealth of details about the implementation of concurrency.

Remote Procedure Call (Section ©12.5.4). Remote procedure call (RPC) merges aspects of events and threads: from the server’s point of view, an RPC is an event executed by a separate thread in response to a request from a client. Whether built into the language or implemented via a stub compiler, it requires a run-time system (dispatcher) with detailed knowledge of calling conventions, concurrency, and storage management.

Transactional Memory (Section 12.4.4). A software implementation of transactional memory must buffer speculative updates, track speculative reads, detect conflicts with other transactions, and validate its view of memory before performing any operation that might be compromised by inconsistency. It must also be prepared to roll back its updates if aborted, or to make them permanent if committed. These operations typically require library calls at the beginning and end of every transaction, and at most read and write instructions in between. Among other things, these calls must understand the layout of objects in memory, the meaning of metadata associated with objects and transactions, and the policy for arbitrating between conflicting transactions.

Dynamic Linking (Section ©14.7). In any system with separate compilation, the compiler generates symbol table information that the linker uses to resolve external references. In a system with fully dynamic (lazy) linking, external references are (temporarily) filled with pointers to the linker, which must then be part of the run-time system. When the program tries to call a routine that has not yet been linked, it actually calls the linker, which resolves the reference dynamically. Specifically, the linker looks up symbol table information describing the routine to be called. It then patches, in a manner consistent with the language’s subroutine calling conventions, the linkage tables that will govern future calls.

EXAMPLE 15.1

The CLI as a run-time system and virtual machine

Like any run-time system, the CLI depends on data generated by the compiler (e.g., type descriptors, lists of exception handlers, and certain content from the symbol table). It also makes extensive assumptions about the structure of compiler-generated code (e.g., parameter-passing conventions, synchronization mechanisms, and the layout of run-time stacks). The coupling between compiler and runtime runs deeper than this, however: the CLI programming interface is so complete as to fully hide the underlying hardware.¹ Such a runtime is known as a *virtual machine*. Some virtual machines—notably the Java Virtual Machine (JVM)—are language-specific. Others, including the CLI, are explicitly intended for use with multiple languages. In conjunction with development of their version of the CLI,² Microsoft introduced the term *managed code* to refer to programs that run on top of a virtual machine. ■

Virtual machines are part of a growing trend toward run-time management and manipulation of programs using compiler technology. This trend is the subject of this chapter. We consider virtual machines in more detail in [Section 15.1](#). To avoid the overhead of emulating a non-native instruction set, many virtual machines use a *just-in-time* (JIT) compiler to translate their instruction set to that of the underlying hardware. Some may even invoke the compiler after the program is running, to compile newly discovered components or to optimize code based on dynamically discovered properties of the program, its input, or the underlying system. Using related technology, some language implementations perform *binary translation* to retarget programs compiled for one machine to run on another machine, or *binary rewriting* to instrument or optimize programs that have already been compiled for the current machine. We consider these various forms of late binding of machine code in [Section 15.2](#). Finally, in [Section 15.3](#), we consider run-time mechanisms to inspect or modify the state of a running program. Such mechanisms are needed by symbolic debuggers and by profiling and performance analysis tools. They may also support *reflection*, which allows a program to inspect and reason about its *own* state at run time.

15.1 Virtual Machines

A *virtual machine* (VM) provides a complete programming environment: its application programming interface (API) includes everything required for correct execution of the programs that run above it. We typically reserve use of the term “VM” to environments whose level of abstraction is comparable to that of a computer implemented in hardware. (A Smalltalk or Python interpreter, for example,

¹ In particular, the CLI defines the instruction set of compiler’s target language: the Common Intermediate Language (CIL) described in [Section 15.1.2](#).

² CLI is an ECMA and ISO standard. CLR—the Common Language Runtime—is Microsoft’s implementation of the CLI. It is part of the .NET framework.

is usually not described as a virtual machine, because its level of abstraction is too high, but this is a subjective call.)

Every virtual machine API includes an instruction set architecture (ISA) in which to express programs. This may be the same as the instruction set of some existing physical machine, or it may be an artificial instruction set designed to be easier to implement in software and to generate with a compiler. Other portions of the VM API may support I/O, scheduling, or other services provided by a library or by the operating system (OS) of a physical machine.

In practice, virtual machines tend to be characterized as either *system* VMs or *process* VMs. A system VM faithfully emulates all the hardware facilities needed to run a standard OS, including both privileged and unprivileged instructions, memory-mapped I/O, virtual memory, and interrupt facilities. By contrast, a process VM provides the environment needed by a single user-level process: the unprivileged subset of the instruction set and a library-level interface to I/O and other services.

System VMs are sometimes called *virtual machine monitors* (VMMs), because they multiplex a single physical machine among a collection of “guest” operating systems—that is, they monitor the execution of multiple virtual machines, each of which runs a separate guest OS. The first widely available VMM was IBM’s CP/CMS, which debuted in 1967. Rather than build an operating system capable of supporting multiple users, IBM used the CP (“control program”) VMM to create a collection of virtual machines, each of which ran a lightweight, single-user operating system (CMS). Today, VMMs are widely used in the server marketplace, where they allow a hosting center to share machines among (mutually isolated) guest OSes. VMMs are also increasingly popular on personal computers, where products like Parallels Desktop and VMware Fusion allow users to run programs on top of more than one OS at once.

It is process VMs, however, that have had the greatest impact on programming language design and implementation. As with system VMs, the technology is decades old: the P-code VM described in [Example 1.15](#) (page 21), for example, dates from the early 1970s. Process VMs were originally conceived as a way to

DESIGN & IMPLEMENTATION

Ahead-of-time (AOT) compilation

While most code for the JVM or the CLI is distributed in byte code format and just-in-time compiled (or interpreted), one can also compile from Java or C# (or most of the .NET languages) directly to machine code. The GNU gcj compiler takes this approach, as does `-aot` mode in the Mono project’s implementation of the CLI. The expected tradeoffs apply: An AOT compiler avoids the start-up latency of JIT compilation, and can afford to implement more expensive optimizations. On the other hand, it forgoes the opportunity to perform certain statically unsafe optimizations (more on this in [Section 15.2.1](#)), or to load program modules on demand. Its machine code output tends to be less dense than byte code, and definitely less portable.

increase program portability and to quickly “bootstrap” languages on new hardware. The traditional downside was poor performance due to interpretation of the abstract instruction set. The tradeoff between portability and performance remained valid through the late 1990s, when early versions of Java were typically an order of magnitude slower than traditionally compiled languages like Fortran or C. With the introduction of just-in-time compilation, however, modern implementations of the Java Virtual Machine (JVM) and the Common Language Infrastructure (CLI) have come to rival the performance of traditional languages on native hardware. We will consider these systems in [Sections 15.1.1](#) and [15.1.2](#).

Both the JVM and the CLI use a stack-based intermediate form (IF): Java byte code (JBC) and CLI Common Intermediate Language (CIL), respectively. As described in [Section 14.2.3](#), the lack of named operands means that stack-based IF can be very compact—a feature of particular importance for code (e.g., applets) distributed over the Internet. At the same time, the need to compute everything in stack order means that intermediate results cannot generally be saved in registers and reused. In many cases, stack-based code for an expression will occupy fewer bytes, but specify more instructions, than corresponding code for a register-based machine.

15.1.1 The Java Virtual Machine

Development of the language that eventually became Java began in 1990–1991, when Patrick Naughton, James Gosling, and Mike Sheridan of Sun Microsystems began work on a programming system for embedded devices. An early version of this system was up and running in 1992, at which time the language was known as Oak. In 1994, after unsuccessful attempts to break into the market for cable TV set-top boxes, the project was retargeted to web browsers, and the name was changed to Java.

DESIGN & IMPLEMENTATION

Optimizing stack-based IF

As we shall see in [Section 15.1.2](#), code for the CLI was not intended for interpretation; it is almost always JIT compiled. As a result, the extra instructions sometimes needed to capture an expression in stack-based form are not a serious problem: reasonably straightforward code improvement algorithms (to be discussed in [Chapter 16](#)) allow the JIT compiler to transform the left side of [Figure 14.4](#) into good machine code at load time. In the judgment of the CLI designers, the simplicity and compactness of the stack-based code outweigh the cost of the code improvement. For Java, the need for compact mobile code (e.g., browser applets) was a compelling advantage, even in early implementations that were interpreted rather than JIT compiled.

The higher level of abstraction of stack-based code also enhances portability. Three-address instructions might be a good fit for execution on SPARC machines, but not on the x86 (a two-address machine).

The first public release of Java occurred in 1995. At that time code in the JVM was entirely interpreted. A JIT compiler was added in 1998 with the release of Java 2. Though not standardized by any of the usual agencies (ANSI, ISO, ECMA), Java is sufficiently well defined to admit multiple compilers and JVMs. Sun's `javac` compiler and HotSpot JVM are the most widely used combination, and the most complete. For Java 7 they are being made available as open source. Other leading projects include Kaffe (an open-source reimplementation of the compiler, JVM, and standard libraries), the IBM Jikes compiler, the GNU `gcj` compiler, and the GNU Classpath library.

Architecture Summary

The interface provided by the JVM was designed to be an attractive target for a Java compiler. It provides direct support for all (and only) the built-in and reference types defined by the Java language. It also enforces both definite assignment (Section 6.1.3) and type safety. Finally, it includes built-in support for many of Java's language features and standard library packages, including exceptions, threads, garbage collection, reflection, dynamic loading, and security.

Of course, nothing requires that Java byte code (JBC) be produced from Java source. Compilers targeting the JVM exist for many other languages, including Ruby, JavaScript, Python, and Scheme (all of which are traditionally interpreted), as well as C, Ada, Cobol, and others, which are traditionally compiled.³ There are even assemblers that allow programmers to write JBC directly. The principal requirement, for both compilers and assemblers, is that they generate correct *class files*. These have a special format understood by the JVM, and must satisfy a variety of structural and semantic constraints.

At start-up time, a JVM is typically given the name of a class file containing the static method `main`. It loads this class into memory, verifies that it satisfies a variety of required constraints, allocates any static fields, links it to any preloaded library routines, and invokes any initialization code provided by the programmer for classes or static fields. Finally, it calls `main` in a single thread. Additional classes (needed by the initial class) may be loaded either immediately or lazily on demand. Additional threads may be created via calls to the (built-in) methods of class `Thread`. The three following subsections provide additional details on JVM storage management, the format of class files, and the JBC instruction set.

Storage Management

Storage allocation mechanisms in the JVM mirror those of the Java language. There is a global *constant pool*, a set of registers and a stack for each thread, a *method area* to hold executable byte code, and a heap for dynamically allocated objects.

³ Compilation of type-unsafe code, as in C, is problematic; we will return to this issue in Section 15.1.2.

Global data The method area is analogous to the code (“text”) segment of a traditional executable file, as described in [Section 14.4](#). The constant pool contains both program constants and a variety of symbol table information needed by the JVM and other tools. Like the code of methods, the constant pool is read-only to user programs. Each entry begins with a one-byte tag that indicates the kind of information contained in the rest of the entry. Possibilities include the various built-in types; character-string names; and class, method, and field references. Consider, for example, the trivial “Hello, world” program:

EXAMPLE 15.2

Constants for “Hello, world”

```
class Hello {
    public static void main(String args[]) {
        System.out.println("Hello, world!");
    }
};
```

When compiled with Sun’s `javac` compiler, the constant pool for this program has 28 separate entries, shown in [Figure 15.1](#). Entry 18 contains the text of the output string; entry 3 indicates that this text is indeed a Java string. Many of the additional entries (7, 11, 14, 21–24, 26, 27) give the textual names of files, classes, methods, and fields. Others (9, 10, 13) are the names of structures elsewhere in the class file; by pointing to these entries, the structures can be self-descriptive. Four of the entries (8, 12, 25, 28) are *type signatures* for methods and fields. In the format shown here, “V” indicates `void`; “Lname;” is a fully qualified class. For methods, parentheses surround the list of argument types; the return type follows. Most of the remaining entries are references to classes (5, 6, 16, 19), fields (2), and methods (1, 4). The final three entries (15, 17, 20) give name and type for fields and methods. The surprising amount of information for such a tiny program stems from Java’s rich naming structure, the use of library classes, and the deliberate retention of symbol table information to support lazy linking, reflection, and debugging. ■

Per-thread data A program running on the JVM begins with a single thread. Additional threads are created by allocating and initializing a new object of the build-in class `Thread`, and then calling its `start` method. Each thread has a small set of base registers, a stack of method call frames, and an optional traditional stack on which to call native (non-Java) methods.

Each frame on the method call stack contains an array of local variables, an *operand stack* for evaluation of the method’s expressions, and a reference into the constant pool that identifies information needed for dynamic linking of called methods. Space for formal parameters is included among the local variables. Variables that are not live at the same time can share a slot in the array; this means that the same slot may be used at different times for data of different types.

Because JBC is stack oriented, operands and results of arithmetic and logic instructions are kept in the operand stack of the current method frame, rather than in registers. Implicitly, the JVM instruction set requires four registers per thread, to hold the program counter and references to the current frame, the top of the operand stack, and the base of the local variable array.

```

const #1 = Method #6.#15;          // java/lang/Object."<init>":()V
const #2 = Field #16.#17;         // java/lang/System.out:Ljava/io/PrintStream;
const #3 = String #18;           // Hello, world!
const #4 = Method #19.#20;       // java/io/PrintStream.println:(Ljava/lang/String;)V
const #5 = class #21;            // Hello
const #6 = class #22;            // java/lang/Object
const #7 = Asciz <init>;
const #8 = Asciz ()V;
const #9 = Asciz Code;
const #10 = Asciz LineNumberTable;
const #11 = Asciz main;
const #12 = Asciz ([Ljava/lang/String;)V;
const #13 = Asciz SourceFile;
const #14 = Asciz Hello.java;
const #15 = NameAndType #7:#8;    // "<init>":()V
const #16 = class #23;           // java/lang/System
const #17 = NameAndType #24:#25; // out:Ljava/io/PrintStream;
const #18 = Asciz Hello, world!;
const #19 = class #26;           // java/io/PrintStream
const #20 = NameAndType #27:#28; // println:(Ljava/lang/String;)V
const #21 = Asciz Hello;
const #22 = Asciz java/lang/Object;
const #23 = Asciz java/lang/System;
const #24 = Asciz out;
const #25 = Asciz Ljava/io/PrintStream;;
const #26 = Asciz java/io/PrintStream;
const #27 = Asciz println;
const #28 = Asciz (Ljava/lang/String;)V;

```

Figure 15.1 Content of the JVM constant pool for the program in [Example 15.2](#). The “Asciz” entries (zero-terminated ASCII) contain null-terminated character-string names. Most other entries pair an indication of the kind of constant with a reference to one or more additional entries. This output was produced by Sun’s `javap` tool.

Slots in the local variable array and the operand stack are always 32 bits wide. Data of smaller types are padded; long and double data take two slots each. The maximum depth required for the operand stack can be determined statically by the compiler, making it easy to preallocate space in the frame.

Heap In keeping with the type system of the Java language, a datum in the local variable array or the operand stack is always either a reference or a value of a built-in scalar type. Structured data (objects and arrays) must always lie in the heap. They are allocated, dynamically, using the `new` and `newarray` instructions. They are reclaimed automatically via garbage collection. The choice of collection algorithm is left to the implementor of the JVM.

To facilitate sharing among threads, the Java language provides the equivalent of monitors with a lock and a single, implicit condition variable per object, as described in [Section 12.4.3](#). The JVM provides direct support for this style of synchronization. Each object in the heap has an associated mutual exclusion lock;

in a typical implementation, the lock maintains a set of threads waiting for entry to the monitor. In addition, each object has an associated set of threads that are waiting for the monitor's condition variable.⁴ Locks are acquired with the `monitorenter` instruction and released with the `monitorexit` instruction. Most JVMs insist that these calls appear in matching nested pairs, and that every lock acquired within a given method be released within the same method (any correct compiler for the Java language will follow these rules).

Consistency of access to shared objects is governed by the Java memory model, which we considered briefly in [Section 12.3.3](#). Informally, each thread behaves as if it kept a private cache of the heap. When a thread releases a monitor or writes a `volatile` variable, the JVM must ensure that all previous updates to the thread's cache have been written back to memory. When a thread enters a monitor or reads a `volatile` variable, the JVM must (in effect) clear the thread's cache so that subsequent reads cause locations to be reloaded from memory. Of course, actual implementations don't perform explicit write-backs or invalidations; they start with the memory model provided by the hardware's cache coherence protocol and use memory barrier (fence) instructions where needed to avoid unacceptable orderings.

Class Files

Physically, a JVM class file is stored as a stream of bytes. Typically these occupy some real file provided by the operating system, but they could just as easily be a record in a database. On many systems, multiple class files may be combined into a Java archive (`.jar`) file.

Logically, a class file has a well-defined hierarchical structure. It begins with a "magic number" (`0x_caf_e_bab_e`), as described in the sidebar on page 662. This is followed by

- Major and minor version numbers of the JVM for which the file was created
- The constant pool
- Indices into the constant pool for the current class and its superclass
- Tables describing the class's superinterfaces, fields, and methods

Because the JVM is both cleaner and more abstract than a real machine, the Java class file structure is both cleaner and more abstract than a typical object file ([Section 14.4](#)). Conspicuously missing is the extensive *relocation* information required to cope with the many ways that addresses are embedded into instructions on a typical real machine. In place of this, byte code instructions in a class file contain references to symbolic names in the constant pool. These become references into the method area when code is dynamically linked. (Alternatively, they may become real machine addresses, appropriately encoded, when the code is JIT

⁴ To save space, a JIT compiler will typically omit the monitor information for any object it can prove is never used for synchronization.

compiled.) At the same time, class files contain extensive information not typically found in an executable object file. Examples include access flags for classes, fields, and methods (`public`, `private`, `protected`, `static`, `final`, `synchronized`, `native`, `abstract`, `strictfp`); symbol table information that is built into the structure of the file (rather than an optional add-on); and special instructions for such high-level notions as throwing an exception or entering or leaving a monitor.

Byte Code

The byte code for a method (or for a constructor or a class initializer) appears in an entry in the class file's method table. It is accompanied by:

- An indication of the number of local variables, including parameters
- The maximum depth required in the operand stack
- A table of exception handler information, each entry of which indicates
 - The byte code range covered by this handler
 - The address (index in the code) of the handler itself
 - The type of exception caught (an index into the constant pool)
- Optional information for debuggers: specifically, a table mapping byte code addresses to line numbers in the original source code and/or a table indicating which source code variable(s) occupy which JVM local variables at which points in the byte code.

Instruction Set Java byte code was designed to be both simple and compact. Orthogonality was a strictly secondary concern. Every instruction begins with a single-byte *opcode*. Arguments, if any, occupy subsequent (unaligned) bytes, with values given in big-endian order. Most instructions actually don't need an argument. Where typical hardware performs arithmetic on values in named registers, for example, byte code pops arguments from, and pushes result to, the operand stack of the current method frame. Even loads and stores are often single-byte instructions. There are, for example, special one-byte integer store instructions for each of the first four entries in the local variable array. Similarly, there are special instructions to push the values -1 , 0 , 1 , 2 , 3 , 4 , and 5 onto the operand stack.

Version 2 of the instruction set (current as of early 2008) defines 204 of the 256 possible opcode values. Five of these serve special purposes (unused, `nop`, debugger breakpoints, implementation dependent). The remainder can be organized into the following categories.

Load/store: Move values back and forth between the operand stack and the local variable array.

Arithmetic: Perform integer or floating point operations on values in the operand stack.

Type conversion: “Widen” or “narrow” values among the built-in types (byte, char, short, int, long, float, and double). Narrowing may result in a loss of precision but never an exception.

Object management: Create or query the properties of objects and arrays; access fields and array elements.

Operand stack management: Push and pop; duplicate; swap.

Control transfer: Perform conditional, unconditional, or multiway branches (switch).

Method calls: Call and return from ordinary and static methods (including constructors and initializers) of classes and interfaces.

Exceptions: throw (no instructions required for catch).

Monitors: Enter and exit (wait, notify, and notifyAll are invoked via method calls).

EXAMPLE 15.3

Byte code for a list insert operation

As a concrete example, consider the following definitions for an integer set, represented as a sorted linked list.

```
public class LLset {
    node head;
    class node {
        public int val;
        public node next;
    }
    public LLset() {           // constructor
        head = new node();    // head node contains no real data
        head.next = null;
    }
    ...
}
```

An insert method for this class appears in [Figure 15.2](#). Java source is on the left; a symbolic representation of the corresponding byte code is on the right. The line at the top of the byte code indicates a maximum depth of 3 for the operand stack and four entries in the local variable array, the first two of which are arguments: the `this` pointer and the integer `v`. Perusal of the code reveals numerous examples of the special one-byte load and store instructions, and of instructions that operate implicitly on the operand stack. ■

Verification Safety was one of the principal concerns in the definition of the Java language and virtual machine. Many of the things that can “go wrong” while executing machine code compiled from a more traditional language cannot go wrong when executing byte code compiled from Java. Some aspects of safety are obtained by limiting the expressiveness of the byte-code instruction set or by checking properties at load time. One cannot jump to a nonexistent address, for example, because method calls specify their targets symbolically by name,

<pre> public void insert(int v) { node n = head; while (n.next != null && n.next.val < v) { n = n.next; } if (n.next == null n.next.val > v) { node t = new node(); t.val = v; t.next = n.next; n.next = t; } // else v already in set } </pre>	<pre> Code: Stack=3, Locals=4, Args_size=2 0: aload_0 // this 1: getfield #4; //Field head:LLset\$node; 4: astore_2 5: aload_2 // n 6: getfield #5; //Field LLset\$node.next:LLset\$node; 9: ifnull 31 // conditional branch 12: aload_2 13: getfield #5; //Field LLset\$node.next:LLset\$node; 16: getfield #6; //Field LLset\$node.val:I 19: iload_1 // v 20: if_icmpge 31 23: aload_2 24: getfield #5; //Field LLset\$node.next:LLset\$node; 27: astore_2 28: goto 5 31: aload_2 32: getfield #5; //Field LLset\$node.next:LLset\$node; 35: ifnull 49 38: aload_2 39: getfield #5; //Field LLset\$node.next:LLset\$node; 42: getfield #6; //Field LLset\$node.val:I 45: iload_1 46: if_icmple 76 49: new #2; //class LLset\$node 52: dup 53: aload_0 54: invokespecial #3; //Method LLset\$node."<init>":(LLset;)V 57: astore_3 58: aload_3 // t 59: iload_1 60: putfield #6; //Field LLset\$node.val:I 63: aload_3 64: aload_2 65: getfield #5; //Field LLset\$node.next:LLset\$node; 68: putfield #5; //Field LLset\$node.next:LLset\$node; 71: aload_2 72: aload_3 73: putfield #5; //Field LLset\$node.next:LLset\$node; 76: return </pre>
---	--

Figure 15.2 Java source and byte code for a list insertion method. Output on the right was produced by Sun's `javac` (compiler) and `javap` (disassembler) tools, with additional comments inserted by hand.

and branch targets are specified as indices within the code attribute of the current method. Similarly, where hardware allows displacement addressing from the frame pointer to access memory outside the current stack frame, the JVM checks at load time to make sure that references to local variables (specified by constant indices into the local variable array) are within the bounds declared.

Other aspects of safety are guaranteed by the JVM during execution. Field access and method call instructions throw an exception if given a null reference. Similarly, array load and store instructions throw an exception if the index is not within the bounds of the array.

When it first *loads* a class file, the JVM checks the top-level structure of the file. Among other things, it verifies that the file begins with the appropriate “magic number;” that the specified sizes of the various sections of the file are all within bounds, and that these sizes add up to the size of the overall file. When it *links* the class file into the rest of the program, the JVM checks additional constraints. It verifies that all items in the constant pool are well formed, and that nothing inherits from a `final` class. More significantly, it performs a host of checks on the byte code of the class’s methods. Among other things, the byte code verifier ensures that every variable is initialized before it is read, that every operation is type-safe, and that the operand stacks of methods never overflow or underflow. All three of these checks require *data flow analysis* to determine that desired properties (initialization status, types of slots in the local stack frame, depth of the operand stack) are the same on every possible path to a given point in the program. We will consider data flow in more detail in Section ©16.4.

DESIGN & IMPLEMENTATION

Verification of class files and byte code

Java compilers are required to generate code that satisfies all the constraints defined by the Java class file specification. These include well-formedness of the internal data structures, type safety, definite assignment, and lack of underflow or overflow in the operand stack. A JVM, however, has no way to tell whether a given class file was generated by a correct compiler. To protect itself from potentially incorrect (or even malicious) class files, a JVM must *verify* that any code it runs follows all the rules. Under normal operation, this means that certain checks (e.g., data flow for definite assignment) are performed twice: once by the Java compiler, to provide compile-time error messages to the programmer, and again by the JVM, to protect against buggy compilers or alternative sources of byte code.

To improve program start-up times and avoid unnecessary work, most JVMs delay the loading (and verification) of class files until some method in that file is actually called (this is the Java equivalent of the *lazy linking* described in Section ©14.7.2). In order to effect this delay, the JVM must wait until a call occurs to verify the last few properties of the code at the call site (i.e., that it refers to a method that really exists, and that the caller is allowed to call).

15.1.2 The Common Language Infrastructure

Work on the system that became the Common Language Infrastructure (CLI) began at Microsoft Corporation in the late 1990s, and was able to benefit from experience with Java and the JVM, which were already well established. The roots of the CLI, however, go back much further than the advent of Java, and it is these deep roots that account for the most significant differences between the virtual machines.

As early as the mid-1980s, Microsoft recognized the need for interoperability among programming languages running on Windows platforms. In a series of product offerings spanning a decade and a half (see sidebar at bottom of page), the company developed increasingly sophisticated versions of its Component Object Model (COM), first to communicate with, then to call, and finally to share data across program components written in multiple languages.

With the success of Java, it became clear by the mid to late 1990s that a system combining a JVM-style run-time system with the language interoperability of COM could have enormous technical and commercial potential. The .NET project set out to realize this potential. It is in some sense a successor to COM, not based on prior code, nor constrained by backward compatibility, but providing a superset of COM's functionality, and equipped with libraries that allow it to interoperate

DESIGN & IMPLEMENTATION

More alphabet soup

Like the Internet standards of [Section 13.3.5](#), Microsoft products can display a sometimes bewildering array of acronyms and marketing names. In 1987, the company introduced a system known as DDE (Dynamic Data Exchange) that provided a uniform way to pass structured data between programs written in multiple languages. By 1990, DDE had evolved into OLE (Object Linking and Embedding), which added the ability to maintain ongoing “conversations” between heterogeneous program components, or even to embed a component written in one language into a larger program written in another language. In 1993, the company introduced COM (Component Object Model), a largely independent system that allowed multilanguage components to be linked into a single executable program. At the same time, OLE gained a standard mechanism, useful in distributed systems, to dynamically *query* a component and discover the interfaces it exports. This enhanced OLE was variously referred to as OLE2, OLE Automation, and simply Automation. COM and OLE were merged into ActiveX in 1996. DCOM (Distributed COM) was introduced that same year as a competitor to CORBA, the industry standard for distributed component systems. In 2000, Microsoft merged DCOM into COM, named it COM+, and built it into the Windows kernel. Today the entire suite of capabilities, subsuming the original DDE, OLE, Automation, COM, ActiveX, and DCOM, is commonly referred to simply as COM.

with older programs. It includes not only a virtual machine, but extensive libraries, servers, and tools for user interface management, database access, security services.

The beta version of .NET was released in 2000. The specification for its virtual machine, the CLI, was standardized by ECMA in 2001. Perhaps its most significant contribution is the definition of a Common Type System (CTS) for all supported languages. Encompassing nearly everything described in [Chapters 7](#) and [9](#) of this book, the CTS provides a superset of what any particular language needs, while requiring common semantics and implementation wherever the type systems of more than one language intersect. In addition to the CTS, the CLI defines a virtual machine architecture, the VES (Virtual Execution System); an instruction set for that machine, the CIL (Common Intermediate Language); and a portable file format for code and metadata, PE (Portable Executable) assemblies.

C# is in some sense the premier language for .NET, and was developed concurrently with it. Several dozen languages have been ported to the CLI, however, and several of these, including Visual Basic, C++, and JScript, are now in widespread use. Several interesting challenges for the CTS have been raised by the development of F#, an ML descendant designed by Microsoft.

Thanks to the ECMA standard, it is possible for organizations other than Microsoft to build implementations of the CLI. The leading such implementation is the open-source Mono project, led by Novell. Mono runs on a wide variety of platforms, but tends to lag slightly behind .NET in the addition of new features. Outside Microsoft, Java and the JVM still dominate. Within Microsoft, most new development today employs C#. Microsoft calls its CLI implementation the Common Language Runtime (CLR); it refers to CIL as Microsoft Intermediate Language (MSIL).

Architecture and Comparison to the JVM

In many ways, the CLI resembles the JVM. Both systems define a multithreaded, stack-based virtual machine, with built-in support for garbage collection, exceptions, virtual method dispatch, and mix-in inheritance. Both represent programs using a platform-independent, self-descriptive, byte code notation. For languages like C#, the CLI provides all the safety of the JVM, including definite assignment, strong typing, and protection against overflow or underflow of the operand stack.

The biggest contrasts between the JVM and CLI stem from the latter's support for multiple programming languages (the following is not a comprehensive list).

Richer Type System The Common Type System ([Section 15.1.2](#)) supports both value and reference variables of structured types (the JVM is limited to references). The CTS also has true multidimensional arrays (allocated, contiguously, as a single operation); function pointers; explicit support for generics; and the ability to enforce structural type equivalence.

Richer Calling Mechanisms To facilitate the implementation of functional languages, the CLI provides explicit tail-recursive function calls ([Section 6.6.1](#)); these discard the caller's frame while retaining the dynamic link. The CLI also

supports both value and reference parameters, variable numbers of parameters (in the fully general sense of C), multiple return values, and nonvirtual methods, all of which the JVM lacks.

Unsafe Code For the benefit of C, C++, and other non-type-safe languages, the CLI supports explicitly unsafe operations: nonconverting type casts, dynamic allocation of non-garbage-collected memory, pointers to non-heap data, and pointer arithmetic. The CLI distinguishes explicitly between *verifiable* code, which cannot use these features, and *unverifiable* code, which can. (Verifiable code must also follow a host of other rules.)

Miscellaneous Again for the sake of multiple languages, the CLI supports global data and functions, local variables whose shapes and sizes are not statically known, optional detection of arithmetic overflow, and rich facilities for “scoped” security and access control.

As in the JVM, every CLI thread has a small set of base registers and a stack of method call frames, each of which contains an array of local variables and an operand stack for expression evaluation. Each frame also contains a local memory pool for variables of dynamic and elaboration-time shape. Incoming parameters have their own separate space in the CLI; in the JVM they occupy the first few slots of the local variable array.

DESIGN & IMPLEMENTATION

Assuming a just-in-time compiler

Like the JVM, the CLI’s behavior is defined in terms of the operation of an abstract virtual machine. Where Java’s virtual machine may in practice be either interpreted or just-in-time compiled, however, the CLI was designed from the outset for just-in-time compilation. Several minor differences between the virtual machines reflect this difference in expected implementations. Arithmetic instructions in JBC generally include an explicit indication of operand type: there are, for example, four separate opcodes for 32- and 64-bit integer and floating-point addition. In the CLI’s Common Intermediate Language (CIL), there is only one `add` instruction: it figures out what to do based on the types of its operands. In type-safe code, of course, the type of every operand is statically known, and either a compiler or an interpreter can inspect the types of arguments and figure out what to do. The compiler, however, only has to do this once, at compile time; the interpreter has to do it every time it encounters the instruction. In a similar vein, slots in the local variable array of the CLI VES can be of arbitrary size, and are required to hold a value of a single, statically known type throughout the execution of the method. For the sake of space efficiency and rapid indexing, the JVM reserves exactly 32 bits for every slot (longs and doubles take two consecutive slots), and a given slot can be used for values of different types at different points in time.

The Common Type System

The VES and CIL provide instructions to manipulate data of certain built-in types. A few additional types are predefined, and have built-in names in CLI metadata. To these, the CTS adds a wide variety of type constructors. For each, it defines both behavior *and* representation. No single language provides all the types of the CTS, but (with occasional compromises) each provides a subset.

The Common Language Specification (CLS) defines a subset of the CTS intended for cross-language interaction. It omits several type constructors provided by the CTS, and places restrictions on others. Standard libraries (collection classes, XML, network support, reflection, extended numerics) restrict themselves (with occasional exceptions) to types in the CLS. Not all languages support the full CLS; code written in those languages cannot make use of library facilities that require unsupported types.

Built-in Types The VES and CIL provide instructions to manipulate the following types.

- Integers in 8-, 16-, 32-, and 64-bit lengths, both signed and unsigned
- “Native” integers, of the length supported by the underlying hardware, again both signed and unsigned
- IEEE floating point, both single and double precision
- Object references and “managed” pointers

Managed pointers are different from references: while typed, they don’t necessarily point to the beginning of a dynamically created object. Specifically, they can refer to fields within an object or to data outside the heap. The CIL makes sure these pointers are known to the garbage collector, which must avoid reclaiming any object *O* when a managed pointer refers to a field inside *O*. More details on pointers and references can be found in the sidebar on page 779.

Beyond the basic hardware-level types, CLI metadata treats Booleans, characters, and strings as built-ins. Booleans and characters are manipulated in the VES using instructions intended for short integers; strings are manipulated by accessing their internal structure.

Constructed Types To the built-in types, the CTS adds the following.

Dynamically allocated instances of class, interface, array, and delegate types.

These are the things to which references (the built-in type) can refer. Arrays can be multidimensional, and are stored in row-major order. Delegates are closures (subroutine references paired with referencing environments).

Methods — Function types.

Properties — Getters and setters for objects.

Events — Lists of delegates, associated with an object, that should be called in response to changes to the object.

Value types — Records (structures), unions, and enumerations.

Boxed value types — Values embedded in a dynamically allocated object so that one can create references to them.

Function pointers — References to static functions: type-safe, but without a referencing environment.

Typed references — Pointers bundled together with a type descriptor, used for C-style variable argument lists.

Unmanaged pointers — As in C, these can point to just about anything, and support pointer arithmetic. They *cannot* point to garbage-collectible objects (or parts of objects) in the heap.

With these type constructors come extensive semantic rules, covering such topics as identity and equality,⁵ casting and coercion, scoping and visibility, mix-in inheritance, hiding and overriding of members, memory layout, initialization, type safety, and verification. The details occupy hundreds of pages in the CLI documentation.

DESIGN & IMPLEMENTATION

References and pointers

The reference and pointer types of the CTS are a source of potential confusion. In a language like Java, reference types provide the only means of indirection. They refer to dynamically allocated instances of class, interface, and array types. Managed pointers provide additional functionality for languages like C# and Microsoft's C++/CLI (formerly Managed C++), which permit references to the insides of objects and to values outside the CLI heap. Managed pointers are understood by the garbage collector, and can be used in type-safe code: If a managed pointer p refers to a field of object O , then the collector will know that O is live. It will also update p automatically whenever it moves O .

Unmanaged pointers exist for the sake of languages like C. They are incompatible with garbage collection, and cannot point to objects in the heap. They are also incompatible with type safety, and cannot be used in verifiable code.

Typed references (`typedrefs`) in the CLI include the information needed to correctly manipulate references to values (e.g., in variable argument lists) whose type cannot be statically determined.

Version 2.0 of the CLI introduced *controlled-mutability* managed pointers (also known, somewhat inaccurately, as *read-only* pointers). Operations on these pointers are constrained to prevent modification of the referenced object. Read-only pointers are used in boxing and array contexts where generics require the ability to generate a pointer to data of a value type, but modification of that data might not be safe.

⁵ These are reminiscent of the relationships tested by `eq` and `eqv` in Scheme, as discussed in Section 10.3.3.

The Common Language Specification Because no single language implements the entire CTS, one cannot use arbitrary CTS types in a general-purpose interface intended for use from many different languages. The Common Language Specification (CLS) defines a subset of the CTS that most (though not all) languages can accommodate. It omits several of the types provided by the CTS, including signed 8-bit integers; unsigned native, 16-, 32-, and 64-bit integers; boxed value types; global static fields and methods; unmanaged pointers; typed references; and methods with variable numbers and types of arguments. The CLS also imposes a variety of restrictions on the use of other types. It establishes naming conventions, limits the use of overloading, and defines the operators and conversions that programs can assume are supported on built-in types. It requires a lower bound of zero on each dimension of array indexing. It prohibits fields and static methods in interfaces. It insists that a constructor be called exactly once for each created object, and that each constructor begin with a call to a constructor of its base class. None of these restrictions applies to program components that operate only within a given language.

Generics As described in Section ©8.4.4, generics were added to Java and C# in very different ways. Partly to avoid the need to modify the JVM, Java generics were defined in terms of *type erasure*, which effectively converts all generic types to `Object` before generating byte code. C# generics were defined in terms of *reification*, which creates a new concrete type every time a generic is instantiated with different arguments. Reified generics have been supported directly by the CLI since .NET version 2.0, introduced by Microsoft in 2005 and codified by ECMA and ISO in 2006.

Reified generic types are fully described in CLI metadata, allowing full type checking and reflection. Consider the following code in C#:

EXAMPLE 15.4

Generics in the CLI and JVM

```
class Node<T> {
    public T val;
    public Node<T> next;
}
...
Node<int> n = new Node<int>();
Console.WriteLine(n.GetType().ToString());
```

If `Node` is an outermost class, the final line will print `Node'1[System.Int32]`. The equivalent code in Java (running on the JVM) will simply print `class Node`. To support generics, version 2 of the CLI extends the rules for type compatibility and verification, and introduces new versions of several CIL instructions. ■

Metadata and Assemblies

Portable Executable (PE) *assemblies* are the rough equivalent of Java `.jar` files: they contain the code for a collection of CLI classes. PE is based on the Common Object File Format (COFF), originally developed for AT&T's System V Unix.

It is the native object file format for Windows and DOS systems, now extended to accommodate CIL as an optional instruction set. Given the requirements of native-code executable files (e.g., relocation—see [Section 14.4](#)), PE is quite a bit more complicated than Java `.class` and `.jar` format. A PE assembly contains a general-purpose PE header, a special CLI header, metadata describing the assembly's types and methods, and CIL code for the methods.

The metadata of an assembly has a complex internal structure. (A diagram of the interconnections among some two dozen different kinds of tables fills two pages of the annotated CLI standard [[MR04](#), pp. 322–323].) The metadata begins with a *manifest* that specifies the files included and directly referenced, the types exported and imported, versioning information, and security permissions. This is followed by descriptions of all the types, and signatures for all the methods. Unlike the Java constant pool, the metadata of an assembly is not directly visible to the assembly's code; it may be rearranged by the JIT compiler in implementation-dependent ways, so long as it remains available to reflection routines at run time (obviously, those routines are also implementation dependent).

The Common Intermediate Language

Just as the CLI VES bears a strong resemblance to the JVM, CIL bears a strong resemblance to JBC. Version 4 of the ECMA standard defines approximately 250 instructions, most with single-byte opcodes. Most instructions take their arguments from, and return results to, the operand stack of the current method frame. Others take explicit arguments representing variables, types, or methods. JBC and CIL are similarly dense—they require roughly the same number of bytes per instruction on average.

Many of the differences between the two intermediate languages are essentially trivial. JBC is big-endian; CIL is little-endian. JBC has explicit instructions for monitor entry and exit; these are method calls in the CLI. CIL allows arbitrary offsets for branches; JBC limits them to 64K bytes.

A few more significant differences stem from the assumption that CIL will always be JIT-compiled, as described in the sidebar on page [777](#). The most obvious difference here is that JBC encodes type information explicitly in opcodes, while CIL requires it to be inferred from arguments. CIL also includes an explicit instruction (`ldtoken`) that will push a “run-time handle” for a method, type, or field. While the metadata of a CIL assembly must all be available at run time, its format may be implementation dependent; the JIT compiler translates `ldtoken` into machine code consistent with that format. In the JVM, the class file constant pool is assumed to be available at run time, in its standard format; an ordinary “load constant” instruction suffices to push the desired reference.

A more subtle difference is the separation of arguments from local variables in the CLI (they share one array in the JVM). Separate arrays admit special one-byte load instructions for both the first few arguments and the first local variables, without requiring that they have interleaved slots; this in turn may make it easier to generate object code in which arguments occupy contiguous locations in

memory (as, for example, in the argument build area of the stack described in Section 8.2.2).

Finally, as already suggested, several features of CIL, not found in JBC, stem from the need to support multiple source languages. We have noted that the CLI provides value types, reference parameters, and optional overflow checking on arithmetic; all of these are reflected in the CIL instruction set. There are also several extra ways to make subroutine calls. Where JBC supports only static and virtual method invocations, CIL has (1) nonvirtual method calls, as in C++ (these implicitly pass *this*, as virtual calls do); (2) indirect calls (i.e., calls through function pointers); (3) tail calls, which discard the caller's frame; and (4) *jumps*, which redirect control to a method after executing some optional prologue (e.g., for *this* pointer adjustment in languages with multiple inheritance; see Section 9.5).

EXAMPLE 15.5

CIL for a list insert operation

To illustrate CIL, let us return to the linked-list set of [Example 15.3](#). The declarations given there are valid in both Java and C#. The `insert` method for this class appears in [Figure 15.3](#). C# source (which is again identical to the Java version) is on the left; a symbolic representation of the corresponding CIL is on the right. As in [Example 15.3](#), there are many examples of special one-byte load and store instructions (here specified with a *.index* suffix on the opcode), and of instructions that operate implicitly on the operand stack. ■

Verification As we have noted, the CLI distinguishes between *verifiable* and *unverifiable* code. Verifiable code must satisfy a large variety of constraints that guarantee type safety and catch many common programming errors. In particular, the VES can be sure that a verifiable program will never access data outside its logical address space. Among other things, this guarantee ensures fault containment for verifiable modules that share a single physical address space.

Unverifiable code can make use of unsafe language features (e.g., unions and pointer arithmetic in C), but must still conform to more basic rules for validity (well-formedness) of CIL. Together, the components of the VES (i.e., the JIT compiler, loader, and run-time libraries) *validate* all loaded assemblies, and *verify* those that claim to be verifiable. Any standard-conforming implementation of the CLI must run all verifiable programs. Optionally, it may also run validated but not verifiable programs.

As in the JVM, verification requires data flow analysis to check type consistency and lack of underflow and overflow in the operand stack. The CLI standard requires verifiable routines to specify that all local variables are initialized to zero. CLI implementations typically perform definite assignment data flow analysis anyway, to identify cases in which those initializations can safely be omitted. The standard also requires numerous checks on individual instructions. Many of these are also performed by the JVM. Local variable references, for example, are statically checked to make sure they lie within the declared bounds of the stack frame. Other checks stem from the presence of unsafe features in the CLI. Verifiable code cannot use unmanaged pointers or unions, for example, nor can it perform most indirect method calls.

```

public void insert(int v) {
    node n = head;
    while (n.next != null
           && n.next.val < v) {
        n = n.next;
    }
    if (n.next == null
        || n.next.val > v) {
        node t = new node();
        t.val = v;
        t.next = n.next;
        n.next = t;
    } // else v already in set
}

.method private hidebysig
    instance default void insert (int32 v) cil managed
{
    // Method begins at RVA 0x210c      // RVA == relative
    // Code size 108 (0x6c)           // virtual address
    .maxstack 3
    .locals init (
        class LLset/node V_0, // n
        class LLset/node V_1) // t
IL_0000: ldarg.0
IL_0001: ldfld class LLset/node LLset::head
IL_0006: stloc.0
IL_0007: br IL_0013 // jump to header of rotated loop
IL_000c: ldloc.0 // n -- beginning of loop body
IL_000d: ldfld class LLset/node LLset/node::next
IL_0012: stloc.0 // n = n.next
IL_0013: ldloc.0 // n -- beginning of loop test
IL_0014: ldfld class LLset/node LLset/node::next
IL_0019: brfalse IL_002f // exit loop if n null
IL_001e: ldloc.0 // n
IL_001f: ldfld class LLset/node LLset/node::next
IL_0024: ldfld int32 LLset/node::val
IL_0029: ldarg.1 // v
IL_002a: blt IL_000c // continue loop
IL_002f: ldloc.0 // n
IL_0030: ldfld class LLset/node LLset/node::next
IL_0035: brfalse IL_004b
IL_003a: ldloc.0 // n
IL_003b: ldfld class LLset/node LLset/node::next
IL_0040: ldfld int32 LLset/node::val
IL_0045: ldarg.1 // v
IL_0046: ble IL_006b
IL_004b: newobj instance void class LLset/node::'.ctor'()
IL_0050: stloc.1 // t
IL_0051: ldloc.1 // t
IL_0052: ldarg.1 // v
IL_0053: stfld int32 LLset/node::val
IL_0058: ldloc.1 // t
IL_0059: ldloc.0 // n
IL_005a: ldfld class LLset/node LLset/node::next
IL_005f: stfld class LLset/node LLset/node::next
IL_0064: ldloc.0 // n
IL_0065: ldloc.1 // t
IL_0066: stfld class LLset/node LLset/node::next
IL_006b: ret
} // end of method LLset::insert

```

Figure 15.3 C# source and CIL for a list insertion method. Output on the right was produced by the Mono project's `gmcs` (compiler) and `monodis` (disassembler) tools, with additional comments inserted by hand. Note that the compiler has rotated the test to the bottom of the `while` loop, which occupies lines `IL_000c` through `IL_002a` in the output code.

✓ CHECK YOUR UNDERSTANDING

1. What is a *run-time system*? How does it differ from a “mere” library?
 2. List some of the major tasks that may be performed by a run-time system.
 3. What is a *virtual machine*? What distinguishes it from interpreters of other sorts?
 4. What is *managed code*?
 5. Why do so many virtual machines use a stack-based intermediate form?
 6. Summarize the architecture of the Java Virtual Machine.
 7. Summarize the content of a Java class file.
 8. Explain the validity checks performed on a class file at load time.
 9. Summarize the architecture of the Common Language Infrastructure. Contrast it with the JVM. Highlight those features intended to facilitate cross-language interoperability.
 10. Describe how the choice of just-in-time compilation (and the rejection of interpretation) influenced the structure of the CLI.
 11. What is the purpose of the Common Language Specification? Why is it only a subset of the Common Type System?
-

15.2 Late Binding of Machine Code

In the traditional conception ([Example 1.7](#)), compilation is a one-time activity, sharply distinguished from program execution. The compiler produces a target program, typically in machine language, which can subsequently be executed many times for many different inputs.

In some environments, however, it makes sense to bring compilation and execution closer together in time. We have made repeated references in this chapter to *just-in-time* (JIT) compilation, which translates a program from source or intermediate form into machine language immediately before each separate run of the program. We consider JIT compilation further in the first subsection below. We also consider language systems that may compile new pieces of a program—or recompile old pieces—after the program begins its execution. In [Sections 15.2.2](#) and [15.2.3](#) we consider *binary translation* and *binary rewriting* systems, which perform compiler-like operations on programs *without* access to source code. Finally, in [Section 15.2.4](#), we consider systems that may download program components from remote locations. All these systems serve to delay the binding of a program to its machine code.

15.2.1 Just-in-Time and Dynamic Compilation

To promote the Java language and virtual machine, Sun Microsystems coined the slogan “write once, run anywhere”—the idea being that programs distributed as Java byte code (JBC) could run on a very wide range of platforms. Source code, of course, is also portable, but byte code is much more compact, and can be interpreted without additional preprocessing. Unfortunately, interpretation tends to be expensive. Programs running on early Java implementations could be as much as an order of magnitude slower than compiled code in other languages. Just-in-time compilation is, to first approximation, a technique to retain the portability of byte code while improving execution speed. Like both interpretation and dynamic linking (Section 14.7), JIT compilation also benefits from the delayed discovery of program components: program code is not bloated by copies of widely shared libraries, and new versions of libraries are obtained automatically when a program that needs them is run.

Because a JIT system compiles programs immediately prior to execution, it can add significant delay to program start-up time. Implementors face a difficult tradeoff: to maximize benefits with respect to interpretation, the compiler should produce good code; to minimize start-up time, it should produce that code very quickly. In general, JIT compilers tend to focus on the simpler forms of target code improvement. Specifically, they often limit themselves to so-called *local* improvements, which operate within individual control flow constructs. Improvements at the *global* (whole method) and *interprocedural* (whole program) level are usually too expensive to consider.

Fortunately, the cost of JIT compilation is typically lessened by the existence of an earlier source-to-byte-code compiler that does much of the “heavy lifting.”⁶ Scanning is unnecessary in a JIT compiler, since byte code is not textual. Parsing is trivial, since class files have a simple, self-descriptive structure. Many of the properties that a source-to-byte-code compiler must infer at significant expense (type safety, agreement of actual and formal parameter lists) are embedded directly in the structure of the byte code (objects are labeled with their type, calls are made through method descriptors); others can be verified with simple data flow analysis. Certain forms of machine-independent code improvement may also be performed by the source-to-byte-code compiler (these are limited to some degree by stack-based expression evaluation).

All these factors allow a JIT compiler to be faster—and to produce better code—than one might initially expect. In addition, since we are already committed to invoking the JIT compiler at run time, we can minimize its impact on program start-up latency by running it a bit at a time, rather than all at once:

⁶ While a JIT compiler could, in principle, operate on source code, we assume throughout this discussion that it works on a medium-level IF like JBC or CIL.

- Like a lazy linker (Section ©14.7.2), a JIT compiler may perform its work incrementally. It begins by compiling only the class file that contains the program entry point (i.e., `main`), leaving *hooks* in the code that call into the run-time system wherever the program is supposed to call a method in another class file. After this small amount of preparation, the program begins execution. When execution falls into the runtime through an unresolved hook, the runtime invokes the compiler to load the new class file and to link it into the program.
- To eliminate the latency of compiling even the original class file, the language implementation may incorporate both an interpreter and a JIT compiler. Execution begins in the interpreter. In parallel, the compiler translates portions of the program into machine code. When the interpreter needs to call a method, it checks to see whether a compiled version is available yet, and if so calls that version instead of interpreting the byte code. We will return to this technique below, in the context of the HotSpot Java compiler and JVM.
- When a class file is JIT compiled, the language implementation can cache the resulting machine code for later use. This amounts to guessing, speculatively, that the versions of library routines employed in the current run of the program will still be current when the program is run again. Because languages like Java and C# require the appearance of late binding of library routines, this guess must be checked in each subsequent run. If the check succeeds, using a cached copy saves almost the entire cost of JIT compilation.

Finally, JIT compilation affords the opportunity to perform certain kinds of code improvement that are usually not feasible in traditional compilers. It is customary, for example, for software vendors to ship a single compiled version of an application for a given instruction set architecture, even though implementations of that architecture may differ in important ways, including pipeline width and depth; the number of physical (renaming) registers; and the number, size, and speed of the various levels of cache. A JIT compiler may be able to identify the processor implementation on which it is running, and generate code that is tuned for that specific implementation. More important, a JIT compiler may be able to *in-line* calls to dynamically linked library routines. This optimization is particularly important in object-oriented programs, which tend to call many small methods. For such programs, dynamic in-lining can have a dramatic impact on performance.

Dynamic Compilation

We have noted that a language implementation may choose to delay JIT compilation to reduce the impact on program start-up latency. In some cases, compilation *must* be delayed, either because the source or byte code was not created or discovered until run time, or because we wish to perform optimizations that depend on information gathered during execution. In these cases we say the language implementation employs *dynamic compilation*. Common Lisp systems have used

dynamic compilation for many years: the language is typically compiled, but a program can extend itself at run time. Optimization based on run-time statistics is a more recent innovation.

Most programs spend most of their time in a relatively small fraction of the code. Aggressive code improvement on this fraction can yield disproportionately large improvements in program performance. A dynamic compiler can use statistics gathered by run-time *profiling* to identify *hot paths* through the code, which it then optimizes in the background. By rearranging the code to make hot paths contiguous in memory, it may also improve the performance of the instruction cache. Additional run-time statistics may suggest opportunities to unroll loops (Exercise ©5.23), assign frequently used expressions to registers (Sections ©5.5.2 and ©16.8), and schedule instructions to minimize pipeline stalls (Sections ©5.5.1 and ©16.6).

In some situations, a dynamic compiler may even be able to perform optimizations that would be unsafe if implemented statically. Consider, for example, the in-lining of methods from dynamically linked libraries. If `foo` is a `static` method of class `C`, then calls to `C.foo` can safely be in-lined. Similarly, if `bar` is a `final` method of class `C` (one that cannot be overridden), and `o` is an object of class `C`, then calls to `o.bar` can safely be in-lined. But what if `bar` is not `final`? The compiler can still in-line calls to `o.bar` if it can prove that `o` will never refer to an instance of a class derived from `C` (which might have a different implementation of `bar`). Sometimes this is easy:

EXAMPLE 15.6

When is in-lining safe?

```
C o = new C(args);
o.bar();           // no question what type this is
```

Other times it is not:

```
static void f(C o) {
    o.bar();
}
```

Here the compiler can in-line the call only if it knows that `f` will never be passed an instance of a class derived from `C`. A dynamic compiler can perform the optimization if it verifies that there exists no class derived from `C` anywhere in the (current version of the) program. It must keep notes of what it has done, however: if dynamic linking subsequently extends the program with code that defines a new class `D` derived from `C`, the in-line optimization may need to be undone. ■

In some cases, a dynamic compiler may choose to perform optimizations that may be unsafe even in the current program, provided that profiling suggests they will be profitable and run-time checks can determine whether they are safe. Suppose, in the previous example, there already exists a class `D` derived from `C`, but profiling indicates that every call to `f` so far has passed an instance of class `C`. Suppose further that `f` makes many calls to methods of parameter `o`, not just the

EXAMPLE 15.7

Speculative optimization

one shown in the example. The compiler might choose to generate code along the following lines:

```
static void f(C o) {
    if (o.getClass() == C.class) {
        ... // code with in-lined calls -- much faster
    } else {
        ... // code without in-lined calls
    }
}
```

An Example System: the HotSpot Java Compiler

HotSpot is Sun's principal JVM and JIT compiler for desktop and server systems. It was first released in 1999, and is available as open source.

HotSpot takes its name from its use of dynamic compilation to improve the performance of hot code paths. Newly loaded class files are initially interpreted. Methods that are executed frequently are selected by the JVM for compilation and are subsequently patched into the program on the fly. The compiler is aggressive about in-lining small routines, and will do so in a deep, iterative fashion, repeatedly in-lining routines that are called from the code it just finished in-lining. As described in the preceding discussion of dynamic compilation, the compiler will also in-line routines that are safe only for the current set of class files, and will dynamically “deoptimize” in-lined calls that have been rendered unsafe by the loading of new derived classes.

The HotSpot compiler can be configured to operate in either “client” or “server” mode. Client mode is optimized for lower start-up latency. It is appropriate for systems in which a human user frequently starts new programs. It translates JBC to static single assignment (SSA) form (a medium-level IF described in Section © 16.4.1) and performs a few straightforward machine-independent optimizations. It then translates to a low-level IF, on which it performs instruction scheduling and register allocation. Finally, it translates this IF to machine code.

Server mode is optimized to generate faster code. It is appropriate for systems that need maximum throughput and can tolerate slower start-up. It applies most classic global and interprocedural code improvement techniques to the SSA version of the program (many of these are described in [Chapter 16](#)), as well as other improvements specific to Java. Many of these improvements make use of profiling statistics.

Particularly when running in server mode, HotSpot can rival the performance of traditional compilers for C and C++. In effect, aggressive in-lining and profile-driven optimization serve to “buy back” both the start-up latency of JIT compilation and the overhead of Java's run-time semantic checks.

Other Example Systems

Like HotSpot, Microsoft's CIL-to-machine-code compiler performs dynamic optimization of hot code paths. The .NET source-to-CIL compilers are also explicitly available to programs through the `System.CodeDom.Compiler` API. A program

EXAMPLE 15.8

Dynamic compilation in the CLR

running on the CLR can directly invoke the compiler to translate C# (or Visual Basic, or other .NET languages) into CIL PE assemblies. These can then be loaded into the running program. As they are loaded, the CLR JIT compiler translates them to machine code. As noted in [Section 10.2](#), C# 3.0 includes lambda expressions reminiscent of those in functional languages:

```
Func<int, int> square_func = x => x * x;
```

Here `square_func` is a function from integers to integers that multiplies its parameter (`x`) by itself, and returns the product. It is analogous to the following in Scheme.

```
(let ((square-func (lambda (x) (* x x)))) ...
```

Given the C# declaration, we can write

```
y = square_func(3);           // 9
```

But just as Lisp allows a function to be represented as a list, so too does C# allow a lambda expression to be represented as a syntax tree:

```
Expression<Func<int, int>> square_tree = x => x * x;
```

Various methods of library class `Expression` can now be used to explore and manipulate the tree. When desired, the tree can be converted to CIL code:

```
square_func = square_tree.Compile();
```

These operations are roughly analogous to the following in Scheme.

```
(let* ((square-tree '(lambda (x) (* x x))) ; note the quote mark
      (square-func (eval square-tree (scheme-report-environment 5))))
  ...
```

The difference in practice is that while Scheme's `eval` checks the syntactic validity of the lambda expression and creates the metadata needed for dynamic type checking, the typical implementation leaves the function in list (tree) form, and interprets it when called. C#'s `Compile` is expected to produce CIL code; when called it will be JIT compiled and directly executed. ■

Many Lisp dialects and implementations have employed an explicit mix of interpretation and compilation. Common Lisp includes a `compile` function that takes the name of an existing (interpretable) function as argument. As a side effect, it invokes the compiler on that function, after which the function will (presumably) run much faster:

```
(defun square (x) (* x x))           ; outermost level function declaration
(square 3)                          ; 9
(compile 'square)
(square 3)                          ; also 9 (but faster :-)
```

EXAMPLE 15.9

Dynamic compilation in
CMU Common Lisp

CMU Common Lisp, a widely used open-source implementation of the language, incorporates two interpreters and a compiler with two back ends. The so-called “baby” interpreter understands a subset of the language, but works stand-alone. It handles simple expressions at the read-eval-print loop, and is used to bootstrap the system. The “grown-up” interpreter understands the whole language, but needs access to the front end of the compiler. The byte code compiler translates source code to an intermediate form reminiscent of JBC or CIL. The native code compiler translates to machine code. In general, programs are run by the “grown-up” interpreter unless the programmer invokes the compiler explicitly from the command line or from within a Common Lisp program (with `compile`). The compiler, when invoked, produces native code unless otherwise instructed. Documentation indicates that the byte code version of the compiler runs twice as fast as the native code version. Byte code is portable and $6\times$ denser than native code. It runs $50\times$ slower than native code, but $10\times$ faster than the interpreter. ■

EXAMPLE 15.10

Compilation of Perl

Like most scripting languages, Perl 5 compiles its input to an internal syntax tree format, which it then interprets. In several cases, the interpreter may need to call back into the compiler during execution. Features that force such dynamic compilation include `eval`, which compiles and then interprets a string; `require`, which loads a library package; and the `ee` version of the substitution command, which performs expression evaluation on the replacement string:

```
$foo = "abc";
$foo =~ s/b/2 + 3/ee;      # replace b with the value of 2 + 3
print "$foo\n";          # prints a5c
```

Perl can also be directed, via library calls or the `perlcc` command-line script (itself written in Perl), to translate source code to either byte code or machine code. In the former case, the output is an “executable” file beginning with `#!/usr/bin/perl` (see the sidebar on page 662 for a discussion of the `#!` convention). If invoked from the shell, this file will feed itself back into Perl 5, which will notice that the rest of the file contains byte code instead of source, and will perform a quick reconstruction of the syntax tree, ready for interpretation.

If directed to produce machine code, `perlcc` generates a C program, which it then runs through the C compiler. The C program builds an appropriate syntax tree and passes it directly to the Perl interpreter, bypassing both the compiler and the byte-code-to-syntax-tree reconstruction. Both the byte code and machine code back ends are considered experimental; they do not work for all programs.

Perl 6, still under development as of 2008, is intended to be JIT compiled. Its virtual machine, called Parrot, is unusual in providing a large register set, rather than a stack, for expression evaluation. Like Perl itself—but unlike the JVM and CLR—Parrot allows variables to be treated as different types in different contexts. Work is underway to target other scripting languages to Parrot, with the eventual goal of providing interoperability similar to that of the .NET languages. ■

✓ CHECK YOUR UNDERSTANDING

12. What is a *just-in-time* (JIT) compiler? What are its potential advantages over interpretation or conventional compilation?
13. Why might one prefer byte code over source code as the input to a JIT compiler?
14. What distinguishes *dynamic compilation* from just-in-time compilation?
15. What is a *hot path*? Why is it significant?
16. Under what circumstances can a JIT compiler expand virtual methods in-line?
17. What is *deoptimization*? When and why is it needed?
18. Explain the distinction between the function and expression tree representations of a lambda expression in C#.
19. Summarize the relationship between compilation and interpretation in Perl.

15.2.2 Binary Translation

Just-in-time and dynamic compilers assume the availability of source code or of byte code that retains all of the semantic information of the source. There are times, however, when it can be useful to recompile object code. This process is known as *binary translation*. It allows already-compiled programs to be run on a machine with a different instruction set architecture. Readers may be familiar, for example, with Apple's Rosetta system, which allows programs compiled for older PowerPC-based Macintosh computers to run on newer x86-based Macs. Rosetta builds on experience with a long line of similar translators.

The principal challenge for binary translation is the loss of information in the original source-to-object code translation. Object code typically lacks both type information and the clearly delineated subroutines and control-flow constructs of source code and byte code. While most of this information appears in the compiler's symbol table, and may sometimes be included in the object file for debugging purposes, vendors usually delete it before shipping commercial products, and a binary translator cannot assume it will be present.

The typical binary translator reads an object file and reconstructs a control flow graph of the sort described in [Section 14.1.1](#). This task is complicated by the lack of explicit information about basic blocks. While branches (the ends of basic blocks) are easy to identify, beginnings are more difficult: since branch targets are sometimes computed at run time or looked up in dispatch tables or virtual function tables, the binary translator must consider the possibility that control may sometimes jump into the middle of a "probably basic" block. Since translated code will generally not lie at the same address as the original code, computed branches must be translated into code that performs some sort of table lookup, or falls back on interpretation.

Static binary translation is not always possible for arbitrary object code. In addition to computed branches, problems include self-modifying code (programs that write to their own instruction space), dynamically generated code (e.g., for single-pointer closures, as described in Example ©8.66), and various forms of introspection, in which a program examines and reasons about its own state (we will consider this more fully in Section 15.3). Fortunately, many common idioms can be identified and treated as special cases, and for the (comparatively rare) cases that can't be handled statically, a binary translator can always delay some translation until run time, fall back on interpretation, or simply inform the user that translation is not possible. In practice, binary translation has proven remarkably successful.

Where and When to Translate

Most binary translators operate in user space, and limit themselves to the non-privileged subset of the machine's instruction set. A few are built at a lower level. When Apple converted from the Motorola 680x0 processor to the PowerPC in 1994, they built a 68K interpreter into the operating system. A subsequent release the following year augmented the interpreter with a rudimentary binary translator that would cache frequently executed instruction sequences in a small (256KB) buffer. By placing the interpreter (emulator) in the lowest levels of the operating system, Apple was able to significantly reduce its time to market: only the most performance-critical portions of the OS were rewritten for the PowerPC, leaving the rest as 68K code. Additional portions were rewritten over time. ■

In the late 1990s, Transmeta Corp. developed an unusual system capable of running unmodified x86 operating systems and applications by means of binary

EXAMPLE 15.11

The Mac 68K emulator

EXAMPLE 15.12

The Transmeta Crusoe processor

DESIGN & IMPLEMENTATION

Emulation and interpretation

While the terms *interpretation* and *emulation* are often used together, the concepts are distinct. *Interpretation*, as we have seen, is a language implementation technique: an interpreter is a program capable of executing programs written in the to-be-implemented language. *Emulation* is an end goal: faithfully imitating the behavior of some existing system (typically a processor or processor/OS pair) on some other sort of system. An emulator may use an interpreter to execute the emulated processor's instruction set. Alternatively, it may use binary translation, special hardware (e.g., a field-programmable gate array—FPGA), or some combination of these.

Emulation and interpretation are also distinct from *simulation*. A simulator models some complex system by capturing “important” behavior and ignoring “unimportant” detail. Meteorologists, for example, simulate the Earth's weather systems, but they do not emulate them. An emulator is generally considered correct if it does exactly what the original system does. For a simulator, one needs some notion of accuracy: how close is close enough?

translation. Their Crusoe and Efficeon processors, sold from 2000 to 2005, ran proprietary “Code Morphing” software directly on top of a wide-instruction-word ISA (distantly related to the Itanium). This software, designed in conjunction with the hardware, translated x86 code to native code on the fly, and was entirely invisible to systems running above it. ■

EXAMPLE 15.13

Static binary translation

Binary translators display even more diversity in their choice of what and when to translate. In the simplest case, translation is a one-time, off-line activity akin to conventional compilation. In the late 1980s, for example, Hewlett Packard Corp. developed a binary translator to retarget programs from their “Classic” HP 3000 line to the PA-RISC processor. The translator depended on the lack of dynamic linking in the operating system: all pieces of the to-be-translated program could be found in a single executable. ■

EXAMPLE 15.14

Dynamic binary translation

In a somewhat more ambitious vein, Digital Equipment Corp. (DEC) in the early 1990s constructed a pair of translators for their newly developed Alpha processor: one (*mx*) to translate Unix programs originally compiled for MIPS-based workstations, the other (VEST) to translate VMS programs originally compiled for the VAX. Because VMS supported an early form of shared libraries, it was not generally possible to statically identify all the pieces of a program. VEST and *mx* were therefore designed as “open-ended” systems that could intervene, at run time, to translate newly loaded libraries. Like the HP system, DEC’s translators saved new, translated versions of their applications to disk, for use in future runs. ■

EXAMPLE 15.15

Mixed interpretation and translation

In a subsequent project in the mid-1990s, DEC developed a system to execute shrink-wrapped Windows software on Alpha processors. (Early versions of Microsoft’s Windows NT operating system were available for both the x86 and the Alpha, but most commercial software came in x86-only versions.) DEC’s FX!32 included both a binary translator and a highly optimized interpreter. When the user tried to run an x86 executable, FX!32 would first interpret it, collecting usage statistics. Later, in the background, it would translate hot code paths to native code, and store them in a database. Once translated code was available (later in the same execution or during future runs), the interpreter would run it in lieu of the original. ■

EXAMPLE 15.16

Transparent dynamic translation

Modern emulation systems typically take an intermediate approach. A fast, simple translator creates native versions of basic blocks or subroutines on demand, and caches them for repeated use within a given execution. For the sake of transparency (to avoid modification of programs on disk), and to accommodate dynamic linking, translated code is usually not retained from one execution to the next. Systems in this style include Apple’s Rosetta; HP’s Aries, which retargets PA-RISC code to the Itanium; and Intel’s IA-32 EL, which retargets x86 code to the Itanium. ■

Dynamic Optimization

In a long-running program, a dynamic translator may revisit hot paths and optimize them more aggressively. A similar strategy can also be applied to programs that don’t need translation—that is, to programs that already exist as machine

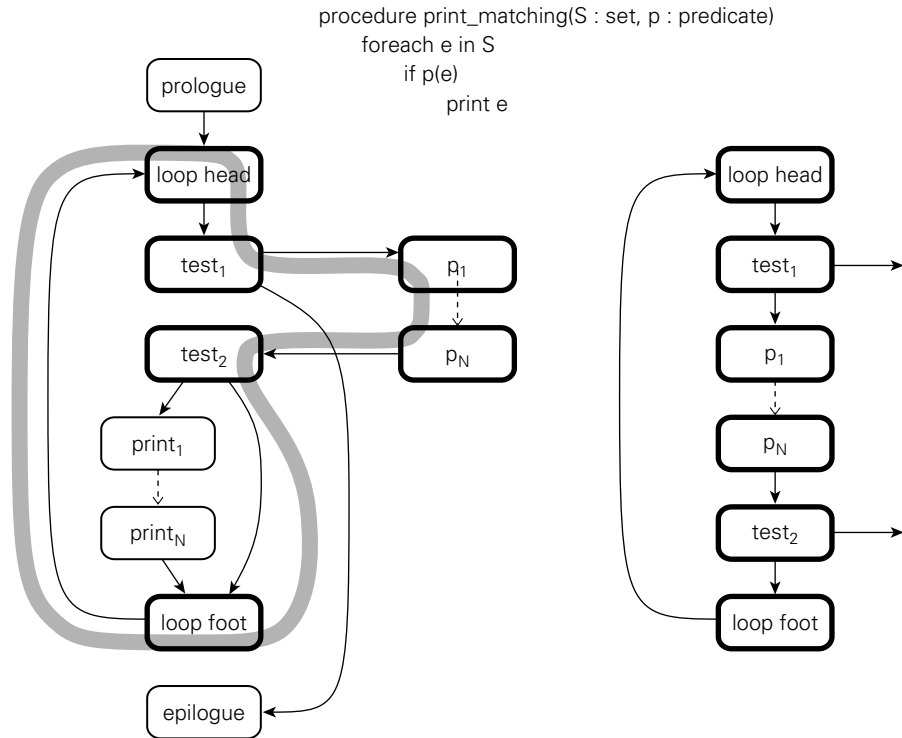

Figure 15.4 Creation of a partial execution trace. Procedure `print_matching` (shown at top) is often called with a particular predicate, `p`, which is usually false. The control flow graph (shown at left, with hot blocks in bold and the hot path in grey) can be reorganized at run time to improve instruction-cache locality and to optimize across abstraction boundaries (trace shown at right).

code for the underlying architecture. This sort of *dynamic optimization* has been reported to improve performance by as much as 20% over already-optimized code, by exploiting run-time profiling information.

EXAMPLE 15.17

The Dynamo dynamic optimizer

Much of the technology of dynamic optimization was pioneered by the Dynamo project at HP Labs in the late 1990s. Dynamo was designed to transparently enhance the performance of applications for the PA-RISC instruction set. A subsequent version, DynamoRIO, was written for the x86. Dynamo's key innovation was the concept of a *partial execution trace*: a hot path whose basic blocks can be reorganized, optimized, and cached as a linear sequence.

An example of such a trace appears in [Figure 15.4](#). Procedure `print_matching` takes a set and a predicate as argument, and prints all elements of the set that match the predicate. At run time, Dynamo may discover that the procedure is frequently called with a particular predicate `p` that is almost never true. The hot path through the flow graph (left side of the figure) can then be turned into the trace at the

right. If `print_matching` is sometimes called with a different predicate p , it will use a separate copy of the code. Branches out of the trace (in the loop-termination and predicate-checking tests) jump either to other traces or, if appropriate ones have not yet been created, back into Dynamo.

By identifying and optimizing traces, Dynamo is able to significantly improve locality in the instruction cache, and to apply standard code improvement techniques across the boundaries between separately compiled modules and dynamically loaded libraries. In [Figure 15.4](#), for example, it will perform register allocation jointly across `print_matchings` and the predicate p . It can even perform instruction scheduling across basic blocks if it inserts appropriate *compensating code* on branches out of the trace. An instruction in block `test2`, for example, can be moved into the loop footer if a copy is placed on the branch to the right. Traces have proven to be a very powerful technique. They are used not only by dynamic optimizers, but by dynamic translators like Rosetta as well, and by binary instrumentation tools like Pin (to be discussed in [Section 15.2.3](#)). ■

15.2.3 Binary Rewriting

While the goal of a binary optimizer is to improve the performance of a program without altering its behavior, one can also imagine tools designed to *change* that behavior. *Binary rewriting* is a general technique to modify existing executable programs, typically to insert instrumentation of some kind. The most common form of instrumentation collects profiling information. One might count the number of times that each subroutine is called, for example, or the number of times that each loop iterates ([Exercise 15.6](#)). Such counts can be stored in a buffer in memory, and dumped at the end of execution. Alternatively, one might log all memory references. Such a log will generally need to be sent to a file as the program runs—it will be too long to fit in memory.

In addition to profiling, binary rewriting can be used to

- Simulate new architectures: operations of interest to the simulator are replaced with code that jumps into a special run-time library (other code runs at native speed).
- Evaluate the coverage of test suites, by identifying paths through the code that are not explored by a series of tests.
- Implement *model checking* for parallel programs, a process that exposes race conditions ([Example 12.2](#)) by forcing a program through different interleavings of operations in different threads.
- “Audit” the quality of a compiler’s optimizations. For example, one might check whether the value loaded into a register is always the same as the value that was already there (such loads suggest that the compiler may have failed to realize that the load was redundant).

- Insert dynamic semantic checks into a program that lacks them. Binary rewriting can be used not only for simple checks like null-pointer dereference and arithmetic overflow, but for a wide variety of memory access errors as well, including uninitialized variables, dangling references, memory leaks, “double deletes” (attempts to deallocate an already deallocated block of memory), and access off the ends of dynamically allocated arrays.

More ambitiously, as described in the sidebar on page 798, binary rewriting can be used to “sandbox” untrusted code so that it can safely be executed in the same address space as the rest of the application.

EXAMPLE 15.18

The ATOM binary rewriter

Many of the techniques used by rewriting tools were pioneered by the ATOM binary rewriter for the Alpha processor. Developed by researchers at DEC’s Western Research Lab in the early 1990s, ATOM was a static tool that modified a program for subsequent execution.

To use ATOM, a programmer would write *instrumentation* and *analysis* subroutines in C. Instrumentation routines would be called by ATOM during the rewriting process. By calling back into ATOM, these routines could arrange for the rewritten application to call analysis routines at instructions, basic blocks, subroutines, or control flow edges of the programmer’s choosing. To make room for inserted calls, ATOM would move original instructions of the instrumented program; to facilitate such movement, the program had to be provided as a set of relocatable modules. No other changes were made to the instrumented program; in particular, data addresses were always left unchanged. ■

An Example System: The Pin Binary Rewriter

With the demise of the Alpha processor, use of ATOM has been largely supplanted by Pin, a binary rewriter developed by researchers at Intel in the early 2000s, and distributed as open source. Designed to be largely machine independent, Pin is currently available for Intel’s four principal instruction sets: the x86, x86-64, Itanium, and ARM.

Pin was directly inspired by ATOM, and has a similar programming interface. In particular, it retains the notions of instrumentation and analysis routines. It also borrows ideas from Dynamo and other dynamic translation tools. Most significantly, it uses an extended version of Dynamo’s trace mechanism to instrument previously unmodified programs at run time; the on-disk representation of the program never changes. Pin can even be *attached* to an already-running application, much like the symbolic debuggers we will study in [Section 15.3.2](#).

Like Dynamo, Pin begins by writing an initial trace of basic blocks into a run-time trace cache. It ends the trace when it reaches an unconditional branch, a predefined maximum number of conditional branches, or a predefined maximum number of instructions. As it writes, it inserts calls to analysis routines (or in-line versions of short routines) at appropriate places in the code. It also maintains a mapping between original program addresses and addresses in the trace, so it can

modify address-specific instructions accordingly. Once it has finished creating a trace, Pin simply jumps to its first instruction. Conditional branches that exit the trace are set to link to other traces, or to jump back into Pin.

Indirect branches are handled with particular care. Based on run-time profiling, Pin maintains a set of predictions for the targets of such branches, sorted most likely first. Each prediction consists of an address in the original program (which serves as a key) and an address to jump to in the trace cache. If none of the predictions match, Pin falls back to table lookup in its mapping between original and trace cache addresses. If match is still not found, Pin falls back on an instruction set interpreter, allowing it to handle even dynamically generated code.

To reduce the need to save registers when calling analysis routines, and to facilitate in-line expansion of those routines, Pin performs its own register allocation for the instructions of each trace, using similar allocations whenever possible for traces that link to one another. In multithreaded programs, one register is statically reserved to point to a thread-specific buffer, where registers can be spilled when necessary. Condition codes are not saved across calls to analysis routines unless their values are needed afterward. For routines that can be called anywhere within a basic block, Pin hunts for a location where the cost of saving and restoring is minimized.

15.2.4 Mobile Code and Sandboxing

Portability is one of the principal motivations for late binding of machine code. Code that has been compiled for one machine architecture or operating system cannot generally be run on another. Code in a byte code (JBC, CIL) or scripting language (JavaScript, Visual Basic), however, is compact and machine independent: it can easily be moved over the Internet and run on almost any platform. Such *mobile code* is increasingly common. Every major browser supports JavaScript; most enable the execution of Java applets as well. Visual Basic macros are commonly embedded not only in pages meant for viewing with Internet Explorer, but also in Excel, Word, and Outlook documents distributed via email. Increasingly, cell phone platforms are using mobile code to distribute games, productivity tools, and interactive media that run on the phones themselves.

In some sense, mobile code is nothing new: almost all our software comes from other sources; we buy it on a DVD or download it over the Internet and install it on our machines. Historically, this usage model has relied on trust (we assume that software from a well-known company will be safe) and on the very explicit and occasional nature of installation. What has changed in recent years is the desire to download code frequently, from potentially untrusted sources, and often without the conscious awareness of the user.

Mobile code carries a variety of risks. It may access and reveal confidential information (spyware). It may interfere with normal use of the computer in annoying ways (adware). It may damage existing programs or data, or save copies of itself

that run without the user's intent (malware of various kinds). In the worst cases, it may use the host machine as a “zombie” from which to launch attacks on other users.

To protect against unwanted behavior, both accidental and malicious, mobile code must be executed in some sort of *sandbox*, as noted on page 689. Sandbox creation is difficult because of the variety of resources that must be protected. At a minimum, one needs to monitor or limit access to processor cycles, memory outside the code's own instructions and data, the file system, network interfaces, other devices (passwords, for example, may be stolen by snooping the keyboard), the window system (e.g., to disable pop-up ads), and any other potentially dangerous services provided by the operating system.

Sandboxing mechanisms lie at the boundary between language implementation and operating systems. Traditionally, OS-provided virtual memory techniques might be used to limit access to memory, but this is generally too expensive for many forms of mobile code. The two most common techniques today—both of which rely on technology discussed in this chapter—are binary rewriting and execution in an untrusting interpreter. Both cases are complicated by an inherent tension between safety and utility: the less we allow untrusted code to do, the less useful it can be. No single policy is likely to work in all cases. Applets may be entirely safe if all they can do is manipulate the image in a window, but macros embedded in a spreadsheet may not be able to do their job without changing the user's data. A major challenge for future work is to find a way to help users—who cannot be expected to understand the technical details—to make informed decisions about what and what not to allow in mobile code.

DESIGN & IMPLEMENTATION

Creating a sandbox via binary rewriting

Binary rewriting provides an attractive means to implement a sandbox. While there is in general no way to ensure that code does what it is supposed to do (one is seldom sure of that even with one's own code), a binary rewriter can

- Verify the address of every load and store, to make sure untrusted code accesses only its own data, and to avoid alignment faults
- Similarly verify every branch and call, to prevent control from leaving the sandbox by any means other than returning
- Verify all opcodes, to prevent illegal instruction faults
- Double-check the parameters to any arithmetic instruction that may generate a fault
- Audit (or forbid) all system calls
- Instrument backward jumps to limit the amount of time that untrusted code can run (and in particular to preclude any infinite loops)

✓ CHECK YOUR UNDERSTANDING

20. What is *binary translation*? When and why is it needed?
 21. Explain the tradeoffs between static and dynamic binary translation.
 22. What is *emulation*? How is it related to interpretation and simulation?
 23. What is *dynamic optimization*? How can it improve on static optimization?
 24. What is *binary rewriting*? How does it differ from binary translation and dynamic optimization?
 25. Describe the notion of a *partial execution trace*. Why is it important to dynamic optimization and rewriting?
 26. What is *mobile code*?
 27. What is *sandboxing*? When and why is it needed? How can it be implemented?
-

15.3 Inspection/Introspection

Symbol table metadata makes it easy for utility programs—just-in-time and dynamic compilers, optimizers, debuggers, profilers, and binary rewriters—to *inspect* a program and reason about its structure and types. We consider debuggers and profilers in particular in [Sections 15.3.2](#) and [15.3.3](#) below. There is no reason, however, why the use of metadata should be limited to outside tools, and indeed it is not: Lisp has long allowed a program to reason about its own internal structure and types (this sort of reasoning is sometimes called *introspection*). Java and C# provide similar functionality through a *reflection* API that allows a program to peruse its own metadata. Reflection appears in several other languages as well, including Prolog (page [565](#)) and all the major scripting languages. In a dynamically typed language such as Lisp, reflection is essential: it allows a library or application function to type check its own arguments. In a statically typed language, reflection supports a variety of programming idioms that were not traditionally feasible.

15.3.1 Reflection

EXAMPLE 15.19

Finding the concrete type of a reference variable

Trivially, reflection can be useful when printing diagnostics. Suppose we are trying to debug an old-style (nongeneric) queue in Java, and we want to trace the objects that move through it. In the `dequeue` method, just before returning an object `rtn` of type `Object` , we might write

```
System.out.println("Dequeued a " + rtn.getClass().getName());
```

If the dequeued object is a boxed `int`, we will see

```
Dequeued a java.lang.Integer
```

More significantly, reflection is useful in programs that manipulate other programs. Most program development environments, for example, have mechanisms to organize and “pretty-print” the classes, methods, and variables of a program. In a language with reflection, these tools have no need to examine source code: if they load the already-compiled program into their own address space, they can use the reflection API to query the symbol table information created by the compiler. Interpreters, debuggers, and profilers can work in a similar fashion. In a distributed system, a program can use reflection to create a general-purpose *serialization* mechanism, capable of transforming an almost arbitrary structure into a linear stream of bytes that can be sent over a network and reassembled at the other end. (Both Java and C# include such mechanisms in their standard library, implemented on top of the basic language.) In the increasingly dynamic world of Internet applications, one can even create conventions by which a program can “query” a newly discovered object to see what methods it implements, and then choose which of these to call.

There are dangers, of course, associated with the undisciplined use of reflection. Because it allows an application to peek inside the implementation of a class (e.g., to list its private members), reflection violates the normal rules of abstraction and information hiding. It may be disabled by some security policies (e.g., in sandboxed environments). By limiting the extent to which target code can differ from the source, it may preclude certain forms of code improvement.

EXAMPLE 15.20

What *not* to do with reflection

Perhaps the most common pitfall of reflection, at least for object-oriented languages, is the temptation to write case (`switch`) statements driven by type information:

```
procedure rotate(s : shape)
  case shape.type of
    square: rotate_square(s)
    triangle: rotate_triangle(s)
    circle:
    ...
    -- don't do this in Java!
    -- no-op
```

While this kind of code is common (and appropriate) in Lisp, in an object-oriented language it is much better written with subtype polymorphism:

```
s.rotate()
-- virtual method call
```

Java 5 Reflection

Java’s root class, `Object`, supports a `getClass` method that returns an instance of `java.lang.Class`. Objects of this class in turn support a large number of reflection operations, among them the `getName` method we used in [Example 15.19](#). A call to `getName` returns the *fully qualified* name of the class, as it is embedded

EXAMPLE 15.21

Java class-naming conventions

in the package hierarchy. For array types, naming conventions are taken from the JVM:

```
int[] A = new int[10];
System.out.println(A.getClass().getName()); // prints "[I"
String[] C = new String[10];
System.out.println(C.getClass().getName()); // "[Ljava.lang.String;"
Foo[] [] D = new Foo[10][10];
System.out.println(D.getClass().getName()); // "[[LFoo;"
```

Here `Foo` is assumed to be a user-defined class in the default (outermost) package. A left square bracket indicates an array type; it is followed by the array's element type. The built-in types (e.g., `int`) are represented in this context by single-letter names (e.g., `I`). User-defined types are indicated by an `L`, followed by the fully qualified class name and terminated by a semicolon. Notice the similarity of the second example (`C`) to entry #12 in the constant pool of [Figure 15.1](#): that entry gives the parameter types (in parentheses) and return type (`V` means void) of `main`. As every Java programmer knows, `main` expects an array of strings. ■

EXAMPLE 15.22

Getting information on a particular class

A call to `o.getClass()` returns information on the concrete type of the object referred to by `o`, not on the abstract type of the reference `o`. If we want a `Class` object for a particular type, we can create a dummy object of that type:

```
Object o = new Object();
System.out.println(o.getClass().getName()); // "java.lang.Object"
```

Alternatively, we can append the pseudofield name `.class` to the name of the type itself:

```
System.out.println(Object.class.getName()); // "java.lang.Object"
```

In the reverse direction, we can use static method `forName` of class `Class` to obtain a `Class` object for a type with a given (fully qualified) character string name:

```
Class stringClass = Class.forName("java.lang.String");
Class intArrayClass = Class.forName("[I");
```

Method `forName` works only for reference types. For built-ins, one can either use the `.class` syntax or the `.TYPE` field of one of the standard wrapper classes:

```
Class intClass = Integer.TYPE; ■
```

Given a `Class` object `c`, one can call `c.getSuperclass()` to obtain a `Class` object for `c`'s parent. In a similar vein, `c.getClasses()` will return an array of `Class` objects, one for each public class declared within `c`'s class. Perhaps more interesting, `c.getMethods()`, `c.getFields()`, and `c.getConstructors()` will

return arrays of objects representing all `c`'s public methods, fields, and constructors (including those inherited from ancestor classes). The elements of these arrays are instances of classes `Method`, `Field`, and `Constructor`, respectively. These are declared in package `java.lang.reflect`, and serve a role analogous to that of `Class`. The many methods of these classes allow one to query almost any aspect of the Java type system, including modifiers (`static`, `private`, `final`, `abstract`, etc.), type parameters of generics (but not of generic instances—those are erased), interfaces implemented by classes, exceptions thrown by methods, and much more. Perhaps the most conspicuous thing that is *not* available through the Java reflection API is the byte code that implements methods. Even this, however, can be examined using third-party tools such as the Apache Byte Code Engineering Library (BCEL) or ObjectWeb's ASM, both of which are open source.

EXAMPLE 15.23

Listing the methods of a Java class

Figure 15.5 shows Java code to list the methods declared in (but not inherited by) a given class. Also shown is output for `AccessibleObject`, the parent class of `Method`, `Field`, and `Constructor`. (The primary purpose of this class is to control whether the reflection interface can be used to override access control [`private`, `protected`] for the given object.) ■

EXAMPLE 15.24

Calling a method with reflection

One can even use reflection to call a method of an object whose class is not known at compile time. Suppose that someone has created a stack containing a single integer:

```
Stack s = new Stack();
s.push(new Integer(3));
```

Now suppose we are passed this stack as a parameter `u` of `Object` type. We can use reflection to explore the concrete type of `u`. In the process we will discover that its second method, named `pop`, takes no arguments and returns an `Object` result. We can call this method using `Method.invoke`:

```
Method uMethods[] = u.getClass().getMethods();
Method method1 = uMethods[1];
Object rtn = method1.invoke(u);    // u.pop()
```

A call to `rtn.getClass().getName()` will return `java.lang.Integer`. A call to `((Integer) rtn).intValue()` will return the value 3 that was originally pushed into `s`. ■

Other Languages

C#'s reflection API is similar to that of Java: `System.Type` is analogous to `java.lang.Class`; `System.Reflection` is analogous to `java.lang.reflect`. The pseudofunction `typeof` plays the role of Java's pseudofield `.class`. More substantive differences stem from the fact that PE assemblies contain a bit more information than is found in Java class files. We can ask for names of formal parameters in C#, for example, not just their types. More significantly, the use of reification instead of erasure for generics means that we can retrieve precise information

```

import static java.lang.System.out;

public static void listMethods(String s)
    throws java.lang.ClassNotFoundException {
    Class c = Class.forName(s);    // throws if class not found
    for (Method m : c.getDeclaredMethods()) {
        out.print(Modifier.toString(m.getModifiers()) + " ");
        out.print(m.getReturnType().getName() + " ");
        out.print(m.getName() + "(");
        boolean first = true;
        for (Class p : m.getParameterTypes()) {
            if (!first) out.print(", ");
            first = false;
            out.print(p.getName());
        }
        out.println(")");
    }
}

```

Sample output for `listMethods("java.lang.reflect.AccessibleObject")`:

```

public java.lang.annotation.Annotation getAnnotation(java.lang.Class)
public boolean isAnnotationPresent(java.lang.Class)
public [Ljava.lang.annotation.Annotation; getAnnotations()
public [Ljava.lang.annotation.Annotation; getDeclaredAnnotations()
public static void setAccessible([Ljava.lang.reflect.AccessibleObject;, boolean)
public void setAccessible(boolean)
private static void setAccessible0(java.lang.reflect.AccessibleObject, boolean)
public boolean isAccessible()

```

Figure 15.5 Java reflection code to list the methods of a given class. Sample output is shown under code.

on the type parameters used to instantiate a given object. Perhaps the biggest difference is that .NET provides a standard library, `System.Reflection.Emit`, to create PE assemblies and to populate them with CIL byte code. The functionality of `Reflection.Emit` is roughly comparable to that of the BCEL and ASM tools mentioned in the previous subsection. Because it is part of the standard library, however, it is available to any program running on the CLI.

All of the major scripting languages (Perl, PHP, Tcl, Python, Ruby, JavaScript) provide extensive reflection mechanisms. The precise set of capabilities varies some from language to language, and the syntax varies quite a bit, but all allow a program to explore its own structure and types. From the programmer's point of view, the principal difference between reflection in Java and C# on the one hand, and in scripting languages on the other, is that the scripting languages—like Lisp—are dynamically typed. In Ruby, for example, we can discover the class of an object, the methods of a class or object, and the number of parameters expected by each method, but the parameters themselves are untyped until the method is

EXAMPLE 15.25

Reflection facilities in Ruby

called. In the following code, method `p` prints its argument to standard output, followed by a newline.

```
squares = {2=>4, 3=>9}
p squares.class                # Hash
p Hash.public_instance_methods.length # 98 -- Hashes have many methods
p squares.public_methods.length   # 98 -- those same methods
m = Hash.public_instance_methods[16]
p m                               # "store"
p squares.method(m).arity         # 2 -- key and value to be stored
```

As in Java and C#, we can also invoke a method whose name was not known at compile time:

```
squares.store(1, 1)           # static invocation
p squares                     # 1=>1, 2=>4, 3=>9
squares.send(m, 0, 0)        # dynamic invocation
p squares                     # 0=>0, 1=>1, 2=>4, 3=>9
```

As suggested at the beginning of this section, reflection is in some sense more “natural” in scripting languages (and in Lisp and Prolog) than it is in Java or C#: detailed symbol table information is needed at run time to perform dynamic type checks; in an interpreted implementation, it is also readily available. Lisp programmers have known for decades that reflection was useful for many additional purposes. The designers of Java and C# clearly felt these purposes were valuable enough to justify adding reflection (with considerably higher implementation complexity) to a compiled language with static typing.

Annotations and Attributes

Both Java and C# allow the programmer to extend the metadata saved by the compiler. In Java, these extensions take the form of *annotations* attached to declarations. Several annotations are built into the programming language. These play the role of pragmas. In Example ©8.74, for example, we noted that the Java compiler will generate warnings when a generic class is assigned into a variable of the equivalent nongeneric class. The warning indicates that the code is not statically type-safe, and that an error message is possible at run time. If the programmer is certain that the error cannot arise, the compile-time warning can be disabled by prefixing the method in which the assignment appears with the annotation `@SuppressWarnings("unchecked")`.

In general, a Java annotation resembles an interface whose methods take no parameters, throw no exceptions, and return values of one of a limited number of predefined types. An example of a user-defined annotation appears in [Figure 15.6](#). If we run the program it will print

EXAMPLE 15.26

User-defined annotations
in Java

```
author:    Michael Scott
date:     July, 2008
revision:  0.1
docString: Illustrates the use of annotations
```

```

import static java.lang.System.out;
import java.lang.annotation.*;

@Retention(RetentionPolicy.RUNTIME)
@interface Documentation{
    String author();
    String date();
    double revision();
    String docString();
}

@Documentation(
    author = "Michael Scott",
    date = "July, 2008",
    revision = 0.1,
    docString = "Illustrates the use of annotations"
)
public class Annotate {
    public static void main(String[] args) {
        Class<Annotate> c = Annotate.class;
        Documentation a = c.getAnnotation(Documentation.class);
        out.println("author:      " + a.author());
        out.println("date:        " + a.date());
        out.println("revision:   " + a.revision());
        out.println("docString:  " + a.docString());
    }
}

```

Figure 15.6 User-defined annotations in Java. `Retention` is a built-in annotation for annotations. It indicates here that `Documentation` annotations should be saved in the class file produced by the Java compiler, where they will be available to run-time reflection.

EXAMPLE 15.27

User-defined annotations
in C#

The C# equivalent of [Figure 15.6](#) appears in [Figure 15.7](#). Here user-defined annotations (known as *attributes* in C#) are classes, not interfaces, and the syntax for attaching an attribute to a declaration uses square brackets instead of an `@` sign. ■

In effect, annotations (attributes) serve as compiler-supported comments, with well-defined structure and an API that makes them accessible to automated perusal. As we have seen, they may be read by the compiler (as pragmas) or by reflective programs. They may also be read by independent tools. Such tools can be surprisingly versatile.

EXAMPLE 15.28

javadoc

An obvious use is the automated creation of documentation. Java annotations (first introduced in Java 5) were inspired at least in part by experience with the earlier javadoc tool, which produces HTML-formatted documentation based on structured comments in Java source code. The `@Documented` annotation, when attached to the declaration of a user-defined annotation, indicates that javadoc should include the annotation when creating its reports. One can easily imagine

EXAMPLE 15.29Intercomponent
communication

more sophisticated documentation systems that tracked the version history and bug reports for a program over time. ■

The various communication technologies in .NET (sidebar on page 775) make extensive use of attributes to indicate which methods should be available for remote execution, how their parameters should be marshalled into messages, which classes need serialization code, and so forth. Automatic tools use these attributes to create appropriate stubs for remote communication, as described (in language-neutral terms) in Section ©12.5.4. ■

EXAMPLE 15.30

Attributes for LINQ

In a similar vein, the .NET 3.0 LINQ mechanism uses attributes to define the mapping between classes in a user program and tables in a relational database, allowing an automatic tool to generate SQL queries that implement iterators and other language-level operations. ■

In an even more ambitious vein, independent tools can be used to modify or analyze programs based on annotations. One could imagine inserting logging code into certain annotated methods, or building a testing harness that called annotated methods with specified arguments and checked for expected results ([Exercise 15.12](#)). JML, the Java Modeling Language, allows the programmer to specify preconditions, post-conditions, and invariants for classes, methods, and statements, much like those we considered in [Section 4.1](#) (page 178). JML builds on experience with an earlier multilanguage, multi-institution project known as Larch. Like javadoc, JML uses structured comments rather than the newer compiler-supported annotations to express its specifications, so they are not automatically included in class files. A variety of tools can be used, however, to verify that a program conforms to its specifications, either statically (where possible) or at run time (via insertion of semantic checks). ■

EXAMPLE 15.31

The Java Modeling Language

EXAMPLE 15.32

Java apt

Java 5 introduced a program called apt designed to facilitate the construction of annotation processing tools. The functionality of this tool was subsequently integrated into Sun's Java 6 compiler. Its key enabling feature is a set of APIs (in `com.sun.mirror`) that allow a tool to peruse the static structure of a Java program (including full information on generics) in much the same way that reflection allows a running program to peruse its own types and structure. ■

15.3.2 Symbolic Debugging

Most programmers are familiar with symbolic debuggers: they are built into most programming language interpreters, virtual machines, and integrated program development environments. They are also available as stand-alone tools, of which the best known is GNU's gdb. The adjective *symbolic* refers to a debugger's understanding of high-level language syntax—the symbols in the original program. Early debuggers understood assembly language only.

In a typical debugging session, the user starts a program under the control of the debugger, or *attaches* the debugger to an already running program. The debugger then allows the user to perform two main kinds of operations. One kind inspects or modifies program data; the other controls execution: starting, stopping, stepping,

```

using System;
using System.Reflection;

[AttributeUsage(AttributeTargets.Class)]
// Documentation attribute can applied only to classes
public class DocumentationAttribute : System.Attribute {
    public string author;
    public string date;    // these should perhaps be properties
    public double revision;
    public string docString;
    public DocumentationAttribute(string a, string d, double r, string s) {
        author = a; date = d; revision = r; docString = s;
    }
}

[Documentation("Michael Scott",
    "July, 2008", 0.1, "Illustrates the use of attributes")]
public class Attr {
    public static void Main(string[] args) {
        System.Reflection.MemberInfo tp = typeof(Attr);
        object[] attrs =
            tp.GetCustomAttributes(typeof(DocumentationAttribute), false);
        // false means don't search ancestor classes and interfaces
        DocumentationAttribute a = (DocumentationAttribute) attrs[0];
        Console.WriteLine("author:    " + a.author);
        Console.WriteLine("date:      " + a.date);
        Console.WriteLine("revision:  " + a.revision);
        Console.WriteLine("docString: " + a.docString);
    }
}

```

Figure 15.7 User-defined attributes in C#. This code is roughly equivalent to the Java version in Figure 15.6. `AttributeUsage` is a predefined attribute indicating properties of the attribute to whose declaration it is attached.

establishing *breakpoints* and *watchpoints*. A breakpoint specifies that execution should stop if it reaches a particular location in the source code. A watchpoint specifies that execution should stop if a particular variable is read or written. Both breakpoints and watchpoints can typically be made *conditional*, so that execution stops only if a particular Boolean predicate evaluates to true.

Both data and control operations depend critically on symbolic information. A symbolic debugger needs to be able both to parse source language expressions and to relate them to symbols in the original program. In `gdb`, for example, the command `print a.b[i]` needs to parse the to-be-printed expression; it also needs to recognize that `a` and `i` are in scope at the point where the program is currently stopped, and that `b` is an array-typed field whose index range includes the current value of `i`. Similarly, the command `break 123 if i+j == 3` needs to parse the expression `i+j`; it also needs to recognize that there is an executable

statement at line 123 in the current source file, and that `i` and `j` are in scope at that line.

Both data and control operations also depend on the ability to manipulate a program from outside: to stop and start it, and to read and write its data. This control can be implemented in at least three ways. The easiest occurs in interpreters. Since an interpreter has direct access to the program's symbol table and is "in the loop" for the execution of every statement, it is a straightforward matter to move back and forth between the program and the debugger, and to give the latter access to the former's data.

The technology of dynamic binary rewriting (as in Dynamo and Pin) can also be used to implement debugger control [ZRA⁺08]. This technology is relatively new, however; as of 2008 it is not yet employed in production debugging tools.

For compiled programs, the third implementation of debugger control is by far the most common. It depends on support from the operating system. In Unix, it employs a kernel service known as `ptrace`. The `ptrace` kernel call allows a debugger to "grab" (attach to) an existing process or to start a process under its control. The tracing process (the debugger) can intercept any signals sent to the traced process by the operating system and can read and write its registers and memory. If the traced process is currently running, the debugger can stop it by sending it a signal. If it is currently stopped, the debugger can specify the address at which it should resume execution, and can ask the kernel to run it for a single instruction (a process known as *single stepping*) or until it receives another signal.

Perhaps the most mysterious parts of debugging from the user's perspective are the mechanisms used to implement breakpoints, watchpoints, and single stepping. The default implementation, which works on any modern processor, relies on the ability to modify the memory space of the traced process—in particular, the portion containing the program's code. As an example, suppose the traced process is currently stopped, and that before resuming it the debugger wishes to set a breakpoint at the beginning of function `foo`. It does so by replacing the first instruction of the function's prologue with a special kind of `trap`.

Trap instructions are the normal way a process requests a service from the operating system. In this particular case, the kernel interprets the trap as a request to stop the currently running process and return control to the debugger. To resume the traced process in the wake of the breakpoint, the debugger puts back the original instruction, asks the kernel to single-step the traced process, replaces the instruction yet again with a `trap` (to reenable the breakpoint), and finally resumes the process. For a conditional breakpoint, the debugger evaluates the condition's predicate when the breakpoint occurs. If the breakpoint is unconditional, or if the condition is true, the debugger jumps to its command loop and waits for user input. If the predicate is false, it resumes the traced process automatically and transparently. If the breakpoint is set in an inner loop, where control will reach it frequently, but the condition is seldom true, the overhead of switching back and forth between the traced process and the debugger can be very high. ■

EXAMPLE 15.33

Setting a breakpoint

EXAMPLE 15.34

Hardware breakpoints

Some processors provide hardware support to make breakpoints a bit faster. The x86, for example, has four *debugging registers* that can be set (in kernel mode) to contain an instruction address. If execution reaches that address, the processor simulates a trap instruction, saving the debugger the need to modify the address space of the traced process and eliminating the extra kernel calls (and the extra round trip between the traced process and the debugger) needed to restore the original instruction, single-step the process, and put the trap back in place. In a similar vein, many processors, including the x86, can be placed in *single-stepping mode*, which simulates a trap after every user-mode instruction. Without such support, the debugger (or the kernel) must implement single-stepping by repeatedly placing a (temporary) breakpoint at the next instruction. ■

EXAMPLE 15.35

Setting a watchpoint

Watchpoints are a bit trickier. By far the easiest implementation depends on hardware support. Suppose we want to drop into the debugger whenever the program modifies some variable x . The debugging registers of the x86 and other modern processors can be set to simulate a trap whenever the program writes to x 's address. When the processor lacks such hardware support, or when the user asks the debugger to set more breakpoints or watchpoints than the hardware can support, there are several alternatives, none of them attractive. Perhaps the most obvious is to single step the process repeatedly, checking after each instruction to see whether x has been modified. If the processor also lacks a single-step mode, the debugger will want to place its temporary breakpoints at successive store instructions rather than at every instruction (it may be able to skip some of the store instructions if it can prove they cannot possibly reach the address of x). Alternatively, the debugger can modify the address space of the traced process to make x 's page unwritable. The process will then take a segmentation fault on every write to that page, allowing the debugger to intervene. If the write is actually to x , the debugger jumps to its command loop. Otherwise it performs the write on the process's behalf and asks the kernel to resume it. ■

Unfortunately, the overhead of repeated context switches between the traced process and the debugger dramatically impacts the performance of software watchpoints: slowdowns of $1000\times$ are not uncommon. Debuggers based on dynamic binary rewriting have the potential to support arbitrary numbers of watchpoints at speeds close to those admitted by hardware watchpoint registers. The idea is straightforward: the traced program runs as partial execution traces in a trace cache managed by the debugger. As it generates each trace, the debugger adds instructions at every store, in-line, to check whether it writes to x 's address and, if so, to jump back to the command loop.

15.3.3 Performance Analysis

Before placing a debugged program into production use, one often wants to understand—and if possible improve—its performance. Tools to profile and analyze programs are both numerous and varied—far too much so to even survey them here. We focus therefore on the run-time technologies, described in this chapter, that feature prominently in many analysis tools.

EXAMPLE 15.36

Statistical sampling

Perhaps the simplest way to measure, at least approximately, the amount of time spent in each part of the code is to *sample* the program counter (PC) periodically. This approach was exemplified by the classic *prof* tool in Unix. By linking with a special *prof* library, a program could arrange to receive a periodic timer signal—once a millisecond, say—in response to which it would increment a counter associated with the current PC. After execution, the *prof* post-processor would correlate the counters with an address map of the program’s code and produce a statistical summary of the percentage of time spent in each subroutine and loop. ■

EXAMPLE 15.37

Call graph profiling

While simple, *prof* had some serious limitations. Its results were only approximate, and could not capture fine-grain costs. It also failed to distinguish among calls to a given routine from multiple locations. If we want to know which of A, B, and C is the biggest contributor to program run time, it is not particularly helpful to learn that all three of them call D where most of the time is actually spent. If we want to know whether it is A’s Ds, B’s Ds, or C’s Ds that are so expensive, we can use the (slightly) more recent *gprof* tool, which relies on compiler support to instrument procedure prologues. As the instrumented program runs, it logs the number of times that D is called from each location. The *gprof* post-processor then assumes that the total time spent in D can accurately be apportioned among the call sites according to the relative number of calls. More sophisticated tools log not only the caller and callee but also the stack *backtrace* (the contents of the dynamic chain), allowing them to cope with the case in which D consumes twice as much time when called from A as it does when called from B or C (see [Exercise 15.14](#)). ■

If our program is underperforming for algorithmic reasons, it may be enough to know where it is spending the bulk of its time. We can focus our attention on improving the source code in the places it will matter most. If the program is underperforming for other reasons, however, we generally need to know *why*. Is it cache misses due to poor locality, perhaps? Branch mispredictions? Poor pipeline performance? Tools to address these and similar questions generally rely on more extensive instrumentation of the code or on some sort of hardware support.

EXAMPLE 15.38

Finding basic blocks with low IPC

As an example of instrumentation, consider the task of identifying basic blocks that execute an unusually small number of instructions per cycle. To find such blocks we can combine (1) the aggregate time spent in each block (obtained by statistical sampling), (2) a count of the number of times each block executes (obtained via instrumentation), and (3) static knowledge of the number of instructions in each block. If basic block i contains k_i instructions and executes n_i times during a run of a program, it contributes $k_i n_i$ dynamic instructions to that run. Let $N = \sum_i k_i n_i$ be the total number of instructions in the run. If statistical sampling indicates that block i accounts for $x_i\%$ of the time in the run and x_i is significantly larger than $(k_i n_i)/N$, then something strange is going on—probably an unusually large number of cache misses. ■

EXAMPLE 15.39

Performance counters on the Pentium M

Most modern processors provide a set of *performance counters* that can be used to good effect by performance analysis tools. The Intel Pentium M processor, for example, has two performance counters that can be configured by the kernel to count any of 47 different kinds of *events*, including branch mispredictions;

TLB (address translation) misses; and various kinds of cache misses, interrupts, executed instructions, and pipeline stalls. Unfortunately, performance counters are generally a scarce resource (one might often wish for many more of them). Their number, type, and mode of operation varies greatly from processor to processor; direct access to them is usually available only in kernel mode; and operating systems do not always export that access to user-level programs with a convenient or uniform interface. Portable tools that make use of performance counters are an active topic of research. ■

✓ CHECK YOUR UNDERSTANDING

28. What is *reflection*? What purposes does it serve?
 29. Describe an inappropriate use of reflection.
 30. Name an aspect of reflection supported by the CLI but not by the JVM.
 31. Why is reflection more difficult to implement in Java or C# than it is in Perl or Ruby?
 32. What are *annotations* (Java) or *attributes* (C#)? What are they used for?
 33. What is javadoc, apt, JML, and LINQ, and what do they have to do with annotation?
 34. Briefly describe three different implementation strategies for a symbolic debugger.
 35. Explain the difference between *breakpoints* and *watchpoints*. Why are watchpoints potentially much more expensive?
 36. Summarize the capabilities provided by the Unix ptrace mechanism.
 37. What is the principal difference between the Unix prof and gprof tools?
 38. For the purposes of performance analysis, summarize the relative strengths and limitations of statistical sampling, instrumentation, and hardware performance counters. Explain why statistical sampling and instrumentation might profitably be used together.
-

15.4 Summary and Concluding Remarks

We began this chapter by defining a run-time system as the set of libraries, essential to many language implementations, that depend on knowledge of the compiler or the programs it produces. We distinguished these from “ordinary” libraries, which require only the arguments they are passed.

We noted that several topics covered elsewhere in the book, including garbage collection, variable-length argument lists, exception and event handling, coroutines and threads, remote procedure calls, transactional memory, and dynamic linking are often considered the purview of the run-time system. We then turned to virtual machines, focusing in particular on the Java Virtual Machine (JVM) and the Common Language Infrastructure (CLI). Under the general heading of late binding of machine code, we considered just-in-time and dynamic compilation, binary translation and rewriting, and mobile code and sandboxing. Finally, under the general heading of inspection and introspection, we considered reflection mechanisms, debugging, and performance analysis.

Through all these topics we have seen a steady increase in complexity over time. Early Basic interpreters parsed and executed one source statement at a time. Modern interpreters first translate their source into a syntax tree. Early Java implementations, while still interpreter-based, relied on a separate source-to-byte-code compiler. More recent Java implementations, as well as implementations of the CLI, enhance performance with a just-in-time compiler. For programs that extend themselves at run time, the CLI allows the source-to-byte-code compiler to be invoked dynamically as well, as it is in Common Lisp. Recent systems may profile and reoptimize already-running programs. Similar technology may allow separate tools to translate from one machine language to another, or to instrument code for testing, debugging, security, performance analysis, model checking, or architectural simulation. The CLI provides extensive support for cross-language interoperability.

Many of these developments have served to blur the line between the compiler and the run-time system, and between compile-time and run-time operations. It seems safe to predict that these trends will continue. More and more, programs will come to be seen not as static artifacts, but as dynamic collections of malleable components, with rich semantic structure amenable to formal analysis and reconfiguration.

15.5 Exercises

- 15.1 Write the formula of [Example 14.4](#) as an expression tree (a syntax tree in which each operator is represented by an internal node whose children are its operands). Convert your tree to an *expression DAG* by merging identical nodes. Comment on the redundancy in the tree and how it relates to [Figure 14.4](#).
- 15.2 We assumed in [Example 14.4](#) and [Figure 14.4](#) that *a*, *b*, *c*, and *s* were all among the first few local variables of the current method, and could be pushed onto or popped from the operand stack with a single one-byte instruction. Suppose that this is not the case: that is, that the push and pop instructions require three bytes each. How many bytes will now be required for the code on the left side of [Figure 14.4](#)?

Most stack-based languages, JBC and CIL among them, provide a swap instruction that reverses the order of the top two values on the stack, and a duplicate instruction that pushes a second copy of the value currently at top of stack. Show how to use swap and duplicate to eliminate the pop and the pushes of `s` in the left side of Figure 14.4. Feel free to exploit the associativity of multiplication. How many instructions is your new sequence? How many bytes?

- 15.3 Using your local implementations of Java and C#, compile the code of Figures 15.2 and 15.3 all the way to machine language. Disassemble and compare the results. Can all the differences be attributed to variations in the quality of the compilers, or are any reflective of more fundamental differences between the source languages or virtual machines?
- 15.4 The speculative optimization of Example 15.7 could in principle be statically performed. Explain why a dynamic compiler might be able to do it more effectively.
- 15.5 Perhaps the most common form of run-time instrumentation counts the the number of times that each basic block is executed. Since basic blocks are short, adding a load-increment-store instruction sequence to each block can have a significant impact on run time.

We can improve performance by noting that certain blocks imply the execution of other blocks. In an `if...then...else` construct, for example, execution of either the `then` part or the `else` part implies execution of the conditional test. If we're smart, we won't actually have to instrument the test.

Describe a general technique to minimize the number of blocks that must be instrumented to allow a post-processor to obtain an accurate count for each block. (This is a difficult problem. For hints, see the paper by Larus and Ball [BL92].)

- 15.6 Download a copy of Pin from rogue.colorado.edu/pin/. Use it to create a tool to profile loops. When given a (machine code) program and its input, the output of the tool should list the number of times that each loop was encountered when running the program. It should also give a histogram, for each loop, of the number of iterations executed.
- 15.7 Outline mechanisms that might be used by a binary rewriter, without access to source code, to catch uses of uninitialized variables, "double deletes," and uses of deallocated memory (e.g., dangling pointers). Under what circumstances might you be able to catch memory leaks and out-of-bounds array accesses?
- 15.8 Extend the code of Figure 15.5 to print information about
- (a) fields
 - (b) constructors
 - (c) nested classes
 - (d) implemented interfaces

- (e) ancestor classes, and their methods, fields, and constructors
 - (f) exceptions thrown by methods
 - (g) generic type parameters
- 15.9 Repeat the previous exercise in C#. Add information about parameter names and generic instances.
- 15.10 Write an interactive tool that accepts keyboard commands to load specified class files, create instances of their classes, invoke their methods, and read and write their fields. Feel free to limit keyboard input to values of built-in types, and to work only in the global scope. Based on your experience, comment on the feasibility of writing a command-line interpreter for Java, similar to those commonly used for Lisp, Prolog, or the various scripting languages.
- 15.11 In Java, if the concrete type of `p` is `Foo`, `p.getClass()` and `Foo.class` will return the same thing. Explain why a similar equivalence could not be guaranteed to hold in Ruby, Python, or JavaScript. For hints, see [Section 13.4.4](#).
- 15.12 Design a “test harness” system based on Java annotations. The user should be able to attach to a method an annotation that specifies parameters to be passed to a test run of the method, and values expected to be returned. For simplicity, you may assume that parameters and return values will all be strings or instances of built-in types. Using the annotation processing facility of Java 6, you should automatically generate a new method, `test()` in any class that has methods with `@Test` annotations. This method should call the annotated methods with the specified parameters, test the return values, and report any discrepancies. It should also call the `test` methods of any nested classes. Be sure to include a mechanism to invoke the `test` method of every top-level class. For an extra challenge, devise a way to specify multiple tests of a single method, and a way to test exceptions thrown, in addition to values returned.
- 15.13 C++ provides a `typeid` operator that can be used to query the concrete type of a pointer or reference variable:

```
if (typeid(*p) == typeid(my_derived_type)) ...
```

Values returned by `typeid` can be compared for equality but not assigned. They also support a `name()` method that returns an (implementation-dependent) character string name for the type. Give an example of a program fragment in which these mechanisms might reasonably be used.

Unlike more extensive reflection mechanisms, `typeid` can be applied only to (instances of) classes with at least one virtual method. Give a plausible explanation for this restriction.

- 15.14 Suppose we wish, as described at the end of [Example 15.37](#), to accurately attribute sampled time to the various contexts in which a subroutine is

called. Perhaps the most straightforward approach would be to log not only the current PC but also the stack *backtrace*—the contents of the dynamic chain—on every timer interrupt. Unfortunately, this can dramatically increase profiling overhead. Suggest an equivalent but cheaper implementation.

15.6 Explorations

- 15.15 Learn about the Java *security policy* mechanism. What aspects of program behavior can the programmer enable/proscribe? How are such policies enforced? What is the relationship (if any) between security policies and the verification process described in the sidebar on page 774?
- 15.16 Learn the details of the CLI verification algorithm (Partition III, [Section 1.8](#) of the ECMA standard, version 4 [Int06]). Pay particular attention to the rules for *merging* compatible types at joins in the control flow graph, and for dealing with generics.
- 15.17 Learn about `taint` mode in Perl and Ruby. How does it compare to sandbox creation via binary rewriting, as described in the sidebar on page 798? What sorts of security problems does it catch? What sorts of problems does it *not* catch?
- 15.18 Learn about *proof-carrying code*, a technique in which the supplier of mobile code includes a proof of its safety, and the user simply verifies the proof, rather than regenerating it (start with the work of Necula [Nec97]). How does this technique compare to other forms of sandboxing? What properties can it guarantee?
- 15.19 Learn about LINQ in C# 3.0. Explain its use of attributes. Write a program that uses it to interface to a database through SQL. Write another program that uses it to process the elements of a set from the `System.Collections` library.
- 15.20 Investigate the *MetaObject Protocol* (MOP), which underlies the Common Lisp Object System. How does it compare to the reflection mechanisms of Java and C#? What does it allow you to do that these other languages do not?
- 15.21 When using a symbolic debugger and moving through a program with breakpoints, one often discovers that one has gone “too far,” and must start the program over from the beginning. This may mean losing all the effort that had been put into reaching a particular point. Consider what it would take to be able to run the program not only forward but *backward* as well. Such a *reverse execution* facility might allow the user to narrow in on the source of bugs much as one narrows the range in binary search. Consider both the loss of information that happens when data is overridden and the nondeterminism that arises in parallel and event-driven programs.

- 15.22 Download and experiment with one of the several available packages for performance counter sampling in Linux (try sourceforge.net/projects/perfctr/ or perfmon2.sourceforge.net/). What do these packages allow you to measure? How might you use the information? (Note: you may need to install a kernel patch to make the program counters available to user-level code.)

15.7 Bibliographic Notes

Aycock [Ayc03] surveys the history of just-in-time compilation. An overview of the HotSpot compiler and JVM can be found in a technical white paper from Sun [Sun02]. Sources of information on the CLI include the ECMA standard [Int06, MR04] and the .NET pages at msdn.microsoft.com.

Arnold et al. [AFG⁺05] provide an extensive survey of adaptive optimization techniques for programs on virtual machines. Deutsch and Schiffman [DS84] describe the ParcPlace Smalltalk virtual machine, which pioneered such mechanisms as just-in-time compilation and the caching of JIT-compiled machine code. Various articles discuss the binary translation technology of Apple's 68K emulator [Tho95], DEC's FX!32 [HH97b], and its earlier VEST and mx [SCK⁺93].

The original papers on Dynamo, Atom, and Pin are by Bala et al. [BDB00], Srivastava and Eustace [SE94], and Luk et al. [LCM⁺05], respectively. Duesterwald [Due05] surveys issues in the design of a dynamic binary optimizer, drawing on her experience with the Dynamo project. Early work on sandboxing via binary rewriting is reported by Wahbe et al. [WLAG93].

Ball and Larus [BL92] describe the minimal instrumentation required to profile the execution of basic blocks. Zhao et al. [ZRA⁺08] describe the use of dynamic instrumentation (based on DynamoRIO) to implement watchpoints efficiently. Martonosi et al. [MGA92] describe a performance analysis tool that builds on the idea outlined in [Example 15.38](#).

16 Code Improvement

In **Chapter 14** we discussed the generation, assembly, and linking of target code in the back end of a compiler. The techniques we presented led to correct but highly suboptimal code: there were many redundant computations, and inefficient use of the registers, multiple functional units, and cache of a modern microprocessor. This chapter takes a look at *code improvement*: the phases of compilation devoted to generating *good* (fast) code. As noted in [Section 1.6.4](#), code improvement is often referred to as *optimization*, though it seldom makes anything optimal in any absolute sense.

Our study will consider simple *peephole* optimization, which “cleans up” generated target code within a very small instruction window; *local* optimization, which generates near-optimal code for individual basic blocks; and *global* optimization, which performs more aggressive code improvement at the level of entire subroutines. We will not cover interprocedural improvement; interested readers are referred to other texts (see the Bibliographic Notes at the end of the chapter). Moreover, even for the subjects we cover, our intent will be more to “demystify” code improvement than to describe the process in detail. Much of the discussion will revolve around the successive refinement of code for a single subroutine. This extended example will allow us to illustrate the effect of several key forms of code improvement without dwelling on the details of how they are achieved.

© IN MORE DEPTH

[Chapter 16](#) can be found in its entirety on the PLP CD.

This page intentionally left blank

Programming Languages Mentioned



This appendix provides brief descriptions, bibliographic references, and (in many cases) URLs for on-line information concerning each of the principal programming languages mentioned in this book. The URLs are accurate as of September 2008, though they are subject to change as people move files around. Some additional URLs can be found in the bibliographic references.

Bill Kinnersley maintains an index of on-line materials for approximately 2500 programming languages at people.ku.edu/~nkinners/LangList/Extras/langlist.htm. Other resources include the Google and Yahoo indices (directory.google.com/Top/Computers/Programming/Languages/ and dir.yahoo.com/Computers_and_Internet/Programming_and_Development/Languages/), and the HyperNews languages list (www.hypernews.org/HyperNews/get/computing/lang-list.html).

Figure A.1 shows the genealogy of some of the more influential or widely used programming languages. The date for each language indicates the approximate time at which its features became widely known. Arrows indicate principal influences on design. Many influences, of course, cannot be shown in a single figure.

Ada: Originally intended to be the standard language for all software commissioned by the U.S. Department of Defense [Ame83]. Prototypes designed by teams at several sites; final '83 language developed by a team at Honeywell's Systems and Research Center in Minneapolis and Alsys Corp. in France, led by Jean Ichbiah. A very large language, descended largely from Pascal. Design rationale articulated in a remarkably clear companion document [IBFW91]. Ada 95 [Int95b] is a revision developed under government contract by a team at Intermetrics, Inc. It fixes several subtle problems in the earlier language, and adds objects, shared-memory synchronization, and several other features. Ada 2005 adds extensive real-time facilities and mix-in inheritance. Freely available implementation distributed by AdaCore Technologies (www.adacore.com/) under terms of the Free Software Foundation's GNU public license.

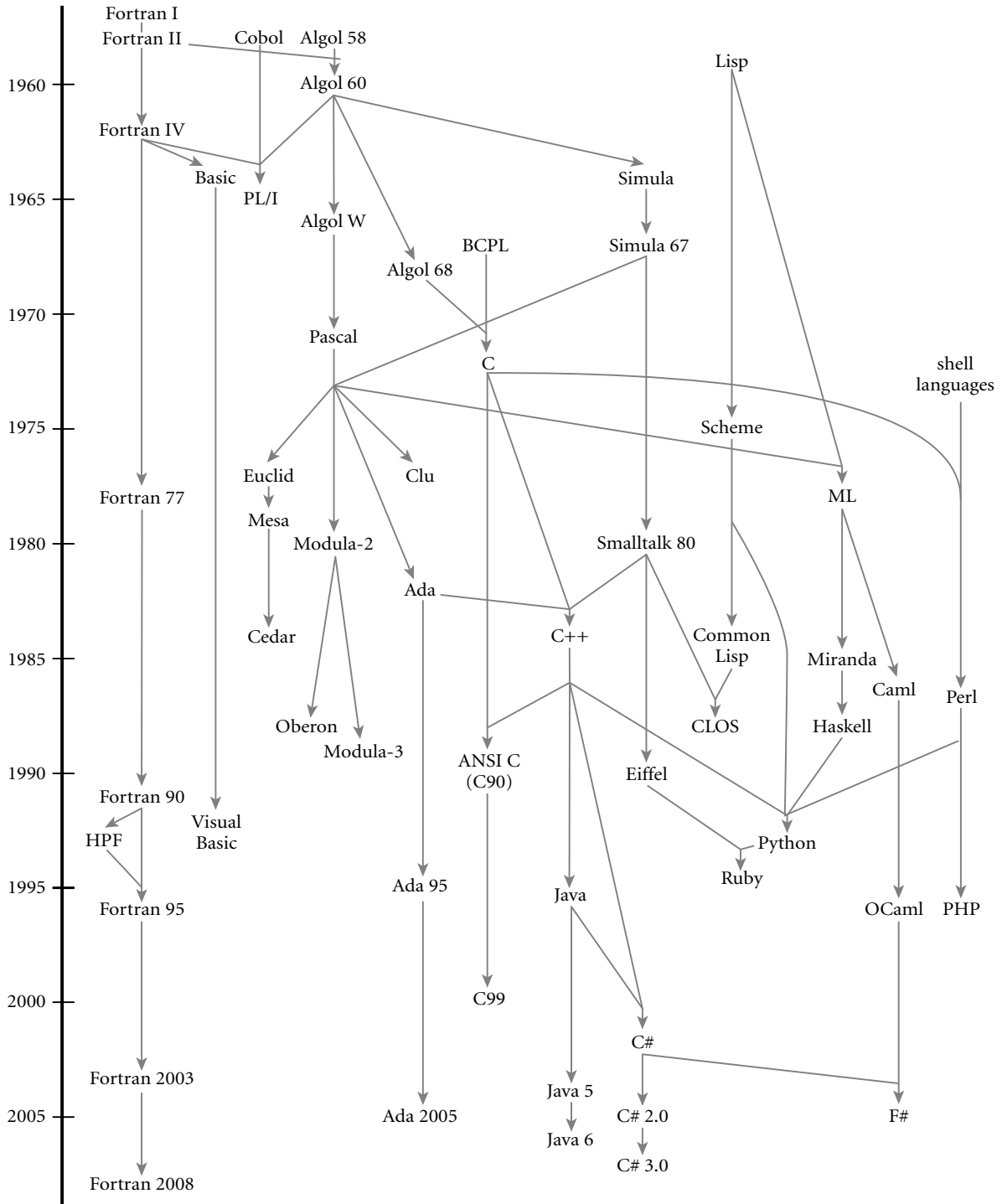

Figure A.1 Genealogy of selected programming languages. Dates are approximate.

- Algol 60:** The original block-structured language. The definition by Naur et al. [NBB⁺63] is considered a landmark of clarity and conciseness. It includes the original use of Backus-Naur Form (BNF).
- Algol 68:** A large and relatively complex successor to Algol 60, designed by a committee led by A. van Wijngaarden. Includes (among other things) structures and unions, expression-based syntax, reference parameters, a reference model of variables, and concurrency. The official definition [vMP⁺75] uses unconventional terminology and is very difficult to read; other sources (e.g., Pagan’s book [Pag76]) are more accessible.
- Algol W:** A smaller, simpler alternative to Algol 68, proposed by Niklaus Wirth and C. A. R. Hoare [WH66, Sit72]. The precursor to Pascal. Introduced the case statement.
- APL:** Designed by Kenneth Iverson in the late 1950s and early 1960s, primarily for the manipulation of numeric arrays. Functional. Extremely concise. Powerful set of operators. Employs an extended character set. Intended for interactive use. Original syntax [Ive62] was nonlinear; implementations generally use a revised syntax due to a team at IBM [IBM87]. On-line resources at www.sigapl.org/.
- Basic:** Simple imperative language, originally intended for interactive use. Original version developed by John Kemeny and Thomas Kurtz of Dartmouth College in the early 1960s. Dozens of dialects exist. Microsoft’s Visual Basic [Mic91], which bears little resemblance to the original, is the most widely used today. Minimal subset defined by ANSI standard [Ame78b].
- C:** One of the most successful imperative languages. Originally defined by Brian Kernighan and Dennis Ritchie of Bell Labs as part of the development of Unix [KR88]. Concise syntax. Unusual declaration syntax. Intended for systems programming. Weak type-checking. No dynamic semantic checks. Standardized by ANSI/ISO in 1990 [Ame90]. Extensions for international character sets adopted in 1994. More extensive changes adopted in 1999 (the C99 standard) [Int99]. Freely available implementation (*gcc*) distributed for many platforms by the Free Software Foundation (www.gnu.org/software/gcc/).
- C#:** Object-oriented language based heavily on C++ and Java. Designed by Anders Hejlsberg, Scott Wiltamuth, and associates at Microsoft Corporation in the late 1990s and early 2000s [HWG04, ECM06]. Intended as the principal language for the .NET platform, a runtime and middleware system for multilanguage distributed computing. Regarded by many as Microsoft’s alternative to Java. Includes most of Java’s features, plus many from C++ and Visual Basic, including both reference and value types, both contiguous and row-pointer arrays, both virtual and nonvirtual methods, operator overloading, delegates, and an “unsafe” superset with pointers. Standardized by ECMA/ISO in 2002 [ECM06]. Commercial resources at msdn.microsoft.com/vcsharp/. Open source implementations available from www.mono-project.com/CSharp_Compiler (no trailing slash on URL).

- C++:** The first object-oriented successor to C to gain widespread adoption. Still widely considered the one most suited to “industrial strength” computing. Designed by Bjarne Stroustrup of Bell Labs. Includes (among other things) generalized reference types, both static and dynamic method binding, extensive facilities for overloading and coercion, and multiple inheritance. No automatic garbage collection. Useful references include Stroustrup’s text [Str97] and the reference manual of Ellis and Stroustrup [ES90]. Standardized by the ISO [Int98]. Freely available implementation included in the gcc distribution (see C). Standard template library documentation at www.sgi.com/tech/stl/. Stroustrup’s own resource page at www.research.att.com/~bs/C++.html.
- Caml and OCaml:** Caml is a dialect of ML developed by Guy Cousineau and colleagues at INRIA (the French national research institute for computer science) beginning in the late 1980s. Evolved into Objective Caml (OCaml) around 1996, under the leadership of Xavier Leroy; the revised language adds modules and object orientation. See also F#. Online resources at caml.inria.fr/.
- Cedar:** See Mesa and Cedar.
- Cilk:** Concurrent extension of C developed by Charles Leiserson and associates at MIT beginning in the mid 1990s, and commercialized by Cilk Arts, Inc. in 2006. Extensions are minimal: a function can be spawned as a separate task; completion of subtasks can be awaited *en masse* with `sync`; tasks can synchronize with each other to a limited degree with `inlets`. Implementation employs a novel, provably efficient *work-stealing* scheduler. On-line resources at supertech.csail.mit.edu/cilk/.
- CLOS:** The Common Lisp Object System [Kee89; Ste90, Chap. 28]. A set of object-oriented extensions to Common Lisp, now incorporated into the ANSI standard language (see Common Lisp). The leading notation for object-oriented functional programming.
- Clu:** Developed by Barbara Liskov and associates at MIT in the late 1970s [LG86]. Designed to provide an unusually powerful set of features for data abstraction [LSAS77]. Also includes iterators and exception handling. Documentation and freely available implementations at pmg.csail.mit.edu/CLU.html.
- Cobol:** Originally developed by the U.S. Department of Defense in the late 1950s and early 1960s by a team led by Grace Murray Hopper. Long the most widely used programming language in the world. Standardized by ANSI in 1968; revised in 1974 and 1985 [Ame85]. Intended principally for business data processing. Introduced the concept of structures. Elaborate I/O facilities. Cobol 2002 [Int02] adds a variety of modern language features, including object orientation.
- Common Lisp:** The standard modern Lisp (see also Lisp). A large language. Includes (among other things) static scoping, an extensive type system, exception handling, and object-oriented features (see CLOS). For years the standard reference was the book by Guy Steele, Jr. [Ste90]. Subsequently standardized

by ANSI [Ame96b]. Abridged hypertext version of the standard available at www.lispworks.com/documentation/HyperSpec/Front/index.htm.

CSP: See Occam.

Eiffel: An object-oriented language developed by Bertrand Meyer and associates at the Société des Outils du Logiciel à Paris [Mey92b]. Includes (among other things) multiple inheritance, automatic garbage collection, and powerful mechanisms for renaming of data members and methods in derived classes. On-line resources at eiffel.com/.

Erlang: A functional language with extensive support for distribution, fault tolerance, and message passing. Developed by Joe Armstrong and colleagues at Ericsson Computer Science Laboratory starting in the late 1980s [AVWW96]. Distributed as open source since 1998. Used to implement a variety of products from Ericsson and other companies, particularly in the European telecom industry. On-line resources at erlang.org/.

Euclid: Imperative language developed by Butler Lampson and associates at the Xerox Palo Alto Research Center in the mid-1970s [LHL⁺77]. Designed to eliminate many of the sources of common programming errors in Pascal, and to facilitate formal verification of programs. Has closed scopes and module types.

F#: A descendant of OCaml developed by Don Syme and colleagues at Microsoft Research. First public release was in 2005 [SGC07]. Differences from OCaml are primarily to accommodate integration with the .NET framework. Online resources at research.microsoft.com/fsharp/.

Forth: A small and rather ingenious stack-based language designed for interpretation on machines with limited resources [Bro87, Int97]. Originally developed by Charles H. Moore in the late 1960s. Has a loyal following in the instrumentation and process-control communities.

Fortran: The original high level imperative language. Developed in the mid-1950s by John Backus and associates at IBM. The most important versions are Fortran I, Fortran II, Fortran IV, Fortran 77, and Fortran 90. The latter two are documented in a pair of ANSI standards [Ame78a, Ame92]. Fortran 90 [MR96] (updated in 1995) is a major revision to the language, adding (among other things) recursion, pointers, new control constructs, and a wealth of array operations. Fortran 2003 [Int04] adds object orientation. The next revision (Fortran 2008) is expected to become official in 2010. It adds several important features, including generics, co-arrays (arrays with an explicit extra “location” dimension for distributed-memory machines), and a DO CONCURRENT construct for loops whose iterations are independent. Fortran 77 continues to be widely used. Freely available `gfortran` implementation conforms to all modern standards, and is distributed as part of the `gcc` compiler suite (www.gnu.org/software/gcc/fortran/). Support for the older `g77` front end was discontinued as of `gcc` version 3.4.

- Haskell:** The leading purely functional language. Descended from Miranda. Designed by a committee of researchers beginning in 1987. Includes curried functions, higher-order functions, nonstrict semantics, static polymorphic typing, pattern matching, list comprehensions, modules, monadic I/O, and layout (indentation)-based syntactic grouping. Haskell 98 [Pey03] is the most recent as of 2008; design of the newer Haskell' is under way. On-line resources at haskell.org/. Several concurrent variants have also been devised, including Concurrent Haskell [JGF96] and pH [NA01].
- Icon:** The successor to Snobol. Developed by Ralph Griswold (Snobol's principal designer) at the University of Arizona [GG96]. Adopts more conventional control-flow constructs, but with powerful iteration and search facilities based on pattern-matching and backtracking. On-line resources at www.cs.arizona.edu/icon/.
- Java:** Object-oriented language based largely on a subset of C++. Developed by James Gosling and associates at Sun Microsystems in the early 1990s [AG98, GJSB05]. Intended for the construction of highly portable, architecture-neutral programs. Defined in conjunction with an intermediate *byte code* format intended for execution on a Java *virtual machine* [LY99]. Includes (among other things) a reference model of (class-typed) variables, mix-in inheritance, threads, and extensive predefined libraries for graphics, communication, and other activities. On-line resources at www.sun.com/java/.
- JavaScript:** Simple scripting language developed by Brendan Eich at Netscape Corp. in the mid 1990s for the purpose of client-side web scripting. Has no connection to Java beyond superficial syntactic similarity. Embedded in most commercial web browsers. Microsoft's JScript is very similar. The two were merged into a single ECMA standard [ECM99] in 1997 (since revised).
- Linda:** A set of language extensions intended to add concurrency to conventional programming languages [ACG86]. Developed by David Gelernter for his doctoral research at SUNY Stony Brook in the early 1980s and later refined by Gelernter and his student, Nicholas Carriero, at Yale University. Based on the notion of a distributed, associative *tuple space*. Has inspired numerous implementations, including Sun's JavaSpaces [FHA99] and IBM's TSpaces (www.almaden.ibm.com/cs/TSpaces/). Commercial implementations available from www.lindaspaces.com/.
- Lisp:** The original functional language [McC60]. Developed by John McCarthy in the late 1950s as a realization of Church's lambda calculus. Many dialects exist. The two most common today are Common Lisp and Scheme (see separate entries). Historically important dialects include Lisp 1.5 [MAE⁺65], MacLisp [Moo78], and Interlisp [TM81].
- Mesa and Cedar:** Mesa [LR80] is a successor to Euclid developed in the 1970s at Xerox's Palo Alto Research Center by a team led by Butler Lampson. Includes monitor-based concurrency. Along with Interlisp and Smalltalk, one of three companion projects that pioneered the use of personal workstations, with

bitmapped displays, mice, and a graphical user interface. Cedar [SZBH86] is a successor to Mesa with (among other things) complete type-safety, exceptions, and automatic garbage collection.

Miranda: Purely functional language designed by David Turner in the mid-1980s [Tur86]. Descended from ML; has type inference and automatic currying. Adds list comprehensions (Section 7.8), and uses lazy evaluation for all arguments. Uses indentation and line breaks for syntactic grouping. On-line resources at miranda.org.uk/.

ML: Functional language with “Pascal-like” syntax. Originally designed in the mid-to-late 1970s by Robin Milner and associates at the University of Edinburgh as the meta-language (hence the name) for a program verification system. Pioneered aggressive compile-time type inference and polymorphism. Has a few imperative features. Several dialects exist; the most widely used are Standard ML [MTHM97] and Caml (see separate entry). Stansifer’s book [Sta92] is an accessible introduction. Standard ML of New Jersey, a project of Princeton University and Bell Labs, has produced freely available implementations for many platforms (www.smlnj.org/).

Modula and Modula-2: The immediate successors to Pascal, developed by Niklaus Wirth. The original Modula [Wir77b] was an explicitly concurrent monitor-based language. It is sometimes called Modula (1) to distinguish it from its successors. The more commercially important Modula-2 [Wir85b] was originally designed with coroutines (Section 8.6), but no real concurrency. Both languages provide mechanisms for module-as-manager style data abstractions. Modula-2 was standardized by the ISO in 1996 [Int96]. Freely available implementation for x86 Linux distributed by the University of Karlsruhe, Germany (www.info.uni-karlsruhe.de/~modula/index.php).

Modula-3: A major extension to Modula-2 developed by Luca Cardelli, Jim Donahue, Mick Jordan, Bill Kalsow, and Greg Nelson at the Digital Systems Research Center and the Olivetti Research Center in the late 1980s [Har92]. Intended to provide a level of support for large, reliable, and maintainable systems comparable to that of Ada, but in a simpler and more elegant form. On-line resources at www.modula3.org/.

Oberon: A deliberately minimal language designed by Niklaus Wirth [Wir88b, RW92]. Essentially a subset of Modula-2 [Wir88a], augmented with a mechanism for type extension (Section 9.2.4) [Wir88c]. On-line resources at www.oberon.ethz.ch/.

Objective-C: An object-oriented extension to C based on Smalltalk-style “messaging.” Designed by Brad Cox and Stepstone Corporation in the early 1980s. Adopted by NeXT Software, Inc., in the late 1980s for their NeXTStep operating system and programming environment. Adopted by Apple as the principal development language for Mac OS X after Apple acquired NeXT in 1997. Substantially simpler than other object-oriented descendants of C. Distinguished by fully dynamic method dispatch and unusual messaging syntax. Freely available implementation included in the gcc distribu-

tion (see C). On-line documentation at developer.apple.com/documentation/Cocoa/Conceptual/ObjectiveC/.

OCaml: See Caml.

Occam: A concurrent language [JG89] based on CSP [Hoa78], Hoare's notation for message-based communication using guarded commands and synchronization `send`. The language of choice for systems built from INMOS Corporation's *transputer* processors, once widely used in Europe. Uses indentation and line breaks for syntactic grouping. On-line resources at wotug.kent.ac.uk/parallel/occam/.

Pascal: Designed by Niklaus Wirth in the late 1960s [Wir71], largely in reaction to Algol 68, which was widely perceived as bloated. Heavily used in the 1970s and 1980s, particularly for teaching. Introduced subrange and enumeration types. Unified structures and unions. For many years the standard reference was Wirth's book with Kathleen Jensen [JW91]; subsequently standardized by ISO and ANSI [Int90]. Freely available implementation distributed by the Free Software Foundation (directory.fsf.org/project/GNUPascal/).

Perl: A general-purpose scripting language designed by Larry Wall in the late 1980s [WCO00]. Includes unusually extensive mechanisms for character-string manipulation and pattern matching based on (extended) regular expressions. Borrows features from C, `sed` and `awk` [AKW88] (two earlier scripting languages), and various Unix *shell* (command interpreter) languages. Is famous/infamous for having multiple ways of doing almost anything. Enjoyed an upsurge in popularity in the late 1990s as a server-side web scripting language. Version 5 released in 1995; version 6 expected in 2009. On-line resources at www.perl.com/. Larry Wall's own Perl page is at www.wall.org/~larry/perl.html.

PHP: A descendant of Perl designed for server-side web scripting. Scripts are typically embedded in web pages. Originally created by Rasmus Lerdorf in 1995 to help manage his personal home page. The name is now officially a recursive acronym (PHP: Hypertext Preprocessor). More recent versions due to Andi Gutmans and Zeev Suraski, in cooperation with Lerdorf. Includes built-in support for a wide range of Internet protocols and for access to dozens of different commercial database systems. Version 5 (2004) includes extensive object-oriented features, mix-in inheritance, iterator objects, autoloading, structured exception handling, reflection, overloading, and optional type declarations for parameters. On-line resources at www.php.net/.

PL/I: A large, general-purpose language designed in the mid-1960s as a successor to Fortran, Cobol, and Algol [Bee70]. Never managed to displace its predecessors; kept alive largely through IBM corporate influence.

Postscript: A stack-based language for the description of graphics and print operations [Ado86, Ado90]. Developed and marketed by Adobe Systems, Inc. Based in part on Forth [Bro87]. Generated by many word processors and

drawing programs. Most professional-quality printers contain a Postscript interpreter.

Prolog: The most widely used logic programming language. Developed in the early 1970s by Alain Colmerauer and Philippe Roussel of the University of Aix–Marseille in France and Robert Kowalski and associates at the University of Edinburgh in Scotland. Many dialects exist. Partially standardized in 1995 [Int95c]. Numerous implementations, both free and commercial, are available. The AI group at CMU maintains a large Prolog repository at www-2.cs.cmu.edu/afs/cs.cmu.edu/project/ai-repository/ai/lang/prolog/0.html; additional information can be found at www2.cs.kuleuven.be/~dtai/projects/ALP/.

Python: A general-purpose, object-oriented scripting language designed by Guido van Rossum in the early 1990s. Uses indentation for syntactic grouping. Includes dynamic typing, nested functions with lexical scoping, lambda expressions and higher-order functions, true iterators, list comprehensions, array slices, reflection, structured exception handling, multiple inheritance, and modules and dynamic loading. On-line resources at www.python.org/.

R: Open source scripting language intended primarily for statistical analysis. Based on the proprietary S statistical programming language, originally developed by John Chambers and others at Bell Labs. Supports first-class and higher-order functions, unlimited extent, call-by-need, multidimensional arrays and slices, and an extensive library of statistical functions. On-line resources at www.r-project.org/.

Ruby: An elegant, general-purpose, object-oriented scripting language designed by Yukihiro “Matz” Matsumoto, beginning in 1993. First released in 1995. Inspired by Ada, Eiffel, and Perl, with traces of Python, Lisp, Clu, and Smalltalk. Includes dynamic typing, arbitrary precision arithmetic, true iterators, user-level threads, first-class and higher-order functions, continuations, reflection, Smalltalk-style messaging, mix-in inheritance, autoloading, structured exception handling, and support for the Tk windowing toolkit. The text by Thomas and Hunt is a standard reference [TFH04]. On-line resources at ruby-lang.org/.

SAC: See Single Assignment C.

Scheme: A small, elegant dialect of Lisp (see also Lisp) developed in the mid-1970s by Guy Steele and Gerald Sussman. Has static scoping and true first-class functions. Widely used for teaching. The Sixth revised standard (R6RS) [SDF⁺07] became official in September 2007; many implementations still adhere to R5RS. Earlier version standardized by the IEEE and ANSI [Ins91]. The book by Abelson and Sussman [AS96], long used for introductory programming classes at MIT and elsewhere, is a classic guide to fundamental programming concepts, and to functional programming in particular. On-line resources at www.schemers.org/.

- Simula:** Designed at the Norwegian Computing Centre, Oslo, in the mid-1960s by Ole-Johan Dahl, Bjørn Myrhaug, and Kristen Nygaard [BDMN73, ND78]. Extends Algol 60 with *classes* and *coroutines*. The name of the language reflects its suitability for discrete-event simulation (Section © 8.6.4). Free Simula-to-C translator available at directory.fsf.org/project/cim/.
- Single Assignment C (SAC):** A purely functional language designed for high-performance computing on array-based data [Sch03]. Developed by Sven-Bodo Scholz and associates at the University of Hertfordshire and several other institutions beginning in 1994. Similar in spirit to Sisal, but with syntax based as heavily as possible on C. On-line resources at www.sac-home.org/.
- Sisal:** A functional language with “imperative-style” syntax. Developed by James McGraw and associates at Lawrence Livermore National Laboratory in the early-to-mid 1980s [FCO90, Can92]. Intended primarily for high-performance scientific computing, with automatic parallelization. A descendant of the dataflow language Val [McG82]. No longer under development at LLNL; available open source from sisal.sourceforge.net/.
- Smalltalk:** The quintessential object-oriented language. Developed by Alan Kay, Adele Goldberg, Dan Ingalls, and associates at the Xerox Palo Alto Research Center throughout the 1970s, culminating in the Smalltalk-80 language [GR89]. Anthropomorphic programming model based on “messages” between active objects. On-line resources at www.smalltalk.org/ and st-www.cs.uiuc.edu/.
- Snobol:** Developed by Ralph Griswold and associates at Bell Labs in the 1960s [GPP71]. The principal version is SNOBOL4. Intended primarily for processing character strings. Includes an extremely rich set of string-manipulating primitives and a novel control-flow mechanism based on the notions of *success* and *failure*. On-line resources at www.snobol4.org/.
- SR:** Concurrent programming language developed by Greg Andrews and colleagues at the University of Arizona in the 1980s [AO93]. Integrates not only sequential and concurrent programming but also shared memory, semaphores, message passing, remote procedures, and rendezvous into a single conceptual framework and simple syntax. On-line resources at www.cs.arizona.edu/sr/.
- Tcl/Tk:** Tool command language (pronounced “tickle”). Scripting language designed by John Ousterhout in the late 1980s [Ous94, WJH03]. Keyword-based syntax resembles Unix command-line invocations and switches; punctuation is relatively spare. Uses dynamic scoping. Supports reflection, recursive invocation of interpreter. Tk (pronounced “tee-kay”) is a set of Tcl commands for graphical user interface (GUI) programming. Designed by Ousterhout as an extension to Tcl, Tk has also been embedded in Ruby, Perl, and several other languages. On-line resources at www.tcl.tk/.
- Turing:** Derived from Euclid by Richard Holt and associates at the University of Toronto in the early 1980s [HMRC88]. Originally intended as a pedagogical

language, but can be used for a wide range of applications. Turing Plus and Object-Oriented Turing are more recent descendants, also developed by Holt's group. On-line resources at <http://compsci.ca/holtsoft/>.

XSL: Extensible Stylesheet Language, standardized by the World Wide Web Consortium. Serves as the standard stylesheet language for XML (Extensible Markup Language), the increasingly ubiquitous standard for self-descriptive tree-structured data, of which XHTML, the successor to HTML, is a dialect. Includes three substandards: XSLT (XSL Transformations) [Wor07b], which specifies how to translate from one dialect of XML to another; XPath [Wor07a], used to name elements of an XML document; and XSL-FO (XSL Formatting Objects) [Wor06], which specifies how to format documents. XSLT, though highly specialized to the transformation of XML, is a Turing complete programming language [Kep04]. Standards and additional resources at www.w3.org/Style/XSL/.

This page intentionally left blank

Language Design and Language Implementation

Throughout this text we have had occasion to remark on the many connections between language design and language implementation. Some of the more direct connections have been highlighted in separate sidebars. We list those sidebars here.

Chapter 1: Introduction

1	Introduction	9
2	Compiled and interpreted languages	18
3	The early success of Pascal	22
4	Powerful development environments	24

Chapter 2: Programming Language Syntax

5	Formatting restrictions	45
6	Nested comments	52
7	Recognizing multiple kinds of token	60
8	Longest possible tokens	62
9	Recursive descent and table-driven LL parsing	83
10	The dangling <code>else</code>	85

Chapter 3: Names, Scopes, and Bindings

11	Binding time	113
12	Recursion in Fortran	116
13	Mutual recursion	128
14	Redeclarations	131
15	Modules and separate compilation	137
16	Dynamic scoping	141
17	Pointers in C and Fortran	145
18	Coercion and overloading	149
19	Binding rules and extent	157
20	Generics as macros	160
21	Separate compilation	© 44

Chapter 4: Semantic Analysis

22	Dynamic semantic checks	178
23	Forward references	189
24	Attribute evaluators	194

Chapter 5: Target Machine Architecture

25	The processor/memory gap	© 67
26	How much is a megabyte?	© 70
27	Delayed load instructions	© 95
28	In-line subroutines	© 100
29	Pseudo-assembly notation	214

Chapter 6: Control Flow

30	Implementing the reference model	227
31	Safety versus performance	236
32	Evaluation order	238
33	Cleaning up continuations	245
34	Short-circuit evaluation	250
35	Case statements	254
36	Numerical imprecision	259
37	For loops	262
38	“True” iterators and iterator objects	264
39	Normal-order evaluation	276
40	Nondeterminacy and fairness	© 119

Chapter 7: Data Types

41	Dynamic typing	292
42	Multilingual character sets	295
43	Decimal types	296
44	Multiple sizes of integers	299
45	Nonconverting casts	310
46	Unification	© 127
47	Struct tags and typedef in C and C++	318
48	The order of record fields	322
49	With statements	© 136
50	The placement of variant fields	© 145
51	Is <code>[]</code> an operator?	327
52	Array layout	337
53	Lower bounds on array indices	341
54	Representing sets	344
55	Implementation of pointers	345
56	Stack smashing	353
57	Pointers and arrays	354
58	Garbage collection	358
59	What exactly is garbage?	360
60	Reference counts versus tracing	363
61	Car and cdr	366

Chapter 8: Subroutines and Control Abstraction

62	Lexical nesting and displays	Ⓒ 170
63	Executing code in the stack	Ⓒ 179
64	Hints and directives	391
65	In-line and modularity	392
66	Parameter modes	395
67	Call by name	Ⓒ 186
68	Call by need	Ⓒ 187
69	Why erasure?	Ⓒ 195
70	Structured exceptions	424
71	Set jmp	427
72	Threads and coroutines	429
73	Coroutine stacks	431

Chapter 9: Data Abstraction and Object Orientation

74	What goes in a class declaration?	454
75	Opaque exports in Modula-2	461
76	The value/reference tradeoff	472
77	Initialization and assignment	474
78	Initialization of "expanded" objects	475
79	Reverse assignment	484
80	The fragile base class problem	485
81	Generics and dynamic method dispatch	488
82	The cost of multiple inheritance	Ⓒ 218

Chapter 10: Functional Languages

83	Iteration in functional programs	516
84	Lazy evaluation	524
85	Monads	529
86	Higher-order functions	531
87	Side effects and compilation	536

Chapter 11: Logic Languages

88	Homoiconic languages	562
89	Reflection	565
90	Implementing logic	567
91	Alternative search strategies	567

Chapter 12: Concurrency

92	What, exactly, is a processor?	583
93	Hardware and software communication	587
94	Task-parallel and data-parallel computing	594
95	Counterintuitive implementation	597
96	Monitor signal semantics	622
97	The nested monitor problem	623
98	Conditional critical regions	624
99	Condition variables in Java	627

100	Side-effect freedom and implicit synchronization	635
101	The semantic impact of implementation issues	© 269
102	Emulation and efficiency	© 271
103	Peeking inside messages	© 277
104	Parameters to remote procedures	© 280

Chapter 13: Scripting Languages

105	Scripting on Microsoft platforms	651
106	Compiling interpreted languages	653
107	Canonical implementations	654
108	Built-in commands in the shell	658
109	Magic numbers	662
110	JavaScript and Java	688
111	How far can you trust a script?	689
112	Thinking about dynamic scoping	695
113	The grep command and the birth of Unix tools	697
114	Automata for regular expressions	699
115	Compiling regular expressions	702
116	Typeglobs in Perl	707
117	Executable class declarations	715
118	Worse Is Better	717

Chapter 14: Building a Runnable Program

119	Postscript	738
120	Type checking for separate compilation	753

Chapter 15: Run-time Program Management

121	Run-time systems	762
122	Ahead-of-time (AOT) compilation	765
123	Optimizing stack-based IF	766
124	Verification of class files and byte code	774
125	More alphabet soup	775
126	Assuming a just-in-time compiler	777
127	References and pointers	779
128	Emulation and interpretation	792
129	Creating a sandbox via binary rewriting	798

Chapter 16: Code Improvement

130	Peephole optimization	© 327
131	Basic blocks	© 329
132	Common subexpressions	© 333
133	Pointer analysis	© 334
134	Loop invariants	© 347
135	Control flow analysis	© 348

Numbered Examples

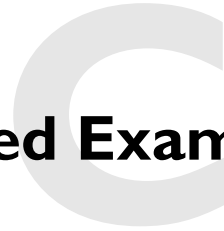

Chapter 1: Introduction

1.1	GCD program in x86 machine language	5
1.2	GCD program in x86 assembler	5

The Art of Language Design

The Programming Language Spectrum

1.3	Classification of programming languages	10
1.4	GCD function in C	12
1.5	GCD function in Scheme	13
1.6	GCD rules in Prolog	13

Why Study Programming Languages?

Compilation and Interpretation

1.7	Pure compilation	16
1.8	Pure interpretation	17
1.9	Mixing compilation and interpretation	18
1.10	Preprocessing	18
1.11	Library routines and linking	19
1.12	Post-compilation assembly	19
1.13	The C preprocessor	20
1.14	Source-to-source translation (C++)	20
1.15	Bootstrapping	21
1.16	Compiling interpreted languages	23
1.17	Dynamic and just-in-time compilation	23
1.18	Microcode (firmware)	23

Programming Environments

An Overview of Compilation

1.19	Phases of compilation	26
1.20	GCD program in C	27
1.21	GCD program tokens	27
1.22	Context-free grammar and parsing	27
1.23	GCD program parse tree	28
1.24	GCD program abstract syntax tree	32

1.25	GCD program assembly code	33
1.26	GCD program optimization	34

Chapter 2: Programming Language Syntax

2.1	Syntax of Arabic numerals	41
-----	---------------------------	----

Specifying Syntax

2.2	Lexical structure of C99	43
2.3	Syntax of numeric constants	44
2.4	Syntactic nesting in expressions	46
2.5	Extended BNF (EBNF)	47
2.6	Derivation of <code>slope * x + intercept</code>	48
2.7	Parse trees for <code>slope * x + intercept</code>	49
2.8	Expression grammar with precedence and associativity	50

Scanning

2.9	Tokens for a calculator language	52
2.10	An ad hoc scanner for calculator tokens	52
2.11	Finite automaton for a calculator scanner	54
2.12	Constructing an NFA for a given regular expression	55
2.13	NFA for $d^*(.d d.)d^*$	55
2.14	DFA for $d^*(.d d.)d^*$	56
2.15	Minimal DFA for $d^*(.d d.)d^*$	59
2.16	Nested case statement automaton	60
2.17	The nontrivial prefix problem	61
2.18	Look-ahead in Fortran scanning	62
2.19	Table-driven scanning	63

Parsing

2.20	Top-down and bottom-up parsing	67
2.21	Bounding space with a bottom-up grammar	70

2.22	Top-down grammar for a calculator language	70
2.23	Recursive descent parser for the calculator language	72
2.24	Recursive descent parse of a “sum and average” program	72
2.25	Driver and table for top-down parsing	76
2.26	Table-driven parse of the “sum and average” program	76
2.27	Predict sets for the calculator language	79
2.28	Left recursion	82
2.29	Common prefixes	83
2.30	Eliminating left recursion	84
2.31	Left factoring	84
2.32	Parsing a “dangling else ”	84
2.33	“Dangling else ” program bug	85
2.34	End markers for structured statements	85
2.35	The need for elsif	85
2.36	Derivation of an id list	87
2.37	Bottom-up grammar for the calculator language	88
2.38	Bottom-up parse of the “sum and average” program	89
2.39	CFSM for the bottom-up calculator grammar	92
2.40	Epsilon productions in the bottom-up calculator grammar	92
2.41	CFSM with epsilon productions	93
2.42	A syntax error in C	99
2.43	Syntax error in C (reprise)	© 1
2.44	The problem with panic mode	© 2
2.45	Phrase-level recovery in recursive descent	© 2
2.46	Cascading syntax errors	© 3
2.47	Reducing cascading errors with context-specific look-ahead	© 4
2.48	Recursive descent with full phrase-level recovery	© 4
2.49	Exceptions in a recursive descent parser	© 5
2.50	Error production for “; else ”	© 6
2.51	Insertion-only repair in FMQ	© 8
2.52	FMQ with deletions	© 8
2.53	Panic mode in yacc/bison	© 11
2.54	Panic mode with statement terminators	© 11
2.55	Phrase-level recovery in yacc/bison	© 11

Theoretical Foundations

2.56	Formal DFA for $d^*(.d d.)d^*$	© 14
2.57	Reconstructing a regular expression for the decimal string DFA	© 15
2.58	A regular language with a large minimal DFA	© 16
2.59	Exponential DFA blow-up	© 16
2.60	0^n1^n is not a regular language	© 19

2.61	Separation of grammar classes	© 20
2.62	Separation of language classes	© 20

Chapter 3: Names, Scopes, and Bindings**The Notion of Binding Time****Object Lifetime and Storage Management**

3.1	Static allocation of local variables	116
3.2	Layout of the run-time stack	117
3.3	External fragmentation in the heap	119

Scope Rules

3.4	Static variables in C	124
3.5	Nested scopes	125
3.6	Static chains	127
3.7	A “gotcha” in declare-before-use	128
3.8	Whole-block scope in C#	129
3.9	“Local if written” in Python	129
3.10	Declaration order in Scheme	129
3.11	Declarations vs definitions in C	130
3.12	Inner declarations in C	131
3.13	Stack module in Modula-2	133
3.14	Module as “manager” for a type	135
3.15	Module types in Euclid	137
3.16	N-ary methods in C++	139
3.17	Modules and classes in a large application	139
3.18	Static vs dynamic scoping	140
3.19	Run-time errors with dynamic scoping	141
3.20	Customization via dynamic scoping	141
3.21	Multiple interface alternative	142
3.22	Static variable alternative	142

Implementing Scope

3.44	The LeBlanc-Cook symbol table	© 30
3.45	Symbol table for a sample program	© 31
3.46	A-list lookup in Lisp	© 33
3.47	Central reference table	© 35
3.48	A-list closures	© 35

The Meaning of Names within a Scope

3.23	Aliasing with parameters	144
3.24	Aliases and code improvement	145
3.25	Overloaded enumeration constants in Ada	146
3.26	Resolving ambiguous overloads	146
3.27	Overloading in Ada and C++	146
3.28	Operator overloading in Ada	147
3.29	Operator overloading in C++	147
3.30	Overloading vs coercion	148
3.31	Generic min function in Ada	150
3.32	Implicit polymorphism in Scheme	150
3.33	Implicit polymorphism in Haskell	150

The Binding of Referencing Environments

3.34	Deep and shallow binding	152
3.35	Binding rules with static scoping	154
3.36	Returning a first-class subroutine in Scheme	156
3.37	An object closure in Java	157
3.38	Function objects in C++	158
3.39	Delegates in C#	158
3.40	Delegates and unlimited extent	159

Macro Expansion

3.41	A simple assembly macro	159
3.42	Preprocessor macros in C	159
3.43	"Gotchas" in C macros	160

Separate Compilation

3.49	Namespaces in C++	Ⓒ 42
3.50	Using names from another namespace	Ⓒ 42
3.51	Packages in Java	Ⓒ 42
3.52	Using names from another package	Ⓒ 43
3.53	Multipart package names	Ⓒ 44

Chapter 4: Semantic Analysis**The Role of the Semantic Analyzer**

4.1	Assertions in Java	178
4.2	Assertions in C	179

Attribute Grammars

4.3	Bottom-up CFG for constant expressions	180
4.4	Bottom-up AG for constant expressions	181
4.5	AG to count the elements of a list	182

Evaluating Attributes

4.6	Decoration of a parse tree	182
4.7	Top-down CFG and parse tree for subtraction	184
4.8	Decoration with left-to-right attribute flow	185
4.9	Top-down AG for subtraction	185
4.10	Top-down AG for constant expressions	185
4.11	Bottom-up and top-down AGs to build a syntax tree	189

Action Routines

4.12	Top-down action routines to build a syntax tree	194
4.13	Recursive descent and action routines	194

Space Management for Attributes

4.19	Stack trace for bottom-up parse, with action routines	Ⓒ 49
4.20	Finding inherited attributes in "buried" records	Ⓒ 50
4.21	Grammar fragment requiring context	Ⓒ 51
4.22	Semantic hooks for context	Ⓒ 52
4.23	Semantic hooks that break an LR CFG	Ⓒ 52
4.24	Action routines in the trailing part	Ⓒ 53
4.25	Left factoring in lieu of semantic hooks	Ⓒ 53
4.26	Operation of an LL attribute stack	Ⓒ 54
4.27	Ad hoc management of a semantic stack	Ⓒ 57
4.28	Processing lists with an attribute stack	Ⓒ 58
4.29	Processing lists with a semantic stack	Ⓒ 59

Decorating a Syntax Tree

4.14	Bottom-up CFG for calculator language with types	197
4.15	Syntax tree to average an integer and a real	197
4.16	Tree grammar for the calculator language with types	197
4.17	Tree AG for the calculator language with types	199
4.18	Decorating a tree with the AG of Example 4.17	201

Chapter 5: Target Machine Architecture**The Memory Hierarchy**

5.1	Memory hierarchy stats	Ⓒ 66
-----	------------------------	------

Data Representation

5.2	Big- and little-endian	Ⓒ 68
5.3	Hexadecimal numbers	Ⓒ 70
5.4	Two's complement	Ⓒ 71
5.5	Overflow in two's complement addition	Ⓒ 72
5.6	Biased exponents	Ⓒ 73
5.7	IEEE floating-point	Ⓒ 73

Instruction Set Architecture

5.8	An <code>if</code> statement in x86 assembler	Ⓒ 76
5.9	Compare and test instructions	Ⓒ 76
5.10	Conditional branches on the MIPS	Ⓒ 77

Architecture and Implementation

5.11	The x86 ISA	Ⓒ 84
5.12	The MIPS ISA	Ⓒ 85
5.13	x86 and MIPS register sets	Ⓒ 86

Compiling for Modern Processors

5.14	Performance \neq clock rate	© 91
5.15	Filling a load delay slot	© 93
5.16	Renaming registers for scheduling	© 94
5.17	Filling a branch delay slot	© 95
5.18	Register allocation for a simple loop	© 97
5.19	Register allocation and instruction scheduling	© 99

Chapter 6: Control Flow**Expression Evaluation**

6.1	A typical function call	221
6.2	Typical operators	221
6.3	Cambridge Polish (prefix) notation	221
6.4	Mixfix notation in Smalltalk	221
6.5	Conditional expressions	222
6.6	A complicated Fortran expression	222
6.7	Precedence in four influential languages	222
6.8	A "gotcha" in Pascal precedence	224
6.9	Common rules for associativity	224
6.10	L-values and r-values	225
6.11	L-values in C	226
6.12	L-values in C++	226
6.13	Variables as values and references	226
6.14	Wrapper objects in Java 2	228
6.15	Boxing in Java 5 and C#	228
6.16	Expression orientation in Algol 68	229
6.17	A "gotcha" in C conditions	229
6.18	Updating assignments	230
6.19	Side effects and updates	230
6.20	Assignment operators	230
6.21	Prefix and postfix inc/dec	231
6.22	Advantages of postfix inc/dec	231
6.23	Simple multiway assignment	232
6.24	Advantages of multiway assignment	232
6.25	Programs outlawed by definite assignment	234
6.26	Indeterminate ordering	235
6.27	A value that depends on ordering	236
6.28	An optimization that depends on ordering	236
6.29	Optimization and mathematical "laws"	237
6.30	Overflow and arithmetic "identities"	237
6.31	Reordering and numerical stability	238
6.32	Short-circuited expressions	238
6.33	Saving time with short-circuiting	239
6.34	Short-circuit pointer chasing	239
6.35	Short-circuiting and other errors	240
6.36	When not to use short-circuiting	240
6.37	Optional short-circuiting	240

Structured and Unstructured Flow

6.38	Control flow with gotos in Fortran	241
6.39	Escaping a nested subroutine	243
6.40	Structured nonlocal transfers	244
6.41	Error checking with status codes	244

Sequencing

6.42	Side effects in a random number generator	247
------	---	-----

Selection

6.43	Selection in Algol 60	247
6.44	Elsif/elif	248
6.45	Cond in Lisp	248
6.46	Code generation for a Boolean condition	249
6.47	Code generation for short-circuiting	249
6.48	Short-circuit creation of a Boolean value	250
6.49	Case statements and nested ifs	251
6.50	Translation of nested ifs	252
6.51	Jump tables	252
6.52	Fall-through in C switch statements	255

Iteration

6.53	Fortran 90 do loop	256
6.54	Modula-2 for loop	256
6.55	Obvious translation of a for loop	257
6.56	For loop translation with test at the bottom	257
6.57	For loop translation with an iteration count	258
6.58	A "gotcha" in the naive loop translation	258
6.59	Changing the index in a for loop	259
6.60	Inspecting the index after a for loop	260
6.61	Combination (for) loop in C	261
6.62	C for loop with a local index	262
6.63	Simple iterator in Python	263
6.64	Python iterator for tree enumeration	263
6.65	Java iterator for tree enumeration	264
6.66	Iterator objects in C++	265
6.67	Passing the "loop body" to an iterator in Scheme	266
6.68	Iteration with blocks in Smalltalk	267
6.69	Imitating iterators in C	267
6.85	Simple generator in Icon	© 111
6.86	A generator inside an expression	© 111
6.87	Generating in search of success	© 112
6.88	Backtracking with multiple generators	© 112
6.70	While loop in Pascal	268
6.71	Post-test loop in Pascal and Modula	268
6.72	Post-test loop in C	269
6.73	Break statement in C	269

6.74	Exiting a nested loop in Ada	269		7.20	Derived types and subtypes in Ada	306	
6.75	Exiting a nested loop in Perl	270		7.21	Name vs structural equivalence	306	
Recursion							
6.76	A "naturally iterative" problem	271		7.22	Contexts that expect a given type	307	
6.77	A "naturally recursive" problem	271		7.23	Type conversions in Ada	308	
6.78	Implementing problems "the other way"	272		7.24	Type conversions in C	309	
6.79	Iterative implementation of tail recursion	272		7.25	Unchecked conversions in Ada	309	
6.80	By-hand creation of tail-recursive code	273		7.26	Conversions and nonconverting casts in C++	309	
6.81	Naive recursive Fibonacci function	274		7.27	Coercion in Ada	311	
6.82	Linear iterative Fibonacci function	274		7.28	Coercion in C	311	
6.83	Efficient tail-recursive Fibonacci function	274		7.29	Coercion vs overloading of addends	312	
6.84	Lazy evaluation of an infinite data structure	276		7.30	Java container of Object	314	
6.89	Avoiding asymmetry with non-determinism		© 115	7.31	Inference of subrange types	315	
6.90	Selection with guarded commands		© 115	7.32	The var placeholder in C# 3.0	315	
6.91	Looping with guarded commands		© 116	7.33	Type inference on string operations	316	
6.92	Nondeterministic message receipt		© 117	7.34	Type inference for sets	316	
6.93	Nondeterministic server in SR		© 117	7.96	Fibonacci function in ML	© 125	
6.94	Naive (unfair) implementation of non-determinism		© 118	7.97	Expression types	© 125	
6.95	"Gotcha" in round-robin implementation of nondeterminism		© 118	7.98	Type inconsistency	© 126	
Chapter 7: Data Types							
7.1	Operations that leverage type information	289		7.99	Polymorphic functions	© 126	
7.2	Errors captured by type information	289		7.100	Polymorphic list operators	© 128	
Type Systems							
7.3	Enumerations in Pascal	297		7.101	List notation	© 128	
7.4	Enumerations as constants	297		7.102	Resolving ambiguity with explicit types	© 128	
7.5	Converting to and from enumeration type	297		7.103	Type classes in Haskell	© 129	
7.6	Distinguished values for enums	298		7.104	Pattern matching of argument tuples	© 129	
7.7	Emulating distinguished enum values in Java 5	298		7.105	Swap in ML	© 130	
7.8	Subranges in Pascal	298		7.106	Run-time pattern matching	© 130	
7.9	Subranges in Ada	298		7.107	ML case expression	© 130	
7.10	Space requirements of subrange type	299		7.108	Coverage of case labels	© 131	
7.11	Void (empty) type	301		7.109	Function as a series of alternatives	© 131	
7.12	Making do without void	301		7.110	Pattern matching of return tuple	© 131	
7.13	Aggregates in Ada	302		7.111	ML records	© 132	
Type Checking							
7.14	Trivial differences in type	304		7.112	ML datatypes	© 132	
7.15	Other minor differences in type	304		7.113	Recursive datatypes	© 132	
7.16	The problem with structural equivalence	304		7.114	Type equivalence in ML	© 132	
7.17	Alias types	305		Records (Structures) and Variants (Unions)			
7.18	Semantically equivalent alias types	305		7.35	A C struct	318	
7.19	Semantically distinct alias types	306		7.36	A Pascal record	318	
				7.37	Accessing record fields	318	
				7.38	Nested records	319	
				7.39	ML records and tuples	319	
				7.40	Memory layout for a record type	320	
				7.41	Nested records as values	320	
				7.42	Nested records as references	321	
				7.43	Layout of packed types	321	
				7.44	Assignment and comparison of records	321	
				7.45	Minimizing holes by sorting fields	322	
				7.46	Pascal with statement	323	
				7.115	Elliptical references in Cobol and PL/I	© 135	
				7.116	Pascal with statement (reprise)	© 135	
				7.117	Modula-3 with statement	© 136	

7.118	Multiple-object with statements	Ⓒ 136	7.72	Tree types in Pascal, Ada, and C	349
7.119	Non-record with statements	Ⓒ 136	7.73	Allocating heap nodes	349
7.120	Emulating with in Scheme	Ⓒ 137	7.74	Object-oriented allocation of heap nodes	350
7.121	Emulating with in C	Ⓒ 137	7.75	Pointer-based tree	350
7.47	Motivation for variant records	324	7.76	Pointer dereferencing	350
7.122	Variant record in Pascal	Ⓒ 139	7.77	Implicit dereferencing in Ada	351
7.123	Fortran equivalence statement	Ⓒ 140	7.78	Pointer dereferencing in ML	351
7.124	Mixing structs and unions in C	Ⓒ 140	7.79	Assignment in Lisp	352
7.125	Breaking type safety with equivalence	Ⓒ 141	7.80	Array names and pointers in C	352
7.126	Union conformity in Algol 68	Ⓒ 141	7.81	Pointer comparison and subtraction in C	353
7.127	Tagged variant record in Pascal	Ⓒ 142	7.82	Pointer and array declarations in C	353
7.128	Breaking type safety with variant records	Ⓒ 142	7.83	Arrays as parameters in C	354
7.129	Untagged variants in Pascal	Ⓒ 143	7.84	Sizeof in C	355
7.130	Ada variants and tags (discriminants)	Ⓒ 143	7.85	Explicit storage reclamation	356
7.131	A discriminated subtype in Ada	Ⓒ 144	7.86	Dangling reference to a stack variable in C++	356
7.132	Discriminated array in Ada	Ⓒ 145	7.87	Dangling reference to a heap variable in C++	356
7.133	Derived types as an alternative to unions	Ⓒ 146	7.134	Dangling reference detection with tombstones	Ⓒ 149
Arrays			7.135	Dangling reference detection with locks and keys	Ⓒ 151
7.48	Array declarations	326	7.88	Reference counts and circular structures	359
7.49	Multidimensional arrays	327	7.89	Heap tracing with pointer reversal	361
7.50	Multidimensional vs built-up arrays	328	Lists		
7.51	Arrays of arrays in C	328	7.90	Lists in ML and Lisp	365
7.52	Array slice operations	328	7.91	List notation	365
7.53	Conformant array parameters in Pascal	331	7.92	Basic list operations in Lisp	366
7.54	Local arrays of dynamic shape in C99	332	7.93	Basic list operations in ML	366
7.55	Stack allocation of elaborated arrays	332	7.94	List comprehensions	367
7.56	Elaborated arrays in Fortran 90	333	7.136	Files as a built-in type	Ⓒ 155
7.57	Dynamic strings in Java and C#	334	7.137	The open operation	Ⓒ 155
7.58	Row-major vs column-major array layout	335	7.138	The close operation	Ⓒ 155
7.59	Array layout and cache performance	336	7.139	Formatted output in Fortran	Ⓒ 157
7.60	Contiguous vs row-pointer array layout	338	7.140	Labeled formats	Ⓒ 157
7.61	Indexing a contiguous array	338	7.141	Printing to standard output	Ⓒ 158
7.62	Pseudo-assembler for contiguous array indexing	339	7.142	Formatted output in Ada	Ⓒ 159
7.63	Static and dynamic portions of an array index	340	7.143	Overloaded put routines	Ⓒ 159
7.64	Indexing complex structures	340	7.144	Formatted output in C	Ⓒ 160
7.65	Pseudo-assembler for row-pointer array indexing	341	7.145	Text in format strings	Ⓒ 160
Strings			7.146	Formatted input in C	Ⓒ 160
7.66	Character escapes in C and C++	343	7.147	Formatted output in C++	Ⓒ 162
7.67	Char* assignment in C	343	7.148	Stream manipulators	Ⓒ 162
Sets			7.149	Array output in C++	Ⓒ 163
7.68	Set types in Pascal	344	7.150	Changing default format	Ⓒ 163
Pointers and Recursive Types			Equality Testing and Assignment		
7.69	Tree type in ML	347	7.95	Equality testing in Scheme	369
7.70	Tree type in Lisp	347			
7.71	Mutually recursive types in ML	348			

Chapter 8: Subroutines and Control Abstraction

Review of Stack Layout

8.1	Layout of run-time stack (reprise)	384
8.2	Offsets from frame pointer	384
8.3	Static and dynamic links	385
8.4	Visibility of nested routines	385

Calling Sequences

8.5	A typical calling sequence	387
8.63	Nonlocal access using a display	© 169
8.64	SGI MIPSpro C calling sequence	© 173
8.65	Gnu Pascal x86 calling sequence	© 177
8.66	Subroutine closure trampoline	© 178
8.67	Register windows on the SPARC	© 181
8.6	Requesting an inline subroutine	391
8.7	In-lining and recursion	392

Parameter Passing

8.8	Infix operators	394
8.9	Control abstraction in Lisp and Smalltalk	394
8.10	Passing an argument to a subroutine	395
8.11	Value and reference parameters	395
8.12	Call-by-value/result	396
8.13	Emulating call-by-reference in C	396
8.14	Const parameters in C	398
8.15	Reference parameters in C++	399
8.16	References as aliases in C++	400
8.17	Returning a reference from a function	400
8.18	Subroutines as parameters in Pascal	401
8.19	First-class subroutines in Scheme	401
8.20	First-class subroutines in ML	402
8.21	Subroutine pointers in C and C++	402
8.68	Jensen's device	© 185
8.22	Default parameters in Ada	404
8.23	Named parameters in Ada	405
8.24	Self-documentation with named parameters	406
8.25	Variable number of arguments in C	406
8.26	Variable number of arguments in Java	407
8.27	Variable number of arguments in C#	408
8.28	Return statement	408
8.29	Incremental computation of a return value	408
8.30	Explicitly named return values in SR	409
8.31	Multivalued returns	409

Generic Subroutines and Modules

8.32	Generic queues in Ada and C++	411
8.33	Generic min function in Ada (reprise)	411
8.34	Generic parameters	411

8.35	Simple constraints in Ada	414
8.36	With constraints in Ada	414
8.37	Generic sorting routine in Java	415
8.38	Generic sorting routine in C#	415
8.39	Generic sorting routine in C++	415
8.40	Generic class instance in C++	416
8.41	Generic subroutine instance in Ada	416
8.42	Implicit instantiation in C++	416
8.69	Generic arbiter class in C++	© 189
8.70	Instantiation-time errors in C++ templates	© 191
8.71	Generic arbiter class in Java	© 192
8.72	Wildcards and bounds on Java generic parameters	© 193
8.73	Type erasure and implicit casts	© 194
8.74	Unchecked warnings in Java 5	© 195
8.75	Java 5 generics and built-in types	© 196
8.76	Sharing generic implementations in C#	© 196
8.77	C# generics and built-in types	© 196
8.78	Generic arbiter class in C#	© 197

Exception Handling

8.43	ON conditions in PL/I	419
8.44	A simple try block in C++	420
8.45	Propagation of an exception out of a called routine	420
8.46	What is an exception?	421
8.47	Parameterized exceptions	422
8.48	Multiple handlers in C++	423
8.49	Exception handler in ML	423
8.50	Finally clause in Modula-3	424
8.51	Stacked exception handlers	425
8.52	Multiple exceptions per handler	425
8.53	Setjmp and longjmp in C	426

Coroutines

8.54	Explicit interleaving of concurrent computations	428
8.55	Interleaving coroutines	429
8.56	Cactus stacks	431
8.57	Switching coroutines	432
8.79	Coroutine-based iterator invocation	© 201
8.80	Coroutine-based iterator implementation	© 201
8.81	Iterator usage in C#	© 202
8.82	Implementation of C# iterators	© 203
8.83	Sequential simulation of a complex physical system	© 205
8.84	Initialization of a coroutine-based traffic simulation	© 205
8.85	Traversing a street segment in the traffic simulation	© 206

8.86	Scheduling a coroutine for future execution	© 206
8.87	Queueing cars at a traffic light	© 206
8.88	Waiting at a light	© 207
8.89	Sleeping in anticipation of future execution	© 207

Events

8.58	Signal trampoline	435
8.59	An event handler in C#	436
8.60	An anonymous delegate handler	437
8.61	An event handler in Java	437
8.62	An anonymous inner class handler	437

Chapter 9: Data Abstraction and Object Orientation

Object-Oriented Programming

9.1	<code>List_node</code> class in C++	451
9.2	<code>List</code> class that uses <code>list_node</code>	453
9.3	Declaration of in-line (expanded) objects	453
9.4	Method declaration without definition	454
9.5	Separate method definition	455
9.6	<code>Property</code> and <code>indexer</code> methods in C#	455
9.7	<code>Queue</code> class derived from <code>list</code>	456
9.8	Base class for general-purpose lists	457
9.9	Overloaded <code>int_list_node</code> constructor	458
9.10	Redefining a method in a derived class	458
9.11	Redefinition that builds on the base class method	458
9.12	Accessing base class members	459
9.13	Renaming methods in Eiffel	459

Encapsulation and Inheritance

9.14	Opaque types in Modula-2	461
9.15	Data hiding in Ada	461
9.16	The hidden <code>this</code> parameter	462
9.17	<code>Private</code> base class in C++	463
9.18	<code>Protected</code> base class in C++	463
9.19	Inner classes in Java	465
9.20	List and queue abstractions in Ada 95	467
9.21	Extension methods in C# 3.0	468

Initialization and Finalization

9.22	Naming constructors in Eiffel	470
9.23	Metaclasses in Smalltalk	471
9.24	Declarations and constructors in C++	473
9.25	Copy constructors	473
9.26	Eiffel constructors and expanded objects	474
9.27	Specification of base class constructor arguments	475

9.28	Specification of member constructor arguments	476
9.29	Invocation of base class constructor in Java	476
9.30	Reclaiming space with destructors	477

Dynamic Method Binding

9.31	Derived class objects in a base class context	478
9.32	Static and dynamic method binding	479
9.33	The need for dynamic binding	480
9.34	Virtual methods in C++ and C#	481
9.35	Virtual methods in Simula	481
9.36	Class-wide types in Ada 95	481
9.37	Abstract methods in Java and C#	482
9.38	Abstract methods in C++	482
9.39	Vtables	483
9.40	Implementation of a virtual method call	483
9.41	Implementation of single inheritance	483
9.42	Casts in C++	484
9.43	Reverse assignment in Eiffel and C#	485
9.44	Inheritance and method signatures	486
9.45	Generics and inheritance	487
9.46	<code>Like</code> in Eiffel	488
9.47	Virtual methods in an object closure	489
9.48	Encapsulating arguments	489
9.49	Deriving from two base classes	491
9.50	Deriving from two base classes (reprise)	© 215
9.51	(Nonrepeated) multiple inheritance	© 215
9.52	Method invocation with multiple inheritance	© 216
9.53	<code>This</code> correction	© 217
9.54	Methods found in more than one base class	© 217
9.55	Overriding an ambiguous method	© 218
9.56	Repeated multiple inheritance	© 219
9.57	Shared inheritance in C++	© 220
9.58	Replicated inheritance in Eiffel	© 220
9.59	Using replicated inheritance	© 220
9.60	Overriding methods with shared inheritance	© 222
9.61	Implementation of shared inheritance	© 222
9.62	Mixing interfaces into a derived class	© 224
9.63	Compile-time implementation of mix-in inheritance	© 224

Object-Oriented Programming Revisited

9.64	Operations as messages in Smalltalk	© 227
9.65	Mixfix messages	© 227
9.66	Selection as an <code>ifTrue: ifFalse:</code> message	© 228
9.67	Iterating with messages	© 228

9.68	Blocks as closures	© 229
9.69	Logical looping with messages	© 229
9.70	Defining control abstractions	© 229
9.71	Recursion in Smalltalk	© 230

Chapter 10: Functional Languages

Historical Origins

Functional Programming Concepts

A Review/Overview of Scheme

10.1	The read-eval-print loop	509
10.2	Significance of parentheses	510
10.3	Quoting	510
10.4	Dynamic typing	510
10.5	Type predicates	511
10.6	Liberal syntax for symbols	511
10.7	Lambda expressions	511
10.8	Function evaluation	512
10.9	If expressions	512
10.10	Nested scopes with let	512
10.11	Global bindings with define	513
10.12	Basic list operations	513
10.13	List search functions	514
10.14	Searching association lists	514
10.15	Multiway conditional expressions	515
10.16	Assignment	515
10.17	Sequencing	515
10.18	Iteration	516
10.19	Evaluating data as code	517
10.20	Denotational semantics of Scheme	518
10.21	Simulating a DFA in Scheme	519

Evaluation Order Revisited

10.22	Applicative and normal-order evaluation	521
10.23	Normal-order avoidance of unnecessary work	522
10.24	Avoiding work with lazy evaluation	524
10.25	Stream-based program execution	525
10.26	Interactive I/O with streams	526
10.27	Pseudorandom numbers in Haskell	526
10.28	The state of the IO monad	528
10.29	Functional composition of actions	528
10.30	Streams and the I/O monad	529

Higher-Order Functions

10.31	Map function in Scheme	530
10.32	Folding (reduction) in Scheme	530
10.33	Combining higher-order functions	530
10.34	Partial application with currying	531
10.35	General-purpose curry function	531
10.36	Tuples as ML function arguments	531

10.37	Optional parentheses on singleton arguments	532
10.38	Simple curried function in ML	532
10.39	Shorthand notation for currying	533
10.40	Folding (reduction) in ML	533
10.41	Curried fold in ML	533
10.42	Currying in ML vs Scheme	533
10.43	Declarative (nonconstructive) function definition	534
10.44	Functions as mappings	© 237
10.45	Functions as sets	© 237
10.46	Functions as powerset elements	© 238
10.47	Function spaces	© 238
10.48	Higher-order functions as sets	© 238
10.49	Curried functions as sets	© 238
10.50	Juxtaposition as function application	© 239
10.51	Lambda calculus syntax	© 239
10.52	Binding parameters with λ	© 240
10.53	Free variables	© 240
10.54	Naming functions for future reference	© 240
10.55	Evaluation rules	© 240
10.56	Delta reduction for arithmetic	© 241
10.57	Eta reduction	© 241
10.58	Reduction to simplest form	© 241
10.59	Nonterminating applicative-order reduction	© 242
10.60	Booleans and conditionals	© 243
10.61	Beta abstraction for recursion	© 243
10.62	The fixed-point combinator Y	© 244
10.63	Lambda calculus list operators	© 244
10.64	List operator identities	© 244
10.65	Nesting of lambda expressions	© 246
10.66	Paired arguments and currying	© 246

Functional Programming in Perspective

Chapter 11: Logic Languages

Logic Programming Concepts

11.1	Horn clauses	546
11.2	Resolution	546
11.3	Unification	546

Prolog

11.4	Atoms, variables, scope, and type	547
11.5	Structures and predicates	547
11.6	Facts and rules	547
11.7	Queries	548
11.8	Resolution in Prolog	549
11.9	Unification in Prolog and ML	549
11.10	Equality and unification	549
11.11	Unification without instantiation	550
11.12	List notation in Prolog	550

11.13	Functions, predicates, and two-way rules	551	12.8	A parallel loop in OpenMP	590
11.14	Arithmetic and the <code>is</code> predicate	551	12.9	A parallel loop in C#	590
11.15	Search tree exploration	552	12.10	<code>forall</code> in Fortran 95	591
11.16	Backtracking and instantiation	553	12.11	Reduction in OpenMP	592
11.17	Order of rule evaluation	554	12.12	Elaborated tasks in Ada	592
11.18	Infinite regression	554	12.13	Co-begin vs fork/join	593
11.19	Tic-tac-toe in Prolog	554	12.14	Task types in Ada	593
11.20	The cut	558	12.15	Thread creation in Java 2	594
11.21	<code>\+</code> and its implementation	558	12.16	Thread creation in C#	595
11.22	Pruning unwanted answers with the cut	559	12.17	Thread pools in Java 5	596
11.23	Using the cut for selection	559	12.18	<code>spawn</code> and <code>sync</code> in Cilk	596
11.24	Looping with <code>fail</code>	559	12.19	Modeling subroutines with fork/join	597
11.25	Looping with an unbounded generator	560	12.20	Multiplexing threads on processes	598
11.26	Character input with <code>get</code>	560	12.21	Cooperative multithreading on a uniprocessor	599
11.27	Prolog programs as data	561	12.22	A race condition in preemptive multithreading	601
11.28	Modifying the Prolog database	561	12.23	Disabling signals during context switch	602
11.29	Tic-tac-toe (full game)	562			
11.30	The <code>functor</code> predicate	562	Implementing Synchronization		
11.31	Creating terms at run time	562	12.24	The basic <code>test_and_set</code> lock	605
11.32	Pursuing a dynamic goal	564	12.25	<code>Test-and-test_and_set</code>	605
11.33	Custom database perusal	565	12.26	Barriers in finite element analysis	606
11.34	Predicates as mathematical objects	566	12.27	The “sense-reversing” barrier	606
11.39	Propositions	Ⓒ 253	12.28	Atomic update with <code>CAS</code>	607
11.40	Different ways to say things	Ⓒ 254	12.29	The M&S queue	609
11.41	Conversion to clausal form	Ⓒ 254	12.30	Write buffers and consistency	610
11.42	Conversion to Prolog	Ⓒ 255	12.31	Distributed consistency	611
11.43	Disjunctive left-hand side	Ⓒ 255	12.32	Scheduling threads on processes	613
11.44	Empty left-hand side	Ⓒ 256	12.33	A race condition in thread scheduling	613
11.45	Theorem proving as a search for contradiction	Ⓒ 256	12.34	A “spin-then-yield” lock	615
11.46	Skolem constants	Ⓒ 257	12.35	The bounded buffer problem	616
11.47	Skolem functions	Ⓒ 257	12.36	Semaphore implementation	617
11.48	Limitations of Skolemization	Ⓒ 257	12.37	Bounded buffer with semaphores	618
Logic Programming in Perspective					
11.35	Sorting incredibly slowly	567	Language-Level Mechanisms		
11.36	Quicksort in Prolog	568	12.38	Bounded buffer monitor	620
11.37	Negation as failure	568	12.39	How to wait for a signal (hint or absolute)	621
11.38	Negation and instantiation	569	12.40	Original CCR syntax	624
Chapter 12: Concurrency					
Background and Motivation					
12.1	Independent tasks in Parallel FX	577	12.41	<code>Synchronized</code> statement in Java	626
12.2	A simple race condition	578	12.42	<code>Notify</code> as hint in Java	626
12.3	Multithreaded web browser	579	12.43	<code>Lock</code> variables in Java 5	627
12.4	Dispatch loop web browser	581	12.44	Multiple <code>Conditions</code> in Java 5	628
12.5	The cache coherence problem	584	12.45	A simple atomic block	630
Concurrent Programming Fundamentals					
12.6	General form of co-begin	590	12.46	Bounded buffer with transactions	630
12.7	Co-begin in OpenMP	590	12.47	Translation of an atomic block	631
			12.48	<code>Future</code> construct in Multilisp	634
			12.49	Futures in C#	634
			12.50	Naming processes, ports, and entries	Ⓒ 263
			12.51	<code>Entry</code> calls in Ada	Ⓒ 263
			12.52	Channels in Occam	Ⓒ 264
			12.53	Datagram messages in Java	Ⓒ 266

12.54	Connection-based messages in Java	Ⓒ 266
12.55	Three main options for send semantics	Ⓒ 268
12.56	Buffering-dependent deadlock	Ⓒ 268
12.57	Acknowledgments	Ⓒ 270
12.58	Bounded buffer in Ada 83	Ⓒ 273
12.59	Timeout and distributed termination	Ⓒ 274
12.60	Bounded buffer in Occam	Ⓒ 274
12.61	Asymmetry of synchronization send	Ⓒ 274
12.62	Timeout in Occam receipt	Ⓒ 276
12.63	Bounded buffer in Erlang	Ⓒ 276
12.64	Bounded buffer in SR	Ⓒ 276
12.65	Peeking at messages in SR and Erlang	Ⓒ 276
12.66	An RPC server system	Ⓒ 280

Chapter 13: Scripting Languages

What Is a Scripting Language?

13.1	Trivial programs in conventional and scripting languages	652
13.2	Coercion in Perl	653

Problem Domains

13.3	"Wildcards" and "globbing"	656
13.4	For loops in the shell	657
13.5	A whole loop on one line	657
13.6	Conditional tests in the shell	657
13.7	Pipes	658
13.8	Output redirection	658
13.9	Redirection of stderr and stdout	659
13.10	Heredocs (in-line input)	659
13.11	Single and double quotes	660
13.12	Subshells	660
13.13	Brace-quoted blocks in the shell	660
13.14	Pattern-based list generation	660
13.15	User-defined shell functions	661
13.16	The #! convention in script files	661
13.17	Extracting HTML headers with sed	663
13.18	One-line scripts in sed	664
13.19	Extracting HTML headers with awk	664
13.20	Fields in awk	665
13.21	Capitalizing a title in awk	665
13.22	Extracting HTML headers with Perl	666
13.23	"Force quit" script in Perl	668
13.24	"Force quit" script in Tcl	670
13.25	"Force quit" script in Python	672
13.26	Method call syntax in Ruby	674
13.27	"Force quit" script in Ruby	675
13.28	Numbering lines with Emacs Lisp	677

Scripting the World Wide Web

13.29	Remote monitoring with a CGI script	681
13.30	Adder web form with a CGI script	681

13.31	Remote monitoring with a PHP script	683
13.32	A fragmented PHP script	684
13.33	Adder web form with a PHP script	684
13.34	Self-posting Adder web form	685
13.35	Adder web form in JavaScript	686
13.36	Embedding an applet in a web page	687
13.37	Embedding an object in a web page	688
13.83	Content versus presentation in HTML	Ⓒ 287
13.84	Well-formed XHTML	Ⓒ 288
13.85	XHTML to display a favorite quote	Ⓒ 289
13.86	XPath names for XHTML elements	Ⓒ 290
13.87	Creating a reference list with XSLT	Ⓒ 292

Innovative Features

13.38	Scoping rules in Python	692
13.39	Superassignment in R	693
13.40	Scoping rules in Tcl	693
13.41	Static and dynamic scoping in Perl	694
13.42	Accessing globals in Perl	695
13.43	Basic operations in POSIX REs	697
13.44	Extra quantifiers in POSIX REs	697
13.45	Zero-length assertions	697
13.46	Character classes	697
13.47	The dot (.) character	698
13.48	Negation and quoting in character classes	698
13.49	Predefined POSIX character classes	698
13.50	RE matching in Perl	698
13.51	Negating a match in Perl	699
13.52	RE substitution in Perl	699
13.53	Trailing modifiers on RE matches	699
13.54	Greedy and minimal matching	701
13.55	Minimal matching of HTML headers	701
13.56	Variable interpolation in extended REs	702
13.57	Variable capture in extended REs	702
13.58	Backreferences in extended REs	703
13.59	Dissecting a floating-point literal	703
13.60	Implicit capture of prefix, match, and suffix	703
13.61	Coercion in Ruby and Perl	704
13.62	Coercion and context in Perl	704
13.63	Explicit conversion in Ruby	705
13.64	Perl arrays	706
13.65	Perl hashes	706
13.66	Arrays and hashes in Python and Ruby	707
13.67	Array access methods in Ruby	707
13.68	Tuples in Python	708
13.69	Sets in Python	708
13.70	Conflated types in PHP, Tcl, and JavaScript	708
13.71	Multidimensional arrays in Python and other languages	708
13.72	Scalar and list context in Perl	709

13.73	Using <code>wantarray</code> to determine calling context	710
13.74	A simple class in Perl	710
13.75	Invoking methods in Perl	711
13.76	Inheritance in Perl	712
13.77	Inheritance via <code>use base</code>	712
13.78	Prototypes in JavaScript	713
13.79	Overriding instance methods in JavaScript	713
13.80	Inheritance in JavaScript	714
13.81	Constructors in Python and Ruby	714
13.82	Naming class members in Python and Ruby	715

Chapter 14: Building a Runnable Program

Back-End Compiler Structure

14.1	Phases of compilation	730
14.2	GCD program abstract syntax tree (reprise)	730
14.3	Intermediate forms in Figure 14.1	735
14.19	ExpressionTree abstraction in Diana	Ⓒ 306
14.20	GCD program in GIMPLE	Ⓒ 307
14.21	An RTL <code>insn</code> sequence	Ⓒ 309
14.4	Computing Heron's formula	737

Code Generation

14.5	Simpler compiler structure	738
14.6	An attribute grammar for code generation	739
14.7	Stack-based register allocation	741
14.8	GCD program target code	742

Address Space Organization

14.9	Linux address space layout	745
------	----------------------------	-----

Assembly

14.10	Assembly as a final compiler pass	747
14.11	Direct generation of object code	747
14.12	Compressing <code>nops</code>	748
14.13	Relative and absolute branches	748
14.14	Pseudoinstructions	748
14.15	Assembler directives	749
14.16	Encoding of addresses in object files	750

Linking

14.17	Static linking	751
14.18	Checksumming headers for consistency	752
14.22	PIC under MIPS/IRIX	Ⓒ 312
14.23	Dynamic linking under MIPS/IRIX	Ⓒ 314

Chapter 15: Run-time Program Management

15.1	The CLI as a run-time system and virtual machine	764
------	--	-----

Virtual Machines

15.2	Constants for "Hello, world"	768
15.3	Byte code for a list insert operation	772
15.4	Generics in the CLI and JVM	780
15.5	CIL for a list insert operation	782

Late Binding of Machine Code

15.6	When is in-lining safe?	787
15.7	Speculative optimization	787
15.8	Dynamic compilation in the CLR	788
15.9	Dynamic compilation in CMU Common Lisp	789
15.10	Compilation of Perl	790
15.11	The Mac 68K emulator	792
15.12	The Transmeta Crusoe processor	792
15.13	Static binary translation	793
15.14	Dynamic binary translation	793
15.15	Mixed interpretation and translation	793
15.16	Transparent dynamic translation	793
15.17	The Dynamo dynamic optimizer	794
15.18	The ATOM binary rewriter	796

Inspection/Introspection

15.19	Finding the concrete type of a reference variable	799
15.20	What <i>not</i> to do with reflection	800
15.21	Java class-naming conventions	800
15.22	Getting information on a particular class	801
15.23	Listing the methods of a Java class	802
15.24	Calling a method with reflection	802
15.25	Reflection facilities in Ruby	803
15.26	User-defined annotations in Java	804
15.27	User-defined annotations in C#	805
15.28	<code> javadoc </code>	805
15.29	Intercomponent communication	806
15.30	Attributes for LINQ	806
15.31	The Java Modeling Language	806
15.32	Java <code> apt </code>	806
15.33	Setting a breakpoint	808
15.34	Hardware breakpoints	809
15.35	Setting a watchpoint	809
15.36	Statistical sampling	810
15.37	Call graph profiling	810
15.38	Finding basic blocks with low IPC	810
15.39	Performance counters on the Pentium M	810

Chapter 16: Code Improvement

- | | | | |
|-------|---|---|-----|
| 16.1 | Code improvement phases | © | 323 |
| 16.2 | Elimination of redundant loads and stores | © | 325 |
| 16.3 | Constant folding | © | 325 |
| 16.4 | Constant propagation | © | 325 |
| 16.5 | Common subexpression elimination | © | 326 |
| 16.6 | Copy propagation | © | 326 |
| 16.7 | Strength reduction | © | 326 |
| 16.8 | Elimination of useless instructions | © | 326 |
| 16.9 | Exploitation of the instruction set | © | 327 |
| 16.10 | The combinations subroutine | © | 328 |
| 16.11 | Syntax tree and naive control flow graph | © | 328 |
| 16.12 | Result of local redundancy elimination | © | 334 |
| 16.13 | Conversion to SSA form | © | 337 |
| 16.14 | Global value numbering | © | 338 |
| 16.15 | Data flow equations for available expressions | © | 341 |
| 16.16 | Fixed point for available expressions | © | 341 |
| 16.17 | Result of global common subexpression elimination | © | 342 |
| 16.18 | Edge splitting transformations | © | 344 |
| 16.19 | Data flow equations for live variables | © | 345 |
| 16.20 | Fixed point for live variables | © | 345 |
| 16.21 | Data flow equations for reaching definitions | © | 347 |
| 16.22 | Result of hoisting loop invariants | © | 348 |
| 16.23 | Induction variable strength reduction | © | 349 |
| 16.24 | Induction variable elimination | © | 349 |
| 16.25 | Result of induction variable optimization | © | 350 |
| 16.26 | Remaining pipeline delays | © | 352 |
| 16.27 | Value dependence DAG | © | 352 |
| 16.28 | Result of instruction scheduling | © | 354 |
| 16.29 | Result of loop unrolling | © | 356 |
| 16.30 | Result of software pipelining | © | 356 |
| 16.31 | Loop interchange | © | 360 |
| 16.32 | Loop tiling (blocking) | © | 360 |
| 16.33 | Loop distribution | © | 361 |
| 16.34 | Loop fusion | © | 362 |
| 16.35 | Obtaining a perfect loop nest | © | 362 |
| 16.36 | Loop-carried dependences | © | 363 |
| 16.37 | Loop reversal and interchange | © | 363 |
| 16.38 | Loop skewing | © | 364 |
| 16.39 | Coarse-grain parallelization | © | 365 |
| 16.40 | Strip mining | © | 366 |
| 16.41 | Live ranges of virtual registers | © | 367 |
| 16.42 | Register coloring | © | 367 |
| 16.43 | Optimized combinations subroutine | © | 367 |

This page intentionally left blank

Bibliography

- [ACC⁺90] Robert Alverson, David Callahan, Daniel Cummings, Brian Koblenz, Allan Porterfield, and Burton Smith. The Tera computer system. *Proceedings of the 1990 International Conference on Supercomputing*, pages 1–6, Amsterdam, The Netherlands, June 1990.
- [ACD⁺96] Cristiana Amza, Alan L. Cox, Sandhya Dwarkadas, Pete Keleher, Honghui Lu, Ramakrishnan Rajamony, Weimin Yu, and Willy Zwaenepoel. TreadMarks: Shared memory computing on networks of workstations. *IEEE Computer*, 29(2):18–28, February 1996.
- [ACG86] Shakil Ahuja, Nicholas Carriero, and David Gelernter. Linda and friends. *IEEE Computer*, 19(8): 26–34, August 1986.
- [ADH⁺98] H. Abelson, R. K. Dybvig, C. T. Haynes, G. J. Rozas, N. I. Adams IV, D. P. Friedman, E. Kohlbecker, G. L. Steele, Jr., D. H. Bartley, R. Halstead, D. Oxley, G. J. Sussman, G. Brooks, C. Hanson, K. M. Pitman, and M. Wand. Revised⁵ report on the algorithmic language Scheme. *Higher-Order and Symbolic Computation*, 11(1):7–105, 1998. Edited by Richard Kelsey, William Clinger, and Jonathan Rees. Available at www.schemers.org/Documents/Standards/R5RS/.
- [Ado86] Adobe Systems, Inc. *PostScript Language Tutorial and Cookbook*. Addison-Wesley, 1986.
- [Ado90] Adobe Systems, Inc. *PostScript Language Reference Manual*, second edition. Addison-Wesley, 1990.
- [AF84] Krzysztof R. Apt and Nissim Francez. Modeling the distributed termination convention of CSP. *ACM Transactions on Programming Languages and Systems*, 6(3): 370–379, July 1984.
- [AFG⁺05] Matthew Arnold, Stephen J. Fink, David Grove, Michael Hind, and Peter F. Sweeney. A survey of adaptive optimization in virtual machines. *Proceedings of the IEEE*, 93(2):449–466, February 2005.
- [AG90] David Abrahams and Aleksey Gurtovoy. *C++ Template Metaprogramming: Concepts, Tools, and Techniques from Boost and Beyond*. Addison-Wesley, 1990.
- [AG96] Sarita V. Adve and Kourosh Gharachorloo. Shared memory consistency models: A tutorial. *IEEE Computer*, 29(12):66–76, December 1996.
- [AG98] Ken Arnold and James Gosling. *The Java Programming Language*, second edition. Addison-Wesley, 1998.
- [AH95] Ole Agesen and Urs Hölzle. Type feedback v. concrete type inference: A comparison of optimization techniques for object-oriented languages. *Proceedings of the Tenth ACM SIGPLAN Conference on Object-Oriented Programming Systems, Languages, and Applications*, pages 91–107, Austin, TX, October 1995.
- [AK02] Randy Allen and Ken Kennedy. *Optimizing Compilers for Modern Architectures: A Dependence-Based Approach*. Morgan Kaufmann, 2002.
- [AKW88] Alfred V. Aho, Brian W. Kernighan, and Peter J. Weinberger. *The AWK Programming Language*. Addison-Wesley, 1988.
- [All69] Frances E. Allen. Program optimization. *Annual Review in Automatic Programming*, 5:239–307, 1969.
- [ALSU07] Alfred V. Aho, Monica S. Lam, Ravi Sethi, and Jeffrey D. Ullman. *Compilers: Principles, Techniques, and Tools*, second edition. Addison-Wesley, 2007.
- [Ame78a] American National Standards Institute, New York, NY. *Programming Language FORTRAN*, 1978. ANSI X3.9–1978.
- [Ame78b] American National Standards Institute. *Programming Language Minimal BASIC*, 1978. ANSI X3.60–1978.
- [Ame83] American National Standards Institute. *Reference Manual for the Ada Programming Language*, January 1983. ANSI/MIL 1815 A–1983.

- [Ame85] American National Standards Institute. *Programming Language COBOL*, 1985. ANSI X3.23–1985. Supersedes earlier ANSI standards from 1968 and 1974.
- [Ame90] American National Standards Institute. *Programming Language C*, 1990. ANSI/ISO 9899–1990. Revision and redesignation of ANSI X3.159–1989.
- [Ame92] American National Standards Institute. *Programming Language, FORTRAN—Extended*, 1992. ANSI X3.198–1992. Also ISO 1539–1991 (E).
- [Ame96a] American National Standards Institute. *Information Technology—Programming Language REXX*, 1996. ANSI INCITS 274-1996/AMD1-2000 (R2001).
- [Ame96b] American National Standards Institute. *Programming Language—Common Lisp*, 1996. ANSI X3.226:1994. Available at www.lispworks.com/documentation/common-lisp.html.
- [AO93] Gregory R. Andrews and Ronald A. Olsson. *The SR Programming Language: Concurrency in Practice*. Benjamin/Cummings, 1993.
- [App91] Andrew W. Appel. *Compiling with Continuations*. Cambridge University Press, 1991.
- [App97] Andrew W. Appel. *Modern Compiler Implementation*. Cambridge University Press, 1997. Text available in ML, Java, and C versions. C version specialized by Maia Ginsburg.
- [App08] Apple Computer, Inc. *The Objective-C 2.0 Programming Language*, 2008. Available as developer.apple.com/documentation/Cocoa/Conceptual/ObjectiveC/ObjC.pdf.
- [Arm07] Joe Armstrong. What’s all this fuss about Erlang? The Pragmatic Programmers, LLC, 2007. Available at www.pragprog.com/articles/erlang.html.
- [AS83] Gregory R. Andrews and Fred B. Schneider. Concepts and notations for concurrent programming. *ACM Computing Surveys*, 15(1):3–43, March 1983.
- [AS96] Harold Abelson and Gerald Jay Sussman. *Structure and Interpretation of Computer Programs*. MIT Press, second edition, 1996. With Julie Sussman. Full text and supplementary resources available at mitpress.mit.edu/sicp/.
- [Ass93] Association for Computing Machinery. *Proceedings of the Second ACM SIGPLAN History of Programming Languages (HOPL) Conference*, Cambridge, MA, April 1993. In *ACM SIGPLAN Notices*, 28(3), March 1993.
- [Ass07] Association for Computing Machinery. *Proceedings of the Third ACM SIGPLAN History of Programming Languages (HOPL) Conference*, San Diego, CA, June 2007.
- [Atk73] M. Stella Atkins. Mutual recursion in Algol 60 using restricted compilers. *Communications of the ACM*, 16(1):47–48, 1973.
- [AU72] Alfred V. Aho and Jeffrey D. Ullman. *The Theory of Parsing, Translation and Compiling* (two-volume set). Prentice-Hall, 1972.
- [AVWW96] Joe Armstrong, Robert Virding, Claes Wikström, and Mike Williams. *Concurrent Programming in ERLANG*, second edition. Prentice Hall International, 1996.
- [AWZ88] Bowen Alpern, Mark N. Wegman, and F. Kenneth Zadeck. Detecting equality of variables in programs. *Conference Record of the Fifteenth ACM Symposium on Principles of Programming Languages*, pages 1–11, San Diego, CA, January 1988.
- [Ayc03] John Aycok. A brief history of just-in-time. *ACM Computing Surveys*, 35(2):97–113, June 2003.
- [BA08] Hans-J. Boehm and Sarita V. Adve. Foundations of the C++ concurrency memory model. *Proceedings of the SIGPLAN 2008 Conference on Programming Language Design and Implementation*, pages 68–78, Tucson, AZ, June 2008.
- [Bac78] John W. Backus. Can programming be liberated from the von Neumann style? A functional style and its algebra of programs. *Communications of the ACM*, 21(8):613–641, August 1978. The 1977 Turing Award lecture.
- [Bag86] Rajive L. Bagrodia. A distributed algorithm to implement the generalized alternative command of CSP. *Proceedings of the Sixth International Conference on Distributed Computing Systems*, pages 422–427, Cambridge, MA, May 1986.
- [BALL90] Brian N. Bershad, Thomas E. Anderson, Edward D. Lazowska, and Henry M. Levy. Lightweight remote procedure call. *ACM Transactions on Computer Systems*, 8(1):37–55, February 1990.
- [Ban97] Utpal Banerjee. *Dependence Analysis*, volume 3 of *Loop Transformations for Restructuring Compilers*. Kluwer Academic Publishers, 1997.
- [Bar84] Hendrik Pieter Barendregt. *The Lambda Calculus: Its Syntax and Semantics*, volume 103 of *Studies in Logic and the Foundations of Mathematics*, revised edition. North-Holland, 1984.
- [BC93] Peter Bumbulis and Donald D. Cowan. RE2C: A more versatile scanner generator. *ACM Letters on Programming Languages and Systems*, 2(1–4):70–84, March–December 1993.
- [BDB00] Vasanth Bala, Evelyn Duesterwald, and Sanjeev Banerjia. Dynamo: A transparent dynamic optimization

- system. *Proceedings of the SIGPLAN 2000 Conference on Programming Language Design and Implementation*, pages 1–12, Vancouver, BC, Canada, June 2000.
- [BDH⁺95] Jehoshua Bruck, Danny Dolev, Ching-Tien Ho, Marcel-Catalin Rosu, and Ray Strong. Efficient message passing interface (MPI) for parallel computing on clusters of workstations. *Proceedings of the Seventh Annual ACM Symposium on Parallel Algorithms and Architectures*, pages 64–73, Santa Barbara, CA, July 1995.
- [BDMN73] Graham M. Birtwistle, Ole-Johan Dahl, Bjørn Myhrhaug, and Kristen Nygaard. *SIMULA Begin*. Auerback Publishers, Inc., 1973.
- [Bec97] Leland L. Beck. *System Software: An Introduction to Systems Programming*, third edition. Addison-Wesley, 1997.
- [Bee70] David Beech. A structural view of PL/I. *ACM Computing Surveys*, 2(1):33–64, March 1970.
- [Ben86] John L. Bentley. *Programming Pearls*. Addison-Wesley, 1986.
- [Ber80] Arthur J. Bernstein. Output guards and nondeterminism in “Communicating Sequential Processes.” *ACM Transactions on Programming Languages and Systems*, 2(2):234–238, April 1980.
- [Ber85] Robert L. Bernstein. Producing good code for the case statement. *Software—Practice and Experience*, 15(10):1021–1024, October 1985. A correction, by Sampath Kannan and Todd A. Proebsting, appears in volume 24, number 2.
- [BFC95] Peter A. Buhr, Michael Fortier, and Michael H. Coffin. Monitor classification. *ACM Computing Surveys*, 27(1):63–107, March 1995.
- [BFKM86] Lee Brownston, Robert Farrell, Elaine Kant, and Nancy Martin. *Programming Expert Systems in OPS5: An Introduction to Rule-Based Programming*. Addison-Wesley, 1986.
- [BGS94] David F. Bacon, Susan L. Graham, and Oliver J. Sharp. Compiler transformations for high-performance computing. *ACM Computing Surveys*, 26(4):345–420, December 1994.
- [BHJL07] Andrew Black, Norman Hutchinson, Eric Jul, and Henry Levy. The development of the Emerald programming language. *HOPL III Proceedings [Ass07]*, pages 11-1–11-51.
- [BHPS61] Yehoshua Bar-Hillel, Micha A. Perles, and Eliahu Shamir. On formal properties of simple phrase structure grammars. *Zeitschrift für Phonetik, Sprachwissenschaft und Kommunikationsforschung*, 14:143–172, 1961.
- [BI82] Alan H. Borning and Daniel H. H. Ingalls. Multiple inheritance in Smalltalk-80. *AAAI-82: The National Conference on Artificial Intelligence*, pages 234–237, Pittsburgh, PA, August 1982.
- [BL92] Thomas Ball and James R. Larus. Optimally profiling and tracing programs. *Conference Record of the Nineteenth ACM Symposium on Principles of Programming Languages*, pages 59–70, Albuquerque, NM, January 1992.
- [BM77] Robert S. Boyer and J. Strother Moore. A fast string searching algorithm. *Communications of the ACM*, 20(10):762–772, October 1977.
- [BN84] Andrew D. Birrell and Bruce J. Nelson. Implementing remote procedure calls. *ACM Transactions on Computer Systems*, 2(1):39–59, February 1984.
- [BO03] Randal E. Bryant and David O’Hallaron. *Computer Systems: A Programmer’s Perspective*. Prentice-Hall, 2003.
- [Boe05] Hans-J. Boehm. Threads cannot be implemented as a library. *Proceedings of the SIGPLAN 2005 Conference on Programming Language Design and Implementation*, pages 261–268, Chicago, IL, June 2005.
- [BOSW98] Gilad Bracha, Martin Odersky, David Stoutamire, and Philip Wadler. Making the future safe for the past: Adding genericity to the Java programming language. *Proceedings of the Thirteenth ACM SIGPLAN Conference on Object-Oriented Programming, Systems, Languages, and Applications*, pages 183–200, Vancouver, BC, Canada, October 1998.
- [Bou78] Stephen R. Bourne. An introduction to the UNIX shell. *Bell System Technical Journal*, 57(6, Part 2):2797–2822, July–August 1978.
- [Bri73] Per Brinch Hansen. *Operating System Principles*. Prentice-Hall, 1973.
- [Bri75] Per Brinch Hansen. The programming language Concurrent Pascal. *IEEE Transactions on Software Engineering*, SE-1(2):199–207, June 1975.
- [Bri81] Per Brinch Hansen. The design of Edison. *Software—Practice and Experience*, 11(4):363–396, April 1981.
- [Bro87] Leo Brodie. *Starting FORTH: An Introduction to the FORTH Language and Operating System for Beginners and Professionals*, second edition. Prentice-Hall Software Series, 1987.
- [Bro96] Kraig Brockschmidt. How OLE and COM solve the problems of component software design. *Microsoft Systems Journal*, 11(5):63–82, May 1996.
- [BS83a] Daniel G. Bobrow and Mark J. Stefik. The LOOPS manual. Technical report, Xerox Palo Alto Research Center, 1983.

- [BS83b] G. N. Buckley and A. Silbershatz. An effective implementation for the generalized input-output construct of CSP. *ACM Transactions on Programming Languages and Systems*, 5(2):223–235, April 1983.
- [BS96] David F. Bacon and Peter F. Sweeney. Fast static analysis of C++ virtual function calls. *Proceedings of the Eleventh ACM SIGPLAN Conference on Object-Oriented Programming, Systems, Languages, and Applications*, pages 324–341, San Jose, CA, October 1996.
- [BW88] Hans-Juergen Boehm and Mark Weiser. Garbage collection in an uncooperative environment. *Software—Practice and Experience*, 18(9):807–820, September 1988.
- [CAC⁺81] Gregory Chaitin, Marc Auslander, Ashok Chandra, John Cocke, Martin Hopkins, and Peter Markstein. Register allocation via coloring. *Computer Languages*, 6(1):47–57, 1981.
- [Cai82] R. Cailliau. How to avoid getting SCHLONKED by Pascal. *ACM SIGPLAN Notices*, 17(12):31–40, December 1982.
- [Can92] David Cann. Retire Fortran? A debate rekindled. *Communications of the ACM*, 35(8):81–89, August 1992.
- [CDW04] Hao Chen, Drew Dean, and David Wagner. Model checking one million lines of C code. *Proceedings of the Network and Distributed System Security Symposium*, pages 171–185, San Diego, CA, February 2004.
- [Cer89] Paul Ceruzzi. *Beyond the Limits—Flight Enters the Computer Age*. MIT Press, 1989.
- [CF58] Haskell B. Curry and Robert Feys. *Combinatory Logic*, volume 1 of *Studies in Logic and the Foundations of Mathematics*. North-Holland, 1958. With two sections by William Craig.
- [CFR⁺91] Ronald Cytron, Jeanne Ferrante, Barry K. Rosen, Mark N. Wegman, and F. Kenneth Zadeck. Efficiently computing static single assignment form and the control dependence graph. *ACM Transactions on Programming Languages and Systems*, 13(4):451–490, October 1991.
- [Che92] Andrew Cheese. *Parallel Execution of Parlog*. Springer-Verlag, 1992.
- [Cho56] Noam Chomsky. Three models for the description of language. *IRE Transactions on Information Theory*, IT-2(3):113–124, September 1956.
- [Cho62] Noam Chomsky. Context-free grammars and push-down storage. *Quarterly Progress Report No. 65*, pages 187–194. MIT Research Laboratory for Electronics, 1962.
- [CHP71] Pierre-Jacques Courtois, F. Heymans, and David L. Parnas. Concurrent control with “readers” and “writers.” *Communications of the ACM*, 14(10):667–668, October 1971.
- [Chu41] Alonzo Church. *The Calculi of Lambda-Conversion*. Annals of Mathematical Studies #6. Princeton University Press, 1941.
- [CL83] Robert P. Cook and Thomas J. LeBlanc. A symbol table abstraction to implement languages with explicit scope control. *IEEE Transactions on Software Engineering*, SE-9(1):8–12, January 1983.
- [Cle86] J. Craig Cleaveland. *An Introduction to Data Types*. Addison-Wesley, 1986.
- [CLFL94] Jeffrey S. Chase, Henry M. Levy, Michael J. Feeley, and Edward D. Lazowska. Sharing and protection in a single-address-space operating system. *ACM Transactions on Computer Systems*, 12(4):271–307, November 1994.
- [CM84] K. Mani Chandy and Jayadev Misra. The drinking philosophers problem. *ACM Transactions on Programming Languages and Systems*, 6(4):632–646, October 1984.
- [CM03] William F. Clocksin and Christopher S. Mellish. *Programming in Prolog*, fifth edition. Springer-Verlag, 2003.
- [Coh81] Jacques Cohen. Garbage collection of linked data structures. *ACM Computing Surveys*, 13(3):341–367, September 1981.
- [Con63] Melvin E. Conway. Design of a separable transition-diagram compiler. *Communications of the ACM*, 6(7): 396–408, July 1963.
- [Cou84] Bruno Courcelle. Attribute grammars: Definitions, analysis of dependencies, proof methods. In Bernard Lorho, editor, *Methods and Tools for Compiler Construction: An Advanced Course*, pages 81–102. Cambridge University Press, 1984.
- [CR01] James H. Cross II and Eric Roberts, editors. *Computing Curricula 2001: Computer Science*. Joint Task Force on Computing Curricula, IEEE Computer Society, Association for Computing Machinery, 2001. Available at www.computer.org/portal/cms_docs_ieeecs/ieeecs/education/cc2001/cc2001.pdf.
- [CS69] John Cocke and Jacob T. Schwartz. Programming languages and their compilers: Preliminary notes. Technical report, Courant Institute of Mathematical Sciences, New York University, 1969.
- [CS98] David E. Culler and Jaswinder Pal Singh (with Anoop Gupta). *Parallel Computer Architecture: A Hardware/Software Approach*. Morgan Kaufmann, 1998.
- [CT04] Keith D. Cooper and Linda Torczon. *Engineering a Compiler*. Morgan Kaufmann, 2004.
- [CW85] Luca Cardelli and Peter Wegner. On understanding types, data abstraction, and polymorphism. *ACM Computing Surveys*, 17(4):471–522, December 1985.

- [CW05] Norman Chonacky and David Winch. Maple, Mathematica, and Matlab: The 3M's without the tape. *Computing in Science and Engineering*, 7(1):8–16, 2005. Available as csdl.computer.org/comp/mags/cs/2005/01/c1008.pdf.
- [Dar90] Jared L. Darlington. Search direction by goal failure in goal-oriented programming. *ACM Transactions on Programming Languages and Systems*, 12(2):224–252, April 1990.
- [Dav63] Martin Davis. Eliminating the irrelevant from mechanical proofs. *Proceedings of a Symposium in Applied Mathematics*, volume 15, pages 15–30. American Mathematical Society, 1963.
- [DB76] L. Peter Deutsch and Daniel G. Bobrow. An efficient incremental automatic garbage collector. *Communications of the ACM*, 19(9):522–526, September 1976.
- [DDH72] Ole-Johan Dahl, Edsger W. Dijkstra, and Charles Antony Richard Hoare. *Structured Programming*. A.P.I.C. Studies in Data Processing #8. Academic Press, 1972.
- [DeR71] Franklin L. DeRemer. Simple LR(k) grammars. *Communications of the ACM*, 14(7):453–460, July 1971.
- [DGAFS⁺80] Robert B. K. Dewar, Jr., Gerald A. Fisher, Edmond Schonberg, Robert Froehlich, Stephen Bryant, Clinton F. Goss, and Michael Burke. The NYU Ada translator and interpreter. *Proceedings of the ACM SIGPLAN Symposium on the Ada Programming Language*, pages 194–201, Boston, MA, December 1980.
- [Dij60] Edsger W. Dijkstra. Recursive programming. *Numerische Mathematik*, 2:312–318, 1960. Reprinted as pages 221–228 of *Programming Systems and Languages*, Saul Rosen, editor. McGraw-Hill, 1967.
- [Dij65] Edsger W. Dijkstra. Solution of a problem in concurrent programming control. *Communications of the ACM*, 8(9):569, September 1965.
- [Dij68a] Edsger W. Dijkstra. Co-operating sequential processes. In F. Genuys, editor, *Programming Languages*, pages 43–112. Academic Press, 1968.
- [Dij68b] Edsger W. Dijkstra. Go To statement considered harmful. *Communications of the ACM*, 11(3):147–148, March 1968.
- [Dij72] Edsger W. Dijkstra. Hierarchical ordering of sequential processes. In Charles Antony Richard Hoare and Ronald H. Perrott, editors, *Operating Systems Techniques*, A.P.I.C. Studies in Data Processing #9, pages 72–93. Academic Press, 1972. Also *Acta Informatica*, 1(8): 115–138, 1971.
- [Dij75] Edsger W. Dijkstra. Guarded commands, nondeterminacy, and formal derivation of programs. *Communications of the ACM*, 18(8):453–457, August 1975.
- [Dij76] Edsger W. Dijkstra. *A Discipline of Programming*. Prentice-Hall, 1976.
- [Dij82] Edsger W. Dijkstra. How do we tell truths that might hurt? *ACM SIGPLAN Notices*, 17(5):13–15, May 1982.
- [Dio78] Bernard A. Dion. *Locally Least-Cost Error Correctors for Context-Free and Context-Sensitive Parsers*. Ph. D. dissertation, University of Wisconsin–Madison, 1978. Computer Sciences Technical Report #344.
- [DMM96] Amer Diwan, J. Eliot B. Moss, and Kathryn S. McKinley. Simple and effective analysis of statically typed object-oriented programs. *Proceedings of the Eleventh ACM SIGPLAN Conference on Object-Oriented Programming, Systems, Languages, and Applications*, pages 292–305, San Jose, CA, October 1996.
- [Dol97] Julian Dolby. Automatic inline allocation of objects. *Proceedings of the SIGPLAN '97 Conference on Programming Language Design and Implementation*, pages 7–17, Las Vegas, NV, June 1997.
- [Dri93] Karel Driesen. Selector table indexing and sparse arrays. *Proceedings of the Eighth ACM SIGPLAN Conference on Object-Oriented Programming Systems, Languages, and Applications*, pages 259–270, Washington, DC, September 1993.
- [DRSS96] Steven Dawson, C. R. Ramakrishnan, Steven Skiena, and Terrence Swift. Principles and practice of unification factoring. *ACM Transactions on Programming Languages and Systems*, 18(5):528–563, September 1996.
- [DS84] L. Peter Deutsch and Allan M. Schiffman. Efficient implementation of the Smalltalk-80 system. *Conference Record of the Eleventh ACM Symposium on Principles of Programming Languages*, pages 297–302, Salt Lake City, UT, January 1984.
- [DSS06] Dave Dice, Ori Shalev, and Nir Shavit. Transactional locking II. *Proceedings of the Twentieth International Symposium on Distributed Computing*, pages 194–208, Stockholm, Sweden, September 2006.
- [Due05] Evelyn Duesterwald. Design and engineering of a dynamic binary optimizer. *Proceedings of the IEEE*, 93(2):436–448, February 2005.
- [Dya95] Lev J. Dyadkin. Multibox parsers: No more hand-written lexical analyzers. *IEEE Software*, 12(5):61–67, September 1995.
- [Ear70] Jay Earley. An efficient context-free parsing algorithm. *Communications of the ACM*, 13(2):94–102, February 1970.
- [ECM99] ECMA International, Geneva, Switzerland. *ECMAScript Language Specification*, third edition, December 1999. ECMA-262, ISO/IEC 16262. Available as

- www.ecma-international.org/publications/files/ECMA-ST/ECma-262.pdf.
- [ECM06] ECMA International, Geneva, Switzerland. *C# Language Specification*, fourth edition, June 2006. ECMA-334, ISO/IEC 23270. Available as www.ecma-international.org/publications/files/ECMA-ST/ECma-334.pdf.
- [Eng84] Joost Engelfriet. Attribute grammars: Attribute evaluation methods. In Bernard Lorho, editor, *Methods and Tools for Compiler Construction: An Advanced Course*, pages 103–138. Cambridge University Press, 1984.
- [Enn06] Robert Ennals. Software transactional memory should not be lock free. Technical Report IRC-TR-06-052, Intel Research Cambridge, 2006.
- [ES90] Margaret A. Ellis and Bjarne Stroustrup. *The Annotated C++ Reference Manual*. Addison-Wesley, 1990.
- [Eve63] R. James Evey. Application of pushdown store machines. *Proceedings of the 1963 Fall Joint Computer Conference*, pages 215–227, Las Vegas, NV, November 1963. AFIPS Press.
- [FCO90] John T. Feo, David Cann, and Rod R. Oldehoeft. A report on the Sisal language project. *Journal of Parallel and Distributed Computing*, 10(4):349–365, December 1990.
- [FG84] Alan R. Feuer and Narain Gehani, editors. *Comparing and Assessing Programming Languages: Ada, C, Pascal*. Prentice-Hall Software Series, 1984.
- [FH95] Christopher W. Fraser and David R. Hanson. *A Retargetable C Compiler: Design and Implementation*. Benjamin/Cummings, 1995.
- [FHA99] Eric Freeman, Susanne Hupfer, and Ken Arnold. *JavaSpaces Principles, Patterns, and Practice*. Pearson Education, 1999.
- [Fin96] Raphael A. Finkel. *Advanced Programming Language Design*. Addison-Wesley, 1996.
- [FL80] Charles N. Fischer and Richard J. LeBlanc, Jr. Implementation of runtime diagnostics in Pascal. *IEEE Transactions on Software Engineering*, SE-6(4):313–319, July 1980.
- [FL88] Charles N. Fischer and Richard J. LeBlanc, Jr. *Crafting a Compiler*. Benjamin/Cummings, 1988.
- [Fle76] Arthur C. Fleck. On the impossibility of content exchange through the by-name parameter transmission technique. *ACM SIGPLAN Notices*, 11(11):38–41, November 1976.
- [FMQ80] Charles N. Fischer, Donn R. Milton, and Sam B. Quiring. Efficient LL(1) error correction and recovery using only insertions. *Acta Informatica*, 13(2):141–54, February 1980.
- [Fos95] Ian Foster. Compositional C++. In *Debugging and Building Parallel Programs*, chapter 5, pages 167–204. Addison-Wesley, 1995. Available in hypertext at www.mcs.anl.gov/dbpp/text/node51.html.
- [Fra80] Nissim Francez. Distributed termination. *ACM Transactions on Programming Languages and Systems*, 2(1):42–55, January 1980.
- [FRF08] Pascal Felber, Torvald Riegel, and Christof Fetzer. Dynamic performance tuning of word-based software transactional memory. *Proceedings of the Thirteenth ACM SIGPLAN Symposium on Principles and Practice of Parallel Programming*, pages 237–246, Salt Lake City, UT, February 2008.
- [FSS83] Stefan M. Freudenberger, Jacob T. Schwartz, and Micha Sharir. Experience with the SETL optimizer. *ACM Transactions on Programming Languages and Systems*, 5(1):26–45, January 1983.
- [FWH01] Daniel P. Friedman, Mitchell Wand, and Christopher T. Haynes. *Essentials of Programming Languages*, second edition. MIT Press, 2001.
- [FY69] Robert R. Fenichel and Jerome C. Yochelson. A Lisp garbage collector for virtual memory computer systems. *Communications of the ACM*, 12(11):611–612, November 1969.
- [GBD⁺94] Al Geist, Adam Beguelin, Jack Dongarra, Weicheng Jiang, Robert Manchek, and Vaidyalingam S. Sunderam. *PVM: Parallel Virtual Machine: A Users' Guide and Tutorial for Networked Parallel Computing*. MIT Press, 1994. Available in hypertext at www.netlib.org/pvm3/book/pvm-book.html.
- [GBJL01] Dick Grune, Henri E. Bal, Criel J. H. Jacobs, and Koen G. Langendoen. *Modern Compiler Design*. John Wiley & Sons, 2001.
- [GDDC97] David Grove, Greg DeFouw, Jeffrey Dean, and Craig Chambers. Call graph construction in object-oriented languages. *Proceedings of the Twelfth ACM SIGPLAN Conference on Object-Oriented Programming, Systems, Languages, and Applications*, pages 108–124, Atlanta, GA, October 1997.
- [GFH82] Mahadevan Ganapathi, Charles N. Fischer, and John L. Hennessy. Retargetable compiler code generation. *ACM Computing Surveys*, 14(4):573–592, December 1982.
- [GG78] R. Steven Glanville and Susan L. Graham. A new method for compiler code generation. *Conference Record of the Fifth Annual ACM Symposium on Principles of Programming Languages*, pages 231–240, Tucson, AZ, January 1978.

- [GG96] Ralph E. Griswold and Madge T. Griswold. *The Icon Programming Language*, third edition. Peer-to-Peer Communications, 1996. Out of print; available on line at www.cs.arizona.edu/icon/lb3.htm. Previous editions published by Prentice-Hall.
- [GJL⁺03] Ronald Garcia, Jaakko Järvi, Andrew Lumsdaine, Jeremy Siek, and Jeremiah Willcock. A comparative study of language support for generic programming. *Proceedings of the Eighteenth ACM SIGPLAN Conference on Object-Oriented Programming, Systems, Languages, and Applications*, pages 115–134, Anaheim, CA, October 2003.
- [GJSB05] James Gosling, Bill Joy, Guy Steele, and Gilad Bracha. *The Java Language Specification*, third edition. Addison-Wesley, 2005. Available in hypertext at java.sun.com/docs/books/jls/.
- [GL05] Samuel Z. Guyer and Calvin Lin. Client-driven pointer analysis. *Science of Computer Programming*, 58(1–2):83–114, October 2005.
- [GLDW87] Robert A. Gingell, Meng Lee, Xuong T. Dang, and Mary S. Weeks. Shared libraries in SunOS. *Proceedings of the 1987 Summer USENIX Conference*, pages 131–145, Phoenix, AZ, June 1987.
- [GM86] Phillip B. Gibbons and Steven S. Muchnick. Efficient instruction scheduling for a pipelined architecture. *Proceedings of the SIGPLAN '86 Symposium on Compiler Construction*, pages 11–16, Palo Alto, CA, July 1986.
- [Gol84] Adele Goldberg. *Smalltalk-80: The Interactive Programming Environment*. Addison-Wesley Series in Computer Science, 1984.
- [Gol07] David Goldberg. Computer arithmetic. In Hennessy and Patterson (third edition of [HP07]), Appendix H. Available at books.elsevier.com/companions/1558605967/appendices/1558605967-appendix-h.pdf.
- [Goo75] John B. Goodenough. Exception handling: Issues and a proposed notation. *Communications of the ACM*, 18(12):683–696, December 1975.
- [Gor79] Michael J. C. Gordon. *The Denotational Description of Programming Languages: An Introduction*. Springer-Verlag, 1979.
- [GPP71] Ralph E. Griswold, J. F. Poage, and I. P. Polonsky. *The Snobol4 Programming Language*, second edition. Prentice-Hall, 1971.
- [GR62] Seymour Ginsburg and H. Gordon Rice. Two families of languages related to ALGOL. *Journal of the ACM*, 9(3):350–371, 1962.
- [GR89] Adele Goldberg and David Robson. *Smalltalk-80: The Language*. Addison-Wesley Series in Computer Science, 1989.
- [Gri81] David Gries. *The Science of Programming*. Texts and Monographs in Computer Science. Springer-Verlag, 1981.
- [GS99] Joseph (Yossi) Gil and Peter F. Sweeney. Space- and time-efficient memory layout for multiple inheritance. *Proceedings of the Fourteenth ACM SIGPLAN Conference on Object-Oriented Programming, Systems, Languages, and Applications*, pages 256–275, Denver, CO, November 1999.
- [GSB⁺93] William E. Garrett, Michael L. Scott, Ricardo Bianchini, Leonidas I. Kontothanassis, R. Andrew McCallum, Jeffrey A. Thomas, Robert Wisniewski, and Steve Luk. Linking shared segments. *Proceedings of the USENIX Winter '93 Technical Conference*, pages 13–27, San Diego, CA, January 1993.
- [GTW78] Joseph A. Goguen, James W. Thatcher, and Eric G. Wagner. An initial algebra approach to the specification, correctness, and implementation of abstract data types. In Raymond T. Yeh, editor, *Current Trends in Programming Methodology*, volume 4, pages 80–149. Prentice-Hall, 1978.
- [Gut77] John Guttag. Abstract data types and the development of data structures. *Communications of the ACM*, 20(6):396–404, June 1977.
- [GWEB83] Gerhard Goos, William A. Wulf, Arthur Evans, Jr., and Kenneth J. Butler, editors. *DIANA: An Intermediate Language for Ada*, volume 161 of *Lecture Notes in Computer Science*. Springer-Verlag, 1983.
- [Hal85] Robert H. Halstead, Jr. Multilisp: A language for concurrent symbolic computation. *ACM Transactions on Programming Languages and Systems*, 7(4):501–538, October 1985.
- [Han81] David R. Hanson. Is block structure necessary? *Software—Practice and Experience*, 11(8):853–866, August 1981.
- [Han93] David R. Hanson. A brief introduction to Icon. In *HOPL II Proceedings [Ass93]*, pages 359–360.
- [Har92] Samuel P. Harbison. *Modula-3*. Prentice-Hall, 1992.
- [HD68] E. A. Hauck and B. A. Dent. Burroughs' B6500/B7500 stack mechanism. *Proceedings of the AFIPS Spring Joint Computer Conference*, volume 32, pages 245–251, 1968. Reprinted as pages 244–250 of Siewiorek, Bell, and Newell [SBN82].
- [HD89] Robert R. Henry and Peter C. Damron. Algorithms for table-driven code generators using tree-pattern matching. Technical Report 89-02-03, Computer Science Department, University of Washington, February 1989.
- [Her91] Maurice P. Herlihy. Wait-free synchronization. *ACM Transactions on Programming Languages and Systems*, 13(1):124–149, January 1991.

- [HGLS78] Richard C. Holt, G. Scott Graham, Edward D. Lazowska, and Mark A. Scott. *Structured Concurrent Programming with Operating Systems Applications*. Addison-Wesley Series in Computer Science. Addison-Wesley, 1978.
- [HH97a] Michael Hauben and Ronda Hauben. *Netizens: On the History and Impact of Usenet and the Internet*. Wiley/IEEE Computer Society Press, 1997. Available at www.columbia.edu/~hauben/netbook/.
- [HH97b] Raymond J. Hookway and Mark A. Herdeg. DIGITAL FX132: Combining emulation and binary translation. *DIGITAL Technical Journal*, 9(1):3–12, 1997.
- [Hin01] Michael Hind. Pointer analysis: Haven't we solved this problem yet? *Proceedings of the ACM SIGPLAN–SIGSOFT Workshop on Program Analysis for Software Tools and Engineering*, pages 54–61, Snowbird, UT, June 2001.
- [HJBG81] John L. Hennessy, Norman Jouppi, Forest Baskett, and John Gill. MIPS: A VLSI processor architecture. *Proceedings of the CMU Conference on VLSI Systems and Computations*, pages 337–346. Computer Science Press, October 1981.
- [HL94] Patricia M. Hill and John W. Lloyd. *The Gödel Programming Language*. Logic Programming Series. MIT Press, 1994.
- [HLM03] Maurice Herlihy, Victor Luchangco, and Mark Moir. Obstruction-free synchronization: Double-ended queues as an example. *Proceedings of the Twenty-Third International Conference on Distributed Computing Systems*, pages 522–529, Providence, RI, May 2003.
- [HM93] Maurice P. Herlihy and J. Eliot B. Moss. Transactional memory: Architectural support for lock-free data structures. *Proceedings of the Twentieth International Symposium on Computer Architecture*, pages 289–300, San Diego, CA, May 1993.
- [HMPH05] Tim Harris, Simon Marlow, Simon Peyton Jones, and Maurice Herlihy. Composable memory transactions. *Proceedings of the Tenth ACM SIGPLAN Symposium on Principles and Practice of Parallel Programming*, pages 48–60, Chicago, IL, June 2005.
- [HMRC88] Richard C. Holt, Philip A. Matthews, J. Alan Rosselet, and James R. Cordy. *The Turing Programming Language: Design and Definition*. Prentice-Hall, 1988.
- [HMU01] John E. Hopcroft, Rajeev Motwani, and Jeffrey D. Ullman. *Introduction to Automata Theory, Languages, and Computation*, second edition. Addison-Wesley, 2001.
- [HO91] W. Wilson Ho and Ronald A. Olsson. An approach to genuine dynamic linking. *Software—Practice and Experience*, 21(4):375–390, April 1991.
- [Hoa69] Charles Antony Richard Hoare. An axiomatic basis of computer programming. *Communications of the ACM*, 12(10):576–580+, October 1969.
- [Hoa74] Charles Antony Richard Hoare. Monitors: An operating system structuring concept. *Communications of the ACM*, 17(10):549–557, October 1974.
- [Hoa75] Charles Antony Richard Hoare. Recursive data structures. *International Journal of Computer and Information Sciences*, 4(2):105–132, June 1975.
- [Hoa78] Charles Antony Richard Hoare. Communicating Sequential Processes. *Communications of the ACM*, 21(8):666–677, August 1978.
- [Hoa81] Charles Antony Richard Hoare. The emperor's old clothes. *Communications of the ACM*, 24(2):75–83, February 1981. The 1980 Turing Award lecture.
- [Hoa89] Charles Antony Richard Hoare. Hints on programming language design. In Cliff B. Jones, editor, *Essays in Computing Science*, pages 193–216. Prentice-Hall, 1989. Based on a keynote address presented at the *First ACM Symposium on Principles of Programming Languages*, Boston, MA, October 1973.
- [Hor51] Alfred Horn. On sentences which are true of direct unions of algebras. *Journal of Symbolic Logic*, 16(1):14–21, March 1951.
- [Hor87] Ellis Horowitz. *Programming Languages: A Grand Tour*, third edition. Computer Software Engineering Series. Computer Science Press, 1987.
- [HP07] John L. Hennessy and David A. Patterson. *Computer Architecture: A Quantitative Approach*, fourth edition. Morgan Kaufmann, 2007. Third edition, 2003.
- [HS08] Maurice Herlihy and Nir Shavit. *The Art of Multiprocessor Programming*. Morgan Kaufmann, 2008.
- [Hud89] Paul Hudak. Conception, evolution, and application of functional programming languages. *ACM Computing Surveys*, 21(3):359–411, September 1989.
- [HWG04] Anders Hejlsberg, Scott Wiltamuth, and Peter Golde. *The C# Programming Language*. Addison-Wesley, 2004.
- [IBFW91] Jean Ichbiah, John G. P. Barnes, Robert J. Firth, and Mike Woodger. *Rationale for the Design of the Ada Programming Language*. Cambridge University Press, 1991.
- [IBM87] IBM Corporation. *APL2 Programming: Language Reference*, 1987. SH20-9227.
- [IEE87] IEEE Standards Committee. IEEE standard for binary floating-point arithmetic. *ACM SIGPLAN Notices*, 22(2):9–25, February 1987.
- [Ing61] Peter Z. Ingerman. Thunks: A way of compiling procedure statements with some comments on procedure

- declarations. *Communications of the ACM*, 4(1):55–58, January 1961.
- [Ins91] Institute of Electrical and Electronics Engineers. *IEEE/ANSI Standard for the Scheme Programming Language*, 1991. IEEE 1178-1990. Available at standards.ieee.org/reading/ieee/std_public/description/busarch/1178-1990_desc.html.
- [Int90] International Organization for Standardization. *Information Technology—Programming Languages—Pascal*, 1990. ISO/IEC 7185:1990 (revision and redesignation of ANSI/IEEE 770X). Available as www.pascal-central.com/docs/iso7185.pdf.
- [Int95a] Intermetrics, Inc., *Ada 95 Rationale*, 1995. Available as www.adahome.com/Resources/refs/rm95.html.
- [Int95b] International Organization for Standardization. *Information Technology—Programming Languages—Ada*, 1995. ISO/IEC 8652:1995 (E). Available in hypertext at www.adahome.com/rm95/.
- [Int95c] International Organization for Standardization. *Information Technology—Programming Languages—Prolog—Part 1: General Core*, 1995. ISO/IEC 13211-1:1995.
- [Int96] International Organization for Standardization. *Information Technology—Programming Languages—Part 1: Modula-2, Base Language*, 1996. ISO/IEC 10514-1:1996.
- [Int97] International Organization for Standardization. *Programming Language Forth*, 1997. ISO/IEC 15145:1997 (revision and redesignation of ANSI X3.215–1994).
- [Int98] International Organization for Standardization. *Programming Languages—C++*, 1998. ISO/IEC 14882:1998.
- [Int99] International Organization for Standardization. *Programming Language—C*, December 1999. ISO/IEC 9899:1999(E).
- [Int02] International Organization for Standardization. *Information Technology—Programming Languages—COBOL*, 2002. ISO/IEC 1989:2002.
- [Int03a] International Organization for Standardization. *The C Rationale*, April 2003. ISO/IEC JTC 1/SC 22/WG 14, revision 5.10.
- [Int03b] International Organization for Standardization. *Information Technology—Portable Operating System Interface (POSIX)*, fourth edition, August 2003. ISO/IEC 9945-1:2003. Also IEEE standard 1003.1, 2004 Edition, and The Open Group Technical Standard Base Specifications, Issue 6. Available as www.opengroup.org/onlinepubs/009695399/.
- [Int04] International Organization for Standardization. *Information Technology—Programming Languages—Fortran—Part 1: Base Language*, November 2004. ISO/IEC FCD 1539-1:2004(E).
- [Int06] International Organization for Standardization. *Information Technology—Common Language Infrastructure (CLI)*, October 2006. ISO/IEC 23271:2006(E). Also ECMA-335, fourth edition, 2006. Available at www.ecma-international.org/publications/standards/Ecma-335.htm.
- [Ive62] Kenneth E. Iverson. *A Programming Language*. John Wiley and Sons, 1962.
- [JG89] Geraint Jones and Michael Goldsmith. *Programming in occam2*, second edition. Prentice-Hall International Series in Computer Science, 1989.
- [JGF96] Simon Peyton Jones, Andrew Gordon, and Sigbjorn Finne. Concurrent Haskell. *Proceedings of the Twenty-Third ACM Symposium on Principles of Programming Languages*, pages 295–308, St. Petersburg Beach, FL, January 1996.
- [JL96] Richard Jones and Rafael Lins. *Garbage Collection: Algorithms for Automatic Dynamic Memory Management*. John Wiley and Sons, 1996.
- [JM94] Joxan Jaffar and Michael J. Maher. Constraint logic programming: A survey. *Journal of Logic Programming*, 20:503–581, May–July 1994.
- [Joh75] Stephen C. Johnson. Yacc—Yet another compiler compiler. Technical Report 32, Computing Science, AT&T Bell Laboratories, 1975.
- [JOR75] Mehdi Jazayeri, William F. Ogden, and William C. Rounds. The intrinsically exponential complexity of the circularity problem for attribute grammars. *Communications of the ACM*, 18(12):697–706, December 1975.
- [Jor85] Harry F. Jordan. HEP architecture, programming and performance. In Janusz S. Kowalik, editor, *Parallel MIMD Computation: The HEP Supercomputer and Its Applications*, pages 1–40. MIT Press, 1985.
- [JPARG68] Walter L. Johnson, James H. Porter, Stephanie I. Ackley, and Douglas T. Ross. Automatic generation of efficient lexical processors using finite state techniques. *Communications of the ACM*, 11(12):805–813, December 1968.
- [JW91] Kathleen Jensen and Niklaus Wirth. *Pascal User Manual and Report: ISO Pascal Standard*, fourth edition. Springer-Verlag, 1991. Revised by Andrew B. Mickel and James F. Miner. ISBN 0-387-97649-3.
- [Kas65] T. Kasami. An efficient recognition and syntax analysis algorithm for context-free languages. Technical Report AFCRL-65-758, Air Force Cambridge Research Laboratory, 1965.

- [Kee89] Sonya E. Keene (with contributions by Dan Gerson.). *Object-Oriented Programming in Common Lisp: A Programmer's Guide to CLOS*. Addison-Wesley, 1989.
- [Kep04] Stephan Kepser. A simple proof for the Turing-completeness of XSLT and XQuery. *Proceedings, Extreme Markup Languages 2004*, Montréal, Canada, August 2004. Available as www.mulberrytech.com/Extreme/Proceedings/html/2004/Kepser01/EML2004Kepser01.html.
- [Ker81] Brian W. Kernighan. Why Pascal is not my favorite programming language. Technical Report 100, Computing Science, AT&T Bell Laboratories, 1981. Reprinted as pages 170–186 of Feuer and Gehani [FG84].
- [Kes77] J. L. W. Kessels. An alternative to event queues for synchronization in monitors. *Communications of the ACM*, 20(7):500–503, July 1977.
- [KKR⁺86] David Kranz, Richard Kelsey, Jonathan Rees, Paul Hudak, James Philbin, and Norman Adams. ORBIT: An optimizing compiler for Scheme. *Proceedings of the SIGPLAN'86 Symposium on Compiler Construction*, pages 219–233, Palo Alto, CA, June 1986.
- [Kle56] Stephen C. Kleene. Representation of events in nerve nets and finite automata. In Claude E. Shannon and John McCarthy, editors, *Automata Studies*, number 34 in Annals of Mathematical Studies, pages 3–41. Princeton University Press, 1956.
- [KMP77] Donald E. Knuth, James H. Morris, and Vaughan R. Pratt. Fast pattern matching in strings. *SIAM Journal of Computing*, 6(2):323–350, June 1977.
- [Knu65] Donald E. Knuth. On the translation of languages from left to right. *Information and Control*, 8(6):607–639, December 1965.
- [Knu68] Donald E. Knuth. Semantics of context-free languages. *Mathematical Systems Theory*, 2(2):127–145, June 1968. Correction appears in Volume 5, pages 95–96.
- [Knu84] Donald E. Knuth. Literate programming. *The Computer Journal*, 27(2):97–111, May 1984.
- [Knu86] Donald E. Knuth. *The TeXbook*. Addison-Wesley, 1986.
- [Kor94] David G. Korn. ksh: An extensible high level language. *Proceedings of the USENIX Very High Level Languages Symposium*, pages 129–146, Santa Fe, NM, October 1994.
- [KP76] Brian W. Kernighan and Phillip J. Plauger. *Software Tools*. Addison-Wesley, 1976.
- [KP78] Brian W. Kernighan and Phillip J. Plauger. *The Elements of Programming Style*, second edition. McGraw-Hill, 1978.
- [KR88] Brian W. Kernighan and Dennis M. Ritchie. *The C Programming Language*, second edition. Prentice-Hall, 1988.
- [Krá73] Jaroslav Král. The equivalence of modes and the equivalence of finite automata. *ALGOL Bulletin*, 35:34–35, March 1973.
- [KS01] Andrew Kennedy and Don Syme. Design and implementation of generics for the .NET Common Language Runtime. *Proceedings of the SIGPLAN 2001 Conference on Programming Language Design and Implementation*, pages 1–12, Snowbird, UT, June 2001.
- [KWS97] Leonidas I. Kontothanassis, Robert Wisniewski, and Michael L. Scott. Scheduler-conscious synchronization. *ACM Transactions on Computer Systems*, 15(1):3–40, February 1997.
- [Lam78] Leslie Lamport. Time, clocks, and the ordering of events in a distributed system. *Communications of the ACM*, 21(7):558–565, July 1978.
- [Lam87] Leslie Lamport. A fast mutual exclusion algorithm. *ACM Transactions on Computer Systems*, 5(1):1–11, February 1987.
- [Lam94] Leslie Lamport. *LaTeX: A Document Preparation System*, second edition. Addison-Wesley Professional, 1994.
- [LCM⁺05] Chi-Keung Luk, Robert Cohn, Robert Muth, Harish Patil, Artur Klauser, Geoff Lowney, Steven Wallace, Vijay Janapa Reddi, and Kim Hazelwood. Pin: Building customized program analysis tools with dynamic instrumentation. *Proceedings of the SIGPLAN 2005 Conference on Programming Language Design and Implementation*, pages 190–200, Chicago, IL, June 2005.
- [Lee06] Edward A. Lee. The problem with threads. *Computer*, 39(5):33–42, May 2006.
- [Les75] Michael E. Lesk. Lex—A lexical analyzer generator. Technical Report 39, Computing Science, AT&T Bell Laboratories, 1975.
- [LG86] Barbara Liskov and John Guttag. *Abstraction and Specification in Program Development*. MIT Press, 1986.
- [LH89] Kai Li and Paul Hudak. Memory coherence in shared virtual memory systems. *ACM Transactions on Computer Systems*, 7(4):321–359, November 1989.
- [LHL⁺77] Butler W. Lampson, J. J. Horning, R. L. London, J. G. Mitchell, and G. J. Popek. Report on the programming language Euclid. *ACM SIGPLAN Notices*, 12(2):1–79, February 1977.
- [LK08] James Larus and Christos Kozyrakis. Transactional memory. *Communications of the ACM*, 51(7):80–88, July 2008.

- [Llo87] John W. Lloyd. *Foundations of Logic Programming*, second edition. Springer-Verlag, 1987.
- [Lom75] David B. Lomet. Scheme for invalidating references to freed storage. *IBM Journal of Research and Development*, 19(1):26–35, January 1975.
- [Lom85] David B. Lomet. Making pointers safe in system programming languages. *IEEE Transactions on Software Engineering*, SE–11(1):87–96, January 1985.
- [Lou03] Kenneth C. Louden. *Programming Languages: Principles and Practice*, second edition. Brooks/Cole–Thomson Learning, 2003.
- [LP80] David C. Luckam and W. Polak. Ada exception handling: An axiomatic approach. *ACM Transactions on Programming Languages and Systems*, 2(2):225–233, April 1980.
- [LR80] Butler W. Lampson and David D. Redell. Experience with processes and monitors in Mesa. *Communications of the ACM*, 23(2):105–117, February 1980.
- [LR06] James R. Larus and Ravi Rajwar. *Transactional Memory*, volume 2 of *Synthesis Lectures on Computer Architecture*. Morgan & Claypool Publishers, 2006.
- [LRS74] Philip M. Lewis II, Daniel J. Rosenkrantz, and Richard E. Stearns. Attributed translations. *Journal of Computer and System Sciences*, 9(3):279–307, December 1974.
- [LS68] Philip M. Lewis II and Richard E. Stearns. Syntax-directed transduction. *Journal of the ACM*, 15(3):465–488, July 1968.
- [LS79] Barbara Liskov and Alan Snyder. Exception handling in CLU. *IEEE Transactions on Software Engineering*, SE–5(6):546–558, November 1979.
- [LS83] Barbara Liskov and Robert Scheifler. Guardians and actions: Linguistic support for robust, distributed programs. *ACM Transactions on Programming Languages and Systems*, 5(3):381–404, July 1983.
- [LSAS77] Barbara Liskov, Alan Snyder, Russel Atkinson, and J. Craig Schaffert. Abstraction mechanisms in CLU. *Communications of the ACM*, 20(8):564–576, August 1977.
- [LT02] Rasmus Lerdorf and Kevin Tatroe. *Programming PHP*. O’Reilly and Associates, 2002.
- [LY99] Tim Lindholm and Frank Yellin. *The Java Virtual Machine Specification*, second edition. Prentice Hall PTR, 1999. Available at java.sun.com/docs/books/jvms/.
- [Mac77] M. Donald MacLaren. Exception handling in PL/I. In David B. Wortman, editor, *Proceedings of an ACM Conference on Language Design for Reliable Software*, pages 101–104, Raleigh, NC, 1977.
- [MAE⁺65] John McCarthy, Paul W. Abrahams, Daniel J. Edwards, Timothy P. Hart, and Michael I. Levin. *LISP 1.5 Programmer’s Manual*, second edition. MIT Press, 1965. Available as www.softwarepreservation.org/projects/LISP/book/LISP%201.5%20Programmers%20Manual.pdf.
- [Mai90] Harry G. Mairson. Deciding ML typability is complete for deterministic exponential time. *Conference Record of the Seventeenth Annual ACM Symposium on Principles of Programming Languages*, pages 382–401, San Francisco, CA, January 1990.
- [Mas76] John R. Mashey. Using a command language as a high-level programming language. *Proceedings of the Second International IEEE Conference on Software Engineering*, pages 169–176, San Francisco, CA, October 1976.
- [Mas87] Henry Massalin. Superoptimizer: A look at the smallest program. *Proceedings of the Second International Conference on Architectural Support for Programming Languages and Operating Systems*, pages 122–126, Palo Alto, CA, October 1987.
- [McC60] John McCarthy. Recursive functions of symbolic expressions and their computation by machine, Part I. *Communications of the ACM*, 3(4):184–195, April 1960.
- [McG82] James R. McGraw. The VAL language: Description and analysis. *ACM Transactions on Programming Languages and Systems*, 4(1):44–82, January 1982.
- [McK04] Kathryn S. McKinley, editor. *20 Years of the ACM SIGPLAN Conference on Programming Language Design and Implementation, 1979–1999*. ACM Press, 2004. Also *ACM SIGPLAN Notices*, 39(4), April 2004.
- [MCS91] John M. Mellor-Crummey and Michael L. Scott. Algorithms for scalable synchronization on shared-memory multiprocessors. *ACM Transactions on Computer Systems*, 9(1):21–65, February 1991.
- [Mey92a] Bertrand Meyer. Applying “design by contract.” *IEEE Computer*, 25(10):40–51, October 1992.
- [Mey92b] Bertrand Meyer. *Eiffel: The Language*. Prentice-Hall, 1992.
- [MF08] Jacob Matthews and Robert Bruce Findler. An operational semantics for Scheme. *Journal of Functional Programming*, 18(1):47–86, 2008.
- [MGA92] Margaret Martonosi, Anoop Gupta, and Thomas Anderson. MemSpy: Analyzing memory system bottlenecks in programs. *Proceedings of the 1992 ACM SIGMETRICS Joint International Conference on Measurement and Modeling of Computer Systems*, pages 1–12, Newport, RI, June 1992.

- [Mic89] Greg Michaelson. *An Introduction to Functional Programming through Lambda Calculus*. International Computer Science Series. Addison-Wesley, 1989.
- [Mic04] Microsoft Corporation. *Microsoft Visual Basic Language Reference*, 1991. Document DB20664-0491.
- [Maged] Maged Michael. Scalable lock-free dynamic memory allocation. *Proceedings of the SIGPLAN 2004 Conference on Programming Language Design and Implementation*, pages 35–46, Washington, DC, June 2004.
- [Mil78] Robin Milner. A theory of type polymorphism in programming. *Journal of Computer and System Sciences*, 17(3):348–375, December 1978.
- [MKH91] Eric Mohr, David A. Kranz, and Robert H. Halstead, Jr. Lazy task creation: A technique for increasing the granularity of parallel programs. *IEEE Transactions on Parallel and Distributed Systems*, 2(3):264–280, July 1991.
- [MLB76] Michael Marcotty, Henry F. Ledgard, and Gregor V. Bochmann. A sampler of formal definitions. *ACM Computing Surveys*, 8(2):191–276, June 1976.
- [MM08] Virendra J. Marathe and Mark Moir. Toward high performance nonblocking software transactional memory. *Proceedings of the Thirteenth ACM SIGPLAN Symposium on Principles and Practice of Parallel Programming*, pages 227–236, Salt Lake City, UT, February 2008.
- [Moo78] David A. Moon. *MacLisp Reference Manual*. MIT Artificial Intelligence Laboratory, 1978.
- [Moo86] David A. Moon. Object-oriented programming with Flavors. *OOPSLA '86 Conference Proceedings: Object-Oriented Programming Systems, Languages, and Applications*, pages 1–8, Portland, OR, September 1986.
- [Mor70] Howard L. Morgan. Spelling correction in systems programs. *Communications of the ACM*, 13(2):90–94, 1970.
- [MOSS96] Stephan Murer, Stephen Omohundro, David Stoutamire, and Clemens Szyperski. Iteration abstraction in Sather. *ACM Transactions on Programming Languages and Systems*, 18(1):1–15, January 1996.
- [MPA05] Jeremy Manson, William Pugh, and Sarita V. Adve. The Java memory model. *Proceedings of the Thirty-Second ACM Symposium on Principles of Programming Languages*, pages 378–391, Long Beach, CA, January 2005.
- [MR96] Michael Metcalf and John Reid. *Fortran 90/95 Explained*. Oxford University Press, 1996.
- [MR04] James S. Miller and Susann Ragsdale. *The Common Language Infrastructure Annotated Standard*. Addison-Wesley, 2004. Based on ECMA-335, 2nd Edition, 2002.
- [MS98] Maged M. Michael and Michael L. Scott. Nonblocking algorithms and preemption-safe locking on multiprogrammed shared memory multiprocessors. *Journal of Parallel and Distributed Computing*, 51:1–26, 1998.
- [MTHM97] Robin Milner, Mads Tofte, Robert Harper, and David MacQueen. *The Definition of Standard ML—Revised*. MIT Press, 1997.
- [Muc97] Steven S. Muchnick. *Advanced Compiler Design and Implementation*. Morgan Kaufmann, 1997.
- [MYD95] Bruce J. McKenzie, Corey Yeatman, and Lorraine De Vere. Error repair in shift-reduce parsers. *ACM Transactions on Programming Languages and Systems*, 17(4):672–689, July 1995.
- [NA01] Rishiyur S. Nikhil and Arvind. *Implicit Parallel Programming in pH*. Morgan Kaufmann, 2001.
- [NBB⁺63] Peter Naur (ed.), J. W. Backus, F. L. Bauer, J. Green, C. Katz, J. McCarthy, A. J. Perlis, H. Rutishauser, K. Samelson, B. Vauquois, J. H. Wegstein, A. van Wijngaarden, and M. Woodger. Revised report on the algorithmic language ALGOL 60. *Communications of the ACM*, 6(1):1–23, January 1963. Original version appeared in the May 1960 issue.
- [ND78] Kristen Nygaard and Ole-Johan Dahl. The development of the Simula languages. *HOPL I Proceedings* [Wex78], pages 439–493.
- [Nec97] George C. Necula. Proof-carrying code. *Conference Record of the Twenty-Fourth ACM Symposium on Principles of Programming Languages*, pages 106–119, Paris, France, January 1997.
- [Nel65] Theodor Holm Nelson. Complex information processing: A file structure for the complex, the changing, and the indeterminate. *Proceedings of the Twentieth ACM National Conference*, pages 84–100, Cleveland, OH, August 1965.
- [Osk08] Mark Oskin. The revolution inside the box. *Communications of the ACM*, 51(7):70–78, July 2008.
- [Ous82] John K. Ousterhout. Scheduling techniques for concurrent systems. *Proceedings of the Third International Conference on Distributed Computing Systems*, pages 22–30, Miami/Ft. Lauderdale, FL, October 1982.
- [Ous94] John K. Ousterhout. *Tcl and the Tk Toolkit*. Addison-Wesley Professional, 1994.
- [Ous98] John K. Ousterhout. Scripting: Higher-level programming for the 21st century. *IEEE Computer*, 31(3):23–30, March 1998.
- [Pag76] Frank G. Pagan. *A Practical Guide to Algol 68*. John Wiley and Sons, 1976.
- [Par72] David L. Parnas. On the criteria to be used in decomposing systems into modules. *Communications of the ACM*, 15(12):1053–1058, December 1972.

- [Pat85] David A. Patterson. Reduced instruction set computers. *Communications of the ACM*, 28(1):8–21, January 1985.
- [PD80] David A. Patterson and David R. Ditzel. The case for the reduced instruction set computer. *ACM SIGARCH Computer Architecture News*, 8(6):25–33, October 1980.
- [PD07] Larry L. Peterson and Bruce S. Davie. *Computer Networks: A Systems Approach*, fourth edition. Morgan Kaufmann, 2007.
- [Pet81] Gary L. Peterson. Myths about the mutual exclusion problem. *Information Processing Letters*, 12(3):115–116, June 1981.
- [Pey87] Simon L. Peyton Jones. *The Implementation of Functional Programming Languages*. Prentice-Hall, 1987.
- [Pey92] Simon L. Peyton Jones. Implementing lazy functional languages on stock hardware: The Spinless Tagless G-machine. *Journal of Functional Programming*, 2(2):127–202, 1992.
- [Pey01] Simon Peyton Jones. Tackling the Awkward Squad: Monadic input/output, concurrency, exceptions, and foreign-language calls in Haskell. In Tony Hoare, Manfred Broy, and Ralf Steinbruggen, editors, *Engineering Theories of Software Construction*, pages 47–96. IOS Press, 2001. Originally presented at the *Marktoberdorf Summer School*, 2000. Revised and corrected version available at research.microsoft.com/~simonpj/papers/marktoberdorf/mark.pdf.
- [Pey03] Simon L. Peyton Jones, editor. *Haskell 98 Language and Libraries: The Revised Report*. Cambridge University Press, 2003. Available at haskell.org/definition/.
- [PH08] David A. Patterson and John L. Hennessy. *Computer Organization and Design: The Hardware-Software Interface*, fourth edition. Morgan Kaufmann, 2008.
- [Pie02] Benjamin C. Pierce. *Types and Programming Languages*. MIT Press, 2002.
- [PQ95] Terrence J. Parr and R. W. Quong. ANTLR: A predicated-LL(*k*) parser generator. *Software—Practice and Experience*, 25(7):789–810, July 1995.
- [Pug00] William Pugh. The Java memory model is fatally flawed. *Concurrency—Practice and Experience*, 12(6):445–455, May 2000.
- [Rad82] George Radin. The 801 minicomputer. *Proceedings of the First International Symposium on Architectural Support for Programming Languages and Operating Systems*, pages 39–47, Palo Alto, CA, March 1982.
- [Ram87] S. Ramesh. A new efficient implementation of CSP with output guards. *Proceedings of the Seventh International Conference on Distributed Computing Systems*, pages 266–273, Berlin, West Germany, September 1987.
- [Rep84] Thomas Reps. *Generating Language-Based Environments*. MIT Press, 1984. Winner of the 1983 ACM Doctoral Dissertation Award.
- [RF93] B. Ramakrishna Rau and Joseph A. Fisher. Instruction-level parallel processing: History, overview, and perspective. *Journal of Supercomputing*, 7(1/2):9–50, May 1993.
- [Rob65] John Alan Robinson. A machine-oriented logic based on the resolution principle. *Journal of the ACM*, 12(1):23–41, January 1965.
- [Rob83] John Alan Robinson. Logic programming—past, present, and future. *New Generation Computing*, 1(2):107–124, 1983.
- [RR64] Brian Randell and Lawford J. Russell, editors. *ALGOL 60 Implementation: The Translation and Use of ALGOL 60 Programs on a Computer*. A.P.I.C. Studies in Data Processing #5. Academic Press, 1964.
- [RS59] Michael O. Rabin and Dana S. Scott. Finite automata and their decision problems. *IBM Journal of Research and Development*, 3(2):114–125, 1959.
- [RS70] Daniel J. Rosenkrantz and Richard E. Stearns. Properties of deterministic top-down grammars. *Information and Control*, 17(3):226–256, October 1970.
- [RT88] Thomas Reps and Timothy Teitelbaum. *The Synthesizer Generator: A System for Constructing Language-Based Editors*. Springer-Verlag, 1988.
- [Rub87] Frank Rubin. ‘GOTO considered harmful’ considered harmful. *Communications of the ACM*, 30(3):195–196, March 1987. Further correspondence appears in Volume 30, Numbers 6, 7, 8, 11, and 12.
- [Rut67] Heinz Rutishauser. *Description of ALGOL 60*. Springer-Verlag, 1967.
- [RW92] Martin Reiser and Niklaus Wirth. *Programming in Oberon—Steps Beyond Pascal and Modula*. Addison-Wesley, 1992.
- [SBG⁺91] Robert E. Strom, David F. Bacon, Arthur P. Goldberg, Andy Lowry, Daniel M. Yellin, and Shaula Alexander Yemini. *Hermes: A Language for Distributed Computing*. Prentice-Hall, 1991.
- [SBN82] Daniel P. Siewiorek, C. Gordon Bell, and Allen Newell. *Computer Structures: Principles and Examples*. McGraw-Hill, 1982.
- [Sch03] Sven-Bodo Scholz. Single assignment C—Efficient support for high-level array operations in a functional setting. *Journal of Functional Programming*, 13(6):1005–1059, 2003.

- [SCK⁺93] Richard L. Sites, Anton Chernoff, Matthew B. Kirk, Maurice P. Marks, and Scott G. Robinson. Binary translation. *Communications of the ACM*, 36(2):69–81, February 1993.
- [Sco91] Michael L. Scott. The Lynx distributed programming language: Motivation, design, and experience. *Compiler Languages*, 16(3/4):209–233, 1991.
- [SDB84] Mayer D. Schwartz, Norman M. Delisle, and Vimal S. Begwani. Incremental compilation in Magpie. *Proceedings of the SIGPLAN '84 Symposium on Compiler Construction*, pages 122–131, Montreal, Quebec, Canada, June 1984.
- [SDDS86] Jacob T. Schwartz, Robert B. K. Dewar, Ed Dubinsky, and Edmond Schonberg. *Programming with Sets: An Introduction to SETL*. Texts and Monographs in Computer Science. Springer-Verlag, 1986.
- [SDF⁺07] Michael Sperber, R. Kent Dybvig, Matthew Flatt, Anton van Straaten, Richard Kelsey, William Clinger, Jonathan Rees, Robert Bruce Findler, and Jacob Matthews. *Revised⁶ Report on the Algorithmic Language Scheme*, September 2007. Available at www.r6rs.org/.
- [SE94] Amitabh Srivastava and Alan Eustace. ATOM: A system for building customized program analysis tools. *Proceedings of the SIGPLAN 1994 Conference on Programming Language Design and Implementation*, pages 196–205, Orlando, FL, June 1994.
- [Seb08] Robert W. Sebesta. *Concepts of Programming Languages*, eighth edition. Pearson/Addison-Wesley, 2008.
- [Set96] Ravi Sethi. *Programming Languages: Concepts and Constructs*, second edition. Addison-Wesley, 1996.
- [SF80] Marvin H. Solomon and Raphael A. Finkel. A note on enumerating binary trees. *Journal of the ACM*, 27(1):3–5, January 1980.
- [SF88] Michael L. Scott and Raphael A. Finkel. A simple mechanism for type security across compilation units. *IEEE Transactions on Software Engineering*, SE-14(8):1238–1239, August 1988.
- [SFL⁺94] Ioannis Schoinas, Babak Falsafi, Alvin R. Lebeck, Steven K. Reinhardt, James R. Larus, and David A. Wood. Fine-grain access control for distributed shared memory. *Proceedings of the Sixth International Conference on Architectural Support for Programming Languages and Operating Systems*, pages 297–306, San Jose, CA, October 1994.
- [SG96] Daniel J. Scales and Kourosh Gharachorloo. Shasta: A low overhead, software-only approach for supporting fine-grain shared memory. *Proceedings of the Seventh International Conference on Architectural Support for Programming Languages and Operating Systems*, pages 174–185, Cambridge, MA, October 1996.
- [SGC07] Don Syme, Adam Granicz, and Antonio Cisternino. *Expert F#*. Apress, 2007.
- [SH92] A. S. M. Sajeev and A. John Hurst. Programming persistence in χ . *IEEE Computer*, 25(9):57–66, September 1992.
- [SHC96] Zoltan Somogyi, Fergus Henderson, and Thomas Conway. The execution algorithm of Mercury: An efficient purely declarative logic programming language. *Journal of Logic Programming*, 29(1–3):17–64, October–December 1996.
- [Sie96] Jon Siegel. *CORBA Fundamentals and Programming*. John Wiley and Sons, 1996.
- [Sip97] Michael Sipser. *Introduction to the Theory of Computation*. PWS Publishing Company, 1997.
- [Sit72] Richard L. Sites. Algol W reference manual. Technical Report STAN-CS-71-230, Computer Science Department, Stanford University, February 1972.
- [SMC91] Joel H. Saltz, Avi Mirchandaney, and Kay Crowley. Run-time parallelization and scheduling of loops. *IEEE Transactions on Computers*, 40(5):603–612, May 1991.
- [SOHL⁺98] Marc Snir, Steve Otto, Steven Huss-Lederman, David Walker, Jack Dongarra, William Gropp, Andrew Lumsdaine, Ewing Lusk, Bill Nitzberg, and William Saphir. *MPI: The Complete Reference*, second edition. MIT Press, 1998. Two-volume set. First edition available in hypertext at www.netlib.org/utk/papers/mpi-book/mpi-book.html.
- [Sri95] Raj Srinivasan. RPC: Remote procedure call protocol specification version 2. Internet Request for Comments #1831, August 1995. Available as www.rfc-archive.org/getrfc.php?rfc=1831.
- [SS71] Dana S. Scott and Christopher Strachey. Toward a mathematical semantics for computer language. In Jerome Fox, editor, *Proceedings, Symposium on Computers and Automata*, pages 19–46. Polytechnic Institute of Brooklyn Press, 1971.
- [SS89] Richard Snodgrass and Karen P. Shannon. *The Interface Description Language: Definition and Use*. Computer Science Press, 1989.
- [Sta92] Ryan D. Stansifer. *ML Primer*. Prentice-Hall, 1992.
- [Sta95] Ryan D. Stansifer. *The Study of Programming Languages*. Prentice-Hall, 1995.
- [Ste90] Guy L. Steele Jr. *Common Lisp—The Language*, second edition. Digital Press, 1990. Available in hypertext at www.cs.cmu.edu/Groups/AI/html/cltl/cltl2.html.

- [Sto77] Joseph E. Stoy. *Denotational Semantics: The Scott-Strachey Approach to Programming Language Semantics*, volume 1. MIT Press, 1977.
- [Str97] Bjarne Stroustrup. *The C++ Programming Language*, third edition. Addison-Wesley, 1997. Second edition, 1991.
- [Sun90] Vaidyalingam S. Sunderam. PVM: A framework for parallel distributed computing. *Concurrency—Practice and Experience*, 2(4):315–339, December 1990.
- [Sun97] Sun Microsystems. *JavaBeans*, August 1997. Version 1.01-A. Available at java.sun.com/javase/technologies/desktop/javabeans/docs/spec.html.
- [Sun02] Sun Microsystems. *The Java HotSpot Virtual Machine, v1.4.1, d2*, September 2002. Available at java.sun.com/products/hotspot/docs/whitepaper/Java_Hotspot.v1.4.1/Java_HSspot_WP.v1.4.1.1002.1.html.
- [Sun04] Håkan Sundell. *Efficient and Practical Non-Blocking Data Structures*. Ph.D. dissertation, Department of Computing Science, Chalmers University of Technology and Göteborg University, 2004. Available as www.cs.chalmers.se/~tsigas/papers/Haakan-Thesis.pdf.
- [SW67] Herbert Schorr and William M. Waite. An efficient machine-independent procedure for garbage collection in various list structures. *Communications of the ACM*, 10(8):501–506, August 1967.
- [SW94] James E. Smith and Shlomo Weiss. PowerPC 601 and Alpha 21064: A tale of two RISCs. *IEEE Computer*, 27(6):46–58, June 1994.
- [SZBH86] Daniel C. Swinehart, Polle T. Zellweger, Richard J. Beach, and Robert B. Hagmann. A structural view of the Cedar programming environment. *ACM Transactions on Programming Languages and Systems*, 8(4):419–490, October 1986.
- [Tan78] Andrew S. Tanenbaum. A comparison of Pascal and ALGOL 68. *The Computer Journal*, 21(4):316–323, November 1978.
- [Tan02] Andrew S. Tanenbaum. *Computer Networks*, fourth edition. Prentice-Hall, 2002.
- [TFH04] Dave Thomas, Chad Fowler, and Andy Hunt. *Programming Ruby—The Pragmatic Programmer’s Guide*, second edition. The Pragmatic Programmers, LLC, 2004. First edition (2001) available in hypertext at www.rubycentral.com/book/.
- [Tho95] Tom Thompson. Building the better virtual CPU. *Byte*, 20(8):149–150, August 1995.
- [Tic86] Walter F. Tichy. Smart recompilation. *ACM Transactions on Programming Languages and Systems*, 8(3):273–291, July 1986.
- [TM81] Warren Teitelman and Larry Masinter. The Interlisp programming environment. *IEEE Computer*, 14(4):25–33, April 1981.
- [TR81] Timothy Teitelbaum and Thomas Reps. The Cornell Program Synthesizer: A syntax-directed programming environment. *Communications of the ACM*, 24(9):563–573, September 1981.
- [Tre86] R. Kent Treiber. Systems programming: Coping with parallelism. Technical Report RJ 5118, IBM Almaden Research Center, April 1986.
- [Tur86] David A. Turner. An overview of Miranda. *ACM SIGPLAN Notices*, 21(12):158–166, December 1986.
- [TWGM07] Fuad Tabba, Cong Wang, James R. Goodman, and Mark Moir. NZTM: Nonblocking zero-indirection transactional memory. *Second ACM SIGPLAN Workshop on Transactional Computing*, Portland, OR, August 2007. Available as www.cs.rochester.edu/meetings/TRANSACT07/papers/tabba.pdf.
- [UKGS94] Ronald C. Unrau, Orran Krieger, Benjamin Gamsa, and Michael Stumm. Experiences with locking in a NUMA multiprocessor operating system kernel. *Proceedings of the First USENIX Symposium on Operating Systems Design and Implementation*, pages 139–152, Monterey, CA, November 1994.
- [Ull85] Jeffrey D. Ullman. Implementation of logical query languages for databases. *ACM Transactions on Database Systems*, 10(3):289–321, September 1985.
- [Uni03] University of Chicago Press Staff. *The Chicago Manual of Style*, fifteenth edition. University of Chicago Press, 2003. Available in hypertext at www.chicagomanualofstyle.org/home.html.
- [US91] David Ungar and Randall B. Smith. SELF: The power of simplicity. *Lisp and Symbolic Computation*, 4(3):187–205, July 1991.
- [UW97] Jeffrey D. Ullman and Jennifer Widom. *A First Course in Database Systems*. Prentice-Hall, 1997.
- [VF82] Thomas R. Virgilio and Raphael A. Finkel. Binding strategies and scope rules are independent. *Computer Languages*, 7(2):61–67, 1982.
- [VF94] Jack E. Veenstra and Robert J. Fowler. Mint: A front end for efficient simulation of shared-memory multiprocessors. *Proceedings of the Second International Workshop on Modeling, Analysis and Simulation of Computer and Telecommunication Systems*, pages 201–207, Durham, NC, January 1994.
- [vMP⁺75] A. van Wijngaarden, B. J. Mailloux, J. E. L. Peck, C. H. A. Koster, M. Sintzoff, C. H. Lindsey, L. G. L. T.

- Meertens, and R. G. Fisker. Revised report on the algorithmic language ALGOL 68. *Acta Informatica*, 5(1–3):1–236, 1975. Also *ACM SIGPLAN Notices*, 12(5):1–70, May 1977.
- [vRD03] Guido van Rossum and Fred L. Drake, Jr. (Editor). *The Python Language Reference Manual*. Network Theory, Ltd., 2003.
- [Wad98a] Philip Wadler. An angry half-dozen. *ACM SIGPLAN Notices*, 33(2):25–30, February 1998. NB: table of contents on cover of issue is incorrect.
- [Wad98b] Philip Wadler. Why no one uses functional languages. *ACM SIGPLAN Notices*, 33(8):23–27, August 1998.
- [Wat77] David Anthony Watt. The parsing problem for affix grammars. *Acta Informatica*, 8(1):1–20, 1977.
- [WCO00] Larry Wall, Tom Christiansen, and Jon Orwant. *Programming Perl*, third edition. O’Reilly and Associates, 2000.
- [Web89] Fred Webb. Fortran story—The real scoop. Submitted to `alt.folklore.computers`, 1989. Quoted by Mark Brader in the ACM *RISKS* on-line forum, volume 9, issue 54, December 12, 1989.
- [Weg90] Peter Wegner. Concepts and paradigms of object-oriented programming. *OOPS Messenger*, 1(1):7–87, August 1990. Expanded version of the keynote address from *OOPSLA ’89*.
- [Wet78] Horst Wettstein. The problem of nested monitor calls revisited. *ACM Operating Systems Review*, 12(1):19–23, January 1978.
- [Wex78] Richard L. Wexelblat, editor. *Proceedings of the ACM SIGPLAN History of Programming Languages (HOPL) Conference*, Los Angeles, CA, June 1978. ACM Monograph Series, Academic Press, 1981.
- [WH66] Niklaus Wirth and Charles Antony Richard Hoare. A contribution to the development of ALGOL. *Communications of the ACM*, 9(6):413–431, June 1966.
- [WHA03] Damien Watkins, Mark Hammond, and Brad Abrams. *Programming in the .NET Environment*. Addison-Wesley, 2003.
- [Wil92a] Paul R. Wilson. Pointer swizzling at page fault time: Efficiently and compatibly supporting huge address spaces on standard hardware. *Proceedings of the International Workshop on Object Orientation in Operating Systems*, pages 364–377, Paris, France, September 1992.
- [Wil92b] Paul R. Wilson. Uniprocessor garbage collection techniques. *Proceedings of the International Workshop on Memory Management*, volume 637 of *Lecture Notes in Computer Science*, pages 1–42. Springer-Verlag, 1992. Workshop held at St. Malo, France, September 1992. Expanded version available as <ftp://ftp.cs.utexas.edu/pub/garbage/bigsurv.ps>.
- [Wir71] Niklaus Wirth. The programming language Pascal. *Acta Informatica*, 1(1):35–63, 1971.
- [Wir76] Niklaus Wirth. *Algorithms + Data Structures = Programs*. Prentice-Hall, 1976.
- [Wir77a] Niklaus Wirth. Design and implementation of Modula. *Software—Practice and Experience*, 7(1):67–84, January–February 1977.
- [Wir77b] Niklaus Wirth. Modula: A language for modular multiprogramming. *Software—Practice and Experience*, 7(1):3–35, January–February 1977.
- [Wir80] Niklaus Wirth. The module: A system structuring facility in high-level programming languages. In Jeffrey M. Tobias, editor, *Language Design and Programming Methodology*, volume 79 of *Lecture Notes in Computer Science*, pages 1–24. Springer-Verlag, 1980. Proceedings of a symposium held at Sydney, Australia, September 1979.
- [Wir85a] Niklaus Wirth. From programming language design to computer construction. *Communications of the ACM*, 28(2):159–164, February 1985. The 1984 Turing Award lecture.
- [Wir85b] Niklaus Wirth. *Programming in Modula-2*, third, corrected edition. Texts and Monographs in Computer Science. Springer-Verlag, 1985.
- [Wir88a] Niklaus Wirth. From Modula to Oberon. *Software—Practice and Experience*, 18(7):661–670, July 1988.
- [Wir88b] Niklaus Wirth. The programming language Oberon. *Software—Practice and Experience*, 18(7):671–690, July 1988.
- [Wir88c] Niklaus Wirth. Type extensions. *ACM Transactions on Programming Languages and Systems*, 10(2):204–214, April 1988. Relevant correspondence appears in Volume 13, Number 4.
- [Wir07] Niklaus Wirth. Modula-2 and Oberon. *HOPL III Proceedings* [Ass07], pages 3–1–3–10.
- [WJ93] Paul R. Wilson and Mark S. Johnstone. Real-time non-copying garbage collection. *OOPSLA ’93 Workshop on Memory Management and Gargage Collection*, Washington, DC, September 1993.
- [WJH03] Brent B. Welch, Ken Jones, and Jeffrey Hobbs. *Practical Programming in Tcl and Tk*, fourth edition. Prentice-Hall, 2003. Sample chapters from previous editions available on line at www.beedub.com/book/.
- [WLAG93] Robert Wahbe, Steven Lucco, Thomas E. Anderson, and Susan L. Graham. Efficient software-based fault isolation. *Proceedings of the Fourteenth ACM Symposium*

- on *Operating Systems Principles*, pages 203–216, Asheville, NC, December 1993.
- [WM95] Reinhard Wilhelm and Dieter Maurer. *Compiler Design*. Addison-Wesley, 1995. Translated from the German by Stephen S. Wilson.
- [WMWM87] Janet H. Walker, David A. Moon, Daniel L. Weinreb, and Mike McMahon. The Symbolics Genera programming environment. *IEEE Software*, 4(6):36–45, November 1987.
- [Wol96] Michael Wolfe. *High Performance Compilers for Parallel Computing*. Addison-Wesley, 1996.
- [Wor05] World Wide Web Consortium. *Character Model for the World Wide Web 1.0: Fundamentals*, February 2005. Available as www.w3.org/TR/charmod/.
- [Wor06] World Wide Web Consortium. *Extensible Stylesheet Language (XSL) Version 1.1*, December 2006. Available as www.w3.org/TR/xsl/.
- [Wor07a] World Wide Web Consortium. *XML Path Language (XPath) 2.0*, January 2007. Available as www.w3.org/TR/xpath20/.
- [Wor07b] World Wide Web Consortium. *XSL Transformations (XSLT) Version 2.0*, January 2007. Available as www.w3.org/TR/xslt20/.
- [WSH77] Jim Welsh, W. J. Sneeringer, and Charles Antony Richard Hoare. Ambiguities and insecurities in Pascal. *Software—Practice and Experience*, 7(6):685–696, November–December 1977.
- [YA93] Jae-Heon Yang and James H. Anderson. Fast, scalable synchronization with minimal hardware support (extended abstract). *Proceedings of the Twelfth Annual ACM Symposium on Principles of Distributed Computing*, pages 171–182, Ithaca, NY, August 1993.
- [You67] Daniel H. Younger. Recognition and parsing of context-free languages in time n^3 . *Information and Control*, 10(2):189–208, February 1967.
- [YTEM04] Junfeng Yang, Paul Twohey, Dawson Engler, and Madanlal Musuvathi. Using model checking to find serious file system errors. *Proceedings of the Sixth USENIX Symposium on Operating Systems Design and Implementation*, pages 273–288, San Francisco, CA, December 2004.
- [Zho96] Neng-Fa Zhou. Parameter passing and control stack management in Prolog implementation revisited. *ACM Transactions on Programming Languages and Systems*, 18(6):752–779, November 1996.
- [ZRA⁺08] Qin Zhao, Rodric Rabbah, Saman Amarasinghe, Larry Rudolph, and Weng-Fai Wong. How to do a million watchpoints: Efficient debugging using dynamic instrumentation. *Proceedings of the Seventeenth International Conference on Compiler Construction*, pages 147–162, Budapest, Hungary, March 2008.

This page intentionally left blank

Index

In each entry, pages in the main text are listed first, followed by pages on the PLP CD. The “ff” designation indicates that coverage continues on following pages.

680x0 architecture, 792
 endian-ness, 374; © 69
 two-address instructions, © 75

A

A-list. *See* association list
ABA problem, 640
Abelson, Harold (Hal), 173, 543, 724
absolute addressing mode, © 85
absolutes. *See also* hints
 monitor signals as, 621ff
abstract syntax tree. *See* syntax tree, abstract
Abstract Window Toolkit for Java, 687; © 153
abstraction, 7, 15, 111ff, 173, 279, 288, 293ff, 381, 383, 451. *See also* control abstraction; data abstraction
 and coercion, 312
 definition, 111, 112
 fault containment, 451
 with generics, 414
 lambda, © 239
 procedural, 219
 and reflection, 800
 stack as example, 133
abstraction-based view of types, 293
accessors, in C#, 437, 455
acknowledgment message, © 270ff
action routine, 29, 176, 191ff, 196; © 20
 bottom-up evaluation, 195

 and error recovery, © 8, © 11ff
 and management of attribute space, © 49ff
 and semantic stack, © 57
activation record. *See* stack frame
Active Server Pages, Microsoft (ASP), 651, 682
ActiveX, 499, 775
actual parameter. *See* parameters, actual
ad hoc polymorphism, 151. *See also* overloading
ad hoc translation scheme, 191
Ada, 7, 11, 278, 287, 819. *See also* Ada 83/95/2005
 accept statement, © 264, © 273
 access (pointer) types, 345ff, 349ff, 357
 aggregates, 233, 302, 349, 508
 arrays, 312, 326ff, 329, 403; © 52
 dynamic, 332ff
 bounded buffer example, 625; © 273ff
 cactus stacks, 432
 case of letters, 44
 case statement, 279
 coercion, 148, 311
 concurrency. *See also* Ada, tasks
 constants, 116
 declaration syntax, © 58
 delay alternative in select statement, © 274
 denotational semantics, 210
 dereferencing, automatic, 351

 elaboration, 122
 entries, © 263
 enumeration types, 298
 erroneous program, 32, 399, 613
 exception handling, 419, 448
 exit statement, 269
 exponentiation, 224
 fixed point types, 296, 374
 floating-point constants, 103
 for loop, 315
 function return value, 409
 garbage collection, 358
 generics, 149, 411ff
 goto statement, 242
 history, 9, 123
 I/O, 404; © 159ff
 in-line subroutines, 391
 intermediate form, 736; © 303ff
 limited extent of local objects, © 209
 mod operator, 374
 and Modula-3, 825
 nested subroutines, 124
 new operation, 350
 numeric types, 313
 NYU interpreter, 210
 operator functions, 147, 221
 overloading, 146ff, 298
 packages (modules), 135, 454, 461
 hierarchical (nested), © 44
 packed types, 321
 parameter passing, 142, 394, 398ff, 404ff, 441, 447; © 279ff

- Ada (*continued*)
- pointers. *See* Ada, **access** (pointer) types
 - precedence levels, 223
 - private** type, 414
 - receive** operation, © 272
 - records, 312, 321
 - rem** operator, 374
 - remote invocation, © 268
 - rendezvous, © 278
 - repeat** loop, lack of, 268
 - scope resolution, 125
 - scope rules, 129, 131, 385
 - select** statement, © 273
 - separate compilation, 161; © 39
 - set types, lack of, 344
 - short-circuit evaluation, 240, 250
 - side effects in functions, 247
 - strings, 316, 343
 - subrange types, 298
 - subtypes, 299, 306, 315
 - synchronization, 624
 - tasks (threads), 12, 122, 399, 428, 586, 590, 592ff
 - terminate** alternative in **select** statement, © 274, © 284
 - type attributes, 378, 404, 414
 - type checking, 179, 291, 303, 306, 311
 - type constraint, 299
 - type conversion, 308
 - type declarations, incomplete, 349
 - unchecked_conversion**, 309
 - unchecked** pragma, 66; © 165
 - variables as values, 226
 - variant records, © 140, © 143ff, © 165ff
- Ada 83, 11, 123
- access** (pointer) types, 345, 378
 - message passing, 624; © 273
 - packages (modules), 133
 - parameter modes, 398
 - subroutines as parameters, lack of, 154, 401
- Ada 95, 123, 819
- access all** (pointer) types, 345, 378
 - aliased** objects, 378
 - class-wide types, 481
 - dangling references, 357, 378
 - first-class subroutines, 157
 - garbage collection, 358
 - GNU compiler (**gnat**), 446, 736; © 306
 - method binding, 480, 498
 - multibyte characters, 45
 - object initialization, 472ff
 - parameter modes, 398
 - protected objects, 624; © 273
 - subroutines as parameters, 401, 410
 - synchronization, 624ff
 - type extension (objects), 138, 450, 467ff, 491, 493
 - variables as values, 472
 - visibility of class members, 468
- Ada 2005
- interface classes, 482; © 224
 - method call syntax, 468
- address space organization, 744ff
- addresses
- of array elements, 338ff
 - assignment to names by assembler, 749ff
 - as a data format, © 68
 - and pointers, 345
 - segments and, 745
 - virtual and physical, 113
- addressing mode, © 75ff, © 85, © 91, © 103
- displacement, © 75
- for global variables, © 88
 - loop unrolling and, © 356
 - on MIPS, © 85
 - and peephole optimization, © 327
 - in position-independent code, © 312, © 317
 - for records, 319
 - with respect to display element, 389
 - with respect to **fp**, 117, 125, 384; © 170, © 175
 - with respect to **sp**, © 173, © 175, © 331
- indexed, 340; © 75
- register indirect, © 75, © 85
- scaled index, © 85
- Adobe Systems, Inc., 657, 677, 826
- Adve, Sarita V., 612, 645, 647
- aggregate, 302, 315
- for array, 338
 - in assignment, © 144
 - in functional programming, 508ff
 - for initialization, 233, 354
 - lambda expression as, 512
 - for linked structure, 349
 - for list, 366
 - in scripting languages, 707
- ahead-of-time (AOT) compilation, 765
- Aho, Alfred V., 39, 211, 664, 759
- AIDA, © 303
- Algol, 7, 85, 111. *See also* Algol 60; Algol 68
- declarations, 131
 - forward references, © 30
 - history, 6
 - if** construct, 222, 281
 - nested subroutines, 124
 - own** (**static**) variables, 124, 133
 - scope rules, 124, 131, 135
 - short-circuit evaluation, lack of, 281
 - void** (empty) type, 301
- Algol 60, 242, 821
- call-by-name parameters, 402; © 185ff
 - function return value, 409
 - goto** statement, 243, 426
 - I/O, © 154
 - if** construct, 108, 229, 248
 - label parameters, 244; © 186
 - loops, 256, 261
 - parameter passing, 244, 275, 402, 426; © 185ff
 - recursion, 447
 - and Simula, 828
 - switch** construct, 242
 - type system, 293
- Algol 68, 294, 821
- assignment, 229
 - assignment operators, 230
 - concurrency, 576, 590
 - conformity clause, © 142
 - dangling references, 356, 357
 - elaboration, 122
 - function return value, 409
 - if** construct, 248
 - label parameters, 244; © 186
 - nondeterminacy (collateral execution), © 115
 - orthogonality, 228, 301

- parameter passing, 244, 402; © 186
- pointers, 345, 378
- references, 400
- semaphores, 617
- statements and expressions, 229, 246
- structures (records), 317ff
- threads, 428
- type checking, 303, 377
- type system, 381
- unions (variant records), 324; © 140, © 141, © 143
- variables as references, 226
- Algol W, 177, 287, 294, 821
 - case statement, 242, 251
 - parameter passing, 396
 - while loop, 268
- alias, 144ff, 368, 707
 - and code improvement, 354; © 332, © 336, © 346
 - definition, 144
 - Fortran equivalence statement, © 141
 - pointers, 144, 145, 354
 - reference parameters, 144, 395, 404, 474; © 279
 - references in C++, 400
 - with statement, © 136
- alias analysis, 145, 179; © 334
- alias type. *See* type, alias
- aliased objects in Ada 95, 378
- alignment, 231, 310, 320, 322, 323, 335, 749; © 68, © 145, © 155
 - of HPF array, 591
- Allen, Frances E., 335
- Allen, Randy, © 355, © 378
- alloca (stack allocation) routine, © 209
- Alpern, Bowen, © 377
- Alpha architecture, 608, 793, 796; © 109
- alpha conversion, © 240
- alphabet of a formal language, 100; © 13ff, © 18
- alternation, 43, 44, 55ff, 100ff, 219
- Alto personal computer, 619
- ambiguity
 - in context-free grammar, 49ff, 84
 - predict-predict conflict, 81
 - shift-reduce conflict, 91
- AMD Corp., 22; © 83, © 84
- AMD64 architecture, © 84, © 103
- America On-Line (AOL), 677
- American National Standards Institute (ANSI), 207, 724, 821–823, 826, 827
- AND parallelism, 636, 645
- Andrews, Gregory R., 647, 828
- annotations
 - in Java and C#, 804ff
 - in RTL, © 309
 - in semantic analysis. *See* parse tree, decoration of; syntax tree, decoration of
- anonymous type. *See* type, anonymous
- ANSI. *See* American National Standards Institute
- anthropomorphism in object-oriented languages, 471, 492ff
- anti-dependence, © 94
- ANTLR (parser generator), 69, 71; © 6
- AOLserver, 677
- Apache Byte Code Engineering Library (BCEL), 802
- Apache web server, 651
- APL, 330, 668, 821
 - arrays, 403
 - dynamic, 335
 - precedence, 224
 - scope rules, 122, 140
- Appel, Andrew W., 39, 211, 543, 759; © 377
- Apple, Inc., 493, 674, 825
 - 68000 emulator, 792, 816
 - Rosetta binary translator, 791, 793, 795
 - XCode, 25
- AppleScript, 650, 652, 677ff
- applet, in Java, 686ff
- applicative-order evaluation, 275ff, 284, 288, 521ff, 534, 575; © 242
- apply function in Lisp/Scheme, 518ff
- apt, 806
- Apt, Krzysztof R., © 284
- Arabic numerals, 41
- architecture, 213ff; © 65ff. *See also* CISC; RISC; specific architectures
 - instruction set, © 75ff
 - MIPS as example, © 84ff
- multiprocessors, 581ff
- processor implementation and, 786; © 78ff
 - x86 as example, © 84ff
- arguments, 29, 33, 116, 383. *See also* parameters, actual
 - encapsulation in object closure, 489
 - evaluation order, 236ff, 275ff, 521ff, 634, 645
 - generic, 411ff
 - in lambda calculus, 534; © 239ff
 - space management, 387ff
 - type checking, 307, 310
 - variable number of, 14, 406ff, 762
 - variable size, 332, 384
- Argus, © 154
- Aries binary translator, 793
- arithmetic operations. *See also* associativity; overflow; precedence
 - in Prolog, 551ff
- arithmetic, computer, © 69ff
- ARM architecture, 585, 796; © 102ff, © 108
 - 16-bit extensions, © 105
 - condition codes, © 77
- Armstrong, Joe, 544, 823
- Arnold, Matthew, 816
- arrays, 325ff
 - address calculations, 338ff
 - allocation, 330ff
 - associative, 326, 706
 - bounds, 326, 330ff, 341
 - checking, 29, 179, 331, 340, 352ff
 - component type, 326
 - as composite type, 300
 - conformant, 331ff, 403
 - declaration of, 326ff
 - dimensions, 330ff
 - dynamic, 333ff
 - element type, 326
 - full-array operations, 329
 - index type, 326
 - memory layout, 335ff. *See also* row-major layout; column-major layout; dope vector
 - multidimensional, 327, 335ff, 708
 - operations, 326ff
 - ragged, 337

- arrays (*continued*)
 - shape, 312, 330ff
 - slices, 328ff, 668; © 366
 - syntax, 326ff
 - ASCII character set (American Standard Code for Information Interchange)
 - .ascii assembler directive, 749
 - and bit sets, 344, 345
 - and Postscript, 738
 - in Prolog, 560, 566
 - and Unicode, 294, 295; © 292
 - ASM byte code framework (ObjectWeb), 802
 - assembler, 6, 15, 24, 734, 746ff, 759
 - address assignment, 749ff
 - directives, 749
 - instruction emission, 748ff
 - macros, 159
 - assembly language, 5ff, 19ff, 33ff, 111, 177, 241, 403, 735, 746ff; © 79
 - pseudo-assembly notation, 214
 - and types, 290ff
 - assertions, 145, 178ff
 - in extended regular expressions, 697, 700, 723
 - assignment, 12, 118, 224ff, 368ff; © 52.
 - See also* side effect; reference model of variables; value model of variables
 - of aggregates, 508
 - of arrays, 329
 - associativity, 224
 - deep, 369ff
 - denotational definition, 293
 - expressions, 107, 224ff
 - of function return values, 408
 - and initialization, 233ff, 473ff
 - in Lisp, 352, 677
 - in ML, 351, 540
 - multiway, 232, 708
 - operators, 230ff
 - and orthogonality, 229
 - of pointers, 346, 358
 - of records, 321; © 143
 - redundant, © 342
 - reverse assignment, 485
 - reversible, © 112
 - in Scheme, 267, 515ff
 - shallow, 369ff
 - in Smalltalk, © 228
 - of strings, 343
 - in Tcl, 670
 - type checking, 310, 313ff
 - type inference, 314
 - of variant records, © 165
 - Association for Computing Machinery (ACM), 39. *See also* Turing Award
 - association list, 514; © 33ff
 - and closures, 157
 - dynamic scoping and, 143, 695
 - associative arrays, 326, 665
 - associativity, 184, 279, 280
 - of assignment, 232
 - of caches, © 92
 - in CFG, 28, 50, 88, 180
 - and code improvement, © 334
 - definition, 50
 - in lambda calculus, © 239
 - of operators, 220, 222ff, 235; © 228
 - AST (abstract syntax tree). *See* syntax tree, abstract
 - atom
 - in Lisp, 348, 364ff
 - in logic programming, 546ff, 564
 - ATOM binary rewriter, 796, 816
 - atomic operation, 578, 602ff, 612, 614ff, 629
 - attribute, 32, 176ff, 181; © 304
 - in C#, 805ff
 - evaluation, 182ff
 - inherited, 184ff, 249ff; © 50ff
 - space management, 196ff; © 49ff
 - ad hoc, © 57
 - synthesized, 183ff, 249, 281
 - attribute evaluator, 194
 - attribute flow, 176, 182ff, 186ff. *See also*
 - attribute grammar, L-attributed; attribute grammar, S-attributed
 - attribute grammar, 3, 176, 180ff, 249
 - code generation example, 738ff
 - copy rule, 181
 - decoration (annotation), 182ff
 - error handling, 199
 - L-attributed, 188ff, 249
 - noncircular, 187
 - and one-pass compilation, 189ff
 - S-attributed, 183, 188ff
 - semantic function, 181ff
 - for syntax trees, 197ff
 - translation scheme, 187
 - type checking example, 197ff
 - well-defined, 187
 - attribute stack, 196; © 49ff
 - bottom-up, 196; © 49ff
 - and parse tree, © 54
 - top-down, 196; © 54ff
 - auto-increment/decrement addressing mode, © 327
 - AutoCAD, 677
 - automata theory, 100ff, 284, 378; © 13ff
 - automaton
 - deterministic, 42, 377, 699, 702; © 13
 - finite, 53, 91, 100, 699, 702; © 13ff.
 - See also* finite automaton Scheme example, 519ff
 - push-down, 42, 100; © 18ff
 - Turing machine, 506
 - available expression, © 341, © 373
 - awk, 7, 12, 650, 664ff, 826
 - associative arrays, 665ff
 - capitalization example, 665ff
 - fields, 665ff
 - hash (associative array) types, 706
 - HTML header extraction example, 664ff
 - regular expressions, 46, 696
 - standardization, 654
 - AWT. *See* Abstract Window Toolkit for Java
 - axiom of choice, © 257
 - axiomatic semantics. *See* semantics, axiomatic
 - axioms, in logic programming, 546
 - Aycock, John, 816
- ## B
- back end
 - of a compiler, 26, 32, 36, 99, 177, 729ff, 738; © 306ff. *See also* code generation; code improvement
 - of a simulator, © 207
 - backoff, in synchronization, 605
 - backtrace, 810, 815
 - backtracking, 539, 552ff, 570; © 112

- Icon generators, 824; © 112
 - and parallelization, 636
 - Prolog search, 552ff, 558ff, 575
 - in recursive descent, © 123
 - Backus, John W., 47, 110, 542, 543, 823
 - Backus-Naur Form, 47ff, 79, 110, 821; © 304
 - extended, 47
 - backward chaining in logic languages, 552, 575
 - backward compatibility
 - C and C++, 475, 485
 - CISC instruction sets, © 103
 - and dynamic linking, 754
 - Java generics, 418; © 195
 - multibyte characters, 45, 295
 - scoping in Perl 5, 694
 - separate compilation in C, 161
 - x86 architecture, © 68, © 84, © 86, © 105
 - XHTML, © 288ff
 - Bacon, David F., 499; © 378
 - bag of tasks model of concurrency, 586, 596; © 366
 - Bagrodia, Rajiv L., © 284
 - Bala, Vasanth, 816
 - Ball, Thomas, 813, 816
 - Banerjee, Utpal, © 378
 - Bar-Hillel, Yehoshua, 110
 - Barendregt, Hendrik Pieter, 543
 - barrier
 - in garbage collection, 364
 - in relaxed memory model, 611, 770
 - in RTL, © 309
 - synchronization mechanism, 604, 606ff, 618
 - Barton, Clara, © 288
 - base (parent) type of subrange, 298
 - base (universe) type of set, 344
 - base class. *See* class, base
 - bash** (Bourne again shell), 12, 656ff
 - the #! convention, 661
 - built-in commands, 658
 - functions, 661
 - heredocs, 659
 - loops, 657
 - pipes and redirection, 658ff
 - quoting and expansion, 660ff
 - tests, queries, and conditions, 657ff
 - Basic, 7, 8, 821. *See also* Visual Basic
 - arrays, 403
 - comments, performance and, 19
 - exponentiation, 15
 - goto statement, 7
 - scope rules, 123
 - type system, 293
 - basic block, 730, 791; © 96, © 321, © 328ff, © 336ff
 - definition, © 96
 - profiling, 813, 816
 - basis of a set of LR items, 89ff, 94
 - batch processing, © 11, © 154
 - scripting, 655
 - BCD. *See* binary-coded decimal
 - BCEL (Apache Byte Code Engineering Library), 802
 - Beck, Leland L., 759
 - Bell Telephone Laboratories, 8, 668, 821, 822, 825, 828; © 40
 - Bell, C. Gordon, © 109
 - Bernstein, Arthur J., © 284
 - Bernstein, Robert L., 287
 - best fit algorithm, 119
 - beta abstraction, © 243, © 245
 - beta reduction, © 240
 - BIB_TEX, © 299, © 301
 - big-endian byte order. *See* endian-ness
 - bignums (arbitrary precision integers), 705
 - binary integers, as a data format, © 68
 - binary rewriting, 764, 784, 795ff
 - for debugging, 808
 - binary search, 253ff, 279, 283, 425
 - binary translation, 764, 784, 791ff, 816
 - binary-coded decimal (BCD)
 - arithmetic, 296; © 89
 - binding, 3, 112ff, 114. *See also* binding rules; binding time; closure; names; scope
 - of array shape, 330ff, 403ff
 - of communication channel to remote procedure, 597
 - definition, 112
 - dynamic, 114; © 34
 - of exception handlers, 419
 - and extent, 157
 - late, 17, 23, 113, 153, 291
 - of methods. *See* method binding
 - name lookup in Lisp, © 35
 - of names within a scope, 144ff
 - overloading, 146ff
 - polymorphism, 148ff
 - in Prolog, 553, 569
 - of referencing environment. *See* binding rules
 - in Scheme, 512ff
 - and scope rules, 121ff
 - static, 114
 - and storage management, 114ff
- binding rules, 122, 151ff, 154. *See also* closure, subroutine
 - deep, 123, 153ff
 - and dynamic scoping, 152ff
 - shallow, 123, 153
 - and static scoping, 154
- binding time, 112ff, 154
- Birtwistle, Graham M., 448
- bison**, 72. *See also* yacc
- Black, Andrew, 380
- Blizzard, 288
- block (syntactic unit), 7, 129
 - definition, 122, 246
 - and exception handling, 420ff
 - nested, 131ff, 141, 142, 167, 691, 721
 - in Ruby, 676
 - in Smalltalk, © 228ff
- block copy operation, 322
- blocking (of process/thread), 580, 587, 598ff, 614ff; © 266ff, © 281. *See also* synchronization, scheduler-based
 - definition, 608
- BMP (Basic Multilingual Plane of Unicode), 295
- BNF. *See* Backus-Naur Form
- Bobrow, Daniel G., 381
- Bochmann, Gregor V., 211
- body
 - of Horn clause, 546, 549
 - of lambda abstraction, © 242
 - of lambda expression, 511
 - of loop, 46, 256ff, 261, 268ff, 284; © 229, © 346ff, © 356
 - of module, 137, 460ff; © 39
 - of object method, 482, 626

- body (*continued*)
 - of remote procedure, 597. *See also* entry, of a message-passing program
 - of structured statement, 93; ©276
 - of subroutine, 392, 408; ©1, ©40, ©131
 - Boehm, Hans-Juergen, 381, 647
 - Boolean type. *See* type, Boolean
 - bootstrapping, 21ff, 765, 790
 - Borning, Alan H., 499
 - bottom-up parsing. *See* parsing, bottom-up
 - bound variable in lambda expression, ©240
 - bounded buffer, 616ff
 - in Ada 83; ©273ff
 - in Ada 95, 625
 - with conditional critical regions, 625
 - in Erlang, ©276, ©277ff
 - in Java, 627
 - and message passing, ©271
 - with monitors, 620
 - in Occam, ©274ff
 - with semaphores, 618
 - in SR, ©276, ©278
 - with transactional memory, 630
 - bounds
 - of array, 330ff, 341
 - of loop, 256ff
 - Bourne, Stephen R., 656, 724
 - boxing, 228ff, 279
 - Boyer, Robert S., 723
 - Bracha, Gilad, 447
 - branch delay, 391; ©94ff, ©352
 - branch instruction, 241; ©66, ©76ff, ©91ff
 - and basic block, ©96, ©321, ©328
 - computed target, 791
 - conditional, 248, 257ff; ©76ff, ©79, ©105
 - delayed, 749; ©93, ©95, ©96, ©106, ©175, ©326
 - in MIPS architecture, ©77, ©88, ©175
 - nullifying, ©89, ©95, ©354
 - in partial execution trace, 796
 - pipelining and, ©94ff
 - in position-independent code, ©312, ©317
 - relative v. absolute, 748
 - in x86 architecture, 748; ©77, ©89
 - branch penalty, ©96
 - branch prediction, 250; ©92, ©96, ©99, ©106, ©352, ©354
 - for object-oriented languages, 498
 - breakpoints, 807ff
 - Brinch Hansen, Per, 619, 624
 - broadcast, 584
 - of monitor condition, 622
 - Bryant, Randal E., ©109
 - Buckley, G. N., ©284
 - buddy system, 120
 - buffer overflow attack, 353; ©179
 - buffering for messaging passing, ©268ff
 - Buhr, Peter A., 648
 - built-in commands in the shell, 658
 - built-in objects. *See* predefined objects
 - built-in type. *See* type, built-in
 - bus, ©66
 - busy-wait synchronization. *See* synchronization, busy-wait
 - Butler, Kenneth J., 759
 - bypassing, in relaxed memory model, 611
 - Byron, Countess Ada Augusta, 424
 - byte code, 797. *See also* Common Language Infrastructure, Common Intermediate Language; Java Virtual Machine, byte code; P-code Common Lisp, 790 Perl, 790
 - byte code engineering library (Apache BCEL), 802
 - byte order. *See* endian-ness
- C**
- C, 7, 8, 11, 27ff, 287, 821. *See also* C99
 - = and ==, 230, 280
 - % (modulo) operator, 374
 - aggregates, 233, 302, 508
 - anachronisms, ©6
 - arithmetic overflow, 37, 238
 - arrays, 312, 326ff, 332, 340, 352, 376
 - memory layout, 337
 - as parameters, 354, 403
 - assignment, 224, 229
 - assignment operators, 230
 - bit fields, 321
 - Boolean type, lack of, 229, 294
 - break statement, 269
 - calling sequence on MIPS, 390; ©173ff
 - case of letters, 44
 - casts, 301, 309
 - coercion, 148, 311
 - compilers, 20, 759. *See also* gcc
 - concurrent programming, 12, 588
 - conditional expression, 222
 - constants, 116, 398
 - dangling references, 356
 - declarations, 354, 383, 398; ©50, ©58
 - dereference (*, ->) operators, 351
 - dynamic semantic checks, lack of, 309; ©151
 - enumeration types, 297
 - for loop, 261
 - forward references, ©30
 - free routine, 120, 356
 - function return value, 409
 - garbage collection, lack of, 346
 - history, 123; ©40
 - I/O, ©155, ©159ff, ©166
 - if statement, 394
 - implementation, 20
 - increment/decrement operators, 222, 231
 - initialization, 234
 - initializers. *See* C, aggregates as an intermediate form, 20, 23, 757
 - iterator emulation, 267
 - machine dependence, 111
 - macros, 159, 171
 - malloc routine, 350
 - nested blocks, 167
 - nested subroutines, lack of, ©172
 - nonconverting type cast, 310
 - numeric constants, 102
 - numeric types, 294, 374
 - orthogonality, 301
 - overloading, 146ff
 - parameter passing, 394ff, 399, 406
 - variable number of arguments, 406
 - pointer arithmetic, 231, 352

- pointers, 145, 345ff, 349ff, 378
 - and arrays, 15, 312, 341, 352ff, 396
 - to nonheap objects, © 137
- post-test (do) loop, 269
- precedence levels, 223
- printf**, 19
- references to subroutines, 402ff, 410
- run-time system, 761
- scope rules, 122, 129, 131
- separate compilation, 133, 161, 753
- setjmp** routine, 426ff
- short-circuit evaluation, 241
- sizeof** operator, 355
- statements and expressions, 160, 229
- static variables, 124, 133
- strings, 102, 343ff, 374
- structures, 312, 317ff
 - memory layout, 323
- subroutine calling sequence, 390;
 - © 173ff
- subroutines as parameters, 154
- switch** statement, 254ff
- syntax errors, 99
- tokens, 28, 43
- type cast (conversion), 301, 309
- type checking, 38, 291, 303
- type declarations, incomplete, 349
- type pun, 310
- type system, 301, 318
- typedef**, 318
- undefined behavior, 32
- unions (variant records), 144, 324;
 - © 140, © 143, © 165
- variables as values, 226
- void** (empty) type, 301
- void*** (universal reference) type, 313
- volatile** variables, 427
- C++, 7, 12, 14, 822. *See also* C
 - arithmetic overflow, 238
 - arrays, 337, 376
 - associative, 326, 327
 - assignment, 235
 - v. initialization, 473ff
 - binary methods, 139
 - and C, 475, 493
 - casts, 309, 484ff
 - classes, 138. *See also* C++, objects
 - nested, 465
 - coercion, 148, 312
 - comments, nested, 52
 - compiler, as preprocessor, 21
 - constructors. *See* C++, objects,
 - initialization
 - copy constructor, 15, 473
 - declarations, 131
 - delete** operation, 120, 356
 - destructors, 356, 453, 477ff
 - exception handling, 419
 - friends**, 464
 - function objects, 158
 - generics. *See* C++, templates
 - I/O, © 161ff
 - implementation, 20, 486
 - inline** subroutines, 391ff
 - interface class, © 218
 - iterator objects, 262ff, 265
 - memory model, 613, 629
 - method binding, 480
 - multibyte characters, 45
 - multiple inheritance, 459, 491;
 - © 215ff
 - ambiguity resolution, © 218
 - name mangling, 753, 759
 - namespace** mechanism, 133, 139;
 - © 42
 - and .NET, 776
 - new** operation, 115, 289, 350
 - numeric types, 295
 - objects, 450ff, 493, 495
 - initialization, 235, 453, 470ff, 475
 - operator functions, 147, 221, 456;
 - © 162
 - overloading, 146ff
 - parameter passing, 142, 399ff, 405ff.
 - See also* C++, references
 - variable number of arguments, 406
- pointers, 345ff
 - to methods, © 232
- precedence levels, 223
- references, 115, 226, 327, 399ff, 446,
 - 456
- run-time type identification, 814
- scope resolution, 125
- scope rules, 129, 189
- sets, 344
- streams, © 162ff
- strings, 343
- structures, 318
- subscript ([]) operator, 327
- templates (generics), 149ff, 411ff,
 - 415ff, 457, 487; © 127, © 189ff
- this**, 451
- type cast (conversion), 309, 484ff
- type checking, 484
 - for separate compilation, 753
- type system, 318
- typeid**, 814
- variables as values, 472
- vector** class, 335
- virtual** methods, 480, 814
- visibility of class members, 454, 463ff,
 - 468ff, 497
- C99, 123, 821
 - backslash character escapes, 343ff
 - _Bool** type, 229
 - comments, nested, 52
 - _Complex** type, 295
 - declarations, 131
 - dynamic shape arrays, 332ff
 - inline** subroutines, 391ff
 - multibyte characters, 45
 - numeric types, 299
 - restrict** qualifier, 145
 - strict aliasing, 145
- C#, 821. *See also* C# 3.0; Common
 - Language Infrastructure; .NET
 - accessors, 437, 455
 - arithmetic overflow, 238, 309
 - arrays, 337
 - associative, 327
 - as** operator, 485
 - attributes, 805ff
 - base**, 459
 - bool** type, 230
 - boxing, 228
 - capitalization, 45
 - casts, 314, 485
 - classes, 138. *See also* C#, objects
 - nested, 465
 - constants, 116
 - decimal type, 296
 - declarations, 131
 - definite assignment, 29, 180, 234, 380,
 - 776
 - delegates, 158, 402, 436, 531, 578,
 - 595; © 197
 - anonymous, 159, 169, 437

- C#** (*continued*)
- events, 436
 - exception handling, 314, 419
 - expression evaluation, 237
 - finalization of objects, 477
 - garbage collection, 120, 346, 358
 - generics, 149, 411, 415ff, 488; © 196ff
 - goto statement, 242
 - history, 9, 589, 776
 - indexer methods, 327, 455ff
 - initialization, 234
 - interface classes, 482; © 224
 - iterators, 262; © 202ff
 - just-in-time compiler, © 371
 - method binding, 480
 - mix-in inheritance, 491
 - multibyte characters, 45
 - namespaces, 133, 135, 139; © 42ff
 - hierarchical (nested), © 44
 - and .NET, 776
 - new operation, 289, 350
 - numeric types, 294
 - object superclass, 314, 457
 - objects, 450
 - initialization, 470, 476, 477
 - operator functions, 147
 - overloading, 146, 298
 - parameter passing, 397, 406
 - variable number of arguments, 408
 - precedence levels, 223
 - property mechanism, 437, 455
 - recursive types, © 132
 - reflection, 565, 799, 802
 - regular expressions, 696
 - run-time system. *See* Common Language Infrastructure
 - scope rules, 189
 - sealed class, 468
 - separate compilation, 162; © 42ff
 - serialization of objects, 800
 - sets, 344
 - strings, 334, 343
 - structs, 472
 - switch statement, 251, 255
 - synchronization, 624, 627
 - threads, 12, 428, 590, 595, 596
 - try...finally, 424
 - type checking, 303
 - unions, lack of, © 146
 - universal reference type, 313
 - unlimited extent, 156, 159, 169, 596
 - variables as references or values, 228, 346, 472
 - vectors (*ArrayList* class), 335
 - virtual methods, 480
 - visibility of class members, 464
- C# 3.0**
- extension methods, 468
 - lambda expressions, 159, 402, 508, 578, 789
 - LINQ, 577, 806
 - Parallel FX, 577, 590, 634
 - syntax trees, 789
 - var placeholder, 315
- cache eviction, © 92
- cache hit, © 67, © 182
- cache line, © 67
- cache miss, 810; © 67, © 95, © 96, © 151, © 354
- caches, 602; © 66ff, © 103
 - and array layout, 336ff, 342
 - associativity, © 92
 - coherence, 584ff, 605; © 179
 - and synchronization, 641
 - direct-mapped, © 92
 - hierarchy, © 66
 - optimization for, 535; © 360ff, © 363, © 365, © 375
 - and parallelization, © 366
 - pipeline and, © 92ff
 - shared, 583
- cactus stack, 431, 448
- Cailliau, R., 173
- call by —. *See* parameter passing, by —
- call graph, 167, 389, 810
- callback function, 434
- caller, of subroutine, 383
- calling sequence, 117ff, 356, 383, 386ff, 405, 424, 430, 761; © 100ff
- C on MIPS, 390; © 173ff
- displays, 389
- dynamic linking, © 312ff
 - and event handling, 435
 - and garbage collection, 359
- generic example, 387ff
- in-line expansion, 391ff
- parameter passing, 393ff
- Pascal on x86, 390; © 176ff
- register windows, 390ff; © 181ff
- registers, saving/restoring, 386ff; © 88, © 101
- static chain, 387
 - for virtual method, 483
- Cambridge Polish notation, 221, 273, 510. *See also* prefix notation
- Cambridge University, 316
- Caml, 531, 822. *See also* ML
- Cann, David, 536
- canonical derivation. *See* derivation of string in CFL
- capability, © 265
- capture of free variable in lambda calculus, © 242
- car function, 366
- Cardelli, Luca, 173, 381, 825; © 251
- cardinal type. *See* type, cardinal
- Carnegie Mellon University, 109
- Carriero, Nicholas, 824
- CAS. *See* compare_and_swap instruction
- cascading error. *See* error, cascading
- case, of letters in names, 7, 44, 104, 547; © 305
- case/switch statement, 7, 29, 71, 104, 177, 242, 251ff, 287, 744; © 116, © 142
 - in C, 254ff
 - finite automata and, 60ff, 63
 - implementation, 251ff
 - in ML, © 130
- cast. *See* type cast
- CC++, 635
- CCR. *See* conditional critical region
- cdr function, 366
- Cedar, 619, 824
 - garbage collection, 357
 - implementation, 757
 - programming environment, 39
- Cell architecture, 585
- central reference table, 597; © 33ff
 - dynamic scoping and, 143, 695
- CFG. *See* context-free grammar
- CFL. *See* language, context-free
- CFSM. *See* characteristic finite-state machine
- CGI (Common Gateway Interface) scripts, 680ff

- disadvantages, 681ff
 - interactive form example, 681ff
 - remote machine monitoring
 - example, 681ff
 - security, 689
 - Chaitin, Gregory, © 367, © 377
 - Chambers, John, 668, 827
 - Chandy, K. Mani, 644
 - channel, for message passing, 597;
 - © 263ff, © 272
 - Chapel, 648
 - character sets. *See also* Unicode
 - localization, 45
 - multilingual, 295, 381
 - characteristic array, 345
 - characteristic finite-state machine (CFSM), 91ff; © 12, © 19
 - epsilon productions, 93
 - characters, as a data format, © 68
 - checksum, 753
 - Chen, Hao, © 377
 - χ , © 154
 - child class. *See* class, derived
 - child package, © 44
 - Chomsky, Noam, 100, 110
 - Chomsky hierarchy, 100; © 13
 - Chonacky, Norman, 724
 - Church, Alonzo, 11, 447, 506ff, 534, 537,
 - 543, 824; © 242
 - Church's thesis, 506
 - Church-Rosser theorem, © 242
 - CIL (Common Intermediate Language).
 - See* Common Language Infrastructure
 - Cilk, 596, 822
 - CISC (complex instruction set computer), 213; © 65. *See also*
 - 680x0 architecture; IBM
 - 360/370 architecture; VAX
 - architecture; x86 architecture;
 - x86-64 architecture
 - array access, 342
 - BCD operations, 296
 - byte operations, © 69
 - condition codes, © 76
 - philosophy of, © 81, © 103
 - register-memory architecture, © 75
 - subroutine calling sequence, 390
 - two-address instructions, © 75
- class, 138ff, 147, 178, 317, 376, 449,
 - 463ff. *See also* abstraction;
 - inheritance; object-oriented
 - languages and programming;
 - type extension
 - abstract, 482ff
 - base, 125, 456ff
 - fragile base class problem, 485
 - methods, modifying, 458ff
 - private, 463ff
 - protected, 463
 - public, 456
 - child. *See* class, derived
 - concrete, 482
 - declaration, 454
 - executable, 715
 - derived, 125, 456ff
 - in Diana, © 305
 - exception as, 422
 - hierarchy, 457ff
 - module and, 136ff
 - nested, 465, 496
 - parent. *See* class, base
 - subclass. *See* class, derived
 - superclass. *See* class, base
- class-based language, 498
 - classification of languages, 11
 - clausal form, 566
 - logic programming and, 566
 - in predicate calculus, © 254ff
 - Cleveland, J. Craig, 381
 - CLI. *See* Common Language Infrastructure
 - client-side web scripting, 680, 686ff
 - clock register, © 119
 - CLOS (Common Lisp Object System),
 - 12, 450, 822
 - class hierarchy, 471
 - MetaObject Protocol (MOP), 815
 - multiple inheritance, 491
 - ambiguity resolution, © 217
 - object initialization, 474, 477
 - type checking, 486
 - type extension, 467
 - close operation, for files, © 155
 - closed scope. *See* scope, closed
 - closed world assumption in Prolog,
 - 568ff
 - closest nested scope rule, 124
- closure
 - object, 157ff, 287, 465, 489ff, 595
 - of a set of LR items, 89ff, 94
 - in Smalltalk, © 229
 - subroutine, 153ff, 156, 401ff, 419, 574,
 - 721, 792; © 171, © 176, © 178
 - continuation as, 246, 426, 517
 - coroutine as, 428
 - and display, © 171, © 209
 - with dynamic scoping, © 35ff
 - as function return value, 410
 - as parameter, 404
 - CLP (Constraint Logic Programming),
 - 574
 - CLR (Common Language Runtime),
 - 764, 776. *See also* Common Language Infrastructure
 - Clu, 822
 - clusters (modules), 133, 460ff
 - encapsulation, 450
 - exception handling, 419
 - garbage collection, 357
 - generics, 149, 411
 - goto statement, 242
 - iterators, 262ff, 288
 - multiway assignment, 232
 - operator functions, 147
 - parameter passing, 396, 447
 - recursive types, 7, 365; © 132
 - scope rules, 135
 - tagcase statement, © 142
 - universal reference type, 313
 - variables as references, 226, 288
 - cluster (module) in Clu, 133
 - cluster of computers, 583, 585
 - Co-Array Fortran, 648, 823
 - co-begin, 589ff, 593
 - Cobol, 822
 - decimal type, 296
 - formatted I/O, © 157
 - goto statement, 7
 - history, 9
 - indexed files, © 156
 - records, 318, 324; © 135
 - Cocke, John, 67; © 109, © 377
 - code generation, 26, 29ff, 33ff, 177, 191,
 - 738ff, 817; © 321ff
 - attribute grammars and, 738ff
 - disabling, 99; © 11

- code generation (*continued*)
 - for expressions, 249
 - GCD example, 738ff
 - in one-pass compiler, 189
 - register allocation, 734, 741ff
 - symbol table and, © 33
- code generator generator, 730, 733, 759; © 351
- code improvement, 26, 33, 177, 817; © 321ff. *See also* alias analysis; available expression; cache, optimization for; common subexpression elimination; constant folding; constant propagation; copy propagation; data flow analysis; escape analysis; in-line subroutine; instruction scheduling; loop transformations; parallelization; reaching definition; redundancy elimination; register allocation; strictness analysis; subtype analysis; value numbering; type propagation
 - “bang for the buck”, © 371
 - combinations example, © 328ff
 - conservative, 180; © 334, © 346, © 363
 - dynamic, 764, 786, 793, 816
 - and expression ordering, 236
 - global, 731ff, 785, 817; © 136, © 322, © 336ff
 - interprocedural, 732, 785; © 322
 - in just-in-time compilers, 785
 - local, 731, 785, 817; © 321, © 328ff
 - optimistic, 180
 - peephole, 817; © 321, © 325ff
 - phases of, © 323ff
 - profile-driven, 786ff
 - source-level, 354; © 333, © 347
 - speculative, 180
 - unsafe, 180, 787
- code morphing, 793
- coercion, 148ff, 176, 209, 235, 303, 311ff, 654
 - and overloading, 149
 - type compatibility and, 311ff
- COFF (Common Object File Format), 780
- Cohen, Jacques, 381
- coherence. *See* caches, coherence; memory model
- Cold Fusion (scripting language), 682
- collection class. *See* container class
- collective communication in MPI, © 285
- Colmerauer, Alain, 545, 574, 827
- column-major layout (of arrays), 335ff; © 360ff
- COM (Microsoft Component Object Model), 499, 648
 - history, 775
 - use of attributes, 806
- combination loops, 261ff
- combinator, fixed-point, 543; © 244, © 249
- command interpreter, 172, 650, 655ff, 668, 826. *See also* shell
 - MS-DOS shell, 650
- comments
 - nested, 52
 - performance and, Basic, 19
 - significant. *See* pragma
 - as statements in `sed` and `Tcl`, 672
- common block in Fortran, 123
- Common Language Infrastructure (CLI), 761, 775ff
 - architectural summary, 776ff
 - calling mechanisms, 776, 782
 - Common Intermediate Language (CIL), 23, 736, 764, 776, 781; © 303
 - v. Java Byte Code, 781
- Common Language Specification (CLS), 778ff
- Common Type System (CTS), 776, 778ff
 - delegates, 778
 - generics, 780
 - history, 775
 - v. Java Virtual Machine, 776ff
- just-in-time compilation, 777
- language interoperability, 775, 776, 782
- metadata, 780ff
- operand stack, 776
- pointers, 778, 779
- type safety, 776
- unsafe code, 777
- verification, 777, 782
 - v. validation, 782
- Virtual Execution System (VES), 776
- Common Language Runtime (CLR), 764, 776. *See also* Common Language Infrastructure
- Common Lisp, 7, 12, 24, 822. *See also* Lisp
 - arrays, 335, 403
 - Boolean constants, 514
 - case of letters, 44
 - `catch` and `throw`, 445, 446
 - CMU compiler, 789
 - complex type, 295
 - exception handling, 421, 445, 446
 - lambda expression, 511
 - loop macro, 256, 261
 - macros, 160
 - multilevel returns (`catch` and `throw`), 244, 245, 285, 421
 - nested subroutines, 124
 - objects. *See* CLOS
 - parameter passing, 405ff
 - programming environment, 9, 24ff, 39
 - rational type, 295
 - `return-from`, 243
 - scope rules, 140, 385
 - sequencing, 246
 - structures, 317ff, 349
 - `unwind-protect`, 424
 - Worse Is Better, 717
- common prefix in CFG, 70, 82ff
- common subexpression elimination, 237, 279, 391; © 172, © 321ff, © 326, © 333
 - global, © 136, © 339ff
- communication, 399, 587ff; © 366. *See also* message passing; remote invocation; remote procedure call
 - hardware and software, 587
 - and nondeterminacy, © 117ff
 - polling, © 272
- communication path, © 267, © 269

- compare_and_swap (CAS) instruction, 606ff, 632
- compilation unit, 750ff; ©42. *See also* separate compilation
- compiled languages, 18
- compilers and compilation, 9, 10, 15, 25ff, 67, 69, 73, 99, 175, 177ff, 191, 213. *See also* scanners and scanning; parsers and parsing; semantic analysis; code generation; code improvement; front end of a compiler; back end of a compiler
 - ahead-of-time (AOT), 765
 - assembler and, 19ff
 - back-end structure, 729ff
 - binding time and, 113
 - compiler family (suite), 33, 735; ©306
 - conditional, 20
 - dynamic compilation, 785ff
 - of functional languages, 272, 536ff, 634
 - history, 6
 - IFs (intermediate forms), 734ff; ©303ff
 - incremental, 191, 205, 211
 - interaction with computer
 - architecture, xxiiiiff, 213ff; ©73, ©81, ©91ff, ©102, ©182
 - interaction with language design, xxiiiiff, 8, 163, 278, 279, 372ff, 439, 639; ©269. *See also* Appendix B
 - assignment operators, 230
 - case/switch statement, 253ff; ©116ff.
 - communication semantics, ©269
 - comparison of records, 322
 - dynamic scoping, 140
 - enumeration types, 297
 - in-line subroutines, 391
 - late binding, 114
 - parameter modes, 395
 - pointer arithmetic, 354
 - scanning and parsing, 102; ©20
 - semicolons, ©6
 - side effects, 536
 - subrange types, 299
 - variant records, ©144
- and interpretation, 16ff, 36, 114
- of interpreted languages, 653
- just-in-time, 23, 392, 730, 764, 784ff, 816; ©371
 - v. interpretation, 766
- late binding and, 23
- and modern processors, 35; ©91ff. *See also* instruction scheduling; register allocation
- passes, 26, 731, 734
 - one-pass, 189ff, 205
- phases, 25ff, 36, 730ff, 734. *See also* scanning; parsing; semantic analysis; code improvement; code generation
 - for query language, 23
 - self-hosting, 21
 - separate. *See* separate compilation
 - unconventional, 23
- complex instruction set computer. *See* CISC
- complex type. *See* type, complex
- component system, binary, 499
 - interface query operation, 800
- component type of array, 326
- composite type. *See* type, composite
- compound statement, 246
- computers, history of, 5ff
- Computing Curricula 2001*, xxiii, xxvi
- concatenation
 - in context-free grammars, 100
 - of lists, 276, 379
 - in regular expressions, 43ff, 55ff, 100
 - of strings, 316, 334, 343; ©9
- conceptual load, abstraction and, 451
- concordance, 719
- concrete syntax tree. *See* parse tree
- concurrency, xxiv, 219, 575ff. *See also* communication; message passing; multiprocessors; shared memory; synchronization; thread
 - languages, 12, 588ff
 - libraries, 588ff
 - message passing, ©263ff
 - motivation, 575, 579
 - multithreaded programs, 579ff
 - dispatch loop alternative, 581ff
 - and nondeterminacy, ©117
 - v. parallelism, 576
 - processes, 586
 - quasiparallelism, 576
 - race condition, 578, 591, 601ff, 604, 613, 633
 - shared memory, 603ff
 - tasks, 586
- Concurrent Haskell, 631, 635, 647, 824
- Concurrent Pascal, 619, 623
- condition codes, 797; ©67, ©76, ©105, ©353
- condition queue, 600ff, 613ff
 - of monitor, 621
- condition synchronization, 603, 616ff
- condition variable
 - in Java, 627
 - in monitor, 620
- conditional compilation, 20
 - and executable class declarations, 715
- conditional critical region (CCR), 624ff
 - v. monitor, 627
- conditional move instruction, ©105, ©108
- conditional trap instruction, ©89
- configuration management, 24; ©311
- conflicts in parsing
 - predict-predict, 81
 - shift-reduce, 91
- conformant array parameters, 331ff, 403
- conformity clause in Algol 68; ©142
- conjunctive normal form, ©255, ©261
- cons cell, 347
- ConScript Unicode Registry, 295
- consensus in concurrent systems, 604
- consequent, of Horn clause, 546
- conservative code improvement. *See* code improvement, conservative
- conservative garbage collection, 364, 381
- consistency. *See* caches, coherence; memory model
- constant
 - compile-time, 116
 - elaboration-time, 116
 - literal, 115, 290, 313, 316
 - manifest, 116
- constant folding, 757; ©325
- constant propagation, ©325

- constrained subtype. *See* subtype, constrained
- constrained variant in Ada, © 144
- constraint-based language, 11
- constraints on generic parameters, 414ff
- constructed type. *See* type, constructed
- constructive proof, 507
- constructive view of types, 293
- constructor function, 235ff, 289, 350, 453, 470ff. *See also* initialization
- choosing, 470
 - copy constructor, 473
 - overloaded, 458
- container class, 262, 313ff, 411, 459, 499; © 229
- contention, in parallel system, 605
- context
- in Perl, 653, 669, 704ff, 709ff; © 51
 - and types, 289
- context block, 432, 599ff, 613
- context switch, 580, 602, 622, 624
- context-free grammar, 3, 27, 42ff, 46ff; © 19ff
- ambiguous, 49ff, 84
 - derivation of string, 48ff
 - left-linear, © 25
 - LL, 67, 70, 82
 - LR, 67, 70
 - nonterminal in, 46
 - parse tree and, 48ff
 - parsing and, 27
 - production in, 46
 - syntax and, 28
 - terminal in, 46
 - tree grammars and, 198
 - variable in, 46
- context-free language, 100, 205; © 19ff
- context-sensitive grammar, 27
- context-specific look-ahead (for syntax error recovery), 99; © 3ff, © 7
- contiguous layout (of arrays), 335ff
- continuations and continuation-passing style, 245ff, 273, 284, 288, 426, 448, 517
- contravariance, in object-oriented systems, © 213
- control abstraction, 112, 217, 219, 383ff, 394, 426. *See also* subroutine; coroutine; continuations; exception handling; generators; iterators
- building from continuations, 246
 - v. data abstraction, 383
 - in Smalltalk, © 229ff
- control flow, 217, 219ff. *See also*
- concurrency; continuations;
 - exception handling; iteration;
 - nondeterminacy; ordering;
 - recursion; selection;
 - sequencing; subroutines
- expression evaluation, 220ff. *See also*
- assignments; associativity;
 - short-circuit evaluation;
 - precedence
- in Prolog, 557ff
 - in Scheme, 515ff
- structured and unstructured, 220, 241ff
- goto alternatives, 242ff
- control flow analysis, © 348
- control flow graph, 730, 791; © 322
- edge splitting, © 344
- control hazard in pipeline, © 91
- conversion. *See* type conversion
- Conway, Melvin E., 448
- Cook, Robert P., 143; © 30
- LeBlanc-Cook symbol table, © 30ff
- Cooper, Keith D., 39, 211, 759; © 109, © 377
- cooperative multithreading, 601
- copy constructor, 15, 473
- copy propagation, © 326
- copy rule, in attribute grammar, 181
- CORBA (Common Object Request Broker Architecture), 495, 499, 648, 775
- core, processor, 583
- Cornell Program Synthesizer, 210
- Synthesizer Generator, 209, 210
- coroutine, 428ff, 448, 598, 763
- context block, 432
 - discrete event simulation example, 433; © 205ff
 - iterator implementation, 433; © 201
 - stacks, 430ff
 - threads and, 429
 - transfer, 432ff
- Courcelle, Bruno, 210
- Courtois, Pierre-Jacques, 647
- Cousineau, Guy, 822
- covariance, in object-oriented systems, © 213
- Cox, Brad J., 825
- Cray 1 architecture, © 108
- Cray, Inc., 585, 607, 647
- critical section, 578, 603ff, 624, 628; © 265
- Crusoe (Transmeta) architecture, 793
- csh (C shell), 12, 650
- CSP (Communicating Sequential Processes), 177, 823, 826. *See also* Occam
- input and output guards, © 283
 - process naming, © 263
 - termination, © 284
- CSS (cascading stylesheet language for HTML), © 288
- CTS (Common Type System). *See* Common Language Infrastructure
- CTSS (Compatible Time Sharing System), 656
- Culler, David E., 648
- Curry, Haskell B., 531, 543
- currying of functions, 531ff, 574, 825; © 238, © 246ff
- cut (!), in Prolog, 557
- CWI Amsterdam, 672
- CYK (Cocke-Younger-Kasami) algorithm, 67
- Cytron, Ronald, © 378
- ## D
- DAG. *See* directed acyclic graph
- Dahl, Ole-Johan, 173, 287, 450, 828
- Damron, Peter C., 759
- dangling `else` problem, 84ff, 108
- dangling reference, 115, 121, 156, 179, 345, 346, 356ff, 357, 796
- locks and keys, 381; © 151ff
 - tombstones, 381; © 149ff
- Darlington, Jared L., 567
- Dartmouth College, 821
- data abstraction, 112, 132ff, 138, 143, 217, 305ff, 381, 383, 411, 449ff, 616, 619ff, 636; © 33, © 80. *See also* class; control abstraction;

- inheritance; modules; object-oriented languages and programming
 - v. control abstraction, 383
- data distribution in HPF, 591
- data flow, 635
- data flow analysis, 774, 782; © 251, © 322, © 336ff, © 340
 - all paths v. any path, © 345
 - backward, © 341, © 345
 - forward, © 341
- data formats in memory, © 68ff. *See also* type
- data hazard in pipeline, © 91
- data members (fields), 451
- data parallelism, 594, 606
- data race, 613
- data race freedom, 612ff
- dataflow language, 11
- datagram, © 265
- Datalog, 574
- DCOM (Microsoft Distributed Component Object Model), 499, 775
- DDE (Microsoft Dynamic Data Exchange), 775
- De Vere, Lorraine, 110
- dead code. *See* instructions, useless
- dead value, © 325
- deadlock, 623ff, 629, 644; © 117, © 269.
- debugger, 15, 24, 143, 806ff; © 30
 - hardware support, 809
 - reverse execution, 815
- decimal type. *See* type, numeric, decimal
- declaration
 - class, 454
 - executable, 715
 - v. definition, 130, 306; © 40, © 41
 - of loop index, 261
 - order, 127ff
 - nested blocks, 131ff
 - in scripting languages, 653
- declarative language, 10, 11, 55, 545, 567, 570, 573; © 296
- decoration in semantic analysis. *See* parse tree, decoration of; syntax tree, decoration of
- deep binding. *See* binding rules, deep
 - deep binding for name lookup in Lisp, © 35
- deep comparisons and assignments (copies), 369ff; © 279
- default parameter. *See* parameter, default
- definite assignment, 29, 180, 234, 380, 774, 776, 782; © 373
- definition v. declaration, 130, 306; © 40, © 41
- Dekker, Theodorus (Dirk) Jozef, 604
- delay slot, © 93ff, © 326
- delayed branch. *See* branch instruction, delayed
- delayed load, © 95, © 106, © 326
- delta reduction, © 241
- denial of service attack, 723
- denormal number, © 73
- denotational semantics. *See* semantics, denotational
- denotational view of types, 293
- Department of Defense, US, 9
- dependence, 577, 611, 635; © 94, © 352
 - anti- (read-write), 635; © 94, © 352
 - flow (write-read), © 94, © 352
 - loop-carried, © 362ff
 - output (write-write), 635; © 94, © 352
- dependence analysis, 591, 633; © 352, © 363, © 378
- dependence DAG, © 352, © 378
- deprecated feature, 688; © 287
- dereferencing of an l-value, 227, 310, 346, 350ff
- DeRemer, Franklin L., 109
- derivation of string in CFL, 48ff
 - canonical, 87ff
 - left-most, 48
 - right-most, 48
- derived class. *See* class, derived
- derived type. *See* type, derived
- descriptor for an array. *See* dope vector
- design patterns, 286
- destructor function, 356, 424, 453, 470, 477ff. *See also* finalization
- deterministic automaton. *See* automaton, push-down; finite automaton, deterministic
- Deutsch, L. Peter, 381, 499, 816
- development environment. *See* programming environment
- devices, memory hierarchy and, © 66
- DFA (deterministic finite automaton). *See* finite automaton, deterministic
- Diana, 736, 759; © 303ff
- dictionary (associative array) type, 706
- Digital Equipment Corp., © 81
 - binary translation tools, 793
 - Systems Research Center, 825
 - Western Research Lab, 796
- Dijkstra, Edsger W., 39, 242, 287ff, 447, 604, 617, 619, 647; © 115ff
- dimensions, array, 330ff
- dining philosophers problem, 644ff
- Dion, Bernard A., 110
- direct-mapped cache, © 92
- directed acyclic graph (DAG)
 - expression DAG, © 331, © 352
 - in instruction scheduling, © 352, © 378
 - as intermediate form, 735ff; © 304, © 331
 - order of clauses in Prolog, 571
 - Prolog example, 554
 - topological sort, 571; © 353
- directive
 - assembler, 749
 - v. hint, 391
- Director, 677
- disambiguating rule in parser generator, 49, 84
- discrete event simulation, 433; © 205ff
- discrete type. *See* type, discrete
- discriminant of a variant record, © 139
- discriminated union, © 143
- disjunctive normal form, © 261
- Disney Corp., 493, 677
- dispatch loop, 581ff
- displacement addressing mode. *See* addressing mode, displacement
- display, 389, 447; © 169ff, © 209
 - v. static chain, 389
- distributed memory multiprocessor, 584
- Diwan, Amer, 499
- DLL (dynamic link library). *See* linkers and linking, dynamic
- d11 hell, © 311

- do loop. *See* loop,
 - enumeration-controlled
 - Document Object Model (DOM), 686, 718
 - Dolby, Julian, 499
 - domain
 - in denotational semantics, 182, 293, 296, 518
 - of function, 79, 534; © 237
 - Donahue, Jim, 825
 - dope vector, 331ff, 462; © 233
 - double-precision floating-point number, © 68, © 73
 - Driesen, Karel, 499
 - driver
 - for LL(1) parser, 77
 - for SLR(1) parser, 97
 - for table-driven scanner, 64
 - DSSSL (SGML stylesheet language), © 288
 - DTD (document type definition), 690; © 289
 - Duesterwald, Evelyn, 816
 - Duff, Thomas D. S., 286, 287
 - Duff's device, 286, 287
 - Dyadkin, Lev. J., 62
 - dynamic arrays, 333ff
 - dynamic binding. *See* binding, dynamic
 - dynamic compilation. *See* compilers and compilation, dynamic compilation
 - dynamic link, subroutine, 117, 385
 - dynamic linker, 745, 750, 754ff, 763, 793; © 311ff
 - dynamic method binding. *See* methods and method binding, dynamic
 - dynamic optimization, 764, 786, 793, 816
 - dynamic programming, © 14
 - dynamic scoping. *See* scope, dynamic
 - dynamic semantics. *See* semantics, dynamic
 - dynamic typing. *See* type checking, dynamic
 - Dynamo dynamic optimizer, 794, 816
 - DynamoRIO, 794, 816
- E**
- Earley, Jay, 67
 - Earley's algorithm, 67
 - early reply, 597; © 283
 - Eclipse, 25
 - ECMA (European standards body), 651, 688, 724, 764, 776, 780, 821, 824
 - ECMAScript, 688, 824
 - edge splitting in control flow graph, © 344
 - Efficeon (Transmeta) architecture, 793
 - Eich, Brendan, 688, 824
 - Eiffel, 7, 448, 823
 - !! (new) operator, 471, 475
 - ANY superclass, 457
 - classes, 138
 - current, 451
 - deferred features and classes, 482
 - design by contract, 244, 446
 - exception handling, 446
 - expanded objects, 472, 474, 476
 - frozen class, 480
 - function return value, 409
 - generics, 149, 411, 488
 - goto statement, 242
 - like types, 489
 - method binding, 480
 - multiple inheritance, 459, 491; © 217ff, © 223
 - ambiguity resolution, © 217, © 222
 - implementation, © 233
 - replicated, © 220
 - objects, 450
 - initialization, 470ff, 474, 477
 - renaming of features, 459; © 218, © 222
 - reverse assignment, 485
 - variables as references or values, 228, 472, 474
 - visibility of class members, 464, 468
 - elaboration, 114, 122
 - of thread/task declaration, 592
 - elaboration-time constants, 116
 - element type of array, 326
 - Elk (Scheme dialect), 652, 724
 - elliptical reference, 324; © 135
 - Ellis, Margaret A., 499; © 215
 - else statement, dangling. *See* dangling else problem
 - elsif keyword, 86
 - emacs, 16, 25, 677ff
 - Emacs Lisp, 652, 677ff, 696
 - Emerald, 380
 - call by move, © 280
 - emulation, 792
 - and efficiency, © 271
 - encapsulation, 133, 161, 173, 460ff. *See also* abstraction; class; modules
 - end marker, syntactic, 70, 85
 - endian-ness, 310, 324, 374, 781; © 68ff, © 155
 - Engelfriet, Joost, 210
 - Enigma code, 506
 - Ennals, Robert, 646
 - entry
 - of a message-passing program, © 263ff
 - of a monitor, 620
 - entry queue of a monitor, 621
 - enumeration. *See* iteration
 - enumeration type, 297ff
 - enumeration-controlled loop, 256ff
 - environment variable, 172
 - EPIC. *See* explicitly parallel instruction set computing
 - epilogue of subroutine, 117, 386
 - episode of a barrier, 607
 - EPS sets, 79, 80
 - epsilon production, 70, 92ff
 - epsilon transition in automaton, 55
 - equality testing, 368ff
 - in the Common Language Infrastructure, 779
 - deep v. shallow, 369ff
 - in ML, © 126, © 128
 - of records, 321
 - in Scheme, 369, 514ff
 - equational reasoning, 534
 - equivalence of types. *See* type equivalence
 - Ericsson Computer Science Laboratory, 544, 823
 - Erlang, 507, 823
 - bounded buffer example, © 276
 - message screening, © 277
 - process naming, © 263

- receive operation, © 272
 - send operation, © 268
 - termination, © 284
 - erroneous program, 32, 613; © 279
 - error productions, 99; © 6ff
 - error reporting
 - for message passing, © 270ff
 - supported by reflection, 799
 - supported by scanner, 51
 - errors. *See also* semantic check; semantic error; syntax error
 - cascading, 99, 199; © 1, © 3ff
 - as exceptions, 244
 - lexical, 63ff
 - escape analysis, 179, 472, 644
 - escape sequence in string, 343
 - eta reduction, © 240
 - ETH (Eidgenössische Technische Hochschule), Zürich, 8
 - Ethernet, 323, 585, 619
 - Euclid, 619, 823
 - aliases, 145
 - assertions, 178
 - encapsulation, 450, 460
 - iterator objects, 262ff
 - module types, 136, 460ff
 - scope rules, 135
 - side effects, 238, 247
 - and Turing, 828
 - Euclid's algorithm, 5, 507; © 116; © 230.
 - See also* greatest common divisor (GCD)
 - Eustace, Alan, 816
 - eval function in Lisp/Scheme, 518ff
 - evaluation order, 597. *See also*
 - applicative-order evaluation;
 - execution order; lazy evaluation; normal-order evaluation
 - of arguments, 161, 236ff, 275ff, 284, 288, 521ff, 634, 645
 - in functional programming, 521ff
 - Evans, Arthur Jr., 759
 - event handling, 434ff, 609, 762
 - implementation, 434
 - for interactive I/O, 434; © 153
 - Evey, R. James, 110
 - Excel, 11, 573
 - exception handling, 219, 244ff, 418ff
 - as alternative to goto, 245
 - at elaboration time, 122
 - and built-in errors, 32, 421; © 130
 - cleanup (finally), 424
 - for communication failures, © 279
 - declaring in subroutine header, 135, 422
 - defining exceptions, 421ff
 - in Emacs Lisp, 678
 - for error recovery in recursive descent, © 5
 - exception propagation, 169, 423ff
 - implementation, 115, 279, 425ff, 762
 - in ML, 423
 - parameters, 422
 - in PL/I, 419
 - structured, 424
 - making do without, 426ff; © 187
 - suppressing, 421
 - execution order. *See also* evaluation order
 - initialization and, 470, 475ff
 - in logic programming, 552ff, 557ff, 567
 - existential quantifier, 568; © 253ff
 - exit, from loop, 259
 - expanded objects, 472, 474, 476. *See also* value model of variables
 - expansion of variables in scripting languages, 656ff, 660ff, 701ff
 - explicit receipt. *See* receive operation, explicit
 - explicitly parallel instruction set computing (EPIC), © 107. *See also* IA-64 (Itanium) architecture
 - exponent of floating-point number, © 72
 - export of names from modules, 133, 454, 461ff
 - opaque, 135, 461ff
 - export tables, for linking, 744
 - expression. *See also* assignment; evaluation, 220ff
 - associativity, 222ff
 - precedence, 222ff
 - ordering within, 235ff, 597
 - referential transparency, 225, 534; © 308
 - short-circuit, 238ff, 248ff, 278, 281
 - v. statement, 220, 225, 229
 - expression-oriented language, 229
 - extension language, 16, 650, 652, 676ff
 - commercial, 677
 - extent, of object definition, 156, 157, 597; © 209
 - and Ada tasks, 593
 - and C# delegates, 156, 159, 169, 402; © 197
 - and continuations, 246, 426
 - and garbage collection, 357, 508
 - and higher-order functions, 531
 - in scripting languages, 156, 668, 691
 - external fragmentation, 119ff, 362; © 151
 - external symbol, 744
- ## F
- F#, 531. *See also* OCaml; ML list comprehensions, 367 and .NET, 776
 - fact, in Prolog, 547, 565
 - failure, of computation in Icon, 294; © 112
 - failure-directed search, 567
 - fairness, 220, 600, 606, 641; © 119, © 274
 - false positive/negative, 632; © 149, © 377
 - fence (memory barrier) instruction, 611ff, 632, 770
 - Fenichel, Robert R., 381
 - Fermat, Pierre de, © 253, © 256
 - last theorem, © 253, © 256
 - Feuer, Alan R., 287
 - Feys, Robert, 543
 - Fibonacci heap, 120
 - Fibonacci numbers, 120, 274ff, 516; © 125
 - fields
 - in awk, 665
 - of object, 451
 - of record, 318
 - Fifth Generation project, 573
 - filename expansion in bash, 656ff

- files, 367ff; © 153ff. *See also* I/O
 - binary, © 154
 - as composite type, 300
 - direct, © 156
 - indexed, © 156
 - internal, © 161
 - memory-mapped, 745
 - persistent, 367; © 154ff
 - random-access, © 156
 - sequential, © 155
 - temporary, 367; © 154
 - text, 368; © 154, © 156ff
 - in Ada, © 159ff
 - in C, © 159ff
 - in C++, © 161ff
 - in Fortran, © 157ff
- finalization. *See also* destructor function
 - garbage collection and, 470, 477ff
 - of module, 137
 - of objects, 469ff
- Findler, Robert Bruce, 210
- finite automaton, 53, 91, 100, 699, 702; © 13ff
 - for calculator tokens, 54
 - deterministic, 42, 377, 699, 702; © 13
 - creation from NFA, 56ff; © 16ff
 - minimization, 59
 - Scheme example, 519ff
 - generation, 55ff
 - implementation, 60ff
 - nondeterministic, 55, 699, 702; © 13
 - backtracking, 702
 - creation from regular expression, 55ff, 699
 - translation to regular expression, © 14ff
- finite element analysis, 606
- Finkel, Raphael A., 282, 288
- Firefox, 579
- firmware, 23; © 80
- FIRST and FOLLOW sets, 79, 80ff, 91ff; © 2ff, © 19ff, © 341ff
- first fit algorithm, 119
- first-class values. *See also* function, higher-order
 - continuations, 246
 - definition, 154
 - Prolog terms, 559
 - subroutines, 154ff, 290, 301, 531; © 125
 - in functional programming, 508ff
 - and iteration, 265
 - and metacomputing, 562
 - in R, 668
- Fischer, Charles N., 39, 100, 110, 211, 381, 759; © 7
- Fisher, Joseph A., © 378
- fixed point of function, 519, 534; © 243, © 251, © 341ff, © 345
- fixed-format language, 45
- fixed-point combinator, © 244ff, © 249
- fixed-point type, 296
- Flash, 677
- Flavors, 499
- Fleck, Arthur C., 447
- flex. *See* lex
- floating-point, © 72ff, © 79, © 92
 - accuracy, 238, 259, 296, 308
 - bias, © 73
 - as a data format, © 68
 - denormal, © 73
 - double-precision, © 68, © 73
 - exponent, © 72
 - extended, © 73
 - fractional part, © 74
 - gradual underflow, © 73
 - history, 366
 - IEEE standard, 234, 238, 296; © 72, © 109, © 161
 - and instruction scheduling, © 99
 - integer conversion, 308
 - mantissa, © 72
 - in MIPS architecture, © 90
 - normalization, © 73
 - scientific notation and, © 72
 - significant, © 72
 - single-precision, © 68, © 73
 - in x86 architecture, © 85, © 86, © 89
- flow dependence, © 94, © 352
- FMQ algorithm, 110; © 7
- folding, 530, 533
- FOLLOW sets, 93
- for loop. *See* loop, enumeration-controlled
- forall loop. *See* loop, parallel
- fork operation, 589, 593ff
- formal language, © 13
- formal machine. *See* automaton
- formal parameter. *See* parameter, formal
- formal subroutine, 401. *See also* first-class values, subroutines
- format of program, lexical, 45
- formatted output
 - in Ada, © 159
 - in C, © 160ff
 - in C++, © 162ff
 - in Emacs Lisp, 678
 - in Fortran, 19; © 157ff
- Forth, 8, 206, 222, 736, 823, 826
 - self-representation (homoiconography), 562
- Fortran, 11, 15, 111, 823. *See also* Fortran 77/90/95/2003/2008
 - arrays, 325ff, 335; © 52
 - assignment, 229
 - case of letters, 44
 - coercion, 148
 - common blocks, 123, 144
 - computed goto, 242
 - concurrent programming, 12, 588
 - declarations, 123, 293, 383; © 50, © 58
 - do loop, 256ff, 284
 - equivalence statement, 144; © 140ff, © 143
 - exponentiation, 222
 - format, fixed, 45
 - formatted I/O, 19; © 157ff
 - function return value, 409, 508
 - goto statement, 7, 241, 259
 - history, 6, 9, 123
 - I/O, © 154, © 161
 - if statement, 248
 - implementation, 9, 19
 - numeric types, 294ff
 - parallel loops, 590
 - parameter passing, 115, 394ff, 441ff
 - pointers, 145
 - precedence levels, 223
 - recursion, 116ff, 508
 - save statement, 123, 133
 - scanning, 62, 102
 - scope rules, 123
 - subroutines as parameters, 401
 - subroutines, library, 19
 - text I/O, © 157ff

- type checking, 329
 - type system, 293, 301
 - Fortran 77
 - recursion, lack of, 271
 - Fortran 90
 - aggregates, 233, 302, 508
 - arrays, 312, 328ff, 376, 403
 - dynamic shape, 333
 - slices, 328
 - do loop, 259
 - internal files, ©161
 - nested subroutines, 124, 401
 - overloading, 147
 - parameter passing, 405ff
 - records, 312, 317ff, 323
 - Fortran 95, 591, 633
 - Fortran 2003, 823
 - `associate` construct, ©136
 - multibyte characters, 45, 294
 - type extension (objects), 450, 467
 - Fortran 2008, 823
 - Fortress, 648
 - forward chaining in logic programming, 552
 - forward declaration, ©41
 - forward reference, 189; ©30
 - forward substitution (code improvement), ©345
 - FP (language), 543
 - fractional part of floating-point number, ©74
 - fragile base class problem, 485
 - fragmentation, 119; ©150
 - external, 119ff, 362; ©151
 - internal, 119, 430
 - frame. *See* stack frame
 - frame pointer, 117, 118, 384
 - Francez, Nissim, ©284
 - Fraser, Christopher, 759
 - free list, 119
 - Free Software Foundation, 42; ©306.
 - See also* `emacs`; `g++`; `gcc`; `gcj`; `GENERIC`; `GIMP`; `GIMPLE`; `gnat`; `gpc`; `RTL`
 - free variable in lambda expression, ©240
 - free-format language, 45
 - Friedman, Daniel P., 288, 448
 - `friend` in C++, 464
 - fringe, of tree, 539
 - front end
 - of a compiler, 26, 32, 36, 177, 729. *See also* parsers and parsing; scanners and scanning; semantic analysis
 - of a simulator, ©207
 - of x86 processor, ©65, ©102
 - full-empty bit, 636
 - `funarg` problem (Lisp), 153
 - function, 383. *See also* subroutine
 - in `bash`, 661
 - currying, 531ff; ©238
 - higher-order, 508, 530ff, 574; ©238
 - functional programming and, 530ff
 - mathematical, ©237ff
 - partial, ©237
 - return value, 116, 408ff, 508
 - semantic. *See* semantic function
 - strict, 523
 - total, ©237
 - function constructor, 531. *See also*
 - lambda expression; C#, delegates; Ruby, blocks; Smalltalk, blocks
 - function object. *See* object closure
 - function space, mathematical, ©238
 - functional form. *See* higher-order function
 - functional languages and programming, 11, 505ff. *See also* Haskell; lambda calculus; Lisp; ML; recursion; Scheme
 - aggregates, 508ff
 - assignment, lack of, 360, 378, 535
 - code improvement, ©377
 - commercial use, 509, 536, 544
 - concurrency, 633ff, 645
 - equational reasoning, 534
 - evaluation order, 521ff
 - lazy evaluation, 523ff
 - first-class subroutines, 155ff, 508ff
 - garbage collection, 120, 346, 508ff
 - higher-order functions, 508, 530ff
 - in-place mutation, 535
 - incremental initialization, 535
 - iteration, 516
 - key concepts, 507ff
 - limitations, 529, 534ff
 - lists, 364ff, 508
 - polymorphism, 508, 510
 - recursion, 508
 - theoretical foundations, 534; ©237ff
 - trivial update problem, 535, 536
 - functional unit, of processor, ©78
 - functor. *See* object closure
 - functor, in Prolog, 547
 - future (parallel processing), 634, 636
 - FX!32 binary translator, 793, 816
- ## G
- `g++` (GNU C++ compiler), ©306
 - Gabriel, Richard P., 717, 724
 - Ganapathi, Mahadevan, 759
 - gap, floating-point, ©73
 - garbage collection, 115, 120, 156, 346, 357ff, 762
 - concurrent, 363
 - conservative, 364, 381
 - of continuations, 245
 - and finalization of objects, 470, 477ff
 - in functional programming, 506, 508ff
 - generational, 363ff
 - in HotSpot, 380
 - incremental, 363, 381
 - mark-and-sweep, 360ff, 381
 - pointer reversal, 361ff
 - and real-time execution, 358
 - reference counts, 358ff; ©151, ©166ff
 - circular structures, 359
 - v. tracing collection, 363
 - in scripting languages, 655
 - stop-and-copy, 362ff, 381
 - tenuring, 378
 - tracing collection, 360ff, 761
 - Garcia, Ronald, 447
 - `gas` (GNU assembler), 6, 748ff; ©76
 - gather operation. ©272, ©278
 - Gaussian elimination, ©375
 - `gcc` (GNU compiler collection), 6, 72, 447, 455, 759; ©76, ©176, ©303, ©306,
 - GCD. *See* greatest common divisor
 - `gcj` (GNU compiler for Java), 765, 767; ©306
 - `gdb` (GNU debugger), 806

- Gehani, Narain, 287
 Gelernter, David, 824
 Genera programming environment, 39
 generate-and-test idiom in logic programming, 560
 generational garbage collection, 363ff
 generators, 268, 288; © 111ff. *See also* iterators
 GENERIC (*gcc IF*), © 306
 generic subroutine or module, 149, 279, 309, 344, 410ff; © 189ff.
 implementation options, 412ff, 597
 implicit instantiation, 416
 and inheritance, 486
 and macros, 160, 413
 and object-oriented programming, 457, 487ff
 parameter constraints, 414ff; © 196
 and reflection, 802; © 195
 reification, 780, 802; © 196
 type erasure, 780, 802; © 194ff
 Gharachorloo, Kourosh, 645, 647
 Gibbons, Phillip A., © 378
 Gil, Joseph (Yossi), 499
 GIMP (GNU Image Manipulation Program), 677
 Gtk, 436
 GIMPLE (*gcc IF*), 736; © 303, © 306ff
 Gingell, Robert A., 759
 Ginsburg, Seymour, 110
 Glanville, R. Steven, 759
 global optimization (code improvement), 731ff, 817; © 336ff
 global variable, 123
 globbing, in shell languages, 656
 glue language, 650, 652, 668ff
 GLUT (OpenGL Utility Toolkit), 436
 gnats (GNU Ada 95 Translator), 446, 736; © 306
 GNU. *See* Free Software Foundation
 goal, in logic programming, 546, 548ff
 goal-directed search, © 112
 Gödel (language), 574
 Goguen, Joseph A., 381
 Goldberg, Adele, 828
 Goldberg, David, © 74, © 109
 Goodenough, John B., 448
 Goos, Gerhard, 759
 Gordon, Michael J. C., 210, 211
 Gosling, James, 766, 824
 Gosper, R. William, 723
 goto statement, 7, 241ff, 259, 283, 287, 426
 alternatives, 242ff, 278
 nonlocal, 243
 gpc (GNU Pascal compiler), © 176ff, © 306
 gprof, 810
 gradual underflow in floating-point arithmetic, © 73
 Graham, Susan L., 759; © 378
 grammar. *See* attribute grammar; context-free grammar
 graph coloring and register allocation, © 367, © 377
 graphical user interface (GUI), 434, 493, 619, 652, 687, 761; © 153ff, © 227. *See also* programming environment
 greatest common divisor (GCD), 12ff, 27ff, 37, 171, 271ff, 730ff; © 116, © 243ff, © 307ff
 in assembly language, 5
 in C, 12, 27
 in machine language, 5
 in Prolog, 13, 571
 in Scheme, 13
 in Smalltalk, © 230
 greedy matching of regular expression, 701, 722
 Greenspun, Philip, 724
 grep (Unix), 46, 696ff
 egrep, 696
 origin, 697
 Gries, David, 211, 288
 Griswold, Madge T., 288
 Griswold, Ralph E., 288, 824, 828; © 123
 Grune, Dick, 39, 543, 759; © 377
 Gtk (GIMP Tool Kit), 436
 guard
 in Ada *select* statement, © 274
 on entry of protected object in Ada 95, 625
 in Occam ALT statement, © 274
 in SR *in* statement, © 118, © 276
 guarded commands, © 115ff, © 122, © 272, © 276
 GUI. *See* graphical user interface
 Guile (Scheme dialect), 652, 724
 Gupta, Anoop, 648
 Gutmans, Andi, 826
 Gutttag, John, 173, 288, 381, 447
 Guyer, Samuel Z., © 377
- ## H
- handle of a right-sentential form, 88
 handler, for event, 434ff
 Hanson, David R., 447, 759; © 121
 Hansson, David Heinemeier, 674
 happens before relationship, 612, 647
 Harbison, Samuel P., 173, 447
 Harvard University, 109, 221, 330
 hash (associative array) type, 706
 hash function, 631, 753; © 31, © 35
 hash table, 61, 240, 253, 326, 344, 640; © 30
 Haskell, 316, 507, 543, 824. *See also* ML
 container classes, 529
 currying, 531
 do construct, 527
 global variables, 529
 I/O, 526ff
 indentation and line breaks, 45
 lazy evaluation, 276, 525, 539
 list comprehensions, 367, 379, 529
 map function, 528
 modules, 133, 135
 monads, 446, 526ff
 overloading, 147; © 129
 parameter passing, 402
 partial functions, 529
 polymorphism, 151
 pseudo-random numbers, 526ff
 side effects, lack of, 525
 tuples, 527
 type classes, 446; © 129
 type system, 293; © 126
 variables as references, 226
 Hauben, Michael, 724
 Hauben, Ronda, 724
 Haynes, Christopher T., 288, 448
 hazard in pipeline, © 91
 head, of Horn clause, 546
 header of module, 137, 462; © 39
 heap, 115, 118ff, 745, 761. *See also* garbage collection; priority

queue; storage allocation and management
 fragmentation, 119
 free list, 119
 in functional programming, 508
 heavyweight process, 586
 Hejlsberg, Anders, 821
 helping, in nonblocking concurrent algorithms, 609
 Hemlock, © 154
 Hennessy, John L., 759; © 74, © 92, © 109
 Henry, Robert R., 759
 HEP architecture, 636
 heredoc, 659
 Herlihy, Maurice P., 630, 646ff
 Hermes, 380, 597
 Heron's formula, 737
 Hewlett-Packard Corp., 206, 493, 585, 736, 793, 794
 hexadecimal notation, © 70
 Heymans, F., 647
 High Performance Fortran (HPF), 591, 633
 higher-order function. *See* function, higher-order
 Hind, Michael, © 334, © 378
 hints, 391, 626
 monitor signals as, 621ff
 history. *See also* Appendix A
 of the #! convention, 662
 of abstraction mechanisms, 449ff
 of Ada, 9, 123
 of Algol, 6
 of C, 123; © 40
 of C#, 9, 589, 776
 of the CLI, 775
 of Cobol, 9
 of COM, 775
 of compilers and compilation, 6
 of computers, 5ff; © 79ff
 of floating-point, 366
 of Fortran, 6, 9, 123
 of functional and logic programming, 506ff
 of HTML, 689
 of Java, 589, 766
 of Lisp, 6, 366, 447
 of math and statistics languages, 668

of Perl, 694
 of PHP, 650
 of PL/I, 9
 RISC, xxiii
 of RISC, © 88, © 93ff, © 103
 of scope rules and abstraction mechanisms, 121ff, 162, 449
 of scripting, 650ff
 of separate compilation, © 44
 of Tcl, 670
 of Unix tools, 697
 Ho, W. Wilson, 759
 Hoare, Charles Antony Richard (Tony), 39, 177, 211, 242, 287, 380ff, 619, 821, 826
 hole in record layout, 320ff
 hole in scope, 125, 129
 Holt, Richard C., 647, 828
 homoiconic language, 517, 537, 561, 562, 570
 Hopcroft, John E., 109
 Hopper, Grace Murray, 822
 Horn, Alfred, 573
 Horn clause, 546; © 255
 Horowitz, Ellis, 39
 hot path, 787, 788, 794
 HotSpot JVM, 380, 767, 788ff
 HP 3000 architecture, 793
 HPF. *See* High Performance Fortran
 HTML (hypertext markup language), 689ff
 and applets, 688
 and CGI scripts, 680ff
 and client scripts, 686
 header extraction example, 663ff, 701
 in *awk*, 664ff
 in Perl, 666ff
 in *sed*, 663
 object embedding, 688
 as output of *javadoc*, 805
 as output of XSLT, © 290
 and PHP scripts, 683ff
 and XML, 689ff
 HTTP (hypertext transport protocol), 681, 718
 Hudak, Paul, 543
 Hunt, Andrew, 827

I

IA-32 EL binary translator, 793
 IA-64 (Itanium) architecture, 585, 793, 796; © 102, © 107, © 108
 atomic instructions, 606
 memory model, 612
 register windows, 391; © 181
 ia32. *See* x86 architecture
 IBM 360/370 architecture
 compare_and_swap, 640
 endian-ness, © 69
 microprogramming, © 80
 IBM 704 architecture, 116, 336, 366
 IBM ACS architecture, © 108
 IBM Corp., 9, 821, 823, 826
 multiprocessors, 585; © 83
 supercomputers, 585, 607
 T. J. Watson Research Center, 335; © 109
 IBM CP/CMS, 765
 Ichbiah, Jean, 819
 Icon, 7, 824
 Boolean type, lack of, 294; © 112
 cset type, 344
 generators, 263ff, 268, 288; © 111ff
 pattern matching, © 131
 strings, 334, 342ff
 suspend statement, © 112
 type checking, © 131
 Id (language), 11
 IDE (integrated development environment). *See* programming environments
 idempotent operation, 247
 identifier, 29, 43. *See also* names
 IDL (Interface Description Language), © 303
 IEEE floating-point standard. *See* floating-point, IEEE standard
 IF. *See* intermediate form
 ILP (instruction-level parallelism), © 93
 immediate error detection problem, © 3, © 20
 immutable object, 227, 334, 397; © 227
 imperative language, 10ff
 imperfect loop nest, © 362

- implementation. *See also* assembler; compilers and compilation; interpreters and interpretation; specific languages and features
 - canonical, 654
 - compilation and interpretation, 16ff, 114
 - counterintuitive, 597
 - language design and, xxiiiif, 3, 8
 - processor architecture and, 213, 786; ©78ff
- implicit receipt. *See* receive operation, implicit
- implicit synchronization, 633ff
- import
 - of names into modules, 133, 454, 691; ©42
 - of names into subroutines, 135
- import tables, for linking, 744
- in-line subroutine, 160, 279, 391ff, 454, 494, 597, 786, 788; ©100. *See also* macros
- incremental compilation. *See* compilers and compilation, incremental
- incremental garbage collection, 381
- indentation, 45, 85
- index type of array, 326
- index, of loop, 256ff, 278. *See also* induction variable
- indexed addressing mode, ©75
- indexed sequential file, ©156
- indexer methods in C#, 455ff
- induction variable, ©348ff
- Industrial Light and Magic, 677
- inference, of types. *See* type inference
- Infiniband, 585
- infinite data structure, 276, 540; ©154. *See also* lazy evaluation
- infix notation, 147, 207, 221ff, 235
 - in ML, 221, 394; ©128
 - in Prolog, 549, 561
 - in R, 221, 668
 - in Smalltalk, 221
 - in Tcl, 672
- information hiding, 132
 - and reflection, 800
- Ingalls, Daniel H. H., 499, 828
- Ingerman, Peter Z., 447
- inheritance, 138, 149, 173, 449, 456ff, 460ff
 - generics and, 486
 - implementation, 483ff; ©215ff, ©232ff
 - mix-in, 482, 491; ©223ff
 - modules and, 460ff
 - multiple, 450, 491ff; ©215ff
 - ambiguity, ©217
 - cost, ©218
 - this correction, ©216, ©217
 - in Perl, 712
 - repeated, 492; ©219ff
 - replicated, 492; ©220ff
 - shared, 481, 492; ©220, ©222ff
 - single, 483ff
 - unions and, ©146
 - in XSD, ©289
- inherited attribute. *See* attribute, inherited
- initialization, 233ff. *See also* assignment; constructor function; definite assignment; finalization
 - and assignment, 15, 233ff, 473ff
 - of complex structures, 535
 - execution order, 470, 475ff
 - of expanded objects, 475
 - of objects, 469ff
 - and variables as references or values, 470, 472ff
 - of variant records, ©143
- INMOS Corp., 826
- input/output. *See* I/O
- INRIA, 822
- insertion sort, 572
- inspector-executor loop transformation, ©376
- instantiation
 - implicit, of generic subroutine, 416
 - of variables in Prolog, 547, 549, 553, 569
- instruction scheduling, 391, 734, 749, 787, 788; ©79, ©92, ©99ff, ©351ff, ©378
 - register allocation and, ©99ff, ©323, ©370
- instruction set architecture (ISA), 765; ©75ff, ©89ff
- instruction-level parallelism, ©93
- instructions
 - as a data format, ©68
 - useless, ©326, ©345
- Intel 64 architecture, ©84, ©103. *See* x86-64 architecture
- Intel Corp., 22, 796; ©81, ©83, ©84, ©102. *See also* x86 architecture; IA-64 (Itanium architecture)
- Interface Description Language (IDL), ©303
- Interlisp, 39, 543, 619; ©227
- interlock hardware, ©95
- intermediate form (IF), 19, 734ff; ©303ff, ©337
 - level of machine dependence, 735; ©329, ©351
 - stack-based, 736
- Intermetrics, 819
- internal fragmentation, 119, 430
- International Organization for Standardization (ISO), 426, 574, 688, 764, 780, 821, 822, 825, 826
- Internet address, ©265
- Internet Explorer, 579, 651, 686, 688
- Internet Information Server, Microsoft (IIS), 651
- interpolation of variables in scripting languages, 656ff, 701ff
- interpreted languages, 18
 - compiling, 653
- interpreters and interpretation, 16ff
 - v. emulation, 792
 - error checking and, 18
 - v. just-in-time compilation, 766
 - late binding, 17, 114
 - metacircular, 518, 565; ©251
 - of P-code, 21ff
 - of Postscript, 23, 657
 - of Scheme, 509
 - and scripting, 653, 662, 668, 677, 682, 686, 688, 707, 717
 - v. virtual machines, 764
- interprocedural code improvement. *See* code improvement, interprocedural
- interrupts, for I/O events, 434ff
- intrinsic function in Fortran, 330

- introspection, 799. *See also* reflection
 - invariant computation in loop, © 346ff
 - of loop, 284, 288
 - of monitor, 621
 - I/O (input/output), 367ff, 761; © 153ff,
 - See also* files; event handling; graphical user interface
 - interactive, © 153ff
 - monads, in Haskell, 525ff
 - streams, 525ff
 - ISA (instruction set architecture), 765; © 75ff, © 89ff
 - ISO. *See* International Organization for Standardization
 - ISO/IEC 10646 standard, 45, 295. *See also* Unicode
 - Itanium. *See* IA-64 (Itanium)
 - architecture
 - item in LR grammar, 89ff
 - Iteration, 219
 - iteration, 256ff. *See also* generators; iterators
 - enumeration-controlled, 256ff
 - logically-controlled, 256, 268ff
 - recursion and, 271ff
 - in Smalltalk, © 228ff
 - iteration count, 258, 260, 284
 - iteration space, © 363
 - iterators, 15, 262ff, 279, 433ff
 - and continuations, 267
 - and coroutines, 433; © 201
 - and first-class functions, 265
 - implementation, 553; © 201ff
 - iterator objects, 264ff; © 202
 - tree enumeration example, 282
 - Iverson, Kenneth E., 330, 724, 821
- J**
- Java, 8, 12, 495, 824. *See also* Java 5/6/7; Java Virtual Machine
 - annotations, 804
 - applets, 686ff, 736
 - arithmetic overflow, 238
 - arrays, 337
 - assignment, 346
 - AWT graphics, 687; © 153
 - `boolean` type, 230
 - boxing, 228
 - variable number of arguments, 407
 - portability, 640
 - precedence levels, 223
 - Real Time Specification for, 358
 - recursive types, 7, 346; © 132
 - reflection, 565, 799, 800ff
 - regular expressions, 696
 - safety, 236
 - scope rules, 129, 189
 - scoped memory, 358
 - `send` operation, © 268
 - separate compilation, 162; © 42ff
 - serialization of objects, 800
 - servlets, 682
 - sets, 344
 - strings, 334, 343
 - `super`, 459, 476
 - Swing graphics, 436ff, 687; © 154
 - synchronization, 624ff, 769
 - threads, 12, 428, 590, 594
 - `try...finally`, 424ff
 - type checking, 179, 303
 - type erasure, 780, 802; © 194ff
 - unions, lack of, © 146
 - universal reference type, 313
 - variables as references or values, 228, 346, 372, 472
 - `Vector` class, 335
 - visibility of class members, 464
 - weak references, 380
 - Java 5, xxii
 - boxing, 228
 - `enum` values, 298
 - generics, 413, 417; © 189, © 192ff
 - locks and conditions, 626ff
 - memory model, 646
 - thread pools and executors, 596
 - Java 6, 806
 - Java 7, 767
 - Java Modeling Language (JML), 806
 - Java Server Pages, 682
 - Java Virtual Machine (JVM), 485, 766ff; © 303
 - architectural summary, 767
 - archive (`.jar`) files, 770, 780
 - byte code, 23, 206, 485, 653, 736, 759, 771ff; © 303
 - v. Common Intermediate Language, 781
 - `break` statement, 270
 - byte code. *See* Java Virtual Machine,
 - byte code
 - capitalization, 45
 - casts, 314, 485
 - classes, 138
 - concurrency library, 626ff
 - condition variables, 627
 - declarations, 131
 - definite assignment, 29, 180, 234, 380, 774
 - events, 437
 - exception handling, 314, 419
 - expression evaluation, 237
 - `final` class, 468, 480
 - finalization of objects, 477
 - fragile base class problem, 485
 - garbage collection, 120, 235, 346, 357
 - generics, 149, 292, 411, 415, 417ff, 488; © 192ff
 - `goto` statement, 242
 - graphical interface, © 153
 - history, 589, 766
 - implementation, 8, 18, 22, 23
 - initialization, 234, 774
 - inner classes, 465
 - anonymous, 437
 - interface classes, 157, 482; © 224ff
 - iterator objects, 262ff
 - and JavaScript, 687ff, 775
 - just-in-time compiler, © 371
 - machine independence, 111
 - memory model, 613, 628ff, 646, 770
 - message passing, © 265
 - method binding, 480; © 224
 - mix-in inheritance, 491
 - monitors, 628, 629
 - multibyte characters, 45
 - naming for communication, © 265
 - `new` operation, 289, 350
 - numeric types, 294
 - object closure, 157, 437, 465, 489
 - `Object` superclass, 314, 457
 - objects, 450
 - initialization, 470, 476
 - overloading, 146, 298
 - packages, 133, 135, 139; © 42ff
 - hierarchical (nested), © 44
 - parameter passing, 397, 406

- Java Virtual Machine (JVM) (*continued*)
 - instruction set, 771
 - list insertion example, 772
 - verification, 772
 - class files, 770
 - v. Common Language Infrastructure, 776ff
 - constant pool, 767ff
 - and languages other than Java, 767, 774
 - operand stack, 768ff, 771ff
 - storage management, 767
 - type safety, 774
 - JavaBeans, 495, 499, 648
 - javadoc, 805
 - JavaScript, 12, 651, 686ff, 824
 - arrays and hashes, 708
 - first-class subroutines, 691
 - interactive form example, 686ff
 - and Java, 687ff, 775
 - numeric types, 705
 - objects, 710ff, 712ff
 - properties, 708, 713
 - prototype objects, 498, 710, 713ff
 - regular expressions, 696
 - scope rules, 691
 - security, 689
 - standardization, 654
 - unlimited extent, 691
 - variables as references or values, 705, 710
 - and XSLT, ©292
 - Jazayeri, Mehdi, 210
 - JBC (Java Byte Code). *See* Java Virtual Machine, byte code
 - JCL, 650
 - Jensen, Jørn, ©185
 - Jensen's device, ©185ff
 - Jensen, Kathleen, 826
 - Jikes Java compiler, 767
 - JML (Java Modeling Language), 806
 - job control in shell languages, 658
 - Johnson, Stephen C., 109
 - Johnson, Walter L., 109
 - Johnstone, Mark S., 381
 - join operation, 589, 593ff
 - Jones, Richard, 381
 - Jordan, Mick, 825
 - Joy, William, 656
 - JavaScript, 651, 688, 776, 824. *See also* JavaScript
 - JSP (Java Server Pages), 651
 - jump code, 248ff
 - jump table for `case/switch` statement, 252ff
 - just-in-time compilation. *See* compilers and compilation, just-in-time
 - JVM. *See* Java Virtual Machine
- K**
- Kaffe Java implementation, 767
 - Kalsow, Bill, 825
 - Kasami, T., 67
 - Kay, Alan, 493, 828
 - Kemeny, John, 821
 - Kennedy, Andrew, 447
 - Kennedy, Ken, ©355, ©378
 - Kernighan, Brian W., 39, 288, 664, 759, 821
 - Kessels, J. L. W., 625
 - keys and locks. *See* locks and keys
 - keywords, 43, 44, 61. *See also* specific keywords and languages
 - predefined names and, 61, 171
 - Kinnersley, Bill, 819
 - Kleene, Stephen C., 41, 109, 506
 - Alonzo Church and, 507
 - Kleene closure, 43, 55ff, 100
 - plus metasympol, 47
 - star metasympol, 41, 44ff
 - Knuth, Donald E., 10, 109, 210
 - Kontothanassis, Leonidas I., 643
 - Korn, David G., 656, 724
 - Kowalski, Robert, 545, 574, 827
 - Kozyrakis, Christos, 648
 - Král, J., 377
 - ksh, 656
 - Kurtz, Thomas, 821
- L**
- L-attributed attribute grammar, 249. *See* attribute grammar, L-attributed
 - l-value, 226, 300, 310, 313, 351; ©52
 - label
 - for `goto`, 241
 - nonlocal, 243
 - as parameter, 244, 402, 426; ©186ff
 - LALR parsing. *See* parsers and parsing, bottom-up
 - lambda (λ) as empty string, 44
 - lambda abstraction, ©239
 - lambda calculus, 11, 447, 506, 534, 543, 824; ©239ff
 - alpha conversion, ©240
 - arithmetic, ©239, ©249
 - beta abstraction, ©243
 - beta reduction, ©240
 - control flow, ©242ff
 - currying, ©246ff
 - delta reduction, ©241
 - eta reduction, ©240
 - functional languages and, 11
 - scope, ©240
 - structures, ©244ff
 - lambda expression, 150, 155, 159, 273, 402, 511, 574, 578; ©228
 - Lampert, Leslie, 605, 647
 - Lampson, Butler W., 619, 823, 824
 - Landin, Peter, 173
 - language, 43. *See also* specific languages
 - classification, 10ff, 503, 570
 - concurrent, 12, 588ff
 - constraint-based, 11
 - context-free, 43, 100; ©19ff
 - ambiguous, ©22
 - dataflow, 11
 - declarative, 10, 11, 545, 567, 570, 573; ©296
 - design, 7ff
 - binding time and, 113
 - extension, 16, 676ff
 - families, 10ff
 - formal, 100; ©13
 - free v. fixed format, 45
 - functional, 11, 505ff
 - glue, 668ff
 - homoiconic, 517, 537, 561, 562, 570
 - imperative, 10ff
 - implementation. *See also* compilers and compilation; interpreters and interpretation
 - binding time and, 113
 - logic, 11, 545ff
 - nondeterministic, ©22
 - object-oriented, 12, 14, 138, 449ff, 492ff, 710ff

- reasons to study, 14ff
- regular, 43, 100
- scripting, 12, 649ff
- strict, 523
- von Neumann, 11
- Larch, 806
- Larus, James R., 648, 813, 816
- late binding. *See* binding, late
- TeX, 723
- Lawrence Livermore National Laboratory, 634, 828
- lazy data structure, 276
- lazy evaluation, 241, 275ff, 279, 288, 523ff, 539; © 187
 - definition, 276
- lazy linking, 774, 786; © 313
- lcc (compiler), 759
- Lea, Doug, iv, 642
- leaf routine, 389; © 171, © 176, © 312, © 331, © 367
- LeBlanc, Richard J., 39, 110, 211, 381, 759
- LeBlanc, Thomas J., 143; © 30
 - LeBlanc-Cook symbol table, © 30ff
- Ledgard, Henry F., 211
- left corner of LR production, 195; © 53
- left factoring, 84; © 53
- left recursion in CFG, 82ff
- left-linear grammar, © 25
- left-most derivation, 48
- Leiserson, Charles, 822
- Lerdorf, Rasmus, 650, 826
- Leroy, Xavier, 822
- Lesk, Michael E., 109
- Lewis, Philip M. II, 109, 210
- lex, 42, 60, 101, 109
- lexical analysis. *See* scanners and scanning
- lexical errors, 63ff
- lexical scope. *See* scope, static
- lexicographic ordering, 329, 416; © 334
- Li, Kai, 648
- library package, 12, 19, 113, 404, 428, 451, 485, 751ff, 761ff; © 154.
 - See also* linkers and linking, run-time system
 - for concurrency, 588ff, 640. *See also* pthread standard (POSIX)
- lifetime, of bindings and objects, 115
- lightweight process, 586
- limited extent. *See* extent, of object
- Linda, 636, 824
- Lindholm, Tim, 759
- line breaks, 45
 - in Python, 673
 - in Ruby, 675
 - in Tcl, 672
- linkage table, © 312ff
- linkers and linking, 15, 19, 24, 734, 750ff, 759
 - binding time and, 113
 - dynamic, 745, 750, 754ff, 763, 785, 793; © 311ff
 - lazy, 774, 786; © 313
 - name resolution, 751ff
 - relocation and, 750ff
 - separate compilation and, © 40
 - static, 750ff
 - type checking and, 751ff
- Linpack performance benchmark, 645
- LINQ, 577, 806
- Lins, Raphael, 381
- lint, 38
- Linux operating system, 9, 22. *See also* Unix
 - address space layout, 745
 - magic numbers, 662
- Liskov, Barbara, 173, 288, 447, 448, 822
- Lisp, 7, 11, 111, 543, 824. *See also* Common Lisp; Scheme
 - aggregates, 302
 - arithmetic operators, 280
 - assignment, 352
 - binding of names, © 35
 - closures, 154
 - cond construct, 248
 - declarations, 383
 - dynamic typing, 365, 508
 - equality testing, 227, 369
 - expression syntax, 221, 394, 438
 - funarg problem, 153
 - function primitive, 153
 - function return value, 410
 - history, 6, 366, 447
 - if construct, 394
 - imperative features, 351
 - implementation, 23, 789
 - late binding, 365
 - lists, 347, 365ff, 513
 - numeric types, 295
 - parameter passing, 394, 396, 406, 447
 - polymorphism, 149, 291, 365, 411, 508
 - recursion, 447
 - recursive types, 7, 349, 365; © 132
 - reflection, 799, 815
 - S-expression, 517; © 309
 - scope rules, 122ff, 129, 140ff, 513
 - self-representation (homoiconography), 17, 122, 365, 509, 517, 537, 562
 - storage allocation, 430, 447
 - strings, 343
 - syntax, 510
 - type checking, 179, 291, 401
 - type system, 293
 - unlimited precision arithmetic, 238
 - variables as references, 226
- list comprehensions, 367, 379, 674
- lists, 347ff, 364ff
 - as composite type, 300
 - dotted notation, 365
 - and functional programming, 505, 508
 - improper, 365, 551
 - in ML, © 127
 - notation, 365
 - programs as (Scheme), 517ff
 - in Prolog, 550ff
 - proper, 365, 513; © 128
 - in Scheme, 513ff
- literal constant. *See* constant, literal
- little-endian byte order. *See* endian-ness
- live value, © 97, © 325
 - range, © 367
 - splitting, © 369
- live variable analysis, © 345, © 356
- LiveScript, 688
- LL grammar, 67, 70, 82ff; © 20ff
- LL language, 84; © 20ff
- LL parsing. *See* parsing, top-down
- Lloyd, John W., 574
- load balancing, 597; © 366
- load delay, 236; © 93ff, © 175
- load penalty, © 93
- load-and-go compilation, 730
- load_linked instruction, 608, 630, 641

- load-store architecture (RISC machines), © 75, © 96
 - loader, 751
 - loading, binding time and, 113
 - local code improvement (optimization), 731, 817; © 328ff
 - local variable, 123
 - locality of access, © 67ff, © 100
 - lock. *See* mutual exclusion; semaphores; spin lock
 - locks and keys (for dangling reference detection), 381; © 151ff
 - logic languages and programming, 11, 545ff. *See also* Prolog
 - arithmetic, 551ff
 - backward chaining, 552
 - clausal form, 566; © 254ff
 - closed world assumption, 568ff
 - code improvement, © 377
 - concurrency, 636ff, 645
 - constructive proofs and, 507
 - execution order, 552ff, 567
 - forward chaining, 552
 - Horn clause, 546
 - limitations, 566ff
 - lists, 550ff
 - predicate calculus, 545
 - reflection, 565
 - resolution and unification, 549ff
 - theoretical foundations, 566; © 253ff
 - logical type. *See* type, Boolean
 - logically controlled loop, 256, 268ff
 - Logo, 8
 - Lomet, David B., 381
 - long instruction word (LIW) architecture, © 107
 - longest possible token rule, 53, 61ff
 - loop, 256ff
 - bounds, 256ff
 - combination, 261ff
 - enumeration-controlled, 256ff, 284, © 372
 - index, 256ff, 278. *See also* induction variable
 - logically controlled, 256, 268ff, 284
 - midtest, 269ff
 - nested, © 362
 - parallel, 590ff, 633
 - post-test, 268
 - pre-test, 268
 - loop invariant computation, © 347ff
 - loop transformations, © 346ff, © 355ff, © 378. *See also* dependence; induction variable; loop invariant computation
 - blocking, © 360
 - distribution, © 361
 - fission, © 361
 - fusion, © 361
 - inspector-executor paradigm, © 376
 - interchange, © 360
 - jamming, © 361
 - peeling, © 362
 - reordering, © 359
 - reversal, © 363
 - skewing, © 364
 - software pipelining, © 356ff
 - splitting, © 361
 - strip mining, © 366
 - tiling, © 360
 - unrolling, 285ff, 787; © 107ff, © 355ff
 - Loops, 499
 - loose name equivalence, 306
 - Lotus 1-2-3, 573
 - Louden, Kenneth C., 39
 - LR grammar, 67, 70; © 20ff
 - LR language, © 20ff
 - LR parsing. *See* parsers and parsing, bottom-up
 - Lucid Corp., 717
 - Luckam, David C., 448
 - Luhn, Hans Peter, 207
 - Luhn formula, 207
 - Luk, Chi-Keung, 816
 - Łukasiewicz, Jan, 206
 - Lynx, iv
 - implementation, 757
- M**
- Mac OS, 586, 825
 - text files, © 156
 - Mach operating system, 586
 - machine dependence/independence, 111
 - machine language, 5, 19, 213, 746ff; © 75ff
 - machine, formal. *See* automaton
 - machine-independent code improvement, 26; © 323ff
 - machine-specific code improvement, 26; © 323ff
 - MacLaren, M. Donald, 448
 - MacLisp, 543
 - Macromedia Corp., 682
 - macros, 159ff, 275ff, 523
 - and call-by-name, 403
 - and generics, 160, 413
 - hygienic, 160
 - v. in-line subroutines, 279, 284, 392
 - and recursion, 161
 - and variable number of arguments in C, 406
 - magic numbers in Unix, 662, 770, 774
 - Mairson, Harry G., 381
 - make tool in Unix, 37, 753; © 41
 - malloc (memory allocation) routine, 350; © 209
 - malware, 797
 - managed code, 764
 - manifest constants, 116
 - Manson, Jeremy, 646, 647
 - mantissa of floating-point number, © 72
 - Maple, 668, 709, 724
 - mapping (associative array) type, 706
 - Marcotty, Michael, 211
 - Mariner 1 space probe, 62
 - mark-and-sweep garbage collection, 360ff, 381
 - marshalling. *See* gather operation
 - Martonosi, Margaret, 816
 - Mashey, John R., 656, 724
 - Massachusetts Institute of Technology, 100, 366, 543, 596, 656, 822, 827
 - Massalin, Henry, © 378
 - Mathematica, 668, 709, 724
 - Matlab, 634, 668, 709, 724
 - Matsumoto, Yukihiro (Matz), 674ff, 827
 - Matthews, Jacob, 210
 - Maurer, Dieter, 543; © 233
 - Maya, 677
 - McCarthy, John, 447, 543, 824
 - McGraw, James R., 828
 - McIlroy, M. Douglas, 697
 - McKenzie, Bruce J., 110
 - megabyte, definition, © 70
 - Mellor-Crummey, John M., iv, 647

- member lookup in object-oriented programming, 482ff
- memoization, 276, 524, 525, 540
- memory, ©66. *See also* alignment; endian-ness; data formats
 - coherence. *See* caches, coherence
 - hierarchy, ©66ff
 - layout. *See* specific data types
 - leak, 121 346, 357, 360, 796; ©166
- memory model, 610ff, 770
 - bypassing, 611
 - C++, 613, 629
 - conflicting operations, 625, 630
 - Java, 613, 628ff, 646
 - sequential consistency, 610ff
 - temporal loop, 611ff
- memory race, 613
- Mercury, 551, 574
- merge function, in SSA form, ©337ff
- Mesa, 619ff, 824; ©227
- message passing, 637; ©263ff. *See also* MPI; PVM; **receive** operation; remote procedure call; **send** operation
 - buffering, ©268ff
 - naming communication partners, ©263ff
 - and nondeterminacy, ©117
 - ordering, ©267
 - peeking, ©277
 - v. shared memory, 583, 587ff
- metacircular interpreter, 518, 565; ©251
- metacomputing, 562
- metadata, 149, 761, 780ff, 789, 799
- methods and method binding, 451
 - abstract, 482; ©223
 - base classes, modifying, 458ff
 - dispatch, 481
 - dynamic, 173, 449, 478ff. *See also* polymorphism, subtype; methods and method binding, virtual
 - closures, 157ff, 465, 489ff, 595
 - and generics, 488
 - extension methods in C#, 468
 - property mechanism in C#, 437, 455
 - redefining, 458, 480
 - static, 479
 - virtual, 480
 - implementation, 483ff
 - pure. *See* methods and method binding, abstract
 - vtable (virtual method table), 483ff
 - overriding, 479ff
- Meyer, Bertrand, 448, 500, 823
- Michael, Maged M., iv, 642, 646, 647
- Michaelson, Greg, 288, 543
- microcode and microprogramming, 23; ©79ff
- microprocessors, ©80ff
- Microsoft Corp., 9, 499, 651, 821, 823. *See also* Active Server Pages; ActiveX; C#; COM; Common Language Infrastructure; DCOM; DDE; F#; Internet Explorer; Internet Information Server; .NET; OLE; Windows operating system; Visual Basic; Visual Studio
 - compilers, 788
 - Microsoft Word, 738
 - Office suite, 651ff
- middle end, of a compiler, 26, 729ff; ©307ff
- midtest loop, 269ff
- Milner, Robin, 316, 381, 825
- Milton, Donn R., 100, 110; ©7
- minimal matching of regular expression, 667, 701, 722
- Minsky, Marvin, 381
- MIPS architecture, 793; ©84ff, ©109
 - 16-bit extensions, ©105
 - atomic instructions, 608
 - C calling sequence, 390; ©173ff
 - conditional branches, ©77ff, ©88
 - conditional trap instruction, ©89
 - dynamic linking, ©312
 - floating-point, ©90
 - instruction encoding, 750
 - MDMX extensions, ©87, ©88
 - memory model, 612
 - register set, ©86ff
- Miranda, 316, 507, 825. *See also* ML currying, 531 and Haskell, 824
 - lazy evaluation, 276, 525
 - list comprehensions, 367
 - parameter passing, 402
 - side effects, lack of, 525
 - type system, 293
- Misra, Jayadev, 644
- MIT. *See* Massachusetts Institute of Technology
- MITI (Japanese Ministry of International Trade and Industry), 573
- mix-in inheritance. *See* inheritance, mix-in
- “mixfix” notation, 222, 394; ©111, ©227
- ML, 11, 574, 825
 - aggregates, 233, 366
 - assignment, 351, 540
 - case expression, ©130
 - currying, 531
 - datatype mechanism, 347; ©132, ©141
 - equality testing, ©126, ©128
 - exception handling, 419, 423
 - first-class functions, 402, 531
 - function return value, 410
 - imperative features, 351
 - infix notation, 221
 - infix operators, 394
 - lazy evaluation, 525
 - lists, 365ff; ©127
 - module types, 136, 488
 - nested subroutines, 124
 - overloading, ©128
 - parameter passing, 394, 396; ©127ff
 - pattern matching, ©129ff
 - pointers, 227, 348, 351
 - polymorphism, 149, 317, 365, 411, 508; ©126
 - records, 304, 318, 319; ©131
 - recursive types, 7, 347, 348, 365; ©132
 - scope rules, 131, 385
 - side effects, ©128
 - strings, 343
 - tuples, 232, 409, 532, 636; ©127, ©129
 - type checking, 179, 180, 303; ©126ff
 - type system, 293, 316ff; ©125ff

- ML (*continued*)
 - unification, 292, 316, 381; © 127
 - unit (empty) type, 301
 - variables as references, 226
- mobile code, 797ff
- mod operator, 374
- model checking, 795; © 377
- Modula, 287
 - dereference (^) operator, 350
 - encapsulation, 450
 - goto statement, 242
 - modules, 460ff
 - parameter passing, 394, 397
 - repeat loop, 268
 - separate compilation, © 39
 - set types, 316
 - threads, 428
 - variant records, © 140
- Modula (1), 85, 825
 - modules, 133, 135
 - monitors, 619
 - scope rules, 135
- Modula-2, 85, 467, 825; © 2
 - address (universal reference) type, 313
 - case of letters, 44
 - case statement, 251
 - conformant array parameters, 332
 - coroutines, 428
 - external modules, 454, 461
 - first-class subroutines, 156
 - function return value, 409, 508
 - garbage collection, lack of, 346
 - I/O, © 158
 - if statement, 248, 251
 - modules, 133ff
 - numeric types, 295
 - opaque types, 461
 - set types, 344
 - subroutines as parameters, 154
 - type checking, 306
 - variant records, © 143ff
- Modula-3, 825
 - arrays, 328
 - capitalization, 45
 - case of letters, 44
 - exception handling, 419
 - first-class subroutines, 157
 - forward references, © 30
 - function return value, 410
 - garbage collection, 120, 346, 357
 - generics, 149, 411
 - implementation, 757
 - method binding, 480
 - modules, 133, 135
 - object initialization, 472ff
 - overloading, 146
 - packed types, 321
 - parameter passing, 405, 447
 - pointers, 345
 - refany (universal reference) type, 313
 - scope rules, 129
 - separate compilation, 161
 - synchronization, 623
 - threads, 595
 - TRY... FINALLY, 424
 - type checking, 303
 - type extension (objects), 138, 450, 467, 491, 493
 - variables as values, 472
 - variant records, lack of, © 143
 - WITH statement, 15; © 136
- module, 132ff, 460ff
 - and classes, 136ff
 - closed scope, 135
 - exports, 133
 - generic. *See* generic subroutine or module
 - header, 462
 - imports, 133
 - information hiding, 132
 - as manager, 135ff
 - and object-oriented programming, 451
 - open scope, 135
 - and separate compilation, © 39ff
 - this parameter, 462ff
 - as type, 136ff, 449
- monads, 446, 525ff, 574
- monitor, 177, 619ff
 - bounded buffer example, 620
 - condition variables, 620
 - v. conditional critical region, 627
 - Java, 628, 629
 - message-passing model, © 283
 - nested calls, 623
 - semantics, 621ff
 - signals as hints and absolutes, 621ff, 624
- Mono, 436, 736, 765, 776, 783
- Moore, Charles H., 823
- Moore, J. Strother, 723
- Moss, J. Eliot B., 630, 648
- Motwani, Rajeev, 109
- MPI (message passing interface), 585, 589, 637, 639, 648
 - collective communication, © 285
 - process naming, © 263
 - receive operation, © 272
 - reduction, © 285
 - send operation, © 268
- MSIL (Microsoft Intermediate Language), 776. *See also* Common Language Infrastructure, Common Intermediate Language
- Muchnick, Steven S., 759; © 109, © 377ff
- multicore processor, xxiii, xxiv, 576, 577, 583; © 65, © 82ff, © 103
- Multics, 656
- multidimensional array, 335ff, 708
- multilevel returns, gotos and, 243ff
- multilingual character set, 295, 381. *See also* Unicode
- Multilisp, 634, 636, 645
- multipass compiler, 202. *See also* compilers and compilation, passes, one-pass
- multiple inheritance. *See* inheritance, multiple
- multiprocessor, 503
 - architecture, 581ff
 - cache coherence, 584ff, 605, 641; © 179
 - distributed memory, 584
 - scheduling, 602
 - single-chip, 576, 577, 583; © 65, © 82ff, © 103
 - symmetric, 583
 - vector. *See* vector processor
- multithreading, 579ff
 - cooperative, 601
 - dispatch loop alternative, 581ff
 - in hardware, 583, 585; © 65, © 82ff
 - need for, 579ff

preemptive, 601
 multiway assignment, 232, 708
 Murer, Stephan, 448
 mutual exclusion, 578, 603; © 265. *See also* synchronization
 in monitor, 621, 623
 walking locks, 628, 642
 mutual recursion, 128
 mutually recursive types, 348
 mx binary translator, 793, 816
 Myhrhaug, Bjørn, 173, 828

N

name equivalence of types, 303ff, 753
 strict v. loose, 306
 name mangling, 753, 759
 named (keyword) parameters, 405ff
 names, 3, 111. *See also* binding; binding rules; communication, naming partners; keywords; scope
 pervasive, 134
 predefined, 44, 61, 125, 134, 171
 qualified, 125, 676, 800; © 42ff, © 52, © 135
 scope resolution operator, 125
 in scripting languages, 691ff
 namespace
 in C++, 133, 139; © 42
 in C#, 133, 139; © 42ff
 in Perl, 710
 in scripting languages, 691
 in XML, © 289, © 294
 NaN (not a number), floating-point, © 73
 Naughton, Patrick, 766
 Naur, Peter, 47, 110, 821. *See also* Backus-Naur Form
 Necula, George, 815
 negation in Prolog, 568ff
 Nelson, Bruce, 648
 Nelson, Greg, 825
 nested monitor problem, 623
 nesting
 of blocks, 131ff, 512ff
 of case statements in scanner, 60ff
 of comments, 52
 in context-free grammar, 46
 of monitor calls, 623
 of subroutines, 124ff, 447, 691ff

access to nonlocal objects, 125
 implementation. *See* calling sequence; display; static link
 and local variables in scripting languages, 692ff
 .NET, 495, 499, 736, 764, 821, 823. *See also* C#; COM; Common Language Infrastructure; F#
 compilers, 788
 LINQ, 577, 806
 Windows Presentation Foundation (WPF), 436
 NetBeans, 25
 Netcraft LTD, 651
 Netscape Corp., 651, 688
 New York University (NYU), 210, 380
 Newell, Allen, © 109
 NeXT Software, Inc., 825
 NFA (nondeterministic finite automaton). *See* finite automaton, nondeterministic
 nibble, 296
 no-wait send, © 268
 nonbinding prefetches, 180
 nonblocking algorithms, 607ff, 646
 nonconverting type cast. *See* type cast, nonconverting
 nondeterminacy, 220, 277; © 115ff
 nondeterministic automaton. *See* automaton, pushdown; finite automaton, nondeterministic
 nondiscriminated union, © 143
 nonlocal objects, access, 125
 nonterminal, of CFG, 46
 nontrivial prefix problem in scanning, 61
 nop (no-op), 748; © 95, © 108
 normal-order evaluation, 275ff, 288, 521ff. *See also* lazy evaluation
 in lambda calculus, 534; © 242ff, © 245
 macros and, 284, 403
 and short-circuiting, 538
 normalization
 of floating-point number, © 73
 of syntax tree for code improvement, © 334

Norwegian Computing Centre, 173, 450, 828
 notation. *See also* regular expressions; context-free grammar
 Cambridge Polish, 221, 273, 510. *See also* prefix notation
 constructive, 534
 for lists, 365
 pseudo-assembly, 214
 Novell, Inc., 776
 nullifying branch. *See* branch instruction, nullifying
 numerals, Arabic, 41
 numeric operations. *See* arithmetic operations
 numeric type. *See* type, numeric
 Numrich, Robert, 647
 Nygaard, Kristen, 173, 450, 828

O

O'Hallaron, David, © 109
 Oak, 766
 Oberon, 85, 287, 825
 modules, 137
 object initialization, 472ff
 type extension (objects), 138, 467, 491; © 146
 variables as values, 472
 object closure, 157ff, 287, 402, 434, 465, 489ff, 595
 object code, 17. *See also* machine language
 binary translation, 791
 executable, 744
 relocatable, 744
 Object Management Group, 499
 object-based language, 498
 object-oriented languages and
 programming, 12, 14, 112, 138, 449ff, 492ff, 710ff. *See also* abstraction; class; constructor function; container class; destructor function; inheritance; methods and method binding; specific object-oriented languages
 anthropomorphism, 492ff
 class-based v. object-based languages, 498, 713

- object-oriented languages and programming (*continued*)
 - code improvement, ©377
 - covariance and contravariance, ©213
 - dynamic method binding, 478ff
 - encapsulation and inheritance, 460ff
 - generics and, 487ff
 - initialization and finalization, 469ff
 - modules and, 136ff, 451
 - multiple inheritance, 491ff; ©215ff
 - polymorphism and, 486ff
 - in scripting languages, 710ff
 - uniform object model, 492
 - Objective-C, 450, 825
 - class hierarchy, 471
 - inheritance, 491
 - method binding, 480
 - object initialization, 477
 - Object superclass, 457
 - polymorphism, 149, 292
 - self, 451
 - super, 459
 - type checking, 486
 - visibility of class members, 465
 - ObjectWeb ASM byte code framework, 802
 - OCaml, 822, 823. *See also* ML
 - Occam, 826. *See also* CSP
 - ALT statement, ©274
 - bounded buffer example, ©274ff
 - channels, ©264
 - indentation and line breaks, 45
 - input and output guards, ©283
 - memory model, 591; ©264
 - Occam 3, ©265
 - receive operation, ©272, ©274
 - remote invocation, ©268
 - send operation, ©268, ©274
 - termination, ©284
 - threads, 428
 - Ogden, William F., 210
 - OLE (Microsoft Object Linking and Editing system), 499, 775
 - Olivetti Research Center, 825
 - Olsson, Ronald A., 759
 - one-pass compiler, 189ff, 205
 - Opal, ©154
 - opaque types and exports. *See* export, opaque
 - open array. *See* conformant array parameters
 - Open Network Computing (ONC) RPC standard, 648
 - open operation, for files, ©155
 - open scope. *See* scope, open
 - open source
 - ANTLR, 69
 - AOLserver, 677
 - Apache Byte Code Engineering Library, 802
 - Apache web server, 651
 - bash, 656
 - CMU Common Lisp compiler, 790
 - compilers and interpreters, xxviii
 - Eclipse, 25
 - gcc, ©306
 - gdb, 806
 - HotSpot JVM, 767, 788
 - language design and, 8, 655, 717
 - Linux, 9
 - Mono, 736, 776, 821
 - NetBeans, 25
 - ObjectWeb ASM byte code framework, 802
 - Open64 compiler, 390
 - Pin binary rewriter, 796, 813, 816
 - Python, 672
 - R scripting language, 668, 827
 - Sisal, 828
 - Valgrind, 171
 - Open64 compiler, 390
 - OpenMP, 589, 639
 - directives, 590ff
 - parallel loops, 590ff
 - reduction, 592
 - thread creation, 590
 - operator, 220. *See also* expression
 - assignment, 230ff
 - associativity, 50
 - precedence, 50
 - in predicate calculus, 566; ©253
 - operator precedence parsing, 109
 - OPS5, 574
 - optimistic code improvement, 180
 - optimization, ©378. *See also* code improvement
 - OR parallelism, 636, 645
 - ordering, 219ff. *See also* concurrency; continuations; control flow; exception handling; iteration; nondeterminacy; recursion; selection; sequencing; subroutines
 - in Prolog, 552ff
 - within expressions, 235ff
 - mathematical identities, 237ff
 - ordinal type. *See* type, discrete
 - ordinal value, of an enumeration constant, 297
 - orthogonality, 228ff, 301ff, 771
 - Oskin, Mark, 648
 - Ousterhout, John K., 615, 651, 670, 724, 828
 - out-of-order execution, ©82, ©92ff, ©94
 - output dependence, ©94, ©352
 - overflow, in binary arithmetic, 29, 37, 238, 279, 309; ©67, ©71, ©76, ©104
 - overloading, 142, 146ff, 298, 312ff, 381
 - in C++, 146ff
 - and coercion, 149
 - of constructors, 458
 - definition, 144
 - in Haskell, ©129
 - in ML, ©128
 - overriding of method definitions, 479ff
- ## P
- P-code, 21ff, 206, 736, 765
 - PA-RISC architecture, 258, 793ff; ©108
 - memory model, 612
 - segmentation, 745
 - packed type. *See* type, packed
 - page fault, 745; ©314
 - panic mode. *See* syntax error, panic-mode recovery
 - Parallel FX, 577, 590, 634
 - parallelism, 576. *See also* concurrency
 - coarse-grain, ©365
 - v. concurrency, 576
 - data parallelism, 594, 606
 - fine-grain, ©366
 - granularity, 576, 577
 - instruction-level, 577; ©378. *See also* instruction scheduling

- loop-level, 590ff; © 365ff
- task parallelism, 594
- thread-level, 577
- vector, 577, 591, 633
- parallelization, © 365ff, © 378
- Parallels Desktop (VMM), 765
- parameter passing, 393ff. *See also*
 - parameters
 - in Ada, 398ff
 - of arrays in C, 354
 - by closure, 401ff
 - by move, © 280
 - by name, 275, 402, 523, 694; © 185ff, © 241
 - by need, 402, 525, 668; © 187
 - by reference, 115, 332, 395. *See also*
 - C++, references
 - ambiguity of, 397ff
 - by result, 399
 - by sharing, 396
 - by value, 332, 395
 - by value/result, 396, 399
 - variable number of arguments, 14, 406ff; © 154
- parameters. *See also* parameter passing
 - actual, 383, 393ff. *See also* arguments
 - C++ references, 399ff
 - closures as, 401ff
 - conformant arrays, 331ff, 403
 - const (read-only), 398, 399
 - of exception, 422
 - formal, 383, 393ff
 - of generics, 411ff
 - label, 244, 402, 426; © 186ff
 - in Lisp/Scheme, 394
 - modes, 394ff
 - named (keyword), 405ff; © 158
 - optional (default), 142, 403ff
 - positional, 405ff
 - of remote procedures, © 280
 - subroutines as, 530ff
 - this, 462ff
 - type checking, 307, 310
- parametric polymorphism. *See*
 - polymorphism, parametric
- PARC. *See* Xerox Palo Alto Research Center
- ParcPlace Smalltalk, 816
- parent type. *See* class, base
- parentheses
 - in arithmetic expressions, 222, 224, 238
 - for array subscripts, 326
 - in Lisp/Scheme, 221, 347, 365, 510
 - in ML tuples, 532; © 130
 - in Prolog, 547
 - in regular expressions, 44
 - in Ruby, 675
 - in shell languages, 660
- Parlog, 574, 637
- Parnas, David L., 173, 647
- Parr, Terrence, 69
- Parrot virtual machine, 790
- parse table
 - LL, 71, 77
 - LR, 92ff
- parse tree (concrete syntax tree), 27ff, 176ff; © 304
 - ambiguity and, 49ff
 - associativity and, 50ff
 - and attribute stack, © 54
 - building automatically, 208
 - decoration (annotation) of, 176ff, 182ff
 - derivations and, 48ff
 - exploration during LL or LR parse, 67ff, 87
 - GCD example, 28ff
 - precedence and, 50ff
 - semantic analysis and, 177
 - sum-and-average example, 76
- parser generator, 71, 82, 91, 101. *See also* ANTLR; yacc
- parsers and parsing, 3, 26, 27ff, 42, 67ff
 - bottom-up (LR, shift-reduce), 67, 87ff
 - attributes and, 196
 - canonical derivations, 87ff
 - CFSM, 91ff
 - epsilon productions, 92ff
 - LALR, 68, 91, 109; © 20ff
 - LR items, 89ff
 - LR(0), 91
 - SLR, 68, 91, 109; © 20ff
 - table-driven, 92ff
 - variants, 91ff; © 20ff
 - complexity, 67
- CYK (Cocke-Younger-Kasami)
 - algorithm, 67
- Earley's algorithm, 67
- operator precedence, 109
- syntax-directed translation, 67
- top-down (LL, predictive), 67, 76ff.
 - See also* recursive descent
 - attributes and, 196
 - EPS sets, 80
 - FIRST and FOLLOW sets, 79ff, 80ff; © 2ff, © 19ff,
 - PREDICT sets, 79ff, 80
 - in Scheme, 541
 - SLL, © 20
 - table-driven, 76ff
- partial execution trace, 794, 796, 809.
 - See also* trace scheduling
- partial redundancy, © 344
- Partitioned Global Address Space (PGAS) languages, 648
- Pascal, 7, 8, 287, 826; © 2
 - aggregates, lack of, 349
 - arithmetic overflow, 238
 - arrays, 326ff, 403
 - binding of referencing environment, 154
 - calling sequence on x86, 390; © 176ff
 - case of letters, 44, 104
 - case statement, 254
 - coercion, 148
 - comments, 102, 104
 - compilers, 21
 - conformant array parameters, 332, 403
 - declaration syntax, © 58
 - dereference (^) operator, 350
 - dispose operation, 120, 356
 - dynamic semantic checks, 381; © 151
 - early success, 22
 - enumeration types, 297
 - and Euclid, 823
 - forward references, 349; © 30
 - function return value, 409, 508
 - garbage collection, lack of, 346
 - GNU compiler (gpc), © 176ff, © 306
 - goto statement, 243, 426
 - grammar, 28
 - I/O, © 154, © 158, © 161, © 166

- Pascal (*continued*)
- if statement, 84, 102, 108, 248, 394;
 - ☉ 6
 - implementation, 8, 21, 736
 - limited extent of local objects, ☉ 209
 - mod operator, 374
 - nested subroutines, 124
 - new operation, 349
 - overloading, 146
 - packed types, 318, 321, 442
 - parameter passing, 115, 394ff
 - pointers, 345ff, 349ff
 - precedence levels, 223
 - records, 318ff
 - repeat loop, 268
 - scope rules, 128, 385
 - semicolons, ☉ 6
 - set types, 300, 316, 344, 374
 - short-circuit evaluation, lack of, 239, 249
 - standardization, 8
 - statements and expressions, 229
 - strings, 104, 316, 343ff
 - subrange types, 298
 - subroutine calling sequence, 390;
 - ☉ 176ff
 - subroutines as parameters, 401
 - type checking, 291, 303, 306
 - type compatibility, 311
 - type inference, 315
 - type system, 301, 380
 - variables as values, 226
 - variant records, 144; ☉ 165, ☉ 166,
 - ☉ 139ff
 - with statement, 15, 323; ☉ 30,
 - ☉ 135ff
- Pascal's triangle, 720ff; ☉ 328
- pass of a compiler, 26, 731, 734
- path of communication. *See* communication path
- pattern matching. *See also* regular expressions
- in *awk*, 664ff
 - greedy, 701, 722
 - in *Icon*, 268, 288; ☉ 111ff
 - minimal, 667, 701, 722
 - in *ML*, ☉ 129ff
 - in scripting languages, 654, 696ff
- Patterson, David A., ☉ 74, ☉ 92, ☉ 109
- PDA. *See* automaton, push-down
- PDF (Portable Document Format),
 - ☉ 156
 - and Postscript, 657
- PE (Portable Executable) assemblies, 776, 780
- peeking
 - at characters in scanner, 53, 61
 - at tokens in parser, 68, 91, 93, 97
 - inside messages, ☉ 277
- peephole optimization, 817; ☉ 321,
 - ☉ 325ff
- Pentium processor, 810; ☉ 79, ☉ 81,
 - ☉ 91, ☉ 102. *See also* x86 architecture
- perfect loop nest, ☉ 362
- performance analysis, 24, 583, 809ff
- performance counters, hardware, 810
- performance v. safety, 178, 279; ☉ 348
- performance versus safety, 236
- Perl, 12, 650, 666ff, 718, 826
 - arrays, 328, 403, 706
 - blessing mechanism, 710
 - byte code, 790
 - canonical implementation, 654
 - and CGI scripting, 680
 - coercion, 704
 - context, use of, 653, 669, 704ff, 709ff;
 - ☉ 51
 - economy of expression, 652
 - error checking, 704
 - first-class subroutines, 691
 - “force quit” example, 668ff
 - hashes, 706
 - HTML header extraction example, 666ff
 - I/O, 666; ☉ 157
 - inheritance, 712
 - last statement, 269
 - modules (packages), 133, 670, 707, 710
 - motto, 666
 - multiway assignment, 232
 - nested subroutines, 691, 721
 - numeric types, 705
 - objects, 673, 707, 710ff
 - pattern matching, ☉ 131
 - and PHP, 826
- regular expressions, 46, 667, 696, 698ff
- remote machine monitoring
 - example, 681ff
- scope rules, 135, 140, 653, 691ff, 694ff
- selective aliasing, 707
- strict 'vars' mode, 691
- syntax trees, 790
- taint mode, 815
- tied variables, 172
- type checking, ☉ 131
- typeglobs, 707
- unlimited extent, 691
- variables as values, 705, 710
- Worse Is Better, 717
- Perl 6
 - just-in-time compilation, 790
 - object orientation, 673, 710
- perlcc, 790
- Perles, Micha A., 110
- persistent files, 367; ☉ 154ff
- pervasive names, 134
- Peterson, Gary L., 605, 647
- Peyton Jones, Simon. L., 543
- PGAS (Partitioned Global Address Space) languages, 648
- pH (language), 507, 516, 535, 633, 647, 824
- phase of compilation, 25ff, 36, 730ff, 734; ☉ 323ff. *See also* scanning; parsing; semantic analysis; code improvement; code generation
- ϕ function, in SSA form, ☉ 337ff
- PHP, 12, 650, 682ff, 826
 - arrays and hashes, 708
 - exception handling, 419
 - interactive form examples, 684ff
 - modules (namespaces), 133
 - nested subroutines, lack of, 691
 - numeric types, 705
 - objects, 710ff, 712ff
 - references, 446
 - regular expressions, 696
 - remote machine monitoring
 - example, 683ff
 - scope rules, 653, 691
 - self-posting, 684ff
 - server-side web scripting, 682ff
 - type checking, 653

- variables as references or values, 705, 710
- and XSLT, ©292
- phrase-level recovery from syntax errors, 99, 110; ©2ff, ©10ff
- PIC (position-independent code), ©312ff
- Pierce, Benjamin C., 381; ©251
- pigeonhole principle, ©19
- piggy-backing of messages, ©271
- Pin binary rewriter, 796, 813, 816
- pipeline stall, ©79, ©81, ©91ff
- pipelining, ©79, ©91ff, ©103. *See also*
 - branch prediction; instruction scheduling
 - branches and, ©94ff
 - caches and, ©92ff
- pipes in scripting languages, 658ff
- PL/I, 826
 - decimal type, 296
 - exception handling, 419, 448
 - first-class labels, 426
 - formatted I/O, ©157
 - history, 9
 - indexed files, ©156
 - label parameters, 244
 - pointers, 345
 - records, 324; ©135
 - subroutines as parameters, lack of, 154
- Plauger, Phillip J., 288, 759
- pointer analysis, ©334
- pointer arithmetic, 178, 352
- pointer reversal in garbage collection, 361ff
- pointer swizzling, ©319
- pointers, 345ff. *See also* dangling
 - reference; garbage collection;
 - reference model of variables
 - and addresses, 345
 - aliases and, 145
 - and arrays in C, 352ff, 396
 - as composite type, 300
 - frame pointer, 384
 - implementation, 345
 - in ML, 351
 - operations, 346ff
 - and parameter passing in C, 396
 - semantic analysis and, 29
- stack pointer, 384
- to subroutines in C, 402
- syntax, 346ff
- Polak, W., 448
- Polish postfix notation, 206ff. *See also* postfix notation
- polling for communication, ©272
- polymorphism, 114, 148ff, 290ff, 312, 317, 348, 381, 486ff, 505
 - ad hoc, 151
 - functional programming and, 508
 - object-oriented programming and, 486ff
- parametric, 149
 - explicit. *See* generic subroutine or module
 - implicit, 150, 291, 317, 505; ©126
- in Scheme, 510
- subtype, 149, 292, 478. *See also*
 - methods and method binding,
 - dynamic
 - type systems and, 291ff
- port, of a message-passing program, ©263
- portability, 8
 - byte code, 8, 21ff, 766, 785, 797
 - character sets, 45
 - Diana, ©304
 - Java, 279
 - nonconverting type casts, 310
 - numeric precision, 37, 294
 - Unix, 8
 - virtual machines, 766
- position-independent code (PIC), ©312ff
- positional parameters, 405ff
- POSIX, ©209
 - pthread standard, 431
 - regular expressions, 696ff
 - select routine, ©123
 - shell, 654, 656
- Post, Emil, 506
- post-test loop, 268
- postcondition of subroutine, 178
- postfix notation, 206ff, 221, 280
- Postscript, 23, 206, 222, 657ff, 736, 738, 826; ©156
- Pouzin, Louis, 656
- PowerPC architecture, 258, 585, 734, 792; ©102ff, ©109ff
 - addressing modes, ©75
- Altivec extensions, 645
- atomic instructions, 608
- condition codes, ©77
- condition-determining delay, ©106
- decimal arithmetic, 296
- memory model, 612
- powerset (in mathematics), ©238
- pragma (compiler directive), 65, 391, 421, 589, 804; ©165
- pre-test loop, 268
- precedence, 280, 394
 - in CFG, 28, 50, 180
 - definition, 50
 - in lambda calculus, ©239
 - of operators, 160, 220, 222ff, 235, 275; ©228
- precondition of subroutine, 178
- predefined names, 44, 125, 134
 - keywords and, 61, 171
- predefined type. *See* type, predefined
- predicate
 - in logic, 566; ©253
 - in logic programming, 546
- predicate calculus, 545, 566; ©253ff
 - Skolemization, ©254, ©257ff
- predication, ©108
- PREDICT sets, 79ff, 80
- predict-predict conflict, 81
- predictive parsing. *See* parsing, top-down
- preemption, 580, 599ff
- prefetching, 180
- prefix argument in Emacs Lisp, 678
- prefix notation, 221, 280, 561. *See also* Cambridge Polish notation
- prefix property, of CFL, ©20
- preprocessor, 18, 20, 24
 - C++ compiler as, 21
- pretty printer, 24
- primary cache, ©66
- primitive type. *See* type, primitive
- Princeton University, 507, 825
- priority queue, 118
- private base class, 463ff
- private member of class, 454ff

- private type, in Ada, 414
 - procedural abstraction, 219. *See also* control abstraction
 - procedure, 383. *See also* subroutine
 - processes, 586, 598
 - lightweight and heavyweight, 586
 - threads and, 586, 598
 - processor. *See also* architecture; microprocessor; multiprocessor; vector processor
 - compiling for modern processors, 35; ©91ff. *See also* instruction scheduling; register allocation definition, 583
 - processor status register, ©66, ©76
 - processor/memory gap, ©67
 - production, of CFG, 46
 - Proebsting, Todd A., ©377
 - Proebsting's Law, ©377
 - prof., 810
 - profile-driven code improvement, 786ff
 - profiler, 24, 797, 809ff
 - basic block, 813, 816
 - program counter (PC), ©66
 - program maintenance, 6
 - programming environments, 24ff
 - Genera, 39
 - for Smalltalk, 24ff
 - Prolog, 7, 11, 505, 547ff, 574, 827
 - arithmetic, 551ff
 - atoms, 547
 - backtracking, 552ff
 - call predicate, 558, 564; ©253
 - character set, 560
 - clause predicate, 565ff
 - clauses, 547ff
 - closed world assumption, 568ff
 - control flow, 557ff
 - cut (!), 557
 - database, 547
 - manipulation, 561ff
 - execution order, 552ff, 557ff, 567
 - facts, 547, 565
 - fail predicate, 558
 - failure-directed search, 567
 - functors, 547
 - generator, 559ff
 - goals, 548ff
 - Horn clause, 547ff
 - implementation, 23, 552ff, 567ff
 - infinite regression, 554ff, 573
 - instantiation, 547, 553, 569
 - lists, 550ff
 - loops, 559
 - negation, 568ff
 - \+ (not) predicate, 556ff, 566, 568ff; ©256
 - parallelization, 636
 - parentheses, 547
 - queries, 548, 552
 - recursive types, 365
 - reflection, 565, 799
 - resolution, 549ff
 - rules, 547
 - search strategy alternatives, 567, 572
 - selection, 559
 - self-representation (homoiconography), 17, 561, 562
 - structures, 547
 - terms, 547
 - tic-tac-toe example, 554ff, 559, 562ff
 - type checking, 547
 - unification, 547, 549ff, 552; ©127
 - variables, 547, 549
 - prologue of subroutine, 117, 386
 - promise, 276
 - pronunciation, of language names, 7
 - proof, constructive v. nonconstructive, 507, 570
 - proof-carrying code, 815
 - proper list. *See* list, proper
 - property mechanism in C#, 455
 - proposition, in predicate calculus, 566; ©253
 - protected base class, 463
 - protected member of class, 463
 - protected objects in Ada, 624; ©273
 - prototype objects in JavaScript, 498, 710, 713ff
 - pseudo-assembly notation, 214
 - pseudo-random number, 247, 526; ©119
 - pseudoinstruction, 748; ©88
 - pthread standard (POSIX), 431
 - ptrace, 808
 - public base class, 456
 - public member of class, 454
 - Pugh, William, 647
 - pumping lemma, 110
 - push-down automaton. *See* automaton, push-down
 - PVM (parallel virtual machine), 648
 - Python, 12, 650, 672ff, 827
 - arrays, 328, 707
 - canonical implementation, 654
 - equality testing, 369
 - exception handling, 419
 - executable class declarations, 715
 - as extension language, 652
 - first-class functions, 531, 655, 691
 - “force quit” example, 672ff
 - hashes, 707
 - indentation and line breaks, 45, 673
 - interpretation, 18
 - iterators, 262, 264
 - lambda expressions, 508
 - list comprehensions, 367, 655
 - list types, 365
 - method binding, 480
 - modules, 135, 139, 670
 - multidimensional arrays, 708
 - multiple inheritance, 491
 - ambiguity resolution, ©217
 - multiway assignment, 232, 708
 - nested subroutines, 124
 - numeric types, 670, 705
 - objects, 138, 450, 710ff, 714ff
 - parameter passing, 405ff
 - polymorphism, 149, 292
 - reflection, 565
 - regular expressions, 46, 674, 696
 - scope rules, 129, 653, 691ff
 - sets, 708
 - try...finally, 424
 - tuples, 409, 636, 708
 - type checking, 653, 704
 - unlimited extent, 691
 - variables as references, 472, 705, 710
 - visibility of class members, 465
 - Python Software Foundation, 672
- ## Q
- quadruples, 735
 - qualified name, 125, 676, 800; ©42ff, ©52, ©135,
 - quantifier, 566, 568ff; ©253ff

- quasiparallelism, 576
- query
 in `bash`, 657ff
 in Prolog, 548, 552; © 255ff
- query language processor, 23
- quicksort, 379, 568, 572
- Quine, Willard Van Orman, 221
- Quiring, Sam B., 100, 110; © 7
- quoting in shell languages, 660ff
- ## R
- R scripting language, 668, 827
- arrays, 328, 668
- automatic parallelization, 634
- call by need, 525
- first-class subroutines, 691
- infix notation, 221
- multidimensional arrays, 709
- parameter passing, 402; © 187
- scope rules, 691ff
- super-assignment, 693
- unlimited extent, 691
- r-value, 226, 351; © 52
- Rabin, Michael O., 109
- Alonzo Church and, 507
- race condition, 578, 591, 601ff, 604, 613, 633
- ragged array, 337
- Rajwar, Ravi, 648
- Ramesh, S., © 284
- Randell, Brian, 447
- random number, pseudo, 247, 526; © 119
- random-access file, © 156
- range, of function, 534; © 237
- rational type. *See* type, numeric, rational
- Rau, B. Ramakrishna, © 378
- reaching definition, © 336, © 347, © 367
- read-eval-print loop, 509ff
- read-modify-write instruction. *See* atomic instruction (primitive)
- read-only parameter, 398
- read-write dependence. *See* dependence, anti-
- reader-writer locks, 606, 625, 628, 641
- ready list, 599ff, 604, 613ff, 640; © 281
- Real Time Specification for Java, 358
- receive operation, © 272ff
- explicit, © 272ff, © 278
- implicit, 597; © 272ff, © 278, © 280
- peeking, © 277
- records, 317ff. *See also* variant records;
 with statement
- assignment, 321
- comparison, 321
- as composite type, 300
- fields, 318
- ordering, 322
- memory layout, 319ff, 597
- holes, 320ff
- nested, 319
- symbol table management, © 29
- syntax and operations, 318ff
- `with` statement, 99, 323; © 367, © 135ff
- recovery from syntax errors
- recursion, 43, 219, 270ff. *See also* tail recursion
- algorithmically inferior programs, 274
- continuation-passing style, 273
- and functional programming, 505, 508
- iteration and, 271ff
- mutual, 128
- in Scheme, 515ff
- recursive descent, 70ff, 128
- attribute management, © 54
- backtracking, © 123
- phrase-level recovery, © 2ff
- v. table-driven top-down parsing, 83
- recursive types, 300, 345ff, 381
- in Scheme, 513
- redeclaration, 131
- redirection of output, 658ff
- reduced instruction set computer. *See* RISC
- reduction, 530, 533
- redundancy elimination. *See also* common subexpression elimination
- global, © 336ff
- induction variables, © 349
- local, © 328ff
- reentrant code, 613
- reference counts, 358ff; © 151, © 166ff
- circular structures, 359
- v. tracing collection, 363
- reference model of variables, 225ff, 233, 288ff, 345, 347ff, 371, 381, 396, 454, 472ff, 597
- implementation, 227
- references
- in C++, 446
- forward, 189; © 30
- initialization and, 470, 472ff
- in PHP, 446
- to subroutines, 152
- and values, 220, 225ff
- referencing environment, 112, 122
- binding and, 151ff
- referential transparency, 225, 534; © 308
- refinement of abstractions, 451
- reflection, 143, 565, 745, 764, 799ff; © 47
- in C#, 802
- and dynamic typing, 799, 804
- and generics, 780, 802; © 195, © 196
- in Java, 800ff
- pitfalls, 800
- in Prolog, 565
- regex library package, 696
- register, © 66
- clock, © 119
- debugging, 809
- FP. *See* frame pointer
- memory hierarchy and, © 66
- PC (program counter), © 66
- processor status, © 66, © 76
- saving/restoring, 386ff
- SP. *See* stack pointer
- virtual, 730; © 97, © 323, © 329ff
- in x86 and MIPS, © 86ff
- register allocation, 391, 734, 741ff, 787, 788; © 96ff, © 366ff
- complexity, © 322
- graph coloring, © 367, © 377
- and instruction scheduling, © 99ff, © 323, © 370
- in partial execution trace, 797
- stack-based, 741
- register indirect addressing mode, © 75, © 85
- register interference graph, © 367
- register pressure, © 323
- common subexpression elimination and, © 326, © 344ff

- register pressure (*continued*)
 - induction variable elimination and, © 349
 - instruction scheduling and, © 354
 - loop reordering and, © 362
 - software pipelining and, © 358
- register renaming, © 82, © 94ff, © 352, © 374
- register spilling, 742; © 97ff, © 355, © 369
- register windows, 390ff; © 181ff
- register-memory architecture (CISC machines), © 75
- register-register architecture (RISC machines), © 75, © 96
- regular expressions, 3, 42ff, 696ff. *See also* pattern matching
 - advanced, 696
 - basic, 696
 - capture of substrings, 667, 699, 701ff, 722
 - compiling, 699, 702
 - creation from DFA, © 14ff
 - extended, 696ff
 - greedy, 701, 722
 - grep**, 46, 696ff
 - Kleene star, 41, 44, 47
 - minimal matching, 667, 701, 722
 - nested constructs, lack of, 46
 - parentheses, 44
 - in Perl, 698ff
 - POSIX, 696ff
 - regex** library package, 696
 - in scripting languages, 654, 696ff
 - translation to DFA, 55ff
 - translation to NFA, 699, 702
- regular language (set), 43, 100
- reification, 780, 802; © 196
- relocation, linking and, 744, 750ff, 770
- remainder, in integer division, 374
- rematerialization, © 370
- remote procedure call (RPC), 589; © 278ff
 - implementation, 763; © 280ff
 - implicit message receipt, 590; © 272
 - message dispatcher, © 280
 - parameters, © 280
 - semantics, © 279
- remote-invocation **send**, © 268
- rendezvous, © 278
- repeat** loop. *See* loop, logically-controlled
- repeated inheritance. *See* see inheritance, repeated
- replicated inheritance. *See* see inheritance, repeated, replicated
- Reps, Thomas, 211
- reserved word. *See* keywords
- resolution, in logic programming, 546, 549ff
- resource hazard in pipeline, © 91
- return value of function, 116, 408ff, 508
- reverse assignment, 485
- reverse execution, 815
- reverse Polish notation, 206ff. *See also* postfix notation
- Rexx, 650, 652, 672, 724
 - context, use of, 653
 - error checking, 704
 - as extension language, 652
 - Object Rexx, 673
 - standardization, 654
- Rice University, 648
- Rice, H. Gordon, 110
- right-most (canonical) derivation, 48, 68, 87ff
- RISC (reduced instruction set computer), 213; © 65, © 81ff. *See also* Alpha architecture; ARM architecture; MIPS architecture; PA-RISC architecture; PowerPC architecture; SPARC architecture
 - byte operations, © 69
 - compilation for, © 91
 - conditional branches, © 77
 - delayed branch, © 93, © 95
 - delayed load, © 95
 - endian-ness, © 69
 - history, xxiii, © 88, © 93ff, © 103
 - implementation of, © 81ff
 - load-store (register-register) architecture, © 75, © 96
 - nullifying branches, © 95
 - philosophy of, © 81, © 103
 - register windows, 390ff; © 181ff
- registers, © 66
 - subroutine calling sequence, 390
 - three-address instructions, © 75
- Ritchie, Dennis M., 8, 821
- RMI. *See* remote method invocation
- Robinson, John Alan, 549, 573
- Rosenkrantz, Daniel J., 109, 210
- Rosetta (Apple) binary translator, 791, 793, 795
- Rosser, J. Barclay, 537; © 242
 - Church-Rosser theorem, © 242
- Rounds, William C., 210
- Roussel, Philippe, 545, 574, 827
- row-major layout (of arrays), 335ff; © 360ff
- row-pointer layout (of arrays), 337ff
- RPC. *See* remote procedure call
- RPG, 650
- RTF (rich text format), © 156
- RTL (GNU register transfer language), 736, 759; © 303, © 309ff
- Rubin, Frank, 287
- Ruby, 12, 650, 674ff, 682, 827
 - access control, 716
 - arrays, 328, 707
 - blocks, 676ff
 - canonical implementation, 654
 - coercion, 704
 - continuations, 246
 - exception handling, 419, 655, 676
 - executable class declarations, 715
 - first-class subroutines, 691
 - “force quit” example, 675ff
 - hashes, 707
 - iterators, 262, 267, 655, 676ff
 - lambda expressions, 508
 - line breaks, 675
 - method binding, 480
 - mix-in inheritance, 491, 676
 - modules, 139, 670, 676
 - multilevel returns (**catch** and **throw**), 244, 245, 421
 - multiway assignment, 232, 655
 - nested blocks, 691, 721
 - nested subroutines, lack of, 691
 - numeric types, 670, 705
 - objects, 138, 450, 493, 655, 674, 710ff, 714ff
 - polymorphism, 149, 292

- on Rails, 651, 674
 - reflection, 655
 - regular expressions, 46, 676, 696
 - scope rules, 691
 - slices, 655
 - taint** mode, 815
 - type checking, 653, 704ff
 - unlimited extent, 691
 - variables as references, 472, 705, 710
 - rule, in Prolog, 547
 - run-time system, xxiv, 761ff. *See also*
 - coroutine; event handling;
 - exception handling; garbage collection; library package;
 - linkers and linking, dynamic;
 - parameter passing, variable number of arguments; remote procedure call (RPC); thread;
 - transactional memory
 - definition, 761
 - relationship to compiler, 761, 812
 - Russell, Lawford J., 447
- S**
- S scripting language, 668
 - S-attributed attribute grammar. *See*
 - attribute grammar, S-attributed
 - S-DSM. *See* software distributed shared memory
 - S-expression, 517; ©309
 - SAC (Single Assignment C), 330, 507, 535
 - safety v. performance, 178, 279; ©348
 - safety versus performance, 236
 - Saltz, Joel, ©376
 - sandboxing, 689, 796ff, 815, 816
 - Sandon, Lydia, 724
 - Sather, 448
 - satisfiability, ©261
 - scalability in parallel systems, 594, 629
 - scalar type. *See* type, scalar
 - scaled index addressing mode, ©85
 - scanner generator, 55ff, 60, 101. *See also*
 - lex
 - scanners and scanning, 3, 26, 27ff, 42, 51ff
 - ad hoc, 52
 - with explicit finite automaton, 53, 60ff
 - lexical errors, 63ff
 - longest possible token rule, 53, 61ff
 - nontrivial prefix problem, 61
 - table-driven, 63ff
 - scatter operation, ©272, ©278, ©280
 - scheduler-based synchronization, 588, 615ff
 - scheduling, 599, 613ff; ©281. *See also*
 - context switch; instruction scheduling; multithreading;
 - self-scheduling; trace scheduling
 - implementation, 613ff
 - on multiprocessor, 602
 - on uniprocessor, 599ff
 - Scheme, 509ff, 827. *See also* Lisp
 - apply** function, 518ff
 - assignment, 515ff
 - association lists, 514
 - bindings, 512ff
 - Boolean constants, 514
 - conditional expressions, 515, 538
 - continuations, 246, 284, 426
 - control flow, 515ff
 - currying, 533
 - delay** and **force**, 275, 635
 - denotational semantics, 210, 518
 - DFA example, 519ff
 - equality testing, 369, 514ff
 - eval** function, 518ff
 - evaluation order, 521ff
 - expression types, 523
 - first-class functions, 156, 401, 691
 - iteration, 266
 - for-each**, 516ff
 - inexact constants, 103
 - lambda** expression, 511, 531
 - lazy evaluation, 539
 - let** construct, 129, 512; ©137
 - lists, 513ff
 - macros, 160, 523
 - map** function, 530
 - nested subroutines, 124
 - numbers and numeric functions, 295, 514, 670, 705
 - operational semantics, 210
 - programs as lists, 517ff
 - quoting, 510
 - rational type, 295
 - recursion, 515ff
 - recursive declarations, 513
 - S-expressions, 517
 - scope rules, 122, 129ff, 140, 385, 513, 691
 - searching, 514
 - self-definition, 517ff
 - self-representation (homoiconography), 122, 517ff, 562
 - special forms, 275, 285, 511, 523
 - symbols, 511
 - type checking, 653, 704
 - type predicate functions, 511
 - unlimited extent, 691
 - variables as references, 705
 - Scheme shell (**scsh**), 723
 - Scherer, William N. III, iv
 - Schiffman, Allan M., 499, 816
 - Schneider, Fred B., 647
 - Scholz, Sven-Bodo, 330, 536, 828
 - Schorr, Herbert, 361, 381
 - Schwartz, Jacob T., 380; ©377
 - scientific notation and floating-point numbers, ©72
 - scope, 3, 112, 121ff. *See also* binding;
 - binding rules; specific languages
 - closed, 135; ©31
 - dynamic, 122, 139ff, 291, 505
 - alternatives, 142
 - conceptual model, 695
 - motivation, 141
 - global variable, 123
 - hole in, 125, 129
 - implementation, 125, 143, 385; ©29ff. *See also* display; static link
 - association list, 143; ©33ff
 - central reference table, 143; ©33ff
 - symbol table, ©29ff
 - lexical. *See* scope, static
 - local variable, 123
 - open, 135, 454
 - scripting languages, 653, 691ff
 - static, 122ff
 - classes, 136ff, 463ff
 - declaration order, 127ff
 - declarations and definitions, 130ff
 - modules, 132ff, 460ff

- scope (*continued*)
 - nested blocks, 131ff, 512ff; © 29
 - nested subroutines, 124ff; © 29
 - own (*static*) variables, 124, 133
 - of undeclared variable in scripting language, 692ff
- scope resolution operator, 125, 455, 459; © 218
- scope stack of symbol table, © 30ff
- scoped memory in Java, 358
- Scott, Dana S., 109, 211
 - Alonzo Church and, 507
- Scott, Michael L., iv, 642, 643, 647
- scripting languages, 12, 649ff. *See also*
 - AppleScript; **awk**; **bash**; Emacs Lisp; JavaScript; Maple; Mathematica; Matlab; Perl; PHP; Python; R; REXX; Ruby; S; Scheme; **sed**; SIOD; Tcl; Tk; VBScript; Visual Basic; XSLT
- access to system facilities, 654
- arrays, 335
- characteristics, 652ff, 691ff, 718
- coercion, 148
- data types, 654ff, 704ff
 - composite, 706ff
 - numeric, 705
- declarations, 653
- definition, 649
- dynamic typing, 293, 653
- extension languages, 652, 676ff
- first-class subroutines, 155
- “force quit” example
 - in Perl, 668ff
 - in Python, 672ff
 - in Ruby, 675ff
 - in Tcl, 670ff
- garbage collection, 120, 346
- general purpose, 668ff
- glue languages, 668ff
- history, 650ff
- interactive use, 652
- magic numbers, 662
- for mathematics, 667ff
- on Microsoft platforms, 651
- modules, 133
- names, 691ff
- object orientation, 710ff
- pattern matching, 654, 696ff
- polymorphism, 291
- problem domains, 655
- quoting, 660ff
- reflection, 565, 799, 803
- report generation, 663ff
- scope rules, 653, 691ff
- shell languages, 655ff
- for statistics, 667ff
- string manipulation, 334, 342, 654, 696ff
- text processing, 663ff
- type checking, 291, 486
- unlimited extent, 156
- variable expansion and interpolation, 656ff, 701ff
- World Wide Web and, 680ff, 797
 - CGI scripts, 680ff
 - client-side scripts, 686ff
 - Java applets, 686ff
 - server-side scripts, 680ff
 - XSLT, XPath, and XSL-FO, © 290ff
- scsh** (Scheme shell), 723
- search path of a shell, 658
- Sebesta, Robert W., 39
- second-class subroutine, 154ff
- secondary cache, © 66
- section of an array. *See* arrays, slices
- security, 689. *See also* sandboxing
 - and binary rewriting, 812
 - Common Language Infrastructure, 777, 781
 - v. functionality, 689
 - Java Virtual Machine, 767, 776
 - JavaScript, 689
 - and reflection, 800
 - stack smashing, 353; © 179
 - taint** mode, 815
- sed**, 650, 663ff, 826
 - HTML header extraction example, 663
 - one-line scripts, 664
 - pattern space, 664
 - regular expressions, 46, 696
 - standardization, 654
- seek operation, for files, © 156
- segmented memory, 345
- segments, 745
 - segment switching in assembler, 749
- select** routine (POSIX), © 123
- Selection, 219
- selection, 247ff
 - case/switch** statement, 251ff
 - if** statement, 247
 - in Prolog, 559
 - short-circuited conditions, 248ff, 278, 281
- selection function. *See* merge function, in SSA form
- Self (language), 498, 500, 710
- self-definition. *See* homoiconic language
- self-hosting compiler, 21
- self-modifying code, 792
- self-scheduling, © 366
- semantic action routine. *See* action routine
- semantic analysis, 29ff, 175ff. *See also*
 - attribute grammar
 - assertions, 178ff
 - invariants, 178, 284, 288
 - pre- and postconditions, 178
 - symbol table and, 29
- semantic check, 18, 175. *See also*
 - semantic error
 - dynamic, 141, 176ff, 365, 381; © 34
 - arithmetic overflow, 238, 309
 - array subscript, 331, 340, 796; © 350
 - conditional trap instruction, © 89
 - dangling reference, 357, 796
 - disabling, 178
 - in linker, 756
 - reverse assignment, 484
 - safety v. performance, 177
 - safety versus performance, 236
 - subrange values, 299, 315ff; © 350
 - type conversion, 307ff, 311, 485
 - uninitialized variable, 234, 280, 796
 - variant records, © 143, © 145
 - static, 177
- semantic error
 - dynamic. *See also* semantic check; type clash
 - and lazy evaluation, 523
 - missing label in **case** statement, 254
 - null pointer dereference, 239, 366
 - unhandled exception, 420
 - static, 99

- ambiguous method reference,
 - © 217, © 222
- attribute grammar handling, 199
- declaration hiding local name, 131
- invalid coercion in Ada, 311
- invalid generic coercion in C++,
 - © 211
- missing default constructor, 473
- missing label in `case` statement,
 - 254; © 131
- missing `vtable` in C++, 484
- misuse of precedence in Pascal, 224
- subrange and packed types as
 - parameters in Pascal, 442
- taking address of non-l-value, 310
- type checking in ML, © 126
- unsupported operation on generic,
 - 416
 - use before declaration, 128
- semantic function, 181ff. *See also*
 - attribute grammar notation, 182ff
- semantic hook, © 52
- semantic stack, © 57
- semantics, 3, 42. *See also* attribute grammar
 - axiomatic, 177, 178, 182, 211, 284, 545
 - denotational, 182, 210, 246, 293, 518
 - dynamic, 29, 140, 175. *See also*
 - semantic check; semantic error
 - of monitors, 621ff
 - operational, 210
 - of remote procedure calls, © 279
 - static, 29, 140, 175
 - v. syntax, 41ff
- semaphores, 242, 617ff, 632
 - binary, 617
 - bounded buffer example, 618
- send** operation, © 267ff
 - buffering, © 268ff
 - emulation of alternatives, © 271ff
 - error reporting, © 270ff
 - synchronization semantics, © 268ff, © 271ff
 - syntax, © 271
- sense-reversing barrier, 606
- sentential form, 48
- sentinel value, 280, 288
- separate compilation, 113, 161ff, 750, 759; © 39ff
 - in C, 133
 - in C++, 455
 - and code improvement, 732
 - common blocks, 123
 - history, © 44
 - and modules, 137, 461, 462
 - in scripting languages, 691
 - type checking, 751ff
- sequencing, 219, 246ff
- sequential consistency, 610ff
- sequential file, © 155
- serialization
 - in concurrent program, 607
 - of objects in messages, 800
 - of transactions, 630
- server-side web scripting, 680ff
- setjmp** routine in C, 426ff
- SETL, 210, 380
- sets, 344ff
 - as composite type, 300
 - implementation, 344
 - in Python, 708
- SGML (standard generalized markup language), © 287ff
- sh**, 650, 656
 - standardization, 654
- shallow binding. *See* binding rules, shallow
- shallow binding for name lookup in Lisp, © 35
- shallow comparisons and assignments (copies), 369ff
- Shamir, Eliahu, 110
- shape of an array. *See* array, shape
- shared inheritance. *See* inheritance, repeated, shared
- shared memory (concurrent), 603ff. *See also* synchronization
 - v. message passing, 583, 587ff
 - scheduler implementation, 613ff
- Sharp, Oliver J., © 378
- Shasta, 288
- Shavit, Nir, 647
- shell, 650, 655ff, 668. *See also* **bash**; command interpreter; scripting languages
- Sheridan, Michael, 766
- shift-reduce parsing. *See* parsing, bottom-up
- shmexec** library package, 647
- short-circuit evaluation, 188, 238ff, 248ff, 275, 278, 281, 538
- side effect, 12, 230, 275ff, 560, 570ff
 - and assignment operators, 230
 - and compilation, 536
 - and concurrency, 635
 - definition, 225
 - of exception handler, 423
 - and functional programming, 507ff, 534
 - and I/O, 525
 - of instruction, © 368
 - and lazy evaluation, 276, 523ff; © 187
 - and macros, 160
 - and nondeterminacy, 279; © 119
 - and ordering, 236ff, 246ff, 525
 - in RTL, © 309
 - in Scheme, 515ff
 - and short-circuit evaluation, 240
 - of Smalltalk assignment, © 228
 - of statement, 301
 - of subroutine call, © 328
- Siewiorek, Daniel P., © 109
- signal
 - in monitor, 620ff
 - cascading, 622
 - hints v. absolutes, 621ff, 624
 - OS, 93, 435ff, 598, 601ff, 609
 - trampoline, 435
- signaling NaN, floating-point, 234; © 74
- significant of floating-point number, © 72
- significant comment. *See* pragma
- Silbershatz, A., © 284
- Silicon Graphics, Inc., 585; © 85
- simple type. *See* type, simple
- Simula, 136, 173, 448, 828
 - cactus stacks, 432
 - call-by-name parameters, 402; © 185ff
 - classes, 138
 - coroutines, 428
 - detach** operation, 429, 433
 - encapsulation, 450, 460
 - inheritance, 491
 - method binding, 480

- Simula (*continued*)
 - object initialization, 475
 - parameter passing, © 185ff
 - type system, 294
 - variables as references, 472
 - virtual methods, 480
- simulation, 433, 792; © 205ff
- Singh, Jaswinder Pal, 648
- Single Assignment C, 328, 330, 507, 535, 633, 828
- single inheritance, 483ff
- single stepping, 808ff
- single-assignment variable, 636ff
- single-precision floating-point number, © 68, © 73
- SIOD (Scheme in One Defun), 677, 724
 - and GIMP, 677
- Sipser, Michael, 109
- Sisal, 11, 507, 516, 535ff, 633, 828
 - compilation, 536
- Skolem, Thoralf, © 254
 - Skolemization, © 254, © 257ff
- slice of an array, 328ff, 668; © 366
- SLL parsing. *See* parsers and parsing, top-down
- SLR parsing. *See* parsers and parsing, bottom-up
- Smalltalk, 7, 12, 173, 450, 493ff, 619, 828; © 227ff
 - anthropomorphism, 471, 493
 - assignment, © 228
 - associativity and precedence, lack of, © 228
 - blocks, © 228
 - class hierarchy, 471
 - classes, 138
 - control abstraction, © 229ff
 - expression syntax, 394, 438; © 227
 - if construct, 394; © 228
 - implementation, 23, 499
 - infix notation, 221
 - inheritance, 491
 - interpretation, 18
 - iteration, 267; © 228ff
 - messages, © 227
 - metaclass, 472
 - method binding, 480
 - multiple inheritance, 499
 - object initialization, 470ff
 - Object superclass, 457
 - object-oriented programming and, 493; © 227ff
 - parameter passing, 396
 - polymorphism, 114, 149, 291ff
 - precedence, 224
 - programming environment, 24ff, 39, 493; © 153, © 154, © 227
 - self, 451; © 230
 - super, 459
 - type checking, 114, 179, 291, 485
 - type system, 293ff
 - unlimited extent, 156
 - variables as references, 226, 472
 - visibility of class members, 465
- Smith, James E., © 109
- Smith, Randall B., 500
- Sneeringer, W. J., 380
- Snobol, 828; © 123
 - pattern matching, © 131
 - scope rules, 122, 140
 - self-representation (homoiconography), 562
 - strings, 334, 342
 - type checking, © 131
- snooping (cache coherence), 584
- Snyder, Alan, 448
- SOAP, 648
- Société des Outils du Logiciel, 823
- socket, © 263
- software distributed shared memory (S-DSM), iii, 288, 587, 648
- software pipelining, © 356ff
- Solomon, Marvin H., 288
- sourceforge.net, 9
- SPARC architecture, 585, 759; © 102ff, © 109
 - addressing modes, © 75
 - atomic instructions, 606
 - condition codes, © 77
 - fence instructions, 611
 - memory model, 612
 - register windows, 391; © 181ff
 - Rock implementation, 631
- special forms in Scheme, 275, 285, 511, 523, 645
- speculation, 219
 - code caching, 786
 - code improvement, 180
 - OR parallelism, 636
 - processor execution, © 82, © 92, © 108
 - transactions, 630ff
- spilling of registers. *See* register spilling
- spin lock, 604ff, 614ff
 - and preemption, 643
 - two-level, 640
- spin-then-yield lock, 614ff
- spinning. *See* synchronization, busy-wait
- spreadsheet, 11
- SQL, 11, 23, 573, 577, 806
- SR, 828
 - bounded buffer example, © 276, © 278
 - capabilities, © 265
 - case statement, lack of, © 116
 - function return value, 409
 - guarded commands, © 115, © 122
 - implementation, 757
 - in statement, © 118, © 276
 - integration of sequential and concurrent constructs, 597
 - line breaks, 45
 - memory model, © 265
 - message screening, © 119, © 276
 - naming for communication, © 265
 - nondeterminacy, © 115
 - receive operation, © 272
 - remote invocation, © 268
 - send operation, © 268
 - termination, © 284
 - threads, 428, 590
- Srivastava, Amitabh, 816
- SSA form. *See* static single assignment form
- stack frame, 117ff, 384ff; © 173ff
 - bookkeeping information, 117
 - with dynamic shape arrays, 334
 - return value, 409
 - temporaries, 116
 - with variable number of arguments, 407
- stack pointer, 118, 384
- stack smashing, 353; © 179
- stack-based allocation and layout, 117ff, 384ff, 745. *See also* calling sequence; stack frame

- backtrace, 810, 815
- for coroutines, 430ff
- exceptions, 425ff
- for iterators, © 202
- for nested thread. *See* cactus stack
- stack-based intermediate language, 736, 766. *See also* Forth; byte code; Postscript
- optimization, 766
- stall of processor pipeline. *See* pipeline stall
- standard input and output, 659
- standardization, 8
- Stanford University, 10, 447; © 85, © 109
- Stansifer, Ryan D., 543, 825
- start symbol of CFG, 46
- statement
 - v. expression, 220, 225, 229
 - in predicate calculus, 566; © 253
- static analysis, 179ff. *See also* alias
 - analysis; escape analysis;
 - semantic check, static; subtype analysis
- static binding. *See* binding, static
- static chain, 127ff, 385
 - v. display, 389
 - maintaining, 387
- static link, subroutine, 126, 385
- static linker, 750
- static method binding, 479
- static objects, storage allocation, 115ff, 124, 133
- static scoping. *See* scope, static
- static semantics. *See* semantics, static
- static single assignment (SSA) form, 788; © 307, © 336ff, © 378
- static typing. *See* type checking, static
- `stdio` library, in C/C++, 406; © 159, © 161
- Stearns, Richard E., 109, 210
- Steele, Guy L. Jr., 822, 827
- stop-and-copy garbage collection, 362ff, 381
- stop-the-world phenomenon in garbage collection, 363
- storage allocation and management, 114ff. *See also* dangling
 - reference; garbage collection;
 - memory, leak
- storage compaction, 120; © 151
- `store_conditional` instruction, 608, 630, 641
- stored program computing, 11
- Stoy, Joseph E., 210, 211
- Strachey, Christopher, 211
- streams
 - in C++, © 162ff
 - in functional programming, 525ff, 540
 - and Unix tools, 697
- strength reduction, © 326, © 349
- strict language, 523
- strict name equivalence, 306
- strictness analysis, 536
- strings, 300, 342ff
 - and scripting languages, 654, 663, 696ff
 - storage management, 343
- strip mining, © 366
- Strom, Robert E., 380
- strongly typed language. *See* type checking, strong
- Stroustrup, Bjarne, 499, 822; © 215, © 218
- structural equivalence of types, 303ff, 377, 753; © 132
- structured programming, 7, 241ff, 287; © 347
 - `goto` alternatives, 242ff, 278
- structures, 317ff. *See also* records
 - in Prolog, 547
- stub
 - for dynamic linkage, © 314
 - in RPC, 806; © 278
- Stumm, Michael, 640
- stylesheet languages, © 288
- subclass. *See* class, derived
- subrange type, 298ff, 315ff
- subroutine, 219, 383ff. *See also* calling
 - sequence; control abstraction;
 - function; leaf routine;
 - parameter passing; parameters;
 - stack frame; stack-based allocation and layout
- closure. *See* closure, subroutine
- epilogue, 117, 386
- first-class. *See* first-class values, subroutines; function, higher-order
- formal, 401. *See also* first-class values, subroutines
- frame pointer, 117, 118, 384
- generic. *See* generic subroutine or module
- impact on code generation and improvement, 454, © 100ff
- in-line. *See* in-line subroutine
- nested. *See* nesting, of subroutines
- object-oriented programming, 455ff
- pointer to, in C, 402
- prologue, 117, 386
- reference to, 152
- second-class, 154ff
- stack pointer, 118, 384
- static allocation for, 116
- subtype, 306, 311, 478. *See also* class, derived
 - constrained, 299, 315
- subtype analysis, 179, 483
- subtype polymorphism. *See* polymorphism, subtype
- success, of computation in Icon, 294; © 112
- Sun Microsystems, Inc., 585, 670, 688, 766, 824
 - HotSpot JVM, 380, 767, 788ff
 - multiprocessors, © 83
- Sundell, Håkan, 646
- SUNY Stony Brook, 824
- super-assignment in R, 693
- superclass. *See* class, base
- superscalar processor, 35, 577; © 82, © 378
- Suraski, Zeev, 826
- Sussman, Gerald Jay, 173, 543, 827
- Sweeney, Peter F., 499
- Swing, 436ff, 687; © 154
- `switch` statement. *See* case/switch statement
- symbol table, 29, 32, 143, 739; © 29ff
 - and action routines, 196
 - and attribute grammar, 739
 - and dynamic linking, 763
 - and interpretation, 808
 - in Java class file, 768, 771

- symbol table (*continued*)
 - mutual recursion with syntax tree, 348
 - in object file, 33, 744, 791, 799ff
 - passing with inherited attributes, 184
 - scope stack, © 30ff
 - semantic analyzer and, 29, 730
 - with statements, © 30ff, © 135
 - symbol, external, 744
 - Symbolics Corp., 39
 - Syme, Don, 447, 823
 - symmetric multiprocessor, 583
 - synchronization, 436, 578, 587ff. *See also*
 - barrier; mutual exclusion;
 - transactional memory
 - in Ada 95, 624ff
 - blocking. *See* synchronization, scheduler-based
 - busy-wait (spinning), 587, 604ff, 615
 - barriers, 606ff
 - and preemption, 643
 - spin locks, 604ff, 614ff, 640
 - condition synchronization, 603, 616ff
 - definition, 587
 - of event handler, 436, 609; © 153
 - granularity, 629
 - implicit, 633ff
 - instruction, 611ff
 - in Java, 626ff
 - in message passing, © 268ff
 - nonblocking, 607ff, 646
 - scheduler-based, 588, 599ff, 615ff. *See also* blocking (of process/thread); conditional critical region; monitor; semaphore
 - synchronization **send**, © 268
 - synchronized method of a Java class, 626
 - syntactic sugar, 221; © 130, © 162
 - array access in Ruby, 707
 - array subscripts, 328, 352
 - CALL channels in Occam, © 264
 - definition, 147
 - equality in Prolog, 549
 - extension methods in C# 3.0, 468
 - method calls in Ruby, 675
 - monads, 526
 - object orientation in Perl, 711
 - origin of term, 173
 - properties in JavaScript, 708
 - regular expressions in Ruby, 676
 - synchronized methods, 626
 - tail recursion, 516, 535, 633
 - test in bash**, 658
 - syntax, 3, 28, 41ff. *See also* context-free grammar; regular expressions recursive structure and, 43 v. semantics, 41ff
 - syntax analysis. *See* parsers and parsing; scanners and scanning
 - syntax error, 72, 99ff; © 1ff
 - bottom-up recovery, © 10ff
 - context-specific look-ahead, 99; © 3ff, © 7
 - error productions, 99
 - misspelling, © 27
 - panic mode recovery, 99; © 1ff, © 10ff
 - phrase-level recovery, 99, 110; © 2ff
 - repair, © 7
 - syntax tree, abstract, 32, 33, 67, 191
 - attribute grammars and, 189ff, 197
 - averaging example, 757
 - basic blocks of, © 96, © 328
 - in C#, 789
 - combinations example, © 328ff
 - construction of, 176ff, 189ff, 194
 - decoration (annotation) of, 32, 176ff, 197ff, 249
 - in Diana, © 304ff
 - GCD example, 32ff, 730ff
 - in integrated development environment, 25
 - and local code improvement, © 334
 - mutual recursion with symbol table, 348
 - v. parse tree, 73
 - in Perl, 790
 - semantic analysis and, 176ff
 - semantic errors and, 199ff
 - syntax tree, concrete. *See* parse tree
 - syntax-directed translation, 67
 - synthesized attribute. *See* attribute, synthesized
- ## T
- table-driven parsing. *See also* parsers and parsing
 - bottom-up, 92ff
 - top-down, 76ff
 - table-driven scanning, 63ff
 - tag of a variant record, 234; © 139
 - tail recursion, 272ff, 516, 535, 597; © 348
 - taint mode in Perl and Ruby, 815; © 377
 - Tanenbaum, Andrew S., 381
 - target code generation compilation phase, 26, 33ff
 - task, 586
 - task parallelism, 594
 - Tcl (tool command language), 12, 650, 652, 670ff, 828. *See also* Tk
 - in AOLserver, 677
 - arrays and hashes, 708
 - canonical implementation, 654
 - comments, 672
 - context, use of, 653
 - error checking, 704
 - as extension language, 652, 672
 - “force quit” example, 670ff
 - Incr Tcl, 673
 - line breaks, 45, 672, 673
 - modules, 670
 - nested subroutines, 691
 - numeric types, 705
 - regular expressions, 671, 696
 - scope rules, 653, 691ff
 - self-representation (homoiconography), 562
 - strings as internal data format, 691
 - variables as values, 705
 - TCOL, © 303
 - TCP Internet protocol, 637; © 265, © 270
 - Teitelbaum, Timothy, 211
 - template metaprogramming, 160; © 190
 - templates, in C++, 149ff, 411, 415ff, 457, 487; © 127, © 189ff. *See also* generic subroutine or module
 - temporal loop, in relaxed memory model, 611ff
 - temporary file, 367; © 154
 - Tera architecture, 636
 - term, in Prolog, 547

- terminal, of CFG, 46
- termination in distributed systems,
 - © 274ff, © 277, © 284
- `test_and_set` instruction, 605ff, 616
- TeX, 10, 23, 723, 738
 - dynamic scoping, 140
- text files. *See* files, text
- text processing, in scripting languages, 663ff
- theorem proving, automated, © 256
- `this` parameter, 462ff
- Thomas, David, 827
- Thompson, Kenneth, 8, 295, 656, 697
 - Thompson shell, 656
- thread, 586. *See also* concurrency;
 - context switch; multithreading; scheduling
- coroutines and, 429
- creation, 589ff
 - co-begin, 589ff, 593
 - early reply, 597
 - implicit receipt, 597; © 272. *See also* remote procedure call
 - in Java 2, 594
 - in Java 5, 596ff
 - launch-at-elaboration, 592ff
 - parallel loops, 590ff
- for event handling, 436
- implementation, 598ff, 763
- preemption, 601ff
- v. process, 586, 598
- stack frame. *See also* cactus stack
- threading of state in functional
 - programs, 527
- thunk, 447; © 185ff, © 279
- tic-tac-toe example in Prolog, 554ff, 559, 562ff
- Tichy, Walter F., 759
- tiling, © 360
- time-out in message passing, © 274
- timing window, 602. *See also* race condition
- Titanium, 648
- Tk, 652, 670, 828
- tokens, 18, 27, 43ff. *See also* scanners and scanning
 - examples, 27
 - misspellings, © 27
 - prefixes, 61ff
 - regular expressions and, 43ff
- tombstones (for dangling reference detection), 381; © 149ff, © 166
 - reference counts, 360; © 151
- Top 500 list, 645
- top-down parsing. *See* parsing, top-down
- topological sort, 571; © 353
- Torzon, Linda, 39, 211, 759; © 109, © 377
- trace scheduling, 180
- tracing garbage collection, 360ff
 - v. reference counts, 363
- trailing part of LR production, 195; © 53
- trampoline
 - in closure implementation, © 179
 - for signal handling, 435
- transactional memory, xxii, 543, 629ff; © 103
 - bounded buffer example, 630
 - challenges, 633
 - implementation, 631, 763
 - nonblocking, 646
 - retry, 630, 632
- transfer operation for coroutine, 432ff
- transition function
 - of finite automaton, © 13
 - of LR-family parser, 91
 - of push-down automaton, © 18
 - of table-driven scanner, 63
- translation scheme, 187. *See also*
 - attribute flow; attribute grammar
 - ad hoc, 191. *See also* action routine
- Transmeta Corp., 792
- transparency, © 279
- transputer, INMOS, 826
- trap instruction, 808; © 89
- TreadMarks, 648
- tree grammar, 197ff, 735
 - v. context-free grammar, 198
- trie, 61
- trivial update problem, 535, 536
- `troff`, 23, 738
- true dependence. *See* dependence, flow
- tuple, 232; © 127, © 129
- tuple space in Linda, 636, 824
- Turing (language), 828
 - aliases, 145
 - and Euclid, 138
 - modules, 133, 138
 - scope rules, 135
 - side effects, 238, 247
- Turing Award, 506. *See also* entries for
 - Fran Allen; John Backus; O.-J. Dahl; Edsger Dijkstra; Tony Hoare; Kenneth Iverson; Alan Kay; Donald Knuth; Butler Lampson; John McCarthy; Robin Milner; Kristen Nygaard; Michael Rabin; Dennis Ritchie; Dana Scott; Ken Thompson; Alan Turing; Niklaus Wirth
- Turing, Alan, 506ff
 - Alonzo Church and, 507
 - Turing completeness, 7, 523, 573; © 190
 - Turing machine, 506
- Turner, David A., 825
- two's complement arithmetic, 238, 307; © 69, © 70ff
- two-level locking, 640
- type, 217
 - alias, 305
 - anonymous, 307
 - Boolean, 294. *See also* short-circuit evaluation
 - built-in, 293ff
 - cardinal, 295
 - classification, 294ff
 - complex, 295
 - composite, 293, 300ff. *See also* arrays; files; lists; pointers; records; variant records; sets
 - inference and, 315ff
 - in scripting languages, 654ff, 706ff
 - constructed, 300
 - derived, 306
 - discrete, 251, 296
 - enumeration, 297ff
 - logical, 294
 - numeric, 294ff. *See also* floating-point arbitrary precision (bignums), 705 decimal, 296; © 89 fixed-point, 296 multi-length, 299 rational, 295, 705

- type (*continued*)
 - in Scheme, 514
 - in scripting languages, 705
 - unsigned, 295
 - opaque, 135, 461ff
 - ordinal. *See* type, discrete
 - packed, 318, 321, 442
 - predefined, 293
 - primitive, 293
 - recursive, 128, 300, 345ff, 381
 - scalar, 297
 - simple, 297
 - subrange, 298ff, 315ff
 - universal reference, 313ff
 - unnamed, 307
 - type attribute, in Ada, 378, 404, 414
 - type cast, 307ff
 - dynamic, 309, 484ff
 - nonconverting, 303, 309ff
 - static. *See* type conversion
 - type checking, 291, 303ff. *See also*
 - coercion; type equivalence; type compatibility; type inference
 - with attribute grammar, 197ff
 - dynamic, 140, 291ff
 - scripting languages and, 653
 - v. static, 292
 - linking and, 751ff
 - in ML, 316ff; © 126ff
 - with separate compilation, 751ff
 - static, 291
 - strong, 291
 - and garbage collection, 359
 - type predicate functions in Scheme, 511
 - and universal reference type, 313ff
 - type clash, 141, 200ff, 291, 297
 - and equality testing in Java and C#, 230
 - and inheritance, 486
 - in Scheme, 510
 - in Smalltalk, 486
 - type class, in Haskell, 446; © 129
 - type compatibility, 289ff, 303, 310ff, 709ff
 - type conformance, 380
 - type consistency in ML, © 126
 - type constraint, 299
 - for generics, 414ff; © 196
 - type constructor, 113, 300, 302; © 130
 - type conversion, 303, 307ff, 484
 - type descriptor
 - for dynamic typing and method dispatch, 486
 - for garbage collection, 359, 361
 - for reverse assignment, 484
 - type equivalence, 289ff, 303ff
 - name, 303ff, 753
 - structural, 303ff, 377, 753; © 132
 - type erasure, © 194ff
 - type extension, 449, 466ff, 494, 825. *See also* class
 - type hierarchy analysis, 499
 - type inference, 290, 303, 314ff, 574, 709ff, 825
 - for composite types, 315ff
 - and generics, 488
 - in ML, 316
 - for static method dispatch, 499
 - for subranges, 315ff
 - type predicate functions in Scheme, 511
 - type propagation, 499
 - type pun. *See* type cast, nonconverting
 - type system, 290ff. *See also*
 - polymorphism; type checking
 - definition and point of view, 293ff
 - orthogonality, 301ff
 - polymorphism and, 291ff
 - purpose, 289
 - type variable, © 126
 - typeglobs in Perl, 707
 - types
 - self-descriptive, 313
 - typestate, 380
- U**
- UCS (Universal Character Set), 295. *See also* Unicode
 - UDP Internet protocol, © 265, © 270
 - Ullman, Jeffrey D., 109
 - undeclared variables, scope of in scripting languages, 692ff
 - Ungar, David, 500
 - Unicode, 45, 294ff, 343
 - character entities, 295; © 292
 - collating elements, 698
 - unification, 570
 - in C++ templates, © 127
 - cost, 381
 - in logic programming, 546ff, 549ff, 552, 558, 636; © 127
 - in ML, 292, 316, 381; © 127
 - Unified Parallel C (UPC), 648
 - uniform object model, 492
 - uninitialized variable, 233, 234, 745, 796
 - unions. *See* variant records
 - unit number (in Fortran I/O), © 157
 - universal quantifier, © 253ff
 - universal reference type, 313ff, 442
 - universe type, of set, 344
 - University of Aix–Marseille, 545, 574, 827
 - University of Arizona, 824, 828
 - University of California at Berkeley, © 109
 - University of California at Los Angeles, 507
 - University of Edinburgh, 545, 574, 827
 - University of Hertfordshire, 828
 - University of Rochester, v
 - University of Toronto, 828
 - University of Wisconsin–Madison, v, 648
 - Unix, 20. *See also* Linux
 - and C, 821
 - grep**, regular expressions and, 46, 697
 - IRIX, © 312
 - magic numbers, 662, 774
 - prof** and **gprof**, 810
 - ptrace**, 808
 - SunOS, 759
 - text files, © 156
 - unlimited extent. *See* extent, of object
 - unnamed type. *See* type, unnamed
 - unsigned integer
 - language-level, 295
 - machine-level, © 69, © 70
 - unstructured control flow, 220, 241ff
 - unwinding of subroutine call stack
 - on exception, 245; © 5
 - on non-local **goto**, 243, 245; © 186
 - UPC (Unified Parallel C), 648
 - urgent queue of monitor, 621
 - URI (uniform resource identifier)
 - of Applet, 687
 - of CGI script, 680ff

- of document type definition (DTD),
 - © 289
- manipulation in XSLT, © 295
- in Perl, 683
- v. URL, 680
- useless instruction, © 326, © 345
- useless symbol in CFG, 49
- Usenet, 287
- UTF-8 character encoding, 295

V

- Val (language), 11, 516
- Valgrind, 171
- value model of variables, 225ff, 345, 371,
 - 395, 396, 454, 472ff
- value numbering, © 377
 - global, © 336ff
 - local, © 331ff
- values
 - initialization and, 470, 472ff
 - l-value, 226, 300, 310, 313, 351; © 52
 - r-value, 226, 351; © 52
 - and references, 220, 225ff
- van Rossum, Guido, 672, 827
- van Wijngaarden, A., 821
- variables. *See also* initialization; names;
 - reference model of variables;
 - scope; value model of variables
 in CFG, 46
 - interpolation (expansion) in
 - scripting languages, 656ff, 701ff
 - in logic programming, 546, 547, 549
 - semantic analysis and, 29
 - undeclared, scope of in scripting
 - languages, 692ff
- variance, of vector, © 97ff
- variant records (unions), 234, 310, 317,
 - 324ff; © 139ff
 - as composite type, 300
 - constrained, © 144
 - and garbage collection, 359
- v. inheritance, 325
- memory layout, © 145
- v. nonconverting casts, 324
- safety, © 141ff
- tag checks, 179; © 143, © 145

- VAX architecture, 793
 - arguments pointer, 440
 - endian-ness, 374; © 69

- length of instructions, © 81
- pipelining, © 81
- subroutine call, 440; © 213
- three-address instructions, © 75

- VBScript, 650ff
- vector processor, 577, 591, 633; © 373,
 - © 378, © 365ff
- very busy expression
- VES (Virtual Execution System). *See*
 - Common Language
 - Infrastructure
- VEST binary translator, 793, 816
- viable prefix, of CFG, © 19
- view of an object, © 215
- virtual machine, xxiii, xxiv, 19, 764ff,
 - 816. *See also* Common
 - Language Infrastructure; Java
 - Virtual Machine
- v. interpretation, 17, 18, 764
- language-specific, 764
- process v. system, 765
- Smalltalk, 816
- virtual machine monitor (VMM),
 - 765
- virtual method table, 483ff
- virtual methods. *See* methods and
 - method binding, virtual
- virtual registers, 730; © 97, © 323,
 - © 329ff. *See also* register
 - allocation
 - and available expressions, © 341ff
 - and live variable analysis, © 345
 - and value numbering, © 331, © 336ff
- visibility of members in object-oriented
 - languages, 456, 463
- VisiCalc, 573
- visitor pattern, 287, 490
- Visual Basic, 776, 821. *See also* Basic;
 - VBScript
 - and scripting, 677ff, 686, 718, 797
 - Visual Basic for Applications (VBA),
 - 651
- Visual Studio, 25
- VLSI, 213; © 80
- VMWare, 765
- volatile variable, 427, 613, 628
- von Neumann, John, 11
 - von Neumann language, 11
- vtable (virtual method table), 483ff

W

- Wadler, Philip, 536, 544
- Wahbe, Robert, 816
- Waite, William H., 361, 381
- Wall, Larry, 650, 666, 826
- Wand, Mitchell, 288, 448
- watchpoints, 807ff
- Watt, David A., 210
- web browser, 579ff
 - scripting, 651, 677, 680, 686ff
- web crawler, 723
- Wegman, Mark N., © 377
- Wegner, Peter, 173, 381, 500; © 251
- Weinberger, Peter, 664
- Weiser, Mark, 381
- Weiss, Shlomo, © 109
- Welsh, Jim, 380
- Wettstein, H., 643
- while loop. *See* loop,
 - logically-controlled
- white space, 45
- wildcards, in shell languages, 656
- Wilhelm, Reinhard, 543; © 233
- Wilson, Paul R., 381
- Wiltamuth, Scott, 821
- Winch, David, 724
- Windows Forms, 436
- Windows operating system, 22. *See also*
 - .NET
 - on Alpha architecture, 793
 - object file format, 781
 - scripting, 651
 - text files, © 156
 - Win32 threads package, 588
- Windows Presentation Foundation
 - (WPF), 436
- Windows Script, 651
- Wirth, Niklaus, 8, 21, 39, 85, 100, 110,
 - 137, 173, 242, 287, 297, 821,
 - 825, 826; © 2, © 158
- Wisniewski, Robert, 643
- with statement, 323; © 135ff, © 367
- Wolfe, Michael, © 378
- workspace (e.g., in Smalltalk or
 - Common Lisp), © 154
- World Wide Web. *See also* scripting
 - languages, World Wide Web
 - and

character model standard, 381
 and the growth of parallel
 computing, 589
 and the growth of scripting, 503, 650,
 717
 security, 689
 World Wide Web Consortium, 680, 686,
 688, 724, 829; © 289
 Worse Is Better, 717, 724
 WPF (Windows Presentation
 Foundation), 436
 write buffer, 610
 write-read dependence. *See* dependence,
 flow
 write-write dependence. *See*
 dependence, output
 Wulf, William A., 759
 WYSIWYG (what you see is what you
 get), 619

X

X10, 648
 x64 architecture. *See* x86-64 architecture
 x86 architecture, 22, 585, 793, 794, 796;
 © 65, © 84ff
 assembly language, 5, 33
 atomic instructions, 606, 611
 binary coded decimal, © 89
 compilation for, © 91

condition-determining delay,
 © 106
 conditional branches, © 77, © 89
 debugging registers, 809
 endian-ness, © 69
 floating-point, © 85, © 86, © 89
 machine language, 5
 memory model, 612
 MMX extensions, 645; © 86
 nops, 748
 Pascal calling sequence, 390; © 176ff
 prefix code for instruction, © 89
 register set, 739; © 86ff
 segmentation, 745
 SSE extensions, 645; © 87ff
 two-address instructions, © 75
 x86-64 architecture, 585, 796; © 84,
 © 86, © 103, © 107
 XCode, 25
 Xerox Palo Alto Research Center
 (PARC), 39, 493, 619, 823, 828;
 © 153, © 227
 XHTML, 690, 724, 829; © 288ff
 quote presentation example, © 289ff
 XML (extensible markup language),
 689ff, 829; © 287ff
 case sensitivity, © 288
 declarations, © 289
 namespaces, © 289, © 294
 tree structure, © 289

well-formedness, © 288
 XML Schema, © 289
 XPath, 829; © 290ff, © 294ff
 XSD (XML Schema Definition
 language), © 289
 XSL (extensible stylesheet language),
 690, 829; © 287ff
 XSL-FO (XSL formatting objects), 829;
 © 290ff
 XSLT (XSL transforms), 11, 573, 690ff,
 829; © 287ff
 bibliographic formatting example,
 © 292ff

Y

yacc, 42, 92, 101, 109
 action routines, © 49ff
 error recovery, © 10ff
 Yale University, 824
 Yang, Junfeng, © 377
 Yeatman, Corey, 110
 Yellin, Frank, 759
 yield, of derivation, 48
 Yochelson, Jerome C., 381
 Younger, Daniel H., 67

Z

Zadeck, F. Kenneth, © 377
 Zhao, Qin, 816