

*Connect, communicate, compute, and commute  
with your MacBook!*

# MacBook™

# FOR DUMMIES®

*Includes coverage  
of the MacBook  
and MacBook Pro*

***A Reference  
for the  
Rest of Us!***

*FREE eTips at [dummies.com](http://dummies.com)®*

**Mark L. Chambers**

*Author of Mac OS® X All-in-One Desk  
Reference For Dummies®*



**MacBook™**  
FOR  
**DUMMIES®**

**by Mark L. Chambers**



WILEY

Wiley Publishing, Inc.



***MacBook***<sup>TM</sup>  
FOR  
**DUMMIES**<sup>®</sup>





**MacBook<sup>TM</sup>**  
FOR  
**DUMMIES<sup>®</sup>**

**by Mark L. Chambers**



WILEY

Wiley Publishing, Inc.

## MacBook™ For Dummies®

Published by  
**Wiley Publishing, Inc.**  
111 River Street  
Hoboken, NJ 07030-5774

[www.wiley.com](http://www.wiley.com)

Copyright © 2006 by Wiley Publishing, Inc., Indianapolis, Indiana

Published by Wiley Publishing, Inc., Indianapolis, Indiana

Published simultaneously in Canada

No part of this publication may be reproduced, stored in a retrieval system or transmitted in any form or by any means, electronic, mechanical, photocopying, recording, scanning or otherwise, except as permitted under Sections 107 or 108 of the 1976 United States Copyright Act, without either the prior written permission of the Publisher, or authorization through payment of the appropriate per-copy fee to the Copyright Clearance Center, 222 Rosewood Drive, Danvers, MA 01923, (978) 750-8400, fax (978) 646-8600. Requests to the Publisher for permission should be addressed to the Legal Department, Wiley Publishing, Inc., 10475 Crosspoint Blvd., Indianapolis, IN 46256, (317) 572-3447, fax (317) 572-4355, or online at <http://www.wiley.com/go/permissions>.

**Trademarks:** Wiley, the Wiley Publishing logo, For Dummies, the Dummies Man logo, A Reference for the Rest of Us!, The Dummies Way, Dummies Daily, The Fun and Easy Way, Dummies.com, and related trade dress are trademarks or registered trademarks of John Wiley & Sons, Inc. and/or its affiliates in the United States and other countries, and may not be used without written permission. Mac and MacBooks are trademarks or registered trademarks of Apple Computer, Inc. in the U.S. and other countries. All other trademarks are the property of their respective owners. Wiley Publishing, Inc., is not associated with any product or vendor mentioned in this book.

**LIMIT OF LIABILITY/DISCLAIMER OF WARRANTY: THE PUBLISHER AND THE AUTHOR MAKE NO REPRESENTATIONS OR WARRANTIES WITH RESPECT TO THE ACCURACY OR COMPLETENESS OF THE CONTENTS OF THIS WORK AND SPECIFICALLY DISCLAIM ALL WARRANTIES, INCLUDING WITHOUT LIMITATION WARRANTIES OF FITNESS FOR A PARTICULAR PURPOSE. NO WARRANTY MAY BE CREATED OR EXTENDED BY SALES OR PROMOTIONAL MATERIALS. THE ADVICE AND STRATEGIES CONTAINED HEREIN MAY NOT BE SUITABLE FOR EVERY SITUATION. THIS WORK IS SOLD WITH THE UNDERSTANDING THAT THE PUBLISHER IS NOT ENGAGED IN RENDERING LEGAL, ACCOUNTING, OR OTHER PROFESSIONAL SERVICES. IF PROFESSIONAL ASSISTANCE IS REQUIRED, THE SERVICES OF A COMPETENT PROFESSIONAL PERSON SHOULD BE SOUGHT. NEITHER THE PUBLISHER NOR THE AUTHOR SHALL BE LIABLE FOR DAMAGES ARISING HEREFROM. THE FACT THAT AN ORGANIZATION OR WEBSITE IS REFERRED TO IN THIS WORK AS A CITATION AND/OR A POTENTIAL SOURCE OF FURTHER INFORMATION DOES NOT MEAN THAT THE AUTHOR OR THE PUBLISHER ENDORSES THE INFORMATION THE ORGANIZATION OR WEBSITE MAY PROVIDE OR RECOMMENDATIONS IT MAY MAKE. FURTHER, READERS SHOULD BE AWARE THAT INTERNET WEBSITES LISTED IN THIS WORK MAY HAVE CHANGED OR DISAPPEARED BETWEEN WHEN THIS WORK WAS WRITTEN AND WHEN IT IS READ.**

For general information on our other products and services, please contact our Customer Care Department within the U.S. at 800-762-2974, outside the U.S. at 317-572-3993, or fax 317-572-4002.

For technical support, please visit [www.wiley.com/techsupport](http://www.wiley.com/techsupport).

Wiley also publishes its books in a variety of electronic formats. Some content that appears in print may not be available in electronic books.

Library of Congress Control Number: 2006926389

ISBN-13: 978-0-470-04859-7

ISBN-10: 0-470-04859-X

Manufactured in the United States of America

10 9 8 7 6 5 4 3 2 1

1B/QY/QY/QW/IN



# About the Author

**Mark L. Chambers** has been an author, computer consultant, BBS sysop, programmer, and hardware technician for more than 20 years — pushing computers and their uses far beyond “normal” performance limits for decades now. His first love affair with a computer peripheral blossomed in 1984 when he bought his lightning-fast 300 BPS modem for his Atari 400. Now he spends entirely too much time on the Internet and drinks far too much caffeine-laden soda.

With a degree in journalism and creative writing from Louisiana State University, Mark took the logical career choice: programming computers. After five years as a COBOL programmer for a hospital system, however, he decided there must be a better way to earn a living — and he became the Documentation Manager for Datastorm Technologies, a well-known communications software developer. Somewhere in between designing and writing software manuals, Mark began writing computer how-to books. His first book, *Running a Perfect BBS*, was published in 1994 — and after a short decade or so of fun (disguised as hard work), Mark is one of the most productive and best-selling technology authors on the planet.

Along with writing several books a year and editing whatever his publishers throw at him, Mark has also branched out into Web-based education, designing and teaching a number of online classes — called *WebClinics* — for Hewlett-Packard.

His favorite pastimes include collecting gargoyles, watching St. Louis Cardinals baseball, playing his three pinball machines and the latest computer games, supercharging computers, and rendering 3-D flights of fancy with TrueSpace — and during all that, he listens to just about every type of music imaginable. Mark’s worldwide Internet radio station, *MLC Radio* (at [www.mlcbbooks.com](http://www.mlcbbooks.com)), plays only CD-quality classics from 1970 to 1979, including everything from Rush to Billy Joel to the Rocky Horror Picture Show.

Mark’s rapidly expanding list of books includes *iMac For Dummies, 4th Edition*; *Mac OS X Tiger All-In-One Desk Reference For Dummies*; *Building a PC For Dummies, 5th Edition*; *Scanners For Dummies, 2nd Edition*; *CD & DVD Recording For Dummies, 2nd Edition*; *PCs All-In-One Desk Reference For Dummies, 2nd Edition*; *Mac OS X Tiger: Top 100 Simplified Tips & Tricks*; *Microsoft Office v. X Power User’s Guide*; *BURN IT! Creating Your Own Great DVDs and CDs*; *The Hewlett-Packard Official Printer Handbook*; *The Hewlett-Packard Official Recordable CD Handbook*; *The Hewlett-Packard Official Digital Photography Handbook*; *Computer Gamer’s Bible*; *Recordable CD Bible*; *Teach*

*Yourself the iMac Visually; Running a Perfect BBS; Official Netscape Guide to Web Animation; and the Windows 98 Troubleshooting and Optimizing Little Black Book.*

His books have been translated into 14 languages so far — his favorites are German, Polish, Dutch, and French. Although he can't read them, he enjoys the pictures a great deal.

Mark welcomes all comments and questions about his books. You can reach him at [mark@mlcbooks.com](mailto:mark@mlcbooks.com), or visit MLC Books Online, his Web site, at [www.mlcbooks.com](http://www.mlcbooks.com).

# Dedication

This book is dedicated to Jody Cooper, a true friend who just won't quit — whether he's elbow-deep in a computer chassis or dancing the Time Warp in front of the Silver Goddess. May our friendship last another 20 years . . . and longer!

# Author's Acknowledgments

It hit me right in the middle of this project — while writing a book about Apple's well-designed Macintosh laptops and software, I had the “best-designed” people in the technology publishing business working alongside me! These folks made sure that what you read is accurate, funny, and easy to understand.

Coincidence? I think not. That's the Wiley Way.

First, I'd like to thank my technical editor, Clint McCarty, whose expert knowledge of Apple hardware and software ensured that I didn't get Firewire 400 mixed up with Firewire 800!

As with every book I've written, I'd like to thank my wife, Anne, and my children, Erin, Chelsea, and Rose, for their support and love — and for letting me follow my dream!

Finally, I need to send my heartfelt thanks — once *again* — to two wonderful editors at Wiley: my project editor, Susan Pink, and my acquisitions editor, Bob Woerner. A book like this wouldn't be possible without the patience, guidance, and hard work that Susan and Bob provide . . . and they're great friends as well. It's win-win!

## **Publisher's Acknowledgments**

We're proud of this book; please send us your comments through our online registration form located at [www.dummies.com/register/](http://www.dummies.com/register/).

Some of the people who helped bring this book to market include the following:

### ***Acquisitions, Editorial, and Media Development***

**Project Editor:** Susan Pink

**Acquisitions Editor:** Bob Woerner

**Technical Editor:** Clint McCarty

**Editorial Manager:** Jodi Jensen

**Media Development Manager:**

Laura VanWinkle

**Editorial Assistant:** Amanda Foxworth

**Cartoons:** Rich Tennant

([www.the5thwave.com](http://www.the5thwave.com))

### ***Composition Services***

**Project Coordinator:** Tera Knapp

**Layout and Graphics:** Jonelle Burns,  
Carl Byers, Andrea Dahl, Lauren Goddard,  
Joyce Haughey, Barbara Moore,  
Barry Offringa, Jill Proll, Alicia B. South,  
Erin Zeltner

**Proofreaders:** Cindy Ballew, Vickie Broyles,  
John Greenough, Christy Pingleton

**Indexer:** Techbooks

---

### ***Publishing and Editorial for Technology Dummies***

**Richard Swadley**, Vice President and Executive Group Publisher

**Andy Cummings**, Vice President and Publisher

**Mary Bednarek**, Executive Acquisitions Director

**Mary C. Corder**, Editorial Director

### ***Publishing for Consumer Dummies***

**Diane Graves Steele**, Vice President and Publisher

**Joyce Pepple**, Acquisitions Director

### ***Composition Services***

**Gerry Fahey**, Vice President of Production Services

**Debbie Stailey**, Director of Composition Services

# Contents at a Glance

---

<b><i>Introduction</i></b> .....	<b>1</b>
<b><i>Part I: Tie Myself Down with a Desktop? Preposterous! ...</i></b>	<b>9</b>
Chapter 1: Hey, It Really Does Have Everything I Need.....	11
Chapter 2: Turning On Your Portable Powerhouse .....	27
Chapter 3: The Laptop Owner's Introduction to Mac OS X .....	39
<b><i>Part II: Shaking Hands with Mac OS X</i></b> .....	<b>51</b>
Chapter 4: Working Magic with the Keyboard and Trackpad.....	53
Chapter 5: Getting to the Heart of the Tiger .....	73
Chapter 6: System Preferences Are Your Friends.....	87
Chapter 7: Sifting through Your Stuff .....	101
<b><i>Part III: Connecting and Communicating</i></b> .....	<b>111</b>
Chapter 8: Taking Your Laptop on Safari.....	113
Chapter 9: .Mac Is .Made for Mac Laptops.....	127
Chapter 10: Spiffy Connections for the Road Warrior .....	139
<b><i>Part IV: Living the iLife</i></b> .....	<b>151</b>
Chapter 11: The Multimedia Joy of iTunes .....	153
Chapter 12: Turning iPhoto into Your Portable Darkroom .....	173
Chapter 13: Making Film History with iMovie HD .....	191
Chapter 14: Creating DVDs on the Road with iDVD .....	209
Chapter 15: GarageBand on the Go .....	229
<b><i>Part V: Sharing Access and Information</i></b> .....	<b>247</b>
Chapter 16: Your Laptop Goes Multiuser .....	249
Chapter 17: Working Well with Networks .....	267
Chapter 18: Making Friends with Wireless Devices .....	287
<b><i>Part VI: The Necessary Evils: Troubleshooting, Upgrading, Maintaining</i></b> .....	<b>299</b>
Chapter 19: When Good Mac Laptops Go Bad .....	301
Chapter 20: Adding New Stuff to Your Laptop.....	313
Chapter 21: Tackling Housekeeping.....	323



<b><i>Part VII: The Part of Tens</i></b> .....	<b>337</b>
Chapter 22: Top Ten Laptop Rules to Follow.....	339
Chapter 23: Top Ten Things to Avoid like the Plague.....	345
<b><i>Index</i></b> .....	<b>351</b>

# Table of Contents

.....

<b><i>Introduction</i></b> .....	<b>1</b>
What's Really Required .....	1
About This Book.....	2
Conventions Used in This Book .....	3
Stuff you type .....	3
Menu commands .....	3
Web addresses .....	4
How This Book Is Organized.....	4
Part I: Tie Myself Down with a Desktop? Preposterous!.....	4
Part II: Shaking Hands with Mac OS X.....	4
Part III: Connecting and Communicating.....	4
Part IV: Living the iLife.....	5
Part V: Sharing Access and Information.....	5
Part VI: The Necessary Evils: Troubleshooting, Upgrading, Maintaining .....	5
Part VII: The Part of Tens .....	5
Icons Used in This Book.....	6
Where to Go from Here.....	6
A Final Word.....	7

## ***Part 1: Tie Myself Down with a Desktop? Preposterous! .... 9***

<b>Chapter 1: Hey, It Really Does Have Everything I Need .....</b>	<b>11</b>
An Overview of Your Mac Laptop .....	12
The parts you probably recognize .....	12
The holes called ports .....	15
Don't forget the parts you can't see.....	16
Location, Location, Location! .....	18
Unpacking and Connecting Your Laptop .....	19
Unpacking for the road warrior .....	19
Connecting cables 101 .....	20
Great, a Lecture about Handling My Laptop.....	21
An Overview of Mac Software Goodness .....	22
What comes with my laptop? .....	22
Connecting to the Internet from your lap .....	22
Applications that rock .....	23
Boot Camp For Dummies.....	24
Other Stuff That Nearly Everyone Wants .....	25

<b>Chapter 2: Turning On Your Portable Powerhouse</b>	<b>27</b>
Tales of the On Button	28
Mark's Favorite Signs of a Healthy Laptop	28
You're Not Going to Lecture Me About Batteries, Are You?	29
Setting Up and Registering Your Laptop	30
Setting up Mac OS X Tiger	31
Registering your Mac	32
Importing Stuff from Another Mac	32
Importing Stuff from Windows (If You Must)	36
<b>Chapter 3: The Laptop Owner's Introduction to Mac OS X</b>	<b>39</b>
Your Own Personal Operating System	40
The Tiger desktop	40
Why get so excited by Tiger?	43
All the Features of Windows (Just Better)	45
Like Windows done right	45
Loading the truck	46
And Just in Case You Need Help	47
Tiger's built-in Help system	48
Apple's Web-based support center	48
Magazines	48
Mac support Web sites	48
Mac newsgroups on Usenet	49
Local Mac user groups	49
<b>Part II: Shaking Hands with Mac OS X</b>	<b>51</b>
<b>Chapter 4: Working Magic with the Keyboard and Trackpad</b>	<b>53</b>
Using the All-Powerful Finder	53
Wait a Second. Where the Heck Is the Right Button?	55
Launching and Quitting Applications with Aplomb	58
Juggling Folders and Icons	60
A field observer's guide to icons	60
Selecting items	63
Copying items	64
Moving things from place to place	66
Duplicating in a jiffy	66
Keys and Keyboard Shortcuts to Fame and Fortune	67
Special keys on the keyboard	67
Using Finder and application keyboard shortcuts	68
Performing Tricks with Finder Windows	69
Scrolling and resizing windows	69
Minimizing and restoring windows	71
Moving and zooming windows	71
Closing windows	72

**Chapter 5: Getting to the Heart of the Tiger . . . . . 73**

Your Home Folder Is Your Homestead ..... 73  
 Personalizing Your Desktop..... 76  
 Customizing the Dock Just So ..... 78  
     Adding dock icons ..... 79  
     Removing dock icons ..... 79  
     Using dock icon menus..... 79  
 Taking Out the Trash ..... 80  
 Saving Time and Trouble with Dashboard and Exposé ..... 82  
     Using Dashboard ..... 82  
     Switching between apps with Exposé..... 83  
 Printing in Mac OS X..... 84

**Chapter 6: System Preferences Are Your Friends . . . . . 87**

An Explanation (in English, No Less) ..... 87  
 Locating That Certain Special Setting ..... 89  
 Introducing Mark’s Favorite Preference Panes ..... 90  
     The Display pane..... 91  
     The Desktop & Screen Saver pane ..... 92  
     The Dashboard & Exposé pane ..... 93  
     The Appearance pane..... 94  
     The Energy Saver pane ..... 96  
     The Dock pane ..... 97  
     The Sharing pane..... 98

**Chapter 7: Sifting through Your Stuff . . . . . 101**

A Not-So-Confusing Introduction to Spotlight ..... 101  
 Searching for all sorts of things with Spotlight ..... 103  
 Working with matching stuff ..... 104  
 Tweaking Spotlight in System Preferences ..... 105  
 Other Search Tools Are Available Too..... 106  
 Putting Sherlock on the Case..... 107  
     Searching that darn Internet for data and pictures ..... 108  
     Getting movie information in the new millennium ..... 109  
     Keep an eye on my stocks, Watson! ..... 109

***Part III: Connecting and Communicating..... 111***

**Chapter 8: Taking Your Laptop on Safari . . . . . 113**

It’s Not Just Another Web Browser ..... 113  
 Handling Basic Safari Chores..... 115  
     Entering Web addresses ..... 115  
     Putting the toolbar to work..... 117

Searching for Specific Web Sites .....	120
It's a snap to search with Google .....	120
Looking back with the History list .....	120
Searching the current page .....	122
Safari Power User Tips and Tools .....	122
Putting down roots with a new home page.....	122
Organizing favorite spots with bookmarks .....	122
Using secure connections .....	125
Reading RSS feeds .....	126
<b>Chapter 9: .Mac Is .Made for Mac Laptops .....</b>	<b>127</b>
Where Is My .Mac Stuff Stored?.....	127
Opening a .Mac Account .....	129
Using Your iDisk on the Road .....	131
It's all in the folders.....	132
Mirror, mirror, on your drive . . . .....	133
Monitoring and configuring your iDisk.....	134
Back Up Your Laptop with .Mac .....	135
Installing Backup .....	136
Saving your stuff.....	136
<b>Chapter 10: Spiffy Connections for the Road Warrior .....</b>	<b>139</b>
Connecting USB and Network Printers.....	139
USB printers .....	140
Networked printers .....	143
Connecting Scanners .....	144
Putting Your iSight Camera to Work .....	145
Using iSight with iChat AV .....	145
Using iSight with Photo Booth.....	146
Using iSight with iMovie HD.....	147
Performing Magic with Front Row and the Apple Remote .....	147
<b>Part IV: Living the iLife .....</b>	<b>151</b>
<b>Chapter 11: The Multimedia Joy of iTunes .....</b>	<b>153</b>
Boy, Check Out That iTunes Window! .....	154
The Lazy iTunes Guide .....	156
Listening to song files, playlists, Internet radio, and audio CDs.....	156
Watching video .....	162
Organizing, sorting, and searching .....	163
Adding or editing song information .....	165
Visualization — music for your eyes .....	167
Pulling in Songs and Spitting 'Em Out .....	168
Importing songs from CD and hard drives .....	168
Buying Billie Holiday from the Apple Music Store .....	169
Burning like a true techno.....	171

**Chapter 12: Turning iPhoto into Your Portable Darkroom . . . . .173**

Shaking Hands with the iPhoto Window .....173  
 Working with Images on Your Laptop.....175  
     Import mode: Coaxing photos from your camera.....176  
     Organize mode: Organizing and sorting your images.....177  
     Edit mode: Removing and fixing stuff the right way .....182  
 Publishing Your Own Photo Book.....185  
 Photocasting for the People! .....188  
 Mailing Photos to Aunt Mildred .....189

**Chapter 13: Making Film History with iMovie HD . . . . .191**

Shaking Hands with the iMovie HD Window.....192  
 A Bird’s-Eye View of Moviemaking.....194  
 Importing the Building Blocks .....195  
     Pulling in video clips .....195  
     Making use of still images .....196  
     Importing and adding audio from all sorts of places.....198  
 Building the Cinematic Basics .....200  
     Adding clips to your movie .....200  
     Removing clips from your movie .....201  
     Deleting clips for good.....201  
     Reordering clips in your movie .....202  
     Editing clips in iMovie HD .....202  
     Adding transitions .....203  
     Oh, we got effects! .....204  
     What’s a masterpiece without titles?.....205  
 Doing iMovie Things iMagically .....206  
 Sharing Your Finished Classic with Others.....207

**Chapter 14: Creating DVDs on the Road with iDVD . . . . .209**

Introducing You and Your Laptop to iDVD .....210  
 Starting a New DVD Project .....212  
     Creating a new project.....212  
     Opening an existing project .....213  
     Automating the whole darn process.....213  
 Creating a DVD from Scratch .....214  
     Choosing just the right theme .....214  
     Adding movies .....215  
     Great, now my audience demands a slideshow .....218  
     Now for the music . . . .....219  
 Giving Your DVD the Personal Touch .....220  
     Using Uncle Morty for your DVD Menu background .....221  
     Adding your own titles .....221  
     Changing buttons like a highly paid professional .....222  
     Give my creation motion! .....222

Previewing Your Masterpiece .....	223
A Word about Automation .....	224
One-click paradise with OneStep DVD.....	225
Exercising control with Magic iDVD.....	226
Recording a Finished Project to a Shiny Disc .....	227

## **Chapter 15: GarageBand on the Go ..... 229**

Shaking Hands with Your Band .....	230
Composing and Podcasting Made Easy.....	232
Adding tracks .....	233
Choosing loops .....	235
Resizing, repeating, and moving loops .....	238
Tweaking the settings for a track .....	243
Sharing Your Songs and Podcasts.....	244
Setting preferences.....	244
Creating MP3 files.....	244

## ***Part V: Sharing Access and Information ..... 247***

### **Chapter 16: Your Laptop Goes Multiuser ..... 249**

Doggone It, Bob's Gotta Share My Mac! .....	249
Throwing the Big Shiny Multiuser Switch.....	250
Assigning access levels.....	251
Adding a new user account .....	251
Tweaking existing user accounts .....	254
Deleting accounts.....	255
Assigning login items and parental controls.....	256
Mundane Chores for the Multiuser Laptop .....	260
Logging on and off in Tiger For Dummies .....	260
A word about what you can (and can't) share .....	263
Protecting your stuff with encryption .....	263

### **Chapter 17: Working Well with Networks ..... 267**

Should You Go Wired or Wireless?.....	268
Be a Pal — Share Your Broadband!.....	270
Using your laptop as a sharing device.....	270
Using a separate Internet sharing device.....	271
What Do I Need for a Wireless Connection? .....	271
Laptop hardware .....	272
Base stations .....	272
Creating or joining a wireless network .....	275
What Do I Need for a Wired Connection?.....	276
Laptop hardware .....	276
Network hardware.....	277
Joining a wired Ethernet network .....	278

Connecting to the Network.....279  
     Verifying that the contraption works.....279  
     Sharing stuff nicely with others.....280  
 Use Your Firewall!.....284

**Chapter 18: Making Friends with Wireless Devices .....287**

Bluetooth: Silly Name for Cool Technology.....288  
     A little Danish history.....288  
     Is your Mac Laptop Bluetooth-ready? .....289  
     Tiger and Bluetooth, together forever.....289  
     Mr. Security speaks — yet again.....292  
 Adding Wireless Keyboards and Mice to Your Laptop.....293  
 Getting Everything in iSync .....294  
 The Magic of Wireless Printing.....296

***Part VI: The Necessary Evils: Troubleshooting, Upgrading, Maintaining .....299***

**Chapter 19: When Good Mac Laptops Go Bad .....301**

Repeat after Me: Yes, I Am a Tech!.....301  
 Step-by-Step Laptop Troubleshooting.....302  
     The number one rule: Reboot!.....302  
     Special keys that can come in handy.....303  
     Using Disk Utility to squash problems .....304  
     Mark’s should-be-patented laptop troubleshooting tree .....307  
 My Mac Needs Professional Help.....312  
     Chatting with Apple Online .....312  
     Local service, at your service.....312

**Chapter 20: Adding New Stuff to Your Laptop .....313**

Adding Memory Always Helps .....313  
     Figuring out how much memory you have .....314  
     Installing memory modules.....315  
 Considering a Hard Drive Upgrade? .....318  
     Consider your external options.....319  
     Gotta have internal.....320  
 A List of Dreamy Laptop Add-Ons.....321  
     Game controllers .....321  
     Video controllers .....322  
     TV hardware.....322  
     Audio hardware .....322  
     DVD recording.....322



<b>Chapter 21: Tackling Housekeeping</b> .....	<b>323</b>
Cleaning Unseemly Data Deposits .....	323
Getting dirty, or cleaning things the manual way .....	324
Using a commercial cleanup tool .....	336
Backing Up Your Treasure.....	326
Saving files.....	327
Saving images.....	328
Commercial backup programs.....	331
Maintaining Hard Drive Health.....	332
Automating Those Mundane Chores .....	333
Building Automator applications .....	333
Running applications at startup .....	335
Updating Mac OS X Automatically .....	336
 <b>Part VII: The Part of Tens.....</b>	 <b>337</b>
 <b>Chapter 22: Top Ten Laptop Rules to Follow.....</b>	 <b>339</b>
Keep Your Laptop in a Bag.....	339
Maximize Your RAM.....	340
Install a Tracker Application .....	341
Keepst Thy Home Folder Encrypted .....	341
Brand Your MacBook.....	342
Disable Your Wireless .....	342
Bring a Surge Protector with You.....	343
Use Tiger's Power Saving Features .....	343
Use an External Keyboard and Mouse.....	344
Not Again! What Is It with You and Backing Up? .....	344
 <b>Chapter 23: Top Ten Things to Avoid like the Plague .....</b>	 <b>345</b>
USB 1.1 Storage Devices .....	345
Phishing .....	346
Oddly Shaped Optical Discs .....	347
Submerged Keyboards .....	347
Antiquated Utility Software.....	348
Software Piracy.....	348
The Forbidden Account .....	348
Unsecured Wireless Connection .....	349
Refurbished Hardware .....	350
Dirty Laptops .....	350
 <b>Index.....</b>	 <b>351</b>

# Introduction

.....

**L**aptop owners are special people.

You see, a laptop owner demands everything from a computer that a desktop owner does: reliability, performance, expandability, and ease of use. Owners of PowerMac desktop computers can draw the line right there, because their computers are designed for a stationary existence. But, you and I are *laptop* owners. We also need that same computer to be an inch thick. We demand that it run for hours on a single battery charge. We require that it be light as a feather.

Today's Apple laptops deliver all that, and more! If you've bought one of these modern masterpieces — or you're thinking about it right now — I applaud your good taste, common sense, and discerning eye. Apple laptops have everything: super performance, a top-shelf LCD screen, rugged reliability, and a trouble-free, powerful operating system. Heck, your Intel-based Apple laptop can even run . . . wait for it . . . Windows XP. (If you absolutely have to, the option is there.)

I wrote this book for myself — and for every other Apple laptop owner who desires to become a laptop techno-wizard. In these pages, you'll find a guide to both your laptop's hardware and Mac OS X Tiger, the latest version of Apple's superb operating system. After I cover the basics that every laptop owner should know, you find out how to accomplish all sorts of cutting-edge audio, visual, and Internet projects. (Oh, and if you already have another of my books, you know that I don't skimp on the power user tips and tricks that'll save you time, effort, *and* money.)

Like my dozen-or-so other *For Dummies* titles, I respect and use the same English language you learned in school, avoiding jargon, ridiculous computer acronyms, and confusing techno-babble whenever possible. (Plus, I try to bring out the humor that's hidden inside every computer. Finding out how to use your Mac should be fun, and not a chore!)

## *What's Really Required*

If you're *not* an engineer with a degree in Advanced Thakamology — imagine that — there's no need to worry! Here's a reasonably complete list of what's *not* required to use this book:

- ✔ I make no assumptions about your previous knowledge of computers — laptop or otherwise — and software. We start at the beginning, which is where every book should start.
- ✔ Still considering buying a MacBook or MacBook Pro? Heck, you don't even need the computer! If you're evaluating whether or not a Mac laptop is right for you, this book is a great choice — I introduce you to both the hardware and software you'll get, so you can easily determine whether a Mac is the machine for you. (It is. Trust me.)
- ✔ Upgrading from the monster that is Windows XP? I have tips, tricks, and entire sections devoted to the hardy pioneers called *switchers!* You'll discover the similarities and differences between the two operating systems, how you can make the switch as easy and quick as possible, and how to run Windows on your new laptop, if you absolutely must.
- ✔ If your friends and family have told you that you're going to spend half your savings on software — or that there's no decent software available for Mac computers — just smile quietly to yourself! These are two persistent myths about Mac computers, and those same folks are going to be blown away by the images, music, movies, and documents you produce. (Oh, by the way, your Mac laptop comes complete with about a ton more software than any PC, laptop, and the iLife suite of applications are better than anything available on a PC is!) To sum up: *You can do virtually everything in this book with the software that came with your Mac!*

So what *is* required? Your Mac laptop and the desire to become a power user — someone who produces the best work in the least amount of time and has the most fun doing it!

This book has been written using the latest MacBook Pro computer, so owners of older Mac laptops that aren't running Intel processors may not be able to follow along with everything I cover. However, if you've upgraded an older G4 laptop with Mac OS X Tiger and the iLife '06 application suite, you should be able to use most of the book with no problem!

## About This Book

Each chapter in this book has been written as a reference on a specific hardware or software topic. Due to the hard work of my editors, you can begin reading anywhere you like because each chapter is self-contained. However, I recommend that you read from front to back, because the linear order of the book makes a great deal of sense.

## Conventions Used in This Book

Even with a minimum of techno-speak, this book needs to cover the special keys you have to press or menu commands you have to choose to make things work — hence our short list of conventions.

### *Stuff you type*

I may ask you to type a command in Mac OS X. That text often appears like this:

**Type me.**

Or like this:

```
Type me.
```

Don't forget that you usually have to press the Return key before anything happens.

### *Menu commands*

I list menu commands using this format:

Edit⇨Copy

This example of shorthand menu instruction indicates that you should click the Edit menu and then choose the Copy menu item.

### **For the technically curious**

Your MacBook is an elegant and sophisticated machine — and as easy-to-use as a computer can be — but from time to time, you may be curious about the technical details surrounding your hardware and software. (You probably

disassembled alarm clocks as a kid, like I did.) Tech stuff is formatted as a sidebar, like this one, and you don't have to read it unless you want to know what makes things tick. (Pun by accident.)

## *Web addresses*

No up-to-date book on a computer would be complete without a bag full of Web addresses for you to check out. When you see these in the text, they'll look like this: [www.mlcbooks.com](http://www.mlcbooks.com).

## *How This Book Is Organized*

After careful thought (read that “flipping a coin”), I divided this book into seven major parts — plus an index, just because you *deserve* one! For your convenience, cross-references to additional coverage of many topics are sprinkled liberally throughout the book.

The Seven Parts Shall Be As Follows.

### *Part I: Tie Myself Down with a Desktop? Preposterous!*

Part I introduces you to the important features of your laptop — you'll find out where all the cables connect — and helps you set up your system. I also introduce Mac OS X Tiger, Apple's operating system that comes preinstalled on your MacBook or MacBook Pro.

### *Part II: Shaking Hands with Mac OS X*

Time to familiarize you with Tiger. In Part II, you find out how to take care of mundane chores (such as moving your stuff), as well as how to customize and personalize your system until it fits like the proverbial glove! Switchers from the PC world will be especially interested in understanding the ins and outs of Mac OS X — and friends, *it ain't hard*. The Mac started out easier to use than a Windows PC, and nothing's changed.

### *Part III: Connecting and Communicating*

In Part III, it's time to jump into the one application you're likely to use every day: your Safari Web browser! You'll also find out more about Apple's .Mac Internet subscriber service and how to connect your laptop for printing, sharing information with your PDA or cell phone, and even videoconferencing! (I told you this thing was powerful, didn't I?)

---

## ***Part IV: Living the iLife***

Ah, readers, you can begin humming happily to yourself right this second! Yep, Part IV provides complete coverage of the latest iLife '06 release, with the names that are the envy of the Windows crowd: iTunes, iPhoto, iMovie HD, iDVD, and GarageBand. You'll find out how to turn your mobile monster computer into the hub for all your digital media — whether you listen to it, display it, compose it, or direct it, this part of the book will *explain* it!

## ***Part V: Sharing Access and Information***

In Part V, I discuss how to share your Mac laptop among a group of people, and how to connect your Mac to a network. (Wired or wireless, makes no difference to us!) I also cover how to share data among wireless devices using Bluetooth technology and iSync, and how to broadcast your music around your house like Wolfman Jack.

## ***Part VI: The Necessary Evils: Troubleshooting, Upgrading, Maintaining***

In Part VI, we cover the stuff my Dad used to call the *Justin Case Guide* — that is, just in case, you want to upgrade your MacBook with more memory or new hardware. If you need to troubleshoot a problem with your hardware or software, check out my should-be-patented troubleshooting guide. Finally, I describe what you can do to help keep your Mac running as fast and as trouble-free as the day you took it out of the box!

## ***Part VII: The Part of Tens***

The two chapters that make up the famous “Part of Tens” section are served in classic Late Night style: Each chapter contains a quick reference of tips and advice on a specific laptop or Macintosh topic. Each list has ten concise tips, and one or two readers have told me that they make excellent tattoos. (Personally, I'm not *that* much of a Mac guru.)

## Icons Used in This Book

Like other technology authors, I firmly believe that important nuggets of wisdom should **stand out** on the page! With that in mind, this *Dummies* book includes a number of margin icons for certain situations.



The most popular icon in the book, you'll find it next to suggestions I make that will save you time and effort — and once or twice, even cash!



These are my favorite recommendations — in fact, I'll bet just about any laptop power user would tell you the same. Follow my Maxims, and you'll avoid the quicksand and pitfalls that I've encountered with all sorts of Macs for well over a decade!



You don't have to know this stuff, but the technologically curious love high-tech details. (Of course, we're great fun at parties, too.)



**Always** read the information for this icon first! I'm discussing something that could harm your hardware or throw a plumber's helper into your software.



The highlighter stuff — not quite as universally accepted (or as important to the author) as a Mark's Maxim, but a good reminder! I use these icons to reinforce that which should be remembered.

## Where to Go from Here

My recommendations on how to proceed? I just happen to have three:

- ✓ If you're thinking about buying a new MacBook or MacBook Pro, the box is still unopened in your living room, or you'd like help setting things up, start with Part I.
- ✓ If you're already on the road with your laptop but you'd like guidance with running Mac OS X — Windows switchers, take note — start with Part II.
- ✓ For all other concerns, use the index or check out the table of contents to jump straight to the chapter you need.

---

## A Final Word

I'd like to thank you for buying this book, and I hope that you find *MacBook For Dummies* valuable! With this book in hand, I believe that you and your Mac will bond as I have with mine. (That sounds somewhat wrong, but it's really not.)

Time for the first Mark's Maxim in this book:



Take your time — finding out how to use your computer isn't a race — and don't worry if you're not a graphic artist, a professional photographer, or a video editor. With your Mac laptop and its software, you don't have to be!





# Part I

# Tie Myself Down with a Desktop? Preposterous!

The 5<sup>th</sup> Wave

By Rich Tennant

©R1CHTENNANT

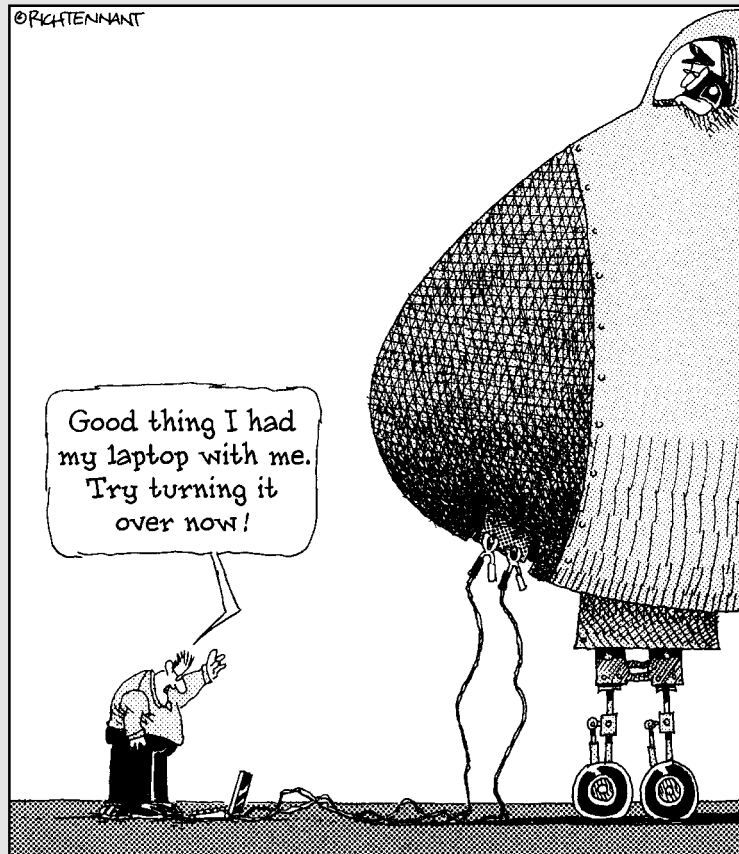

## *In this part . . .*

**Y**our journey as a Mac road warrior — pun intended — begins with a description of your laptop itself, as well as the details you need to know when unpacking and setting up your newest family member. You'll also find an introduction to Mac OS X Tiger, the latest version of Apple's super-popular operating system.

## Chapter 1

# Hey, It Really Does Have Everything I Need

---

### *In This Chapter*

- ▶ Identifying the important parts of your Mac laptop
  - ▶ Locating the right home for your computer
  - ▶ Plugging stuff in and getting hooked up
  - ▶ Playing with your bundled software
  - ▶ Buying additional stuff that you might need
- 

**M**ost action films have one scene in common: I call it the “gear up” scene, where the good guys strap on their equipment in preparation for battle. (It doesn’t matter what era — you see “gear up” scenes in *Gladiator*, *Aliens*, and virtually every movie Arnold has made.) You’re sure to see lots of clicking straps and equipping of offensive weapons (and sometimes even a dash of war paint). The process usually takes a minute or so, all told with whiplash camera work and stirring martial music in the background.

Well, fellow Macintosh road warrior, it takes only *two seconds* and *one move* for you to gear up: closing the lid. That’s because your Mac is a self-contained world, providing virtually everything you’ll find on a desktop Power Mac. This is indeed the decade of the laptop, meshing nicely with your cell phone and that wireless connection at your local coffee shop. You have selected the right companion for the open road.

Unlike some of Apple’s other designs, such as the Mac Mini or the iMac, your MacBook looks similar to a PC laptop running Windows. (In fact, an Intel-based Mac laptop can run Windows, if you absolutely must.) But your laptop holds a number of pleasant surprises that no PC laptop can offer! In this chapter, I introduce you to the hardware and all the major parts of the machine — and you’ll even find out how to unpack and connect your computer. And, as frosting on the cake, I’ll preview the software that Apple is so proud of, as well as the accessories that you should buy now instead of later.

Welcome to your Mac laptop, good reader. Let’s gear up!

## An Overview of Your Mac Laptop

Sure, your MacBook Pro may be only an inch thin, but a lot of superb design lives inside, and you'll encounter the same parts that you'd find in a desktop machine. In this section, I discuss those important parts — both the stuff you can see and the stuff that's shoehorned within.

### *The parts you probably recognize*

Every laptop requires some of the same gizmos. Figure 1-1 helps you track them down. Of course, as you'd expect, a computer has a body of sorts in which all the innards and brains are stored, a display screen, a keyboard, a mouse or other pointing device, and ports for powering and exchanging data with outside toys.

#### *That magnificent screen*

What a view you have! Today's Mac laptops feature a 13", 15", or 17" LCD display.

LCD screens use far less electricity than their antique CRT ancestors do, and they emit practically no radiation.

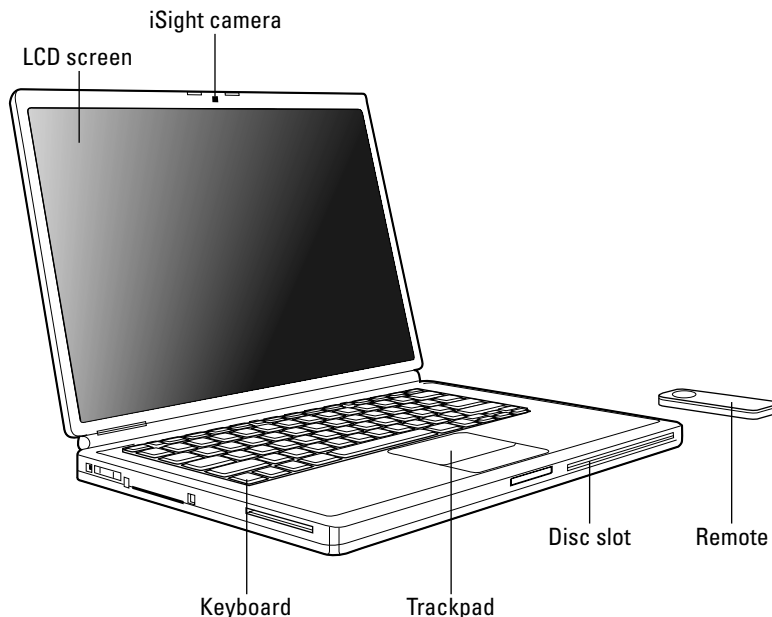

**Figure 1-1:**  
The  
charismatic  
form of a  
typical Mac  
laptop.

## Feeling outdated? Never!

Are you using an older iBook or PowerBook? It seems that Apple's product line changes every time you tear a page from your 12-month calendar, and every new generation of laptops includes new whiz-bang features. Sometimes you can add those features separately to your older machine — such as an external iSight camera or an AirPort Extreme card — but you can't update things like your iBook's motherboard. Sigh.

Here's my take on this situation: If your older laptop does what you need at a pace you can accept, there is *no need* to upgrade it.

Skeptical? Here's the proof: Before my recent upgrade to a MacBook Pro, yours truly was lugging a pristine iBook G3, which booted Tiger and did absolutely everything that I demanded. (A little

more patience was required, certainly, but technology authors are simply *brimming* with patience.) The moral is here too: Avoid the upgrade fever unless you really need a new companion!

If your laptop bears the iBook or PowerBook logo, you can still enjoy this book and discover new tips and tricks from it! Unless the new breed of Intel-based Mac laptops has a feature that you absolutely can't use on your iBook (such as booting directly into Windows), you can sail on with your current computer, fiercely proud of The Bitten Apple that appears on the cover. Although this book was written with the MacBook and MacBook Pro lines in mind, virtually everything you read here still applies to your older laptop.

Apple's laptop screens offer a *widescreen* aspect ratio (the screen is considerably wider than it is tall), which augurs well for those who enjoy watching DVD movies. (A favorite editor of mine loves it when I use the antique word *augur*, meaning *to predict or foretell*.)



That reminds me: Throw away your printed dictionary! You won't need it because Mac OS X Tiger includes the fantastic Sherlock application, which uses the Internet to retrieve definitions from [Dictionary.com](http://Dictionary.com). More on Sherlock in Chapter 7 . . . and yes, it does contain *augur*.

### The keyboard and trackpad

Hey, here's something novel for your laptop — unlike the external input devices on a standard desktop computer, your Mac has a built-in keyboard and trackpad (which does the job of a mouse). The keyboard is a particular favorite of mine because from here

- ✔ You can either control the sound volume or mute all that noise completely
- ✔ High-end Mac laptops have illuminated keyboards, which are perfect for darkened dorm rooms and airplane flights
- ✔ A handy-dandy Media Eject key lets you eject a CD or DVD

### ***The disc slot***

You'll notice a long groove at the bottom-right corner of your MacBook or MacBook Pro. No, it's not for your credit card. This slot accepts CDs and DVDs into your optical drive. If the drive is empty, loading a disc is as simple as sliding it in an inch or so; the drive sucks in the disc automatically. (And we don't need a stinkin' floppy. Macs haven't had floppy drives for years now, and the PC types are just beginning to follow.)



“Luke, the printed label side of the disc should always be *facing you* when you load a disc. Always.”

### ***Food for your ears***

A machine this nice had better have great sound, and the Mac doesn't disappoint. You have a couple of options for Mac laptop audio:

- ✓ Mac laptops sport built-in stereo speakers (and a microphone to boot).
- ✓ Use built-in optical/digital Line Out ports to connect your Mac's audio to a pair of headphones, or a more powerful (and expensive) external speaker system, or a home stereo system.

### ***The power cable***

Sorry, can't get a wireless power system . . . yet. (Apple's working hard on that one.) However, the MacBook Pro was the first major release of a laptop with a magnetic power connector; the MacBook followed suit soon after. The MagSafe connector reduces the chances of your pride and joy being yanked off a desk when someone trips over the power cord. Now that's *sassy*.

### ***The Apple remote***

Oh, here's a pleasant surprise that you won't find with most PC laptop boxes: the remote looks like an iPod Shuffle, but it allows you to control your laptop wireless from across the room. (Think DVD viewings, presentations, and lazy iTunes listening.)

### ***The power button***

Yep, you have one of these, too. It's on the upper right, next to the keyboard.

### ***The iSight camera***

Have you noticed that tiny square lens above your screen? That's a built-in iSight camera, which allows you to chat with others in a videoconferencing environment using Tiger's iChat feature. You can even take photos with it, using the PhotoBooth software that comes with your laptop, or set up a travelin' Webcam.

### *The battery compartment*

You can open the cover on the bottom of your laptop to switch batteries. Many road warriors who constantly use their laptops for extended periods swear by extra batteries, especially if they're on site in the middle of nowhere and there's not an AC outlet to be found.

Of course, your laptop automatically charges the battery while it's plugged in, so you shouldn't have to remove the battery unless you're replacing it or switching it with another battery.

## *The holes called ports*

The next stop on your tour of Planet Laptop is Port Central — those rows of holes on the sides of your computer. Each port connects a different type of cable or device, allowing you to easily add all sorts of functionality to your computer.

Each of these stellar holes is identified by an icon to help you identify it. Here's a list of what you'll find, and a quick rundown on what these ports do.

Connections for external devices and networking:

- ✔ **FireWire:** These ports are the standard in the Apple universe for connecting external hard drives and DVD recorders, but they do double-duty as the connector of choice for peripherals like your iPod and your digital video (DV) camcorder. (A *peripheral* is another silly techno-nerd term that means a separate device you connect to your computer.) Depending on the model of laptop you chose, you'll have one of the older FireWire 400 ports, and you may also have a much faster FireWire 800 port.
- ✔ **USB:** Short for *Universal Serial Bus*, the familiar USB port is the jack-of-all-trades in today's world of computer add-ons. Most external devices that you want to connect to your laptop (such as portable hard drives, scanners, and digital cameras) use a USB port. Depending on the model of laptop, you'll have either two or three USB 2.0 ports available. USB 2.0 connections are much faster than the old USB 1.1 standard, but they still accept USB 1.1 devices running at the slower speed.  
Get the lowdown on FireWire and USB ports in Chapter 20.
- ✔ **Ethernet:** Today's Mac laptops include a standard 10/100/1000 Ethernet port, so the laptop is ready to join your existing wired Ethernet network. (Alternatively, you can go wireless for your network connection; more on that in the next section and in Chapters 17 and 20.)





- ✔ **ExpressCard/34:** When you need the absolute fastest performance possible from an external device, you can connect that device to your laptop using the ExpressCard slot. These cards are the descendants of the popular PCMCIA (or PC Card) cards, which many models of older Mac PowerBooks and iBooks can use.

Connections for external video and audio:

- ✔ **VGA/DVI connector:** In case that splendid screen isn't good enough, you can buy an adapter for this port that allows you to send the video signal from your laptop to another VGA or DVI monitor, or even S-Video output for your TV and VCR.
- ✔ **Headphone/Optical Output:** You can send the high-quality audio from your rectangular beast to a set of standard headphones or an optical digital audio device such as a high-end home theater system.
- ✔ **Optical Line In:** Last (but certainly not least) is the optical audio Line In jack, which allows you to pipe the signal from another audio device into your laptop. This one comes in particularly handy when you record MP3 files from your old vinyl albums or when you want to record loops in GarageBand.

## *Don't forget the parts you can't see*

When you bought your new digital pride and joy, you probably noticed a number of subtle differences between the low-end MacBook and the uber-expensive top-end MacBook Pro model. I call these differences the *Important Hidden Stuff* (or IHS, if you're addicted to acronyms already), and they're just as important as the parts and ports that you can see.

Internal storage devices:

- ✔ **CPU:** Today's Mac laptops feature — gasp! — Intel processors, which run faster and cooler than the old G4 processors that powered the iBook and PowerBook models. Of course, the faster the processor, the better. (Definitely *not* rocket science.)
- ✔ **Hard drive:** MacBook and MacBook Pro laptops use the latest in hard drive technology: *serial ATA* hard drives, which are significantly faster than the EIDE hard drives used in previous Mac laptop models. (You don't need to worry about what ATA and EIDE mean here. Really.) As you might expect, the MacBook Pro laptop line has a larger capacity hard drive as standard equipment, but you can special-order a MacBook from Apple with a larger hard drive.

✔ **Optical drive:** Okay, I'm cheating a little here. I mention the optical drive in an earlier section, but all you can see is the slot, so it qualifies as an IHS item. Depending on your Mac, your computer includes one of the following:

- A DVD-R/CD-RW SuperDrive (which can play and record both CDs and DVDs)
- A DVD/CD-RW combo drive (which can record CDs but only read DVDs)

If your laptop can't burn DVDs with the internal drive, don't give up hope of recording your own DVD movies. Thanks to those handy FireWire ports, it's child's play to add an external DVD recorder.



Time for a plug: If you're interested in recording your own audio and data CDs, or you have an itch to burn DVD movies, I can highly recommend the bestselling *CD & DVD Recording For Dummies*, Second Edition (Wiley). It's written by yours truly; hence the solid recommendation. You'll find everything you need to know to use Roxio's Toast recording software. In a few minutes, you'll be burning your own shiny digital treasures.

Wireless communications devices:

✔ **Wireless Ethernet:** "Look, Ma, no wires!" As I mention earlier, you can connect your laptop to an existing wireless Ethernet network by adding an AirPort Extreme card (either as an installed option or after you've started using the computer). With wireless connectivity, you can share documents with another computer in another room, share a single high-speed Internet connection betwixt several computers, or enjoy wireless printing. Truly *sassy!*



Although Apple would want you to build your wireless wonderland with an Apple AirPort Extreme base station — go figure — you can use your Mac with any standard 802.11g wireless network. And yes, PCs and Macs can intermingle on the same wireless network without a hitch. (Scandalous, ain't it?)

✔ **Bluetooth:** Let's get the old "digital pirate" joke out of the way: "Arrgh, matey, I needs me a wireless parrot." (Engineers again . . . sheesh.) Although strangely named, Bluetooth is another form of wireless connectivity. This time, however, the standard was designed for accessories such as your keyboard and mouse, and devices such as a personal digital assistant (PDA) and a cell phone.

Video display device:

- ✔ **Video card:** If your applications rely heavily on high-speed 3-D graphics, you'll be pleased as punch to learn that today's MacBook Pro line of laptops come equipped with cards such as the ATI Mobility Radeon X1600. This card is well-suited to 3-D modeling, video editing, and well, honestly, blasting the enemy into small smoking pieces with aplomb. As of this writing, the MacBook line uses an integrated video card, so it's not a good choice for hard-core gaming or 3-D design.

## Location, Location, Location!

If you choose the wrong spot to park your new laptop, I can guarantee that you'll regret it. Some domiciles and office cubicles don't offer a choice — you have one desk at work, for example, and nobody's going to hand over another one — but if you can select a home for your Mac, consider the important placement points in this section:



- ✔ **Keep things cool.** Your new laptop is silent, but that super fast Intel Core Duo processor generates heat. Make sure the location you choose is far from heating vents and shielded from direct sunlight. I also recommend a laptop cooling pad, which elevates the base of your laptop to allow air to circulate underneath.

- ✔ **Outlets are key!** Your computer needs a minimum of at least one nearby outlet, and perhaps as many as three:

- A standard AC outlet
- A telephone jack (if you have an Apple modem for connecting to the Internet or sending and receiving faxes)
- A nearby Ethernet jack (if you use the Mac's built-in Ethernet port for connecting to a wired Ethernet network)

If you prefer to send your data over the airwaves, consider wireless networking for your Mac — I discuss everything you need to know in Chapter 17.



- ✔ **Don't forget the lighting.** Let me act as your Mom. (I know that's a stretch, but bear with me.) She'd say, "You can't possibly expect to work without decent lighting! You'll go blind!" She's right, you know. You need a desk or floor lamp at a minimum.

- ✔ **Plan to expand.** If your laptop hangs out on a desk, allow an additional foot of space on each side. That way, you have room for external peripherals, more powerful speakers, and an external keyboard and mouse if you need one.



If you want to keep an external keyboard handy, consider a laptop shelf — these Plexiglas or metal stands elevate your laptop several inches above the desk, putting the screen at a better ergonomic position and allowing you to park your keyboard and external mouse underneath.

## Unpacking and Connecting Your Laptop

You're going to love this section — it's short and sweet because the configuration of a laptop on your desktop is a piece of cake. (Sorry about the cliché overload, but this really *is* easy.)

### Unpacking for the road warrior

Follow these guidelines when unpacking your system:



- ✓ **Check for damage.** I've never had a box arrive from Apple with shipping damage, but I've heard horror stories from others (who claim that King Kong must have been working for That Shipping Company).

Check all sides of your box before you open it. If you find significant damage, take a photograph (just in case).

- ✓ **Search for all the parts.** When you're removing those chunks o' Styrofoam, make certain that you've checked all sides of each foam block for parts snuggled therein or taped for shipment.
- ✓ **Keep all packing materials.** Do *not* head for the trash can with the box and packing materials. Keep your box and all packing materials for at least a year, until the standard Apple warranty runs out. If you have to ship the laptop to an Apple service center, the box and the original packing is the only way for your machine to fly.

And now, a dramatic Mark's Maxim about cardboard containers:

Smart computer owners keep their boxes far longer than a year. If you sell your laptop or move across the country, for example, you'll want that box. *Trust me on this one.*

- ✓ **Store the invoice for safekeeping.** Your invoice is a valuable piece of paper, indeed.

Save your original invoice in a plastic bag, along with your computer's manuals and original software, and other assorted hoo-hah. Keep the bag on your shelf or stored safely in your desk, and enjoy a little peace of mind.



✓ **Read the Mac's manual.** “Hey, wait a minute, Mark — why do I have to read the manual from Apple along with this tome?” Good question, and here's the answer: The documentation from Apple might contain new and updated instructions that override what I tell you here. (For example, “*Never* cut the red wire. Cut the blue wire instead.” Or something to that effect.) Besides, Apple manuals are rarely thicker than a restaurant menu.

## *Connecting cables 101*

Your laptop makes all its connections simple, but your computer depends on you to get the outside wires and thingamabobs where they go.

### *The absolutely essential connection*

After your new Mac is resting comfortably in its assigned spot (I assume that's a desktop), you need to make just one required connection: the power cable! Plug the cable into the corresponding socket on the Mac first, and then plug 'er into that handy AC outlet.

### *Adding the Internet to the mix*

If you have Internet access or a local computer network, you need to make at least one of the following connections in this section.



If you don't have *any* Internet service, start with local dialup Internet access. (Owners of MacBook and MacBook Pro laptops will need an external USB modem, because these models no longer have an internal modem.) You can check high-speed options later — typically, your local cable and telephone companies can provide you with more information on your long-term choices for Internet service.

If you get on the Internet by dialing a standard phone number and your laptop has an internal or external USB modem, just make two more connections:

- 1. Plug one of the telephone cable's connectors into your external modem port.**
- 2. Plug the other telephone cable connector into your telephone line's wall jack.**

After you get your account information from your ISP, Chapter 17 has the details on configuring your modem and Internet settings for dialup access.

If you have high-speed Internet service, or if you're in an office or school with a local computer network, you can probably connect through your laptop's built-in Ethernet port. You make two connections:

1. **Plug one end of the Ethernet cable into the Ethernet port on the Mac.**
2. **Plug the other end of the Ethernet cable into the Ethernet port from your network.**

Your network port is probably one of the following: an Ethernet wall jack, an Ethernet hub or switch, or a cable or DSL Internet router (or sharing device).



Will you be joining a wireless network? If so, you'll find the information you need on installing an AirPort Extreme wireless card in an older Mac laptop in Chapter 20, and all the details you need to configure Tiger for wireless networking in Chapter 17.

## *Great, a Lecture about Handling My Laptop*

Proper handling of your laptop is important, so we'll take a moment to cover the Rules of Proper Laptop Department. Okay, perhaps I'm lecturing a bit, but a little common sense goes a long way when handling any computer equipment, and your laptop is no different. (Scolding mode off.)

Keep these rules in mind while opening and carrying your laptop:

- ✓ **The cover is your friend.** Open your laptop's cover slowly, without jerking or bending it.
- ✓ **Close it before you move it.** By closing your laptop, you put your Mac OS X operating system into sleep mode, and the hard drive automatically spins down (making it safer to move). The laptop is still on, and will spring back to life once you open the cover.
- ✓ **Be nice to your keyboard.** Don't press too hard on those keys! Use the same amount of pressure that you use with a desktop computer keyboard.
- ✓ **Keep food and drinks far away.** Care to turn your laptop into a very expensive doorstop? Then go ahead and park your soda next to it. (Oh, and crumbs are perfect if you're interested in buying replacement keyboards.)
- ✓ **Keep your laptop as level as possible.** Using your laptop while it's tilted too far in any direction can eventually cause problems with your hard drive. I kid you not.

## *An Overview of Mac Software Goodness*

This section answers the most common of all novice computer questions: “What the heck will I *do* with this thing?” You’ll find additional details and exciting factoids about the software that you get for free, software you’ll want to buy, and stuff you can do on the Internet.

### *What comes with my laptop?*

Currently, Apple laptops ship with the following major software applications installed and ready to use:

- ✓ **The iLife 2006 suite:** You know you want these applications! They turn your Mac into a digital hub for practically every kind of high-tech device on the planet, including DV camcorders, digital cameras, portable music players, PDAs, and even cell phones.  
Chapters 11–15 focus on the major applications that make up iLife: iMovie HD, iDVD, iTunes, iPhoto, and GarageBand.
- ✓ **Office 2004 and iWork trial versions:** You can try both of those productivity suites, but expect to buy the full shooting match if you want to continue using either one.
- ✓ **QuickBooks for Mac:** Track your expenses, build a budget (and watch it evaporate), and plan for your financial future. Your checkbook suddenly becomes manageable and tax time becomes easier when you organize your financial world with QuickBooks.
- ✓ **Photo Booth and Front Row:** You’ll discover more about these applications in Chapter 10 — for now, suffice it to say that Photo Booth works with your laptop’s iSight camera, while Front Row is the remote-control software you’ll use with your Apple remote.



The installed software on your Mac might change as new programs become available.

### *Connecting to the Internet from your lap*

What is a modern computer without the Internet? Apple gives you great tools to take full advantage of every road sign and off-ramp on the Information Superhighway right out of the box:

- ✓ **Web surfing:** I use Tiger’s Apple Safari Web browser every single day. It’s faster and better designed than Internet Explorer, with unique features such as tabbed browsing and built-in RSS feeds.

If *tabbed browsing* and *RSS feeds* sound like ancient Aztec to you, don't worry. Chapter 8 is devoted entirely to Safari.

- ✓ **Web searches:** Sherlock can search the entire Internet for stocks, movie listings, airline schedules, dictionaries, and foreign language translations. I explain this Internet sleuth in Chapter 7.
- ✓ **Chat:** *iChat* lets you use your Mac to chat with others around the world for free using the Internet — by keyboard, voice, or full-color video. This is awesome stuff straight out of Dick Tracy and Buck Rogers. If you've never seen a video chat, you'll be surprised by just how good your friends and family look!

Always wear a shirt when videoconferencing.

- ✓ **E-mail:** Soldier, Apple's got you covered. The Mail application is a full-featured e-mail system, complete with defenses against the torrent of junk mail awaiting you. (Imagine a hungry digital saber-toothed tiger with an appetite for spam.) Send pictures and attached files to everyone on the planet, and look doggone good doing it.



## Applications that rock

Dozens of small applications are built into Mac OS X. I mention them in later chapters, but here are four good examples to whet your appetite:

- ✓ **iCal:** Keep track of your schedule and upcoming events, and even share your calendar online with others in your company or your circle of friends. See how to keep your life in order in Figure 1-2.
- ✓ **DVD Player:** Put all that widescreen beauty to work and watch your favorite DVD movies with DVD Player! You have all the features of today's most expensive standalone DVD players, too, including a spiffy onscreen control that looks like a remote.
- ✓ **Address Book:** Throw away that well-thumbed collection of fading addresses. Tiger's Address Book can store, search, and recall just about any piece of information on your friends, family, and acquaintances.
- ✓ **Chess:** Ah, but this isn't the chessboard your Dad used! Play the game of kings against a tough (and configurable) opponent — your MacBook — on a beautiful 3-D board. Heck, your Mac even narrates the game by speaking the moves!



You can use the data you store in your Address Book in other Apple applications included with Tiger, such as Apple Mail and iChat.



**Figure 1-2:**  
Hey, isn't  
that iCal  
running on  
your Mac?  
You are  
iTogether!

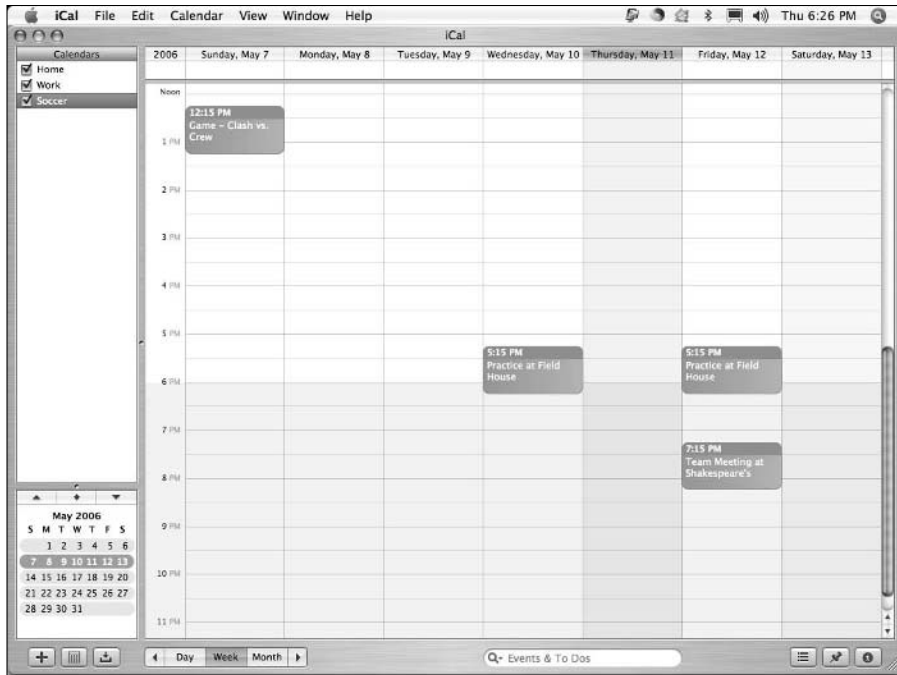

## *Boot Camp For Dummies*

Although Mac OS X Leopard — the next version of Mac OS X — is still being polished, one particularly exciting feature of this upcoming release is available now. You can use Apple's Boot Camp utility and your licensed copy of Windows XP to install and boot Windows on your Intel-based MacBook or MacBook Pro laptop!

Boot Camp creates a Windows-friendly *partition* (or section) on your hard drive, where all your Windows files are stored. Other than the slightly strange key assignments you'll have to remember, early adopters of Boot Camp report that it's surprisingly reliable and easy to use. However, I strongly urge that you back up your laptop on a regular basis; inviting Windows to your Mac laptop also invites potential viruses as well.

For more information on Boot Camp and how you can download and install it, visit Apple's Mac OS X page at [www.apple.com/macosx/](http://www.apple.com/macosx/).

## Other Stuff That Nearly Everyone Wants

No man is an island, and no computer is either. I always recommend the same set of stuff for new PC and Mac owners. These extras help keep your new computer clean and healthy (and some make sure you're happy as well):



✔ **Surge suppressor:** Even an all-in-one computer like your laptop can fall prey to a power surge. I recommend one of these:

- A basic surge suppressor with a fuse can help protect your Mac from an overload.
- A UPS (uninterruptible power supply) costs a little more, but it does a better job of filtering your AC line voltage to prevent brownouts or line interference from reaching your computer.

Of course, your laptop's battery immediately kicks in if you experience a blackout, so a UPS is less important for your computer. However, any computer tech will tell you that filtered AC current is far better for your laptop, and your UPS will also provide power for external devices that *don't* have a battery.



✔ **Screen wipes:** Invest in a box of premoistened screen wipes. Your Mac's screen can pick up dirt, fingerprints, and other unmentionables faster than you think.

Make sure your wipes are especially meant for LCD or laptop computer screens.

✔ **Blank CDs and DVDs:** Depending on the type of optical drive installed in your laptop — and the type of media you're recording, such as computer data CDs, DVD movies, or audio CDs — you'll want blank discs for

- CD-R (record once)
- CD-RW (record multiple times)
- DVD-R (record once)

✔ **Cables:** Depending on the external devices and wired network connectivity you'll be using, these are

- A standard Ethernet cable (for wired networks or high-speed Internet)
- FireWire or USB cables for devices you already have



Most hardware manufacturers are nice enough to include a cable with their products, but there are exceptions, especially USB printers. *Shame on those cheapskates!*

- ✔ **A restraining cable:** For those who are a little more security-conscious or tend to use their laptops in public places, a standard Kensington laptop lock slot is provided on your computer's case. The principle is the same as a bicycle cable lock: if your laptop is secured by a cable to a sturdy fixture, it's going to be nearly impossible for it to walk off with someone else.
- ✔ **A wrist rest:** You might have many reasons to buy a new Mac laptop, but I know that a bad case of carpal tunnel syndrome is not one of them. Take care of your wrists by carrying a keyboard wrist rest in your laptop bag.

## Chapter 2

# Turning On Your Portable Powerhouse

---

### *In This Chapter*

- ▶ Turning on your laptop
- ▶ Checking your Mac for proper operation
- ▶ Monitoring your battery and heat level
- ▶ Setting up Mac OS X Tiger
- ▶ Registering your MacBook or MacBook Pro
- ▶ Using Migration Assistant
- ▶ Copying information from a Windows PC

---

**I**n Chapter 1, you got as far as unpacking your Mac laptop and connecting a number of cables to it, but unless you bought this computer solely as a work of modern art, it's time to turn *on* your Mac and begin living The Good Life. (Plus, you still get to admire that Apple design whilst using iTunes.) After you get your new beauty powered on, I will help you with an initial checkup of your laptop's health.

I also familiarize you with the initial chores that you need to complete — such as using the Mac OS X Setup and moving the data and settings from your existing computer to your MacBook or MacBook Pro — before you settle in with your favorite applications.

In this chapter, I assume that Mac OS X Tiger was preinstalled on your Mac or that you just completed an upgrade to Tiger from an earlier version of Mac OS X.

## Tales of the On Button

Your Mac's power switch is located on the right side of the keyboard. Press it now to turn on your Mac, and you will hear the pleasant startup tone that's been a hallmark of Apple computers for many years. The power button will also light up. Don't be alarmed if you don't immediately see anything onscreen because it takes a few seconds for the initial Apple logo to appear.



In my experience, sometimes a simple quick press of the power button on some Mac laptop models just doesn't do it. Rather, you actually have to hold the button down for a count of two or so before the computer turns on. However, if your Mac laptop ever locks up tight (and you can't quit an application, as I demonstrate in Chapter 4), the power button gives you another option: hold it down for a count of five and your Mac shuts off.

As the Apple logo appears, you see a twirling, circular high-tech progress indicator that looks like something from a *James Bond* movie. That's the sign that your Mac is loading Tiger and checking your internal drive for problems. Sometimes the twirling circle can take a bit longer to disappear. As long as it's twirling, though, something good is happening.

Next, Tiger displays the soon-to-be-quite-familiar Aqua Blue (yup, that's its name) background while it loads certain file sharing, networking, and printing components (and such). This time, you get a more conservative progress bar, but the result is the same. Just wait patiently a bit longer.

At last, your wait is rewarded, and you see the Tiger Setup Assistant.

## Mark's Favorite Signs of a Healthy Laptop

Before you jump into the fun stuff, don't forget an important step — a quick prelim check of the signs that your new mobile Mac survived shipment intact and happy.

If you can answer “yes” to each of these questions, your Mac likely made the trip without serious damage:

- 1. Does the case show signs of damage?**

It's pretty easy to spot damage to your Mac's svelte design. Look for scratches and puncture damage.

- 2. Does the LCD screen work, and is it undamaged?**

Does the cover open smoothly? Are any individual dots (or *pixels*) on your LCD monitor obviously malfunctioning? Bad pixels appear black or in a different color than everything surrounding them. (Techs call these irritating anarchists *dead pixels*. A 13" MacBook screen has literally hundreds of thousands of pixels, and unfortunately, many new LCD screens include one or two dead ones.

### 3. Do the keyboard and trackpad work?

Check your Mac's built-in trackpad by moving your finger across its surface; the cursor should move on your screen. To check the keyboard, press the Caps Lock key on the left and observe whether the Caps Lock light turns on and off.

If you do notice a problem with your laptop (and you can still use your Safari browser and reach the Web), you can make the connection to an Apple support technician at [www.apple.com](http://www.apple.com). If your MacBook Pro remains dead — like an expensive paperweight — and you can't get to the Internet, you can check your phone book for a local Apple service center. Chapter 19 also offers troubleshooting information.

## *You're Not Going to Lecture Me About Batteries, Are You?*

No, this is not going to be a lecture. In fact, the only lecture I'll put you through in this book concerns backing up. (Which you should do.) Instead, consider these tips as your rules of the road for monitoring and charging your battery:

- ✔ **Keep your laptop plugged into an AC socket when possible.** I take every opportunity to top off my laptop's battery, and so should you.
- ✔ **Your battery recharges faster when your laptop is off or in sleep mode.** Have only half an hour to charge your battery before you're away from an AC socket? In that case, don't use your MacBook whilst it's plugged in and charging. For the most juice you can scavenge, turn off your laptop or leave it in sleep mode.
- ✔ **Monitor your battery level from the Finder menu.** I love Tiger's battery monitoring system! Your laptop's battery life is displayed in the Finder menu as a percentage of power remaining (with a fully charged battery registering at 100%). Keep in mind that the percentage shown is estimated using your current System Preference settings and power usage, so if you change your Energy Saver settings or remove a USB device that draws power from your laptop, you'll see that change reflected in the battery meter.

## Hot patootie, is my laptop steam-powered?

It's a well-known fact that laptops generate heat. Today's super-fast multicore processors can work up a head of steam — pun intended — while you're using them, and even though your laptop has a fan, some of that heat is simply radiated from the bottom of the computer.

What you may not realize, however, is just how *much* heat your MacBook or MacBook Pro can produce! You're not going to be scalded if you shift your MacBook from a desk to your lap (Apple dislikes lawsuits as much as the next company), but if you've been using that laptop for hours, it will be uncomfortably hot!

To avoid that burning sensation, buy a laptop stand or cooling pad for your desk. These nifty metal or Plexiglas pedestals raise your laptop up off of your desk, allowing air to flow under the bottom of the computer for better cooling. Also, a laptop stand elevates the screen to a more ergonomic position. (The keyboard may suddenly be harder to use, naturally, but that's yet another reason why I recommend an external keyboard when you're using your Mac laptop at a semipermanent desk location; it saves wear and tear on your laptop keyboard, and you get a full-size keyboard.)

- ✔ **Turn off unnecessary hardware to conserve battery power.** If you want to conserve battery power as much as possible, disconnect any USB or FireWire devices, and turn off your AirPort and Bluetooth wireless hardware if you're not connected to a network. You can save power also by reducing the brightness of your display from your laptop's keyboard, by using sleep mode, and by removing CDs and DVDs from your drive.
- ✔ **Calibrate your battery.** You can “train” your battery to provide the maximum charge by calibrating it; Apple recommends that you recalibrate your battery once a month. First, charge your battery until the Finder menu battery meter indicates that the unit is fully charged at 100%, and then keep your laptop connected to an AC socket for another two hours to ensure a maximum charge. Now disconnect the power cord and use your laptop on battery power until it's fully discharged and it automatically switches to sleep mode (make sure that you've closed all your applications when you see the low battery warning dialog box, so you don't lose anything). Allow your laptop to sleep (or turn it off) for a full five hours. Finally, reconnect the AC cord and fully charge your battery. You're finished!

## Setting Up and Registering Your Laptop

After your Mac is running and you've given it the once-over for obvious shipping damage, your next chore is to set up your laptop. Unlike other tasks in this book, I won't cover the setup process step-by-step. Apple contextually

tweaks the questions that you see during setup on a regular basis, and the questions are very easy to answer. Everything is explained onscreen, complete with onscreen Help if you need it.

However, I do want you to know what to expect as well as what information you need to have at hand. I also want you to know about support opportunities like Apple's .Mac Internet services. Hence this section: Consider it a study guide for whatever your MacBook's setup procedure has to throw at you.

## Setting up Mac OS X Tiger

After you start your computer for the first time — or if you just upgraded from Mac OS 9 or an earlier version of Mac OS X — your laptop will likely launch Tiger Setup automatically. (Note that some custom install options, such as the Archive and Install option, may not launch the setup procedure.) The setup process takes care of a number of different tasks:

- ✔ **Setup provides Tiger with your personal information.** As I mention in Chapter 1, your Mac ships with a bathtub full of applications, and many of those use your personal data (such as your address and telephone number) to automatically fill out your documents.

If that stored personal information starts you worrying about identity theft, I congratulate you. If you're using your common sense, it *should*. However, in this case, Apple doesn't disseminate this information anywhere else, and the applications that use your personal data won't send it anywhere, either. And Safari, the Apple Web browser, fills out forms on a Web page automatically *only* if you give your permission.

- ✔ **Setup configures your language and keyboard choices.** Mac OS X is a truly international operating system, so you are offered a chance to configure your laptop to use a specific language and keyboard layout.
- ✔ **Setup configures your e-mail accounts in Apple Mail.** If you already have an e-mail account set up with your ISP, keep the e-mail account information that the ISP provided handy to answer these questions. The info should include the incoming POP3 and outgoing SMTP mail servers you'll be using, your e-mail address, and your login name and password.
- ✔ **Setup allows you to open a trial subscription with Apple's .Mac service.** Apple's .Mac subscription service provides you with online file storage, iSync capability across multiple computers, backups to your online storage, Apple e-mail accounts (through both Web mail and the Apple Mail application), photocasting, podcasting, and your own acre of iWeb site on the Internet. I go into all these in detail in Chapter 9, but for now, just sign up (or sign in, if you already have an existing account) and take the opportunity to feel smug about owning an Apple computer.





- ✔ **Setup sends your registration information to Apple.** As a proud owner of a Mac laptop, take advantage of the year of hardware warranty support and the free 90 days of telephone support — but you have to register to use 'em. Rest assured that all this info is confidential.
- ✔ **Setup launches Migration Assistant.** This assistant guides you through the process of *migrating* (an engineer's term for *moving*) your existing user data from your old Mac or PC to your new laptop. Naturally, if your MacBook is your first computer, you can skip this step with a song in your heart! (Read more on Migration Assistant in the section, "Importing Stuff from Another Mac.")

## Registering your Mac

I'll be honest here: I know that many of us, myself included, don't register every piece of computer hardware we buy. For example, I didn't register my wireless Bluetooth adapter that I bought for my older iBook because the total expenditure was only around \$40, the gizmo has no moving parts, and I'm never likely to need technical support to use it or get it fixed.

However, your MacBook is a different kettle of fish altogether, and I *strongly* recommend that you register your purchase with Apple during the setup process. You spent a fair amount on your computer, and it's an investment with a significant number of moving parts.

Even the hardest of techno-wizards would agree with this important Mark's Maxim:



If you don't register your new laptop, you can't receive support.

And rest assured that Apple is not one of those companies that constantly pesters you with e-mail advertisements and near-spam. I've registered every Apple computer I've owned, and I've never felt pestered. (And I have an extremely low tolerance for spam.)

## Importing Stuff from Another Mac

If you're upgrading from an older Mac running Mac OS X to your new laptop, I have great news for you: Apple includes *Migration Assistant*, a utility application that can help you copy (whoops, I mean, *migrate*) all sorts of data from your old Mac to your new machine. The list of stuff that gets copied over includes the following:

- ✔ **User accounts:** If you set up multiple user accounts (so that more than one person can share the computer), the utility ports them all to your new Mac.
- ✔ **Network settings:** Boy, howdy, this is a real treat for those with manual network settings provided by an ISP or a network administrator! Migration Assistant can re-create the entire network environment of your old Mac on your new laptop.
- ✔ **System Preference settings:** If you're a fan of tweaking and customizing Mac OS X to fit you like a glove, rejoice. Migration Assistant actually copies over all the changes that you've made in System Preferences on your old Mac! (Insert sound of angelic chorus: *Hallelujah!*)
- ✔ **Documents:** The files in your Documents folders are copied to your new Mac.
- ✔ **Applications:** Migration Assistant tries its best to copy over the third-party applications that you've installed in your Applications folder on the older Mac. I say *tries its best* because you might have to reinstall some applications, anyway. Some developers create applications that spread out all sorts of files across your hard drive, and Assistant just can't keep track of those nomadic files. And some other applications make the trek just fine, but you might have to reenter their serial numbers.



Setup launches Migration Assistant automatically if you indicate that you need to transfer stuff during the setup process, but you can always launch Migration Assistant manually at any time. You'll find it in the Utilities folder inside your Applications folder; just double-click the Migration Assistant icon.

To use Migration Assistant to copy your system from your older Mac, you need a FireWire cable to connect the computers. If you don't already have one, you can pick one up at your local Maze o' Wires electronics store or at your computer store. (This cable will probably come in handy in the future as well, so it's not a one-use wonder.)

Follow these steps to use Migration Assistant:

- 1. Click Continue on the opening screen.**

Assistant prompts you for the account name and password that you created during the setup procedure, as shown in Figure 2-1. Your account is an *admin account*, meaning that you have a higher security level that allows you to change things in Tiger. (See Chapter 16 for much more detail on user accounts.)

- 2. Type your password and then click OK.**

Characters in your password are displayed as bullet characters for security.



**Figure 2-1:**  
Enter your  
admin  
password  
to use  
Migration  
Assistant.

3. **Click From Another Mac and then click Continue.**
4. **Connect a FireWire cable between the two computers and then click Continue.**
5. **Restart your older Mac while holding down the T key. Continue holding down the T key until you see the FireWire symbol appear on your older machine.**

This restarts your older computer in *FireWire Target Disk mode*, in which your older Mac essentially becomes a huge external FireWire hard drive. (Neat trick.)
6. **Click Continue.**
7. **Select the check boxes next to the user accounts that you want to transfer from your older machine (see Figure 2-2) and then click Continue.**

The Assistant displays how much space is required to hold the selected accounts on your new laptop's hard drive.
8. **Select the check boxes next to the applications and files that you want to copy (see Figure 2-3) and then click Continue.**

**Figure 2-2:**  
Select the  
user  
accounts  
you want to  
migrate.



**Figure 2-3:**  
Would you  
like  
applications  
and files  
with that  
migration?

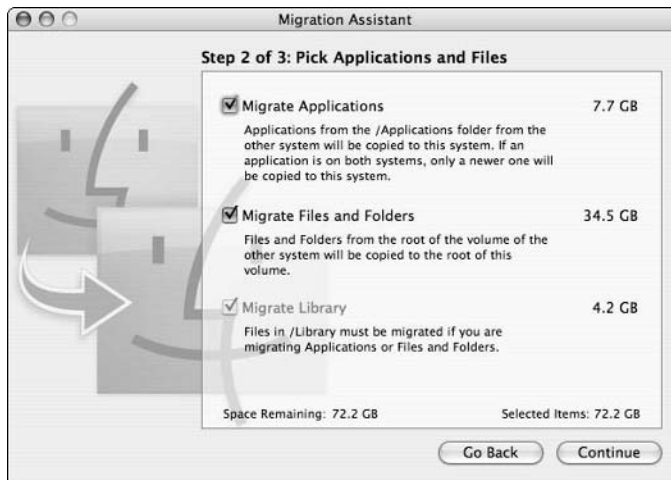

9. Select the check boxes next to the settings that you want to transfer (see Figure 2-4).

Normally, you want to migrate all three groups of settings.

10. Click the Migrate button.

11. After everything is copied, press and hold the power button on your older Mac to shut it off. Then disconnect the FireWire cable.

**Figure 2-4:**  
Copy Mac  
OS X  
settings  
with  
Migration  
Assistant.



## Importing Stuff from Windows (If You Must)

If you're a Windows-to-Mac *switcher*, you made a wise choice, especially if you're interested in the creative applications in the iLife suite! Although you could choose to start your Apple computing life anew, you probably want to migrate some of your existing documents and files from that tired PC to your bright, shiny, new MacBook Pro.

Unfortunately, Mac OS X has no Windows Migration Assistant. However, if you're moving from a Windows PC to a Mac, you can copy your files manually from a CD or DVD, a USB Flash drive, or over a network. (Note, however, that today's Mac laptops don't come with a floppy drive. And trust me, you wouldn't want to use one to move anything that matters, anyway.)



The Mac OS X Help system contains an entire subsection on specific tricks you can use when switching from Windows to Mac, including how to connect to a Windows network and how to connect the two computers together directly.

Even with Boot Camp — Apple's dual-boot feature that allows you to run both Tiger and Windows XP on your MacBook or MacBook Pro — manually moving existing Windows applications such as Paint Shop Pro to your

laptop's hard drive usually won't work. That's because most Windows software installs all sorts of necessary files in several folders across your hard drive. Instead, you'll have to install Windows XP on your Mac laptop (using Boot Camp) and then reinstall your Windows applications.

In general, however, you *can* move the document files you've created — such as Office documents, movies, photos, and music — without a problem. Table 2-1 illustrates what can be moved between Windows XP and Mac OS X as well as the application you use in Tiger to open those files and documents.

<i>File Type</i>	<i>Windows XP Location</i>	<i>Mac OS X Location</i>	<i>Mac App</i>
Music files	My Music folder	Music folder	iTunes
Video and movie files	My Videos folder Player	Movies folder	QuickTime/DVD
Digital photos	My Pictures folder	Pictures folder	iPhoto
Mac Office documents	My Documents folder	Documents folder	Office/iWorks



If you don't mind investing around \$50, use the Move2Mac software utility, which does most of the work of Migration Assistant for those switching from a Windows PC. From Detto Technologies ([www.detto.com/move2mac](http://www.detto.com/move2mac)), Move2Mac comes complete with a special USB-to-USB cable that connects your two computers for high-speed copying. You can choose what you want to transfer to your new Mac (use Table 2-1 as a guide), and the copying is performed automatically for you. Plus, Move2Mac transfers goodies such as your home page and bookmarks from Internet Explorer, desktop backgrounds, and even your Address Book contacts and account settings from Outlook Express. Move2Mac makes switching much easier, and I can highly recommend it.



## Chapter 3

# The Laptop Owner's Introduction to Mac OS X

---

### *In This Chapter*

- ▶ Introducing Mac OS X Tiger
  - ▶ Appreciating the UNIX core underneath Tiger
  - ▶ Recognizing similarities between Windows XP and Tiger
  - ▶ Getting help while learning about Tiger
- 

**I**n the other books that I've written about Mac OS X Tiger, I use all sorts of understated phrases to describe my operating system of choice, such as *elegantly reliable*, *purely powerful*, and *supremely user-friendly*.

But *why* is Tiger such a standout? To be specific, why do creative professionals and computer techno-wizards across the globe hunger for the very same Mac OS X that runs your Mac laptop? Why is Tiger so far ahead of Windows XP in features and performance? Good questions, all!

In this chapter, I answer those queries and satisfy your curiosity about your new big cat. I introduce the main elements of the Tiger desktop, and I show you the fearless UNIX heart that beats underneath Tiger's sleek exterior. I also point out the most important similarities between Tiger and Windows XP, and I outline the resources available if you need help with Mac OS X.

Oh, and I promise to use honest-to-goodness English in my explanations, with a minimum of engineer-speak and indecipherable acronyms. (Hey, you've got to boast about Tiger in turn to your family and friends. Aunt Harriet might not be as technologically savvy as we are.)



## Your Own Personal Operating System

Tiger is a special type of software called an *operating system*. You know, OS, as in *Mac OS*. That means Tiger essentially runs your MacBook Pro and also allows you to run all your other applications, such as Keynote or Photoshop CS2. Tiger is the most important computer application — or *software* — that you run.



Think of a pyramid, with Tiger as the foundation and other applications running on top.

You're using the operating system when you aren't running a specific application, such as when you perform these actions:

- ✓ Copying files from a CD to your hard drive
- ✓ Choosing a different screensaver

Sometimes, Tiger even peeks through an application while it's running. For example, actions like these are also controlled by Tiger:

- ✓ The Open, Save and Save As dialog boxes you see when working with files in Photoshop CS2
- ✓ The Print dialog that appears when you print a document in Microsoft Word 2004

In this section, I escort you around the most important hotspots in Tiger, and you meet the most interesting onscreen thingamabobs that you use to control your laptop. (I told you I wasn't going to talk like an engineer!)

### The Tiger desktop

The Tiger desktop isn't made of wood, and you can't stick your gum underneath. However, it does indeed work much like the surface of a traditional desk. You can store things there, organize things into folders, and take care of important tasks such as running other applications. Heck, you even have a clock and a trash can.

Gaze upon Figure 3-1 and follow along as you venture to your desktop and beyond.

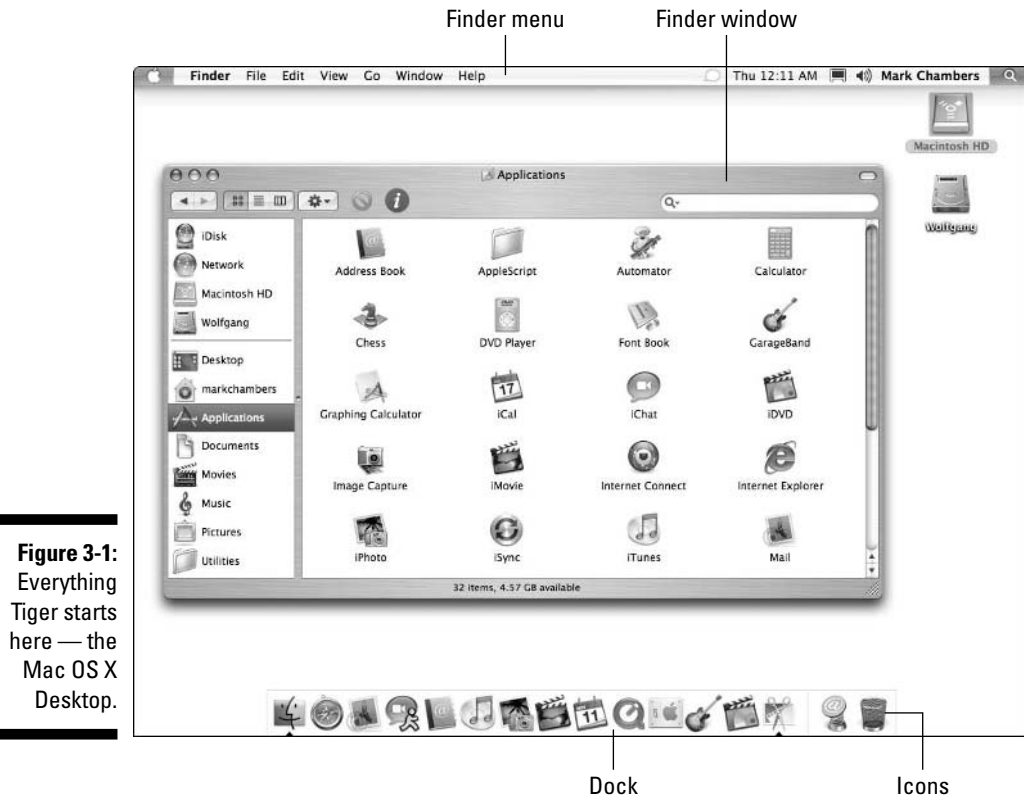

**Figure 3-1:** Everything Tiger starts here — the Mac OS X Desktop.

### *Meet me at the dock*

The dock is the closest thing to the dashboard of a car that you're likely to find on a Macintosh. It's a pretty versatile combination — it's one part organizer, one part application launcher, and one part system monitor. From here, you can launch applications, see what's currently running, and display or hide the windows shown by your applications.

Each icon in the dock represents one of the following:

- ✓ An application that you can run (or is currently running)
- ✓ An application window that's minimized (shrunk)
- ✓ A Web page
- ✓ A document or folder on your system

- ✓ A network server or shared folder
- ✓ Your trash



I cover the dock in more detail in Chapter 5.

The dock is highly configurable. You can

- ✓ Move it to different sides of the screen
- ✓ Make it disappear and call it back
- ✓ Resize it

### *Dig those crazy icons*

By default, Tiger always displays at least one icon on your desktop: your Mac's internal hard drive. To open a hard drive and view or use the contents, you double-click the icon. Other icons that might appear on your desktop can represent

- ✓ CDs and DVDs
- ✓ An iPod
- ✓ External hard drives or USB Flash drives
- ✓ Applications, folders, and documents
- ✓ Files you've downloaded from the Internet
- ✓ Network servers you've accessed

Chapter 4 provides the good stuff on icons and their uses in Tiger.

### *This menu has no food*

The Finder menu isn't found in a restaurant. Instead, you find it at the top of the desktop, where you can use it to control your applications. Virtually every application that you run on your Mac has a menu. (Chapter 4 dives deep into the depths of the Finder.)



To use a menu command, follow these steps:

- 1. Click the menu group (such as File or Edit).**
- 2. Choose the desired command from the list that appears.**



Only two menu groups are in *every* Mac OS X application: the *Apple menu* (which is identified with that jaunty Apple Corporation icon, ) and the *application menu* (which always bears the name of the active application). For instance, the DVD Player menu group appears when you run Tiger's DVD Player, and the Word menu group appears when you launch Microsoft Word 2004. I cover these two common groups in more detail in Chapters 4 and 5.

## Isn't Windows XP the latest thing?

You've seen highly customized "pocket rocket" compact cars with the flashy paint jobs, huge noisy mufflers, and aerodynamic fiberglass stuff. You might think that these cars are real road racers, but what's underneath is different. The 4-cylinder engine that you *don't* see is stock. These cars don't perform any better than a mundane model straight from the factory.

The same holds true for Microsoft Windows XP, which was another attempt by the folks at Redmond to put a modern face on an antique operating system. Forget the flashy colors and

the visual effects: Windows XP is simply more of the same (and it's now several years old to boot). Sure, it's more reliable and faster than Windows 98 and Windows ME, but you can forget real performance or innovation.

Unfortunately, if you're running PC hardware, the only other practical choice for a computing novice is Linux, which is still regarded as too complex by major manufacturers such as Dell and Hewlett-Packard. Therefore, with a PC, you're usually stuck with Windows XP, or you've picked up an expensive paperweight.

### *There's always room for one more window*

You're probably already familiar with the ubiquitous window itself. Both Tiger and the applications that you run use windows to display things such as

- ✓ The documents that you create
- ✓ The contents of your hard drive

The window in Figure 3-1 is a Finder window, where Tiger gives you access to the applications, documents, and folders on your system.

Windows are surprisingly configurable. I cover them at length in Chapter 4.

## *Why get so excited by Tiger?*

How Tiger's core is designed makes more of a difference than all the visual bells and whistles, which tend to be similar between Windows XP and Mac OS X Tiger (and Linux as well, for that matter). Time for a Mark's Maxim:



Sure, Tiger's elegant exterior is a joy to use, but Mac OS X is a *better* operating system than Windows because of the unique UNIX muscle that lies underneath!

So what should you and I look for in Mac OS X? Keep in mind that today's computer techno-wizard demands three requirements for a truly high-powered software wonderland, and that Tiger easily meets all three:



## It's Apple to the rescue!

UNIX is the super-reliable operating system that powers most of the high-performance servers that make up the Internet. UNIX has built-in support for virtually every hardware device ever wrought by the hand of Man (including all the cool stuff that came with your laptop) and is well designed and highly efficient to boot.

Unfortunately, standard UNIX looks as hideous as DOS, complete with a confusing command line, so ease-of-use for normal human beings like you and I goes out the door. Enter the genius types at Apple, who figured several years ago that all UNIX needed was a state-of-the-art, novice-friendly interface! To wit: Mac OS X was developed with a UNIX foundation (or *core*), so it shares the same reliability and performance as UNIX. However, the software engineers at Apple (who know a thing or two about ease of use) made it good looking and easy to use.

This is the secret to the worldwide fever over Mac OS X: It blends the best of UNIX (an established super-powered operating system) with the best of earlier Macintosh operating systems

such as Mac OS 9. Mac OS X is easy to use, *and* it runs tight, concentric *sassy* rings around anything that Microsoft is likely to offer for the next several years.

That's as far as I delve into the foundation of Tiger in this volume — which is understandable, because there's lots more laptop real estate to cover! It's my job to help you use the features and controls in Tiger, not turn you into a bearded UNIX nerd with a pocket protector and suspenders. In fact, you never see the UNIX running underneath Tiger (unless you want to, by running the Terminal application). Instead, Mac laptop owners can stay safely in the elegant world of drag-and-drop and point-and-click.

If you're interested in all the details about what makes Mac OS X tick, as well as its settings and features, I can heartily recommend another of my books, the bestselling (and extremely heavy) *Mac OS X Tiger All-in-One Desk Reference For Dummies*. It comprehensively covers everything Tiger — more than 700 pages devoted to Mac OS X and its companion applications!

- ✔ **Reliability:** Your operating system has to stay up and running reliably for as long as necessary — I'm talking *months* here — without lockups or error messages. If an application crashes, the rest of your work should remain safe, and you should be able to shut down the offending software.
- ✔ **Performance:** If your computer has advanced hardware, your operating system must be able to use those resources to speed things up big-time. The operating system has to be highly configurable, and it has to be updated often to keep up with the latest in computer hardware.

"Mark, what do you mean by *advanced hardware*?" Well, examples include

- True 64-bit computing
- Multiple processors (like more than one G5 chip in your computer)
- A huge amount of RAM (we're talking 4GB or more)
- Enough hard drive space to make use of a RAID array





If all that sounds like ancient Sumerian, gleefully ignore this technical drabble and keep reading.

- ✓ **Ease of use:** All the speed and reliability in the world won't help an operating system if it's difficult to use.

DOS was the PC operating system of choice before the arrival of Windows. It was doomed because it wasn't intuitive or easy to master, requiring a PC owner to remember all sorts of commands that looked like hieroglyphics. (This is one of the reasons why the Macintosh was so incredibly popular in the days of DOS-based PCs — Macs had a mouse, and they were a snap to learn and use.)

## All the Features of Windows (Just Better)

You might have heard of the *Windows switcher*: an intelligent species that's becoming more and more common these days. Switchers are former PC owners who have abandoned Windows and bought a Macintosh, thereby joining the Apple faithful running Mac OS X. (Apple loves to document this migration on its Web site.) Because today's Macintosh computers are significantly faster than their PC counterparts — and you get neat software such as Tiger and the iLife suite when you buy a new Mac — switching makes perfect sense.

### Like Windows done right

Switchers aren't moving to totally unfamiliar waters. Windows XP and Tiger share a number of important concepts. Familiarizing yourself with Tiger takes far less time than you might think.

Here's an overview of the basic similarities between the two operating systems:

- ✓ **The desktop:** The Tiger desktop is a neat representation of a real physical desktop, and Windows XP uses the same idea:
  - You can arrange files, folders, and applications on your desktop to help keep things handy.
  - Application windows appear on the desktop.
- ✓ **Drives, files, and folders:** Data is stored in files on your hard drive(s), and those files can be organized in folders. Both Tiger and Windows XP use the same file/folder concept.

- ✓ **Specific locations:** Both Windows XP and Tiger provide every user with a set of folders to help keep various types of files organized. For example, the My Videos folder in Windows XP corresponds to the Movies folder that you find in your Home folder in Tiger.
- ✓ **Running programs:** Both Tiger and Windows XP run programs (or applications) in the same manner:
  - Double-clicking an application icon launches that application.
  - Double-clicking a document runs the corresponding application and then automatically loads the document.
- ✓ **Window control:** Yep, both operating systems use windows, and those windows can be resized, hidden (or minimized), and closed in similar fashions. (Are you starting to see the connections here?)
- ✓ **Drag-and-drop:** One of the basics behind a GUI (a ridiculous acronym that stands for *graphical user interface*) like Windows XP and Tiger is the ability to drag documents and folders around to move, delete, copy, and load them. Drag-and-drop is one of the primary advantages of both of these operating systems — copying a file by dragging it from one window to another is intuitive and easy enough for a kid to accomplish.
- ✓ **Editing:** Both Tiger and Windows XP offer similar cut-and-paste editing features. You've likely used cut, copy, and paste for years, so this is familiar stuff.

## Loading the truck

Most folks use a high-capacity external hard drive when moving their documents from a PC to a laptop. If you're a Windows switcher, remember that you won't have to copy any applications or support files, so you'll be transferring only the files you created. For example, a Switcher is likely to copy media files (such as music tracks and video clips), word-processing and spreadsheet documents, and the like.

Keep in mind that a folder you've created on your PC's hard drive copies just fine under Tiger, so you can leave your files arranged in their current folders to help keep them organized. For example, if you stored all your Quicken data files for the last few years in a folder named Financial Archives, go ahead and copy that entire folder to the external drive.



If you're undertaking a switch from Windows XP to Tiger, I highly recommend using Move2Mac (\$150) from Detto Technologies ([www.detto.com](http://www.detto.com)). This application automatically takes care of most migration chores, such as moving the files that you select from XP to their corresponding locations in Tiger. Move2Mac also transfers your contacts, e-mail settings, and Internet

configuration to your new Mac. The package comes complete with a specially designed USB cable for connecting the two computers, so you don't even need an external hard drive to make the switch.



Wondering what you can do about Windows-only applications that you leave behind if you switch? Are you a Mac owner who must run a program that's available only for Windows? If you're running a MacBook or MacBook Pro, you can use Boot Camp to install and run Microsoft Windows XP directly. But what if you're running an older iBook or PowerBook? Believe it or not, Microsoft comes to the rescue with Virtual PC 7 (as shown in Figure 3-2). Virtual PC allows your Mac laptop to run multiple virtual copies of Windows 98, Me, 2000, or XP . . . you can even run Linux! (The operating system and software that you install and run within your virtual PC hardware environment can't tell the difference.)

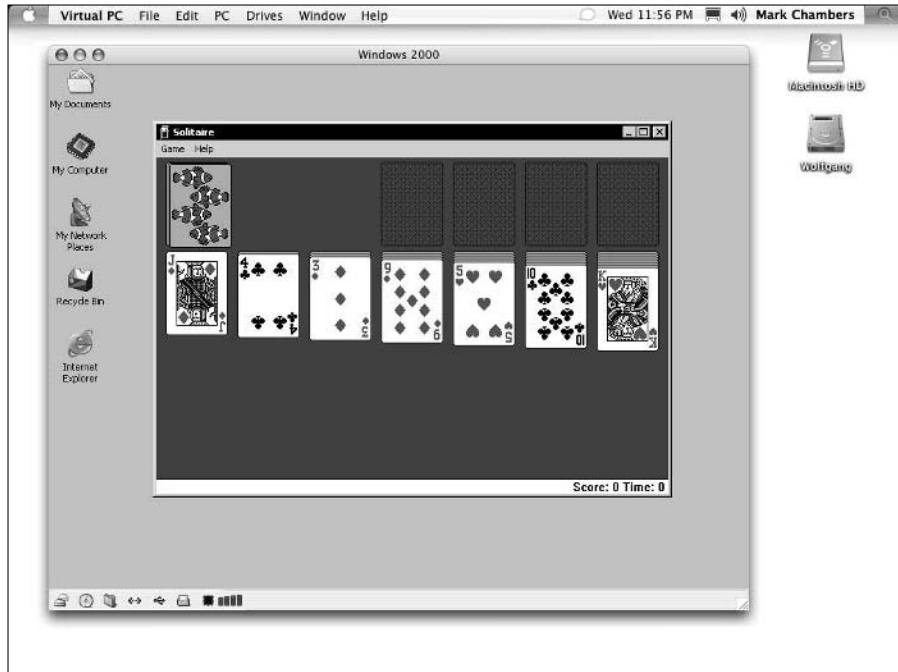

**Figure 3-2:**  
Hey, isn't  
that  
Windows  
running on  
my Tiger  
Desktop?

## *And Just in Case You Need Help . . .*

You can call on the resources in this section if you need additional help while you're learning to tame the Tiger. Some of the help resources are located on the Internet, so your Web browser will come in handy.



## *Tiger's built-in Help system*

Sometimes the help you need is as close as the Help group on the menu. You can get help for either

- ✓ **A specific application:** Just click Help.
- ✓ **Actions and functions in Tiger:** Click a Finder window and then press  $\text{⌘}+?$  to summon the top-level Mac OS Help menu.

After the Help viewer appears on your screen, click in the Ask a Question box and type a short phrase that sums up your query (such as *startup keys*). Press Return to list the topics that most closely match your search phrase. To display the Help text for an entry in the topic list, just double-click it.

## *Apple's Web-based support center*

Apple has online product support areas for every hardware and software product that it manufactures. Visit [www.apple.com](http://www.apple.com) and click the Support tab at the top of the Web page. The Search box works just like the Mac OS Help system, but the knowledge base that Apple provides online has a *lot* more answers.

## *Magazines*

Many magazines (both in print and online) offer tips and tricks on using and maintaining Mac OS X Tiger. My online favorites are Macworld ([www.macworld.com](http://www.macworld.com)) and MacAddict ([www.macaddict.com](http://www.macaddict.com)).

## *Mac support Web sites*

A number of individuals and groups offer support forums on the Web, and you can often find help from other Mac owners on these sites within a few hours of posting a question. I'm fond of MacFixIt ([www.macfixit.com](http://www.macfixit.com)) and MacMinute ([www.macminute.com](http://www.macminute.com)).

## *Mac newsgroups on Usenet*

You can find lots of help (typically dispensed with a healthy dose of opinion) in Usenet newsgroups such as `comp.sys.mac.system` and `comp.sys.mac.applications`. Simply post a message and then check back within a few hours to read the replies.

## *Local Mac user groups*

I would be remiss if I didn't mention your local Mac user group. Often a user group maintains its own Web site and discussion forum. If you can wait until the next meeting, you can even ask your question and receive a reply from a real-live human being . . . quite a thrill in today's Web-riffic world!



# Part II

# Shaking Hands with Mac OS X

The 5<sup>th</sup> Wave

By Rich Tennant

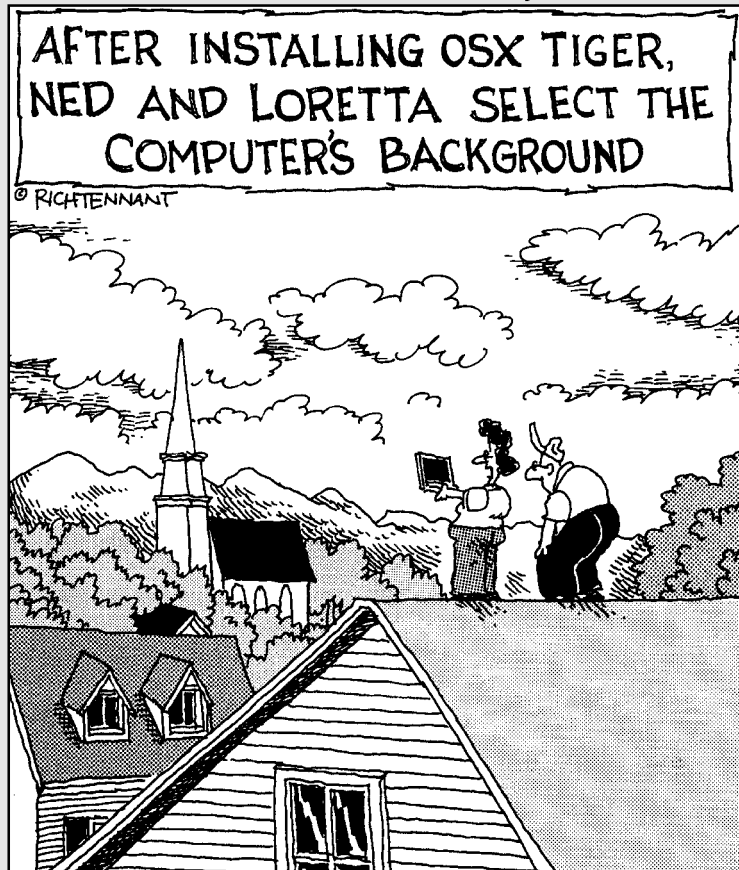

"Oh - I like this background much better than  
the basement."

## *In this part . . .*

**I**t's time to delve deeper into the workings of Mac OS X Tiger. I'll show you how to perform all sorts of common tasks, as well as how to customize your system, how to change settings in System Preferences, where your personal files are stored, and how to use the latest Spotlight search technology to find *anything* you've stored on your MacBook or MacBook Pro!

## Chapter 4

# Working Magic with the Keyboard and Trackpad

---

### *In This Chapter*

- ▶ Introducing the highlights of the Finder
  - ▶ Discussing that missing mouse button
  - ▶ Launching and quitting applications
  - ▶ Identifying and selecting icons
  - ▶ Using keyboard shortcuts to speed things up
  - ▶ Managing windows in Tiger
- 

**A**h, the Finder — many admire its scenic beauty, but you shouldn't ignore its unsurpassed power nor its many moods. And send a postcard while you're there.

Okay, so Tiger's Finder might not be *quite* as majestic as the mighty Mississippi River, but it's the basic toolbox that you use every single day while piloting your laptop. The Finder includes the most common elements of Mac OS X: window controls, common menu commands, icon fun (everything from launching applications to copying files), network connections, keyboard shortcuts, and even emptying the trash. In fact, one could say that if you master the Finder and use it efficiently, you're on your way to becoming a power user! (My editor calls this the Finder "window of opportunity." She's a hoot.)

This chapter is your Finder tour guide. Grab your laptop and we're ready to roll.

## *Using the All-Powerful Finder*

This is a hands-on tour, with none of that "On your right, you'll see the historic Go menu" for you! Time to get off the bus and start the tour with Figure 4-1, in which I show you around the most important elements of the Finder. (In the final section, "Performing Tricks with Finder Windows," I give you a close-up view of window controls.)

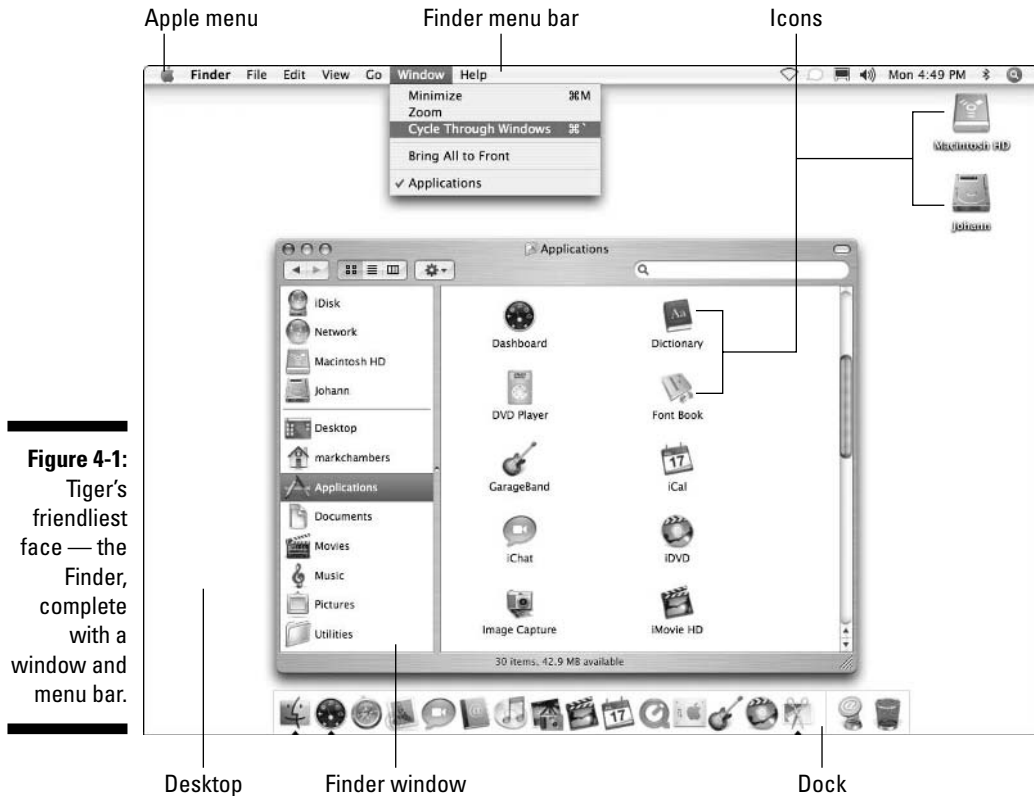

**Figure 4-1:**  
Tiger's  
friendliest  
face — the  
Finder,  
complete  
with a  
window and  
menu bar.

The popular attractions include

- ✓ **The Finder menu bar:** Whenever the Finder itself is ready to use (or, in Mac-speak, whenever the Finder is the *active* application), the Finder menu bar appears at the top of your screen. You know the Finder is active and ready when the word *Finder* appears to the left of the menu bar.

A *menu* is simply a list of commands. When you click a menu (such as the File menu), it extends down so that you can see the commands it includes. While the menu is extended, you can choose any enabled menu item (just click it) to perform that action. You can tell that an item is enabled if its name appears in black; conversely, a menu command is disabled if it's grayed-out — clicking it does nothing.

A menu path like File⇒Save is just a visual shortcut that tells you to click the File menu and then click Save from the drop-down menu that appears.

- ✓ **The Apple menu (🍏):** This is a special menu because it appears both in the Finder and in every application menu that you run. It doesn't matter whether you're in iTunes or Photoshop or Word — if you can see a menu bar, the Apple menu is there. No matter where you are in Tiger, the





Apple menu contains common commands to use, such as Restart, Shut Down, and System Preferences.

I should point out that some applications, such as Front Row and Apple's DVD Player, may hide the Finder menu bar when they're in full-screen mode. However, you can still access the menu bar, even when it's not visible: Just move your cursor to the top edge of the screen, and the menu bar will usually burst forth.

- ✓ **The Finder desktop:** Your Finder desktop serves the same purpose as your physical desktop: You can store stuff here (files, alias icons, and so on), and it's a solid, stable surface where you can work comfortably. Application windows as well as other applications such as your Stickies notes and your DVD player appear on the desktop. Just click an application there to launch it.



Your desktop is easy to customize. For instance, you can use your own images to decorate the desktop, organize it to store new folders and documents, arrange icons how you like, or put the dock in another location. Don't worry — I cover all this in other areas of the book — I just want you to know that you don't have to settle for what Apple gives you as a default desktop.

- ✓ **All sorts of icons:** This is a Macintosh computer, after all, replete with tons of make-your-life-easier tools. Check out the plethora of icons on your desktop as well as icons in the Finder window itself. Each icon is a shortcut of sorts to a file, folder, network connection, or device in your system, including applications that you run and documents that you create. Refer to Figure 4-1 to see the icon for my Mac's hard drive, labeled Macintosh HD. Sometimes you click an icon to watch it do its thing (like icons on the dock, which I cover next), but usually you double-click an icon to make something happen.
- ✓ **The dock:** The dock is a launching pad for your favorite applications, network connections, and Web sites. You can also refer to it to see what applications are running. Click an icon there to open the item (for example, the postage stamp icon represents Apple's Mail application, while the spiffy compass will launch your Safari Web browser).
- ✓ **The Finder window:** Finally! The simple Finder window in Figure 4-1 displays the contents of my Applications folder. You'll use Finder windows to launch applications, perform disk chores such as copying and moving files, and navigate your hard drive.

## Wait a Second. Where the Heck Is the Right Button?

Tiger takes a visual approach to everything, and what you see in Figure 4-1 is designed for point-and-click convenience because the *trackpad* is your primary



navigational tool while you're using your MacBook or MacBook Pro. You move your finger over the surface of the trackpad, and the cursor follows like an obedient pup. The faster you move your finger, the farther the cursor goes. You click an item, it opens, you do your thing, and life is good.



**Never use any object other than your finger on the trackpad!** No pencils (including the eraser end), pens, or chopsticks; they can damage your trackpad in no time at all.

If you've grazed on the other side of the fence — one of Those Who Were Once Windows Users — you're probably accustomed to using a trackpad or mouse with at least two buttons. This brings up the nagging question: "Hey, Mark! Where the heck is the right button?"

In a nutshell, the right mouse button simply ain't there. At least, if you're using your Mac laptop's trackpad, it simply ain't there. The entire bottom of the trackpad is one huge button, and you click something by pressing down anywhere on the top surface of the aforementioned bump.

Lean in closer, and I'll tell you a secret. (Dramatic pause.) This is one of the few disagreements that I have with my friends at Apple Computer, Inc. Apple once felt that a mouse needed but one button, and until the arrival of the Mighty Mouse on Apple's desktop models, it was the only button you got. And you liked it. And you still do, if you're using a Mac laptop's trackpad.



In fact, you don't even need to press the trackpad button to perform magic: If you tap the trackpad quickly, your Mac laptop counts that as a click. Two fast taps act as a double-click. Also, if you move two fingers over the surface of the trackpad at once, the Finder window or application *scrolls* the contents of the window up or down. (For example, you can use the scroll function to move up and down through the pages of a document or to move up and down through a long Web page.) You can control the sensitivity and operation of your trackpad from the Keyboard & Mouse pane in System Preferences.

If you're like me, you feel that a right button is pretty doggone essential. In fact, when my laptop is on my desk at home, I plug in a Logitech optical trackball (a really fancy mouse, in effect). This neat device has both a right mouse button and a scroll wheel. So here's a Mark's Maxim that I think you'll appreciate more and more as you use your laptop:



If you can afford a new USB mouse or trackball with more than one button, *buy it*. You can thank me later with an e-mail message, which you can send to [mark@mlcbooks.com](mailto:mark@mlcbooks.com).

In fact, a new industry is springing up for tiny USB mousing devices especially made for laptops. Some devices are smaller than a business card, but they still carry a full complement of two buttons and a scroll wheel. You can

carry one of these mini-mice in your laptop bag and eschew your trackpad completely. In fact, in this book I'm going to refer to the pointer as the "mouse pointer," whether you're using your trackpad or a mouse.

Clicking the right mouse button performs the same default function in Tiger that it does in Windows. Namely, when you click the right mouse button on most items — icons, documents, even your desktop — you get a *contextual menu* of things. That is, you get more commands specific to that item. (Boy howdy, I hate that word *contextual*, but that's what engineers call it. I call it the right-click menu, and I promise to refer to it as such for the rest of the book.) Figure 4-2 illustrates a typical convenient right-click menu with all sorts of cool items at my disposal.

If you're using your laptop's trackpad or one-button mouse, don't despair. You can still display a right-click menu: Just hold down the Control key while you click. (The cursor gains a tiny, funky looking menu sidecar when you hold down Control to indicate that you're going to right-click something.)

Pressing an extra key, as you might imagine, can be a real downer, especially if your non-trackpad-using hand is busy doing something else. Hence my preceding Mark's Maxim. Someday, Apple will finally throw in the towel and add a second trackpad button to their laptops.



**Figure 4-2:**  
Well-adjusted folks call this a right-click menu.

## Launching and Quitting Applications with Aplomb

Now it's time for you to pair your newly found trackpad acumen with Tiger's Finder window. Follow along with this simple exercise. Move your cursor over the iTunes icon on the dock. (This icon looks like an audio CD with a green musical note on it.) Click the trackpad button (or tap your finger on the trackpad) once. Whoosh! Tiger *launches*, or starts, the iTunes application, and you see a window much like the one in Figure 4-3.



If an application icon is already selected (which I discuss in the next section), you can simply press  $\text{⌘}+\text{O}$  to launch it. The same keyboard shortcut works with documents, too.

Close window



**Figure 4-3:**  
Clicking a dock icon to launch that application.

In addition to the dock, you have several other ways to launch an application or open a document in Tiger:

- 
- ✔ **From the Apple menu ():** A number of applications can always be launched anywhere in Tiger from the Apple menu:
    - *System Preferences:* This is where you change all sorts of settings, such as your display background and how icons appear.
    - *Software Update:* This uses the Internet to see whether update patches are available for your Apple software.
    - *Mac OS X Software:* This launches the Safari browser and displays software you can download for your Mac.
  - ✔ **From the desktop:** If you have a document that you've created or an application icon on your desktop, you can launch or open it here by *double-clicking* that icon (clicking the trackpad button twice or tapping the trackpad twice in rapid succession when the cursor is on top of the icon).

Double-clicking a device or a network connection on your desktop opens the contents in a Finder window. This works for CDs and DVDs that you've loaded as well as external hard drives and USB Flash drives. Just double-click 'em to open them and display their contents in a Finder window. Applications and documents launch from a CD, a DVD, or an external drive just like they launch from your internal drive (the one that's named Macintosh HD), so you don't have to copy stuff from the external drive just to use it. (You can't change the contents of most CDs and DVDs; they're read-only, so you can't write to them.)
  - ✔ **From the Recent Items selection:** When you click the Apple menu and hover your mouse over the Recent Items menu item, the Finder displays all the applications and documents you've used over the last few computing sessions. Click an item in this list to launch or open it.
  - ✔ **From the Login Items list:** Login Items are applications that Tiger launches automatically each time you log in to your user account. I cover Login Items in detail in Chapter 16.
  - ✔ **From the Finder window:** You can also double-click an icon in the confines of a Finder window to open it (for documents), launch it (for applications), or display its contents (for a folder).

After you finish using an application, you can quit that application to close its window and return to the desktop. Here are a number of ways to quit an application:



- ✓ **Press ⌘+Q.** This keyboard shortcut quits virtually every Macintosh application on the planet.
- ✓ **Choose the Quit command in the menu.** To display the Quit command, click the application's name — its menu — from the menu bar. This menu is always to the immediate right of the Apple menu. (For example, Safari displays a Safari menu, and that same spot in the menu bar is taken up by iCal when iCal is the active application. In Figure 4-3, look for the iTunes menu, right next to )
- ✓ **Choose Quit from the dock.** You can Control-click (or right-click) an application's icon on the dock and choose Quit from the right-click menu that appears.  
A running application displays a small black triangle under its icons on the dock.
- ✓ **Click the Close button on the application window (refer to Figure 4-3).** Some applications quit entirely when you close their window, such as the System Preferences window or Apple's DVD Player. Other applications might continue running without a window, such as Safari or iTunes; to close these applications, you have to use another method in this list.
- ✓ **Choose Force Quit from the Apple menu, or press ⌘+Option+Esc. This is a last-resort measure!** Use this only if an application has frozen and you can't use another method in this list to quit. Force-quitting an application doesn't save any changes to any open documents in that application!

## Juggling Folders and Icons

Finder windows aren't just for launching applications and opening the files and documents you've created. You can use the icons in a Finder window to select one or more specific items or to copy and move items from place to place within your system.

### *A field observer's guide to icons*

All icons are not created equal. Earlier in this chapter, I introduced you to your MacBook's hard drive icon on the desktop. Here is a little background on the other types of icons that you may encounter during your laptop travels:

- ✓ **Hardware:** These are your storage devices, such as your hard drive and DVD drive, as well as external peripherals such as your iPod and printer.
- ✓ **Applications:** These icons represent the applications (or programs) that you can launch. Most applications have a custom icon that incorporates

the company's logo or the specific application logo, so they're very easy to recognize, as you can see in Figure 4-4. Double-clicking an application usually doesn't load a document automatically; you typically get a new blank document, or an Open dialog box from which you can choose the existing file you want to open.



**Figure 4-4:** A collection of some of my favorite application icons.

- ✓ **Documents:** Many of the files on your hard drive are documents that can be opened in the corresponding application, and the icon usually looks similar to the application's icon. Double-clicking a document automatically launches the required application (as long as Mac OS X recognizes the file type).
- ✓ **Files:** Most of the file icons on your system are mundane things (such as preference and settings files, text files, log files, and miscellaneous data files), yet most are identified with at least some type of recognizable icon that lets you guess what purpose the file serves. You also come across generic file icons that look like a blank sheet of paper (used when Tiger has no earthly idea what the file type is).
- ✓ **Aliases:** An *alias* acts as a link to another item elsewhere on your system. For example, to launch Adobe Acrobat, you can double-click an Adobe Acrobat alias icon that you created on your desktop instead of the actual Acrobat application icon. The alias essentially acts the same way as the original icon, but it doesn't take up the same space — only a few bytes for the icon itself, compared with the size of the application. Plus, you don't have to go digging through folders galore to find the original application icon. (For you Windows switchers, an alias is the same

as a *shortcut*. But Macs had it *first*. Harrumph.) You can always identify an alias by the small curved arrow at the base of the icon — and the icon might also sport `alias` at the end of its name.

You can create an alias in two ways. Here's one:

1. **Select the item.**

The following section has details about selecting icons.

2. **Choose File⇧Make Alias, or press ⌘+L.**

Figure 4-5 illustrates a number of aliases, arranged below their linked files.

**Figure 4-5:**  
No, not the famous girl-spy TV show. These are alias icons in Tiger.

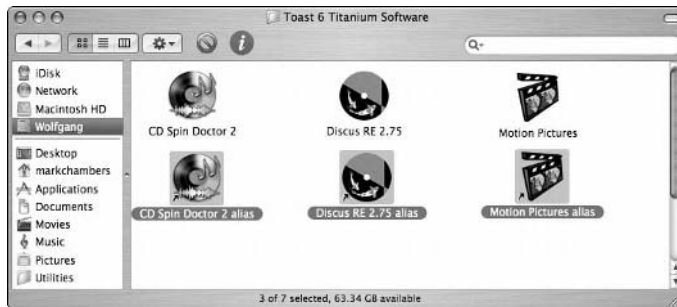

Here's the other way to create an alias:

1. **Hold down ⌘+Option.**

2. **Drag the original icon to the location where you want the alias.**

Note that this funky method doesn't add the `alias` tag to the end of the alias icon name!



So why bother to use an alias? Two good reasons:

- ✓ **Launch an application or open a document from anywhere on your drive.** For example, you can start Apple's Pages application directly from the folder where you store the documents for your current Pages project.
- ✓ **Send an alias to the Trash without affecting the original item.** When that Pages project is finished, you can safely delete the entire folder without worrying about whether Pages will run the next time you double-click the application icon!



If you move or rename the original file, Tiger is smart enough to update the alias, too! However, if the original file is deleted (or if the original is moved to a different volume, such as an external hard drive), the alias no longer works.

## Selecting items

Often, the menu commands or keyboard commands that you perform in the Finder need to be performed on something: Perhaps you're moving an item to the trash or getting more information on the item or creating an alias for that item. To identify the target of your action to the Finder, you need to select one or more items on your desktop or in a Finder window. In this section, I show you just how to do that.

### Selecting one thing

Tiger gives you a number of options when selecting just one item for an upcoming action:

- ✓ **Move your mouse pointer over the item and click.** A dark border, or *highlight*, appears around the icon, indicating that it's selected.
- ✓ **Type the first few letters of the icon's name.** As soon as you type enough letters to match an item name uniquely, Tiger highlights (and selects) that item.
- ✓ **If an icon is already highlighted on your desktop or in a window, move the selection highlight to another icon in the same location by using the arrow keys.** To move through the icons alphabetically, press Tab to go forward or Shift+Tab to go backward. To shift the selection highlight alphabetically, press Tab (to move in order) or Shift+Tab (to move in reverse order).



Selecting items in the Finder doesn't actually *do* anything to them. You have to perform an action on the selected items to make something happen.

### Selecting a whole bunch of things

You can also select multiple items with aplomb by using one of these methods:

- ✓ **Drag a box around adjacent items.** If that sounds like ancient Sumerian, here's the explanation: Click a spot above and to the left of the first item; then hold down the trackpad button and drag down and to the right. (This is *dragging* in Mac-speak.) A box outline like the one in Figure 4-6 appears to indicate what you're selecting. Any icons that appear within the box outline are selected when you release the mouse button.





**Figure 4-6:**  
Drag a box  
around  
icons to  
select them.

- ✓ **Click the first item to select it and then hold down the Shift key while you click the last adjacent item.** Tiger selects both items and everything between them.
- ✓ **Press ⌘+A to select all the items in a window.**
- ✓ **Hold down the ⌘ key while you click each item.** This method works with nonadjacent items.



Check out the status line at the bottom of a Finder window. It tells you how much space is available on the drive you're working in as well as how many items are displayed in the current Finder window. If you've selected items, it also shows you how many you've highlighted.

## *Copying items*

Want to copy items from one Finder window to another, or from one location (such as a CD-ROM) to another (such as your desktop)? Très easy. Just use one of these methods:



## My, what an attractive sidebar . . . and so useful!

I like as few icons on my desktop as possible. I created a separate folder, named Incoming, and put all the items that might otherwise end up on my desktop into that folder. In fact, I recently added my Incoming folder to my Finder window

sidebar so that it's available immediately from any Finder window. To do this, just drag the folder into the column at the left side of the Finder window and drop it in the sidebar's list of folder icons.



- ✓ **To copy one item to another location on the same drive:** Hold down the Option key (you don't have to select the icon first) and then click and drag the item from its current home to the new location.

To put a copy of an item in a folder, just drop the item on top of the receiving folder. If you hold the item that you're dragging over the destination folder for a second or two, Tiger opens up a new window so you can see the contents of the target.

- ✓ **To copy multiple items to another location on the same drive:** Select them all first (see the preceding section, "Selecting a whole bunch of things"), hold down the Option key, and then drag-and-drop one of the selected items where you want it. All the items that you selected follow the item you drag. (Rather like lemmings. Nice touch, don't you think?)

To help indicate your target when you're copying or moving files, Tiger highlights the location to show you where the items will end up. (This works whether the target location is a folder or a drive icon.) If the target location is a window, Tiger adds a highlight to the window border.

- ✓ **To copy one or multiple items on a different drive:** Click and drag the icon (or the selected items if you have more than one) from the original window to a window you've opened on the target drive. You can also drag one item (or a selected group of items) and simply drop the items on top of the drive icon on your desktop.

The items are copied to the top level, or *root*, of the target drive.



If you try to move or copy something to a location that already has an item with the same name, Figure 4-7 illustrates the answer: You get a dialog box that prompts you to decide whether to replace the file or to stop the copy/move procedure and leave the existing file alone. Good insurance, indeed.

**Figure 4-7:**  
It's your choice, but replace the existing file only if you're sure of what you're doing.



## *Moving things from place to place*

Moving things from one location to another location on the same drive is the easiest action you can take. Just drag the item (or selected items) to the new location. The item disappears from the original spot and reappears in the new spot.

## *Duplicating in a jiffy*

If you need more than one copy of the same item in a folder, use Tiger's Duplicate command. I use Duplicate often when I want to edit a document but ensure that the original document stays pristine, no matter what. I just create a duplicate and edit that file instead.

To use Duplicate, you can either

- ✓ Click an item to select it and then choose File⇨Duplicate.
- ✓ Control-click the item and choose Duplicate from the right-click menu.

The duplicate item has the word `copy` appended to its name.



Duplicating a folder also duplicates all the contents of that folder, so creating a duplicate folder can take some time to create if the original folder was stuffed full.

## Keys and Keyboard Shortcuts to Fame and Fortune

Your Mac's keyboard might not be as glamorous as your trackpad, but any Macintosh power user will tell you that using keyboard shortcuts is usually the fastest method of performing certain tasks in the Finder, such as saving or closing a file. I recommend committing these shortcuts to memory and putting them to work as soon as you begin using your laptop so that they become second nature to you as quickly as possible.

### Special keys on the keyboard

Apple's laptop keyboards have a number of special keys that you may not recognize — especially if you've made the smart move and decided to migrate from the chaos that is Windows to Mac OS X! Table 4-1 lists the keys that bear strange hieroglyphics on the Apple keyboard as well as what they do.

<i>Action</i>	<i>Symbol</i>	<i>Purpose</i>
Media Eject		Ejects a CD or DVD from your optical drive
Audio Mute		Mutes (and restores) all sound produced by your Mac
Brightness		Increases or decreases the brightness of your LCD screen
Keyboard illumination		Increases, decreases, or turns off the brightness of your keyboard backlighting (PowerBooks and MacBook Pro only)
Volume Up		Increases the sound volume
Volume Down		Decreases the sound volume

(continued)

**Table 4-1 (continued)**

<i>Action</i>	<i>Symbol</i>	<i>Purpose</i>
Control	⌘	Displays the right-click/ Control-click menu
Command	⌘	Primary modifier for menus and keyboard shortcuts
Del	⌫	Deletes the selected text
Option	⌥	Modifier for keyboard shortcuts

## *Using Finder and application keyboard shortcuts*

The Finder is chock-full of keyboard shortcuts that you can use to take care of common tasks. Some of the handiest shortcuts are in Table 4-2.



But wait, there's more! Most of your applications also provide their own set of keyboard shortcuts. While you're learning a new application, display the application's Help file and print a copy of the keyboard shortcuts as a handy cheat sheet.

**Table 4-2 Tiger Keyboard Shortcuts of Distinction**

<i>Key Combination</i>	<i>Location</i>	<i>Action</i>
⌘+A	Edit menu	Selects all (works in the Finder too)
⌘+C	Edit menu	Copies the highlighted item(s) to the clipboard
⌘+H	Application menu	Hides the application
⌘+M	Window menu	Minimizes the active window to the dock (also works in the Finder)
⌘+O	File menu	Opens an existing document, file, or folder (also works in the Finder)
⌘+P	File menu	Prints the current document
⌘+Q	Application menu	Exits the application
⌘+V	Edit menu	Pastes the contents of the clipboard at the current cursor position

<b>Key Combination</b>	<b>Location</b>	<b>Action</b>
⌘+X	Edit menu	Cuts the highlighted item to the clipboard
⌘+Z	Edit menu	Reverses the effect of the last action you took
⌘+?	Help menu	Displays the Help system (works in the Finder, too)
⌘+Tab	Finder	Switches between open applications
⌘+Option+M	Finder	Minimizes all Finder windows to the dock
⌘+Option+W	Finder	Closes all Finder windows



If you've used a PC before, you're certainly familiar with three-key shortcuts — the most infamous being Ctrl+Alt+Delete, the beloved shutdown shortcut nicknamed the Windows Three Finger Salute. Three-key shortcuts work the same way in Tiger (but you'll be thrilled to know you won't need to reboot using that notorious Windows shortcut). If you're new to computing, just hold down the first two keys simultaneously and press the third key.

## Performing Tricks with Finder Windows

In this section of your introduction to Mac OS X, I describe basic windows management in Tiger: how to move things around, how to close windows, and how to make 'em disappear and reappear like magic.

### Scrolling and resizing windows

Can you imagine what life would be like if you couldn't see more than a single window's worth of stuff? Shopping would be curtailed quite a bit — and so would the contents of the folders on your hard drives!

That's why Tiger adds *scroll bars* that you can click and drag to move through the contents of the window. You can either

- ✓ Click the scroll bar and drag it
- ✓ Click anywhere in the empty area above or below the bar to scroll pages one at a time

Figure 4-8 illustrates both vertical and horizontal scroll bars in a typical Finder window.

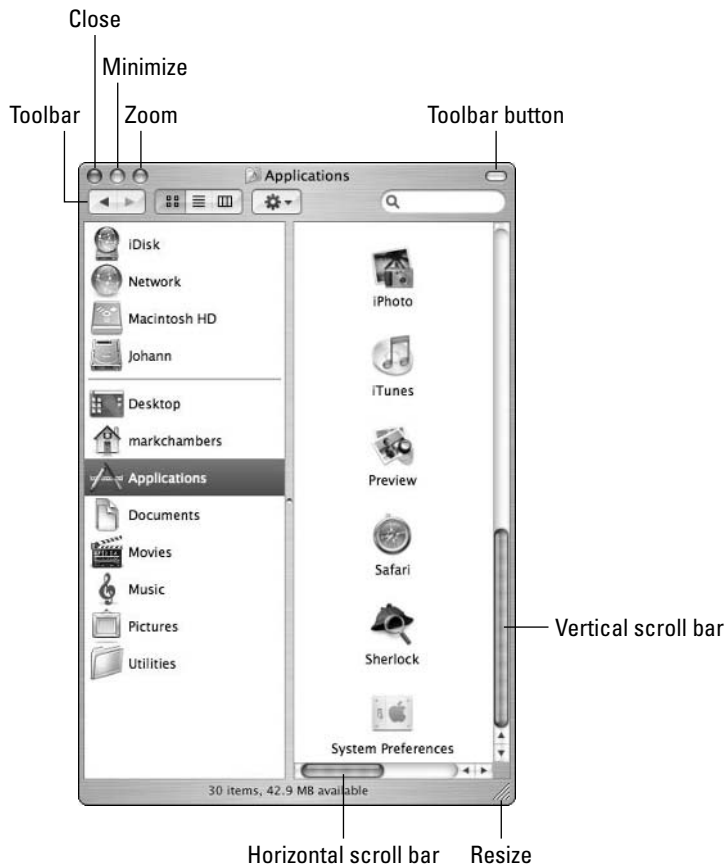

**Figure 4-8:**  
A plethora  
of helpful  
window  
controls.



Often, pressing the Page Up and Page Down keys moves you through a document one page at a time. Also, pressing the arrow keys moves your insertion cursor one line or one character in the four compass directions.

You can also resize most Finder and application windows by enlarging or reducing the window frame itself. Move your mouse pointer over the resize handle in the lower-right corner of the window (which smartly bears a number of slashed lines to help it stand out) and then drag the handle in any direction until the window is the precise size you need.



## Only one can be active at once

Yes, here's a special Mark's Maxim in the Mac OS X universe. Only one application window can be active in Tiger at any time. You can always tell which window is active:

- ✓ The active window is on top of other windows.
- ✓ The Close, Minimize, and Zoom buttons of the active window are in color. Note,

though, that you can still use an inactive window's Close, Minimize, and Zoom buttons.

- ✓ Any input you make by typing or by moving your mouse pointer appears in the active window.
- ✓ Mac OS X *dims* inactive windows that you haven't minimized.

## Minimizing and restoring windows

Resizing a window is indeed helpful, but maybe you simply want to banish the doggone thing until you need it again. That's a situation for the Minimize button, which also appears in Figure 4-8. A *minimized* window disappears from the desktop but isn't closed: It simply reappears on the dock as a miniature icon. Minimizing a window is easy: Move your mouse pointer over the yellow Minimize button at the top-left corner of the window — a minus sign appears in the button to tell you that you're on target — and then click.



Hold down the Shift key whilst you minimize, and prepare to be amazed when the window shrinks in slow motion like Alice in Wonderland!

To restore the window to its full size again (and its original position on the desktop), just click its window icon on the dock.

## Moving and zooming windows

Perhaps you want to move a window to another location on the desktop so you can see the contents of multiple windows at the same time. Click the window's *title bar* (that's the top frame of the window, which usually includes a document or application name) and drag the window anywhere you like. Then release the trackpad button.



Many applications can automatically arrange multiple windows for you. Choose Window⇨Arrange All (if that menu item appears).



## Toggleing toolbars the Tiger way

Time to define a window control that's actually *inside* the window for a change. A *toolbar* is a strip of icons that appears under the window's title bar. These icons typically perform the most common actions in an application; the effect is the same as if you used a menu or pressed a keyboard shortcut. Toolbars are popular these days. You see 'em in everything from the Finder window to most application windows.

You can banish a window's toolbar to make extra room for icons, documents, or whatever it happens to be holding. Just click the little lozenge-shaped button at the right corner of the window. (You guessed it — the Toolbar button is also shown in Figure 4-8.) One note: By toggling the Finder toolbar off, you also lose the Finder window sidebar.

To see all that a window can show you, use the Zoom feature to expand any Finder or application window to its maximum practical size. Note that a zoomed window can fill the entire screen, or (if that extra space isn't applicable for the application) the window might expand only to a larger part of the desktop. To zoom a window, move your mouse pointer over the green Zoom button (refer to Figure 4-8 yet again) at the top-left corner of the window. When the plus sign appears in the Zoom button, click to claim the additional territory on your desktop. (You can click the Zoom button again to automatically return the same window to its original dimensions.)

## Closing windows

When you're finished with an application or no longer need a window open, move your mouse pointer over the red Close button at the top-left corner of the window. When the X appears in the button, click it. (And yes, I can get one more reference out of Figure 4-8, which I'm thinking of nominating as Figure of the Year.)



If you have more than one window open in the same application and you want to close 'em all in one swoop, hold down the Option key while you click the Close button on any of the windows.

If you haven't saved a document and you try to close that application's window, Tiger gets downright surly and prompts you for confirmation. "Hey, human, you don't really want to do this, do you?" If you answer in the affirmative — "Why, yes, machine. Yes, indeed, I want to throw this away and not save it." — the application discards the document that you were working on. If you decide to keep your document (thereby saving your posterior from harm), you can save the document under the same filename or under a new name.

## Chapter 5

# Getting to the Heart of the Tiger

---

### *In This Chapter*

- ▶ Making the most of your Home folder
- ▶ Arranging your desktop for greater efficiency
- ▶ Adding timesavers to the dock
- ▶ Using the trash (and rescuing precious stuff from it)
- ▶ Using Exposé and the Dashboard to perform desktop magic
- ▶ Printing documents

---

**W**hen you're no longer a novice to Tiger and the basics of Finder, turn your attention to a number of more advanced topics 'n tricks that will turn you into a Mac laptop power user — which, after all, is the goal of every civilized consciousness on Planet Earth.

Consider this chapter a grab bag of Tiger knowledge. Sure, I jump around a little, but these topics are indeed connected by a common thread: They're all sure-fire problem-solvers and speeder-uppers. (I can't believe the latter is really a word, but evidently it is. My editors told me so.)

## *Your Home Folder Is Your Homestead*

Each user account that you create in Tiger is a self-contained universe. For example, each user has a number of unique characteristics and folders devoted just to that person, and Tiger keeps track of everything that user changes or creates. (I describe the innate loveliness of multiple users living in peace and harmony on your laptop in Chapter 16.)

This unique universe includes a different system of folders for each user account on your system. The top-level folder uses the short name that Tiger

assigns when that user account is created. Naturally, the actual folder name is different for each person, so Mac techno-types typically refer to this folder as your *Home folder*.

Each account's Home folder contains a set of subfolders, including

- ✓ Movies
- ✓ Music
- ✓ Pictures
- ✓ Library
- ✓ Public
- ✓ Sites (Web pages created by the user)
- ✓ Documents (created by the user)

Although you can store your stuff at the *root* (top level) of your hard drive, that horde of files, folders, and aliases can get crowded and confusing *very* quickly. Here's a Mark's Maxim to live by:



Your Home folder is where you hang out and where you store your stuff. Use it to make your computing life *much* easier!



Create subfolders within your Documents folder to organize your files and folders even further. For example, I create a subfolder in my Documents folder for every book that I write. That way, I can quickly and easily locate all the documents and files associated with that book project.

In Chapter 16, I discuss security in your Home folder and what gets stored where. For now, Figure 5-1 shows how convenient your Home folder is to reach because it appears in the Finder window sidebar. One click of your Home folder, and all your stuff is right in front of you.

In addition to using the Finder window sidebar, you can reach your Home folder in other convenient ways:

- ✓ **From the Go menu:** Choose Go⇨Home to display your Home folder immediately from the Finder window. You can press ⌘+Shift+H to accomplish the same thing.
- ✓ **From the Open and Save dialog boxes:** Tiger's standard File Open and File Save dialog boxes also include the same Home folder (and subfolder) icons as the Finder window sidebar.

✔ **Within any new Finder window you open:** If you like, you can set every Finder window that you open to do so automatically within your Home folder.

- Choose *Finder* → *Preferences* to display the dialog box you see in Figure 5-2.
- Click the arrow button on the right side of the *New Finder Windows Open pop-up menu*.  
A menu pops up (hence the name).
- Click the *Home* entry in the menu.
- Click the red *Close* button at the top-left corner of the dialog box.

You're set to go. From now on, every Finder window you open displays your Home folder as the starting location!



Here's another reason to use your Home folder to store your stuff: Tiger expects your stuff to be there when you use Apple's Backup application or when you migrate your files from an older Mac to a new Mac.

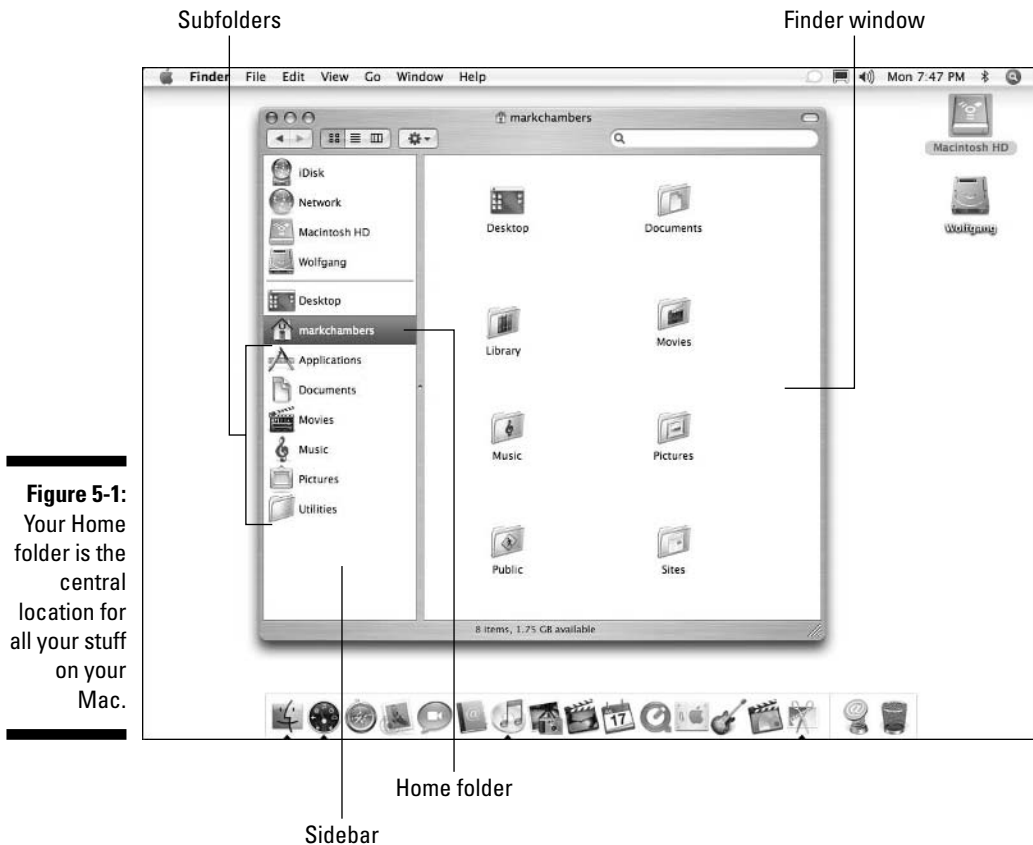

**Figure 5-1:** Your Home folder is the central location for all your stuff on your Mac.



**Figure 5-2:** Set Tiger to open your Home folder within new Finder windows.

## Personalizing Your Desktop

Most folks put all their documents, pictures, and videos on their Tiger desktop because the file icons are easy to locate! Your computing stuff is right in front of you . . . or *is* it?

Call me a finicky, stubborn fussbudget — go ahead, I don't mind — but I prefer a clean Tiger desktop without all the iconic clutter. In fact, my desktop usually has just three or four icons even though I use my MacBook Pro several hours every day. It's an organizational thing; I work with literally hundreds of applications, documents, and assorted knickknacks every day. Sooner or later, you'll find that you're using that many, too.

When you keep your stuff crammed on your desktop, you end up spending more time scanning your screen for a particular file, alias, or type of icon than simply looking in your Documents folder! Plus, you'll likely find yourself looking at old icons that no longer mean anything to you or stuff that's covered in cobwebs that you haven't used in years. Stale icons . . . *yuck*.

I recommend that you arrange your desktop so you see only a couple of icons for the files or documents that you use the most. Leave the rest of the desktop for that cool image of your favorite actor or actress.

I can recommend a number of other favorite tweaks that you can make to your desktop (besides keeping things clean):

✔ **Keep desktop icons arranged as you like.**

- a. From the Finder menu, choose *View*⇨*Show View Options*.
- b. Select the *Keep Arranged By* check box.
- c. From the pop-up menu, choose the criteria that Tiger uses to automatically arrange your desktop icons, including the item name, the last modification date, or the size of the items.

I like things organized by name.

✔ **Choose a favorite background.**

- a. Hold down the *Control* key while you click any open spot on your desktop. (Or, if you use a pointing thing with a right mouse button, click that instead.)
- b. From the pop-up menu that appears, choose *Change Desktop Background*.

You see the Desktop & Screen Saver pane, as shown in Figure 5-3. Browse through the various folders of background images that Apple provides or use an image from your iPhoto library.



**Figure 5-3:**  
Choose a more interesting desktop background.

✔ **Display everything that's connected.**

- a. Choose *Finder* → *Preferences*.
- b. Make sure that all three of the top check boxes (*Hard Disks*; *CDs, DVDs, and iPods*; and *Connected Servers*) are selected.

If your computer is connected to an external network or you've loaded an external hard drive or device, that shows up on your desktop. You can double-click that desktop icon to view your external stuff.

## Customizing the Dock Just So

If the dock seems like a nifty contraption to you, you're right — it's like one of those big NASA control rooms. From the dock — that icon toolbar at the bottom of Tiger's desktop — you can launch an application, monitor what's running, and even use the pop-up menu commands to control the applications that you launch. (Hey, that NASA analogy is even better than I thought!)

When you launch an application — either by clicking an icon on the dock or by double-clicking an icon in a Finder window or on the desktop — the icon begins to bounce hilariously on the dock to indicate that the application is loading. (So much for my Mission Control analogy.) After an application is running, the application icon appears on the dock with a tiny triangle underneath. That way, you can easily see what's running at any time just by glancing at the dock.



You can hide most applications by pressing  $\mathbb{H}$ +H. Although the application itself is still running, it might not appear on the dock.



Some applications run in the *background* — that is, they don't show up on the dock. You generally don't even know that these applications are working for you. However, if you need to see in detail what's going on, you can always use the Activity Monitor utility to view everything that's happening on your MacBook. (For example, an Apple support technician might ask you to run Activity Monitor to help troubleshoot a problem.) To run the Activity Monitor:

1. **Open a Finder window.**
2. **Click the Utilities folder in the sidebar or press  $\mathbb{H}$ +Shift+U.**
3. **Double-click the Activity Monitor icon.**

## Adding dock icons

Ah, but the dock can offer more than just a set of default icons! You can add your own MIS (or *Most Important Stuff*) to the dock, making it the most convenient method of taking care of business without cluttering up your desktop. You can add



- ✓ **Applications:** Add an application to your dock by dragging the application icon from a Finder window into the area to the left of the *separator line* (which appears between applications and folders or documents). The existing dock icons move aside so that you can place the new neighbor in a choice location.

Do not try to add an application anywhere to the right of the separator line. You can't put applications there — and Tiger might even think that you want the application dumped in the trash!

- ✓ **Files and folders:** Would you like to add files and folders to the dock? They belong in the area to the right of the separator line. Again, drag the desired folders and volume icons to the dock and deposit them in the desired spot.
- ✓ **Web URLs:** Sure, you can add your favorite Web site from Safari! Drag it from the Safari address bar into the area to the right of the separator line. When you click the URL icon, Safari opens the page automatically.

## Removing dock icons

You can remove an icon from the dock at any time (as long as the application isn't running). In fact, I recommend that every Tiger user remove the default icons that never get used to make more room available for your favorite icons. The only two icons you can't remove are the Finder and Trash icons.

To remove an icon from the dock, just click and drag it off the dock. You're rewarded with a ridiculous puff of smoke straight out of a Daffy Duck cartoon! (One of the Mac OS X developers was in a fun mood, I guess.)



When you delete an icon from the dock, all you delete is the dock icon: The original application, folder, or volume is not deleted.

## Using dock icon menus

From the Dock menu, you can open documents, open the location of the item in a Finder window, set an application as a login item (which I discuss at length in Chapter 16), control the features in some applications, and engage in other assorted fun, depending on the item.



To display the pop-up Dock menu for an icon:

1. **Move your mouse over the icon.**
2. **Click and hold the mouse button for a second or two.**

Note that you can also hold the Control key down and click the icon. Or if you have a right mouse button, click it to display the menu.



In Chapter 6, I cover the dock settings you can change in System Preferences. You can change the same settings from the Apple menu if you hover your mouse over the dock item, which displays a submenu with the settings.

## Taking Out the Trash

Another sign of a Mac laptop power user is a well-maintained trash bin. It's a breeze to empty discarded items you no longer need, and you can even rescue something that you suddenly discover you still need!

The Tiger trash bin resides on the dock, and it works just like the trash has always worked in Mac OS X: Simply drag selected items to the trash to delete them.



Note one very important exception: If you drag an external device or a removable media drive icon on your desktop to the trash (such as an iPod, a DVD, or an external hard drive), the Trash icon automatically turns into a giant Eject icon, and the removable device or media is ejected or shut down — not erased. Repeat, *not erased*. (That's why the Trash icon changes to the Eject icon — to remind you that you're not doing anything destructive.)

Here are other methods of chucking items you select to go to the wastebasket:

- ✓ **Choose File⇨Move to Trash.**
- ✓ **Click the Action button on the Finder toolbar and choose Move to Trash from the list that appears.**
- ✓ **Press ⌘+Delete.**
- ✓ **Hold down Control (or press the right mouse button) while clicking the item; then choose Move to Trash from the menu that appears.**

You can always tell when the trash contains at least one item because the Trash icon is full of crumpled paper! However, you don't have to unfold a wad of paper to see what the trash holds: Just click the Trash icon on the dock to display the contents of the trash in a new window. To rescue something from the trash, drag the item(s) from the Trash window to the desktop or any

other folder in a Finder window. (If you're doing this for someone else who's not familiar with Tiger, remember to act like it was a lot of work, and you'll earn big-time DRP, or *Data Rescue Points*.)

When you're sure that you want to permanently delete the contents of the trash, use one of these methods to empty the trash:

✔ **Choose Finder⇨Empty Trash.**

✔ **Choose Finder⇨Secure Empty Trash.**

If security is an issue around your laptop and you want to make sure that no one can recover the files you've sent to the trash, the Secure Empty Trash command takes a little time but helps to ensure that no third-party hard-drive repair or recovery program could resuscitate the items you discard.

✔ **Press ⌘+Shift+Delete.**

✔ **Hold down Control while clicking the Trash icon on the dock and then choose Empty Trash from the contextual menu.**

If your mouse has extra buttons, you can right-click to display the contextual menu.



## Previewing images and documents the Tiger way

Tiger offers a Swiss-Army-knife-type application for viewing image files and documents in Preview, Adobe's PDF format. You can use Preview to display digital photos in several popular image formats, including TIFF, GIF, PICT, PNG, JPEG, and Windows Bitmap.

I know, if that were the total of Preview's features, it wouldn't deserve coverage here. So, what else can it do? Here's a partial list (just my favorites, mind you):

✔ **Use Preview to add a bookmark at the current page in a PDF document by choosing Bookmarks⇨Add Bookmark.**

✔ **Fill out a form in a PDF document by choosing Tools⇨Text Tool.**

Click a field; if a blue highlight appears, you can type text into that field. After you complete the form, you can fax or print it.

✔ **Take a screen snapshot (saving the contents of your screen as a digital photo) by choosing File⇨Grab⇨Timed Screen.**

✔ **Convert an image into another format or into a PDF file by choosing File⇨Save As.**

✔ **Resize or rotate an image using the commands on the Tools menu.**

Tiger automatically loads Preview when you double-click an image in a format that it recognizes or when you double-click a PDF file. It also acts as the Print Preview window, as you can read elsewhere in this chapter. However, if you want to launch Preview manually, open a Finder window, click the Applications folder in the sidebar, and then double-click the Preview icon.

## *Saving Time and Trouble with Dashboard and Exposé*

Mac power users tend to wax enthusiastic over the convenience features built into Tiger. In fact, we show 'em off to our PC-saddled friends and family. Two of the features that I've demonstrated the most to others are Tiger's brand-new Dashboard display and the amazing convenience of Exposé. In this section, I show 'em off to you as well. (Then you can become the Tiger evangelist on *your* block.)

### *Using Dashboard*

The idea behind the Dashboard is deceptively simple yet about as revolutionary as it gets for a mainstream personal computer operating system. *Dashboard* is an alternate desktop that you can display at any time by using the keyboard or your mouse; the Dashboard desktop holds *widgets* (small applications that each provide a single function). Examples of default widgets that come with Tiger include a calculator, a world clock, a weather display, and a dictionary/thesaurus.

Oh, did I mention that you're not limited to the widgets that come with Tiger? Simply click the plus button at the bottom of the Dashboard display and drag new widgets to your Dashboard from the menu at the bottom of the screen. To remove a widget while you're in this mode, click the X icon that appears next to each widget. When you've finished adjusting your widgets — that sounds a bit strange, but I mean no offense — click the plus button again to return to your Dashboard display.



Widgets can also be rearranged any way you like by dragging them to a new location.

Simple applications like these are no big whoop — after all, Tiger has always had a calculator and a clock. What's revolutionary is how you access your widgets. You can display and use them anywhere in Tiger, at any time, by simply pressing the Dashboard key. To banish Dashboard and return to your Tiger desktop, just press the Dashboard key again.

The default key is F12, but you can change the Dashboard key in the Dashboard & Exposé pane in System Preferences (or even turn it into a key sequence, such as Option+F12). You can also click the Dashboard icon on the dock to summon and dismiss your Dashboard widgets.

## Switching between apps with Exposé

Exposé is a racy sounding feature, but (like Dashboard) it's all about convenience. If you typically run a large number of applications at the same time, Exposé can be a real timesaver, allowing you to quickly switch between a forest of different application windows (or display your desktop instantly without those very same windows in the way). The feature works in three ways:

- **Press the All Windows key (or key sequence) to display all your application windows on a single screen, as shown in the truly cool Figure 5-4.**

Click the window that you want to make active. By default, F9 is the All Windows key; but depending on your model of Mac laptop, you may have to press fn+F9 instead.

- **Press the Application Windows key (or key sequence) to display all the windows that have been opened by the active application.**

This comes in handy with those mega-applications like Photoshop Elements or FileMaker Pro, in which you often have three or four windows open at one time. Again, you can click the window that you want to make active. By default, F10 is the Application Windows key, but you may have to press fn+F10 instead.

**Figure 5-4:**  
With Exposé, you can instantly see every open application's window(s).

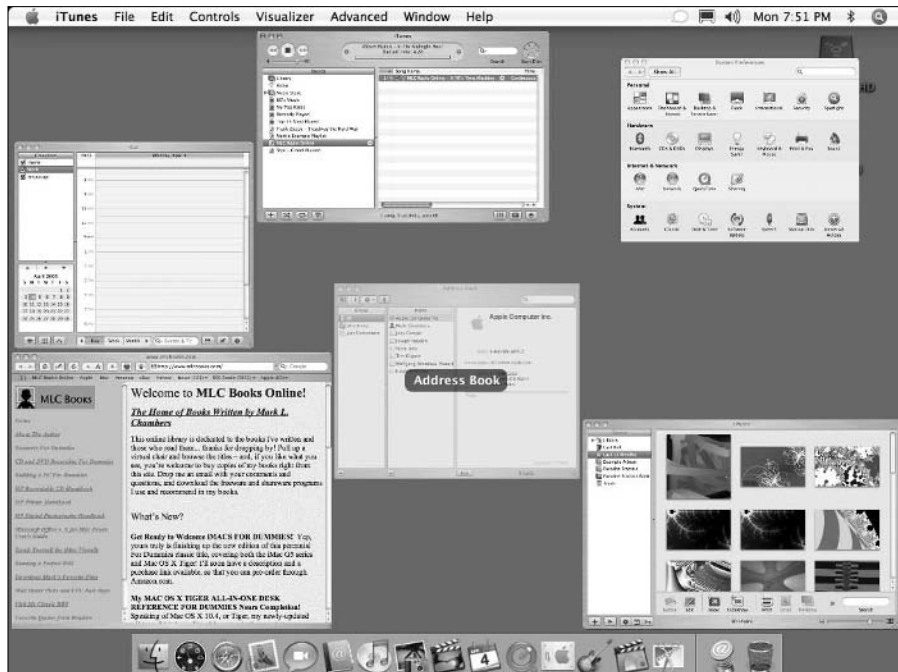

- ✓ **Press the Desktop key (or key sequence) to move all your application and Finder windows to the sides of your desktop so you can access your desktop icons.**

After you're finished with your desktop and want to restore your windows to their original locations, press the Desktop key to put things right again. The default Desktop key is F11.



You can activate both Exposé and Dashboard by using your mouse instead of the keyboard:

1. **Click the System Preferences icon on the dock.**
2. **Click the Dashboard & Exposé icon to display the settings.**
3. **Click the desired screen corner pop-up menu to choose what function that screen corner will trigger.**
4. **Press ⌘+Q to save your changes and exit System Preferences.**

When you move your mouse pointer to that corner, Dashboard or Exposé automatically kicks in!

## Printing in Mac OS X

Tiger makes document printing a breeze. Because virtually all Mac printers use a Universal Serial Bus (USB) port, setting up printing couldn't be easier. Turn on your printer and connect the USB cable between the printer and your laptop; Tiger does the rest.



Printer manufacturers supply you with installation software that might add cool extra software or fonts to your system. Even if Tiger recognizes your USB printer immediately, I recommend that you still launch the manufacturer's Mac OS X installation disc. For example, my new Epson printer came with new fonts and a CD/DVD label application, but I wouldn't have 'em if I hadn't installed the Epson software package.

After your printer is connected and installed, you can use the same procedure to print from just about every Mac OS X application on the planet! To print using the default page layout settings — standard 8½-x-11" paper, portrait mode, no scaling — follow these steps:

1. **Within the active application, choose File⇨Print or press the ⌘+P shortcut.**

Mac OS X displays the Print dialog box, as shown in Figure 5-5.

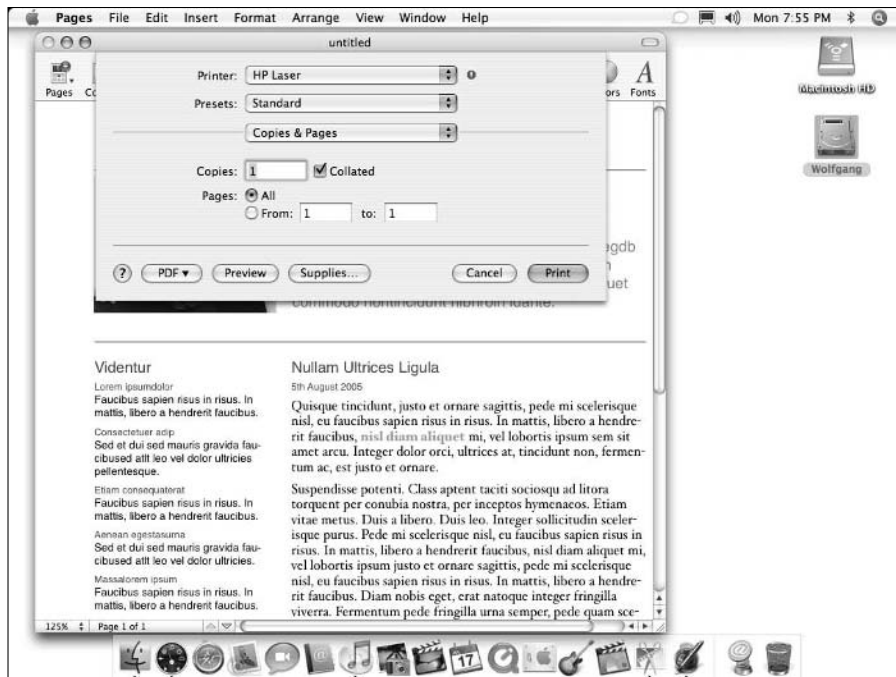

**Figure 5-5:**  
Preparing to  
print the  
Great  
American  
Novel.

**2. If you want to print from a different printer connected to your laptop or print over a network connection to a shared printer on another computer:**

**a. Click the Printer pop-up menu.**

In this pop-up menu, Tiger displays all the printers that you can access.

**b. Click the desired printer to select it.**

**3. If you want to check what the printed document will look like, click Preview.**

If you have to make changes to the document or you need to change the default print settings, click Cancel to return to your document. (You have to repeat Step 1 to display the Print dialog box again.)

**4. For more than one copy, click in the Copies field and type the number of copies you need.**

*Collation* (separating copies) is also available, and it doesn't cost a thing!





5. **To print a range of selected pages, select the From radio button and then enter the starting and ending pages.**

To print the entire document, leave the default Pages option set to All.

6. **If the application offers its own print settings, such as collating and grayscale printing, make any necessary changes to those settings.**

To display these application-specific settings, click the Copies & Pages pop-up menu in the Print dialog box and choose the desired settings pane that you need to adjust. (You can blissfully ignore these settings and skip this step if the defaults are fine.)

7. **When you're set to go, click the Print button.**



You can also save an electronic version of a document in the popular Adobe Acrobat PDF format from the Print dialog box — without spending money on Adobe Acrobat. (Slick.)

1. **Click the PDF button to display the destination list.**
2. **Click Save as PDF.**

Tiger prompts you with a Save As dialog box, where you can type a name for the PDF document and specify a location on your hard drive where the file should be saved.

Heck, if you like, you can even fax a PDF or send it as an e-mail attachment! Just choose these options from the destination list instead of Save as PDF.

## Chapter 6

# System Preferences Are Your Friends

---

### *In This Chapter*



- ▶ Navigating System Preferences
  - ▶ Searching for specific controls
  - ▶ Customizing Tiger through System Preferences
- 

**R**emember the old TV series *Voyage to the Bottom of the Sea*? You always knew you were on the bridge of the submarine *Seaview* because it had an entire wall made up of randomly blinking lights, crewmen darting about with clipboards, and all sorts of exotic-looking controls on every available surface. You could fix just about anything by looking into the camera with grim determination and barking out an order. After all, you were On The Bridge. Virtually all the dialog and action inside the sub took place on that one (expensive) set: It was the nerve center of the ship and a truly happenin' place to be.

In the same vein, I devote this entire chapter to the System Preferences window and all the settings within it. After all, if you want to change how Tiger works or customize its features, this one window is the nerve center of Mac OS X and a truly happenin' place to be. Sorry, you won't find a built-in wall of randomly blinking lights — but you will find exotic controls just about everywhere.

## *An Explanation (in English, No Less)*

The System Preferences window (as shown in Figure 6-1) is a self-contained beast, and you can reach it in a number of ways:

- ✓ Clicking the System Preferences icon on the dock, which resembles a light switch next to the Apple logo. (Don't ask me, I just work here.)
- ✓ Choosing ⇨System Preferences.
- ✓ Choosing ⇨Dock⇨Dock Preferences.



- ✓ Clicking the Time and Date display in the Finder menu and then choosing the Open Date and Time menu item.
- ✓ Control-clicking (or right-clicking) any uninhabited area of your desktop and choosing Change Desktop Background.
- ✓ Clicking most of the Finder menu status icons (including Bluetooth, AirPort, Display, Modem, and Clock) and then choosing the Open Preferences menu item.

When the System Preferences window is open, you can click any of the group icons to switch to that group's *pane*; the entire window morphs to display the settings for the selected pane. For example, Figure 6-2 illustrates the Sound pane, which allows you to set a system alert sound, configure your laptop's built-in microphone, and choose from several different output options.

Many panes also include a number of tabbed buttons at the top — in the case of the Sound pane, you have Sound Effects, Output, and Input. You can click these tabs to switch to another *tab* within the same pane. Many panes in System Preferences have multiple tabs. This design allows our friends at Apple to group a large number of similar settings in the same pane (without things getting too confusing).

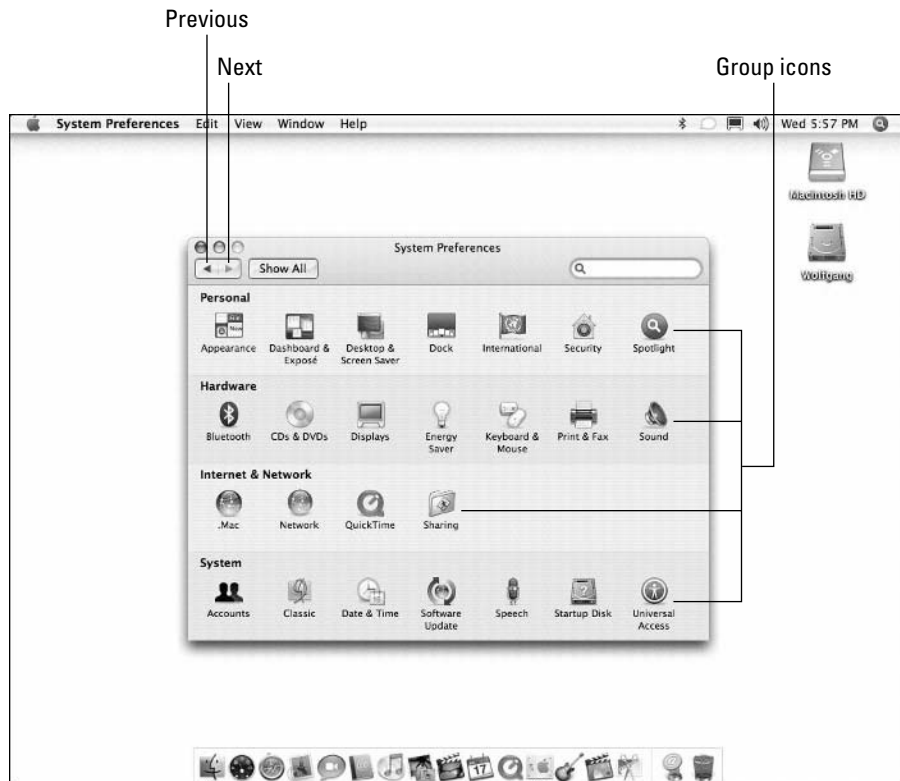

**Figure 6-1:**  
The powerhouse of settings and switches: System Preferences.

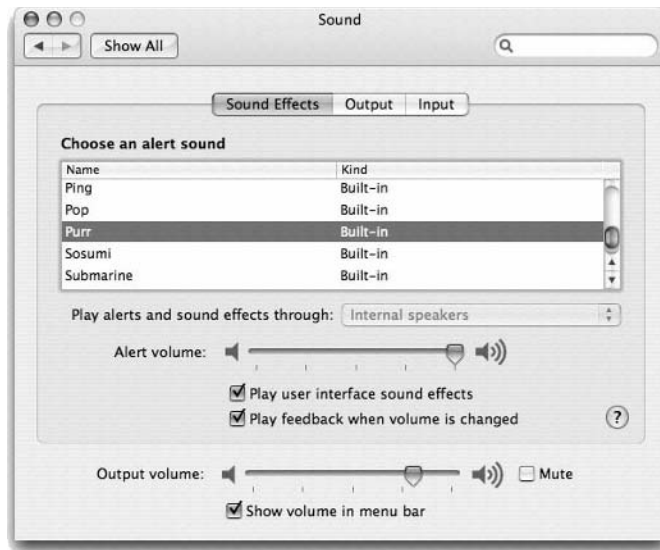

**Figure 6-2:**  
The Sound  
pane,  
proudly  
showing off  
the Sound  
Effects tab.

To return to the top-level System Preferences tab from any pane, just click the Show All button (top left), or press  $\text{⌘}+\text{L}$ . You can also click the familiar Previous and Next buttons to move backward through the panes you've already visited and then move forward again, in sequence. (Yep, these buttons work just like the browser controls in Safari. Sometimes life is funny that way.)

You won't find an OK button that you have to click to apply a System Preferences change — Apple's developers do things the right way. Your changes to the settings in a pane are automatically saved when you click Show All or when you click the Close button on the System Preferences window. You can also press  $\text{⌘}+\text{Q}$  to exit the window and save all your changes automatically . . . a favorite shortcut of mine.



If you see an Apply Now button in a pane, you can click it to immediately apply any changes you've made, without exiting the pane. This is perfect for some settings that you might want to try first before you accept them, such as many of the controls on the Network pane. However, if you're sure about what you've changed and how those changes will affect your system, it's not necessary to click Apply Now. Just exit the System Preferences window or click Show All as you normally would.

## Locating That Certain Special Setting

Hey, wouldn't it be great if you could search through all the different panes in System Preferences — with all those countless radio buttons, check boxes, and slider controls — from one place? Even when you're not quite sure exactly what it is you're looking for?

Figure 6-3 illustrates exactly that kind of activity taking place. Just click in the System Preferences Search box (in the upper right, with the magnifying glass icon) and type just about anything. For example, if you know part of the name of a particular setting you need to change, type that. Tiger highlights the System Preferences panes that might contain matching settings. And if you're a *Switcher* from the Windows world, you can even type in what you might have called the same setting in Windows XP!

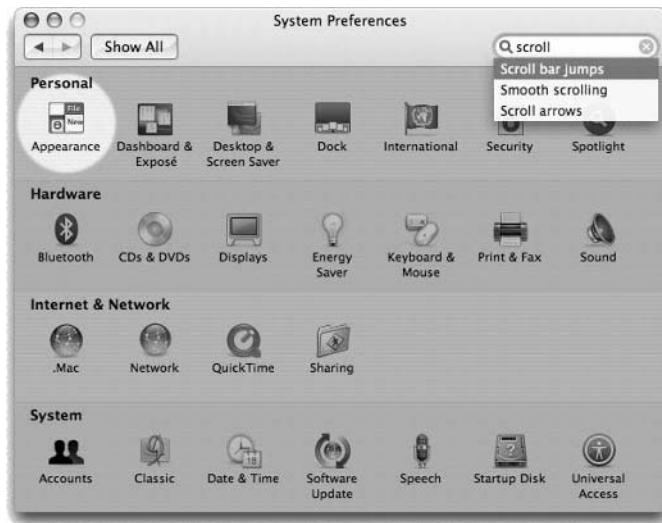

**Figure 6-3:** Searching for specific settings is a breeze with the Search box.

The System Preferences window dims, and the group icons that might contain what you're looking for stay highlighted. *Slick.*



You can also search for System Preferences controls using the Spotlight menu and Spotlight window. Find more on this cool feature in Chapter 7.

If you need to reset the Search box to try again, click the X icon that appears at the right side of the box to clear it.

## Introducing Mark's Favorite Preference Panes

Time to get down to brass tacks. In this section, I discuss the most often used panes in System Preferences and the magic you can perform in each one! I won't discuss every pane because I cover many of them in other chapters. However, this chapter covers just about all the settings that you're likely to

use on a regular basis. (Some System Preferences panes, such as the Universal Access or Classic panes, you might never need to open.)

## The Display pane

If you're a heavy-duty game player or you work with applications such as video editing and 3-D modeling, you probably find yourself switching the characteristics of your monitor on a regular basis. To switch those settings more easily, visit the Display pane (see Figure 6-4), which includes two tabs:



- ✓ **Display:** Click a screen resolution from the Resolutions list on the left. Tiger displays the number of colors (or *color depth*) allowed at that resolution, and you can choose a color depth from the Colors pop-up menu. (Typically, it's a good idea to use the highest resolution and the highest number of colors.) Because laptops running Tiger have a flat-panel LCD, the refresh rate is disabled. However, if you're using a CRT display, I recommend choosing the highest refresh rate allowed. To change the brightness level of your display, drag the Brightness slider.

When you select the Show Displays in Menu Bar check box, you can switch resolutions and color levels right from the Finder menu!

- ✓ **Color:** Your Mac can use a *color profile* file that controls the colors on your display. This setting comes in handy for graphic artists and illustrators who need color output from their printer that closely matches the colors displayed by the laptop. Click the Calibrate button to launch Display Calibrator, which can create a custom ColorSync profile and calibrate the colors that you see on your monitor.

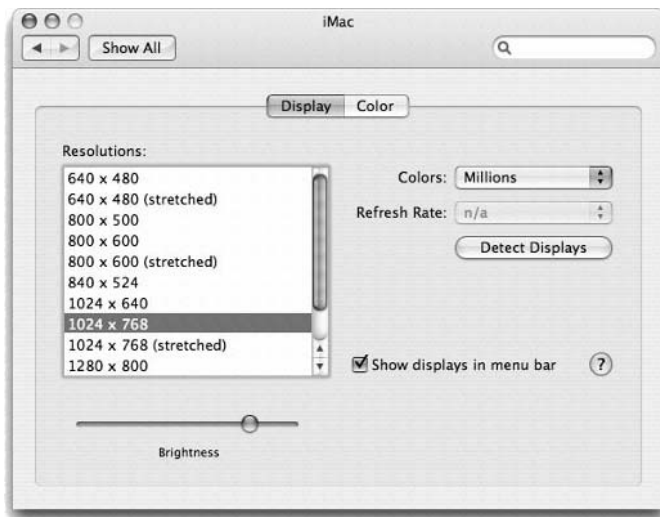

**Figure 6-4:** The Display tab also comes in a handy Finder menu bar size!

## The Desktop & Screen Saver pane

Hey, no offense to the aqua blue desktop background, but who doesn't want to choose his or her own background? And what about that nifty screensaver you just downloaded from the Apple Web site? You can change both your background and your screen saver using the Desktop & Screen Saver pane.

The settings on the Desktop tab (as shown in Figure 6-5) are



- ✓ **Current desktop picture:** To change your desktop background, click a thumbnail. You can also drag a picture from a Finder window or the desktop and drop it into the *well* (the fancy Apple word for the square box with the sunken look). Tiger automatically updates your desktop so you can see the results. To open another collection of images from Apple, click the collection folder in the list on the left of the tab. (I recommend the stunning images in the Nature folder.) If you want to open a different folder with your own images, click the Choose Folder entry in the left column and navigate to that folder.

To add your own folder as a collection in the list, drag the folder to the well from a Finder window.

- ✓ **Arrangement:** You can *tile* your background image (repeat it across the desktop), center it, and stretch it to fill the screen. Because the images from Apple are all sized correctly already, the Arrangement control appears only when you're using your own pictures.
- ✓ **Change Picture:** If you'd like a bit of automatic variety on your desktop, select the Change the Picture check box. You can click the drop-down list box to set the delay period. The images in the current collection or folder are displayed in the sequence in which they appear in the thumbnail list.
- ✓ **Random Order:** Select this check box to throw caution utterly to the wind and display random screens from the current collection or folder!

The settings on the Screen Saver tab are



- ✓ **Screen Savers:** Click the screen saver that you want to display from the Screen Savers list. Tiger displays an animated preview of the selected saver on the right. You can also click the Test button to try out the screen saver in full-screen mode. (Move your mouse a bit to end the test.) If the selected screen saver has any settings you can change, the Options button displays them.
- ✓ **Start Screen Saver:** Drag this slider to choose the period of inactivity that triggers the screen saver. Choose Never to disable the screen saver.

- ✔ **Use Random Screen Saver:** Another chance to rebel against conformity! Select this check box, and Tiger chooses a different screen saver each time.
- ✔ **Hot Corners:** Click any of the four pop-up menus at the four corners of the screen to select that corner as an *activating hot corner*. (Moving your mouse pointer there immediately activates the screen saver.) You can also specify a corner as a *disabling hot corner* — as long as the mouse pointer stays in that corner, the screen saver is disabled. Note that you can also set the Dashboard and Exposé activation corners from here. (Read on for the entire lowdown.)

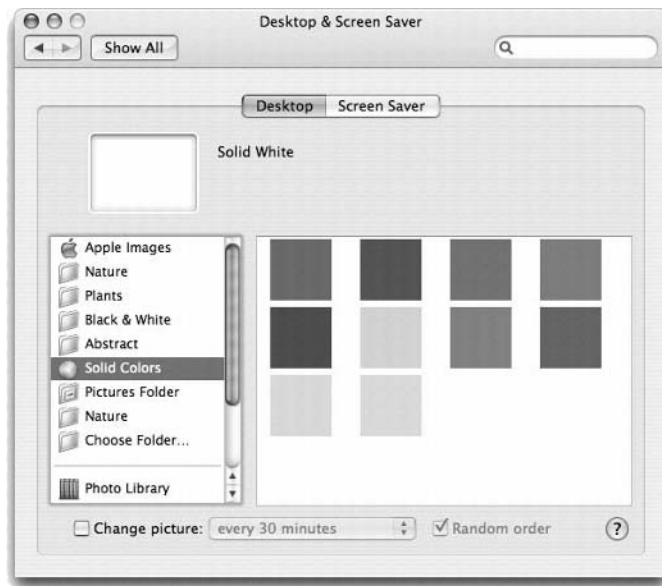

**Figure 6-5:**  
Show the  
Man who's  
boss and  
choose your  
own  
desktop  
background.

## The Dashboard & Exposé pane

The pane you see in Figure 6-6 illustrates the settings that control Tiger's Dashboard and Exposé features. The settings are

- ✔ **Active Screen Corners:** The screen corner pop-up menus operate just like those in the Screen Savers tab, which I describe in the preceding section. Click a corner's list box to set it as
  - An Exposé *All Windows* corner (displays all windows on your desktop)
  - An Exposé *Application Windows* corner (displays only the windows from the active application)

- An Exposé *Desktop* corner (moves all windows to the outside of the screen to uncover your desktop)
- A *Dashboard* corner (displays your Dashboard widgets). Widgets are small applications that each perform a single task; they appear when you invoke the awesome power of Dashboard.

These pop-up menus can also set the activate and disable hot corners for your screen saver.

✓ **Keyboard and Mouse Shortcuts:** Pretty straightforward stuff here. Click each pop-up menu to set the key sequences (and mouse button settings) for all three Exposé functions as well as for Dashboard.



If you hold down a modifier key — Shift, Control, Option, or ⌘ — while a shortcut pop-up menu is open, Tiger adds that modifier key to the selections you can choose! (Perfect for those folks who already have the F11 key in use by another application. Make your desktop shortcut key the Shift+F11 key sequence instead.) I should also note that your default shortcuts may be different (or may require the function key) depending on the laptop model you're using.

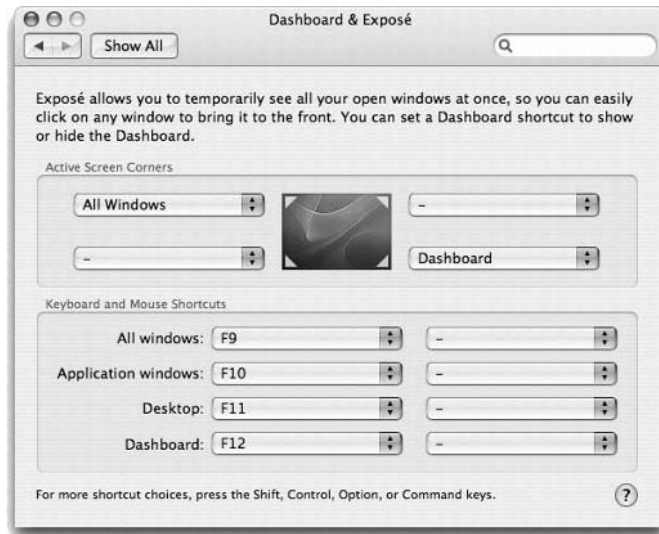
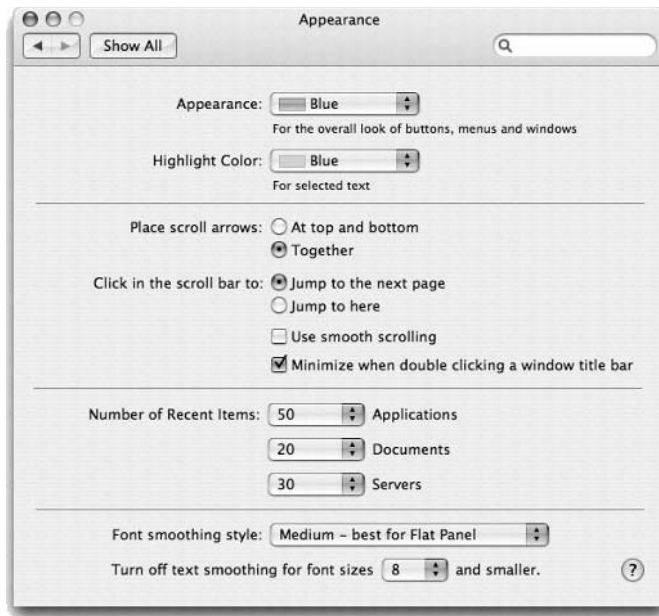

**Figure 6-6:**  
The  
Dashboard  
& Exposé  
pane in  
System  
Preferences.

## The Appearance pane

The talented Appearance pane (shown in Figure 6-7) determines the look and operation of the controls that appear in application windows and Finder windows. It looks complex, but I cover each option here.

**Figure 6-7:**  
Appearances might not be everything, but they're easy to find in System Preferences.



The settings are

- ✓ **Appearance:** Click this pop-up menu to specify the color Tiger uses for buttons, menus, and windows.
- ✓ **Highlight Color:** Click this pop-up menu to choose the color that highlights selected text in fields, pop-up menus, and drop-down list boxes.
- ✓ **Place Scroll Arrows:** Select a radio button here to determine whether the arrows that control the scroll bar in a window appear together at the bottom of the scroll bar or separately at the top and bottom of the scroll bar.
- ✓ **Click in the Scroll Bar To:** By default, Tiger scrolls to the next or previous page when you click in an empty portion of the scroll bar. Select the Jump to Here radio button to scroll the document to the approximate position in relation to where you clicked. (Smooth scrolling slows down scrolling, which some people prefer.)



You can minimize a Finder or application window by simply double-clicking the window's title bar. To enable this feature, select the Minimize When Double Clicking a Window Title Bar check box.

- ✓ **Number of Recent Items:** By default, Tiger displays ten recent applications, documents, and servers in the Recent Items item in the Apple menu. Need more? Just click the corresponding pop-up menu and specify up to 50 items.



- ✔ **Font Smoothing Style:** This feature performs a little visual magic that makes the text on your monitor or flat-panel look more like the text on a printed page. Most laptop owners should choose Standard (for a typical CRT monitor used as a secondary screen) or Medium (for your laptop's flat-panel LCD display).
- ✔ **Turn Off Text Smoothing for Font Sizes:** Below a certain point size, text smoothing doesn't help fonts look any smoother on the screen. By default, any font displayed at 8 points or smaller isn't smoothed, which is a good choice for a Mac laptop with a flat-panel LCD screen.

## The Energy Saver pane

I'm an environmentalist — it's surprising how many techno-types are colored green — so I think the two tabs of the Energy Saver pane (shown in Figure 6-8) are pretty doggone important. When you use them correctly, you can not only save electricity but even invoke the Power of Tiger to automatically start and shut down your Mac whenever you like!

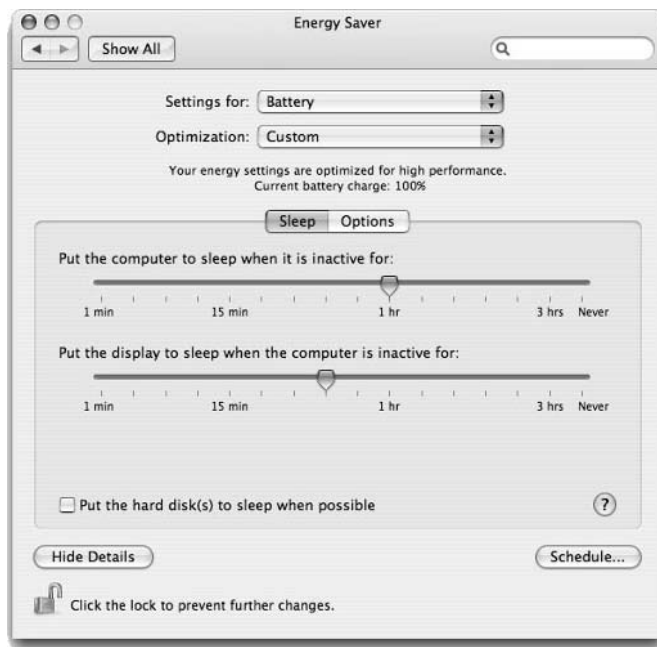

**Figure 6-8:** Reduce your Mac laptop's power consumption from the Energy Saver pane.

The tabs are as follows:

- ✔ **Sleep:** To save electricity, drag the Put the Computer to Sleep When It Is Inactive For slider to a delay period that triggers sleep mode when you're away from the keyboard for a significant period of time. (I prefer 30 minutes.) If your Mac must always remain alert and you want to disable sleep mode entirely, choose Never. You can set the delay period for blanking your monitor separately from the sleep setting with the Put the Display to Sleep When the Computer Is Inactive For slider. To conserve the maximum juice and cut down on wear, select the Put the Hard Disk(s) to Sleep When Possible check box to power-down your hard drives when they're not needed. (This might cause a delay of a second or two while loading or saving files because the drives must spin back up.)



You can set Tiger to start or shut down your Mac laptop at a scheduled time. Click the Schedule button and then select the desired schedule (the Start Up/Wake check box and the Shut Down/Sleep pop-up menu) to enable them. Set the trigger time by clicking the up and down arrows next to the time display for each schedule. Click OK to return to the Energy Saver pane.

- ✔ **Options:** From this tab, you can specify events that can awaken your Mac from sleep mode, such as a ring signal from your modem. If you prefer to send your laptop to sleep by pressing the Power button, select the Allow Power Button to Sleep the Computer check box. Tiger can also restart your Mac automatically after a power failure.



If you're running an older laptop that uses a G4 processor, the Processor Performance pop-up menu appears in the Options tab. You can use this control to fine-tune the performance of your laptop's processor to reduce its power consumption and heat buildup. Choose Automatic to allow Tiger to monitor and tweak your processor's performance whenever possible. Choose Highest if you want the best possible performance at all times — note that this setting may result in significant heat buildup, especially on older G4-based Mac laptops. Choose the Reduced option if you need to conserve battery power or reduce heat buildup.

## The Dock pane

I'll come clean: I think the dock is the best thing since sliced bread! (I wonder what people referred to before sliced bread was invented?) You can use the settings shown in Figure 6-9 to configure the dock's behavior until it fits your personality like a glove:

- ✔ **Dock Size:** Pretty self-explanatory. Just drag the slider to change the scale of the dock.



- ✔ **Magnification:** When you select this check box, each icon on your dock swells up like a puffer fish when you move your mouse cursor over it. (Just how much it inflates is determined by the Magnification slider.) I like this feature because I resize my dock so it's smaller, and I have a large number of dock icons.
- ✔ **Position on Screen:** Select a radio button to position the dock on the left, bottom, or right edge of your Mac's desktop.
- ✔ **Minimize Using:** Tiger includes two cool animations that you can choose from when shrinking a window to the dock (and expanding it back to the desktop). Click the Minimize Using pop-up menu to specify the genie-in-a-bottle effect or a scale-up-or-down-incrementally effect.  
  
If animation isn't your bag or you want to speed up the graphics performance of an older Mac laptop, you can turn off these minimizing effects by clicking the Minimize Using checkbox to deselect it.
- ✔ **Animate Opening Applications:** Are you into aerobics? How about punk rock and slam dancing? Active souls who like animation likely get a kick out of the bouncing application icons on the dock. They indicate that you've launched an application and it's loading. You can turn off this bouncing behavior by disabling this check box.
- ✔ **Automatically Hide and Show the Dock:** Select this check box, and the dock disappears until you need it. (Depending on the size of your dock, the desktop that you gain can be significant.) To display a hidden dock, move your mouse pointer over the edge of the desktop you selected with the Position on Screen radio button.

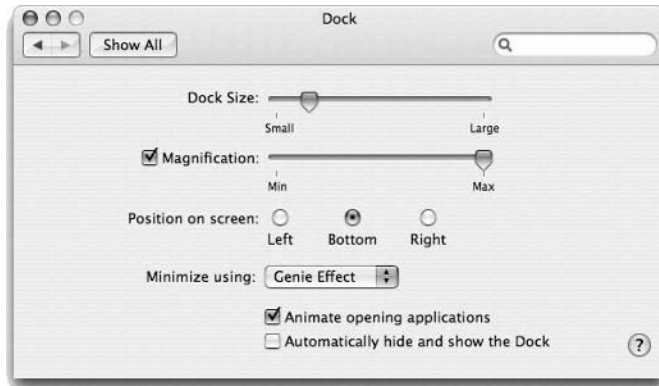

**Figure 6-9:**  
Customize  
your dock  
using these  
controls.

## The Sharing pane

So you're in a neighborly mood, and you want to share your toys with others on your local wired or wireless network. Perhaps you'd like to start your own

Web site or protect yourself against the Bad Guys on the Internet. All these fun diversions are available from the Sharing pane in System Preferences, as shown in Figure 6-10.



**Figure 6-10:** Share your toys with others using the controls on the Sharing pane.

Here's the lowdown on the three tabs the Sharing pane offers:

- ✔ **Services:** Each entry in the services list controls a specific type of sharing, including Personal File Sharing (with other Macs), Windows Sharing (with PCs running Windows), Personal Web Sharing, Remote Login, FTP Access, Apple Remote Desktop, Remote Apple Events, Printer Sharing, and Xgrid. (More on these services and what they do appears in Chapter 17.) To turn on any of these services, select the On check box for that service. To turn off a service, choose it from the list and click the Stop button that appears, or just disable the On check box for that service.

To change the default network name assigned to your laptop during Tiger's setup process, click in the Computer Name text box and type the new name.

- ✔ **Firewall:** You can enable Tiger's powerful built-in Internet firewall from this tab — and I strongly urge you to do so! A *firewall* blocks communication to any sharing service not allowed in the list. To enable communications with a service, select the entry in the list and select the On check box to enable it. (Note that Tiger takes care of this automatically when you start a service on the Services tab.)





Need to create an opening (or *port*) in your firewall for an application? Click the New button and specify a new port by entering a port number and assigning it a name. The new port appears in the list, and you can turn it on and off like any other port. You can also edit or delete the selected port.

If you find that your Mac suddenly can't connect to other computers (or share services that you were able to share) after you turn on your firewall, one (or more) of your ports is set incorrectly. (This often happens if you turn off a port manually.) Review each service that you've turned on, and then make sure the corresponding ports are opened on the Firewall tab.

✔ **Internet:** To share an Internet connection from your Mac laptop to the rest of the computers on your network, click the Share Your Connection From pop-up menu and choose the proper port. For just about every network, you should choose the Built-in Ethernet port (naturally, wireless folks can choose AirPort). Then click Start.

Security is always an issue when you share your Internet connection with others. Chapter 17 includes information on common-sense security rules you should follow while networking!

## Chapter 7

# Sifting through Your Stuff

---

### *In This Chapter*

- ▶ Understanding how Spotlight works
  - ▶ Searching for data, files, and folders using Spotlight
  - ▶ Using the results you get from a Spotlight search
  - ▶ Searching with the Find dialog box and the Search box
  - ▶ Searching for stuff on the Internet with Sherlock
- 

**W**hat would you say if I told you that you could search your entire system for *every single piece* of data connected with a person — and only in the time it takes to type that person’s name? And I’m not just talking about files and folders that might include that person’s name. I mean *every* e-mail message and *every* iCal calendar or event that references that person and even that person’s Address Book card to boot? Heck, how about if that search could dig up every occurrence of the person’s name *inside* your electronic PDF documents?

You’d probably say, “That makes for good future tech — I’ll bet I can do that in five or ten years. It’ll take Apple at least that long to do it . . . and just in time for me to buy a new laptop! (Harrumph.)”

Don’t be so hasty: You can do it right now. The technology is a new Mac OS X feature named *Spotlight*, built right into Tiger. In this chapter, I show you how to use it like a Mac power guru. I also show you how to take advantage of Sherlock, the best Internet search tool ever.

## *A Not-So-Confusing Introduction to Spotlight*

Invoking the magic of Spotlight is a snap. As you can see in Figure 7-1, the Spotlight search field always hangs out on the right side of the Finder menu bar. You can either click once on the magnifying glass icon or just press F5. Either way, Tiger displays the Spotlight search box.



**Figure 7-1:**  
Soon to be a  
good friend  
of yours —  
the Spotlight  
search box.

Spotlight works by *indexing* — in other words, searching for and keeping track of keywords in your files. In fact, Tiger indexes the contents of your laptop's hard drive into a huge file, which it constantly maintains as you create and modify files. Tiger can search this index file in a fraction of a second after you enter your search criteria. The index file contains all sorts of data, including quite a bit of information from various documents — hence Spotlight's ability to present matching data inside your files and application records.



When you first boot Tiger, it spends anywhere from a few minutes to an hour or two creating the Spotlight index file. If you click the Spotlight icon whilst indexing is taking place, you'll see a progress bar indicating how much longer you have to wait before you can use Spotlight. Creating this full index happens only once, so it's no great burden to bear.

You can search for any string of text characters in Spotlight. You'll be surprised at everything this plucky feature will search. For example, Spotlight searches through your Address Book contacts, mail messages, iCal calendars, iChat transcripts, and even System Preferences! Yep, you can even use it to find specific settings in all those System Preferences panes, such as *printer sharing* or *Dashboard*. Spotlight locates and displays matching files and folders — like that *other* operating system — but it performs searches in the blink of an eye.

Spotlight matches only those items that include all your search text: Therefore, if you enter just the word *horse*, you're likely to get far more matches than if you enter a word string, such as *horse show ticket*.



If you add metadata to your documents (such as the Comments field in a Word document or the keywords embedded in a Photoshop image), Spotlight can match that information as well. Other recognized file formats include AppleWorks documents, Excel spreadsheets, Keynote presentations, Pages documents, and third-party applications that offer a Spotlight plug-in.



Spotlight works so seamlessly — and so doggone fast — because it's literally built into the core of Tiger (unlike that other operating system that begins with a *W*, which uses a separate program to search and can take a couple of minutes to return just matching filenames). Spotlight's integration into the heart of Tiger allows those high-IQ Apple developers (and even smart folks outside the company) to easily use it elsewhere within Tiger — more on this later in the chapter.

## *Searching for all sorts of things with Spotlight*

To begin a Spotlight search, display the Spotlight box, click in it, and start typing. As soon as your finger presses the first key, you'll see matching items start to appear. Check out Figure 7-2, in which I typed only a single character. (No need to press Return, by the way. This is all automatic from here on.) As you continue to type, Spotlight's results are updated in real-time to reflect the new characters.

Spotlight displays what it considers the top 20 matching items within the Spotlight menu itself. These most relevant hits are arranged into categories such as Documents, Images, and Folders. You can change the order in which categories appear (using the Spotlight pane in System Preferences, which I cover a bit later in this chapter).



Using internal magic, Spotlight presents the Top Hit category (with what it considers the single most relevant match) at the top of the search results, as also shown in Figure 7-2. You'll find that the Top Hit is often just what you're looking for. To open or launch the Top Hit item from the keyboard, press **⌘+Return**.

Didn't find what you were after? Click the X icon that appears at the right side of the Spotlight box to reset the box and start over.

If all you know about the item you're searching for is what type of file it is — for example, you know it's a QuickTime movie, but you know nothing about the title — just use the file type, such as *movies*, all by itself as the keyword in the Spotlight field. This trick works with *image* files and *audio* files, too.





**Figure 7-2:**  
A Spotlight  
menu  
search  
takes as  
little as one  
character.



Here's another trick that's built into Spotlight: You can type a relative time period — such as *yesterday*, *last week*, or *last month* — and Spotlight will match every item that was created or received within that period. That's 100 percent *sassy*!

## *Working with matching stuff*

After you run a fruitful search, and Spotlight finds the proverbial needle in your system's haystack, what's next?

Just click the item — that's all it takes. Depending on the type of item, Tiger does one of four things:

- ✓ Launches an application
- ✓ Opens a specific pane in System Preferences (if the match is the name of a setting or contained in the text on a Preferences pane)
- ✓ Opens a document or data item, such as an Address Book card
- ✓ Displays a folder in a Finder window

To see all sorts of useful info about each Spotlight menu item, click the Show All item (above the Top Hit listing) to expand your Spotlight menu into the Spotlight Results window, as shown in Figure 7-3. From the keyboard, you can press the Results window shortcut key, which you can set from System Preferences (more on this in a page or two).

**Figure 7-3:**  
The Spotlight Results window offers more ways to group and sort your matches.

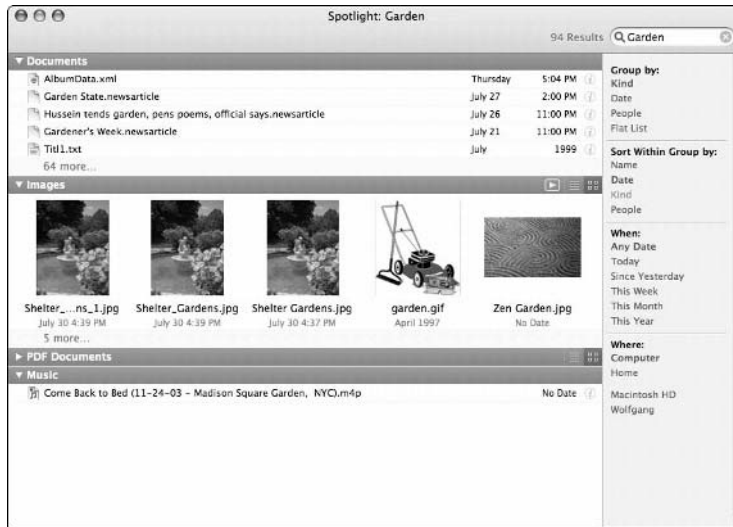

The category groups in the upper-right side of the Results window allow you to group your results by different categories. You can also specify how items are sorted within each group by clicking the option you want under the Sort Within Group By heading. Spotlight displays images as thumbnails to make them easier to differentiate.

To display the details about any item in the list (without selecting it, which closes the Results window), click the *Info icon* (lowercase italic *i* in a circle) at the right side of the item entry. After you locate the item you want, click it to open, launch, or display it, just like you would in the Spotlight menu.



Use the filter settings in the column at the right to display or hide items by the date they were created or last saved (the When section) or by their source (such as your hard drive or Home folder).

## *Tweaking Spotlight in System Preferences*

The System Preferences window boasts a new Spotlight icon, which you can use to customize what search matches you'll see and how they'll be presented. To adjust these settings, click the System Preferences icon on the dock (look for the light switch) and then click the Spotlight icon (under Personal).

### *Configuring the Search Results settings*

From the Search Results tab of the Spotlight Preferences pane, you can

- ✔ **Choose your categories:** To disable a category (typically, because you don't use those types of files), select the check box next to the category to clear it.
- ✔ **Specify the order in which categories appear within Spotlight:** Drag the categories into the order that you want them to appear in the Spotlight menu and Results window.
- ✔ **Select new Spotlight menu and Spotlight Results window keyboard shortcuts:** In fact, you can enable or disable either keyboard shortcut, as you like. Click the pop-up menu to choose a key combination.

### *Marking stuff off-limits*

Click the Privacy tab to add disks and folders that should *never* be listed as results in a Spotlight search. The disks and folders that you add to this list won't appear even if they match your search string. This safeguard can come in handy for organizations (such as hospitals) that are required by law to protect their patient or client data. You can also select a removable hard drive here, which is often stored in a safe, after-hours.

To add a private location, click the Add button (which bears a plus sign) and navigate to the desired location. Then click the location to select it and then click Choose. (If you already have the location open in a Finder window, you can drag folders or disks directly from the window and drop them into the list.)

## *Other Search Tools Are Available Too*

For a few years now, the Finder window toolbar has featured a Search box and Tiger has included a Find dialog box, but even the older Search features in Tiger have been updated to take advantage of Spotlight technology. Now you can use file types (such as *image* or *movie*) and relative time periods (such as *yesterday* and *last week*) in the Finder window Search box and Find displays!

I typically use the Finder window Search box if I need to do a simple file or folder name search — it works the same as using the Spotlight search field. Just begin typing, and use the X button in the Search box to reset the field. To choose a specific location for your search — such as your Home folder or a hard drive volume — click the desired button along the top of the Search results display. The Finder window automatically turns into a Results display.

Tiger also includes the oldest Search method in the book: the Find display. (It used to be a dialog box all by itself, but now the Find controls are displayed in the Finder window, so it's more of an extension to the Finder window.) Choose File⇨Find or press ⌘+F to display the Find controls. From here, you can click pop-up menus to choose a specific filename or portion of a filename. Other modifiers include the file type, content, label color, file size, and the last date the file was opened. Again, click the location buttons at the top of the window to choose where to search.

The Find display, however, is a little more sophisticated than the toolbar Search box. You can click the plus (+) button next to a search criterion field in the Find display to add another field, allowing for matches based on more than one condition. Click the minus (-) button next to a search criterion field to remove it.

After you find a match, both of these older search methods work the same: Click the item once to display its location, or double-click it to launch or open it. Files can also be moved or copied from the Results and Find displays with the standard drag and Option+drag methods. You can return to the more mundane Finder window display by clicking the Back button on the toolbar.



These older search methods can also do one thing that Spotlight doesn't offer: You can use them to create a new *Smart Folder*. Click the Save button in either the Finder window Search Results or the Find display. You'll be prompted to specify the name and location for the new Smart Folder and whether it should appear in the Finder window sidebar. After you create the folder, Tiger automatically updates the contents of the Smart Folder with whatever items match the criteria you've saved. You'll never have to search using the same text or criteria again! (Each icon in a Smart Folder is a link to the file or folder, so nothing gets moved, and no extra space is wasted with multiple copies of the same items.) You can work with the files and folders inside a Smart Folder as if they were the actual items themselves.

## Putting Sherlock on the Case

No chapter on searching in Mac OS X would be complete without that famous Internet sleuth, *Sherlock* (as shown in Figure 7-4). Conan Doyle himself would be proud indeed if he could see just how much information Tiger's Sherlock application can pluck from Web pages, Internet search engines, and all sorts of content providers.

Each *channel*, or search type, in Sherlock has a different function. To see a short description of what each can do, just click the Channels button. In this section, I demonstrate how to use three of the most useful channels to track down the information you need.

**Figure 7-4:**  
Elementary,  
dear reader.  
If it's on the  
Internet, I'll  
wager  
Sherlock  
can find it!

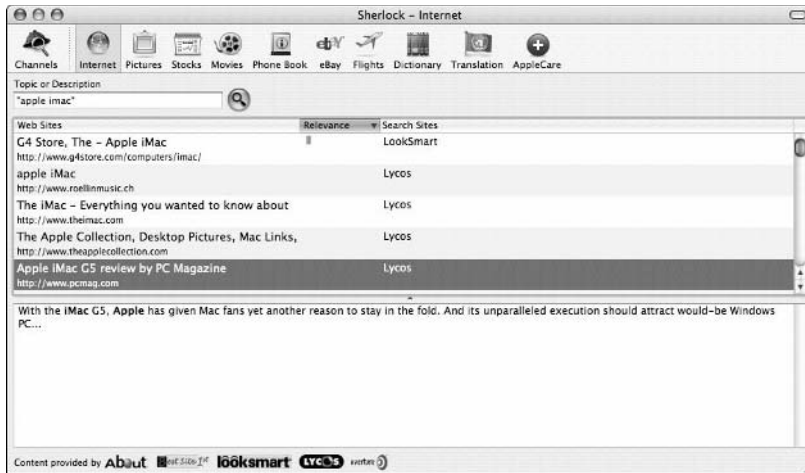

Okay, I know you're going to roll your eyes, but I have to remind you that you need an Internet connection to use Sherlock. Otherwise, Sherlock is about as useful as a pair of swim fins in the Sahara.

## *Searching that darn Internet for data and pictures*

If you're using Safari, check out the Google search box conveniently located in the Safari toolbar. (Still, Sherlock can perform the same duties if you choose the Internet channel.) You'll find Sherlock in your Applications folder on your laptop's boot drive. (Click the Applications icon in the sidebar that appears in any Finder window to open your Applications folder.) After you double-click the Sherlock icon to launch the application, follow these steps to track down specific information from Web sites around the world, using a number of Internet search engines:

1. **Click the Internet channel button.**
2. **Type the phrase Elvis Parade into the Topic or Description box, and then click the Search button (yep, it's the button with the magnifying glass).**

To force a search for an exact phrase, surround it with quotes.

3. **When you find the perfect match for your search, click that entry to display the summary text.**

I'll bet you didn't know there were so many parades featuring Elvis impersonators, did you?



- 4. To display the entire Web page in all its glory, double-click the entry.**

Sherlock launches Safari (or whatever you've installed as a default browser).

## *Getting movie information in the new millennium*

Ready to take in a good movie? Yep, you guessed it, Sherlock can help! To search local theaters for information on a movie — and watch the trailer to boot — follow these steps:

- 1. Click the Movies channel button.**
- 2. Click the Movies button to search by movie name.**

You can also search by theater name by clicking the Theaters button. To filter the results you'll get, enter a different city/state combination or Zip code in the Find Near box.
- 3. Click the Showtime pop-up menu and then select today's date.**
- 4. When you find a listing that looks good, click that entry to display the summary text.**

Sherlock automatically downloads a thumbnail of the movie poster (and, if available, the QuickTime movie trailer). If you have a broadband or network Internet connection, click the Play button in the QuickTime viewer window to watch the trailer.
- 5. In the center column, click the theater you want to display a list of the show times for the selected film.**

## *Keep an eye on my stocks, Watson!*

What better stock to monitor than Apple? I use the Stocks channel all the time to keep up on the latest news and information on a number of stocks.

Follow these steps to monitor a stock:

- 1. Click the Stocks channel button.**
- 2. In the Company Name or Ticker Symbol box, type Apple (or its ticker symbol, AAPL).**

(I would check Microsoft's stock, but it hasn't been doing so well recently.)

3. Press Return or click the Search button.
4. To display the text of a news item (or a link to the story on the Web), click the desired headline.

Sherlock displays the text of the news item in the summary section, and Safari launches automatically to display Web pages.

5. To switch to another stock you've recently been watching, click the stock entry in the list at the top of the window.



Like any other public-access stock ticker, the quotes you see on the Stocks channel are delayed 15 minutes. (Go figure.)

# Part III

# Connecting and Communicating

## The 5<sup>th</sup> Wave

By Rich Tennant



"I can be reached at home on my cell phone, I can be reached on the road with my pager and PDA. Soon I'll be reachable on a plane with e-mail. I'm beginning to think identity theft wouldn't be such a bad idea for a while."



## *In this part . . .*

**Y**ou want to do the Internet thing, don't you? Sure you do — and in this part, I describe and demonstrate your Safari Web browser. You also find out about Apple's .Mac Internet subscription service, and how you can store, back up, and synchronize your data online. Finally, this part fills you in on connecting important stuff such as printers and scanners, as well as how you can use your cool-looking Apple remote and your laptop's built-in iSight Webcam.

## Chapter 8

# Taking Your Laptop on Safari

---

### *In This Chapter*

- ▶ Identifying the major controls in Safari
  - ▶ Jumping to a site and navigating the Web
  - ▶ Searching for information and recently visited sites
  - ▶ Recognizing secure connections
  - ▶ Specifying a home page
  - ▶ Putting bookmarks to work
  - ▶ Staying current with an RSS feed
- 

**L**ooking for that massive Microsoft monster of a Web browser on your MacBook Pro? You know, the one that practically everyone uses in the Windows world. What's it called? I forget the name.

You see, I use a Mac laptop, and I proudly surf the Web using a lean, mean — and *very* fast — browser application. That's Safari, of course, and it just keeps getting better with each new version of Mac OS X. Safari delivers the Web the right way, without the wait.

If you need a guide to Safari, this is your chapter. Sure, you can start using it immediately, but wouldn't you rather read a few pages so you can surf like a power user?

## *It's Not Just Another Web Browser*

Safari could almost be mistaken for a Finder window! Figure 8-1 illustrates the Safari window, with the most important controls and whatnots marked. To launch Safari, click the spiffy-looking compass icon on the dock.

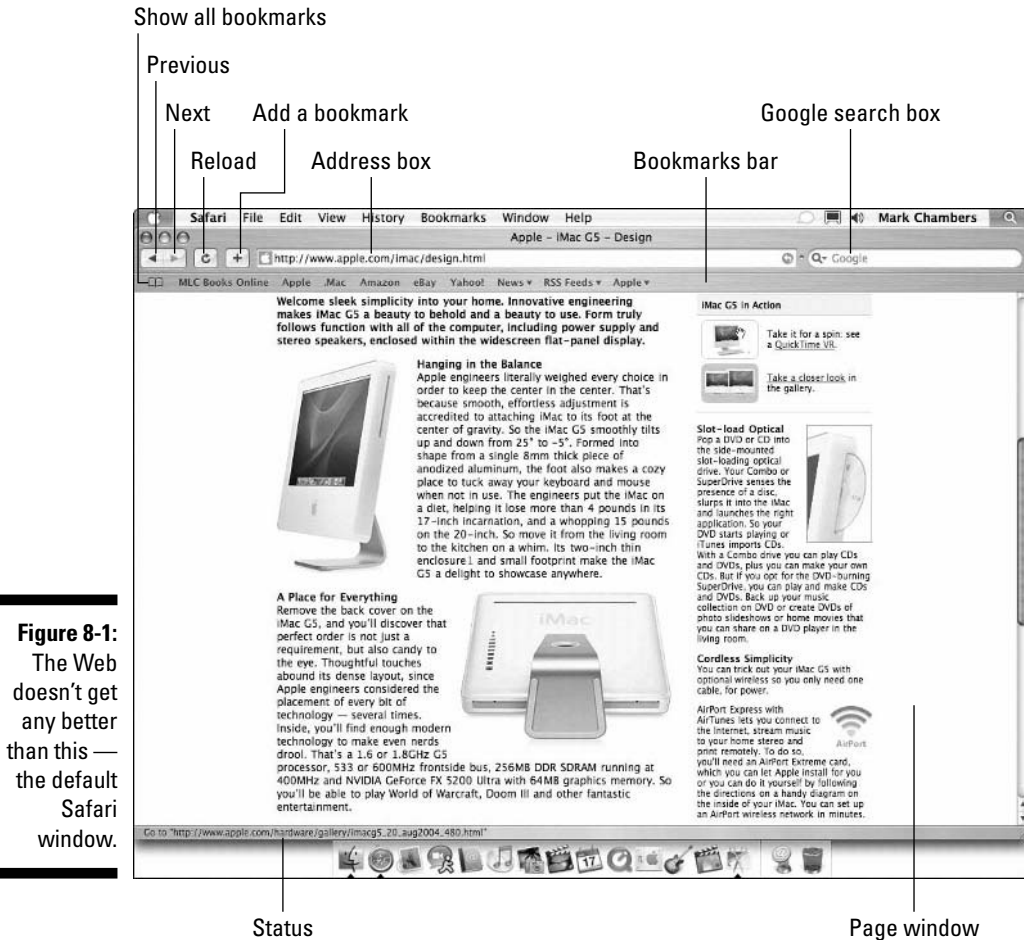

**Figure 8-1:**  
The Web doesn't get any better than this — the default Safari window.

Let's begin with introductions all around to the stuff in Figure 8-1:

- **Previous and Next buttons:** Click the Previous button (left-facing triangle) to surf backwards — no small feat on water but no big deal here. Safari simply returns you to the last page you visited, and each additional click takes you back one page further. If you've moved one or more pages backward, you can click the Next button (right-facing triangle) to move forward through those same pages again.
- **Reload button:** Clicking this button (circular arrow) reloads, or refreshes, the current page, updating the page with the latest information from the Web server. This feature is useful for Web sites that change periodically, such as [www.cnn.com](http://www.cnn.com) or your stockbroker's Web site.

- ✔ **Add a Bookmark button:** Click this button (a plus sign) to add the current page to your collection of *bookmarks*, which are favorite sites that you return to regularly. (More about bookmarks later in the section “Organizing favorite spots with bookmarks.”)
- ✔ **Address box:** You can enter a Web site’s address (URL) manually in this box, or you can drag a Web address from another application here to jump directly to that page.
- ✔ **Google search box:** One of the slicker features of Safari, this box (look for the magnifying glass) allows you to search Google for keywords that you type without having to visit `www.google.com` first.
- ✔ **Show All Bookmarks button:** Clicking this button, which looks like an open book, displays (or hides) a special screen from which you can organize your bookmark collections and select a specific bookmark. You can also add or remove bookmarks from the bookmarks bar and Bookmarks menu from this screen.
- ✔ **Bookmarks bar:** This button strip (which appears below the Safari toolbar) allows you to jump directly to your most important bookmarks.
- ✔ **Page window:** No surprises here! This window displays the contents of the current Web page, including all sorts of stuff such as links to other pages, images, animated graphics, pop-up windows (if you want them), and anything else that appears on a Web page.
- ✔ **Status bar:** Not particularly flashy, but I like the status bar nevertheless because it updates you with information on what you’re doing, what’s currently loading, or what will load if you click a link.

## Handling Basic Safari Chores

Sure, you’re likely saying, “Mark, I already know this stuff. I can operate a Web browser blindfolded — while listening to *The Best of Air Supply*, even.” I know that most browsers work in the same way, and Safari shares most of those mechanics. However, I’m a thorough guy (just ask my editors). Therefore, just in case you’ve never used a browser before, let me show you how to surf.

And no giggling from the Peanut Gallery.

### Entering Web addresses

The most mundane method of crossing the Web and visiting a specific site is manually typing the Web page address — more technically called a URL, short for *Uniform Resource Locator* — directly into the address box. Click the tiny image icon that appears at the beginning of the address box, start typing, and then press Return after you enter the entire address. Boom, you’re there.

## Tabs: Love 'em or leave 'em

Safari offers an alternate method of displaying multiple Web pages — Tabbed browsing mode. With Safari open, just choose Safari → Preferences to display the Preferences dialog box and then click the Tabs button. From here, select the Enable Tabbed Browsing check box to turn on tabs.

In *Tabbed browsing mode*, Safari doesn't open a new window or replace the current Web page when you click a link. Instead, a tab representing the new page appears under the bookmarks bar, and you can click it to switch pages. However, you have to open a link or a bookmark as a tab by holding down the ⌘ key while you click. Otherwise, Safari acts as it usually does and replaces the contents of the window with the new page.

In fact, this area below the bookmarks bar becomes a separate strip called the *tab bar*. To remove a tabbed page from the tab bar, click the X button next to the tab's title. (If less than two tabs are active, the tab bar automatically disappears, unless you've enabled the Always Show Tab Bar check box on the Tabs pane of the Preferences dialog box.)

To be honest, I'm not a huge fan of tabs because I tend to surf the Web in a linear fashion and don't often keep multiple windows open. (Evidently, Apple thinks that most people fall in the same category because Tabbed browsing is disabled by default.) However, if you do a lot of comparison shopping or research, or you find yourself with a dozen Safari windows open at once, tabs might be just the ticket for you.

However, other methods of entering addresses are a bit easier than all that hunt-and-peck action:



- ✔ **Click a link:** If the page that's currently displayed includes an underlined link to another page, you can click the colored link text to jump to that page.  
  
Links can also be attached to images. You know when you're over a link because the mouse cursor changes to a pointing hand.
- ✔ **Use the Google search box:** A Google results page contains links to Web pages that match your search criteria. (More on Google later in the upcoming section, "It's a snap to search with Google.")
- ✔ **Double-click an HTML file:** If an application saves an HTML file on your drive, you can display that page by double-clicking the file icon to make Safari launch and load the page automatically. (HTML is the computer "language" of Web pages. When you visit a Web site on the Internet, you're actually receiving a series of commands that tell Safari what text to display and how to display it. These commands can also be saved as a file to your hard drive.)
- ✔ **Click a bookmark:** Bookmarks can appear on the Bookmarks menu or the bookmarks bar, and a single click automatically sends you to that site.
- ✔ **Click a Web address icon:** A Web address icon looks like a spring-loaded @ symbol. By default, the Tiger dock contains the perfect example. On

the right side of the dock, you see a Web address icon. Clicking that icon takes you to the Mac OS X home page on the Apple Web site, as shown in Figure 8-2. You can drag any Web address to the right side of the dock (to the right of the vertical line) to create your own dock Web address icon.

- ✓ **Drag-and-drop; cut-and-paste:** You can cut or copy a Web address from a document and paste it into the Safari address box. Often you can drag-and-drop an address into the address box as well.

## Putting the toolbar to work

You can specify which controls — buttons — should appear on the Safari toolbar. For example, if you don't use the Add a Bookmark button very often, you can hide it to make room for another control that sees more action:

- ✓ **To add a toolbar control:** Choose View⇧Customize Address Bar. A sheet appears in which you can drag controls to and from the toolbar.
- ✓ **To return to the default set of Safari toolbar controls:** Drag the preset default group back to the toolbar.

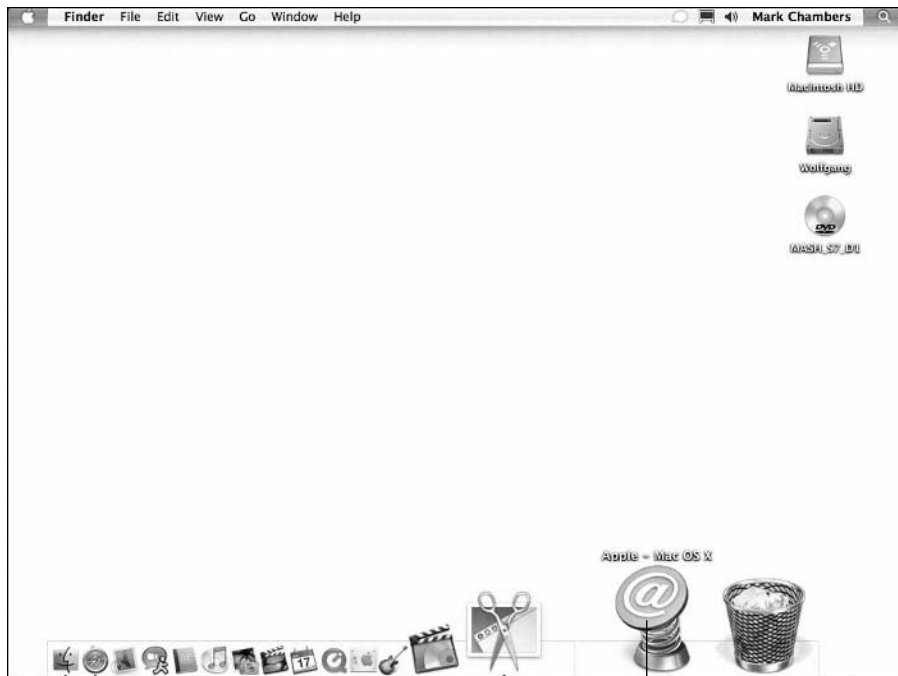

**Figure 8-2:**  
Add a Web  
page to the  
dock.

Click this Web address icon to launch Safari



## What about downloading?

The default Safari configuration can handle just about any type of download file you throw at it, including movies, MP3 audio, disk images, and executable applications. Just click the download link, and the Downloads window pops up to keep you informed of the status of the transfer. Things work the way they're supposed to, even the first time you run Safari after you unpack your new laptop.

However, I am going to persist in reminding you about the possibility of malicious files and the damage they can do to your system. These include viruses, *Trojan horses* (applications that appear to be harmless but are designed to do Very Bad Things), and Java applets. Here are the rules: *Never download or run any application from a Web site that you don't trust, and always run an antivirus application to scan anything you download.* Nuff said.

Although I discuss most of the Safari toolbar buttons earlier in this chapter, two or three don't appear on the default toolbar configuration. You can see them in Figure 8-3. Here's a rundown on the controls that you can add to the toolbar:

- ✔ **Home:** Click this button (which looks like a house) to return immediately to your home page. To find more on selecting a home page, see the "Putting down roots with a new home page" section, later in this chapter.
- ✔ **AutoFill:** This button (look for the pencil) is great if you do a lot of online shopping or regularly fill out forms online. Click AutoFill, and Safari does its best to automatically complete online forms with the information that you provide in the AutoFill section of the Safari Preferences dialog box. (Choose Safari⇨Preferences to display this dialog box.) You can choose to AutoFill with data from your personal Address Book card, and you can also specify whether AutoFill should take care of names and passwords.



AutoFill works its magic for *anyone* who's sitting at the keyboard. If your Mac is in a public location and you can't guarantee that you'll be the one using it (or you're worried about security in general), *fill out forms manually*. We're talking about *your* personal information here — even your login names and passwords, if you choose!

Don't provide any personal information to any Web site unless the connection is secure. Skip to the upcoming section, "Using secure connections."

- ✔ **Text size:** These two buttons (small and large capital As) allow you to decrease or increase the point size of the text on your Web pages. This feature is great for those who prefer larger text for better readability.

- ✔ **Bug:** Strange name, but a click of the Bug button (um, look for the spider-ant critter) helps Apple improve Safari! If you visit a Web page that doesn't display properly in Safari (hence the name *Bug*, which is developer-speak for an error in an application), click this button to display a sheet in which you can describe the problem. When you then click Submit, your Bug report is automatically sent to the hard-working Apple developers responsible for Safari, who check out the page themselves to see whether they can correct what's wrong for a future version of Safari. In fact, the Bug feature is one of the reasons why Apple was able to fine-tune Safari's compatibility so quickly after the browser was introduced.
- ✔ **Print Page:** Click this icon (printer, natch) to print the current page displayed in Safari.

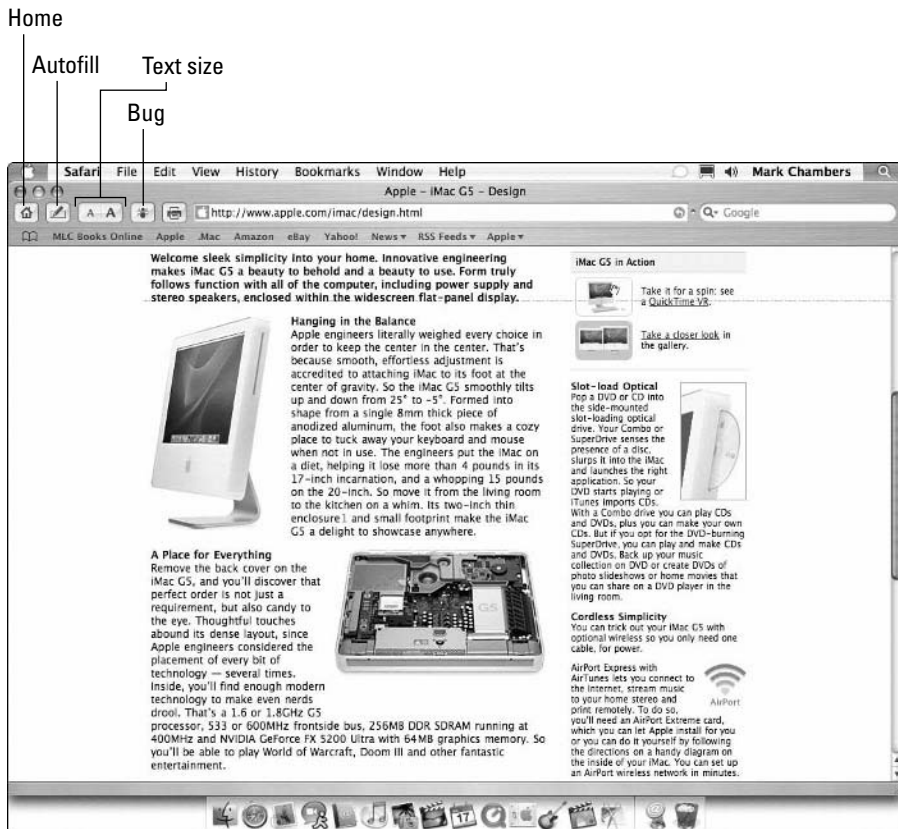

**Figure 8-3:**  
The lesser-known buttons on the Safari toolbar.



## *Searching for Specific Web Sites*

I honestly can't imagine how anyone could find anything on the Web without today's modern Web search engines. In my opinion, the best online Web search on the Internet can be found at the familiar Google.com home page. I've been using Google now for the last several years (long before it became oh-so trendy and fashionable). There's no better way to find that one Web page that offers a complete listing of the hair stylists Elvis used in 1958.

However, searching isn't always about where you're going — sometimes, it's more important to look where you've *been*. If you need to search through the Web sites that you visited in the recent past and return to a specific page, you need to comb Safari's History list.

Finally, Safari allows you to find specific text within the current page. And believe me, with some of the humongous, 23-screen behemoth pages that I've recently visited, you really appreciate the ability to zero in on the phrase *ripe avocado* in two or three seconds!

In this section, I jaw about all three of these search resources. Read along, and you'll be well prepared to search the Web sites behind you, under you, and in front of you.

### *It's a snap to search with Google*

Before Safari arrived on the scene, Mac owners had to bookmark Google.com, or make Google their home page — or, in the worst case, actually type the address manually. (Oh, the horror!) The designers and bigwigs at Apple knew that they wanted to beat Microsoft at the browser game, so they added the Google search box to the Safari toolbar . . . and knocked the pitch right out of the ballpark.

To search for something, simply click your mouse cursor on the Google search box on the Safari toolbar, type a word or short phrase, and press Return. Figure 8-4 illustrates the result of a search that I did using the phrase *Stradivarius violins*. If I had wanted to narrow the search to the most relevant pages, I could have enclosed the search text in quotes — "*Stradivarius violins*" — to search for precisely that text.

### *Looking back with the History list*

Safari's History list records any page visit. Click the History menu at any time to

- ✔ **Return to your home page:** You can also press **⌘+Shift+H** at any time.
- ✔ **Mark a page for SnapBack:** The first page that you open in a window (or the page that appears when you click a bookmark) is automatically set as the *SnapBack* page.
  - To return immediately to the SnapBack page, just click the orange SnapBack button that appears at the right end of the Address box.
  - To mark the active page as the SnapBack page, you can choose Mark Page for SnapBack from the History menu. (For example, if you were visiting the Apple site and you decide that you'd rather SnapBack to the Support page instead of the Apple welcome page, you would display the Support page and choose this command.)
- ✔ **Visit pages ordered by date:** You see a number of submenus, including Earlier Today and then previous days. To view the History list for an earlier date, move your mouse pointer over the desired date and then click the desired page.
- ✔ **Clear the list:** If you want to clear the History list — for security reasons or just to remove old entries — you can do so from the History menu.



**Figure 8-4:**  
The results  
of a Google  
search for  
the finest  
violins.

## *Searching the current page*

You can always press ⌘+F (or choose Edit⇨Find⇨Find) to display the Find dialog box. Type the word or phrase that you're looking for in the Find box and then click Next to display each occurrence in order, all the way to the bottom of the page. To search upward to the top of the page, click Previous.

Safari highlights any match that it finds and jumps to that spot within the page. Convenient indeed.

## *Safari Power User Tips and Tools*

Safari is easy to use and handles simple Web surfing as well as any other browser — click here, click there, and you're navigating the Web. But what about the features that a power user needs? They're here as well!

In this section, I mention the most popular features among the experienced Mac surfing set.

### *Putting down roots with a new home page*

You have a number of different ways to jump to your home page, but how do you *set* your home page in the first place? Follow these steps to move in to your new home page:

- 1. Visit the page that you want to use as your home page.**
- 2. Choose Safari⇨Preferences.**

The Safari Preferences dialog box appears.
- 3. Click Set to Current Page.**
- 4. Click the Close button (which carries an X) in the Preferences dialog box to return to your (new) home page.**

### *Organizing favorite spots with bookmarks*

Bookmarks make it easy to return to your favorite hangouts in cyberspace.



Sometimes a technology author has to use the same word over and over and yet even over again. In this section, I claim the world record for using the term *bookmark* — it's a small triumph, but I take whatever comes my way.

To set a bookmark for the current page, just click the Add a Bookmark button on the Safari toolbar, which looks like big plus sign. (There's high intelligence at work here, I'm telling you.)

Figure 8-5 illustrates the sheet that appears, in which you can

- ✓ Enter a name for the bookmark.
- ✓ Specify whether you want the bookmark to appear in the bookmarks bar, the Bookmarks menu, or an existing Bookmarks folder.

To return to a bookmark, use one of these methods:

- ✓ **Click a bookmark button on the bookmarks bar.**
- ✓ **Click the Bookmarks menu and select a bookmark.**
- ✓ **Press a Bookmark keyboard shortcut.** Safari assigns a keyboard shortcut to the keys that appear on the bookmarks bar. For example, pressing  $\text{⌘}+1$  is the same as clicking the first Bookmark button on the bookmarks bar.
- ✓ **Click the Show All Bookmarks button at the left side of the bookmarks bar.** A full-screen Bookmark library appears (see Figure 8-6), in which you can drag-and-drop all your bookmarks to the bookmarks bar, the Bookmarks menu, or to collection folders that you can create.

Collection folders are great for organizing; I have more than 200 bookmarks, and I'd need a separate computer to keep track of 'em if I didn't use collections. Anyway, you can Control-click (or right-click) on any bookmark in the Bookmarks screen to display the pop-up menu, and then click Open to display the page. To close the Bookmarks screen, just click the Show All Bookmarks button in the Safari toolbar a second time.



Your Address Book appears as a collection folder in the Bookmarks library screen. You can click this collection to immediately access all Web sites stored as contact information in your Address Book; then you can create bookmarks directly from those sites.

I now hereby close my record-setting *bookmark* section. Thank you.

**Figure 8-5:**  
Creating  
a new  
bookmark —  
a handy,  
powerful  
stuff.

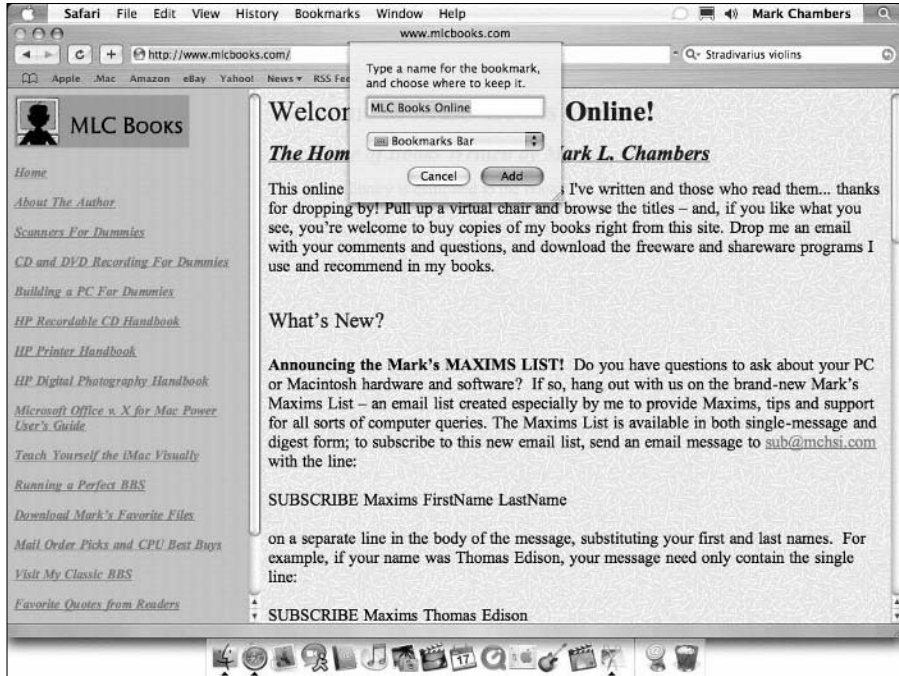

**Figure 8-6:**  
The  
Bookmarks  
library  
screen in  
action.

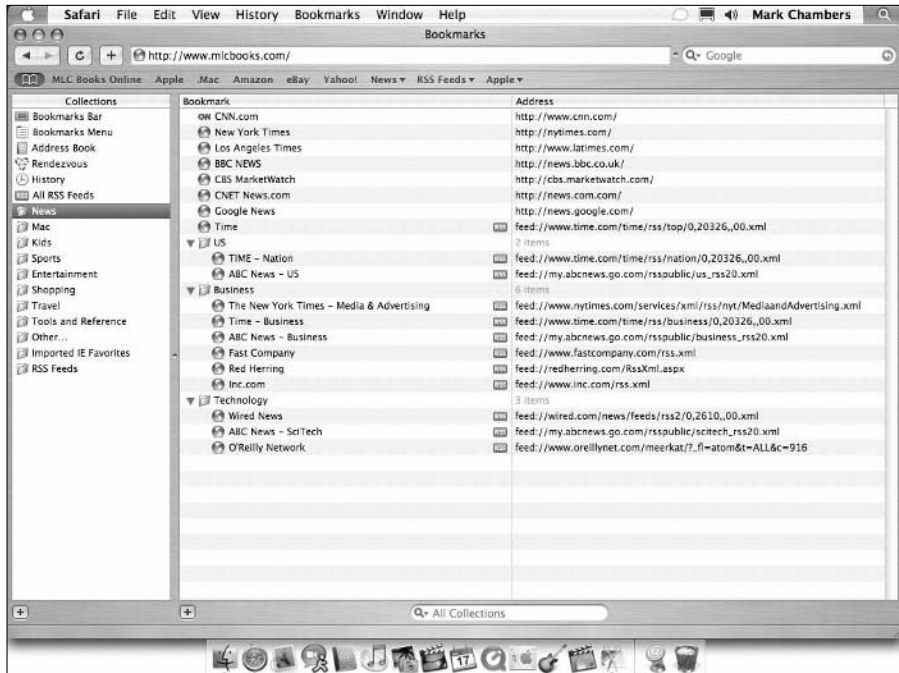

## Using secure connections

I love shopping on the Web, but I'm always cautious — and you should be, too. Safari indicates that your connection to the current Web page is secure (or encrypted) by displaying a padlock icon in the upper-right corner of the Safari window, as shown in Figure 8-7.

Here comes the only rule that you have to remember about secure connections in Safari. (In fact, it's a Mark's Maxim.)



*Never* — I mean *never* — enter any valuable personal or financial information on a Web page unless you see the secure connection padlock symbol.

This type of information includes

- ✓ Obvious things such as your credit card number, address, and telephone number
- ✓ Not-so-obvious things such as your Social Security number and a login/password combination

Padlock

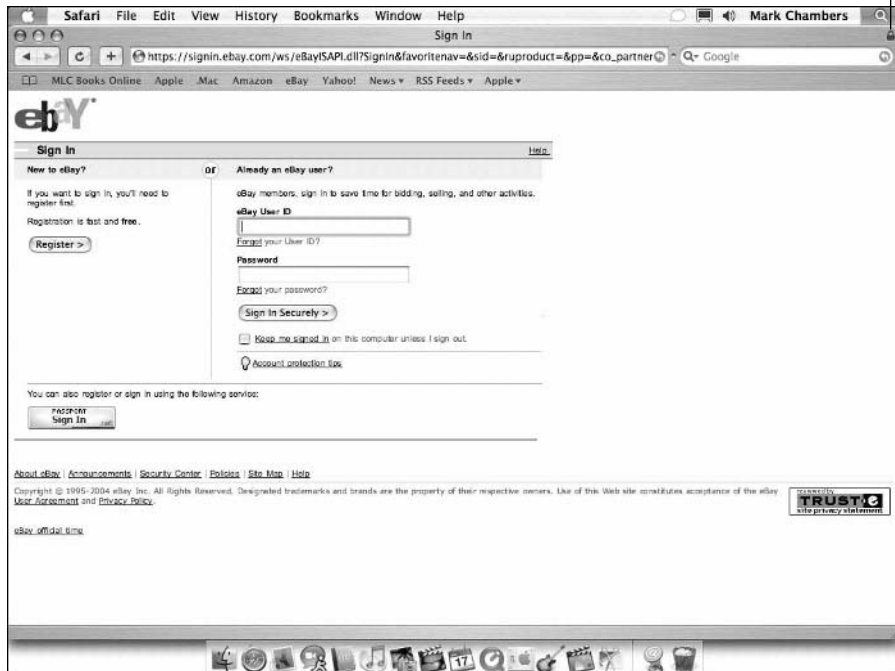

**Figure 8-7:**  
eBay provides a secure connection when you're entering your ID and password.



If a site doesn't provide a secure connection and asks you for personal information, *find another spot in cyberspace to do your business*. Your identity should remain yours.

## Reading RSS feeds

Almost time to exit stage right, but before leaving this discussion of Safari, I want to cover a feature that's new with Tiger: Safari now has the ability to receive *RSS* (short for *RDF Site Summary*) newsfeeds. A Web site that provides RSS content sends updated news or information in a short headline format — almost like the old AP and UPI teletype machines that newspapers once used. You can recognize RSS Web addresses by their `feed://` prefixes.

Safari displays RSS headlines in a list format. They're easy to scan with a glance, with no popup advertisements or unnecessary graphics, either.



A square blue RSS icon appears at the right side of the address box to let you know that the Web server you're visiting has RSS feeds available. Click this RSS icon to display the newsfeed provided by that Web server.

The RSS feature has its own pane in the Safari Preferences dialog box, in which you can specify the time delay before Safari checks for updated articles. You can also assign a color to new articles, which is a great help for those who like to ride the latest tech wave (like I do). RSS feeds can be bookmarked just like a typical Web page, too, and Apple provides a number of RSS sites as a default drop-down list on the bookmarks bar.

## Chapter 9

# .Mac Is .Made for Mac Laptops

---

### *In This Chapter*

- ▶ Understanding online storage
  - ▶ Opening a new .Mac account
  - ▶ Using your iDisk
  - ▶ Backing up your hard drive using .Mac
- 

**R**eaders often ask me to name my favorite reasons why they should switch — that is, why should a Windows user who *thinks* all is well move to the Apple universe? Of course, I always mention the superior hardware and how much of a better job Tiger does as an operating system. But here's my favorite selling point: "Apple simply does things right the first time, and everyone else plays catch-up."

And then I pose this question: "What if you could reach a hard drive with 1GB of your files over any Internet connection — anywhere in the world — and it just *showed up* on your desktop automatically?" Usually, I get a thoughtful silence after that one, and another person decides to learn more — about Apple's .Mac online hosting service, that is. In this chapter, I save you the trouble of researching all the benefits of .Mac. Heck, that's one of the reasons why you bought this book, right?

## *Where Is My .Mac Stuff Stored?*

The question that everyone asks is, "Where is my .Mac stuff stored?" Best that I answer this one first. I'll begin with a definition. The online hard drive offered to .Mac subscribers (read about subscribing in the following section) is an *iDisk*, and it's well integrated into Mac OS X. In fact, if you didn't know the background, you might think that iDisk was simply another internal hard drive. Figure 9-1 illustrates my iDisk icon on my desktop. The Finder window displays the contents; notice the folders visible there. (More on these folders later in the chapter.)



**Figure 9-1:**  
My iDisk at  
work. Looks  
like a  
normal hard  
drive,  
doesn't it?

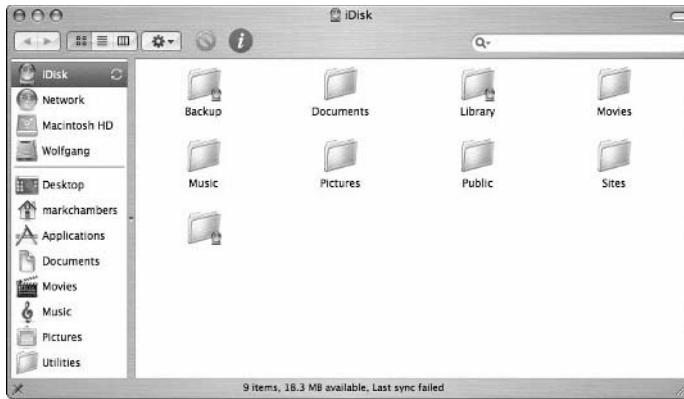

The files that I add to my iDisk are stored on an Apple server, location unknown. Literally. The physical storage (a massive file server that holds uncounted gigabytes of data) could be in Cupertino, or it might be in Timbuktu. There's a whole bunch of storage sites, too. You and I don't need to care about the *where* part because

- ✔ **Your iDisk is always available.** Oh, yes. 24/7, your files are waiting for you.
- ✔ **Your iDisk is secure.** Apple goes to great lengths to guarantee the security of your data, encrypting the transfer of files and folders whenever you use your iDisk. You can also password-protect any data that you want to offer to others, just in case.
- ✔ **Your iDisk works even when you aren't on the Internet.** Yep, you read that right: You can create new documents and modify files to your heart's content while you're on a flight or relaxing on the beach. iDisk automatically updates whatever's changed the next time you connect to the Internet.

## Is .Mac an ISP?

.Mac is many things, but it isn't an ISP. You need to join an ISP first because you need an existing Internet connection to use the services and features included in .Mac membership. This makes a lot of sense, considering that most of us already have Internet access. (Plus, Apple doesn't have to worry with all the support and

hardware headaches that an ISP has to deal with.) .Mac works with the ISP that you already have, so you don't have to worry about AOL or EarthLink conflicting with .Mac. (However, I can't guarantee that your system administrator at work will allow .Mac traffic across his or her pristine network..)

Now that I've piqued your interest (and answered the most common questions about iDisk), return to the .Mac service for a moment so I can show you how to set up your account.

## Opening a .Mac Account

If you haven't already opened your .Mac account, you get a chance to sign up when you turn on your Mac for the first time and also when you install (or upgrade) Mac OS X. However, if you decided to pass on .Mac at that time, you can always join in the fun by following these steps:

1. Click the **System Preferences icon on the dock.**
2. Click the **.Mac icon.**
3. Click the **Sign Up button.**

Safari launches and displays Apple's .Mac Welcome page ([www.mac.com](http://www.mac.com), .Mac tab).

4. Follow the onscreen instructions for choosing a member name and password.

When you've finished, you're rewarded with your login information.

5. Close Safari.
6. Enter your name and password into the text boxes in the .Mac System Preferences pane.

Figure 9-2 illustrates an example login that I created.



**Figure 9-2:** The .Mac pane in System Preferences keeps track of your login information.

Like the convenient operating system that it is, Tiger handles all your .Mac login chores automatically from this point on.



If you're a dialup Internet user, you were dreading this moment. Here it is. I'm truly sorry, but in my opinion, a high-speed broadband connection is a requirement to take full advantage of a .Mac subscription. You can certainly still use all the functionality of .Mac with any type of Internet connection, but you're going to spend from now until the next Democratic presidency waiting for files to copy and things to happen.

If you decide to sign up for a full year's .Mac membership, I salute you for your discerning taste in online services. However, you can also opt for a 60-day trial subscription at this point, to check out things at your leisure. Table 9-1 shows the major storage differences between a free trial subscription and a full \$100 yearly subscription to .Mac.

<i>Status</i>	<i>iDisk/E-Mail Storage</i>	<i>Data Transfer Limit</i>	<i>Backup</i>
Trial	50MB total	1GB/Month	100MB limit
Subscriber	1GB total	10GB/Month	No limit



A .Mac subscription also allows you to synchronize your e-mail, Address Book contact information, and Safari bookmarks between multiple Macs. What a boon when you're on the road with your laptop!

As a trial member to .Mac, you're limited to reading your .Mac e-mail through the Web-based browser offered on the .Mac Web site, as shown in Figure 9-3. That's neat, certainly, and you can use Web mail from any computer with an Internet connection. However, as a full subscriber, you can also send and receive .Mac e-mail seamlessly from Tiger's Mail application, which is the preferred method for checking your messages.

If you decide that you want the extra functionality of a .Mac subscription, upgrading is easy. When you open the .Mac pane in System Preferences and click the iDisk button, Tiger displays a countdown reminder telling you how many days remain on your trial period. Just click Join Now to upgrade. You can also visit the .Mac Web site at any time and click Join Now to access the same Web-based subscription system.

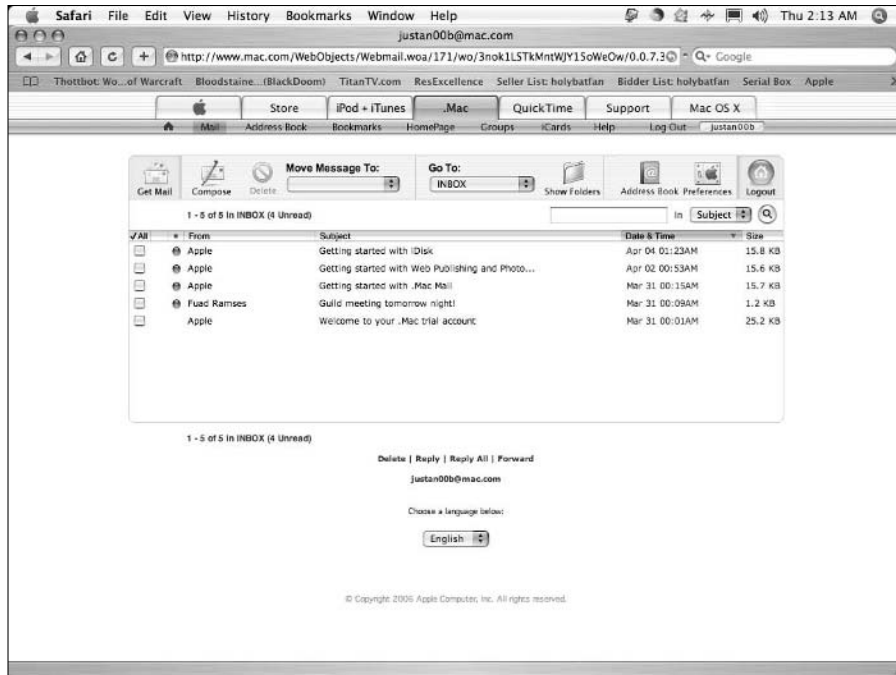

**Figure 9-3:**  
The .Mac  
Web-based  
e-mail  
system.

Besides the features that I discuss at length in this chapter that are of special interest to road warriors, your .Mac subscription also provides support for

- ✓ Web site creation and hosting using iWeb and HomePage
- ✓ *Photocasting* (where you can automatically update your online photo albums and share them with others)
- ✓ *Blogging* (the now-almost-banal art form that involves sharing an online journal with the world at large)

## Using Your iDisk on the Road

So how do you open your iDisk? Tiger gives you a number of different avenues:

- ✓ **Choose Go → iDisk from the Finder menu and then choose My iDisk from the submenu.** Keyboard types can press ⌘+Shift+I instead. The Finder Go menu also includes a shortcut to access another .Mac member's Public folder.

- ✓ **Click the iDisk icon in the Finder window sidebar.**
- ✓ **Click the iDisk button on your Finder toolbar.** It's easy to add an iDisk button. Open a Finder window, and then choose View⇨Customize Toolbar. Drag the iDisk icon up to the toolbar and click Done.

After you open your iDisk, an iDisk volume icon also pops up on your desktop. You can open the little scamp later in your computing session by simply double-clicking it. The desktop iDisk icon hangs around until you log out, restart, or shut down your laptop.

## *It's all in the folders*

Your iDisk contains a number of different folders. Some are similar to the subfolders in your Home folder, but others are unique to the structure of your iDisk. In this section, I provide the details on the iDisk folder family.



You can't store files or create folders in the root (or top level) of an iDisk.

### *Storage folders*

Everything that you copy to or create on your iDisk must be stored in one of these six folders (refer to Figure 9-1 to see them):

- ✓ **Documents:** Store the documents that you create with your applications in this folder, which only you can access.
- ✓ **Movies:** This folder stores your QuickTime movies (including any that you might use in your .Mac Web pages).
- ✓ **Music:** iTunes music and playlists go here.
- ✓ **Pictures:** JPEG and GIF digital images that you store in this folder can be used with other .Mac services (such as your Web pages) or in iPhoto.
- ✓ **Public:** The files that you store in this folder are meant to be shared with other people (as well as offered on your .Mac Web pages). You can also allow others to copy and save files to your Public folder (more on this later in this section).
- ✓ **Sites:** You can use HomePage to create Web pages in this folder, or you can add Web pages that you've created with your own applications.

These folders can be opened in a Finder window just like any typical folder on your laptop's internal hard drive, and you can open and save documents to your iDisk folders using all your applications. In other words, these six iDisk folders act just like normal, everyday folders. Pretty doggone neat!

### *Funky specialized folders*

Your iDisk contains three folders that you *can't* use to store stuff (directly, anyway):



- ✓ **Backup:** This is the storage vault for the backup files created with the .Mac Backup application.

Because you have read access to the Backup folder, you can copy the backup files from this folder to a CD, DVD, or removable drive on your Mac. (I cover backing up later in this chapter.)

- ✓ **Library:** Like the Library folders that you find in the root of your hard drive (and in your Home folder), this folder stores all sorts of configuration settings for the .Mac features that you're using, such as your Backup settings.

- ✓ **Software:** This read-only folder is a special case. Apple stuffs this folder full of a wide variety of the latest in freeware and shareware as well as commercial demo software. You can copy whatever you like from the Software folder to your Mac's desktop and then install your new toy from that local copy. (Oh, and the contents of the Software folder don't count against your total storage space limit.) Enjoy!

## *Mirror, mirror, on your drive . . .*

You can use your iDisk even if you aren't connected to the Internet. This magic is accomplished through a *mirror*, or local copy of your iDisk, that's stored on your local hard drive. ("Hey, wasn't I supposed to be getting *away* from storing things locally?") If you choose to use a mirror — you can disable this feature if you like — Tiger automatically synchronizes any files that you've created or changed on your local iDisk copy the next time you connect to the Internet. This is a great feature if you have Macs in different locations because you can update and synchronize your iDisk files from any of your computers — automatically!



Without a mirror, you *must* have an active Internet connection to use iDisk.

To enable (or disable) the mirror feature, open System Preferences, click the .Mac icon, and then click the iDisk tab to display the settings you see in Figure 9-4. Click the Start button, and — after a moment of preparation, complete with its own dialog box — the text above the button reads iDisk Syncing On.



If you use a copy of your iDisk on your hard drive — and I recommend it — choose to synchronize automatically. This ensures that your files get updated even if you're somewhat forgetful, like I am.



**Figure 9-4:**  
Configure  
iDisk within  
System  
Preferences.



A mirror makes things much faster when you browse your iDisk or when you save and load documents from your iDisk. Tiger actually uses your local copy from your hard drive and then updates your remote iDisk files in the background while you work. (Tiger is updating your iDisk whenever you see that silly animated circular-yin-yang-thinglet rotating next to your iDisk icon in the Finder window. You'll know it when you see it.)

## *Monitoring and configuring your iDisk*

The iDisk tab in System Preferences groups all the configuration settings you can make to your iDisk and your .Mac account. In this section, I review the controls you'll find here.

At the top of the tab is the iDisk Storage area. Concerned about how much of your 25MB (for trial users) or 250MB (for subscribers) remains? The Disk Space bar graph displays how much of your iDisk space is free. The middle section, which I discussed in the preceding section, allows you to create a local copy of your iDisk on your hard drive. At the bottom of the tab are the settings for your Public folder.

I strongly recommend that you set a password to protect the contents of your Public folder — click the Password Protect Your Public Folder check box to enable it, and then click the Set Password button to enter a new password. Then anyone trying to open your Public folder must enter the password. If you haven't supplied that person with the proper password, he can't open your Public folder. It's that simple. (There's nothing more embarrassing than discovering that the bikini shots from your vacation are available for every .Mac user to peruse.)

## Putting .Mac Mail to work

If you decide to take advantage of a .Mac subscription, you can easily set up Tiger's Mail application to send and receive messages from your .Mac address. Launch the Mail application, and then choose Mail⇨Preferences. Click the Accounts button in the toolbar, and then click the Add button (which sports a plus sign) at the bottom of the window. Click the Account Type pop-up menu and then click .Mac. Type a description, press tab to complete the other

fields, including your full name, .Mac name, and password. When everything's filled in, click the Close button on the Preferences window, and then click Save when prompted by Mail. That's it! You created a new account for your .Mac messages, and you can now retrieve them on your laptop and through the Web mail system at [www.mac.com](http://www.mac.com). In fact, Mail is probably pulling down at least two messages from Apple as you read this.



This extra level of security has one drawback. If you password-protect your Public folder, it can't be used to store anything that you offer on your .Mac Web pages.

While you're in the iDisk tab, you can configure your Public folder security settings. You can decide whether others should be able to

- ✓ Only read the contents of your Public folder. By default, the Public folder is set to read-only.
- ✓ Copy documents to your Public folder. To give others the ability to save and copy, select the Read & Write radio button.

## Back Up Your Laptop with .Mac

My editors have heard me drone on and on long enough about how important it is to back up your hard drive. They probably rub their eyes when they encounter yet another instance of my preaching about *the wages of backup sloth and losing everything but hindsight*.

Well, you're lucky, because I was just about to launch into another round of backup warnings. .Mac subscribers get a great utility application called Backup 3 when they join the club. Backup is a great application that saves a copy of your treasured data on just about any media on the planet, including

- ✓ Your iDisk (using the Backup folder I describe earlier in this chapter)
- ✓ An external USB or FireWire hard drive



- ✓ Recordable CD or DVD media
- ✓ Network servers
- ✓ Your iPod



Before you get too enthusiastic about backing up to your iPod, heed this: Your iPod's tiny hard drive isn't meant to handle the same serious thrashing as a full-size external hard drive. Personally, I've never used my iPod as a backup destination, and I don't recommend that you do either (unless no other recording media is handy and you absolutely must have a backup).

## *Installing Backup*

Backup isn't built into Tiger; you have to download it from the .Mac site at [www.mac.com](http://www.mac.com). After the compressed image file has been downloaded and mounted on your desktop, you see the Backup installation folder. Double-click the `Backup.pkg` file to begin the installation. After installation is complete, you can find Backup in your Applications folder.

## *Saving your stuff*

Nothing is more important to a proud Mac laptop owner than a secure backup. In this section, I demonstrate how you can produce both manual backups (whenever you like) and automated backups (which are scheduled at regular intervals). *Do it!*

### *Manual backups*

After you've double-clicked the Backup application, you're presented with the main Backup window. Beginning a backup is as easy as selecting the check boxes next to the items that you want to safeguard and then clicking Continue. Figure 9-5 shows the default backup sets (or *plans*) provided by Apple. If one or more of these plans fit the bill, you need only click Back Up; by default, the data is saved to CD or DVD media.

"But wait. What if I want to select folders or files for my backup that aren't in the default plans?" No problem, just create your own plan as follows:

- 1. From the main Backup window, Click the Add button under Backup Items — which bears a plus sign.**
- 2. Click the Custom plan, and then click Choose Plan.**
- 3. In the box at the top, type a new plan name for this group of files.**
- 4. Click the Add button.**

Backup opens a file/folder selection sheet.

5. Click the **Files and Folders** button.
6. **Navigate to the file or folder that you want to back up and click it to select it.**
7. **Click Include this folder, and then click Done.**  
You return to the Custom Plan dialog box.  
You're limited to backing up a total of 100MB with a trial membership.
8. **Click the Add button (again, bearing a plus sign) under Destination and Schedule.**
9. **Choose a destination and a folder to store the data using the Destination and Folder pop-up menus.**
10. **Click OK to save your changes.**
11. **In the Custom Plan dialog box, click Backup Now.**

The rest is cake as your irreplaceable stuff is saved to your destination.



**Figure 9-5:**  
Backup 3  
represents  
online  
peace of  
mind.



If you just want to create a new plan and don't need to back up data immediately, click Close in the Custom Plan dialog box instead of Backup Now to save your changes and return to the Backup window.

If you ever need to restore from your backup, click the desired plan from the Backup window and then click Restore. Backup leads you through the restore process with the same aplomb.

### *Scheduled automatic backups*

You can schedule unattended backups with Backup. To add or edit a schedule for an existing plan, select it in the Backup window list and click the Action button (which bears a tiny gear symbol). A drop-down menu appears. Click Edit, and the Plan dialog box appears, allowing you to make changes to the items, destination, or schedule for that plan.

To add a schedule for a new plan, use the schedule option that appears while you're selecting a destination (Steps 8 through 10 in the preceding section). Follow these steps to set things up for automatic backup goodness:

- 1. On the Destination and Schedule sheet, select the Automatically Back Up at the Following Times check box.**
- 2. Click the pop-up menus next to the options:**
  - Select the time period (Day, Week, Month, 3 Months, or 6 Months) depending on how often your files are changed.
  - Set the backup time of day (and day of the week or month, if necessary).
- 3. Click OK.**
- 4. If you don't want to back up the data immediately, click the Close button in the Custom Plan dialog box.**

Your next scheduled backup time appears beside your custom plan in the list.

The Backup 3 application itself doesn't need to be running for the automated backup to kick off.



Scheduled backups require that

- ✓ **Your laptop remains awake.** Make sure that you're logged in and that Sleep mode is disabled on the Energy Saver pane in System Preferences.
- ✓ **Your Mac has something to write on:**
  - *If you're saving to iDisk*, your laptop must make an Internet connection.
  - *If you're saving to CD or DVD*, blank media must be loaded.
  - *If you're saving to an external drive or iPod*, that device must be connected and turned on.

## Chapter 10

# Spiffy Connections for the Road Warrior

---

### *In This Chapter*

- ▶ Adding a printer or scanner to your system
  - ▶ Working with your iSight camera
  - ▶ Using Front Row and the Apple remote
- 

**T**his chapter is all about getting interesting things into — and out of — your MacBook or MacBook Pro. Some are more common (almost mundane these days) and pretty easy to take care of, such as scanners and printers. Then I might surprise you with something new to you, such as the iSight video camera, which is built into your laptop and the perfect companion to Photo Booth and iChat AV.

I also show you how to use your Apple remote with the magnificent Front Row menu application. Control your laptop wirelessly from across the room (or use your keyboard if your remote is hiding somewhere between the couch cushions).

Sure, you can connect your MacBook Pro to a printer and do some serious work — but then again, you could snap your photo and send it to your friends as an e-mail attachment or upload it to your blog. Decisions, decisions!

## *Connecting USB and Network Printers*

All hail the USB port! It's the primary connection point for all sorts of goodies. In this section, I concentrate on adding a USB printer and a typical USB scanner to your system.

If you're itching to connect a USB digital camera for use with iPhoto, let me redirect you to Chapter 12, where I cover the iPhoto experience in depth.

## USB printers

Connecting a USB printer to your Mac is duck soup. Don't you wish all things in life were this easy? You might very well be able to skip most of the steps in this section, depending on whether your printer came with an installation disc. (Virtually all do, but you may have bought yours used from eBay or elsewhere.



Your printer needs to be fully supported in Mac OS X:

- ✓ If the software is designed for earlier versions of Mac OS X (such as 10.2 or 10.3), it probably works with Tiger.
- ✓ I *always* recommend visiting the manufacturer's Web site to download the latest printer driver and support software after you install your printer. That way, you know that you're up-to-date.



Save and close your files before installing your printer. You might have to restart your laptop to complete the installation.

The physical connections for your printer are simple:

- ✓ Make sure that your printer's USB cable is plugged into both your Mac and the printer itself.
- ✓ The printer should be plugged into an AC wall socket and turned on (after the USB connection has been made).

Don't forget to add the paper!

The finishing printer installation steps depend on whether or not you have a manufacturer's installation CD for your printer.

### *Sure, I have the install disc*

If your printer comes with the manufacturer's installation disc, follow these steps when everything is connected and powered on:



**1. Insert the installation disc in your laptop's optical drive.**

The disc contents usually appear in a Finder window. If they don't, double-click the installation disc icon on the desktop to open the window.

**2. Double-click the installation application to start the ball rolling.**

**3. Follow the onscreen instructions.**

Files get copied to your hard drive.

**4. You might have to restart your Mac.**

You're ready to print!



Don't forget to visit your printer manufacturer's Web site to check whether any driver updates are available for your particular model.

### *Whoops, I have diddly-squat — software-wise*

Didn't get an installation CD? Try installing the printer without software or downloading the software from the manufacturer's Web site.

If you didn't get an installation CD with your printer, maybe you're lucky enough that your printer's driver was included in your installation of Mac OS X. Here's how to check for that pesky driver after you connect the printer and switch it on:



- 1. Open a Finder window and navigate to the Utilities folder.**

The Utilities folder is usually inside your Applications folder.

- 2. Double-click the Printer Setup Utility icon.**

- 3. Check the Printer list in the Printer Setup Utility window to see whether your printer has already been added automatically in Tiger.**

Figure 10-1 shows an example. If your printer appears here, dance a celebratory jig. You can close the Utility window and choose that printer from the Print dialog box in your applications.



**Figure 10-1:** If Mac OS X recognizes your printer, you're ready to go.

If you don't have installation software and your Mac doesn't automatically match the printer with a driver, adding the printer manually is your last installation option. Follow these steps:

- 1. Open a Finder window and navigate to the Utilities folder.**

- 2. Double-click the Printer Setup Utility icon.**

- 3. Click the Add icon on the Printer Setup Utility toolbar.**

- 4. Click the Print Using pop-up menu.**

The list of supported printer models appears.

### 5. Click the closest match to your printer in the Print Using list.

Figure 10-2 shows an example of some of the printer models recognized in Tiger. If you don't find an exact match for your printer, you have a couple of options:

- Look for just the brand name, such as EPSON.
- Try the generic USB setting. If you choose USB, Tiger defaults to Auto Select for the printer model. You can manually change this if the automatic selection wasn't right.

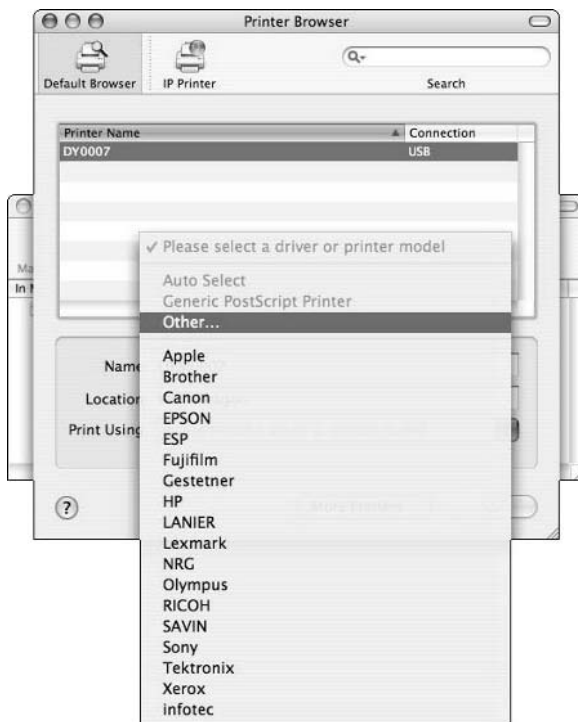

**Figure 10-2:**  
Choosing  
my  
LabelWriter  
from the  
Add sheet's  
drop-down  
list.

### 6. Click Add.

The other option is to check the manufacturer's Web site for your printer's software. Look for special software drivers that the printer might need and installation applications. If the manufacturer offers an installation application for your printer, download the application and run it.



Install any drivers you find *before* you run an installation application.

## Networked printers

Need to access a shared or networked printer? Business travelers know all about using “foreign” printers whenever possible! In case you’ve never made a printer connection to a well-connected (network) printer, here’s a rundown on what your laptop can use:

- ✓ **Ethernet wired networks.** You can use a printer that’s shared on another computer on your network or a printer with standalone network hardware.
- ✓ **AirPort and AirPort Extreme Wireless networks — if your Mac laptop has AirPort or AirPort Extreme hardware.** You can also use printers on wireless networks that don’t use Apple hardware, as long as those networks are Wi-Fi certified 802.11b or 802.11g.
- ✓ **Wireless networks that don’t use Apple hardware, as long as those networks are Wi-Fi certified 802.11b or 802.11g.**



If you’re printing over any network, you need these snippets of information for the printer:

- ✓ The shared printer name (for this info, ask the network administrator or the person using the computer to which the shared printer is connected)
- ✓ The Workgroup name (for shared printers connected to a PC running Windows)

If the printer is connected to a Macintosh computer on your network, you don’t have to configure anything on your Mac. When you want to use the printer, just select it from the Printer drop-down list box in the Print dialog box.

If the printer is connected to a Windows PC, you have to set up the printer before you use it. Follow these steps:

### 1. Run Printer Setup Utility.

“Hey, can’t I reach the functionality that Printer Setup Utility offers from System Preferences?” Yep, indeed you can. Click Print & Fax, and then click the Add Printer button (which carries a plus sign). Tiger launches the Printer Setup Utility, and you’re in business.

### 2. Click Add.

### 3. Click the More Printers button.

Choose Windows Printing from the first pop-up menu.

### 4. Choose the Workgroup name from the second pop-up menu.

The available network printers appear in the Printer list.

### 5. Click the desired printer name and then click Add.



## Connecting Scanners

USB and FireWire scanners practically install themselves. As long as the model is listed as Mac OS X compatible and it supports the TWAIN device standard (just about all scanners do), things really *are* plug-and-play.

If you have the scanner manufacturer's installation disc, go ahead and use it. However, most scanners don't require specialized drivers, so even that orphan model that you picked up from Uncle Milton last year should work (if it's recognized by Mac OS X). It doesn't hurt to check the manufacturer's Web site to see whether any of the software has been updated since the disc was produced.



If your older scanner isn't supported by Mac OS X, a third-party application may be able to help. Get thee hence to Hamrick Software at [www.hamrick.com](http://www.hamrick.com) and download a copy of the latest version of VueScan. This great scanning application supports more than 500 scanner models, including a number that don't work with Tiger otherwise. At \$50, it's a world-class bargain to boot.

Ready to go? Make sure that your scanner is powered on and connected to your Mac (and that you load a page or photograph to scan). If your scanner's installation disc provided you a proprietary scanning application, I recommend that you use that application to test your scanner. In fact, it's Mark's Maxim time!



If your printer or scanner includes bundled applications, *use* them!

Sure, Mac OS X has the Printer Setup Utility for printers and the Image Capture application for scanners and digital cameras, but these are bare-bones tools compared with the print manager and image acquisition software that comes bundled with your hardware. I turn to Tiger's built-in hardware handling stuff only when I don't have anything better.

Hey, I'm not saying that anything's wrong with Image Capture (shown in Figure 10-3), which is in your Applications folder. However, don't expect Image Capture to support any specialized features offered by your scanner (such as one-button e-mail or Web publishing). You have to use the application especially designed for your manufacturer and model to take advantage of any extras that it offers.

**Figure 10-3:**  
Preparing  
to inhale  
images with  
Image  
Capture.



## Putting Your iSight Camera to Work

When I first got started in computers in the early '80s, the very idea of chatting with someone in full-motion color video with sound was the stuff of dreams — or you were watching the TV show *Buck Rogers in the 25th Century*. (Remember that one, with Gil Gerard and Erin Gray?) Your camera and your VCR were analog . . . *if* you could afford such luxuries.

Ah, what a difference two decades make. Now you can use the Dynamic Duo of your laptop's iSight camera (check it out in Figure 10-4) and Tiger's iSight-savvy software. With iChat AV, you can videoconference in style, and with Photo Booth you can snap digital pictures just like the old automatic photo booth at your local arcade. Heck, if you like, you can even capture live video for use in iMovie HD!

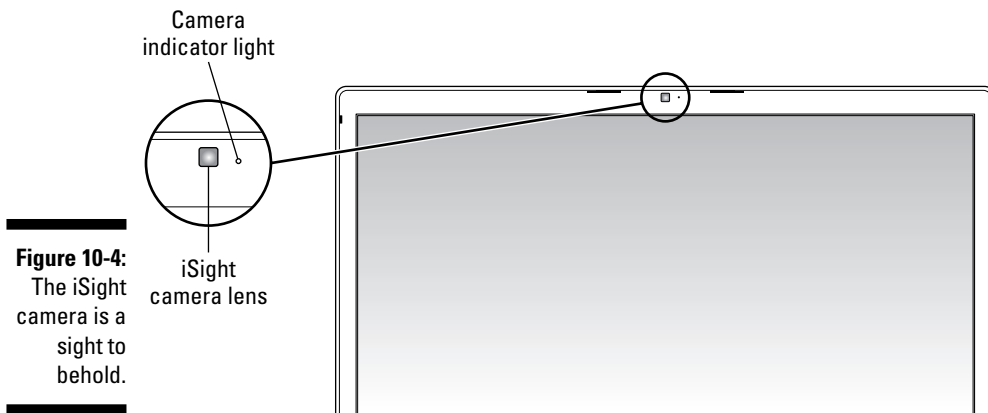

**Figure 10-4:**  
The iSight camera is a sight to behold.

Your iSight camera's indicator light will glow green whenever you're taking a snapshot or recording video (just to make sure you're not caught "indisposed" in front of your friends and coworkers).

If you're using an older Mac laptop that doesn't include a built-in iSight camera, you can still buy the external model from Apple and continue merrily on your way.

## Using iSight with iChat AV

Although your MacBook comes ready for videoconferencing, you should understand two caveats before embarking on the Voyage of Video Chat:

- ✔ **Speed is an issue.** To take advantage of video in iChat AV, you need a fast Internet connection — at least high-speed DSL or cable Internet, or even a connection between computers on the same network.
- ✔ **All participants need a video camera.** Plenty of folks online have bought an iSight camera and then suddenly realized that most of their iChat AV buddies didn't have video capability!

Even with an iSight camera installed, you can still join text-based and audio chats. (Your Mac has a built-in microphone, so even if your online buddies aren't equipped with video hardware, you can enjoy an audio chat.) iChat AV displays audio and video buttons next to each person on your buddy list to help you keep track of who can communicate with you and how they can do it.

Starting a video chat is as simple as launching iChat AV from the dock (or from your Application folder). Then in the buddy list, click any buddy entry with a Camera button next to it to connect.

## *Using iSight with Photo Booth*

With Photo Booth, you can always snap a quick picture of yourself for use on your Web page or even for safekeeping in your iPhoto library. Although the photos it can capture at 640 x 480 resolution are nowhere near as high a quality as those produced by today's crop of digital cameras, everything's built-in, so there's no need to drag your Canon or Nikon from town to town or classroom to classroom.

To snap an image in Photo Booth, follow these steps:

- 1. Launch Photo Booth from the dock or from the Applications folder.**
- 2. (Optional) Choose an effect you'd like to apply to your image.**

Photo Booth can produce some of the simple effects you may be familiar with from Photoshop, such as a black-and-white image or a fancy colored pencil filter. Although you can always launch your favorite image editor afterwards to use a filter or effect on a photo — for example, the effects available in iPhoto — Photo Booth can apply these effects automatically as soon as you take the picture.

- 3. Click the Camera button.**

Photo Booth allows you to save your image directly to your iPhoto library, or you can save it to your hard drive for later use.

## *Using iSight with iMovie HD*

“Wait a second, Mark, don’t I need an expensive digital camcorder to produce video clips for use in iMovie HD?” Definitely not! In fact, your laptop’s iSight camera can capture those clips for you — think of the party possibilities! (Or the opportunity for practical jokes. But then again, you’re not that kind of person, now *are* you?)

To capture video directly from your iSight camera into iMovie HD, follow these steps:

- 1. Launch iMovie HD from the dock or from the Applications folder.**
- 2. Click the Import Video/Editing switch (the toggle switch under the monitor window that sports camera and scissors icons) to switch to Import Video mode.**
- 3. Click the Camera icon (which is just to the left of the Import Video/Editing switch) to display the pop-up menu, and click Built-in iSight.**
- 4. When you’re ready to start recording video, click the Record with iSight button.**

iMovie HD automatically displays the incoming video in the monitor window as it’s recorded. (As you might expect, the goofy behavior on the part of the distinguished cast usually starts at about this moment.)

- 5. Click the Record with iSight button again to stop recording.**

After you’ve ended the recording, iMovie HD creates the video clip and adds it to your Clips pane.

I go into a lot more detail on iMovie HD in Chapter 13, but that’s the gist of recording video clips with your MacBook or MacBook Pro.

## *Performing Magic with Front Row and the Apple Remote*

Your Mac laptop’s beautiful LCD screen would seem to be the perfect artist’s canvas or the ideal display for your image editing, presentations, and important documents. However, with Apple’s Front Row software, you can do much more than paint, present, or edit images, and you don’t even have to touch the keyboard (unless you decide to, that is).

In fact, Front Row has four distinct functions:

- **Watching DVD movies using DVD Player:** If you've already loaded a DVD into your optical drive, you can watch it. (Sorry, your Mac laptop will not load the DVD for you. I guess *some* things have to remain manually driven for a few years yet.)
- **Viewing photos and slide shows:** Front Row calls upon iPhoto, so that you can see your albums, film rolls, and slide shows.
- **Displaying videos using QuickTime Player:** You can choose any video you've downloaded from the iTunes Music Store or saved to your Movies folder.
- **Coaxing your favorite music from your iTunes library:** You'll find your songs and playlists available from Front Row.

All this is accomplished with the simple infrared Apple remote you see in Figure 10-5. Like everything from Apple, it's simple, well-designed, and downright elegant.

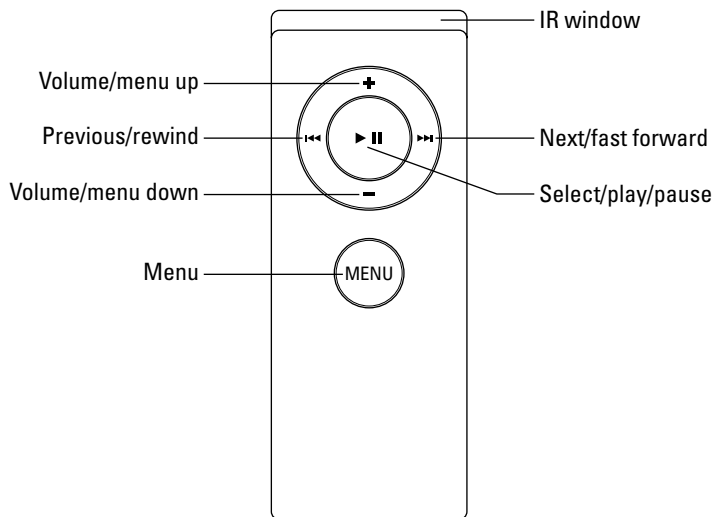

**Figure 10-5:**  
Is it an iPod  
Shuffle? No,  
it's the  
Apple  
Remote!



You don't even have to elevate your posterior from your easy chair to launch Front Row! Just press the Menu button on the remote, and as long as your Mac laptop is on, Front Row runs automatically. To put your laptop to sleep after a night of fun, press and hold the Select/play/pause button. *Sassy!*

Table 10-1 includes the important functions of the Apple remote in Front Row.

**Table 10-1 Front Row Functions Controlled by the Apple Remote**

<i>Action</i>	<i>Purpose</i>
Menu	Press to launch Front Row or to return to the previous menu from within Front Row
Volume/menu down	Press to navigate down through menu options or to lower the volume while media is playing
Volume/menu up	Press to navigate up through menu options or to raise the volume while media is playing
Select/play/pause	Press to select a menu item or play or pause media from within iTunes, DVD Player, QuickTime, or iPhoto
Next/fast forward	Press to skip to the next song or DVD chapter, or hold down to fast forward through a song
Previous/rewind	Press to skip to the previous song or DVD chapter, or hold down to rewind a song

Of course, those Apple software designers knew that you might find yourself on the road without your Apple remote, so they provided keyboard shortcuts that you can also use to control Front Row. Table 10-2 explains the keyboard shortcuts.

**Table 10-2 Front Row Functions Controlled by the Keyboard**

<i>Action</i>	<i>Keyboard Equivalent</i>
Menu	Command-Esc to enter the menu; Esc to exit it
Volume/menu down	Down arrow
Volume/menu up	Up arrow
Select/play/pause	Spacebar or Return
Next/fast forward	Right arrow
Previous/rewind	Left arrow



Note that Front Row has no configuration or settings menu. Front Row is what designers call a *front-end application*, which means that it launches the Tiger applications necessary to display or play the media you select.



Your Apple remote is not designed to work with any other applications at the time of this writing — for example, you can't use it as a presentation aide in PowerPoint, or as a playback controller in GarageBand. However, it's a sure bet that Apple will continue to add functionality to the Apple remote in the future, so check the Apple remote section of Tiger's online help system to keep tabs on what's happening!

# Part IV

# Living the iLife

## The 5th Wave

By Rich Tennant

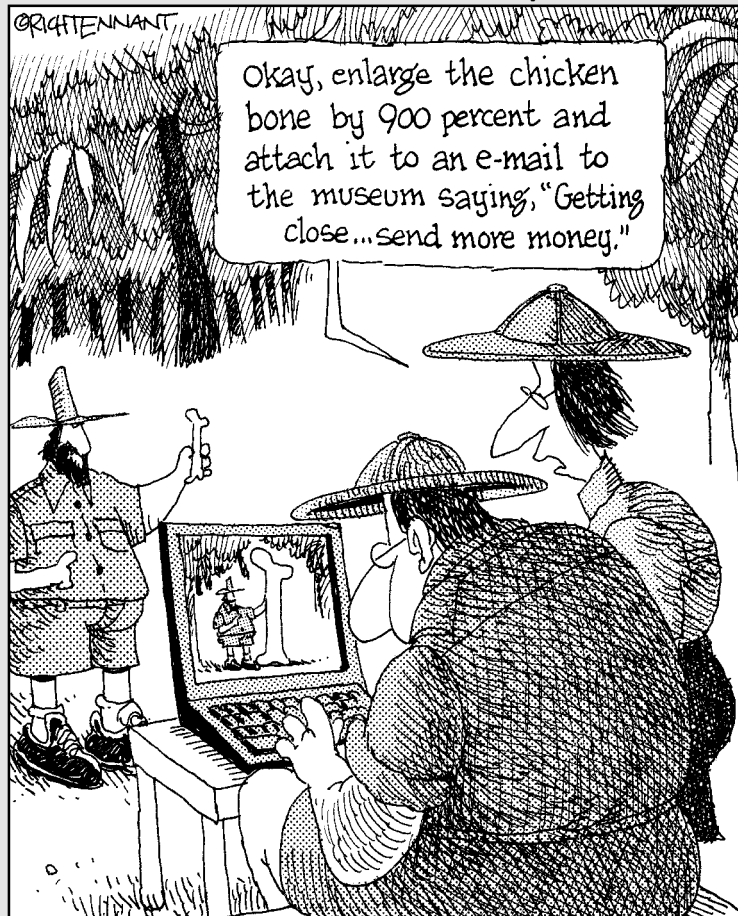



## *In this part . . .*

**H**ere they are, the applications that everyone craves. This part covers iTunes, iPhoto, iMovie HD, iDVD, and GarageBand like your Grandma's best quilt. You discover how to share your images, music, and video clips among the iLife '06 applications on your Mac laptop and how to create everything from your own DVDs to a truly awesome hardcover photo album!

## Chapter 11

# The Multimedia Joy of iTunes

---

### *In This Chapter*

- ▶ Shaking hands with the iTunes window
  - ▶ Listening to your music and watching video
  - ▶ Subscribing to podcasts
  - ▶ Organizing your music just so
  - ▶ Adding album information
  - ▶ Ripping music from CDs and other sources
  - ▶ Burning your own audio CDs
- 

**S**ometimes, words just aren't enough. iTunes is that kind of perfection.

To envision how iTunes changes your Mac, you have to paint the picture with *music* — music that's easy to play, easy to search, and easy to transfer from place to place. Whether it be classical, alternative, jazz, rock, hip-hop, or folk, I can *guarantee* you that you won't find a better application than iTunes to fill your life with your music.

Wait a second. Did I mention the podcasts you can listen to or download to your iPod? Yep, iTunes allows you to subscribe to those cutting-edge broadcasts that are sweeping the Internet, either from the iTunes Music Store or from your cousin Harold's Web site.

Oh, and don't forget the moving pictures! Yep, you can now use iTunes to download television shows and classic music videos from the iTunes Music Store to your hard drive.

In this chapter, I lead you through all the features of my absolute favorite member of the iLife suite, and it's going to be pretty doggone obvious how much I appreciate this one piece of software.

## Boy, Check Out That iTunes Window!

Indeed, Figure 11-1 shows off the iTunes window like the jewel that it is. I complete the roll call of switches and controls in Figure 11-2; there are just too many neat WUDs (Wonderful User Devices) to list them all in one pass.

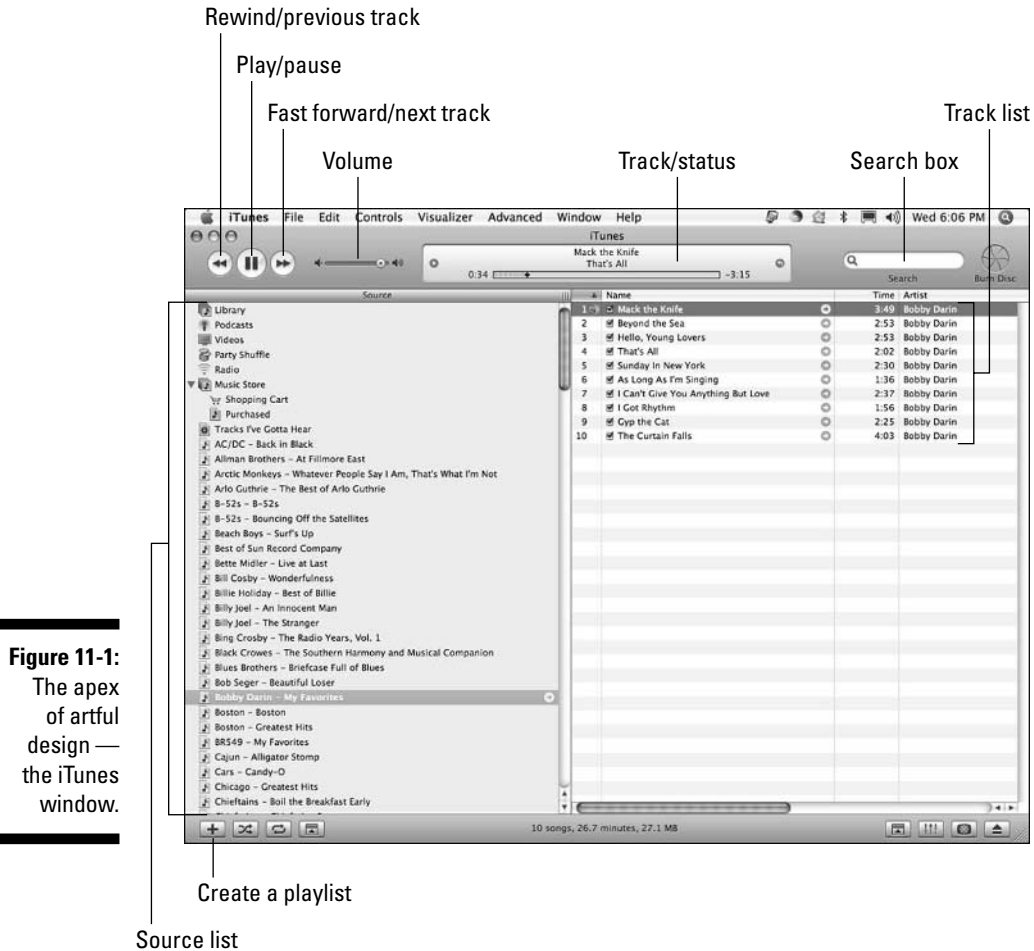

**Figure 11-1:**  
The apex  
of artful  
design —  
the iTunes  
window.



This isn't the only face of the iTunes window. It morphs into something different when you're browsing music from the Apple Music Store, and you can also decide to watch animation while you listen. More on these different looks later.

Before I dive into a discussion of how to use all this good stuff, let me introduce you to the controls that you'll use most often in the iTunes window:

- ✔ **Source list:** Imagine all your albums listed alphabetically — or, even better, playlists of your favorite songs that you create to match your particular mood. You find both in the source list, along with a handful of special categories called Library, Podcasts, Videos, Party Shuffle, Radio, and Music Store. (As you can tell from Figure 11-1, I listen to a wide range of musical genres.)
- ✔ **Rewind/previous track:** Click and hold down this button to move backward quickly through the song that's currently playing. Clicking returns you to the beginning of the track, and double-clicking this button takes you to the previous track in the list.
- ✔ **Play:** Recognize it from your old cassette deck? Click Play, and iTunes begins playing the selected music or podcast from the Track list or the selected video from the video thumbnail display. (I tell you more about selecting your favorite hits in the following section.) While your music or video is playing, this bad boy turns into a Pause button, which you can click to pause your music. To begin playing again where you paused, click the button again.
- ✔ **Forward/next track:** Click and hold this button down to move forward through a song at a fast clip. Click it normally to jump directly to the next track in the list.
- ✔ **Volume:** Drag this unassuming control to raise or lower the volume within iTunes. Go figure.
- ✔ **Track list:** Ah, you knew I'd get to this sooner or later. The track list displays all the songs, radio stations, and assorted whatnot that you can play in iTunes. Double-clicking an item in the track list starts it playing immediately. When you select Videos in the source list, the track list turns into a scrolling collection of thumbnails, each of which corresponds to a TV show or music video.
- ✔ **Track/status display:** A cool-looking LCD display in the middle of brushed chrome . . . oh, yes. The display usually shows you the progress of the current song and also rotates to inform you of the track name and artist. iTunes also uses the display to show prompts and messages about things such as burning discs and importing music.

Note those two tiny icons at both sides of the track display:

- Click the Play icon on the left side, and the track display transforms into a graphic bar display like those on the finest stereo systems. (Click the icon again to return to the normal display.)



- Click the circular icon at the right side of the display, and iTunes returns the selection highlight in the track list to the song that's currently playing.

- ✓ **Search box:** This works much like the Search box in the Finder window toolbar. You can type artist, album, and song names here. Then press Return, and iTunes presents you with items that match in the track list.
- ✓ **Create a playlist:** Click this button to add a new empty playlist to your source list, ready to be filled with whatever songs or items you crave.

That's the quick tour. Simple, elegant, and powerful as a Ferrari. Time to get started playing music and watching videos!

## *The Lazy iTunes Guide*

In this section, I show you how to take care of business: playing your music (in all its many forms), enjoying a podcast, creating playlists, organizing your collection, and watching your music. (No, that last one wasn't a typo. Just wait.)

### *Listening to song files, playlists, Internet radio, and audio CDs*

iTunes recognizes a number of audio file formats, and you can listen to any of them:

- ✓ **MP3:** Unless you've been hiding under a rock for the last few years, you'll recognize this popular format. MP3 files produce excellent quality at a small size, but a discerning ear can hear the effects of the compression used to shrink an MP3 file. (Oh, and these files aren't copy-protected.)
- ✓ **AAC:** Apple's AAC format offers better compression than MP3, so your songs are smaller and sound better. However, AAC files might be copy-protected, so they can't be shared among more than a handful of Macs. When you buy and download music from the Apple Music Store (which I crow about later in this chapter), the songs that you get are in AAC format.
- ✓ **AIFF:** AIFF was the original high-quality format for audio files on the Mac, but they're uncompressed and just too big, so most folks have left them behind in favor of MP3 and AAC.
- ✓ **WAV:** Microsoft's original Windows audio format is similar to AIFF. WAV format songs can reach the highest quality possible, but they're so honking huge that practically no one uses WAV format any longer.
- ✓ **Apple Lossless:** Audiophiles love this new format from Apple because the compression doesn't affect the sound quality (as it does with MP3

and AAC files), yet Apple Lossless files are much smaller than AIFF and WAV files and sound as good. Is this the perfect audio format? Stay tuned, friends: Only time will tell. Oh, and yes, copy protection is included at no extra charge.

Okay, enough techno-info. Back to the music! iTunes makes it easy to listen to a song:

- **From a Finder window:** Double-click the song icon (as shown in Figure 11-2) or drag the song file from the window to the iTunes icon on the dock. iTunes launches automatically, if necessary, and the song appears in the track list while it plays. You can also drag a song file from a Finder window directly to the iTunes track list.
- **From the iTunes track list:** Double-click the track entry.

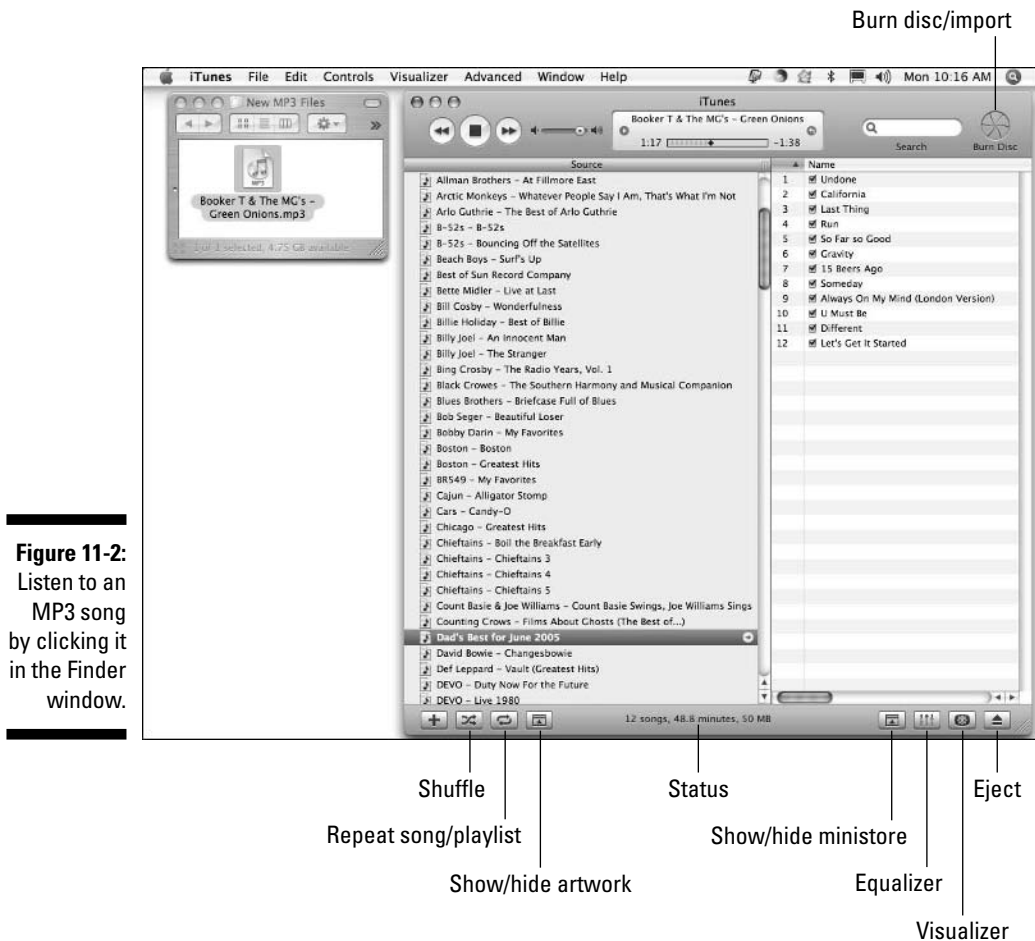

**Figure 11-2:** Listen to an MP3 song by clicking it in the Finder window.

## Yes, Virginia, you can broadcast your music

If you've been following the Apple scene for the last year or so, you might already know about another of Apple's wireless success stories: the AirPort Express base station. Okay, I'm guilty — the AirPort Express is actually covered in Chapter 17. However, I want to mention it here as well because you can use one of these neat devices to stream music to any room (and any standard stereo system) in your house, and that counts as wireless device-style magic to me.

Naturally, you need an existing AirPort Extreme wireless network (connected to your Mac) that's already operating to send your music across the airwaves. In essence, you're using the AirPort Express as a music receiver instead of a base station. All your iTunes playlists are sent over the wireless connection to the AirPort Express unit, which in turn sends it across a

standard audio out cable to the Line In jack or optical digital connector on your stereo.

Here's how simple it is: You plug the AirPort Express into the AC wall socket next to your stereo or boom box (in fact, even a set of AC or battery-powered speakers will work) and connect an audio out cable from the base station to the sound system. Wait until the status light turns green to indicate that the unit is online. Then run the AirPort Express Assistant on your laptop, which leads you through the setup process with onscreen prompts.

iTunes recognizes your remote audio hookup automatically. All you have to do is click the remote unit in the pop-up menu at the bottom-right corner of the iTunes window, and you're suddenly Wolfman Jack!

That's all there is to it! A tiny "playing" speaker appears next to the song in the track list. If you pause iTunes, the speaker goes silent, but it remains next to the track to indicate what you're going to hear if you click Play again. Although the highlight cursor may be on another song or playlist, that tiny speaker icon always sticks next to whatever's playing.



TIP

Speaking of the Play button, you really don't have to click it. Instead, you can press the spacebar to play or pause a song in iTunes. In fact, pressing the right-arrow key works the same as clicking the iTunes Next track button, and pressing the left-arrow key works just like clicking the Previous track button.



TIP

While you're listening to a song, notice the cursor as it moves along the progress bar in the Status display. Feel free to click and drag that cursor to the left and right, which works the same as using the Rewind and Fast forward controls, respectively. (In fact, I use this method exclusively because it lets me cover a lot of musical ground when I'm listening to a 24-minute track from Frank Zappa.)

If you get tired of hearing an album in the same order that you memorized years ago, make use of the Shuffle button. Click a playlist and then click the Shuffle button (labeled in Figure 11-2). The button turns blue, and iTunes mixes the order of your music automatically. To exit shuffle mode, click the Shuffle button again. (If you click the Library entry at the top of the source list

and click Shuffle, you get a wild mix taken from every song you've collected.) Note that Shuffle doesn't change the order of the songs in the track list.



You can specify whether iTunes should shuffle by songs or albums. Choose iTunes⇨Preferences, click the Advanced toolbar button, and then click either Shuffle Song or Album.

### *Listening to a playlist*

I show you how to create a playlist later in the chapter, but for now, you can consider it a unit, like a traditional vinyl album or audio CD. A *playlist* can be a collection of songs that you choose yourself and organize by genre (such as *Boudreaux's Favorite Zydeco Hits*), or it can include the songs that appear in an actual album (such as Fleetwood Mac's *Rumours*). In other words, the contents of a playlist are up to you. It's a container, like a folder in the Finder window.

Listening to a playlist is simplicity itself: Just click the desired playlist in the source list and then click Play or press the spacebar. iTunes immediately shows you the contents of the playlist in the track list and starts to play the first track.



While you're listening to a playlist, feel free to browse other music in your collection; iTunes keeps track of what song is due next, even if you're looking at a different playlist. To jump to a specific track in a different playlist that you're browsing, just double-click it. iTunes immediately switches to that track and continues to play the rest of the new playlist that you just selected.

Out of the box, iTunes stops playing after it reaches the end of the last song in a playlist. Don't like that? Then you'll be ecstatic to learn that a single click of the Repeat song/playlist button (labeled in Figure 11-2) repeats all the songs in the playlist. (The button turns blue when Repeat is on.) If you click the same button again, a tiny 1 icon appears, and only the current song repeats. A third and final press of the Repeat button turns the feature off, and you're back to Start. (Click the Library icon at the top of your Source list, click Repeat, and the tunes keep on coming until you choose to stop them. For my collection, that'll take almost *four solid days!*)

### *Tuning in to streaming Internet radio*

A neat Internet technology that you might not have heard of is called *streaming radio*, which plays music. iTunes can receive and play streaming radio in real time. The music sounds just as if the broadcast were traveling across the airwaves instead of that expensive cable modem. (Well, except for the fade-outs and static, but you won't miss those.)

To display the variety of Internet radio stations provided by Apple, click the Radio icon in the source list. Figure 11-3 illustrates the wide selection, categorized by genre. I guess the folks in Cupertino enjoy their music, too!





**Figure 11-3:**  
Suddenly  
the Internet  
means more  
than e-mail  
and the  
Web.

Recognize those right-facing triangle icons from the Finder window's list mode? Yep, just click a triangle to expand or collapse that category to see the entries it contains. To start playing, double-click a station entry.

## Hey, do you remember the '70s?

Do you remember Farrah Fawcett, disco balls, and the AMC Javelin? Do you yearn for the incomparable music that dates from 1970 to 1979? Then, my friend, do I have an Internet radio station for you! It's called *MLC Radio Online* (I bet you saw that coming, didn't you?), and it features the absolute best from the Decade That Shall Never Come Again. Rock, folk, disco, soul, and even the beginnings of New Wave and Alternative. (And yes, it does

include *Kung Fu Fighting* by Carl Douglas. After all, the song was *hot*.)

MLC Radio Online requires a high-speed connection (DSL, cable modem, or satellite) because all those hits are 128 Kbps, CD quality! It isn't in Apple's default list — are you listening, Mr. Jobs? — but the station address is on my Web site, MLC Books Online, at [www.mlcbooks.com](http://www.mlcbooks.com). See you there, *Starsky & Hutch* fans!



A station's *bit rate* means a lot, especially if you're using a dialup modem connection. The higher the bit rate, the better the sound. A bit rate of 128 Kbps gives you CD-quality sound, but it takes a high-speed Internet connection (such as a DSL or cable modem connection) to move all that data fast enough to provide uninterrupted music. (You'll know this is the problem if iTunes keeps pausing during play so that it can catch up to the station's data.) Therefore, if you're using a dialup connection, I recommend that you stick with stations offering music at around FM quality, which is 56 Kbps or less.



You can also tune in to an Internet radio station by entering that station's Web address directly into iTunes. Press  $\text{⌘}+U$  (or, for the keyboard-wary, choose Advanced⇨Open Stream) to display a text box in which you can type or paste the station's Web address. Click OK, and sit back.

### ***Listening to a podcast***

Unless you've been doing the hermit gig for the last couple of years, you've likely heard of *podcasts*, which are much like radio shows (typically talk radio, usually opinionated, practically never boring). Instead of being broadcast by a traditional radio station, however, podcasts are distributed by companies and individuals as MP3 files. You can listen to them on your laptop using iTunes or download the podcast to your iPod for later listening on the move.

The iTunes Music Store includes a separate section for podcasts. (In fact, you don't even have to visit the iTunes Music Store to view the Podcast directory: Just click the Podcast Directory link at the bottom of the window.) When you find a podcast you like, you can subscribe to it by clicking the Subscribe button. iTunes automatically downloads the latest edition of a subscribed podcast each time you're connected to the Internet. To unsubscribe from a podcast, click it in the podcast list in iTunes and then click the Unsubscribe button.



You can also subscribe to a podcast offered on a specific Web site. Choose Advanced⇨Subscribe to Podcast, and then enter the URL (or Web address) provided by the podcaster.

You listen to a podcast in iTunes in the same way you listen to an individual track: Click the Podcast entry in the source list and then double-click the desired podcast in the list.

### ***Giving your audio CDs the treatment***

To play a music CD, load the disc into your laptop. By default, iTunes launches automatically whenever you load a music CD. Click the CD icon in the source list to select it, and then click the Play button and start enjoying yourself.



The Rewind and Forward buttons also function as Previous track and Next track when you're listening to a CD. Click the Previous track button once, and iTunes returns to the beginning of the track that's currently playing. (If you've used home or car CD systems, you'll immediately recognize this behavior.) To make the move to the previous track, double-click the button.

## Doing the iPod dance

If you're the proud owner of an iPod, I salute you. My old 15GB model is still chugging away and still has a little room left for a few more songs. Each time you plug your iPod into its cradle, iTunes automatically updates your iPod's hard drive with any changes, additions, or deletions you've made to your library. It's all pretty automatic.

I wish I had more space to go into more detail on advanced settings for the iPod in iTunes, but

this is a book dedicated to your Mac laptop, and my editors tell me that I must concentrate on that glamorous piece of Apple hardware. If you'd like a comprehensive guide to *everything* that you can do with iTunes and iPod, *iPod & iTunes For Dummies*, 2nd Edition (by Tony Bove and Cheryl Rhodes; Wiley) devotes a full 384 pages to the dynamic duo. Gee, I only got 16 pages to cover all of iTunes. Sometimes life is *so* unfair.



To specify what action iTunes should take after it's launched by loading a CD, choose iTunes⇨Preferences and then click the General toolbar button. Click the On CD Insert pop-up menu and choose your weapon.

To eject the disc, you can simply click the Eject button (labeled in Figure 11-2). iTunes immediately sends the disc packing.



If you'd rather not have iTunes launch all by itself when you load an audio CD, open System Preferences and click the CDs & DVDs icon. Then click the When You Insert a Music CD drop-down list box and choose the action that you prefer, or choose Ignore if nothing should happen.

## Watching video

Watching video in iTunes is similar to listening to your music. To view your video collection, click the Videos entry in the source list; iTunes displays your videos as thumbnails, as shown in Figure 11-4. From here, you can

- Double-click a video thumbnail.
- Drag any QuickTime-compatible video clip from the Finder window to the iTunes window. (These typically include video files ending in .mov or .mp4.)

The player window you see in Figure 11-4 sports a slider bar that you can drag to move through the video. You can also pause the video by clicking the Pause button.

**Figure 11-4:**  
Watching  
a video  
from my  
collection —  
Michael  
Jackson's  
Thriller.



## *Organizing, sorting, and searching*

What good is having the world's largest music collection if you can't find anything? In this section, I help you get organized by showing you how to create playlists, sort stuff, and rearrange tracks as you see fit.

### *Creating playlists and moving your music*

The Library category in the source list is the Big Kahuna. Click Library, and you see every song in your collection, all in one huge list. The playlist is the other side of the coin because it allows you to compartmentalize your music any way you please.

You can create a playlist in several ways:

- ✓ **Click the Create New Playlist button (which bears a plus sign) at the bottom of the iTunes window.**
- ✓ **Choose File⇨New Playlist.**
- ✓ **Press ⌘+N.**

No matter which method you choose, a new entry named `untitled playlist` appears in the source list. The entry is actually a text entry box, ready for you to type a more descriptive name. Do so, and press Return. Bam! You've created an empty playlist.



Change your mind about a playlist name? No problem! You can rename a playlist just like you rename a file in the Finder window: Click the file to select it, pause for a second, and then click again. The edit box reappears, and you can type the name that you really want.



As you can tell from the figures in this chapter, I prefer to name most of my playlists with artist or band name first, then a dash, and then the album name. (This helps keep things organized alphabetically in the source list. When you have almost 1500 songs in your Library, the alphabet becomes a truly handy tool.) Most of my playlists are albums, so this makes sense. If you, on the other hand, prefer to build your playlists song by song, *My Favorite Swedish Rock Ballads* might work better as a name. It's all up to you!

After you create your new playlist, you can drag songs from your Library and drop them on top of the playlist entry in the source list. Alternatively, you can click the playlist name in the source list and then drag the songs into the track list. To choose multiple files at once, hold down  $\mathbb{C}$  while you click.

To delete a track from a playlist, click it to highlight the song and then press the Delete key. Note, however, that the song *isn't* deleted from your collection unless you click the Library entry in the source list and delete the song there as well. Deleting a playlist works the same way: Click the playlist to select it, and then press Delete.



You can also select songs in the track list and create a playlist that contains those tracks. Click the desired tracks to select 'em and then choose `File` → `New Playlist from Selection`. You still get the playlist name edit box, but the playlist already contains the files that you chose.

After the songs that you want are in your new playlist — however they got there — they don't have to remain in the order in which you first see them. For example, to move a song from the Track 2 position to the Track 3 position, click the song and drag it to the desired spot. (iTunes creates a ghost entry to help you keep track of where that track is going. Sorry, bad pun.)



This same drag-and-drop functionality works throughout most of iTunes. Drag tracks here and there to organize your music into the playlists that you create. It's just plain fun.

### ***Searching for every artist named Elvis***

(Don't laugh, I've done it.) You can use the Search box in the iTunes toolbar to locate a string of text. For example, follow these steps to find whether Elvis is in the building:

1. **Click the Library entry in the source list to select it.**

In most cases, you want to click the Library entry so that your search encompasses your entire music collection. However, if you have a really *huge* playlist to search, you can select the individual playlist instead.

2. **Click the magnifying glass icon.**

This displays a short pop-up menu from which you can choose to search through just one data field — the Artist, Album, Composer, or Song Name. The default is All, which doesn't limit the search to any one field; any match of any of the four criteria counts.

3. **Click in the Search box and type the text that you want to match.**

iTunes immediately goes to work and displays the matches (within the criteria that you select) in the track list.

4. **Click the X icon on the right side of the Search box.**

iTunes erases the search text, and the rest of your collection reappears. Now you can try another search, if you like.

By the way, the search for Elvis returned just two songs: *Elvis Has Just Left the Building* (Frank Zappa) and *Hound Dog* (the King himself). Note to self: Get more Elvis.

### *Sorting your music every which way*

Check out those buttons atop each column in the track list. They work just like the buttons at the top of each column in a Finder window when you're using list mode. Click Song Name, for example, and your selected playlist or your entire Library is sorted by song name.



The ability to sort by artist, album, and genre can provide interesting pickings for new playlists. Never before has it been so easy to compose your own greatest-hits collection from your favorite band or from a specific musical style.

Oh, and if the artist name, album name, or genre doesn't appear for songs in your track list, don't worry — that just means you need to add the information, and that's the next topic.

## *Adding or editing song information*

Many of the MP3 and AAC files that you add to your collection already have *tags* — that's the techno-nerd name for the information that's embedded in a song file, which iTunes displays in the track list, like the year the song was released and the album name.

But what if a track (or an entire playlist) has no tags, or the tags are wrong? You can add or edit them yourself. Follow these steps:

**1. Click the desired songs to select them.**

To select every song in the playlist, click the first track and then press **⌘+A**.

**2. Press **⌘+I**.**

Mac fanatics everywhere can immediately identify what appears as the Get Info keyboard shortcut. The Info dialog box for the selected tracks appears, as shown in Figure 11-5. (If you're adding information for just one song, click the Info button to get to the same spot. Personally, I usually find myself adding song information for every song in a playlist, so I usually see the Multiple Song version.)

**3. Click in each field that you want to add or edit, and then enter the new tag information.**

Remember, the same information that you add is embedded in every song that you select, so it needs to apply equally. For example, if you select songs from AC/DC, Louis Armstrong, and Hank Williams Sr., you probably wouldn't want to apply the Genre tag *Rock* to all of them!



**Figure 11-5:**  
Add  
information  
for multiple  
songs.

#### 4. After you're finished, click OK.

iTunes displays a progress bar as it embeds the tag data in the songs.



If you're wondering about that square marked Artwork, you can indeed drag an image of the album cover to the square to embed it. (This trick works exceptionally well with thumbnails dragged from the Amazon Web site.) To display album art while a song is playing, press  $\text{⌘}+G$  to toggle the Artwork pane on and off.

## Visualization — music for your eyes

Speaking of artwork, iTunes can display a kaleidoscopic animated light show right out of Woodstock for your visual pleasure. Click the Visualization button (Figure 11-2 yet again) to enter the light show or press  $\text{⌘}+T$ . Figure 11-6 gives you an idea of the beautiful patterns that you might see.

To switch your laptop into mind-blowing full-screen mode, press  $\text{⌘}+F$ . You even get an MTV-style song information block in the lower-left corner!

To exit visualization mode and get back to work — like I should right now — press  $\text{⌘}+T$  again or click your mouse button.



**Figure 11-6:**  
Hey, dig that  
crazy light  
show!



## Pulling in Songs and Spitting 'Em Out

In this final section, I cover three important tasks: Two involve getting songs into iTunes (by importing them and buying them), and the last instructs you on how to get music out of iTunes (by burning your own audio CDs). I trust you'll be paying attention.

### Importing songs from CD and hard drives

It's easy to import — or, as the process is more popularly called, *rip* — music from music CDs that you own. First, however, it's a good idea to set up your encoder (the software that actually converts a track from digital to MP3 format), so go ahead and launch iTunes by clicking the iTunes icon on the dock. Then follow these steps:

1. Choose iTunes ⇨ Preferences to display the Preferences dialog box.
2. Click the Importing button on the toolbar.
3. Click the Import Using pop-up menu and then choose one of the following:

- **MP3 Encoder:** Gives the best compatibility with other computers and devices. If you choose MP3 encoder, click the Setting drop-down list box and choose Higher Quality (192 Kbps).

In my experience, this bit rate gives you the best combination of good audio quality and smaller file sizes.

- **Apple Lossless Encoder:** Gives the best sound, although the file sizes will be larger than MP3 format.

4. Click OK.

That takes care of your encoder settings — a process that you need to perform only once. Now you're ready to do the deed. With iTunes running, follow these steps to add the songs to your Library:

1. Load a music CD into your Mac.

If you have an active Internet connection, iTunes attempts to identify the tracks and name them for you.

2. Click the check boxes of any tracks that you want to import.
3. Click the Import button at the right side of the iTunes window.

Figure 11-7 illustrates iTunes importing my favorites from a Ray Charles music CD.



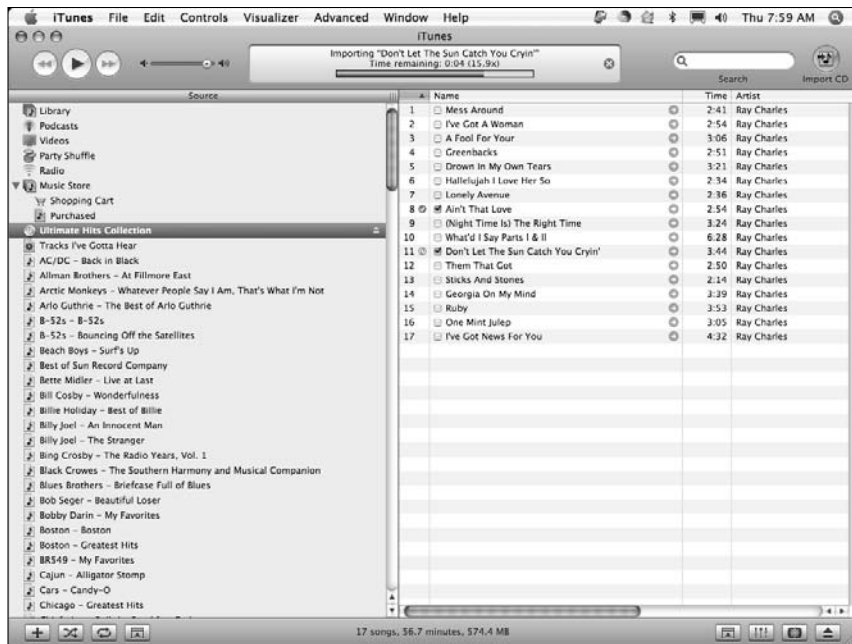

**Figure 11-7:**  
Add songs  
to iTunes  
from an  
audio CD.

To import songs from files you've downloaded or copied to your hard drive, follow these steps:

1. **Open a Finder window and navigate to the location where the songs are stored.**
2. **If you want, create a new playlist to hold the songs, as I describe earlier in the chapter.**  
You can also import the songs straight into your Library and organize them later.
3. **In the Finder window, select all the songs that you want to import.**
4. **Drag the song files into the iTunes window and drop them either on top of the desired playlist or into the track list itself.**

iTunes takes a second to verify the files and assign their tag information, and then your new tracks appear in your playlist or the Library.

## *Buying Billie Holiday from the Apple Music Store*

As long as you have an active Internet connection — and I fervently hope that it's a high-speed DSL or cable modem connection — the Apple Music

Store is ready to serve your needs, with well over a million tracks for you to choose from! Most single tracks are only \$0.99 each, and most full albums are \$9.99 at the time of this writing.

The first time that you access the Music Store, you provide your credit card and e-mail account information over a secure connection. From that point onward, the Music Store remembers them and logs you in automatically. You buy the tracks, albums, and videos you want, with no silly strings attached. (Most podcasts offered on the Music Store are free.)

To browse or buy, click the Music Store entry in the source list. After a moment or two, you see the entrance to the Store (as shown in Figure 11-8). To browse, simply

- Click an album cover from the entrance page.
- Click a link to one of the day's top songs or albums.
- Click the Choose Genre pop-up menu and select your passion.
- Click the Power Search link to perform an advanced search for just that one artist or album.

**Figure 11-8:**  
Browse the shelves of the iTunes Music Store.





If you're interested in buying a track or album (but don't have the desire or time to browse), click the Show/hide ministore button to display a separate Music Store pane for the currently highlighted track. Your playlist remains in view while you peruse the information, and you can even buy from the Ministore pane. To dismiss the Ministore pane, click the button again.

As you drill deeper into your favorite media, notice the back and forward arrows and the Home icon right under the iTunes track display. These controls work just like a Web browser, moving you to previous and next pages, or returning you to the top-level entrance page (respectively). *Nice.*

Oh, and those little arrows next to the album and artist names in the iTunes track list? If you already clicked one to experiment, you know that they automatically take you to the Music Store so that you can purchase more music by the same (or similar) artists.

If you decide to buy a track or an album, just click the corresponding Add Song or Add Album button. The tracks that you marked are saved in the Shopping Cart subentry (under the Music Store entry in your iTunes Source list). After you've finished shopping, click the Shopping Cart entry and click the Buy Now button. iTunes immediately begins downloading your new music, and the tracks are saved to the Purchased Music playlist (again, immediately below the Music Store entry in the source list).

Now you can move the music you bought to anywhere in your collection, building a new playlist or distributing them amongst your existing playlists. Enjoy!

## *Burning like a true techno*

Are you ready to record your own music and MP3 CDs? Sure you are! You can play the music CDs that you burn in just about any audio CD player or computer these days, but MP3 discs are a little more specialized. Because they are actually data discs that contain your music in MP3 format, you can store a lot more music on a single disc. (Luckily, more and more audio CD players, boom boxes, and computers can recognize and play an MP3 disc.) Still, here's the Mark's Maxim to live by:



If you want the broadest compatibility, burn a standard audio CD.

To specify which type of disc you want to create, launch iTunes and follow these steps:

1. Choose iTunes⇨Preferences to display the Preferences dialog box.
2. Click the Burning button on the toolbar.



**3. Click either Audio CD or MP3 CD.**

Don't burn a data CD unless you'll only read the disc on a computer. If you're burning a disc for your car or home audio CD player, choosing data CD is a good definition of a *bad idea*.

**4. Click OK.**

After you configure the type of disc that you want to burn, follow these steps to burn the contents of a playlist to an audio or MP3 CD:

**1. In the iTunes Source list, select the playlist that you want to burn.**

**2. Click the Burn Disc icon at the upper right of the iTunes window.**

The icon changes into a truly neat burning symbol, and you're prompted to load a blank CD-R.

Never use a CD-RW to record an audio CD unless you're sure that your audio player supports rewriteable media — again, for the best compatibility, use a CD-R.

**3. Load the blank disc.**

iTunes displays the total songs and time for the recording.

**4. Click the Burn Disc icon again, and await your new music or MP3 CD with a smile on your face!**



## Chapter 12

# Turning iPhoto into Your Portable Darkroom

---

### *In This Chapter*

- ▶ Introducing the elements of the iPhoto window
  - ▶ Importing images from a camera or your hard drive
  - ▶ Arranging your photos the right way
  - ▶ Basic editing in iPhoto
  - ▶ Printing your own coffee-table book
  - ▶ Photocasting your pictures to friends and family
  - ▶ Sending images through e-mail
- 

**i**Photo, my favorite image cataloging-editing-sharing tool, is probably right at the top of the popularity ratings when it comes to the iLife 2006 suite because virtually every Mac owner is likely to have a digital camera or a scanner. Digital video (DV) camcorders have certainly grown more plentiful over the past three or four years, and the iPod is the hottest piece of music hardware on the planet at the time of this writing, but the digital camera has reached what those funny (strange) marketing people refer to as *saturation*.

With this in mind, I'm willing to bet that iPhoto is either the first or the second iLife application that you fall in love with (running neck-and-neck with iTunes). In this chapter, I show you how you can organize, print, share, and display your digital photographs with true Apple panache!

## *Shaking Hands with the iPhoto Window*

In Figure 12-1, you can see most of the major controls offered in iPhoto. (Other controls automatically appear when you enter different modes — I cover them in upcoming sections of this chapter.)

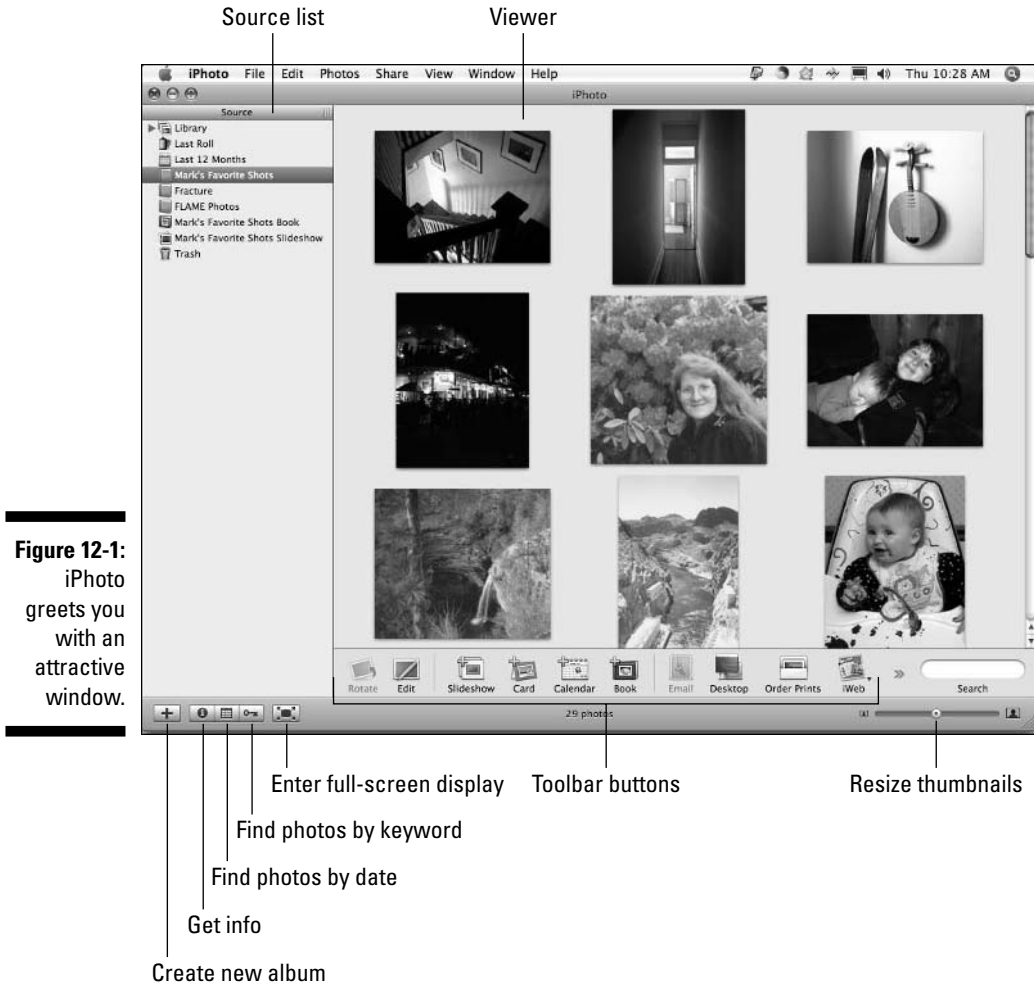

Although these controls and sections of the window are covered in more detail in the following sections, here's a quick rundown of what you're looking at:

➤ **Source list:** This list of image locations determines which photos iPhoto displays.

- You can choose to display either your entire image library or just the last “roll” of digital images that you downloaded from your camera.
- You can create new *albums* of your own that appear in the source list; albums make it much easier to organize your photos.



- ✓ **Viewer:** This pane displays the images from the currently selected photo source.  
You can drag or click to select photos in the viewer for further tricks, such as assigning keywords and image editing.
- ✓ **Create New Album button:** Click this button to add a new blank album, book, or slideshow to your source list.
- ✓ **Get Info button:** Click this button to display information on the currently selected photos.
- ✓ **Find Photos by Date button:** Click this button to view photos added in a specific month or date. While you're viewing the calendar, click the tiny Date toggle button at the top left of the calendar display to switch between month and date displays. (A month or date that appears in bold contains at least one image.)
- ✓ **Find Photos by Keyword button:** Click this button to view photos that you've marked with one or more keywords. (More on this later in the chapter.)
- ✓ **Enter Full Screen button:** Click this button to switch to a full-screen display of your photos. In full-screen mode, the images in the selected album appear in a film strip across the top of the screen, and you can click one to view that image using your laptop's entire screen real estate. You can also use the same controls that I discuss later in this chapter for editing and adjusting images — just move the mouse cursor to the top edge of the full-screen display to show the menu, or to the bottom edge to show the toolbar.
- ✓ **Toolbar buttons:** This group of buttons selects an operation you want to perform on the images you've selected in the viewer.
- ✓ **Thumbnail Resize slider:** Drag this slider to the left to reduce the size of the thumbnails in the viewer. This allows you to see more thumbnails at once, which is a great boon for quick visual searches. Drag the slider to the right to expand the size of the thumbnails, which makes it easier to differentiate details between similar photos in the viewer.

## *Working with Images on Your Laptop*

Even a superbly designed image display and editing application like iPhoto would look overwhelming if everything were jammed into one window. Thus, Apple's developers provide different operation modes (such as editing and book creation) that you can use in the one iPhoto window. Each mode allows you to perform different tasks, and you can switch modes at just about any time by clicking the corresponding toolbar button.



In this section, I discuss three of these modes — import, organize, and edit — and what you can do when you're in them. Then I conclude the chapter with sections on publishing and sharing your images.

## *Import mode: Coaxing photos from your camera*

In *import* mode, you're ready to download images directly from your digital camera — as long as your specific camera model is supported in iPhoto. You can find out which cameras are supported by visiting the Apple iPhoto support page at [www.apple.com/macosx/upgrade/cameras.html](http://www.apple.com/macosx/upgrade/cameras.html).

Follow these steps to import images:

### **1. Connect your digital camera to your laptop.**

Plug one end of a USB cable into your camera and the other end into your Mac's USB port, and prepare your camera to download images.

### **2. Launch iPhoto.**

Launch iPhoto by clicking its icon in the dock (or in your Applications folder).

The first time that you launch iPhoto, you have the option of setting its auto-launch feature — I recommend this feature, which starts iPhoto automatically whenever you connect a camera to your laptop.

### **3. Type a roll name for the imported photos.**



## **Importing images from your hard drive**

If you have a folder of images that you've already collected on your hard drive, a CD, a DVD, an external drive, or a USB Flash drive, adding them to your library is easy. Just drag the folder from a Finder window and drop it into the source list in the iPhoto window. iPhoto automatically creates a new album using the folder name, and you can sit back while the images are imported into that new album. iPhoto recognizes images in several formats: JPEG, GIF, RAW, PNG, PICT, and TIFF.

If you have individual images, you can drag them as well. Select the images in a Finder window and drag them into the desired album in the source list. To add them to the album currently displayed in the viewer, drag the selected photos and drop them in the viewer instead.

If you'd rather import images by using a standard Mac Open dialog box, choose **File** ⇧ **Import to Library**. Simplicity strikes again!



#### 4. Type a description for the roll.

If you don't expect to download these images again to another computer or another device, you can select the Delete Items from Camera after Importing check box to enable it. iPhoto automatically deletes all the images after they've been downloaded from the camera. This saves you a step and helps eliminate the guilt that can crop up when you nix your pix. (Sorry, I couldn't resist.)

#### 5. Click the Import button to import your photographs from the camera.

The images are added to your Photo Library, where you can organize them into individual albums, as well as in a separate “virtual” film roll in the source list.

“What’s that about a roll, Mark? I thought I was finally getting away from that!” Well, you are — at least a physical roll of film — but after you download the contents of your digital camera, those contents count as a virtual roll of film in iPhoto. You can always display those images by clicking Last Roll or by choosing a specific roll (both are in the source list). Think about that . . . it’s pretty tough to arrange old-fashioned film prints by the roll in which they originally appeared, but iPhoto makes it easy for you to see just which photos were part of the same download group!

## *Organize mode: Organizing and sorting your images*

In the days of film prints, you could always stuff another shoebox with your latest photos or buy another sticky album to expand your library. Your digital camera, though, stores images as files instead, and many folks don't print their digital photographs. Instead, you can keep your entire collection of digital photographs and scanned images well ordered and easily retrieved by using iPhoto's *organize* mode. Then you can display them as a slideshow, print them to your system printer, use them as desktop backgrounds, or burn them to an archive disc.

### *A new kind of photo album*

The key to organizing images in iPhoto is the *album*. Each album can represent any division you like, be it a year, a vacation, your daughter, or your daughter's ex-boyfriends. Follow these steps:

#### 1. Create a new album.

You can either choose File⇨New Album or click the plus (+) button at the bottom of the source list. The New Album sheet appears, as shown in Figure 12-2.

2. Type the name for your new photo album.
3. Click OK.

iPhoto also offers a special type of album called a *Smart Album*, which you can create from the File menu. A Smart Album contains only photos that match certain criteria that you choose, using the keywords and rating that you assign your images. Other criteria include recent film rolls, text in the photo filenames, dates the images were added to iPhoto, and any comments you might have added. Now here's the really nifty angle: iPhoto *automatically* builds and maintains Smart Albums for you, adding new photos that match the criteria (and deleting those that you remove from your Photo Library)! Smart Albums carry a gear icon in the source list.

You can display information about the currently selected item in the information panel under the source list — just click the Show Information button at the bottom of the iPhoto window, which sports the familiar “i-in-a-circle” logo. You can also type a short note or description in the comment box. For more in-depth information, select the desired item and then press **⌘+I**.



**Figure 12-2:**  
Add a new  
album in  
iPhoto.



You can rename an image by selecting it in the viewer — you'll notice that the Title and Date fields below the source list turn into text edit boxes, so you can simply click in either box to type a new name or alter the photo's date-stamp. The same method works when you select a photo album in the source list — you can change the album name from the Album text box.

You can drag images from the viewer into any album you choose. For example, you can move an image to another album by dragging it from the viewer to the desired album in the source list.

To remove a photo that has fallen out of favor, follow these steps:

1. **In the source list, select the desired album.**
2. **In the viewer, select the photo (click it) that you want to remove.**
3. **Press Delete.**



When you remove a photo from an album, you *don't* remove the photo from your collection (which is represented by the Library entry in the source list). That's because an album is just a group of links to the images in your collection. To completely remove the offending photo, click the Library entry to display your entire collection of images and delete the picture there, too.

To remove an entire album from the source list, just click it in the source list to select it — in the viewer, you can see the images that it contains — and then press Delete.



Change your mind? Daughter's ex is back in the picture, so to speak? iPhoto comes complete with a handy-dandy Undo feature. Just press  $\text{⌘}+Z$ , and it's like your last action never happened. (A great trick for those moments when you realize you just deleted from your Library your only image of your first car.)

### ***Organizing with keywords***

"Okay, Mark, iPhoto albums are a great idea, but do you really expect me to look through 20 albums just to locate pictures with specific functions?" Never fear, good Mac owner. You can also assign descriptive *keywords* to images to help you organize your collection and locate certain pictures fast. iPhoto comes with a number of standard keywords, and you can create your own as well.

To illustrate, suppose you'd like to identify your images according to special events in your family. Birthday photos should have their own keyword, and anniversaries deserve another. By assigning keywords, you can search for Elsie's sixth birthday or your silver wedding anniversary, and all related photos with those keywords appear like magic! (Well, *almost* like magic. You need to choose View⇨Keywords, which toggles the Keyword display on and off in the viewer.)

iPhoto includes a number of keywords that are already available:

- ✓ Favorite
- ✓ Family
- ✓ Kids
- ✓ Vacation
- ✓ Birthday
- ✓ Grayscale
- ✓ Widescreen
- ✓ Checkmark



What's the Checkmark all about, you ask? It's a special case — adding this keyword displays a tiny check mark icon in the bottom-right corner of the image. The *checkmark* keyword comes in handy for temporarily identifying specific images because you can search for just your check-marked photos.

To assign keywords to images (or remove keywords that have already been assigned), select one or more photos in the viewer. Choose Photos⇨Get Info and then click the Keywords tab to display the Keywords pane, as shown in Figure 12-3.



**Figure 12-3:**  
Time to add  
keywords  
to these  
selected  
images.

## You're gonna need your own keywords

I'll bet you take photos of other things besides just kids and vacations — and that's why iPhoto allows you to create your own keywords. Display the iPhoto Preferences dialog box by pressing ⌘+, (comma), click the Keywords button on the toolbar, and then click Add (the button with the plus sign). iPhoto adds a new unnamed keyword to the list as an edit box, ready for you to type its name.

You can rename an existing keyword from this same dialog box, too. Click a keyword to select it and then click Rename. Remember, however, that renaming a keyword affects *all the images that were tagged with that keyword*. That might be confusing when, for example, photos originally tagged as Family suddenly appear with the keyword Foodstuffs. To remove an existing keyword from the list, click the keyword to select it and then click Delete.

Click the check box next to the keywords that you want to attach to the selected images to mark them. Or, click the marked check boxes next to the keywords that you want to remove from the selected images to disable them.

### *Digging through your library with keywords*

Behold the power of keywords! To sift through your entire collection of images by using keywords, click the Find Photos by Keyword button at the bottom of the iPhoto window. iPhoto displays the Keywords panel, and you can click one or more keyword buttons to display just the photos that carry those keywords.



The images that remain in the viewer after a search must have *all* the keywords that you specified. If an image is identified, for example, by only three of four keywords you chose, it won't be a match and it won't appear in the viewer.

### *Playing favorites by assigning ratings*

Be your own critic! iPhoto allows you to assign any photo a rating of anywhere from zero to five stars. I use this system to help me keep track of the images that I feel are the best in my library. Select one (or more) images and then assign a rating using one of the following methods:

- ✓ Choose Photos⇨My Rating, and then choose the desired rating from the pop-up submenu.
- ✓ Use the ⌘+0 through ⌘+5 shortcuts.

### *Sorting your images just so*

The View menu provides an easy way to arrange your images in the viewer by a number of different criteria. Choose View⇨Arrange Photos, and then click

the desired sort criteria from the pop-up submenu. You can arrange the display by film roll, date, title, or rating. If you select an album in the source list, you can also choose to arrange photos manually, which means that you can drag-and-drop thumbnails in the viewer to place them in the precise order you want them.



Naturally, iPhoto allows you to print selected images, but you can also publish photos on your .Mac Web site. Click the Home Page button in the toolbar, and iPhoto automatically uploads the selected images and leads you through the process of creating a new Web page using the Home Page online wizard.

## *Edit mode: Removing and fixing stuff the right way*

Not every digital image is perfect — just look at my collection if you need proof. For those shots that need a pixel massage, iPhoto includes a number of editing tools that you can use to correct common problems.

The first step in any editing job is to select the image you want to fix in the viewer. Then click the Edit button on the iPhoto toolbar to switch to the Edit panel controls, as shown in Figure 12-4. Now you're ready to fix problems, using the tools that I discuss in the rest of this section.



**Figure 12-4:**  
iPhoto is now in edit mode — watch out, image problems!

### *Rotating tipped-over shots*

If an image is in the wrong orientation and needs to be turned to display correctly, click the Rotate button to turn it once in a counterclockwise direction. Hold down the Option key while you click the Rotate button to rotate in a clockwise direction.

### *Crop 'til you drop*

Does that photo have an intruder hovering around the edges of the subject? You can remove some of the border by *cropping* an image, just as folks once did with film prints and a pair of scissors. (We've come a long way.) With iPhoto, you can remove unwanted portions of an image — it's a great way to get Uncle Milton's stray head (complete with toupee) out of an otherwise perfect holiday snapshot.

Follow these steps to crop an image:

- 1. Select the portion of the image that you want to keep.**

In the viewer, click and drag on the part that you want. When you drag, a semi-opaque rectangle appears to help you keep track of what you're claiming. (Check it out in Figure 12-5.) Remember, whatever's outside this rectangle will disappear after the crop is completed.



**Figure 12-5:**  
Select the  
stuff that  
you want to  
keep in your  
photo.



## 2. If you want, choose a preset size.

If you'd like to force your cropped selection to a specific size — such as 4 x 3 for an iDVD project — select that size from the Constrain drop-down list box (to the left of the Crop button).

## 3. Click the Crop button in the Edit panel.

Oh, and don't forget that you can use iPhoto's Undo feature if you mess up and need to try again — just press ⌘+Z.



iPhoto features multiple Undo levels, so you can press ⌘+Z several times to travel back through your last several changes.

### *Enhancing images to add pizzazz*

If a photo looks washed-out, click the Enhance button to increase (or decrease) the color saturation and improve the contrast. Enhance is automatic, so you don't have to set anything, but keep in mind that Enhance isn't available if any part of the image is selected. (If the selection rectangle appears in the viewer, click anywhere outside the selected area to banish the rectangle before you click Enhance.)



To compare the enhanced version with the original photo, press Control to display the original image. When you release the Control key, the enhanced image returns. (This way, if you aren't satisfied, you can press ⌘+Z and undo the enhancement immediately.)

### *Removing rampant red-eye*

Unfortunately, today's digital cameras can still produce the same “zombies with red eyeballs” as traditional film cameras. *Red-eye* is caused by a camera's flash reflecting off the retinas of a subject's eyes, and it can occur with both humans and pets.

iPhoto can remove that red-eye and turn frightening zombies back into your family and friends! Click the Red-Eye button, and then select a demonized eyeball by clicking in the center of it. To complete the process, click the X in the button that appears in the image.

### *Retouching like the stars*

iPhoto's Retouch feature is perfect for removing minor flecks or lines in an image (especially those you've scanned from prints). Click Retouch, and you'll notice that the mouse cursor turns into a crosshair — just drag the cursor across the imperfection. Like the Enhance feature, you can compare the retouched and the original versions of the image by holding down and releasing the Control key.

### *Switching to black-and-white or sepia*

Ever wonder whether a particular photo in your library would look better as a black-and-white (or *grayscale*) print? Or perhaps an old-fashioned *sepia*

tone in shades of copper and brown? Just click the Effects button to convert an image from color to shades of gray or brown, respectively.

### *Adjusting brightness and contrast manually*

Click Adjust to perform manual adjustments on brightness and contrast (the light levels in your image). To adjust the brightness and contrast, make sure that nothing's selected in the image, and then drag the Brightness/Contrast sliders until the image looks the way that you want.



While you're editing, you can use the Next and Previous buttons to move to the next image in the current album (or back to the previous image).

## *Publishing Your Own Photo Book*

Book mode unleashes what I think is probably the coolest feature of iPhoto: the chance to design and print a high-quality bound photo book! After you complete an album — all the images have been edited just the way you want, and the album contains all the photos you want to include in your book — iPhoto can send your images as data over the Internet to a company that will print and bind your finished book for you. (No, they don't publish *For Dummies* titles, but then again, I don't get high-resolution color plates in most of my books, either.)

At the time of this writing, you can order many different sizes and bindings, including an 8.5-by-11-inch softcover book with 20 single-sided pages for about \$20 and a hardbound 8.5-by-11-inch keepsake album with 10 double-sided pages for about \$30 (shipping included for both). Extra pages can be added at \$0.70 and \$1.00 a pop, respectively.

iPhoto 6 can also produce and automatically order calendars and greeting cards, using a process similar to the one I describe in this section for producing a book. Who needs that stationery store in the mall anymore?



If you're going to create a photo book, make sure to use only the best quality images with the highest resolution. The higher the resolution, the better the photos will look in the finished book. I always try to use images of more than 1000 pixels in both the vertical and horizontal dimensions.

To create a photo book, follow these steps:

- 1. Click the desired album in the source list to select it.**
- 2. Click the Book toolbar button.**
- 3. Select the size of the book and a theme.**

Your choices determine the number of pages and layout scheme, as well as the background graphics for each page.

#### 4. Click Choose Theme.

iPhoto displays a dialog box asking whether you want to lay out your photos manually or allow iPhoto to do everything automatically. Automatic mode is fine, but I'm a thorough guy, so we'll lay out this book manually.

#### 5. Click Manually to display the controls you see in Figure 12-6.

In Book mode, the viewer changes in subtle ways. It displays the current page at the bottom of the display and adds a scrolling row of thumbnail images above it. This row of images represents the remaining images from the selected album that you can add to your book. You can drag any image thumbnail into one of the photo placeholders to add it to the page. You can also click the Page button at the left of the thumbnail strip — it looks like a page with a turned-down corner — to display thumbnails of each page in your book. (To return to the album image strip, click the Photos button under the Page button.)



**Figure 12-6:**  
Preparing  
to publish  
my own  
coffee-table  
masterpiece.

## I really need a slideshow

You can use iPhoto to create slideshows! Click the album you want to display and then click the Slideshow button in the toolbar; you'll notice that iPhoto adds a Slideshow item in the source list. The same scrolling thumbnail strip appears at the top of the viewer — this time displaying the images in the album. Click and drag the thumbnails so that they appear in the desired order.

To choose a background music for your slideshow, click the Music button on the Slideshow toolbar to display the tracks from your iTunes library. Drag the individual songs you want to the song list at the bottom of the sheet — you can drag them to rearrange their order in the list as well. Click OK to accept your song list.

To configure your slideshow, click the Settings button on the Slideshow toolbar. In the sheet that appears, you can specify the amount of time that each slide remains on the screen, as well as an optional title and rating displays. I can recommend the Automatic Ken Burns

effect — yep, the same one in iMovie — which lends an animated movement to each image. Widescreen laptop owners will appreciate the Slideshow Format pop-up menu, which allows you to choose a 16:9 widescreen display for your slideshow.

Click the Adjust button to modify the settings for a specific slide (useful for keeping a slide onscreen for a longer period of time or for setting a different transition than the default transition you choose from the Slideshow toolbar).

To display a preview of a single slide and its transitions, click the desired slide and then click Preview; this is a handy way of determining whether your delay and transition settings are really what you want for a particular slide. When you're ready to play your slideshow, click the Play button, and iPhoto switches to full-screen mode. You can share your completed slideshow by clicking Share in the iPhoto menu, where you can send the slideshow to iDVD (for later burning onto a DVD), export it as a QuickTime movie, or send it through e-mail.

- 6. Rearrange the page order to suit you by dragging the thumbnail of any page from one location to another in the strip.**
- 7. On the Book toolbar below the page view, you can adjust a variety of settings for the final book, including the book's theme, page numbers, and comments.**

At this point, you can also add captions and short descriptions to the pages of your photo album. Click any one of the text boxes in the page display and begin typing to add text to that page.
- 8. When you're ready to publish your book, click the Buy Book button.**
- 9. In a series of dialog boxes that appear, iPhoto guides you through the final steps to order a bound book.**

Note that you'll be asked for credit card information



I wouldn't attempt to order a book using a dialup modem connection. The images are likely far too large to be sent successfully. If possible, use a broadband or network connection to the Internet while you're ordering. If your only connection to the Internet is through a dialup modem, I recommend saving your book in PDF format and having it printed at a copy shop or printing service instead. (Choose File⇨Print, and then click the Save as PDF button.)

## Photocasting for the People!

iPhoto 6 introduces a new feature called *photocasting* that does for images what podcasting does for audio: You can share your photos with friends, family, business clients, and anyone else with an Internet connection! (Your adoring public doesn't even require a Mac; they can use That Other Kind of Computer.) However, you *must* be a .Mac subscriber to photocast albums to others — if you haven't heard the news on Apple's .Mac service yet, see Chapter 9 for the details.

Here's how photocasting works: You designate an album to share by selecting it in the source list and then clicking the Photocast button on the iPhoto toolbar. iPhoto displays the Publish a Photocast sheet, as shown in Figure 12-7.



If the Photocast button doesn't appear on your toolbar, it's because there's not enough room on the toolbar at your current screen resolution! Click the double-right arrow button (>>) to display the remaining toolbar buttons.

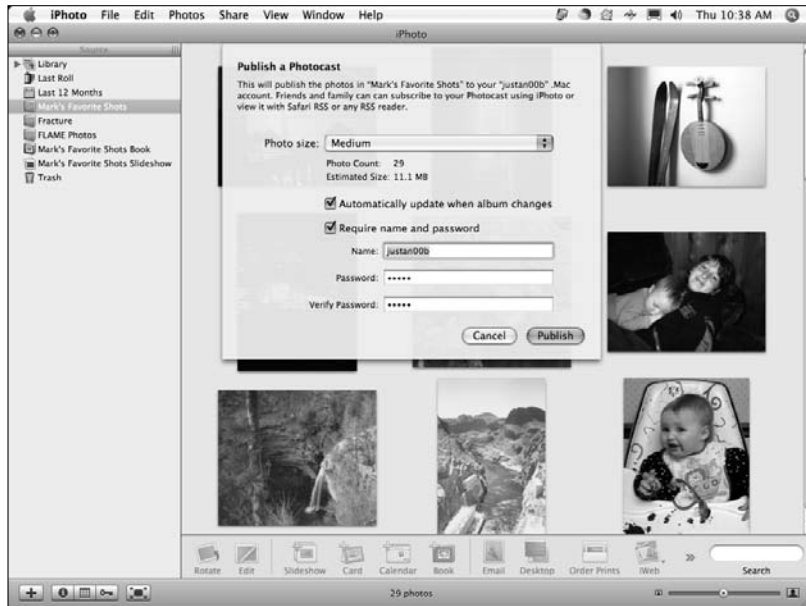

**Figure 12-7:**  
Treat others  
to your  
soccer  
photos,  
automati-  
cally!

Specify the size of the images you want to offer (full size is highest quality, natch, but also takes the longest time to upload and download). By default, any changes you make to the contents of this album are automatically updated on your .Mac account and, in turn, are updated automatically to everyone who receives your images. You can turn this feature off, however, if you have a large number of images and you update often (which can result in your sister's computer downloading a lot of data).



Prefer a little security for those images? In that case, you can require that your photocast audience enter a login name and password before they can receive your photos.

Click Publish, and you'll see that iPhoto indicates, with a cool twirling progress icon to the right of the album in the source list, that your images are being uploaded. When the process is complete, iPhoto indicates, with a special networky-looking icon to the right of the album, that the album is being photocasted. You're on the air!

Now for the other side of the coin: By clicking Announce Album on the iPhoto toolbar, iPhoto automatically prepares an e-mail message in Apple Mail that announces your new photocast! Just add the recipient names and click Send. This spiffy message includes complete photocast subscription instructions for

- ✓ **Folks using iPhoto 6 on a Mac:** As you can imagine, this is the easiest receive option to configure. After these folks are subscribed, they get an automatically updated album of the same name that appears in their source list, and they can use those images in their own iPhoto projects!
- ✓ **Folks using Windows or an older version of iPhoto:** These subscribers can use any Web browser with RSS support (like the Safari browser that comes with Tiger) or any RSS reader. (In effect, your photocast becomes an RSS feed for those without iPhoto 6.)

## *Mailing Photos to Aunt Mildred*

iPhoto can help you send your images through e-mail by automating the process. The application can prepare your image and embed it automatically in a new message.

To send an image through e-mail, select it and then click the Email button in the toolbar. The dialog box shown in Figure 12-8 appears, allowing you to choose the size of the images and whether you want to include their titles and comments as well.



**Figure 12-8:**  
Preparing to  
send an  
image  
through  
Apple Mail.



Keep in mind that most ISP (Internet service provider) e-mail servers won't accept an e-mail message that's more than 1MB or 2MB, so watch that Size display. If you're trying to send a number of images and the size goes over 2MB, you might have to click the Size drop-down list and choose a smaller size (reducing the image resolution) to get them all embedded in a single message.

When you're satisfied with the total file size and you're ready to create your message, click the Compose button. iPhoto automatically launches Apple Mail (or whatever e-mail application you specify) and creates a new message containing the images, ready for you to click Send!

## Chapter 13

# Making Film History with iMovie HD

---

### *In This Chapter*

- ▶ Taking stock of the iMovie HD window
  - ▶ Importing and adding media content
  - ▶ Using transitions in your movie
  - ▶ Working with visual effects
  - ▶ Putting text titles to work
  - ▶ Using Magic iMovie to create movies automatically
  - ▶ Sharing your movie with others
- 

**R**emember those home movies that kids used to make in high school? They were entertaining and fun to create, and your friends were impressed. In fact, some kids are so downright inspired that you're not surprised when you discover at your high school reunion that they became graphic artists or are involved in video or TV production.

iMovie HD 6, part of the iLife '06 suite, makes moviemaking as easy as filming those homemade movies. Apple has simplified all the technical stuff, such as importing video and adding audio, so you can concentrate on your creative ideas. In fact, you won't find techie terms like *codecs* or *keyframes* in this chapter. I guarantee that you'll understand what's going on at all times. (How often do you get a promise like that with video editing software?)

With iMovie HD, your digital video (DV) camcorder, and the other parts of the iLife suite, you can soon produce and share professional-looking movies, with some of the same creative effects and transitions used by those Hollywood types.

If you turn out to be a world-famous Hollywood-type director in a decade or so, don't forget the little people along the way!



## Shaking Hands with the iMovie HD Window

If you've ever tried a professional-level video editing application, you probably felt like you were suddenly dropped in the cockpit of a jumbo jet. In iMovie HD, though, all the controls you need are easy to use and logically placed.



Video editing takes up quite a bit of desktop space. In fact, you can't run iMovie HD at resolutions less than 1024 x 768, nor would you want to.

To launch iMovie HD, click the iMovie HD icon on the dock. (It looks like a director's clapboard.) You can also click the Application folder in any Finder window sidebar and then double-click the iMovie HD icon.

When you first launch iMovie HD, the application displays a top-level dialog box, as shown in Figure 13-1. From here, you can create a new iMovie HD project, open an existing project, or let iMovie HD do things automatically through Magic iMovie. (I cover Magic iMovie later in the section, "Doing iMovie Things iMagically.")

To follow the examples I show you here, follow these strenuous steps:

1. Click the **Create a New Project** button.
2. When iMovie HD prompts you to type a name for your project, do so.
3. Click **Create**.

You're on your way! Check out Figure 13-2: This is the whole enchilada, in one window.



**Figure 13-1:**  
You'll see this when you launch iMovie HD for the first time.

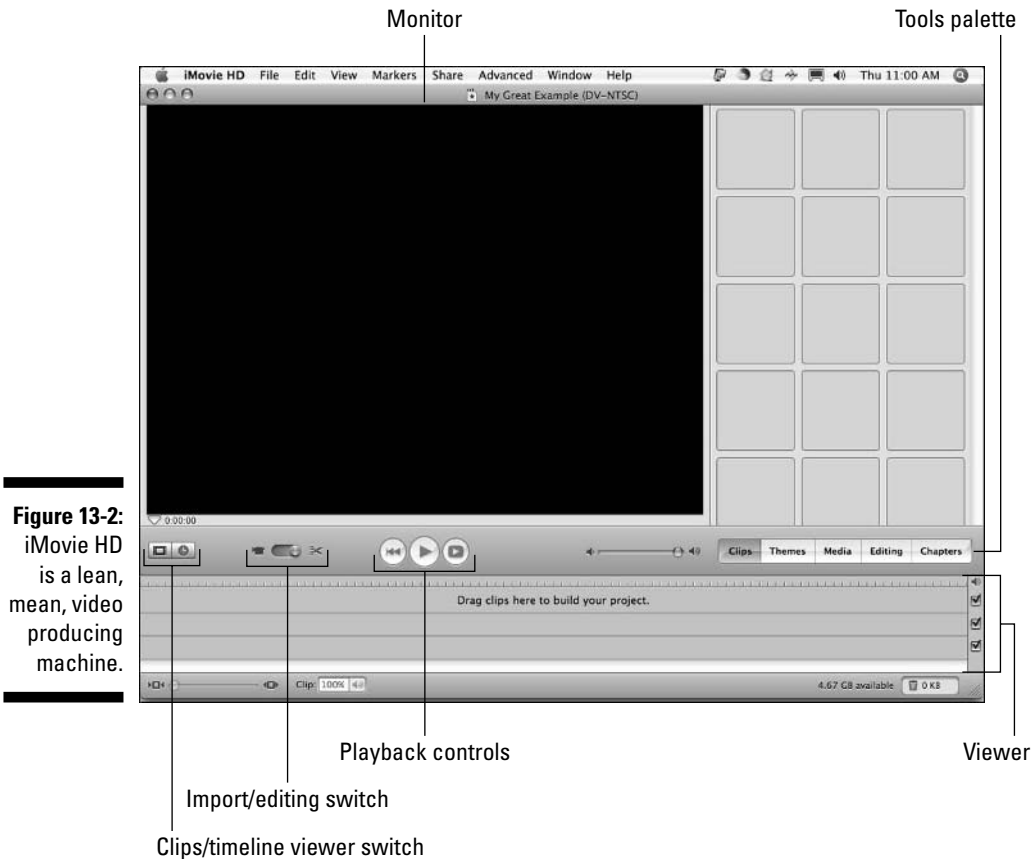

**Figure 13-2:** iMovie HD is a lean, mean, video producing machine.

The controls and displays that you'll use most often follow:

- ✓ **Monitor:** Think of this just like your TV or computer monitor. Your video clips, still images, and finished movie play here.
- ✓ **Tools palette:** This row of buttons allows you to switch between your media clips (video clips, photos, and audio) and the various tools that you use to make your film. For example, Figure 13-2 illustrates the Clips pane, which appears when you click the Clips button (go figure).  
*Hint:* All the video clips that you use to create your movie are stored in the Clips pane. I show you what each of the panes in the Tools palette looks like as you tackle different tasks in this chapter.
- ✓ **Clips/timeline viewer:** iMovie HD switches between two views — the clips viewer and the timeline viewer — and I cover 'em both later in this chapter. The buttons that you use to toggle between the two views are labeled in Figure 13-2, which is displaying the clips viewer.

- ✓ **Playhead:** The vertical line that you see in the viewer is the *playhead*, which indicates the current editing point while you're creating your movie. When you're playing your movie, the playhead moves to follow your progress through the movie.
- ✓ **Scrubber bar:** This bar makes it easy to crop, trim, or split a selected clip. The entire length of a clip that you select is covered by the scrubber bar, so you can drag the playback handle at the top of the bar to quickly move through the clip.
- ✓ **Playback controls:** If these look familiar, it's no accident: These controls are used to play your movie (in window and full-screen mode) and to return the playhead to the beginning of the movie. A different set of controls appears when you import digital video from your DV camcorder.
- ✓ **Import/editing switch:** Click this switch to toggle between importing DV clips from your DV camcorder and editing your movie.

Those are the major highlights of the iMovie HD window. A director's chair and megaphone are optional, of course, but they do add to the mood.

## *A Bird's-Eye View of Moviemaking*

I don't want to box in your creative skills here — after all, you can attack the moviemaking process from a number of angles. (Pun unfortunately intended.) However, I've found that my movies turn out the best when I follow a linear process, so before I dive into specifics, allow me to provide you with an overview of moviemaking with iMovie HD.

Here's my take on the process, reduced to seven steps:

1. **Import your video clips either directly from your DV camcorder or from your hard drive.**
2. **Drag your new selection of clips from the Clips pane to the viewer and arrange them in the desired order.**
3. **Import or record audio clips (from iTunes, GarageBand, or external sources such as audio CDs or audio files you've recorded yourself) and add them to your movie.**
4. **Import your photos (directly from iPhoto or from your hard drive) and place them where needed in your movie.**
5. **Add professional niceties such as audio, transitions, effects, and text to the project.**

6. **Preview your film and edit it further if necessary.**
7. **Share your finished film with others through the Web, e-mail, or a DVD that you create and burn with iDVD 6. (Read all about iDVD 6 in Chapter 14.)**

That's the first step-by-step procedure in this chapter. I doubt that you'll even need to refer back to it, however, because you'll soon see just how easy it is to use iMovie HD.

## *Importing the Building Blocks*

Sure, you need video clips to create a movie of your own, but don't panic if you have but a short supply. You can certainly turn to the other iLife applications for additional raw material. (See, I told you that integration thing would come in handy.)

Along with video clips you import from your DV camcorder, iSight camera, and hard drive, you can also call on iPhoto for still images (think credits) and iTunes for background audio and effects. In this section, I show you how.

### *Pulling in video clips*

Your Mac laptop is already equipped with the two extras that come in handy for video editing: namely, a large hard drive and a FireWire port. Because virtually all DV camcorders today use a FireWire connection to transfer clips, you're all set. (And even if your snazzy new DV camcorder uses a USB 2.0 connection, you're still in the zone!) Here's the drill if your clips are on your DV camcorder:

1. **Plug the proper cable into your laptop.**
2. **Set the DV camcorder to VTR (or VCR) mode.**  
Some camcorders call this Play mode.
3. **Slide the import/editing switch (labeled in Figure 13-2) to the left.**

The playback controls under the monitor change subtly, now mirroring the controls on your DV camcorder. This allows you to control the unit from iMovie HD. *Keen!* You also get an Import button as a bonus.

4. **Locate the section of video that you want to import by using the playback controls.**



5. Click **Stop** and then **rewind to a spot a few seconds before the good stuff**.
6. Click the **Play** button again (**this may not be necessary on all cameras**).
7. Click the **Import** button at the bottom of the monitor.  
iMovie HD begins transferring the footage to your laptop.
8. **When the desired footage is over, click the Import button again to stop the transfer.**  
iMovie HD automatically adds the imported clip to your Clips pane.
9. Click **Stop** to end the playback and admire your handiwork.



If your clips are already on your hard drive, rest assured that iMovie HD can import them, including those in *high-definition video* (HDV) format. iMovie HD also recognizes a number of other video formats, as shown in Table 13-1.

<b>File Type</b>	<b>Description</b>
DV	Standard digital video
iSight	Live video from your laptop's iSight camera
HDV	High-definition (popularly called <i>widescreen</i> ) digital video
MPEG-4	A popular format for streaming Internet and wireless digital video

To import a video file, follow this bouncing ball:

1. Click the **Clips** button on the **Tools** palette to display the **Clips** pane.
2. Choose **File**⇧**Import**.
3. **Double-click** the clip to add it to the **Clips** pane.

Alternatively, you can also drag a video clip from a Finder window and drop it in the Clips pane.

## *Making use of still images*

Still images come in handy as impressive-looking titles or as ending credits to your movie. (Make sure you list a gaffer and a best boy to be truly professional.) However, you can use still images also to introduce scenes or to

separate clips according to your whim. For example, I use stills when delineating the days of a vacation within a movie or different Christmas celebrations over time.

Here are two methods of adding stills to your movie:

- ✓ **Adding images from iPhoto:** Click the Media button in the Tools palette and then click the Photos button, and you'll experience the thrill that is your iPhoto library, right from iMovie HD (as shown in Figure 13-3). You can elect to display your entire iPhoto library or more selective picks like specific albums or film rolls. When you find the image you want to add, just drag it to the right spot in the viewer.
- ✓ **Importing images from your hard drive:** Choose File→Import to add images in any format supported by iPhoto: TIFF, JPEG, GIF, PICT, PNG, and PSD. These images show up in the Clips pane, and you can drag them to the viewer just as if they were video clips. If you're a member of the International Drag-and-Drop society, you can drag images directly from a Finder window and drop them into the viewer as well.



**Figure 13-3:** Pulling still images from iPhoto is child's play.

## Importing and adding audio from all sorts of places

You can pull in everything from Wagner to Weezer as both background music and sound effects for your movie. In this section, I focus on how to get those notes into iMovie HD and then how to add them to your movie by dragging them to the timeline viewer.

You can add audio from a number of sources:

- ✓ **Adding songs from iTunes:** Click the Audio button at the top of the Media pane to display the contents of your iTunes library. In the scrolling list box, click the desired playlist, such as the Dinah Washington playlist I selected in Figure 13-4. (If you've exported any original music you've composed in GarageBand to your iTunes Library, you can use those songs in your own movie!) You can add a track at the current location of the playhead in the timeline viewer by clicking the song to select it and then clicking the Place at Playhead button.

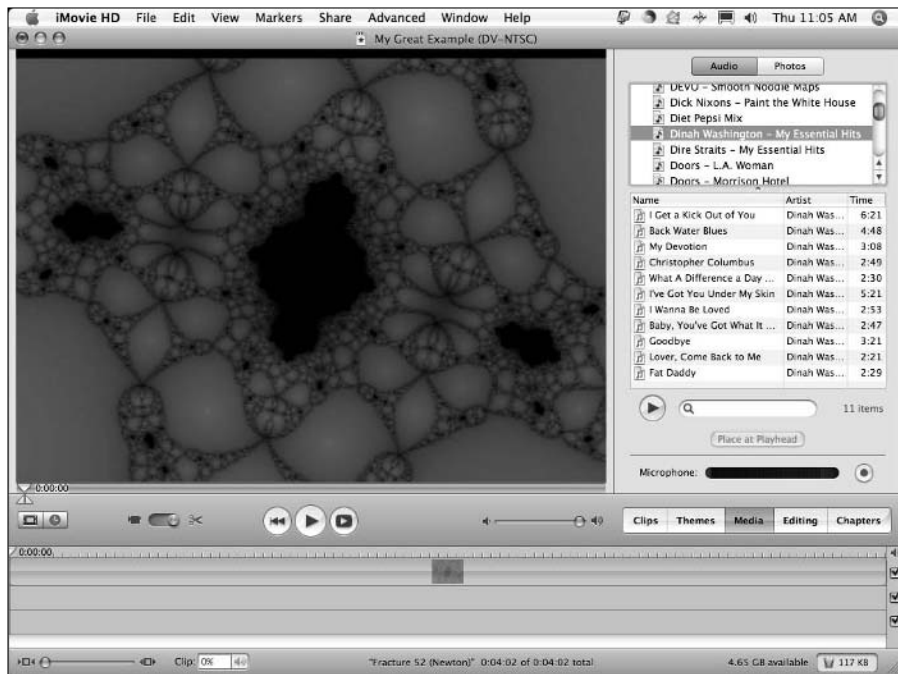

**Figure 13-4:** Calling on my iTunes library to add Dinah Washington to my iMovie.



- ✓ **Adding sound effects:** Yep, if you need the sound of a horse galloping for your Rocky Mountain vacation clips, click either Standard Sound Effects or Skywalker Sound Effects in the scrolling list box. iMovie HD includes a number of top-shelf audio effects from Skywalker Studios that you can use in the second audio track on the timeline viewer. This way, you can add sound effects even when you've already added a background song. Again, to add a sound effect at the current location of the playhead in the timeline viewer, click the effect to select it and then click Place at Playhead.

If you have several gigabytes of music in your iTunes library, it might be more of a challenge to locate “Me and Bobby McGee” by Janis Joplin, especially if she’s included in a compilation. Let your Mac do the digging for you! Click in the Search box below the track list and begin typing a song name. iMovie HD narrows down the song titles displayed to those that match the characters you type. To reset the search box and display all your songs in the library or selected playlist, click the X icon that appears to the right of the box.

- ✓ **Ripping songs from an audio CD:** Load an audio CD and then choose Audio CD from the scrolling list box. iMovie HD displays the tracks from the CD, and you can add them at the current playhead position the same way as iTunes songs.
- ✓ **Recording directly from a microphone:** Yep, if you’re thinking voice-over narration, you’ve hit the nail on the head. Check out the “Narration the easy way” sidebar for the scoop.
- ✓ **Importing audio from your hard drive:** Choose File⇨Import to import digital audio in any format recognized by QuickTime. The big players are MP3, AAC, Apple Lossless, WAV, and AIFF. The audio you import is inserted in the viewer at the current playhead location. Of course, you’re also welcome to drag audio files from a Finder window and drop them into the viewer.



iMovie HD displays all the audio for your movie in two tracks in the timeline viewer, so you won’t see your audio in the clips viewer.



With the arrival of iMovie HD 6, you can fine-tune the audio that you add to your project. With the desired audio track selected, click the Editing button in the Tools palette, and then click the Audio FX button. You’ll see an array of audio controls that allow you to reduce the ambient noise in an audio track, apply the reverb effect you’d expect in a cathedral or an arena, and even apply precise changes with a graphic equalizer! To hear what the audio sounds like with the effect applied, click Preview — if you like what you hear, click Apply.



## Narration the easy way

Ready to create that award-winning nature documentary? You can add voice-over narration to your iMovie HD project that would make Jacques Cousteau proud. In fact, you can record your voice as you watch your movie playing, allowing perfect synchronization with the action! To add narration, follow these steps:

1. **If you're not already using the timeline viewer, click the clips viewer/timeline viewer switch.**
2. **Drag the playhead in the timeline viewer to the point where the narration should begin.**
3. **Click the Media button on the Tools palette.**
4. **Click the Audio button.**
5. **Click the Play button in the monitor playback controls.**
6. **Click the Record button in the Audio pane.**

You can monitor the volume level of your voice with the Microphone meter.
7. **Watch the video while you narrate, so that you can coordinate your narration track with the action.**
8. **Click Stop in the Audio pane.**

iMovie HD adds your recorded audio in the timeline viewer. If you need to try again, press Delete to remove the audio clip and repeat the steps.

## Building the Cinematic Basics

Time to dive in and add the building blocks to create your movie. Along with video clips, audio tracks, and still images, you can add Hollywood-quality transitions, optical effects, and animated text titles. In this section, I demonstrate how to elevate your collection of video clips into a real-life furshlug-giner *movie*.

### Adding clips to your movie

You can add clips to your movie using the clip viewer or the timeline viewer. The Dynamic Duo work like this:

- ✓ **Clip viewer:** This displays your clips and still images. Each clip that you add occupies the same space. This is a great view for rearranging the clips and still images in your movie.
- ✓ **Timeline viewer:** This displays clips with relative sizes. The length of each clip in the timeline viewer is relative to the duration of the scene. (In plain English, a 60-second clip that you add to the timeline viewer appears half the length of a 120-second clip.)

To add a clip to your movie

1. Click the Clips button on the Tools palette to display the Clips pane.
2. Drag the desired clip from the Clips pane to the spot where it belongs in either viewer.

Do this several times, and you have a movie, just like the editors of old used to do with actual film clips. This is a good point to mention a moviemaking Mark's Maxim:



Preview your work — and do it often.

Use the View Fullscreen playback button under the monitor to watch your project while you add content. If you've ever watched directors at work on today's movie sets, they're constantly watching a monitor to see what things will look like for the audience. You have the same option in iMovie HD!

## *Removing clips from your movie*

Don't like a clip? Bah. To banish a clip from your movie:

1. Click the clip in the viewer to select it.
2. Press Delete.

The clip disappears, and iMovie HD automatically rearranges the remaining clips and still images in your movie.

If you remove the wrong clip, don't panic. Instead, use iMovie HD's Undo feature (press  $\text{⌘}+Z$ ) to restore it.

## *Deleting clips for good*



iMovie HD has its own separate trash system (different from Mac OS X trash). It's located at the bottom of the application window. If you decide that you don't need a clip or still image and you want to delete it from your iMovie HD project completely, drag the media item from either the Clips pane or from either viewer and drop it on top of the Trash icon. (Note that deleting a clip or still image from iMovie HD does not delete it from your hard drive.)

To delete the contents of the iMovie HD trash, choose File⇨Empty Trash. To display the contents of the iMovie HD trash, click the Trash icon; to retrieve an item that you suddenly decide you still need, drag the item back into the viewer.

## Reordering clips in your movie



If Day One of your vacation appears after Day Two, you can easily reorder your clips and stills by dragging them to the proper space in the clip viewer. When you release the mouse, iMovie HD automatically moves the rest of your movie aside with a minimum of fuss and bother.

## Editing clips in iMovie HD

If a clip has extra seconds of footage at the beginning or end, you don't want that superfluous stuff in your masterpiece. Our favorite video editor gives you the following functions:

- ✓ **Crop:** Deletes everything from the clip except a selected region
- ✓ **Split:** Breaks a single clip into multiple clips
- ✓ **Trim:** Deletes a selected region from the clip

Before you can edit, however, you have to select a section of a clip:

1. **Click a clip in the Clips pane to display it in the monitor.**
2. **Drag the playback head on the *scrubber bar* (that blue bar below the monitor) to the beginning of the section that you want to select.**
3. **Shift-click anywhere on the scrubber bar to the right of the starting point.**

The selected region turns yellow when you select it. You're ready to edit that selected part of the clip.



Note the handles that appear at the beginning or ending of the selection. You can make fine changes to the selected section by dragging them.

- ✓ **To crop:** Choose Edit⇨Crop. Everything but the selected region is removed.
- ✓ **To split:** Choose Edit⇨Split Video Clip at Playhead. The clip is divided into two clips.
- ✓ **To trim:** Choose Edit⇨Clear. The selected section disappears.

## Adding transitions

Many iMovie HD owners approach transitions as *visual bookends*: They merely act as placeholders that appear between video clips. Nothing could be further from the truth because judicious use of transitions can make or break a scene. For example, which would you prefer after a wedding ceremony — an abrupt, jarring cut to the reception or a gradual fadeout to the reception?



Today's audiences are sensitive to transitions between scenes. Try not to overuse the same transition. Also weigh the visual impact of a transition carefully.

iMovie HD includes a surprising array of transitions, including old favorites (such as Fade In and Dissolve) and some nifty stuff you may not be familiar with (such as Billow and Disintegrate). To display your transition collection, click the Editing button on the Tools palette and then click the Transitions button in the upper right of the screen, as shown in Figure 13-5.

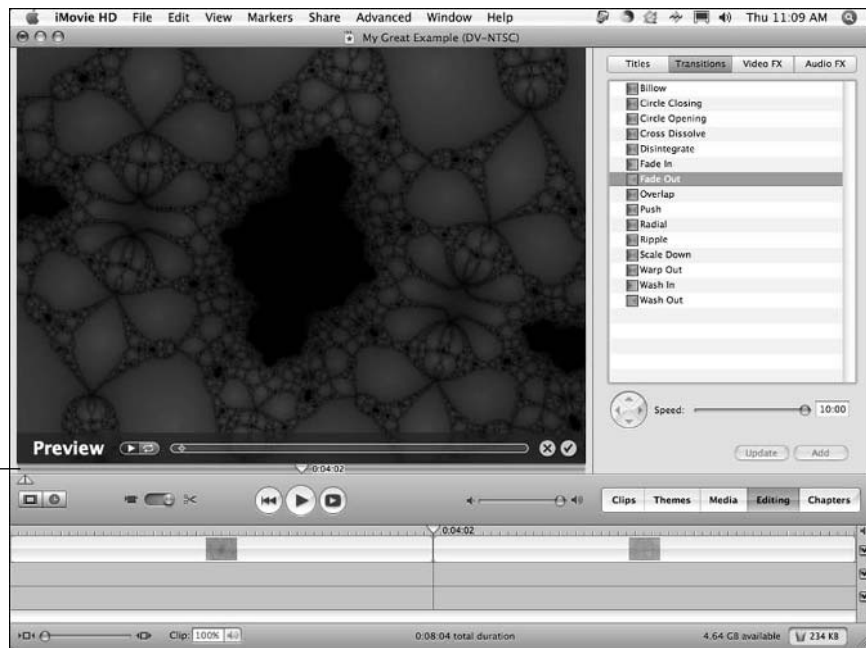

**Figure 13-5:**  
Add transitions for flow between clips in iMovie HD.

Scrubber bar

To see what a particular transition looks like, click it in the list to display the transition in the monitor. (If things move too fast, slow down the preview with the speed slider, which appears at the bottom of the Transition list.)

Adding a transition couldn't be easier: Drag the transition from the list in the Transitions pane and drop it between clips or between a clip and a still image. In iMovie HD 6, transitions are usually applied in real time — however, if you're working with an older laptop, the transition may take a few seconds to render. (If rendering time is required, iMovie HD displays a red progress bar in the viewer to indicate how much longer rendering will take.)

## *Oh, we got effects!*

iMovie HD offers a number of fun visual effects that you can add to your clips and stills. These aren't the full-blown visual effects of the latest science-fiction blockbuster, but then again, your movie already stars Uncle Humphrey, and most people would consider him a special effect.

For example, to immediately change a clip (or your entire movie) into an old classic, you can choose the Aged Film or Sepia effect to add that antique look.

To view the effects, click the Editing button on the Tools palette, and then click the Video FX button at the top of the screen. Click an effect from the list in the pane (see Figure 13-6) to display the options you can customize for that particular effect. The settings you can change vary for each effect, but most include the Effect In and Effect Out sliders, which allow you to gradually add an effect over a certain amount of time from the beginning of the clip and then phase it out before the clip ends. When you make a change to the settings, you see the result in the monitor window.

To add an effect to a clip or still image in the timeline viewer:

- 1. Click the clip or image to select it.**

The selection turns blue.

- 2. Click the desired effect.**

- 3. Make any necessary adjustments to the settings for the effect.**

- 4. When everything looks perfect, click Apply.**

Like transitions, effects take a few seconds to render. The faster your laptop, the shorter the time. Such is the life of a techno-wizard.

**Figure 13-6:**  
Adding a favorite effect of mine — the iMovie HD Aged Film effect.

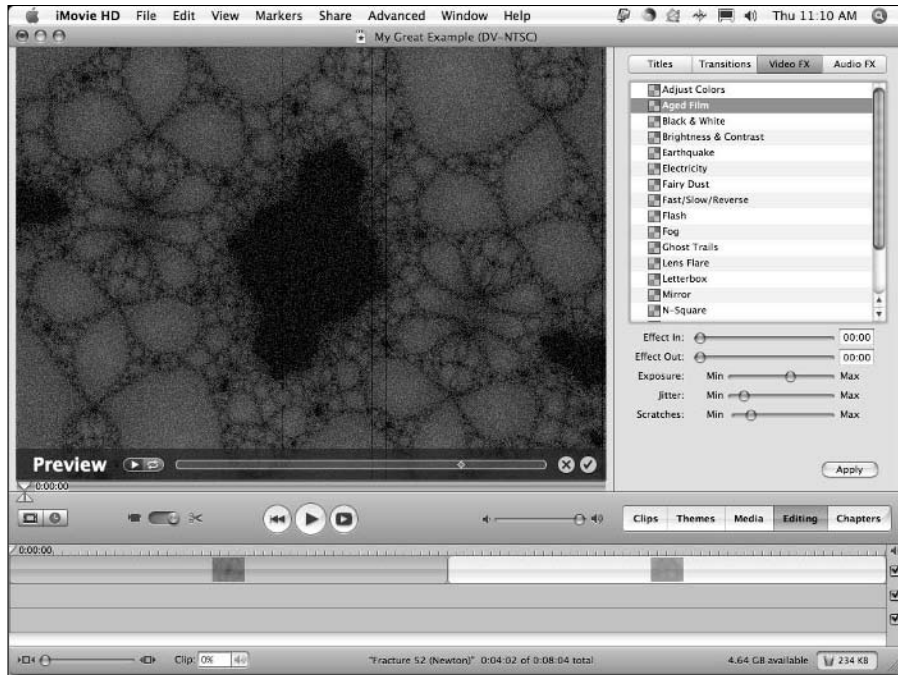

## *What's a masterpiece without titles?*

The last stop on our iMovie HD Hollywood Features Tour is the Titles pane. You'll find it by clicking the Editing button, as shown in Figure 13-7. You can add a title with a still image, but iMovie HD also includes everything you need to add basic animated text to your movie.

Most of the controls you can adjust are the same for each animation style. You can change the speed of the animation, the font, the size of the text, and the color of the text. You can even add an optional black background, but doing so actually inserts a new clip into your movie to show the text, which may affect the timing of your sound effects or narration.

To add a title

1. **Select an animation style from the list.**
2. **Type one or two lines of text in the text boxes at the bottom of the Titles pane.**



**Figure 13-7:**  
Add  
subtitles for  
your next  
foreign  
language  
film.

### 3. Make any changes to the settings specific to the animation style.

iMovie HD displays a preview of the effect in the monitor with the settings that you choose.

### 4. Drag the animation style from the list to the timeline.

The title appears in the timeline viewer as a clip.

## Doing iMovie Things iMagically

iMovie HD makes things just about as easy as can be with *Magic iMovie*, which you can use to create your movie automatically from the settings you choose from just one dialog box. (I know, it sounds like a corny name, but the feature is truly cool.) If you're in a hurry or you want to produce something immediately after an event (and you can do without the creative extras that I discuss earlier in this chapter), a Magic iMovie is the perfect option.

In fact, the close integration of iMovie HD and iDVD 6 can automate the process of downloading video from your DV camcorder and producing a finished DVD. As you can read in Chapter 14, iDVD has a similar feature called *OneStep DVD* that can create a DVD video from your Magic iMovie!

Follow these steps to let iMovie HD take care of moviemaking automatically:

- 1. Connect your DV camcorder to your laptop using a FireWire cable.**
- 2. Turn the camcorder on.**
- 3. Set it to VCR (or VTR) mode.**
- 4. Launch iMovie HD, then:**
  - *If you see the opening top-level dialog box, click Make a Magic iMovie.*
  - *If you had a project open and that project appears instead, choose File⇨Make a Magic iMovie.*
- 5. Type a project name and choose a location.**
- 6. Choose a video format.**

Typically, you'll want to use DV, DV widescreen, or the proper HDV resolution format. (Of course, there's always the iSight format, if your laptop has a built-in iSight camera.)
- 7. Click Create.**

iMovie HD displays the Magic iMovie dialog box.
- 8. In the Movie Title box, type a name for your movie.**
- 9. If your tape needs to be rewound before the capture starts, select the Rewind the Tape before Capturing the Movie check box.**
- 10. If you want transitions between scenes, select the Use Transitions check box, and then choose the transition you want from the pop-up menu.**
- 11. If you want a soundtrack, select the Play a Music Soundtrack check box, and then click the Choose Music button to browse your iTunes music library or to select an audio CD that you've loaded.**
- 12. Select the Send to iDVD check box.**

This ships your finished movie directly to iDVD, which launches automatically.
- 13. Click Create.**

## *Sharing Your Finished Classic with Others*

Your movie is complete, you've saved it to your hard drive, and now you're wondering where to go from here. Click Share on the application menu bar, and you'll see that iMovie HD can unleash your movie upon your unsuspecting family and friends (and even the entire world) in a number of ways:



- ✔ **E-mail:** Send your movie to others as an e-mail attachment. iMovie HD even launches Apple's Mail application automatically!
- ✔ **iWeb:** Share your movie with the world at large by using it with iWeb and posting it on your .Mac Web site. (I provide more .Mac details to chew on in Chapter 9.)
- ✔ **Videocamera:** Transfer your finished movie back to your DV camcorder.
- ✔ **iPod:** Truly *the* option to choose if you'd like to watch your movie on an iPod with video support.
- ✔ **GarageBand:** Export your movie to GarageBand, where it can be added to a podcast for that truly professional look.
- ✔ **iDVD:** iMovie HD can export your movie into an iDVD project, where you can use it to create a DVD video.
- ✔ **QuickTime:** Any computer with an installed copy of QuickTime can display your movies, and you can use QuickTime movies in Keynote presentations as well.
- ✔ **Bluetooth:** If you have Bluetooth hardware installed on your laptop, you can transfer your movie to a Bluetooth device.

When you choose a sharing option, iMovie HD displays the video quality for the option. If you decide to send your movie through e-mail, for example, it's reduced as far as possible in file size, and the audio is reduced to mono instead of stereo. The Videocamera and Bluetooth options give you onscreen instructions for readying the target device to receive your movie.



If you're worried about permanently reducing the quality of your project by sharing it through e-mail or your .Mac Web site, fear not! When you choose a sharing option to export your movie, your original project remains on your hard drive, unchanged, so you can share a better quality version at any time in the future!

After you adjust any settings specific to the desired sharing option, click Share to start the ball rolling.

## Chapter 14

# Creating DVDs on the Road with iDVD

---

### *In This Chapter*

- ▶ Traversing the iDVD window
  - ▶ Starting an iDVD project
  - ▶ Tweaking and adjusting your DVD Menu
  - ▶ Previewing your (nearly) finished DVD
  - ▶ Doing things automatically with OneStep DVD and Magic iDVD
  - ▶ Burning your finished masterpiece
- 

**H**ow does the adage go? Oh, yes, it's like this:

Any DVD movie must be a pain to create. You'll need a ton of money for software, too. And you'll need hours of training that will cause your brain to explode.

Funny thing is, *DVD authoring* — the process of designing and creating a DVD movie — really was like that for many years. Only video professionals could afford the software and tackle the training needed to master the intricacies of DVD Menu design.

Take one guess as to the company that changed all that. Apple's introduction of iDVD was a revolution in DVD authoring. Suddenly you, your kids, and Aunt Harriet could all design and burn DVDs with movies and picture slideshows. Dear reader, this iDVD thing is *huge*.

Plus, you'll quickly find out that iDVD 6 is tightly connected to all the other slices of your digital hub — in plain English, you can pull content from iTunes, iPhoto, and iMovie HD as easily as a politician makes promises.

In this chapter, I show you how your Mac laptop can take on Hollywood as well as how you can produce a DVD movie with content that's as good as any you'd rent at the video store!

## Introducing You and Your Laptop to iDVD

Figure 14-1 shows the whole “kit and kaboodle.” (Okay, Mark, drop it.) The iDVD 6 window was designed by the same smart people who brought you the iMovie HD window. You have to supply your own digital video clips, background audio, and digital photographs, of course.

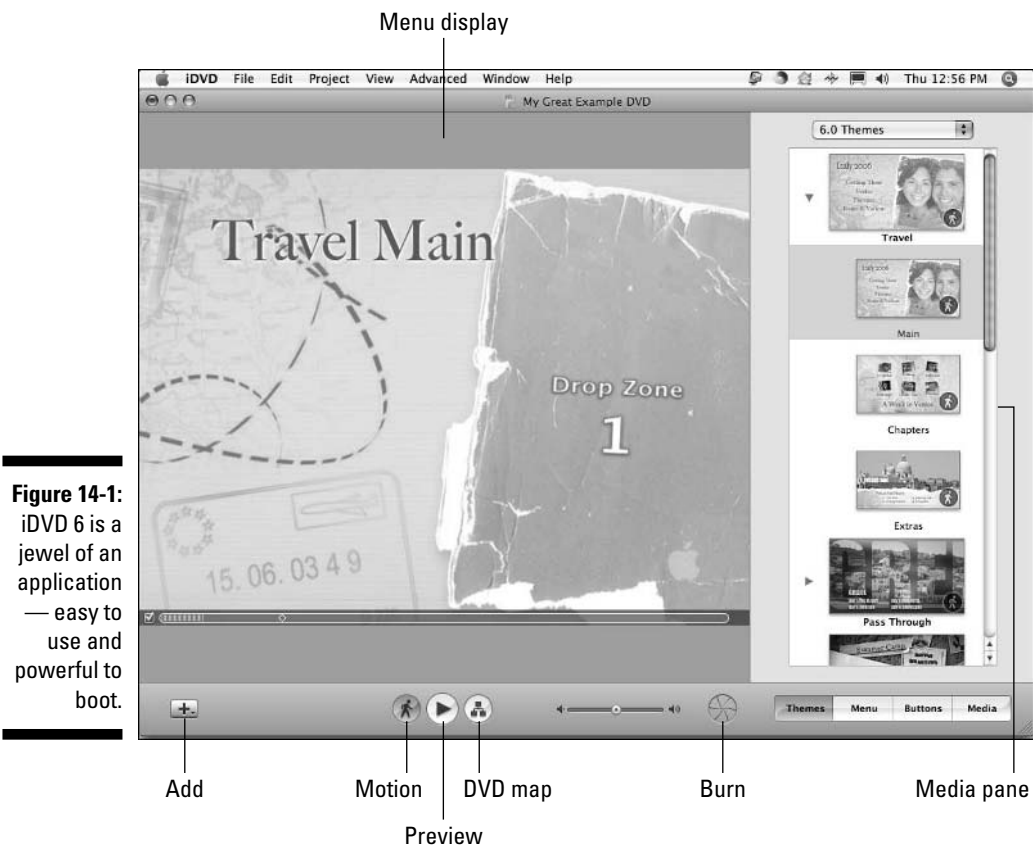

Take a moment to appreciate iDVD — no secondary windows to fiddle with or silly palettes strung out everywhere. (Can you tell that I've had my fill of old-style DVD authoring applications?) Allow me to list the highlights of the iDVD window:

- ✓ **Menu display:** This section takes up the largest part of the iDVD window, with good reason. You create your project here. In this case, *Menu* refers to your DVD Menu, not the menu at the top of your laptop's display.
- ✓ **Media pane:** You add video, still images, and audio to your project from here, as well as tweak and fine-tune things. The Media pane actually comprises four separate panes. To choose a new pane, click one of these buttons at the bottom of the screen:
  - *Themes:* You apply themes (such as Travel Cards, Wedding White, and Baby Mobile) to your DVD Menu to give it a certain look and feel.
  - *Menu:* From here, you can change the look of the menus displayed by your project by editing text and drop zones.
  - *Buttons:* These options apply to the item currently selected, such as drop shadows on your text titles or the appearance of your menu buttons.
  - *Media:* From here, you can add media items, such as video clips and photos, to your menu.
- ✓ **Add button:** From this drop-down list (which sports a dapper plus sign), you can choose one of three types of buttons to add to a project. The choices are
  - *Add Submenu:* Choose this item to add a new submenu button to your DVD Menu. The person using your DVD Menu can click a button to display a new submenu that can include additional movies or slideshows. (If that sounds like ancient Greek, hang on. All becomes clearer later in the chapter in the section, "Adding movies.")

In iDVD 6, a Menu can hold only 12 buttons, so submenus let you pack more content on your DVD. (Older versions of the application only allowed 6 buttons, so don't feel too cheated.) Anyway, each submenu you create can hold another 12 buttons.
  - *Add Movie:* Yep, this is the most popular button in the whole shooting match. Click this menu item to add a new movie clip to your menu.
  - *Add Slideshow:* If you want to add a slideshow to your DVD — say, using photos from your hard drive or pictures from your iPhoto library — click this menu item.



- ✔ **Motion:** Click this button to watch the animation cycle used with the current iDVD theme. Note that the animation *playhead* (the movie's timeline marker) moves below the Menu display to indicate where you are in the animation cycle. Like other playheads in the iLife suite, you can click-and-drag the diamond-shaped playhead button to move anywhere in the animation cycle. The animation repeats (just as it will on your finished DVD) until you click the Motion button again.
- ✔ **DVD Map:** Click the Map button to display the organizational chart for your DVD Menu. Each button and submenu that you add to your top-level DVD Menu is displayed here, and you can jump directly to a particular item by double-clicking it. Use this road map to help design the layout of your DVD Menu system or to get to a particular item quickly. To return to the Menu display, click the Map button again.
- ✔ **Preview:** To see how your DVD Menu project looks when burned to a DVD, click Preview. You get a truly nifty onscreen remote control that you can use to navigate your DVD Menu, just as if you were watching your DVD on a standard DVD player. To exit Preview mode, click the Stop button on the remote control. Read more about this control in the upcoming section, "Previewing Your Masterpiece."
- ✔ **Burn:** Oh, yeah, you know what this one is for — recording your completed DVD movie to a blank disc.

That's the lot! Time to get down to the step-by-step business of making movies.

## Starting a New DVD Project

When you launch iDVD 6 for the first time (or if you close all iDVD windows), you get the sporty menu shown in Figure 14-2. Let's take a moment to discover more about these four choices.

### Creating a new project

If you choose Create a New Project, iDVD prompts you to type a name for your new DVD project and to set a location where the project files should be saved. By default, the very reasonable choice is your Documents folder. You also get to choose whether your project will display in a Standard (full screen) aspect ratio of 4:3, or a Widescreen aspect ratio of 16:9. If you've been watching DVD movies for some time, you recognize these two terms.



You'll probably crave Widescreen format if you have a widescreen TV — go figure — but both formats will display on both types of televisions.

Click Create, and the iDVD window appears in all its glory.



**Figure 14-2:**  
Will that  
be create  
or edit,  
manual or  
automatic?

## *Opening an existing project*

If you've used iDVD and had a DVD project open the last time you quit the application, iDVD automatically loads the DVD project you were working on. However, you can open any DVD you've created by clicking Open an Existing Project. (To choose a different existing project from the iDVD window, press  $\mathbb{C}+O$ , or choose File⇨Open Recent.)

## *Automating the whole darn process*

If you are a fan of click-it-and-forget-it (or are in a hurry), you can throw caution to the wind and allow iDVD to create your latest epic for you! iDVD offers two automated methods of creating a DVD movie disc. One method has been around since the last version of the application, and the other is brand new with iDVD 6.

### *Using OneStep DVD*

With OneStep, iDVD does most of the work automatically, using the media clips and photos that you specify. To allow iDVD to help you create a movie, click the OneStep DVD button on the top-level menu (refer to Figure 14-2). If you've already opened a project, choose File⇨OneStep DVD from the application's menu bar (to import clips directly from your camera) or OneStep DVD from Movie (to select a clip to import from your hard drive).

I tell you more about the OneStep DVD feature later in the "A Word about Automation" section.

### *Using Magic iDVD*

Magic iDVD is the newcomer on the block, and it falls neatly between total automation (with OneStep DVD) and total manual control. Click the Magic iDVD button on the top-level menu (as shown in Figure 14-2). If you've already opened a project, you can choose File⇨Magic iDVD from the menu bar to choose a theme, drop specific movies and photos into filmstrips, and choose an audio track.

Unlike OneStep DVD, you get to preview the finished product. If it's to your liking, you can choose to either burn the disc directly or create a full-blown iDVD project with the results. *Sweet.*

You'll find out more about the new Magic iDVD feature later in the "A Word about Automation" section.

## *Creating a DVD from Scratch*

Doing things the old-fashioned, creative, and manual way (following the examples in this section) involves four basic steps:

- 1. Design the DVD Menu.**

Choose a theme and any necessary buttons or links.

- 2. Add media.**

iTunes.

- 3. Tweak.**

Adjust and fine-tune your DVD Menu settings.

- 4. Finish things up.**

Preview and burn your DVD, or save it to your hard drive.

## *Choosing just the right theme*

The first step to take when manually designing a new DVD Menu system is to add a theme. In the iDVD world, a *theme* is a preset package that helps determine the appearance and visual appeal of your DVD Menu, including a background image, menu animation, an audio track, and a group of settings for text fonts and button styles.

iDVD helps those of us who are graphically challenged by including a wide range of professionally designed themes for all sorts of occasions, ranging from old standbys such as weddings, birthdays, and vacations to more

generic themes with the accent on action, friendship, and technology. To view the included themes, click the Themes button in the lower-right corner of the iDVD window (see Figure 14-3).

To choose a theme for your project — or to see what a theme looks like on your menu — click any thumbnail and watch iDVD update the Menu display.



If you decide while creating your DVD Menu that you need a different theme, you can change themes at any time. iDVD won't lose a single button or video clip that you add to your DVD Menu. You'll be amazed at how the look and sound of your DVD Menu completely changes with just the click of a theme thumbnail.

## Adding movies

Drop zones and themes are cool, but most folks want to add video to their DVD. To accomplish this, iDVD uses *buttons* as links to your video clips. In fact, some iDVD Movie buttons display a preview of the video they will display! To play the video on a DVD player, you select the Movie button with the remote control, just like you do for a commercial DVD.



**Figure 14-3:**  
Select a  
new theme  
from the  
Themes  
pane.



## Taking advantage of drop zones

Most of Apple's animated themes include special bordered areas marked as drop zones. These locations have nothing to do with skydiving; rather, a *drop zone* is a placeholder in the Menu that can hold a single video clip or photograph. When you drag a video clip or an image to a drop zone, that clip or picture is added to the animation in Apple's theme! Think about that for a moment; I know I did. You can actually personalize a Hollywood-quality animated DVD menu with *your own photos and video!*

Most of the themes included with iDVD 6 include at least one drop zone, and some are practically jam-packed with drop zones. For example, the amazing Baby Mobile theme has a whopping six drop zones! If you think a menu looks just fine without anything in a drop zone, however, you don't have to put anything there. The words *Drop Zone* disappear when you preview or burn your DVD.

To add a video clip or image to a drop zone, simply drag the clip or photo from a Finder window and drop it on the drop zone. You can also drag clips or photos from other sources, including the Movie and iPhoto panes in iDVD, the iMovie HD window, or the iPhoto window. (Remember, Apple is anything but strict on these matters.) Remember, drop zones don't act as links or buttons to other content — the stuff you add to a menu's drop zones appear only as part of the theme's animation cycle.

If you're adding something to a dynamic drop zone (which disappears and reappears during the menu animation cycle), click the Motion button to activate the animation, and then click it again to stop the animation cycle. Now click-and-drag the scrubber bar until the desired drop zone is in view. To delete the contents of a drop zone, Control-click (or right-click) the drop zone and choose Clear.

To add a Movie button, drag a QuickTime movie file from the Finder and drop it onto your DVD Menu display. (Note that only MPEG-4 QuickTime movies are supported — older MPEG-1 and MPEG-2 movie clips may be rejected.) Alternatively, launch iMovie HD and drag a clip from the iMovie HD clip palette into the iDVD window, or click the Add button and choose Add Movie from the drop-down menu.



iDVD and iMovie HD are soul mates, so you can also display the iDVD Media pane and then click Movies from the pop-up menu. Now you can drag clips from your Movies folder.

No matter the source of the clip, when you drop it onto your DVD menu, iDVD adds a Movie button, as you can see in Figure 14-4. Note that some buttons appear as text links rather than actual buttons. The appearance of a Movie button in your DVD menu is determined by the theme you choose.



A Movie button doesn't have to stay where iDVD places it! To move a Movie button to another location, click-and-drag it to the desired spot. By default, iDVD aligns buttons to an invisible grid. If you don't want such order imposed on your creativity, turn off this grid function by clicking the button to select it, clicking the Buttons button (at the bottom of the Media pane), and selecting the Free Positioning radio button.

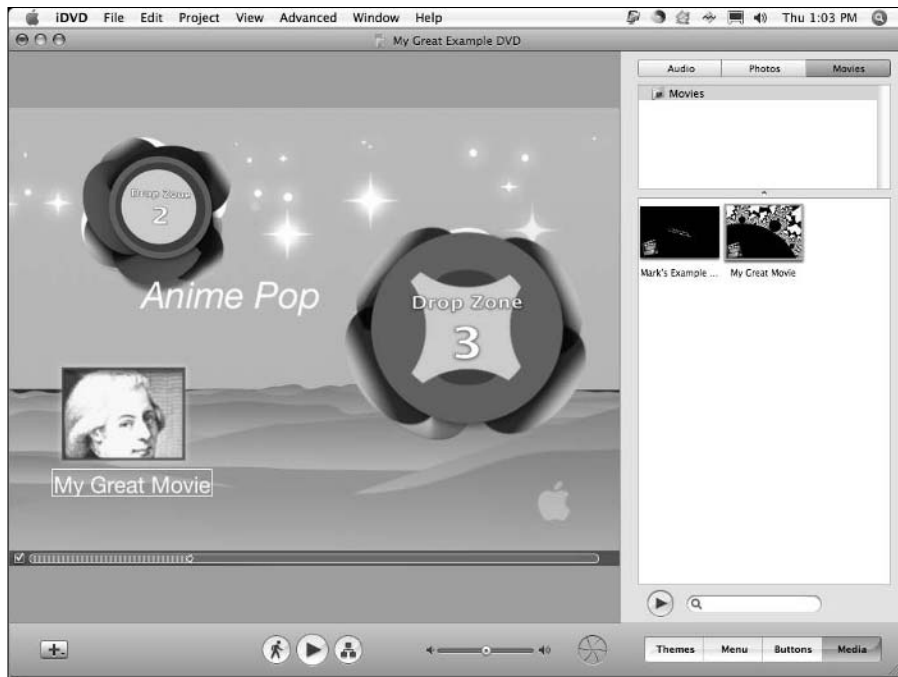

**Figure 14-4:**  
A new  
Movie  
button  
appears on  
your pristine  
DVD Menu.

You can have up to 12 buttons on your iDVD Menu. To add more content than 12 buttons allow, add a submenu by clicking the Add button and choosing Add Submenu from the drop-down menu. Now you can click the submenu button to jump to that screen and drag up to another 12 movie files into it.



Keep in mind your target audience while you create your DVD. Standard TV sets have a different *aspect ratio* (height to width) and *resolution* (number of pixels on the screen) than a digital video clip, and a standard TV isn't as precise in focusing that image on the tube. If you selected the Standard aspect ratio when you created the project, you can make sure that your DVD content looks great on a standard TV screen by following these steps:

1. **Click View on the old-fashioned iDVD menu (the one at the top of the screen).**
2. **Choose the Show TV Safe Area command.**

You can also press the convenient ⌘+T shortcut. iDVD adds a smaller rectangle within the iDVD window to mark the screen dimensions of a standard TV.

If you take care that your menu buttons and (most of) your background image fit within this smaller rectangle, you're assured that folks with a standard television can enjoy your work. To turn off the TV Safe Area rectangle, press ⌘+T again.

If your entire family is blessed with a fleet of HD TVs (or you chose the Widescreen aspect ratio for this project), leave the Show TV Safe Area option off. Today's widescreen displays can handle just about any orientation.

## *Great, now my audience demands a slideshow*

Many Mac owners don't realize that iDVD can use not only video clips but also digital photos as content. In fact, you can add a group of images to your DVD Menu by using Slideshow buttons, which allow the viewer to play back a series of digital photographs. iDVD handles everything for you, so there's no tricky timing to figure out or weird scripts to write. Just click the Add button at the bottom of the iDVD window and choose Add Slideshow. iDVD places a Slideshow button on your DVD Menu.

After the Slideshow button is on tap, you need to add the content — in this case, by choosing the images that iDVD adds to your DVD Menu. Follow these steps to select your slideshow images:

1. **Double-click the Slideshow Menu button — the one you just added to the menu — to open the Slideshow display (see Figure 14-5).**



**Figure 14-5:**  
Who needs a projector anymore? iDVD can create a great slideshow.

2. Click the **Media** button (bottom right of the screen).
3. Click the **Photos** button (top right of the screen) to display your iPhoto library and photo albums.
4. **Drag your favorite image thumbnails from the Photos list and drop them into the My Slideshow window.**



You can also drag images straight from a Finder window or the iPhoto window itself. (Those Apple folks are soooooo predictable.)

5. **Drag the photos in the My Slideshow window around to set their order of appearance in your slideshow.**
6. **To add audio to these pictures, drag your favorite audio file from the Finder and drop it in the Audio well in the My Slideshow window.**

The Audio well is the box bearing the speaker icon, next to the volume control below the My Slideshow window.

Alternatively, click the Audio button to select an audio track from your iTunes library, iTunes playlists, or GarageBand creations.

7. **Click the Return button to return to your DVD Menu.**



You can choose which image you want to appear on the Slideshow button. Click the Slideshow button that you added and see the slider that appears above the Slideshow button. Drag this slider to scroll through the images you added. When you find the image that you want to use for the Slideshow button in the DVD Menu, click the Slideshow button again to save your changes.

## *Now for the music . . .*

Most of the Apple-supplied themes already have their own background music for your menu, so you might not even need to add music to your DVD Menu. However, if you want to change the existing background music (or if your menu currently doesn't have any music), adding your own audio to the current menu is child's play!

1. **Click the Media button.**
2. **Click the Audio button to reveal the musical Shangri-La shown in Figure 14-6.**
3. **Drag an audio file from the iTunes playlist or GarageBand folder display and drop it on the menu background.**

iDVD 6 accepts every sound format that you can use for importing (or *encoding*) in iTunes: AIFF, MP3, AAC, Apple Lossless, and WAV audio files.



**Figure 14-6:**  
You'll do a lot of fine-tuning from the Settings pane.



Alternately, you can click the song you'd like to use and then click Apply.

4. Click the **Motion** button (labeled in Figure 14-1) to watch your DVD Menu animation cycle set to the new background audio.
5. Click the **Motion** button again to stop the animation and return to serious work.

## *Giving Your DVD the Personal Touch*

You can easily make changes to the default settings provided with the theme you chose. iDVD offers all sorts of controls that allow you to change the appearance and behavior of buttons, text, and the presentation of your content. In this section, I show you how to cast out iDVD's (perfectly good) defaults and then tweak things to perfection.

## *Using Uncle Morty for your DVD Menu background*

Hey, Uncle Morty might not be a supermodel, but he has birthdays and anniversaries, and iDVD is more than happy to accommodate you in documenting those milestones! Follow these steps to change the background of your DVD Menu:

1. **Click the Menu button.**
2. **Get an image using one of the following methods:**
  - Drag an image from the Finder and drop it into the Background well in the Menu section.
  - Drag the image directly into the Menu display.
  - To use an image from your iPhoto library, click the Media button and choose Photos, and then drag the desired image into the Menu display.

iDVD updates the DVD menu to reflect your new background choice.

## *Adding your own titles*

The one tweak you'll probably have to perform in every iDVD project is changing titles. Unfortunately, the default labels provided by iDVD are pretty lame, and they appear in two important places:

- ✓ **Menu title:** Your large main title usually appears at the top of the DVD Menu.
- ✓ **Button captions:** Each Movie and Slideshow button that you add to your menu has its own title.

To change the text in your Menu title or the titles below your buttons, follow these steps:

1. **Select the text by clicking it.**
2. **Click it again to edit it.**

A rectangle with a cursor appears to indicate that you can now edit the text.

3. **Type the new text and press Return to save the change.**

## Changing buttons like a highly paid professional

Customizing Movie buttons? You can do it with aplomb! Follow these steps:

1. **Click Buttons.**
2. **Click any Movie button from the DVD Menu to select it.**

A slider appears above the button, which you can drag to set the thumbnail picture for that button in your DVD Menu. (Naturally, this is only for animated buttons, not text buttons.)

Enable the Movie check box to animate the button.

3. **To create a Movie button with a still image, drag a picture from a Finder window or the Media pane and drop it on top of the button.**
4. **Adjust the properties for the button as desired with the controls in the Button section of the Media panel.**



Table 14-1 describes the button properties.

<i>Movie Button Property</i>	<i>What It Does</i>
Style thumbnail	Changes the frame shape of the Movie button.
Snap to Grid	Forces placement of a Movie button on an imaginary grid.
Free Positioning	Unlike Snap to Grid, allows Movie buttons to be placed in a freeform arrangement.
Transition	Determines the transition that occurs when the button is clicked (before the action occurs).
Size	Adjusts the size of the button and the caption text. Move the slider to the right to increase the button and caption size.

## Give my creation motion!

Earlier in this chapter, you found out how to use a different image for your background, but what about using an animated background? You can use any QuickTime movie from your iMovie HD library to animate your DVD Menu background! Didn't I tell you that this iDVD thing was *huge*?



Keep in mind that your background movie should be a short clip; 20–30 seconds is optimal. A clip with a fade-in at the beginning and a fade-out at the end is the best choice because iDVD loops your background clip continuously, and your animated background flows seamlessly behind your menu.

I'm not talking drop zones here. (See the sidebar, "Taking advantage of drop zones.") By using a movie clip as a background, you're replacing the entire animation sequence rather than just a single area of the background.

Follow these steps to add a new animated background:

1. **Click your old friend, the Menu button.**
2. **Drag a movie from the Finder and drop it into the Background well.**  
You can click the Movies button in the Media pane to instantly display your iMovie collection.
3. **Click the Motion button in the iDVD window to try out your new background.**
4. **Click the Motion button again to stop the animation cycle.**

## *Previewing Your Masterpiece*

Figure 14-7 captures the elusive Preview remote control — truly an awesome sight. When you click Preview, the Media pane disappears, and your DVD Menu appears exactly as it will on the finished DVD.

Ah, but appearances aren't everything: You can also use your DVD Menu! Click the buttons on the remote control to simulate the remote on your DVD player, or think outside the box and click a menu button directly with your mouse pointer. iDVD presents the video clip, runs the slideshow, or jumps to a submenu, just as it will with the completed disc.

This is a great time to test-drive a project before you burn it to disc. To make sure you don't waste a blank DVD, make certain that everything you expect to happen actually happens. Nothing worse than discovering that Aunt Edna's slideshow from her Hong Kong trip actually displays your family's summer trip to the zoo (whoops). If you made a mistake or something needs tweaking, click the Preview button again, and you're back to the iDVD window proper, where you can edit or fine-tune your project.





**Figure 14-7:**  
Preview  
mode — an  
incredible  
simulation  
indeed.



iDVD 6 allows you to save your project as a standard Mac OS X *disc image* rather than as a simple project file (or a physical DVD) — a good idea for those laptops without a SuperDrive on board, because you can use Apple's Disk Utility to open and mount the disc image as if it were a burned disc. If you move the disc image to another Mac with a SuperDrive, you can use Disk Utility to burn it on that machine. To save an iDVD project as a disc image, choose **File**→**Save as Disc Image** (or press **⌘+Shift+R**). For the complete word on disc images, visit Chapter 21 — hey, you didn't think I'd leave you out in the cold, did you?

## *A Word about Automation*

At the beginning of the chapter, I mention the easy way to produce an iDVD disc or project, using either OneStep DVD (for complete automation) or Magic iDVD (for partial automation). In this section, I provide you with the details.

## One-click paradise with OneStep DVD

If you're in a hurry to create a DVD from clips on your DV camcorder and you don't mind losing your creative input, OneStep DVD is just the ticket. In short, iDVD 6 allows you to plug in your DV camcorder, answer a question or two, and then sit back while the application does *all* the work. iDVD 6 imports the DV clips, creates a basic menu design, and burns the disc automatically!

Using OneStep DVD will appeal to any laptop owner with a SuperDrive. Right after a wedding or a birthday, for example, why not produce a DVD that you can give as a gift? Photographers who cover those same special events might consider selling a DVD made with OneStep DVD. If you happen to capture something incredibly unique — such as a UFO landing or an honest politician — you can use OneStep DVD to create an instant backup of the clips on your DV camcorder. You can even keep your friends and family up-to-date with the progress of your vacation by sending them a daily DVD of your exploits! (You gotta admit, even Grandma would consider that eminently *sassy!*)

Follow these steps to start the OneStep DVD process:

1. **Click the OneStep DVD button on the iDVD 6 top-level menu (refer to Figure 14-2).**

Alternately, choose File⇨OneStep DVD. iDVD displays the dialog box shown in Figure 14-8.

If you want to use OneStep DVD with an existing movie on your laptop's hard drive, choose File⇨OneStep DVD from Movie instead. iDVD prompts you for the video clip to use.



**Figure 14-8:**  
Connect your DV camcorder, and OneStep DVD does the rest.



2. **Following the prompts, connect the FireWire cable from your DV camcorder; then turn on the camcorder and set it to VCR mode.**
3. **Click OK.**
4. **Load a blank DVD.**

## Exercising control with Magic iDVD

Got a little extra time? For those who prefer to make just a few choices and let iDVD do the rest, the new Magic iDVD feature just plain rocks! However, you can't import clips directly from your DV camcorder like you can with OneStep DVD — instead, you select one of the following:

- ✓ An iDVD theme
- ✓ Video clips you've already created with iMovie HD or dragged from the Finder
- ✓ Photos from your iPhoto library or dragged from the Finder
- ✓ Audio from your iTunes playlist or dragged from the Finder

Follow these steps to start the OneStep DVD process:

1. Click the Magic iDVD button on the iDVD 6 top-level menu (refer to Figure 14-2).

iDVD displays the window you see in Figure 14-9.

2. Click in the DVD Title box and type a name for your disc (or project).
3. Click to select a theme from the Theme strip.

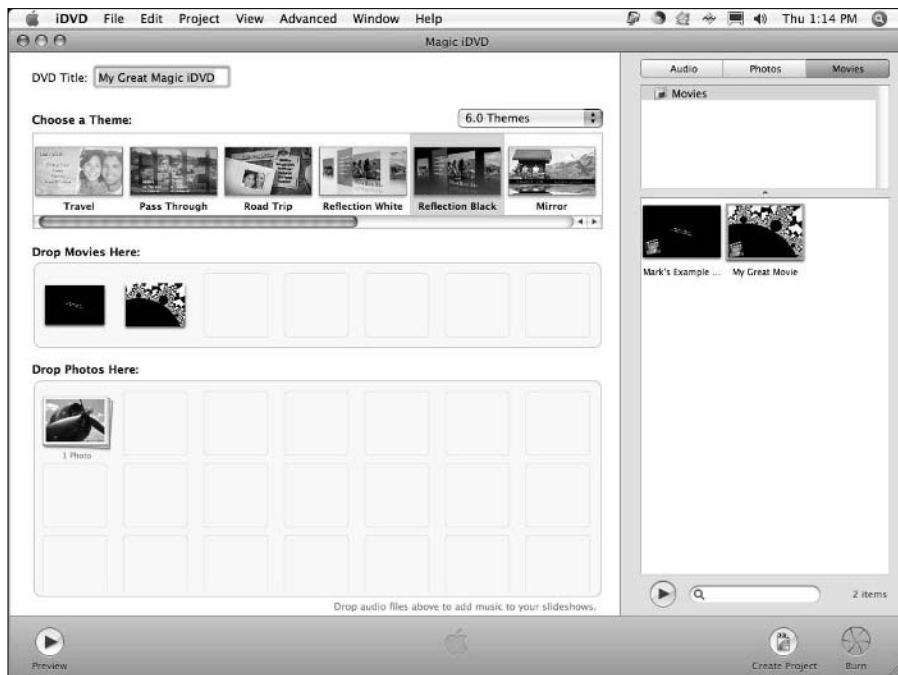

**Figure 14-9:** With Magic iDVD, you make some basic choices and iDVD does the work.

4. Click the **Movies** button and drag the desired clips into the **Drop Movies Here** strip.
5. To add a slideshow, click the **Photos** button and drag the desired photos into the **Drop Photos Here** strip.
6. To add audio for your slideshow, click the **Audio** button and drag the desired song into the **Drop Photos Here** strip (a speaker icon appears in the first cell of the strip to indicate that you've added a soundtrack).
7. Click **Preview** to see a preview of the finished project, complete with remote control. To exit Preview mode, click **Exit**.
8. To open the project in its current form in the main iDVD window, click **Create Project**.
9. To record your completed project directly to DVD, load a blank DVD and click **Burn**.

To return to the iDVD main window at any time, just click the **Close** button on the Magic iDVD window.

## *Recording a Finished Project to a Shiny Disc*

When you're ready to record your next Oscar-winning documentary on family behaviors during vacation, just follow these simple words.

1. Click the **Burn** button at the bottom of the iDVD window.

I have to admit, the **Burn** button that appears has to be my favorite single control in all my 20+ years of computing! It looks powerful, it looks sexy . . . it wants to *burn*. (Sorry about that.)

2. After iDVD asks you to insert a blank DVD-R into the SuperDrive, load a blank DVD-R, DVD-RW, DVD+R, or DVD+RW (depending on the media your Mac laptop can handle).



Your SuperDrive might be able to burn and read a DVD+R, DVD-RW, or DVD+RW, but what about your DVD player? Keep in mind that only DVD-Rs are likely to work in older DVD players. The latest generation of DVD players are likely DVD+R compatible as well, but I've seen only a handful of DVD players that can handle rewriteable media at the time of this writing. Therefore, remember the destination for the discs you burn and choose your media accordingly.

After a short pause, iDVD begins burning the DVD. The application keeps you updated with a progress bar.



Hey, while you're waiting, how about a timely book recommendation? If you want to discover how to burn all sorts of data, audio, and exotic CD and DVD formats, I can heartily recommend another of my books, *CD & DVD Recording For Dummies*, 2nd Edition (Wiley). It's a comprehensive manual for recording on the Mac. You'll find complete coverage of the popular Toast recording application from Roxio, too.

When the disc is finished, you're ready to load it into your favorite local DVD player, or you can load it back into your Mac and enjoy your work using Apple's DVD Player.

Either way, it's all good!

## Chapter 15

# GarageBand on the Go

---

### *In This Chapter*

- ▶ Touring the GarageBand window
  - ▶ Adding tracks to your songs and podcasts
  - ▶ Resizing, repeating, adding, and moving loops
  - ▶ Adding just the right effect
  - ▶ Recording with a microphone or MIDI instrument
  - ▶ Importing your new hit into iTunes
- 

**D**o you dream of making music? I've always wanted to join a band, but I never devoted the time nor learned to play the guitar. You know the drill: Those rock stars struggled for years to gain the upper hand over an instrument, practicing for untold hours, memorizing chords, and . . . wait a second. I almost forgot. You don't need to do *any* of that now!

Apple's GarageBand 3 (included in the iLife '06 suite) lets a musical wanna-be (like yours truly) make music with my MacBook Pro — complete with a driving bass line, funky horns, and a set of perfect drums that never miss a beat. In fact, the thousands of prerecorded loops on tap in GarageBand even allow you to *design* your music to match that melody running through your head, from techno to jazz to alternative rock.

Oh, and did I mention that GarageBand 3 also produces podcasts? That's right, you can record your voice and easily create your own show, and then share it with others from your iWeb site! Heck, add photos if you like. You'll be the talk of your family and friends and maybe even your Mac user group.

This chapter explains everything you need to know to create your first song (or your first podcast). I also show you how to import your hit record into iTunes so you can listen to it on your iPod with a big silly grin on your face (like I do) or add it to your next iMovie HD or iDVD project as a royalty-free soundtrack.

Oh, and don't be too smug when you think of all that practicing and hard work you missed out on. What a shame!

## Shaking Hands with Your Band

As you can see in Figure 15-1, the GarageBand window isn't complex at all, and that's good design. In this section, I list the most important controls so you know your Play button from your Loop Browser button.



**Figure 15-1:**  
The Garage-  
Band  
window —  
edged in  
wood grain,  
no less.

Your music-making machine includes



- ✓ **Track list:** In GarageBand, a *track* is a discrete instrument that you set up to play one part of your song. For example, a track in a classical piece for string quartet would have four tracks — one each for violin, viola, cello, and bass. This list contains all the tracks in your song arranged so that you can easily see and modify them, like the rows in a spreadsheet. A track begins in the list, stretching out to the right all the way to the end of the song. As you can see in the upper-left of Figure 15-1, I already have one track defined — a Grand Piano.

If you're creating a podcast, a *Podcast artwork track* like the one you see at the very top of the list in Figure 15-1 can also appear.

- ✓ **Timeline:** This scrolling area holds the loops (see the following bullet) that you add or record, allowing you to move and edit them easily. As a song plays, the timeline scrolls to give you a visual look at your music. (Bear with me; you'll understand that cryptic statement in a page or two.)
- ✓ **Loop:** This is a prerecorded clip of an instrument being played in a specific style and tempo. Loops are the building blocks of your song. You can drag loops from the loop browser to a track and literally build a bass line or a guitar solo. (It's a little like adding video clips to the timeline in iMovie HD to build a film.)
- ✓ **Playhead:** This vertical line is a moving indicator that shows you the current position in your song as it scrolls by in the timeline. You can drag the playhead to a new location at any time. The playhead also acts like the insertion cursor in a word processing application: If you insert a section of a song or a loop from the clipboard, it appears at the current location of the playhead. (More on copying and inserting loops later, so don't panic.)
- ✓ **Create a New Track button:** Click this button to add a new track to your song.
- ✓ **Track Info button:** If you need to display the instrument used in a track, click the track to select it and then click this button. You can also control settings such as Echo and Reverb from the dialog box that's displayed.
- ✓ **View/Hide Loop Browser button:** Click the button with the striking eye icon to display the Loop Browser at the bottom of the window; click it again to close it. You can see more tracks at a time without scrolling by closing the Loop Browser.
- ✓ **View/Hide Media Browser button:** Click this button (which bears icons of a filmstrip, slide, and musical note) to display the media browser at the right side of the window; click it again to close it. By closing the media browser, you'll see more of your tracks. If you're already familiar with iDVD or iMovie HD, you recognize this pane in the GarageBand window — it allows you to add media (in this case, still images or video clips) to your GarageBand project for use in a podcast.



- ✓ **Return to Beginning button:** Clicking this button immediately moves the playhead back to the beginning of the timeline.
- ✓ **Play button:** Hey, old friend! At last, a control that you've probably used countless times before — and it works just like the same control on your audio CD player. Click Play, and GarageBand begins playing your entire song. Notice that the Play button turns blue. To stop the music, click Play again; the button loses that sexy blue sheen, and the playhead stops immediately. (If playback is paused, it begins again at the playhead position when you click Play.)
- ✓ **Time/Tempo display:** This cool-looking LCD display shows you the current playhead position in seconds. You can also click the time/tempo indicator (the blue LED numerical display at the bottom of the window) to change the tempo (or speed) of your song.
- ✓ **Volume slider:** Here's another familiar face. Just drag the slider to raise or lower the volume.

Of course, more controls are scattered around the GarageBand window, but these are the main controls used to compose a song . . . which is the next stop!

## *Composing and Podcasting Made Easy*

In this section, I cover the basics of composition in GarageBand, working from the very beginning. Follow along with this running example:

**1. Press  $\mathbb{C}+N$ .**

GarageBand displays the Project Select dialog box.

**2. Click **New Music Project** to create a new song.**

GarageBand displays the New Project dialog box, as shown in Figure 15-2.

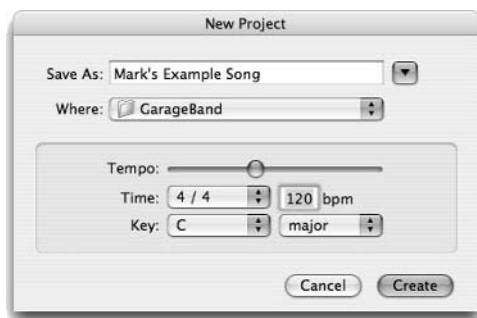

**Figure 15-2:**  
Start  
creating  
your new  
song here.



3. **Type a name for your new song, and then drag the Tempo slider to select the beats per minute (bpm).**

A GarageBand song can have only one tempo (or speed) throughout, expressed as beats per minute.

4. **If you want to adjust the settings for your song, you can select the**

- Time signature (the Time box)
- Key (the Key box).



If you're new to music *theory* (the rules/syntax by which music is created and written), just use the defaults. Most of the toe-tappin' tunes that you and I are familiar with fit right in with these settings.

5. **Click the Create button.**

You see the window shown in Figure 15-1. (The Emotional Piano 03 section in the middle of Figure 15-1 — which I show you how to add in the next section — is an example of a typical loop.)

## Adding tracks

Although I'm not a musician, I am a music lover, and I know that many classical composers approached a new work in the same way you approach a new song in GarageBand: by envisioning the instruments that you want to hear. (I imagine Mozart and Beethoven would have been thrilled to use GarageBand, but I think they did a decent job with pen and paper too.)



If you've followed along to this point, you've noticed two problems with your GarageBand window:

- ✓ **The tiny keyboard in the middle of your GarageBand window.** You can record the contents of a software instrument track by “playing” the keyboard, clicking the keys with your mouse. (As you might imagine, this isn't the best solution.) If you're a musician, the best method of recording your own notes is with a MIDI instrument, which I discuss later in the chapter. For now, you can banish the keyboard window by clicking the window's Close button.
- ✓ **The example song has only one track.** If you want to write the next classical masterpiece for Grand Piano (the default track when you create a new song in GarageBand), that's fine. Otherwise, on the GarageBand menu bar, choose Track⇨Delete Track to start with a clean slate.



These are the four kinds of tracks you can use in GarageBand 3:

- ✓ **Software instrument tracks:** These tracks aren't audio recordings. Rather, they're mathematically precise algorithms that your Mac *renders* (or builds) to fit your needs. If you have a MIDI instrument connected to your laptop, you can create your own software instrument tracks — more on MIDI instruments later in this chapter.  
  
In this chapter, I focus on software instrument tracks, which are the easiest for a non-musician to use.
- ✓ **Real instrument tracks:** A real instrument track is an actual audio recording, such as your voice or a physical instrument without a MIDI connection.
- ✓ **Podcast artwork track:** You get only one of these — they hold photos that will appear on a video iPod (or a window on your iWeb site) when your podcast is playing.
- ✓ **Video tracks:** the video sound track appears if you're *scoring* (adding music) to an iMovie HD movie. Along with the video sound track, you get a cool companion video track that shows the clips in your movie. (More on this in the sidebar titled "Look, I'm John Williams!" later in this chapter.)

Time to add a software instrument track of your very own. Follow these steps:

1. **Click the Create a New Track button (which carries a plus sign), labeled in Figure 15-1.**

GarageBand displays the New Track dialog box.

2. **Click the Software Instrument button and then click Create.**

See all those great instruments in the Track Info pane on the right?

3. **Choose the general instrument category by clicking it.**

I chose Drum Kits.

4. **From the right column, choose your specific style of weapon, such as Jazz Kit for a jazzy sound.**

Figure 15-3 illustrates the new track that appears in your list when you follow these steps.

If you're creating a podcast and you want to add a series of still images that will appear on a video iPod's screen (or on your iWeb page), follow these steps:

1. **Click the View Media Browser button (labeled in Figure 15-1).**
2. **Click the Photos button.**



**Figure 15-3:**  
The new  
track  
appears,  
ready to  
rock.

GarageBand displays all of the photos in your iPhoto library and film rolls.

**3. Drag an image from your iPhoto library in the media browser to the Track list.**

The Podcast track appears at the top of the Track list, and you can add and move images in the list at any time, just like the loops that you add to your instrument tracks. (More on adding and rearranging the contents of a track later in this section.)

## *Choosing loops*

When you have a new, empty track, you can add something that you can hear. You do that by adding loops to your track from the loop browser — Apple provides you with thousands of loops to choose from — and photos from your media browser. Click the Loop Browser button (which bears the all-seeing eye) to display your collection, as shown in Figure 15-4.

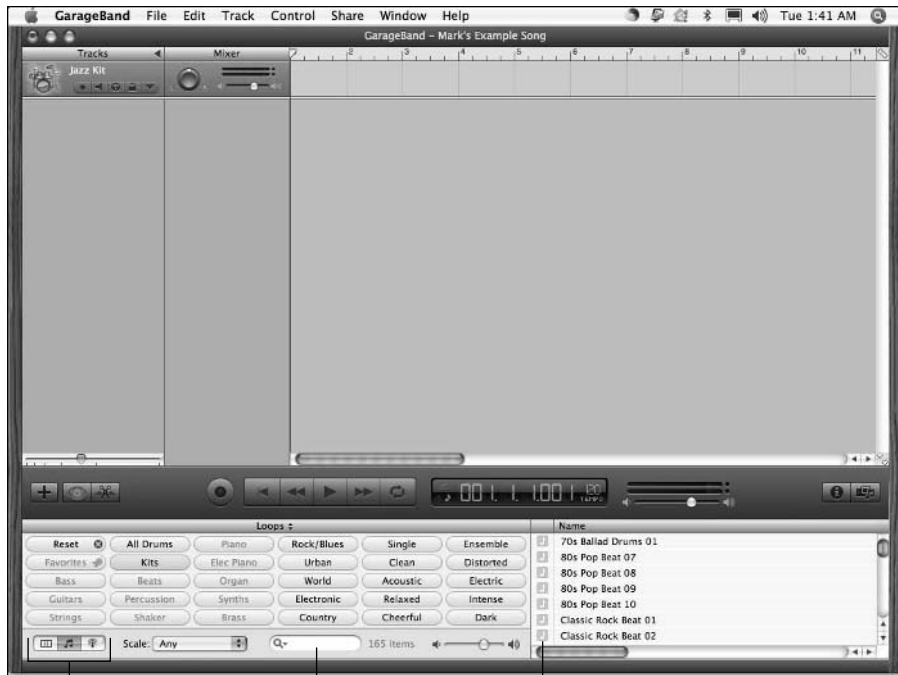

**Figure 15-4:**  
The loop  
browser,  
shown in  
button view.

View: column/button/podcast sounds      Search      Software instrument loop icon



If your browser looks different from what you see in Figure 15-4, that's because of the view mode you're using, just like the different view modes available for a Finder window. The three-icon button in the lower-left corner of the loop browser toggles the browser display between column, musical button, and podcast sounds view. Click the middle of the three buttons to switch to button mode.

### *Looking for just the right loop*

The track in this running example uses a jazz drum kit, but we haven't added a loop yet. (Refer to Figure 15-3.) Follow these steps to search through your loop library for just the right rhythm:

#### **1. Click the button that corresponds to the instrument you're using.**

In our example, this is the Kits button in the loop browser. Click it, and a list of different beats appears in the pane to the right of the browser window. (Check out Figure 15-4 for a sneak peek.)

**2. Click one of the loops with a green musical note icon.**

Go ahead, this is where things get fun! GarageBand begins playing the loop nonstop, allowing you to get a feel for how that particular loop sounds.



Because I'm using only software instruments in this track (and throughout this chapter), you should choose only software instrument loops, which are identified with a green musical note icon.

**3. Click another entry in the list, and the application immediately switches to that loop.**

Now you're beginning to understand why GarageBand is so cool for both musicians and the note-impaired. It's like having your own band, with members that never get tired and play whatever you want while you're composing. (Mozart would have *loved* this.)



If you want to search for a particular instrument, click in the Search box (labeled in Figure 15-4) and type the text you want to match. GarageBand returns the search results in the list.

**4. Scroll down the list and continue to sample the different loops until you find one that fits like a glove.**

For this reporter, it's Lounge Jazz Drums 01.

**5. Drag the entry to your Jazz Kit track and drop it at the very beginning of the timeline (as indicated by the playhead).**

Your window should look like Figure 15-5.



If you want that same beat throughout the song, you don't need to add any more loops to that track (more on extending that beat in the next section). However, if you want the drum's beat to change later in the song, you add a second loop after the first one in the *same* track. For now, leave this track as-is.



Whoops! Did you do something that you regret? Don't forget that you can undo most actions in GarageBand by pressing the old standby  $\text{⌘}+Z$  immediately afterward.

### *Second verse, same as the first*

As you compose, you can add additional tracks for each instrument that you want in your song:

- ✓ Each track can have more than one loop.
- ✓ Loops *don't* have to start at the beginning; you can drop a loop anywhere in the timeline.

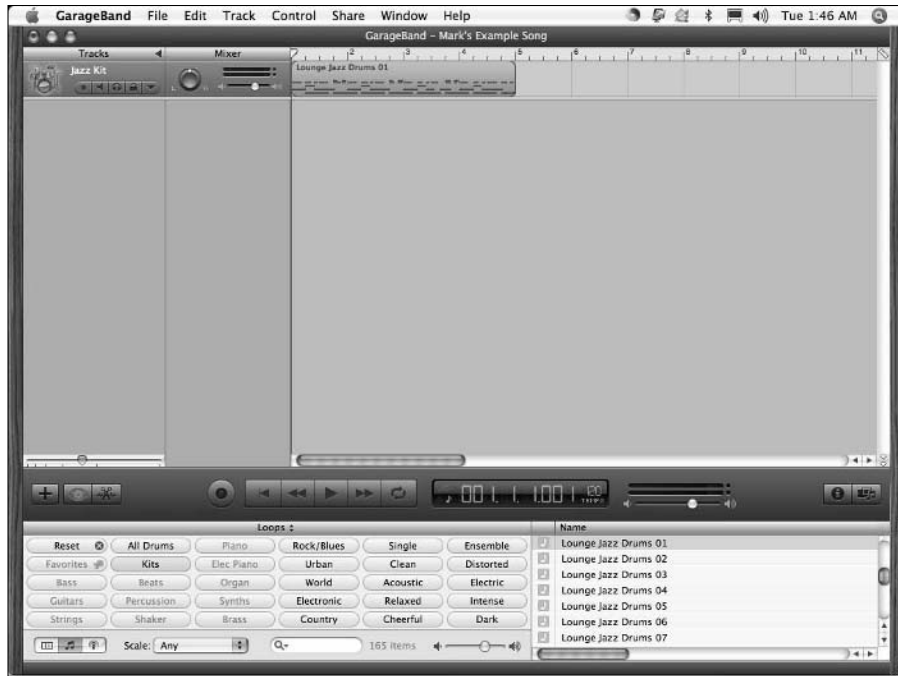

**Figure 15-5:**  
A track with  
a loop  
added.

For example, in Figure 15-6, you can see that my drum kit kicks in first, but my bass line doesn't begin until some time later (for a funkier opening).



You put loops on separate tracks so they can play simultaneously on different instruments. If all your loops in a song are added on the same track, you only hear one loop at any one time, and all the loops use the same software instrument. By creating multiple tracks, you give yourself the elbow room to bring in the entire band at the same time. It's uber-convenient to compose your song when you can see each instrument's loops and where they fall in the song.



Click the Reset button in the loop browser to choose another instrument or genre category.

## *Resizing, repeating, and moving loops*

If you haven't already tried listening to your entire song, try it now. You can click Play at any time without wreaking havoc on your carefully created tracks. Sounds pretty good, doesn't it?

**Figure 15-6:**  
My timeline  
with a jazz  
organ and a  
smooth  
bass  
onboard.  
Cool,  
Daddy-o!



## Look, I'm John Williams!

You too can be a famous composer of soundtracks . . . well, perhaps not quite as famous as Mr. Williams, but even he had to start somewhere. To add a GarageBand score to an iMovie HD project, you must start the process from within iMovie HD. With the desired project open in iMovie HD, click the Share menu and then click GarageBand. Click the Share button, and GarageBand automatically launches with the video track and video sound track visible.

At this point, you add and modify instrument tracks and loops just like you would any other GarageBand project. The existing sound for the iMovie HD project appears in the video sound

track. A Video Preview pane appears on top of the Track Info pane on the right side of the GarageBand window — when you click the Play button, the video is shown as well, so that you can check your work and tweak settings (as described later in the chapter).

After you've finished your composing, you can click Share on the menu bar and choose to export your work to iDVD, as a QuickTime movie directly to your hard drive, or to iWeb as a video podcast. Note that you can't return to iMovie HD with your project, so scoring should be a final step in the production of your movie.



## Join in and jam . . . or talk!

As I mention elsewhere in this chapter, GarageBand is even more fun if you happen to play an instrument! (And yes, I'm envious, no matter how much I enjoy the techno and jazz music that I create. After all, take away my MacBook and I'm back to playing the kazoo.)

Most musicians use MIDI instruments to play music on the computer. That pleasant-sounding acronym stands for *Musical Instrument Digital Interface*. A wide variety of MIDI instruments are available these days, from traditional MIDI keyboards to more exotic fun, such as MIDI saxophones. For example, Apple sells a 49-key MIDI keyboard from M-Audio for around \$100 — it uses a USB connection to your Mac.

Most MIDI instruments on the market today use a USB connection. If you have an older instrument with traditional MIDI ports — they're round, so you'll never confuse them with a USB connector — you need a USB-to-MIDI converter. You can find this type of converter on the Apple Web

site for around \$50. (If you're recording your voice for a podcast, things are easier because you can use your laptop's built-in microphone.)

After your instrument is connected, you can record tracks using any software instrument. Create a new software instrument track as I demonstrate in this chapter, select it, and then play a few notes. Suddenly you're playing the instrument you chose! (If nothing happens, check the MIDI status light — which appears in the time display — to see whether it blinks with each note you play. If not, check the installation of your MIDI connection and make sure you've loaded any required drivers.)

Drag the playhead to a beat or two before the spot in the timeline where you want your recording to start. This gives you time to match the beat. Then click the big red Record button and start jamming or speaking! When you're finished, click the Play button to stop recording.

But wait: I bet the song stopped after about five seconds, right? (You can watch the passing seconds using either the Time/Tempo display or the second rule that appears at the very top of the timeline.) I'm sure that you want your song to last more than five seconds! After the playhead moves past the end of the last loop, your song is over. Click Play again to pause the playback; then click the Return to Beginning button (labeled in Figure 15-1) to move the playhead back to the beginning of the song.

The music stops so soon because your loops are only so long. Most are five seconds in length, and others are even shorter. To keep the groove going, you have to do one of three things:

- ✓ **Resize the loop.** Hover your mouse cursor over either the left or right edge of most loops, and an interesting thing happens: Your cursor changes to a vertical line with an arrow pointing away from the loop. That's your cue to click and drag — and as you drag, most loops expand to fill the space you're making, repeating the beats in perfect time. By resizing a loop, you can literally drag the loop's edge as long as you like.

- ✔ **Repeat the loop.** Depending on the loop that you chose, you might find that resizing it won't repeat the measure. Instead, the new part of the loop is simply dead air. In fact, the length of many loops is limited to anywhere from 1 to 5 seconds. However, if you move your cursor over the side of a loop that you want to extend, it turns into a vertical line with a circular arrow, which tells you that you can click and *repeat* the loop. GarageBand actually adds multiple copies of the same loop automatically, for as far as you drag the loop. In Figure 15-7, I've repeated the bass loop that you saw in Figure 15-6.
- ✔ **Add a new loop.** You can switch to a different loop to change the flow of the music. Naturally, the instrument stays the same, but there's no reason why you can't use a horn riff loop in your violin track (as long as it sounds good played by a violin)! To GarageBand, a software instrument track is compatible with *any* software instrument loop that you add from the loop browser as long as that loop is marked with our old friend, the green musical note.



You can also use the familiar cut ( $\text{⌘}+X$ ), copy ( $\text{⌘}+C$ ), and paste ( $\text{⌘}+V$ ) editing keys to cut, copy, and paste loops from place to place — both on the timeline and from track to track. And you can click a loop and drag it anywhere. After all, you're working under Mac OS X.

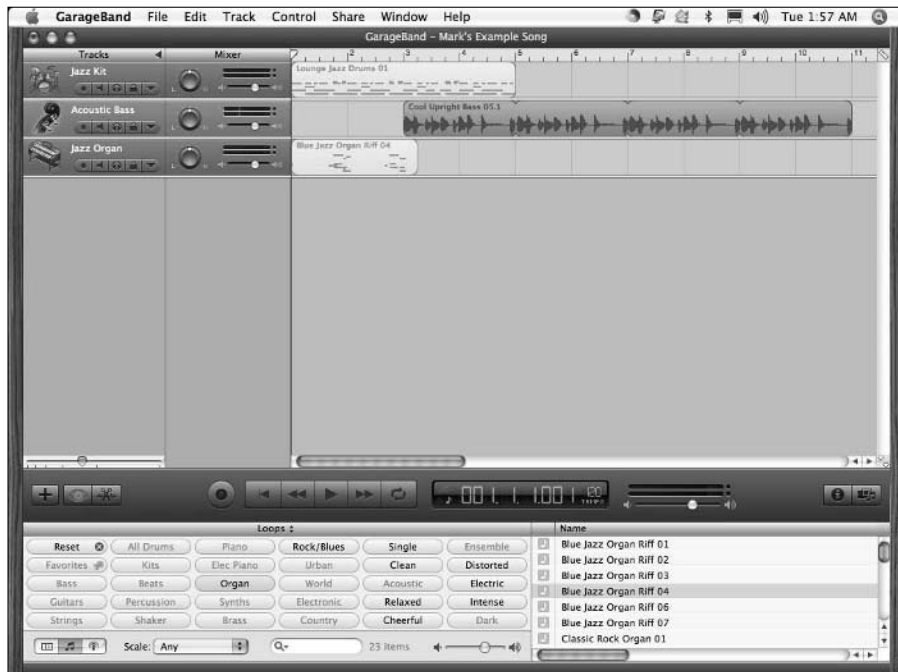

**Figure 15-7:**

By repeating the bass loop, you can keep the thump flowing.



Each track can be adjusted so that you can listen to the interplay between two or more tracks or hear how your song sounds without a specific track:

- ✓ Click the tiny speaker button under the track name in the list, and the button turns blue to indicate that the track is muted. To turn off the mute, click the speaker icon again.
- ✓ You can change the volume or balance of each individual track by using the mixer that appears next to the track name. This comes in handy if you want an instrument to sound louder or confine that instrument to the left or right speaker.

A track doesn't have to be filled for every second with one loop or another. As you can see in Figure 15-8, my first big hit — I call it *Turbo Techno* — has a number of repeating loops with empty space between them as different instruments perform solo. Not bad for an air guitarist who can barely whistle. Listen for it soon at a rave near you!



**Figure 15-8:** The author's upcoming techno hit — produced on a Mac.

## Tweaking the settings for a track

You don't think that John Mayer or U2 just "play and walk away," do you? No, they spend hours after the recording session is over, tweaking their music in the studio and on the mixing board until every note sounds just like it should. You can adjust the settings for a track, too. The tweaks that you can perform include adding effects (pull a Hendrix and add echo and reverb to your electric guitar track) and kicking in an equalizer (for fine-tuning the sound of your background horns).

To make adjustments to a track, follow these steps:

1. Click the desired track in the track list to select it.
2. Click the Track Info button (labeled in Figure 15-1).
3. Click the Details triangle at the bottom to expand the dialog box and show the settings shown in Figure 15-9.
4. Select the check box of each effect you want to enable.

Each of the effects has a modifier setting. For example, you can adjust the amount of echo to add by dragging its slider.



**Figure 15-9:**  
Finesse your tune by tweaking the sound of a specific track.

5. To save the instrument as a new custom instrument — so that you can choose it the next time you add a track — click the Save Instrument button.
6. Click the Track Info button again to return to GarageBand.

Time for a Mark's Maxim:



*Save your work often* in GarageBand, just like in the other iLife applications. One power blackout, and you'll never forgive yourself. Press ⌘+S, and enjoy the peace of mind.

## Sharing Your Songs and Podcasts

After you finish your song, you can play it whenever you like through GarageBand. But then again, that isn't really what you want, is it? You want to share your music with others with an audio CD or download it to your iPod so that you can enjoy it yourself while walking through the mall!

iTunes to the rescue! Just like the other iLife applications that I cover in this book, GarageBand can share the music you make through the digital hub that is your Mac.

### Setting preferences

The first step of the export process is to set the iTunes preferences in GarageBand:

1. Choose **GarageBand**⇨**Preferences**, and then click **General** to display the settings you see in **Figure 15-10**.
2. Click in each of the three text boxes to type the playlist, composer name, and album name for the tracks you create.

You can leave the defaults as-is, if you prefer. Each track that you export is named after the song's name in GarageBand.

### Creating MP3 files

After you set your Export preferences, you can create an MP3 file from your song or podcast project in just a few simple steps:

1. Open the song that you want to share.



**Figure 15-10:**  
Setting  
iTunes  
Export pref-  
erences.

## 2. Choose Share → Send Song to iTunes.

After a second or two of hard work, your laptop opens the iTunes window and highlights the new (or existing) playlist that contains your new song, as shown in Figure 15-11.

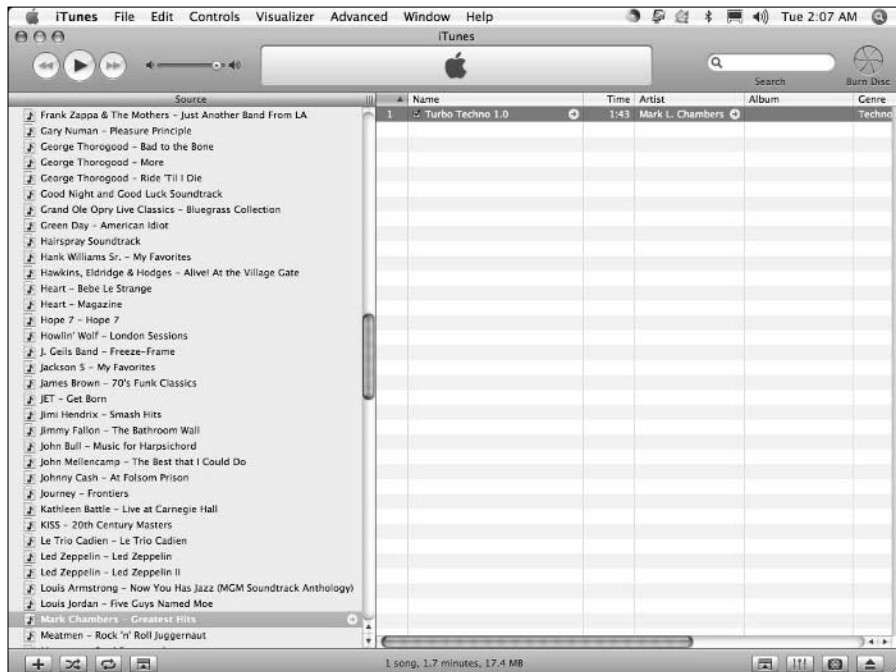

**Figure 15-11:**  
Now you  
really *are*  
a  
rock star!



GarageBand includes an entire book's worth of features, settings, and other stuff, so there just isn't enough space in a single chapter of this laptop-driven tome to cover it all. If you'd like to dive in to everything that GarageBand offers, I heartily recommend *GarageBand For Dummies* (Wiley), written by fellow Mac guru Bob LeVitus. He can take you from one end of GarageBand to the other in no time flat!

# Part V

# Sharing Access and Information

The 5<sup>th</sup> Wave

By Rich Tennant



“He saw your laptop and wants to know if he can check his Hotmail.”



## *In this part . . .*

**R**eady to share your Mac laptop among all the members of your family? If you want to synchronize your Bluetooth cell phone with your Mac, or you've decided to build a wireless home network, you've come to the right place. In this part, I show you how to provide others with access to your documents and data — securely, mind you, and with the least amount of hassle.

## Chapter 16

# Your Laptop Goes Multiuser

---

### *In This Chapter*

- ▶ Enjoying the advantages of a multiuser Mac
  - ▶ Understanding access levels
  - ▶ Adding, editing, and deleting user accounts
  - ▶ Restricting access for managed accounts
  - ▶ Configuring your login window
  - ▶ Sharing files with other users
  - ▶ Securing your stuff with FileVault
- 

**E**verybody wants a piece (of your Mac laptop, that is).

Perhaps you live in a busy household with kids, significant others, grandparents, and a wide selection of friends — all clamoring for a chance to spend time on the Internet, or take care of homework, or enjoy a good game.

On the other hand, your Mac might occupy a classroom or a break room at your office — someplace public, yet *everyone* wants his or her own private Idaho on your laptop, complete with a reserved spot on the hard drive and a hand-picked attractive desktop background.

Before you throw your hands up in the air in defeat, read this chapter and take heart! Here you find all the step-by-step procedures, explanations, and tips to help you build a multiuser Mac that's accessible to all.

Oh, and you still get to use it too. That's not being selfish.

## *Doggone It, Bob's Gotta Share My Mac!*

Okay, so you don't need Cinderella, Snow White, or that porridge-loving kid with the trespassing problem. Instead, you have your brother Bob.

Every time Bob visits your place, it seems he needs to do “something” on the Internet, or he needs a moment with your laptop to bang out a quick message using his Web-based e-mail application. Unfortunately, Bob’s forays onto your Mac always result in stuff getting changed, such as your desktop settings, your Address Book, and your Safari bookmarks.

What you need, good reader, is a visit from the Account Fairy. Your problem is that you have only a single user account on your system, and Tiger thinks that Bob is *you*. By turning your laptop into a multiuser system and giving Bob his own account, Tiger can tell the difference between the two of you, keeping your druthers separate!

With a unique user account, Tiger can track all sorts of things for Bob, leaving your computing environment blissfully pristine. A user account keeps track of stuff such as

- ✓ Address Book contacts
- ✓ Safari bookmarks and settings
- ✓ Desktop settings (including background images, screen resolutions, and Finder tweaks)
- ✓ iTunes libraries, just in case Bob brings his own music (sigh)
- ✓ Web sites that Bob might ask you to host on your computer (resigned sigh)

Plus, Bob gets his own reserved Home folder on your Mac’s hard drive, so he’ll quit complaining about how he can’t find his files. Oh, and did I mention how user accounts keep others from accessing *your* stuff? And how you can lock Bob out of things such as applications, iChat, Mail, and Web sites (including that offshore Internet casino site he’s hooked on)?

Naturally, this is only the tip of the iceberg. User accounts affect just about everything you can do in Tiger. The moral of my little tale? A Mark’s Maxim to the rescue:



Assign others their own user accounts, and let Tiger keep track of everything. You can share your Mac with others and live happily ever after!

## *Throwing the Big Shiny Multiuser Switch*

Get one thing straight right off the bat: *You* are the administrator of your laptop. In network-speak, an *administrator* (or *admin* for short) is the one who has the power to Do Unto Others — creating new accounts, deciding who gets access to what, and generally running the multiuser show. In other words, think of yourself as the Monarch of Mac OS X (the ruler, not the butterfly).



I always recommend that there should be only one or perhaps two accounts with administrator-level access on any computer. This makes good sense because you can be assured that no one will monkey with your Mac while you're away from the keyboard. Why a second admin account? You might need to assign a second administrator account to a *trusted* individual who knows as much about Tiger as you do. (Tell 'em to buy a copy of this book.) That way, if something breaks or an account needs to be tweaked in some way and you're not around, the other person can take care of it whilst you're gone.

In this section, I explain the typical duties of a first-class Mac laptop administrator. (Yet another title for your resume!)

## Assigning access levels

Tiger provides three levels of user accounts:

- ✓ **Admin (administrator):** See the beginning of this section.
- ✓ **Standard:** Perfect for most users, these accounts allow access to just about everything but don't let the user make drastic changes to Tiger or create new accounts.
- ✓ **Managed:** These are standard accounts with specific limits assigned by you or by another admin account.

Another Mark's Maxim is in order:



Assign other folks standard-level accounts, and then decide whether each new account needs to be modified to restrict access as a managed account. *Never* assign an account admin-level access unless you deem it truly necessary.

Standard accounts are quick and easy to set up, and I think they provide the perfect compromise between access and security. You'll find that standard access allows your users to do just about anything they need to do, with a minimum of hassle.

Managed accounts are highly configurable, so you can make sure that your users don't end up trashing the hard drive, sending junk mail, or engaging in unmonitored chatting. (*Note:* Parents, teachers, and those folks designing a single public-access account for a library or organization — this means *you*.)

## Adding a new user account

All right, Mark, enough pregame jabbering — show this good reader how to set up new accounts! Your Mac already has one admin-level account set up

for you (created during the initial Tiger set-up process). To add a new account, follow these steps:

1. **Click the System Preferences icon on the dock, and then click the Accounts icon.**

The Accounts pane shown in Figure 16-1 appears.



**Figure 16-1:**  
Add new  
user  
accounts  
here.

2. **Click the New User button — the one with the plus sign at the bottom of the accounts list.**

The new user sheet shown in Figure 16-2 appears.

If your New User button appears dimmed, your Accounts pane is locked. Remember that you can toggle the padlock icon at the lower-left corner of most of the panes in System Preferences to turn on and off the ability to make setting changes. To gain access, do the following:

- a. *Click the padlock icon to make changes to the Accounts pane.*
- b. *When Tiger prompts you for your admin account password, enter it.*
- c. *Click OK.*

Now you can click the New User button.



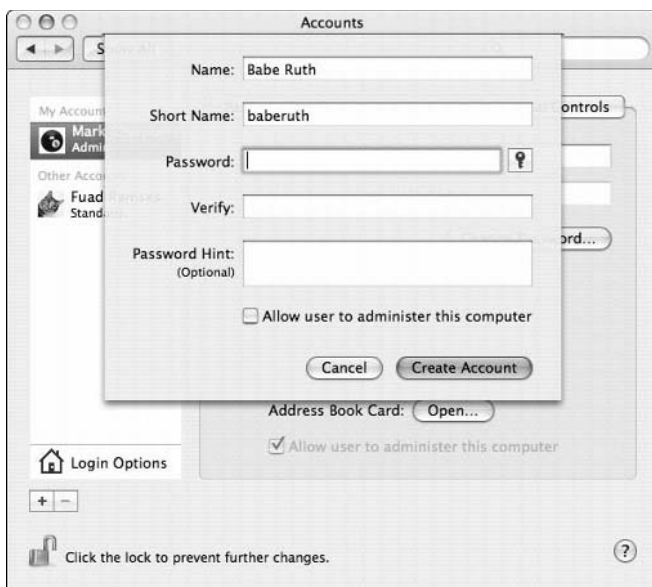

**Figure 16-2:**  
Fill out those  
fields, and  
you have a  
new user.



3. In the Name text box, type the name that you want to display for this account. Press Tab to move to the next field.

Tiger displays this name on the Login screen, so behave!

4. Tiger automatically generates the user's *short name* (for use in iChat, and for naming the user's Home folder), but you can type a new one if you want. (No spaces, please.) Then press Tab.
5. In the Password text box, type the password for the new account. Press Tab to move to the next field.

Run out of password ideas? No problem! Click the key button to display the new Password Assistant, from which Tiger can automatically generate password suggestions of the length you specify. After you generate the password you want, press  $\text{⌘}+\text{C}$  to copy the password, click in the Password text box on the new user sheet, and then press  $\text{⌘}+\text{V}$  to paste it.

6. In the Verify text box, retype the password you chose. Press Tab again to continue your quest.
7. Tiger can provide a password hint after three unsuccessful login attempts. To offer a hint, type a short question in the Password Hint text box.

From a security standpoint, password hints are taboo. (I never use 'em. If someone is having a problem logging in to a computer I administer, you better believe I want to know *why*.) Therefore, I strongly recommend that you skip this field — and if you *do* offer a hint, *keep it vague!* Avoid hints like, “Your password is the name of the Wookiee in Star Wars.” Geez.



**8. Decide the account level status.**

If you want the standard level account, do not select the Allow User to Administer This Computer check box. If you want the administrator level, select the check box.

You should have only one or two admin accounts, and your account is already an admin account.

**9. Click the Create Account button.**

You'll note that the new account shows up in the list at the left of the Accounts pane.

Each user's Home folder has the same default subfolders, including Movies, Music, Pictures, Sites, and such. A user can create new subfolders within his or her Home folder at any time.

Here's one more neat fact about a user's Home folder: No matter what the account level, most of the contents of a Home folder can't be viewed by other users. (Yes, that includes admin-level users. This way, everyone using your laptop gets his or her own little area of privacy.) Within the Home folder, only the Sites and Public folders can be accessed by other users — and only in a limited fashion. More on these folders later in this chapter.

## *Tweaking existing user accounts*

Next, you consider the basic modifications you can make to a user account, such as changing existing information or selecting a new picture to represent that user's unique personality.

To edit an existing account, log in with your admin account, display the System Preferences window, and click Accounts to display the account list. Then, follow these steps:

**1. Click the account that you want to change.**

Don't forget to unlock the Accounts pane if necessary. See the earlier section, "Adding a new user account," to read how.

**2. Edit the settings you want to change.**

For example, you can reset the user's password or (if absolutely necessary) upgrade the account to Admin level.

**3. Click the Picture tab, and then click a thumbnail image to represent this user (as shown in Figure 16-3).**

An easy way to get an image is to use one from your hard drive:

- a. Click the Edit button and drag a new image from a Finder window into the Images well (the sunken-looking square).





**Figure 16-3:** Sometimes it's a challenge to choose the image that best represents a user.

Alternatively, you can click the Snapshot button (which bears a tiny camera) to grab a picture from your iSight video camera.

*b. Click Set to return to the Accounts pane.*

Tiger displays this image in the Login list next to the account name.

**4. When everything is correct, press  $\text{⌘}+\text{Q}$  to close the System Preferences dialog box.**



Standard-level users have some control over their accounts — they're not *helpless*, y'know. Standard users can log in, open System Preferences, and click Accounts to change the account password or picture, as well as the card marked as theirs in the Address Book. All standard users can also set up login items, which I cover later in this chapter. Note, however, that managed users might not have access to System Preferences, so they can't make changes.

## *Deleting accounts*

Not all user accounts last forever. Students graduate, co-workers quit, kids move out of the house (at last!), and Bob might even find a significant other who has a faster cable modem. We can only hope.



Anyway, no matter what the reason, you can delete a user account at any time. Log in with your admin account, display the Accounts pane in System Preferences, and then follow these steps to eradicate an account:

1. **Click the account that you want to delete.**
2. **Click the Delete User button (which bears the Minus Sign of Doom).**

Tiger displays a confirmation sheet, as shown in Figure 16-4. By default, the contents of the user's Home folder are saved in a file in the Deleted Users folder when you click OK. (This safety is a good idea if the user might return in the future, allowing you to retrieve his or her old stuff — however, this option is available only if you have enough space on your hard drive to create the Home folder file.)

**Figure 16-4:**  
This is your last chance to save the stuff from a deleted user account.



3. **To clean up completely, click the Delete Immediately button.**

Tiger wipes everything connected with the user account off your hard drive.

4. **Press ⌘+Q to close the System Preferences dialog box.**

Time once again for a Mark's Maxim:



*Always delete unnecessary user accounts. Otherwise, you're leaving holes in your Mac's security.*

## *Assigning login items and parental controls*

Every account on your laptop can be customized. Understandably, some settings are accessible only to admin-level accounts, and others can be adjusted by standard-level accounts. In this section, I introduce you to the things that can be enabled (or disabled) within a user account.

### Automating with login items

*Login items* are applications or documents that can be set to launch or load automatically as soon as a specific user logs in — for example, Apple Mail or Address Book. In fact, a user *must* be logged in to add or remove login items. Even an admin-level account can't change the login items for another user.



A user must have access to the Accounts pane in the System Preferences window to use login items. As you can read in the following section, a user can be locked out of System Preferences, which makes it impossible for login items to be specified for that account. (Go figure.)

To set login items for your account, follow these steps:

1. Click the **System Preferences icon on the dock**, and then click the **Accounts icon**.
2. Click the **Login Items tab** to display the settings shown in Figure 16-5.



**Figure 16-5:**  
Add apps to  
your login  
items list.

3. Click the **Add button (with the plus sign)** to display a file selection sheet.
4. **Navigate to the application you want to launch each time you login**, click it to select it, and then click **Add**.

If you're in the mood to drag-and-drop, just drag the applications you want to add from a Finder window and drop them directly into the list.

5. Press **⌘+Q** to quit System Preferences and save your changes.



Login items are launched in the order they appear in the list, so feel free to drag the items into any order you like.

### *Managing access settings for an account*

A standard-level account with restrictions is a managed account. (You can read about these earlier in this chapter.) With these accounts, you can restrict access to many different places in Tiger and your Mac's applications using *parental controls*. (Naturally, admin-level accounts don't need parental controls because an admin account has no restrictions.)



In short, parental controls come in handy in preventing users — family members, students, co-workers, friends, or the public at large — from damaging your computer, your software, or Tiger itself. If an account has been restricted with parental controls, the account description changes from Standard to Managed in the Accounts list.

To display the parental controls for a standard account, log in with an admin-level account, open System Preferences, and click Accounts. Click the Standard account in the list and then click the Parental Controls tab to display the categories you see in Figure 16-6:

- ✓ **Mail:** From this category, you can specify “good” (read that “trusted” and “nice”) e-mail addresses with which this user can exchange mail.
- ✓ **Finder & System:** Choose this category to specify what operating system features the user can access (including the System Preferences window itself). You can also switch an account to use Simple Finder, which I explain in a moment.

If you're adding an account that will be shared among many people, I especially recommend disabling the Change Password check box. Disable this option, and your generic student or public access account keeps the same password no matter who uses it.

- ✓ **iChat:** Select this category to specify the admin-approved instant messaging accounts with which this user can chat.
- ✓ **Safari:** Selecting this check box simply turns on site access controls in Safari. (To actually specify “good” sites that the user can visit, you have to log in as the user and launch Safari.)



To restrict one or more features or functions in a category, mark the corresponding check box to enable it, and then click the Configure button to select the restrictions. (Mail displays the Configure sheet automatically. There's always gotta be an exception.)



For the ultimate in restrictive Tiger environments — think public access or kiosk mode — you can assign the Simple Finder to an account, as shown in Figure 16-7. Even the dock itself is restricted, sporting only the Finder icon, the trash, Dashboard, and folders that allow the user to access his or her documents and applications.



**Figure 16-6:**  
You don't have to be a parent to assign Parental Controls!



**Figure 16-7:**  
The Simple Finder is pretty doggone simple.

## Mundane Chores for the Multiuser Laptop

After you're hip on user accounts and the changes you can make to them, turn to a number of topics that affect all users of your laptop — things such as how they'll log in, how a user can share information with everyone else on the computer, and how each user account can be protected from unscrupulous outsiders with state-of-the-art encryption. (Suddenly you're James Bond! I told you Tiger would open new doors for you.)

### Logging on and off in Tiger For Dummies

Hey, how about the login screen itself? How do your users identify themselves? Time for another of my "Shortest books in the *For Dummies* series" special editions. (The title's practically longer than the entire book.)

Tiger offers four methods of logging folks into your multiuser Mac laptop:



- ✓ **The username and password login:** This is the most secure type of login screen you'll see in Tiger because you have to type your account username and your password. (A typical hacker isn't going to know all the usernames on your Mac.) Press Return or click the Log In button to complete the process.

When you enter your username and password, you see bullets instead of your password to ensure security. Otherwise, someone could simply look over your shoulder and see your password.

- ✓ **The list login:** This login screen offers a good middle of the road between security and convenience. Click your account username in the list and type your password when the login screen displays the password prompt. Press Return or click the Log In button to continue.
- ✓ **Fast User Switching:** This feature allows another user to sit down and log in while the previous user's applications are still running in the background. This is perfect for a fast e-mail check or a scan of your eBay bids without forcing someone else completely off the laptop. When you turn on Fast User Switching, Tiger displays the currently active user's name on the right side of the Finder menu bar (see Figure 16-8).

To switch to another account:

- Click the current user's name in the Finder menu.
- Click the name of the user who wants to log in.

Tiger displays the login window, just as if the Mac had been rebooted.

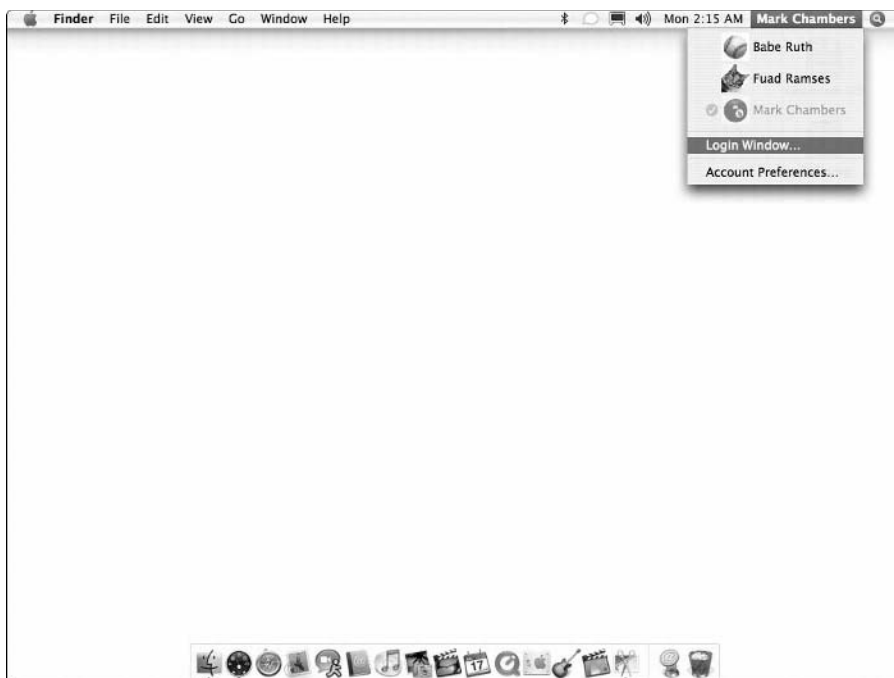

**Figure 16-8:**  
The Fast  
User  
Switching  
menu,  
unfurled for  
all to see.



The previous user's stuff is still running, so you definitely shouldn't reboot or shut down the laptop!

To switch back to the previous user:

- a. Click the user name again in the Finder menu.
- b. Click the previous user's name.

For security, Tiger prompts you for that account's login password.

✓ **Auto login:** This is the most convenient method of logging in but offers no security whatsoever. Tiger automatically logs in to the specified account when you start or reboot your Mac.

I *strongly recommend* that you use auto login only if

- Your laptop is in a secure location (complete with a cable lock, as covered in Chapter 1).
- You are the only one using your Mac.
- You're setting up a public-access laptop, in which case you want your Mac to immediately log in with the public account.

*Never* set an admin-level account as the auto login account. This is the very definition of ASDI, or *A Supremely Dumb Idea*. Nothing quite like a stolen laptop with no security, I always say!



To set up a username/password or list login, open System Preferences, click the Accounts icon, and then display the Login Options settings (see Figure 16-9). Select the List of Users radio button for a list login screen, or select the Name and Password radio button to require your users to type their full username and password.



**Figure 16-9:** Configure your login settings from the Login Options pane.

To enable Fast User Switching, select the Enable Fast User Switching check box.

To set Auto Login, select the Automatically Log in As check box. Click the account name pop-up menu and choose the account that Tiger should use (as shown by the now-legendary Figure 16-9).

Logging out of Tiger all the way (without Fast User Switching) is a cinch. Just click the Apple menu () and then choose Log Out. (Or from the keyboard, press  $\text{⌘}+\text{Shift}+\text{Q}$ .) A confirmation dialog box appears that will automatically log you off in two minutes, but don't forget that if someone walks up and clicks Cancel, he or she will be using your laptop with your account! Your Mac returns to the login screen, ready for its next victim. Heed this Mark's Maxim:



Always click the Log Out button on the Logout Confirmation dialog box before you leave your Mac.

## *A word about what you can (and can't) share*

You might wonder where shared documents and files reside on your Mac. That's a good question. Like just about everything in Tiger, there's a simple answer. The Users folder on your laptop contains a *Shared* folder. To share a file or folder, it must be placed in the Shared folder for standard- and managed-level users to be able to open it.



You don't have to turn on Personal File Sharing in the Sharing pane of System Preferences to use Shared folders on your Mac. Personal File Sharing affects only network access to your machine by users of other computers.



Admin-level accounts have the advantage because they can access virtually any location on the Mac's hard drive. Therefore, if one admin-level user wants to save a document for another admin-level user, that document can reside in other folders on your system besides just the Shared folder. (Personally, I don't mind using the Shared folder because it guarantees that other users can access it, but privacy between admin users is a closely guarded perk.)

Each user account on your laptop also has a *Public* folder in that user's Home folder. This is a read-only folder that other users of your Mac can access: They can only open and copy the files it contains. (Sorry, no changes to existing documents from other users, or new documents from other users.) Every user's Public folder contains a *Drop Box* folder, where other users can copy or save files (but can't view the contents). Think of the Drop Box as a mailbox where you drop off stuff for the other user.

## *Protecting your stuff with encryption*

Allowing others to use your laptop always incurs a risk — especially if you store sensitive information and documents on your computer. Although your login password should ensure that your Home folder is off-limits to everyone else, consider an extra level of security to prevent even a dedicated hacker from accessing your stuff.



To this end, Tiger includes *FileVault*, which automatically encrypts the contents of your Home folder. Without the proper key (in this case, either your login password or your admin's master password), the data contained in your Home folder is impossible for just about anyone to read. (I guess the FBI or NSA would be able to decrypt it, but they're not likely a worry at your place!)

The nice thing about FileVault is that it's transparent to you and your users. In other words, when you log in, Tiger automatically takes care of decrypting and encrypting the stuff in your Home folder for you. You literally won't know that FileVault is working for you — which is how computers are *supposed* to work.

To turn on FileVault protection for a specific account, follow these steps:

1. **Click the System Preferences icon on the dock, and then click the Security icon.**
2. **If necessary, click Set Master Password to create a master password.**

Note that you need to be logged in with an admin-level account to set a master password. However, you need to do this only once, no matter how many accounts you're hosting on your Mac. Using this master password, any Admin-level user can unlock any Home folder for any user.



Before you move to Step 3, note that you must be logged in using the account that requires the FileVault protection. Therefore, if you had to log in using your admin-level account to set a master password, you have to log out and log in again using the account you want to protect. Arrgh.

3. **Click the Turn on FileVault button.**
4. **Enter your account's login password when prompted (see Figure 16-10), and click OK.**
5. **Click the Turn on FileVault button on the confirmation screen.**
6. **After Tiger encrypts your Home folder and logs you out, log in again normally.**

You're done!



Remember those passwords. Again, *do not forget* your account login password, and make doggone sure that your admin user never forgets the master password! If you forget these passwords, you can't read anything in your Home folder, and even the smartest Apple support technician can do nothing to help.

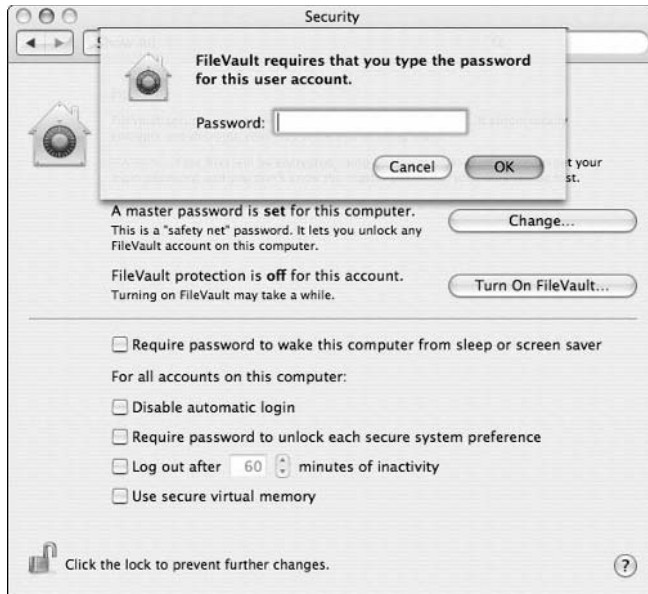

**Figure 16-10:**  
Your account password becomes your FileVault password.



## Chapter 17

# Working Well with Networks

---

### *In This Chapter*

- ▶ Choosing between wired and wireless networks
  - ▶ Sharing an Internet connection
  - ▶ Collecting the bits and pieces for a wireless connection
  - ▶ Gathering the stuff you need for a wired connection
  - ▶ Making the network connection
  - ▶ Protecting your Mac with a firewall
- 

**I**n my book (get it — *my book*), network access ranks right up there with air conditioning and the microwave oven. Like other “taken for granted, but I can’t imagine life without them” kinds of technologies, it’s hard to imagine sharing data from your laptop with others around you without a network. Sure, I’ve used a *sneakernet* (the old-fashioned term for running back and forth between computers with a floppy disk to copy files), but these days, Apple computers don’t even *have* floppy drives. (And no self-respecting computer should still have one.)

Nope, networking is here to stay. Whether you use it to share an Internet connection, challenge your friends to a relaxing game of WWII battlefield action, or stream your MP3 collection to other computers using iTunes, you’ll wonder how you ever got along without one. In this chapter, I fill you in on all the details you need to know to get your new MacBook or MacBook Pro hooked up to a new (or an existing) network.



If you have just your Mac and an Internet connection (either through a dialup modem or a high-speed DSL/cable modem) and you have no plans to add another computer or a network printer, a network isn’t necessary.

## What exactly is the network advantage?

If you have other family members with computers or if your laptop is in an office with other computers, here's just a sample of what you can do with a network connection:

- ✔ **Share an Internet connection:** This is *the* major reason why many families and most small businesses install a network. Everyone can simultaneously use the same DSL or cable Internet connection on every computer on the network.
- ✔ **Copy and move files of all sizes:** Need to get a 4GB iDVD project from one Mac to another? With a network connection, you can accomplish this task in just minutes. Otherwise, you'd have to burn that file to a DVD-R or use an external hard drive. A network connection makes copying as simple as dragging the project folder from one Finder window to another.
- ✔ **Share documents across your network:** Talk about a wonderful collaboration tool. For example, you can drop a Word document or Keynote presentation file in your Public folder and ask for comments and edits from others in your office.
- ✔ **Stream music:** With iTunes, you can share your MP3 collection on your laptop with other Macs and PCs on your network. Your ears can't tell the difference!
- ✔ **Play multiplayer games:** Invite your friends over and tell 'em that you're hosting a *LAN party*, the techno-nerd term for a large gathering of game players, connected through the same network, all playing the same multiplayer game. (Suddenly you'll see firsthand just how devious a human opponent can be.) Each participant needs to buy a copy of the same game, naturally, but the fun you'll have is worth every cent you spend. Don't forget the chips!

If your laptop isn't within shouting distance of an existing network and you don't plan on buying any more computers, a network isn't for you. Because the whole idea of a network is to share documents and applications with others, a lone Mac hanging out in your home with no other computers around won't need a network.

## Should You Go Wired or Wireless?

If you decide that you indeed need a network for your home or office, you have another decision to make: Should you install a *wired* network (which involves running cables between your computers) or a *wireless* network (which doesn't require any computer-connecting cables)?

Your first instinct is probably to choose a wireless network for convenience. After all, this option allows you to eliminate running cables behind furniture (or in the ceiling of your office building). Ah, but I must show you the advan-

tages to a wired network as well. Table 17-1 gives the lowdown to help you make up your mind.

<i>Function</i>	<i>Wireless Networks</i>	<i>Wired Networks</i>
Speed	Moderate	Much Faster
Security	Moderate	Better
Convenience	Better	Worse
Compatibility	Confusing standards	Easier to understand
Cables	Few (or none)	Required

Now for the biggest decision of all: Should you choose a wired network, a wireless network, or a combination of both? Here are the advantages of each type of network:

✔ **Wired:** A wired network offers two significant perks over a wireless network:

- *Faster speeds:* Wired networks that are compatible with your Mac are up to twice as fast as the fastest 802.11g wireless connections.

The performance of a wireless connection is reduced by both interference (from structures such as concrete walls and household appliances such as some wireless phones and microwave ovens) and distance.

- *Better security:* A wired network doesn't broadcast a signal that can be picked up outside your home or office, so it's more secure.

Hackers can attack through your Internet connection. Hence the "Use Your Firewall!" section, later in this chapter.

✔ **Wireless:** A wireless connection has only one advantage, but it's a big one: *convenience*.

Accessing your network anywhere in your home or office — without cables — is so easy. Plus, you can easily connect to all sorts of wireless devices, such as a wireless printer. (By using an AirPort Express mobile Base Station, even your home stereo can get connected to your MP3 collection on your laptop.)



## It's easy to graft wireless access to a wired network

Are you caught in the middle between wired and wireless networking? Or perhaps you're already using a wired network but would be absolutely thrilled by the idea of sitting on your deck in the sunshine whilst checking your e-mail on your laptop. By using both technologies, you can get the faster transfers of a wired network between all the computers in your office.

That is the configuration I use in my home office. My family gets all the convenience a wireless network offers, and everyone can connect to the Internet from anywhere in our house. On the other hand, my office computers have the faster performance and tighter security of a wired network. *Sassy indeed!*

## Be a Pal — Share Your Broadband!

Time to see what's necessary to share an Internet connection — in this section, I cover two methods of connecting your network to the Internet. And before you open your wallet, keep in mind that you may be able to use your Mac to share your broadband connection across your home network . . . that is, when you're not doing the road warrior thing!

### *Using your laptop as a sharing device*

You can use your Mac laptop to provide a shared wireless Internet connection across your network, using either

- ✓ **A broadband DSL or cable connection**
- ✓ **A dialup modem**



You should try sharing a dialup modem Internet connection only if you have no other option. A dialup modem connection can't handle the data transfer speeds for more than one computer to access the Internet comfortably at one time. And today's Mac laptops no longer come with internal modems. Sharing a dialup connection just isn't practical.

Your laptop uses OS X Tiger's built-in Internet connection sharing feature to do the job, but naturally your Mac must remain turned on to allow Internet sharing. I show you how to do this in the upcoming section "Internet connection."

## Using a separate Internet sharing device

If you decide to use a dedicated Internet sharing device (often called an *Internet router*) to connect to your cable or DSL modem, you'll have to buy the additional hardware. But your laptop doesn't have to remain turned on just so everyone can get on the Internet.

Internet routers can include either wired or wireless network connections — many include both.

Setting up an Internet router is a simple matter. The configuration usually involves a number of different settings in System Preferences that vary according to the model of router you're installing. Grab a Diet Coke, sit down with the router's manual, and follow the installation instructions you'll find there.



Most Internet routers offer a DHCP server, which automatically assigns IP addresses, and I *strongly* recommend that you turn on this feature! (You discover more about DHCP later in the chapter, in the sidebar titled “The little abbreviation that *definitely* could.”)

## What Do I Need for a Wireless Connection?

Most *normal* folks — whom I define as those who have never met a network system administrator, and couldn't care less — think that connecting to a network probably involves all sorts of arcane chants and a mystical symbol or two. In this section, I provide you with the shopping list that you need to set up a network or connect to a network that's already running.

If your laptop came with built-in AirPort Extreme wireless support (as all current models do) and you already have an AirPort Extreme or Express base station, you're set to go. Otherwise, hold on tight as I lead you through the hardware requirements for wireless networking.



The maximum signal range of any wireless network can be reduced by intervening walls or by electrical devices such as microwave ovens and wireless phones that can generate interference.



## Laptop hardware

Connecting a laptop to an existing wireless network requires only a single piece of hardware: an AirPort Extreme wireless card. (Remember, you need to buy an AirPort card only if you're using an older Mac laptop that didn't come with built-in wireless hardware.) To wit:

- ✓ If your laptop arrived with AirPort Extreme wireless hardware, you're ready to go.
- ✓ If you need to add wireless support to your laptop, you need an AirPort Extreme card.

After the card is safely ensconced in the confines of your laptop's sleek case, you can skip to the next section.



You can use some PC-compatible 802.11g cards in your Mac laptop, but not all wireless cards are supported. Plus, you'll have to do a little additional configuration dancing to join an AirPort Extreme network. (Unfortunately, the passwords used by the two types of hardware are incompatible.) For the whole story, visit [www.apple.com/support/](http://www.apple.com/support/) and search for article number 106864, entitled "AirPort Extreme: Getting an equivalent network password."

I bought an AirPort Extreme card, thus avoiding any additional work. Sounds like a Mark's Maxim!



If you don't want the hassle of tweaking PC hardware to accommodate your Mac laptop, buy Apple hardware and software.

## Base stations

If you decide that you want to build your own network, you eschew cables, or you want to add wireless support to your existing wired network, you need a *base station*. The base station can act as a bridge between computers using wireless and your existing wired network, or a base station can simply act as a central switch for your wireless network.

You can use either a cool Apple Base Station or a boring 802.11g generic wireless base station. However, the Apple hardware requires less configuration and tweaking.

### Apple base stations

As listed in Table 17-2, your laptop can work with three Apple base station models for wireless networking:



- ✓ **AirPort Extreme:** I recommend AirPort Extreme if your network needs
  - The faster 802.11g transfer speeds
  - The enhanced antenna, which provides greater range
- ✓ **AirPort Express:** I recommend AirPort Express, shown in Figure 17-1, if you want to
  - *Carry your wireless base station* with you (it's much smaller than Apple's other base stations)
  - *Connect your home stereo* for wireless music streaming using the AirTunes feature in iTunes
- ✓ **AirPort (discontinued):** You might find the original AirPort base station on eBay or at a garage sale. Go ahead and pick it up if you want to save cash, unless you're considering multiplayer gaming or high-speed file transfers over your wireless network.

The 802.11g standard used by the AirPort Extreme and AirPort Express base stations delivers a connection that's several times faster than the old AirPort base station's 802.11b.

<b>Feature</b>	<b>AirPort Extreme</b>	<b>AirPort Express</b>	<b>AirPort</b>
Price	\$200	\$130	\$80 (used)
Users (maximum)	50	10	50
802.11g support	Yes	Yes	No
802.11b support	Yes	Yes	Yes
LAN Ethernet jack (high-speed Internet connection)	Yes	Yes	Yes
WAN Ethernet jack (wired computer network)	Yes	No	No
Stereo mini-jack	No	Yes	No
USB printer port	Yes	Yes	No
Maximum signal range (approximate)	150 feet (standard) 250 (with add-on antenna)	150 feet	100 feet
AC adapter	Separate	Built-in	Separate



The names of Apple's base stations are irritatingly similar; Apple usually does a better job in differentiating their product names. Jot down the name of your model on a Sticker on your laptop's desktop so you don't get confused.

**Figure 17-1:**  
The AirPort Express portable base station.

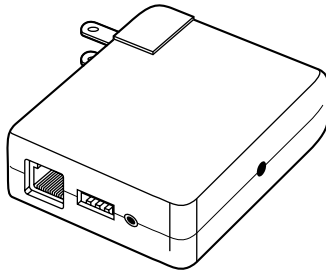

Installing an Apple base station is simple:

- 1. If you have a DSL or cable modem, connect it to the Ethernet LAN jack on the base station.**
- 2. If you have a wired Ethernet computer network, connect it to the WAN (wide area network) jack on the base station.**
- 3. If you have a USB printer, connect it to the USB port on the base station.**

I cover the steps to share a printer in the “Printer: section.

- 4. Connect the power cable from the AC power adapter.**

AirPort Express has a built-in AC adapter, so you just plug AirPort Express into the wall.

- 5. Switch on your base station.**
- 6. Run the installation software provided by Apple on your Mac.**



### *Non-Apple base stations*

If your wireless base station was manufactured by another company besides Apple, the installation procedure is almost certainly the same. (Naturally, you should take a gander at the manufacturer's installation guide just to make sure, but I've added many different brands of these devices and used the same steps for each one.)

However, I should note that there is an extra hurdle to connecting to a non-Apple base station using an AirPort or AirPort Extreme card. More on this in the next section. For now, just remember that I recommend using Apple wireless hardware with your Mac whenever possible. It's a little easier!

## *Creating or joining a wireless network*

As far as I'm concerned, there are only two types of base stations on the planet: Apple and non-Apple (which includes all 802.11b and 802.11g base stations). In these two sections, I relate what you need to know to get onboard using either type of hardware.

### *AirPort*

To create or join a wireless network that's served by any flavor of Apple base station, follow these steps on each Mac with wireless support:

1. **Click the System Preferences icon on the dock.**
2. **Click the Network icon.**
3. **From the Show pop-up menu, choose AirPort.**
4. **Select the Show AirPort Status in Menu Bar check box.**
5. **Click the Apply Now button.**
6. **Click the AirPort status icon on the Finder menu bar.**
7. **From the AirPort menu, choose an existing network connection that you'd like to join.**



Some wireless networks might not appear in your AirPort menu list. These are *closed networks*. You can't join a closed network unless you know the exact network name (which is far more secure than simply broadcasting the network name). To join a closed network, follow these steps:

1. **Select Other from the AirPort menu.**
2. **Type the name of the network.**
3. **Enter the network password, if required.**

To disconnect from an AirPort Extreme network, click the AirPort menu and either choose Turn AirPort Off or connect to another AirPort network.

### *Non-Apple base stations*

If you're using an AirPort card to connect to a non-Apple base station, you need to follow a specific procedure that takes care of the slightly different password functionality used by standard 802.11b/g hardware.

To read or print the latest version of this procedure, fire up Safari and visit [www.apple.com/support/](http://www.apple.com/support/) — search for the number 106250 (the Apple Knowledge Base article number). This article provides the details on how to convert a standard wireless encrypted password to a format that your AirPort card can understand.

## *What Do I Need for a Wired Connection?*

If you're installing a wired network, your Mac laptop already comes with most of what you need for joining your new cabled world. You just connect the hardware and configure the connection. Don't forget that you also need cables (check the sidebar titled "Can I save money by making my own cables?") and an inexpensive Ethernet switch or hub. (If you're using an Internet router or other hardware sharing device, it likely has a built-in 4- or 8-port hub.)

### *Laptop hardware*

Your Ethernet 10/100/1000 port (which looks like a slightly oversized modem port) is located in the line of ports on the side of your laptop, ready to accept a standard Ethernet Cat5 cable with RJ-45 connectors. If you're connecting to an existing wired network, you need a standard Cat5 Ethernet cable of the necessary length — I recommend a length of no more than 25 feet, because cables longer than that are often subject to line interference (which can slow down or even cripple your connection). You also need a live Ethernet port from the network near your Mac. Plug the cable into your laptop, and then plug the other end into the network port.

### **Can I save money by making my own cables?**

You can either purchase premade Cat5 cables, or you can (try) to make your own. However, you most definitely *don't* save money by making your own cables — at least, not if you're connecting computers that are located within 25 feet or so of one another. I strongly recommend that you buy premade Cat5 Ethernet cables (which come in a number of standard lengths) for two important reasons:

- ✔ **You can be guaranteed that the cables work.**
- ✔ **You don't have to build the things yourself.**

Nothing is harder to troubleshoot than a shorted or faulty Ethernet cable — that's the voice of experience talking there.

If you're wiring multiple rooms in your house or office, you have to install your own cabling. That's when I suggest you either call your local computer store for help or enlist the aid of someone you know who has successfully installed Ethernet cable. If you're building a home, you can get your home wired for an Ethernet network at the same time as the AC wiring is installed — it's expensive, but if you're a computer maven you'll budget that cost!

## Network hardware

If you don't know your hub from your NIC, don't worry — I provide you with a description of the hardware you need for your wired network in this section.

### Components

If you're building your own wired network, you need

- ✓ **A central connection gizmo:** You can use either a *hub* or a *switch* (which is faster and slightly more expensive). The gizmo's job is to provide more network ports for the other computers in your network. They typically come in 4- and 8-port configurations.



As I mentioned earlier in this chapter, most Internet routers (sometimes called Internet sharing devices) include a built-in hub or switch, so if you've already invested in an Internet router, make doggone sure that it doesn't come equipped with the ports you need before you go shopping for a hub or switch!

- ✓ **A number of Cat5 Ethernet cables:** The number is determined by how many computers you're connecting.



Many companies sell *do-it-yourself networking kits* that contain everything you need for a small four-computer network, including cables and a hub. These kits are a great buy (typically selling for less than \$100), but most include a PC Ethernet NIC (*Network Interface Card*) that your laptop doesn't need. (If you have a PC that doesn't have a network card, you can use the card in that computer.) If you don't need an Ethernet NIC for any of your computers, look for a do-it-yourself kit that comes with just the cables and the hub or switch (these usually go for \$50 or a little less). I recommend Linksys kits.

### Connections

After you assemble your cables and your hub or switch, connect the Ethernet cables from each of your computers to the hub or switch, and then turn on the hub. (Most need AC power to work.) Check the manual that comes with your hub to make sure that the lights you're seeing on the front indicate normal operation. Colors vary by manufacturer, but green is usually good. Huzzah!

When your hub is powered on and operating normally, you're ready to configure Mac OS X for network operation. (Now you can add network technician to your rapidly growing computer résumé!)

## Joining a wired Ethernet network

After all the cables have been connected and your central connection gizmo is plugged in and turned on, you've essentially created the hardware portion of your network. Congratulations! (Now you need a beard and suspenders.)

With the hardware in place, it's time to configure Tiger. In this section, I assume you're connecting to a network with an Internet router, hub, or switch that includes a DHCP server.

Follow these steps on each Mac running Mac OS X that you want to connect to the network:

1. Click the **System Preferences icon on the dock.**
2. Click the **Network icon (under Internet & Network).**
3. From the **Show pop-up menu, choose Built-in Ethernet.**
4. From the **Configure IPv4 pop-up menu on the TCP/IP tab, choose Using DHCP (see Figure 17-2).**
5. Click the **Apply Now button.**



Enjoy automatic goodness as Mac OS X connects to the DHCP server to obtain an IP address, a subnet mask, a gateway router IP (Internet protocol) address, and a Domain Name System (DNS) address. (Without a DHCP server, you'd have to add all this stuff manually. Ugh.)

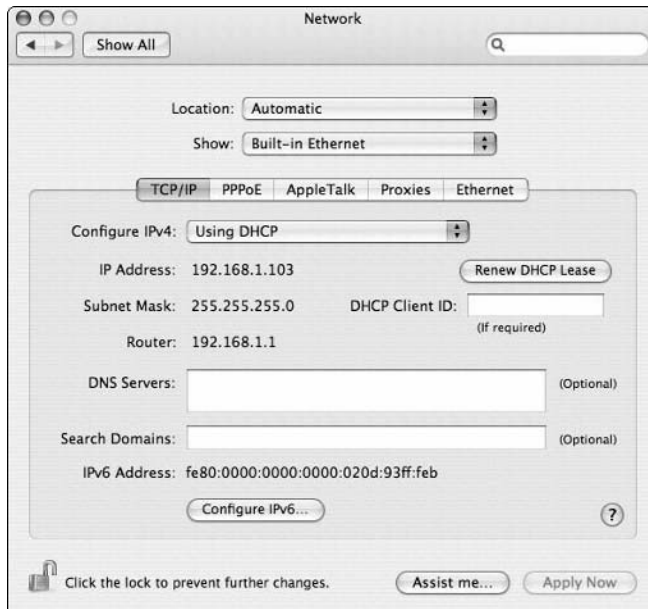

**Figure 17-2:**  
All hail  
DHCP, the  
magical  
networking  
fairy!

A few seconds after clicking the Apply Now button, the DHCP information provided by your network should appear. You might also notice that the DNS Servers field is empty, but fear not because Mac OS X is using DNS server information provided by the DHCP server.

**6. Press ⌘+Q to quit System Preferences and save your settings.**

You're on!

## Connecting to the Network

All right! Now the hardware is powered up, the cables (if any) are installed and connected, and you've configured Tiger. You're ready to start (or join) the party. In this section, I show you how to verify that you're connected, and how to share data and devices with others on your network.

### Verifying that the contraption works

After you have at least two computers on a wired or wireless network, test whether they're talking to each other over the network by pinging them. (No, I didn't make up the term, honest.) Essentially, *pinging* another computer is like yelling, "Are you there?" across a crevasse.

To ping another computer on the same network from any Mac running Tiger, follow these steps:

- 1. Open a Finder window, click Applications, and then click Utilities.**
- 2. Double-click the Network Utility icon to launch the application.**
- 3. Click the Ping tab.**
- 4. In the Please Enter the Network Address to Ping text field, enter the IP address of the computer that you want to ping.**



If you're pinging another Mac running Tiger, you can get the IP address of that machine by simply displaying the Network pane within System Preferences, which always displays the IP address. If you're trying to ping a PC running Windows XP and you don't know the IP address of that machine, click Start, right-click My Network Places, and then click Properties. From the Network Connections window, right-click your Local Area Network connection icon and choose Status. Click the Support tab, and the IP address of that PC is proudly displayed.

- 5. Select the Send Only x Pings radio button and enter 5 in the text field.**



## The little abbreviation that *definitely* could

You know, some technologies are just *sassy*. (So much for my uber-tech image.) Anyway, these well-designed technologies work instantly, you don't have to fling settings around like wrapping paper on Christmas day, and every computer on the planet can use them: Mac, Windows, Linux, and even the laptops used by funny-looking folks from Roswell, New Mexico.

*Dynamic Host Configuration Protocol*, or DHCP for short, is about as sassy as it gets. This protocol enables a computer to automatically get all the technical information necessary to join a network. Let me hear you say, "*Oh yeah!*" Just about every network device on the planet can use DHCP these days, including Internet routers, hubs, switches, and (go figure) Mac OS X. Today's networking hardware and operating systems provide a *DHCP server*, which flings the proper settings at every computer on the network all by itself. Your Mac just accepts the settings and relaxes in a placid networking nirvana.

In this book, you can bet the farm that I assume you want to use DHCP and that your network hardware supports it as well — remember, virtually all networking stuff made in the last few years can use DHCP. That way, I won't spend 30 pages leading you through the twisting alleyways of manual network settings. (If you're really into such things, I spend those 30 pages and explain every single techno-wizard detail in my book *Mac OS X Tiger All-in-One Desk Reference For Dummies*, [Wiley]. It's about 800 pages long — hence the comprehensive angle.)

If you're connecting to an existing network, tell the network administrator that you're taking the easy route and using DHCP. One word of warning, however: Adding more than one DHCP server on a single network causes a civil war, and your system will lock up tight. Therefore, before adding hardware with a DHCP server to an existing network, ask that network administrator to make sure that you aren't making a mistake.

### 6. Click the Ping button.

- **Yay!**: If everything is working, you should see results similar to those shown in Figure 17-3, in which I'm pinging my Windows server at IP address 192.168.1.106, across my wired Ethernet network.



The address 192.168.1.xxx is a common series of local network IP addresses provided by Internet routers, hubs, and switches with DHCP servers, so don't freak if you have the same local IP address.

- **Nay!**: If you *don't* get a successful ping, check your cable connections, power cords, and Mac OS X settings. Folks using a wireless connection might have to move closer to the network base station to connect successfully, especially through walls.

## Sharing stuff nicely with others

It works . . . by golly, it works! Okay, now what do you *do* with your all-new shining chrome network connection? Ah, my friend, let me be the first to

congratulate you, and the first to show you around! In this section, I cover the most popular network perks. (And the good news is that these perks work with both wired and wireless connections.)

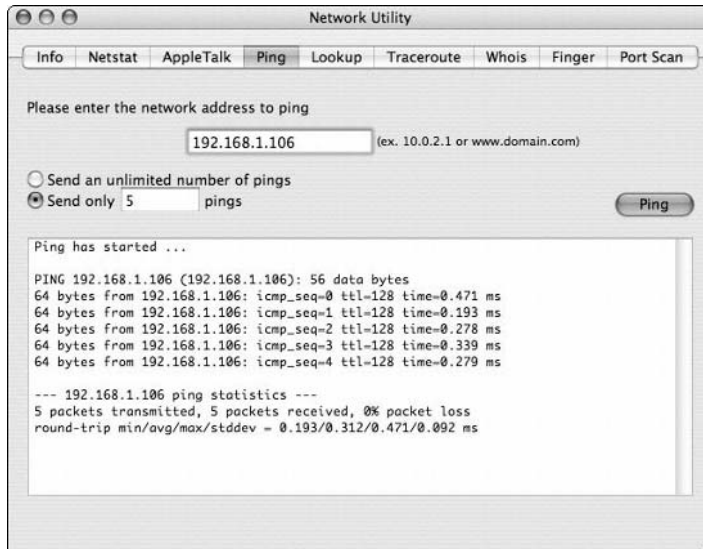

**Figure 17-3:**  
Look, Ma,  
I'm pinging!

### *Internet connection*

If your DSL or cable modem plugs directly into your Mac (instead of a dedicated Internet sharing device or Internet router), you might ponder just how the other computers on your wireless network can share that spiffy high-speed broadband connection. Tiger comes to the rescue!

Follow these steps to share your connection:

- 1. Click the System Preferences icon on the dock.**
- 2. Click the Sharing icon (under Internet & Network).**
- 3. Click the Internet tab.**
- 4. From the Share Your Connection From pop-up menu, choose Built-in Ethernet.**
- 5. Select the AirPort check box (in the To Computers Using list).**

Tiger displays a warning dialog box, stating that connection sharing could affect your ISP or violate your agreement with your ISP. I've never heard of this happening, but if you want to be sure, contact your ISP and ask the good folks there.

6. Click OK in the warning dialog box to continue.
7. Click Start to enable Internet sharing.
8. Click the Close button to exit System Preferences.



Sharing an Internet connection wirelessly (without an Internet router or a dedicated hardware device) through Mac OS X requires your laptop to remain on continuously. Because most laptop owners are nomadic in nature, this isn't likely to be a permanent solution, but I want you to be aware that your laptop can do double-duty as a wireless Internet router.



You can share a dialup modem Internet connection, but don't be surprised if you quickly decide to shelve the idea of sharing a 56 Kbps connection. Those dinosaurs are s-l-o-w beyond belief.

### Files

You can swap all sorts of interesting files with other Macintosh computers on your network. When you turn on Personal File Sharing, Tiger lets all Macs on the network connect to your laptop and share the files in your Public folder.

Follow these steps to start sharing files and folders with others across your network:

1. Click the System Preferences icon on the dock.
2. Click the Sharing icon.
3. Click the Services tab.
4. Enable the connections for Mac and Windows sharing.
  - If you want to share files with other Macs on your network, select the *Personal File Sharing* check box.

Other Mac users can connect to your computer by clicking Go on the Finder menu and choosing the Network menu item. The Network window appears, and your Mac is among the choices.
  - If you want to share files with networked PCs running Windows, select the *Windows Sharing* check box.

Windows XP users should be able to connect to your Mac from their My Network Places window (or, with pre-XP versions of Windows, from the Network Neighborhood). Those lucky Windows folks also get to print to any shared printers you've set up. (The following section covers shared printers.)
5. Click the Close button to exit System Preferences.



Tiger conveniently reminds you of the network name for your laptop at the bottom of the Sharing pane.

### *Printers*

Boy, howdy, do I love describing easy procedures, and sharing a printer on a Mac network ranks high on the list! You can share a printer that's connected to your Mac (or your AirPort Extreme or AirPort Express base station) by following these very simple steps:

1. **Click the System Preferences icon on the dock.**
2. **Click the Print & Fax icon (under Hardware).**
3. **Click the Sharing tab.**
4. **Select the Share These Printers with Other Computers check box.**
5. **Click the printers that you want to share.**
6. **Click the Close button to exit System Preferences.**

A printer that you share automatically appears in the Print dialog box on other computers connected to your network.

### *A Web site*

Web jockeys tell you that Mac OS X is a great platform for running a Web site that you can access from either the Internet or your local network. In fact, it's ridiculously easy to engage the mind-boggling power of Tiger's Apache Web server. (Keep in mind, however, that your Mac must always be on and connected to the Internet; otherwise, your Web pages won't be available to your folks in Schenectady.) Road warriors on the move can still use a Web server on a laptop from time to time, though — for example, you might want to demonstrate a Web site you've created to a client or offer files for downloading from your site over your client's network.

To begin serving Web pages, follow these steps:

1. **Click the System Preferences icon on the dock.**
2. **Click the Sharing icon.**
3. **Click the Services tab.**
4. **Select the Personal Web Sharing check box.**
5. **Click the Close button to exit System Preferences.**

To check out the default HTML page that ships with Apache, launch Safari and visit this URL, replacing *username* in the address with your username:

```
http://127.0.0.1/~username/
```

To add pages to your Web server, navigate to the Sites folder that resides in your Home folder. Because this is the root of your Apache Web server, the files that you add to this folder are accessible from your Web server.



Don't forget that folks connecting to your Web site across the Internet must use your public IP address, while others on the same network you're connected to can use your laptop's private IP address! (The 127.0.0.1 IP address that I just mentioned is a special address that allows your laptop to connect with itself. Rather egocentric, but it works.) Your Mac's IP address appears in the Built-in Ethernet description on the Network pane in System Preferences. If you're using an Internet router or Internet connection sharing device, your *public* IP address might be different. Check the documentation for the device to determine how to find your public IP address. If you're unsure about what IP address to use on a "foreign" network, ask the company's network administrator.

## Use Your Firewall!

The following Mark's Maxim, good reader, isn't a request, a strong recommendation, or even a regular Maxim — consider it an *absolute commandment* (right up there with *Get an antivirus application now*).



Turn on your firewall *now*.

By connecting your network to the Internet, you open a door to the outside world. As a consultant to several businesses and organizations in my home town, I can tell you that the outside world is chock-full of malicious individuals who would *dearly love* to inflict damage on your data or take control of your laptop for their own purposes. Call 'em hackers, call 'em delinquents, or call 'em something I can't repeat, but *don't let them in!*

Oh, and it's a bad idea to take a client's network security for granted while you're on the road. (They might not have a copy of this book.) *You still need that protection.*

Tiger comes to the rescue again with the firewall built into Mac OS X. When you use this, you essentially build a virtual brick wall between you and the hackers out there (both on the Internet and even within your local network). Follow these steps:

1. **Click the System Preferences icon on the dock.**
2. **Click the Sharing icon.**
3. **Click the Firewall tab.**

4. Click **Start** to activate your firewall.
5. Click the **Close** button to exit **System Preferences**.

Tiger even keeps track of the Internet traffic that you *do* want to reach your laptop, such as Web page requests and file sharing. When you activate one of the network features that I demonstrate in the preceding section, Tiger automatically opens a tiny hole (called a *port* by net-types) in your firewall to allow just that type of communication to your Mac.

For example, if you decide to allow FTP access on the Services pane (in System Preferences, on our old friend the Sharing pane), Tiger automatically enables the check box to allow FTP access on the Firewall panel. (You can also control which ports are active directly from the Firewall panel.)

You can also add ports for applications that aren't on the firewall's Allow list — this includes third-party Instant Messaging clients and multiplayer game servers. Click **New**, and then click the **Port Name** pop-up menu to display the default list of external network applications (which includes applications such as ICQ, IRC, and Retrospect). From here, you have two options:

- ✔ If the application is listed, you're in luck: Click it and then click **OK** to open the default ports for that application.
- ✔ If the application isn't listed, click **Other** and type the TCP port and UDP port listed in the application's documentation. Click **OK** to open the ports you specified.



## Chapter 18

---

# Making Friends with Wireless Devices

---

### *In This Chapter*

- ▶ Using Bluetooth for wireless connections
  - ▶ Adding wireless keyboards and mice
  - ▶ Moving data amongst devices with iSync
  - ▶ Printing over a Bluetooth wireless connection
- 

**L**et's talk cordless. Your Mac is already pretty doggone all-inclusive because everything that most other computers string together with cords has been integrated into the laptop's case, including the monitor and speakers. Depending on the connection options that you choose when you buy your laptop (or what you've added since), the only cord that you absolutely need might be your AC power cord.

For most of us, this introduces an entirely new realm of possibilities . . . and that results in more questions. Exactly how do other wireless devices communicate with your Mac? Can you really share the data on your laptop with your cell phone or your PDA? Can you sit in the comfort of your overstuffed recliner and watch a DVD from 15 feet away?

In this chapter, I describe to you what's cooking in the world of wireless devices. I won't delve into wireless Ethernet networking between your Mac and other computers — that's covered in depth in the confines of Chapter 17 — and I won't discuss the Apple remote in this chapter, because it's covered in Chapter 10. However, I *do* cover the wireless Bluetooth connections that you can make with other devices besides computers.



## Bluetooth: Silly Name for Cool Technology

Originally, wireless computer connections were limited to IR (short for infrared) and 802.11b (the original Wi-Fi specification for wireless Ethernet networks). This was fine — after all, what were you gonna connect to your Mac besides other computers? Ah, but progress marches on.

### *A little Danish history*

Enter the explosion in popularity of modern cell phones and personal digital assistants (PDAs). In 1998, a consortium of big-name cell phone, PDA, and computer laptop manufacturers decided that their products needed a method of communicating with each other. This new wireless standard needed to be inexpensive and consume as little battery power as possible, so designers decided to keep the operational distance limited to a maximum of about 30 feet. Plus, the idea was to keep this new wireless system as hassle-free as possible: Everyone agreed that you should simply be able to walk within range of another device, and the two would link up immediately and automatically. Thus *Bluetooth* was born!

Bluetooth has been incorporated into a range of peripherals and devices, including

- ✓ Cell phones
- ✓ PDAs
- ✓ Laptops
- ✓ Wireless computer peripherals such as keyboards and mice
- ✓ Printers
- ✓ Music players
- ✓ Headphones



Does the name Bluetooth sound faintly like Viking-speak to you? It should. For some absolutely ridiculous reason, the companies that developed the Bluetooth standard decided to name their creation after the tenth century Danish king Harald Blatand, nicknamed Bluetooth, who succeeded in joining Denmark and Norway in a political alliance. Hence the rather Viking and runic-looking Bluetooth symbol. (Geez, these folks need to take a day off. Read comic books, or play with a Slinky. *Something.*)

## *Is your Mac Laptop Bluetooth-ready?*

Danish royalty aside, you still need to know whether your Mac is ready for a Bluetooth connection. At the time of this writing, all of Apple's laptop offerings come with internal Bluetooth hardware, but if you're using an older Mac laptop without Bluetooth built-in, you're currently out of the Bluetooth loop.

However, you don't need to pitch your faithful Mac if it doesn't yet talk to the pirate! You can add Bluetooth capability to your computer with a simple USB Bluetooth adapter. The USB Bluetooth adapter from Belkin ([www.belkin.com](http://www.belkin.com)) sells online for about \$30. It includes automatic data encryption, which is necessary only if there's a hacker within about 30 to 60 feet of your computer, but more security is always better in my book. The adaptor can link with up to seven other Bluetooth devices simultaneously. (Come to think of it, there were a lot of people within 30 feet of my MacBook Pro during my last LAN party bash. I guess this stuff really *is* important!)

## *Tiger and Bluetooth, together forever*

You'd expect a modern, high-tech operating system like Mac OS X to come with Bluetooth drivers. You'd be right, but Apple has gone a step further: Tiger comes with a System Preferences pane and a utility application to help your Mac connect with the Bluetooth devices that are probably hanging out in your coat pockets.

The Bluetooth pane in System Preferences allows you to

- ✓ **Set up new Bluetooth devices:** Click the Devices tab and then click Setup New Device to run the Bluetooth Setup Assistant, which configures Bluetooth devices for use with Tiger.

By following the device-specific onscreen instructions, you can choose to set up a number of common Bluetooth toys, including a keyboard, mouse, cell phone, and printer — or you can work with other types of devices by choosing Other. The Setup Assistant searches for your Bluetooth device and makes sure that it's ready to party with your laptop.

Your Bluetooth device must be in range and *discoverable* (more on this in the next section) before you run the Bluetooth Setup Assistant.

- ✓ **Configure Bluetooth connections:** Click the Sharing tab to create, remove, enable, or disable your Bluetooth connections, using them as virtual serial ports (for the simple transfer of data) or virtual modems (for bidirectional transfers, such as using an Internet connection through a Bluetooth cell phone). The two types of data exchange that you can enable or disable from this tab are



- **File transfers:** Bluetooth devices can browse the folder that you specify and receive files from your Mac.
- **File exchanges:** Your laptop can browse and receive files from Bluetooth devices.

These openings to the outside world are presented as individual connections in the Service Name list, and you can toggle them on and off individually. You can also specify whether a Bluetooth port is encrypted. Figure 18-1 shows an active Bluetooth virtual modem that's set up to allow my laptop to sync up with my Palm Pilot, using the Bluetooth-PDA-Sync service.



**Figure 18-1:**

You can add, delete, enable or disable Bluetooth ports from the Sharing tab.



If you know you won't be using Bluetooth devices while you're on the road, disabling a Bluetooth service on a laptop can help conserve battery power.

The other Bluetooth resource that you can use is the standalone application *Bluetooth File Exchange*. (Yes, you can call it *BFE* if you like. I do whenever possible.) You'll have to launch BFE the old-fashioned way — it's located in your Utilities folder, inside your Applications folder. Much like a traditional FTP application, double-clicking the Bluetooth File Exchange icon presents you with a file selection dialog box — you're choosing the file(s) you want to send to the connected Bluetooth device! You can also elect to browse the files on a networked Bluetooth device so that you can see what the owner of that device is offering.



The Bluetooth icon appears in the System Preferences window only if your laptop has Bluetooth hardware.

You can also set up your defaults for file exchanges from the Bluetooth pane in System Preferences. Click the Sharing tab and then select the Bluetooth File Exchange check box to display the settings shown in Figure 18-2. Here you can control what Tiger does when you receive files or Personal Information Manager (PIM) data with Bluetooth File Exchange. For instance, with these settings, Tiger can

- ✓ Prompt you for permission to receive each file or PIM item
- ✓ Accept all files and PIM items without restriction or prompting
- ✓ Save all incoming files and items to the folder that you specify
- ✓ Offer only the files and items in the folder that you specify when other Bluetooth items browse your Mac



**Figure 18-2:**  
Configure  
file  
exchanges  
in System  
Pref-  
erences.



Personally, I'm all for the defaults in Tiger for file exchanges:

- ✓ I want to know when someone's sending me something.
- ✓ I want anything I receive to be saved in my Documents folder.
- ✓ If I turn on File Transfer, I want to allow others to browse the contents of my Public folder.

However, feel free to adjust, enable, and disable to your heart's content.

## Mr. Security speaks — yet again

From a security standpoint, several settings in the Bluetooth pane of System Preferences can really lock things down (or open things up) in Bluetooth networking. The settings in question are

- ✔ **Discoverable (Settings tab):** Click the Settings tab to display the pane shown in Figure 18-3. When you select the Discoverable check box, other Bluetooth devices in range can recognize that your computer has a Bluetooth port ready. Naturally, you usually want this enabled so that your devices can automatically connect to each other, but you can disable it and connect manually if you want to keep strange Bluetooth devices at arm's length.
- ✔ **Encryption (Sharing tab):** I *always* recommend that you force other Bluetooth devices to encrypt the connection because it once again helps ensure that others don't simply sidle up to your laptop and start pulling down files or your PIM data.

Each service in the Service Name list on the Sharing pane has a check box in the Encrypted column (denoted by the key icon). Leave this check box selected on each service, and you'll be a happy puppy.

- ✔ **Require Pairing for Security (Sharing tab):** When this check box is enabled, the selected service has to be *paired* with your cell phone or Bluetooth device. A passkey is entered when you set up the device on your Mac, and that passkey must also be entered into your device. (This is a one-time deal, so you don't need to remember the passkey.) If a Bluetooth connection is attempted and the passkeys don't match, the link is disabled and the connection is broken.



**Figure 18-3:**  
Keep tight control over Bluetooth connections from the Settings tab.

- ✔ **Show Bluetooth Status in the Menu Bar (Settings tab):** I recommend that you enable this feature. The Bluetooth menu lets you conveniently toggle your laptop's discovery status as well as set up a device or send and browse files. (You can also see what devices are connected to your Mac with the click of a menu icon. 'Nuff said.)

## *Adding Wireless Keyboards and Mice to Your Laptop*

The current crop of Mac laptops arrive at your doorstep in a fully wireless configuration — Apple throws in an internal Bluetooth adapter and an internal AirPort Extreme wireless card. Everything's already included for you. Therefore, you can indeed work keyboard and mouse magic from across the room from your laptop, using a wireless keyboard and mouse. (Or perhaps you just want a full-size keyboard and external mouse to use when you're working from your home or office.)

A number of wireless Bluetooth keyboard/mouse packages are on the market, and any one of 'em should work fine with your Mac. In fact, you can buy Apple's wireless Bluetooth keyboard and mouse separately, for a total of about \$120. Other offerings from Logitech and our old buddy Microsoft run about the same amount.

When shopping for a Bluetooth keyboard/mouse desktop, keep these facts in mind:



- ✔ **Some keyboards are created more than equal.** Many of today's third-party keyboards are encrusted with extra function buttons that do everything from opening your e-mail application to searching your kitchen cabinets for another can of spray cheese.  
I like these programmable function keys — they can bring up your favorite applications with a single keystroke while you're relaxing 20 feet away — so look for the keyboard that offers the most programmable keys in your price range.
- ✔ **Rodents crave energy.** Does the wireless mouse come with its own recharging stand? If so, that's a big plus. Depending on how much you use your laptop, a mouse that runs on standard batteries can go through a set in as little as a month's time! (Not surprisingly, many computer owners use rechargeable batteries in their wireless mice.) In fact, some wireless mice include an on/off switch to help conserve battery power.
- ✔ **Wireless doesn't always mean Bluetooth.** Just because a keyboard or mouse is wireless doesn't automatically make it a Bluetooth device. Plenty of wireless RF (radio frequency) devices are out there, too. These toys need their own transmitters, which are usually USB-based as well,

so things can get confusing. Therefore, read the box or technical specifications carefully to make sure you're buying Bluetooth.

- ✓ **Bluetooth stuff isn't self-cleaning.** Sure, your new wireless keyboard and mouse can hang out with you on the sofa, but that doesn't mean they're happy sharing your nacho puffs and grape soda. Look for an optical mouse that doesn't use a ball, and check whether a prospective keyboard can be easily cleaned and maintained before you buy it.

Most Bluetooth devices are controlled through the Bluetooth pane in System Preferences. However, wireless keyboards and mice are a special case because they're monitored through the Bluetooth section of the Keyboard & Mouse pane, as shown in Figure 18-4. (You can even add a new wireless device from this tab — geez, those Apple designers give you a dozen roads to the same spot on the map, don't they?)

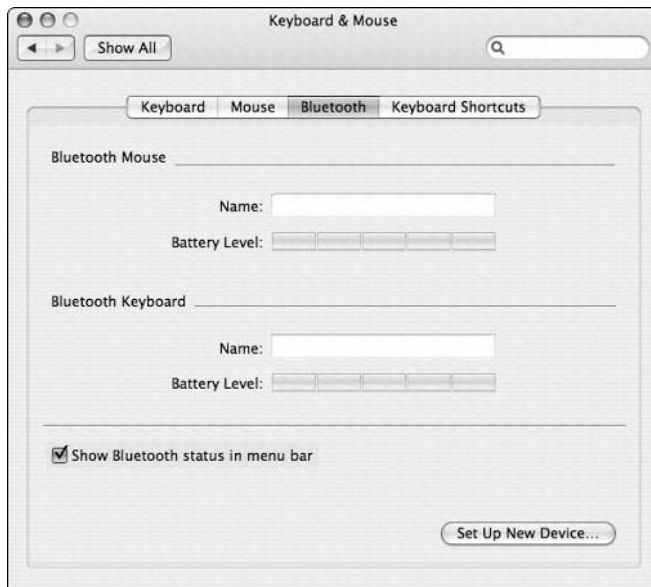

**Figure 18-4:** Check your Bluetooth keyboard and mouse battery levels.

## Getting Everything in iSync

No jokes about boy bands, please. *iSync* is the data transfer and synchronizing utility application that ships with Tiger, and it works fine with both wired and wireless Bluetooth connections. The difference between Bluetooth File Exchange and *iSync* is a matter of intelligence:

- ✓ BFE merely transfers files and dumps them in the folders you specify.
- ✓ iSync copies and updates your Address Book, Safari, and iCal information between devices. iSync compares the information on both your laptop and your devices and makes sure they end up the same.

iSync also allows you to synchronize data between multiple computers using your .Mac membership so that the contacts, bookmarks, and calendar data on your iBook match the data on your Mac. You can control what gets sent from the .Mac pane in System Preferences. (For more on .Mac, visit Chapter 9.)



Just because your phone or PDA supports Bluetooth *doesn't* mean that iSync is guaranteed to work. I know a few Mac owners who are still seething over incompatible devices. For a complete list of the Bluetooth phones, PDAs, and other devices that work with iSync, visit [www.apple.com/isync/devices.html](http://www.apple.com/isync/devices.html).

After your supported Bluetooth device is linked to your Mac, follow these steps to add the new device to iSync and synchronize your data:

1. **Click the Finder icon on the dock.**
2. **Click Applications in a Finder window's sidebar, and then double-click iSync.**
3. **Press ⌘+N.**
4. **Click Scan to display any Bluetooth devices in range.**
5. **Double-click the device you want to use.**

The window expands to allow you to specify the data to synchronize. Other settings might appear as well, depending on the device. For example, Figure 18-5 illustrates the available data that can be synchronized with my iPod. Because you can't surf the Web on an iPod — *yet* — the Bookmarks option doesn't appear.

6. **Select the check boxes for each data type you want to exchange.**
7. **Click Sync Devices.**



*Never* disconnect a device while a synchronization is in progress — the data being transferred could become corrupt or your laptop could lock up.



Deleting a calendar event or a contact on either your laptop or the Bluetooth device deletes that same data from the other machine! For example, if you decide you no longer need your personal contacts on your Mac at work and you delete 'em, *they'll be deleted from your PDA when you synchronize*. When I say that iSync creates a mirror image on both sides of the connection, I'm not lying — additions appear and deletions disappear.



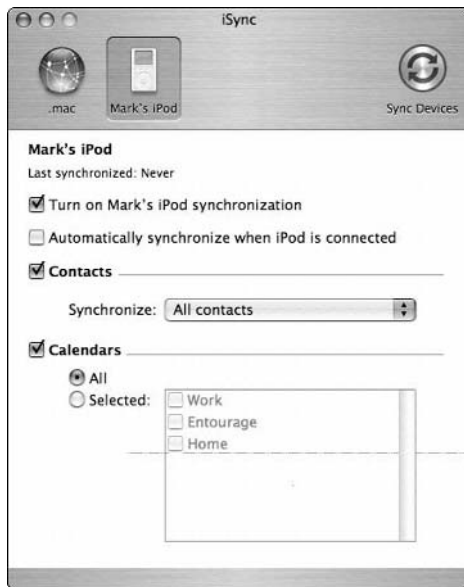

**Figure 18-5:**  
Specify the  
stuff to sync  
with an  
iPod.

## The Magic of Wireless Printing

To your Mac laptop, a wireless Bluetooth printer is just another Bluetooth connection — but to you, it's the very definition of convenience, especially if desk space is limited next to your Mac. Just set that paper-producing puppy up anywhere in the 30–60 foot range, plug it in, set up the printer in Tiger, and let 'er rip.



Not all printer manufacturers produce Bluetooth models that communicate properly with your Mac. Make sure that the Bluetooth printer you buy supports HCRP. (Another jawbreaker acronym. This time it stands for *Hardcopy Cable Replacement Protocol*.)

You have two options when installing a Bluetooth printer:

- ✓ Whenever possible, use the printer manufacturer's software. A printer might require a driver that a typical Bluetooth device doesn't need.
- ✓ You can usually successfully set up a printer using the Bluetooth Setup Assistant, which you can run from the Devices pane in the Bluetooth pane of System Preferences:

- 1. Make sure your printer is set as discoverable.**

Check your printer manual to determine how to switch your printer to discoverable mode.

- 2. Click the Set Up New Device button.**

- 3. Choose to install a printer.**

- 4. Follow the onscreen instructions.**

Luckily, after you successfully set up a Bluetooth printer, you can just press **⌘+P** to open the Print dialog box and choose that printer from the Printer pop-up menu. No big whoop . . . and that's the way it *should* be.



# Part VI

# The Necessary Evils: Troubleshooting, Upgrading, Maintaining

The 5<sup>th</sup> Wave

By Rich Tennant

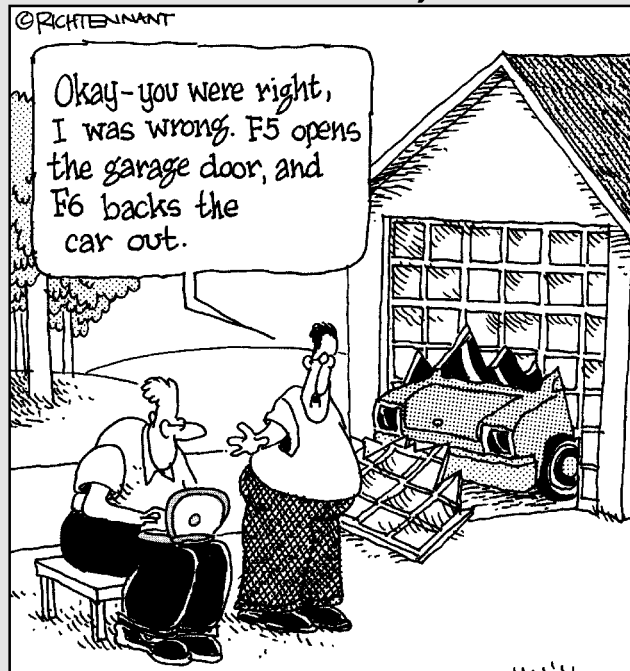

## *In this part . . .*

**N**o computer is *completely* trouble-free — and if your MacBook or MacBook Pro starts acting strangely (like a Windows PC), the troubleshooting tips you'll find in this part will help you get your favorite machine back to normal. I also provide you with all the guidance you need to maintain your Mac properly as well as step-by-step instructions for upgrading your laptop with goodies like additional RAM or external storage devices.

## Chapter 19

# When Good Mac Laptops Go Bad

---

### *In This Chapter*

- ▶ Avoiding the blame (righteously)
  - ▶ Putting basic troubleshooting precepts to work
  - ▶ Using Mark's Troubleshooting Tree
  - ▶ Getting help
- 

**I**wish you weren't reading this chapter. Because you are, I can only surmise that you're having trouble with your Mac, and that it needs fixing. (The other possibility — that you just like reading about solving computer problems — is more attractive, but much more problematic.) Therefore, consider this chapter a crash course in the logical puzzle that is computer *troubleshooting*: namely, the art of finding out What Needs Fixing. You also see what you can do when you just plain can't fix the problem by yourself.

Oh, and you're going to encounter a lot of tips in this chapter — all of them learned the hard way, so I recommend committing them to memory on the spot!

## *Repeat after Me: Yes, I Am a Tech!*

*Anyone* can troubleshoot. Time to put these common troubleshooting myths to rest:

- ✓ **It takes a college degree in computers to troubleshoot.** Tell that to my troubleshooting kid in junior high. She'll think it's a hoot because she has an Apple laptop of her own (and another in the classroom). You can follow all the steps in this chapter without any special training.
- ✓ **I'm to blame.** Ever heard of viruses? Failing hardware? Buggy software? Any of those things can be causing the problem. Heck, even if you do something by accident, I'm willing to bet it wasn't on purpose.

- ✔ **I need to buy expensive utility software.** Nope. You can certainly invest in a commercial testing and repair utility if you like. My favorites are TechTool Pro from Micromat ([www.micromat.com](http://www.micromat.com)) and Disk Warrior from Alsoft ([www.alfsoft.com](http://www.alfsoft.com)), but a third-party utility isn't a requirement for troubleshooting. (I do, however, consider an antivirus application a must-have, and you should have one already. Hint, hint.)
- ✔ **There's no hope if I can't fix it.** Parts fail, and computers crash, but your Apple Service Center can repair just about any problem. And (ahem) if you've backed up your laptop (as I've preached throughout this book), you'll keep that important data even if a new hard drive is in your future.
- ✔ **It takes forever.** Wait until you read the number one rule in the next section; the first step takes but 30 seconds and often solves the problem. Not all problems can be fixed so quickly, but if you follow the procedures in this chapter, you should fix your laptop (or at least know that the problem requires outside help) in a single afternoon.

With those myths banished for good, you can get down to business and start feeling better soon.

## *Step-by-Step Laptop Troubleshooting*

In this section, I walk you through my Should-Be-Patented Troubleshooting Tree as well as Tiger's built-in troubleshooting application, Disk Utility. I also introduce you to a number of keystrokes that can make your Mac jump through hoops.

### *The number one rule: Reboot!*

Yep, it sounds silly, but the fact is that rebooting your Mac can often solve a number of problems. If you're encountering the following types of strange behavior with your laptop, a reboot might be all you need:

- ✔ Intermittent problems communicating over a network
- ✔ A garbled screen, strange colors, or screwed-up fonts
- ✔ The Swirling Beach Ball of Doom that won't go away after several minutes
- ✔ An application that locks up
- ✔ An external device that seems to disappear or can't be opened

Always try a reboot before beginning to worry. *Always.*

Try to save all open documents before you reboot. That might not be possible, but try to save what you can.

If you need to force an application to quit so you can reboot, follow these steps to squash that locked application:

- 1. Click the Apple () menu and choose Force Quit.**

The Force Quit Applications dialog box appears.

- 2. Click the name of the offending application, and then click the Force Quit button.**

If you can get everything to quit, you should be able to click the Apple menu and choose Shut Down without a problem.

If your laptop simply won't shut down (or you can't get the offending application to quit), do what must be done:

- 1. Press and hold your Mac's Power button until it shuts itself off.**

You have to wait about four seconds for your Mac to turn itself off.

- 2. Wait five seconds to allow your hard drive to spin down.**

- 3. Press the Power button again to restart the computer.**

After everything is back up, check whether the problem is still apparent. If you use your Mac for an hour or two and the problem doesn't reoccur, you've likely fixed it!

## *Special keys that can come in handy*

A number of keys have special powers over your laptop. No, I'm not kidding! These keys affect how your Mac starts up, and they can come in handy whilst troubleshooting.

### *Tricks you can do with your friendly Shift key*

The Shift key has a number of special functions:

- ✔ **Disable automatic login.** Hold down the left Shift key and the trackpad button down after the screen lights up.
- ✔ **Prevent your login items from running.** If Tiger displays a *multiuser login screen*, hold down Shift at the login screen while you click the Login button. If *your laptop doesn't display a login screen*, hold down Shift either when you push your Mac Power button or immediately after the screen blanks during a restart.



## Why is rebooting so darn effective?

Rebooting fixes problems because it *resets* everything. Your network connection, for example, may be acting up or may have timed out, and rebooting restores it. Rebooting also fixes problems due to brownouts or those notorious AC

power flickerings that we all notice from time to time. Such interruptions in constant juice may not bother you or me (or your less-intelligent toaster), but they can play tricks on your Mac that rebooting corrects.

### *Startup keys*

Table 19-1 provides the lowdown on startup keys. Hold the indicated key down either when you push your Mac Power button or immediately after the screen blanks during a restart.

<i>Key</i>	<i>Effect on Your Mac</i>
C	Boots from the CD or DVD that's loaded in your optical drive
Media Eject	Ejects the CD or DVD in your optical drive
Option	Displays a boot menu, allowing you to choose the operating system
Shift	Prevents your login items from running
T	Starts your laptop in FireWire Target Disk mode
⌘+V	Show Mac OS X console messages
⌘+S	Starts your laptop in single user mode
⌘+Option+P+R	Resets parameter RAM (PRAM)

Some of the keys in Table 19-1 may never be necessary for your machine, but then again you might be instructed to use them by an Apple technician. I'll warrant that you'll use at least the C startup key fairly often.

## *Using Disk Utility to squash problems*

Tiger's Disk Utility is a handy tool for troubleshooting and repairing your hard drive. You can find it in the Utilities folder in your Applications folder. Fire up Disk Utility, click the First Aid tab, and you see the powerful looking window shown in Figure 19-1.

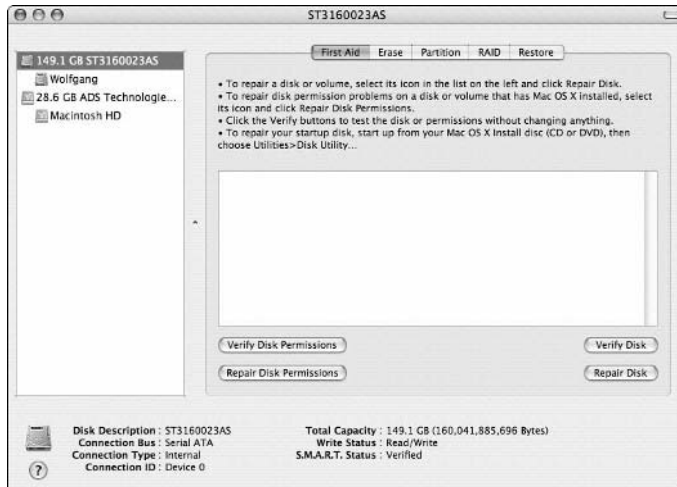

**Figure 19-1:**  
The  
physician  
of hard  
drives —  
Tiger's Disk  
Utility.

In the left column of the Disk Utility window, you can see



- ✓ The *physical* hard drives in your system (the actual hardware)
- ✓ The *volumes* (the data stored on the hard drives)  
A volume is always indented below the physical drive entry.
- ✓ CD or DVD discs currently loaded on your laptop
- ✓ USB or FireWire flash drives

For example, in Figure 19-1, I have two hard drives (the 149.1GB and 28.6GB entries), and each has a single volume (the Wolfgang and the Macintosh HD entries, respectively).



The information at the bottom of the Disk Utility window contains the specifications of the selected drive or volume . . . things such as capacity, free space, and the number of files and folders for a volume, or connection type and total capacity for a drive.

### ***Repairing disk permissions***

Because Tiger is built on a UNIX base, lots of permissions can apply to the files on your drive — that is, who can open (or read or change) every application, folder, and document on your hard drive. Unfortunately, these permissions are often messed up by wayward applications or power glitches, or by application installers that do a sub-par job of cleaning up after themselves. And if the permissions on a file are changed, applications might lock up or refuse to run.



I recommend repairing your disk permissions with Disk Utility once a week, and before installing Mac OS X updates.



## Danger, Will Robinson!

Many Disk Utility functions can actually **wipe your hard drive clean of data or trash your existing system** instead of repairing them!

These advanced functions aren't likely to help you with troubleshooting a problem with your existing volumes anyway. Unless you're intimately familiar with Disk Utility

- ✓ Don't partition and erase drives
- ✓ Don't set up RAID arrays
- ✓ Don't restore files from disk images (until you've read my tutorial covering this process in Chapter 21)

until an Apple technician tells you to do so.

Follow these steps to repair the permissions on your Mac's hard drive:

- 1. Save and close any open documents, and make sure that you're logged in with an admin account.**

Chapter 16 shows you how to log in as an admin user.

- 2. Double-click the Disk Utility icon in the Utilities folder.**

- 3. Click the volume that you want to check.**

- 4. Click the Repair Disk Permissions button.**

I don't worry about verifying. If something's wrong, you end up clicking Repair Disk Permissions anyway. Just click Repair Disk Permissions; if nothing pops up, that's fine.

- 5. To finish the process, always reboot after repairing permissions.**

This shows you whether a problem has been corrected!

### *Repairing disks*

Disk Utility can check the format and health of both hard drives and volumes with Verify Disk — and, if the problem can be corrected, fix any error using Repair Disk.



Using Disk Utility to repair your hard drive carries a couple of caveats:

- ✓ **You can't verify or repair the boot disk or boot volume.** This makes sense because you're using that disk and volume right now.

To verify or repair your boot hard drive, you need to boot from your Mac OS X installation disc by using the C startup key. (See Table 19-1 for keys that come in handy.) After your laptop has booted using the Mac OS X installation disc, choose the Utilities menu and click Disk Utility.

You should be able to select your boot hard drive or volume, and the Verify Disk and Repair Disk buttons should be enabled.

- ✔ **You can't repair CDs and DVDs.** CDs and DVDs are read-only media and thus can't be repaired (at least by Disk Utility). If your Mac is having trouble reading a CD or DVD disc, either wipe the disc with a soft cloth to remove dust, oil, and fingerprints, or invest in a disc-cleaning contrivance of some sort.

If you need to verify and repair a disk or volume, follow these steps:

1. **Save all your open documents and reboot from either an external drive or your Mac OS X Installation disc.**
2. **Double-click the Disk Utility icon in the Utilities folder.**
3. **In the list at the left side of the Disk Utility window, click the disk or volume that you want to check.**
4. **Click the Repair Disk button.**
5. **If changes were made (or if you had to boot from a disc or external drive), reboot after repairing the disk or volume.**

## *Mark's should-be-patented laptop troubleshooting tree*

As the hip-hop artists say, "Alright, kick it." And that's just what my Mac Laptop Troubleshooting Tree is here for. If rebooting your Mac hasn't solved the problem, follow these steps in order until either the solution is found, or you run out of steps — more on that in the next section.

### **Should I reinstall Mac OS X?**

Whether or not Mac OS X should be reinstalled when the operating system develops major problems gets a lot of attention on Mac-related Internet discussion boards and Usenet newsgroups — and the answer is a definitive *perhaps*. (I know, that's really helpful.)

Here's the explanation. You *shouldn't* lose a single byte of data by reinstalling Mac OS X, so it's definitely okay to try it. However, reinstalling Mac OS X isn't a universal balm that fixes all software errors because the problem that you're encountering may be due to a buggy

application, or a hard drive that's going critical, or a video card with faulty memory modules. If the trouble you're having is due to a corrupted Mac OS X System Folder, reinstalling Tiger may or may not correct the problem.

Therefore, the debate rages on. I would certainly follow the Laptop Troubleshooting Tree all the way to the end before I would even consider reinstalling Tiger, and I would recommend that you contact an Apple support technician on the Apple Web site before you take this step.

### ***Step 1: Investigate recent changes***

This is a simple step that many novice Mac owners forget. Simply retrace your steps and consider what changes you made recently to your system. Here are the most common culprits:



- ✔ **Did you just finish installing a new application?** Try uninstalling it by removing the application directory and any support files that it may have added to your system. (And don't forget to keep your applications current with the most recent patches and updates from the developer's Web site.)

From time to time, an application's *preference file* — which stores all the custom settings you make — can become corrupted. Although the application itself is okay, it might act strangely or refuse to launch. To check your preference files, try scanning your laptop's applications with Preferential Treatment, a freeware AppleScript utility by Jonathan Nathan, available from his Web site at <http://homepage.mac.com/jonn8/as>.

- ✔ **Did you just apply an update or patch to an application?** Uninstall the application and reinstall it without applying the patch. If your Mac suddenly works again, check the developer's Web site or contact its technical support department to report the problem.
- ✔ **Did you just update Tiger using Software Update?** Updating Tiger can introduce problems in applications that depend on specific routines and system files. Contact the developer of the application and look for updated patches that bring your software in line with the Tiger updates. (And use Software Update in automatic mode to check for Mac OS X updates at least once a week.)
- ✔ **Did you just make a change in System Preferences?** Return the options that you changed back to their original settings; then consult Chapter 6 for information on what might have gone wrong. (If the setting in question isn't in Chapter 6, search Tiger's online help or the Apple support Web site for more clues.)
- ✔ **Did you just connect (or reconnect) an external device?** Try unplugging the device and rebooting to see whether the problem disappears. Remember that some peripherals need software drivers to run — and without those drivers installed, the device won't work correctly. Check the device's manual or visit the company's Web site to search for software that you might need.

If you haven't made any significant changes to your system before you encountered the problem, proceed to the next step.

### ***Step 2: Run Disk Utility***

The preceding section shows how to repair disk permissions on your Tiger boot drive.



If you're experiencing hard drive problems, consider booting from your Mac OS X Installation CD or DVD to run a full-blown Repair Disk checkup on your boot volume.

### ***Step 3: Check your cables***

It's a fact that cables work themselves loose, and they fail from time to time. Check all your cables to your external devices — make sure that they're snug — and verify that everything's plugged in and turned on. (Oh, and don't forget to check your cables for crimps or even Fluffy's teeth marks.)



If a FireWire or USB device is acting up, try swapping cables around to see whether you have a bad one. A faulty cable can leave you pulling your hair out in no time.

### ***Step 4: Check your trash***

Check the contents of your trash to see whether you recently deleted files or folders by accident. Click the Trash icon on the dock once to display the contents. If something's been deleted by mistake, drag it back to its original folder, and try running the application again. I know this one from experience, when a slight miscalculation while selecting files to delete resulted in an application that would lock up every time I tried to launch it.

### ***Step 5: Check your Internet, wireless, and network connections***

Now that always-on DSL and cable modem connections to the Internet are common, don't forget an obvious problem: Your laptop can't reach the Internet because your ISP is down!

Check your Internet connection by pinging `www.apple.com`, as follows:

- 1. Open your Utilities folder (inside your Applications folder).**
- 2. Double-click Network Utility.**
- 3. Click the Ping tab.**
- 4. Enter `www.apple.com` in the Address box.**
- 5. Click Ping.**

You should see successful ping messages similar to those in Figure 19-2. If you don't, your ISP or network is likely experiencing problems.

**Figure 19-2:**  
Ping  
apple.com  
to check  
your  
Internet  
connection.

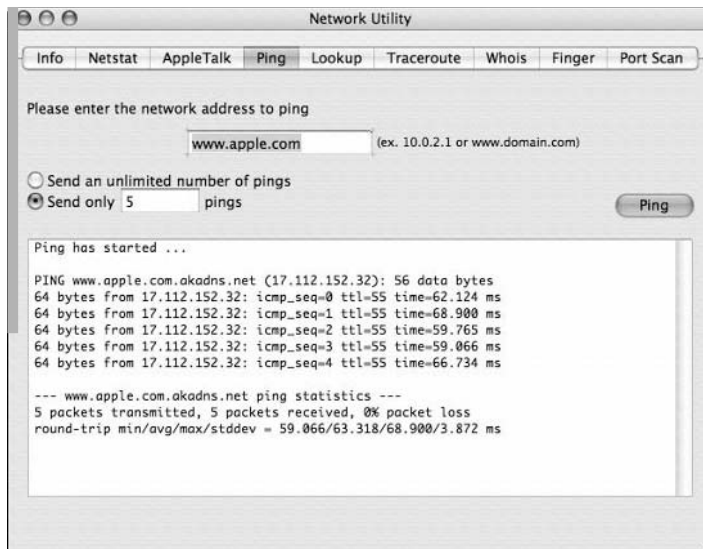

### Step 6: Think virus

If you've made it to this point, it's time to run a full virus scan — and make sure that your antivirus application has the latest updated data files, too. My antivirus application of choice is Virus Barrier X from Intego ([www.intego.com](http://www.intego.com)). If a virus is detected and your antivirus application can't remove it, try quarantining it instead — this basically disables the virus-ridden application and prevents it from infecting other files.

### Step 7: Disable your login items

Mac OS X may be encountering problems with applications that you've marked as login items in System Preferences. In this step, I show you how to identify login problems and how to fix 'em.

It's time to use another nifty startup key (refer to Table 19-1). This time, hold down Shift during startup (if your Mac doesn't display the Login screen) or hold down Shift at the Login screen while you click the Login button.

These tricks disable your account's login items, which run automatically every time you log in to your laptop. If one of these login items is to blame, your Mac will simply encounter trouble — automatically! — every time you log in.

If your laptop works fine with your login items disabled, follow this procedure for each item in the login items list:

1. **Open System Preferences, click Accounts, and then click the Login Items button.**

**2. Delete an item from the list, and then reboot normally.**

You can delete the selected item by clicking the Delete button, which bears a minus sign.

**3. If your Mac doesn't start up normally, go back to Step 2.****4. When your Mac starts up normally with the remaining login items enabled, you've discovered the perpetrator — you'll likely need to delete that application and re-install it.****5. Don't forget to add each of the *working* login items back to the Login items list!*****Step 8: Turn off your screen saver***

This is a long shot, but it isn't unheard of to discover that a faulty, bug-ridden screen saver has locked up your laptop. If you aren't running one of the Apple-supplied screen savers and your computer never wakes up from Sleep mode or hangs while displaying the screen saver, you've found your prime suspect. Open System Preferences, click Desktop & Screen Saver, click the Screen Saver button, and then do one of the following:

- ✓ Switch to an Apple screen saver
- ✓ Drag the Start slider to Never. If this corrects the problem, you can typically remove the screen saver by deleting the offending saver application in the Screen Savers folder inside your Mac OS X Library folder. If you can't find the screen saver application, try typing the saver name in the Spotlight search box.

***Step 9: Run System Profiler***

Ouch. You've reached Step 9, and you still haven't uncovered the culprit. At this point, you've narrowed the possibilities down to a serious problem, like corrupted files in your Mac OS X System Folder or hardware that's gone south. Fortunately, Tiger provides you with System Profiler, which displays real-time information on all the hardware in your system. Click the Apple menu and choose About This Mac; then click More Info. Click each one of the Hardware categories in turn, double-checking to make sure that everything looks okay.



You don't have to understand all the technical hieroglyphics, but if a Hardware category doesn't return what you expect or displays an error message, that's suspicious. (Naturally, if your laptop doesn't have a specific type of hardware onboard — including Fibre Channel, PC Cards, PCI Card, or Parallel SCSI hardware — you won't get any information from those categories.)



The Diagnostics category indicates whether your Mac passed the Power On self-test successfully.



## *My Mac Needs Professional Help*

Don't worry, friend reader — just because you've reached the end of my Mac laptop tree doesn't mean you're out of luck. In this section, I discuss the online help available on Apple's Web site as well as local help in your own town.

### *Chatting with Apple Online*

If you haven't visited Apple's Support site, run — don't walk — to [www.apple.com/support/hardware](http://www.apple.com/support/hardware). Click the proper laptop category to find

- ✔ **A Laptop Troubleshooting Assistant**, which queries you on the symptoms being displayed by your Mac and offers possible solutions
- ✔ **The latest patches, updates, and how-to tutorials** for your Mac
- ✔ **The Laptop and Mac OS X discussion boards**, which are moderated by Apple
- ✔ **Tools** for ordering spare parts, checking on your remaining warranty coverage, and searching the Apple knowledge base
- ✔ **Do-it-yourself instructions** (PDF files) that you can follow to repair or upgrade your Mac

Apple also offers a real-time Web Chat Support system, where you can converse in real-time chat with an Apple technician. So far, I haven't needed it, but it sounds like a winning feature.

### *Local service, at your service*

In case you need to take in your Mac for service, an Apple Store or Apple Authorized Service Provider is probably in your area. To find the closest service, launch Safari and visit <http://wheretobuy.apple.com/locator/service.html>.

That's the Find Service page on the Apple Web site. You can search by city and state or zip code. The results are complete with the provider's mailing address, Web site address, telephone number, and even a map of the location!

Always call your Apple service provider before you lug your (albeit lightweight) laptop all the way to the shop. Make sure that you know your Mac's serial number (which you can display in System Profiler) and which version of Mac OS X you're using.

## Chapter 20

# Adding New Stuff to Your Laptop

---

### *In This Chapter*

- ▶ Adding memory
  - ▶ Performing surgery on your Mac laptop
  - ▶ Upgrading your hard drive
  - ▶ Adding USB and FireWire devices
  - ▶ Reviewing what add-ons are available
- 

**A**s the old saying goes, “No laptop is an island.” Somebody famous wrote that, I’m sure.

Without getting all philosophical — or invoking the all-powerful Internet yet again — the old saying really *does* make sense. All computer owners will likely add at least one peripheral (external device) to their system, such as a joystick, an iPod, a backup drive, or a scanner. I talk about the ports on your Mac that accept these external connections in Chapter 1. Those holes aren’t there just to add visual interest to the sides of your treasured MacBook. In this chapter, I cover your USB and FireWire ports (and what you can plug into them) in detail.

Ah, but what about the stuff *inside* your MacBook Pro? That’s where things get both interesting and scary. In this chapter, I describe what you can add to the innards of your computer as well as how to get inside if you work up the courage to go exploring.

## *Adding Memory Always Helps*

Hey, wait a second. No *however* stuck on the end of that heading? You mean for once, there isn’t an exception? Aren’t all computers different? Just keep in mind this Mark’s Maxim:



More memory helps. *Always.*

## Let's get grounded!

Follow one cardinal rule when the unguarded insides of any computer are in easy reach: *Always ground yourself before you touch anything!* Your body can carry enough static electricity to damage the circuitry and chips that make up the brains of your Mac, and touching those parts without grounding yourself is an invitation for disaster.

Grounding yourself is easy to do: Just touch a metal surface for a few seconds before you dig in. After you ground yourself, you can then

safely handle both the internal components of your laptop and any new hardware components that you might be installing (such as memory modules or a hard drive).

If you walk anywhere in the room — hunting for a screwdriver, perhaps, or taking a sip of liquid reinforcement that you've stashed a comfortable distance away — you *must* ground yourself again before you get back to work. *Remember:* You can pick up a static charge by simply walking. Go figure.

Period. End of statement. No matter what type of computer you own, how old it is, or what operating system you use, adding copious amounts of memory to your system (to the maximum it supports) significantly improves the performance of your operating system (and practically every application that you run).



Memory maximizes the power of your computer: The more memory you have, the less data your laptop must temporarily store on its hard drive. Without getting into a discussion of virtual memory and other techno-gunk, just consider that extra memory as extra elbowroom for your applications and your documents. Believe me, both Mac OS X and Windows XP efficiently make use of every kilobyte of memory that you can provide.

## Figuring out how much memory you have

To see how much memory you currently have in your computer, click the Apple menu (🍏) and choose About This Mac. The dialog box that appears lists the total memory you're toting in megabytes or gigabytes.

Your MacBook or MacBook Pro has sockets for two DDR SDRAM memory modules. (Don't fret over what all the abbreviations mean. Rest assured that this memory type is fast.) These modules are available with up to 1GB of memory, so you can install as much as 2GB of memory in your Mac.

How you plan memory upgrades depends on how much memory you want. If your Mac uses the two default 256MB modules supplied by Apple, you have a couple of options:



- ✓ **Upgrade with 1GB of RAM** by removing one 256MB module and inserting a 1GB memory module in one of the empty slots. At the time of this writing, a 1GB memory module should set you back about \$125 or so.

1280MB of memory is plenty for running applications from the iLife and iWork suites, as well as any of the applications bundled with Tiger.

- ✓ **Install 2GB (2048MB) of total memory** by removing both of the standard 256MB modules and inserting a 1GB module in each slot.

If your primary applications include video editing, game playing, or image editing, you can use all the memory your laptop can hold.

## *Installing memory modules*

I'm happy to report that adding extra memory to your system is one of the easiest internal upgrades that you can perform on any computer. Therefore, I recommend that you add your own memory yourself. If you simply don't want to mess with your Mac's internal organs, your local Macintosh service specialist will be happy to install new RAM modules for you (for a price).

Follow these steps to add extra memory to a MacBook or MacBook Pro:

### **1. Get ready to operate:**

- a. Spread a clean towel on a stable work surface, such as your kitchen table.**

**The towel helps protect your screen from scratches.**

- b. Find a Phillips screwdriver.**

- c. Shut down your laptop and wait at least 10 minutes for it to cool down.**

- d. Unplug all cables from the computer.**

### **2. Close the computer and flip it over on top of the towel.**

### **3. Ground thyself!**

Check out the "Let's get grounded!" sidebar in this chapter.

### **4. Remove the battery.**

Slide both of the release latches up to pop out the battery (as shown in Figure 20-1), and then lift it out.

### **5. Remove the two screws holding the memory door closed.**

Place the two screws in a handy plastic bowl for safekeeping. Tah-dah! That wasn't much of a challenge, was it? Here's your chance to gaze with rapt fascination at a portion of the bare innards of your favorite computer.

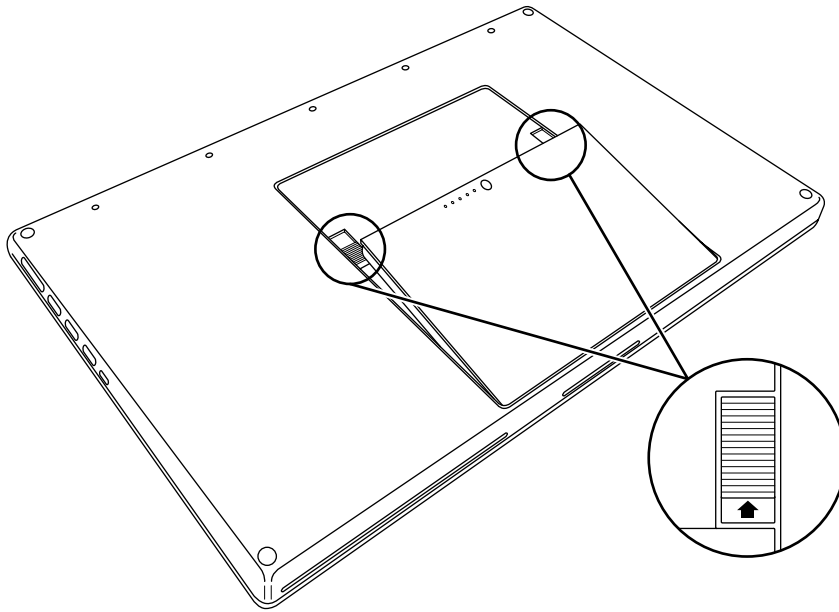

**Figure 20-1:**  
Slide the  
release  
latches.

#### 6. Locate the memory modules in your Mac's svelte chassis.

Figure 20-2 illustrates their position.

### Climbing inside your Mac laptop

This section on laptop upgrades is short for a reason: Laptops simply aren't *meant* to be disassembled. As I've mentioned several times in this book, internal expansion in your MacBook or MacBook Pro is severely limited — basically, you can add extra memory and swap out your hard drive. Adding memory is easy, while swapping out your hard drive requires more work and considerable preparation.

Therefore, I always recommend that you seek professional servicing when you need to repair your laptop. For example, if your laptop's LCD screen is cracked or broken, do *not* try to fix it

yourself! Sure, you may see a number of used LCD panels on eBay, but these parts aren't designed to be easily swapped out like a desktop computer's video card. Besides, if you make a mistake when trying to fix something deep in the bowels of your laptop, you may end up causing more damage than you repair.

The moral of the story? Let your local Apple dealer's service technicians perform major surgery on your laptop, and buy an AppleCare Protection Plan that will cover your laptop like a blanket for up to three years!

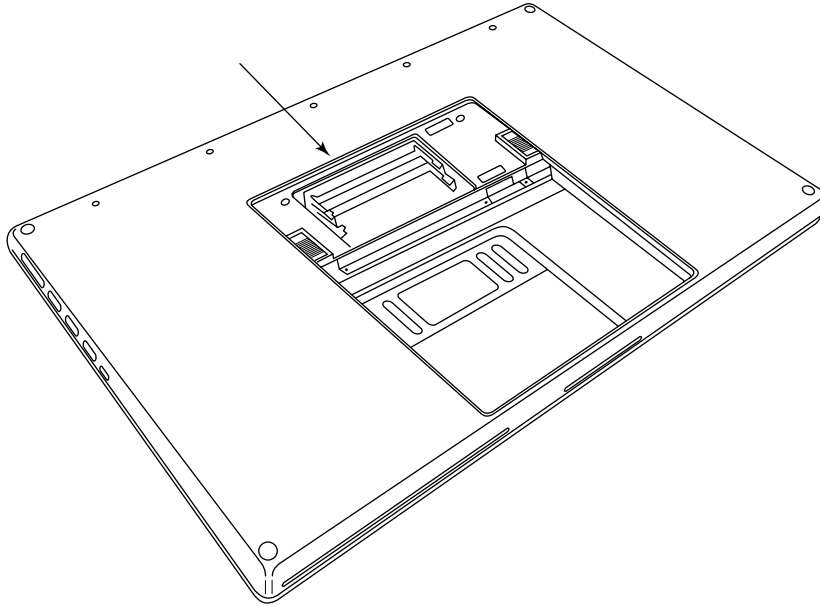

**Figure 20-2:**

The two Mac laptop memory slots are right here.

**7. If you're replacing an existing memory module, remove it.**

To remove a memory module, gently spread the two tabs at the ends of the socket apart (as shown in Figure 20-3) and then lift and slide the module away from the socket.

**Figure 20-3:**

Remove a memory module like a pro.

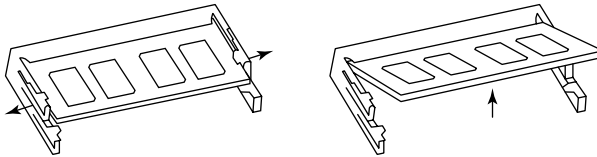

Save the old module in the static-free packaging that held the new module. Your old RAM (which you can now sell on eBay) will be protected from static electricity.

**8. Position the new module in the socket.**

- a. Line up the module's gold connectors toward the socket, at a 25 degree angle.
- b. Line up the notch in the module with the matching spacer in the socket.

See what I mean in Figure 20-4.

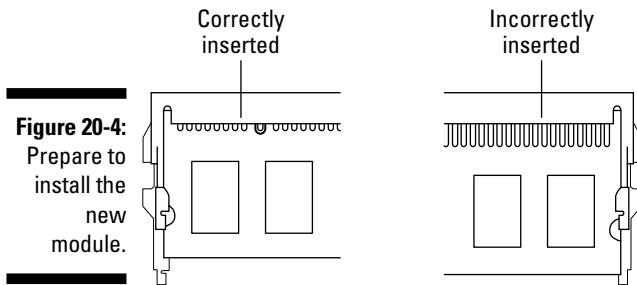

**Figure 20-4:**  
Prepare to  
install the  
new  
module.

9. Press gently (but firmly) on both ends of the module until the module's tabs click into place on both ends of the socket.

Figure 20-5 shows the direction you should press on the module.

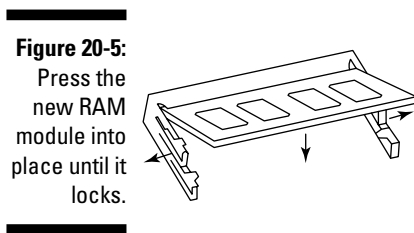

**Figure 20-5:**  
Press the  
new RAM  
module into  
place until it  
locks.

10. Replace the memory door and battery.

To replace the memory door and battery, just reverse the steps. (Rather like changing the oil on my Dad's 1970 Ford pickup truck.)

## Considering a Hard Drive Upgrade?

Okay, this is *almost* a trick question. The answer is yes, you can indeed upgrade your hard drive. But before you start cruisin' the Internet for a 320GB monster, I have two suggestions:

- ✓ Don't upgrade your internal hard drive yourself.
- ✓ Be sure you *really need* a hard drive upgrade.

Apple's pretty generous when configuring hard drive storage for its base systems (current models run with anywhere from a 60 to 120GB drive).

Most folks simply don't need more than 60GB of hard drive space (even with Windows loaded in a separate partition for use with Boot Camp). You're likely

to find that you still have plenty of elbow room for a typical family's needs on your hard drive unless you're heavily into

- ✓ Digital video (DV)
- ✓ Cutting-edge video games
- ✓ Tons of digital audio



If you're running short on hard drive space, consider cleaning up your existing hard drive by deleting all the accumulated crud you don't need, such as

- ✓ Game and application demos
- ✓ Duplicate or work copies of images and documents
- ✓ Archived files you've downloaded from the Internet
- ✓ The contents of your trash

## *Consider your external options*

If you do need additional hard drive space, I recommend using an external drive. Use a high-speed FireWire or USB port to connect a second hard drive the quick and easy way.

Most of today's FireWire and USB peripherals don't even require the driver software that Mac old-timers remember with such hatred. You simply plug in a FireWire or USB device, and it works. You can move your external drive between different Macs with a minimum of fuss and bother.

An external hard drive can do anything that your internal hard drive can do. You can boot from it, for example, or install a different version of Mac OS X (great for beta testers like me).

Note this one downside to using external drives: Data transfers more slowly this way than using an internal drive. That's why most Mac owners use their external drives for storing little-used documents and applications.



### *Putting a port to work*

Mac laptops carry three kinds of high-speed ports. These are similar in performance and operation. Any one of them is a good match for connecting any external device.

- ✓ **USB 2.0:** The USB standard is popular because it's just as common in the PC world as in the Mac world. (Most PCs don't have a FireWire port.) Your laptop carries its USB 2.0 ports on the side of the case. Some hardware manufacturers make one USB device that works on both types of computers.





I heartily recommend that you avoid using any USB 1.1 devices (except, perhaps, a USB 1.1 keyboard or mouse). USB 1.1 is very slow compared with the USB 2.0 standard (although you can connect a USB 1.1 device to a USB 2.0 port with no problem). You should buy only USB 2.0 external hard drives, CD/DVD recorders, or Flash drives. 'Nuff said.

- ✓ **FireWire 400:** FireWire (also called *IEEE 1394*) is the port of choice for most digital video camcorders. I recommend that you use your FireWire port for connecting an external drive to your laptop — again, you can find this port on the side of your MacBook or MacBook Pro.
- ✓ **FireWire 800:** When the good folks at Apple recognized that USB 2.0 devices were as fast as FireWire 400 devices, they got the devious idea to up the ante (and Mac owners reap the rewards). The new FireWire 800 port is indeed twice as fast as FireWire 400, and it is — *hands down* — the fastest external connection you can make to your laptop.

At the time of this writing, only the 17-inch MacBook Pro came equipped with FireWire 800. If you have one, use it with a FireWire 800 hard drive, and you will *never* be sorry. Unfortunately, FireWire 800 ports are not backwards-compatible with FireWire 400 ports. Luckily, however, the 17-inch MacBook Pro sports one of each type.

### ***Connecting an external drive***

With FireWire or USB, you can install an external hard drive without opening your Mac's case:



- 1. Connect the FireWire or USB cable betwixt the drive and your computer.**
- 2. Plug the external drive into a convenient surge protector or UPS (Uninterruptible Power Supply).**
- 3. Switch on the external drive.**
- 4. If the drive is unformatted, partition and format the external drive.**

The drive comes with instructions or software for you to do this.

The drive immediately appears on the desktop.

## ***Gotta have internal***

If you decide that you have to upgrade your existing internal hard drive — or if your internal drive fails and needs to be replaced — I strongly recommend that you take your Mac laptop to an authorized Apple service center and allow the techs there to sell you a drive and make the swap. Here are three darned good reasons why:

- ✔ **Selection:** If you're worried about choosing the proper drive, your friendly neighborhood Apple technician can order the right type and size of drive for you.
- ✔ **Difficulty:** Swapping a hard drive in your Mac laptop isn't anywhere as easy as adding RAM modules (although the hard drive is much easier to reach on the MacBook than it is on the MacBook Pro).
- ✔ **Backup:** That very same Apple service technician can back up all the data on your existing drive, format the new drive, and move all your data to its new mansion, so you won't lose a single document. That will save you time and possible angst.

If you're an experienced and confident techno-soul, you can find a PDF file detailing how you can remove your MacBook's internal hard drive. Go to the Support section of the Apple Web site ([www.apple.com/support/macbook](http://www.apple.com/support/macbook)).



Make certain that you have a complete and up-to-date backup of your data before you remove your existing hard drive! Otherwise, you're walking into a field of land mines without a map.

## *A List of Dreamy Laptop Add-Ons*

The USB and FireWire toys in this section might add a cord to your collection at the side of your Mac, but they're well worth the investment, and they can revolutionize how you look at technologies such as television, digital audio, and computer gaming.

### *Game controllers*

If you're ready to take a shot at the enemy — whether they be Nazi soldiers, chittering aliens, or the latest jet fighters — you'll likely find your keyboard and mouse somewhat lacking. (And if that enemy happens to be a friend of yours playing across the Internet, you'll be ruthlessly mocked while you're fumbling for the right key combination.) Instead, either

- ✔ Pick up a USB joystick or gamepad
- ✔ Invest in a whiz-bang game controller such as the Belkin Nostromo n50 SpeedPad (\$30 from [www.belkin.com](http://www.belkin.com)), which incorporates a minikeyboard and gamepad



You can configure the keys on the Nostromo for each game you play!

## *Video controllers*

For armchair directors, specialized USB digital video controllers make editing easier. For example, the ShuttleXpress from Contour Design ([www.contourdesign.com](http://www.contourdesign.com)) provides a five-button jog control that can be configured to match any DV editor. For \$60, you'll have the same type of editing controller as dedicated video editing stations costing several thousand dollars.

## *TV hardware*

To watch (and record) the incoming signal from the satellite or cable feed on your laptop, use the EyeTV digital video recorder from Elgato Systems ([www.elgato.com](http://www.elgato.com)) and avoid shelling out for a TiVo. The units include a 124-channel TV tuner and a built-in MPEG encoder, so you can pause live TV and schedule recording times. EyeTV has a couple of products for your Mac:

- ✓ EyeTV EZ USB (\$149)
- ✓ EyeTV 500 (\$349)

The more expensive model uses a FireWire connection and a better MPEG encoder so you can capture DVD-quality video.

## *Audio hardware*

Ready to put GarageBand to the test with your favorite version of “Chopsticks”? You'll need a USB keyboard. Consider the eKeys 37 from M-Audio ([www.m-audio.com](http://www.m-audio.com)), which retails for a mere \$60. It provides 37 keys and uses a USB connection.

Another neat audio favorite of mine is the USB-powered radioSHARK from Griffin Technology ([www.griffintech.com](http://www.griffintech.com)), which allows you to add AM/FM radio to your Mac, complete with recording capability, a pause feature, and scheduled recording, all for \$70.

## *DVD recording*

If you crave today's hottest DVD recording technology, look no further than LaCie's Slim 8X DVD-RW/±RW dual-layer/dual-format DVD recorder! This USB 2.0 jewel can burn 8.5GB of data onto a single disc and ships complete with Roxio's Toast recording application. Read all the details at the LaCie site at [www.lacie.com](http://www.lacie.com), where you can pick one up for about \$200.

## Chapter 21

# Tackling Housekeeping

---

### *In This Chapter*

- ▶ Cleaning unnecessary stuff off your hard drive
  - ▶ Backing up your data
  - ▶ Correcting disk and permission errors
  - ▶ Automating tasks in Tiger
  - ▶ Updating Mac OS X automatically
- 

**N**othing runs better than a well-oiled machine — and Tiger is no exception. With a little maintenance, you can ensure that your laptop is performing as efficiently as possible.

In this chapter, I demonstrate how you can make good use of every byte of storage space provided by your hard drive, and how to back up and restore that hard drive to an external drive or a DVD. Your hard drive also benefits from a periodic scan for permission errors.

Tiger's new Automator application is a great housekeeping tool — it allows your Mac to perform tasks automatically that used to require your attention. I show you how you can create Automator applications and set them up to run by themselves. (It sounds a little spooky, but you'll have a ball!)

And it's important to never forget about updating Mac OS X itself. But then again, if you configure Software Update to run automatically, you can live life free and easy, watching your favorite soaps and eating ice cream (or frozen yogurt — your choice).

## *Cleaning Unseemly Data Deposits*

*Criminy!* Where does all this stuff *come* from? Suddenly that spacious 80GB hard drive has 3GB left, and you start feeling pinched.

Before you consider buying a new external hard drive or upgrading your internal hard drive, take the smart step: Sweep your hard drive clean of unnecessary and space-hogging software.

## *Getting dirty, or cleaning things the manual way*

If you're willing to dig into your data a little, there's no reason to buy additional software to help you clean up your hard drive. All you need is the willpower to announce, "I simply don't need this application any longer." (Sometimes, that's tougher than it may seem.)

### *Unnecessary files and unneeded folders*

Consider all the stuff that you probably don't really need:

- ✓ Game demos and shareware that you no longer play
- ✓ Movie trailers and other QuickTime video files that have long since passed into obscurity
- ✓ Temporary files that you created and promptly forgot
- ✓ Log files that chronicle application installations and errors
- ✓ Stuffit archives that you downloaded and no longer covet
- ✓ iTunes music that no longer appeals to your ear

How hard is it to clean this stuff off your drive? Easier than you might think!

- ✓ Files are easily deleted.
- ✓ You can get rid of the lion's share of any application (often the entire application) by deleting its application folder created during the installation process.

Removing an application or file from your hard drive usually requires two simple steps:

- 1. Display the file or application folder in a Finder window.**
- 2. Delete the file or folder using one of these methods:**
  - Drag the icon to the trash.
  - Press ⌘+Delete.
  - Select the icon and click the Delete button on the Finder toolbar (if you've added one).

Truly, no big whoop.



Mac owners like you and I can once again feel superior to the XP Zombies because most Mac OS X applications don't need a separate, silly uninstall program. In fact, Macintosh software developers have always followed a simple general rule: All (or virtually all) of an application's support data should reside in a single folder.



Don't forget to actually *empty* the trash, or you'll wonder why you aren't regaining any hard drive space. (Tiger works hard to store the contents of the trash until you manually delete it, just in case you want to undelete something.) To get rid of that stuff permanently and reclaim the space:

1. **Click the Trash icon on the dock and hold the mouse button down until the pop-up menu appears.**
2. **Choose Empty Trash.**

### *Associated files in other folders*

Some applications install files in different locations across your hard drive. (Applications in this category include Microsoft Office and Photoshop.) How can you clear out these "orphan" files after you delete the application folder?

The process is a little more involved than deleting a single folder:

1. **In a Finder window, click the Search text box and type the name of the application.**

Figure 21-1 shows this search. I want to remove Corel Painter, so I've searched for

- Every file that has the word *Painter* in its name
- Every HTML and PDF document that contains the word *Painter*

2. **Decide which of these files belong to the to-be-deleted application.**

Be sure that the files you choose to delete are part of the deleted application. For example, a text file with the name *Michelangelo, That Famous Painter* might not be part of Corel Painter.

Many associated files either

- Have the same icon as the parent application
- Are in the Preferences, Caches, or Application Support folders

3. **In the Search Results window, click the associated file(s) that you want to delete and drag them to the trash.**

Don't empty the trash immediately after you delete these files. Wait a few hours or a day. If you find that you've deleted a file you need, you can easily restore it from the trash.





**Figure 21-1:**  
Mining  
a hard  
drive for  
additional  
files to  
delete.

## Using a commercial cleanup tool

If you'd rather use a commercial application to help you clean up your hard drive, a number of them are available — but most are shareware and perform only one task. For example, TidyUp! from Hyperbolic Software ([www.hyperbolicsoftware.com](http://www.hyperbolicsoftware.com)) finds duplicate files and folders on your hard drive, matching by criteria such as filename, size, and extension. It's a good tool at \$30.

For a comprehensive cleanup utility, I recommend Spring Cleaning from Allume Systems ([www.allume.com](http://www.allume.com)) — the same folks who produce the archiving utility Stuffit. Spring Cleaning sells for \$50. Not much crud squeaks by all those search routines, including duplicates, orphan preference files, and log files. Spring Cleaning even includes a separate feature called MacUninstaller that can help automate the steps that I cover in the preceding section.

## Backing Up Your Treasure

I'm not going to lecture you about backing up your hard drive . . . well, perhaps just for a moment. Imagine what it feels like to lose *everything* — names, numbers, letters, reports, presentations, saved games, and all your photographs and music. Then ask yourself, “Self, isn't all that irreplaceable stuff worth just a few hours every month?”



Time for a Mark's Maxim:

*Back up.* On a regular basis. Then store those DVDs or that external backup device somewhere safe, away from calamities. Take my word for it — you will thank me some day!

You can back up your files either by saving them or by creating a backup image. I describe both methods in this section.

## *Saving files*

The simplest method of backing up files is simply to copy the files and folders to an external hard drive or a CD or DVD. Nothing fancy, but it works.

### *External hard drive*

If you have an external hard drive connected to your laptop, you can drag files to it from the internal hard drive:

- 1. Open separate Finder windows for**
  - The external hard drive
  - The internal hard drive
- 2. Select the desired files you want to back up from your internal drive.**
- 3. Drag the selected files to the external drive window.**



Chapter 20 covers external hard drives.

### *Recordable CDs and DVDs*

You can burn backup files to a recordable CD or DVD. To use the Finder's Burn feature with a CD or DVD, follow these steps:

- 1. Load a blank disc into your laptop's optical drive.**

If you're using the default settings in the CDs & DVDs pane in System Preferences, a dialog box appears, asking for a disc name.
- 2. Drag the files and folders that you want to back up into the disc's Finder window.**

They can be organized any way you like.
- 3. Choose File⇧Burn Disc from the menu.**
- 4. Choose the fastest recording speed possible.**
- 5. Click Burn.**



If you've invested in Toast Titanium from Roxio ([www.roxio.com](http://www.roxio.com)) or another CD/DVD recording application, you can create a new disc layout to burn your backup disc.



You can save that disc layout and use it again. This simplifies the process of backing up the same files in the future (if you don't move folders or files from their current spot).

## *Saving images*

Tiger's Disk Utility can create a basic backup on a disk image. You won't have to buy a commercial backup application.



Disk Utility doesn't have cool scheduling features or automatic restores, so you have to select and drag stuff manually. If you want features like automatic scheduling or support for multiple backup sets, you need a commercial backup utility such as Retrospect Backup.

### *Creating backups*

A backup image is a single file that contains multiple files and folders — rather like a StuffIt archive but easily mounted or restored on any Mac running Tiger.

The image can be created on

- ✓ A CD, a DVD, an external hard drive, or even your iPod
- ✓ Your Mac's built-in hard drive



If you back up on the built-in hard drive, you'll lose *both* your live files and your backup if something happens to that hard drive. Rather unwise, if you think about it.

Follow these steps to create the image on your internal hard drive:

- 1. Open a Finder window, click Applications, and then click Utilities.**
- 2. Double-click the Disk Utility icon.**

The Disk Utility window appears.

- 3. Choose File⇧New.**

The Image Type options pop-up menu appears.

- 4. Select the desired image type from the pop-up menu:**

- **If you're backing up several folders or an entire volume, choose *Blank Image* from the pop-up menu.** The New Blank Image dialog box appears, as shown in Figure 21-2.

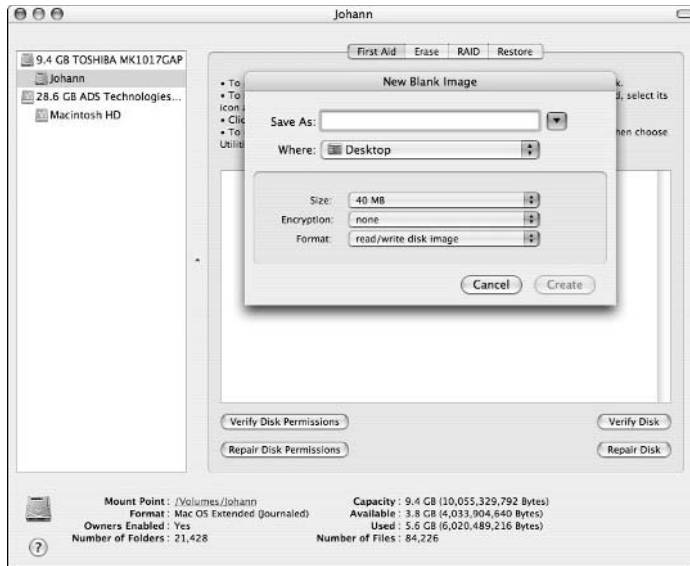

**Figure 21-2:**  
Preparing a  
blank image  
file as a  
simple  
backup.

- **If you're backing up only the contents of a single folder, choose *Image from Folder*.** With this option, you won't have to drag things. Disk Utility simply copies everything in the folder that you select — whether all your crown jewels are in a single folder, or whether you've copied everything that you want to back up into a single folder.



This is a neat way of backing up MP3 files in your iTunes folder.

**5. Enter the necessary information on the New Blank Image dialog box:**

- Type a name for the image in the Save As box.**
- Choose a location from the Where pop-up menu.**
- Choose a size for the image file.**

I recommend that you select a size at least 10MB larger than the total size of the files that you want to back up. (That way, you won't run out of space when you realize that you didn't include your digital photographs of downtown Fresno.) To do this, select the file(s) or volume that you're going to back up and press **⌘+I** to display the Get Info dialog box, which lists the total size for the selected items.



You can choose sizes that match the capacity of either a CD (660MB) or a DVD (4.7GB).

- Choose whether or not you want the image to be encrypted for security.** I like to leave a backup image unencrypted, so I don't have to remember a password.



If you encrypt an image and you forget the password, you cannot recover that data!

6. **Set Format to Read/Write Disk Image.**
7. **Click the Create button.**

The Disk Utility displays a progress bar to indicate how long the process will take.

8. **Open two windows to drag and drop files:**
  - a. **Open a Finder window and navigate to the desired location.**
  - b. **Double-click the Image icon on your desktop.**

The disk image displays its blank vista in a separate window.

9. **In the Finder window, select the files and folders that you want to copy.**
10. **Drag the selected files and folders from the Finder window to the image window.**



An image file operates just like any other hard drive or optical drive on your laptop. You can eject it by dragging the icon to the trash or by selecting it and pressing  $\text{⌘}+\text{E}$ . However, if you log off, turn off your Mac, or restart your Mac, the image icon disappears — you'll have to navigate to the location where you stored it and double-click the image file to mount it on your desktop again.

### *Restoring from a backup*

If you have to use your backup, you can use Disk Utility's Restore feature. Follow these steps:

1. **Mount the disk image by double-clicking the image icon in a Finder window.**

The disk image icon appears on your desktop.
2. **Launch the Disk Utility by double-clicking its icon in the Utilities folder.**
3. **Click the backup image icon at the left side of the window, and then click the Restore button (see Figure 21-3).**
4. **Drag the image icon to the Source box.**
5. **Drag the destination disk to the Destination box.**

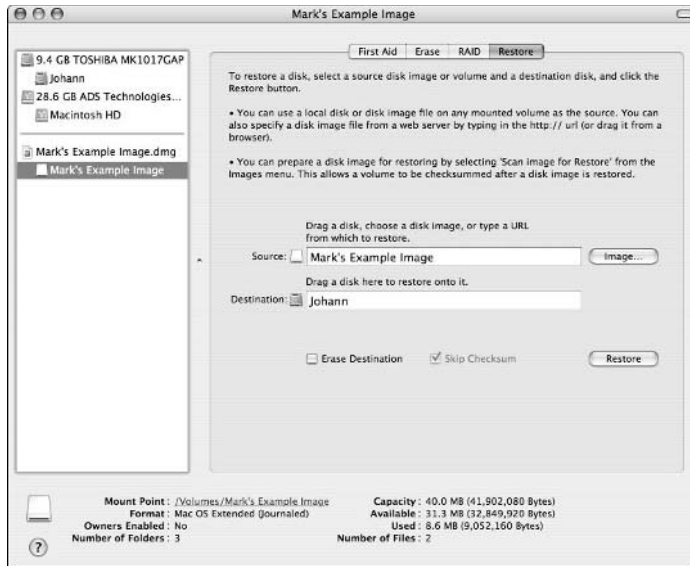

**Figure 21-3:**  
Restoring  
files from an  
image —  
good  
thinking on  
your part!

**6. Make doggone sure that the Erase Destination check box is disabled (clear)!**

The only time to use Erase Destination is when you're restoring your data onto an empty, formatted drive. And that's not today.

**7. Click Restore.**



## Commercial backup programs

If you prefer your backups to be automated on a regular schedule and you'd be happier with all the bells and whistles of a commercial application, you can choose from scads of backup applications on the shelves at your local Software Hut. These applications make it much easier to back up your entire drive in one fell swoop, without dragging or any manual labor.



My favorite backup application has always been Dantz Retrospect ([www.dantz.com](http://www.dantz.com)), as shown in Figure 21-4, which sells for the princely sum of \$129. The application can back up to tape drives, external hard drives, CDs and DVDs, and even a host FTP server over the Internet.

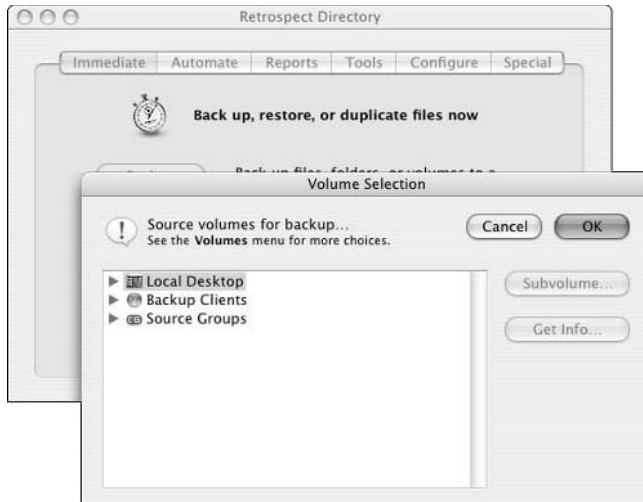

**Figure 21-4:**  
Dantz  
Retrospect,  
hard at work  
ensuring my  
peace of  
mind.

## Maintaining Hard Drive Health

Shifty-eyed, sneaky, irritating little problems can bother your hard drive: *permissions errors*. Incorrect disk and file permissions can

- ✓ Make your Mac lock up
- ✓ Make applications act screwy or refuse to run at all
- ✓ Cause weird behavior in a Finder window or System Preferences

### What causes permission errors?

Permission errors are usually introduced on your system when a faulty installer makes a mistake copying files to your system. Sometimes, the application itself has a bug that produces errors when it tries to open or close files or use Mac OS X system functions. Fortunately, you don't have to investigate what causes a permission error. (That's good because you and I aren't likely to understand such techno-gibberish, anyway.) You just need to know that Disk Utility fixes the errors.

Here's a little-known fact about Mac OS X: Your startup disk is automatically checked for most errors every time you start (or restart) your laptop. Therefore, you don't have to worry about hard drive errors "creeping up" over time, like they do under Windows. Each time you start your Mac, it's like you're running Disk Utility's Repair Disk feature automatically.

Didn't I *tell* you this operating system was the best on planet Earth?

To keep Tiger running at its best, I recommend that you fix permissions errors at least once a week. To do so, follow these steps:

1. **Open a Finder window, click Applications, and then click Utilities.**
2. **Double-click the Disk Utility icon.**
3. **Click the volume in the left column that you want to check.**
4. **Click the Repair Disk Permissions button.**

Disk Utility does the rest, and then displays a message about whatever it has to fix. (When will someone invent a *car* with a Repair Me button?)

## *Automating Those Mundane Chores*

One new feature in Tiger — Automator — has generated a lot of excitement. Automator can create applications with a compiled form of AppleScript. That might sound daunting — akin to building your own nuclear submarine single-handedly over a long weekend — but Automator is actually easy to use. Heck, you might find it downright *fun!*

### *Building Automator applications*

Automator applications are built by using a drag-and-drop approach. If you're familiar with how iMovie works, you'll feel right at home here; the tasks that you arrange in the Automator window run sequentially, just like the video clips that you drag into an iMovie window.

You can create a simple Automator application with these steps:

1. **Open the Finder menu.**
2. **Press ⌘+N to open a new Finder window.**
3. **Click the Applications folder in the Finder window sidebar (housed on the left side of the window).**
4. **Double-click the Automator icon.**

The Automator window appears, as shown in Figure 21-5.

5. **In the Library column, click the Tiger application that you want automated.**

A list of actions appears that you can perform with that application.

**Figure 21-5:**  
The Automator window qualifies as user-friendly.

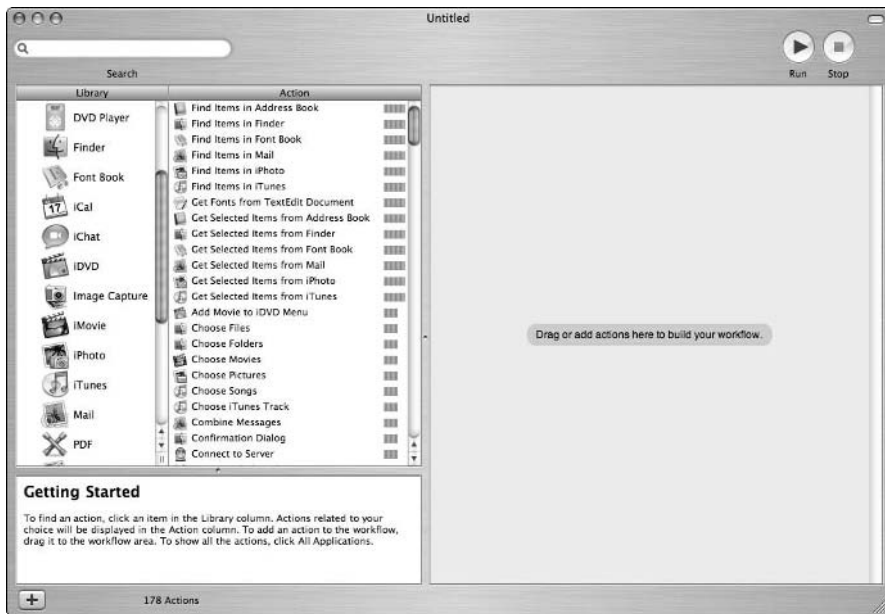

**6. Drag the desired action into the Workflow area (right side).**

If the action that you selected can be modified with any criteria, you can change the settings to your heart's content.

**7. Click Run to test your script.**

Figure 21-6 illustrates a script that I designed. It automatically downloads new photos from my digital camera, creates a new iPhoto album with those images, and then displays them and allows me to mark them as Approved or Rejected, with an option to delete them. Pretty slick stuff for ten minutes' worth of work and testing, wouldn't you say? (I call it *Mark's Photo Processor* . . . which I'm sure will make me a millionaire someday!)

**8. If the script runs properly, press ⌘+Shift+S to save your application.**

Automator displays a Save As dialog box.



If the script croaks or doesn't work quite the way you intended, you can remove and rearrange actions to your heart's content. (To remove an action, click the X button in the upper right of the action block.) You might also consider tweaking the action-specific settings or using the Ask When Run option to make sure that an action gets the right input.

**9. Type a name for your new program.**

**10. Click File Format and then choose Application.**

**11. Click Save.**

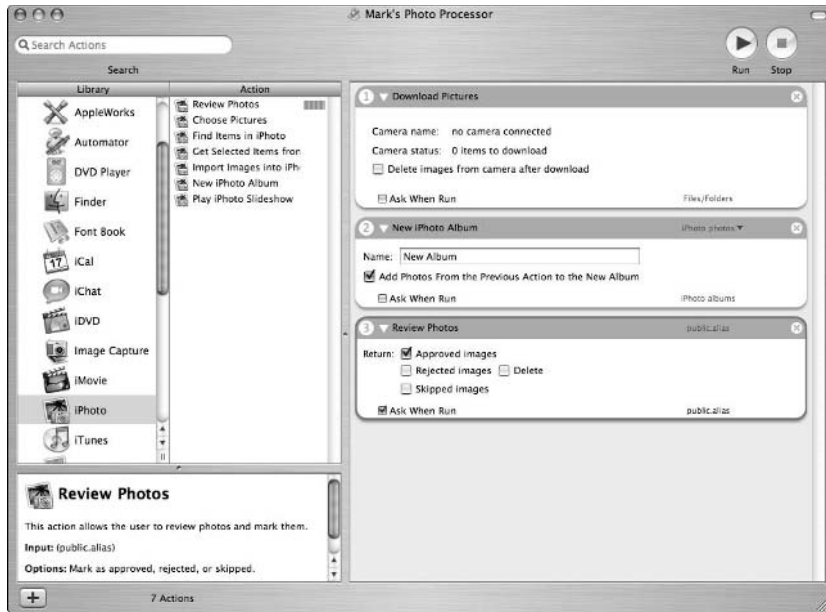

**Figure 21-6:**  
Hey, I'm a  
software  
developer!  
When do I  
get my  
Ferrari?



You can build an Automator application that uses values that you type (a software developer calls it your *input*) each time you run it. To set your application for manual input, select the Ask When Run check box. This allows your application to prompt you with a dialog box requesting the necessary values (such as an iTunes playlist or a specific folder on your hard drive).

## *Running applications at startup*

If your Automator application should run every time you log in, follow these steps to set it up as a login item:

1. **Open System Preferences.**
2. **Display the Accounts pane.**
3. **Click the Login Items button.**
4. **Click the plus button at the bottom of the list.**
5. **Navigate to the location of your new Automator application.**
6. **Click Add.**



Now your Automator application is *really* automatic. Watch your significant other gape in amazement as your MacBook Pro begins to work without your touching the keyboard!



Many third-party applications have their own Automator actions after installation. Check the developer's Web site often to see whether additional Automator applications have been added that you can download.

## Updating Mac OS X Automatically

I prefer my laptop to take care of cleaning up after itself, so updating Tiger should be automatic as well. In Mac OS X Tiger, operating system updates are performed by the Software Update application.



Software Update uses the Internet, so you need an Internet connection to shake hands with the Apple server and download any updates.

Software Update can be found in two convenient spots:

- ✓ **Apple menu:** Click the Apple menu (🍏) and then click Software Update, which displays the Update dialog box and alerts you to anything new that's available.
- ✓ **System Preferences:** Click the Software Update icon to display the Software Update pane. If you take the System Preferences route, you can set Software Update to check for updates automatically:
  - a. **Mark the Check for Updates check box to enable it.**
  - b. **Choose the time period from the Check for Updates pop-up menu.**



Software Update covers every Apple application, so I usually check once a day just to make sure that I don't miss anything.

If something needs to be updated, the program alerts you, either automatically downloading the update(s) or displaying a dialog box letting you know what you can patch (depending on the settings you choose in the System Preferences Software Update pane).

You can even check for updates immediately from System Preferences. That, dear reader, is just plain thoughtful design.

# Part VII

# The Part of Tens

The 5<sup>th</sup> Wave

By Rich Tennant



### *In this part . . .*

**A**h, what book in the *For Dummies* series is truly complete without the Part of Tens? Here you'll find lots of this author's raw opinion: my best tips for Mac laptop road warriors, as well as my infamous "Top Ten Things to Avoid Like the Plague."

## Chapter 22

# Top Ten Laptop Rules to Follow

---

### *In This Chapter*

- ▶ Protect your laptop while you're in transit
  - ▶ Pack that Mac with RAM
  - ▶ Track your Mac with a hidden beacon
  - ▶ Encrypt your Mac's Home folder
  - ▶ Engrave or tag your laptop
  - ▶ Save energy by disabling wireless hardware
  - ▶ Use a surge protector
  - ▶ Control your power setting
  - ▶ Use external input devices with your laptop
  - ▶ Back up your laptop
- 

**A**h, the sedentary life of a desktop Mac — it sits there, like a bump on a log, comfortable and immobile. As long as you have a stable surface and an uninterrupted power supply, your iMac, Mac Mini, or Power Mac is a happy puppy.

But you, good reader, are *mobile!* Whether you're on campus or attending a convention, your Mac laptop is rarely running in the same spot, so it's susceptible to all sorts of road warrior pitfalls. In this chapter, I remind you of ten of the most important rules that every laptop owner should follow to prevent chaos and carnage while traveling.

## *Keep Your Laptop in a Bag*

Sure, using a laptop case or bag *sounds* like common sense — but Mac laptops are so doggone sexy that you'd be surprised how many people carry them around without any protection at all. These Mac owners hear phrases

like “rugged titanium” and “Sudden Motion Sensor hard drive protection” and figure that their laptop can tackle a construction site, a college campus, or a hotel room with impunity.

Part of that is indeed true. Mac laptops are some of the toughest laptops ever made, but they’re not immune to bumps, scratches, and the (I hope) rare fall. But if you carry your Mac from place to place without any protection, it’ll soon look like a boxer after a bad fight.

If you’re like me, you’re proud that your computers remain in pristine condition, so use a laptop bag or case that offers ample padding and a convenient shoulder strap or carry handle. (My laptop bag even converts to a backpack, and it includes plenty of extra space for power supplies, discs, and all the assorted hoo-hah that you know you need to carry with you.) Spend an extra \$30 on a laptop bag, and your \$1000 computer can weather the worst the world will dish out.

Some folks think that a laptop bag draws too much attention. If you’re a member of this group, consider a *well-padded* laptop sleeve that will allow you to carry your Mac in your backpack or briefcase. Remember, though, that the padding is the important thing — without that extra cushion, you might as well just toss your unprotected laptop in with the rest of your books and must-have equipment.

## *Maximize Your RAM*

Like any other computer running Windows or Mac OS X, your laptop will benefit from all the system RAM you can squeeze into it. (Chapter 20 describes how to add memory and the benefits of extra RAM.) However, additional memory is even *more* effective with a laptop, because your Mac laptop’s internal hard drive runs more slowly than the corresponding internal hard drive in a full-size desktop Mac. Therefore, the virtual memory functionality built into Tiger (which I also describe in Chapter 20) will be even slower for your laptop, resulting in mediocre performance during memory-intensive tasks such as video and image editing.

With a full complement of RAM, your laptop’s performance will rival the performance of a desktop computer with the same processor — and you’ll be using it on the go!

## *Install a Tracker Application*

The unthinkable happens: your laptop is stolen while you're on vacation or on a business trip, and you know that the chances that it will be returned are next to nil. You've resigned yourself to replacing it (and all your data). But wait! What if I told you that you might just receive an e-mail message on your desktop computer that tells you the Internet IP address of the thief or perhaps even the telephone number he or she is using?

If this scenario sounds a little like a James Bond movie, you'll be surprised to learn that several *tracker applications* are available for Tiger that will run invisibly on your laptop. A tracker application turns your Mac into a transmitting beacon, advertising its current location and all the Internet information it can get to you — allowing you to alert police and apprehend the crook (who might be in the middle of creating an iPhoto library).

For example, XTool Computer Tracker from StealthSignal ([www.stealthsignal.com](http://www.stealthsignal.com)) sends a signal to the company's security center each time your laptop is connected to the Internet or a telephone line, as well as when the computer is rebooted or a user logs on. In fact, you can even delete files on your laptop remotely, even though you don't have physical control of your Mac! XTool Computer Tracker costs \$49 a year, which is pocket change for a corporate road warrior or design professional who depends on both the laptop and the irreplaceable data it contains.

## *Keepest Thy Home Folder Encrypted*

In Chapter 6, I discuss a number of System Preferences panes. The Security pane is particularly important to laptop users because it allows you to encrypt your Tiger Home folder. Encryption prevents just about anyone from accessing (or even *identifying*) any of the files you've stored in your Home folder. The robust encryption provided by Tiger will certainly stymie just about anyone but the NSA and FBI. (I won't even go there.)

In System Preferences, click Security, and then click Set Master Password to create a backup password that will unlock your Home folder, just in case. (Your login account password is your primary password.) Select Turn On FileVault, and Tiger takes care of automatically encrypting and unencrypting files as necessary.

Remember: To take full advantage of an encrypted Home folder, you need the proper login mode (as I discuss in Chapter 16). Think about this possible security backdoor: From the Accounts pane, you've set your laptop to automatically log you in every time you boot your Mac. This is the very definition of Not Secure, because your login account password automatically disables the FileVault encryption! Therefore, make sure that you actually have to log in to access your account; for the full scoop, see Chapter 16.

## *Brand Your MacBook*

Put your brand on your laptop! Whether it be with an engraving tool on the bottom of the machine (my personal favorite) or a permanent metal tag, your Mac deserves some sort of identifying information. After all, most of the people in the world are honest, and you may not need that tracking software I mentioned earlier. You may have left your laptop by accident, and someone would like to return it to you. (Don't forget to offer a reward!)

Some laptop owners will want to include their name and address and other contact information, while other road warriors may feel comfortable with just their name and e-mail address. Whatever you choose, branding your laptop is as important as backing it up.

## *Disable Your Wireless*

Funny how we don't think about it, but wireless communications take juice, and that power comes straight from your laptop's battery! Because your Mac laptop likely came with a built-in Airport or Airport Express card and built-in Bluetooth hardware, you're constantly broadcasting — sending and receiving, or at least *trying* to exchange data with others.

And therein lies the rub: If you're not *connected* to a wireless network or a Bluetooth device, you're wasting your precious battery power. That's why Tiger gives you the ability to turn off your wireless Ethernet and Bluetooth hardware to save energy. And when you're sitting in a crowded auditorium without access to an AC socket or a wireless network, the energy savings you reap when you disable your wireless hardware can be significant.

In fact, you may have to disable your wireless connectivity in situations where cell phones are not allowed, such as an airplane flight or in certain areas of a hospital. And, because I'm a security-conscious kind of guy, I always disable my wireless hardware whenever I'm not using it (even if I am in range of a wireless network). Call me overly careful, but none of my shared files have ever been sucked out of my MacBook without my permission!

---

To turn off your wireless Ethernet from the Tiger Finder menu, click the Airport status icon and choose Turn Airport On/Off from the menu. To turn off your Bluetooth hardware from the Finder menu, click the Bluetooth icon and choose Bluetooth Off.

## *Bring a Surge Protector with You*

I'll be honest: I usually am not a huge supporter of surge protectors because I think they do only half the job. That job is protecting both your hardware *and* your data . . . and, as you probably know, a surge protector doesn't provide backup power in case of a brownout or total loss of power like a UPS (Uninterruptible Power Supply) can.

A surge protector is adequate protection from a massive power spike like an overload or a lightning strike, but most of us will never see one of those in our computing lifetime. We will, however, be hit with sudden loss of power, and usually at exactly the wrong moment. (Think Great American Novel Takes a Nosedive.)

So why am I suggesting a surge protector for your laptop? Well, you simply can't drag a UPS unit with you wherever you go, because they're too doggone heavy and bulky. Therefore, you have to take what you can get, so bring your surge protector along for your hotel room or conference table. (Of course, when you're at home or your own office, I strongly recommend that you invest in a good UPS to protect your laptop.)

Oh, and don't forget that you may need several more AC sockets for external devices like a hard drive, projector, and portable printer; a surge protector can provide the extra power, even when your host can't.

## *Use Tiger's Power Saving Features*

Apple allows you considerable control over how fast your CPU will run — a real boon to power hungry laptop owners. In System Preferences, click Energy Saver to display the Settings For and Optimization list boxes.

If you're running your laptop while connected to an AC outlet, click the Settings For drop-down list box and click Power Adapter, and then click the Optimization list box and choose the Better Performance setting. This setting provides the best performance your laptop's processor can provide, but it will also use the most electricity. All your applications will run their fastest.



If your laptop is running on battery power and you need to conserve as much power as possible, click the Settings For drop-down list box and click Battery, then choose Better Battery Life from the Optimization list box. Now you're squeezing the maximum amount of computing time out of your remaining battery power. (Your laptop will also run much cooler.)

## *Use an External Keyboard and Mouse*

Does your laptop remain at your home, dorm room, or office for long periods of time? If so, I recommend that you invest in an external keyboard and an external mouse for two very good reasons:

- ✓ Adding external input devices will help lower the wear and tear on your laptop's keyboard and trackpad.
- ✓ External input devices are generally more comfortable and convenient to use than those offered by your Mac laptop, especially for gaming.

If price is no obstacle, a wireless keyboard and mouse will allow you far more freedom of movement — but a standard USB keyboard and mouse will do just as fine a job and will cost considerably less.

In fact, you can have two external keyboards if you like: one to work with your laptop while you're running Tiger (which will have all the keys unique to an Apple keyboard) and one to use when you're running Windows (with those gnarly Windows-specific keys). *Techno-suave*.

## *Not Again! What Is It with You and Backing Up?*

Yes, it's one of the Top Ten Laptop Rules as well. I'm not kidding: If you think you don't need to back up on a regular basis, **you will eventually lose every byte of data you have**. Period. It's only a matter of time. Even if you have incredible luck and don't do something you regret with a Finder window, your Mac is just a machine, and it will wear out in the long run. That's why hard drive manufacturers list MTBF figures for their hard drives — MTBF stands for Mean Time Between *Failures*.

Backing up your hard drive isn't difficult and doesn't take long. Chapter 21 explains everything you need to know. When you've finished your first full backup, drop me a line at [mark@mlcbooks.com](mailto:mark@mlcbooks.com) with the title, "I've Got Laptop Peace of Mind!" We can celebrate together.

## Chapter 23

# Top Ten Things to Avoid like the Plague

---

### *In This Chapter*

- ▶ Dodging USB 1.1 storage devices
  - ▶ Shunning e-mail and Web phishing expeditions
  - ▶ Skirting those strange-sized discs
  - ▶ Keeping liquids at arm's length
  - ▶ Banishing outdated disk utilities
  - ▶ Eschewing pirated software
  - ▶ Steering clear of the root/System Administrator account
  - ▶ Sidestepping unsecured public wireless networks
  - ▶ Spurning refurbished hardware
  - ▶ Expelling dust and dirt
- 

**I**f you've read other books that I've written in the *For Dummies* series, you might recognize the title of this chapter — it's a favorite Part of Tens subject of mine. I don't like to see any computer owner fall prey to pitfalls. Some are minor, such as not keeping your laptop clean, while others are downright catastrophic, such as providing valuable information to persons unknown over the Internet. All these potential mistakes, however, share one thing in common: They're *easy to prevent* with a little common sense, as long as you're aware of them. That's my job — in this chapter, I fill in what you need to know. Consider these pages as experience gained easily!

## ***USB 1.1 Storage Devices***

Man, that is the definition of sluggish. Let's see, what could I be talking about? Oh, yes . . . only a USB 1.1 external device such as a hard drive or CD-ROM drive could be as slow as a turtle on narcotics. Unfortunately, you still find countless examples of USB 1.1 storage hardware hanging around. eBay is stuffed to the gills with USB 1.1 hard drives, and your family and

friends will certainly want to bestow that old 4x CD-RW drive to you as a gift. (This is one that you should politely refuse immediately, just like your Aunt Harriet's fruitcake.) These drives were considered cool in the early days of the colorful iMac G3, when USB was a new technology. Today, a USB 1.1 hard drive is simply a slow-as-maple-syrup-in-January *embarrassment*.

I do admit that plenty of great USB 1.1 devices are still around these days, such as joysticks, keyboards, mice, and other controllers, along with printers and scanners that work just fine with slower transfer rates. However, if a peripheral's job is to store or move data *quickly* — including hard drives, network connections, CD-ROM drives, and USB Flash drives — give a USB 1.1 connection a wide berth, opting instead for a USB 2.0 or FireWire device.

## Phishing

Phishing is no phun. No, that's not a misspelling. In Internet lingo, *phishing* refers to an attempt by unsavory characters to illegally obtain your personal information. If that sounds like an invitation to identity theft, it is — and thousands of sites have defrauded individuals like you and me (along with banks and credit card companies) out of billions of dollars.

A phishing scam works like this: You get an e-mail purporting to be from a major company or business, such as eBay, a government agency, or a major credit card company. The message warns you that you have to update your login or financial information to keep it current, or that you have to validate your information every so often — and even provides you with a convenient link to an official-looking Web page. After you enter your oh-so-personal information on that bogus page, it's piped directly to the bad guys, and they're off to the races.



No *legitimate* company or agency will solicit your personal information through an e-mail message!



**Never respond to these messages.** If you smell something phishy, open your Web browser and visit the company's site (the *real* one) directly. Then contact the company's customer support department. They'll certainly want to know about the phishing expedition, and you can help by providing them with the e-mail and Web addresses used in the scam.

In fact, sending any valuable financial information through unencrypted e-mail — even to those whom you know and trust — is a bad idea. E-mail messages can be intercepted or read from any e-mail server that stores your messages.

## Oddly Shaped Optical Discs

Your Mac laptop's optical drive is a marvel of precision — and it's doggone svelte to boot. All of Apple's current laptop models feature the latest optical drives, which don't require silly trays. Just slide your CD or DVD disc inside the drive, and it smoothly disappears from sight. Press the Eject key, or drag the disc icon on your desktop to the trash, and the disc appears like magic. No need to give the loading and ejecting procedures a second thought, right? Well, good reader, that's true *only* if you're loading a standard size 1.2mm thick, 120mm *round* CD or DVD disc into your drive! Notice that I didn't say:

- ✔ **An 80mm mini-disc:** Yes, they're cute. Yes, they're used by all sorts of devices these days, from DV camcorders to digital cameras. And no, they're not supported by many slot-loading drives, so there's a good chance one will refuse to eject.
- ✔ **A credit-card or triangular-shaped disc:** Friends, these discs just aren't *natural!* Of course, that's part of their pizzazz for advertisers, who give them away in scads. A square disc will work in a tray-loading drive, but a slot drive will likely get indigestion and refuse to eject it.
- ✔ **A super-thick disc:** Sure, a tray DVD drive will likely be able to accept a disc with a thick printed paper label, but if that disc is more than 1.5mm thick, it can actually damage your laptop's slot-loading drive. Consider these words: "Marge, it's stuck in there!" Now imagine how you would feel if you were the one saying that.



All three of these oddly shaped discs share one thing in common: The damage you may cause by attempting to use one in your MacBook or MacBook Pro is not covered under your Apple warranty. A weighty statement indeed.

## Submerged Keyboards

Do you really want a submerged keyboard? Your answer should be an unequivocal "No!" — and that's why everyone should make it a rule to keep all beverages well out of range of keyboards, trackpads, and external devices such as speakers and mice. If a soda spill comes in contact with your Mac, you're likely to be visited with intermittent keyboard problems (or, in the worst-case scenario, a short in an external peripheral or your laptop's motherboard). Suffice it to say that 12 inches of open space can make the difference between a simple cleanup and an expensive replacement!

## Antiquated Utility Software

Mac OS 9 was (and still is) a great operating system for older Macs, but if you're using Mac OS X, you must turn in your older utility programs — such as an older copy of Symantec's Norton Utilities that supports only Mac OS 9. I know that you spent good money on 'em, but these older disk utility applications can do more damage than good to a hard drive under Mac OS X. Even utility software designed for earlier versions of Mac OS X, such as Panther and Jaguar, should be strictly avoided!

A number of things change when Apple makes the leap to a new version of Mac OS X, including subtle changes to disk formats, memory management in applications, and the support provided for different types of hard drives. By using an older utility application, you could find yourself with corrupted data. Sometimes a complete operating system reinstall is necessary. Now that you're using Mac OS X Tiger, make sure that you diagnose and repair disk and file errors using only a utility application specifically designed to run in Tiger, such as TechTool Pro from Micromat ([www.micromat.com](http://www.micromat.com)). Your laptop's hard drive will definitely thank you.

## Software Piracy

This one's a no-brainer: Don't endorse software piracy. Apple's overall market share among worldwide computer users currently weighs in at less than 10 percent. Software developers know this and have to expect (and *receive*) a return on their investment, or they're going to find something more lucrative to do with their time. As a shareware author, I can attest to this firsthand.

Pirated software seems attractive — the price is right, no doubt about it — but if you use an application without buying it, you're cheating the developer, who will eventually find Macintosh programming no longer worth the time and trouble. Believe me, a MacBook is a great machine, and Tiger is a great operating system, but the sexiest laptop and the best hardware won't make up for an absence of good applications. Pay for what you use, and everyone benefits.

## The Forbidden Account

You may never have encountered the *root*, or *System Administrator*, account in Mac OS X — and that's always A Good Thing. Note that I'm not talking about a standard Administrator (or Admin) account here. Every Mac needs at least one Admin account (in fact, it might be the only visible account on your computer), and any Standard user account can be toggled between Standard and Admin

status with no trouble at all. The root account, though, is a different beast altogether, and that's why it's disabled by default. All UNIX systems have a root account. Tiger is based on a UNIX foundation, so it has one too. Anyone logging in with the root account can do *anything* on your system, including deleting or modifying files in the System folder (which no other account can access). Believe me, deliberately formatting your hard drive is about the only thing worse than screwing up the files in your System folder.

Luckily, no one can access the root/System Administrator account by accident. In fact, you can't assign the root account through System Preferences at all; you have to use the NetInfo Manager application located in Utilities (in your Applications folder). Unless an Apple support technician tells you to enable and use it, you should promptly forget that the root account even exists.

## *Unsecured Wireless Connection*

Okay, I like free Internet access as much as the next technology author — it's cool, it's convenient, and public access wireless networks are popping up all over the world. Heck, New Orleans is currently installing citywide free wireless Internet access — perfect for checking your e-mail whilst you're catching beads or listening to jazz! More and more cities are certain to follow.

However, just because something's *free* doesn't mean that it's *safe*. Unfortunately, the free public wireless access you're likely to encounter is not secure: Anyone can join, and the information you send and receive can be intercepted by any hacker worthy of the name. A public network uses no WEP (Wired Equivalent Privacy) key, so no encryption is involved, and therefore no guarantee that your private e-mail, your company's financial spreadsheets, and your Great American Novel aren't being intercepted while you're uploading and downloading them in the airport.

If you *must* use your laptop on an unsecured public network, make sure that the connection itself is secure instead. For example, don't check your e-mail using a Web browser unless your ISP or e-mail service offers an encrypted SSL connection. (Yep, we're back to that little padlock that appears in Safari, which I discuss in Chapter 8. It's not just for ordering things online!) If you need to establish a secure connection with your home or office network, use an SSL-enabled Virtual Private Networking client, which allows you to transfer files and remotely operate a host computer with bulletproof security. (Visit [www.openvpn.net](http://www.openvpn.net) and download a free copy of OpenVPN for Mac OS X. You'll sleep better at night, road warrior.)

## Refurbished Hardware

Boy, do I hate refurbished stuff. I make it a point to dispel the myth that you're actually saving money when you buy a refurbished (or "remanufactured") piece of hardware. Think about what you get when you buy a refurbished external hard drive, for example. It's likely that the drive was returned as defective, of course, and was then sent back to the factory. There the manufacturer probably performed the most cursory of repairs (just enough to fix the known problem), perhaps tested the unit for a few seconds, and then packed it back up again. Legally, retailers can't resell the drive as a new item, so they have to cut the price so low that you're willing to take the chance.

Before you spend a dime on a bargain that's *remanufactured* — I can't get over that term — make sure that you find out how long a warranty you'll receive, if any. Consider that the hardware is likely to have crisscrossed the country at least once, and that it's likely to have picked up a few bumps and bruises during its travels. Also, you have no idea how well the repairs were tested or how thoroughly everything was inspected.

I don't buy refurbished computers or hardware, and most of the tales that I've heard of folks who do have ended badly. Take my advice and spend the extra cash on trouble-free, new hardware that has a full warranty.

## Dirty Laptops

Clean your machine. Every computer (and every piece of computer hardware) appreciates a weekly dusting. I know Mac owners who celebrate each passing year by opening up their machines to blow them clean of dust bunnies with a can of compressed air. (I'm one of them, as a matter of fact.) You'll find instructions on how to open your case in Chapter 20.



Adding memory to your laptop or perhaps a new AirPort Extreme wireless card to an older PowerBook or iBook? Seeing as how you have to open your Mac anyway, take advantage of the chance to use that trusty can of compressed air.

On the outside of your laptop, your screen should be cleaned at least once every two or three days. Never spray anything directly on your screen or your Mac's case. I highly recommend the premoistened LCD cleaning wipes typically used for notebook computers. Your laptop's case really doesn't need a special cleaning agent — in fact, you shouldn't use any solvents — but a thorough wipe with a soft cloth should keep your case in spotless shape.

# Index

---

## • A •

- AAC audio format, 156
- active window, determining, 71
- Activity Monitor, 78
- Address Book application, 23
- administrator accounts, 250–251, 261
- advanced hardware, defined, 44
- AIFF audio format, 156
- AirPort, AirPort Extreme, or AirPort Express base stations. *See also* wireless networks
  - adding card to your laptop, 17
  - broadcasting music using, 158
  - comparison of, 273–274
  - connecting network printers, 143
  - installing, 274
  - joining a wireless network, 275
  - PC-compatible cards with, 272
  - sharing a printer, 283
- albums (iPhoto), 177–179
- aliases, 61–63
- Allume Systems' Spring Cleaning, 326
- Alsoft's Disk Warrior, 302
- Apache Web server, 283–284
- Apple
  - networking products, 272–274
  - registering your laptop with, 32
  - Web-based support center, 48, 312
- Apple Lossless audio format, 156–157, 168
- Apple menu
  - Force Quit command, 60, 303
  - icon identifying, 42
  - Mac OS X Software command, 59
  - overview, 54–55
  - Recent Items, 59, 95
  - Software Update command, 59, 308, 336
  - System Preferences command, 59
- Apple Music Store, 154, 161, 169–171
- Apple remote, 14, 148–150
- application menu, 42
- applications. *See also specific applications*
  - Activity Monitor for, 78
    - adding to dock, 79
    - antiquated, avoiding, 348
    - Automator for, 333–336
    - cleanup utilities, 326
    - Close button, 60
    - frozen, forcing to quit, 60, 303
    - imported by Migration Assistant, 33
  - Internet tools, 22–23
  - launching, 58–59, 61
  - in .Mac service Software folder, 133
  - piracy, avoiding, 348
  - preference file corrupt, 308
  - printer software, 140–142
  - quitting, 59–60
  - scanner software, 144
  - shipped with laptops, 22–23
  - switching between using Exposé, 83–84
  - trackers, 341
  - troubleshooting utilities, 302
  - widgets, 82
  - Windows/Mac similarities, 46
- arrow keys, selecting using, 63
- aspect ratio for iDVD video, 217
- audio. *See also specific applications*
  - built-in speakers and microphone for, 14
  - connections for, 14, 16
  - editing in iMovie HD, 199
  - file formats supported by iTunes, 156–157
  - iChat using, 146
  - importing into iMovie HD, 198–199
  - sound effects for movies, 199
  - special keys for, 67
- Audio Mute key, 67
- auto login, 261, 262, 303
- Automator applications, 333–336



## • B •

### background

- changing for desktop, 77, 92
- changing for menu (iDVD), 221, 222–223

### backing up

- CDs and DVDs, 327–328
- commercial tools for, 331–332
- disk images for, 328–330
- external hard drive, 327
- installing Backup application, 136
- with .Mac service, 135–138
- manually, 136–137
- media for, 135–136
- need for, 302, 326–327, 344
- restoring from backup, 137, 330–331
- scheduling automatic backups, 138
- selecting files and folders for, 136–137

### Backup application, 135–138

### bags for laptops, 339–340

### battery

- calibrating, 30
- compartment for, 15
- conserving power, 30, 343–344
- Energy Saver preferences, 96–97
- monitoring and charging, 29

### Belkin

- Bluetooth adapter, 289
- Nostromo n50 SpeedPad, 321

### BFE (Bluetooth File Exchange) application, 290–291, 294–295

### bit rate for streaming radio, 161

### black-and-white photos, 184–185

### Blatand, Harald (Bluetooth), 288

### blogging feature (.Mac), 131

### Bluetooth

- adapter for, 289
- BFE application, 290–291, 294–295
- configuring connections, 289–290
- described, 17
- determining if supported, 289
- file exchanges and transfers, 290–291
- history of, 288
- iSync utility with, 294–296
- keyboard, 293–294
- menu, 293
- mouse, 293–294
- origin of name, 288
- printers, 296–297

### security settings, 292–293

### setting up new devices, 289

### System Preferences, 289–293

### transferring movies to devices, 208

### wireless devices versus, 293–294

### bookmarks (Safari), 115–116, 123

### Boot Camp utility, 24, 47

### boot disk, repair not possible for, 306

### Bove, Tony (*iPod & iTunes For Dummies*), 162

### branding your MacBook, 342

### brightness adjustment for photos, 185

### Brightness key, 67

## • C •

### cables

- checking, 309
- for Internet connection sharing, 270
- MacBook connections for, 20–21
- networking, 277
- set to have on hand, 25–26
- for USB printers, 84, 140
- wired versus wireless networks and, 269

### calibrating

- battery, 30
- LCD screen, 91

### camcorders. *See* DV camcorders

### cameras, digital, 176–177

### caring for your laptop, 21

### carpal tunnel syndrome, avoiding, 26

### cases for laptops, 339–340

### *CD & DVD Recording For Dummies* (Chambers), 17, 228

### CDs

- avoiding non-standard discs, 347
- backing up, 327–328
- as backup media, 136
- for copying files from a PC, 36
- displaying on desktop, 78
- importing images from, 176
- importing songs from, 168–169, 199
- loading, 14
- Media Eject key for, 13, 67, 304
- music, playing with iTunes, 161–162
- opening in Finder, 59
- optical drives for, 17
- recording with iTunes, 171–172

- stopping from launching when
  - loaded, 162
  - types of, 25
- Chambers, Mark
  - CD & DVD Recording For Dummies*, 17, 228
  - e-mail address, 56
  - Mac OS X Tiger All-in-One Desk Reference For Dummies*, 44, 280
  - MacBook For Dummies*, 1–7
  - MLC Books Online, 160
  - MLC Radio Online, 160
- charging your battery, 29
- Chess application, 23
- cleaning up your hard drive
  - associated files in other folders, 325–326
  - commercial tools for, 326
  - emptying the trash, 325
  - need for, 323
  - unnecessary files and folders, 324–325
- cleaning your laptop, 25, 350
- closed wireless networks, 275
- closing. *See* quitting or closing
- color depth, 91
- color profile, 91
- Command key, 68
- connecting cables
  - for Internet service, 20–21
  - for networking, 277
  - power cord, 20
  - for USB printers, 84, 140
- contextual menus, 57
- Contour Design's ShuttleXpress, 322
- contrast adjustment for photos, 185
- Control key, 68
- cooling pad, 18, 30
- copying items. *See also* importing
  - Duplicate command for, 66–67
  - iDisk mirror on local hard drive, 133–134
  - loops (GarageBand), 240
  - network advantages for, 268
  - overview, 65
- cordless connections. *See* Bluetooth
- CPU, 16, 97
- cropping photos (iPhoto), 183–184
- CRT versus LCD screen, 12
- **D** •
  - Dantz Retrospect backup utility, 331–332
  - Dashboard application, 82, 93–94
  - dead pixels, 29
  - Del key, 68
  - deleting. *See* removing or deleting
  - desktop. *See also* dock; Finder
    - changing background for, 77, 92
    - cluttered versus uncluttered, 76
    - displaying connected items on, 78
    - icons, 42, 77
    - launching applications from, 59
    - overview, 40–43
    - Windows/Mac similarities, 45
  - Detto Technologies' Move2Mac utility, 37, 46–47
  - DHCP (Dynamic Host Configuration Protocol), 271, 280
  - digital cameras, 176–177
  - disc image, saving iDVD project as, 224
  - discoverable Bluetooth port, 292
  - disk image backup, 328–330
  - Disk Utility
    - backing up with, 328–330
    - caveats for, 306
    - launching, 304
    - repairing hard disks with, 306–307
    - repairing permissions with, 305–306, 332–333
    - restoring from backup with, 330–331
    - window, 304–305
  - Disk Warrior (Alsoft), 302
  - displaying. *See also* finding; opening
    - connected items on desktop, 78
    - contextual or right-click menus, 57
    - dock, hiding and showing, 98
    - Home folder, 74–76
    - information for Spotlight items, 105
    - photo information in iPhoto, 178
    - pop-up menu for dock icons, 79–80
    - Preview application for, 81
    - previewing DVDs, 223–224
    - previewing movies, 201
    - toolbars (toggling on and off), 72
    - trash contents, 80

## dock

- adding icons to, 79
- checking running applications on, 78
- hiding and showing automatically, 98
- launching applications from, 58
- overview, 41–42, 55
- pop-up menu for icons, 79–80
- quitting applications from, 60
- removing icons from, 79
- System Preferences, 97–98

Documents folder, 33, 74

DOS operating system, 45

drivers for printer, installing, 84, 140–142

Drop Box folder, 263

duplicating. *See* copying items

## DV camcorders

- importing clips from, 195–196, 225
- Magic iDVD feature with, 226
- Magic iMovie feature with, 206–207
- OneStep DVD feature with, 225
- transferring movies to, 208

DV video format, 196

DVD Player application, 23

DVDs. *See also* iDVD application

- avoiding non-standard discs, 347
- backing up, 327–328
- as backup media, 136
- for copying files from a PC, 36
- discs for recording, 25
- displaying on desktop, 78
- importing images from, 176
- loading, 14
- Media Eject key for, 13, 67, 304
- opening in Finder, 59
- optical drives for, 17
- USB recorders, 322
- widescreen aspect ratio for movies, 13

Dynamic Host Configuration Protocol (DHCP), 271, 280

## ● E ●

effects (iMovie HD), 204–205

eKeys 37 keyboard (M-Audio), 322

Elgato Systems' EyeTV, 322

e-mail. *See* Mail application

## encryption

- Bluetooth setting for, 292
- FileVault, 263–265, 341–342

enhancing photos (iPhoto), 184

environment for your laptop, 18–19, 21

erasing. *See* removing or deleting

## exporting

- movies from iMovie HD, 207–208
- songs from GarageBand, 244–245

Exposé application, 83–84, 93–94

ExpressCard/34 slot, 16

EyeTV (Elgato Systems), 322

## ● F ●

Fast User Switching feature, 260–261, 262

## file formats supported

- audio, 156–157, 219
- video, 196

## files

- adding to dock, 79
- Bluetooth exchanges and transfers, 290
- copying, 65–67
- imported by Migration Assistant, 33
- moving, 66
- orphan, removing, 325–326
- Personal File Sharing, 282
- removing unnecessary, 324–325
- repairing permissions, 305–306, 332–333
- selecting for backup, 136–137
- sharing with Windows, 282

FileVault encryption, 263–265, 341–342

Finder. *See also* dock

- adding items to sidebar, 65
- desktop, 55
- icons, 55
- importance of mastering, 53
- keyboard shortcuts, 68–69
- launching applications from, 59
- menu bar, 42, 54–55
- opening CDs and DVDs in, 59
- opening iDisk in, 131–132
- opening windows in Home folder, 75–76
- parental controls for, 258–259
- playing songs on iTunes from, 157
- resizing windows, 70
- scrolling windows, 69
- search methods in, 106–107
- sidebar, 65, 72
- Spotlight feature, 101–106
- toggling toolbar on and off, 72
- window, 55

## finding

- creating Smart Folders for results, 107
- digital cameras supported in iPhoto, 176
- Find display for, 107
- Finder Search box for, 106
- Internet sites with Sherlock, 107–110
- photos using keywords, 181
- songs and artists in iTunes, 164–165
- Spotlight feature for, 101–106
- System Preferences settings, 89–90
- text on Web pages in Safari, 122
- Web sites with Safari, 120–122

firewall, 99–100, 284–285

FireWire, 15, 144, 320, 322

Flash drives, 36, 59

## folders

- adding to dock, 79
- duplicating, 67
- Home, 73–76, 254, 263–265
- iDisk, 132–133
- Public, 132, 134–135, 263
- removing unnecessary, 324–325
- selecting for backup, 136–137
- Shared, user accounts and, 263
- Smart Folders, 107
- Windows versus Mac locations, 37
- Windows/Mac similarities, 45

fonts, 84, 96

forcing applications to quit, 60, 303

Front Row application, 22, 147–149

## • G •

game controllers, 321

games, multiplayer, 268

GarageBand application

- adding new loops, 241
- adding tracks, 233–235
- adjusting song settings, 233
- adjusting tracks, 242, 243–244
- buttons and controls, 231–232
- choosing loops, 235–238
- creating a new project, 232–233
- creating MP3 files from songs, 244–245
- cut, copy, and paste for loops, 241
- empty space between loops, 242
- exporting movies to, 208
- iMovie HD projects with, 233, 239

keyboard instrument on screen, 233

MIDI instruments with, 233, 234, 240, 322

overview, 229

placing loops on separate tracks, 238

podcast creation using, 229, 234–235

repeating loops, 241

resizing loops, 240

saving your songs, 244

setting iTunes preferences in, 244

sharing songs and podcasts, 244–245

tempo for songs, 233

track types available, 234

view modes, 236

window, 230–232

*GarageBand For Dummies* (LeVitus),  
244–245

Go menu, 74

Google search box (Safari), 115, 120

graphics. *See* iPhoto application

grayed-out items on menus, 54

Griffin Technology's radioSHARK, 322

grounding yourself, 314

GUI (graphical user interface), 46

## • H •

Hamrick Software's VueScan  
application, 144

handling your laptop, 21

hard drives. *See also* backing up

as backup media, 135

displaying on desktop, 78

external, 319–320, 327

iDisk copy on, 133–134

importing images from, 176

importing songs to iTunes from, 168–169

MacBook versus MacBook Pro, 16

opening in Finder, 59

refurbished, avoiding, 350

repairing disks, 306–307

repairing permissions, 305–306, 332–333

upgrading, 318–321

hardware. *See also specific kinds*

advanced, defined, 44

checking working of, 28–29

for Internet connection sharing, 270–271

MacBook overview, 12–18

refurbished, avoiding, 350

for wireless networking, 272–275

HCRP (Hardcopy Cable Replacement Protocol), 296

HDV video format, 196

headphone connector, 16

heat generated by MacBooks, 30

help, 36, 48–49

hints for passwords, 253

Home folder

defined, 73–74

displaying, 74–76

FileVault encryption, 263–265, 341–342

opening Finder windows within, 75–76

organizing Documents folder in, 74

privacy of, 254

subfolders, 74

for user accounts, 254

housekeeping

automating tasks, 333–336

backing up, 326–332

cleaning up your hard drive, 323–326

repairing permissions, 332–333

updating Mac OS X automatically, 336

hub, networking, 277

Hyperbolic Software's TidyUp!, 326

## • 1 •

iBooks, upgrading, 13

iCal application, 23, 24

iChat application, 23, 145–146, 258–259

icons

aliases, 61–63

for Apple menu, 42

desktop, 42, 77

dock, 41–42, 79

Finder, 55

guide to, 60–62

in margins of this book, 6

iDisk. *See also* .Mac service

backing up to, 135–138

configuring, 134–135

defined, 127

folders, 132–133

location of, 127–128

mirror copy on local hard drive, 133–134

opening, 131–132

Public folder, 132, 134–135

security, 134–135

System Preferences, 133, 134

iDVD application

adding movies to DVDs, 211, 215–218

adding music to DVDs, 219–220

adding slideshows to DVDs, 211, 218–219

adding submenus to DVDs, 211

adding titles to DVDs, 221

animated background for menu, 222–223

aspect ratio for video, 217

audio file formats supported, 219

automating DVD creation, 213–214, 224–227

button customization, 222

buttons, 211–212, 216–217

changing menu background, 221, 222–223

creating a DVD from scratch, 214–220

creating a new project, 212–213

deleting drop zone contents, 216

drop zones, 216

ease of use, 209

exporting movies to, 208

iMovie HD integration with, 206, 216

integration with other applications, 209

Magic iDVD feature, 214, 226–227

OneStep DVD feature, 213, 225

opening an existing project, 213

previewing your DVD, 212, 223–224

recording project to disc, 227–228

resolution for video, 217

saving project as disc image, 224

themes, 214–215, 216

TV Safe Area command, 217–218

window, 210–212

iLife suite, 22. *See also specific programs*

Image Capture application, 144

images. *See* iPhoto application

iMovie HD application

adding clips to movies, 200–201

adding music with GarageBand, 233, 239

automating moviemaking, 206–207

basic steps for moviemaking, 194–195

clip viewer, 200

controls used most often, 193–194

creating a new project, 192

deleting clips permanently, 201

editing audio tracks, 199

editing clips, 202

- effects, 204–205
- iDVD integration with, 206, 216
- importing audio, 198–199
- importing video clips, 195–196
- iSight camera with, 147
- launching, 192
- Magic iMovie feature, 206–207
- overview, 191
- previewing movies, 201
- recording narration, 199, 200
- removing clips from movies, 201
- reordering clips in movies, 202
- screen resolution for, 192
- sharing movies, 207–208
- sound effects for movies, 199
- stills for movies, 196–197
- timeline, 200
- titles for movies, 205–206
- transitions, 203–204
- trash, 201
- Undo feature, 201
- video formats supported, 196
- window, 192–194
- importing
  - from another Mac, 32–36
  - audio into iMovie HD, 198–199
  - images from digital cameras, 176–177
  - images from disks, 176
  - songs to iTunes, 168–169
  - stills into iMovie HD, 197
  - video clips into iMovie HD, 195–196
  - video clips with OneStep DVD, 225
  - from Windows, 36–37, 46–47
- installing
  - Apple base station, 274
  - Backup application, 136
  - Bluetooth printers, 296–297
  - memory modules, 315–318
  - network printers, 143
  - reinstalling Mac OS X, 307
  - tracker applications, 341
  - USB printers, 84, 140–142
- Intego's Virus Barrier X, 310
- Intel CPU, 16, 97
- Internet connection
  - checking, 309–310
  - Ethernet networking for, 20–21
  - firewall for, 284–285
  - iChat AV requirements, 146
  - modem cables for, 20
  - needed for .Mac service, 128
  - needed for Sherlock, 108
  - for ordering photo books, 188
  - sharing, 100, 268, 270–271, 281–282
  - software for, 22–23
  - streaming radio requirements, 161
- Internet resources. *See also* .Mac service
  - Apple Mac OS X page, 24
  - Apple Music Store, 169–171
  - Apple service locations, 312
  - Apple support center, 48, 312
  - Backup application, 136
  - Belkin, 321
  - Bluetooth adapter, 289
  - Boot Camp utility, 24
  - cleanup utilities, 326
  - Contour Design, 322
  - Dantz Retrospect backup utility, 331–332
  - dictionary definitions, 13
  - Elgato Systems, 322
  - finding with Safari, 120–122
  - finding with Sherlock, 108–109
  - Griffin Technology, 322
  - iPhoto support page, 176
  - iSync support information, 295
  - LaCie, 322
  - .Mac Welcome page, 129
  - magazines, 48
  - MLC Books Online, 160
  - Move2Mac utility, 37, 46
  - network hardware support, 272, 276
  - newsgroups, 49
  - passwords for networks, 272
  - podcasts, 161
  - Preferential Treatment utility, 308
  - printer software, 141, 142
  - scanner software, 144
  - StealthSignal, 341
  - streaming radio, 159–161
  - support Web sites, 48
  - Virus Barrier X, 310
  - VueScan application, 144
  - Web address conventions in this book, 4
- Internet router, 271
- invoice, saving, 19
- IP address for Web sharing, 283, 284

- iPhoto application
    - adding slideshows to DVDs, 218–219
    - albums, 177–179
    - Apple support page, 176
    - arranging photos in viewer, 181–182
    - changing datestamp for photos, 179
    - controls, 173–175
    - creating keywords, 181
    - deleting images from cameras, 177
    - displaying photo information, 178
    - editing photos, 182–185
    - e-mailing photos, 189–190
    - finding photos using keywords, 179, 181
    - importing images, 176–177
    - keywords for organizing photos, 179–181
    - operation modes, 175–176
    - organize mode, 177–182
    - photocasting feature, 131, 188–189
    - publishing photo books, 185–188
    - rating photos, 181
    - renaming keywords, 181
    - renaming photos, 179
    - rolls of photos, 177
    - slideshow creation using, 187
    - standard keywords, 180
    - Undo feature, 179
  - iPod & iTunes For Dummies* (Bove and Rhodes), 162
  - iPods. *See also* podcasts
    - backing up to, 136
    - displaying on desktop, 78
    - iTunes integration with, 162
    - transferring movies to, 208
  - iSight camera
    - overview, 14, 145
    - using with iChat AV, 145–146
    - using with iMovie HD, 147
    - using with Photo Booth, 146
  - iSight video format, 196
  - iSync utility, 294–296
  - iTunes application
    - adding music to DVDs, 219–220
    - adding or editing tags, 165–167
    - adding songs to iMovie HD, 198
    - audio file formats supported, 156–157
    - broadcasting music using, 158
    - buying songs from Music Store, 169–171
    - capabilities of, 153
    - controls used most often, 155–156
    - deleting tracks from playlists, 164
    - importing songs, 168–169
    - iPods with, 162
    - keyboard shortcuts, 158
    - listening to playlists with, 159
    - listening to podcasts with, 161
    - playing music CDs with, 161–162
    - playing songs with, 157–158
    - playlist creation, 163–164
    - preferences, 159, 162
    - recording CDs using, 171–172
    - reordering songs in playlists, 164
    - repeating playlists, 159
    - searching for songs and artists, 164–165
    - sending GarageBand songs to, 244–245
    - setting preferences in GarageBand, 244
    - shuffle mode, 158–159
    - sorting songs in, 165
    - streaming radio with, 159–161
    - visualization mode, 167
    - watching video with, 162–163
    - window, 154–156
  - iWork application suite, 22
- **K** •
- keyboard
    - Bluetooth, 293–294
    - caring for, 21, 347
    - checking working of, 29
    - configuring, 31
    - external, 19, 30, 344
    - features of, 13
    - Front Row functions controlled by, 149
    - special keys on, 67–68
    - startup keys, 304
    - wrist rest for, 26
  - Keyboard illumination key, 67
  - keyboard shortcuts
    - for Dashboard, 82, 94
    - for Exposé, 83, 94
    - in Finder (table), 68–69
    - for Front Row, 149
    - for iTunes, 158
    - for launching applications, 58
    - for quitting applications, 60
    - startup keys, 304

## • L •

LaCie Slim DVD recorder, 322  
 laptop bags, 339–340  
 laptop stand, 19, 30  
 launching. *See also* displaying; opening  
   Activity Monitor, 78  
   aliases for, 62  
   applications, 58–59, 61  
   Automator applications, 335–336  
   Dashboard, 82, 84  
   Disk Utility, 304  
   Exposé, 83, 84  
   iMovie HD, 192  
   Migration Assistant, 32, 33  
   Preview application, 81  
   Safari Web browser, 113  
   Software Update, 336  
 LCD screen  
   changing resolution and color depth, 91  
   checking working of, 28–29  
   cleaning, 25, 350  
   color profile for, 91  
   cracked or broken, 316  
   overview, 12–13  
   resolution for iMovie HD, 192  
   screen saver, 92–93, 311  
   special keys for, 67  
   System Preferences, 91  
 LeVitus, Bob (*GarageBand For Dummies*),  
   244–245  
 lighting, 18  
 Line In connection, 16  
 Line Out connections, 14, 16  
 Linksys networking kits, 277  
 Linux operating system, 43, 47  
 list login, 260, 262  
 loading CDs or DVDs, 14  
 location for your laptop, 18–19, 21  
 login items  
   defined, 59, 257  
   disabling, 303, 304, 310–311  
   launching applications from, 59  
   setting for your account, 257–258  
 login to .Mac service, 129–130  
 login to user accounts  
   auto, 261, 262, 303  
   Fast User Switching, 260–261, 262

list, 260, 262  
 username and password, 260, 262

## • M •

Mac OS X. *See also specific features*  
 actions controlled by, 40  
 desktop (overview), 40–43, 76–78  
 ease of use, 45  
 firewall, 284–285  
 further information, 44  
 Leopard version (forthcoming), 24  
 locked up, shutting down, 28  
 operating system defined, 40  
 performance, 44  
 power-on display, 28  
 reinstalling, 307  
 reliability, 44  
 setting up, 30–32  
 UNIX core of, 43, 44  
 updating automatically, 336  
 Virtual PC 7 for running Windows, 47  
 Windows compared to, 43, 45–47  
*Mac OS X Tiger All-in-One Desk Reference  
 For Dummies* (Chambers), 44, 280  
 .Mac service  
   backing up using, 135–138  
   blogging feature, 131  
   configuring your iDisk, 134–135  
   described, 127  
   folders on iDisk, 132–133  
   iDisk location, 127–128  
   Internet connection needed for, 128  
   ISPs versus, 128  
   login, 129–130  
   Mail application with, 130, 135  
   mirroring iDisk on hard drive, 133–134  
   opening an account, 129–131  
   opening your iDisk, 131–132  
   photocasting feature, 131, 188–189  
   posting movies on, 208  
   Public folder, 132, 134–135  
   security, 134–135  
   System Preferences for iDisk, 133, 134  
   trial membership, 31, 130  
   Web site hosting using, 131  
 MacAddict Web site, 48



- MacBook For Dummies* (Chambers)  
 conventions, 3–4  
 icons in margins, 6  
 organization, 4–5  
 overview, 1, 2  
 requirements, 1–2  
 MacFixIt Web site, 48  
 MacMinute Web site, 48  
 Macworld Web site, 48  
 Magic iDVD feature, 214, 226–227  
 Magic iMovie feature, 206–207  
 MagSafe power connector, 14, 20  
 Mail application  
   configuring, 31  
   described, 23  
   .Mac service integration with, 130, 135  
   parental controls for, 258–259  
   sending movies with iMovie HD, 208  
   sending PDF documents, 86  
   sending photos with iPhoto, 189–190  
 managed user accounts, 251, 258–259  
 manual, need for reading, 20  
 Mark’s Maxim icon, 6  
 M-Audio’s eKeys 37 keyboard, 322  
 Media Eject key, 13, 67, 304  
 memory  
   advantages of adding, 313–314, 340  
   determining amount you have, 314  
   installing modules, 315–318  
   upgrade options, 314–315  
 menus. *See also specific menus*  
   Bluetooth, 293  
   contextual or right-click, 57  
   conventions in this book, 3  
   Finder menu bar, 42, 54–55  
   grayed-out items on, 54  
   using, 54  
 Micromat’s TechTool Pro, 302  
 Microsoft. *See also Windows* (Microsoft)  
   Office trial version, 22  
   Virtual PC 7, 47  
 MIDI (Musical Instrument Digital Interface)  
   with GarageBand, 233, 234, 240, 322  
 Migration Assistant, 32–36  
 minimizing windows, 71  
 mirroring iDisk on hard drive, 133–134  
 MLC Books Online, 160  
 MLC Radio Online, 160  
 monitoring your battery, 29  
 mouse. *See also trackpad*  
   Bluetooth, 293–294  
   replacing trackpad with, 56–57, 344  
 Move2Mac utility (Detto Technologies),  
   37, 46–47  
 movie information, finding, 109  
 moving items. *See also importing*  
   to another location on same drive, 66  
   arranging icons on desktop, 77  
   arranging windows, 71  
   Movie buttons (iDVD), 216  
   network advantages for, 268  
   reordering clips in movies, 202  
   reordering songs in playlists, 164  
   windows, 71  
 MPEG-4 video format, 196  
 MP3 audio format  
   for importing songs to iTunes, 168  
   overview, 156  
   for podcasts, 161  
   recording CDs with iTunes, 171–172  
   saving GarageBand songs in, 244–245  
   standard audio CD format versus, 171  
 multiplayer games, 268  
 Music Store (Apple), 154, 161, 169–171  
 Musical Instrument Digital Interface (MIDI)  
   with GarageBand, 233, 234, 240, 322
- N •
- naming. *See renaming*  
 narration, recording in iMovie HD, 199, 200  
 Nathan, Jonathan (programmer), 308  
 networking. *See also wireless networks*  
   benefits of, 267–268  
   combining wired and wireless, 269, 270  
   components, 277  
   connecting cables, 277  
   connecting printers, 143  
   connecting to the network, 279–284  
   DHCP, 271, 280  
   displaying servers on desktop, 78  
   do-it-yourself kits for, 277  
   firewall for, 284–285  
   for Internet connection sharing, 100, 268,  
     270–271, 281–282  
   Internet service using, 20–21  
   joining a network, 275–276, 278–279  
   laptop hardware for, 276

non-Apple hardware support, 272, 276  
 opening connections in Finder, 59  
 Personal File Sharing, 282  
 port for, 15  
 preferences for sharing, 98–100  
 for printer sharing, 283  
 printing over a network, 85, 283  
 for serving Web pages, 283–284  
 settings imported for, 33  
 testing the network (pinging), 279–280, 309–310  
 wired versus wireless, 268–269  
 newsgroups, 49  
 Nostromo n50 SpeedPad (Belkin), 321

## • O •

Office suite (Microsoft), 22  
 OneStep DVD feature, 213, 225  
 opening. *See also* displaying; launching  
   CDs and DVDs in Finder, 59  
   existing iDVD project, 213  
   Finder windows in Home folder, 75–76  
   iDisk, 131–132  
   Spotlight search box, 101  
   System Preferences window, 59, 87–88  
 operating system, 40. *See also* Mac OS X  
 optical drives, 17  
 optical output connector, 16  
 Option key, 68  
 OS X. *See* Mac OS X  
 outlets, needs for, 18

## • P •

pairing for security (Bluetooth), 292  
 parental controls for user accounts, 258–259  
 passwords  
   for FileVault encryption, 264  
   hints for, 253  
   importance of remembering, 264  
   for .Mac service, 129  
   for networks, 272  
   for user account login, 260, 262  
   for user accounts, 253  
 PDF format, saving documents to, 86  
 permissions, repairing, 305–306, 332–333

Personal File Sharing, 282  
 Personal Web Sharing, 283–284  
 phishing scams, 346  
 Photo Booth application, 22, 146  
 photocasting feature (.Mac), 131, 188–189  
 pictures or photos. *See* iPhoto application  
 ping-pong a network, 279–280, 309–310  
 placement for your laptop, 18–19, 21  
 playing  
   music CDs with iTunes, 161–162  
   playlists with iTunes, 159  
   podcasts with iTunes, 161  
   songs in GarageBand, 232  
   songs with iTunes, 157–158  
   streaming radio with iTunes, 159–161  
   video with iTunes, 162–163  
 playlists (iTunes)  
   adding GarageBand songs to, 244–245  
   creating, 163–164  
   defined, 159  
   deleting tracks from, 164  
   listening to, 159  
   recording to CDs, 171–172  
   reordering songs in, 164  
   repeating, 159  
 podcasts  
   in Apple Music Store, 161  
   GarageBand for creating, 229, 234–235  
   listening with iTunes, 161  
   sharing with GarageBand, 244–245  
 ports  
   audio and video, 14  
   Bluetooth, discoverable setting for, 292  
   Ethernet, 15  
   ExpressCard/34, 16  
   firewall settings for, 100, 285  
   FireWire, 15, 320  
   USB, 15, 319–320  
 power button, 14, 28  
 power conservation, 30, 343–344  
 power cord (MagSafe), 14, 20  
 power protection hardware, 25, 343  
 power saving features, 343–344  
 PowerBooks, upgrading, 13  
 preference files, corrupt, 308  
 Preferential Treatment utility (Nathan), 308  
 previewing. *See* displaying  
 Printer Setup Utility, 144

## printing

- Bluetooth printers for, 296–297
- connecting network printers, 143
- connecting USB printers, 84, 140–142
- over a network, 85, 143, 283
- to PDF format, 86
- steps for, 84–86
- Web pages from Safari, 119

## privacy, 106, 254

## processor (CPU), 16, 97

programs. *See* applications; *specific programs*

## Public folder, 132, 134–135, 263

## publishing photo books (iPhoto), 185–188

## • Q •

## QuickTime, displaying movies with, 208

## quitting or closing

- applications, 59–60
- frozen applications, 60, 303
- System Preferences window, 89
- windows, 72

## • R •

## radioSHARK (Griffin Technology), 322

RAM. *See* memory

## rating photos (iPhoto), 181

## RDF Site Summary (RSS) feeds, 126

## rebooting, problems solved by, 302–303, 304

## recording

- iDVD project to disc, 227–228
- MIDI instruments, 233, 234, 240
- music or MP3 CDs, 171–172
- narration in iMovie HD, 199, 200

## red-eye removal for photos (iPhoto), 184

## refresh rate, 91

## refurbished hardware, avoiding, 350

## registering your laptop, 32

## reinstalling Mac OS X, 307

## reliability of Mac OS X, 44

## Remember icon, 6

## remote control, 14, 148–150

## removing or deleting

- albums in iPhoto, 179
- associated files in other folders, 325–326

## by dragging to trash, 80

## drop zone contents (iDVD), 216

## icons from dock, 79

## images from cameras, 177

## movie clips from movies, 201

## movie clips permanently, 201

## photos from albums in iPhoto, 179

## tracks from playlists, 164

## trash contents permanently, 81, 325

## unnecessary files and folders, 324–325

## user accounts, 255–256

## renaming

## files linked to aliases, 63

## keywords (iPhoto), 181

## photos in iPhoto viewer, 179

## playlists (iTunes), 164

repairing. *See also* troubleshooting

## hard disks, 306–307

## permissions, 305–306, 332–333

## professional help for, 316

## repeating

## loops (GarageBand), 241

## playlists (iTunes), 159

## resizing

## loops (GarageBand), 240

## minimizing and restoring windows, 71

## windows, 70

## zooming windows, 72

## resolution

## changing for display, 91

## for iDVD video, 217

## iMovie HD requirements, 192

## restoring

## from backup, 137, 330–331

## items from trash, 80–81

## minimized windows, 71

## restraining cable, 26

## retouching photos (iPhoto), 184

Rhodes, Cheryl (*iPod & iTunes For Dummies*), 162

## right-click menus, 57

## root/System Administrator account, 348–349

## rotating photos (iPhoto), 183

## routers, Internet, 271

## Roxio Toast recording software, 17, 328

## RSS (RDF Site Summary) feeds, 126

running. *See* launching; opening



- Safari Web browser
  - adding controls to toolbar, 117, 118–119
  - adding URLs to dock, 79
  - Address box, 115
  - bookmarks, 115, 122–124
  - buttons, 114–115, 118–119
  - described, 22–23
  - entering Web addresses, 115–117
  - Google search box, 115, 120
  - History list, 120–121
  - launching, 113
  - overview, 113–115
  - Page window, 115
  - parental controls for, 258–259
  - preferences, 116
  - reading RSS feeds with, 126
  - returning to default toolbar controls, 117
  - searching for Web sites using, 120–122
  - searching the current Web page, 122
  - secure connections in, 125–126
  - setting home page for, 122
  - SnapBack page, 121
  - status bar, 115
  - Tabbed browsing mode, 116
  - toolbar, 117–119
- saving. *See also* backing up
  - document to PDF format, 86
  - GarageBand songs, 244
  - iDVD project as disc image, 224
  - Photo Booth images, 146
  - System Preferences changes, 89
- scanners, connecting, 144
- scoring, 233, 239
- screen. *See* LCD screen
- screen saver, 92–93, 311
- searching. *See* finding
- security. *See also* passwords
  - Bluetooth settings for, 292–293
  - closed wireless networks for, 275
  - deleting unneeded user accounts for, 256
  - FileVault encryption, 263–265, 341–342
  - firewall for, 284–285
  - iDisk, 134–135
  - phishing scams, 346
  - for photocasting, 189
  - Safari connections, 125–126
  - Spotlight privacy settings, 106
  - System Preferences, 98–100
  - wired versus wireless networks and, 269
  - wireless connections and, 349
- selecting
  - highlight color for, 95
  - movie clip sections (iMovie HD), 202
  - overview, 63–64
- sepia photos, 184–185
- setting up your system
  - connecting cables, 20–21
  - Mac OS X configuration, 30–32
  - unpacking, 19–20
- Shared folder, user accounts and, 263
- sharing. *See also* networking; user accounts
  - Internet connection, 100, 268, 270–271, 281–282
  - movies (iMovie HD), 207–208
  - Personal File Sharing, 282
  - podcasts, 161, 229, 234–235, 244–245
  - preferences for, 98–100
  - publishing photo books (iPhoto), 185–188
  - songs (GarageBand), 244–245
- Sherlock application
  - described, 23, 107
  - dictionary lookups using, 13
  - Internet channel, 108–109
  - Movies channel, 109
  - Stocks channel, 109–110
  - viewing channel descriptions, 107
- shortcut keys. *See* keyboard shortcuts
- shortcuts (aliases), 61–63
- ShuttleXpress (Contour Design), 322
- sleep mode preferences, 97
- slideshows, 187, 218–219
- Slim DVD recorder (LaCie), 322
- Smart Albums (iPhoto), 178
- Smart Folders, creating, 107
- SnapBack page (Safari), 121
- sneakernet, 267
- software. *See* applications; *specific software*
- Software Update feature, 59, 308, 336
- sorting
  - photos in iPhoto viewer, 181–182
  - songs in iTunes, 165

sound. *See* audio

Spotlight feature

- clicking on found items, 104
- displaying information on items, 105
- displaying the search box, 101
- filtering items by date or source, 105
- grouping results, 105
- overview, 101–103
- privacy settings, 106
- searching with, 103–104
- System Preferences, 105–106

Spring Cleaning (Allume Systems), 326

stand for laptop, 19, 30

standard user accounts, 251, 255

starting. *See* launching; opening

StealthSignal's XTool Computer

Tracker, 341

stock information, finding, 109–110

stopping. *See* quitting or closing

streaming music over a network, 268

streaming radio, 159–161

subscribing to podcasts, 161

support. *See* technical support

surge suppressor, 25, 343

S-Video adapter, 16

switch, networking, 277

switching from Windows, 36–37, 45–47,  
90, 127

synchronizing Bluetooth devices, 294–296

System Administrator/root account,  
348–349

System Preferences

Appearance pane, 94–96

Apply Now button, 89

Bluetooth pane, 289–293

CDs & DVDs pane, 162

closing, 89

Dashboard & Exposé pane, 93–94

Desktop pane, 92

Displays pane, 91

Dock pane, 97–98

Energy Saver pane, 96–97

finding settings, 89–90

iDisk pane, 133, 134

imported by Migration Assistant, 33

launching, 59, 87–88

navigating in, 88–89

parental controls for, 258–259

Screen Saver pane, 92–93

Security pane, 341

Sharing pane, 98–100, 281–282, 283, 285

Software Update pane, 336

Spotlight pane, 105–106

for trackpad, 56

troubleshooting changes, 308

System Profiler, 311

## • T •

Technical Stuff icon, 6

technical support

Apple online support, 48, 312

iPhoto support page, 176

registering required for, 32

TechTool Pro (Micromat), 302

themes (iDVD), 214–215, 216

TidyUp! (Hyperbolic Software), 326

Tiger. *See* Mac OS X

Tip icon, 6

Toast recording software (Roxio), 17, 328

trackball, 56–57. *See also* mouse; trackpad

tracker applications, 341

trackpad

for activating Dashboard and Exposé, 84

checking working of, 29

clicking by tapping, 56

launching applications using, 58–59

mouse replaced by, 13

objects other than finger on, 56

overview, 55–57

preferences for, 56

quitting applications using, 59–60

replacing with mouse, 56–57, 344

right button lacking on, 56–57

scrolling using, 56

selecting items using, 63–64

transitions (iMovie HD), 203–204

trash

checking for deleted files, 309

deleting contents permanently, 81, 325

displaying contents, 80

dragging devices or drives to, 80

in iMovie HD, 201

methods for moving items to, 80

restoring items from, 80–81

**troubleshooting**

- Apple Support site for, 312
- checking cables, 309
- checking trash for deleted files, 309
- defined, 301
- disabling login items, 303, 304, 310–311
- Disk Utility for, 304–307, 308–309
- investigating recent changes, 308
- Laptop Troubleshooting Tree, 307–311
- local service for, 312
- myths about, 301–302
- network testing (pinging), 279–280, 309–310
- quitting frozen applications, 60, 303
- rebooting to solve problems, 302–303, 304
- reinstalling Mac OS X, 307
- repairing hard disks, 306–307
- repairing permissions, 305–306, 332–333
- Shift key tricks for, 303
- shutting down Mac OS X when locked, 28
- startup keys for, 304
- submitting Bug reports for Safari, 119
- System Profiler for, 311
- turning off screen saver, 311
- utility software for, 302
- viruses, 310

**turning on your laptop, 28****TV**

- hardware, 322
- iDVD video for, 217–218

**• U •****Uniform Resource Locators. *See* URLs****Universal Serial Bus. *See* USB****UNIX as Mac OS X core, 43, 44****unpacking your system, 19–20****updates, troubleshooting, 308****upgrades**

- add-ons, 321–322
  - grounding yourself before installing, 314
  - hard drive, 318–321
  - to MacBook from other laptops, 13
  - memory, 314–318, 340
  - professional help for, 316, 320–321
- UPS (uninterruptible power supply), 25, 343**

**URLs (Uniform Resource Locators). *See* *also* Internet resources**

- adding to dock, 79
- for Apache Web server, 283
- conventions in this book, 4
- entering in Safari, 115–117

**USB (Universal Serial Bus)**

- avoiding 1.1 storage devices, 345–346
- DVD recorders, 322
- Flash drives, 36, 59
- game controllers, 321
- hard drives, 319–320
- MIDI instruments, 240, 322
- mousing devices, 56–57
- ports for, 15
- printers, 84, 140–142
- radio, 322
- scanners, 144
- TV hardware, 322
- USB-to-MIDI converter, 240
- video controllers, 322

**Usenet newsgroups, 49****user accounts**

- adding a new account, 251–254
  - administrator, 250–251, 261
  - assigning access levels, 251
  - auto login, 261, 262
  - benefits of, 250
  - deleting, 255–256
  - Drop Box folder for, 263
  - editing existing accounts, 254–255
  - Fast User Switching feature, 260–261, 262
  - FileVault encryption for, 263–265
  - Home folder, 73–76, 254
  - imported by Migration Assistant, 33
  - list login, 260, 262
  - login items for, 257–258
  - managed, 251, 258–259
  - need for, 249–250
  - parental controls for, 258–259
  - root/System Administrator, 348–349
  - Shared and Public folders with, 263
  - standard, 251, 255
  - username and password login, 260, 262
- user groups, 49**

## • U •

VGA/DVI connector, 16  
 video. *See also* iDVD application; iMovie  
   HD application  
   cards for, 18  
   connections for, 16  
   formats supported by iMovie HD, 196  
   importing clips into iMovie HD, 195–196  
   playing with iTunes, 162–163  
 video cameras. *See* DV camcorders  
 video cards, 18  
 video controllers, 322  
 videoconferencing, 14  
 viewing. *See* displaying; finding; playing  
 Virtual PC 7 (Microsoft), 47  
 Virus Barrier X (Intego), 310  
 viruses, 310  
 visual effects (iMovie HD), 204–205  
 visualizing audio in iTunes, 167  
 Volume Down key, 67  
 Volume Up key, 67  
 VueScan application (Hamrick Software), 144

## • W •

Warning! icon, 6  
 WAV audio format, 156  
 Web addresses. *See* URLs (Uniform Resource Locators)  
 Web server, 283–284  
 Web sites. *See* Internet resources  
 widescreen aspect ratio, 13  
 widgets, 82  
 Windows (Microsoft)  
   Boot Camp utility for, 24  
   external keyboard for, 344  
   importing items from, 36–37, 46–47  
   Mac OS X compared to, 43, 45–47  
   photocasting to, 189  
   running on a Mac, 11, 47  
   sharing files with, 282  
   switching from, 36–37, 45–47, 90, 127

windows (on screen). *See also specific applications*  
   active, determining, 71  
   appearance preferences, 94–96  
   opening within Home folder, 75–76  
   overview, 43  
   switching using Exposé, 83–84  
   toolbars, 72  
   using and navigating, 69–72  
 wireless connections. *See* Bluetooth  
 wireless networks. *See also* networking  
   AirPort hardware for, 143, 271  
   Apple base stations for, 272–274, 275  
   avoiding unsecured connections, 349  
   checking, 309–310  
   closed, 275  
   combined with wired networks, 269, 270  
   connecting network printers, 143  
   convenience as advantage of, 269  
   described, 17  
   disabling when not connected, 342–343  
   interference with, 271  
   for Internet connection sharing, 271, 281–282  
   joining, 275–276  
   laptop hardware for, 272  
   maximum signal range, 271  
   non-Apple base stations for, 274–276  
   non-Apple hardware support, 272, 276  
   Personal File Sharing, 282  
   for printer sharing, 283  
   for serving Web pages, 283–284  
   wired Ethernet versus, 268–269  
 wrist rest, 26

## • X •

XTool Computer Tracker (StealthSignal), 341

## • Z •

zooming windows, 72